

DeviceNet Safety
NE1A-HDY01

Mobile Console

OPERATION MANUAL

OMRON







DeviceNet Safety
NE1A-HDY01
Mobile Console Operation Manual

Produced April 2009

Notice:

OMRON products are manufactured for use according to proper procedures by a qualified operator and only for the purposes described in this manual.

The following conventions are used to indicate and classify precautions in this manual. Always heed the information provided with them. Failure to heed precautions can result in injury to people or damage to property.

-  **WARNING** Indicates a potentially hazardous situation which, if not avoided, will result in minor or moderate injury, or may result in serious injury or death. Additionally, there may be significant property damage.
-  **Caution** Indicates a potentially hazardous situation which, if not avoided, may result in minor or moderate injury, or property damage.
-  Indicates a general CAUTION or WARNING precaution for which there is no specified symbol.
-  Indicates the risk of explosion under specific conditions.
-  Indicates general prohibitions for which there is no specific symbol.
-  Indicates general mandatory actions for which there is no specific symbol.

OMRON Product References

All OMRON products are capitalized in this manual. The word “Unit” is also capitalized when it refers to an OMRON product, regardless of whether or not it appears in the proper name of the product.

The abbreviation “PLC” means Programmable Controller.

Visual Aids

The following headings appear in the left column of the manual to help you locate different types of information.

IMPORTANT Indicates important information on what to do or not to do to prevent failure to operation, malfunction, or undesirable effects on product performance.

Note Indicates information of particular interest for efficient and convenient operation of the product.

1,2,3... 1. Indicates lists of one sort or another, such as procedures, checklists, etc.

Trademarks and Copyrights

DeviceNet, DeviceNet Safety, EtherNet/IP, EtherNet/IP Safety, CIP, and CIP Safety are registered trademarks of the ODVA.

Windows is a registered trademark of Microsoft Corporation in the United States and other countries.

Other product names and company names in this manual are trademarks or registered trademarks of their respective companies.

© **OMRON, 2009**

All rights reserved. No part of this publication may be reproduced, stored in a retrieval system, or transmitted, in any form, or by any means, mechanical, electronic, photocopying, recording, or otherwise, without the prior written permission of OMRON.

No patent liability is assumed with respect to the use of the information contained herein. Moreover, because OMRON is constantly striving to improve its high-quality products, the information contained in this manual is subject to change without notice. Every precaution has been taken in the preparation of this manual. Nevertheless, OMRON assumes no responsibility for errors or omissions. Neither is any liability assumed for damages resulting from the use of the information contained in this publication.

TABLE OF CONTENTS

PRECAUTIONS	xv
1 Intended Audience	xvi
2 General Precautions	xvi
3 Safety Precautions	xviii
4 Precautions for Safe Use	xx
5 Precautions for Correct Use	xxi
6 Regulations and Standards	xxi
7 Checking the Contents of the Package	xxii
8 Definition of Terms	xxii

SECTION 1

Introduction	1
1-1 Overview of Mobile Console	2
1-2 Part Names and Functions	7
1-3 Control Keys	9
1-4 Stylus	11
1-5 External Connectors	12
1-6 Starting and Stopping the Mobile Console and Standby Mode	13
1-7 Using the Battery Pack	15
1-8 Using the Memory Card	19
1-9 Replacing the Clock Battery	21
1-10 Attaching the Hand Strap	23

SECTION 2

Screen Names and Console Settings	25
2-1 Screen Names and Functions	26
2-2 Console Settings	29

SECTION 3

Online Operations	37
3-1 Basic Online Operations	38
3-2 Reading Device Information	42
3-3 Replacing a Device	49
3-4 Uploading Parameters	52
3-5 Downloading Parameters	54
3-6 Resetting a Device	58
3-7 Changing the Mode	60
3-8 Locking/Unlocking Devices	61

TABLE OF CONTENTS

SECTION 4

Specifications	63
4-1 Mobile Console Ratings and Specifications	64
4-2 Battery Pack Ratings and Specifications	65
4-3 Charger Ratings and Specifications	66
4-4 Dimensions	67
Index	69
Revision History	71

About this Manual:

This manual describes the NE1A-HDY01 DeviceNet Safety Mobile Console (called simply the Mobile Console in this manual). Please read this manual carefully and be sure you understand the information provided before attempting to use the Mobile Console. Be sure to read the precautions provided in the following section.

The Mobile Console features easy operation by tapping a touch screen with a stylus. It is a portable maintenance terminal that can be used for maintaining NE0A/NE1A-series Controllers and DST1-series Safety I/O Terminals.

The following manuals provide information on the DeviceNet and DeviceNet Safety.

DeviceNet Safety Mobile Console Operation Manual (this manual) (Z921)

This manual describes the specifications, functions, and operating procedures of the Mobile Console.

DeviceNet Safety NE0A Series Safety Network Controller Operation Manual (Z916)

This manual describes the specifications, functions, and operating procedures of the NE0A-series Safety Network Controllers.

DeviceNet Safety NE1A Series Safety Network Controller Operation Manual (Z906)

This manual describes the specifications, functions, and operating procedures of the NE1A-series Controllers.

DeviceNet Safety System Configuration Manual (Z905)

This manual explains how to configure the DeviceNet Safety system using the Network Configurator.

DeviceNet Safety I/O Terminal Operation Manual (Z904)

This manual describes the models, specifications, functions, and operating procedures of the DST1 Series.

EtherNet/IP-DeviceNet Router Operation Manual (Z912)

This manual describes the specifications, functions, and operating procedures of the EtherNet/IP-DeviceNet Router.

DeviceNet Operation Manual (W267)

This manual describes the construction and connection of a DeviceNet network. It provides detailed information on the installation and specifications of cables, connectors, and other peripheral equipment used in the network, and on the supply of communications power. Obtain this manual and gain a firm understanding of its contents before using a DeviceNet network.

CS/CJ Series DeviceNet Units Operation Manual (W380)

This manual describes basic setup and standard communications using CS/CJ-series DeviceNet Units.

<p> WARNING Failure to read and understand the information provided in this manual may result in personal injury or death, damage to the product, or product failure. Please read each section in its entirety and be sure you understand the information provided in the section and related sections before attempting any of the procedures or operations given.</p>

Read and Understand this Manual

Please read and understand this manual before using the product. Please consult your OMRON representative if you have any questions or comments.

Warranty and Limitations of Liability

WARRANTY

OMRON's exclusive warranty is that the products are free from defects in materials and workmanship for a period of one year (or other period if specified) from date of sale by OMRON.

OMRON MAKES NO WARRANTY OR REPRESENTATION, EXPRESS OR IMPLIED, REGARDING NON-INFRINGEMENT, MERCHANTABILITY, OR FITNESS FOR PARTICULAR PURPOSE OF THE PRODUCTS. ANY BUYER OR USER ACKNOWLEDGES THAT THE BUYER OR USER ALONE HAS DETERMINED THAT THE PRODUCTS WILL SUITABLY MEET THE REQUIREMENTS OF THEIR INTENDED USE. OMRON DISCLAIMS ALL OTHER WARRANTIES, EXPRESS OR IMPLIED.

LIMITATIONS OF LIABILITY

OMRON SHALL NOT BE RESPONSIBLE FOR SPECIAL, INDIRECT, OR CONSEQUENTIAL DAMAGES, LOSS OF PROFITS OR COMMERCIAL LOSS IN ANY WAY CONNECTED WITH THE PRODUCTS, WHETHER SUCH CLAIM IS BASED ON CONTRACT, WARRANTY, NEGLIGENCE, OR STRICT LIABILITY.

In no event shall the responsibility of OMRON for any act exceed the individual price of the product on which liability is asserted.

IN NO EVENT SHALL OMRON BE RESPONSIBLE FOR WARRANTY, REPAIR, OR OTHER CLAIMS REGARDING THE PRODUCTS UNLESS OMRON'S ANALYSIS CONFIRMS THAT THE PRODUCTS WERE PROPERLY HANDLED, STORED, INSTALLED, AND MAINTAINED AND NOT SUBJECT TO CONTAMINATION, ABUSE, MISUSE, OR INAPPROPRIATE MODIFICATION OR REPAIR.

Application Considerations

SUITABILITY FOR USE

OMRON shall not be responsible for conformity with any standards, codes, or regulations that apply to the combination of products in the customer's application or use of the products.

At the customer's request, OMRON will provide applicable third party certification documents identifying ratings and limitations of use that apply to the products. This information by itself is not sufficient for a complete determination of the suitability of the products in combination with the end product, machine, system, or other application or use.

The following are some examples of applications for which particular attention must be given. This is not intended to be an exhaustive list of all possible uses of the products, nor is it intended to imply that the uses listed may be suitable for the products:

- Outdoor use, uses involving potential chemical contamination or electrical interference, or conditions or uses not described in this manual.
- Nuclear energy control systems, combustion systems, railroad systems, aviation systems, medical equipment, amusement machines, vehicles, safety equipment, and installations subject to separate industry or government regulations.
- Systems, machines, and equipment that could present a risk to life or property.

Please know and observe all prohibitions of use applicable to the products.

NEVER USE THE PRODUCTS FOR AN APPLICATION INVOLVING SERIOUS RISK TO LIFE OR PROPERTY WITHOUT ENSURING THAT THE SYSTEM AS A WHOLE HAS BEEN DESIGNED TO ADDRESS THE RISKS, AND THAT THE OMRON PRODUCTS ARE PROPERLY RATED AND INSTALLED FOR THE INTENDED USE WITHIN THE OVERALL EQUIPMENT OR SYSTEM.

PROGRAMMABLE PRODUCTS

OMRON shall not be responsible for the user's programming of a programmable product, or any consequence thereof.

Disclaimers

CHANGE IN SPECIFICATIONS

Product specifications and accessories may be changed at any time based on improvements and other reasons.

It is our practice to change model numbers when published ratings or features are changed, or when significant construction changes are made. However, some specifications of the products may be changed without any notice. When in doubt, special model numbers may be assigned to fix or establish key specifications for your application on your request. Please consult with your OMRON representative at any time to confirm actual specifications of purchased products.

DIMENSIONS AND WEIGHTS

Dimensions and weights are nominal and are not to be used for manufacturing purposes, even when tolerances are shown.

PERFORMANCE DATA

Performance data given in this manual is provided as a guide for the user in determining suitability and does not constitute a warranty. It may represent the result of OMRON's test conditions, and the users must correlate it to actual application requirements. Actual performance is subject to the OMRON Warranty and Limitations of Liability.

ERRORS AND OMISSIONS

The information in this manual has been carefully checked and is believed to be accurate; however, no responsibility is assumed for clerical, typographical, or proofreading errors, or omissions.

PRECAUTIONS

1	Intended Audience	xvi
2	General Precautions	xvi
3	Safety Precautions	xviii
4	Precautions for Safe Use	xx
5	Precautions for Correct Use	xxi
6	Regulations and Standards	xxi
7	Checking the Contents of the Package	xxii
8	Definition of Terms	xxii

1 Intended Audience

This manual is intended for the following personnel, who must have knowledge of electrical systems (an electrical engineer or the equivalent).

- Personnel in charge of introducing FA and safety systems into production facilities
- Personnel in charge of designing FA and safety systems
- Personnel in charge of managing FA facilities
- Personnel who have the qualifications, authority, and obligation to provide safety during each of the following product phases: mechanical design, installation, operation, maintenance, and disposal

2 General Precautions

The user must operate the product according to the performance specifications described in the operation manuals.

Before using the product under conditions which are not described in the manual or applying the product to nuclear control systems, railroad systems, aviation systems, vehicles, combustion systems, medical equipment, amusement machines, safety equipment, and other systems, machines, and equipment that may have a serious influence on lives and property if used improperly, consult your OMRON representative.

Make sure that the ratings and performance characteristics of the product are sufficient for the systems, machines, and equipment, and be sure to provide the systems, machines, and equipment with double safety mechanisms.

This manual provides information for programming and operating the Unit. Be sure to read this manual before attempting to use the Unit and keep this manual close at hand for reference during operation.

 **WARNING** Heed the following items during system configuration to ensure that safety-related components are configured in a manner that allows the system functions to operate sufficiently.

• Risk Assessment

The proper use of safety devices described in this Manual as it relates to installation conditions and mechanical performance and functions is a prerequisite for their use. When selecting or using a safety device, risk assessment must be conducted with the aim of identifying potential danger factors in equipment or facilities in which the safety device is to be applied, during the development stage of the equipment or facilities. Suitable safety devices must be selected under the guidance of a sufficient risk assessment system. An insufficient risk assessment system may lead to the selection of unsuitable safety devices.

- Typical related international standards: ISO 14121, Safety of Machinery -- Principles of Risk Assessment

• Safety Measures

When using safety devices to build systems containing safety-related components for equipment or facilities, the system must be designed with the full understanding of and conformance to international standards, such as those listed below, and/or standards in related industries.

- Typical related international standards: ISO 12100, Safety of Machinery -- Basic Concepts and General Principles for Design
IEC 61508, Safety Standard for Safety Instrumented Systems (Functional Safety of Electrical/Electronic/Programmable Electronic Safety-related Systems)

- **Role of Safety Device**

The safety devices are provided with safety functions and mechanisms as stipulated in relevant standards, but suitable designs must be used to allow these functions and mechanisms to operate properly inside system constructions containing safety-related components. Build systems that enable these functions and mechanisms to perform properly, based on a full understanding of their operation.

- Typical related international standards: ISO 14119, Safety of Machinery -- Interlocking Devices Associated with Guards -- Principles of Design and Selection

- **Installation of Safety Device**

The construction and installation of systems with safety-related components for equipment or facilities must be performed by technicians who have received suitable training.

- Typical related international standards: ISO 12100, Safety of Machinery -- Basic Concepts and General Principles for Design

- **Complying with Laws and Regulations**

The safety devices conform to the relevant regulations and standards, but make sure that they are used in compliance with local regulations and standards for the equipment or facilities in which they are applied.

- Typical related international standards: IEC 60204, Safety of Machinery -- Electrical Equipment of Machines

- **Observing Precautions for Use**











When putting the selected safety devices to actual use, heed the specifications and precautions in this Manual and those in the Operation Manuals that comes with the products. Using the products in a manner that deviates from these specifications and precautions will lead to unexpected failures in equipment or devices, and to damages that result from such failures, due to insufficient operating functions in safety-related components.

- **Moving or Transferring Devices or Equipment**







When moving or transferring devices or equipment, be sure to include this Manual to ensure that the person to whom the device or equipment is being moved or transferred will be able to operate the system properly.

- Typical related international standards: ISO 12100, Safety of Machinery -- Basic Concepts and General Principles for Design
IEC 61508, Safety Standard for Safety Instrumented Systems (Functional Safety of Electrical/Electronic/Programmable Electronic Safety-related Systems)





3 Safety Precautions

 WARNING	
<p>Serious personal injury or fire may occasionally occur due to leakage, rupture, combustion, or heat generation. Use only the peripheral devices specified by OMRON.</p> <ul style="list-style-type: none"> • Battery Pack: RB-B2001A • Charger: RB-C2001 • Power Cable: NE1A-BTCHG-JP NE1A-BTCHG-EU (packed together) 	
<p>Serious personal injury or fire may possibly occur due to rupture, combustion, or heat generation. Observe the following precautions on the built-in lithium-ion battery and lithium battery.</p> <ul style="list-style-type: none"> • Do not use, place, or store the Product at high temperatures or in a location exposed to sunlight. • Do not heat the Product or expose it to fire. • Do not allow the Product to be deformed by pressure or subjected to strong shock. • When replacing the Battery Pack or the clock battery, do not allow the connection terminals to come into contact with metal parts. • Do not disassemble or modify the Product. 	
<p>Serious personal injury or fire may occasionally occur due to rupture, combustion, or heat generation. Do not attempt to charge the clock battery. It is a lithium primary battery.</p>	
<p>Serious personal injury may occasionally occur due to electric shock, rupture, combustion, or heat generation. Do not place the Product in water or operate it with wet hands.</p>	
<p>Serious personal injury may possibly occur due to loss of safety functions. Observe the following precautions.</p> <ul style="list-style-type: none"> • Do not use the NE1A-HDY01 Mobile Console directly or indirectly in applications for detecting humans to ensure safety. • Perform a user test before operating the system, and check to make sure that all the device configuration data and operations are correct. • After replacing a device, check to make sure that the replacement device is in the appropriate configuration and is operating correctly 	 
<p>Serious personal injury or fire may possibly occur due to rupture, combustion, or heat generation. Observe the following precautions.</p> <ul style="list-style-type: none"> • When carrying or storing the Battery Pack or the clock battery, insulate them with a material such as tape to prevent metal parts from coming into contact with the Battery Pack connection terminals. • If any abnormality, such as smoke or an unusual odor or noise, occurs during operation, immediately turn OFF the power switch and stop using the Product. 	
<p>Personal injury may occasionally occur. Stop using the Product immediately if the touch screen is damaged.</p> <ul style="list-style-type: none"> • If leaked fluid comes into contact with skin or clothing, immediately flush it thoroughly with clean water. • If leaked fluid comes into contact with the eyes or mouth, do not rub it. Flush thoroughly with clean water and then consult a physician. 	
<p>Personal injury may occasionally occur. Stop using the Product immediately if leaked fluid or an unusual odor from the Battery Pack or clock battery is detected.</p> <ul style="list-style-type: none"> • If there are flames nearby, move the Product away from the flames. Failure to do so may result in leaked fluid catching fire, causing rupture or combustion. • If leaked fluid comes into contact with skin or clothing, immediately rinse it thoroughly with clean water. • If leaked fluid comes into contact with the eyes or mouth, do not rub it. Flush thoroughly with clean water and then consult a physician. 	

■ Warnings on RB-B2001A Battery Pack

 WARNING	
<p>Serious personal injury or fire may occasionally occur due to rupture, combustion, or heat generation.</p> <ul style="list-style-type: none"> • Do not short-circuit the plus (+) and minus (-) terminals of the Battery Pack. • Do not use, place, or store the Battery Pack in a location exposed to sunlight. • Do not heat the Battery Pack or expose it to fire. • Do not drop the Battery Pack or allow it to be subjected to severe shock. 	
<p>Serious personal injury or fire may occasionally occur due to leakage, rupture, combustion, or heat generation.</p> <ul style="list-style-type: none"> • Do not use a charger other than the one specified by OMRON for charging the Battery Pack. • Do not disassemble or modify the Battery Pack. • Do not use the Battery Pack with a device other than the NE1A-HDY01 Mobile Console. • Do not place the Battery Pack in water or operate it with wet hands. 	 
<p>When carrying or storing the Battery Pack, insulate it with material, such as tape, to prevent metal parts from coming into contact with the Battery Pack connection terminals. Failure to do so may result in short-circuiting, occasionally causing serious personal injury or fire due to rupture, combustion, or heat generation.</p>	
<p>Personal injury may occasionally occur.</p> <p>If leakage or an unusual odor from the Battery Pack is detected, stop using the Battery Pack immediately.</p> <ul style="list-style-type: none"> • If there are flames nearby, move the Battery Pack away from the flames. Failure to do so may result in leaked fluid catching fire, causing rupture or combustion. • If leaked fluid comes into contact with skin or clothing, immediately rinse it thoroughly with clean water. • If leaked fluid comes into contact with the eyes or mouth, do not rub it. Flush thoroughly with clean water and then consult a physician. 	

■ Warnings on RB-C2001 Charger

 WARNING	
<p>If the charge indicator is flashing red, or if charging does not finish even though the specified time has been exceeded, stop charging and remove the power plug from the outlet. Failure to do so may occasionally result in serious personal injury or fire due to leakage, rupture, combustion, or heat generation.</p>	
<p>Using other devices may occasionally result in serious personal injury or fire due to leakage, rupture, combustion, or heat generation.</p> <p>Do not use the Charger for charging any Battery Pack other than the one specified by OMRON.</p>	
<p>Serious personal injury may occasionally occur due to electric shock, rupture, combustion, or heat generation. Do not place the Product in water or operate it with wet hands.</p>	
<p>Serious personal injury may occasionally occur due to combustion, heat generation, or electric shock. Observe the following precautions.</p> <ul style="list-style-type: none"> • When not charging, remove the power supply plug from the outlet. • Do not damage the Charger power cable, modify it, place heavy objects on it, or bend it past its natural bending radius. 	

4 Precautions for Safe Use

• Before Operation

When opening the package, perform a visual check for any damage. Lightly shake the Product and listen for any unusual sounds.

• Storage and Operating Environments

Do not store or operate the Product in any of the following locations.

- Locations subject to direct sunlight
- Locations subject to temperatures or humidity outside the range specified in the specifications
- Locations subject to condensation as the result of severe changes in temperature
- Locations subject to steam.
- Locations subject to corrosive or flammable gases
- Locations subject to dust (especially iron dust) or salts
- Locations subject to water, oil, or chemicals
- Locations subject to shock or vibration

Take appropriate and sufficient measures when installing systems in the following locations. Inappropriate and insufficient measures may result in malfunction.

- Locations subject to static electricity or other forms of noise
- Locations subject to strong electromagnetic fields
- Locations subject to possible exposure to radioactivity
- Locations close to power supplies

The Mobile Console is a Class A product. It may cause radio interference in residential areas, in which case the user may be required to take adequate measures to reduce interference.

• Power Supply

Do not connect the Charger to a power supply that exceeds the ratings.

• Periodic Inspections and Maintenance

Always turn OFF the power switch before installing or replacing the Battery Pack or clock battery.

• Disposal

- When disposing of the Battery Pack or clock battery, insulate the plus (+) and minus (-) terminals of the battery with tape.
- Follow all local government regulations as applicable when disposing of the Mobile Console and used batteries.
- The Battery Pack is a lithium-ion secondary battery. It can be recycled.



5 Precautions for Correct Use

Observe the following precautions in order to prevent Product failure, Product malfunction, or adverse effects on the performance of the Product.

- **Handling the Memory Card**

Do not perform any of the following operations while the Memory Card is being accessed. Doing so may cause data to be lost.

- Turning OFF the Mobile Console power switch
- Removing the Battery Pack
- Removing the Memory Card

- **Handling the Touch Screen**

- Use the enclosed stylus for touch screen operations. Using a sharp object may scratch the touch screen surface so that the screen cannot be used for inputs.
- Do not press hard on or rub the touch screen surface. Doing so may not only cause damage but may break the glass.

- **Cleaning**

Use a clean, dry cloth for cleaning. If dirt cannot be removed using a dry cloth, dampen the cloth with a neutral cleaning solution, wring the cloth out tightly, and then wipe the dirty section.

Never use benzene or thinner, or other volatile solvents or chemical cloths, to clean the Product. Doing so may discolor the surface or cause damage.

6 Regulations and Standards

The NE1A-HDY01 has been determined to conform to the EC EMC Directive by conforming to the following standards.

Certifying organization	Standards
TÜV Rheinland	IEC 61131-2 IEC 61000-6-4 CISPR 16-1-2 CISPR 16-2-1 CISPR 16-2-3

7 Checking the Contents of the Package

■ NE1A-HDY01 Mobile Console

The following items should be included in the package. Check to make sure that all of the items are included, and that there is no leakage or damage.

Name	Description	Quantity
Mobile Console	NE1A-HDY01	1
Hand strap		1
Instruction Sheet		1
SYSMAC ID registration card (Japanese)		1
SYSMAC ID registration card (English)		1
Address sheet		1

• Defective Display Pixels

The liquid-crystal panel has been made using very advanced technology, but there may be defective display pixels that produce gaps or bright points (points that remain lit) on the display. This is an inherent aspect of liquid crystals and does not indicate any product failure. We do our utmost to minimize defective display pixels, but with current manufacturing technology, it is impossible to eliminate them completely.

■ Charger and Battery Set NE1A-BTCHG-JP (for Japan)/NE1A-BTCHG-EU (for Europe)

Name	Description	Quantity
Charger	RB-C2001	1
Battery Pack	RB-B2001A	1
Power Cable	Power cable for the specified destination	1
Instruction Sheet		1

■ RB-B2001A Replacement Battery Pack

Name	Description	Quantity
Battery Pack	RB-B2001A	1
Instruction Sheet		1

8 Definition of Terms

The following terms are used in describing the NE1A-HDY01.

Term	Definition
Mobile Console	A portable terminal that is used to perform maintenance for Safety Network Controllers and Safety I/O Terminals. "Mobile Console" is the name of OMRON's NE1A-HDY01.
Battery Pack	The RB-B2001A Lithium-ion Battery Pack.
Network Configurator	A software application that is used to build, set, and manage DeviceNet, DeviceNet Safety, and EtherNet/IP networks. "Network Configurator" is the name of OMRON's WS02-CFSC-J/E.
Safety	Refers to devices, functions, or data for which special safety measures for use in safety controls have been implemented.
Standard	Refers to devices, functions, or data for Standard applications. "Standard" is used to distinguish Standard Devices, functions, or data from those for which special safety measures for use in safety controls have been implemented.

Term	Definition
Safety Network Controller	A controller that supports Safety Networks and has a high reliability for use in safety controls. "Safety Network Controller" is the name of the Controllers in OMRON's NE0A Series, NE1A Series, and other series.
Standard Programmable Controller (Standard PLC)	A Programmable Controller (PLC) that is used for Standard Controls. "Standard PLC" is used to distinguish a PLC for Standard Controls from a PLC for Safety Controls.
Safety I/O Terminal	A Remote I/O Terminal for use in safety controls. "Safety I/O Terminal" is the name of the terminals in OMRON's DST1 Series.
Remote I/O Terminal	A Remote I/O Terminal for use in Standard Controls.
Safety Input device	An input device for which special measures for use in safety controls have been implemented. Emergency stop switches and safety door switches are examples of Safety Input devices.
Safety Output device	An output device for which special measures for use in safety controls have been implemented. Safety relays are an example of a Safety Output device.
locking the configuration/device	A configuration (device) is locked to indicate that the suitability of downloaded Safety Parameters has been verified by the user in system testing. Locking the configuration (device) protects the data saved in the device. The configuration data can be changed by unlocking the configuration (device).
safety signature	A certification for configuration data transferred to a device from the Network Configurator. The safety signature is used by the device to verify that the configuration data is correct.

SECTION 1

Introduction

The section provides an overview of the Mobile Console, describes its parts and functions, describes basic operating procedures, and provides hardware handling procedures. Read this section before you attempt to use the Mobile Console.

1-1	Overview of Mobile Console	2
1-1-1	Mobile Console.....	2
1-1-2	Mobile Console Functions	4
1-1-3	Differences with Network Configurator Functions	6
1-2	Part Names and Functions.....	7
1-2-1	Front	7
1-2-2	Rear.....	8
1-3	Control Keys	9
1-3-1	Control Keys.....	9
1-3-2	Power Mode Key	9
1-3-3	Character Keys	9
1-3-4	Function Keys.....	10
1-4	Stylus.....	11
1-4-1	Stylus	11
1-5	External Connectors	12
1-5-1	External Connectors	12
1-6	Starting and Stopping the Mobile Console and Standby Mode	13
1-6-1	Starting and Stopping the Mobile Console.....	13
1-6-2	Standby Modes	13
1-6-3	Status Indicators	14
1-7	Using the Battery Pack	15
1-7-1	Replacing the Battery Pack.....	15
1-7-2	Charging the Battery.....	17
1-8	Using the Memory Card	19
1-8-1	Inserting the Memory Card.....	19
1-8-2	Removing the Memory Card	20
1-9	Replacing the Clock Battery	21
1-9-1	Replacing the Clock Battery.....	21
1-10	Attaching the Hand Strap	23
1-10-1	Strap Position	23
1-10-2	Attaching the Strap	23

1-1 Overview of Mobile Console

This section gives an overview of the Mobile Console.

1-1-1 Mobile Console

The Mobile Console is a mobile maintenance terminal for DeviceNet Safety Networks. It can be connected to Safety Devices on the DeviceNet Safety Network using a USB cable to monitor individual devices and to support replacing devices. The user interface features a lightweight, compact body and an easy touch screen so that work can be carried out standing up, making it useful for identifying the location of device errors using the monitoring function and reducing the time required for maintenance, such as replacing devices. The Mobile Console is perfect for maintenance work onsite where a laptop cannot easily be brought in.

Application Range of Mobile Console on the DeviceNet Safety Network

Application Range of Mobile Console

Devices in the following range can be maintained with the Mobile Console when it is connected to the Safety Network Controller.

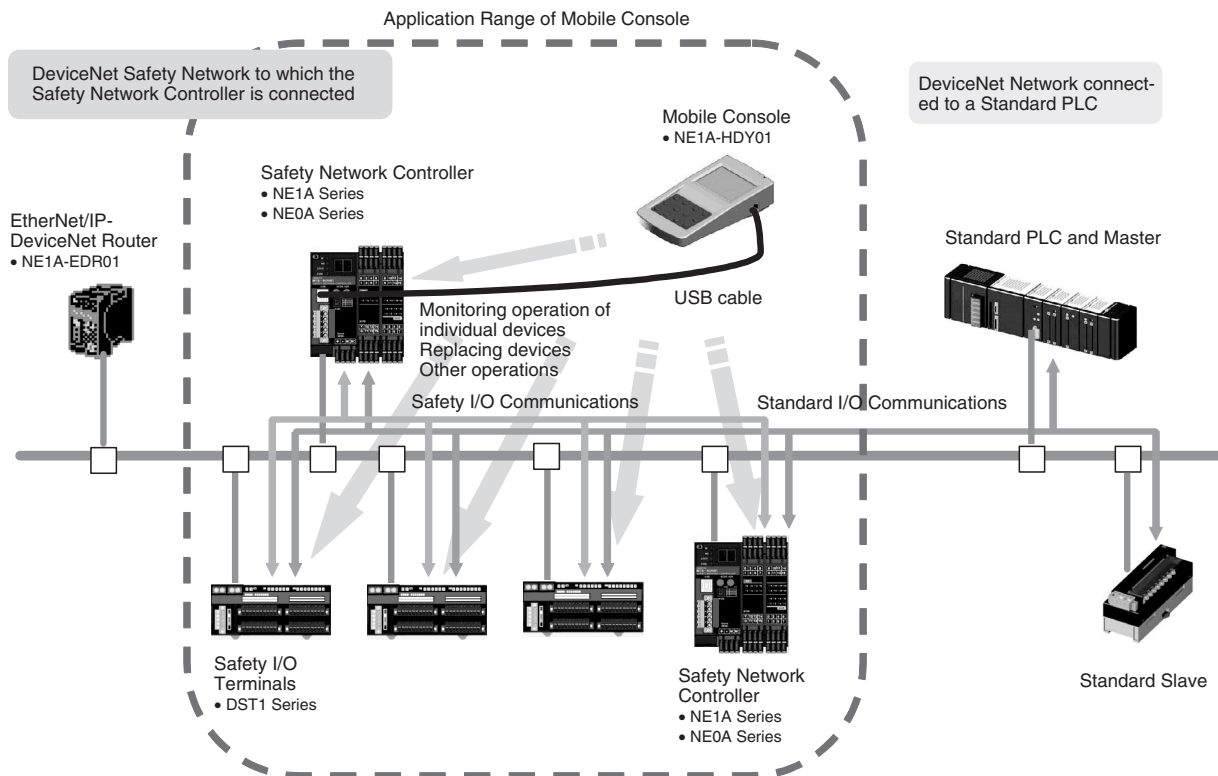

Connectable DeviceNet Safety Devices

Devices in the following series can be maintained by using the Mobile Console.

Series	Model
NE1A Series	NE1A-SCPU01
	NE1A-SCPU01-V1 (unit version 1.0 or 2.0)
	NE1A-SCPU02 (unit version 1.0 or 2.0)
NE0A Series	NE0A-SCPU01

Series	Model
DST1 Series	DST1-ID12SL-1
	DST1-MD16SL-1
	DST1-MRD08SL-1
	DST1-XD0808SL-1

Note Ethernet/IP-DeviceNet Routers, Standard PLCs, Standard Masters, and Standard Slaves are not in the application range of the Mobile Console.

Features of the Mobile Console

Easy Operation with a Touch Screen

Operating the Mobile Console is performed simply by tapping the touch screen with a stylus.

Compatible with DeviceNet Safety Devices

The Mobile Console is compatible with NE0A/NE1A-SCPU Safety Network Controllers as well as DST1-series Safety I/O Terminals.











Affinity with the Network Configurator









The Mobile Console uses device parameter files (*.dvp) created by the Network Configurator. Device parameter files can be downloaded to the Safety Network Controllers and Safety I/O Terminals.

Display of Errors and Countermeasures

The status of and countermeasures for errors are displayed in a dialog box.

1-1-2 Mobile Console Functions

	Function name	Icon	Description	Reference
DeviceNet Safety System Functions (Online Functions)	Monitor		Displays the connected device's I/O terminal status. Errors occurring at the connected device will be displayed on the Maintenance Tab Page.	3-2-2
	Device Status		Displays the device status as well as information on alarms and warnings. Errors occurring at the connected device will be displayed on the Maintenance Tab Page.	3-2-3
	Change Target		This function is used to change the connected device.	3-1-3
	Error History		Displays the error history of the connected device. Errors occurring at the connected device will be displayed on the Maintenance Tab Page.	3-2-4
	Upload		Uploads parameters from the connected device and saves them to the Memory Card.	3-4
	Device Property		Displays the properties of the connected device.	3-2-5
	Download		Device parameters copied to the Memory Card are downloaded to the connected device.	3-5
	Replace Device		Device parameters uploaded from the connected device are downloaded after replacing the device. This function cannot be used if a system error occurs due to a fatal hardware error in the device that is being replaced.	3-3
	Change Mode		Changes the operating mode of the connected device.	3-7
	Lock Unlock		Locks or unlocks the connected device.	3-8
	Reset		Resets the connected device.	3-6

	Function name	Icon	Description	Reference
Console Settings	Monitor Settings		Sets the time interval for refreshing data displayed by the monitor function.	2-2-1
	Brightness		The brightness of the screen can be selected from three levels.	2-2-2
	Memory Card Format		This function is used to format a Memory Card.	2-2-3
	Date/Time		This function is used to set the date and time.	2-2-4
	Stylus		This function is used to set the double-tap speed and to calibrate the touch screen.	2-2-5
	Power Management		This function is used to set the power saving features.	2-2-6
	Language		This function is used to set the language used by the Mobile Console.	2-2-7
	Version		Displays the Mobile Console version information.	2-2-8

Note Refer to 3-2-6 *Saving the Screen Image* for information on saving the screen image showing monitor results (Fn + F2 Keys).

1-1-3 Differences with Network Configurator Functions

The differences between the Mobile Console and Network Configurator functions are outlined in the following table.

OK: Possible, ---: Not possible

Item		Mobile Console	Network Configurator
Controllable DeviceNet Safety Devices		<ul style="list-style-type: none"> • NE1A-SCPU Series • NE0A Series • DST1 Series 	<ul style="list-style-type: none"> • NE1A-SCPU Series • NE0A Series • DST1 Series
Managed files		*.dvf (device parameter files) created by Network Configurator	*.ncf (network configuration files)
File memory		Memory Card only	Saved in computer
Changing target connection		OK (Target connection can be changed within same network)	OK (Change network) Select Change Connect Network from the Network Menu.
Parameters	Upload	OK (by device)	OK
	Download	OK (by device) Verification executed at the same time.	OK
	Compare	---	OK
	Lock, Unlock	OK Verification executed at the same time.	OK
	Edit	---	OK
	Read	OK (by device)	OK
	Save	OK (by device)	OK
Creating and editing programs		---	OK
Monitoring (Monitor, Device Status, Device Property)		OK	OK
Device replacement (Automatic upload/download function)		OK	---
Resetting		OK	OK
Changing the mode		OK	OK
Changing passwords		---	OK

1-2 Part Names and Functions

1-2-1 Front

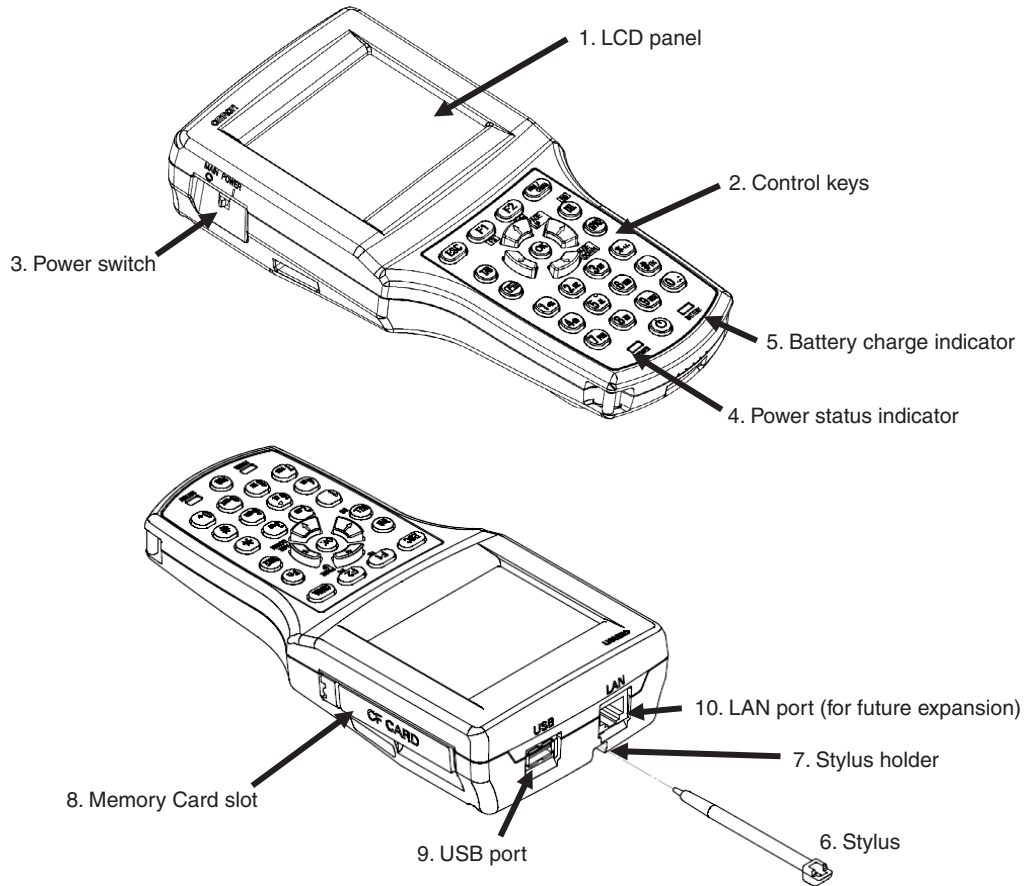

1	LCD panel	The LCD panel is a touch screen that can be used with the stylus. Refer to <i>2-1-1 Main Window</i> for the screen names.
2	Control keys	Refer to <i>1-3 Control Keys</i> .
3	Power switch	Refer to <i>1-6-1 Starting and Stopping the Mobile Console</i> .
4	Power status indicator	Refer to <i>1-6-3 Status Indicators</i> .
5	Battery charge indicator	Refer to <i>1-6-3 Status Indicators</i> .
6	Stylus	This is a pen for tapping the touch screen to navigate the controls. Refer to <i>1-4 Stylus</i> .
7	Stylus holder	The stylus can be stored in the holder when it is not being used.
8	Memory Card slot	The Memory Card is inserted in this slot. Refer to <i>1-8 Using the Memory Card</i> .
9	USB port	The USB port is used to connect the Mobile Console to an NE0A/NE1A-series Safety Network Controller. Refer to <i>1-5-1 External Connectors</i> .
10	LAN port	This port is for future expansion. It cannot currently be used.

1-2-2 Rear

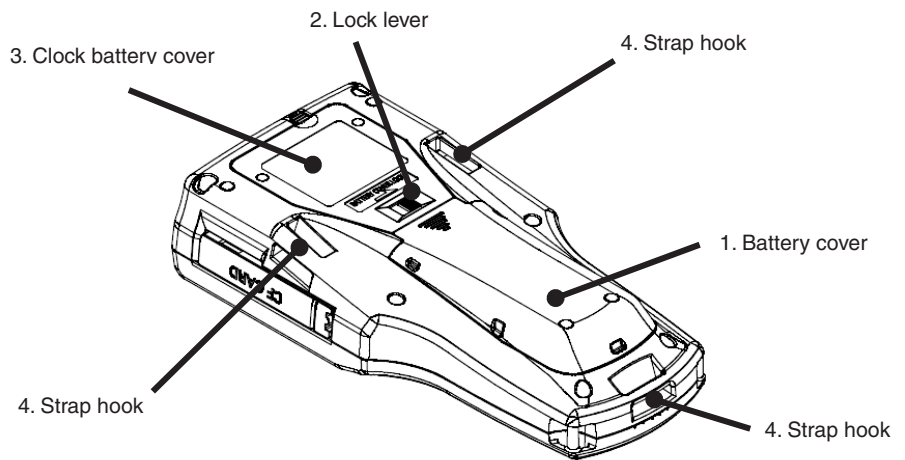

1	Battery cover	Covers the rechargeable battery pack.
2	Lock lever	Locks the battery cover.
3	Clock battery cover	Covers the clock battery.
4	Strap hooks	Used to attach the hand strap.

1-3 Control Keys

1-3-1 Control Keys

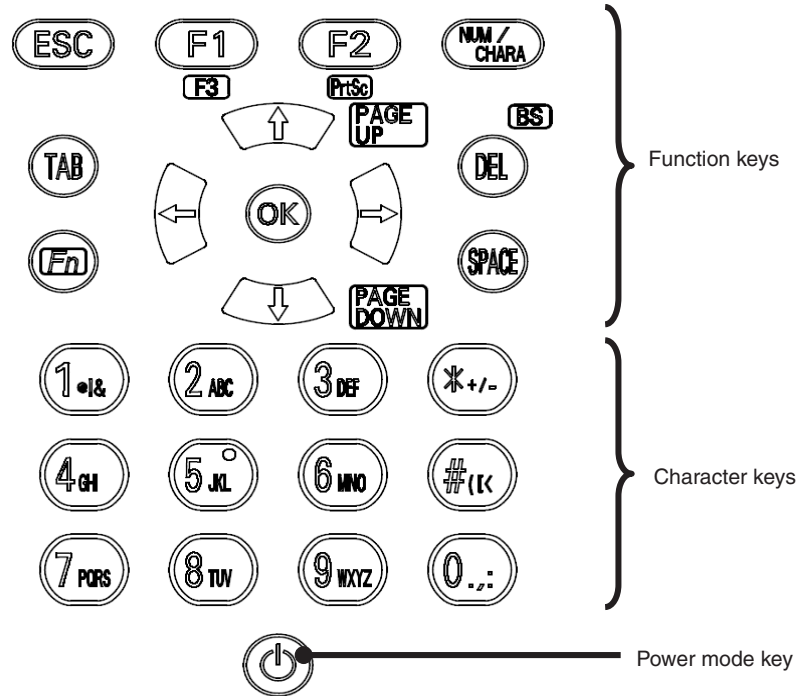

1-3-2 Power Mode Key

The Mobile Console has two standby modes to reduce the rate of consumption of charge of the battery pack. The standby modes are the Suspended Mode and the Deep Sleep Mode. Refer to *1-6-2 Standby Modes* for details.

The **Power Mode** Key can be used to enter or exit the standby modes.

Purpose	Procedure
To enter suspended mode	Hold down the Power Mode Key.
To enter deep sleep mode	Leave the Mobile Console in Suspended Mode for the set time (15 min max.)
To return from suspended or deep sleep mode	Press the Power Mode Key.

1-3-3 Character Keys

You can switch between the following character input modes using the **NUM/CHARA** Key.

- Number mode
- Alphabet and symbol mode

Multiple characters are assigned to one key for the alphabet and symbol input mode. Press the key a number of times until the desired character is displayed.

Key	Number mode	Alphabet and symbol mode
1 @!&	1	@ → ! → & → % → → ? → \$ → \
2 abc	2	a → b → c → A → B → C
3 def	3	d → e → f → D → E → F
4 ghi	4	g → h → i → G → H → I

Key	Number mode	Alphabet and symbol mode
5 jkl	5	j → k → l → J → K → L
6 mno	6	m → n → o → M → N → O
7 pqrs	7	p → q → r → s → P → Q → R → S
8 tuv	8	t → u → v → T → U → V
9 wxyz	9	w → x → y → z → W → X → Y → Z
0 .,: :	0	. → , → : → ; → " → ' → ` → _
* +/-	*	+ → / → - → = → ^ → ~
# (<	#	(→) → [→] → < → > → { → }

1-3-4 Function Keys

Key	Function
ESC	Escape
F1	Not used.
F2	Not used.
NUM/CHARA	Changes the input mode. Refer to 1-3-3 Character Keys.
TAB	Tab
DEL	Delete
↑	Move up
↓	Move down
→	Move right
←	Move left
OK	Enter
SPACE	Space
Fn+F1	Not used.
Fn+F2	Print screen
Fn+↑	Page up
Fn+↓	Page down
Fn+Del	Backspace

Print Screen: Fn + F2

The current display on the LCD screen can be converted to an image file and saved to the Memory Card. The image will be saved with the date and time as the file name.

IMPORTANT The Mobile Console cannot access image files saved to the Memory Card. Use a computer to access the image files.

1-4 Stylus

1-4-1 Stylus

The Mobile Console has a stylus that can be stored in a special holder on the back of the Console.

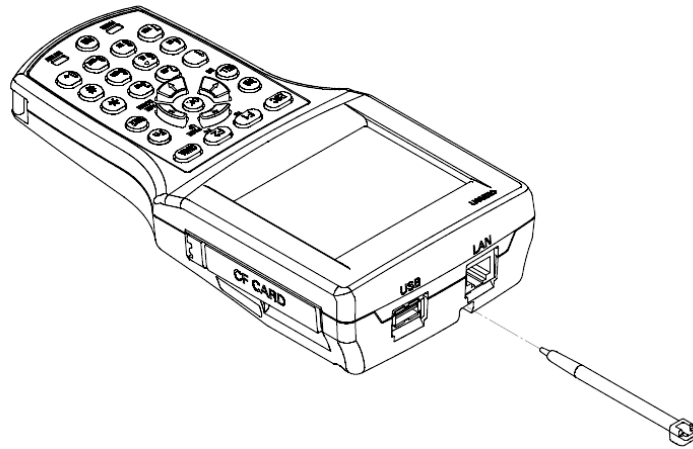

- Note**
- (1) Use the enclosed stylus for touch screen operations. Using a sharp object may scratch the touch screen surface so that the screen cannot be used for inputs.
 - (2) Do not press hard on or rub the touch screen surface. Doing so may not only cause damage but may break the glass.

1-5 External Connectors

The Mobile Console is equipped with a USB port for connection to external devices. (It also has a LAN port that is for future expansion.)

1-5-1 External Connectors

To connect a USB cable, remove the protective cap covering the connector and connect the cable.

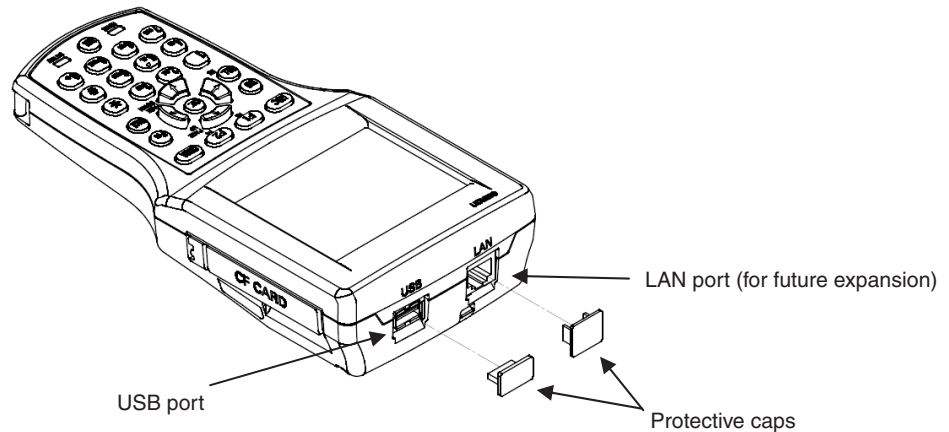

USB Communications Connector

Connect the USB communications connector to the USB port of a NE1A-series Controller. USB version 1.1 is supported. Use a commercially available USB cable.

IMPORTANT Make sure that the USB cable is less than 3 m.

LAN Connector

The LAN connector cannot be used. It will be used for future expansion.

1-6 Starting and Stopping the Mobile Console and Standby Mode

1-6-1 Starting and Stopping the Mobile Console

The Mobile Console will start when the power switch is turned ON. It will stop when the power switch is turned OFF.

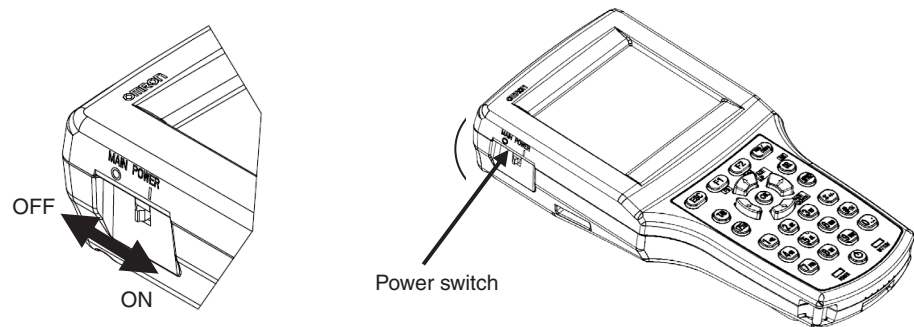

1-6-2 Standby Modes

The Mobile Console has two standby modes to reduce the rate of consumption of charge in the battery pack. The standby modes are the Suspended Mode and the Deep Sleep Mode.

Standby mode	Description	Setting method	Recovery method	Battery holding time (See note 1.)
Suspended Mode	The Mobile Console is held in the state it was before it was suspended. It can be returned to the original state quickly.	1. Hold down the Power Mode Key or 2. Leave the Mobile Console with the power turned ON for the set time without using it (20 min max.). (See note 2.)	Press the Power Mode Key	64 hours
Deep Sleep Mode	Consumption of battery is even lower than in Suspended Mode, however the state of the Mobile Console will not be held.	Leave the Mobile Console in Suspended Mode for the set time without using it (15 min max.). (See note 2.)	Press the Power Mode Key	1,000 hours

- Note**
- (1) The battery holding time is the estimated maximum time that the Mobile Console can hold the mode if the battery is fully charged. The actual time will vary with the operating environment and the state of the battery.
 - (2) Refer to 2-2-6 *Power Management Settings* for the setting method.

IMPORTANT Turn OFF the power switch if the Mobile Console will not be used for a long period of time.

1-6-3 Status Indicators

The power supply mode and amount of charge left in the main battery can be checked using LED indicators.

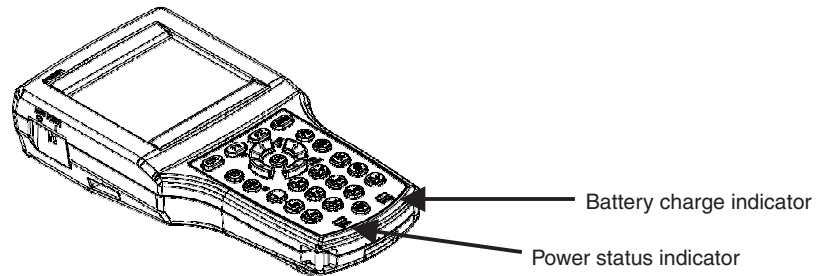

Power Mode

The power mode can be identified according to the combination of the power status indicator and the battery charge indicator.

Status	Power status indicator	Battery charge indicator
Power ON	Lit	Lit
Suspended Mode	Not lit	Lit
Deep Sleep Mode	Not lit	Not lit
Power OFF	Not lit	Not lit

Battery Power

The color of the battery charge indicator changes with the amount of charge left in the battery pack. A message will be displayed saying that the remaining charge is low when the remaining charge falls below 10%.

Battery charge indicator	Battery power	Notes
Green indicator	Approx. 70% to 100%	---
Orange indicator	Approx. 30% to 70%	To continue using the Mobile Console, replace the battery. After an orange indicator, the battery will be exhausted after about 3.5 hours. (See note.)
Red indicator	Approx. 0% to 30%	Immediately replace the battery. After a red indicator, the battery will be exhausted after about 1 hour. (See note.)

Note The times are estimates and are provided only as guidelines. The actual time will depend on the operating environment and operating conditions.

1-7 Using the Battery Pack

The RB-B2001A Battery Pack must be used.

IMPORTANT Make sure that the power switch is turned OFF before you install or replace the battery pack.

1-7-1 Replacing the Battery Pack

- 1,2,3... 1. Turn OFF the power switch.
2. Slide the lock lever on the back in the direction indicated by the arrow to unlock the battery cover.

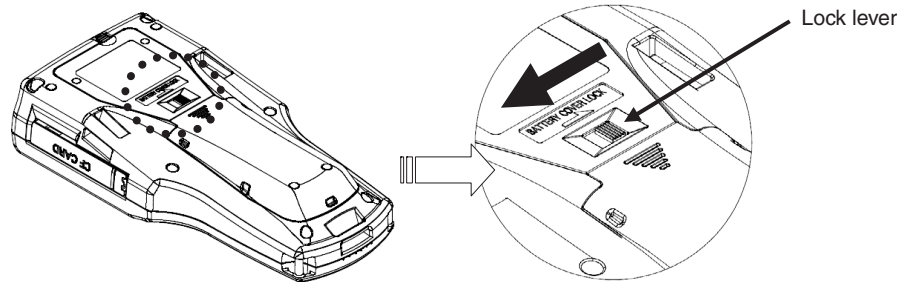

3. Lightly press the grip section of the battery cover and slide it in the direction indicated by the arrow to remove it.

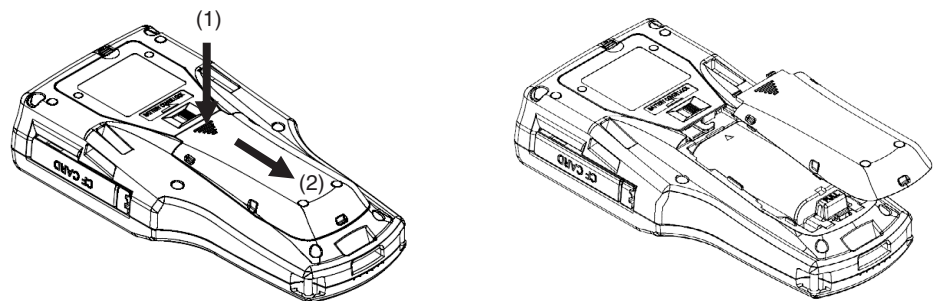

4. Pull out the battery stopper.

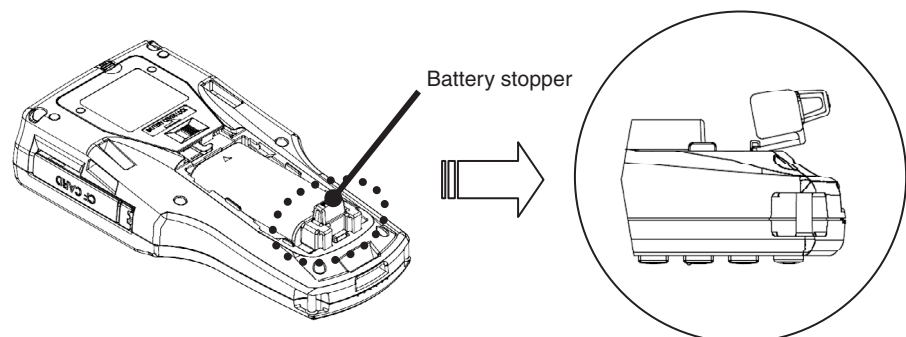

5. Slide the battery pack in the direction indicated by the arrow to remove it.

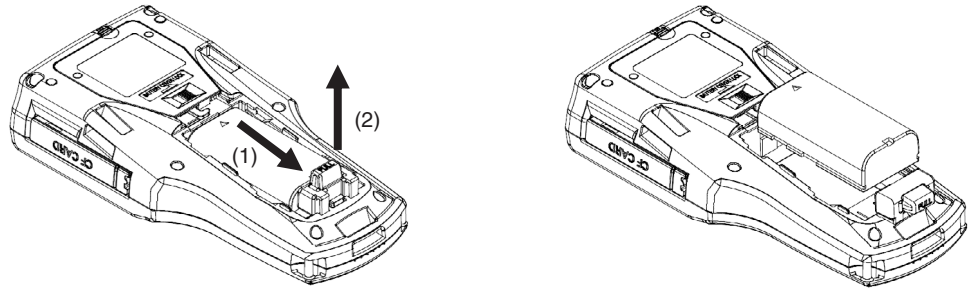

6. Insert a charged battery pack and slide it in the direction indicated by the arrow.

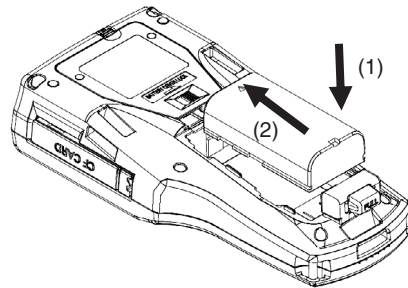

7. Place the battery stopper firmly in place.

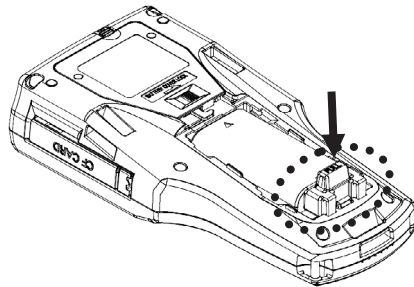

8. Replace the battery cover.

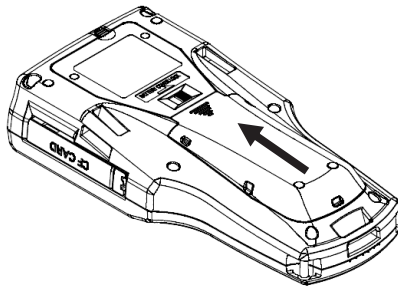

9. Slide the lock lever in the direction indicated by the arrow to lock the battery cover.

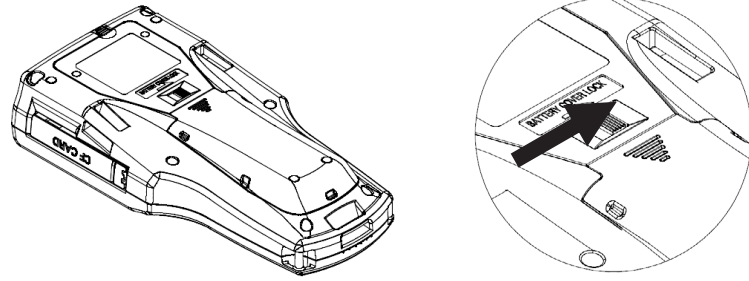

1-7-2 Charging the Battery

The battery must be charged when using the Mobile Console for the first time or if it has not been used for a long time

- 1,2,3... 1. Insert the cable into the charger.

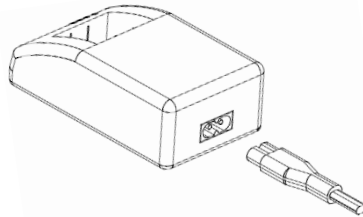

2. Insert the AC plug of the cable into an AC socket.
 3. Insert the battery pack into the charger. The charger indicator will turn ON when charging starts.

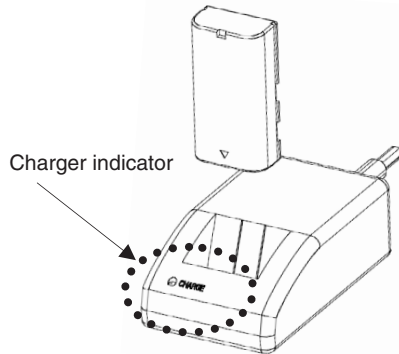

Charger Indicator

Color	Status	Meaning
---	■	Battery is not inserted.
Green	◻	Charging complete
Red	◻	Charging
	◻◻	Error

◻ : Lit ◻◻ : Flashing ■ : Not lit

4. Charging the battery has been completed when the green indicator turns ON.

Note The battery takes approximately 3 hours to recharge depending on the operating environment, operating conditions, and the state of the battery.



IMPORTANT Make sure that the temperature is between 0 and 40°C, that the humidity is between 20% and 85%, and that there is no condensation. The battery may not charge fully in conditions outside these ranges. It may also damage the battery pack.

IMPORTANT The capacity of the battery reduces to approximately 60% of its original state after recharging it 300 times. Replace the Battery Pack if the charge only lasts for a short time.

IMPORTANT When disposing of the Battery Pack, insulate the plus (+) and minus (-) terminals of the battery with tape.

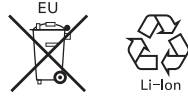
- Follow all local government regulations as applicable when disposing of the Battery Pack.
- The Battery Pack is a lithium-ion secondary battery. Please recycle it.



 WARNING	
If the charge indicator is flashing red, or if charging does not finish even though the specified time has been exceeded, stop charging and remove the power plug from the outlet. Failure to do so may occasionally result in serious personal injury or fire due to leakage, rupture, combustion, or heat generation.	
Using other devices may occasionally result in serious personal injury or fire due to leakage, rupture, combustion, or heat generation.	
Do not use the Charger for charging any Battery Pack other than the one specified by OMRON.	

1-8 Using the Memory Card

The following data is saved in the Memory Card.

- Data to be downloaded to or uploaded from connected devices.
- Images of the screen captured by the print screen function of the Mobile Console.

Note Use the following OMRON Memory Cards.

- HMC-EF183 128 MB
- HMC-EF283 256 MB
- HMC-EF583 512 MB

1-8-1 Inserting the Memory Card

- 1,2,3...** 1. Pull out the slot cover for the Memory Card on the Mobile Console.

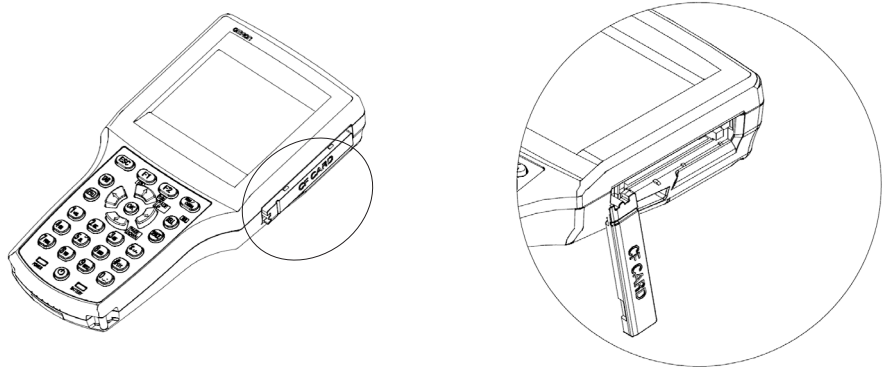

2. Insert the Memory Card into the slot.

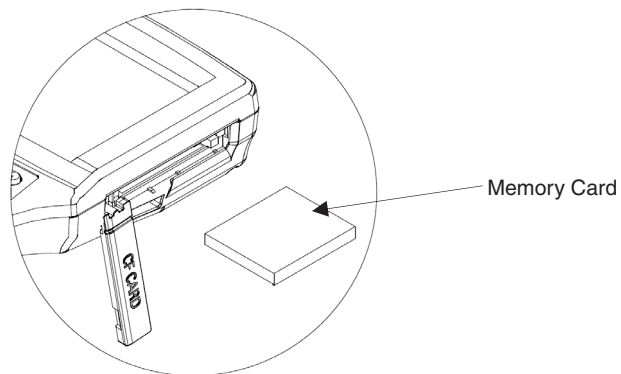

3. Return the slot cover to its original position.

1-8-2 Removing the Memory Card

- 1,2,3... 1. Pull out the slot cover on the Mobile Console for the Memory Card.

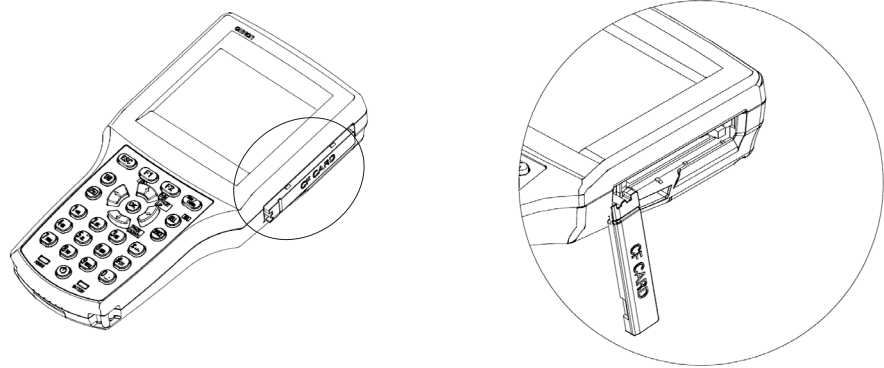

2. The eject lever will be extended if it is pressed in. Press it again to eject the Memory Card.

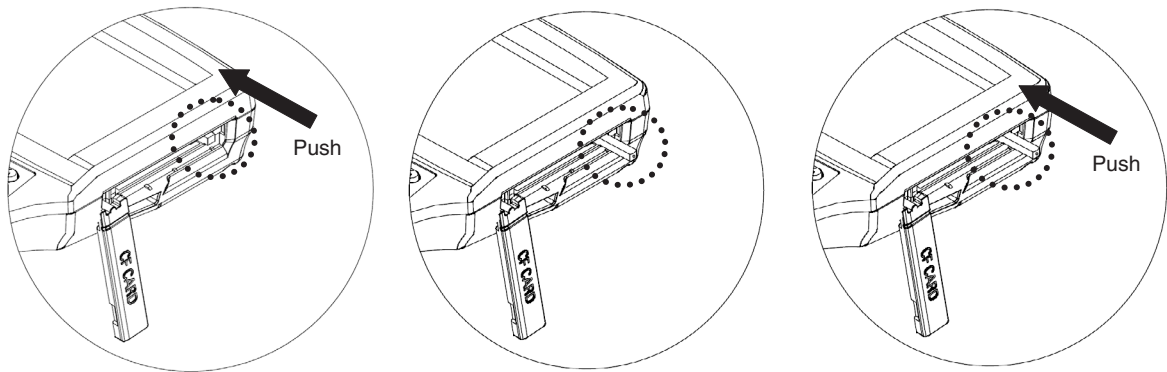

3. Pull out the Memory Card by grabbing it with your fingers.

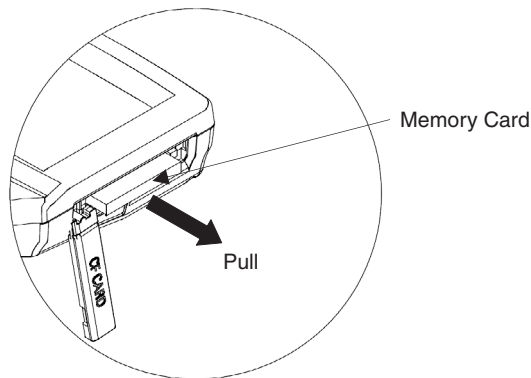

4. Close the slot cover.

1-9 Replacing the Clock Battery

1-9-1 Replacing the Clock Battery

The Mobile Console uses a battery for the clock to keep the date and time settings when the battery pack is being replaced. If the clock settings are lost, replace the clock battery with the following procedure.

- 1,2,3...
1. Remove the stylus.
 2. Undo the two screws on the back of the Mobile Console using a Phillips screwdriver. (Screw size: M2 × 8.)

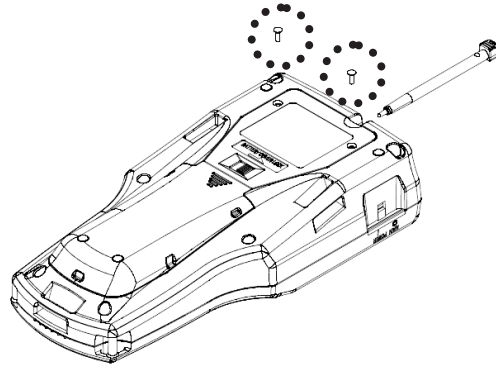

3. Place your finger where the stylus is inserted and pull off the clock battery cover.

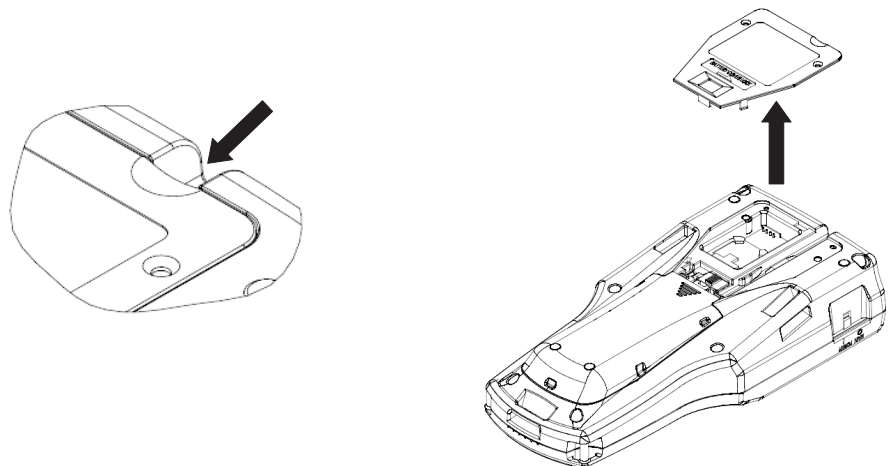

4. Press the clock battery in the holder as if to insert it and then remove it.

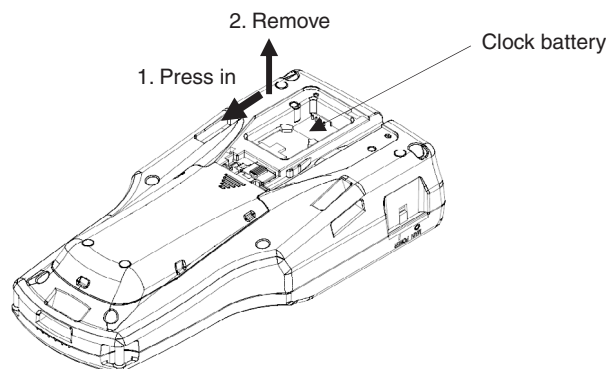

5. Place a new battery in the holder.
6. Replace the clock battery cover and secure it with the screws.

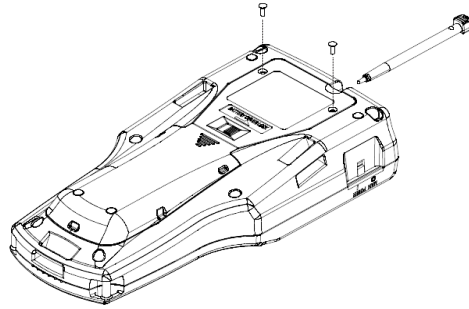

Clock Battery Model

Use a BR2032 Coin Lithium Battery as the clock battery.

Product specifications	BR2032 Coin Type Lithium Battery Voltage: 3 V Dimensions: 20.0 (diameter) × 3.2 mm (thickness)
Recommended battery	Panasonic Corporation model

IMPORTANT When disposing of the battery, insulate the plus (+) and minus (-) terminals of the battery with tape. Follow all local government regulations as applicable when disposing of the battery.

1-10 Attaching the Hand Strap

A strap can be attached to the Mobile Console for holding the Console. Attach the strap to the strap hooks for either a left-hand or right-hand grip.

1-10-1 Strap Position

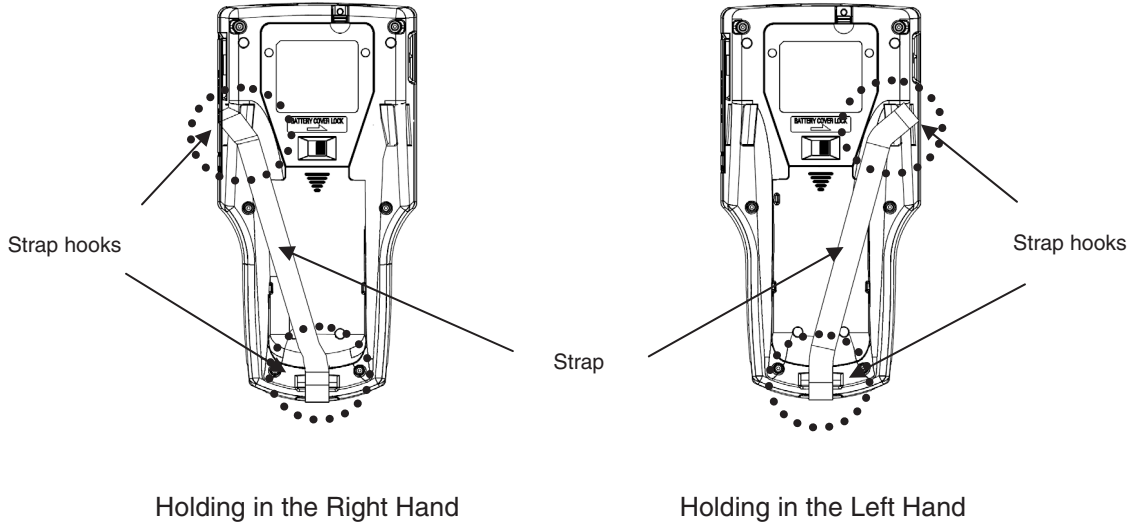

1-10-2 Attaching the Strap

- 1,2,3...**
1. Thread the strap through the strap hooks for a left-hand or right-hand grip.
 2. Fold the ends of the strap over the strap hooks and secure them with the adjusters.
 3. Adjust the length of the strap.

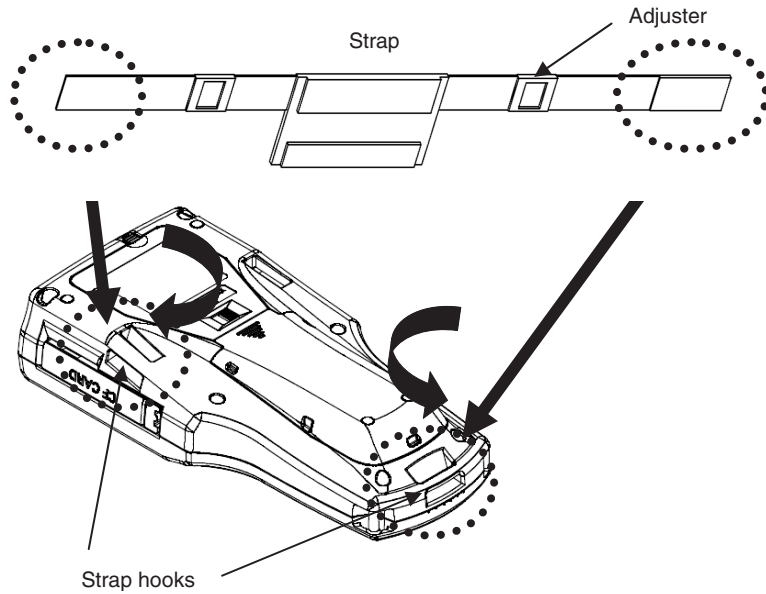

SECTION 2

Screen Names and Console Settings

This section describes the names of functions of elements on the Mobile Console screen and describes system settings for the Mobile Console.

2-1	Screen Names and Functions	26
2-1-1	Main Window	26
2-1-2	Function Icons	27
2-2	Console Settings	29
2-2-1	Setting the Monitor Refresh Time	29
2-2-2	Adjusting the Brightness	29
2-2-3	Formatting the Memory Card	30
2-2-4	Setting the Date and Time	31
2-2-5	Setting the Stylus Properties	32
2-2-6	Power Management Settings	33
2-2-7	Language Settings	34
2-2-8	Displaying the Version Information	35

2-1 Screen Names and Functions

2-1-1 Main Window

When the Mobile Console power supply is turned ON, the Main Window will be displayed on the screen. Icons for functions supported by the Mobile Console and information about connected DeviceNet Safety Devices will be displayed.

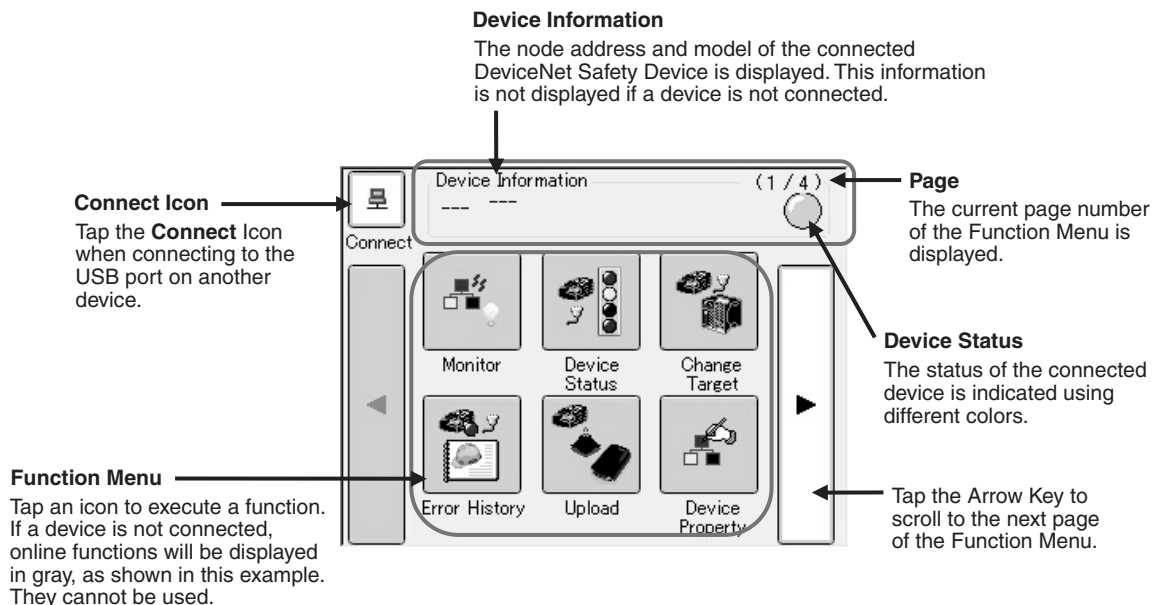



















Main Window When Connected to A DeviceNet Safety Device



Main Window When Connected Online to a DeviceNet Safety Device

2-1-2 Function Icons

	Icon	Function name	Description	Reference
DeviceNet Safety System Functions (Online Functions)		Monitor	Displays the connected device's I/O terminal status. Errors occurring at the connected device will be displayed on the Maintenance Tab Page.	3-2-2
		Device Status	Displays the device status as well as details of alarms and warnings. Errors occurring at the connected device will be displayed on the Maintenance Tab Page.	3-2-3
		Change Target	This function is used to change the connected device.	3-1-3
		Error History	Displays the error history of the connected device. Errors occurring at the connected device will be displayed on the Maintenance Tab Page.	3-2-4
		Upload	Uploads parameters from the connected device and saves them to the Memory Card.	3-4
		Device Property	Displays the properties of the connected device.	3-2-5
		Download	Device parameters copied to the Memory Card are downloaded to the connected device.	3-5
		Replace Device	Device parameters uploaded from the connected device are downloaded after replacing the device. This function cannot be used if a system error occurs due to a fatal hardware error in the device that is being replaced.	3-3
		Change Mode	Changes the operating mode of the connected device.	3-7
		Lock Unlock	Locks or unlocks the connected device.	3-8
		Reset	Resets the connected device.	3-6

	Icon	Function name	Description	Reference
Console Settings		Monitor Settings	Sets the time interval for refreshing data displayed by the monitor function.	2-2-1
		Brightness	The brightness of the screen can be selected from three levels	2-2-2
		Memory Card Format	This function is used to format a Memory Card.	2-2-3
		Date/Time	This function is used to set the date and time.	2-2-4
		Stylus	This function is used to set the double-tap speed and to calibrate the touch screen.	2-2-5
		Power Management	This function is used to set the power saving features.	2-2-6
		Language	This function is used to set the language used by the Mobile Console.	2-2-7
		Version	Displays the Mobile Console version information.	2-2-8

Note Refer to 3-2-6 *Saving the Screen Image* for information on saving the screen image showing monitor results (Fn + F2 Keys).

2-2 Console Settings

Set the Mobile Console using the functions on pages 3 and 4 of the Main Window.

2-2-1 Setting the Monitor Refresh Time

Set the monitor refresh timer value for the data acquired by the monitor function.

- 1,2,3... 1. Tap the **Monitor Settings** Icon in the Main Window (3/4).

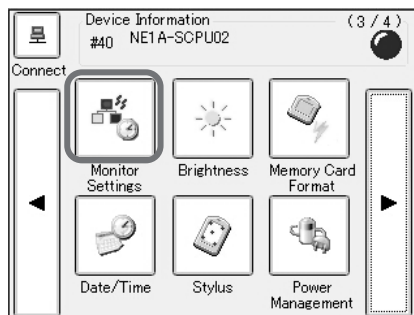

The following dialog box will be displayed.

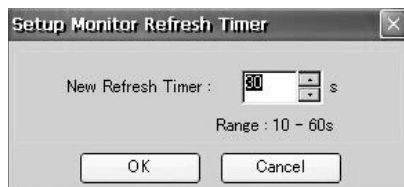

2. Set the new refresh timer value and tap the **OK** Button.
The new setting will be applied and the display will return to the Main Window.

2-2-2 Adjusting the Brightness

The brightness of the screen can be adjusted to one of three levels.

- 1,2,3... 1. Tap the **Brightness** Icon in the Main Window (3/4).

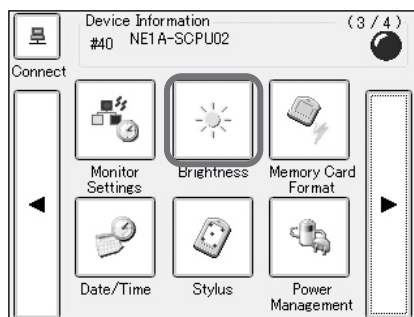

The following dialog box will be displayed.

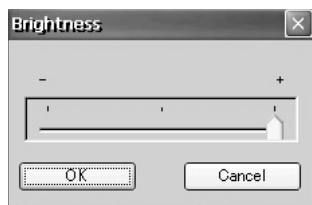

2. Move the pointer on the brightness scale with the stylus to adjust the brightness.
3. Tap the **OK** Button.
The setting will be applied and the display will return to the Main Window.

2-2-3 Formatting the Memory Card

The Memory Card can be formatted.

- 1,2,3...**
1. Insert the Memory Card to be formatted into the Mobile Console.
 2. Tap the **Memory Card Format** Icon in the Main Window (3/4).

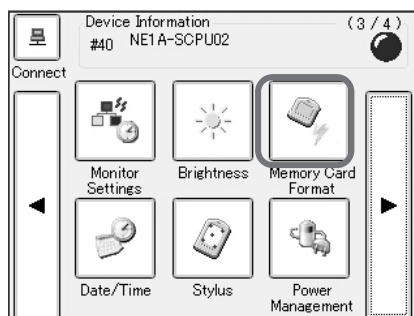

The following dialog box will be displayed.

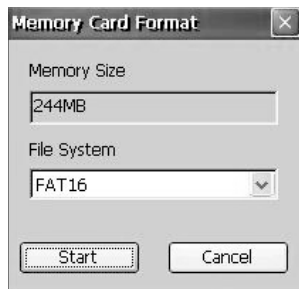

3. After selecting the file system, tap the **Start** Button.
A confirmation dialog box will be displayed.
4. Tap the **Yes** Button.
Formatting will start. When formatting the Memory Card has been completed, the following dialog box will be displayed.



5. Tap the **OK** Button.
The display will return to the Memory Card Format Dialog Box.
6. If you are finished formatting Memory Cards, tap the **Cancel** Button.

The display will return to the Main Window.

Note To format another Memory Card, insert the Memory Card and repeat the above procedure from step 3.

IMPORTANT All of the data will be deleted from the Memory Card when you format it. Be sure to copy any required data to a computer before you format the Memory Card.

2-2-4 Setting the Date and Time

Set the current date, time, and time zone.

Make sure that the date and time settings are correct because the file names of the screen images captured by the print screen function will consist of date and time stamps.

- 1,2,3... 1. Tap the **Date/Time** Icon in the Main Window (3/4).

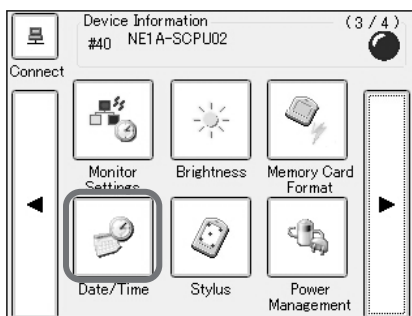

The following dialog box will be displayed.

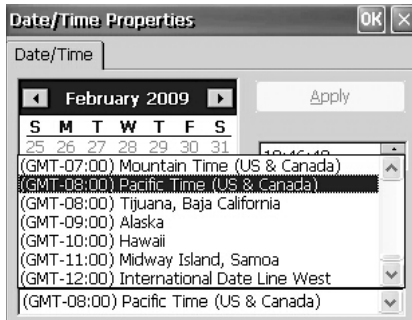

2. Set the current date, time, and time zone.
 3. Tap the **OK** Button.

The settings will be applied and the display will return to the Main Window.

2-2-5 Setting the Stylus Properties

This function is used to set the double-tap speed and calibrate the touch screen.

- 1,2,3... 1. Tap the **Stylus** Icon in the Main Window (3/4).

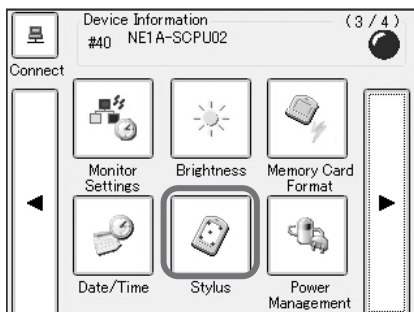

The following dialog box will be displayed.

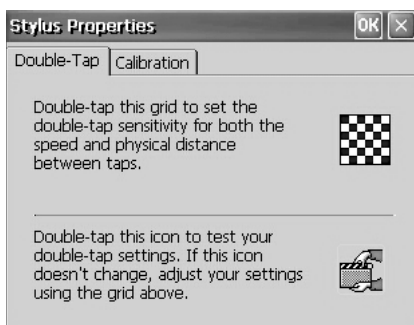

2. Double-tap the checkerboard to set the double-tap speed, then double-tap the icon at the bottom right of the dialog box to test the settings.
3. To calibrate the touch screen, tap the **Calibration** Tab.



4. Tap the **Recalibrate** Button and follow the instructions that are displayed on the screen.

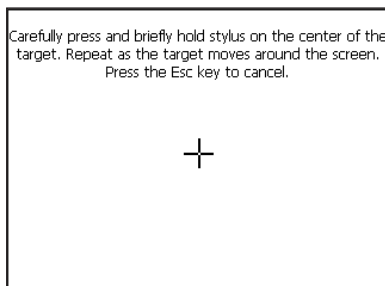

When the instructions have been completed, the following display will appear.

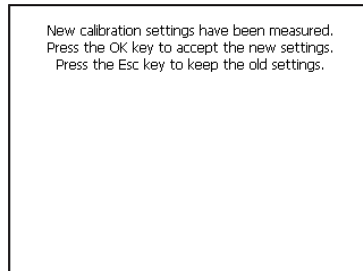

5. Press the **OK** Key or tap the screen. The settings will be applied and the display will return to the Stylus Properties Dialog Box.

2-2-6 Power Management Settings

The following parameters can be adjusted to reduce the energy consumed by the Mobile Console.

- Time until backlight is turned OFF.
- Time from when the backlight turns OFF until entering Suspended Mode.
- Time from entering Suspended Mode until entering Deep Sleep Mode.

1,2,3...

1. Touch the **Power Management** Icon in the Main Window (3/4).

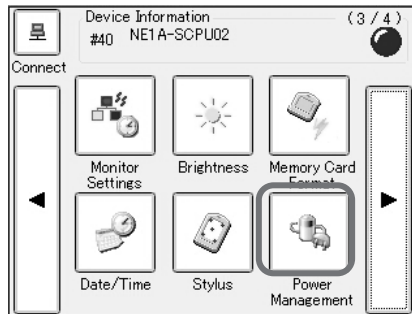

The following dialog box will be displayed.



2. Set the time until turning OFF the backlight, the time from turning OFF the backlight until entering Suspended Mode, and the time from entering Suspended Mode until entering Deep Sleep Mode.
3. Tap the **OK** Button. The settings will be applied and the display will return to the Main Window.

2-2-7 Language Settings

Select the language used for the display on the Mobile Console. Japanese or English can be selected.

- 1,2,3... 1. Tap the **Language** Icon in the Main Window (4/4).

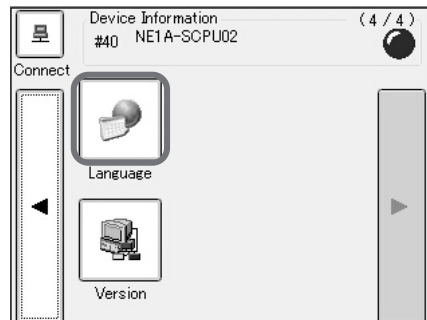

The following dialog box will be displayed.

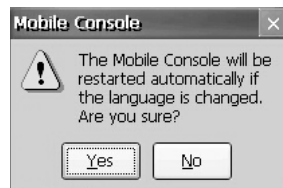

2. Tap the **Yes** Button.



3. Select the desired language and tap the **OK** Button.

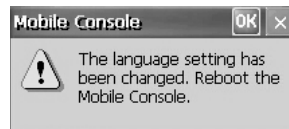

4. Tap the **OK** Button.

The setting will be applied when the Mobile Console is restarted. The display will return to the Main Window.

2-2-8 Displaying the Version Information

Version information for the Mobile Console can be displayed.

- 1,2,3... 1. Tap the **Version** Icon in the Main Window (4/4).

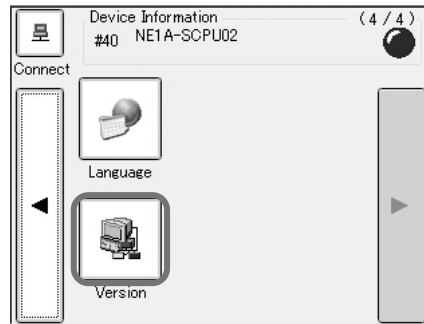

The version information will be displayed.

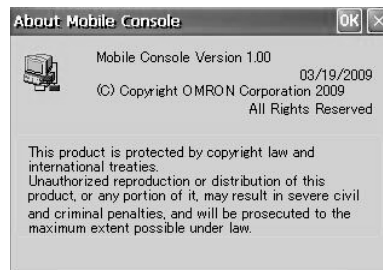

2. Tap the **OK** Button.
The display will return to the Main Window.

SECTION 3

Online Operations

This section describes how to read device information, replace devices, and otherwise perform device operations online.

3-1	Basic Online Operations	38
3-1-1	Connecting the Mobile Console	38
3-1-2	Specifying Network Numbers	38
3-1-3	Changing the Connected Device.	40
3-1-4	Inputting Characters	41
3-2	Reading Device Information	42
3-2-1	Overview.	42
3-2-2	Reading Parameters	43
3-2-3	Reading Device Status, Alarms, and Warning Information	44
3-2-4	Reading the Error History.	46
3-2-5	Displaying Properties	47
3-2-6	Saving the Screen Image	48
3-3	Replacing a Device	49
3-4	Uploading Parameters	52
3-5	Downloading Parameters	54
3-5-1	Creating Device Parameter Files	54
3-5-2	Downloading the File	54
3-6	Resetting a Device.	58
3-6-1	Reset Types	58
3-6-2	Resetting a Device	59
3-7	Changing the Mode	60
3-8	Locking/Unlocking Devices	61

3-1 Basic Online Operations

This section describes the procedure for online operations. Make sure that you read through the material before performing online operations.

3-1-1 Connecting the Mobile Console

The Mobile Console can be used by connecting it to the USB port on an NEOA/NE1A-series Controller.

When the Mobile Console is connected to the USB port of an NEOA/NE1A-series Controller, the following Main Window will be displayed. The device status will be displayed in the Main Window.

Connect Icon

Tap the **Connect** Icon when the Mobile Console is reconnected to the USB port of a different NEOA/NE1A-series Controller.

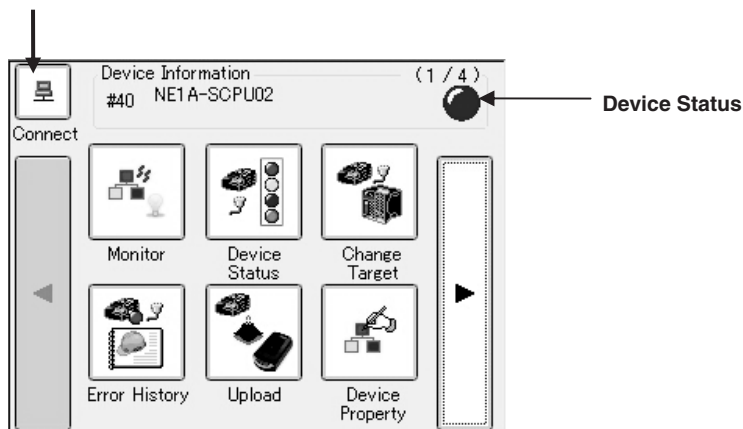

Note If the USB cable is removed and reconnected to a different NEOA/NE1A-series Controller after the Mobile Console has been connected online, tap the **Connect** Icon.

Device Status

The device status is indicated by the following colors.

Color	Status
Blue	RUN
Green	IDLE
Yellow	Warning
Red	Alarm
Gray with white border	Disconnected
Gray with green border	Default status (not configured)

3-1-2 Specifying Network Numbers

DeviceNet Safety supports building more than one network. Even if the user system contains only one network, a network number must be set.

For the Mobile Console to communicate with a device in the following cases, the network number must be specified.

- To connect to a device that is still in the default status, e.g., when replacing a device
- When resetting a device to the default status from the Mobile Console

The procedure for specifying the network number when connecting to a device in the default status is given below.

- 1,2,3... 1. Physically connect to the device in the default status and tap the **Connect** Button.



The following dialog box will be displayed.

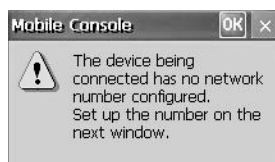

2. Tap the **OK** Button. The following dialog box will be displayed.

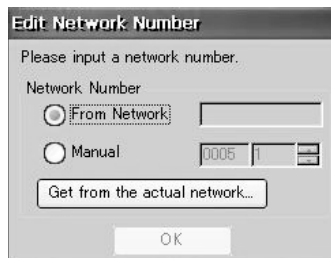

3. Tap the **Get from the actual network** Button.

When the network number is acquired from the network, it will be displayed as shown below.

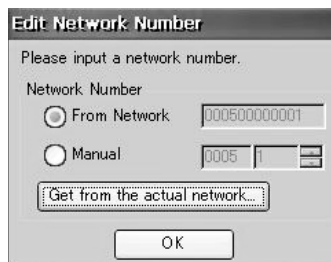

4. Tap the **OK** Button.
This completes specifying the network number. The Main Window will be displayed.

IMPORTANT Turn ON the DeviceNet network power supply before getting the network number from the network. If there is more than one network number of the same network, confirm the correct number and select it.

Note (1) If a manually set network number is read from the network, it will be displayed with zeros from the 5th to the 8th digit as shown below.

Example: 000500000001

- (2) If the network number was set manually and you know the number, you can also set it manually.

Confirming the Network Number from the Network Configurator

The network number set in the user's system can be confirmed with the following procedure.

- 1,2,3...**
1. From the Network Configurator, open the network configuration file (*.ncf) that was downloaded to the system.
 2. Select **Network - Properties** from the menu bar.

The following dialog box will be displayed.

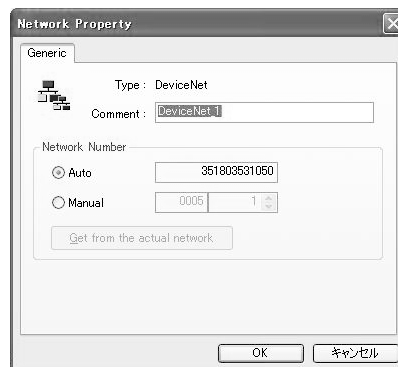

3. Check the network number that is displayed.

3-1-3 Changing the Connected Device

This section describes how to change the connected device. You can connect online to any device connected to the same DeviceNet network as the NE0A/NE1A Controller to which the USB cable is connected. The Mobile Console can be connected to devices that are on the same DeviceNet network as the NE0A/NE1A-series Controller connected with the USB cable.

- 1,2,3...**
1. Tap the **Change Target** Icon in the Main Window (1/4 or 2/4).

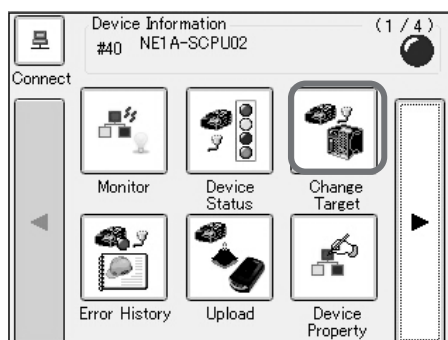

The following dialog box will be displayed. Devices on the same DeviceNet network as the NE0A/NE1A-series Controller connected with the USB cable will be displayed.

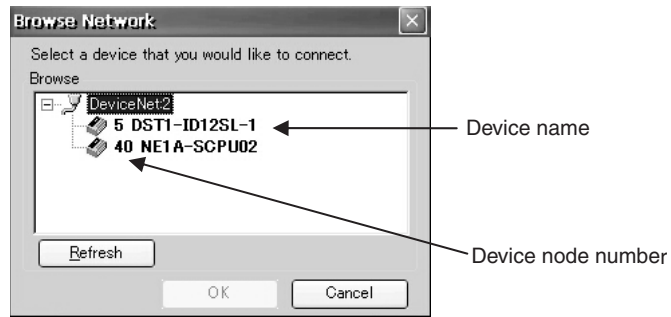

- 2. Select the device that you would like to connect to and tap the **OK** Button. The target device will be changed and the display will return to the Main Window.

3-1-4 Inputting Characters

Characters for file names and passwords can be entered easily by tapping the input panel with the stylus.

Example: Save Device Parameter Dialog Box

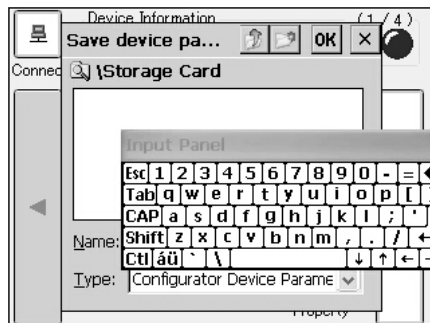





Characters can also be input using keys on the Mobile Console.

3-2 Reading Device Information

3-2-1 Overview

The following information can be read from the device using the Mobile Console.

Icon	Function name	Description
	Monitor	Displays the connected device's I/O terminal status. Errors occurring at the connected device will be displayed on the Maintenance Tab Page. (See note 1.)
	Device Status	Displays the device status as well as information on alarms and warnings. Errors occurring at the connected device will be displayed on the Maintenance Tab Page. (See note 1.)
	Error History	Displays the error history of the connected device. Errors occurring at the connected device will be displayed on the Maintenance Tab Page. (See note 1.)
	Device Property	Displays the properties of the connected device.

- Note**
- (1) The contents of the **Maintenance** Tab for the Monitor, Device Status, and Error History functions are the same. The items displayed will depend on the connected device.
 - (2) The device status will be displayed as an icon in the Main Window when a device is online. (Refer to *3-1-1 Connecting the Mobile Console*.)
 - (3) The screen displaying the device information can be converted to a JPEG image file and saved to the Memory Card. (Refer to *3-2-6 Saving the Screen Image*.)

Procedure

- 1,2,3...**
1. Connect the Mobile Console to the USB port of the NE0A/NE1A-series Controller.
 2. Tap the **Change Target** Icon and specify the device to be monitored.
 3. Tap the **Monitor, Device Status, Error History, or Device Property** Icon to read the device information.

- Note** The device information (parameters and errors) depends on the device that is connected. Refer to the device manual for details on parameters and errors.

3-2-2 Reading Parameters

The status of the I/O terminals on an NE0A/NE1A-series or DST1-series Controller can be monitored. Monitoring the status can help in troubleshooting errors occurring at the I/O terminals. The displayed parameters will depend on the device that is connected. Refer to the device manual for details on parameters.

- 1,2,3... 1. Tap the **Monitor** Icon in the Main Window (1/4).

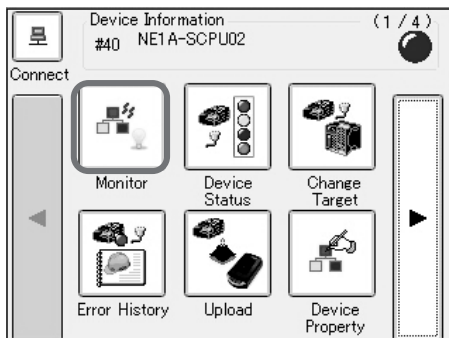

The current status of the I/O terminals will be displayed on the Parameters Tab Page.

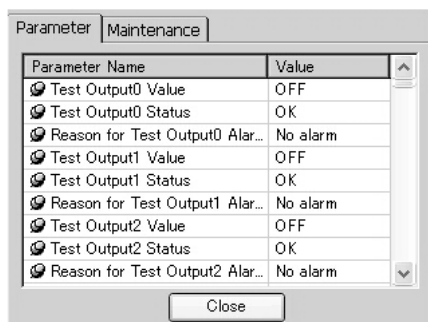

2. Tap the **Maintenance** Tab.

If an error exists in the connected device, the following will be displayed.

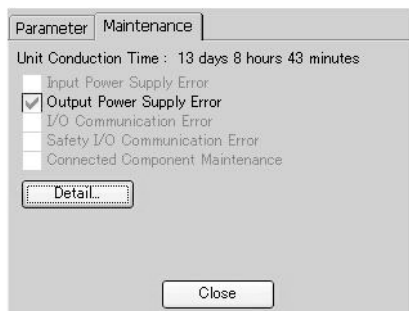

- Tap the **Detail** Button. The maintenance counter present values for local input terminals, local output terminals, and test output terminals will be displayed as shown below.

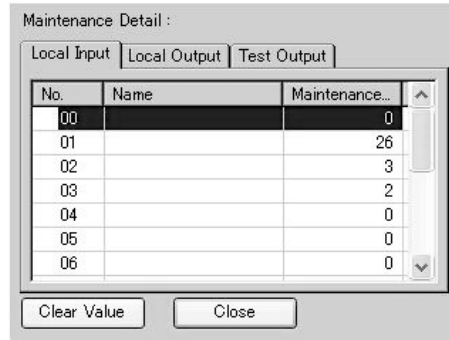

- Tap the **Clear Value** Button to reset the terminal maintenance counters to 0.

3-2-3 Reading Device Status, Alarms, and Warning Information

The status of the connected device as well as information on alarms and warnings can be displayed. The displayed parameters depend on the device that is connected.

- 1,2,3... 1. Tap the **Device Status** Icon in the Main Window (1/4).

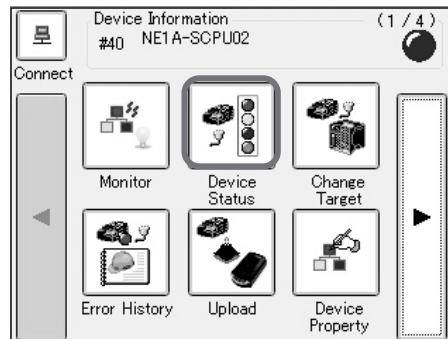



The following dialog box will be displayed on the Status Tab Page. The device status, as well as current alarms and warnings, will be displayed.

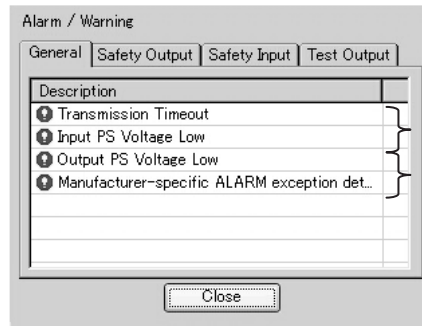

- Tap the **Detail** Button to display details on current alarms and warnings as shown below.



Error information will be displayed in pairs.

- Tap the Detail Button to identify the error. The  icon will be displayed for alarms and the  icon for warnings.
 - The Detail of Alarm/Warning Dialog Box has the following tab pages: General, Safety Output, Safety Input, and Test Output.
The General Tab Page displays the current errors.
The other tab pages display errors occurring at the output terminals, the input terminals, and the test output terminals.
2. Tap the **Maintenance** Tab.

- Current errors in the device will be displayed as shown below.

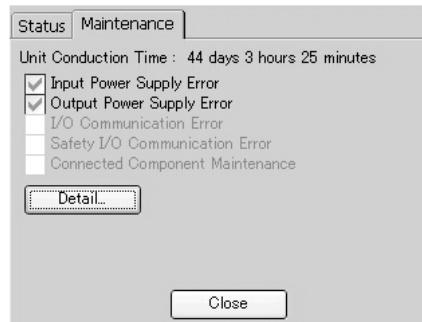

- Refer to 3-2-2 Reading Parameters for details on the Maintenance Tab Page.

3-2-4 Reading the Error History

The error history of the NE0A/NE1A-series or DST1-series Controller can be displayed. The number of records that can be saved depends on the device. Some errors are not deleted even if power supply is interrupted because they are saved in nonvolatile memory. Other errors are deleted when the power supply is interrupted because they are saved in the RAM. Refer to the device manual for details.

- 1,2,3... 1. Tap the **Error History** Icon in the Main Window (1/4).

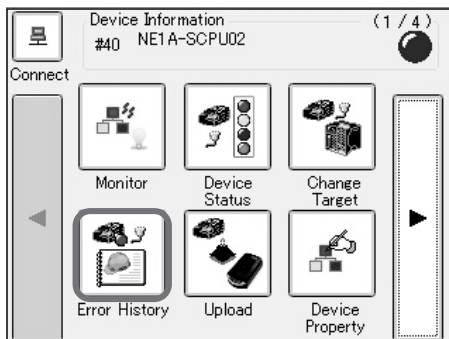

The following dialog box with the device error history will be displayed.

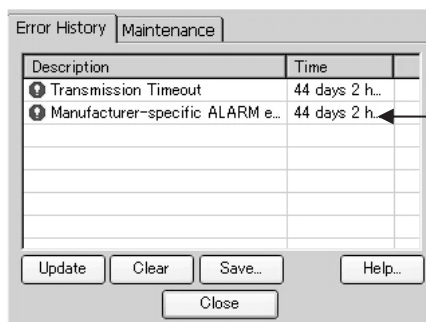

Double-tap an error (or select the error and tap the **Help** Button) to display the countermeasures.

Example of Countermeasures:

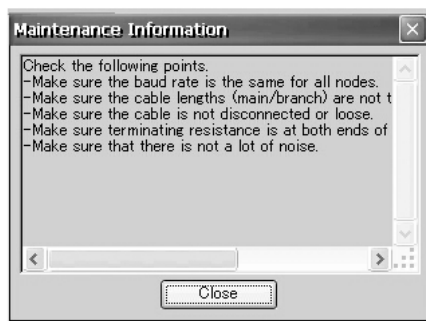

Item or Button	Description
Description	Gives the error.
Time	Displays the total ON time of the device when the error occurred. The display will always be 0 for a DST1-series Controller.
Update Button	Updates the error history.
Clear Button	Deletes the error history saved in the device.

Item or Button	Description
Save Button	Saves the error history information to the Memory Card in CSV format.
Help Button	Select an error and tap the Help Button to display the counter-measures.

2. Tap the **Maintenance** Tab.

Current errors in the connected device will be displayed as shown below.

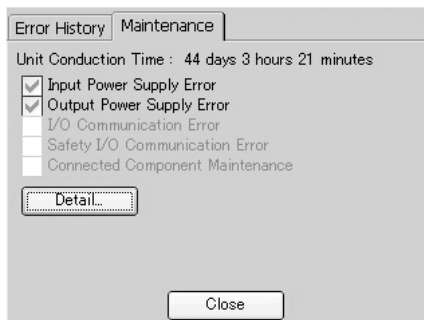

- Refer to 3-2-2 Reading Parameters for details on the Maintenance Tab Page.

3-2-5 Displaying Properties

The device information and safety signature of the connected device can be displayed.

1,2,3... 1. Tap the **Display Property** Icon in the Main Window (1/4).

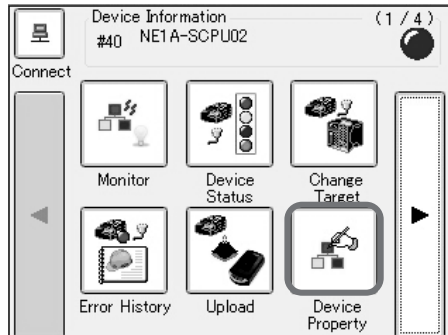

The device information and safety signature of the connected device will be displayed.



3-2-6 Saving the Screen Image

The screen that displays the device information can be converted to an image file in JPEG format and saved to the Memory Card.

1,2,3...

1. Press the **Fn** Key and **F2** Key together.

An image file with the date (YMD) and time (HMS) as the file name will be saved to the Memory Card (example: 20090121144005.jpg)

- If the screen is saved correctly, the file name and a message indicating that the save was completed will be displayed.
- If a Memory Card is not inserted, the message "Cannot find the save location" will be displayed.

IMPORTANT The Mobile Console cannot access image files saved on the Memory Card. Use a computer to access the image files.

3-3 Replacing a Device

Devices can be easily replaced using the Replace Device function.

IMPORTANT If a system error occurs due to a hardware error or other fatal error in the device that is being replaced, “H” will be displayed on the leftmost digit of the 7-segment display on an NE1A-series Controller or the MS indicator will light red on an NE0A-SCPU01 or DST1-series Controller. If that occurs, the Replace Device function cannot be used, but you can use the download function to download the device parameters to the new device. Refer to *3-5 Downloading Parameters* for information on downloading.

IMPORTANT Before replacing a device using the Replace Device function, be sure that the Safety Device configuration data of the user system had been validated or locked. If the Replace Device function is used for a device that is not validated or locked, the system may not operate properly with the replaced device. Refer to *3-5-1 Creating Device Parameter Files* for information on validating and locking devices.

- 1,2,3...**
1. Connect the Mobile Console to the device to be replaced.
 2. Tap the **Replace Device** Icon in the Main Window.

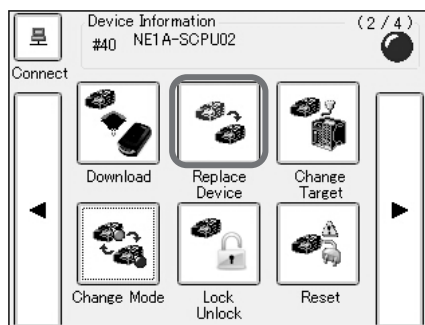

The following dialog box will be displayed.

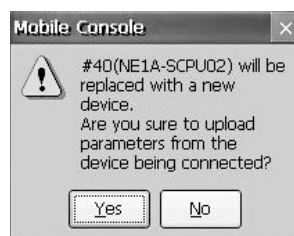

3. Tap the **Yes** Button.
Parameters will be uploaded from the connected device.
 - If you tap the **No** Button, the operation will be stopped and the display will return to the Main Window.

The following dialog box will be displayed when upload has been completed.



IMPORTANT When replacing a device, replace it with a device that is in the factory-default status. The operation may not be performed correctly if a device is replaced with a configured device.

4. After replacing the device, tap the **Yes** Button.
 - If the Mobile Console is connected directly to a device via a USB cable, remove the USB cable and replace the device. Connect the USB cable to the new device and tap the **Yes** Button.



5. Check the safety signature of the device parameters to be downloaded and tap the **Close** Button.

The following dialog box will be displayed if the configuration is locked.



6. Tap the **Yes** Button.

The password input dialog box will be displayed.



7. Enter the password of the connected device.

Downloading will begin. When it has been completed, the safety signature read from the connected device will be displayed.



8. Check the safety signature and tap the **Close** Button.

A dialog box asking whether to lock the device configuration will be displayed.



9. To lock the configuration, tap the **Yes** Button.

If the device was in RUN mode before being replaced, the following dialog box will be displayed.

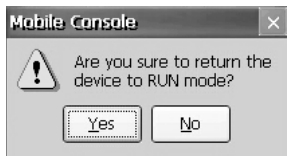

10. Tap the **Yes** Button or the **No** Button.

- Tapping the **Yes** Button will set the device to RUN mode.
- Tapping the **No** Button will keep the device in IDLE mode.



11. Tap the **OK** Button.

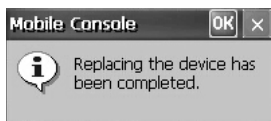

This completes replacing the device.

12. Tap the **OK** Button.

The display will return to the Main Window.

IMPORTANT A device password cannot be set with the Mobile Console. Set the device password from the Network Configurator.

Note Devices can also be replaced in the same way by using the following procedure: Upload the parameters and save them to a file, replace the device, download the parameters, and then lock/unlock the configuration.

WARNING	
<p>Serious personal injury may possibly occur due to loss of safety functions. Observe the following precautions.</p> <p>After replacing a device, check to make sure that the replacement device is in the appropriate configuration and is operating correctly</p>	

3-4 Uploading Parameters

Parameter information of the connected device can be saved to a Memory Card.

- 1,2,3...
1. Set the Memory Card in the Mobile Console.
 2. Tap the **Upload** Icon in the Main Window (1/4).

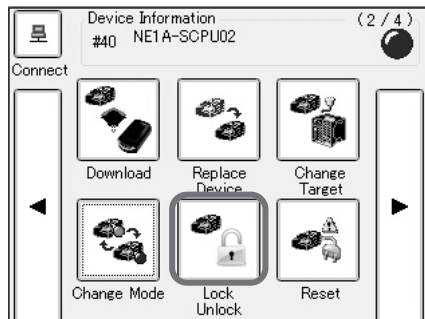

The following dialog box will be displayed.



3. Tap the **Yes** Button.
 - Tapping the **No** Button will cancel uploading.

When uploading the device parameters has been completed, the Save Device Parameter Dialog Box will be displayed. The file name will be automatically input as shown in the following figure.

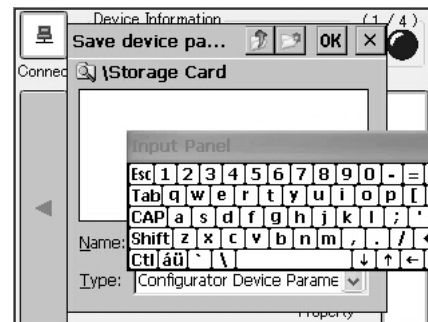
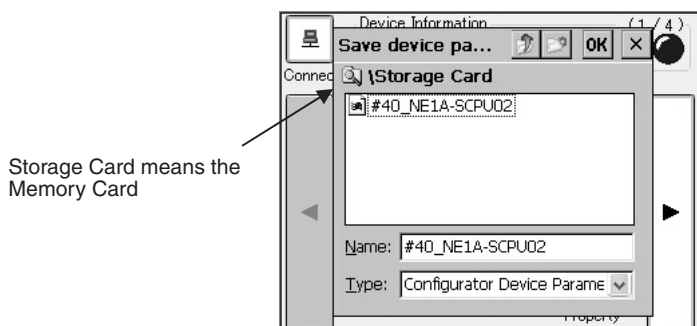

4. Check the location and file name for saving the file, and then tap the **OK** Button.
 - Use the input panel or keys on the Mobile Console to change the file name if necessary.
 - The following dialog box will be displayed if no Memory Card is inserted. Insert the Memory Card and tap the **OK** Button.

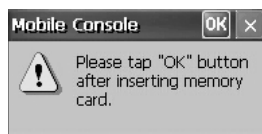

IMPORTANT Always specify the Memory Card folder as the save folder. The file cannot be deleted or copied if it is saved in Mobile Console memory.

When saving the file has been completed, the safety signature of the uploaded device parameters will be displayed.

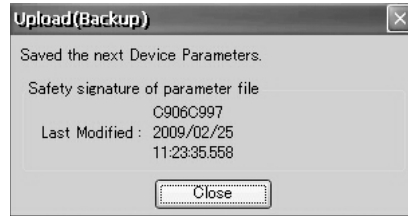

5. Check the safety signature and tap the **Close** Button. The display will return to the Main Window.

3-5 Downloading Parameters

Parameter information saved in the Memory Card can be downloaded to the device that is connected online.

3-5-1 Creating Device Parameter Files

The device parameter files downloaded from the Mobile Console to a device (*.dvf) are created on the Network Configurator.

- 1,2,3...
1. Start the Network Configurator and open the network configuration file (*.ncf).
 2. Confirm that the configuration for the device to which the parameter will be downloaded has been verified or locked (an S mark or locked mark will be displayed).

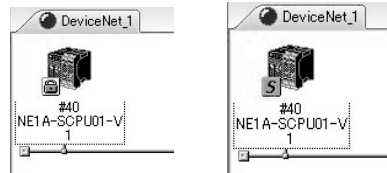

IMPORTANT The device parameter file (*.dvf) used by the Mobile Console is created from a network configuration file (*.ncf) that has been verified or locked. The system may not operate properly if the file is not verified or locked.

3. Select the device and then select **Device - Parameters - Save** from the menu bar.

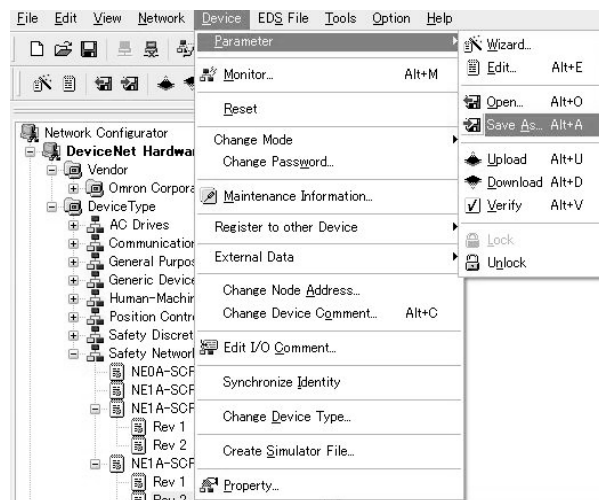

4. A device parameter file will be created in the specified folder.

3-5-2 Downloading the File

Use the following procedure to download the device parameter file (*.dvf) from the Mobile Console to a device.

- 1,2,3...
1. Save the device parameter file on a Memory Card and set the Memory Card in the Mobile Console.
 2. Tap the **Download** Icon in the Main Window (2/4).

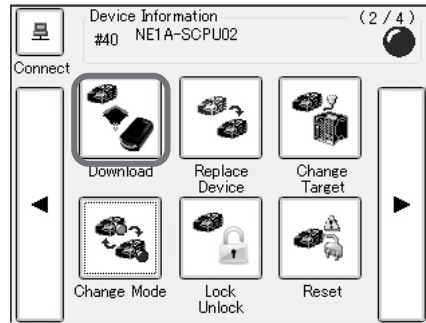

The following dialog box will be displayed.

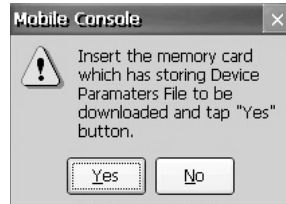

3. Tap the **Yes** Button.
 - Tapping the **No** Button will cancel downloading.

The Open Device Parameter Dialog Box will be displayed.

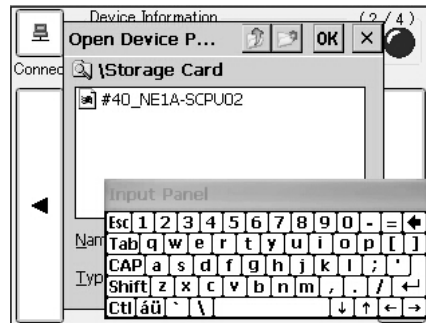

4. Specify the location and name of the file to be downloaded. Tap the **OK** Button on the top right of the dialog box.

The safety signature of the file to be downloaded will be displayed.



5. Check the safety signature and tap the **Close** Button.

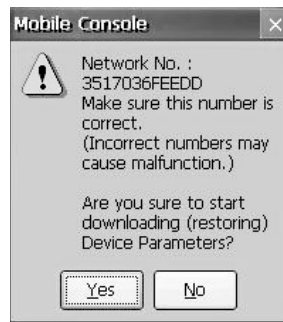

IMPORTANT Always confirm that the network number is correct. Operation may not be correct if the device is configured with the wrong network number.

6. Check the network number and tap the **Yes** Button.
If the device is locked, the following dialog box will be displayed.



7. Tap the **Yes** Button.
A dialog box prompting the input of a password will be displayed.



8. Enter the password of the connected device and tap the **OK** Button.
Downloading will begin. When it has been completed, the safety signature read from the connected device will be displayed.



9. Check the safety signature and tap the **Close** Button.
A dialog box asking whether to lock the device configuration will be displayed.



10. To lock the configuration, tap the **Yes** Button. If the device was in RUN mode before downloading, the following dialog box will be displayed asking whether the device should be returned to RUN mode.



11. Tap the **Yes** Button or the **No** Button.
 - Tap the **Yes** Button to return to RUN mode.
 - Tap the **No** Button to leave the device in IDLE mode.

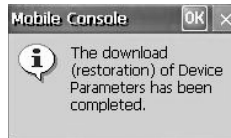

12. Tap the **OK** Button.
The display will return to the Main Window.

IMPORTANT A device password cannot be set with the Mobile Console. Set the device password from the Network Configurator.

WARNING	
<p>Serious personal injury may possibly occur due to loss of safety functions. Observe the following precautions.</p> <p>Perform a user test before operating the system, and check to make sure that all the device configuration data and operations are correct.</p> <p>After replacing a device, check to make sure that the replacement device is in the appropriate configuration and is operating correctly</p>	

3-6 Resetting a Device

This section describes how to reset a Safety Device.

3-6-1 Reset Types

The following three methods can be used to reset a Safety Device.

Reset type	Description
Reboot	This is the same as turning the power OFF and ON.
Reboot and reset configuration	All configuration information saved in the device's nonvolatile memory will be returned to the default values and the device will be restarted.
Reboot and reset configuration without specified items	All configuration information in the device's nonvolatile memory other than specified items will be returned to the default values and the device will be restarted.

The Safety Device saves the following configuration information in nonvolatile memory.

Type	Default setting	Set when	Description
Node address (software setting)	63	Node address is changed.	The node address at startup when software settings are enabled.
Baud rate (software setting)	125 Kbit/s	Baud rate is changed	The baud rate at startup when the software settings are enabled (NE1A-series Controller only).
TUNID (Target Unique Node Identifier)	Not set	First time parameters are downloaded.	The identifier of the local node in the Safety Network consisting of the network number and node address.
Password	No password	Password is changed.	The password for the device.
CFUNID (Configuration Owing UNID)	Not set	First time parameters are downloaded.	The UNID of the configuration source.
OCPUNID (Output Connection Point Owing UNID)	Not set	First time safety communications are started.	The UNID of the Safety Master that opens a safety output connection.

The information above is saved in nonvolatile memory in the device. It will not be cleared by restarting the power supply. To clear the information (to return to the default settings), select the *Reboot and reset configuration* or *Reboot and reset configuration without ...* Option when resetting.

3-6-2 Resetting a Device

Use the following procedure to reset a device.

- 1,2,3... 1. Tap the **Reset** Icon in the Main Window (2/4).

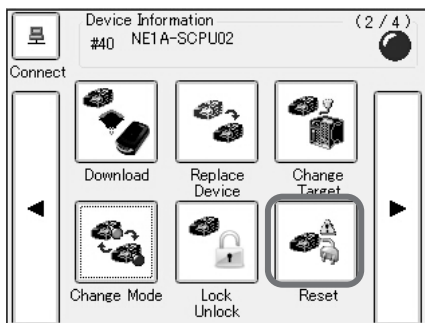

The following dialog box will be displayed.

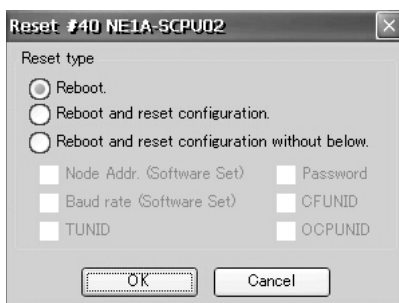

2. Select the reset type and tap the **OK** Button.

The device password input dialog box will be displayed.

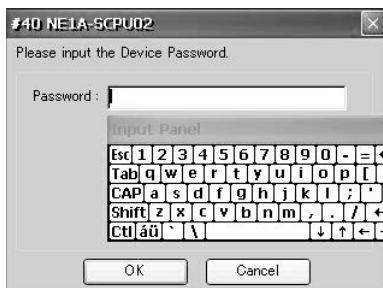

3. Enter the password of the connected device and tap the **OK** Button.
 4. If the connected device is locked, follow the instructions displayed on the screen and enter the password. Tap the **OK** Button.
 After resetting, the display will return to the Main Window.

IMPORTANT A device password cannot be set with the Mobile Console. To not reset the password, select the *Reboot and reset configuration without below* Option and select the Password Check Box before resetting.

- Note**
- (1) The network number must be specified to reset the configuration to the default settings. Refer to 3-1-2 *Specifying Network Numbers* for information on specifying the network number.
 - (2) Depending on the reset type and device status, it may not be possible to reset. Refer to the manual for the connected device for reset types and device status.

3-7 Changing the Mode

This section describes how to change the mode of the Safety Device.

- 1,2,3... 1. Tap the **Change Mode** Icon in the Main Window (2/4).

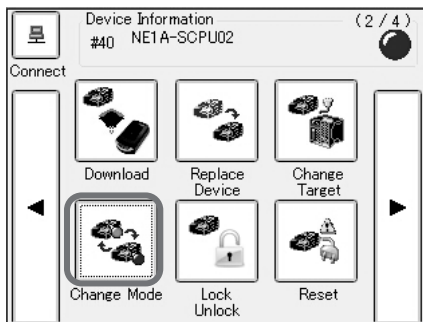

The following dialog box will be displayed.

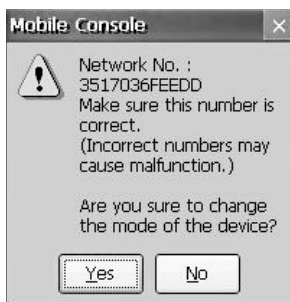

IMPORTANT Always confirm that the network number is correct. Operation may not be correct if the device is configured with the wrong network number.

2. Check the network number and then tap the **Yes** Button.

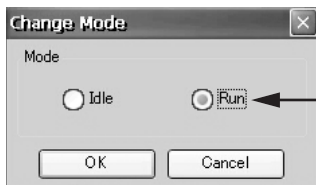

The option for the current mode will be selected. If no option is selected, the current mode is neither Idle nor Run.

3. Select the mode and tap the **OK** Button.
The device password input dialog box will be displayed.



4. Enter the password of the connected device and tap the **OK** Button.
After the mode is changed, the display will return to the Main Window.

Note The mode cannot be changed for a DST1-series Controller.

3-8 Locking/Unlocking Devices

The connected device can be locked or unlocked.

IMPORTANT Lock the device only after performing user testing to validate the Safety Functions for verified device configuration data.

- 1,2,3... 1. Tap the **Lock/Unlock** Icon in the Main Window (2/4).

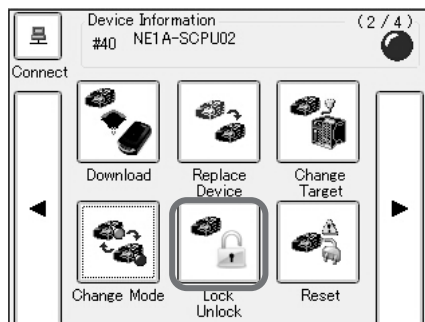

Uploading parameters from the connected device will be started.

The following dialog box will be displayed when the upload has been completed.



Note This dialog box will not be displayed if the device is not locked.

2. Check the safety signature of the device to be locked or unlocked, and then tap the **Close** Button.

One of the following dialog boxes will be displayed.

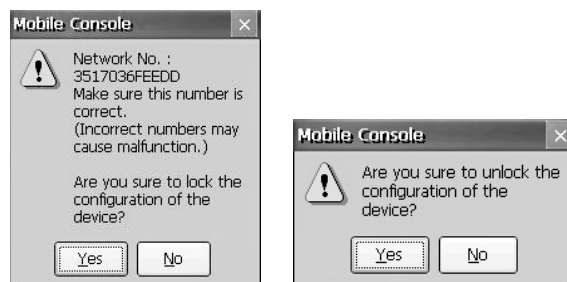

- Make sure that the network number is correct before locking a device.

IMPORTANT Always confirm that the network number is correct. Operation may not be correct if the device is configured with the wrong network number.

3. Tap the **Yes** Button or the **No** Button.

The device password input dialog box will be displayed to enable locking or unlocking the device.



4. Enter the password of the connected device and tap the **OK** Button. When completed, the display will return to the Main Window.

SECTION 4

Specifications

This section provides the ratings, specifications, and dimensions of the Mobile Console, Battery Pack, and Charger.

4-1	Mobile Console Ratings and Specifications	64
4-1-1	General Specifications	64
4-1-2	Performance Specifications	64
4-2	Battery Pack Ratings and Specifications.	65
4-2-1	General Specifications of the RB-B2001A Battery Pack.	65
4-3	Charger Ratings and Specifications	66
4-3-1	General Specifications of the RB-C2001 Charger	66
4-4	Dimensions	67
4-4-1	Mobile Console.	67
4-4-2	Charger	68
4-4-3	Battery Pack	68

4-1 Mobile Console Ratings and Specifications

4-1-1 General Specifications

Item	Specifications
Power supply	RB-B2001A Battery Pack
Operating temperature	0 to 45°C
Storage temperature	-10 to 60°C
Humidity	20% to 90% (with no condensation)
Vibration resistance	3.5 mm at 5 to 8.4 Hz, 9.8 m/s ² at 8.4 to 150 Hz
Shock resistance	196 m/s ² for 11 ms
Weight	0.36 kg max. without Battery Pack
Degree of protection	IP50 or equivalent (with Memory Card cover and connector caps or harness mounted)

4-1-2 Performance Specifications

Item		Specifications	
Display area	Display panel	Display device	3.5-inch TFT color LCD
		Number of pixels	320 × 240 dots
		Display color	65,536 colors
	Backlight	Service life (See note 1.)	50,000 hours (25°C)
		Brightness adjustment	The brightness can be adjusted by touch screen operation.
		Automatic OFF function	Yes (The set time can be changed.)
POWER indicator	Normal operation: Green Suspended mode: Not lit		
Operating section	Touch screen	Method	Resistive membrane
		Service life	10,000,000 operations (continuous keystroke input) 100,000 characters (continuous character input with stylus)
	Keyboard	26 keys	
USB interface		One USB 1.1 port	
Memory Card slot		1 slot The following OMRON Memory Cards are recommended: HMC-EF183 (128 Mbytes) HMC-EF283 (256 Mbytes) HMC-EF583 (512 Mbytes)	
Battery Pack service life (See note 2.)		300 charge/discharge cycles	
Continuous operating time (See note 3.)		6 hours	

- Note**
- (1) This is the estimated time before brightness is reduced by half at room temperature and humidity. It is provided for reference only. Lamp service life greatly depends on the ambient temperature. It is shortened at high or low temperatures, and is especially shortened in a low-temperature environment.
 - (2) This is the estimated time before the battery capacity drops below 60%. It is provided for reference only. The time depends on the operating temperature and other conditions.
 - (3) This is an estimated time. It is provided for reference only. The time depends on the operating temperature and other conditions.

4-2 Battery Pack Ratings and Specifications

4-2-1 General Specifications of the RB-B2001A Battery Pack

Item	Specifications
Battery type	Secondary lithium-ion battery
Nominal capacity	2000 mAh
Rated voltage	7.4 V
Operating temperature	0 to 45°C
Operating humidity	10% to 90% (with no condensation)
Charging method	Charge with the RB-C2001 Special Charger.
Charging time	3 hours (See note.)
Weight	0.11 kg max.

Note The charging time is an approximation and is provided only as a guideline. The actual time will depend on the operating environment, operating conditions, and the state of the battery.

4-3 Charger Ratings and Specifications

4-3-1 General Specifications of the RB-C2001 Charger

Item		Specifications
Operating voltage		100 to 240 VAC, 50/60 Hz
Charging specifications	Charging voltage/current	8.4 V/1 A
	Status indicators	LED indicators are used for the following status. <ul style="list-style-type: none"> • No battery or pre-charge: Not lit • Charging normal: Lit red • Charging complete: Lit green • Error detected: Flashing red
Ambient operating temperature		0 to 40°C
Ambient storage temperature		-20 to 60°C
Operating humidity		20% to 85% (with no condensation)
Weight		0.15 kg max.
Applicable laws and standards		<ul style="list-style-type: none"> • Electrical Appliance and Material Safety Law • UL 1310 • IEC 60950 • EN 55022 Class B

4-4 Dimensions

4-4-1 Mobile Console

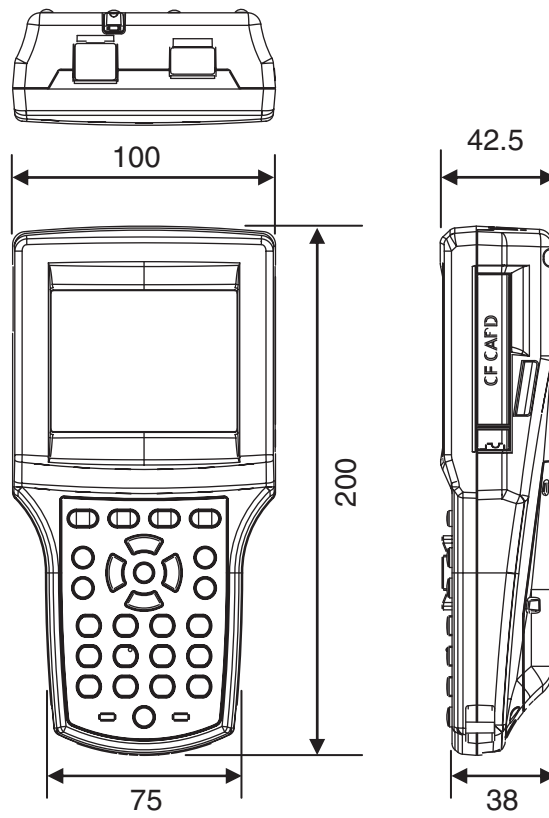

4-4-2 Charger

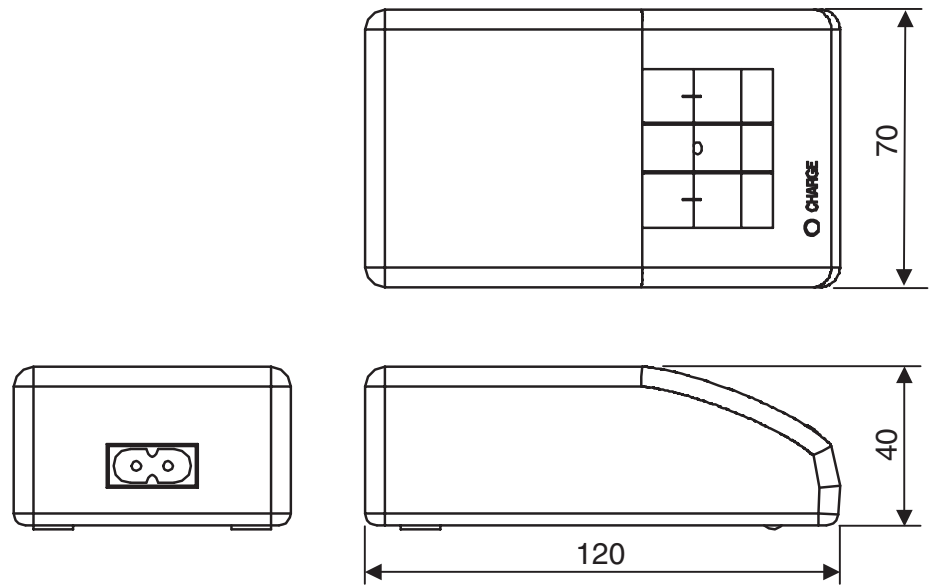

4-4-3 Battery Pack

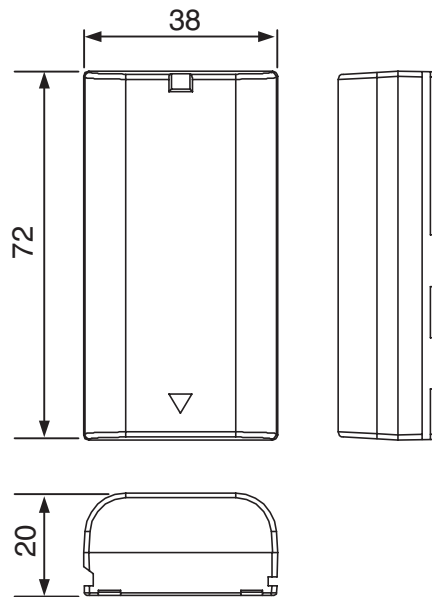

Index

A

alarms, 45

B

backlight, 33, 64
battery charge indicator, 7, 14
battery cover, 8, 15
battery holding time, 13
Battery Pack, xxii, 15, 65
Brightness Icon, 29

C

Calibration Tab, 32
Change Mode Icon, 60
Change Target Icon, 40
character keys, 9
charger, 17, 66
clock battery, 21, 22
clock battery cover, 8
control keys, 7, 9

D

Date/Time Icon, 31
Deep Sleep Mode, 13, 33
definition of terms, xxii
Device Status Icon, 44
dimensions, 67
display
 Connect Icon, 26
 Device Information, 26
 function menu, 26
 page, 26
Display Property Icon, 47
Double-Tap Tab, 32
Download Icon, 54

E

Error History Icon, 46

F

formatting, 30
function icons, 27
function keys, 10

G

general precautions, xvi

H

hand strap, 23

I

input panel, 41
inputting characters, 41

L

LAN port, 7, 12
Language Icon, 34
LCD panel, 7
LED indicators, 14
lock lever, 8, 15
Lock/Unlock Icon, 61
locking the configuration/device, xxiii

M

Main Window, 26
Maintenance Tab, 43
Memory Card, 19
Memory Card Format Icon, 30
Memory Card slot, 7
Mobile Console, xxii, 2, 64
Mobile Console functions, 4
Mobile Console settings, 29
Monitor Icon, 43
Monitor Settings Icon, 29

N

Network Configurator, xxii

network numbers, 38

O

online operations, 38

P

Parameters Tab, 43

Power Management Icon, 33

Power Mode Key, 9

power status indicator, 7, 14

power switch, 7, 13

precautions for safe use, xx

R

regulations, xxi

Remote I/O Terminal, xxiii

Replace Device Icon, 49

Reset Icon, 59

reset types, 58

S

safety, xxii

Safety I/O Terminal, xxiii

Safety Input device, xxiii

Safety Network Controller, xxiii

Safety Output device, xxiii

safety precautions, xviii

safety signature, xxiii

saving the screen image, 48

specifications, 64

Standard, xxii

Standard PLC, xxiii

Standard Programmable Controller, xxiii

standards, xxi

standby modes, 13

starting, 13

Status Tab, 44

stopping, 13

Storage Card, 52

strap, 23

strap hooks, 8, 23

stylus, 7, 11

stylus holder, 7, 11

Stylus Icon, 32

stylus properties, 32

Suspended Mode, 13, 33

T

time zone, 31

U

Upload Icon, 52

USB port, 7, 12

V

Version Icon, 35

W

warnings, 45

Revision History

The manual revision is indicated at the end of the Cat. No. printed at the lower left of back cover of the manual.

Cat. No. Z921-E1-01



Revision code

The following table outlines the changes made to the manual during each revision. Page numbers refer to the previous version.

Revision code	Date	Revised content
01	April 2009	Original production

OMRON Corporation
Industrial Automation Company

Safety Devices Division
Shiokoji Horikawa, Shimogyo-ku,
Kyoto, 600-8530 Japan
Tel: (81) 75-344-7093/Fax: (81) 75-344-8197

Regional Headquarters

OMRON EUROPE B.V.
Wegalaan 67-69-2132 JD Hoofddorp
The Netherlands
Tel: (31)2356-81-300/Fax: (31)2356-81-388

OMRON SCIENTIFIC TECHNOLOGIES INC.

6550 Dumbarton Circle, Fremont
CA 94555-3605 U.S.A.
Tel: (1) 510-608-3400/Fax: (1) 510-744-1442

OMRON ASIA PACIFIC PTE. LTD.

No. 438A Alexandra Road # 05-05/08 (Lobby 2),
Alexandra Technopark, Singapore 119967
Tel: (65) 6835-3011/Fax: (65) 6835-2711

OMRON (CHINA) CO., LTD.

Room 2211, Bank of China Tower,
200 Yin Cheng Zhong Road,
PuDong New Area, Shanghai, 200120, China
Tel: (86) 21-5037-2222/Fax: (86) 21-5037-2200

Authorized Distributor:

© OMRON Corporation 2009 All Rights Reserved.
In the interest of product improvement,
specifications are subject to change without notice.