

**DeviceNet Safety
NE0A Series**

Safety Network Controller

OPERATION MANUAL

OMRON

DeviceNet Safety
NE0A Series
Safety Network Controller
Operation Manual

Revised October 2022

Notice:

OMRON products are manufactured for use according to proper procedures by a qualified operator and only for the purposes described in this manual.

The following conventions are used to indicate and classify precautions in this manual. Always heed the information provided with them. Failure to heed precautions can result in injury to people or damage to property.



WARNING

Indicates a potentially hazardous situation which, if not avoided, will result in minor or moderate injury, or may result in serious injury or death. Additionally, there may be significant property damage.



Indicates general prohibitions for which there is no specific symbol.



Indicates general mandatory actions for which there is no specific symbol.

OMRON Product References

All OMRON products are capitalized in this manual. The word “Unit” is also capitalized when it refers to an OMRON product, regardless of whether or not it appears in the proper name of the product.

The abbreviation “PLC” means Programmable Controller. “PC” is used, however, in some Programming Device displays to mean Programmable Controller.

Visual Aids

The following headings appear in the left column of the manual to help you locate different types of information.

IMPORTANT Indicates important information on what to do or not to do to prevent failure to operation, malfunction, or undesirable effects on product performance.

Note Indicates information of particular interest for efficient and convenient operation of the product.

1,2,3... 1. Indicates lists of one sort or another, such as procedures, checklists, etc.

Trademarks and Copyrights

DeviceNet and DeviceNet Safety are registered trademarks of the Open DeviceNet Vendors Association.

Other product names and company names in this manual are trademarks or registered trademarks of their respective companies.

© **OMRON, 2008**

All rights reserved. No part of this publication may be reproduced, stored in a retrieval system, or transmitted, in any form, or by any means, mechanical, electronic, photocopying, recording, or otherwise, without the prior written permission of OMRON.

No patent liability is assumed with respect to the use of the information contained herein. Moreover, because OMRON is constantly striving to improve its high-quality products, the information contained in this manual is subject to change without notice. Every precaution has been taken in the preparation of this manual. Nevertheless, OMRON assumes no responsibility for errors or omissions. Neither is any liability assumed for damages resulting from the use of the information contained in this publication.

TABLE OF CONTENTS

PRECAUTIONS	xvii
1 Intended Audience	xviii
2 General Precautions	xviii
3 Safety Precautions	xx
4 Precautions for Safe Use	xxii
5 Additional Precautions According to ANSI/ISA 12.12.01	xxiv
6 Regulations and Standards	xxiv
7 Unit Versions of NE0A-series Controllers	xxv
SECTION 1	
Overview of the NE0A-series Safety Network Controllers.	1
1-1 About NE0A-series Safety Network Controllers	2
1-2 System Configuration	5
SECTION 2	
Nomenclature and Specifications	9
2-1 Nomenclature	10
2-2 Specifications	17
2-3 Local Safety I/O Functions	23
SECTION 3	
Response Performance	33
3-1 Start Time	34
3-2 Reaction Time	36
SECTION 4	
General Procedure	37
4-1 Overview of Procedure	38
SECTION 5	
Installation and Wiring	39
5-1 Installation	40
5-2 Wiring	43
SECTION 6	
Creating Configurations.	47
6-1 Overview	48
6-2 Creating a Virtual Network	49
6-3 Configuring NE0A-series Controllers	53
6-4 Descriptions of Logic Commands	66
6-5 Remote I/O Allocations	83
6-6 Saving Project Files	90

TABLE OF CONTENTS

SECTION 7

Connecting Online and Downloading	91
7-1 Overview	92
7-2 Connecting Online	93
7-3 Downloading to Devices	96
7-4 Verifying the Configuration	97
7-5 Uploading from Devices	98
7-6 Reset	99
7-7 Access Control with Password	100

SECTION 8

Operation and Operating Modes	101
8-1 NE0A-series Controller Operating Modes	102
8-2 Changing the Operating Mode	104
8-3 Configuration Lock and Automatic Operation	105
8-4 Changing the Configuration	107
8-5 Behavior for Power Supply Interruptions	108

SECTION 9

Monitoring	109
9-1 Monitoring Devices	110
9-2 Monitoring Safety Logic	114
9-3 Force-setting and Force-resetting Outputs	115
9-4 Maintenance Mode	118

SECTION 10

Safety Distributed Control Systems	125
10-1 Overview	126
10-2 Determining the System Configuration and Defining the System Parameters	127
10-3 Starting an NE0A-series Controller	130
10-4 Building the System	131

SECTION 11

Maintenance and Inspection	133
11-1 Inspection	134
11-2 NE0A-series Controller Replacement	135

TABLE OF CONTENTS

SECTION 12

Troubleshooting	137
12-1 Indicators and Error Processing.....	138
12-2 Troubleshooting with Error History	140
12-3 Troubleshooting by Monitoring Parameters	143
12-4 Online Operation Errors with USB Connection	146
12-5 Errors When Downloading	147
12-6 Errors When Resetting.....	149
12-7 Errors When Changing Modes	150

Appendices

A Application Templates	151
B DeviceNet Explicit Messages	167
C Installing the NE0A USB Port Driver	175
D Using the Password Recovery Tool	179
E Calculated Values of PFD and PFH	183

Glossary	185
-----------------------	------------

Index	189
--------------------	------------

Revision History	193
-------------------------------	------------

About this Manual:

This manual describes the installation and operation of the NE0A-series Safety Network Controller.

Please read this manual carefully and be sure you understand the information provided before attempting to install or operate an NE0A-series Controller. Be sure to read the precautions provided in the following section.

The following manuals provide information on the DeviceNet and DeviceNet Safety.

DeviceNet Safety NE0A Series Safety Network Controller Operation Manual (this manual) (Z916)

This manual describes the specifications, functions, and usage of the NE0A-series Safety Network Controllers.

DeviceNet Safety System Configuration Manual (Z905)

This manual explains how to configure the DeviceNet Safety system using the Network Configurator.

DeviceNet Safety NE1A Series Safety Network Controller Operation Manual (Z906)

This manual describes the specifications, functions, and usage of the NE1A-series Safety Network Controllers.

DeviceNet Safety DST1 Series Safety I/O Terminal Operation Manual (Z904)

This manual describes the DST1-series Slave models, specifications, functions, and application methods in detail.

DeviceNet Operation Manual (W267)

This manual describes the construction and connection of a DeviceNet network. It provides detailed information on the installation and specifications of cables, connectors, and other peripheral equipment used in the network, and on the supply of communications power. Obtain this manual and gain a firm understanding of its contents before using a DeviceNet system.



WARNING

Failure to read and understand the information provided in this manual may result in personal injury or death, damage to the product, or product failure. Please read each section in its entirety and be sure you understand the information provided in the section and related sections before attempting any of the procedures or operations given.

Read and Understand this Manual

Please read and understand this manual before using the product. Please consult your OMRON representative if you have any questions or comments.

Terms and Conditions Agreement

Warranty, Limitations of Liability

Warranties

● Exclusive Warranty

Omron's exclusive warranty is that the Products will be free from defects in materials and workmanship for a period of twelve months from the date of sale by Omron (or such other period expressed in writing by Omron). Omron disclaims all other warranties, express or implied.

● Limitations

OMRON MAKES NO WARRANTY OR REPRESENTATION, EXPRESS OR IMPLIED, ABOUT NON-INFRINGEMENT, MERCHANTABILITY OR FITNESS FOR A PARTICULAR PURPOSE OF THE PRODUCTS. BUYER ACKNOWLEDGES THAT IT ALONE HAS DETERMINED THAT THE PRODUCTS WILL SUITABLY MEET THE REQUIREMENTS OF THEIR INTENDED USE.

Omron further disclaims all warranties and responsibility of any type for claims or expenses based on infringement by the Products or otherwise of any intellectual property right.

● Buyer Remedy

Omron's sole obligation hereunder shall be, at Omron's election, to (i) replace (in the form originally shipped with Buyer responsible for labor charges for removal or replacement thereof) the non-complying Product, (ii) repair the non-complying Product, or (iii) repay or credit Buyer an amount equal to the purchase price of the non-complying Product; provided that in no event shall Omron be responsible for warranty, repair, indemnity or any other claims or expenses regarding the Products unless Omron's analysis confirms that the Products were properly handled, stored, installed and maintained and not subject to contamination, abuse, misuse or inappropriate modification. Return of any Products by Buyer must be approved in writing by Omron before shipment. Omron Companies shall not be liable for the suitability or unsuitability or the results from the use of Products in combination with any electrical or electronic components, circuits, system assemblies or any other materials or substances or environments. Any advice, recommendations or information given orally or in writing, are not to be construed as an amendment or addition to the above warranty.

See <http://www.omron.com/global/> or contact your Omron representative for published information.

Limitation on Liability; Etc

OMRON COMPANIES SHALL NOT BE LIABLE FOR SPECIAL, INDIRECT, INCIDENTAL, OR CONSEQUENTIAL DAMAGES, LOSS OF PROFITS OR PRODUCTION OR COMMERCIAL LOSS IN ANY WAY CONNECTED WITH THE PRODUCTS, WHETHER SUCH CLAIM IS BASED IN CONTRACT, WARRANTY, NEGLIGENCE OR STRICT LIABILITY.

Further, in no event shall liability of Omron Companies exceed the individual price of the Product on which liability is asserted.

Application Considerations

Suitability of Use

Omron Companies shall not be responsible for conformity with any standards, codes or regulations which apply to the combination of the Product in the Buyer's application or use of the Product. At Buyer's request, Omron will provide applicable third party certification documents identifying ratings and limitations of use which apply to the Product. This information by itself is not sufficient for a complete determination of the suitability of the Product in combination with the end product, machine, system, or other application or use. Buyer shall be solely responsible for determining appropriateness of the particular Product with respect to Buyer's application, product or system. Buyer shall take application responsibility in all cases.

NEVER USE THE PRODUCT FOR AN APPLICATION INVOLVING SERIOUS RISK TO LIFE OR PROPERTY OR IN LARGE QUANTITIES WITHOUT ENSURING THAT THE SYSTEM AS A WHOLE HAS BEEN DESIGNED TO ADDRESS THE RISKS, AND THAT THE OMRON PRODUCT(S) IS PROPERLY RATED AND INSTALLED FOR THE INTENDED USE WITHIN THE OVERALL EQUIPMENT OR SYSTEM.

Programmable Products

Omron Companies shall not be responsible for the user's programming of a programmable Product, or any consequence thereof.

Disclaimers

Performance Data

Data presented in Omron Company websites, catalogs and other materials is provided as a guide for the user in determining suitability and does not constitute a warranty. It may represent the result of Omron's test conditions, and the user must correlate it to actual application requirements. Actual performance is subject to the Omron's Warranty and Limitations of Liability.

Change in Specifications

Product specifications and accessories may be changed at any time based on improvements and other reasons. It is our practice to change part numbers when published ratings or features are changed, or when significant construction changes are made. However, some specifications of the Product may be changed without any notice. When in doubt, special part numbers may be assigned to fix or establish key specifications for your application. Please consult with your Omron's representative at any time to confirm actual specifications of purchased Product.

Errors and Omissions

Information presented by Omron Companies has been checked and is believed to be accurate; however, no responsibility is assumed for clerical, typographical or proofreading errors or omissions.

PRECAUTIONS

1	Intended Audience	xviii
2	General Precautions	xviii
3	Safety Precautions	xx
4	Precautions for Safe Use	xxii
5	Additional Precautions According to ANSI/ISA 12.12.01	xxiv
6	Regulations and Standards	xxiv
7	Unit Versions of NE0A-series Controllers	xxv

1 Intended Audience

This manual is intended for the following personnel, who must have knowledge of electrical systems (an electrical engineer or the equivalent).

- Personnel in charge of introducing FA and safety systems into production facilities
- Personnel in charge of designing FA and safety systems
- Personnel in charge of managing FA facilities
- Personnel who have the qualifications, authority, and obligation to provide safety during each of the following product phases: mechanical design, installation, operation, maintenance, and disposal

2 General Precautions

The user must operate the product according to the performance specifications described in the operation manuals.

Before using the product under conditions which are not described in the manual or applying the product to nuclear control systems, railroad systems, aviation systems, vehicles, combustion systems, medical equipment, amusement machines, safety equipment, and other systems, machines, and equipment that may have a serious influence on lives and property if used improperly, consult your OMRON representative.

Make sure that the ratings and performance characteristics of the product are sufficient for the systems, machines, and equipment, and be sure to provide the systems, machines, and equipment with double safety mechanisms.

This manual provides information for programming and operating the Unit. Be sure to read this manual before attempting to use the Unit and keep this manual close at hand for reference during operation.

 **WARNING** It is extremely important that a PLC and all PLC Units be used for the specified purpose and under the specified conditions, especially in applications that can directly or indirectly affect human life. You must consult with your OMRON representative before applying a PLC System to the above-mentioned applications

 **WARNING** This is the Operation Manual for the NEOA-series Safety Network Controllers. Heed the following items during system construction to ensure that safety-related components are configured in a manner that allows the system functions to sufficiently operate.

• Risk Assessment

The proper use of the safety device described in this Operation Manual as it relates to installation conditions and mechanical performance and functions is a prerequisite for its use. When selecting or using this safety device, risk assessment must be conducted with the aim of identifying potential danger factors in equipment or facilities in which the safety device is to be applied, during the development stage of the equipment or facilities. Suitable safety devices must be selected under the guidance of a sufficient risk assessment system. An insufficient risk assessment system may lead to the selection of unsuitable safety devices.

- Typical related international standards: ISO 14121, Safety of Machinery -- Principles of Risk Assessment

- **Safety Measures**

When using this safety device to build systems containing safety-related components for equipment or facilities, the system must be designed with the full understanding of and conformance to international standards, such as those listed below, and/or standards in related industries.

- Typical related international standards: ISO/DIS 12100, Safety of Machinery -- Basic Concepts and General Principles for Design IEC 61508, Safety Standard for Safety Instrumented Systems (Functional Safety of Electrical/Electronic/Programmable Electronic Safety-related Systems)

- **Role of Safety Device**

This safety device is provided with safety functions and mechanisms as stipulated in relevant standards, but suitable designs must be used to allow these functions and mechanisms to operate properly inside system constructions containing safety-related components. Build systems that enable these functions and mechanisms to perform properly, based on a full understanding of their operation.

- Typical related international standards: ISO 14119, Safety of Machinery -- Interlocking Devices Associated with Guards -- Principles of Design and Selection

- **Installation of Safety Device**

The construction and installation of systems with safety-related components for equipment or facilities must be performed by technicians who have received suitable training.

- Typical related international standards: ISO/DIS 12100, Safety of Machinery -- Basic Concepts and General Principles for Design IEC 61508, Safety Standard for Safety Instrumented Systems (Functional Safety of Electrical/Electronic/Programmable Electronic Safety-related Systems)

- **Complying with Laws and Regulations**

This safety device conforms to the relevant regulations and standards, but make sure that it is used in compliance with local regulations and standards for the equipment or facilities in which it is applied.

- Typical related international standards: IEC 60204, Safety of Machinery -- Electrical Equipment of Machines

- **Observing Precautions for Use**













When putting the selected safety device to actual use, heed the specifications and precautions in this Operation Manual and those in the Instruction Manual that comes with the product. Using the product in a manner that deviates from these specifications and precautions will lead to unexpected failures in equipment or devices, and to damages that result from such failures, due to insufficient operating functions in safety-related components.

- **Moving or Transferring Devices or Equipment**

When moving or transferring devices or equipment, be sure to include this Operation Manual to ensure that the person to whom the device or equipment is being moved or transferred will be able to operate it properly.

- Typical related international standards: ISO/DIS 12100 ISO, Safety of Machinery -- Basic Concepts and General Principles for Design IEC 61508, Safety Standard for Safety Instrumented Systems (Functional Safety of Electrical/ Electronic/ Programmable Electronic Safety-related Systems)







3 Safety Precautions



 WARNING	
<p> Serious injury may possibly occur due to loss of required safety functions. Do not use the NE0A-series Controller's test outputs as safety outputs. </p>	
<p> Serious injury may possibly occur due to loss of required safety functions. Do not use DeviceNet standard I/O data or explicit message data as safety data. </p>	
<p> Serious injury may possibly occur due to loss of required safety functions. Do not use indicators or 7-segment display on the NE0A-series Controller for safety operations. </p>	
<p> Serious injury may possibly occur due to breakdown of safety outputs or test outputs. Do not connect loads beyond the rated value to the safety outputs and test outputs. </p>	
<p> Serious injury may possibly occur due to loss of required safety functions. Wire the NE0A-series Controller properly so that the 24-VDC line does NOT touch the outputs accidentally or unintentionally. </p>	
<p> Serious injury may possibly occur due to loss of required safety functions. Ground the 0-V line of the power supply for external output devices so that the devices do NOT turn ON when the safety output line or the test output line is grounded. </p>	
<p> Serious injury may possibly occur due to loss of required safety functions. Clear previous configuration data before connecting the devices to the network. </p>	
<p> Serious injury may possibly occur due to loss of required safety functions. Set suitable node addresses and a suitable baud rate before connecting the devices to the network. </p>	
<p> Serious injury may possibly occur due to loss of required safety functions. Perform user testing and confirm that all of the device configuration data and operation is correct before starting system operation. </p>	
<p> Serious injury may possibly occur due to loss of required safety functions. When replacing a device, configure the replacement device suitably and confirm that it operate correctly. </p>	
<p> Outputs may operation, possibly causing serious injury. Take sufficient safety measures before force-setting or force-resetting any bits in memory. </p>	
<p> Serious injury may possibly occur due to loss of required safety functions. Use appropriate components or devices according to the requirements given in the following table. </p>	

Control device	Requirements
Emergency stop switch	Use approved devices with a direct opening mechanism compliant with IEC/EN 60947-5-1.
Door interlocking switch or limit switch	Use approved devices with a direct opening mechanism compliant with IEC/EN 60947-5-1 and capable of switching micro-loads of 4 mA at 24 VDC.
Safety sensor	Use approved devices compliant with the relevant product standards, regulations, and rules in the country where they are used.
Relay with forcibly guided contacts	Use approved devices with forcibly guided contacts compliant with IEC 61810-3. For feedback signals, use devices with contacts capable of switching micro-loads of 4 mA at 24 VDC.

Control device	Requirements
Contactors	Use contactors with a forcibly guided mechanism and monitor the auxiliary NC contact to detect contactor failures. For feedback signals, use devices with contacts capable of switching micro-loads of 4 mA at 24 VDC.
Other devices	Evaluate whether devices used are appropriate to satisfy the requirements of the safety category level.

Security Measures

 WARNING	
<p>Anti-virus protection</p> <p>Install the latest commercial-quality antivirus software on the computer connected to the control system and maintain to keep the software up-to-date.</p>	
<p>Security measures to prevent unauthorized access</p> <p>Take the following measures to prevent unauthorized access to our products.</p> <ul style="list-style-type: none"> • Install physical controls so that only authorized personnel can access control systems and equipment. • Reduce connections to control systems and equipment via networks to prevent access from untrusted devices. • Install firewalls to shut down unused communications ports and limit communications hosts and isolate control systems and equipment from the IT network. • Use a virtual private network (VPN) for remote access to control systems and equipment. • Adopt multifactor authentication to devices with remote access to control systems and equipment. • Set strong passwords and change them frequently. • Scan virus to ensure safety of USB drives or other external storages before connecting them to control systems and equipment. 	
<p>Data input and output protection</p> <p>Validate backups and ranges to cope with unintentional modification of input/output data to control systems and equipment.</p> <ul style="list-style-type: none"> • Checking the scope of data • Checking validity of backups and preparing data for restore in case of falsification and abnormalities • Safety design, such as emergency shutdown and fail-soft operation in case of data tampering and abnormalities 	
<p>Data recovery</p> <p>Backup data and keep the data up-to-date periodically to prepare for data loss.</p>	
<p>When using an intranet environment through a global address, connecting to an unauthorized terminal such as a SCADA, HMI or to an unauthorized server may result in network security issues such as spoofing and tampering. You must take sufficient measures such as restricting access to the terminal, using a terminal equipped with a secure function, and locking the installation area by yourself.</p>	

 WARNING	
When constructing an intranet, communication failure may occur due to cable disconnection or the influence of unauthorized network equipment. Take adequate measures, such as restricting physical access to network devices, by means such as locking the installation area.	
When using a device equipped with the SD Memory Card function, there is a security risk that a third party may acquire, alter, or replace the files and data in the removable media by removing the removable media or unmounting the removable media. Please take sufficient measures, such as restricting physical access to the Controller or taking appropriate management measures for removable media, by means of locking the installation area, entrance management, etc., by yourself.	

4 Precautions for Safe Use

■ Handling with Care

Do not drop the NE0A-series Controller or subject it to excessive vibration or mechanical shock. The NE0A-series Controller may be damaged and may not function properly.

■ Installation and Storage Environment

Do not use or store the NE0A-series Controller in any of the following locations:

- Locations subject to direct sunlight
- Locations subject to temperatures or humidity outside the range specified in the specifications
- Locations subject to condensation as the result of severe changes in temperature
- Locations subject to corrosive or flammable gases
- Locations subject to dust (especially iron dust) or salts
- Locations subject to water, oil, or chemicals
- Locations subject to shock or vibration

Take appropriate and sufficient measures when installing systems in the following locations. Inappropriate and insufficient measures may result in malfunction.

- Locations subject to static electricity or other forms of noise
- Locations subject to strong electromagnetic fields
- Locations subject to possible exposure to radioactivity
- Locations close to power supplies

The NE0A-series Controller is a class A product designed for industrial environments. Use in residential area may cause radio interference, in which case the user may be required to take adequate measures to reduce interference.

■ Installation and Mounting

- Use the NE0A-series Controller within an enclosure with IP54 protection or higher according to IEC/EN 60529.

- Use DIN Track (TH35-7.5 according to IEC 60715) to install the NE0A-series Controller into the control panel. Mount the NE0A-series Controller to the DIN Track using PFP-M End Plates (not included with the NE0A-series Controller) to prevent it falling off the DIN Track because of vibration.
- Space must be provided around the NE0A-series Controller, at least 5 mm from its side and at least 50 mm from its top and bottom surfaces, for ventilation and wiring.

■ Installation and Wiring

- Use the following to wire external I/O devices to the NE0A-series Controller.

Solid wire	0.2 to 2.5 mm ² (AWG 24 to AWG 12)
Stranded (flexible) wire	0.34 to 1.5 mm ² (AWG 22 to AWG 16) Stranded wires should be prepared by attaching insulated bar terminals (DIN 46228-4 standard compatible) to the ends before connecting them.

- Disconnect the NE0A-series Controller from the power supply before starting wiring. Devices connected to the NE0A-series Controller may operate unexpectedly.
- Properly apply the specified voltage to the NE0A-series Controller inputs. Applying an inappropriate DC voltage or any AC voltage will cause the NE0A-series Controller to fail.
- Be sure to separate the communications cables and I/O cables from near high-voltage/high-current lines.
- Be cautious not to get your fingers caught when attaching connectors to the plugs on the NE0A-series Controller.
- Tighten the DeviceNet connector screws correctly (0.25 to 0.3 N·m).
- Incorrect wiring may lead to loss of safety functions. Wire conductors correctly and verify the operation of the NE0A-series Controller before using the system in which the NE0A-series Controller is incorporated.
- After wiring is completed, be sure to remove label for wire clipping prevention on the NE0A-series Controller to enable heat to escape or proper cooling.
- When grounding the internal circuit power supply, always ground the 0-V side.
- Use separate power supplies for the internal circuit power supply and the I/O power supply.
- Do not connect the internal circuit power supply to a relay or other control component.
- Do not use a cable that is longer than 3 m for the internal circuit power supply.

■ Power Supply Selection

Use a DC power supply satisfying the following requirements.

- The secondary circuits of the DC power supply must be isolated from the primary circuit by double insulation or reinforced insulation.
- The DC power supply must satisfy the requirements for class 2 circuits or limited voltage/current circuits given in UL 508.
- The output hold time must be 20 ms or longer.

■ **Periodic Inspections and Maintenance**

- Disconnect the NE0A-series Controller from the power supply before replacing the Controller. Devices connected to the NE0A-series Controller may operate unexpectedly.
- Do not disassemble, repair, or modify the NE0A-series Controller. Doing so may lead to loss of safety functions.

■ **Disposal**

- Be cautious not to injure yourself when dismantling the NE0A-series Controller.

5 Additional Precautions According to ANSI/ISA 12.12.01

The NE0A-series Controller is suitable for use in Class I, Div. 2, Group A, B, C, D or Non-Hazardous Location Only.

WARNING - Explosion Hazard - Substitution of Components May Impair Suitability For Class I, Div. 2.

WARNING - Explosion Hazard - Do Not Disconnect Equipment Unless Power Has Been Switched OFF or the Area Is Known To Be Non-Hazardous.

WARNING - Explosion Hazard - Do Not Disconnect USB Connector Unless Power Has Been Switched OFF or the Area Is Known To Be Non-Hazardous.

6 Regulations and Standards

The NE0A-SCPU01 has been certified as follows:

Certifying organization	Standards
TÜV Rheinland	IEC 61508 part1-7 EN ISO 13849-1: 2015 EN ISO 13849-2 IEC 61131-2 EN 62061 IEC 61326-3-1 EN 60204-1 EN ISO 13850 NFPA 79 ANSI RIA15.06, ANSI B11.19
UL (See note.)	ANSI/UL 1998 UL 508 ANSI/ISA 12.12.01 IEC 61508 CSA C22.2 No142 CSA C22.2 No213

■ **Conformance to KC Certification**

When you use this product in South Korea, observe the following precautions.

<p>A 급기기 (업무용 방송통신기자재)</p>
<p>이 기기는 업무용(A 급) 전자파적합기기로서 판매자또는 사용자는 이 점을 주의하시기 바라며,가정외의지역에서 사용하는 것을 목적으로 합니다.</p>

7 Unit Versions of NE0A-series Controllers

Checking the Unit Version

A “unit version” has been introduced to manage NE0A-series Safety Network Controllers according to differences in functionality accompanying Unit upgrades even though the model numbers are the same. The unit version can be checked on the product itself or using the Network Configurator.

Note The Network Configurator maintains a revision number to manage device functions for DeviceNet and EtherNet/IP. Refer to *Checking the Unit Version with the Network Configurator* on page xxv for the relationship between NE0A-series Controller unit versions and the revisions.

Checking the Unit Version on the Product Nameplate

The unit version (Ver. □.□) is listed near the lot number on the nameplate of the products for which unit versions are being managed, as shown below.

- Unit versions for the NE0A-SCPU01 start at unit version 1.0.

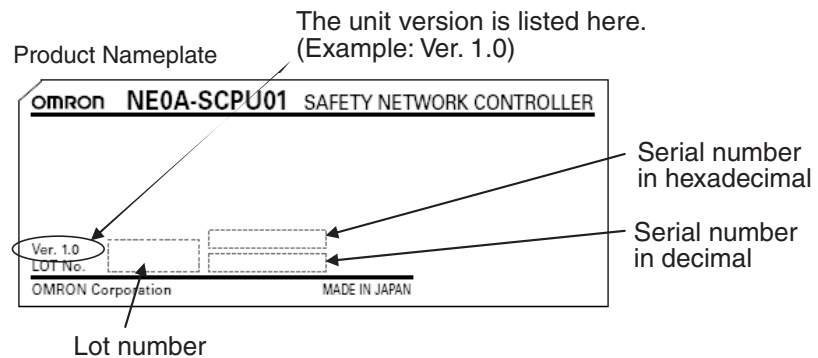

Checking the Unit Version with the Network Configurator

The following procedure can be used to check the unit version from the Network Configurator.

- 1,2,3...**
1. Select **Network - Upload** to upload the configuration information. The device icons will be displayed, as shown in the following diagram.

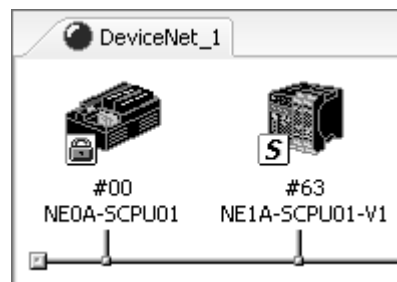

2. Right-click on a device icon to display the popup menu shown below and select **Property** from the menu.

The following Property Dialog Box will be displayed.



The device name and revision are given in the Property Dialog Box. The NE0A-series Controllers are listed in the following table.

Model	Revision	Unit version
NE0A-SCPU01	1.01	1.0

Checking the Unit Version with the Unit Version Label

The following unit version labels are provided with the Controller.

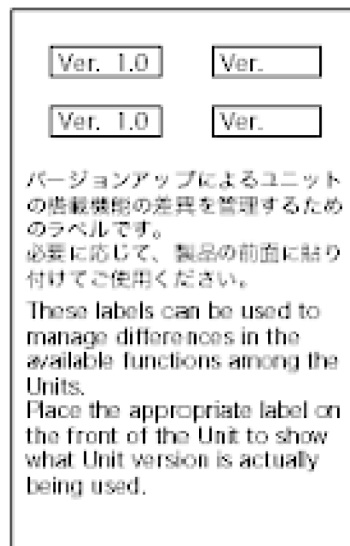

These labels can be attached to the front of the Controllers to differentiate between Controller with different unit versions from the front of the Controller.

SECTION 1

Overview of the NE0A-series Safety Network Controllers

This section provides an overview of the NE0A-series Safety Network Controllers and the type of system configuration in which they are used.

1-1	About NE0A-series Safety Network Controllers	2
1-1-1	Introduction to the NE0A-series Safety Network Controllers	2
1-1-2	Features of the NE0A-series Controllers	3
1-1-3	Models	4
1-2	System Configuration	5
1-2-1	DeviceNet Safety System Overview	5
1-2-2	System Configuration Examples	5
1-2-3	Connecting to a Network Configurator	8

1-1 About NE0A-series Safety Network Controllers

1-1-1 Introduction to the NE0A-series Safety Network Controllers

NE0A-series Safety Network Controllers are programmable safety logic controllers. They are designed for small-scale safety control and provide functions such as safety logic operations, safety local I/O control functions, and DeviceNet Safety Slave communications.

An NE0A-series Controller allows the user to construct safety control circuits that meet the requirements for Safety Integrity Level 3 (SIL 3) according to IEC 61508 (Functional Safety of Electrical/Electronic/Programmable Electronic Safety-related Systems) and the requirements for Safety Category 4 of EN 954-1.

As shown in the following example system configuration, a safety distributed control system can be constructed with an NE0A-series Controller for each safety control block. With this system, the following operations are enabled.

- As Safety Logic Controllers, the NE0A-series Controllers execute safety logic operations and directly control local safety outputs.
- As DeviceNet Safety Slaves, the NE0A-series Controllers perform safety I/O communications with the NE1A-series DeviceNet Safety Master.
- As a DeviceNet Standard Slave, the NE0A-series Controller communicates with the DeviceNet Standard Master.

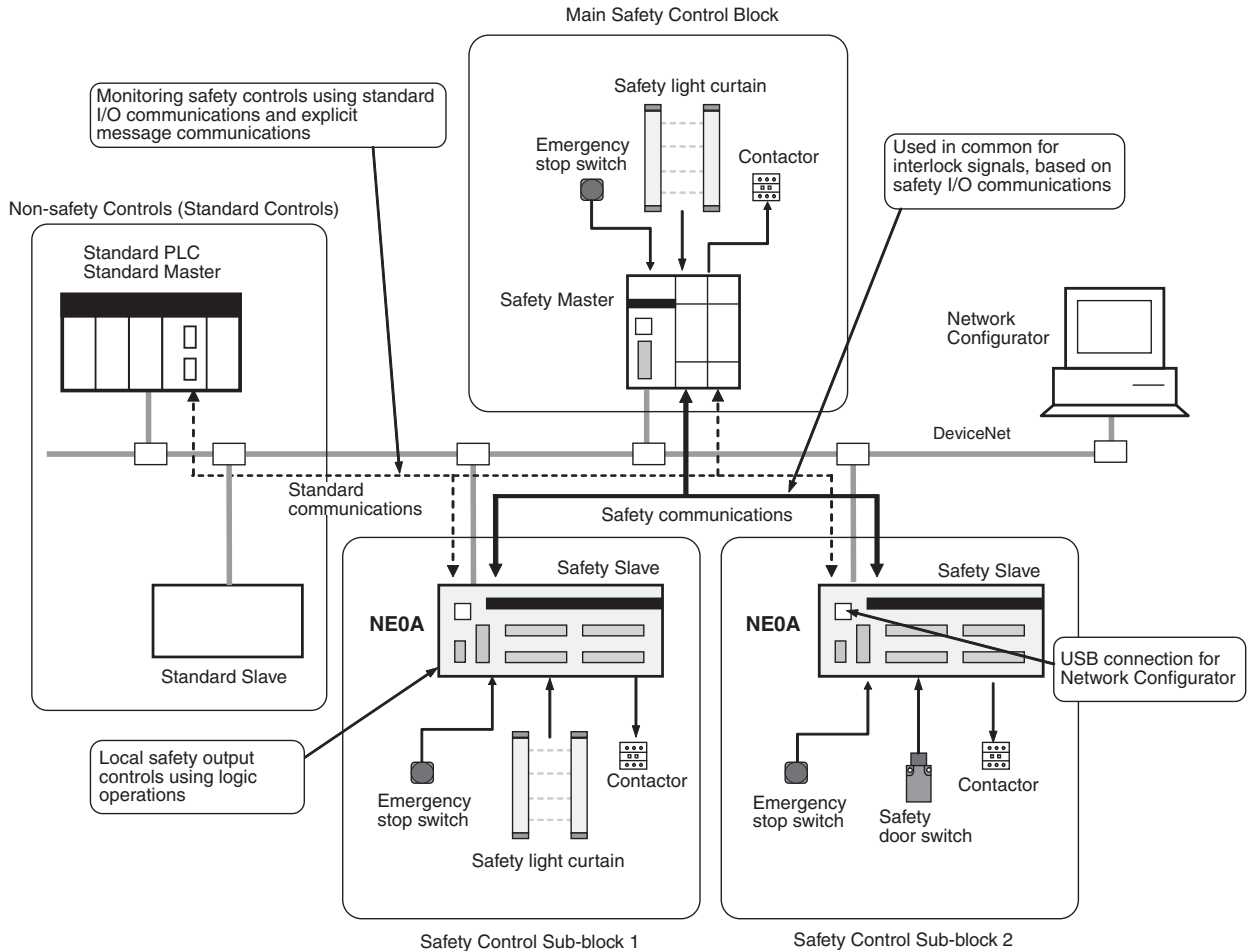

1-1-2 Features of the NE0A-series Controllers

Constructing Safety Distributed Control Systems for Facilities

Distributing Safety Control with DeviceNet Safety

Safety control blocks, such as for individual pieces of equipment, can be connected with less wiring by using DeviceNet cables. Using DeviceNet Safety communications enables transferring interlock signals and other safety data between blocks, and achieves centralized monitoring with DeviceNet standard communications.

Shorter Safety Response Times

Safety response times can be shortened because local safety outputs can be directly controlled without using the Safety Master.

USB Communications

The Network Configurator can be directly connected using USB cable.

Force-set/reset

Remote I/O signals from a Safety Master can be force-set or force-reset without the Safety Master present, enabling debugging NE0A-series Controllers individually.

Application Templates

Reducing Design Work with Certified Safety Circuits

Using the preinstalled application templates greatly reduces work for constructing circuits that comply with safety standards.

Safety Logic Operations

Constructing Safety Circuits with Software

Safety circuits can be programmed with a wizard to handle various applications, such as emergency stops, door switches with lock functions, and teaching modes. The safety circuits that are created can be easily debugged by using a graphical software tool.

Local Safety I/O

Labor-saving Cage Clamp Terminal Block

- I/O cables can be wired without having to tighten screws.
- The terminal block is removable.
- The terminal block is structured to prevent incorrect insertion.

Wide Range of I/O Wiring Error Detection Functions

- For safety inputs, external wiring errors, such as faulty connected devices, wiring mistakes, disconnected wires, short-circuiting, and ground faults, can be detected.
- Using safety outputs in combination with the safety logic EDM function enables detecting errors such as contact weld faults in output devices such as safety relays and contactors.
- Detected errors are shown using the I/O indicators on the front of the NE0A-series Controller, making it easy to identify their location. In addition, the cause of an error can be identified using the Network Configurator.

Safety Inputs

- Contact output devices, such as emergency stop switches and semi-conductor output devices such as light curtains, can be connected.
- ON and OFF input delays can be set.
- In compliance with Category 4, two related inputs can be set as dual channels.

Safety Outputs

- ON and OFF output delays can be set.
- In compliance with Category 4, two related outputs can be set as dual channels.

DeviceNet Safety and DeviceNet Standard Communications

Simple Settings

Only the node address needs to be set using a rotary switch. The baud rate is recognized automatically, so it does not need to be set.

DeviceNet Safety Communications

- A maximum of two connections for safety I/O communications can be set for Safety I/O Slaves.
- Safety I/O communications can be used to exchange safety interlock signals such as emergency stop signals with the NE1A-series Safety Master.

DeviceNet Standard Communications

- A maximum of two connections for standard I/O communications can be set for Standard Slaves.
- Standard I/O communications and explicit message communications can be used to monitor NE0A-series Controller status and error information from a standard PLC, enabling errors that occur at the Controller to be immediately identified by standard controls at the PLC.

Access Control with Passwords

Configuration Lock

The configuration downloaded to the NE0A-series Controller can be locked. A password is required to clear the lock, so unauthorized changes can be prevented.

Restrictions on User Operations

A password must be entered to perform operations such as changing the operating mode, downloading data, or force-setting/resetting bits, thus preventing unintentional access to the NE0A-series Controllers.

Maintenance Functions

Monitoring I/O Power Supply Voltage

The local I/O power supply is monitored, and an error occurs if the voltage is incorrect.

Monitoring Unit Power-ON Time

The total time that power is ON for the internal circuit can be calculated and saved in the NE0A-series Controller.

Monitoring the Number of Bit Operations

The number of times each input or output bit turns ON can be counted and saved in the NE0A-series Controller.

Monitoring Total ON Time

The total time that each input or output bit is ON can be calculated (unit: s) and saved in the NE0A-series Controller.

1-1-3 Models

The following table lists the model number of the NE0A-series Controller and the numbers of I/O points.

Model	Number of I/O points		
	Safety inputs	Test outputs	Safety outputs
NE0A-SCPU01	12 (See note.)	2	6 (semiconductors)

Note IN10 and IN11 are for the reset switch or EDM feedback connection only.

1-2 System Configuration

1-2-1 DeviceNet Safety System Overview

DeviceNet is an open-field, multi-vendor, multi-bit network, which combines the controls in the machine and line control levels with information. The DeviceNet Safety network adds safety functions to the conventional DeviceNet standard communications protocol. The DeviceNet Safety concept has been approved by a third-party organization (TÜV Rhineland).

Just as with DeviceNet, DeviceNet Safety-compliant devices from third-party vendors can be connected to a DeviceNet Safety network. Also, DeviceNet-compliant devices and DeviceNet Safety-compliant devices can be combined and connected on the same network.

By combining DeviceNet Safety-compliant products, a user can construct a safety control/network system that meets the requirements for Safety Integrity Level (SIL) 3 according to IEC 61508 (Functional Safety of Electrical/Electronic/Programmable Electronic Safety-related Systems) and the requirements for Safety Category 4 according to EN 954-1.

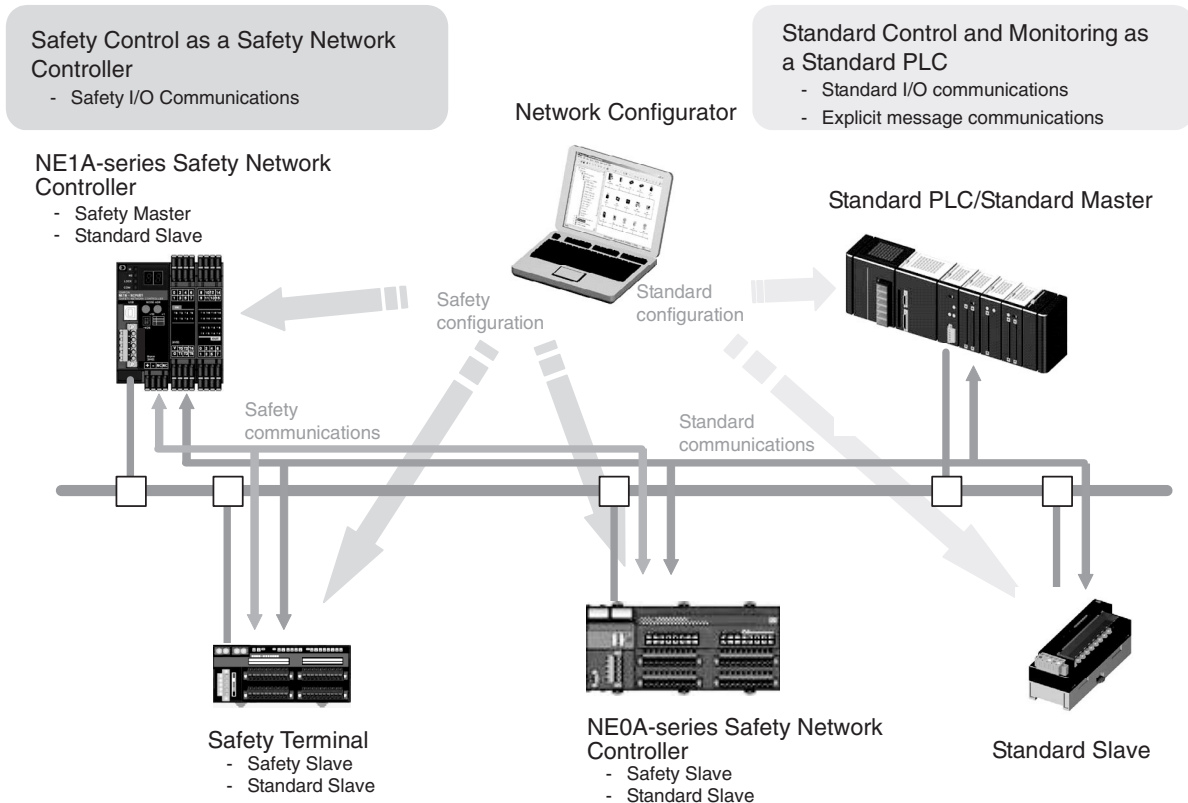

1-2-2 System Configuration Examples

The following examples illustrate safety control systems using NE0A-series Controllers.

- DeviceNet Safety System
- DeviceNet System
- Stand-alone System

Safety Distributed Control System with DeviceNet Safety

In this example, a safety distributed control system is constructed using a Safety Master and NE0A-series Controllers. In this system, the Safety Master controls the entire system while the NE0A-series Safety Slaves control safety for sub-blocks. The Safety Master executes safety I/O communications with NE0A-series Safety Slaves. This enables exchanging safety data, such as interlock signals, between the NE0A-series Controllers and the Safety Master.

In addition, using standard I/O communications to assign NE0A-series Controller status information (Unit general status and local I/O errors) and logic operation results to a standard PLC enables central monitoring of the safety control system by the standard PLC.

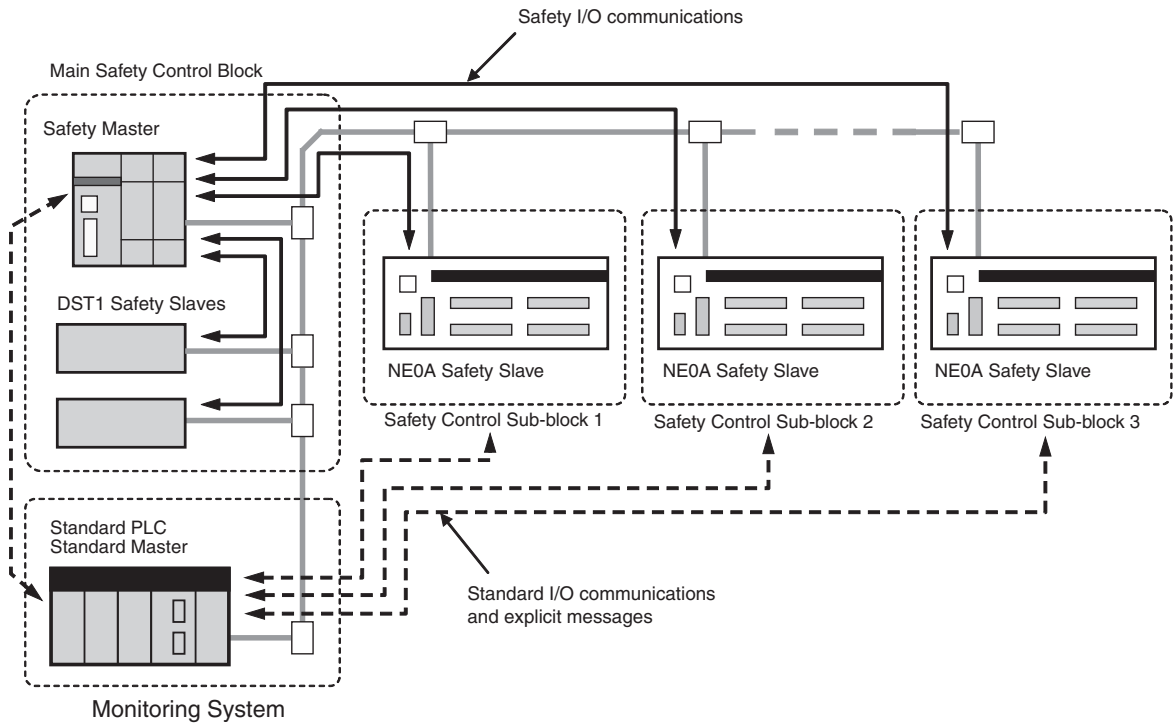

- Note**
- The NE0A-series Controller uses two Safety Master connection resources (IN and OUT). For example, up to 16 NE0A-series Controllers can communicate with one NE1A-SCPU01-V1 Controller, which supports a total of 32 connections.
 - A maximum total of 64 standard nodes and safety nodes can be connected on the same network.

IMPORTANT The data attributes handled by standard I/O communications and explicit message communications are non-safety data. The necessary measures for safety data are not taken for this data during data generation. Therefore, do not use this data to configure the Safety Control System.

Centralized Monitoring System with DeviceNet

If safety control blocks requiring a small number of I/O points must be distributed, a safety control system can be constructed using only NE0A-series Controllers without a Safety Master. In this case, the NE0A-series Controllers operate only as DeviceNet Standard Slaves, and do not handle safety I/O communications.

When small-scale safety control blocks are distributed, monitoring with less wiring is enabled from a centralized monitoring system through the DeviceNet network. Error locations and probably causes of errors can be easily identified by using standard I/O communications and explicit messages to assign NE0A-series Controller status information and logic operation results to the standard PLC.

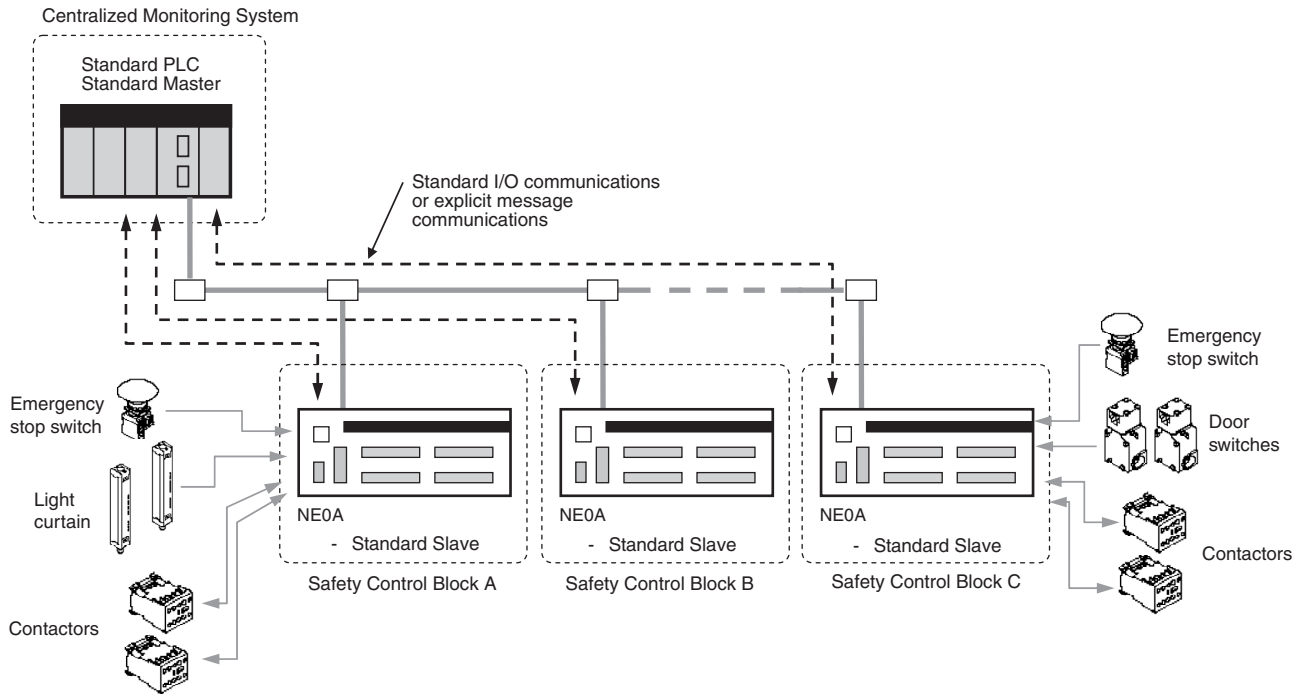

IMPORTANT The data attributes handled by standard I/O communications and explicit message communications are non-safety data. The necessary measures for safety data are not taken for this data during data generation. Therefore, do not use this data to configure the Safety Control System.

Standalone System

If there are only a few I/O points, the NEOA-series Controller can be used as Standalone Controller.

The Controller's DeviceNet communications can be disabled through settings made from the Network Configurator to enable the NEOA-series Controller to operate as Standalone Controller.

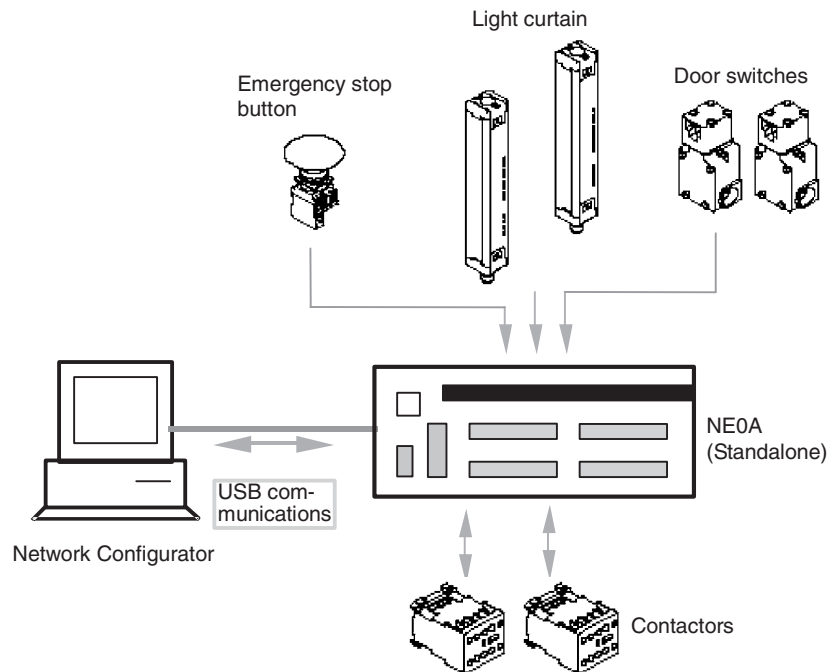

IMPORTANT Use a USB port connection to set Standalone Mode. DeviceNet communications are stopped when Standalone Mode is set, and so setting is not possible from the DeviceNet port.

1-2-3 Connecting to a Network Configurator

Note For details on connecting to a Network Configurator, refer to 7-2 *Online Connection* in this manual or to the *DeviceNet Safety System Configuration Manual* (Cat. No. Z905).

SECTION 2

Nomenclature and Specifications

This section provides the component names and specifications of the NE0A-series Safety Network Controllers. It also describes the local safety I/O functions that are available.

2-1	Nomenclature	10
2-1-1	Nomenclature	10
2-1-2	Indicator Area	11
2-1-3	Switch Settings	13
2-1-4	DeviceNet Communications Connector	13
2-1-5	USB Communications Connector	14
2-1-6	Input/Output Terminals and Internal Connections	15
2-1-7	Dimensions and Weight	16
2-2	Specifications	17
2-2-1	General Specifications	17
2-2-2	DeviceNet Communications Specifications	18
2-2-3	I/O Specifications	19
2-2-4	Wiring I/O Devices	20
2-3	Local Safety I/O Functions	23
2-3-1	Local I/O Comments	23
2-3-2	I/O Power Monitor	23
2-3-3	Local Safety Inputs	23
2-3-4	Local Safety Output Functions	29

2-1 Nomenclature

This section describes the part names and functions of the NE0A-series Controllers.





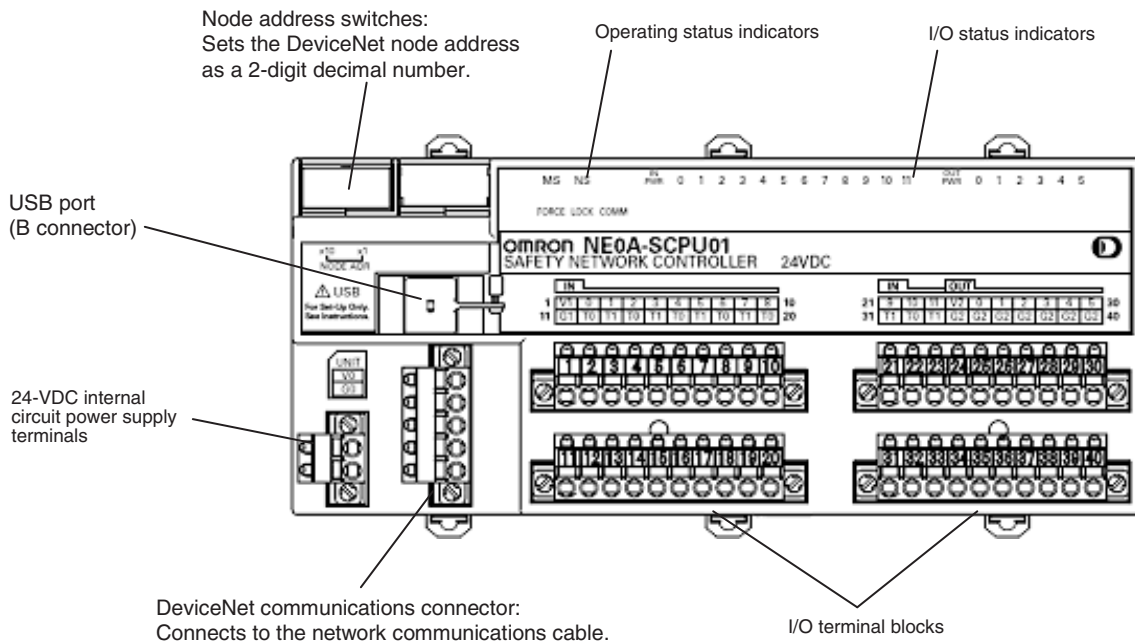













2-1-1 Nomenclature

NE0A-SCPU01



2-1-2 Indicator Area













Operating Status Indicators

Indicator name	Color	Status	Meaning
MS (Module Status)	Green		RUN Mode
			IDLE Mode
	Red		Critical fault (fatal error) (See note.)
			Abort status (minor error, such as incorrect switch setting or Force Mode timeout)
	Green/red		Initialization or waiting for configuration
	---		Internal circuit power supply not being supplied.
NS (Network Status)	Green		Online with I/O or explicit message connection established.
			Online with I/O or explicit message online connection not established.
	Red		Unable to communicate. (Bus Off error or duplicated node addresses detected.)
			I/O communications error
	---		<ul style="list-style-type: none"> Internal circuit power supply not being supplied. (MS indicator also not be lit.) Communications power supply not being supplied. Offline. Stand-alone operation (DeviceNet communications disabled).
FORCE (Force-set/reset Status)	Yellow		Force-setting/resetting enabled. (Force Mode) (Force-setting/resetting is being used.)
	---		Force-setting/resetting disabled. (Force-setting/resetting is not being used.)
LOCK (Configuration Lock)	Yellow		Configuration is valid and locked.
			Configuration is valid and not locked.
			No valid configuration.
COMM (USB)	Yellow		Data communications in progress.
			Data communications not in progress.

 : ON,  : Flashing,  : OFF

Note A system error has been caused by a malfunction or incorrectly wired safety output terminals.

I/O Status Indicators

Indicator name	Color	Status	Meaning
IN PWR (Input Power)	Green		Input power supply normal.
			Input power supply not being supplied.
OUT PWR (Output Power)	Green		Output power supply normal.
			Output power supply not being supplied.
IN 0 to n (See note.) (IN Status)	Yellow		Input signal ON.
	Red		<ul style="list-style-type: none"> • Error detected in input circuits. • Discrepancy (input data mismatch) in Dual Channel Mode settings.
			Error detected in other input in Dual Channel Mode (with no error for this input).
	-		<ul style="list-style-type: none"> • Input signal OFF. • Initialization in progress. • Waiting for configuration. • Fatal error
OUT 0 to n (See note.) (OUT Status)	Yellow		Output signal ON.
	Red		<ul style="list-style-type: none"> • Error detected in output circuits. • Dual channel violation (output data mismatch) in Dual Channel Mode. • EDM error occurred (when EDM (weld check) is enabled).
			Error detected in other output in Dual Channel Mode (with no error for this output).
	-		<ul style="list-style-type: none"> • Input signal OFF. • Initialization in progress. • Waiting for configuration. • Fatal error

 : ON,  : Flashing,  : OFF

Note “n” indicates the terminal number.

 WARNING	
Serious injury may possibly occur due to loss of required safety functions. Do not use the NEOA-series Controller's indicators for safety operations.	

Note The errors are indicated by indicator combinations. For the meanings of specific indications, refer to *SECTION 12 Troubleshooting*.

2-1-3 Switch Settings

Node Address Switches

Set the DeviceNet node address using the rotary switches on the front of the NEOA-series Controller.

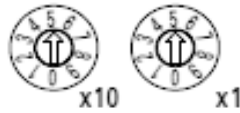

Method	Two-digit decimal number
Range	0 to 63 (default: 63)

IMPORTANT

- Turn OFF the communications power supply before setting the node address.
- Do not change the rotary switches while the power is ON. The Controller will detect this as a change in the configuration and will switch to ABORT State.
- Use a small, flat-blade screw driver to set the node address. Be careful not to damage the switches.

2-1-4 DeviceNet Communications Connector

Labels are placed on the DeviceNet communication connectors for the colors of the communications wires. By matching the communications wire colors with the label colors, you can check to see if wires are in the correct locations. The colors of the wires are as follows:

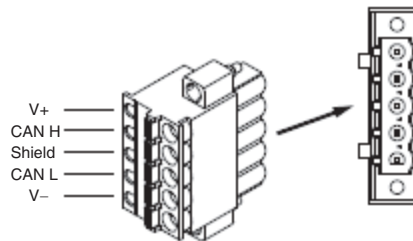

Color	Description
Red	Power supply cable positive (V+)
White	Communications data high signal (CAN H)
-	Shield
Blue	Communications data low signal (CAN L)
Black	Power supply cable negative (V-)

For details on communications specifications, wiring, and communications power supply methods, refer to the *DeviceNet Operation Manual* (Cat. No. W267).

IMPORTANT

- When connecting the communications connector to the NEOA-series Controller, tighten the connector screws to a torque of 0.25 to 0.3 N·m.
- Turn OFF the power supply to the NEOA-series Controller, communications power supply, and all nodes on the network before starting any wiring operations.
- Keep the communications cables separate from high-voltage cables and power lines.

2-1-5 USB Communications Connector

A personal computer must be connected to the NE0A-series Controller to use the Network Configurator. Use a commercially available USB cable for the connection. The connector on the cable to the NE0A-series Controller is a B-type male USB connector.

IMPORTANT The USB cable must be no longer than 3 m.

2-1-6 Input/Output Terminals and Internal Connections

NE0A-SCPU01

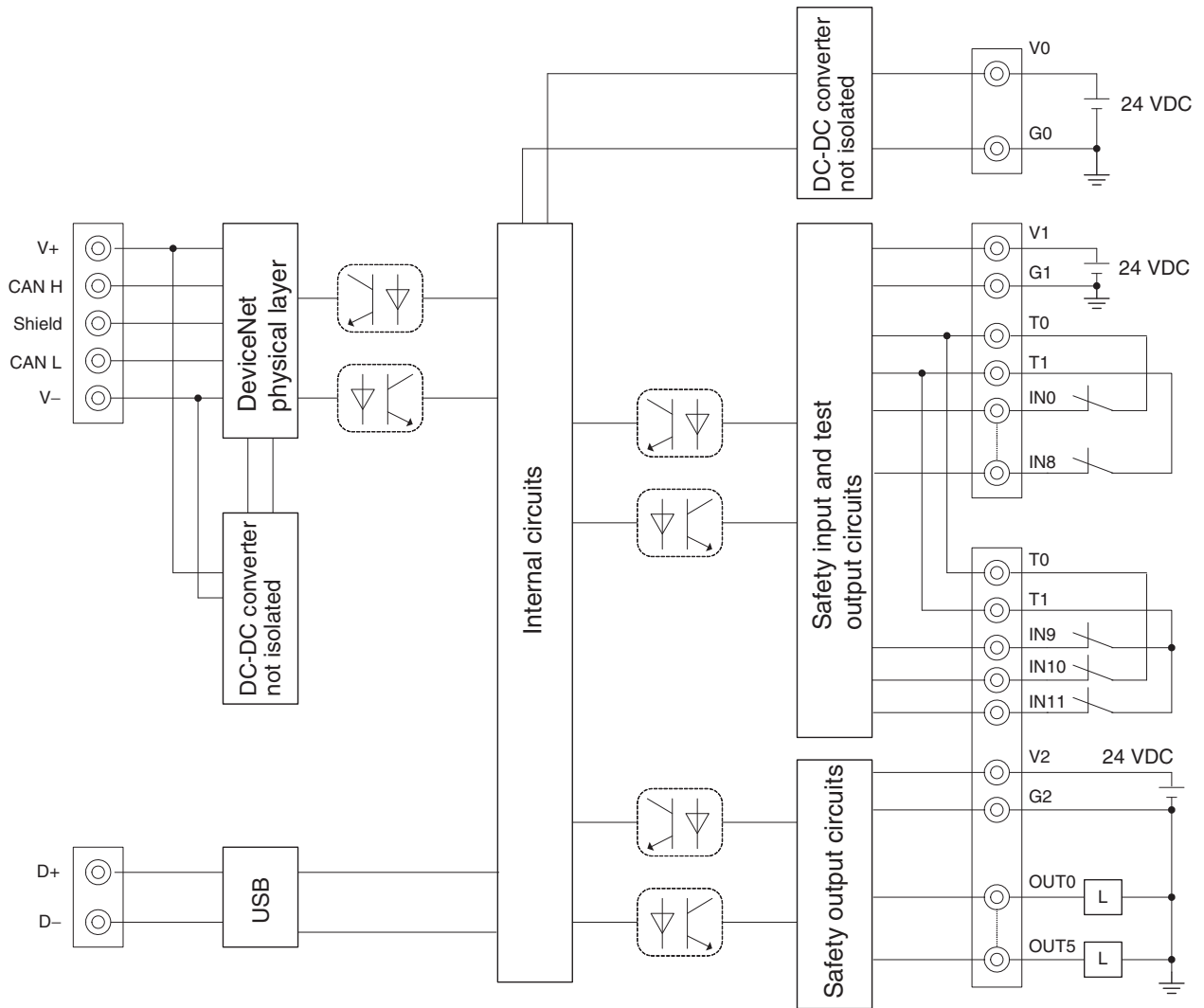

Terminal No.	Terminal name	Description
---	V0	Power supply terminals for internal circuits (24 VDC)
---	G0	
1	V1	Power supply terminals for external input devices and test outputs (24 VDC)
11	G1	
24	V2	Power supply terminals for external output devices (24 VDC)
34	G2	
2-10	IN0 to IN8	Safety input terminals IN10 and IN11 are used for a reset switch or for connecting EDM feedback.
21-23	IN9 to IN11	
12-20 31-33	T0 to T1	Test output terminals connected to safety inputs IN0 to IN11. T0 and T1 output different test pulse patterns. The T0 terminals are internally connected and the T1 terminals are internally connected.
25-30	OUT0 to OUT5	Safety output terminals
35-40	G2	Common terminals Terminals 34 to 40 are internally connected.

2-1-7 Dimensions and Weight

Dimensions

NE0A-SCPU01

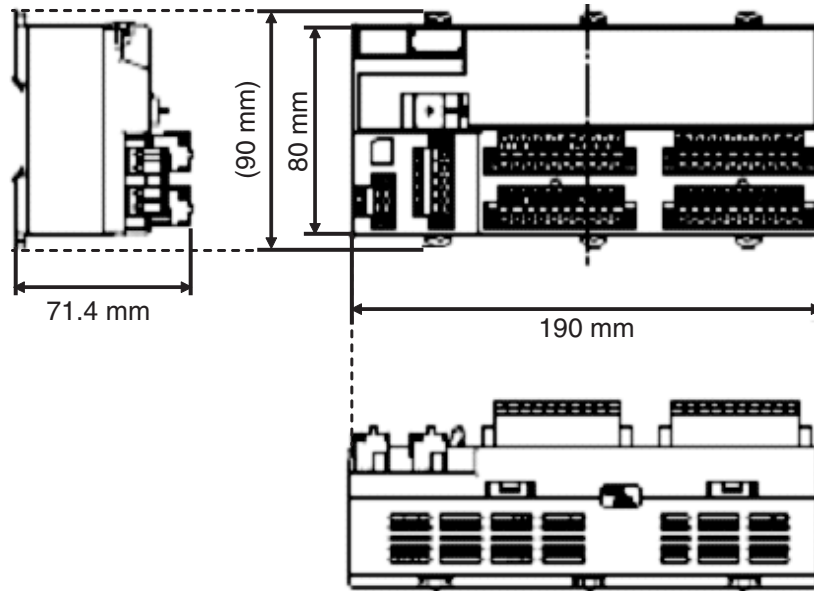

Weight

Model	Weight
NE0A-SCPU01	440 g max.

2-2 Specifications

2-2-1 General Specifications

NE0A-SCPU01

Item		Specifications
DeviceNet supply voltage		11 to 25 VDC (Supplied from communications connector.)
Device supply voltage V0 (See note.)		20.4 to 26.4 VDC (24 VDC, -15% to 10%)
I/O supply voltages V1 and V2 (See note.)		20.4 to 26.4 VDC (24 VDC, -15% to 10%)
Current consumption	DeviceNet	15 mA at 24 VDC
	Internal logic circuits	110 mA at 24 VDC
	I/O power supply (See note 2.)	80 mA at 24 VDC for inputs 80 mA at 24 VDC for outputs
Overvoltage category		II
EMC		Conforms to IEC 61131-2.
Vibration resistance		0.35 mm at 10 to 57 Hz, 50 m/s ² at 57 to 150 Hz
Shock resistance		150 m/s ² for 11 ms
Mounting		DIN Track (TH35-7.5/TH35-15 according to IEC 60715)
Operating temperature		-10 to 55°C
Humidity		10% to 95% (with no condensation)
Storage temperature		-40 to 70°C
Degree of protection		IP20
Serial interface		USB Ver. 1.1
Weight		440 g max.

Note 1: V0 to G0: For internal logic circuits, V1 to G1: For external input devices and test outputs, V2 to G2: For external output devices.

2: This does not include the current consumption of the externally connected devices.

2-2-2 DeviceNet Communications Specifications

Item	Specifications			
Communications protocol	Conforms to DeviceNet.			
Connection method	The multidrop and T-branch connections can be combined (for main line and branch lines).			
Baud rate	500 kbits/s, 250 kbits/s, 125 kbits/s			
Communications medium	Special cable with 5 lines (2 communications lines, 2 power lines, 1 shield line)			
Communications distance	Baud rate	Maximum network length	Branch length	Total length
	500 kbits/s	100 m max. (100 m max.)	6 m max.	39 m max.
	250 kbits/s	250 m max. (100 m max.)	6 m max.	78 m max.
	125 kbits/s	500 m max. (100 m max.)	6 m max.	156 m max.
The numbers in parentheses are the lengths when Thin Cable is used.				
Communications power supply	11 to 25 VDC			
Connected nodes	63 nodes max.			
Safety I/O communications	Safety Slave Function: <ul style="list-style-type: none"> • 2 (one each for IN and OUT) With multi-cast inputs, however, communications is possible for a maximum of 15 Safety Masters. • Connection type: Single-Cast, Multi-Cast 			
Standard I/O communications	Standard Slave Function <ul style="list-style-type: none"> • Maximum number of connections: 2 • Connection type: Poll, Bit-strobe, COS, Cyclic 			
Message communications	Maximum message length: 502 bytes			

2-2-3 I/O Specifications

Safety Inputs

Item	Specifications
Input type	Current sinking (PNP)
ON voltage	11 VDC min. between each input terminal and G1
OFF voltage	5 VDC max. between each input terminal and G1
OFF current	1 mA max.
Input current	4.5 mA

Test Outputs

Item	Specifications
Output type	Current sourcing (PNP)
Rated output current	60 mA max.
Residual voltage	1.2 V max. between each output terminal and V1
Leakage current	0.1 mA max.

IMPORTANT Test outputs can be used only for outputs with test pulses. They are connected to safety inputs through contact output devices.

Safety Outputs

Item	Specifications
Output type	Current sourcing (PNP)
Rated output current	0.5 A per output
Residual voltage	1.2 V max. between each output terminal and V2
Leakage current	0.1 mA max.

IMPORTANT If the channel mode of a safety output terminal is set as *Safety Pulse Test*, an OFF pulse signal (pulse width: 580 μ s) will be output to diagnose the output circuit when the safety output turns ON. Check the input response time of the output device to be sure that this OFF pulse will not cause malfunctions. Refer to 2-3 *Local Safety I/O Functions* for information on the channel mode.

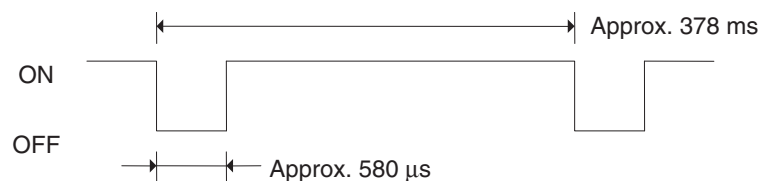

2-2-4 Wiring I/O Devices

Wiring Input Devices

Refer to the following information for input device selection and wiring.

■ Devices with Mechanical Contact Outputs

Examples: Emergency stop buttons and safety limit switches

These devices use both a safety input terminal and test output terminal. A safety input terminal inputs the test output signal (pulse output) of the NEOA-series Controller via a contact output device.

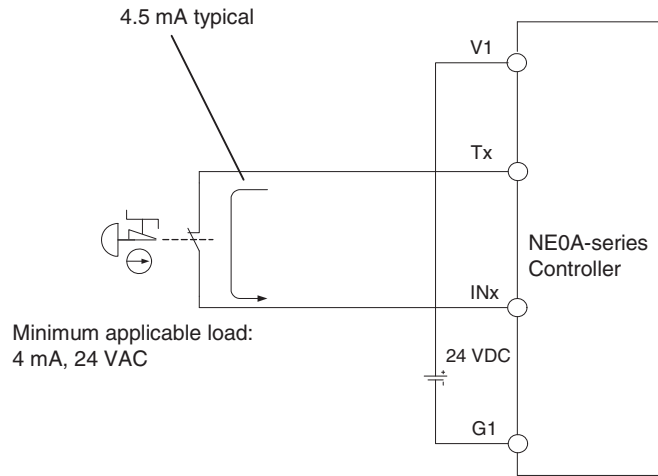

■ Devices with PNP Semiconductor Outputs (Current Sourcing)

Example: Light curtains

A PNP semiconductor output signal from this type of device is input to the NEOA-series Controller's safety input terminal.

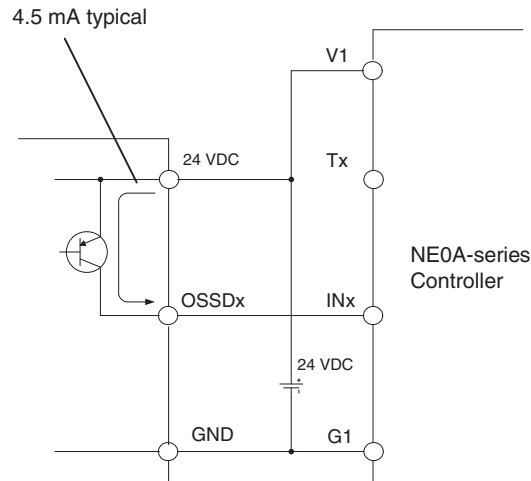

⚠ WARNING

Serious injury may possibly occur due to loss of required safety functions. Use appropriate components or devices according to the requirements given in the following table.



Controlling devices	Requirements
Emergency stop switch	Use approved devices with a direct opening mechanism compliant with IEC/EN 60947-5-1.
Door interlocking switch or limit switch	Use approved devices with a direct opening mechanism compliant with IEC/EN 60947-5-1 and capable of switching micro-loads of 4 mA at 24 VDC.
Safety sensor	Use approved devices compliant with the relevant product standards, regulations, and rules in the country where they are used.
Relay with forcibly guided contacts	Use approved devices with forcibly guided contacts compliant with EN 50205. For feedback, use devices with contacts capable of switching micro-loads of 4 mA at 24 VDC.
Contactors	Use contactors with a forcibly guided mechanism and monitor the auxiliary NC contact to detect contactor failures. For feedback, use devices with contacts capable of switching micro-loads of 4 mA at 24 VDC.
Other devices	Evaluate whether devices used are appropriate to satisfy the requirements of the safety category level.





IMPORTANT

- Properly apply the specified voltage to the NE0A-series Controller’s inputs. Applying an inappropriate DC voltage or any AC voltage may cause reduced safety functions, damage to the NE0A-series Controller, or a fire.
- Be sure to separate I/O cables from high-voltage/current lines.
- Use I/O cables of 30 m or less.
- Do not apply the power supply to the test output terminals. Doing so may result in product damage or burning.

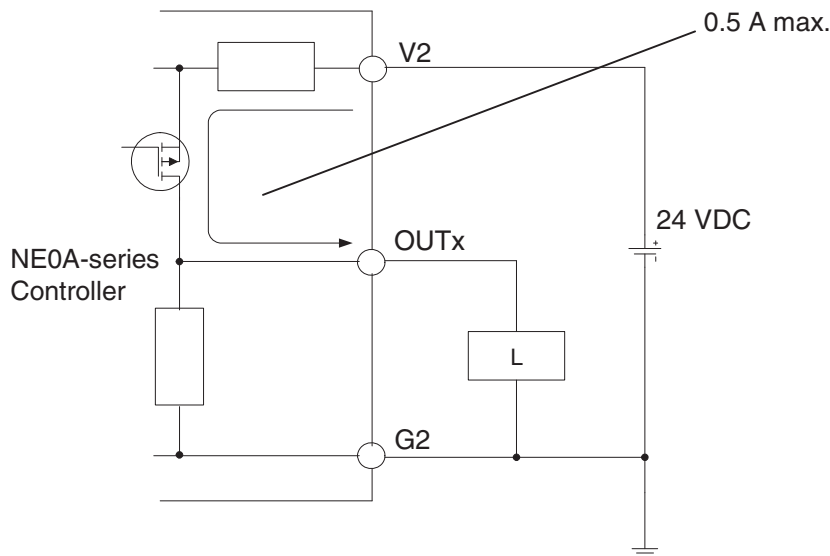
Wiring Output Devices

Refer to the following diagram for selection and wiring of output devices.



 WARNING	
<p>Serious injury may possibly occur due to breakdown of outputs. Do not connect loads beyond the rated value to the safety outputs and the test outputs.</p>	
<p>Serious injury may possibly occur due to loss of required safety functions. Wire the NE0A-series Controller properly so that 24-VDC lines do NOT touch the safety outputs and the test outputs accidentally or unintentionally.</p>	
<p>Serious injury may possibly occur due to loss of required safety functions. Ground the 0-V line of the power supply for external output devices so that the devices do NOT turn ON when the safety output line or the test output line is grounded.</p>	
<p>Serious injury may possibly occur due to loss of required safety functions. Use appropriate components or devices according to the requirements given in the following table.</p>	

Controlling Devices	Requirements
<p>Contactors</p>	<p>Use contactors with a forcibly guided mechanism and monitor the auxiliary NC contact to detect contactor failures.</p> <p>For feedback, use devices with contacts capable of switching micro-loads of 4 mA at 24 VDC.</p>
<p>Other devices</p>	<p>Evaluate whether devices used are appropriate to satisfy the requirements of safety category level.</p>

IMPORTANT

- Be sure to separate I/O cables from high-voltage/current lines.
 - Use output cables of 30 m or less (the output cable length).
 - Do not apply the power supply to the test output terminals. Doing so may result in product damage or burning.
- In addition, if an attempt is made to start the Unit while power is being applied to the output terminals, a fatal error will occur, the MS indicator will light red, and the Unit will not start normally.

2-3 Local Safety I/O Functions

2-3-1 Local I/O Comments

An optional name of up to 32 characters can be registered in the NE0A-series Controller for each I/O terminal, using the Network Configurator. I/O comments are registered in the safety logic settings of the NE0A-series Controller and in the NE1A-series Logic Editor as I/O tag names, enabling easy conceptualization of what is actually being controlled and simplifying programming.

Note For details on making settings using the Network Configurator, refer to 6-3-3 *Setting Local I/O Terminals (Safety Wizard)*.

2-3-2 I/O Power Monitor

The I/O power supply input can be monitored to confirm if it is normal. If an I/O terminal on the NE0A-series Controller is set to any setting other than Not Used and the normal power supply voltage is not input, an error will be detected and can be confirmed using the following:

- The IN PWR and OUT PWR indicators on the front of the Unit will turn OFF.
- The error will be registered in the error history and can be monitored using the Network Configurator.
- The error will be shown in the Unit general status and can be monitored using an NE1A-series Standard PLC.

Note (1) For details on the indicators, refer to 2-1-2 *Indicator Area*.
 (2) For details on the error history, refer to *SECTION 12 Troubleshooting*.
 (3) For details on Unit general status, refer to 6-5 *Remote I/O Allocations*.

2-3-3 Local Safety Inputs

Overview

Connecting to Contact Output Safety Devices

A test pulse signal for the NE0A-series Controller is input by connecting to a contact output device. Input signal line errors, such as the following, can be detected by inputting the test pulse signal.

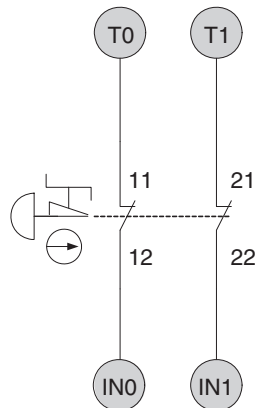

The following can be detected by using the test pulse signal.

- Contact with the power supply line (positive side)
- Ground faults
- Short-circuits between input signal lines

Connecting Semiconductor Output Safety Devices

The output from a 24-VDC semiconductor, such as the OSSD output from a Light Curtain, is input. Errors in the OSSD output signal line (i.e., the NE0A-series Controller's input signal line) is detected at the external connection device.

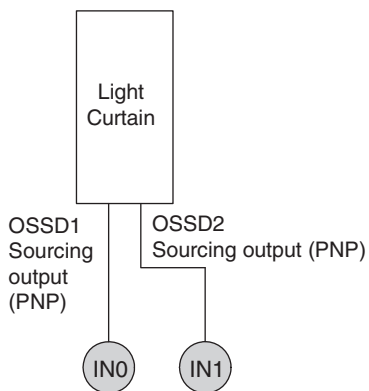

Input Channel Mode

Set the input channel mode for the safety inputs according to the type of the external device to be connected.

Channel mode	Symbol	Description
Not Used	---	Specifies to not use an external input device.
Test pulse from test out	[P]	Specifies connecting a safety device with a contact output in combination with a test output.
Used as safety input	[s]	Specifies connecting a safety device with a semiconductor output, such as a light curtain.
Used as standard input	[ST]	Specifies connecting a standard device (i.e., non-safety device).

Note These symbols are used for notation in the displays for confirming I/O settings in the Safety Wizard.

Test Pulses

Detecting Input Signal Line Errors with Test Pulses (Input Circuit Diagnosis)

A test pulse is output from the test output terminal to diagnose the internal circuit when the external input contact turns ON. Using this function, short-circuits between input signal lines and the power supply (positive side), and short-circuits between input signal lines can be detected.

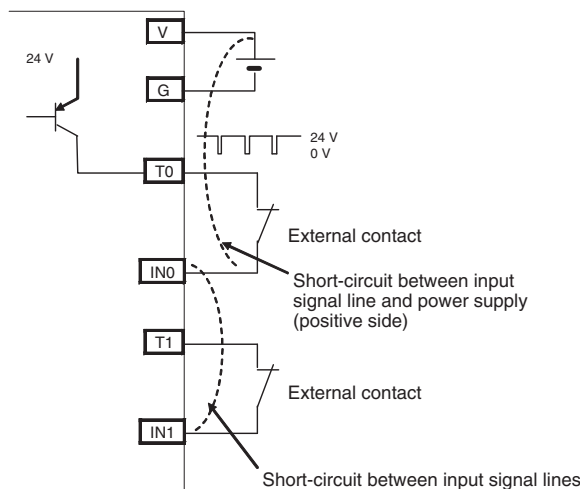

If an error is detected, safety input data and individual safety input status will turn OFF.

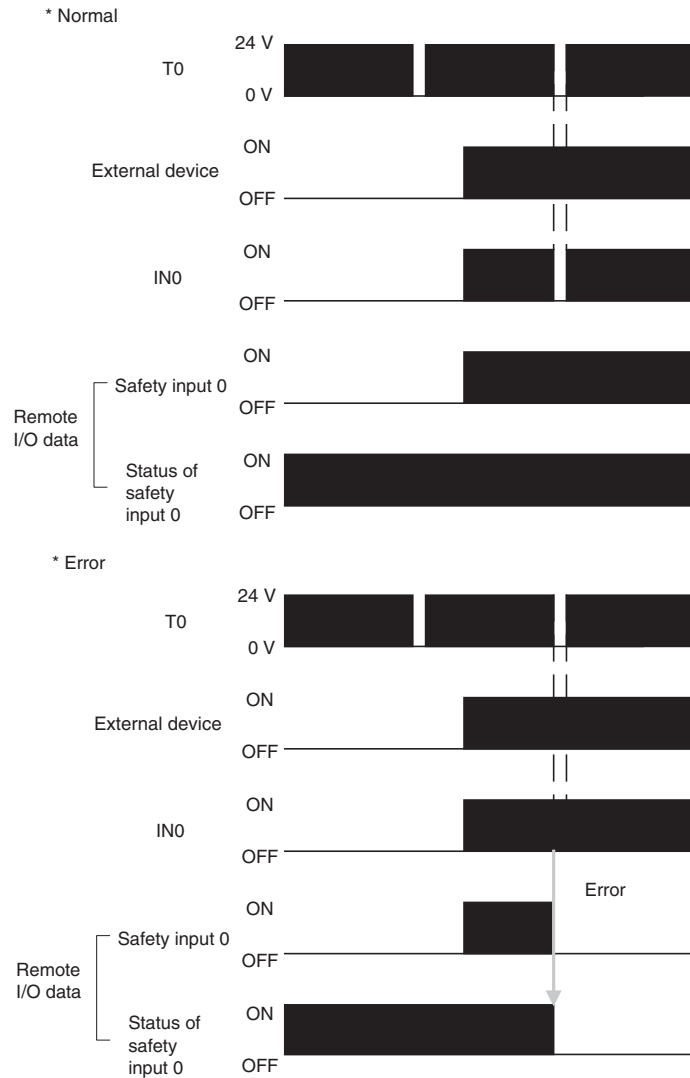

Test Source

When the input channel mode is set to *Test pulse from test out*, select the test output to use for the test source. Specify different test outputs if it is necessary to detect short-circuits between input wiring.

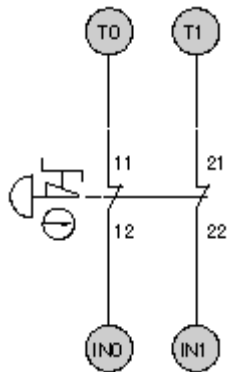

If detecting short-circuits between input wiring is required.

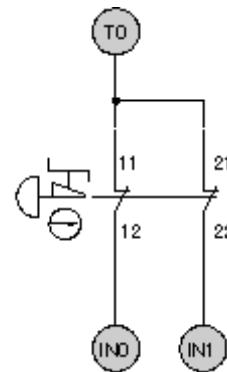

If detecting short-circuits between input wiring is not required.

- Note**
- (1) For the NE0A-SCPU01, you can select T0 or T1 as the test source.
 - (2) Change the test source by using the settings in the Safety Wizard, as described below.

- 1,2,3...**
1. Click the **Advanced Edit** Button in the Edit Input Bits Window or the Edit Output Bits Window.
 2. Open the safety input settings for the safety input, and change the test source.

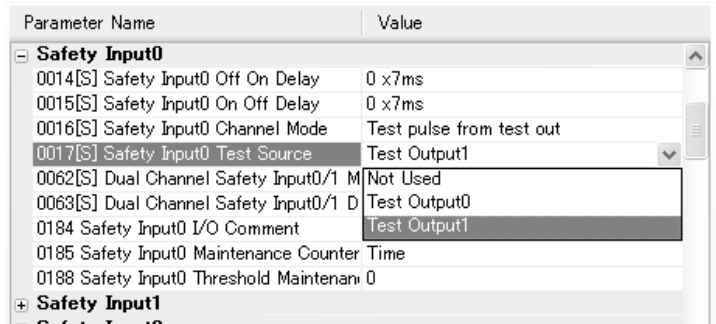

Input Delays

ON delays and OFF delays can be set for the safety inputs of the NE0A-series Controller between 0 and 994 ms (in increments of 7 ms). The effect of chattering from external devices can be reduced by increasing these values.

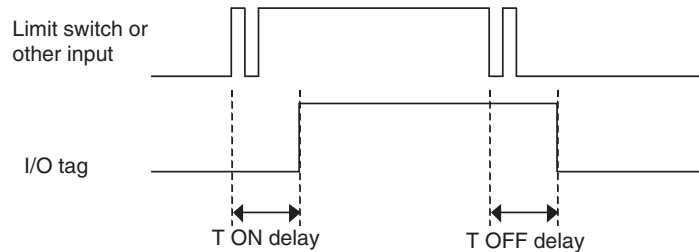

IMPORTANT Add both the input ON delay and input OFF delay to the I/O response performance. For further details, refer to 3-2 Reaction Time.

Single Channel and Dual Channel Modes

The NE0A-series Controller can use safety inputs with a single channel mode or dual channel mode. For dual channel mode, you can further select equivalent logic or complementary logic.

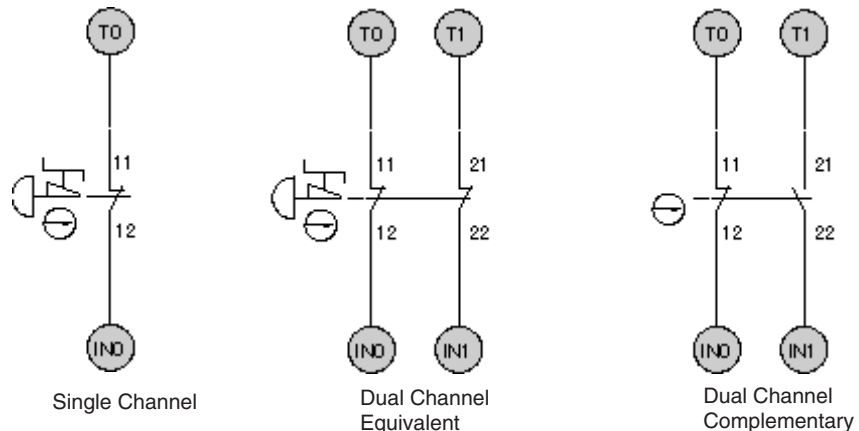

The following actions can be performed if Dual Channel Mode is set:

- Evaluating the data of two inputs and inputting the results to safety logic operations.
- Evaluating the discrepancy time between the data of two inputs.

Channel mode	Symbol	Description
Single Channel	---	Used as an independent safety input.
Dual Channel Equivalent	[e]	Used as a Dual Channel Equivalent Input with the paired safety input.
Dual Channel Complementary	[c]	Used as a Dual Channel Complementary Input with the paired safety input.

Note These symbols are used for notation in the display for confirming I/O settings in the Safety Wizard.

Dual Channel Evaluation

The data input to the safety input terminals is checked for logic discrepancies using dual channels when dual channel mode is set.

Channel mode	Input signals of safety input terminals		Value after evaluation		Meaning of status
	IN (n)	IN (n+1)	IN (n)	IN (n+1)	
Single Channel	0	---	0	---	Inactive (OFF)
	1	---	1	---	Active (ON)
Dual Channel Equivalent	0	0	0	0	Inactive (OFF)
	0	1	0	0	Discrepant
	1	0	0	0	Discrepant
	1	1	1	1	Active (ON)
Dual Channel Complementary	0	0	0	1	Discrepant
	0	1	0	1	Inactive (OFF)
	1	0	1	0	Active (ON)
	1	1	0	1	Discrepant

n = Even number

Discrepancy Time Evaluation (Monitoring Logic Discrepancies between Two Inputs)

For two inputs set in Dual Channel Mode, the time is monitored from a change in the value of one input to a change in the value of the other input (called the discrepancy time). When the value of the other input does not change within the set discrepancy time, it is treated as an error. The discrepancy time can be set in increments of 10 ms between 0 (disabled) and 65,530 ms. In the Safety Wizard, it is set to 500 ms. The discrepancy time cannot be set in Single Channel Mode.

Operation for Dual Channel Equivalent Inputs: Normal Operation

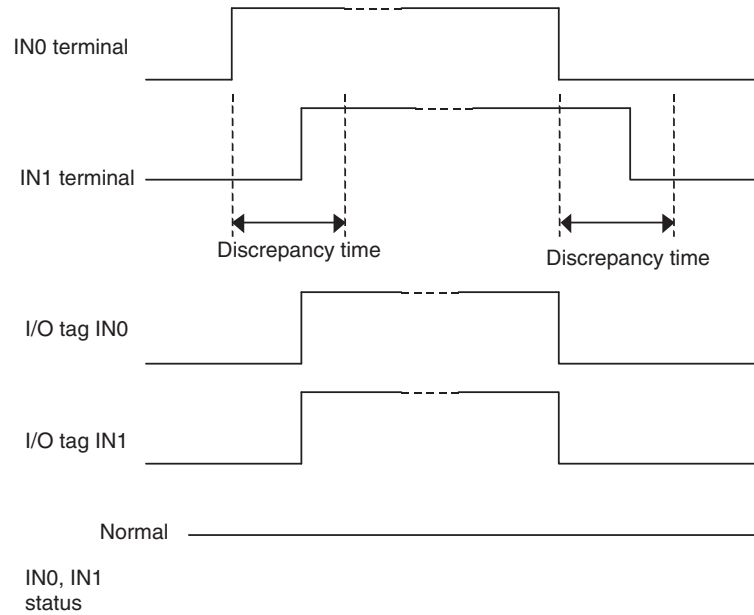

Operation for Dual Channel Equivalent Inputs: Discrepancy Error

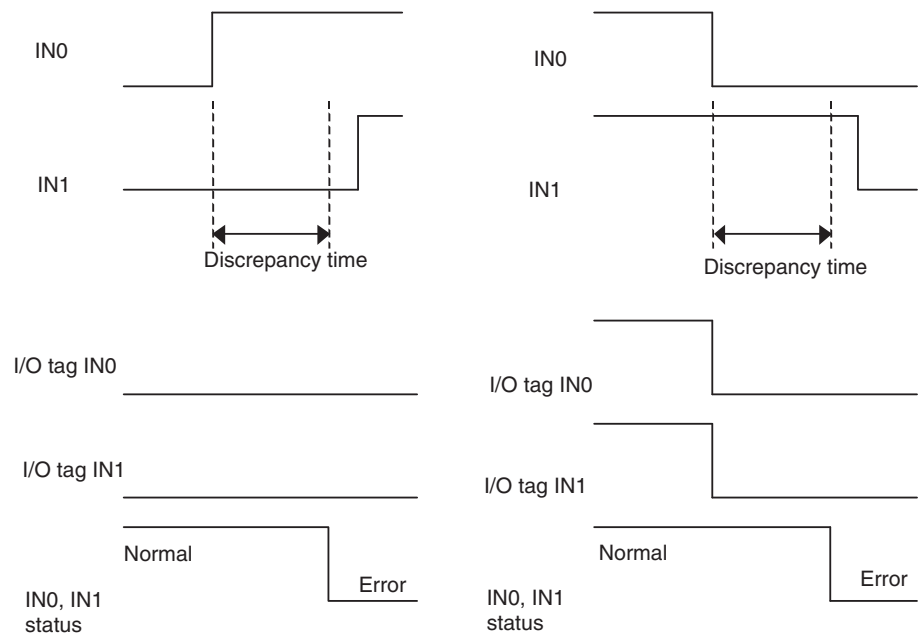

Error Handling

Behavior at Error Detection in Single Channel Mode

The following operations are performed if an error is detected during self-diagnosis.

- Input evaluation results corresponding to safety inputs for which errors have been detected are made inactive.
- The indicator of the safety input with the error lights red.
- The error appears in the error history.
- The NE0A-series Controller continues to operate.

Behavior at Error Detection in Dual Channel Mode

The following operations are performed if an error is detected during self-diagnosis.

- Input evaluation results corresponding to safety input pairs for which errors have been detected are made inactive.
- The indicators of both the safety input terminals with the error light red.
- The error appears in the error history.
- The NE0A-series Controller continues to operate.

The following operations are performed if an error is detected in one of the two inputs.

- Input evaluation results corresponding to safety input pairs for which errors have been detected are made inactive.
- The indicator of the safety input with the error lights red, and the indicator of the other input flashes red
- The error appears in the error history.
- The NE0A-series Controller continues to operate.

Error Latch Time Setting

The time to latch the error state when an error occurs in a safety input or test output can be set. The error state will continue until the error latch time passes even if the cause of the error is momentarily removed. When monitoring errors from a monitoring system, take the monitoring interval into account when setting the error latch time. The error latch time can be set in increments of 10 ms between 0 and 65,530 ms. The default is 1,000 ms.

Resetting Errors

All the following conditions must be met to reset errors that occur in the safety inputs.

- The cause of the error is removed.
- The latch error time has elapsed.
- An inactive signal is input (e.g., pressing the emergency stop button or opening a door).

2-3-4 Local Safety Output Functions**Overview**

The safety outputs of the NE0A-series Controller can be flexibly set to handle various applications by selecting the setup and wiring to match the type of external device to be connected and the safety level to be achieved.

The safety outputs of the NE0A-series Controller can detect output signal line errors, such as the following.

- Contact with the power supply line (positive side, only when the output is OFF)
- Ground faults

If the test pulse is enabled, the following errors can be detected.

- Contact with the power supply line (positive side, when the output is ON or OFF)
- Ground faults
- Short-circuits between output lines

Output Channel Mode

Set the output channel mode for the safety outputs according to the external device that is connected.

Channel mode	Symbol	Description
Not Used	---	An output device is not connected.
Safety	[S]	A test pulse is not output when the output is ON. Contact with the power supply line (positive side) when the output is OFF and ground faults will not be detected.
Safety Pulse Test	[P]	A test pulse is output when the output is ON. Contact with the power supply line (positive side) with output ON or OFF, ground faults, and short-circuits between output signals can be detected.

Note These symbols are used for notation in the displays for confirming I/O settings in the Safety Wizard.

IMPORTANT If the channel mode is set to the Safety Pulse Test Mode, an OFF pulse signal (pulse width: 580 ms) will be output to diagnose the output circuit when the safety output turns ON. Check the input response time of the control device connected to the NE0A-series Controller to be sure that this OFF pulse will not cause malfunctions.

Single Channel and Dual Channel

The safety outputs of the NE0A-series Controller can be used in Single Channel or Dual Channel Mode. (Only equivalent logic can be used in Dual Channel mode.)

The following operations are performed when Dual Channel Mode is set.

- An error occurs if the two outputs from the safety logic operation are not equivalent.
- If an error is detected in at least one of the two output terminals, the two outputs for the external device are both turned OFF.

Channel Mode	Description
Single Channel	Used as an independent safety input terminal.
Dual Channel	Used as Dual Channel output with a paired safety input. The output can turn ON if the paired safety input is normal.

Note There is no discrepancy time setting for safety outputs.

Dual Channel Evaluation

The data input to the safety input terminals is checked for logic discrepancies when Dual Channel Mode is set.

Channel mode	Values after logic operation		Output signals from safety output terminals		Meaning of status
	OUT (n)	OUT (n+1)	OUT (n)	OUT (n+1)	
Single Channel	0	---	0	---	Inactive (load OFF)
	1	---	1	---	Active
Dual Channel	0	0	0 (OFF)	0 (OFF)	Inactive (load OFF)
	0	1	0 (OFF)	0 (OFF)	Output data error (load OFF)
	1	0	0 (OFF)	0 (OFF)	Output data error (load OFF)
	1	1	1 (ON)	1 (ON)	Active

n = Even number

Error Handling

Behavior at Error Detection in Single Channel Mode

The following operations are performed if an error is detected during self-diagnosis.

- The safety inputs for which errors have been detected are made inactive regardless of the results of the safety logic operations.
- The indicator of the safety input with the error lights red.
- The error appears in the error history.
- The NE0A-series Controller continues to operate.

Behavior at Error Detection in Dual Channel Mode

The following operations are performed if an error is detected in one of the two inputs.

- Outputs to external devices are immediately made inactive regardless of the results of the safety logic operations.
- The indicator of the safety input with the error lights red, and the indicator of the other input flashes red.
- The error appears in the error history.
- The NE0A-series Controller continues to operate.

The following operations are performed if the two outputs from the output terminals are not equivalent.

- Outputs to external devices are made inactive regardless of the results of the safety logic operations
- The indicators of both the safety input terminals with the error light red.
- The error appears in the error history
- The NE0A-series Controller continues to operate

Error Time Latch Setting

Error latching is provided, just as with safety input circuits. The error latch time can be set in increments of 10 ms between 0 and 65,530 ms. The default is 1,000 ms.

Resetting Errors

All the following conditions must be met to reset errors that occur in the safety input terminals.

- The cause of the error must be removed.
- The latch error time must have elapsed.
- The output signal to the output terminal must be inactive after safety logic operations for the corresponding safety output terminal.

SECTION 3

Response Performance

This section provides information require to access the response performance of the NE0A-series Safety Network Controllers.

3-1	Start Time	34
3-2	Reaction Time	36
3-2-1	Reaction Time Concepts	36
3-2-2	Local Input and Local Output Reaction Times	36
3-2-3	Input Reaction Time	36
3-2-4	Output Reaction Time	36

3-1 Start Time

Operation Flow

The following flowchart shows the operation cycle of the NE0A-series Controller.

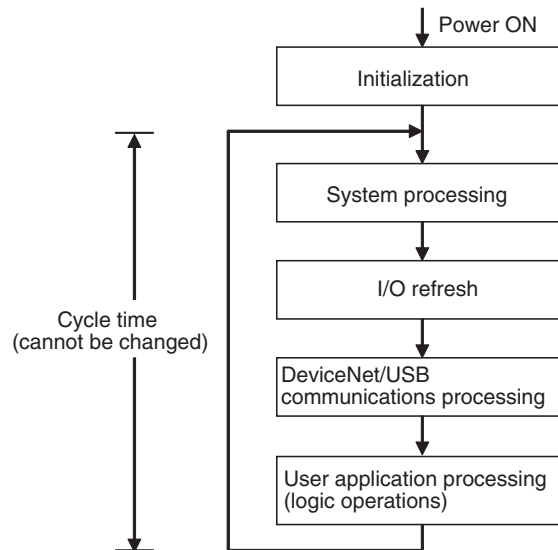

Initialization Time

The NE0A-series Controller performs initialization when the power supply is turned ON. During initialization, the NE0A-series Controller performs hardware self-diagnosis. The initialization takes up to 5 s to be completed from the time that the power is turned ON.

DeviceNet Network Online Connection Time

Once the NE0A-series Controller has completed initialization, it will connect to the DeviceNet network after the following operations have been executed:

- Automatic baud rate detection
- Node address duplication check

When the online connection has been established, the NS indicator will light or flash green.

The time required to connect to the network depends on the system configuration.

The NE0A-series Controller matches the baud rate to the network baud rate, so it cannot detect the baud rate and connect to the network if there are no frames being sent over the network. The time required for the NE0A-series Controller to connect to the network will therefore depend on the system configuration, as shown in the following examples, so calculate the time according to the system being used.

Example 1: Communications Frames Continuously Being Sent Over the Network

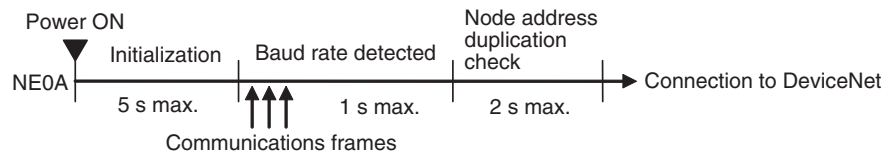

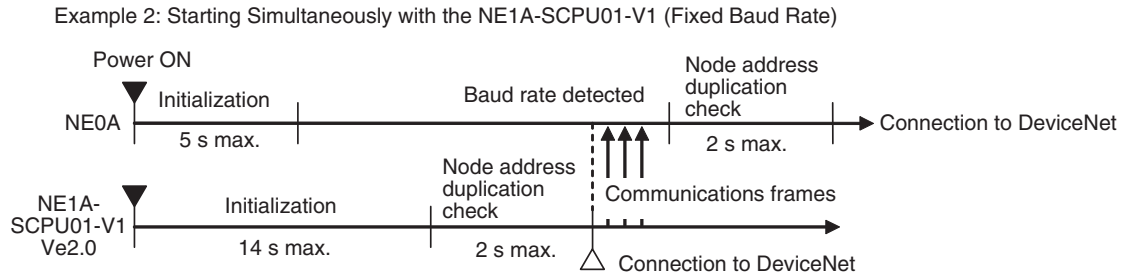

Time Until Start of NE0A-series Controller Operation (RUN Mode)

When the NE0A-series is set for automatic operation (i.e., Automatic Execution Mode), operation (RUN) will start within 5 s after the power is turned ON. To confirm from an NE1A-series Controller or standard PLC whether NE0A-series Controller operation has started normally, monitor the RUN Status Flag and the Normal Status Flag in the General Status, in the Remote Input Byte Area, or by using an additional output.

- Note**
- (1) For details on General Status and the Remote Input Byte Area, refer to *6-5 Remote I/O Allocations*.
 - (2) For details on additional outputs, refer to *6-4-6 Safety Output Evaluation*.

3-2 Reaction Time

3-2-1 Reaction Time Concepts

The reaction time is the time required to stop machine operation in a worst-case scenario considering the occurrence of faults and failures in the safety chain.

The reaction time is used to calculate the safety distance.

3-2-2 Local Input and Local Output Reaction Times

NE0A-series Controller local input, logic operation, and local output reaction times can be determined as given below.

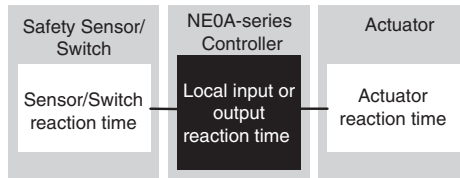

Local input or output reaction time = 20 ms + Input ON/OFF delay time + Output ON/OFF delay time

3-2-3 Input Reaction Time

The input reaction time is the time from when an input terminal signal is changed until the signal is sent to the network. The input reaction time is determined as given below.

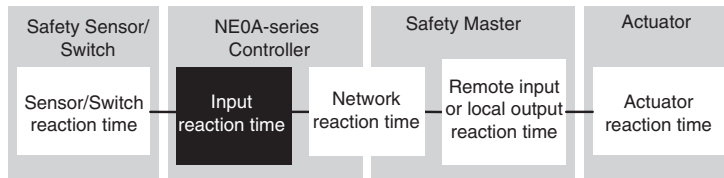

Input reaction time = 25 ms + Input ON/OFF delay time

3-2-4 Output Reaction Time

The output reaction time is the time from when a network signal is received until the output terminal is changed.

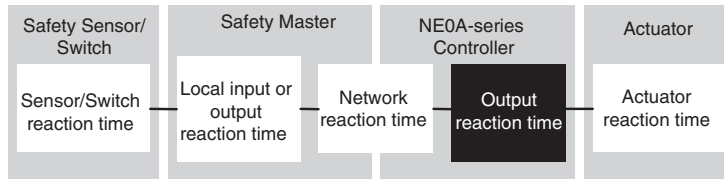

Output reaction time = 10 ms + Output ON/OFF delay time

Note For details on overall system reaction times, refer to the *DeviceNet Safety System Configuration Manual* (Cat. No. Z905).

SECTION 4

General Procedure

This section describes the overall procedure required to use an NE0A-series Safety Network Controller.

4-1	Overview of Procedure	38
-----	-----------------------------	----

4-1 Overview of Procedure

The following diagram shows the general procedure for using NE0A-series Controllers. For details on the network configuration and connection types, refer to the *DeviceNet Operation Manual* (Cat. No. W267).

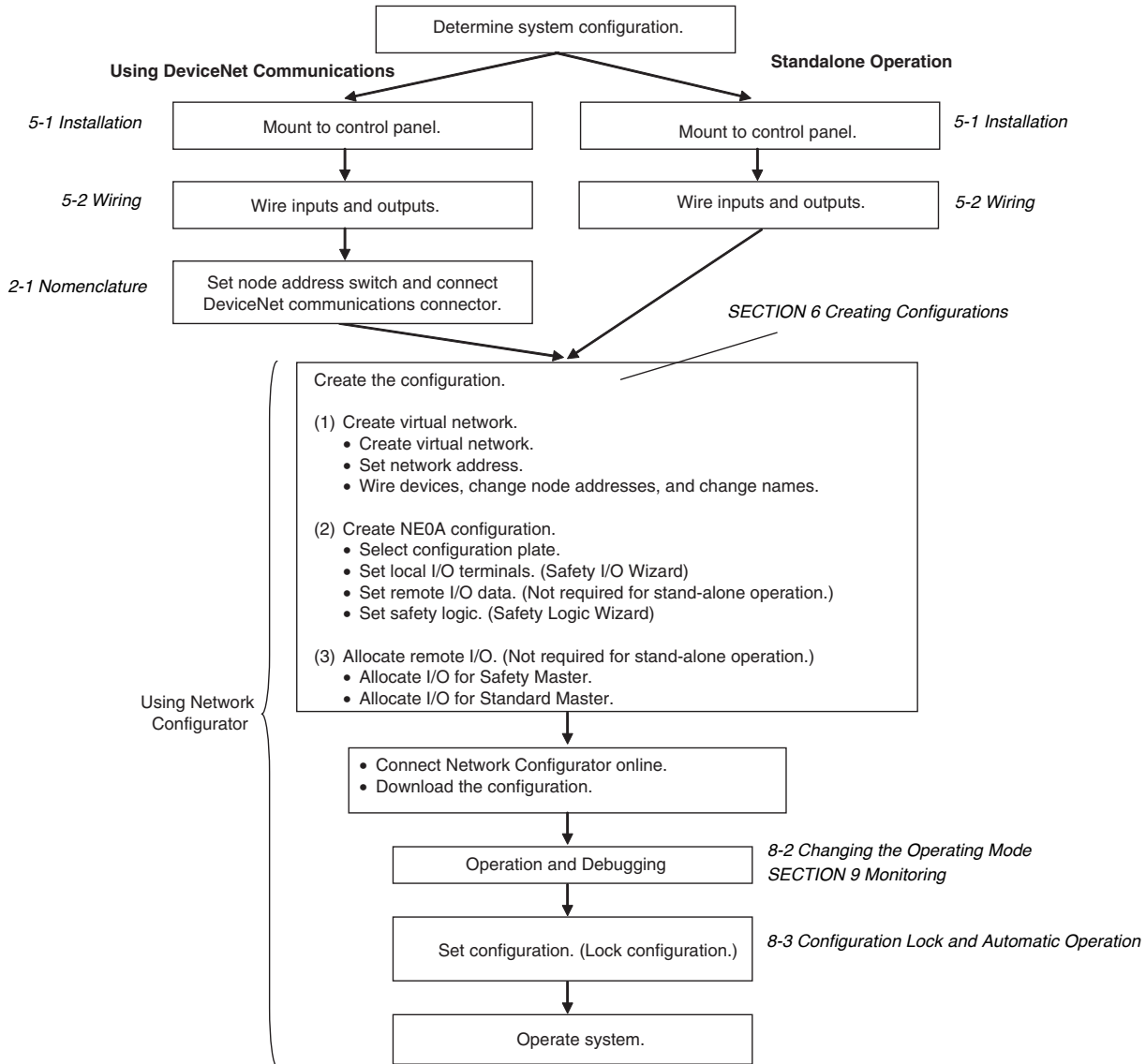

SECTION 5

Installation and Wiring

This section describes how to install and wire an NEOA-series Safety Network Controller.

5-1	Installation.	40
5-1-1	Requirements for Installation and Wiring	40
5-1-2	Mounting to the Control Panel	41
5-2	Wiring	43
5-2-1	General Instructions on Wiring.	43
5-2-2	Wiring the Power Supply and I/O Lines.	44

5-1 Installation

5-1-1 Requirements for Installation and Wiring

Consider the following for installation and wiring to improve the reliability of the NEOA-series Safety Network Controller System and to fully exploit the system's capabilities.

Installation and Storage Environment

Do not use or store the NEOA-series Controller in any of the following locations.

- Locations subject to direct sunlight
- Locations subject to temperatures or humidity outside the ranges specified in the specifications
- Locations subject to condensation as the result of severe changes in temperature
- Locations subject to corrosive or flammable gases
- Locations subject to dust (especially iron dust) or salts
- Locations subject to water, oil, or chemicals
- Locations subject to shock or vibration

Take appropriate and sufficient measures when installing systems in the following locations. Inappropriate and insufficient measures may result in malfunction.

- Locations subject to static electricity or other forms of noise
- Locations subject to strong electromagnetic fields
- Locations subject to possible exposure to radioactivity
- Locations close to power supplies

5-1-2 Mounting to the Control Panel

- Use the NE0A-series Controller in an enclosure with IP54 protection or higher according to IEC/EN 60529.
- Use DIN Track (TH35-7.5/TH35-15 according to IEC 60715) to mount the NE0A-series Controller in the control panel. Mount the Controller to the DIN Track using PFP-M End Plates (not included with the NE0A-series Controller) to prevent it from falling off the DIN Track because of vibration.
- Provide sufficient space around the NE0A-series Controller, at least 5 mm at the sides and at least 50 mm at the top and bottom, for ventilation and wiring.

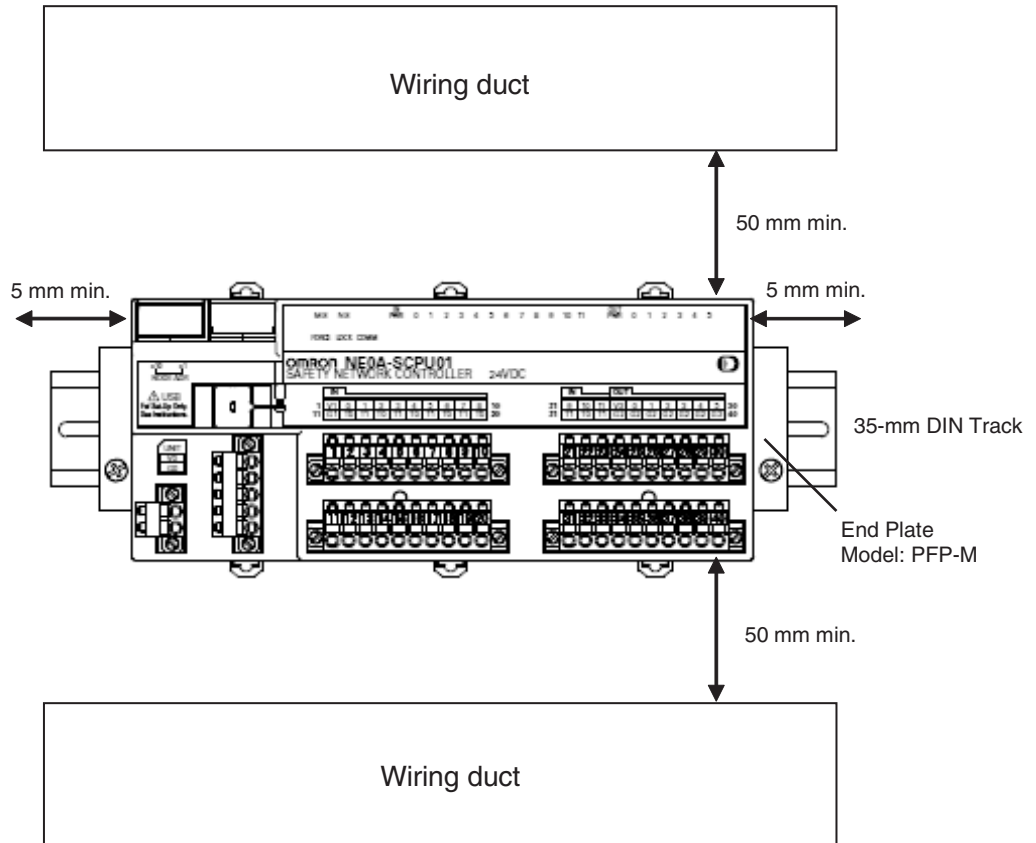

Note The NE0A-series Controller can be mounted only to DIN Track. Do not screw the Controller to the control panel.

Mounting

To ensure proper ventilation, mount the NE0A-series Controller as shown in the following diagram.

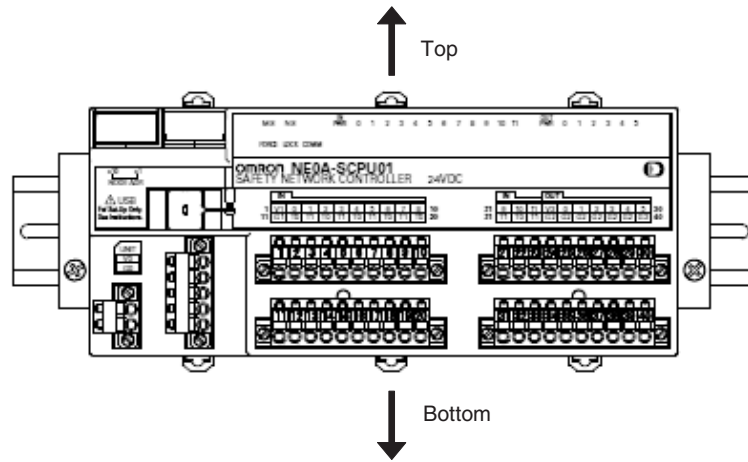

Do not mount the NE0A-series Controller as in the following diagrams.

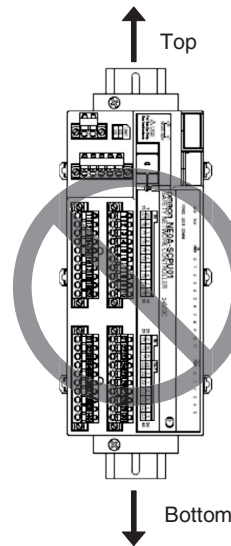
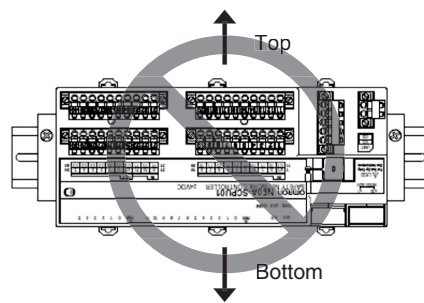
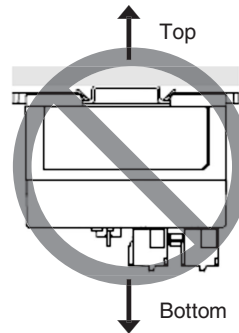
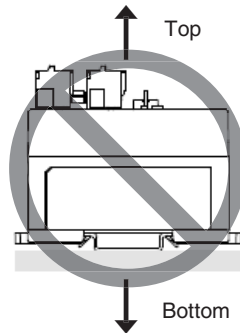

Note Refer to 2-1-7 Dimensions and Weight for dimensions and weights.

5-2 Wiring

5-2-1 General Instructions on Wiring

Precaution:

- Use separate power supplies for the internal circuit power supply and the I/O power supply.
- Do not connect the internal circuit power supply to a relay or other control component.
- Do not use a cable that is longer than 3 m for the internal circuit power supply.
- To prevent wire clippings from getting into the NE0A-series Controller, do not remove the label on the Controller before wiring has been completed.
- After wiring has been completed, be sure to remove the label from the Controller to enable heat dissipation for proper cooling.

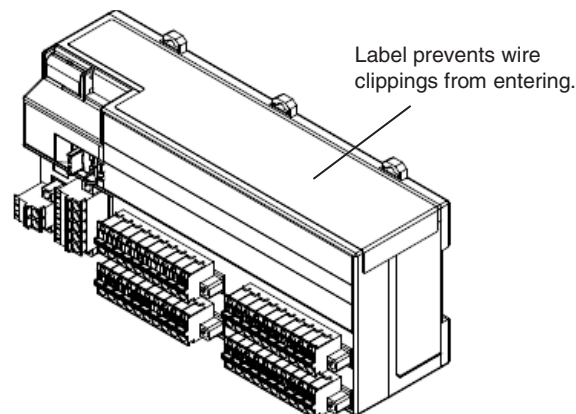

- Disconnect the NE0A-series Controller from the power supply before starting any wiring operations. Devices connected to the Controller may operate unexpectedly if wiring is performed with the power supply connected.
- Be careful not to get your fingers caught when attaching connectors to the plugs on the NE0A-series Controller.
- Do not apply power to the output terminals. Doing so will cause damage to or burning of the product. In addition, if an attempt is made to start the Unit while power is being applied to the output terminals, a fatal error will occur, the MS indicator will light red, and the Unit will not start correctly.

Note

- For details on setting the node address switch and wiring the DeviceNet communications connector and USB cable, refer to *2-1 Nomenclature*.
- For details on I/O wiring, refer to *Appendix A Application Templates*.

5-2-2 Wiring the Power Supply and I/O Lines

Wire Sizes

Use the following wires to connect external I/O devices to the NEOA-series Controller.

Solid wire	0.2 to 2.5 mm ² (AWG 24 to AWG 12)
Stranded (flexible) wire	0.34 to 1.5 mm ² (AWG 22 to AWG 16) Stranded wires should be prepared by attaching ferrules with plastic insulation collars (DIN 46228-4 standard compatible) before connecting them.

Recommended Materials and Tools

Insulated Pin Terminals

Use a pin terminal with an insulated cover compliant with the DIN 46228-4 standard. Pin terminals similar in appearance but not compliant with the standard may not match the terminal block on the NEOA-series Controller. (The wiring dimensions are rough standards. Confirm the dimensions beforehand.) Use wires of the same diameter if two-wire pin terminals are used.

- Note**
- When wiring with pin terminals, be sure to insert pin terminals all the way into the terminal block.
 - When using two-wire pin terminals, use wires of the same diameter.
 - When using two-wire pin terminals, insert the pin terminal so that metal portion of the pin terminal is inserted straight into the terminal block, i.e., so that the long sides of the insulating cover are vertical.

Reference Specifications (Product Specifications for Phoenix Contact)

Model of pin terminal		Wire dimensions		Pin terminal specifications					Dimensions
		Cross-sectional area of conductor (mm ²)	AWG	Stripped length of insulation (mm)	Overall length L1 (mm)	Length of metal part L2 (mm)	Inner diameter of conductor D1 (mm)	Inner diameter of insulative cover D2 (mm)	
One-wire pin terminals	Al 0,34-8TQ	0.34	22	10	12.5	8	0.8	2.0	*1
	Al 0,5-10WH	0.5	20	10	16	10	1.1	2.5	
	Al 0,75-10GY	0.75	18	10	16	10	1.3	2.8	
	Al 1-10RD	1.0	18	10	16	10	1.5	3.0	
	Al 1,5-10BK	1.5	16	10	18	10	1.8	3.4	
Two-wire pin terminals	Al-TWIN 2 x 0,75-10GY	2 x 0.75	-	10	17	10	1.8	2.8/5.0	*2
	Al-TWIN 2 x 1-10RD	2 x 1	-	10	17	10	2.05	3.4/5.4	

*1: One-wire Pin Terminal *2: Two-wire Pin Terminal

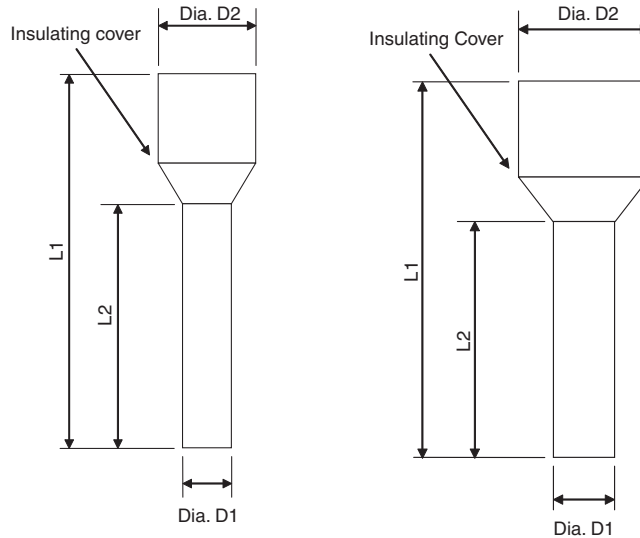

Terminal Crimping Tool

Manufacturer	Model
Phoenix Contact	CRIMPFOX UD6 or CRIMPFOX ZA3

Power Supply Selection

Use a DC power supply satisfying the following requirements.

- The secondary circuits of the DC power supply must be isolated from the primary circuit by double insulation or reinforced insulation.
- The DC power supply must satisfy the requirements for class 2 circuits or limited voltage/current circuits defined in UL 508.
- The output hold time must be 20 ms or longer.

SECTION 6

Creating Configurations

This section describes how to configure an NE0A-series Safety Network Controller.

6-1	Overview	48
6-2	Creating a Virtual Network	49
6-2-1	Starting the Network Configurator	49
6-2-2	Creating a Virtual Network	49
6-3	Configuring NE0A-series Controllers	53
6-3-1	Starting the Safety Wizard	53
6-3-2	Application Templates	54
6-3-3	Setting Local I/O Terminals (Safety Wizard)	58
6-3-4	Setting Networks	59
6-3-5	Overview of Safety Logic Settings (Safety Logic Wizard)	61
6-3-6	Checking the Settings	65
6-4	Descriptions of Logic Commands	66
6-4-1	Safety Input Evaluation	66
6-4-2	Input Condition Operations	70
6-4-3	Reset Operation	73
6-4-4	Output Condition Operation	76
6-4-5	Welding Check (EDM: External Device Monitoring) Operation	79
6-4-6	Safety Output Evaluation	81
6-5	Remote I/O Allocations	83
6-5-1	Overview	83
6-5-2	Types of Data	83
6-5-3	Supported I/O Data (I/O Assembly Data)	85
6-5-4	Allocations to a Safety Master	87
6-5-5	Allocations to a Standard Master	88
6-6	Saving Project Files	90
6-6-1	Saving Project Files	90
6-6-2	Reading Project Files	90
6-6-3	Protecting Project Files with Passwords	90

6-1 Overview

Network Configurator version 2.1 is used to create NEOA-series Controller configurations.

Network Configurator Window

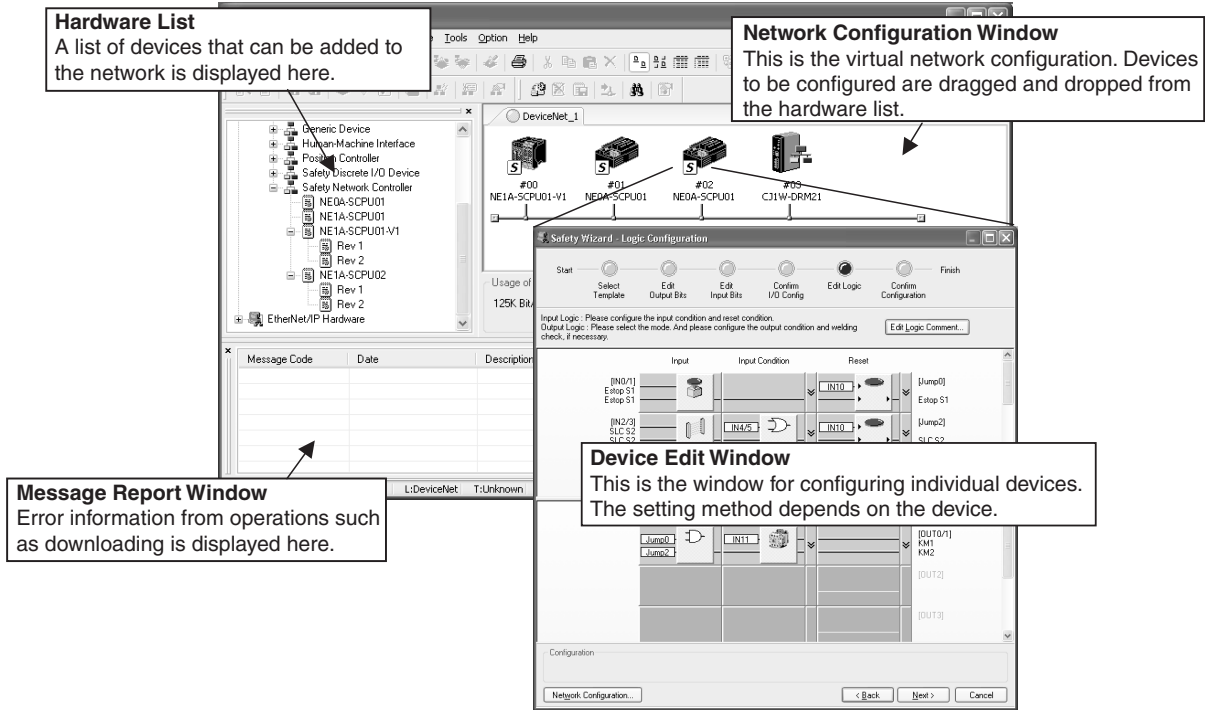

Basic Flow

Use the following basic flow in the Network Configurator to create configurations and download them to the devices.

- 1,2,3...
1. Create a virtual network using the Network Configurator running on a personal computer.
 2. Add to the virtual network the same devices as in the actual network.
 3. Configure each device.
 4. Download the configurations to the actual network.

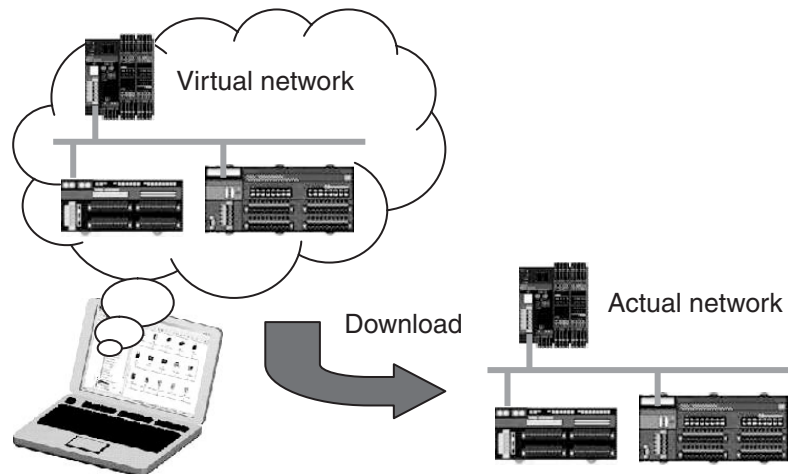

6-2 Creating a Virtual Network

This section describes how to start the Network Configurator and create a virtual network.

- 1,2,3...
1. Create a virtual network
 2. Set a network number.
 3. Allocate devices to the virtual network.
 4. Change the node addresses of the devices.
 5. Change the comments for the devices.

6-2-1 Starting the Network Configurator

Select **Programs - OMRON Network Configurator for DeviceNet Safety - Network Configurator** from the Start Menu.

6-2-2 Creating a Virtual Network

What Is a Virtual Network?

The Network Configurator is used to create a network on the personal computer that is identical to the actual network. The network on the computer is called a virtual network.

Creating a Virtual Network

Create a virtual network using the *DeviceNet_1* Network Tree, which appears when the Network Configurator is started. A new *DeviceNet_1* Network Tree can be created by selecting **File - New - DeviceNet** from the Menu Bar.

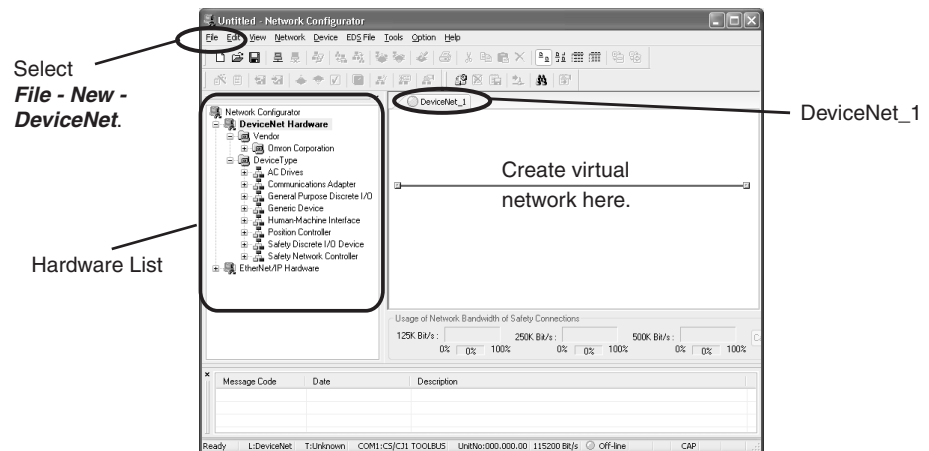

Setting the Network Numbers

First, set the network numbers.

What Is a Network Number?

Multiple networks can be constructed in a DeviceNet Safety System, and each of the networks is given a unique network number. The network number is combined with the node address to give each device a unique identification number.

■ TUNID (Target Unique Node Identifier)

The value that combines the network number with the node address is called the TUNID and is used to uniquely identify each device. When the Configurator performs actions such as downloading the configuration, it checks whether the TUNIDs match to prevent access to different devices.

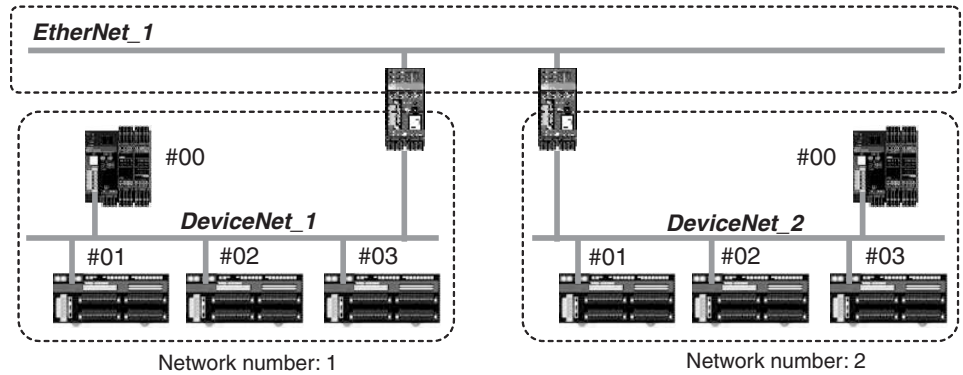

Setting the Network Number Automatically or Manually

The Network Configurator sets the network number automatically, so it is normally not necessary to change this setting. Using the manual setting is recommended, however, if virtual networks will be created on different computers.

Automatic setting (default)

Manual setting

The Network Configurator automatically generates a number based on the date and time.

Set a unique value for each network.

IMPORTANT Set a unique network number for each network. If connections are made to more than one network with the same network number, the system may operate unpredictably.

Acquiring Network Numbers

The network number can be acquired from the actual network in the following two ways:

- ✓ Acquire the network number along with the overall network configuration by uploading the network.
- ✓ Acquire only the network number by clicking the **Get from the actual network** Button on the Network Property Dialog Box.

Resetting the Network Number

To change a network number that has been downloaded to a device, the device must be reset to its defaults. Refer to 7-6 *Reset* for information on resetting.

Placing Devices in a Virtual Network

Next, select the required devices from the hardware list, beginning with the NEOA-series Controller, and drag and drop them into the virtual network. The NEOA-series Controller is included in the **Device Type - Safety Network Controller** group.

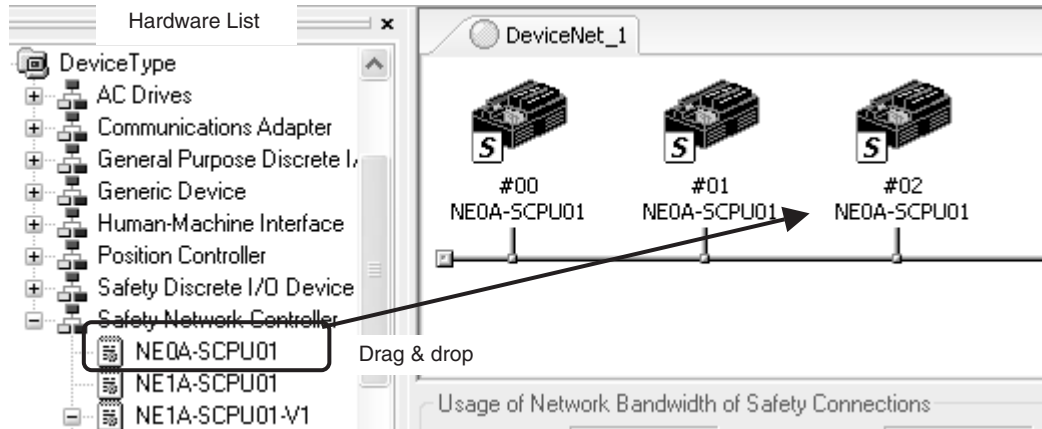

- Note**
- Press the **Delete** Key to delete a device from the virtual network.
 - Devices can be moved to different positions on the virtual network. To move a device, right-click on the device to select it, and then drag and drop it in the new position.

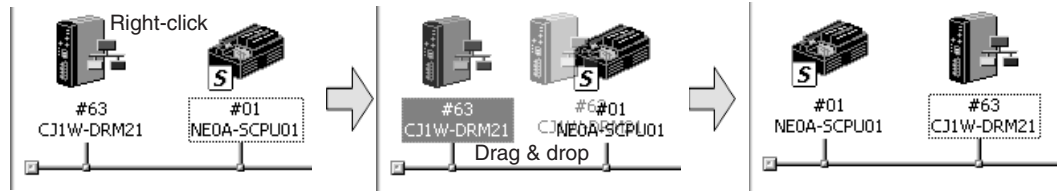

Changing the Node Address of a Device

Next, change the node addresses of the devices on the virtual network so that they match the node address switch settings for the actual devices.

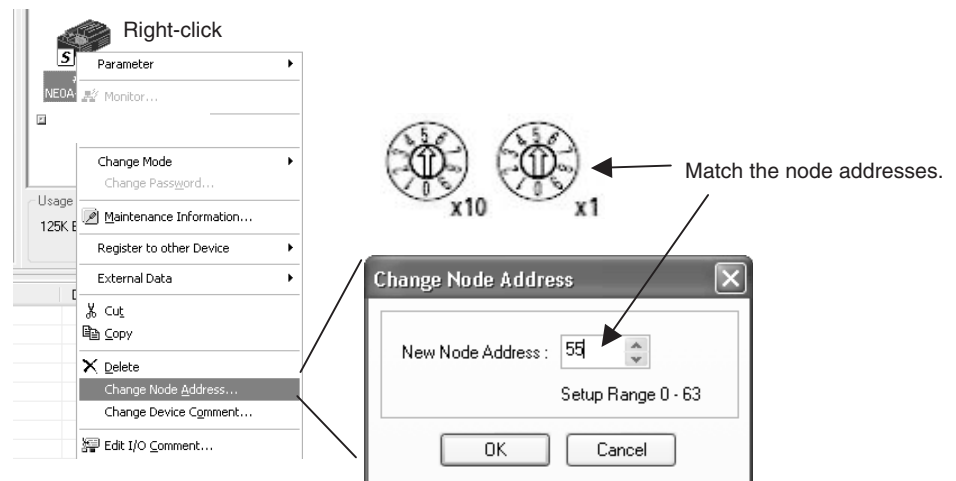

- Note**
- The node addresses will affect memory allocations of the I/O Memory Area for the OMRON CS/CJ-series DeviceNet Master Unit if fixed allocations are used

for the NEOA-series Controllers. For details, refer to *6-5-5 Allocations to a Standard Master*.

Changing Device Comments

Optional comments, such as device names or control panel names, can be set for devices on a virtual network by right-clicking and selecting **Change Device Comment** from the pop-up menu.

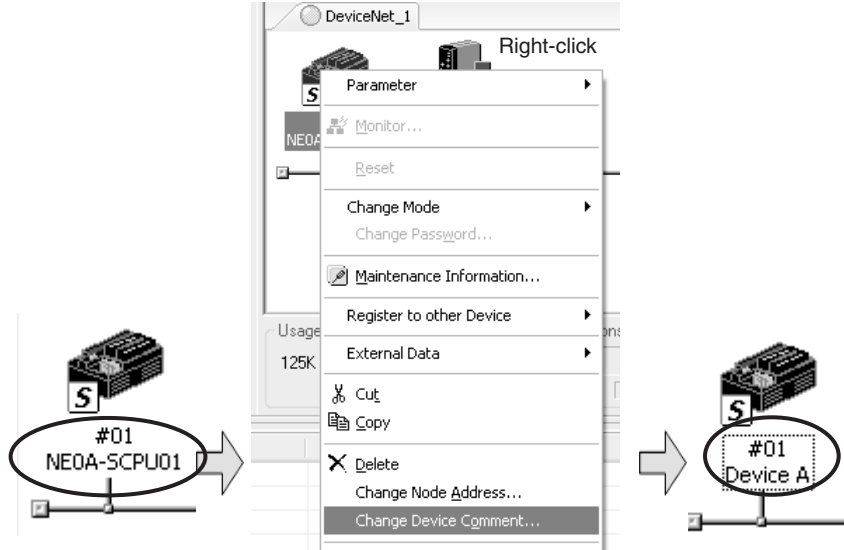

6-3 Configuring NE0A-series Controllers

This section describes how to use the NE0A-series Setting Wizard to create the configuration for an NE0A-series Controller. Use the following basic procedure:

- 1,2,3...**
1. Start the NE0A Setting Wizard called the Safety Wizard.
 2. Set the application template.
 3. Set the logical I/O terminals using the Safety Wizard.
 - Set the logical input terminals.
 - Set the logical output terminals.
 - Check the local I/O settings.
 4. Make the network settings.
 - Enable or disable (standalone) DeviceNet communications.
 - Set the remote I/O data.
 - Set the default connection path.
 5. Make the safety logic settings.
 6. Check the settings.

6-3-1 Starting the Safety Wizard

To start the Safety Wizard, double-click the NE0A-series Controller that is to be configured. The configuration for the NE0A-series Controller is created using windows displayed by the Safety Wizard. Make the settings in the order they are displayed by the Wizard.

The screenshot shows the 'Safety Wizard - Logic Configuration' window. At the top, there is a progress bar with buttons for 'Start', 'Select Template', 'Edit Output Bits', 'Edit Input Bits', 'Confirm I/O Config', 'Edit Logic', 'Confirm Configuration', and 'Finish'. Below this, there are instructions for 'Input Logic' and 'Output Logic'. The main area is divided into sections for 'Input', 'Input Condition', 'Reset', 'Output Condition', 'Welding Check(EDM)', and 'Output'. Each section contains a grid of terminals and their associated logic blocks. Callouts provide the following instructions:

- 'Settings can be made while checking the present phase.' (points to the progress bar)
- 'Click the button to jump to any setting phase.' (points to the 'Edit Logic' button)
- 'Click to set the function block parameters.' (points to the 'Jump' buttons in the logic grid)
- 'Click to set function block parameters.' (points to the 'Jump' buttons in the logic grid)
- 'Click to select the function block.' (points to the 'Jump' buttons in the logic grid)
- 'Set the DeviceNet communications and remote I/O data.' (points to the 'Network Configuration...' button)
- 'Click to cancel the NE0A-series Controller configuration. The settings up to that point will not be saved. To save the settings, go to the *Confirm Configuration* phase and click the **Finish** Button.' (points to the 'Cancel' button)
- 'Click to return to previous setting phase.' (points to the '< Back' button)
- 'Click to move to next setting phase.' (points to the 'Next >' button)

6-3-2 Application Templates

First, select whether an application template is to be used or whether to start creating the configuration from the default settings. Application templates can be used to more efficiently create the configuration for the NE0A-series Controller.

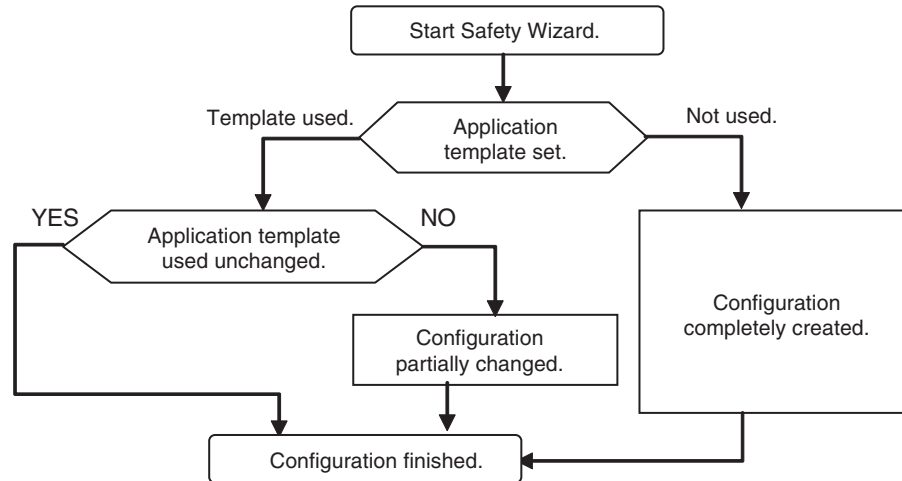

What Is an Application Template?

An application template is NE0A-series Controller the configuration created in advance. In addition to the pre-installed templates, user-created the configuration can be saved as templates.

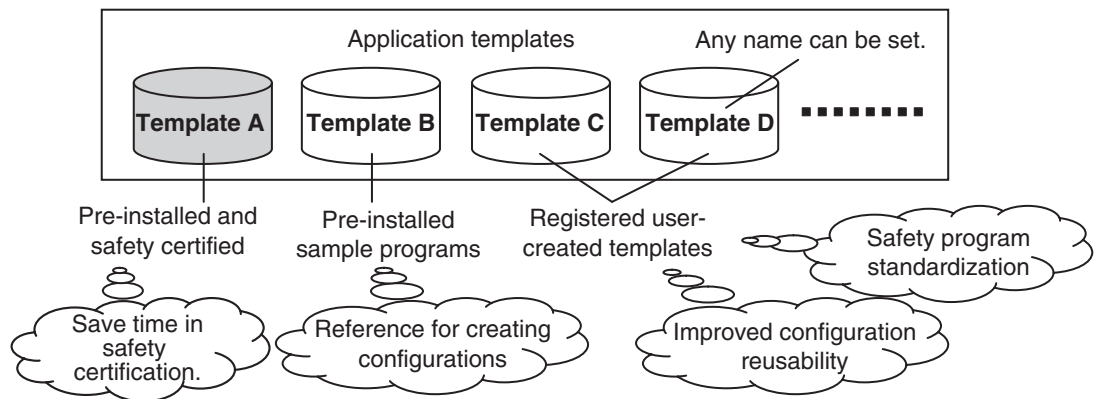

IMPORTANT Even when using a safety-certified application template, confirm that the safety functions are working correctly in the environment where they are to be used before beginning system operation.

When Not Using Application Templates

Select the option to not use an application template, and click the **Next** Button. Then set the local I/O terminals and the safety logic in the window that is displayed.

When Using Application Templates

- 1,2,3... 1. Select the application template that is to be used.

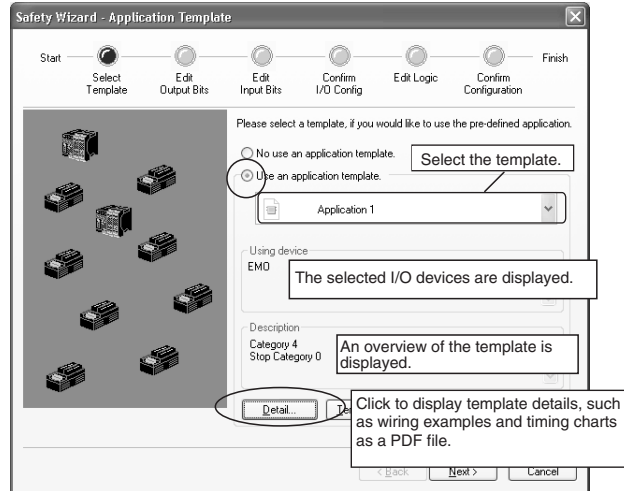

2. Confirm the configuration for the application and make any changes as required.

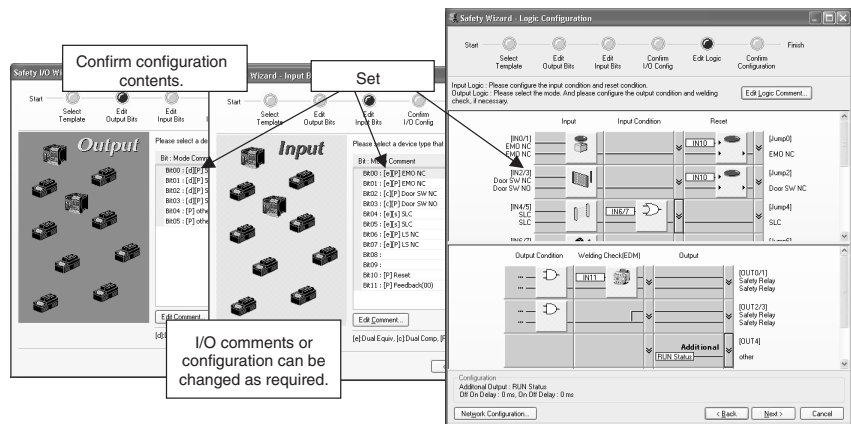

3. Confirm the configuration.

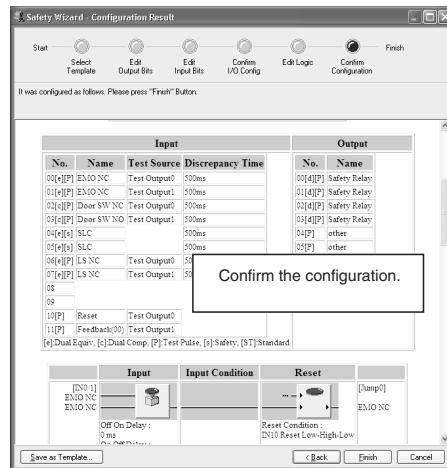

Saving Application Templates

A user-created configuration can be saved as an application template. Once the configuration has been saved as a template, it can be selected as an application template.

- 1,2,3... 1. In the Wizard's Confirm Configuration Window, click **Save as template** Button.
- 2. Select whether to update an existing template or to save a new template.

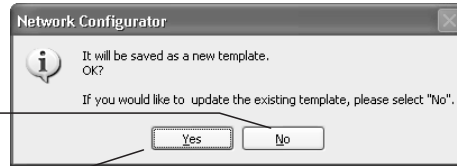

- 3-1) When saving a new template, input the template name, password, device information, and a description of the template. Protecting the template with a password prevents unintentional changes.

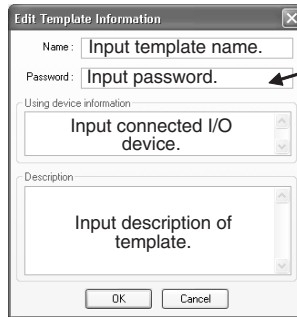

Use 6 to 16 characters.

- 3-2) When updating an existing template, select the template to be overwritten.

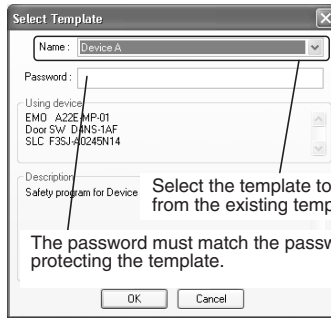

Select the template to be updated from the existing templates.

The password must match the password protecting the template.

Exporting Application Templates

Application templates that have been created and saved can be exported to other computers.

- 1,2,3... 1. Click the **Template Management** Button in the first Select Template Window in the Wizard.
- 2. Select the **User** Tab in the Template Management Window. The pre-installed application templates are saved on the **System** Tab Page and cannot be exported.

3. Select the application template to export and then click the **Export** Button. The template will be saved in the specified location, and the exporting will be completed. Two files will be saved: an xxx.ini file (where xxx stands for the user-set name) and a xxx.wzd file. Use these two files as a set.

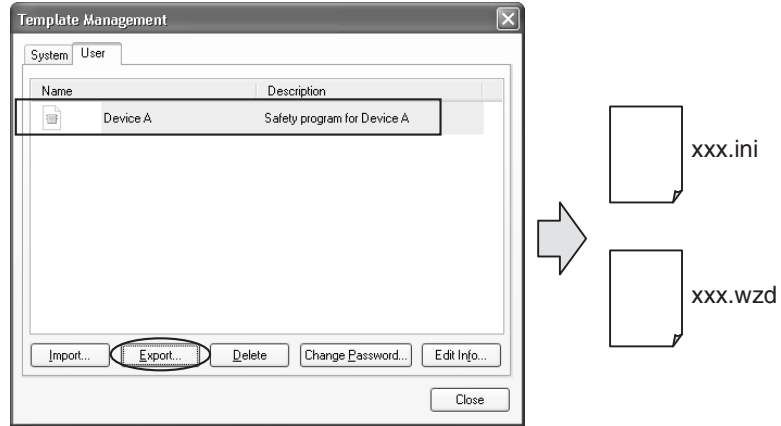

Importing Application Templates

Application templates that were exported from another computer can be imported.

- 1,2,3... 1. Click the **Template Management** Button in the first Template Setting Window in the Wizard.
2. Click the **User** Tab in the Template Management Window, and then click the **Import** Button.

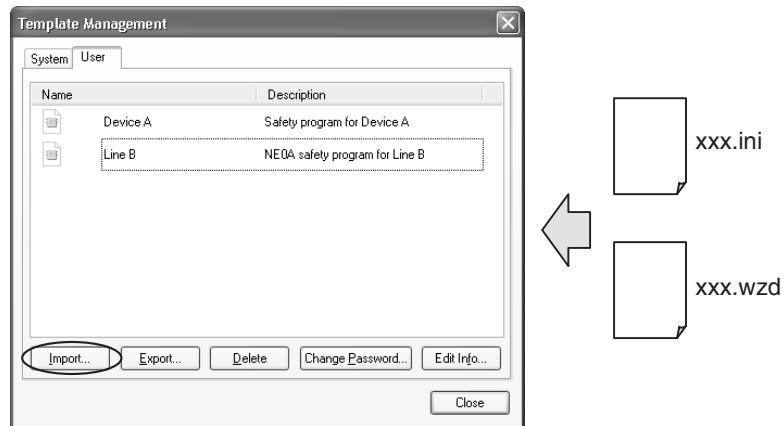

Note Importing is possible only if xxx.ini and xxx.wzd are in the same folder. Also, the file name (without the file name extension) for both files must be the same.

6-3-3 Setting Local I/O Terminals (Safety Wizard)

Local I/O terminal settings are made by selecting the I/O devices to be connected.

Setting Outputs

Outputs are set by selecting the devices to be connected to the output terminals. Also select feedback terminals if safety relay and connector welding checks (EDM) are to be performed.

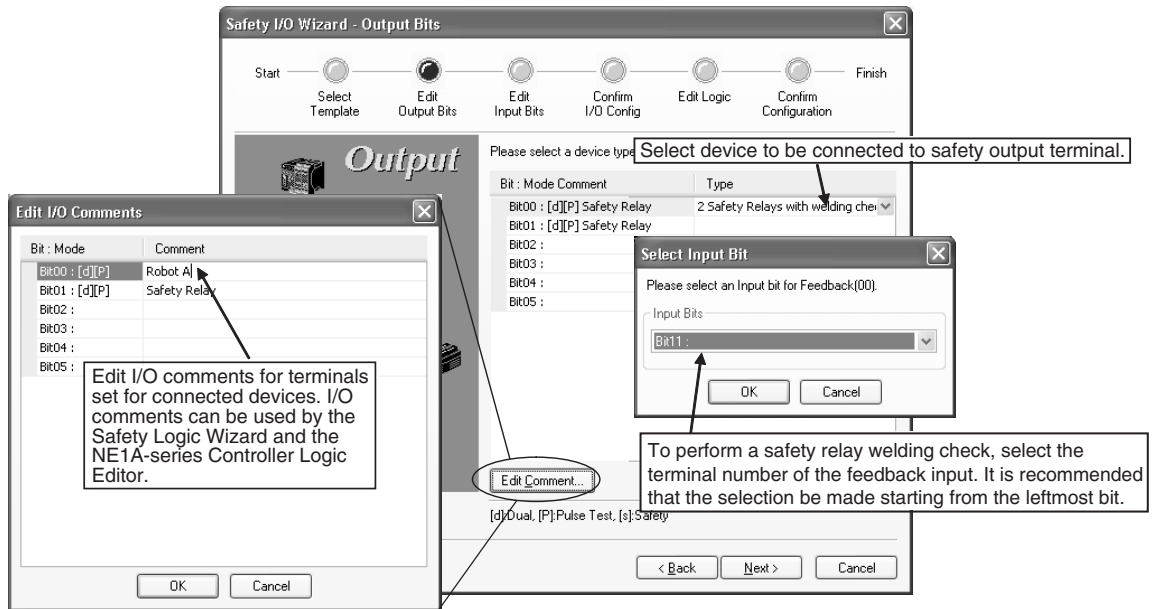

Setting Inputs

Inputs are set by selecting the devices to be connected to the input terminals.

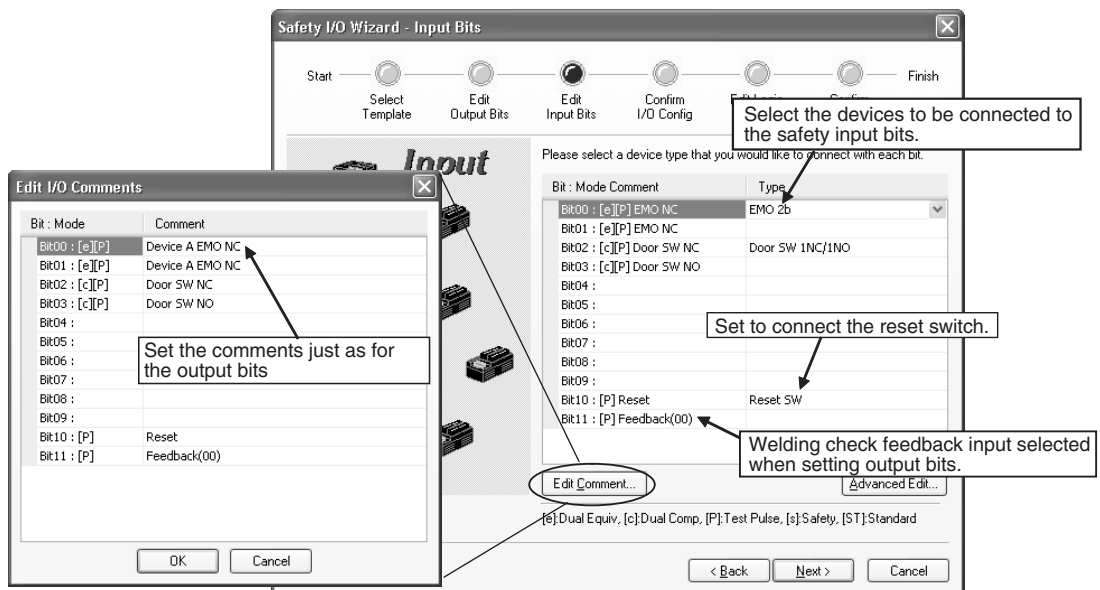

Note The leftmost two bits (bit 10: IN10, bit 11: IN11) can be selected only for reset switches or welding checks.

Checking I/O Terminal Setting Results

Check the terminal settings that have been made so far.

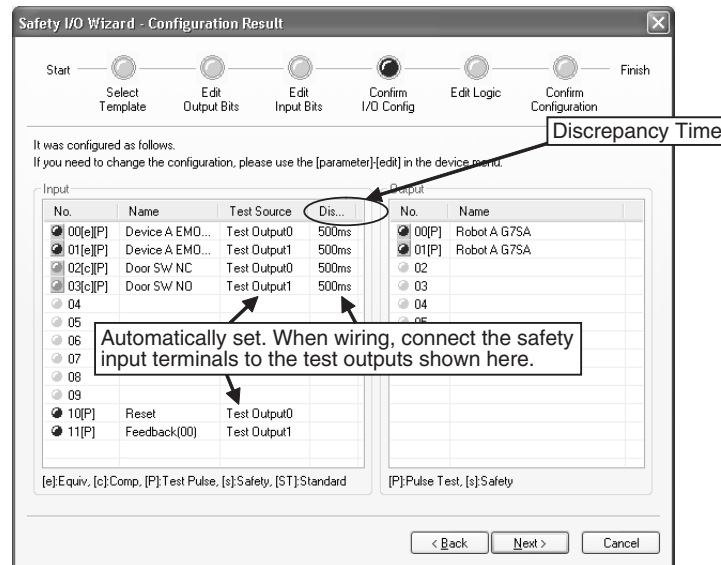

- Note**
- (1) For details on local I/O terminal setting parameters, such as [e] *Equiv* and [c] *Comp*, refer to 2-3 *Local Safety I/O Functions*.
 - (2) You can change the test source by clicking the **Advanced Edit** Button in the Edit Input Bits Window or Edit Output Bits Window.
 - (3) Make the settings for discrepancy time and delay time in the Logic Functions Window. Refer to 6-4-1 *Safety Input Evaluation* for details.

6-3-4 Setting Networks

Next, set the network functions. Set the following items in the Edit Logic Window by clicking the **Network Configuration** Button.

- 1,2,3...
1. Enable or disable DeviceNet communications.
 2. Set the remote I/O data.
 3. Set the default connection path for standard I/O communications.

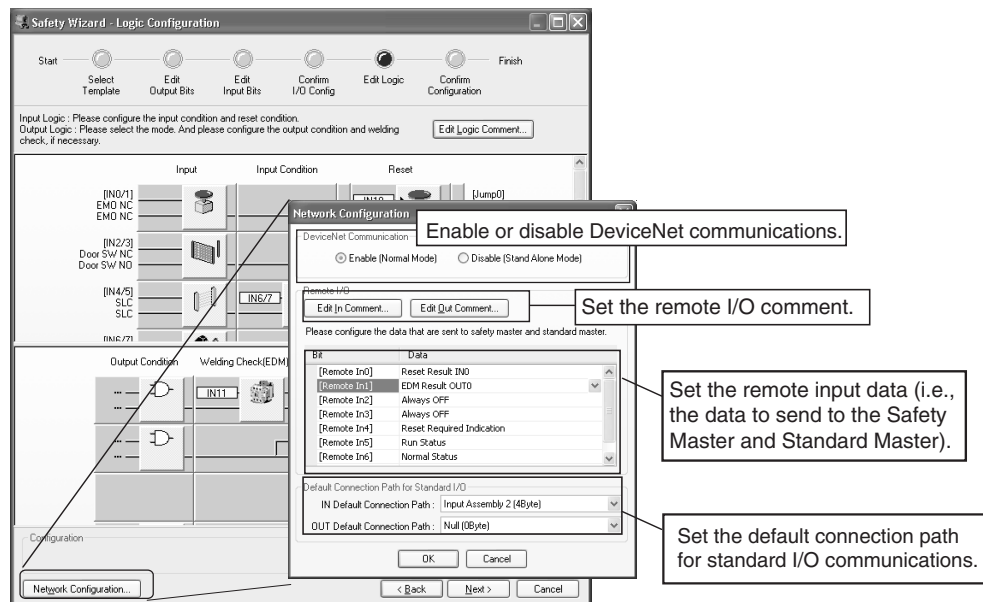

Enabling or Disabling DeviceNet Communications

Set whether DeviceNet communications are to be enabled or disabled. Disable DeviceNet communications when using the Standalone Mode.

IMPORTANT When DeviceNet communications are disabled (Standalone Mode), download the configuration directly to the NE0A-series Controller USB port.

Setting Remote I/O Data

What Is Remote I/O Data?

Remote I/O data is the general name for data exchanged via DeviceNet communications between NE0A-series Controllers and the NE1A-series Safety Master or Standard Master. The term is used to indicate either safety I/O communications data or standard I/O communications data.

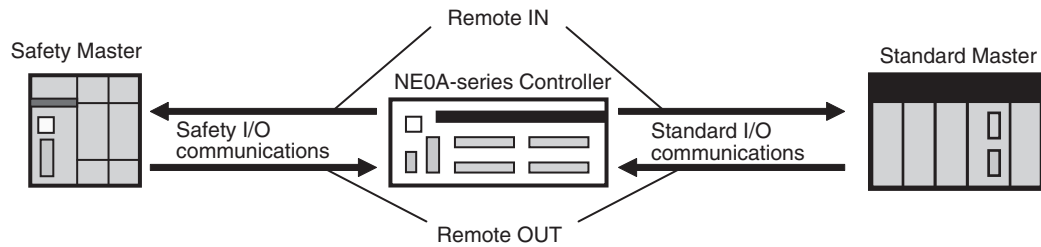

Setting Remote I/O Comments

Optional comments (names) can be set for remote I/O data sent and received by the NE0A-series Controllers. These comments can be used in the safety logic settings of the NE0A-series Controller and the NE1A-series Logic Editor. Set the remote I/O comment by clicking the **Edit in Comment Button** or **Edit Out Comment Button** in the Network Configuration Window.

This block contains screenshots of four software windows with annotations:

- Network Configuration:** Shows the 'Remote I/O' section with 'Edit In Comment...' and 'Edit Out Comment...' buttons. A table lists bits and their data:

Bit	Data
[Remote In0]	Reset Result IN0
[Remote In1]	EDM Result OUT0
[Remote In2]	Always OFF
[Remote In3]	Always OFF
[Remote In4]	Reset Required Indication
[Remote In5]	Ref Status
[Remote In6]	Normal Status
- Edit Comments:** A table showing bit names and their corresponding comments:

Bit	Comment
[Remote Out0]	Interlock Signal
[Remote Out1]	Driving preparation Signal
[Remote Out2]	Driving Mode
[Remote Out3]	Maintenance Mode
[Remote Out4]	Reset
[Remote Out5]	
[Remote Out6]	
[Remote Out7]	
- NE0A-series Logic Wizard:** Shows 'Select Output Conditions' with 'Remote I/O' selected under 'OR' conditions.
- NE1A-series Logic Editor:** Shows a list of safety outputs including 'Interlock Signal', 'Driving preparation Signal', 'Driving Mode', 'Maintenance Mode', 'Reset', and 'Remote-Output Signal #5' through '#7'. The 'Interlock Signal' is highlighted.

Annotations with arrows indicate that the comments set in the 'Edit Comments' window are used in the 'NE0A-series Logic Wizard' and 'NE1A-series Logic Editor'.

Setting Remote Input Data

Set the data to be sent from the NE0A-series Controller to the Safety Master or Standard Master. NE0A-series internal status and safety logic operation results can be set. The result of safety logic operations set here is displayed with a mark in the Edit Logic Window.

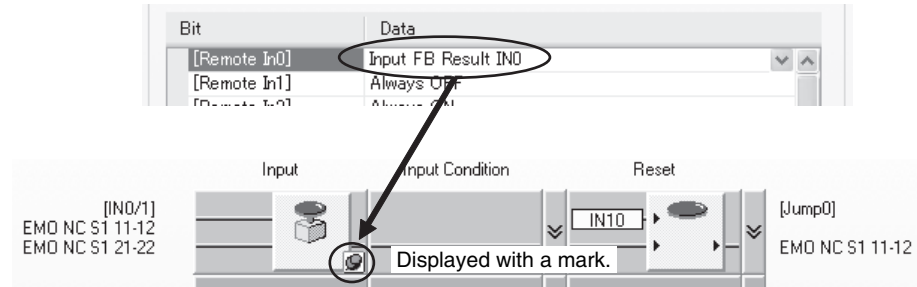

Note For details on remote I/O data and the data that can be set, refer to 6-5 *Remote I/O Allocations*.

Setting the Default Connection Path for Standard I/O Assembly Data

The default connection path must be changed when communicating with a Standard Master that cannot change I/O assembly data. This kind of Standard Master can perform standard I/O communications with a Standard Slave using the default I/O assembly data only. Therefore, the default standard I/O assembly data must be changed.

CS/CJ-series DeviceNet Unit

The I/O assembly data can be changed for a CS/CJ-series DeviceNet Unit, so there is no need to change this setting. Even if this function is used to change the data, the CS/CJ-series DeviceNet Unit settings will be given priority.

Using a Standard Master That Cannot Change Default Standard I/O Assembly Data

Select the I/O assembly data to be allocated in the Standard Master.

IMPORTANT Either safety I/O communications or standard I/O communications, but not both, can be used for remote output data for the NE0A-series Controller. While safety I/O communications are being used with an NE1A-series Safety Master, standard I/O communications cannot be used with the Standard Master. Route the communications through the Safety Master.

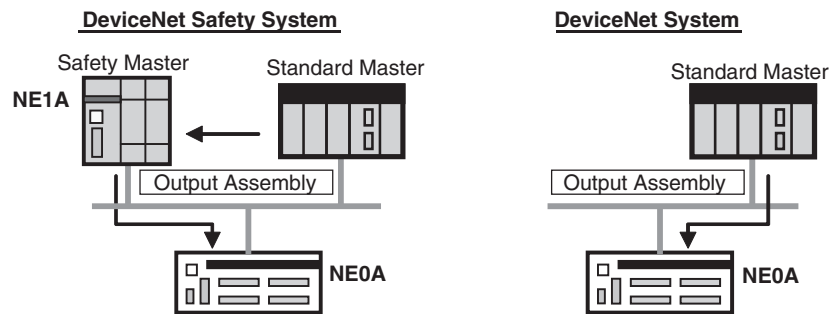

Note “Null” means that I/O assembly data is not used, i.e., that the data size is 0 bytes. The output connection size for a Bit-Strobe connection is always 0 bytes.

6-3-5 Overview of Safety Logic Settings (Safety Logic Wizard)

Finally, set the safety logic. Safety logic control can be easily performed by setting a combination of I/O data from local I/O terminals and remote I/O data from a Standard Master or Safety Master with the logic operations supported by the NE0A-series Controller.

In addition, the safety status can be monitored from standard controls by using the safety output terminals as additional outputs and outputting data such as error information.

NE0A-series Controller Logic Operations

As shown in the following figure, when RUN mode is entered, local safety inputs are processed in order from safety input evaluations to input condition operation to reset operation, and the result is reflected in the jump address.

Local safety outputs are processed in order from jump address value to output condition operation to welding checks (EDM operation) to safety output evaluation, and the operation result is reflected.

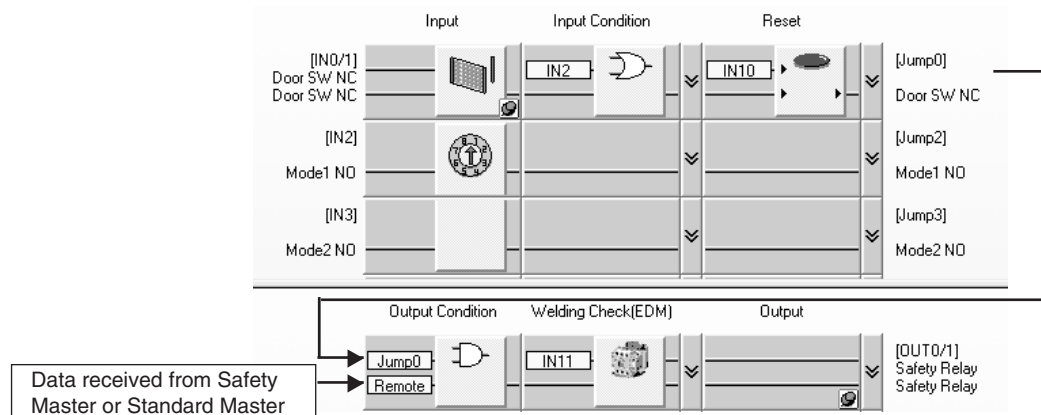

Safety Input Logic Parameter Setting Operations

- Safety Input Evaluation (“Input” in the Above Figure)
Input circuit diagnosis, dual channel (discrepancy time) evaluation, and input ON/OFF delays are performed. External wiring errors can be detected.
- Input Condition Operation
An OR or AND is taken of the safety input evaluation results.
- Reset Operation
Reset operation can be performed for the input condition operation results. This function is used to prevent safety outputs from being automatically turned ON when an emergency stop is cleared (OFF to ON).

Operation for Safety Output Logic Parameter Settings

- Output Condition Operation
An AND is taken of the safety input logic results. This function is used to construct safety circuits (safety controls) to turn safety outputs ON and OFF when multiple safety input devices are combined.
- Welding Check (EDM: External Device Monitoring) Operation
EDM operation can be performed for output condition operation results. This function is used to detect contact weld faults and external wiring errors in safety output devices such as safety relays and contactors.
- Safety Output Evaluation (“Output: in the Above Figure)
Output ON/OFF delays, dual channel evaluation, and output circuit diagnosis are performed on EDM operation results. This function can be used to detect external wiring errors.

**NE0A-series
Controller Additional
Outputs**

Safety output terminals can be set as additional outputs for the NE0A-series Controller. Error information can be output, along with same and inverse values for other local I/O terminals can be output. These outputs are used for monitor applications and lock clear signal outputs for safety door switches with lock mechanisms.

Note For details on additional outputs, refer to 6-4-6 Safety Output Evaluation.

Safety Logic Setting Example

The following example shows how to set the safety logic. In this example, the application shown in the following diagram is set. The emergency stop switch and interlock signal are manually reset, and the safety door switch is automatically reset.

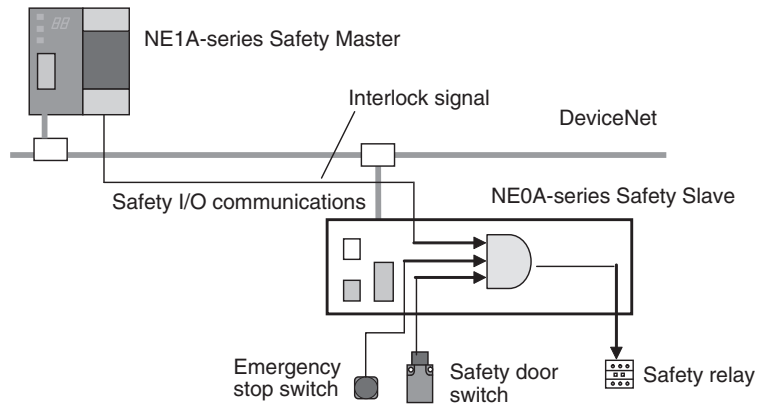

- 1,2,3... 1. Set the local I/O terminals and remote I/O data.
First set the local I/O terminals and remote I/O data using the procedures shown in 6-3-3 Setting Local I/O Terminals (Safety Wizard) and 6-3-4 Setting Networks.

Local I/O Terminal Settings

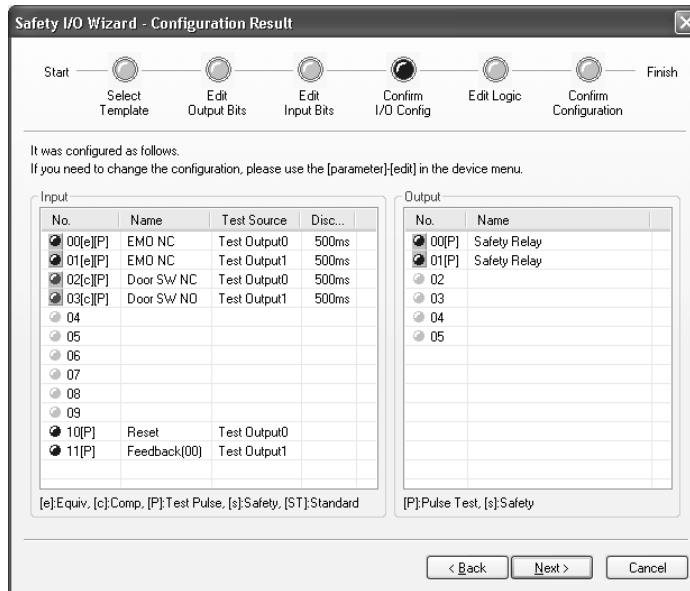

Remote I/O Terminal Settings

These settings are used only for remote outputs.

Bit	Comment
[Remote Out0]	Interlock Signal
[Remote Out1]	
[Remote Out2]	
[Remote Out3]	
[Remote Out4]	
[Remote Out5]	
[Remote Out6]	
[Remote Out7]	

2. Set the input logic and the output logic.

Input Logic

Set the safety input logic. In this example, the safety input device is not disabled, so there is no need to set the input condition.

The next example shows an application in which an emergency stop switch is manually reset and a safety door switch is automatically reset.

Output Logic

Set the safety output logic. In this example, the output is turned OFF by pressing an emergency stop switch or by opening a safety door. An interlock signal is also received from the Safety Master to turn OFF the output. In other words, an AND operation will be used between the emergency stop switch, safety door switch, and remote I/O interlock signal.

The screenshot shows the 'Safety Wizard - Logic Configuration' window. At the top, there are five steps: Start, Select Template, Edit Output Bits, Edit Input Bits, Confirm I/O Config, and Edit Logic. The 'Edit Logic' step is active.

Input Logic Configuration:

- Input Condition:** A logic diagram shows inputs [IN0/1] EMO NC, [IN2/3] Door SW NC, and [IN4] connected to an AND gate. A callout states: "The welding check feedback input is automatically set for the terminal set in the local I/O settings." Another callout points to [IN10] with the text: "Set the emergency stop switch to manual reset. The reset switch is connected to IN10, so select 'IN10 Low-High-Low.'" A callout points to [Jump0] EMO NC with the text: "This is the jump address. It is the input for the output condition operation."
- Reset:** A callout points to the Reset button with the text: "I/O comments for input logic operation results can be edited. The default is for the same comment as for the local input." Below this, a 'Select Reset Conditions' dialog is shown with 'Bit' set to [IN10 Reset] and 'Condition' set to 'Low-High-Low'.
- Output Condition:** A callout points to the AND gate with the text: "Set the AND condition to control the output."

Output Logic Configuration:

- Output:** The output is set to [OUT0/1] Safety Relay. A callout points to the AND gate with the text: "The safety door switch is auto reset, so this setting is not required."
- Select Remote I/O:** A dialog box is open showing 'Remote I/O' bits. [Remote Out0] Interlock Signal is selected. A callout points to this selection with the text: "Select the remote output data."

IMPORTANT

- The default status for the reset condition is for an auto reset. The setting must be changed to use a manual reset.
- The default status for the output conditions is for an AND operation for all conditions. Change the setting according to the application.

Note For details on individual blocks, refer to 6-4 Descriptions of Logic Commands.

6-3-6 Checking the Settings

Check the settings for the NE0A-series Controller that have been made so far, and then click the **Finish** Button.

The settings for communications and remote I/O data for the system configuration is displayed first.

Local I/O settings are displayed. Then the logic settings are displayed.

Remote Input		Remote Output	
Bit	Comment	Bit	Comment
00		00	Interlock Signal
01	Always OFF	01	
02	Always OFF	02	
03	Always OFF	03	
04	Reset Required Indication	04	
05	Run Status	05	
06	Normal Status	06	
07	Always ON	07	

Input				Output	
No.	Name	Test Source	Discrepancy Time	No.	Name
00[e][P]	EMO NC	Test Output0	500ms	00[d][P]	Safety Relay
01[e][P]	EMO NC	Test Output1	500ms	01[d][P]	Safety Relay
02[e][P]	Door SW NC	Test Output0	500ms	02	
03[e][P]	Door SW NC	Test Output1	500ms	03	

6-4 Descriptions of Logic Commands

This section describes the individual blocks for NEOA-series safety settings.

6-4-1 Safety Input Evaluation

From here on the safety logic setting blocks will be described individually. This description is of the safety input evaluation.

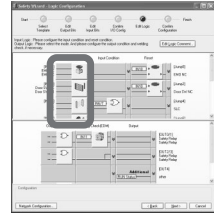

The safety input evaluation logic performs input device and input circuit diagnosis (using test pulses to diagnose internal circuits and external devices and wiring), dual channel (discrepancy time) evaluation, and input ON/OFF delays. External wiring errors can be detected.

- Note**
- For details on input device and input circuit diagnosis, input ON/OFF delays, and dual channel evaluation, refer to *2-3 Local Safety I/O Functions*.
 - The leftmost two local input terminals are used only for reset switches and welding check (EDM) feedback signal inputs.

Diagrams and Functions

The local I/O terminal settings made with the Safety Wizard are saved in the safety input evaluation blocks. Icons for the input devices selected by the local I/O terminal settings will be displayed. The operations performed here depend on the input devices.

Emergency Stop Pushbuttons, Door Switches, Limit Switches, and Light Curtains (Dual Channel Inputs)

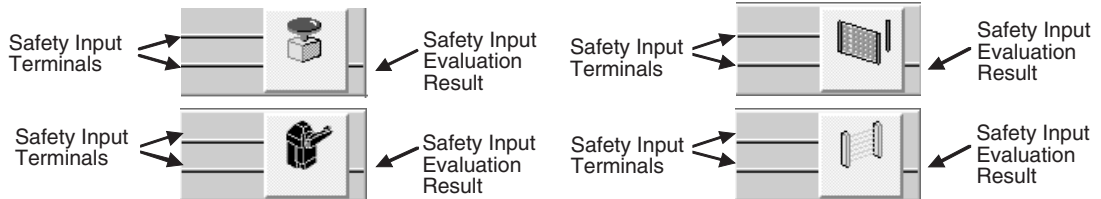

Dual channel evaluation is executed for the results of input device and input circuit diagnosis and input ON/OFF delays performed for the local input terminal values. The result is output to the next input condition operation.

Emergency Stop Switches, Door Switches, Limit Switches, and Light Curtains (Single Channel Inputs)



The result of input device diagnosis, input circuit diagnosis, and input ON/OFF delays performed for the local input terminal value is output to the next input condition operation.

Enable Switches



Dual channel evaluation and enable switch monitoring are executed for the result of input device and input circuit diagnosis and input ON/OFF delays performed for the local input terminal values, and the result is output to the next input condition operation.

- **Enable Switch Monitoring**
Even if ON is correctly input to the safety input terminal when the mode changes from IDLE to RUN, the safety input evaluation result will not turn ON. The safety input evaluation result will turn ON only after the pulse input changes from OFF to ON.

Note At the Safety Wizard, release and grip inputs for 4-contact enable switches operate as other input devices (single channel).

User Mode Switches

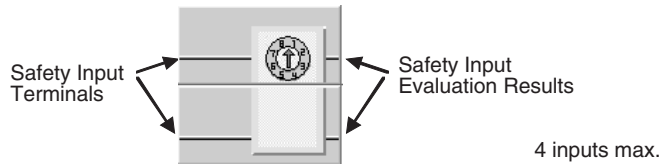

User mode switch monitoring is executed for the result of input device and input circuit diagnosis and input ON/OFF delays performed for the local input terminal values, and the result is output to the next input condition operation.

- **User Mode Switch Monitoring**
The mode switch that can be connected to this User Mode Switch function block must be a 1-of-N type switch (i.e., one of N settings is ON). The function block supports mode switches for a maximum of four modes. This function block detects the next error in addition to errors detected by input device and input circuit diagnosis and dual channel evaluation.

Error	Safety input evaluation result
Two or more inputs ON for 2 s or longer	OFF
All inputs OFF for 2 s or longer	OFF

Reset Switches and Welding Check (EDM) Feedback Inputs



The result of input device and input circuit diagnosis and input ON/OFF delays performed for the local input terminal value is output to the next input condition operation.

Other Input Devices (Dual Channel, Single Channel)

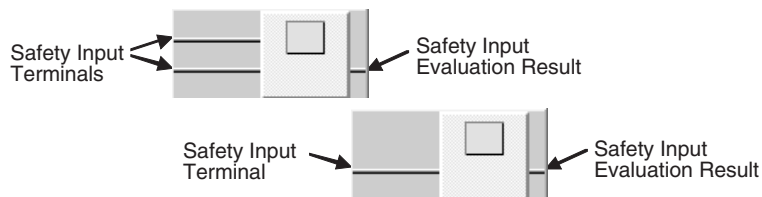

The operation is the same as for the Emergency Stop Switch function block.

Parameters That Can Be Set

Input ON/OFF Delay Time

An input terminal ON delay (Off On Delay) or OFF delay (On Off Delay) can be set by clicking this function block.

Name	Setting range
Off On Delay	0 to 994 ms (unit: 7 ms)
On Off Delay	0 to 994 ms (unit: 7 ms)

Discrepancy Time (Dual Channel Evaluation)

The discrepancy time is the allowable time discrepancy between dual input values. When dual input terminals are set, the time can be set by clicking this function block.

Name	Setting range
Discrepancy time	0 to 65,530 ms (unit: 10 ms) Discrepancy errors are not detected if the time is set to 0.

Error Processing and Resets

Error	Operation when an error occurs			Error reset
	Safety input evaluation result	Safety input terminal I/O indicator	Safety input status	
External wiring error	OFF	Lit red	0 (Error)	Eliminate the error and then turn the safety input terminal from OFF to ON.
Two-input logic discrepancy (discrepancy error)	OFF	Lit red	0 (Error)	
Error in other channel of dual channels	OFF	Flashing red	0 (Error)	Eliminate the error so that only one input is ON and all other points are OFF.
User mode switch error	OFF	Lit red	0 (Error)	
Internal circuit error	OFF	Lit red	0 (Error)	Replace the Unit.

Note These error will not be detected if the power supply for the inputs is not applied correctly.

Timing Charts

Emergency Stop Switches, Door Switches, Limit Switches, Light Curtains, and Other Input Devices (Dual Channel Inputs)

Equivalent Logic

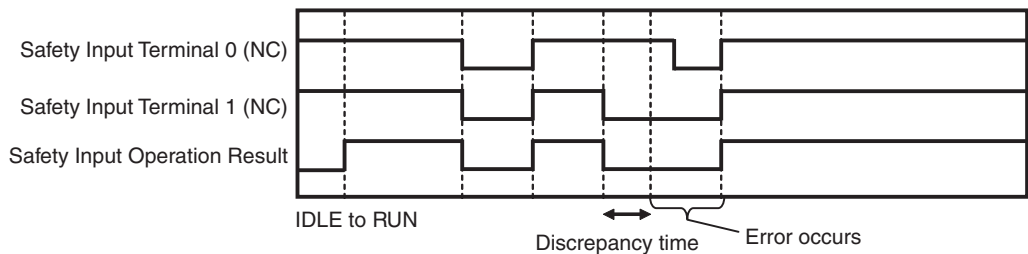

Complementary Logic

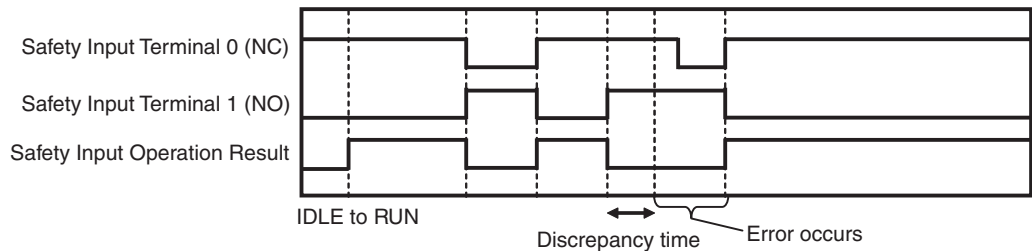

Emergency Stop Switches, Door Switches, Limit Switches, Light Curtains, Other Input Devices (Single Channel Inputs), Reset Switches, and Welding Check (EDM) Feedback Inputs

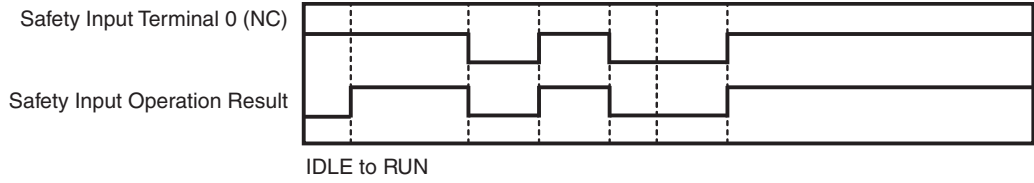

Enable Switch (Two-contact Input Setting)

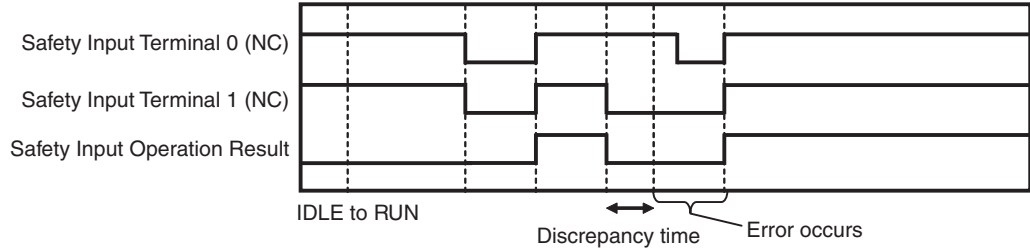

User Mode Switch (Two-setting Input Setting)

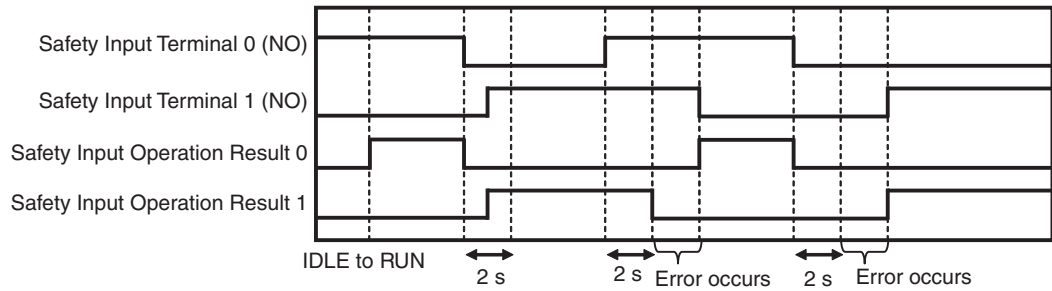

6-4-2 Input Condition Operations

OR and AND operations can be used for safety input evaluation results.

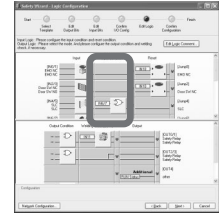

Diagrams and Functions

The input condition operation is selected from the following options.

Data used for input condition signals is selected from the local input terminals or remote I/O. Multiple input condition signals can be specified.

Routing (No Input Conditions)



The safety input evaluation result is output unchanged to the next reset operation.

OR Operation

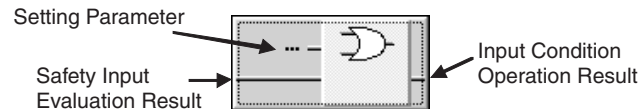

The safety input evaluation result is output to the specified input condition signal, and the result of the OR operation is output to the next reset operation.

AND/OR Operation

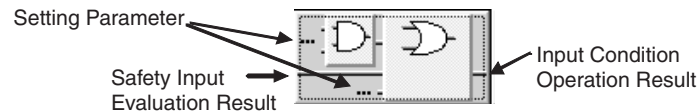

First, an AND is taken of the input condition signals specified for the AND operation. An OR operation is then taken of the result of the AND operation, and the input condition signal and safety input evaluation result specified for the OR operation. The result is output to the next reset operation.

AND Operation

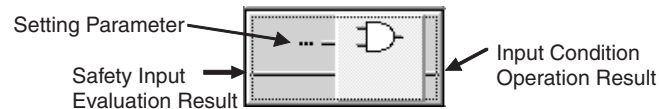

An AND is taken of the safety input evaluation result and the specified input condition signal, and the result is output to the next reset operation.

OR/AND Operation

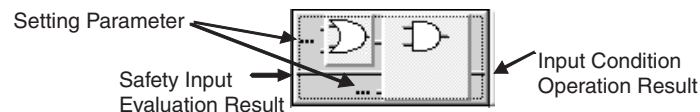

First, an OR is taken of the input condition signals specified for the OR operation. An AND operation is then taken of the result of the OR operation, and the input condition signal and safety input evaluation result specified for the AND operation. The result is output to the next reset operation.

Parameters That Can Be Set

Data That Can Be Set for Input Condition Signals ...

Name	Option	Setting range
Input condition signal	Remote output	Remote output data with I/O comments set, as described in 6-3-4 <i>Setting Networks</i> .
	Local input	Safety input terminals. Leftmost two terminals cannot be selected.

Note The leftmost two local input terminals are used exclusively for reset switches and welding check (EDM) feedback signal inputs and cannot be selected.

Truth Tables

OR Operation

Input conditions IN0/1: [Remote Out0] OR [IN2/3] OR [IN4/5] OR [IN0/1]

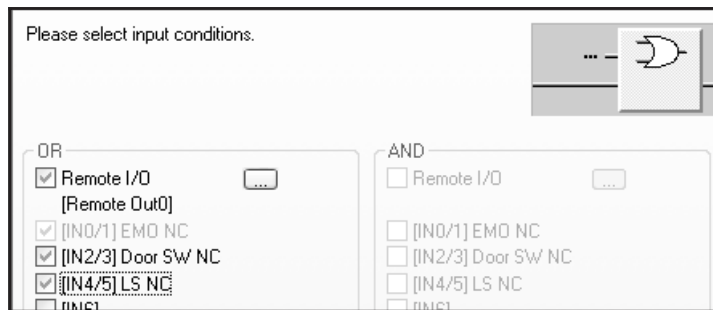

Safety input evaluation result [IN0/1]	Remote Out0	[IN2/3]	[IN4/5]	Input condition operation result
0	0	0	0	0
0	1	x	x	1
0	x	1	x	1
0	x	x	1	1
1	x	x	x	1

0: OFF, 1: ON, x: Either ON or OFF

AND/OR Operation

Input conditions IN2/3: ([Remote Out1] AND [IN4/5]) OR [IN2/3]

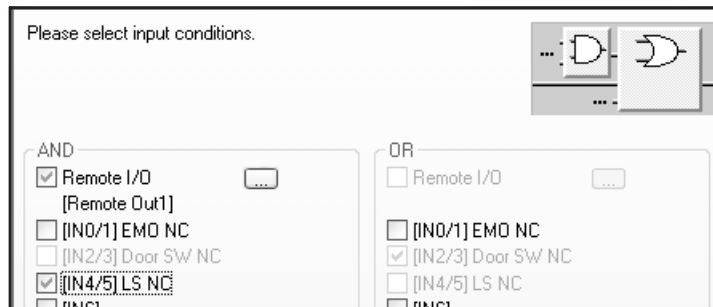

Safety input evaluation result [IN2/3]	Remote Out1	[IN4/5]	Input condition operation result
0	0	0	0
0	1	0	0
0	0	1	0

Safety input evaluation result [IN2/3]	Remote Out1	[IN4/5]	Input condition operation result
0	1	1	1
1	x	x	1

0: OFF, 1: ON, x: Either ON or OFF

AND Operation

Input conditions IN0/1: [Remote Out0] AND [IN2/3] AND [IN4/5] AND [IN0/1]

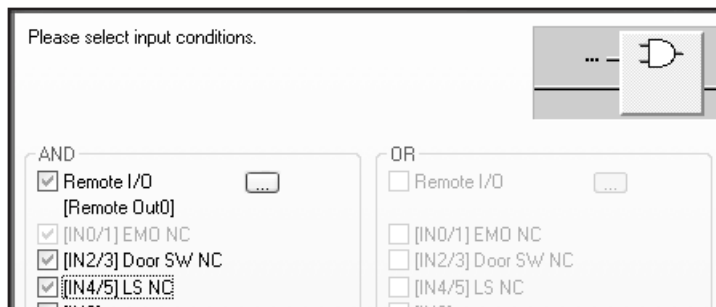

Safety input evaluation result [IN0/1]	Remote OUT0	[IN2/3]	[IN4/5]	Input condition operation result
0	x	x	x	0
1	0	x	x	0
1	x	0	x	0
1	x	x	0	0
1	1	1	1	1

0: OFF, 1: ON, x: Either ON or OFF

OR/AND Operation

Input conditions IN2/3: ([IN0/1] OR [IN4/5]) AND [Remote Out0] AND [Remote Out1] AND [IN2/3]

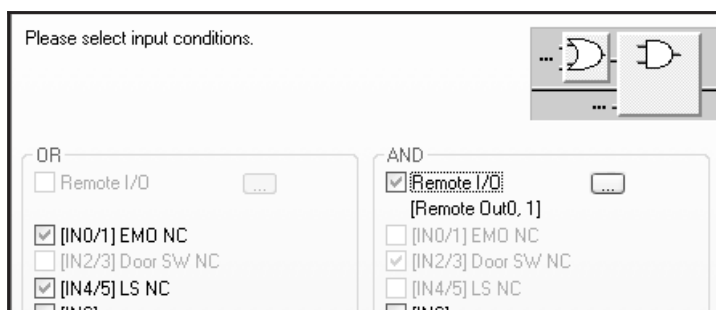

Safety input evaluation result [IN2/3]	Remote OUT0	Remote OUT1	[IN0/1]	[IN4/5]	Input condition operation result
0	x	x	x	x	0
1	0	x	x	x	0
1	x	0	x	x	0
1	x	x	0	0	0
1	1	1	1	0	1
1	1	1	0	1	1
1	1	1	1	1	1

0: OFF, 1: ON, x: Either ON or OFF

6-4-3 Reset Operation

Reset operations can be performed for input condition operation results.

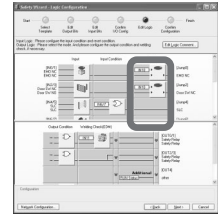

Diagrams and Functions

Reset operation is selected from the following options.

Data used for bypass signals is selected from the local input terminals or remote I/O.

Auto Reset



ON is automatically output as the safety input logic result when the input condition operation result turns ON.

Manual Reset L-H-L

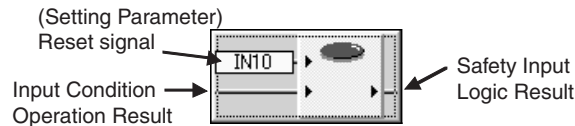

ON is output as the safety input logic result if the reset signal is correctly input when the input condition operation result is ON. Using a manual reset can prevent the equipment from automatically restarting when the NEOA-series Controller power is turned ON, or when the operating mode is changed (from IDLE to RUN), or when a signal from a safety input device changes from OFF to ON.

■ Low-High-Low

Safety input logic operation result ON conditions:

- Input condition operation result is ON.
- In addition, the reset signal goes Low-High-Low.

■ Rising Edge

Safety input logic result ON conditions:

- Input condition operation result is ON.
- In addition, the reset signal goes from Low to High.

IMPORTANT

- The result of the safety input logic operation will turn ON when an auto reset is specified if the power supply of the NEOA-series Controller is started, the operating mode is changed from IDLE to RUN, or the signal from the safety input device goes from OFF to ON.
- If the rising edge is set, noise or other momentary pulse signals will trigger a reset, and the result of the safety input logic operations will turn ON. Therefore, setting Low-High-Low is recommended.

Precautions in Using Reset Signals

■ **Low-High-Low**

The following Low-High-Low reset signal is required.

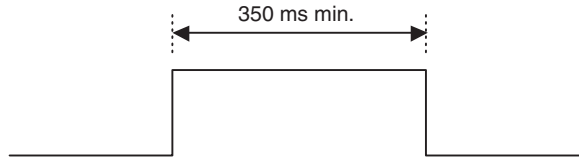

■ **Rising Edge**

The following rising edge reset signal is required.



Parameters That Can Be Set

Data That Can Be Set for Reset Signals

Name	Options	Setting range
Reset signal	Remote output	Remote output data with I/O comments set, as described in 6-3-4 <i>Setting Networks</i> .
	Local input	Safety input terminals. All terminals can be selected.

Data That Can Be Set for Reset Conditions

- Low-High-Low
- Rising Edge

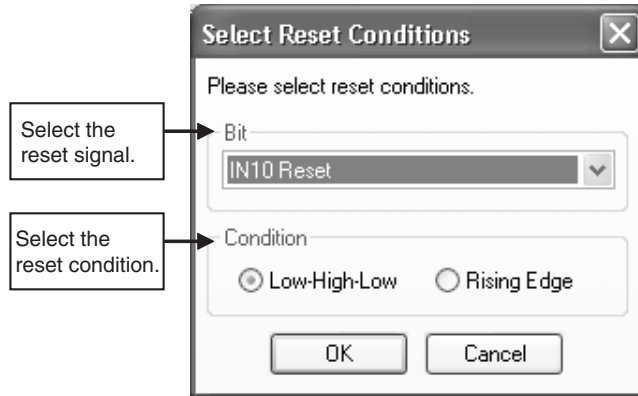

Reset Required Indication

The reset required indication can be monitored as an additional output or remote I/O data. The reset required indication becomes a 1-Hz pulsing output if the following conditions are satisfied for all devices:

The input condition operation result is ON for all reset operations for which the safety input logic operation result is OFF.

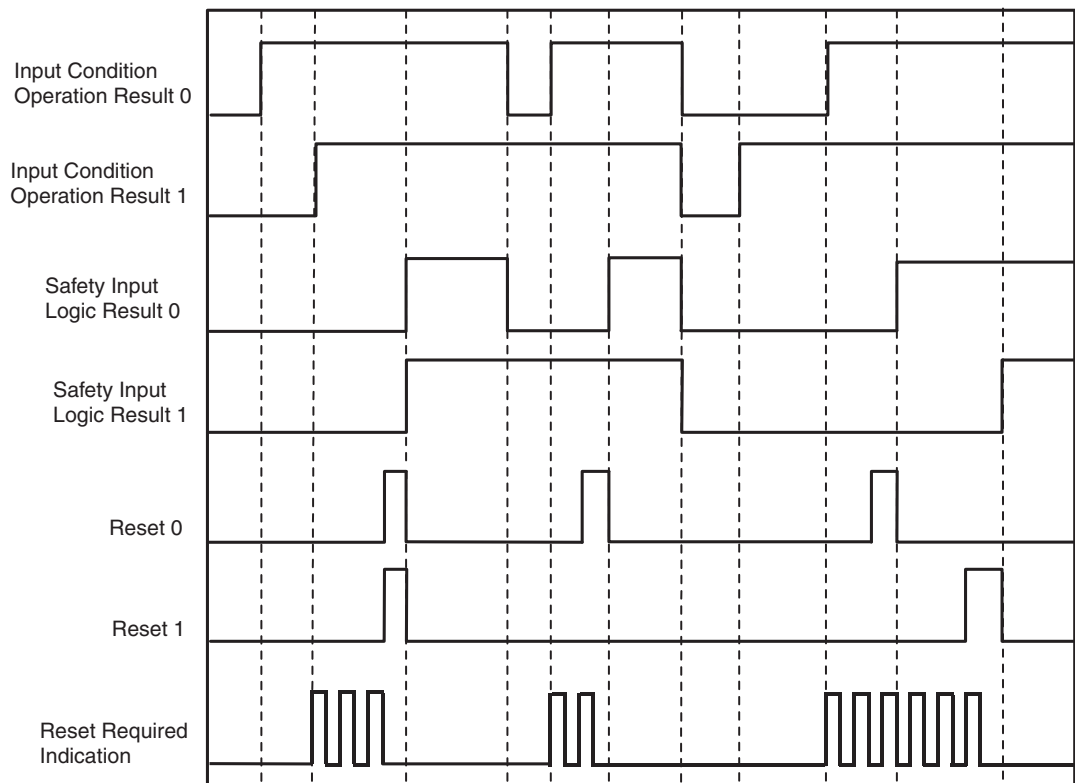

Timing Charts

Manual Reset Low-High-Low

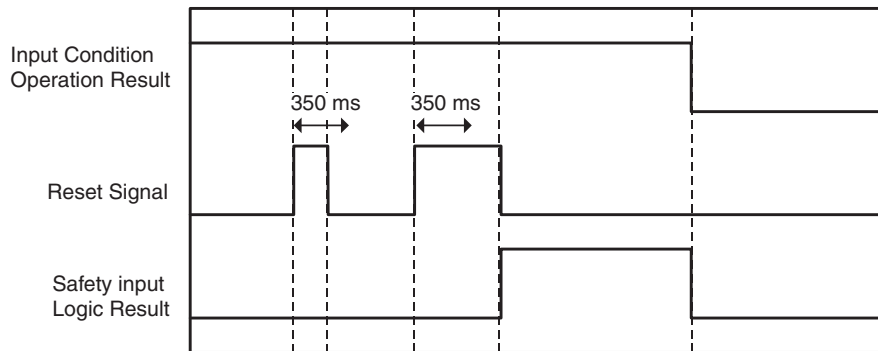

Manual Reset Rising Edge

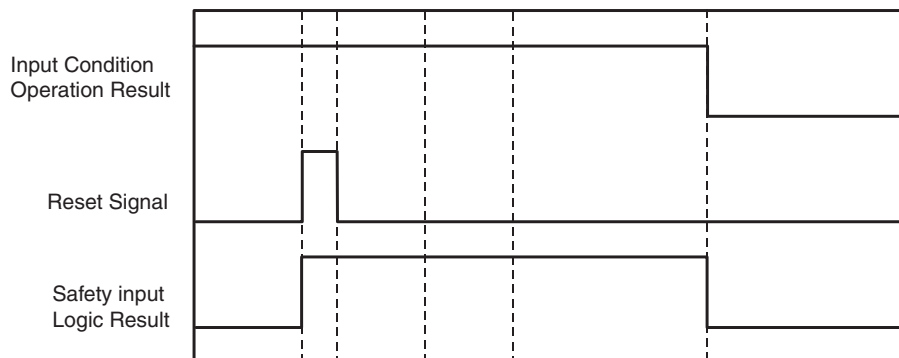

6-4-4 Output Condition Operation

An AND is taken of the safety input logic results.

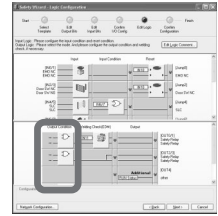

Diagrams and Functions

The output condition operation is selected from the following options. Data used for output condition signals is selected from the safety input logic result or remote I/O data. Multiple data selections can be made.

Routing (No AND Operation)

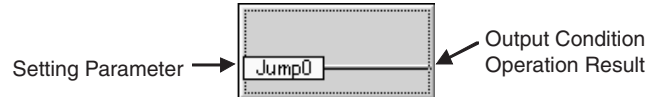

The selected output condition signal is output to the next EDM operation.

AND Operation

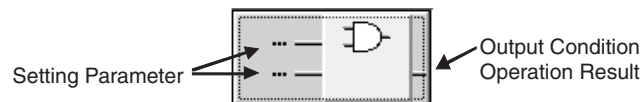

An AND is taken of the selected output condition signal and the result is output to the next EDM operation.

OR/AND Operation

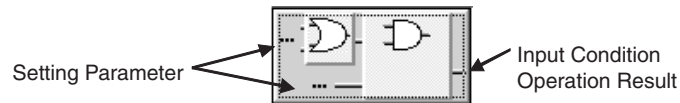

First, an OR is taken of the input condition signals specified for the OR operation. An AND operation is then taken of the result of the OR operation and the safety input evaluation result specified for the AND operation. The result is output to the next EDM operation.

Parameters That Can Be Set

Data That Can Be Set for Output Condition Signals ...

Name	Options	Setting range
Output condition signal	Remote output	Remote output data with I/O comments set, as described in 6-3-4 Setting Networks
	Jump address	Input logic operation result data

The jump address consists of the following data. I/O comments for this data can be changed in the Edit Logic Comment. The default I/O comment is the same as the I/O comment for the logical input on the same line.

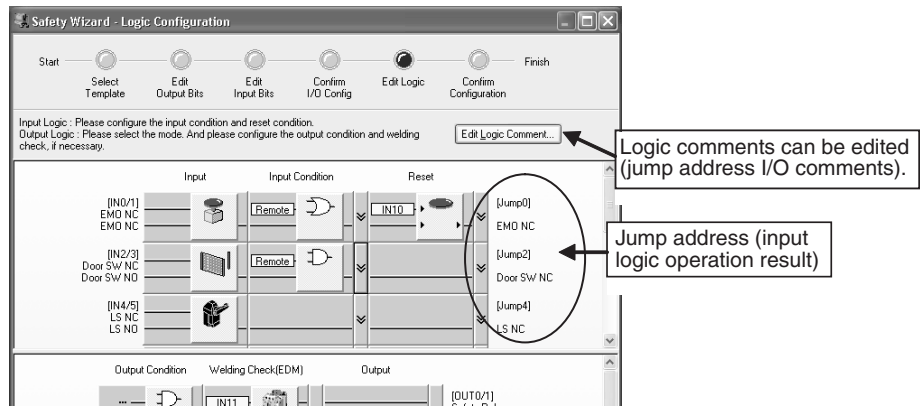

Truth Tables

AND Operation

Output conditions: [Jump0] AND [Jump2] AND [Jump4]

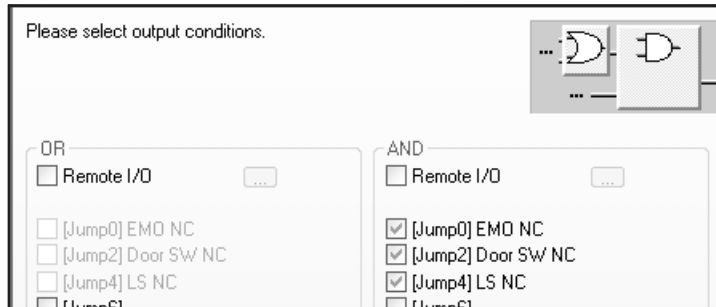

Jump0	Jump2	Jump4	Output condition operation result
0	x	x	0
1	0	x	0
1	x	0	0
1	1	1	1

0: OFF, 1: ON, x: Either ON or OFF

OR/AND Operation

Output conditions: ([Jump2] OR [Jump4]) AND [Remote Out0] AND [Jump0]

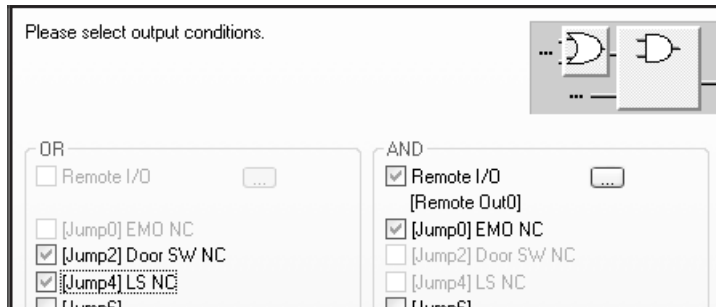

Jump2	Jump4	Remote Out0	Jump0	Input condition operation result
x	x	0	x	0
x	x	x	0	0
0	0	1	1	0

Jump2	Jump4	Remote Out0	Jump0	Input condition operation result
0	1	1	1	1
1	0	1	1	1
1	1	1	1	1

0: OFF, 1: ON, x: Either ON or OFF

6-4-5 Welding Check (EDM: External Device Monitoring) Operation

Welding check (EDM) operation can be performed for output condition operation results.

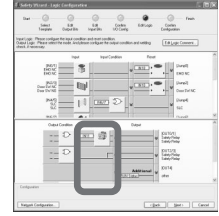

Diagrams and Functions

The EDM operation is selected from the following options.

Data used for EDM feedback is selected from the local input terminals.

Routing (EDM Not Used): Single Channel Output

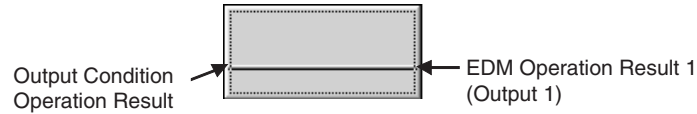

Routing (EDM Not Used): Dual Channel Output

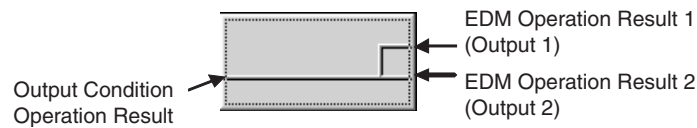

EDM feedback is not evaluated. The same value as for the safety output condition operation result is output to Output 1 and Output 2.

EDM: Single Channel Output

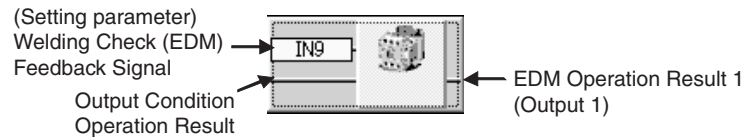

EDM: Dual Channel Output



EDM feedback is evaluated. When the safety output logic result changes from OFF to ON, Output 1 and Output 2 are changed from OFF to ON. Here, the feedback input must be changed from ON to OFF within a fixed time period.

Likewise, when the safety output logic result changes from ON to OFF, Output 1 and Output 2 are changed from ON to OFF. Here, the feedback input must be changed from OFF to ON within a fixed time period.

If the feedback input is not properly changed within the fixed time period, an EDM error occurs. Output 1 and Output 2 turn OFF and a safety output terminal error (EDM error) occurs.

Using EDM makes it possible to detect contact weld faults and external wiring errors (disconnections) in safety output devices such as safety relays and contactors.

Precautions in Using Welding Check (EDM) Operation

Feedback Monitoring Time (T_{EDM})

The EDM feedback time for the NE0A-series Controller is as given below and cannot be changed.

$$T_{EDM} = 300 \text{ ms}$$

- + EDM feedback input ON delay/OFF delay time
- + Output ON delay/OFF delay time

Parameters That Can Be Set

Data That Can Be Set for Feedback Signals

Name	Options	Setting range
Feedback signal	Local input	Safety input terminals. All terminals can be selected.

EDM Error Operation and Error Reset

Error	Operation when an error occurs			Error reset
	Outputs 1 and 2	Safety output terminal I/O indicator	Safety output status	
EDM feedback time error	OFF (safety status)	Lit (red)	0 (error)	After the error has been removed, the output condition result turns ON.

Timing Charts

Routing (EDM Not Used): Dual Channel Output

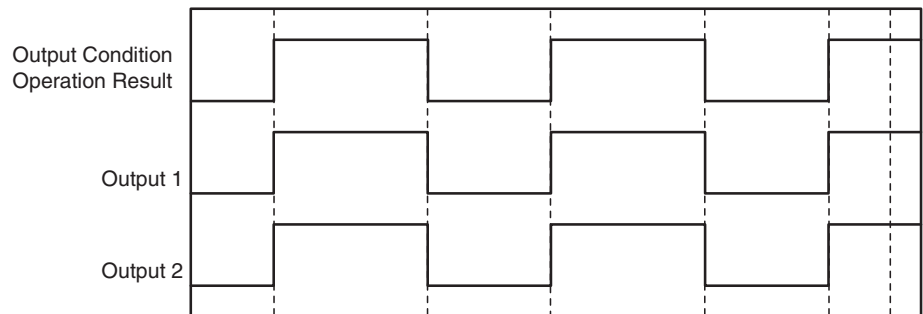

EDM: Dual Channel Output

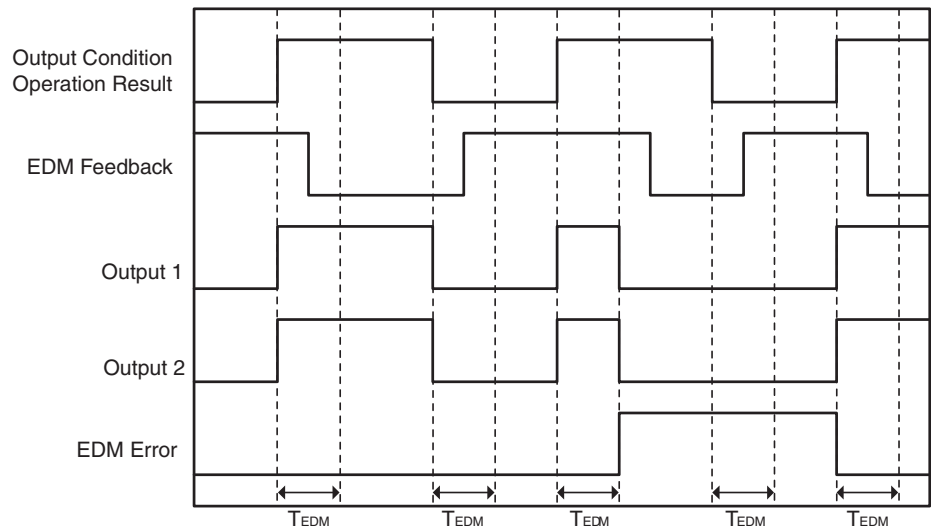

6-4-6 Safety Output Evaluation

Make the output mode (logic and additional outputs) and output delay settings.

Safety output evaluation logic performs dual channel evaluation and output circuit diagnosis (diagnosis of internal circuits and external devices and wiring using test pulses) of values after output delays, and sends outputs to safety output terminals.

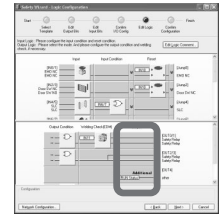

Note For details on dual channel evaluation and output circuit diagnosis, refer to 2-3 Local Safety I/O Functions.

Output Mode

Either a safety logic operation result or additional output data can be selected.

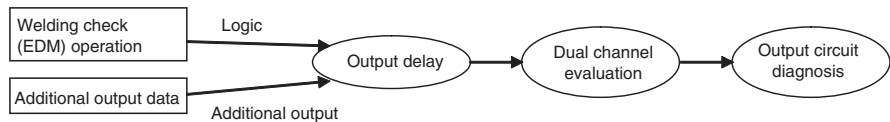

Logic

An output delay is executed for the safety logic operation result, i.e., the welding check (EDM) operation result, and the result is output to the safety output terminal.

Additional Outputs

A local I/O terminal can be set for an additional output, and the same value, inverse value, or error information can be output. This function is used for monitor applications and lock clear signal outputs for safety door switches with lock mechanisms.

The following items can be selected for use as additional outputs.

Additional output data	Description	Attribute
Same value as safety output terminal	Outputs the same value as one of safety outputs N (N: Even-numbered outputs)	Safety
Inverse value of safety output terminal	Outputs the inverse value of one of safety outputs N (N: Even-numbered outputs)	Safety
Same value as safety input terminal	Outputs the same value as one of the safety inputs (N: All inputs)	Safety
Inverse value of safety input terminal	Outputs the inverse value of one of the safety inputs (N: All inputs)	Safety
Reset Required Indication	Reset required signal. Reset signal required pulses for reset operations in logic operations. Refer to 6-4-3 Reset Operation.	Non-safety
RUN Status Flag	RUN Status Flag 0: Not RUN mode 1: RUN mode	Non-safety
Normal Status Flag	Unit Normal Status Flag 0: Error occurred. (See SECTION 12 Troubleshooting.) 1: Normal	Non-safety
Forced S/R Mode Flag	Force-setting/resetting Mode Flag 0: Not force-setting/resetting mode 1: Force-setting/resetting mode	Non-safety
Always ON Flag	Always ON data	Safety

IMPORTANT If additional output is set, outputs will be reflected in the safety outputs even in IDLE mode.

- Note**
- An additional output can be used only when the output terminal is set as a single channel.
 - An ON and OFF delay can be set for the safety output terminal even when an additional output is set.

Output Delays

ON Delay

After the EDM operation result has changed from OFF to ON, the output signal remains OFF for the time set for the ON delay (0 to 300,000 ms, in increments of 100 ms). It turns ON after the set time also if the EDM operation result is still ON after the set time. ON delays can be set for additional output data in the same way.

OFF Delay

After the EDM operation result has been changed from ON to OFF, the output signal remains ON for the time set for the OFF delay (0 to 300,000 ms, in units of 100 ms). It turns OFF if the EDM operation result is still OFF after the set time. OFF delays can be set for additional output data in the same way.

- Note**
- When the same data as for other output terminals is set as additional output data, the ON and OFF delay settings for those terminals are not reflected in the additional data.

Example: Assume, for example, that the following settings are made.

OUT 0: Output from internal logic and an OFF delay of 2,000 ms

OUT 2: Same value as additional output. OUT 0 with OFF delay of 1,000 ms

Here, OUT 2 will change from ON to OFF 1,000 ms after the OUT 0 EDM operation result changes from ON to OFF.

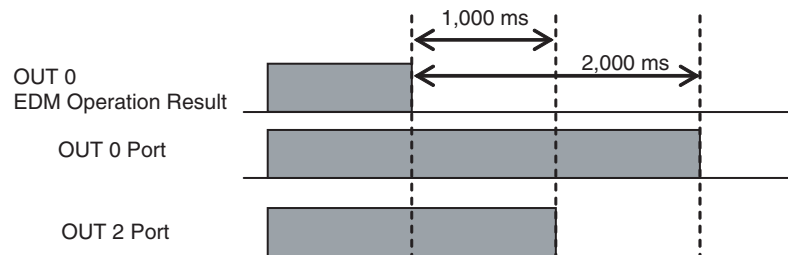

6-5 Remote I/O Allocations

This section describes the procedures for NE0A-series Controller allocations to Safety Masters and Standard Masters.

6-5-1 Overview

The NE0A-series Controller internally supports multiple sets of remote I/O data (I/O assembly data). To specify the I/O data, use the Network Configurator to specify the connection path.

6-5-2 Types of Data

The following table shows the types of data in the NE0A-series Controller.

Input data (Controller to Master)		Contents	Attribute	
Input data	Safety input terminal data	ON/OFF value after safety input evaluation 0: Input terminal OFF or error 1: Input terminal ON	Safety	
	Safety input terminal status	Normal Status Flag based on safety input evaluation. Used to monitor safety input terminal errors, such as disconnections, ground faults, and short-circuits. 0: Error 1: Normal (no error)	Non-safety	
	Safety output data	Safety output terminal monitored value 0: Output terminal OFF 1: Output terminal ON	Non-safety	
	Safety output status	Normal Status Flag based on safety output evaluation 0: Error 1: Normal (no error)	Non-safety	
	General status	Bit 0	Input Power Supply Voltage Error Flag 0: Normal power supply is ON. 1: Voltage error or power supply is OFF.	Non-safety
		Bit 1	Output Power Supply Voltage Error Flag 0: Normal power supply is ON. 1: Power supply voltage error or power supply is OFF.	
		Bit 2	Network Power Supply Voltage Error Flag 0: Normal power supply is ON, or Stand-alone Mode 1: Voltage error or power supply is OFF.	
Bit 3		Unit Maintenance Flag 0: Lower than set monitor value 1: Equal to or higher than set monitor value		
Bit 4		RUN Status Flag 0: Not RUN 1: RUN		
Bit 5		Local I/O Error Flag 0: All terminals normal 1: I/O terminal error (See <i>12-2 Troubleshooting with Error History.</i>)		
Bit 6	Unit Normal Status Flag 0: Error (See <i>12-3 Troubleshooting by Monitoring Parameters.</i>) 1: Normal (no error)			

Input data (Controller to Master)		Contents		Attribute
Input data	General status	Bit 7	Connected Component Maintenance Flag 0: All I/O points are lower than set monitor value 1: One or more I/O point is same as or higher than set monitor value	Non-safety
	Remote Input Byte Data	NE0A-series Controller internal status and logic operation results can be specified. For details, refer to 6-3-4 <i>Setting Networks</i> .		
	Reset Required Indication	Reset required signal. Reset signal required pulses for reset operations in logic operations. Refer to 6-4-3 <i>Reset Operation</i> .		Non-safety
	RUN Status Flag	Same as for General Status Bit 4 (Operating Mode Flag).		Non-safety
	Normal Status Flag	Same as for General Status Bit 6 (Unit Normal Flag).		Non-safety
	Forced S/R Mode Flag	Forced S/R Mode Flag 0: Not force-setting/resetting mode 1: Force Mode (Force-setting and force-resetting are enabled.)		Non-safety
	Always ON Flag	Always ON data. Used to detect whether I/O communications with the NE0A-series Controller are established at the Safety Master or Standard Master.		Safety
Logic Operation Result	Individual block operation results for safety logic block operations		Safety	
Output data (Master to Controller)		Contents		Attribute
Output data	Remote Output Byte Data	Can be used for logic operations for data received from the Safety Master or Standard Master. (See note.)		Depends on Master.

Note Output data can be assigned to either the Safety Master or the Standard Master only.

IMPORTANT With non-safety data, the required measures are not taken in the data creation process for the data to be treated as safety data. Do not use non-safety data when configuring a safety system. In addition, even safety data becomes non-safety data when standard I/O communications is used for an input. Do not use standard I/O communications when for inputs in a safety system.

Safety I/O Terminal Data

Safety input terminal data is not the data directly from the safety input terminals, but rather it is the value after input evaluation (input device and input circuit diagnosis, input ON/OFF delays, and dual channel evaluation).

Note For details on input device and input circuit diagnosis, input ON/OFF delays, and dual channel evaluation, refer to 2-3 *Local Safety I/O Functions*.

Status of Safety I/O Terminals

The status of the safety I/O terminals is used to monitor safety I/O terminal errors, such as ground faults and short-circuits. This enables identifying the location of the error.

Note If an error is detected, refer to 12-3 *Troubleshooting by Monitoring Parameters* for information on causes and how to remove them.

RUN Status and Normal Status Flags

Combining the RUN Status Flag and the Normal Status Flag enables the Safety Master or Standard Master to detect whether the NEOA-series Controller is operating normally.

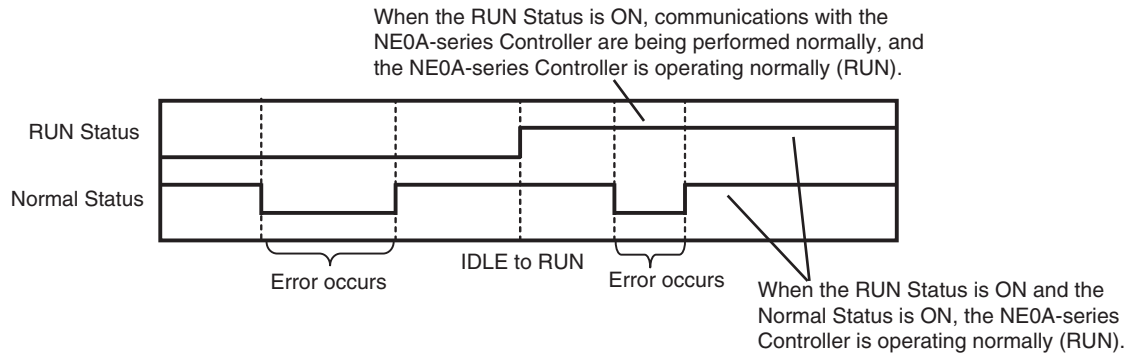

Always ON Data

You check whether safety I/O communications or standard I/O communications with the NEOA-series Controller are being performed normally for the Safety Master and Standard Master.

Relationship between Safety Logic Operations and Remote Input Data

The results of safety logic operations for the NEOA-series Controller can be sent to the Safety Master and Standard Master. The following figure shows data that can be sent and the names of that data.

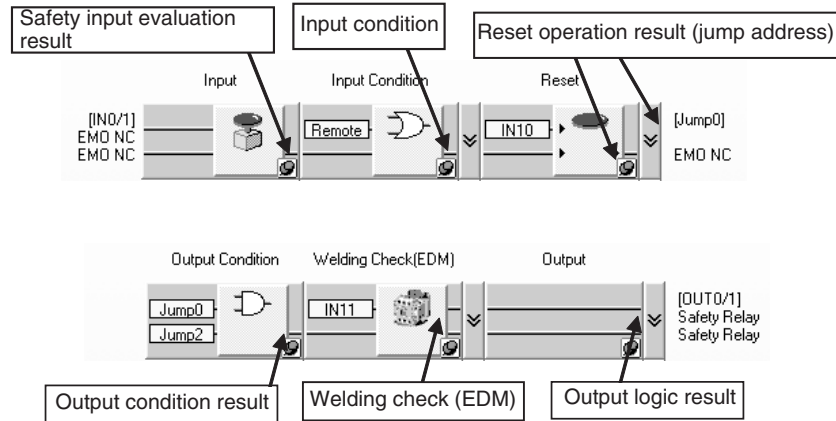

6-5-3 Supported I/O Data (I/O Assembly Data)

The NEOA-series Controller supports the I/O assembly data indicated below.

What Is I/O Assembly Data?

I/O assembly data is data held in a device that is collected to be accessed by external devices. Specifically, it is batch I/O data consisting of the data described in 6-5-2 Types of Data. Multiple I/O data can be sent or received in a batch by simple specifying this I/O assembly data as a connection path from the Safety Master or Standard Master.

Input Assembly Data (Remote Input Area: NEOA-series Controller to Master)

The same NEOA-series Controller input assembly data can be allocated to both the Safety Master and the Standard Master, or even to more than one Safety Master.

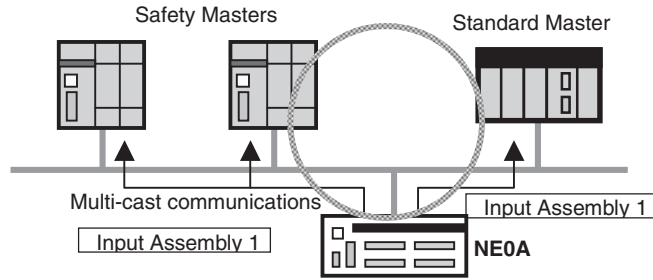

Output Assembly Data (Remote Output Data: Master to NE0A-series Controller)

The same NE0A-series Controller output assembly data cannot be allocated to both the Safety Master and the Standard Master, and it cannot be allocated to more than one Safety Master. If it is allocated to both the Safety Master and the Standard Master, a connection will be established with the remote device where communications are started first, and connection errors will occur for remote devices connected later.

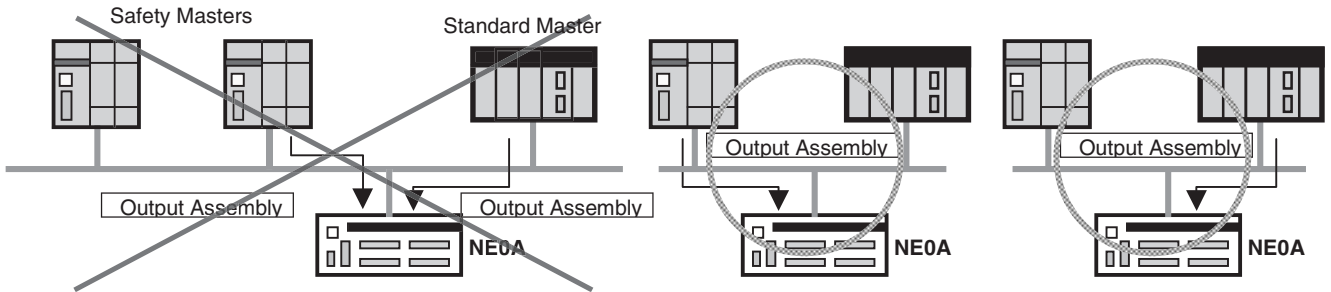

NE0A-SCPU01

The following tables show the default I/O assembly data values.

Safety I/O Connection

Default value (Assembly instance No.)	
IN	Input assembly 1 (No. 3B0)
OUT	Output assembly (No. 356)

Standard I/O Connection

Connection	Default value (Assembly instance No.)	
	Poll	IN
	OUT	None
Bit strobe	IN	Input assembly 2 (No. 3B1)
	OUT	None
COS	IN	Input assembly 2 (No. 3B1)
	OUT	None
Cyclic	IN	Input assembly 2 (No. 3B1)
	OUT	None

Input Type

Either safety or standard I/O communications can be selected.

Input Assembly 1

Instance (Hex)	Byte	Bit 7	Bit 6	Bit 5	Bit 4	Bit 3	Bit 2	Bit 1	Bit 0
3B0	0	Remote Input Byte Data							

Input Assembly 2

Instance (Hex)	Byte	Bit 7	Bit 6	Bit 5	Bit 4	Bit 3	Bit 2	Bit 1	Bit 0
3B1	0	Remote Input Byte Data							
	1	Safety Input Terminal No. 7	Safety Input Terminal No. 6	Safety Input Terminal No. 5	Safety Input Terminal No. 4	Safety Input Terminal No. 3	Safety Input Terminal No. 2	Safety Input Terminal No. 1	Safety Input Terminal No. 0
	2	Safety Output Terminal No. 3 Monitor	Safety Output Terminal No. 2 Monitor	Safety Output Terminal No. 1 Monitor	Safety Output Terminal No. 0 Monitor	Safety Input Terminal No. 11	Safety Input Terminal No. 10	Safety Input Terminal No. 9	Safety Input Terminal No. 8
	3	Reserved for system.						Safety Output Terminal No. 5 Monitor	Safety Output Terminal No. 4 Monitor

Input Assembly 3

Instance (Hex)	Byte	Bit 7	Bit 6	Bit 5	Bit 4	Bit 3	Bit 2	Bit 1	Bit 0
3B2	0	Remote Input Byte Data							
	1	Safety Input Terminal No. 7	Safety Input Terminal No. 6	Safety Input Terminal No. 5	Safety Input Terminal No. 4	Safety Input Terminal No. 3	Safety Input Terminal No. 2	Safety Input Terminal No. 1	Safety Input Terminal No. 0
	2	Safety Output Terminal No. 3 Monitor	Safety Output Terminal No. 2 Monitor	Safety Output Terminal No. 1 Monitor	Safety Output Terminal No. 0 Monitor	Safety Input Terminal No. 11	Safety Input Terminal No. 10	Safety Input Terminal No. 9	Safety Input Terminal No. 8
	3	Safety Input Terminal No.5 Status	Safety Input Terminal No.4 Status	Safety Input Terminal No.3 Status	Safety Input Terminal No.2 Status	Safety Input Terminal No.1 Status	Safety Input Terminal No.0 Status	Safety Output Terminal No. 5 Monitor	Safety Output Terminal No. 4 Monitor
	4	Safety Output Terminal No.1 Status	Safety Output Terminal No.0 Status	Safety Input Terminal No.11 Status	Safety Input Terminal No.10 Status	Safety Input Terminal No.9 Status	Safety Input Terminal No.8 Status	Safety Output Terminal No.7 Status	Safety Output Terminal No.6 Status
	5	Reserved for system.				Safety Output Terminal No.5 Status	Safety Output Terminal No.4 Status	Safety Output Terminal No.3 Status	Safety Output Terminal No.2 Status
6	General Status								

Output Type

Either safety or standard I/O communications can be selected, but both cannot be selected at the same time.

Output Assembly

Instance (Hex)	Byte	Bit 7	Bit 6	Bit 5	Bit 4	Bit 3	Bit 2	Bit 1	Bit 0
356	0	Remote Input Byte Data							

6-5-4 Allocations to a Safety Master

This section describes the information required for NE0A-series Controller allocations to an NE1A-series Safety Master. For details on the allocation procedure, refer to the *DeviceNet Safety System Configuration Manual* (Cat. No. Z905).

**Safety I/O
Communications
Specifications**

Item		Specifications
Number of supported connections		
Inputs (NE0A-series Controller to Master)	1	(Communications are possible, however, with up to 15 Safety Masters using Multi-Cast connection.)
Outputs (Master to NE0A-series Controller)	1	
Connection type		
Inputs (NE0A-series Controller to Master)	Single-Cast, Multi-Cast	
Outputs (Master to NE0A-series Controller)	Single-Cast	
Expected packet interval (EPI)	Min.: 10 ms, Max.: 500 ms	

6-5-5 Allocations to a Standard Master

This section describes the information required for NE0A-series Controller allocations to a Standard Master, an CS/CJ-series DeviceNet Master Unit. For details on the allocation procedure, refer to *A-2 Editing CS/CJ-series DeviceNet Unit Parameters* in the *DeviceNet Safety System Configuration Manual* (Cat. No. Z905).

Standard I/O Communications Specifications

Item	Specifications
Number of supported connections	2 (Poll, bit strobe, COS, cyclic)
Expected packet interval (EPI) (communications cycle time)	Min.: 10 ms, Max.: 500 ms

I/O Assembly Data That Can Be Transmitted

The following I/O assembly data can be transmitted for NE0A-series Controller allocations to a CS/CJ-series DeviceNet Master Unit.

**DeviceNet Safety System
(Safety I/O
Communications with
NE0A-series Controller)**

O: Communications (allocations) enabled, ×: Communications (allocations) not enabled

I/O communications	I/O assembly data			
	Input Assembly			Output Assembly
	1	2	3	
Safety I/O communications	O	O	O	O
Standard I/O communications	O	O	O	×

DeviceNet System

O: Communications (allocations) enabled, ×: Communications (allocations) not enabled

I/O communications	I/O assembly data			
	Input Assembly			Output Assembly
	1	2	3	
Standard I/O communications	O	O	O	O

Note Either safety I/O communications or standard I/O communications, but not both, can be used for NE0A-series Controller remote output data. While safety I/O communications are being used with the NE1A-series Safety Master, standard I/O communications cannot be used with the Standard Master. Route the communications through the Safety Master.

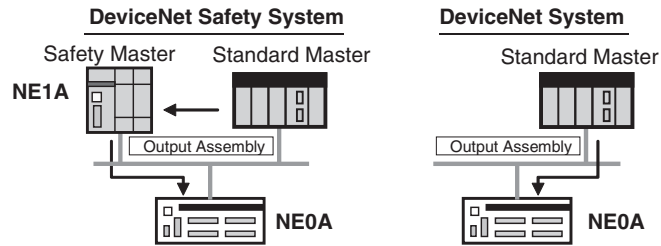

Communications Cycle Time

For NE0A-series Controller allocations to a CS/CJ-series DeviceNet Master Unit, set the communications cycle time to a minimum of 10 ms. If a value of less than 10 ms is set, a standard I/O communications timeout will occur.

Fixed Allocations to a CS/CJ-series DeviceNet Master Unit

Be careful of NE0A-series Controller node addresses for NE0A-series Controller when using fixed allocations for CS/CJ-series CPU Unit I/O memory.

For example, the NE0A-SCPU01 Input Assembly 2 fixed allocation is four bytes in size, so two words are allocated in CS/CJ-series CPU Unit I/O memory. Therefore the Controller node address + 1 must not be used). If three NE0A-SCPU01 Controllers are used, allocate #00, #02, and #04 to the Controllers and do not use #01, #03, and #05.

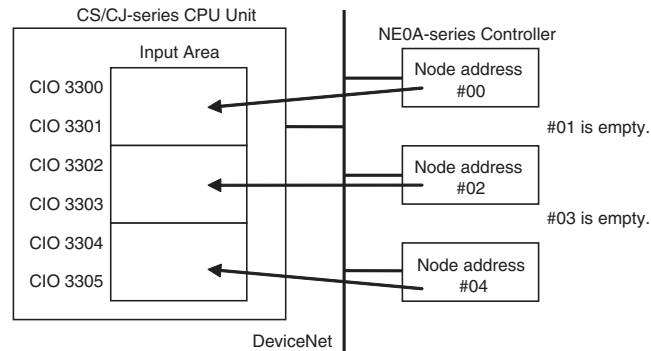

⚠ WARNING

Of the NE0A-series Controller internal status data allocated to the Safety Master, do not use non-safety data for safety input signals. Doing so may cause safety function failure and serious bodily injury. With non-safety data, the required measures are not taken in the data creation process for the data to be treated as safety data.

6-6 Saving Project Files

6-6-1 Saving Project Files

This function saves the configurations for all devices on the network, including the NEOA-series Controller configurations up to this point. To save a configuration, select **File - Save** or **File - Save As**.

6-6-2 Reading Project Files

To read a project file, select **File - Open**.

6-6-3 Protecting Project Files with Passwords

A password can be set for a project file to prevent unauthorized personnel from inadvertently changing the file. A password is requested in the following cases.

Saving a Project File

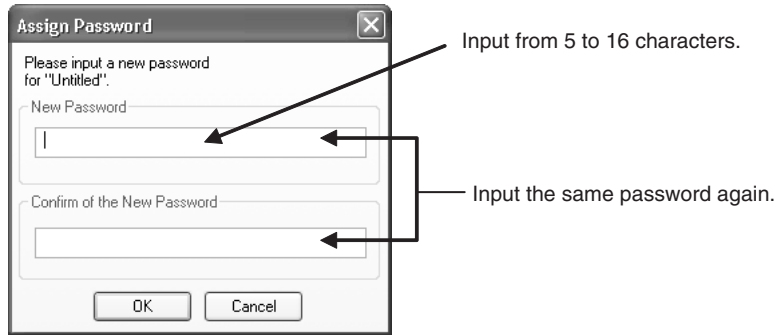

Reading Project Files

A password is requested before a project file can be read. Input the password that has been set. If the passwords do not match, the file will open in Protect Mode. In Protect Mode, operations such as saving files, downloading parameters, and changing device status are restricted.

For details on the protect mode, refer to the *DeviceNet Safety System Configuration Manual* (Cat. No. Z905).

Changing a Password

A password that has been set can be changed by selecting **File - Change Password**.

Note

- For security, it is recommended that passwords be set for network configuration files.
- Do not forget the password once it has been set. If the password is forgotten, the network configuration file will only open in Protect Mode and it cannot be edited.

SECTION 7

Connecting Online and Downloading

This section describes how to connect to an NE0A-series Safety Network Controller and download the configuration to it.

7-1	Overview	92
7-2	Connecting Online	93
7-2-1	Online Connection Procedure	93
7-3	Downloading to Devices	96
7-3-1	Procedure for Downloading to a Device	96
7-4	Verifying the Configuration	97
7-4-1	Verification Procedure	97
7-5	Uploading from Devices	98
7-5-1	Procedure for Uploading from a Device	98
7-5-2	Procedure for Uploading from the Network	98
7-6	Reset	99
7-6-1	Reset Types	99
7-6-2	Reset Type and NE0A-series Controller Status	99
7-6-3	Procedure for Resetting	99
7-7	Access Control with Password	100
7-7-1	Scope of Access Control	100
7-7-2	Lost Device Passwords	100
7-7-3	Procedure for Setting Device Passwords	100

7-1 Overview

An NEOA-series Controller configuration created on a virtual network, as described in *SECTION 6 Creating Configurations*, is downloaded to the NEOA-series Controller on the actual network. To download a configuration to the NEOA-series Controller, the Network Configurator must be connected online.

There are various ways to connect online, including via DeviceNet or via the USB port of an NEOA-series or NE1A-series Controller. The method described here is how to connect via the USB port of an NEOA-series or NE1A-series Controller.

- Note**
- (1) The OMRON NEOA USB Port Driver must be installed to connect the Network Configurator online using the USB port for the NEOA-series Controller. For information on the driver installation procedures, refer to *Appendix C Installing the NEOA USB Port Driver*.
 - (2) For details on other methods of connecting online, refer to the *DeviceNet Safety System Configuration Manual (Cat. No. Z905)*.

Basic Flow of Operations

The basic flow of operations for downloading as follows:

- 1,2,3...**
1. Connecting online (connecting the Network Configurator and NEOA-series Controller)
 2. Downloading to the device
 3. Verify the configuration.

In addition to the above, this section also describes the following online operations.

■ Uploading from Devices

Reading the configuration from a device.

■ Resetting Devices

Restarting a device and deleting a set configuration to return to the default settings.

■ Setting Device Passwords

Setting device passwords to prevent unauthorized access to devices (for changing configurations, changing modes, etc.).

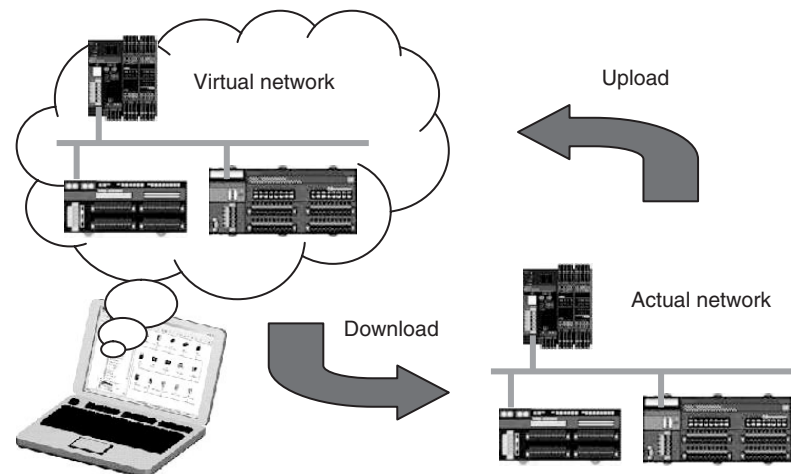

7-2 Connecting Online

This section describes the procedure for connecting the Network Configurator online.

7-2-1 Online Connection Procedure

Connecting to the NE1A-series USB Port

- 1,2,3... 1. Select **Interface - NExA USB Port** from the Options Menu.
2. Click the **Online** Icon ().



3. Click the **OK** Button in the Select Connect Network Port Dialog Box.
4. Click the **OK** Button in the Select Connected Network Dialog Box.

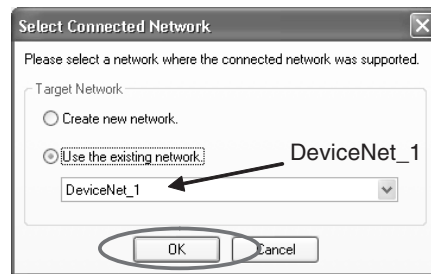

5. When the online connection has been successfully established,  **On-line** will be displayed in the bottom right of the Network Configurator window.

Note When both an NE0A-series Controller and an NE1A-series Controller are connected on an actual network, it is recommended that the online connection be made through the USB port of the NE1A-series Controller. Connecting online in this way enables shorter download and upload times to the overall network than through the NE0A-series Controller.

Connecting to the NE0A-series USB Port

In addition to the Network Configurator and the USB connection for the NE0A-series Controller, NE0A-series Controllers can be connected online to DeviceNet at a specified baud rate. The baud rate is set using automatic baud rate detection at the time when the NE0A-series Controller is turned ON. Therefore, when communications frames are not being sent over the network, the Controller will remain offline. This function can be used effectively in these cases.

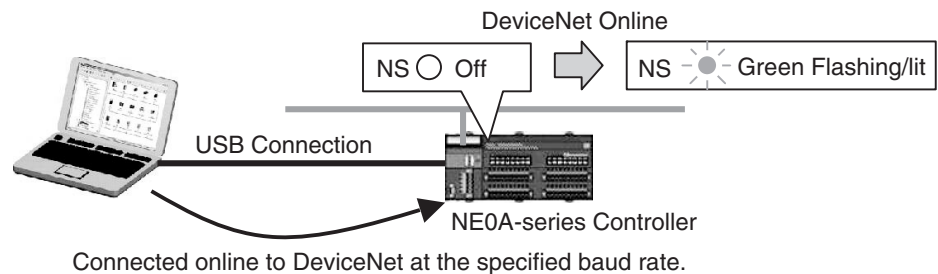

- Note**
- (1) There will be no communications frames on the network in the following situations.
 - ✓ When there are no devices present on the network that control the baud rate (e.g., NE1A-series Controller or Standard Master).
 - ✓ When the NE1A-series Controller is not performing safety I/O communications because it is not in RUN Mode.
 - ✓ When the Master functions on the Standard Master are stopped, and standard I/O communications are not being performed.
 - ✓ When the NE0A-series Controller is waiting for DeviceNet online processing due to the difference in start times between the NE1A- and NE0A-series Controllers.
 - (2) For information on connecting online to DeviceNet, refer to *3-1 Start Time*.
 - (3) For information on errors that may occur during online operations, refer to *12-4 Online Operation Errors with USB Connection*.

- 1,2,3...**
1. Select **Interface - NExA USB Port** from the Options Menu.
 2. Click the **Online Button** ().



3. In the Setup Interface Dialog Box, select the option in the Baud Rate Area that corresponds to the baud rate setting for the NE0A-series Controller connected by USB. If the Unit is already connected online to DeviceNet, this dialog box will not appear.

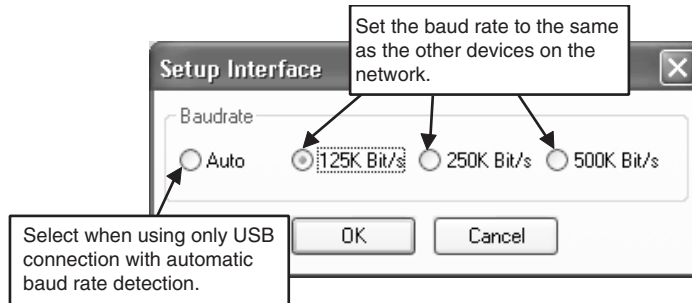

IMPORTANT If there are other devices already online on the same network, set the baud rate to the same baud rate as the devices. If devices on the network have different baud rates, a bus off error will occur, and communications will not function correctly.

Note If a network power supply error or other error occurs and prevents connecting online to DeviceNet even when the baud rate has been specified, use the USB connection.

4. The Select Connected Network Dialog Box will be displayed. Click the **OK** Button.

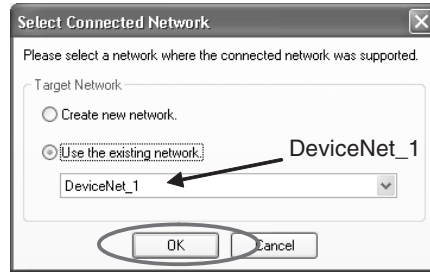

7-3 Downloading to Devices

Once the online connection has been established, there are two ways to download a configuration to the NE0A-series Controller, as shown below. Downloading to devices alone is normally sufficient, so that is the method described in this section.

Download method	Description
Device downloading	This method downloads the configuration to only a selected device on the virtual network.
Network downloading	This method downloads the configuration to all of the devices on the virtual network, and it compares the configurations of the virtual network and the actual network.

7-3-1 Procedure for Downloading to a Device

- 1,2,3...**
1. Right-click the device on the virtual network to which the configuration is to be downloaded, and select **Parameters – Download** from the pop-up menu. It is also possible to select multiple devices.
 2. Input the device password when prompted. To use the same password for downloading to more than one device, select the box for that purpose.

- Note**
- It is recommended that the default status be used for downloading to the NE0A-series Controller. If not using the default status, then perform a reset.
 - Connect to the NE0A-series USB port to download the configuration when DeviceNet communications are disabled (Standalone).
 - It is recommended that device passwords be set to prevent unauthorized or unintentional changes to configurations. For information on device passwords, refer to *7-7 Access Control with Password*.
 - For details on errors that occur during downloads, and on downloading procedures, refer to *SECTION 12 Troubleshooting*.
 - The time required to download may be longer if the NE1A-/NE0A-series Controllers are in RUN Mode. The time required to download can be reduced by changing to IDLE Mode.

7-4 Verifying the Configuration

After the download is finished, a verification is performed to check that the configuration that was created has been correctly downloaded to the device. If the verification confirms that the configuration is correct, a report created from data uploaded from the device will be displayed.

Devices with verified configurations will have a green “S” icon display by them in the Network Configurator.



IMPORTANT Be sure to use the report that is displayed after the verification has finished to check that the confirmation that was created matches the configuration that was downloaded.

7-4-1 Verification Procedure

- 1,2,3...**
1. Right-click the device to download on the virtual network, and select **Parameter - Verify** from the menu. Multiple devices can be selected for verification.
 2. The report will be created if a message appears saying that no differences were found in the parameters.
 3. Check the contents of the report, and then click the **Save** Button.
 4. A message will ask if it is OK to mark the device for a verified configuration. Click the **Yes** Button, and the icon will turn green.

Note After verification has been finished, a configuration lock can be set for devices that have already been user tested. For information on locking configurations, refer to *8-3 Configuration Lock and Automatic Operation*.

7-5 Uploading from Devices

There are two methods for uploading NE0A-series Controller configurations, as shown below.

Upload method	Description
Device uploading	This method uploads the configuration from only a selected device on the virtual network.
Network uploading	This method uploads the configuration to all of the devices on the virtual network.

7-5-1 Procedure for Uploading from a Device

Right-click the device on the virtual network from which the configuration is to be uploaded, and select **Parameters – Upload** from the pop-up menu. It is also possible to select multiple devices.

Note For details on uploading from devices, refer to the *DeviceNet Safety System Configuration Manual* (Cat. No. Z905).

7-5-2 Procedure for Uploading from the Network

Click the **Upload from Network** Icon in the toolbar.



Note For details on uploading from networks, refer to the information on uploading network configurations from actual networks in the *DeviceNet Safety System Configuration Manual* (Cat. No. Z905).

7-6 Reset

7-6-1 Reset Types

The Network Configurator can reset the NE0A-series Controller in the following three ways. A password is required to enter reset.

Reset type	The configuration	MS indicator	Error history	Maintenance data
Emulate cycling power	Settings before the reset are retained.	Same as before reset.	Log before the reset is retained.	Values before reset are retained.
Return to the default configuration, and then emulate cycling power. (Initialize all data.)	Initialization (Default)	Flashing red and green. (Waiting for configuration.)	Initialized. (All data cleared.)	Values before reset are retained.
Return to the default configuration except to preserve the following parameters, and then emulate cycling power. (Retain specified data.)	Depends on user specifications.	Depends on user specifications.	Initialized. (All data cleared.)	Values before reset are retained.

The configuration includes local I/O settings, logic settings, network numbers, and passwords. The NE1A-series Controller stores this data in its nonvolatile memory. Some information, however, cannot be changed once it is set. Select the corresponding reset type to return the information to the default parameter settings.

7-6-2 Reset Type and NE0A-series Controller Status

Depending on the reset type and NE0A-series Controller's status, reset might not be possible.

Reset type	NE0A-series Controller's status	
	Configuration lock - LOCK indicator lit.	Configuration lock - LOCK indicator flashing.
Emulate cycling power	Able to reset	Able to reset (See note.)
Return to the default configuration, and then emulate cycling power.	Unable to reset	Able to reset (See note.)
Return to the default configuration except to preserve the following parameters, and then emulate cycling power.	Unable to reset	Able to reset (See note.)

Note Resetting is not possible after safety I/O communications have been started.

7-6-3 Procedure for Resetting

- 1,2,3...**
1. Right-click on the device on the virtual network that is to be reset, and select **Reset** from the pop-up menu.
 2. In the Device Reset Window, input the reset type and the device password.

Note For details on errors that occur during resets, refer to *SECTION 12 Troubleshooting*.

7-7 Access Control with Password

The NE0A-series Controller can register a device password in its nonvolatile memory. The device password can be used to prevent unauthorized or unintentional access to the Controller from a person other than a user (i.e., a safety manager). No device password is set by default; the user must register one.

Use the Network Configurator to set or change the device password for the NE0A-series Controller.

7-7-1 Scope of Access Control

The following operations require the user to enter a device password. The NE0A-series Controller does not perform the following operations unless the password is correct.

- Downloading the configuration
- Locking or unlocking the configuration
- Executing the NE0A-series Controller reset service
- Changing the operating mode
- Changing the password

7-7-2 Lost Device Passwords

Contact your OMRON representative if you lose your password. For details, refer to *Appendix D Using the Password Recovery Tool*.

7-7-3 Procedure for Setting Device Passwords

- 1,2,3...
1. Right-click on the device on the virtual network for which the password is to be reset, and select **Change password** from the pop-up menu.
 2. In the Password Change Window shown below, input the current password and the new password.

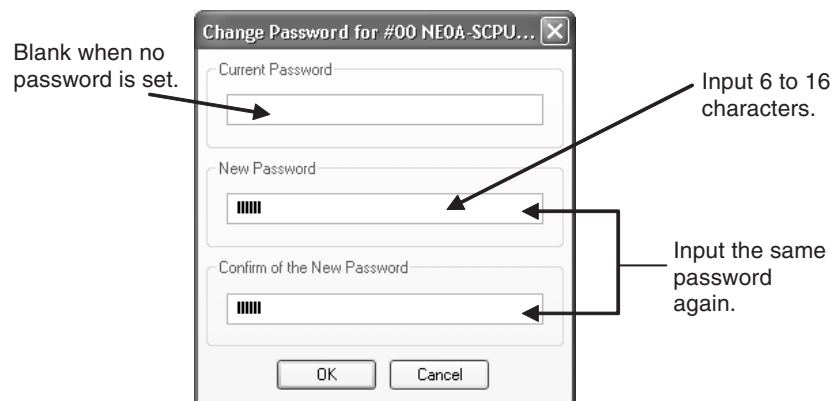

Note For details on device passwords, refer to the *DeviceNet Safety System Configuration Manual* (Cat. No. Z905).

SECTION 8

Operation and Operating Modes

This section describes general operation and the operating modes of the NE0A-series Safety Network Controllers.

8-1	NE0A-series Controller Operating Modes	102
8-1-1	Overview of Operating Modes	102
8-1-2	Functions Supported in Each Operating Mode.	103
8-2	Changing the Operating Mode	104
8-2-1	Moving between Operating Modes	104
8-2-2	Procedure for Changing Modes	104
8-3	Configuration Lock and Automatic Operation	105
8-3-1	Configuration Lock.	105
8-3-2	Configuration Lock Procedure	105
8-3-3	Starting Operating Mode Using Automatic Operation.	105
8-3-4	Unlocking the Configuration	106
8-4	Changing the Configuration	107
8-4-1	Procedure for Changing the Configuration.	107
8-5	Behavior for Power Supply Interruptions.	108
8-5-1	Behavior in Voltage Drop	108
8-5-2	Automatic Recovery from Voltage Drops	108

8-1 NE0A-series Controller Operating Modes

8-1-1 Overview of Operating Modes

The NE0A-series Controller supports the operating modes listed in the following table. The operating mode can be confirmed by checking the MS indicator on the front of the NE0A-series Controller, by using the Network Configurator. (Right-click and select Monitor, see note 1), or by monitoring the RUN Status Flag (see note 2).

- Note**
- (1) Refer to *9-1 Monitoring Devices*.
 - (2) Refer to *6-5 Remote I/O Allocations* and *6-4-6 Safety Output Evaluation*.

Operating mode	Description	MS indicator status	Network Configurator monitor display	RUN Status Flag
RUN Mode	All functions are supported, including safety logic.	Lit green	Running	ON
IDLE Mode	Initialization has been completed, and the Controller is waiting to move to RUN Mode. All DeviceNet communications (safety I/O, standard I/O, message communications) are supported.	Flashing green	Idling	OFF
CONFIGURING Mode	Waiting for the configuration to be downloaded.	Flashing green/red	Configuration in progress or waiting for TUNID setting.	OFF
Abort	<p>A minor error occurred.</p> <p>The NE0A-series Controller goes into this mode in the following cases. The power supply must be cycled or a reset performed from the Network Configurator to reset to RUN Mode.</p> <ol style="list-style-type: none"> 1. The NE0A-series Controller's switch settings are changed after configuration is completed. 2. The Force Mode (i.e., mode for performing Force-set and force-reset) time expires. 	Flashing red	Abort	OFF
Critical Error (system failure)	A critical error has occurred. The NE0A-series Controller stops all operations and goes into the safe state.	Lit red	System failure	OFF
Initialization	Self-diagnosis is being performed to ensure safety functions.	Flashing green/red	Self-testing	OFF

8-1-2 Functions Supported in Each Operating Mode

The following table shows the status of each NE0A-series Controller operating mode, and the operations that are supported from the Network Configurator in each mode.

Operating mode	Safety functions			Standard functions		Operations from Network Configurator					
	Safety logic operations	Safety I/O communications	Logical I/O control (including test outputs)	Standard I/O communications	Message communications	Configuration download	Configuration lock/unlock	Reset	Password changes	Online monitoring	Force-setting/resetting
RUN Mode	Executed	Supported	I/O refreshed	Supported	Supported	Supported	Supported	Supported (See note 1.)	Supported	Supported	Supported (See note 3.)
IDLE Mode	Stopped	Stopped	Safe state (See note 2.)	Stopped	Supported	Not supported	Supported				
CONFIGURING Mode								Not supported			
Abort						Not supported	Supported				
Critical Error (system failure)						Not supported	Not supported	Not supported	Not supported		
Initialization						Not supported	Not supported	Not supported			

- Note**
- (1) Support depends on the type of reset and whether the configuration is locked. Refer to 7-6 *Reset* for details.
 - (2) The safe state means the following:
 - Local safety output terminals are OFF.
 - Safety I/O communications data is OFF.
 - (3) Force-setting and force-resetting can be performed only if the configuration is unlocked.

8-2 Changing the Operating Mode

8-2-1 Moving between Operating Modes

The following diagram shows mode changes after initialization.

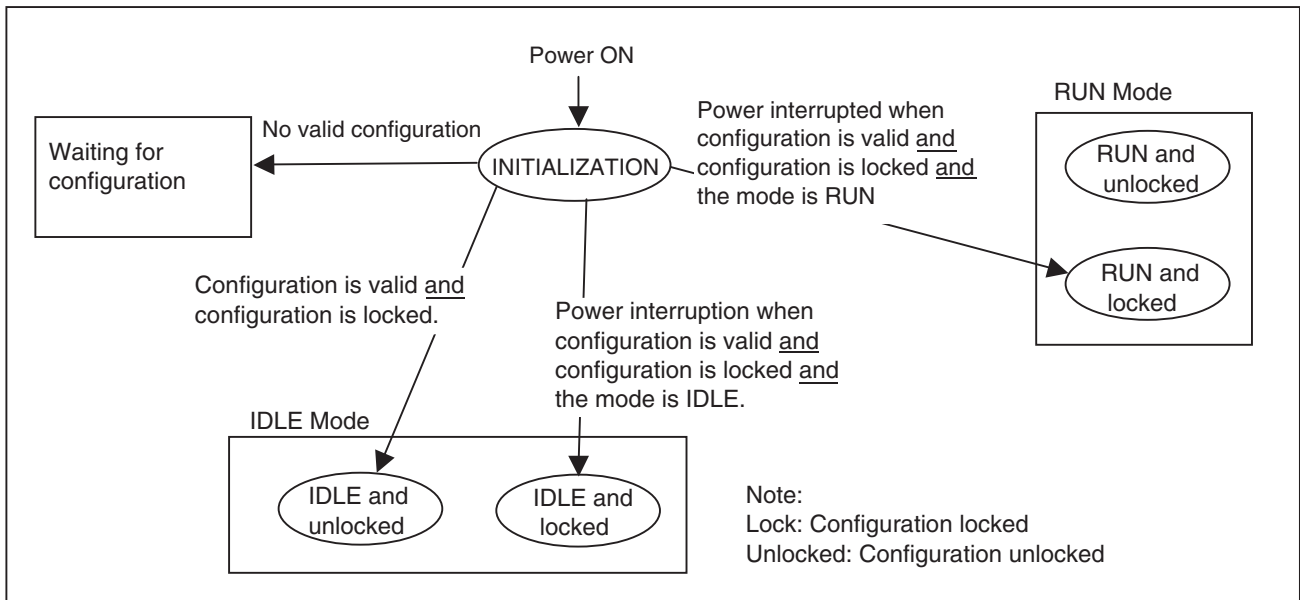

The following diagram shows mode changes for RUN Mode, IDLE Mode, and CONFIGURING Mode.

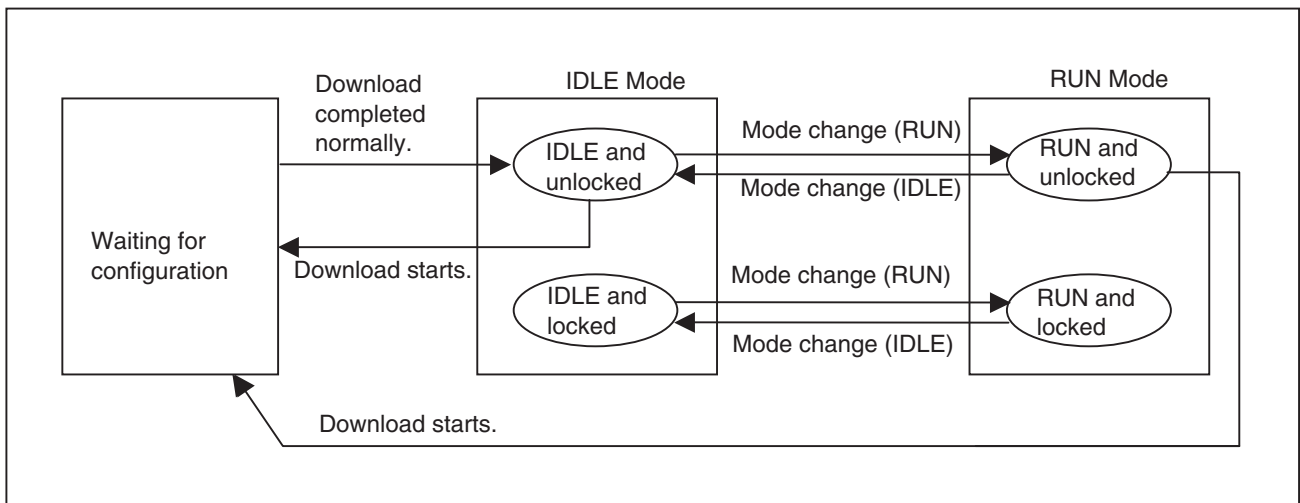

8-2-2 Procedure for Changing Modes

After the configuration for the NE0A-series Controller has been downloaded, start the safety logic operation by changing the mode using the Network Configurator as shown in the diagram above.

- 1,2,3... 1. Right-click the NE0A-series Controller in the virtual network and select **Mode Change – RUN**. To return to IDLE Mode, select **Mode Change – IDLE**.
2. Enter the device password when prompted. To continue using the same password for more than one mode change, select the check box for that purpose.

8-3 Configuration Lock and Automatic Operation

8-3-1 Configuration Lock

The configuration saved in the NE0A-series Controller can be locked to protect the data after it has been downloaded, verified, and user tests have been performed. Once the configuration is locked, the configuration cannot be changed until it is unlocked.

The following occurs when the configuration lock is set.

- The LOCK indicator on the front face of NE0A-series Controller lights yellow. (When unlocked, the indicator will flash yellow.)
- On the Network Configurator, the icon indicating the LOCK status is displayed.

Icon indicating lock status.



Note After the data has been locked, the lock icon will turn yellow if the configuration in the virtual network is changed.

8-3-2 Configuration Lock Procedure

The configuration can be locked as soon as the configuration has been verified. The procedure is as follows:

- 1,2,3...
1. Right-click the NE0A-series Controller on the virtual network and select **Parameters – Verify**. If the parameters match for the NE0A-series Controller on the virtual network and the actual NE0A-series Controller, then a report will be automatically displayed.
 2. Confirm that the report matches the configuration that has been set, and click the **Close** Button to close the report. Then click the **Yes** Button in each of the following two dialog boxes.

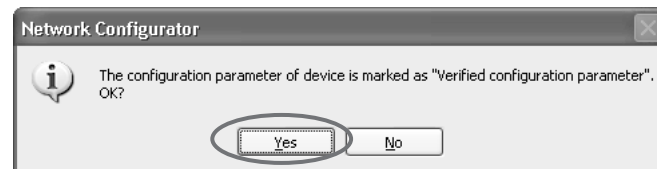

Note For details on the configuration lock procedure, refer to 3-9 *Configuration Lock* in the *DeviceNet Safety System Configuration Manual* (Cat. No. Z905).

8-3-3 Starting Operating Mode Using Automatic Operation

If the following conditions are satisfied, the NE0A-series Controller can be started in RUN Mode without having to change the mode from the Network Configurator.

- The configuration is locked.
- The power was turned OFF after changing to RUN Mode.

IMPORTANT Be sure to turn OFF the power while in RUN Mode. Even if the configuration is locked, the Controller will not start in RUN Mode the next time if the power is turned OFF while in IDLE Mode.

8-3-4 Unlocking the Configuration

This section describes how to unlock the configuration.

- 1,2,3...**
1. Right-click the NEOA-series Controller in the virtual network, and then select **Unlock** from the pop-up menu.

IMPORTANT Device passwords must be entered to unlock the configuration.

8-4 Changing the Configuration

This section describes how to change the NE0A-series Controller configuration after the configuration has been downloaded or after operation has been started.

8-4-1 Procedure for Changing the Configuration

To change the NE0A-series Controller configuration, first carefully check system safety and then unlock the configuration lock and reset to the NE0A-series Controller default setting. The procedure for changing the configuration is as follows:

- 1,2,3...**
1. Check the system safety.
 2. Change the NE0A-series and NE1A-series Controller operating mode from RUN to IDLE.
 3. Unlock the NE0A-series Controller configuration.
 4. Reset to the NE0A-series Controller to the default settings.
 5. Download the configuration to the NE0A-series Controller.
 6. Change the NE0A-series and NE1A-series Controller operating mode from IDLE to RUN.
 7. Perform the user tests.
 8. Verify and lock the configuration.

IMPORTANT After changing the NE0A-series Controller configuration, confirm that the safety functions are functioning properly before starting operation.

8-5 Behavior for Power Supply Interruptions

8-5-1 Behavior in Voltage Drop

Low Power Supply Voltage for the Internal Circuits

If the power supply voltage for the internal circuit drops to 20.4 V or lower, the NE0A-series Controller will turn OFF the outputs.

Low Power Supply Voltage for Output Circuits

If the power supply voltage for outputs drops to 20.4 V or lower when the power supply voltage for the internal circuit is normal, the NE0A-series Controller will continue operation but will stop refreshing outputs.

The OUT PWR indicator or the I/O power supply monitor function of the NE0A-series Controller can be used to check whether the output power supply voltage is being supplied.

Method 1: Using the Network Configurator for Monitoring

Refer to *9-1-1 Monitoring Status* and *9-1-4 Monitoring Error History*.

Method 2: Using DeviceNet Communications for Monitoring General Status

General Status can be monitored with DeviceNet communications using safety I/O, standard I/O, or explicit message communications. For details, refer to *6-5 Remote I/O Allocations* and *Appendix B DeviceNet Explicit Messages*.

8-5-2 Automatic Recovery from Voltage Drops

Power Supply Voltage for the Internal Circuits

If the power supply recovers (to 20.4 V or more) after a fluctuation in the power supply voltage, the following might occur:

1. Operation will automatically restart or
2. A critical error will occur, which will require cycling the power supply to restart operation.

These operations occur because the NE0A-series Controller's operation becomes unstable and it detects a self-diagnosis error. Operation (1) occurs if the power supply to the Controller is completely stopped because the power supply voltage is 20.4 V or lower, and operation (2) occurs if the power supply fluctuates around the lower operation limit of the internal power/voltage detection circuit.

Power Supply Voltage for the Output Circuits

I/O refreshing is automatically restarted when the power supply is recovered (to 20.4 V or more). The I/O power monitor error is also automatically canceled.

SECTION 9

Monitoring

This section describes how to monitor system operation.

9-1	Monitoring Devices	110
9-1-1	Monitoring Status	110
9-1-2	Monitoring Parameters	110
9-1-3	Monitoring Maintenance	112
9-1-4	Monitoring Error History	112
9-2	Monitoring Safety Logic	114
9-2-1	Monitoring Safety Logic	114
9-3	Force-setting and Force-resetting Outputs	115
9-3-1	Force Mode	115
9-4	Maintenance Mode	118
9-4-1	Maintenance Display Mode	118
9-4-2	Monitoring Maintenance	120
9-4-3	Monitoring the Run Hours	121
9-4-4	Monitoring the Contact Operation Counters	122
9-4-5	Monitoring the Total ON Times	123

9-1 Monitoring Devices

The Network Configurator can be used for online monitoring of NEOA-series Controller internal status, error history, and safety logic operations. Monitoring is used for safety logic debugging and for troubleshooting when an error occurs.

9-1-1 Monitoring Status

NEOA-series Controller operating modes and errors can be checked.

- 1,2,3... 1. Right-click the NEOA-series Controller on the virtual network and select **Monitor** from the pop-up menu.

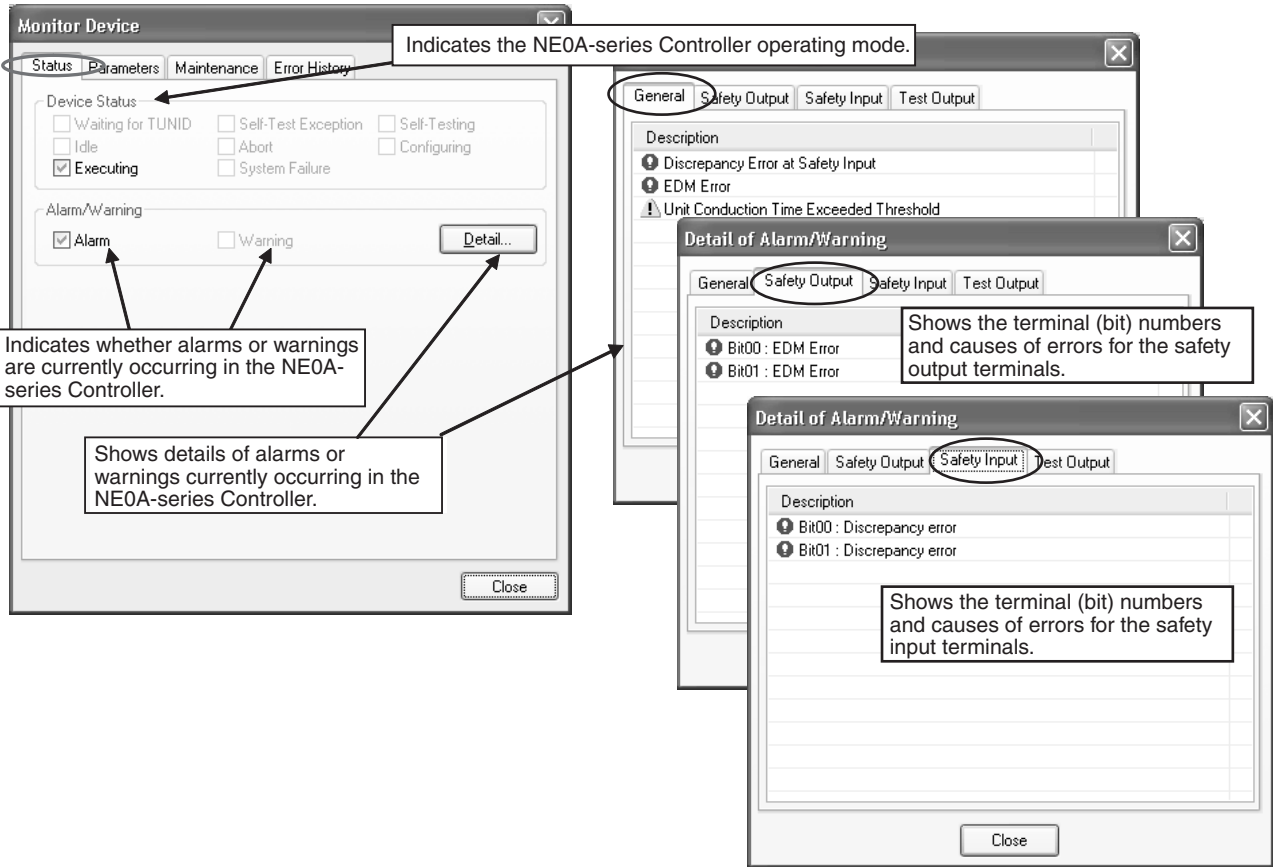

Alarms (🚨) and Warnings (⚠️)

Devices will not operate normally if an alarm occurs, so the cause of the alarm must be removed. Devices continue to operate when a warning occurs, but it is recommended that the cause of the warning be removed because problems may occur later.

IMPORTANT For details on alarms and warnings, and on removing the causes, refer to *SECTION 12 Troubleshooting*.

9-1-2 Monitoring Parameters

The values and evaluation status of local I/O terminals and causes of errors in the NEOA-series Controller can be checked in a list.

- 1,2,3... 1. Right-click the NEOA-series Controller on the virtual network, and then select **Monitor**.

- Click the **Parameters** Tab in the Monitor Device Window.

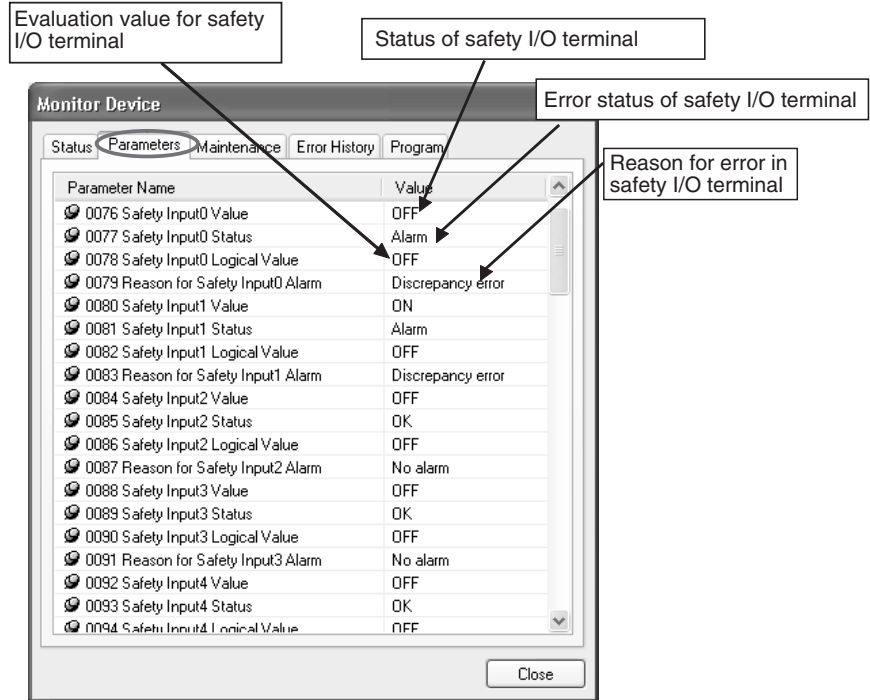

Status of Test Output Terminals

Item	Description
Reason for Test Output Alarm	The reason for the test output terminal error is displayed.

Status of Safety Input Terminals

Item	Description
Safety Input Value	The input value to the safety input terminal is displayed.
Safety Input Status	The result of evaluating the safety input terminal is displayed. OK: No error is occurring for the safety input terminal. Alarm: An error is occurring for the safety input terminal.
Safety Input Logical Value	The value for the safety input terminal after evaluation is displayed. The safety input terminal will be read as OFF if an error has occurred even if the safety input value to the safety input terminals is OFF.
Reason for Safety Input Alarm	The reason for the safety input terminal error is displayed.

Status of Safety Output Terminals

Item	Description
Safety Output Value	The value output to safety output terminal is displayed.
Safety Output Monitor Value	The value of monitored output for safety output terminal is displayed.
Safety Output Status	The result of evaluating the safety output terminal is displayed. OK: No error is occurring for the safety input terminal. Alarm: An error is occurring for the safety input terminal.
Reason for Safety Output Alarm	The reason for the safety output terminal error is displayed.

- Note** (1) Evaluation of safety input terminals includes the following:
- Diagnosis of input devices and input circuits

- Dual channel evaluation
 - User mode switch monitoring and other input function block processing
- (2) Evaluation of safety input terminals includes the following:
- Dual channel evaluation
 - Output circuit evaluation

The result of welding check (EDM) calculation is also displayed for the status of safety output terminals. For details, refer to *6-4 Descriptions of Logic Commands* and *2-3 Local Safety I/O Functions*.

IMPORTANT Refer to *SECTION 12 Troubleshooting* for information on causes and remedies for errors that can be checked by monitoring parameters.

9-1-3 Monitoring Maintenance

Refer to *9-4 Maintenance Mode*.

9-1-4 Monitoring Error History

Past and present NE0A-series Controller errors can be checked. Ten errors will be saved in the Controller's internal EEPROM, and they are still saved even when the power is turned OFF and back ON.

- 1,2,3...
1. Right-click the NE0A-series Controller on the virtual network and select **Monitor** from the pop-up menu. The Monitor Device Window will be displayed.
 2. Click the **Error History** Tab.

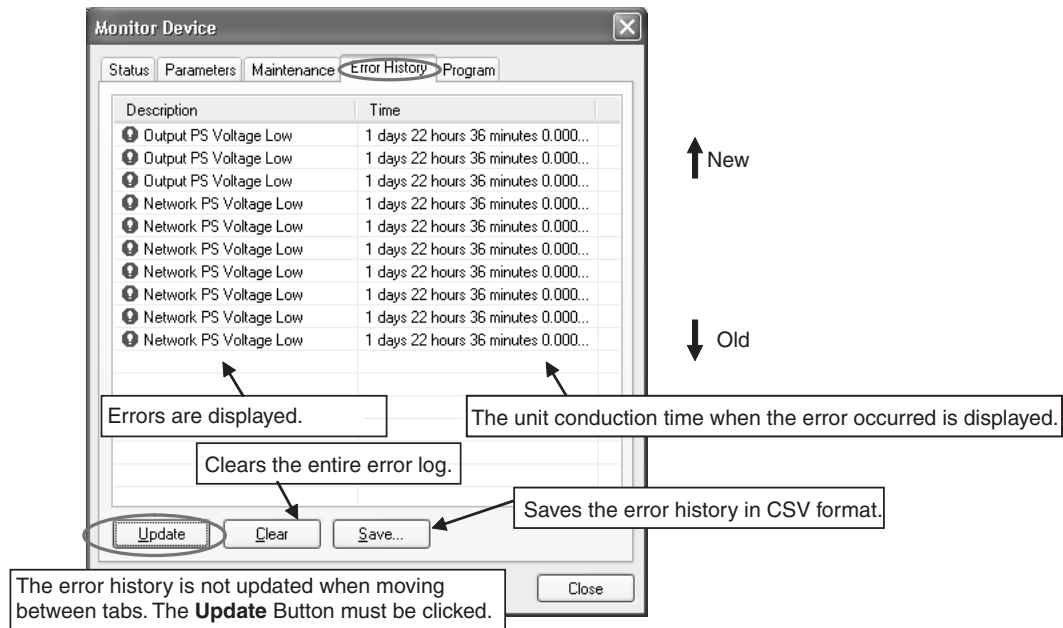

IMPORTANT For details on alarms and warnings, and on removing the causes, refer to *SECTION 12 Troubleshooting*.

- Note**
- The unit conduction time is the total time that the NE0A-series Controller has been operating normally with the power ON. The time is saved every six minutes.
 - You can check the present unit conduction time by referring to the run hours on the Maintenance Tab Page.

- The error history display is not updated by moving between tabs (i.e., opening another tab page and then again opening the Error History Tab Page). To update the display, you must click **Update** Button.

9-2 Monitoring Safety Logic

You can graphically monitor the safety logic of the NEOA-series Controller by using the Network Configurator. You can also perform debugging without a Safety Master by force-setting and force-resetting bits.

9-2-1 Monitoring Safety Logic

- 1,2,3... 1. Right-click the NEOA-series Controller on the virtual network, select **Monitor**, click the **Program** Tab, and then click the **Execute** Button.

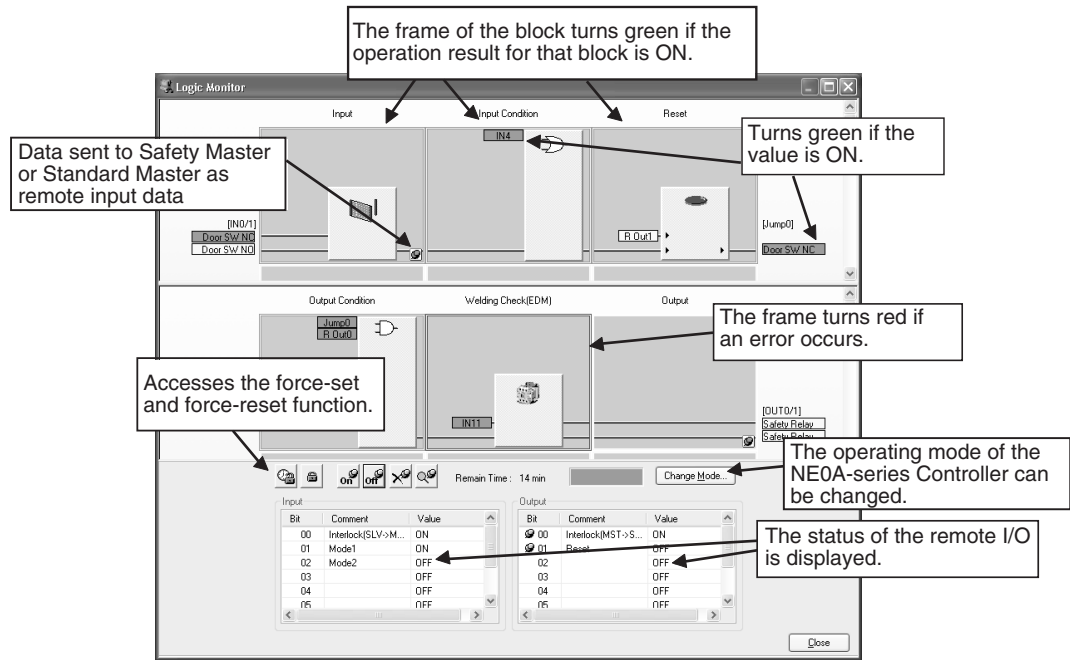

9-3 Force-setting and Force-resetting Outputs

Remote outputs from Safety Masters or Standard Masters can be force-set and force-reset on the Safety Logic Monitoring Windows. When an output is force-set or force-reset, the output status used in logic operations is turned ON or OFF regardless of the actual ON/OFF status of the remote outputs.

Note Force-setting and force-resetting outputs can be performed only when the configuration of the NE0A-series Controller is unlocked.

⚠ WARNING

Take sufficient safety measures when force-setting or force-resetting outputs. The output may occasionally operate and result in serious bodily injury.



9-3-1 Force Mode

It is necessary to change the NE0A-series Controller to Force Mode to force-set or force-reset outputs.

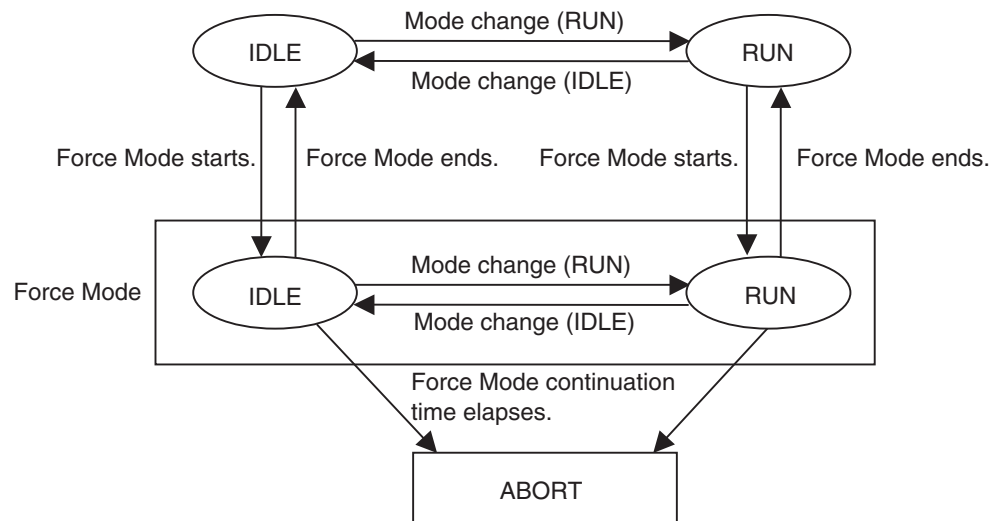

Starting Force Mode

You must input the device password to change to Force Mode. Also, the configuration must be unlocked.

Monitoring Force Mode Time

A limit can be set for the time that the NE0A-series Controller will continue in Force Mode. The duration time is specified when Force Mode is started or restarted. The upper limit of the duration time is 24 hours. The NE0A-series Controller will end Force Mode if the specified duration time elapses.

Ending Force Mode

There are three ways to end Force Mode.

Ending Force Mode with the Network Configurator

- The NE0A-series Controller enters the normal mode when Force Mode is ended.
- The outputs that were force-set or force-reset are returned to the actual output values when Force Mode is ended.

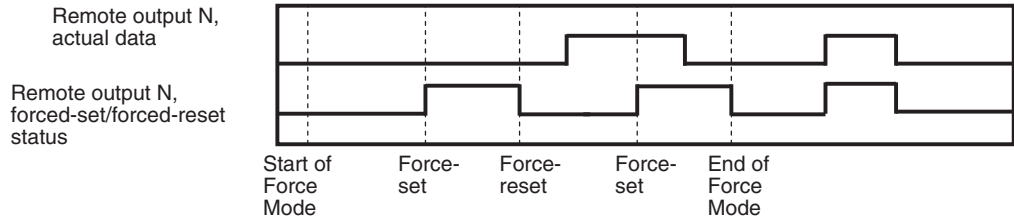

Elapse of Force Mode Duration Time

The NE0A-series Controller will switch to Abort Mode if Force Mode continues longer than the specified duration time. To start RUN Mode again, cycle the power or reset the device with the Network Configurator.

Changing NE0A-series Controller to a Mode Other Than IDLE or RUN

The mode will be changed by downloading, resetting, turning OFF the power supply, or changing the node address switches. The Force Mode will continue, however, if a change is made between IDLE Mode and RUN Mode.

Force Mode at Startup

If the power supply is turned OFF while the NE0A-series Controller is in Force Mode, the Controller will start the next time in normal mode. Start the Force Mode again if required.

Procedure and Windows

1. Starting Force Mode

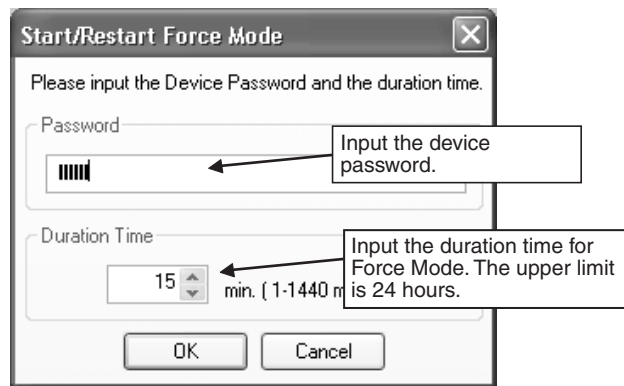
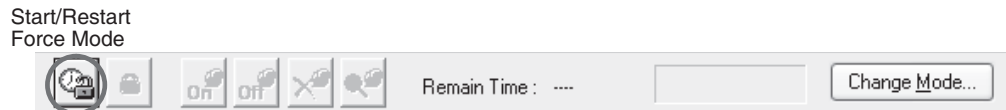

Press the **Start/Restart Force Mode** Button in the Logic Monitoring Window. Enter the device password and duration time in the following dialog box.



2. Force-setting/resetting Bits

Select the desired output bit and then press one of the following buttons.

Button	Operation	Description
	Force-set	The output will be turned ON regardless of the actual ON/OFF status.
	Force-reset	The output will be turned OFF regardless of the actual ON/OFF status.

Button	Operation	Description
	Cancel forced status	The force-set or force-reset status will be cleared and the output will return to the actual ON/OFF status.
	Get forced status	The status of the output is read from the device to see if it is force-set or force-reset.

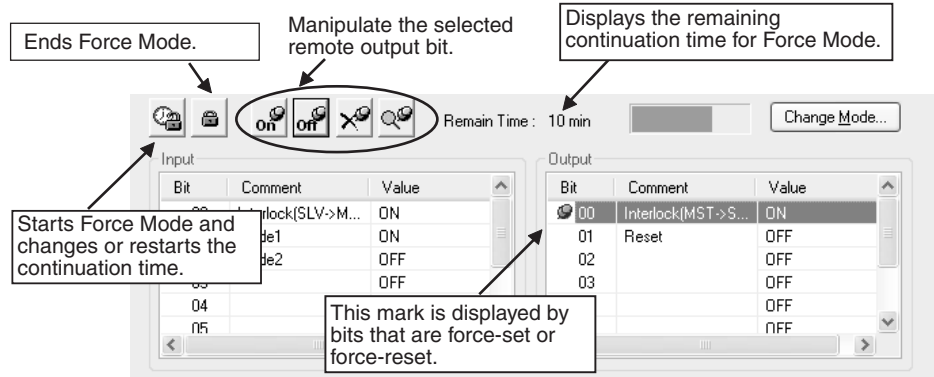

Closing the Logic Monitor While Continuing in Force Mode

You can close the Logic Monitor while continuing in Force Mode. You can perform debugging with only an NE0A-series Controller without a Safety Master if the NE0A-series Controller is used in combination with a Safety Master.

Procedure

Click the **Close** Button in the lower right corner of the Logic Monitor Window to maintain the force-set and force-reset status of the remote outputs that has been set until that point.

Procedure for Restarting

Once the Logic Monitor Window has been closed, the right to perform force-set or force-reset outputs will be lost. To force-set or force-reset outputs again, click the **Start/Restart Force Mode** Button, and then enter the device password and duration time.

You will be able to obtain the right to force-set or force-reset output with the force-set or force-reset status that was saved.

Extending the Duration Time for Force Mode

Click the **Start/Restart Force Mode** Button to extend the duration time for Force Mode.

9-4 Maintenance Mode

9-4-1 Maintenance Display Mode

By switching the Network Configurator to Maintenance Mode while connected online, it is possible to display NE0A-series Controller status information without opening the Monitor Window.



In Maintenance Mode, the status of devices on the virtual network is displayed by status display icons. If a fatal error occurs in the system while the system is operating, this function makes it possible to identify the node at which the error has occurred. Once the node has been identified, the details of the error can be checked by double-clicking to open the Monitor Window.

The background color will be displayed in light blue in the Maintenance Display Mode Window.

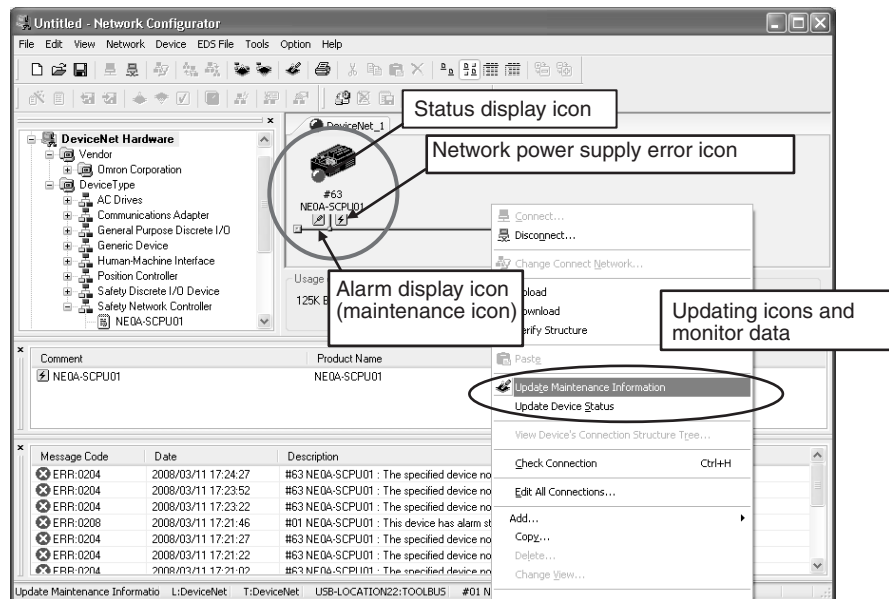

Meanings of Icons

Status Display Icons

These icons show the operating status of the devices and whether there are any current alarms or warnings.

Icon	Status
Gray with white border	Offline
Gray with green border	Default status (Not configured.)
Green	No error in IDLE Mode.
Blue	No error in RUN Mode.
Yellow	Warning
Red	Alarm

Alarm Display Icons (Maintenance Icons)

These icons show the status of any generated alarms and warnings. The following bits for general status are displayed in the following cases. Refer to *6-5 Remote I/O Allocations* for information on general status.

Bit 0	Input Power Supply Voltage Error Flag 1: Voltage error or power supply is OFF.
Bit 1	Output Power Supply Voltage Error Flag 1: Voltage error or power supply is OFF.
Bit 2	Network Power Supply Voltage Error Flag 1: Voltage error or power supply is OFF.
Bit 3	Unit Maintenance Flag 1: Equal to or higher than set monitor value.
Bit 5	Local I/O Error Flag 1: I/O terminal error (See <i>12-2 Troubleshooting with Error History</i> .)
Bit 6	Unit Normal Status Flag 0: Error (See <i>12-3 Troubleshooting by Monitoring Parameters</i> .)
Bit 7	Connection Device Maintenance Flag 1: Output terminal is at or above monitor setting.

Network Power Supply Error Icon

This icon is displayed when the device detects a network power supply error.

Updating Icons

The icons are not updated automatically. Use the following procedure to update the icons manually.

Updating Device Status Display Icons

The device status display is automatically updated when the following operations are executed using the Network Configurator.

- Uploading networks
- Downloading networks
- Downloading parameters
- Updating device status
- Changing the device mode (RUN/IDLE)
- Resetting a device

The display can also be updated at any time while connected online, by selecting **Network - Update device status**.

Automatic Updating of Device Status Display Icons

When the Network Configurator is connected to the system and is connected online, device information can be received automatically and the status can be displayed.

To have the device status updated and displayed immediately upon connecting online, select **Update Device Status automatically, when it was connected on Network** from the Options Menu.

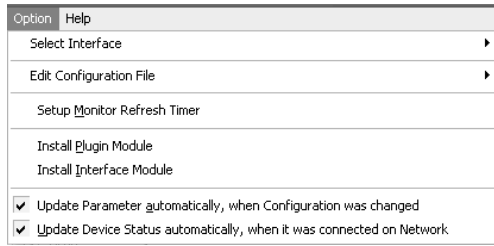

Updating Alarm Display Icons (Maintenance Icons)

The alarm icons displayed will be updated by performing the following action in the Network Configurator.

- Updating maintenance data

9-4-2 Monitoring Maintenance

You can check the present values of maintenance parameters, such as general status, unit conduction time, contact operation counter, and total ON time.

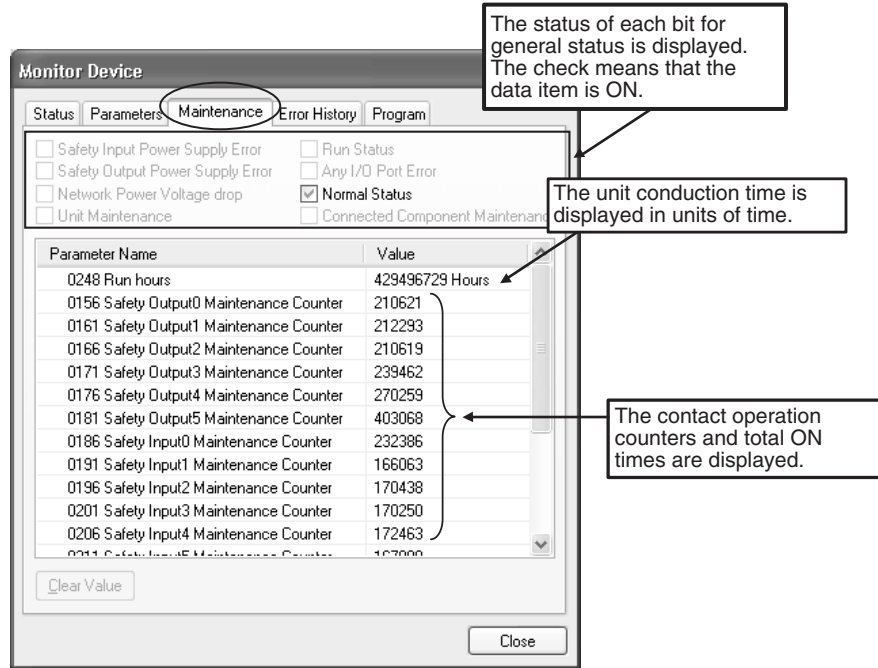

Note Refer to 6-5 Remote I/O Allocations for information on general status.

9-4-3 Monitoring the Run Hours

Description

An NE0A-series Controller totals the number of hours the internal circuit power is supplied and internally saves it in non-volatile memory. If the cumulative time reaches the set threshold value, the Unit Maintenance Flag will turn ON in the General Status.

- Measurement time: 0 to 429,496,729.5 hours
(stored data: 0000 0000 to FFFF FFFF hex)
- Measurement unit: 0.1 hour

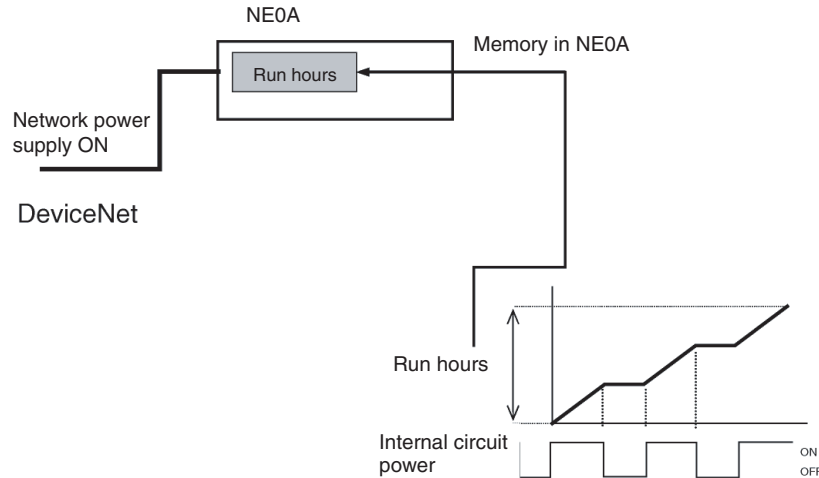

The user can monitor this information using the Network Configurator and explicit messages.

- Note**
- The run hours monitoring function totals the time when the internal circuit power supply is correctly applied. This does not include the time when the power is OFF.
 - The run hours are measured in 0.1-hour increments. When the Threshold Run Hours parameter is set on the Network Configurator and when the run hours are monitored, however, the time will be in 1-hour increments.

Procedure for Making Settings with the Network Configurator

- 1,2,3...**
1. Right-click the NE0A-series Controller, select **Wizard - Edit Output Bits** or **Wizard - Edit Input Bits**, and then click the **Advanced Edit** Button.
 2. Set the threshold value in the *Threshold Run Hours* Field of the *General* Parameter Group. If the value is set to 0, the run hours value will not be checked.

9-4-4 Monitoring the Contact Operation Counters

Description

An NE0A-series Controller totals the number of times each safety input contact and safety output contact turns ON and internally saves the data in non-volatile memory. If the value of a counter reaches the threshold value, the Connected Component Maintenance Flag in General Status will turn ON.

- Measurement count: 0 to 4,294,967,295 counts
(stored data: 0000 0000 to FFFF FFFF hex)
- Measurement unit: Operations
- Maximum resolution: 142.8 Hz

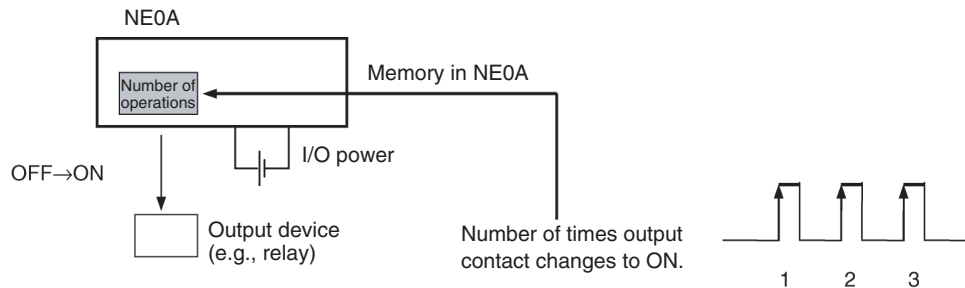

The user can monitor this information using the Network Configurator and explicit messages.

- Note**
- One contact cannot be used at the same time for both the time and count monitoring functions. Select only one of these in the *Maintenance Counter Mode Choice*.
 - If the *Maintenance Counter Mode Choice* is changed, the counter or time data saved internally will be cleared.
 - This function does not operate when the I/O power supply is OFF.

Procedure for Making Settings with the Network Configurator

- 1,2,3...
1. Right-click the NE0A-series Controller, select **Wizard - Edit Output Bits** or **Wizard - Edit Input Bits**, and then click the **Advanced Edit** Button.
 2. Set the Maintenance Counter Mode Choice Parameter and Threshold Maintenance Counter Parameter for each I/O of the safety input group and safety output group. If the value is set to 0, the maintenance counter value will not be checked.

9-4-5 Monitoring the Total ON Times

Description

An NE0A-series Controller totals the time each safety input contact and safety output contact is ON, and saves it internally in non-volatile memory. If a cumulative time reaches the threshold value, the Connected Component Maintenance Flag in General Status will turn ON.

- Measurement time: 0 to 4,294,967,295 seconds
(stored data: 0000 0000 to FFFF FFFF hex)
- Measurement unit: Seconds

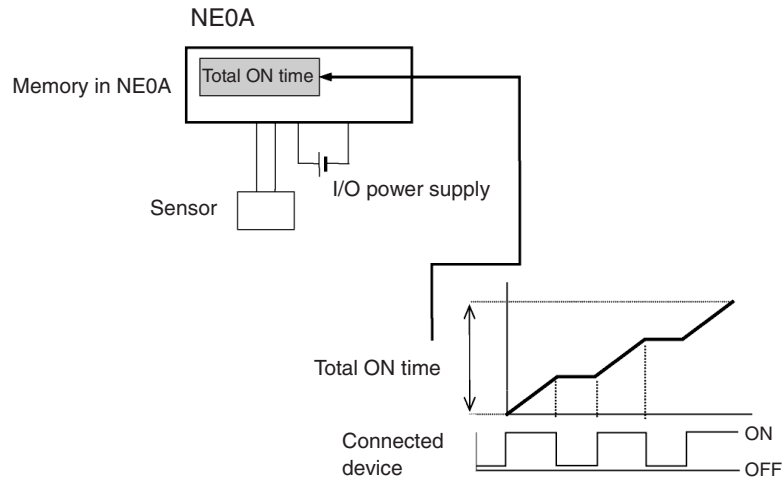

The user can monitor this information using the Network Configurator and explicit messages.

- Note**
- One contact cannot be used at the same time for both the time and count monitoring functions. Select only one of these in the *Maintenance Counter Mode Choice*.
 - If the *Maintenance Counter Mode Choice* is changed, the counter or time data saved internally will be cleared.
 - This function does not operate when the I/O power supply is OFF.
 - The time monitor checks if the connected component is ON approximately every second. This should be noted when the time is measured in increments of 1 second or less.

Measuring 0.5-second ON Time

In *Figure A*, the actual ON time is 0.5 seconds x 3, or 1.5 seconds. Operation is ON only once when measurements are made, however, so the time is measured as 1 second.

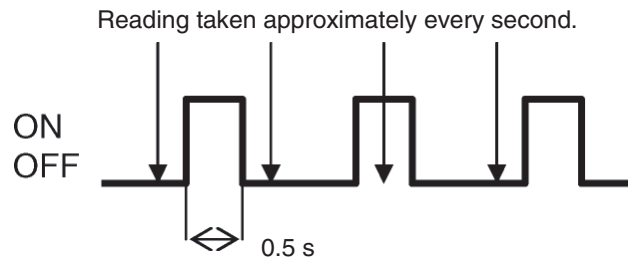

Figure A

In *Figure B*, the actual ON time is 0.5 seconds x 3, or 1.5 seconds. Operation is ON twice when measurements are made, however, so the time is measured as 2 seconds.

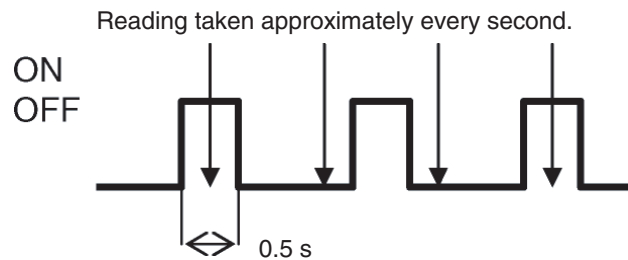

Figure B

Measuring 1.5-second ON Time

In *Figure C*, the actual ON time is 1.5 seconds x 2, or 3 seconds. Operation is ON four times when measurements are made, however, so the time is measured as 4 seconds.

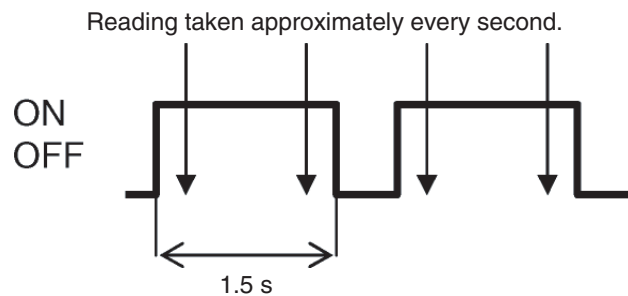

Figure C

Procedure for Making Settings with Network Configurator

- 1,2,3...
1. Right-click the NE0A-series Controller, select **Wizard - Edit Output Bits**, and then click the **Advanced Edit** Button.
 2. Set the Maintenance Counter Mode Choice Parameter and Threshold Maintenance Counter Parameter for each contact of the safety input group and safety output group. If the value is set to 0, the maintenance counter value will not be checked.

SECTION 10

Safety Distributed Control Systems

This section describes distributed control systems designed for safety applications.

10-1	Overview	126
10-2	Determining the System Configuration and Defining the System Parameters	127
10-2-1	Determining the System Configuration	127
10-2-2	Defining the System Parameters	127
10-2-3	Creating a Virtual Network	128
10-2-4	Distributing Project Files (.ncf)	129
10-3	Starting an NE0A-series Controller	130
10-3-1	NE0A-series Controller Configuration	130
10-3-2	Downloading the Configuration and Changing the Operating Mode	130
10-3-3	Debugging Individual Controllers	130
10-3-4	Saving Configurations	130
10-3-5	Distributing Configuration Files (.dvh)	130
10-4	Building the System	131
10-4-1	Reading Individual NE0A-series Configurations	131
10-4-2	NE1A-series Configuration and Startup	131

10-1 Overview

This section describes the procedures for safety distribution control systems using NE0A-series Controllers, from creating the configuration using multiple personal computers until the system is ready for actual operation.

What Is a Safety Distributed Control System?

A safety distributed control system is a system with a DeviceNet Safety-compatible Safety Network Controller (NE1A Series or NE0A Series) installed in each safety control block, and in which safety data, such as safety interlock signals, are exchanged between the individual safety blocks.

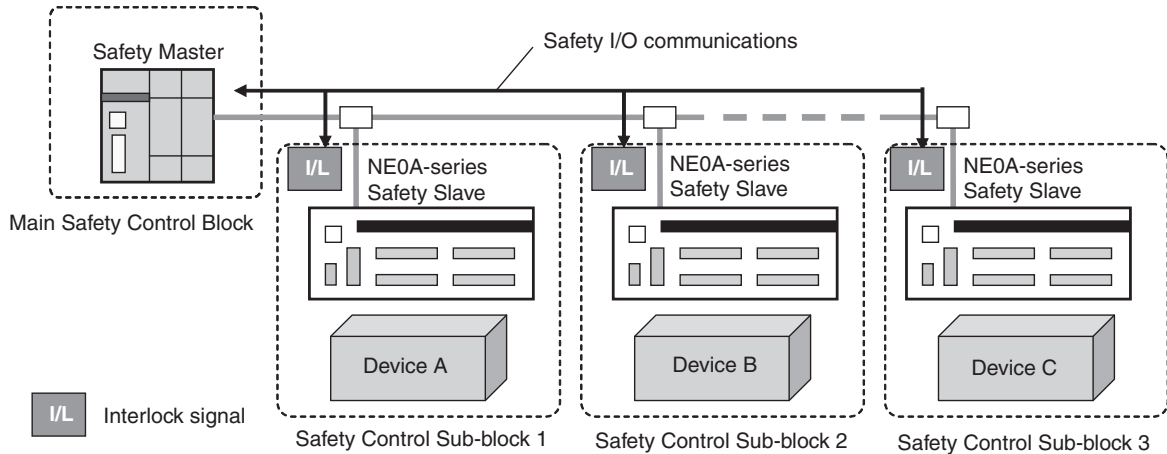

NE0A-series Controllers can be used to construct this type of system, and the configuration and setup can be executed individually for each safety control block.

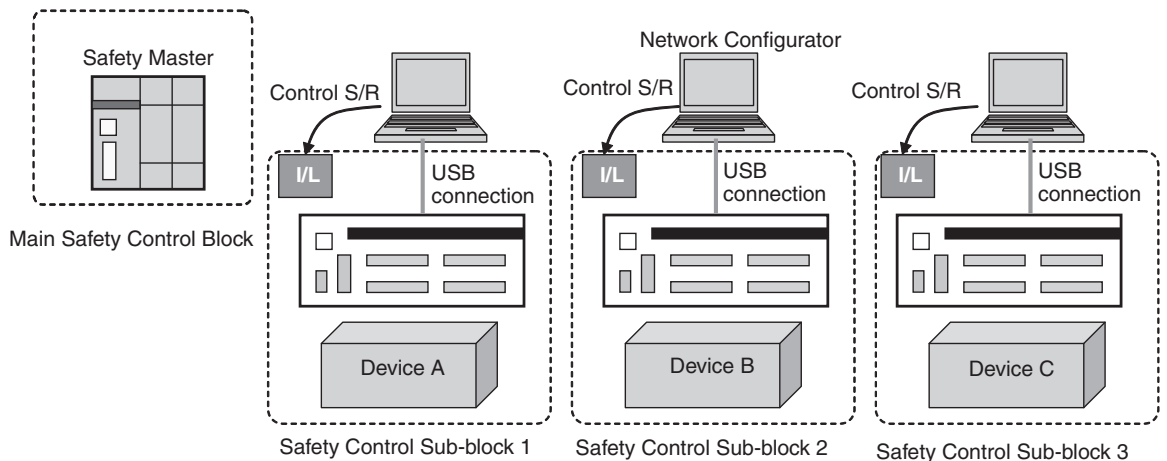

Procedure for Setting Up a Safety Distributed Control System

Use the following procedure to set up a safety distributed control system using NE0A-series Controllers.

1. Determine the system configuration and define the system parameters.
 2. Individually configure and set up the NE0A-series Controller in each safety control sub-block.
 3. Combine the NE1A-series Safety Master configurations into one system.
- These procedures are described on the following pages.

10-2 Determining the System Configuration and Defining the System Parameters

First the system designer determines the system configuration. A virtual network is created on the Network Configurator according to this system configuration.

10-2-1 Determining the System Configuration

Determine the configuration for the safety distributed control system.

- Determine the models and the numbers of DeviceNet and DeviceNet Safety devices, such as NE1A-series, NE0A-series, and DST1-series Controllers.
- Determine the DeviceNet configuration (such as distances, network power supply wiring, and baud rate).
- Determine the communications bandwidths that can be used for safety I/O communications and standard I/O communications.

10-2-2 Defining the System Parameters

Define the system parameters, such as the network number and remote I/O comments, required for setting up the safety distributed control system using Network Configurators from different personal computers.

Safety Distributed Control System Parameters

Network Number

The same network number must be used for all devices on the same DeviceNet network. In other words, all of the devices on the virtual network for each Network Configurator must have the same network number.

Example:

Network numbers	0005, 1
-----------------	---------

Note For details on network numbers, refer to *6-2-2 Creating a Virtual Network*.

Remote I/O Comments

The interface between the NE1A-series and NE0A-series Controllers can be unified by setting the same remote I/O comments for all of the NE0A-series Controller.

Example: Setting Common Remote I/O Comments for Remote Inputs 0, 1, 5, 6, and 7, and Remote Outputs 0, 1, 2, and 3

Bit	Remote inputs (NE0A to NE1A)	Remote outputs (NE1A to NE0A)
0	Interlock (from sub-block)	Interlock (to sub-block)
1	Ready Signal (from sub-block)	Ready Signal (to sub-block)
2	Not used (Can be defined for each device.)	Normal Mode
3	Not used (Can be defined for each device.)	Teaching Mode
4	Not used (Can be defined for each device.)	Not used (Can be defined for each device.)
5	RUN Status	Not used (Can be defined for each device.)

Bit	Remote inputs (NE0A to NE1A)	Remote outputs (NE1A to NE0A)
6	Normal Status	Not used (Can be defined for each device.)
7	Always ON	Not used (Can be defined for each device.)

- Note**
- For details on remote I/O comments, refer to 6-3-4 *Setting Networks*.
 - A maximum of 32 characters can be used for a remote I/O comment.

10-2-3 Creating a Virtual Network

A virtual network is created according to the system configuration and the system parameters.

Setting the Network Number

Set the network number defined in 10-2-2 *Defining the System Parameters*.

Arranging Devices on the Virtual Network

Arrange the devices on the virtual network and create the system configuration. Change node addresses and device names as required.

Setting Remote I/O Comments for an NE0A-series Controller

Input the remote I/O comments for the NE0A-series Controller on the virtual network as defined in 10-2-2 *Defining the System Parameters*.

Open the NE0A-series Safety Wizard and set the remote I/O comments from the network settings in the Edit Logic phase.

- Note**
- For details on remote I/O comments, refer to 6-3-4 *Setting Networks*.
 - The same remote I/O comments can be efficiently set for multiple NE0A-series Controllers by using the Device Copy function. First, set the remote I/O comments for one NE0A-series Controller. Then, copy and paste to duplicate all of the configuration for that Controller, including the remote I/O comments, to the other Controllers.

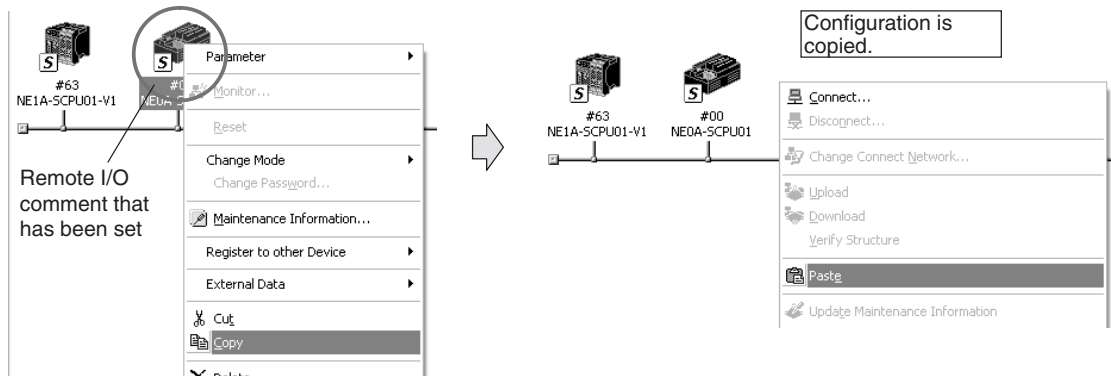

Saving the Project File

After setting the above system parameters, save the project file without setting a password.

- Note** For details on saving project files, refer to 6-6 *Saving Project Files*.

10-2-4 Distributing Project Files (.ncf)

Project files that have been saved are distributed to personnel in charge of sub-block design. These personnel then use the project files to configure and set up individual NE0A-series Controllers.

10-3 Starting an NE0A-series Controller

The sub-block designers use the project files they have received (as described in *10-2-4 Distributing Project Files (.ncf)*) to configure and set up individual NE0A-series Controllers.

10-3-1 NE0A-series Controller Configuration

Configure your NE0A-series Controller as described in *SECTION 6 Creating Configurations*.

IMPORTANT

- Do not change the network number. Doing so will cause incorrect safety I/O communications when connected with an NE1A-series Controller.
- Do not change remote I/O comments. If they must be changed, then do so in consultation with the system designer.

10-3-2 Downloading the Configuration and Changing the Operating Mode

Download the configuration to your NE0A-series Controller, as described in *SECTION 7 Connecting Online and Downloading*, and *SECTION 8 Operation and Operating Modes*.

10-3-3 Debugging Individual Controllers

When there is no NE1A-series Safety Master and safety I/O communications are not executed, the NE0A-series remote output data is always 0, so debugging is performed using force-set/reset function of the Network Configurator.

- Note**
- (1) Force-setting and force-resetting can be performed only when the configuration is unlocked.
 - (2) For details on force-setting/resetting, refer to *9-3 Force-setting and Force-resetting Outputs*.

10-3-4 Saving Configurations

After an NE0A-series Controller has been debugged, save the Controller configuration.

- 1,2,3...**
1. Right-click the NE0A-series Controller, and select **Parameters – Save** from the pop-up menu.
 2. Save the configuration under a file name in consultation with the system designer.

10-3-5 Distributing Configuration Files (.dvh)

A configuration file that has been saved is provided to the system designer. The system designer then uses the configuration to build the system.

10-4 Building the System

The system designer uses the NE0A-series configuration files that have been received (as described in *10-3-5 Distributing Configuration Files (.dvh)*) to build the system with the NE1A-series Controller configurations.

10-4-1 Reading Individual NE0A-series Configurations

Use Network Configurator project files (created as described in *10-2-3 Creating a Virtual Network*) to read individual NE0A-series configuration files (received as described in *10-3-5 Distributing Configuration Files (.dvh)*).

Reading Configurations

- 1,2,3...
1. Right-click the NE0A-series Controller.
 2. Select **Parameters – Read** from the pop-up menu.

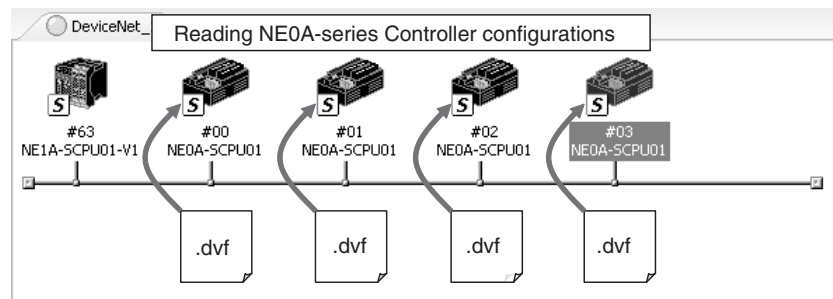

10-4-2 NE1A-series Configuration and Startup

After the configurations have been read for all of the NE0A-series Controllers, configure the NE1A-series Controller, download the configuration, and start the Controller.

- Note**
- For details on the NE1A-series Controller configuration, downloading the configuration, and startup, refer to the *NE1A-series DeviceNet Safety Network Controller Operation Manual* (Cat. No. Z906).
 - The NE1A-series Controller can also be configured (setting safety connections, creating the user program, etc.) before the NE0A-series Controller configuration files are read.
 - For security purposes, it is recommended that passwords be set for project files (.ncf) after the system has been built. For details, refer to *6-6 Saving Project Files*.

SECTION 11

Maintenance and Inspection

This section describes the inspections and replacement procedure used for an NE0A-series Safety Network Controller.

11-1 Inspection	134
11-2 NE0A-series Controller Replacement.	135

11-1 Inspection

To use an NE0A-series Controller's functions in the best condition, daily or periodical inspection must be performed.

- Check that the NE0A-series Controller is used within the range of specifications.
- Check that installation conditions and wiring of the NE0A-series Controller are proper.
- Diagnose the safety functions to maintain a level of operating reliability in safety functions.

11-2 NE0A-series Controller Replacement

Note the following points when you find a defect and replace the NE0A-series Controller:

- Do not disassemble, repair, or modify the NE0A-series Controller. To do so is dangerous because the original safety functions would be lost.
- Replace the unit in conditions where safety is ensured.
- To prevent electric shocks or unexpected performance of the device, perform the replacement after turning OFF the power supply.
- Check that there is no error in the new unit after replacement.
- When returning the defective unit for repair, attach a sheet of paper to the unit describing in as much detail as possible the defect. Send the unit to the OMRON branch or sales office listed in the back of this operation manual.

 **WARNING**

Serious injury may possibly occur due to loss of required safety function. To restart operation after replacing the NE0A-series Controller, reset all necessary configuration information, such as the safety logic. Check that the safety functions perform properly before starting actual operation.



SECTION 12

Troubleshooting

This section describes troubleshooting errors that can occur during operation.

12-1	Indicators and Error Processing	138
12-2	Troubleshooting with Error History	140
12-3	Troubleshooting by Monitoring Parameters	143
12-3-1	Safety Input Errors	143
12-3-2	Test Output Errors.	144
12-3-3	Safety Output Errors.	145
12-4	Online Operation Errors with USB Connection	146
12-4-1	Overview.	146
12-4-2	Errors and Countermeasures When Selecting Interface.	146
12-4-3	Error Messages and Countermeasures	146
12-5	Errors When Downloading	147
12-5-1	Outline	147
12-5-2	Error Messages and Countermeasures	147
12-6	Errors When Resetting	149
12-6-1	Outline	149
12-6-2	Error Messages and Countermeasures	149
12-7	Errors When Changing Modes	150
12-7-1	Outline	150
12-7-2	Error Messages and Countermeasures	150

12-1 Indicators and Error Processing

MS		NS		LOCK	I/O PWR	I/O		Description	Probable cause and remedy
Green	Red	Green	Red	Yellow	Green	Yellow	Red		
		-	-		-	-	-	Safety I/O communications in progress in RUN mode (normal status)	Normal status
		-	-	-	-	-	-	IDLE mode	Normal status
					-	-	-	Safety I/O communications, standard I/O communications, or explicit message communications in progress	Normal status
					-	-	-	Initialization in process or waiting for configuration	
				-	-	-	-	Waiting for Safety or Standard Master connection	
				-	-	-	-	DeviceNet is offline.	Check the following items. <ul style="list-style-type: none"> • Are lengths of cables (trunk and branch lines) correct? • Are cables disconnected or loose? • Are Terminating Resistors connected to both ends of the trunk line only? • Is noise interference excessive? • Is the network power supply appropriate? • Is there a device (e.g., Master) that sets the baud rate in the network? • Is operation set to stand-alone?
				-	-	-	-	Standalone setting	
				-	-	-	-	Communications timeout	Check the following items and restart the Safety Network Controller.
-	-			-	-	-	-	BusOff status (communications stopped due to consecutive data errors)	<ul style="list-style-type: none"> • Are lengths of cables (trunk and branch lines) correct? • Are cables disconnected or loose? • Are Terminating Resistors connected to both ends of the trunk line only? • Is noise interference excessive? • Is the network power supply appropriate? • Is the bandwidth used appropriate?
-	-			-	-	-	-	Node address duplication	

MS		NS		LOCK	I/O PWR	I/O		Description	Probable cause and remedy
Green	Red	Green	Red	Yellow	Green	Yellow	Red		
■	◻◻	■	-	-	-	-	-	Switch settings are incorrect	Check the node address, and then restart the Safety Network Controller.
		◻◻	■					Force Mode timeout	Restart the Safety Network Controller.
■	◻◻	■	■	■	Input - Output ■	■	■	Critical error	Make sure the signal wire is not contacting the positive side of the power supply Replace the Safety Network Controller if the system failure still occurs after turning the power supply ON again.
-	-	-	-	-	■	■	■	Input/output power is not supplied.	Check the following items. • Are cables disconnected? • Is the I/O power voltage within specifications?
-	-	-	-	-	◻◻	■	◻◻	An error occurred in an input/output circuit.	Refer to 12-2 Troubleshooting with Error History.
-	-	-	-	-	◻◻	■	◻◻	When dual channels are set: An error occurred in the other channel.	

◻◻ : Lit ◻◻ : Flashing ■ : Not lit -: User-set

12-2 Troubleshooting with Error History

The NE0A-series Controller internally stores up to 10 error history records. The history is updated each time an error occurs. When more than ten records exist, the oldest record will be deleted. The error history can be read using the Network Configurator.

Message	Countermeasure
Safety Network Controller Series System Failures	
System Failure	Make sure the signal wire is not contacting the positive side of the power supply. Replace the Safety Network Controller if the system failure still occurs after turning ON the power.
Invalid Configuration	Configure the Safety Network Controller correctly.
Switch Setting Mismatch	Check to see if the node address is the same as the node address used for the previous configuration. If not, set the node address to that of the previous configuration, or configure the Safety Network Controller again. If the error occurs again, replace the Safety Network Configurator.
Force Mode Timeout	The duration time for Force Mode has elapsed. Restart the Safety Network Controller or reset it using the Network Controller.
DeviceNet Communications Errors	
Network PS Voltage Low	Check the following items <ul style="list-style-type: none"> • Is the power supply voltage within the specified range? • Is a cable disconnected?
Duplication MAC ID	Check the node addresses of other nodes. After setting the node addresses to eliminate address duplication, turn ON the power to the Safety Network Controller again.
Transmission Timeout	Check the following items.
BusOff	<ul style="list-style-type: none"> • Are cable lengths (trunk and branch lines) correct? • Are cables disconnected or loose?
Standard IO Connection Timeout	<ul style="list-style-type: none"> • Are Terminating Resistors connected to both ends of the trunk line and only to both ends of the trunk line?
Safety I/O Connection Timeout	<ul style="list-style-type: none"> • Is noise interference excessive? • Is the network power supply appropriate? • Is the bandwidth appropriate?
Test Output Terminal-related Failures	
Stuck-at-high Detected at Test Output	Make sure the output signal wire is not contacting the positive side of the power supply. If the wiring is okay, replace the Safety Network Controller.
Overload Detected at Test Output	Check the wiring to see if a ground fault occurred in the output signal line.
Undercurrent is detected using muting lamp	Check the wiring to see if an output signal line is disconnected. If the wiring is okay, replace the external lamp.
Safety Input Terminal-related Failures	
Internal input failure at Safety Input	Cycle the power supply to the Safety Network Controller. If the failure still occurs, replace the Controller.

Message	Countermeasure
Discrepancy Error at Safety Input	<p>Check the following points:</p> <ul style="list-style-type: none"> • Make sure the input signal wire is not contacting the positive side of the power supply. • Make sure the input signal wire does not have an earth fault. • Make sure the input signal wire is not disconnected. • Make sure there is not a short circuit between input signal wires. • Make sure a failure has not occurred in the connected device. • Make sure the set value of the discrepancy time is valid. <p>To recover from these failures, the following conditions are required:</p> <ul style="list-style-type: none"> • The latch input error time must have passed, and the cause of the error must have been removed. • The target safety input terminal inputs must turn OFF. <p>When changing the discrepancy time, reconfiguration is required.</p>
External Connected Device Failure at Safety Input	
Input Function Block Status Error	<p>A user mode switch error occurred. Check the wiring and connected devices as above.</p> <p>Refer to <i>6-4-1 Safety Input Evaluation</i> for information on user mode switch errors.</p>
Safety Output Terminal-related Failures	
Cross Connection Detected at Safety Output	<p>Check the following points:</p> <ul style="list-style-type: none"> • Make sure there is no overcurrent for the output. • Make sure the output signal wire does not have an earth fault. • Make sure the output signal wire is not contacting the positive side of the power supply. • Make sure there is not a short circuit between output signal wires. • Make sure the I/O power supply voltage is set within the specification range. <p>To recover from these failures, the following conditions are required:</p> <ul style="list-style-type: none"> • The latch output error time must have passed, and the cause of the error must have been removed. • The output signal from the user application for the target safety output must turn OFF.
Stuck-at-high Detected at Safety Output	
Short Circuit Detected at Safety Output	
Over Current Detected at Safety Output	
Dual Channel Output failure	Check the program to see if output data for dual channels are the same.
EDM error	<p>Check the following items.</p> <ul style="list-style-type: none"> • Is the output signal line disconnected? • Is the output signal line grounded? • Make sure the output signal wire is not contacting the positive side of the power supply. • Is there a contactor or relay contact weld fault?
Maintenance Information	
Total On Time or Contact Operation Counter Exceeded Threshold at Any Point	-
Unit Conduction Time Exceeded Threshold	-
Error Related to Power Supply for I/O	

Message	Countermeasure
Output PS Voltage Low	Check the following items.
Input PS Voltage Low	<ul style="list-style-type: none">• Are cables disconnected?• Is the power supply voltage within specifications?

12-3 Troubleshooting by Monitoring Parameters

Errors related to local I/O can be read from the Safety Input Status, Test Output Status, and Safety Output Status Normal Flags, using safety or standard I/O communications. Error details can be read using Network Configurator parameter monitoring or explicit messages.

- Note**
- Errors that occur will be cleared after being latched for 1,000 ms. The error latch time can be changed.
 - For details on reading errors using safety or standard I/O communications, refer to *6-5 Remote I/O Allocations*.
 - For information on reading details using the Network Configurator, refer to *9-1-1 Monitoring Status* or *9-1-2 Monitoring Parameters*.

12-3-1 Safety Input Errors

Code	Error	Probable cause	Countermeasure
0x01	Configuration invalid	The configuration is invalid.	Configure the Safety Network Controller correctly.
0x02	External test signal failure	1. The power supply (positive side) is in contact with the input signal line. 2. Short-circuit between input signal lines 3. Trouble with the connected device	1. 2. Check the wiring. 3. Replace the connected device.
0x03	Internal input failure	Trouble with the internal circuits	Replace the Safety Network Controller if the system failure still occurs after turning the power supply ON again.
0x04	Discrepancy error	1. Ground fault or break in an input signal line 2. Trouble with the connected device 3. The discrepancy time setting is not satisfied.	1. Check the wiring. 2. Replace the connected device. 3. Change the time setting.
0x05	Failure of the associated dual channel input	Dual channels are set and an error occurred in the other channel.	Remove the error in the other channel.
0x06	User Mode Switch Error	1. Two or more inputs are ON for 2 s or longer. 2. All inputs are OFF for 2 s or longer.	Check the wiring or replace the connected device.

Explicit Message for Reading the Cause of the Error

Explicit message	Read/write	Function	Command					Response
			Service code	Class ID	Instance ID	Attribute ID	Data size	
Safety Input Cause of Error Information Read	Read	Reads the cause for the Normal Flag specified by the instance ID turning OFF. (See note.)	0E hex	3D hex	01 to 0C hex	6E hex	-	0: No error or error code

- Note** The instance numbers for safety inputs 0 to 11 are 1 to 12 (01 to 0C hex), respectively.

12-3-2 Test Output Errors

Code	Error	Probable cause	Countermeasure
0x01	Configuration invalid	The configuration is invalid.	Configure the Safety Network Controller correctly.
0x02	Overload detected	1. Ground fault or short-circuit of an output signal line 2. Trouble with the connected device	1. Check the wiring. 2. Replace the connected device.
0x05	Stuck-at-high detected	1. The power supply (positive side) is in contact with the output signal line. 2. Trouble with the internal circuit	1. Check the wiring. 2. Replace the Safety Network Controller.
0x06	Under current is detected using muting lamp	1. Disconnection of an output signal line. 2. Trouble with the connected device	1. Check the wiring. 2. Replace the connected device.

Explicit Message for Reading the Cause of the Error

Explicit message	Read/write	Function	Command					Response
			Service code	Class ID	Instance ID	Attribute ID	Data size	
Test Output Cause of Error Information Read	Read	Reads the cause for the Normal Flag specified by the instance ID turning OFF. (See note.)	0E hex	307 hex	01 to 02 hex	76 hex	-	0: No error or error code

Note The instance numbers for test outputs 0 to 1 are 1 to 2 (01 to 02 hex), respectively.

12-3-3 Safety Output Errors

Code	Error	Probable cause	Countermeasure
0x01	Configuration invalid	The configuration is invalid.	Configure the Safety Network Controller correctly.
0x02	Over current detected	Trouble with the connected device	Replace the connected device.
0x03	Short circuit to low	Ground fault of the output signal line	Check the wiring.
0x04	Stuck at high	<ol style="list-style-type: none"> 1. The power supply (positive side) is in contact with the output signal line. 2. Trouble with the internal circuit 3. The I/O power supply voltage is not within specifications. 	<ol style="list-style-type: none"> 1. Check the wiring. 2. Replace the Safety Network Controller. 3. Make sure the I/O power supply voltage is within specifications.
0x05	Failure of the associated dual channel output	Dual channels are set and an error occurred in the other channel.	Remove the error in the other channel.
0x08	Dual channel violation	Wrong setting for output data	Check the program.
0x09	Cross connection detected	Short-circuit between output signal lines.	Check the wiring.
0x0A	EDM Error	<ol style="list-style-type: none"> 1. Break in the EDM feedback signal line, or contact with power supply (positive side), or ground fault 2. Contactor or relay contact weld fault 	<ol style="list-style-type: none"> 1. Check the wiring. 2. Replace the contactor or relay.

Explicit Message for Reading the Cause of the Error

Explicit message	Read/write	Function	Command					Response
			Service code	Class ID	Instance ID	Attribute ID	Data size	
Safety Output Cause of Error Information Read	Read	Reads the cause for the Normal Flag specified by the instance ID turning OFF. (See note.)	0E hex	3B hex	01 to 06 hex	6E hex	-	0: No error or error code

Note The instance numbers for safety outputs 0 to 5 are 1 to 6 (01 to 06 hex), respectively.

12-4 Online Operation Errors with USB Connection

12-4-1 Overview

Online communications may fail when the Network Configurator is connected to the USB port of the NE0A-series Controller. The cause of the error can be determined from the error information displayed on the Network Configurator.

12-4-2 Errors and Countermeasures When Selecting Interface

Error	Countermeasure
The <i>NExA USB Port</i> Option is not displayed when you select Options - Select Interface .	<ol style="list-style-type: none"> 1. The NE0A USB port driver may not be installed. Refer to <i>Checking the NE0A USB Driver</i> and then check the driver installation. If it is not installed properly, install it again, and then select Options - Select Interface again. 2. If the driver is properly installed, restart the computer, and then select Options - Select Interface again.
The <i>NE1A USB Port</i> Option is not displayed when you select Options - Select Interface .	Network Configurator of version 2.0□ or lower is installed. Upgrade to version 2.1 or higher.

12-4-3 Error Messages and Countermeasures

Message displayed on the Network Configurator	Countermeasure
Opening the interface failed.	<ol style="list-style-type: none"> 1. The USB cable may be unplugged. Check the connection and the try to open the interface again. 2. The power of the NE0A-series Controller may not be supplied correctly. Apply the correct power and then try to open the interface again. 3. An incorrect interface may be selected. Select Options - Select Interface and then select the NExA USB Port Option. Try to open the interface again. 4. The NE0A USB port driver may not be installed. Refer to <i>Checking the NE0A USB Driver</i> and then check the driver installation. If it is not installed properly, install it again, and then open the interface again.
Cannot be performed in present mode.	<p>Online DeviceNet communications of the NE0A-series Controller failed.</p> <ul style="list-style-type: none"> • To use only a USB connection and not connect online to DeviceNet, select Auto Detection. • Does the selected baud rate match other nodes in the network? • Are lengths of cables (trunk and branch lines) correct? • Are Terminating Resistors connected to both ends of the trunk line and only both ends? • Is noise interference excessive? • Is the network power supply appropriate? • Is the bandwidth used appropriate?
Incorrect parameter	The NE0A-series Controller is connected online to DeviceNet with a baud rate other than the value that has already been set. Perform the action again.

12-5 Errors When Downloading

12-5-1 Outline

An NE0A-series Controller may return an error when configuration data is downloaded to the Controller. The cause of the error can be determined from the error information displayed on the Network Configurator.

12-5-2 Error Messages and Countermeasures

Message displayed on the Network Configurator	Countermeasure
Cannot be executed in the current mode.	Abort (MS indicator flashes red) has occurred. Set the switches correctly or execute reset (restarting with factory default settings) to clear the configuration data.
The device is locked.	The configuration data is locked. (LOCK indicator is lit.) Release the lock.
The TUNID is different.	<p>The device is waiting for a TUNID setting after being reset (NS indicator is flashing green/red) or the TUNID of the Network Configurator is different from the device when downloading. Use the following steps to check the setting.</p> <ol style="list-style-type: none"> 1. Reset the device to the default settings, and then download the parameters again. If safety I/O communications cannot be established with the Safety Master after the parameters have been downloaded, the network number may be different from the other devices. In that case, perform step 2 or 3 below. 2. Select Network – Upload in the Network Configurator. Unify the network numbers and reset all devices to the default settings. Once reset, download the parameters to all devices again. 3. Select Network – Property, and then click the Get from Network Button in the Network Number Field in the dialog box that appears. If there are multiple network numbers, select one of these numbers to unify all to that network number.
Privilege violation.	<ol style="list-style-type: none"> 1. The password that is being used does not have the right to change the configuration. Check to see if the password is correct. 2. An attempt was made to set Standalone Mode through a DeviceNet connection. Connect the Network Configurator via the USB connector and download the configuration again.
Cannot be executed in the current device mode.	Downloading from more than one Network Configurator at the same time. Wait until other downloads have been completed.
Connection can not be opened.	<ol style="list-style-type: none"> 1. A connection could not be established with the NE0A-series Controller when downloading to the Controller via DeviceNet. Check the device power supply, and then try downloading again. 2. A connection cannot be established with the network configuration because the connection resources that are usable by devices are being used for a safety I/O connection with the Safety Master. Change the operating mode of the Safety Master for which the safety connection is registered to IDLE Mode. 3. If the cause is other than the above, communications may be unstable due to noise. Check the following items. <ul style="list-style-type: none"> • Do the baud rates match for all nodes? • Are the lengths of cables (trunk and branch lines) correct? • Is a cable disconnected or loose? • Is terminating resistance installed at both ends of the trunk line?

Message displayed on the Network Configurator	Countermeasure
Message could not be sent.	Downloaded via USB to the NE0A-series Controller but could not connect to the NE0A-series Controller. Check the following items and download again. <ul style="list-style-type: none"> • Is power supplied to the device? • Is the USB cable disconnected?
Message could not be received.	
Connection failed.	Tried to configure a device on the DeviceNet network via the NE0A-series Controller's USB port, but connection failed. Check the following items and download again. <ul style="list-style-type: none"> • Is power supplied to the device? • Is the USB cable disconnected? If the above cause does not apply, noise or other factors may be making communications unstable. Check the following items. <ul style="list-style-type: none"> • Do all nodes have the same baud rate? • Are the lengths of cables (trunk and branch lines) correct? • Is the cable disconnected or loose? • Is the terminating resistance only on both ends of the trunk line? • Is noise interference excessive?

12-6 Errors When Resetting

12-6-1 Outline

The NE0A-series Controller may return an error response when it is reset. The messages displayed on the Network Configurator can be used to identify and correct the error.

12-6-2 Error Messages and Countermeasures

Message displayed on the Network Configurator	Countermeasures
Cannot execute in current mode.	The specified reset cannot be executed in the current Controller status. Refer to <i>7-6 Reset</i> and change the operating mode or configuration lock status of the Controller. Then execute the reset again.
The device has a different TUNID. The device TUNID will be used to reset. Is that OK?	The TUNID saved to the device and the TUNID specified by Network Configurator do not match. Check that the device node address matches and execute the reset if it is OK to use the device TUNID.
Access error	The password used does not provide authority to change configurations. Check that the correct password is being used.
The device cannot be accessed or the device type or password is different.	1. The device has just been reset or the power cycled and the device is not ready for communications (i.e., not online with the NS indicator flashing or lit green.) Check that the device is communications ready then reset.
	2. The device specified for reset may not support that service. Check that the device node address is correct.
	3. The configuration data is locked. (The LOCK indicator is lit.) Remove the lock then execute the specified reset.
	4. The device is performing safety I/O communications and cannot, therefore, execute the specified reset. Change the operating mode of the relevant Safety Master to IDLE mode. Then execute the specified reset.
	5. You do not have the right to perform reset with the password being used. Check that the password being used is correct.
Connection failed.	1. Tried to reset a device on the DeviceNet network via the NE0A-series Controller's USB port, but connection failed. Check that power is turned ON to the device and reset again. If the above cause does not apply, noise or other factors may be making communications unstable. Check the following items. <ul style="list-style-type: none"> • Do all nodes have the same baud rate? • Are the lengths of cables (trunk and branch lines) correct? • Is the cable disconnected or loose? • Is the terminating resistance only on both ends of the trunk line? • Is noise interference excessive?
	2. The NE0A-series Controller may not be connected to DeviceNet (i.e., offline) if the NS indicator is OFF when an attempt is made to reset a device on the DeviceNet using the USB of the NE0A-series Controller. Using the Network Configurator, go offline by selecting Network - Cancel Connection , and then go online again by selecting Network - Connection .

12-7 Errors When Changing Modes

12-7-1 Outline

The NE0A-series Controller may return an error response when its operating mode is being changed. The messages displayed on the Network Configurator can be used to identify and correct the error.

12-7-2 Error Messages and Countermeasures

Message Displayed on the Network Configurator	Countermeasures
Cannot be executed in the current mode.	<ol style="list-style-type: none"> 1. The device has not been configured (Configuring Mode). Download the device parameters. 2. Abort has occurred. Set the switches correctly or execute reset (restarting with factory default settings) to clear the configuration data. Once the configuration data is cleared, download the device parameters again.
Already set to the specified mode.	The device is already in the specified operating mode.
The device has a different TUNID.	The TUNID saved to the device and the TUNID specified by the Network Configurator do not match. Check that the device node address matches. If it does, it means that the device network number and the network number in the Network Configurator do not match. To match the network numbers, select Network – Upload in the Network Configurator or reset the device to its default and then download again.
Access error	The password used does not provide authority to change the operating mode. Check that the correct password is being used.
The device cannot be accessed or the device type or password is different.	<ol style="list-style-type: none"> 1. The device has just been reset or the power cycled and the device is not ready for communications (i.e., not online with the NS indicator flashing or lit green.) Check that the device is ready for communications then change the operating mode. 2. The device for which the operating mode change request was made may not support that service. Check that the device node address is correct.
Connection failed.	<ol style="list-style-type: none"> 1. Tried to change the operating mode of a device on the DeviceNet network via the NE0A-series Controller’s USB port, but connection failed. Check that power is turned ON to the device and reset again. If the above cause does not apply, noise or other factors may be making communications unstable. Check the following items. <ul style="list-style-type: none"> • Do all nodes have the same baud rate? • Are the lengths of cables (trunk and branch lines) correct? • Is the cable disconnected or loose? • Is the terminating resistance only on both ends of the trunk line? • Is noise interference excessive? 2. The NE0A-series Controller may not be connected to DeviceNet (i.e., offline) if the NS indicator is OFF when an attempt is made to change the operating mode of a device on the DeviceNet using the USB of the NE0A-series Controller. Using the Network Configurator, go offline by selecting Network - Cancel Connection, and then go online again by selecting Network - Connection.

Appendix A

Application Templates

This appendix shows the NE0A-series Controller application templates supported by Network Configurator version 2.10 or higher. Refer to Network Configurator documentation for information on the Network Configurator. (Start the NE0A-series Setup Wizard and access the detail from the Application Template Setting Tab Page.)

Application Template 1

Safety category	Safety device	Stop category	Reset
4	Emergency stop pushbutton	0	Manual

Application Overview

Motor M stops when emergency stop pushbutton S1 is pressed.

Wiring Diagram

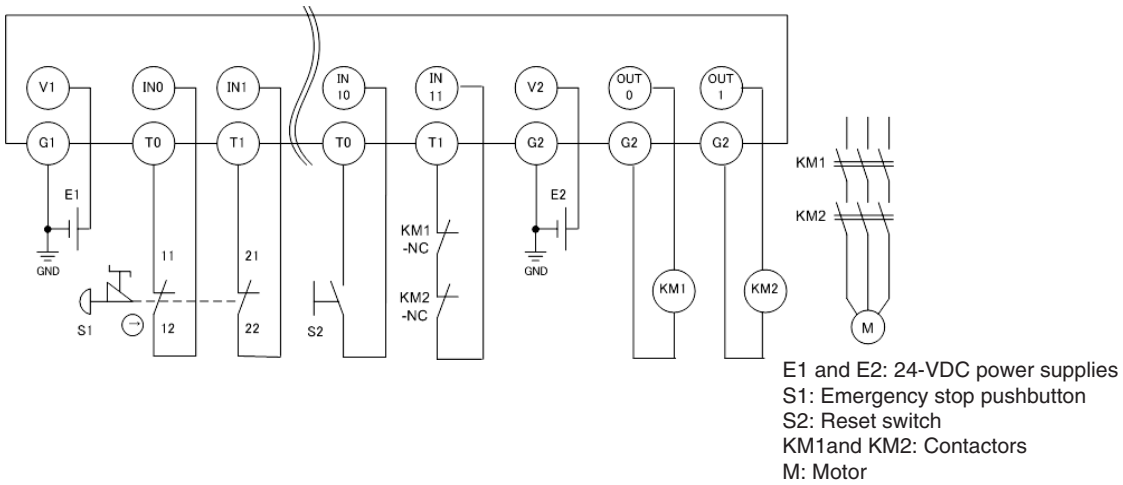

- Note**
- (1) Connect a 24-VDC power supply to terminals V0 and G0 (power supply terminals for internal circuits).
 - (2) This example shows the NE0A-SCPU01 Controller's terminal layout.

Timing Diagram

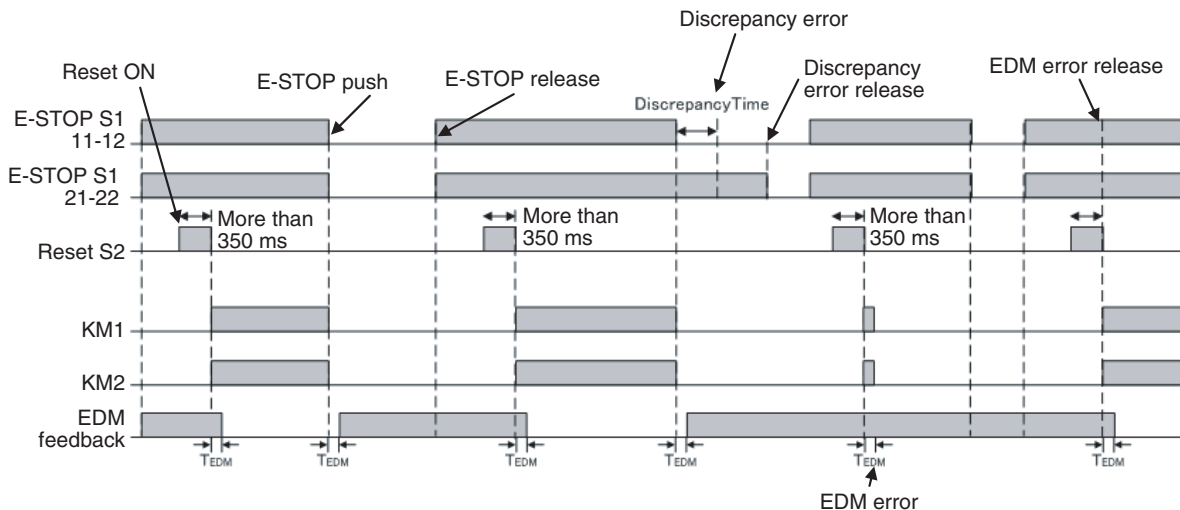

Safety I/O Terminal Settings

Input				Output	
No.	Name	Test Source	Discrepancy Time	No.	Name
00[e] [P]	EMO NC S1 11-12	Test Output0	500ms	00[d][P]	contactor KM1
01[e] [P]	EMO NC S1 21-22	Test Output1	500ms	01[d][P]	contactor KM2
02				02	
03				03	
04				04	
05				05	
06					
07					
08					
09					
10[P]	Reset S2	Test Output0			
11[P]	Feedback KM1/KM2 (welding check)	Test Output1			

[e]:Dual Equiv, [c]:Dual Comp, [P]:Test Pulse, [s]:Safety, [ST]:Standard

[d]:Dual, [P]:Pulse Test, [s]:Safety

Safety Logic Settings

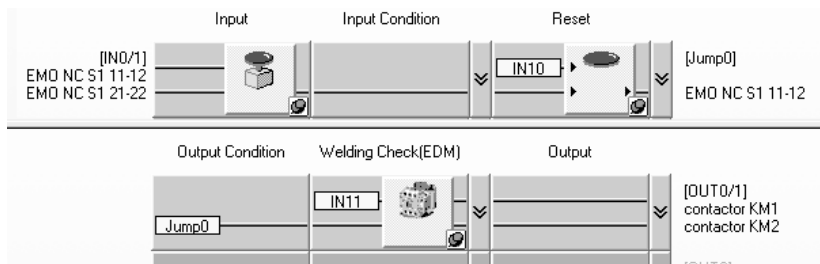

IMPORTANT

- Perform a function test every six months to detect contact welding failures on contactors.
- It is the user’s responsibility to make sure that the entire system complies with standards.

Application Template 2

Safety category	Safety device	Stop category	Reset
4	Safety limit switch	0	Auto

Application Overview

Motor M stops when safety gate 1 (S1, S2) is opened.

Wiring Example

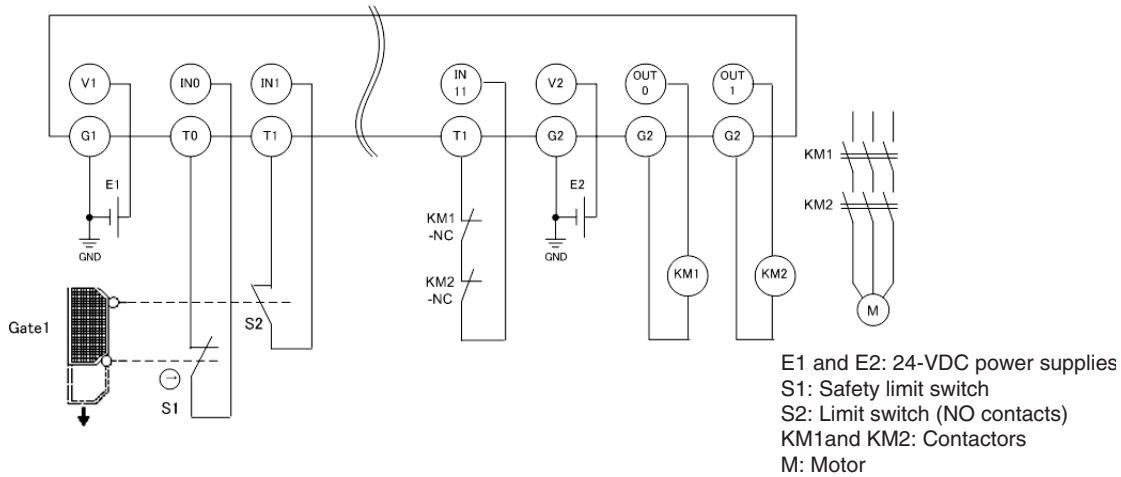

- Note**
- (1) Connect a 24-VDC power supply to terminals V0 and G0 (power supply terminals for internal circuits).
 - (2) This example shows the NE0A-SCPU01 Controller's terminal layout.

Timing Diagram

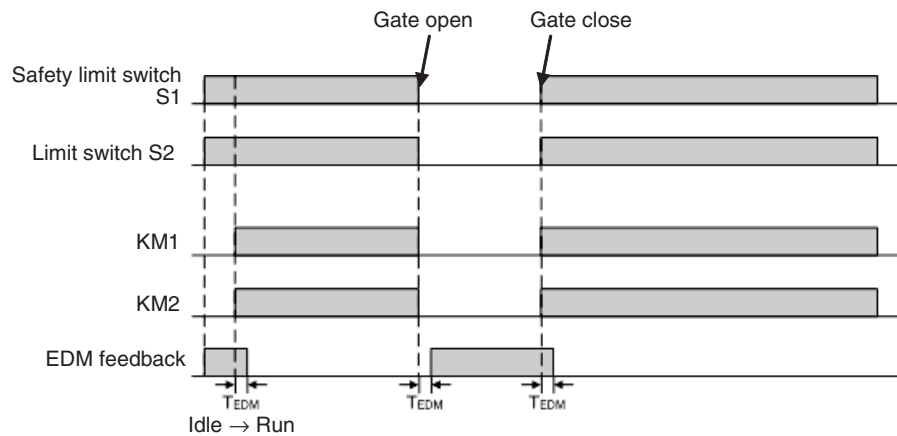

Safety I/O Terminal Settings

Input				Output	
No.	Name	Test Source	Discrepancy Time	No.	Name
00[e] [P]	Door SW NC S1	Test Output0	500ms	00[d][P]	contactor KM1
01[e] [P]	Door SW NC S2	Test Output1	500ms	01[d][P]	contactor KM2
02				02	
03				03	
04				04	
05				05	
06					
07					
08					
09					
10					
11[P]	Feedback KM1/KM2 (welding check)	Test Output1			

[d]:Dual Equiv. [c]:Dual Comp. [P]:Test Pulse, [s]:Safety, [ST]:Standard

Safety Logic Settings

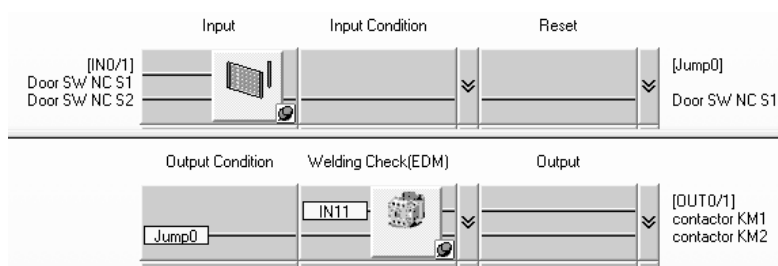

IMPORTANT

- Perform a function test every six months to detect contact welding failures on contactors.
- It is the user's responsibility to make sure that the entire system complies with standards.

Application Template 3

Safety category	Safety device	Stop category	Reset
4	Safety limit switch	0	Auto
	Emergency stop pushbutton	0	Manual

Application Overview

M1 stops when safety gate 1 (S3, S4) is opened.

M2 stops when safety gate 2 (S5, S6) is opened.

Both M1 and M2 stop when the emergency stop pushbutton S1 is pressed.

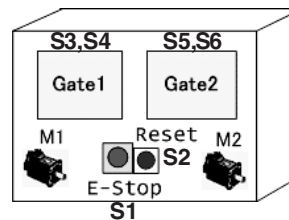

Wiring Example

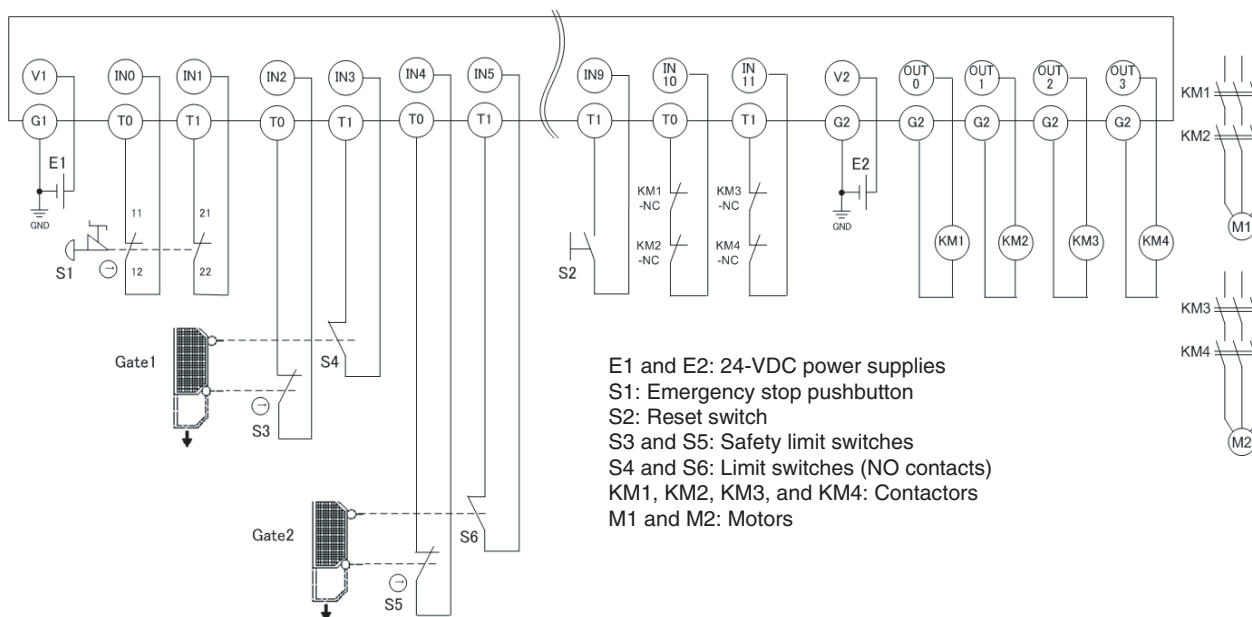

- E1 and E2: 24-VDC power supplies
- S1: Emergency stop pushbutton
- S2: Reset switch
- S3 and S5: Safety limit switches
- S4 and S6: Limit switches (NO contacts)
- KM1, KM2, KM3, and KM4: Contactors
- M1 and M2: Motors

- Note**
- (1) Connect a 24-VDC power supply to terminals V0 and G0 (power supply terminals for internal circuits).
 - (2) This example shows the NE0A-SCPU01 Controller's terminal layout.

Timing Diagram

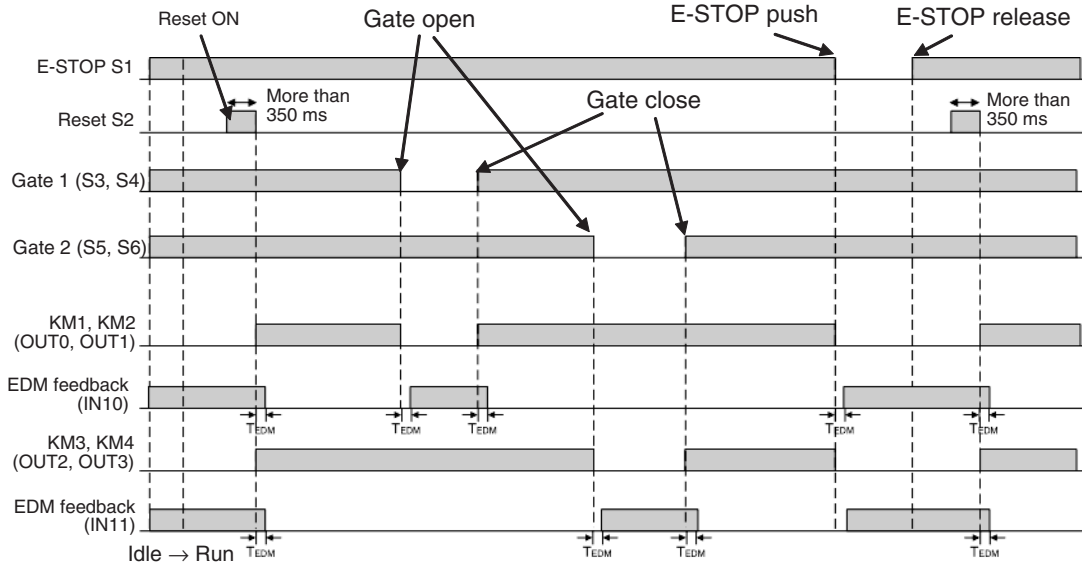

Safety I/O Terminal Settings

Input				Output	
No.	Name	Test Source	Discrepancy Time	No.	Name
00[e] [P]	EMO NC S1 11-12	Test Output0	500ms	00[d][P]	contactor KM1
01[e] [P]	EMO NC S1 21-22	Test Output1	500ms	01[d][P]	contactor KM2
02[e] [P]	Door SW NC S3	Test Output0	500ms	02[d][P]	contactor KM3
03[e] [P]	Door SW NC S4	Test Output1	500ms	03[d][P]	contactor KM4
04[e] [P]	Door SW NC S5	Test Output0	500ms	04	
05[e] [P]	Door SW NC S6	Test Output1	500ms	05	
06					
07					
08					
09[P]	Reset S2	Test Output1			
10[P]	Feedback KM1/KM2 (welding check)	Test Output0			
11[P]	Feedback KM3/KM4 (welding check)	Test Output1			

[d]:Dual, [P]:Pulse Test, [s]:Safety

[e]:Dual Equiv, [c]:Dual Comp, [P]:Test Pulse, [s]:Safety, [ST]:Standard

Safety Logic Settings

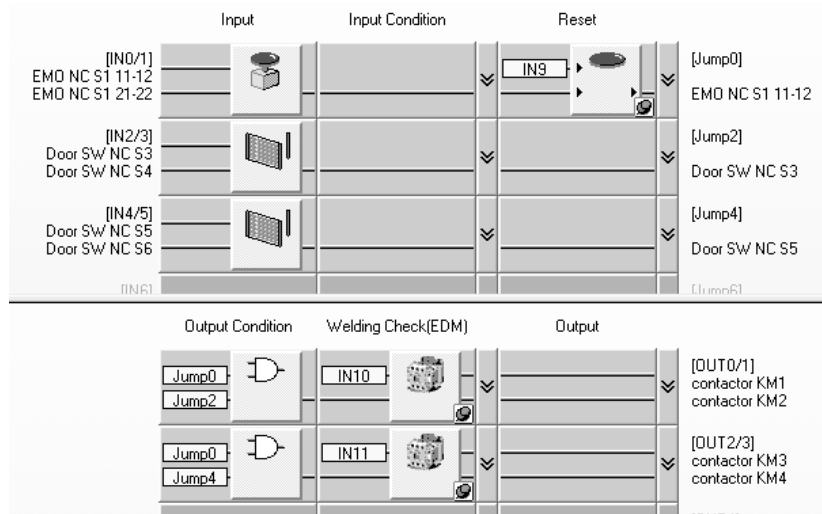

IMPORTANT

- Perform a function test every six months to detect contact welding failures on contactors.
- It is the user's responsibility to make sure that the entire system complies with standards.

Application Template 4

Safety category	Safety device	Stop category	Reset
4	<ul style="list-style-type: none"> • Emergency stop pushbutton • Safety light curtain (SLC1) • Safety light curtain (SLC2) 	0	Manual

Application Overview

SLC detects a human body and SLC3 detect the robot arm (hazard).
 The output goes OFF when light is intercepted for both simultaneously.
 The output also goes OFF when emergency stop pushbutton S1 is pressed.

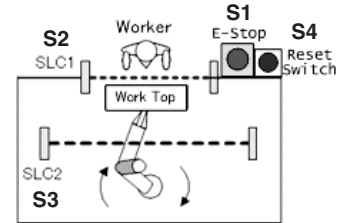

Wiring Example

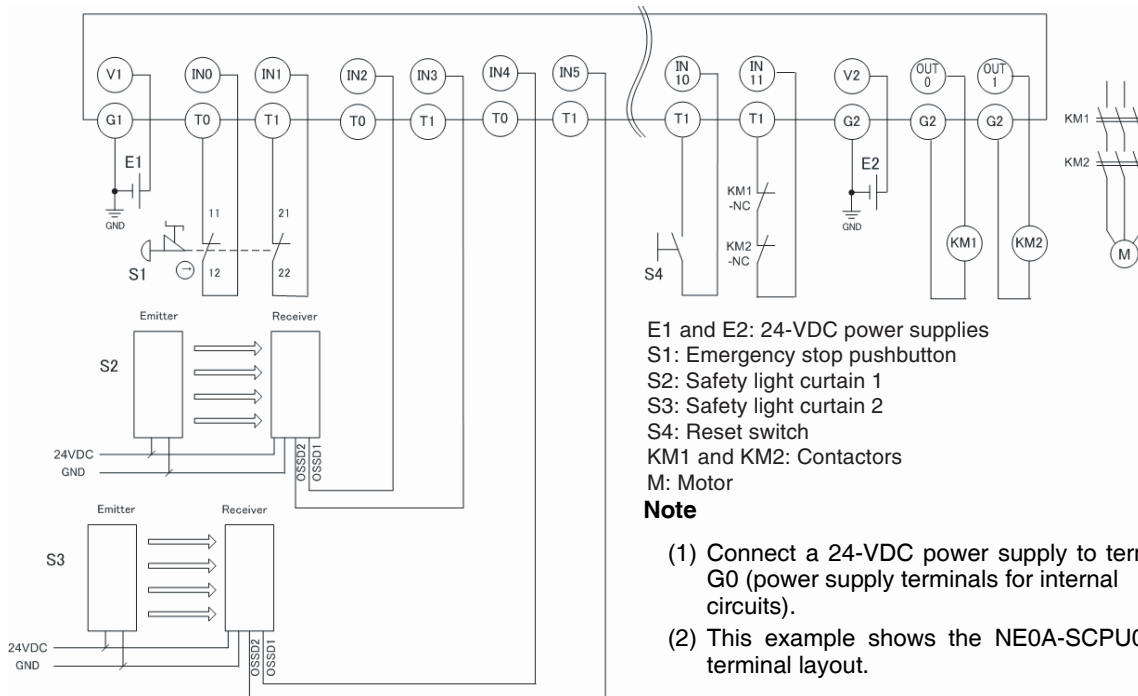

- E1 and E2: 24-VDC power supplies
- S1: Emergency stop pushbutton
- S2: Safety light curtain 1
- S3: Safety light curtain 2
- S4: Reset switch
- KM1 and KM2: Contactors
- M: Motor

Note

- (1) Connect a 24-VDC power supply to terminals V0 and G0 (power supply terminals for internal circuits).
- (2) This example shows the NE0A-SCPU01 Controller's terminal layout.

Timing Diagram

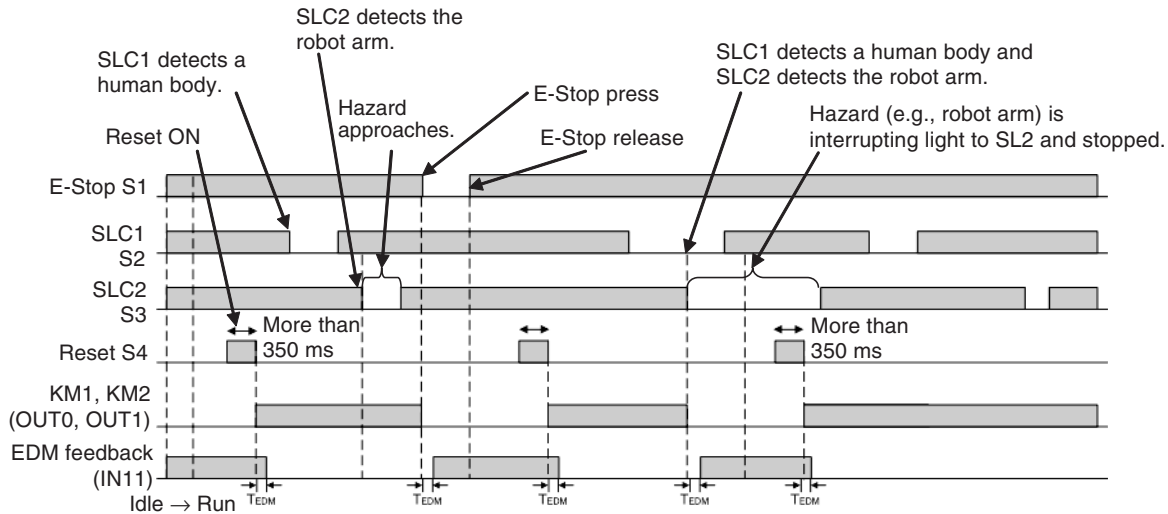

Safety I/O Terminal Settings

Input				Output	
No.	Name	Test Source	Discrepancy Time	No.	Name
00[e] [P]	EMO NC S1 11-12	Test Output0	500ms	00[d][P]	contactor KM1
01[e] [P]	EMO NC S1 21-22	Test Output1	500ms	01[d][P]	contactor KM2
02[e] [s]	SLC1 S2		500ms	02	
03[e] [s]	SLC1 S2		500ms	03	
04[e] [s]	SLC2 S3		500ms	04	
05[e] [s]	SLC2 S3		500ms	05	
06					
07					
08					
09					
10[P]	Reset S4	Test Output0			
11[P]	Feedback KM1/KM2 (welding check)	Test Output1			

[d]:Dual, [P]:Pulse Test, [s]:Safety

[e]:Dual Equiv, [c]:Dual Comp, [P]:Test Pulse, [s]:Safety, [ST]:Standard

Safety Logic Settings

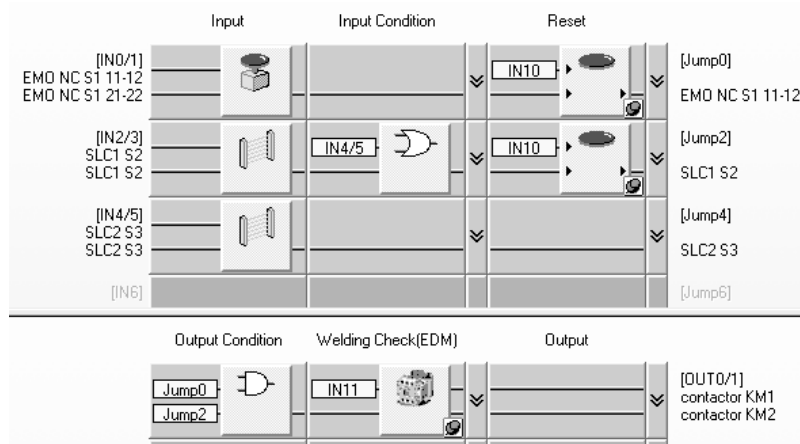

IMPORTANT

- Perform a function test every six months to detect contact welding failures on contactors.
- It is the user's responsibility to make sure that the entire system complies with standards.

Application Template 5

Safety category	Safety device	Stop category	Reset
4	<ul style="list-style-type: none"> • Emergency stop pushbutton • Safety light curtain (SLC1) • Limit switch 	0	Manual

Application Overview

SLC1 detects a human body and the limit switch detect the location of the robot arm (hazard).

Output goes OFF when both are intercepted simultaneously.

The output also goes OFF when emergency pushbutton S1 is pressed.

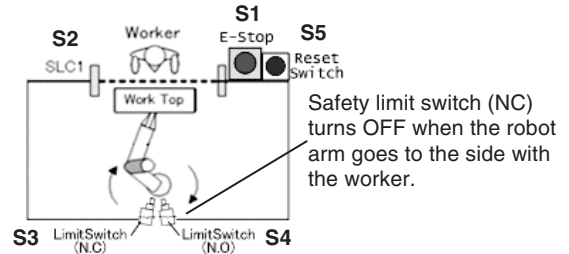

Wiring Example

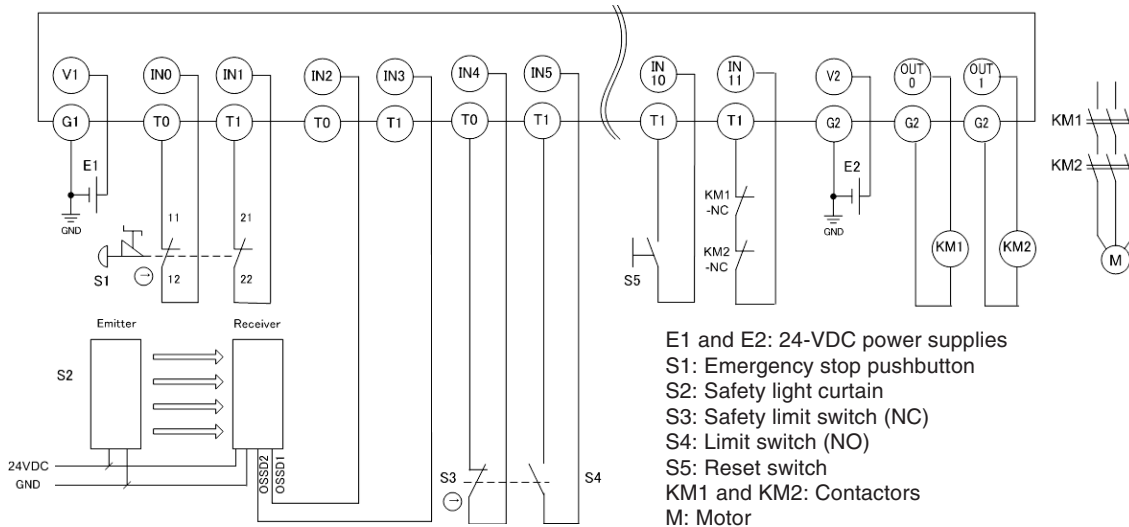

- Note**
- (1) Connect a 24-VDC power supply to terminals V0 and G0 (power supply terminals for internal circuits).
 - (2) This example shows the NE0A-SCPU01 Controller's terminal layout.

Timing Diagram

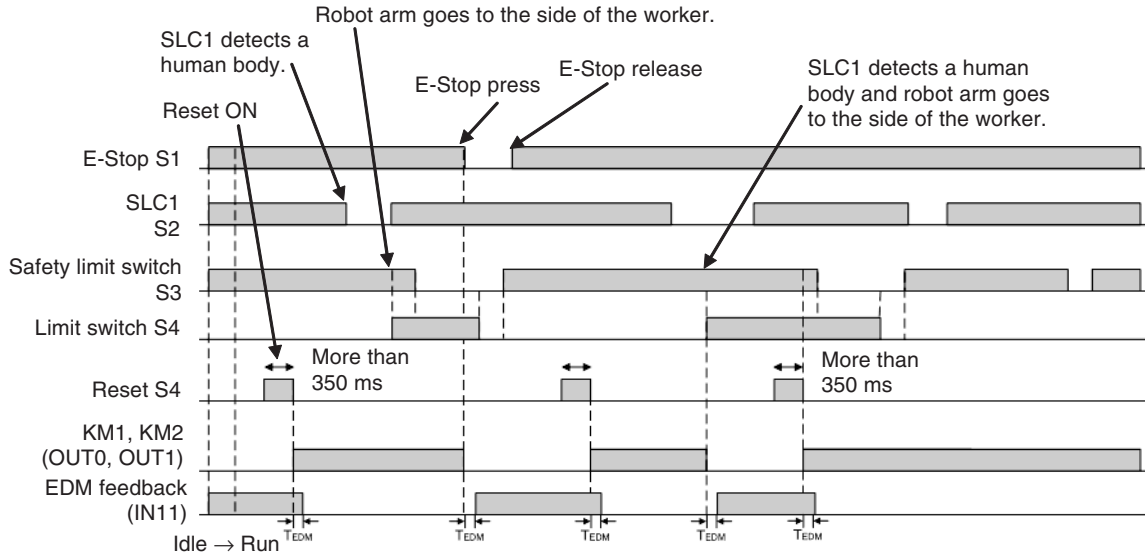

Safety I/O Terminal Settings

Input				Output	
No.	Name	Test Source	Discrepancy Time	No.	Name
00[e] [P]	EMO NC S1 11-12	Test Output0	500ms	00[d][P]	contactor KM1
01[e] [P]	EMO NC S1 21-22	Test Output1	500ms	01[d][P]	contactor KM2
02[e] [s]	SLC1 S2		500ms	02	
03[e] [s]	SLC1 S2		500ms	03	
04[c] [P]	Limit SW NC S3	Test Output0	500ms	04	
05[c] [P]	Limit SW NO S4	Test Output1	500ms	05	
06					
07					
08					
09					
10[P]	Reset S5	Test Output0			
11[P]	Feedback KM1/KM2 (welding check)	Test Output1			

[e]:Dual Equiv. [c]:Dual Comp. [P]:Test Pulse, [s]:Safety, [ST]:Standard

[d]:Dual, [P]:Pulse Test, [s]:Safety

Safety Logic Settings

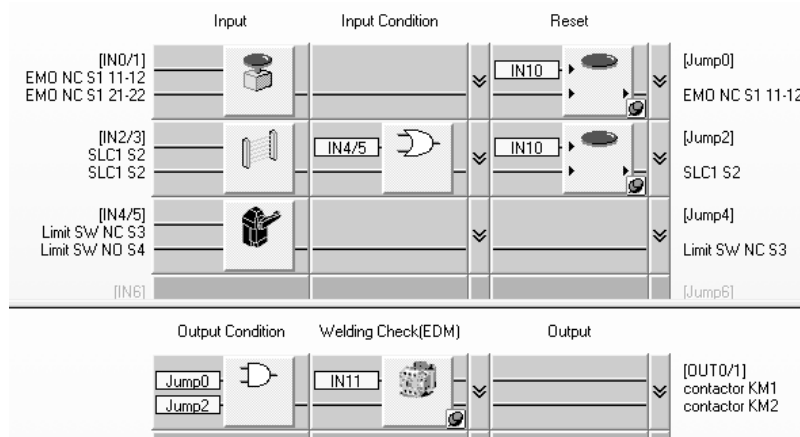

IMPORTANT

- Perform a function test every six months to detect contact welding failures on contactors.
- It is the user's responsibility to make sure that the entire system complies with standards.

Application Template 6

Safety category	Safety device	Stop category	Reset
4	<ul style="list-style-type: none"> • Emergency stop pushbutton • Safety door switch with mechanical lock • User mode switch 	0	Manual

Application Overview

When the user mode is normal operation, the safety gate (S2, S3) cannot be opened. The outputs will be turned OFF by switching to maintenance mode, and after 5 s it will be possible to open the safety gate. The outputs also go OFF when emergency pushbutton S1 is pressed.

Wiring Example

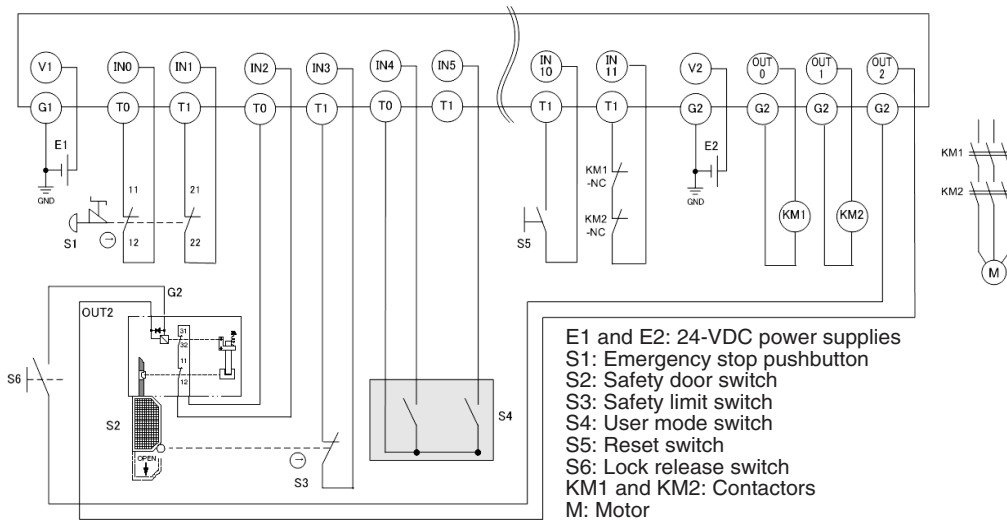

- E1 and E2: 24-VDC power supplies
- S1: Emergency stop pushbutton
- S2: Safety door switch
- S3: Safety limit switch
- S4: User mode switch
- S5: Reset switch
- S6: Lock release switch
- KM1 and KM2: Contactors
- M: Motor

- Note**
- (1) Connect a 24-VDC power supply to terminals V0 and G0 (power supply terminals for internal circuits).
 - (2) This example shows the NE0A-SCPU01 Controller's terminal layout.

Timing Diagram

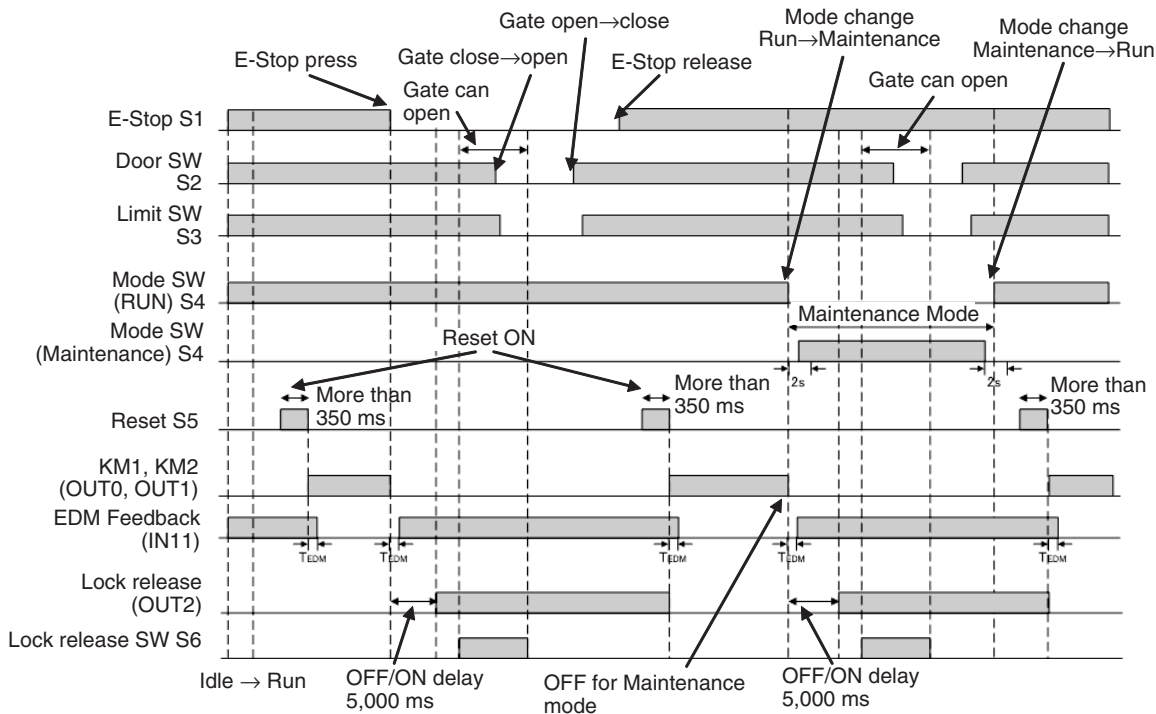

Safety I/O Terminal Settings

Input				Output	
No.	Name	Test Source	Discrepancy Time	No.	Name
00[e] [P]	EMO NC S1 11-12	Test Output0	500ms	00[d] [P]	contactor KM1
01[e] [P]	EMO NC S1 21-22	Test Output1	500ms	01[d] [P]	contactor KM2
02[e] [P]	Door SW NC S2	Test Output0	500ms	02[s]	Door Lock Release
03[e] [P]	Door SW NC S3	Test Output1	500ms	03	
04[P]	Mode SW S4 -RUN Mode-	Test Output0		04	
05[P]	Mode SW S4 -Maintenance Mode-	Test Output0		05	
06					
07					
08					
09					
10[P]	Reset S5	Test Output0			
11[P]	Feedback KM1/KM2 (welding check)	Test Output1			

[e]:Dual Equiv, [c]:Dual Comp, [P]:Test Pulse, [s]:Safety, [ST]:Standard

Safety Logic Settings

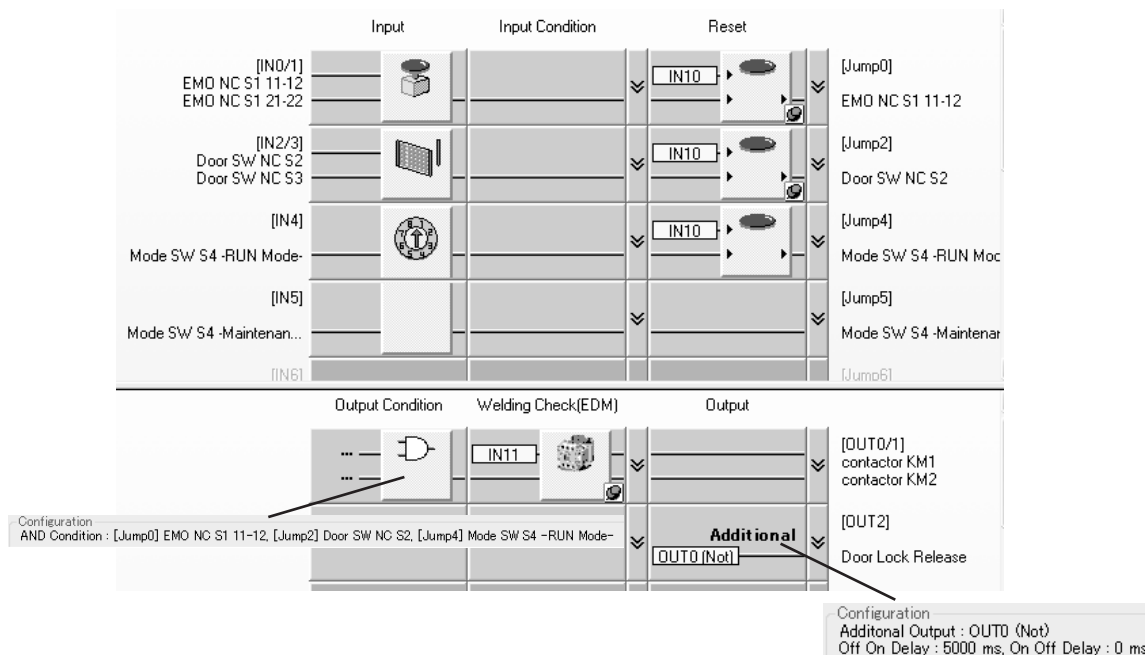

IMPORTANT

- Perform a function test every six months to detect contact welding failures on contactors.
- It is the user's responsibility to make sure that the entire system complies with standards.

Appendix B

DeviceNet Explicit Messages

DeviceNet explicit messages sent from the Master Unit to the NE0A-series Controller can be used to read or write any parameter of a specified Controller. The NE0A-series Controller processes the command sent from the Master Unit and then returns a response.

Basic Format of Explicit Messages

The basic format of each command and response is shown below.

Command Block

Destination node address	Service code	Class ID	Instance ID	Attribute ID	Data
--------------------------	--------------	----------	-------------	--------------	------

Destination Node Address

The node address of the Unit that is sending the explicit message is specified with one hexadecimal byte.

Service Code, Class ID, Instance ID, and Attribute ID

The parameters used for specifying the command, processing object, and processing content.

Note The number of bytes designated for the class ID, instance ID, and attribute ID depend on the Master Unit. When sent from an OMRON DeviceNet Master, the class ID and instance ID are 2 bytes (4 digits) each, and the attribute ID is 1 byte (2 digits).

Data

Data is not required when a read command is used.

Response Block

Normal Response Block

Number of bytes received	Source node address	Service code	Data
--------------------------	---------------------	--------------	------

Error Response Block

Number of bytes received 0004 hex (fixed)	Source node address	Service code	Error code
--	---------------------	--------------	------------

Number of Bytes Received

The number of bytes received from the source node address is returned in hexadecimal. When an error response is returned for an explicit message, the number of bytes is always 0004 hex.

Source Node Address

The node address of the node from which the command was sent is returned in hexadecimal.

Service Code

For normal completions, the service code specified in the command with the leftmost bit turned ON is stored as shown in the following table.

Function	Command service code	Response service code
Read data	10 hex	90 hex
Write data	0E hex	8E hex
Reset	05 hex	85 hex
Save	16 hex	96 hex

When an error response is returned for an explicit message, the value is always 94 hex.

Data

Read data is included only when a read command is executed.

Error Code

The explicit message error code. For details, refer to the list of error codes in the following table.

Error Codes

Code	Error name	Cause
08FF	Service not supported	The service code is incorrect.
09FF	Invalid attribute value	The specified attribute value is not supported. The data written was outside the valid range.
16FF	Object does not exist	The specified Instance ID is not supported.
15FF	Too much data	The data is larger than the specified size.
13FF	Not enough data	The data is smaller than the specified size.
0CFF	Object state conflict	The specified command cannot be executed due to an internal error.
20FF	Invalid parameter	The specified operation command data is not supported.
0EFF	Attribute not settable	An attribute ID supported only for reading has been executed for a write service code.
10FF	Device state conflict	The specified command cannot be executed due to an internal hardware error.
14FF	Attribute not supported	The specified attribute is not supported.
19FF	Store operation failure	The data cannot be stored in memory.
2AFF	Group 2 only server general failure	The specified command or attribute is not supported or the attribute was not set.

Explicit Messages

Reading Unit Status

Explicit message	Read/write	Function	Command					Response
			Service Code	Class ID	Instance ID	Attribute ID	Data size	
General Status	Read	Reads 8 bits of general status.	0E hex	95 hex	01 hex	65 hex	-	1 byte

Setting and Monitoring the Unit Conduction Time

Explicit message	Read/write	Function	Command					Response
			Service Code	Class ID	Instance ID	Attribute ID	Data size	
Unit Conduction Time Monitor Threshold	Read	Reads the monitor threshold for the Unit Conduction Time (unit: 0.1 h) of the NEOA-series Controller.	0E hex	95 hex	01 hex	73 hex	-	4 bytes 0000 0000 to FFFF FFFF hex (0 to 4,294,967,295)
Unit Conduction Time Present Value	Read	Reads the present value for the Unit Conduction Time (unit: 0.1 h) of the NEOA-series Controller.	0E hex	95 hex	01 hex	71 hex	-	4 bytes 0000 0000 to FFFF FFFF hex (0 to 4,294,967,295)
Unit Conduction Time Flag	Read	Reads the monitor status of Unit Conduction Time of the NEOA-series Controller.	0E hex	95 hex	01 hex	72 hex	-	1 byte 00 hex: Within range 01 hex: Over range (over the monitor value)

Monitoring Force-set/Force-reset Status

Explicit message	Read/write	Function	Command					Response
			Service Code	Class ID	Instance ID	Attribute ID	Data size	
Force-set/reset Status	Read	Reads the status to see if force-setting/resetting is possible in the NEOA-series Controller.	0E hex	309 hex	01 hex	14 hex	-	1 byte 00 hex: Normal mode 01 hex: Force-set/reset Mode
Force-set/reset Time Remaining	Read	Reads the remaining time (unit: min) that force-setting/resetting can be continued in the NEOA-series Controller.	0E hex	309 hex	01 hex	17 hex	-	4 bytes 0000 0000 to 0000 05A0 hex (0 to 1,440 min)

Monitoring I/O Assembly Data

These messages are used to read data on local I/O terminals and remote I/O. Refer to *6-5 Remote I/O Allocations* for information on each assembly data item.

Explicit message	Read/write	Function	Command					Response
			Service Code	Class ID	Instance ID	Attribute ID	Data size	
Input Assembly1	Read	Reads 8 bits of the Remote Input Byte Data	0E hex	04 hex	3B0 hex	03 hex	-	1 byte
Input Assembly2	Read	Reads Input Assembly 2.	0E hex	04 hex	3B0 hex	03 hex	-	4 bytes
Input Assembly3	Read	Reads Input Assembly 3.	0E hex	04 hex	3B0 hex	03 hex	-	7 bytes
Output Assembly	Read	Reads 8 bits of the Remote Output Byte Data	0E hex	04 hex	3B0 hex	03 hex	-	1 byte

Setting and Monitoring Safety Inputs

- Total ON Time and Contact Operation Counter
- Error Causes

Setting/Monitoring Individual Terminals

Explicit message	Read/write	Function	Command					Response
			Service Code	Class ID	Instance ID	Attribute ID	Data size	
Terminal Maintenance Information Monitor Mode	Read	Reads the monitor mode for maintenance information of the input specified by the instance ID.	0E hex	3D hex	01 to 0C hex	65 hex	-	1 byte 00 hex: Total ON time mode 01 hex: Contact operation counter mode
Input Set Value for Total ON Time or Contact Operation Counter	Read	Reads the set value for the total ON time (unit: s) or number of contact operations (unit: operations) of the input specified by the instance ID.	0E hex	3D hex	01 to 0C hex	68 hex	-	4 bytes 0000 0000 to FFFF FFFF hex (0 to 4,294,967,295)
Input Total ON Time or Contact Operation Counter Read	Read	Reads the set value for the total ON time (unit: s) or number of contact operations (unit: operations) of the input specified by the instance ID.	0E hex	3D hex	01 to 0C hex	66 hex	-	4 bytes 0000 0000 to FFFF FFFF hex (0 to 4,294,967,295)
Input Total ON Time or Contact Operation Counter Reset	Reset	Resets the total ON time or number of contact operations (unit: operations) for time input specified by the instance ID.	05 hex	3D hex	01 to 0C hex	66 hex	-	-
Input Monitor Status for Total ON Time or Contact Operation Counter Read	Read	Reads the set value for the total ON time (unit: s) or number of contact operations (unit: operations) of the input specified by the instance ID.	0E hex	3D hex	01 to 0C hex	67 hex	-	1 byte 00 hex: Within range 01 hex: Over range (over the monitor value)
Safety Input Cause of Error Information Read	Read	Reads the cause for the normal flag specified by the Instance ID turning OFF.	0E hex	3D hex	01 to 0C hex	6E hex	-	1 byte Refer to 12-3-1 Safety Input Errors.

Monitoring Test Output Terminals

Explicit message	Read/write	Function	Command					Response
			Service Code	Class ID	Instance ID	Attribute ID	Data size	
Test Output Cause of Error Read	Read	Reads the cause for the normal flag specified by the Instance ID turning OFF.	0E hex	307 hex	01 to 02 hex	76 hex	-	1 byte Refer to 12-3-2 Test Output Errors.

Setting and Monitoring Safety Outputs

- Total ON Time and Contact Operation Counter
- Error Causes

Setting/Monitoring Individual Terminals

Explicit message	Read/write	Function	Command					Response
			Service Code	Class ID	Instance ID	Attribute ID	Data size	
Terminal Maintenance Information Monitor Mode Read	Read	Reads the monitor mode for maintenance information of the output specified by the instance ID.	0E hex	3B hex	01 to 06 hex	65 hex	-	1 byte 00 hex: Total ON time mode 01 hex: Contact operation counter mode
	Write	Writes the monitor mode for maintenance information of the output specified by the instance ID.	10 hex	3B hex	01 to 06 hex	65 hex	1 byte 00 hex: Total ON time mode 01 hex: Contact operation counter mode	-
Output Set Value for Total ON Time or Contact Operation	Read	Reads the set value for the total ON time (unit: s) or number of contact operations (unit: operations) of the output specified by the instance ID.	0E hex	3B hex	01 to 06 hex	68 hex	-	4 bytes 0000 0000 to FFFF FFFF hex (0 to 4,294,967,295)
	Write	Writes the set value for the total ON time (unit: s) or number of contact operations (unit: operations) of the output specified by the instance ID.	10 hex	3B hex	01 to 06 hex	68 hex	4 bytes 0000 0000 to FFFF FFFF hex (0 to 4,294,967,295)	-
Output Total ON Time or Contact Operation Counter Read	Read	Reads the set value for the total ON time (unit: s) or number of contact operations (unit: operations) of the output specified by the instance ID.	0E hex	3B hex	01 to 06 hex	66 hex	-	4 bytes 0000 0000 to FFFF FFFF hex (0 to 4,294,967,295)
Output Total ON Time or Contact Operation Counter Reset	Reset	Resets the total ON time or number of contact operations for time output specified by the instance ID.	05 hex	3B hex	01 to 06 hex	66 hex	-	-
Output Monitor Status for Total ON Time or Contact Operation Counter Read	Read	Reads the set value for the total ON time or number of contact operations of the output specified by the instance ID.	0E hex	3B hex	01 to 06 hex	67 hex	-	1 byte 00 hex: Within range 01 hex: Over range (over the monitor value)
Safety Output Cause of Error Information Read	Read	Reads the cause for the normal flag specified by the Instance ID turning OFF.	0E hex	3B hex	01 to 06 hex	6E hex	-	1 byte Refer to 12-3-3 Safety Output Errors.

Monitoring All Safety I/O at Once

- Total ON Time and Contact Operation Counter
- Error Cause

Explicit message	Read/write	Function	Command					Response
			Service Code	Class ID	Instance ID	Attribute ID	Data size	
Total ON Time or Contact Operation Counter Read	Read	Reads the conduction times or contact operation counters for all safety inputs and outputs.	0E hex	95 hex	01 hex	7B hex	-	72 bytes (See note 1.)
Safety I/O Cause of Error Read	Read	Reads the causes of errors for all safety inputs and outputs.	0E hex	04 hex	361 hex	03 hex	-	19 bytes (See note 2.)

Note (1) The read format for the conduction times or contact operation counters for all safety inputs and outputs is as follows:

Byte	Bit 7	Bit 6	Bit 5	Bit 4	Bit 3	Bit 2	Bit 1	Bit 0
0 to 3	Conduction time or contact operation counter for safety input 0							
4 to 7	Conduction time or contact operation counter for safety input 1							
8 to 11	Conduction time or contact operation counter for safety input 2							
12 to 15	Conduction time or contact operation counter for safety input 3							
16 to 19	Conduction time or contact operation counter for safety input 4							
20 to 23	Conduction time or contact operation counter for safety input 5							
24 to 27	Conduction time or contact operation counter for safety input 6							
28 to 31	Conduction time or contact operation counter for safety input 7							
32 to 35	Conduction time or contact operation counter for safety input 8							
36 to 39	Conduction time or contact operation counter for safety input 9							
40 to 43	Conduction time or contact operation counter for safety input 10							
44 to 47	Conduction time or contact operation counter for safety input 11							
48 to 51	Conduction time or contact operation counter for safety output 0							
52 to 55	Conduction time or contact operation counter for safety output 1							
56 to 59	Conduction time or contact operation counter for safety output 2							
60 to 63	Conduction time or contact operation counter for safety output 3							
64 to 67	Conduction time or contact operation counter for safety output 4							
68 to 71	Conduction time or contact operation counter for safety output 5							

(2) The read format for the causes of errors for all safety inputs and outputs is shown below. Refer to *12-3 Troubleshooting by Monitoring Parameters* for information on the causes of errors.

Byte	Bit 7	Bit 6	Bit 5	Bit 4	Bit 3	Bit 2	Bit 1	Bit 0
0 to 7	Reserved by system.							
8	Cause of error for safety input 1				Cause of error for safety input 0			
9	Cause of error for safety input 3				Cause of error for safety input 2			
10	Cause of error for safety input 5				Cause of error for safety input 4			
11	Cause of error for safety input 7				Cause of error for safety input 6			
12	Cause of error for safety input 9				Cause of error for safety input 8			
13	Cause of error for safety input 11				Cause of error for safety input 10			
14	Cause of error for safety output 1				Cause of error for safety output 0			
15	Cause of error for safety output 3				Cause of error for safety output 2			
16	Cause of error for safety output 5				Cause of error for safety output 4			

Byte	Bit 7	Bit 6	Bit 5	Bit 4	Bit 3	Bit 2	Bit 1	Bit 0
17	Cause of error for test output 1				Cause of error for test output 0			
18	Reserved by system.							

Using Explicit Messages

The following example shows how to use explicit messages with an NE0A-series Controller using a CS1W-DRM21 DeviceNet Unit (Master).

Example: Reading the Cause of an Error for a Local Safety Input

Example Conditions

DeviceNet Unit node address: 05

Unit number: 0

Unit address: FE hex (or 10 hex)

NE0A-series Controller node address: 11

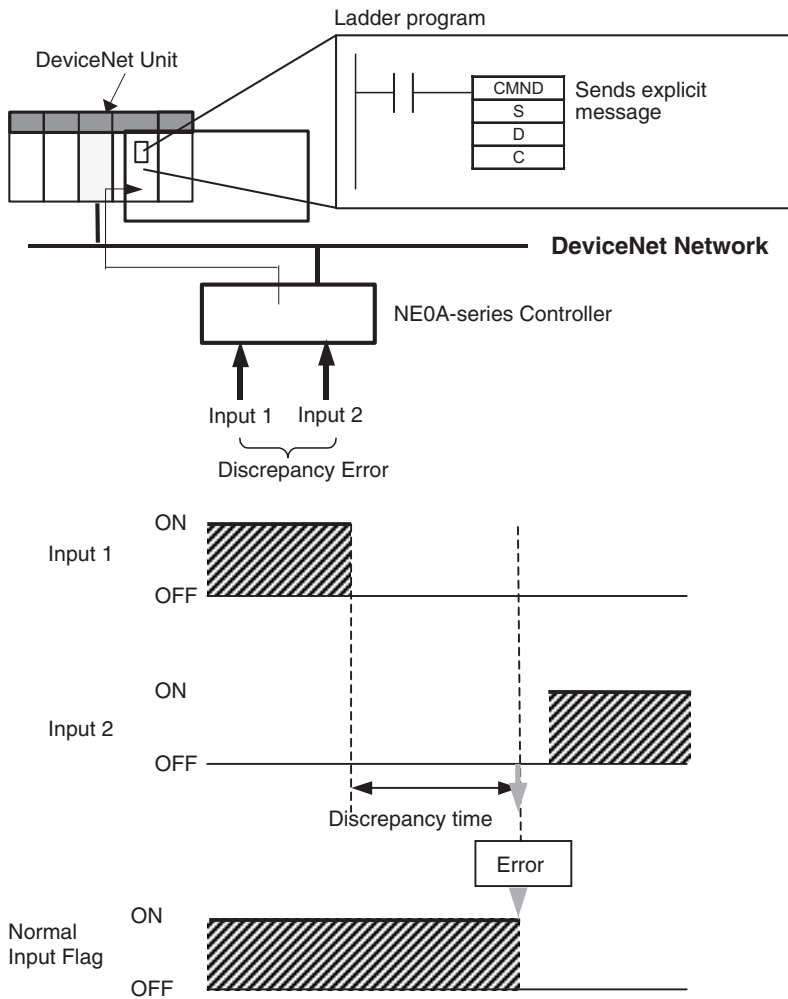

Command Details**[CMND S D C]**

S: D01000

D (first response word): D02000

C: D00000

Contents of S

Address	Contents	Meaning
D01000	2801 hex	Command code
D01001	0B0E hex	NE0A-series Controller node address: 11 Service code: 0E hex
D01002	003D hex	Class ID: 003D hex
D01003	0001 hex	Instance ID: 0001 hex
D01004	6E** hex	Attribute ID: 6E** hex (Set any value for **.)

Contents of C

Address	Contents	Meaning
D00000	0009 hex	Number of bytes of command data
D00001	0009 hex	Number of bytes of response data
D00002	0000 hex	Destination DeviceNet Unit network address: 0
D00003	05FE hex	Destination DeviceNet Unit node address: 5 Destination DeviceNet Unit address: FE hex (or 10 hex)
D00004	0000 hex	Response required Communications port number: 0 Number of retries: 0
D00005	003C hex	Response monitoring time: 6 s

Response**Contents of D**

Address	Contents	Meaning
D02000	2801 hex	
D02001	0000 hex	
D02002	0003 hex	
D02003	0B8E hex	Response source node address: 11 (0B hex) Normal completion: 8E hex
D02004	0400 hex	Safety input cause of error information: 0004 ↑ Discrepancy Error

Appendix C

Installing the NE0A USB Port Driver

The NE0A USB port driver must be installed to connect the Network Configurator online using the NE0A-series Controller's USB port.

- Note**
- (1) The NE0A USB port driver must be installed even if the NE1A USB port driver has already been installed.
 - (2) Install the Network Configurator before installing the NE0A USB port driver. Refer to the instruction guide included with the Network Configurator CD-ROM for information on the procedure for installing the Network Configurator.
 - (3) The files required for installing the NE0A USB port driver will be copied to the following location on the computer when the Network Configurator is installed.
Folder where the Network Configurator is installed: \SafetyDrivers\USB
Default settings for installed folder: C:\Program Files\OMRON\Network Configurator

Installing the NE0A USB Port Driver

Step 1

Turn ON the power supply to the NE0A-series Controller and connect the USB cable to the computer. If the Network Configurator is open, save and close it.

Step 2

The system will find new hardware, and the Found New Hardware Wizard will start. Select the *No, not this time* Option, and then click the **Next** Button.



Step 3

Select the *Install from a list or specific location (Advanced)* Option, and then click the **Next** Button.

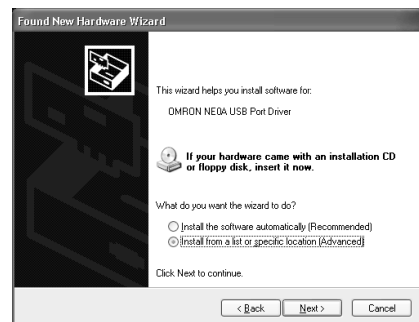

Step 4

Select the *Search for the best driver in these locations* Option and then select the *Include this location in the search* Option. Specify *\Safety-Drivers\USB* in the Network Configurator installation folder as the folder to be searched for the driver, and then click the **Next** Button.

Default settings for installed folder: C:\Program Files\OMRON\Network Configurator

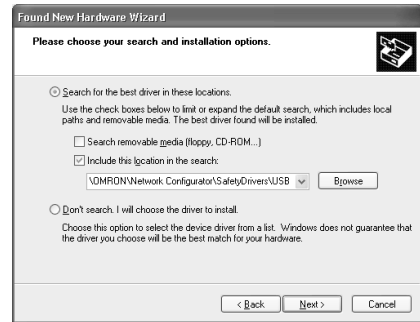

Step 5

A message may be displayed during installation to warn that the driver has not passed Windows Logo testing. There is no error. Click the **Continue Anyway** Button to proceed to the next step.



Step 6

The driver will be installed.



Step 7

Last, click the **Finish** Button to complete installation of the NE0A USB port driver.

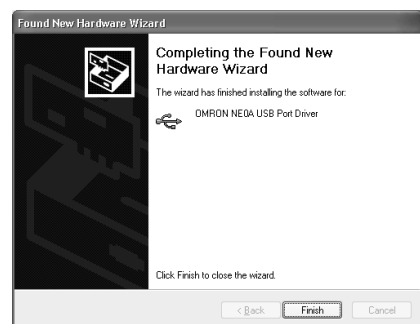

Checking the NE0A USB Driver

Step 1

Turn ON the power supply to the NE0A-series Controller and connect the USB cable to the computer.

Step 2

Right-click the **My Computer** Icon in Windows and select **Properties**. In the System Properties Window, click the **Hardware** Tab, and then click the **Device Manager** Button to open the Device Manager.

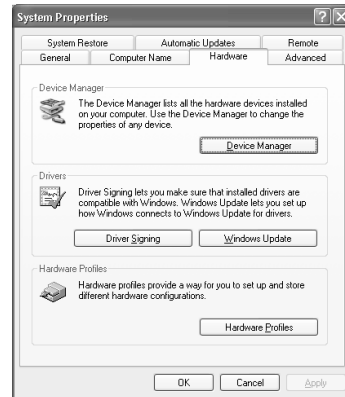

Step 3

Open the *Universal Serial Bus controllers* Listing. If *OMRON NE0A USB Port Driver* is displayed there, the driver is correctly installed. If it is not displayed, right-click, select **Update Driver**, and then install the NE0A USB port driver again.

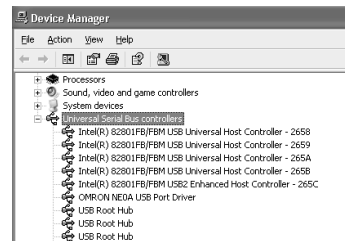

Appendix D

Using the Password Recovery Tool

If the password set for a device is lost, use the Password Recovery Tool to reset the password and to return to the state without any password setting (default settings).

Use the following procedure to reset a device password.

1. Prepare the computer for connecting to the DeviceNet via a USB port or DeviceNet Interface Card.
2. Select **Program - OMRON Network Configurator for DeviceNet Safety - Password Recovery Tool** (when using the default program folder names) from the Start Menu. The Password Recovery Tool will start, and the following Main Window will be displayed.

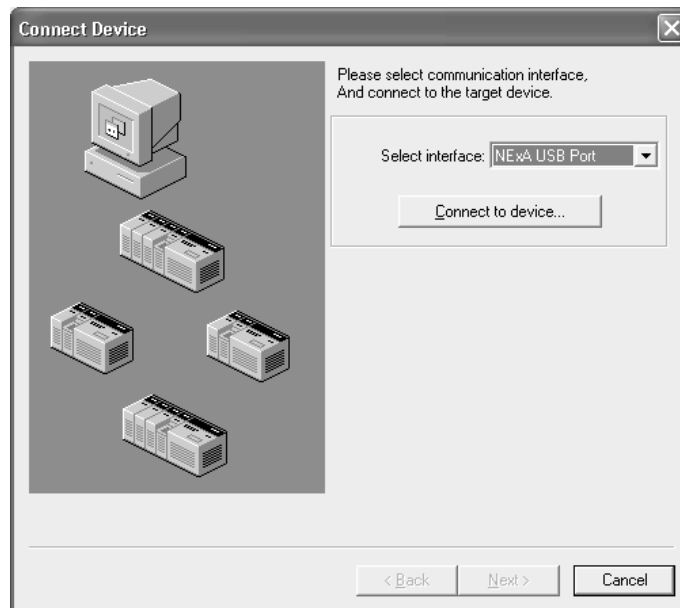

3. Select an interface for connecting to the network and click the **Connect to device** Button. Click the **Refresh** Button when the window to search for the destination device is displayed.

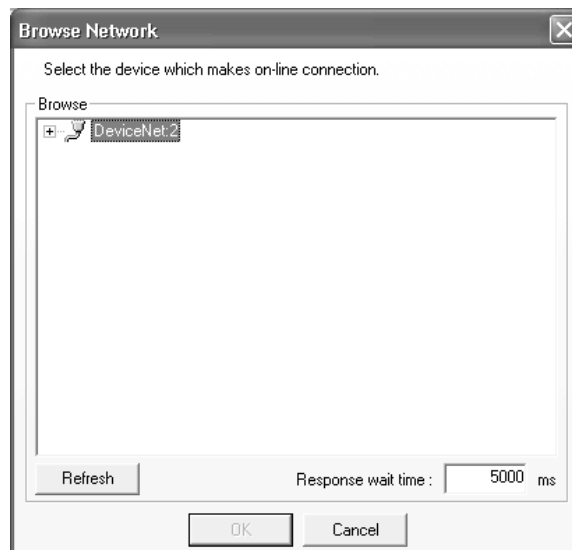

- Set the node address range to search for and click the **OK** Button.

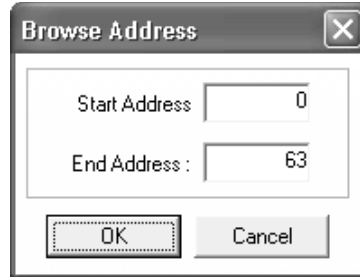

- The devices in the network will be displayed. Select a device for which to reset the password and click the **OK** Button.

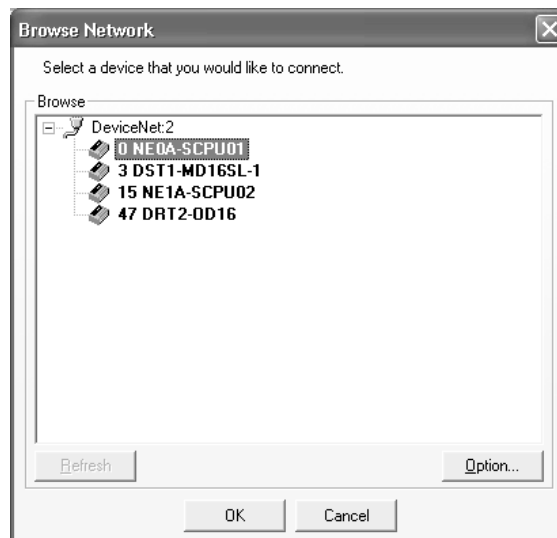

- The necessary information for resetting the password will be displayed. The information is required when inquiring from the Support Center. Print the information by outputting to a text file and or copying to another application using the clipboard.

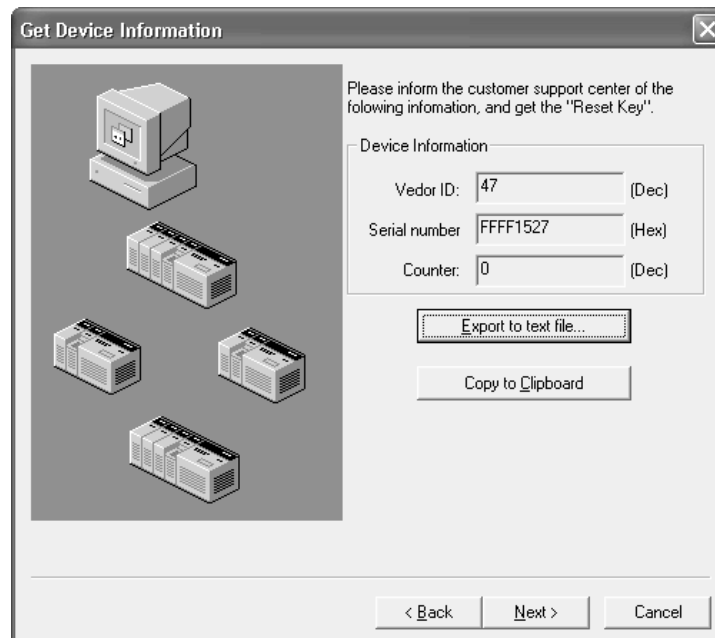

- Click the **Next** Button to display the Reset Key Enter Window. Enter the Reset Key obtained from the Support Center and click the **Reset** Button.

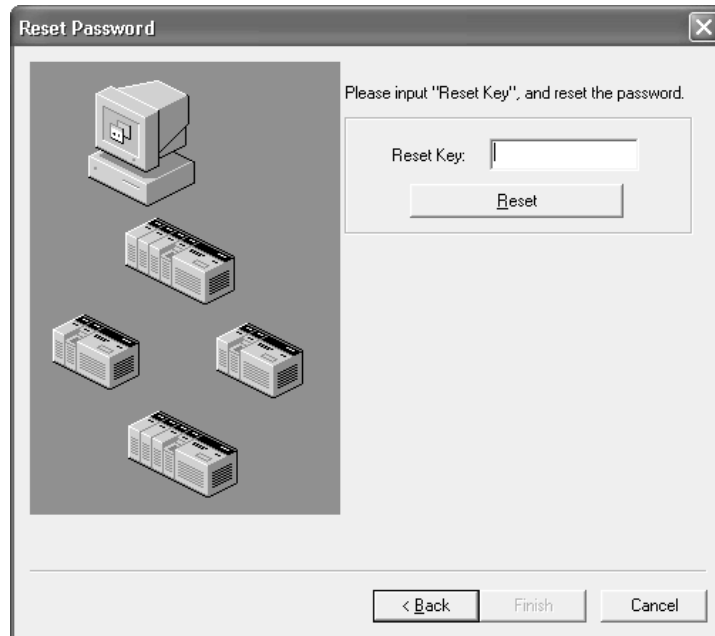

- If the password is successfully reset, the following dialog box will be displayed. The device will be returned to the state without any password setting (default setting). Click the **OK** Button to close the dialog box. Click the **Finish** Button in the Password Recovery Tool Window to exit.



Appendix E

Calculated Values of PFD and PFH

Calculated values of PFD and PFH of the NE0A-series Controller are given in the following tables. These values must be calculated for the overall devices within the system to comply with the SIL level required for application.

Meaning of PFD and PFH

PFD	PFD stands for “probability of failure on demand.” PFD expresses the average probability of failure of a system or device when it is demanded. This value is used to calculate the safety integrity level (SIL) of a safety system.
PFH	PFH stands for “probability of failure per hour.” PFH expresses the probability of failure per hour for a system or device. This value is used to calculate the safety integrity level (SIL) of a safety system.

Calculated PFD Values

Model	Proof test interval (years)	PFD
NE0A-SCPU01	0.25	9.95E-08
	0.5	1.96E-07
	1	3.88E-07
	2	7.73E-07

Calculated PFH Values

Model	PFH
NE0A-SCPU01	8.81E-11

Glossary

Term	Definition
assembly	Internal data in a device gathered as one group to be accessed externally.
bit-strobe connection	One of the connection types for I/O communications in DeviceNet standard communications. For a bit-strobe connection, the Master broadcasts a message and the Slaves that receive the message return input data. Communications are performed on a communication cycle, just as for poll connections, but effective communications are possible for Input Slaves.
Busoff	Status that occurs when the error rate on the DeviceNet network is extremely high over a communications cable. An error is detected when the internal error counter in a device exceeds a certain threshold value. Countermeasures based on error corrective actions are required when a busoff occurs.
CAN	An acronym for Controller Area Network. CAN is a highly reliable yet low-cost communications protocol standardized by the ISO.
CIP	An acronym for Common Industrial Protocol. CIP is an open multivender communications protocol. It enables communications between various devices without restrictions due to network types or differences in devices. DeviceNet and EtherNet/IP and CIP networks.
CIP safety	A safety extension of the CIP that supports IEC 61508 SIL3 and EN 954-1 Safety Category 4. A safety layer is added to the CIP application layer so that traditional CIP communications and CIP safety communication can coexist simultaneously without interfering with each other, achieving highly reliable safety communications. DeviceNet Safety and EtherNet/IP Safety are CIP Safety-compliant networks based on DeviceNet and EtherNet/IP Safety.
configure	Using the Network Configurator to built a network and set devices.
configuration	The device setting parameters. The configuration is set in devices using the Network Configurator. There are parameters related to safety functions and parameter not related to safety functions. Parameters related to safety functions are protected by a safety signature.
configuration lock	Indicates that device operation has been checked by user testing and that the parameters that have been set related to safety functions have been verified.
connection	A logical communications path used to communicate between devices.
connection type	The connection types are as follows depending on the communications method. DeviceNet Standard Communications <ul style="list-style-type: none"> • Poll connection • Bit-strobe connection • COS connection • Cyclic connection • Explicit message connection DeviceNet Safety Communications <ul style="list-style-type: none"> • Single-cast connection • Double-cast connection
COS connection	An acronym for Change of State. One of the connection types for I/O communications in DeviceNet standard communications. For this connection type, data is sent after a set period of time elapses, just as for a cyclic connection, but data can also be sent when data changes or a data send request is received from the application. Conditions depend on the device. A COS connection enables effective communications for changes in data or requests from applications without being dependent on the communications cycle of the Master. COS connections cannot be used at the same time as cyclic connections.

Glossary

Term	Definition
cyclic connection	<p>One of the connection types for I/O communications in DeviceNet standard communications.</p> <p>For a cycle connection, data is sent after a set period of time elapses. A cyclic connection enables sending data on a cycle that is different from the communications cycle of the Master.</p>
DeviceNet	A CIP-compliant network that uses CAN technology. DeviceNet is mainly used as a field network to connect controllers, sensors, and other devices.
DeviceNet Safety	A DeviceNet that complies with CIP Safety, i.e., IEC 61508 SIL3 and EN 954-1 Safety Category 4.
discrepancy time	The time period from a change in one of two inputs until the other input changes. When using a dual-channel input, a suitable time must be set depending on the characteristics of the connected devices.
dual channel	Using two inputs or outputs as the input or output for redundancy.
Dual Channel Complementary	Setting to evaluate that two logic states are complementary.
Dual Channel Equivalent	Setting to evaluate that two logic states are equivalent.
EPI	<p>An acronym for Expected Packet Interval.</p> <p>The interval of safety data communications between the Safety Master and the Safety Slave through an established connection.</p>
error latch time	The time period to hold an error state (control data, status data, and LED indications).
EtherNet/IP	A CIP-compliant network that uses TCP/IP technology. EtherNet/IP can coexist with other TCP/IP-based protocols in high-capacity, high-speed networks.
EtherNet/IP Safety	An EtherNet/IP network that complies with CIP Safety, i.e., IEC 61508 SIL3 and EN 954-1 Safety Category 4.
explicit message connection	A connection type for explicit messages in DeviceNet standard communications.
Fault Present	Several function blocks have Fault Present as an optional output. This is an error output that indicates that the applicable function block has detected an internal logic error or an input data timing error.
multi-cast connection	<p>One of the connection types for DeviceNet Safety communications.</p> <p>With a multi-cast connection, multi-cast input data can be sent from a Safety Slave to up to 15 Safety Masters. This connection type can be set only for a Safety Slave input. It cannot be set for outputs. This connection type enables effective communications when sharing the data from one Safety Slave between more than one Safety Master.</p>
Network Configurator	A software tool used to set networks and devices for CIP and CIP Safety.
node	A generic name for devices to which addresses are allocated in a network. Nodes are sometimes also called devices.
offline	The state in which a device is not connected to the network or in which communications are not possible because they have not been set from the Network Configurator.
online	The state in which communications through the network are possible.
open type	<p>The opening method for a safety connection. One of three types is selected in the settings of a connection to the Safety Master. Refer to <i>5-1 Safety Connection Settings</i> in the <i>DeviceNet Safety System Configuration Manual</i> (Cat. No. Z905) for details.</p> <ul style="list-style-type: none"> • Configuring the target device • Checking the safety signature • Only opening
PFD	<p>An acronym for Probability of Failure on Demand.</p> <p>Shows the average failure rate for a system or device demand. Used for calculating the SIL (Safety Integrity Level) for a safety system.</p>
PFH	<p>An acronym for Probability of Failure per Hour.</p> <p>Shows the failure rate per hour for a system or device. Used for calculating the SIL (Safety Integrity Level) for a safety system.</p>

Glossary

Term	Definition
poll connection	<p>One of the connection types for I/O communications in DeviceNet standard communications.</p> <p>For a poll connection, output data is sent from the Master and Slaves that receive the output data return input data. This connection type is used for cyclic communications with Slaves that have both inputs and outputs.</p>
reaction time	The worst-case response time required to move the system to a safe state after a safety input occurs (e.g., an emergency stop switch is pressed, a light curtain is interrupted, or a safety door is opened) or a device fails. The system reaction time includes the reaction time of sensors and actuators, just as it includes the reaction time of controllers and networks.
safe state	The state of a component or device when the risk of human harm reduced to a permissible level.
safety chain	The logical chain to actualize a safety function, that consists of the input device (sensor), the control device (including a remote I/O device), and the output device (actuator).
safety controller	A controller with high reliability used for safety control. A safety network controller is a controller that is compatible with a safety network. Safety controllers and safety network controllers are sometimes generically referred to as safety PLCs.
safety network controller	
safety data	Extremely reliable data, with the risk of human harm reduced to a permissible level.
safety function	A function executed by a safety-related system to achieve a safe state for a machine hazard.
safety network number	<p>A unique number set for a safety network. With CIP Safety, a system can be built that included multiple networks. In this type of configuration, devices are uniquely identified and mutually confirmed using a TUNID that combines the network number and node address.</p> <p>The Network Configurator automatically sets network numbers for communications. Network numbers can also be specified by the user.</p>
safety protocol	The communications hierarchy added to actualize highly reliable communications.
safety signature	A certificate of the configuration issued to a device from the Network Configurator. The device verifies that the configuration is correct by using the safety signature.
single channel	Using only one input or output as the input or output.
single-cast connection	<p>One of the connection types for DeviceNet Safety communications.</p> <p>With a single-cast connection, a Safety Master and Safety Slave communications 1:1. This connection can be set for either an input or an output, and separate connections are needed for each.</p>
standard	In this manual, items used for general control purposes are called “standard” to differentiate them from devices, functions, data, and other items for which safety measures have been applied.
test pulse	A signal used to detect external wiring coming into contact with the power supply (positive) or short circuits between signal lines.
TUNID	<p>An acronym for Target Unique Network Identifier.</p> <p>The TUNID is the UNID of the local node. The TUNID is automatically set when configuring devices with the Network Configurator. The set TUNID is saved in nonvolatile memory in the device and used in the future.</p>
UNID	<p>An acronym for Unique Network Identifier.</p> <p>An ID used to uniquely identify once device in and configuration of multiple networks. The UNID consists of the Safety Network number and node address.</p>

Glossary

Index

A

- access control, 100
- additional outputs, 63
- allocations, 83, 87, 88
- Always ON Flag, 81
- application templates, 54, 151
 - exporting, 56
 - importing, 57
 - managing, 57
 - saving, 56
- assembly data, 85
- auto reset, 73
- automatic operation, 105
- automatic recovery
 - voltage drops, 108

C

- centralized monitoring system, 7
- changing modes
 - errors, 137
- COMM indicator, 11
- communications cycle time, 89
- configuration, 53
 - changing, 107
 - locking, 105
 - saving as templates, 56
 - unlocking, 106
 - uploading, 98
 - verifying, 97
- configuration lock, 138
- Connected Component Maintenance Flag, 122, 123
- contact operation counters, 122
- contact output devices, 19
- CS/CJ-series DeviceNet Master Unit
 - fixed allocations, 51
- current consumption, 17

D

- DC power supply, 45
- default connection path, 61
- delays, 26
- device comments
 - changing, 52
- device passwords

- setting, 100
- device status
 - updating display icons, 119
- DeviceNet
 - centralized monitoring system, 6
- DeviceNet communications
 - connector, 13
 - enabling, 60
 - specifications, 18
- DeviceNet network
 - connection time, 34
- DeviceNet Safety
 - distributed control system, 6
- dimensions, 16
- DIN Track, 41
- discrepancy error, 28
- discrepancy time, 27
- distributed control system
 - parameters, 127
- downloading, 96
 - errors, 147
- downloading to devices, 96
- dual channels, 26, 27, 29, 30
 - complementary logic, 26
 - equivalent logic, 26

E

- EDM, 58
- enable switches, 66
- error codes, 168
- error history, 140
 - monitoring, 112
- error latch time, 29
- errors
 - resetting, 29, 31
- explicit messages, 167
 - application example, 173
 - basic format, 167
 - list, 169
- external device monitoring, 79

F

ferrules, 44
file name extensions
 dvf, 130
 ini, 57
 ncf, 129, 131
 wzd, 57
FORCE indicator, 11
Forced S/R Mode Flag, 81
force-setting and force-resetting outputs, 115

G

general precautions, xviii
general status, 83
glossary, 185

I

I/O assembly data, 83, 85
I/O comments, 23
I/O data, 61, 83, 85
I/O power monitor, 23
I/O specifications, 19
I/O tags, 23
I/O terminals, 15
importing, 57
IN PWR indicator, 12
indicators, 11, 12
 troubleshooting, 138
initialization time, 34
input assembly data, 85
input channel mode, 24
input condition operations, 62
input devices, 20
input indicators, 12
input settings, 58
input/output terminals and internal connections, 15
inspection, 134
installation, 40
installation location, 40
interface
 selecting, 93
 selection precautions, 146
internal connections, 15

L

laws and regulations, xix
local I/O comments, 23
local safety I/O, 3, 23
local safety inputs, 23
local safety outputs, 29
LOCK indicator, 11
LOCK LED, 105
locking
 configuration, 105
logic command reference, 66
logic comments, 53, 76
logic operations, 62

M

maintenance
 monitoring, 118
Maintenance Counter Mode, 122, 124
Maintenance Counter Mode Choice, 122
maintenance counter value, 124
Maintenance Display Mode, 118
manual reset, 73
models, 4
module status, 11
monitoring, 110
monitoring devices, 110
monitoring the contact operation counters, 122
monitoring the run hours, 121
monitoring the total ON times, 123
mounting
 control panel, 41
MS indicator, 11

N

NE0A-series Controller
 starting individually, 130
NE0A-series Setting Wizard, 53
Network Configurator, 48
network status, 11
networks
 setting, 59
node address
 changing, 51

node address switches, 13
nomenclature, 10
non-safety data, 89
Normal Status Flag, 81
NS indicator, 11

O

OFF delays, 82
ON delays, 82
online connection procedure, 93
operating modes, 102
operation flow, 34
options, 93
OUT PWR indicator, 12
output assembly data, 86
output channel mode, 30
output condition operations, 76
output delays, 82
output devices, 21
output indicators, 12
output mode, 81
output settings, 58

P

parameters
 monitoring, 110
password, 100
password file protection, 90
Password Recovery Tool, 179
passwords
 changing, 90
 forgotten passwords, 179
 lost passwords, 100
 recovery, 179
 setting, 100
PFD
 calculated values, 183
PFH
 calculated values, 183
PNP semiconductor outputs, current sourcing, 20
power supply
 operation for voltage drops, 108
 wiring, 44
power supply terminals
 external input devices and test outputs, 15

external output devices, 15
internal circuits, 15

procedure
 general, 38
project files
 distributing, 129
 password protection, 90
 reading, 90
 saving, 90

R

reaction time, 36
remote I/O
 allocation, 83
remote I/O comments, 60
remote I/O data, 60
 setting, 60
remote input data, 83
reset, 99
reset operations, 73
Reset Required Indication, 74, 81
reset required signal, 81
reset types, 99
resetting, 99
 errors, 149
resetting devices, 99
run hours
 monitoring, 121
RUN Status Flag, 81

S

safety chain, 36
safety configuration, 5
safety data, 84
safety distributed control system, 6
safety input errors, 143
safety input evaluation, 66
safety input terminals, 15
 status, 111
safety logic
 monitoring, 114
safety logic settings, 61
 example, 63
Safety Master
 allocations, 87

- Safety Network Controllers, 2
- safety output errors, 144
- safety output evaluation, 81
- safety output terminals, 15
 - failures, 141
 - status, 15, 111
- safety precautions, xx
- Safety Terminal, 5
- Safety Wizard, 53, 66
- self-diagnosis
 - errors, 28, 29
- setting the threshold run hours, 121
- seven-segment display, 12
- specifications, 17
- Standalone Mode, 60
- standalone system, 8
- standard configuration, 5
- standard I/O assembly data
 - default connection path, 61
- standards, xviii, xxiv
- start time, 34
- starting individual Controllers, 130
- starting operation
 - time required, 35
- starting operation mode, 105
- status
 - monitoring, 110
- symbols
 - c, 27
 - e, 27
 - P, 24, 30
 - s, 24, 30
 - ST, 24
- system
 - combining configuration files, 131
- system configuration, 5
- system parameters, 128

T

- test output errors, 144
- test output terminals, 15
 - failures, 140
 - status, 111
- test pulses, 24
- test source, 25
- Threshold Maintenance Counter, 122

- threshold maintenance counter, 122, 124
- Threshold Run Hours, 121
- tools, 44
- troubleshooting, 137
- TUNID, 49

U

- unlocking
 - configuration, 106
- uploading, 98
 - from devices, 98
- uploading from the network, 98
- USB communications connector, 14
- USB connection
 - online operation errors, 146
- USB port driver
 - checking, 177
 - installing, 175
- user mode switch, 67, 164

V

- verification, 97
- virtual network
 - creating, 49, 128

W

- weight, 16
- welding check operation, 67
- wiring, 43
 - wiring I/O, 44
 - wiring input devices, 20
 - wiring output devices, 21

Revision History

A manual revision code appears as a suffix to the catalog number on lower left corners of the front and back covers of the manual.

Cat. No. Z916-E1-03



Revision code

The following table outlines the changes made to the manual during each revision. Page numbers refer to the previous version.

Revision code	Date	Revised content
01	March 2008	Original production
02	May 2021	<i>Terms and Conditions Agreement</i> Updated descriptions. <i>6. Regulations and Standards</i> Added <i>Conformance to KC Certification.</i> <i>2-2-1 General Specifications</i> Added a specification of current consumption of I/O power supply.
03	October 2022	Revisions for adding safety precautions regarding security.

Revision History

OMRON Corporation Industrial Automation Company

Kyoto, JAPAN

Contact : www.ia.omron.com

Regional Headquarters

OMRON EUROPE B.V.

Wegalaan 67-69, 2132 JD Hoofddorp
The Netherlands
Tel: (31) 2356-81-300 Fax: (31) 2356-81-388

OMRON ASIA PACIFIC PTE. LTD.

438B Alexandra Road, #08-01/02 Alexandra
Technopark, Singapore 119968
Tel: (65) 6835-3011 Fax: (65) 6835-2711

OMRON ELECTRONICS LLC

2895 Greenspoint Parkway, Suite 200
Hoffman Estates, IL 60169 U.S.A.
Tel: (1) 847-843-7900 Fax: (1) 847-843-7787

OMRON (CHINA) CO., LTD.

Room 2211, Bank of China Tower,
200 Yin Cheng Zhong Road,
PuDong New Area, Shanghai, 200120, China
Tel: (86) 21-5037-2222 Fax: (86) 21-5037-2200

Authorized Distributor:

©OMRON Corporation 2008-2022 All Rights Reserved.
In the interest of product improvement,
specifications are subject to change without notice.

Cat. No. Z916-E1-03 1022