

OMRON

V440-F C-Mount Code Reader

User Manual



NOTE

- All rights reserved.
- No part of this publication may be reproduced, stored in a retrieval system, or transmitted, in any form, or by any means, mechanical, electronic, photocopying, recording, or otherwise, without the prior written permission of OMRON.
- No patent liability is assumed with respect to the use of the information contained herein. Moreover, because OMRON is constantly striving to improve its high-quality products, the information contained in this manual is subject to change without notice. Every precaution has been taken in the preparation of this manual. Nevertheless, OMRON assumes no responsibility for errors or omissions.

Neither is any liability assumed for damages resulting from the use of the information contained in this publication.

Trademarks

- Sysmac and SYSMAC are trademarks or registered trademarks of OMRON Corporation in Japan and other countries for OMRON factory automation products.
- Microsoft, Windows, Windows Vista, Excel, and Visual Basic are either registered trademarks or trademarks of Microsoft Corporation in the United States and other countries.
- ODVA, CIP, CompoNet, DeviceNet, and EtherNet/IP are trademarks of ODVA.
- QR Code is a registered trademark of DENSO WAVE INCORPORATED.

Other company names and product names in this document are the trademarks or registered trademarks of their respective companies.

Copyrights

Microsoft product screen shots reprinted with permission from Microsoft Corporation.

Terms and Conditions Agreement

Warranty, Limitations of Liability

Warranties

● Exclusive Warranty

Omron's exclusive warranty is that the Products will be free from defects in materials and workmanship for a period of twelve months from the date of sale by Omron (or other such period expressed in writing by Omron). Omron disclaims all other warranties, express or implied.

● Limitations

OMRON MAKES NO WARRANTY OR REPRESENTATION, EXPRESS OR IMPLIED, ABOUT NON-INFRINGEMENT, MERCHANTABILITY OR FITNESS FOR A PARTICULAR PURPOSE OF THE PRODUCTS. BUYER ACKNOWLEDGES THAT IT ALONE HAS DETERMINED THAT THE PRODUCTS WILL SUITABLY MEET THE REQUIREMENTS OF THEIR INTENDED USE.

Omron further disclaims all warranties and responsibility of any type for claims or expenses based on infringement by the Products or otherwise of any intellectual property right.

● Buyer Remedy

Omron's sole obligation hereunder shall be, at Omron's election, to (i) replace (in the form originally shipped with Buyer responsible for labor charges for removal or replacement thereof) the non-complying Product, (ii) repair the non-complying Product, or (iii) repay or credit Buyer an amount equal to the purchase price of the non-complying Product; provided that in no event shall Omron be responsible for warranty, repair, indemnity or any other claims or expenses regarding the Products unless Omron's analysis confirms that the Products were properly handled, stored, installed and maintained and not subject to contamination, abuse, misuse, or inappropriate modification. Return of any Products by Buyer must be approved in writing by Omron before shipment. Omron Companies shall not be liable for the suitability or unsuitability or the results from the use of Products in combination with any electrical or electronic components, circuits, system assemblies or any other materials or substances or environments. Any advice, recommendations or information given orally or in writing, are not to be construed as an amendment or addition to the above warranty.

See <http://www.omron.com/global> or contact your Omron representative for published information.

Limitation on Liability; Etc.

OMRON COMPANIES SHALL NOT BE LIABLE FOR SPECIAL, INDIRECT, INCIDENTAL, OR CONSEQUENTIAL DAMAGES, LOSS OF PROFITS OR PRODUCTION, OR COMMERCIAL LOSS IN ANY WAY CONNECTED WITH THE PRODUCTS, WHETHER SUCH CLAIM IS BASED IN CONTRACT, WARRANTY, NEGLIGENCE, OR STRICT LIABILITY.

Further, in no event shall liability of Omron Companies exceed the individual price of the Product on which liability is asserted.

Application Considerations

Suitability of Use

Omron Companies shall not be responsible for conformity with any standards, codes, or regulations which apply to the combination of the Product in the Buyer's application or use of the Product. At Buyer's request, Omron will provide applicable third party certification documents identifying ratings and limitations of use which apply to the Product. This information by itself is not sufficient for a complete determination of the suitability of the Product in combination with the end product, machine, system, or other application or use. Buyer shall be solely responsible for determining appropriateness of the particular Product with respect to Buyer's application, product or system. Buyer shall take application responsibility in all cases.

NEVER USE THE PRODUCT FOR AN APPLICATION INVOLVING SERIOUS RISK TO LIFE OR PROPERTY WITHOUT ENSURING THAT THE SYSTEM AS A WHOLE HAS BEEN DESIGNED TO ADDRESS THE RISKS, AND THAT THE OMRON PRODUCT(S) IS PROPERLY RATED AND INSTALLED FOR THE INTENDED USE WITHIN THE OVERALL EQUIPMENT OR SYSTEM.

Programmable Products

Omron Companies shall not be responsible for the user's programming of a programmable Product, or any consequence thereof.

Disclaimers

Performance Data

Data presented in Omron Company websites, catalogs, and other materials, is provided as a guide for the user in determining suitability and does not constitute a warranty. It may represent the result of Omron's test conditions, and the user must correlate it to actual application requirements. Actual performance is subject to Omron's Warranty and Limitations of Liability.

Change in Specifications

Product specifications and accessories may be changed at any time based on improvements and other reasons. It is our practice to change part numbers when published ratings or features are changed, or when significant construction changes are made. However, some specifications of the Product may be changed without any notice. When in doubt, special part numbers may be assigned to fix or establish key specifications for your application. Please consult with your Omron's representative at any time to confirm actual specifications of purchased Product.

Errors and Omissions



Information presented by Omron Companies has been checked and is believed to be accurate; however, no responsibility is assumed for clerical, typographical, or proofreading errors or omissions.

Safety Precautions

Meanings of Signal Words



● Symbols and Meanings of Safety Precautions Described in this Document

In order for the product to be used safely, the following indicators are used in this document to draw your attention to safety precaution statements. Precaution statements with graphical indicators are intended to maintain user safety.

 WARNING	<p>Indicates a potentially hazardous situation which, if not avoided, will result in minor or moderate injury, or may result in serious injury or death.</p> <p>Additionally, there may be significant property damage.</p>
 CAUTION	<p>Indicates a potentially hazardous situation which, if not avoided, may result in minor or moderate injury or in property damage.</p>

Meanings of Alert Symbols

The following alert symbols are used in this document.

	<p>General Prohibition</p> <p>Indicates general prohibitions, including warnings, for which there is no specific symbol.</p>
	<p>General Caution</p> <p>Indicates general cautions, including warnings, for which there is no specific symbol.</p>
	<p>Electrical Hazard</p> <p>Indicates the possible danger of electric shock under specific conditions.</p>

Alert Statements in This Document

The following alert statements apply to the product in this document. Each alert statement also appears at the locations needed in this document to attract your attention



This product must be used according to this document. Failure to observe this may result in impairment of functions and performance of the product.



This product is not designed or rated for ensuring safety of persons. Do not use it for such purposes.



Never connect the AC power supply with this product. When the AC power supply is connected, it causes electric shock and fire.



When using equipment that is connected to an AC power source such as an AC adapter or PoE injector, use it within the rated voltage range. Usage with a voltage higher than what it is rated for may cause serious personal injury due to electric shock, or serious physical damage due to fire or equipment failure. Do not touch any part of the device while in operation, or immediately after turning OFF the power.



Please design the system as a whole so that it remains safe even in the event of a failure of the product or an error due to an external product. Abnormal operation may result in a serious accident.



Precautions for Safe Use

Conditions for the Safe Use of This Product

- Please do not use this product directly or indirectly to detect the human body for the purpose of ensuring safety. In the same application, please use the safety sensor that is published in our sensor catalog.
- This product is designed and manufactured as a general-purpose product for use in general industrial applications. Use of the product is NOT intended in the following critical applications, and doing so will void the warranty, unless otherwise specifically agreed upon by the manufacturer.
 - a) Applications with stringent safety requirements, including but not limited to nuclear power control equipment, combustion equipment, aerospace equipment, railway equipment, elevator/lift equipment, amusement park equipment, medical equipment, safety devices and other applications that could physically harm the operator.
 - b) Applications that require high reliability, including but not limited to supply systems for gas, water and electricity, etc., 24 hour continuous operating systems, financial settlement systems and other applications that handle rights and property.
 - c) Applications under severe operating conditions or in a severe environment, including but not limited to outdoor equipment, equipment exposed to chemical contamination, equipment exposed to electromagnetic interference and equipment exposed to vibration and shocks.
 - d) Applications under operating conditions and environments not described in product specifications.
 - *1. In addition to the applications listed from (a) to (d) above, this product (see definition) is not intended for use in vehicles designed for human transport (including two-wheeled vehicles). Do NOT use this product for vehicles designed for human transport. Please contact our sales staff for information on our automotive line of products.
 - *2. The above is part of the Terms and Conditions Agreement. Please carefully read the contents of the guarantee and disclaimers described in our latest version of the catalog, datasheets, and user manuals.

Installation Environment

- Do not use the product in areas where flammable or explosive gases are present.
- Be careful when installing the product. Product and mounting brackets may have sharp edges that can cause injury.
- Always use the lens cover when storing the product.
- To ensure safety of operation and maintenance, do not install the product close to high-voltage devices or other power devices.
- Make sure that all accessories, such as lights and lenses, are mounted securely.
- Make sure to tighten all installation screws securely.

Power Supply and Wiring

- Make sure to use the product with the power supply voltage specified by the user manual.
- Do not connect Code Reader to AC power. Applying AC power will cause the unit to fail.
- Use a wire size suitable to the current consumption and length of wire.
- Use a DC power supply with safety measures against high-voltage spikes (safety extra low-voltage circuits on the secondary side). If the system must meet UL standards, use a UL Class 2 power supply.
- Confirm that the following conditions are met before applying power to the reader:
 - Correct voltage and polarity;
 - Proper load and output wiring;
 - All wiring is correct for the application.

Ground

- Ensure that the power supply circuit of the unit is insulated from the internal circuit. Refer to the user manual.
- Check wiring again before turning on the unit.

Security Measures

● Anti-Virus Protection

Install the latest commercial-quality antivirus software on the computer connected to the control system and maintain to keep the software up to date.

● Security Measures to Prevent Unauthorized Access

Take the following measures to prevent unauthorized access to our products:

- Install physical controls so that only authorized personnel can access control systems and equipment.
- Reduce connections to control systems and equipment via networks to prevent access from untrusted devices.
- Install firewalls to shut down unused communications ports and limit communications hosts and isolate control systems and equipment from the IT network.
- Use a virtual private network (VPN) for remote access to control systems and equipment.
- Adopt multifactor authentication to devices with remote access to control systems and equipment.
- Set strong passwords and change them frequently.
- Scan for viruses to ensure safety of USB drives or other external storage devices before connecting them to control systems and equipment.

● Data Input and Output Protection

Validate backups and ranges to cope with unintentional modification of input/output data to control systems and equipment.

- Check the scope of data.
- Check validity of backups and prepare data for restore in case of falsification or abnormalities.
- Safety design, such as emergency shutdown and fail-soft operation in case of data tampering or abnormalities.

● Data Recovery

Back up and update data periodically to prepare for data loss.

When using an intranet environment through a global address, connecting to an unauthorized terminal such as a SCADA, HMI or to an unauthorized server may result in network security issues such as spoofing and tampering.

You must take sufficient measures such as restricting access to the terminal, using a terminal equipped with a secure function, and locking the installation area by yourself.

When constructing an intranet, communication failure may occur due to cable disconnection or the influence of unauthorized network equipment. Take adequate measures, such as restricting physical access to network devices, by such means as locking the installation area.

When using a device equipped with the SD Memory Card function, there is a security risk that a third party may acquire, alter, or replace the files and data in the removable media by removing or unmounting the removable media. Please take sufficient measures, such as restricting physical access to the controller or taking appropriate management measures for removable media, by means of locking the installation area, entrance management, etc.

● Software

To prevent computer viruses, install antivirus software on the computer where you use this software. Make sure to keep the antivirus software updated.

Keep your computer's OS updated to avoid security risks caused by a vulnerability in the OS.

Always use the latest version of this software to add new features, increase operability, and enhance security.

Manage usernames and passwords for this software carefully to protect them from unauthorized uses.

Set up a firewall (e.g., disabling unused communication ports, limiting communication hosts, etc.) on a network for a control system and devices to separate them from other IT networks.

Make sure to connect to the control system inside the firewall.

Use a virtual private network (VPN) for remote access to a control system and devices from this software.

Other

- Use only the cables designed specifically for the product. Use of other products may result in malfunction of, or damage to, the product.
- Always turn OFF the power of the reader and peripheral devices before connecting or disconnecting a cable. Connecting the cable with power supply on may result in damage to the reader or peripheral devices.
- Do not apply torsion stress to the cable. It may damage the cable.
- Secure the minimum bending radius of the cable. Otherwise the cable may be damaged.
- Do not attempt to dismantle, repair, or modify the product.
- Should you notice any abnormalities, immediately stop use, turn OFF the power supply, and contact your OMRON representative.
- While the power is ON or immediately after the power is turned OFF, the case is still hot. Do not touch the case.
- When disposing of the product, treat it as industrial waste.
- Do not drop the product or apply excessive vibration or shock to the product. Doing so may cause malfunction or burning of internal components.

Precautions for Correct Use

Installation and Storage Sites

Install and store the product in a location that meets the following conditions:

- Surrounding temperature of 0 to +40°C (–50 to +75°C in storage).
- No rapid changes in temperature (place where dew does not form).
- Relative humidity of between 5 and 85%.
- No presence of corrosive or flammable gases.
- Place free of dust, salts and iron particles.
- Place free of vibration and shock.
- Place out of direct sunlight.
- Place where it will not come into contact with water, oils, or chemicals.
- Place not affected by strong electromagnetic waves.
- Do not place near high-voltage or high-power equipment.

Ambient Temperature

- For good heat dissipation, maintain sufficient distance between the product and other objects.
- Do not install the product immediately above significant sources of heat, such as heaters, transformers, or large-capacity resistors.
- Do not allow the ambient temperature to exceed an operating temperature range.
- Provide a forced-air cooling fan or air conditioning if the ambient temperature is near the upper range of operating temperature range. This will keep the ambient temperature from exceeding the upper operating temperature range.

Noise Resistance

- Do not install the reader in a cabinet containing high-voltage equipment.
- Do not install the reader within 200 mm of power cables.
- To use the V440-F reader in an environment with a high level of noise, use the filter cable V430-WXXF-XM.
- Do not apply excessive force to connectors. They may break and cause the product to malfunction.

Maintenance

- Turn OFF the power and ensure safety before maintenance.
- Optical components should be cleaned with a lens-cleaning cloth.
- Lightly wipe off dirt with a soft cloth.
- Do not use thinners or benzene.
- To ensure safe access for operation and maintenance, keep the reader as separate as possible from high-voltage equipment and power machinery.
- When maintaining the product, be careful not to contact high-pressure or other electrical equipment.

Regulations and Standards

Using Product Outside Japan

This regulation applies to V440-F Code Readers and peripheral devices.

If you export (or provide a non-resident with) this product or a part of this product that falls under the category of goods (or technologies) specified by the Foreign Exchange and Foreign Trade Control Law as those which require permission or approval for export, you must obtain permission or approval (or service transaction permission) pursuant to the law.

Conformance to EC/EU Directives and UK Legislation

This regulation applies to V440-F Code Readers and peripheral devices.

- This product is in compliance with all applicable directives: 2014/30/EU, 2014/35/EU, 2011/65/EU, and UK Legislation 2016 No. 1091 Electromagnetic Compatibility Regulations 2016.
- EMC-related performance of the OMRON devices will vary depending on the configuration, wiring, and other conditions of the equipment or control panel on which the OMRON devices are installed. The customer must, therefore, perform the final check to confirm that devices and the overall machine conform to EMC standards.

Conformance to UL Standards

This regulation applies to V440-F Code Readers and peripheral devices.

- This product complies with UL Standards.
- UL60950-1 2nd-edition, 2014 (Class III).

Korean Radio Regulation (KC)

사용자안내문

이 기기는 업무용 환경에서 사용할 목적으로 적합성평가를 받

Guide for Users

This equipment has been evaluated for conformity in a commercial environment. When used in a residential environment, it may cause radio interference.

Radio Frequency Interference Requirements: FCC



This equipment has been tested for compliance with FCC (Federal Communications Commission) requirements and has been found to conform to applicable FCC standards. To comply with FCC RF exposure compliance requirements, this device must not be co-located with or operate in conjunction with any other antenna or transmitter. Changes or modifications not expressly approved by the party responsible for compliance could void the user's authority to operate the equipment.

Class A Statement

NOTE: This equipment has been tested and found to comply with the limits for a Class A digital device, pursuant to part 15 of the FCC Rules. These limits are designed to provide reasonable protection against harmful interference when the equipment is operated in a commercial environment. This equipment generates, uses, and can radiate radio frequency energy and, if not installed and used in accordance with the instruction manual, may cause harmful interference to radio communications. Operation of this equipment in a residential area is likely to cause harmful interference in which case the user will be required to correct the interference at his own expense.

Class B Statement

NOTE: This equipment has been tested and found to comply with the limits for a Class B digital device, pursuant to part 15 of the FCC Rules. These limits are designed to provide reasonable protection against harmful interference in a residential installation. This equipment generates, uses and can radiate radio frequency energy and, if not installed and used in accordance with the instructions, may cause harmful interference to radio communications. However, there is no guarantee that interference will not occur in a particular installation. If this equipment does cause harmful interference to radio or television reception, which can be determined by turning the equipment off and on, the user is encouraged to try to correct the interference by one or more of the following measures:

- Reorient or relocate the receiving antenna.
- Increase the separation between the equipment and receiver.
- Connect the equipment into an outlet on a circuit different from that to which the receiver is connected.
- Consult the dealer or an experienced radio/TV technician for help.

Radio Frequency Interference Requirements: Canada

This device complies with Industry Canada ICES-003. Operation is subject to the following two conditions: (1) This device may not cause harmful interference, and (2) this device must accept any interference received, including interference that may cause undesired operation. Cet appareil est conforme à la norme ICES-003 d'Industrie Canada. Son fonctionnement est soumis aux deux conditions suivantes: (1) l'appareil ne doit pas produire de brouillage, et (2) l'utilisateur de l'appareil doit accepter tout brouillage radioélectrique subi, même si le brouillage est susceptible d'en compromettre le fonctionnement.

Revision History

The manual's part number and revision letter appear on the first and last pages.



Revision	Date	Revised Content
A	April 2021	First publication.
B	November 2021	General improvements.
C	August 2022	Security Measures update.
D	November 2022	UKCA compliance information added.
E	May 2023	General improvements.

Table of Contents

Terms and Conditions Agreement.....	3
Safety Precautions.....	5
Precautions for Safe Use	7
Precautions for Correct Use	9
Regulations and Standards	10
Revision History.....	12

Section 1 Overview of WebLink Interface

1-1 Introduction.....	1-2
1-2 Splash Screen.....	1-3
1-3 Navigation Bar	1-4
1-4 Flash Icon.....	1-5
1-5 Help Icon	1-6
1-6 Application Settings Icon.....	1-7
1-7 Left Panel	1-8
1-8 Right Panel.....	1-10
1-9 Image Area	1-11

Section 2 Quick Start

2-1 Check Hardware	2-2
2-2 Position the Reader and Set Up Optics.....	2-3
2-3 Connect the System.....	2-7
2-4 Connect to WebLink.....	2-11
2-5 Explore the Start View.....	2-15
2-6 Create a New Setup or Load an Existing Setup.....	2-16
2-7 Explore the Setup View.....	2-17
2-8 Configure Read Cycle Settings	2-18
2-9 Configure Acquire Settings	2-19
2-10 Configure Symbology and Decode Settings.....	2-20
2-11 Format Output and Configure Match String	2-23
2-12 Configure Output 1, 2, 3 Settings.....	2-25
2-13 Run the Application.....	2-26

Section 3 Start

3-1 Start	3-2
3-2 Assisted Setup.....	3-4
3-3 Reader Information.....	3-5
3-4 Setup Buttons	3-6

Section 4 Setup

4-1	Setup.....	4-2
4-2	Train using Autocalibration	4-4
4-3	Cycle	4-9
4-4	Acquire	4-18
4-5	Decode.....	4-19
4-6	Matrix Mode.....	4-22
4-7	Match String.....	4-30
4-8	Format Output.....	4-34
4-9	Outputs	4-43
4-10	Configuration Database	4-45
4-11	Configure Daisy Chain (If Required by Application)	4-67
4-12	Favorites.....	4-75

Section 5 Run

5-1	Run.....	5-2
5-2	Counts	5-3
5-3	Rate	5-4
5-4	Matrix Info	5-5
5-5	Read Time.....	5-6
5-6	Output Data	5-7
5-7	Image History.....	5-8

Section 6 Application Settings

6-1	Application Settings Menu.....	6-2
6-2	Save	6-3
6-3	New	6-4
6-4	Load	6-5
6-5	Advanced.....	6-6
6-6	Language.....	6-7
6-7	Terminal.....	6-8
6-8	Beeper	6-9
6-9	Image Storage.....	6-10
6-10	Reset Application or Factory Settings.....	6-21
6-11	Activate Account Management.....	6-22
6-12	About WebLink	6-30

Section 7 Terminal

7-1	Send.....	7-2
7-2	Find	7-3
7-3	Filters.....	7-4

Section 8 **Advanced Settings**

8-1	Introduction.....	8-2
8-2	Camera Setup	8-3
8-3	Communications	8-5
8-4	Read Cycle	8-13
8-5	Symbologies	8-14
8-6	I/O.....	8-23
8-7	Symbol Quality	8-33
8-8	Match String.....	8-34
8-9	Diagnostics	8-35
8-10	Image Storage.....	8-36
8-11	Configuration Database	8-37
8-12	Differences from Default.....	8-38

Appendices

Appendix A	General Specifications.....	A-1
Appendix B	Electrical Specifications	B-1
Appendix C	Serial Command Usage	C-1
Appendix D	Communications	D-1
Appendix E	Calibration.....	E-1
Appendix F	Read Cycle	F-1
Appendix G	Symbologies	G-1
Appendix H	I/O Parameters	H-1
Appendix I	Symbol Quality	I-1
Appendix J	Matchcode.....	J-1
Appendix K	Camera and IP Setup	K-1
Appendix L	Configuration Database.....	L-1
Appendix M	Utilities	M-1
Appendix N	Output Format	N-1
Appendix O	Firmware Update	O-1
Appendix P	Communications Protocol.....	P-1
Appendix Q	ASCII Table	Q-1
Appendix R	Q & A	R-1
Appendix S	Glossary of Terms.....	S-1



1

Overview of WebLink Interface

This section provides a general overview of the WebLink user interface, which is designed for V440-F configuration, testing, and runtime.

1-1	Introduction	1-2
1-2	Splash Screen	1-3
1-3	Navigation Bar	1-4
1-4	Flash Icon	1-5
1-5	Help Icon	1-6
1-6	Application Settings Icon	1-7
1-7	Left Panel	1-8
1-8	Right Panel	1-10
1-9	Image Area	1-11

1-1 Introduction

The browser-based WebLink interface enables quick and easy configuration and testing of V440-F readers without the need to install or access files on a host system.

WebLink is reliable, lightweight, and operating-system-independent without compromising the power and depth of its tool set.

WebLink offers novice users an intuitive way to connect, configure, monitor, and troubleshoot a reader, and provides the power and flexibility expected by advanced users.

1-2 Splash Screen

After you open a browser and **enter your reader's IP address**, the first thing you will see is the **splash screen** shown below. You will also see a progress bar as your WebLink session starts.

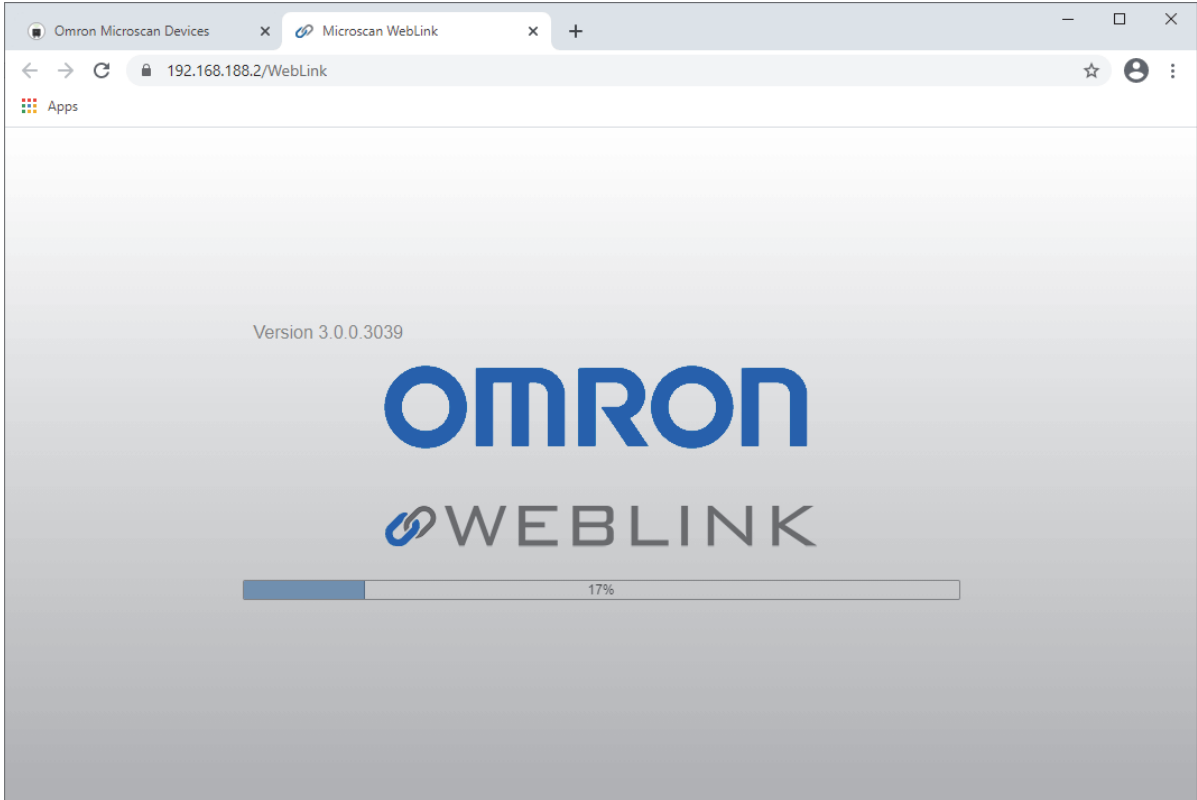

1-3 Navigation Bar

The **navigation bar** at the top of the WebLink interface features buttons for three primary views: **Start**, **Setup**, and **Run**.

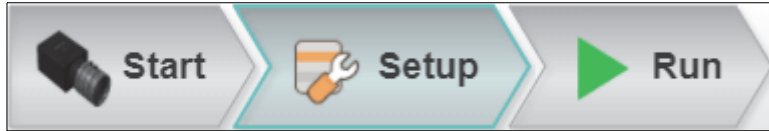

1-4 Flash Icon

The **flash icon** allows you to save current settings to the reader for reboot. When the current reader settings match those saved in flash memory, the disk icon changes from **red** to **blue**.

1-4-1 Save to Flash Memory



1-4-2 Saved to Flash Memory



1-5 Help Icon

The **help icon** is located to the right of the **flash icon**. Click this icon to open **WebLink Help**.

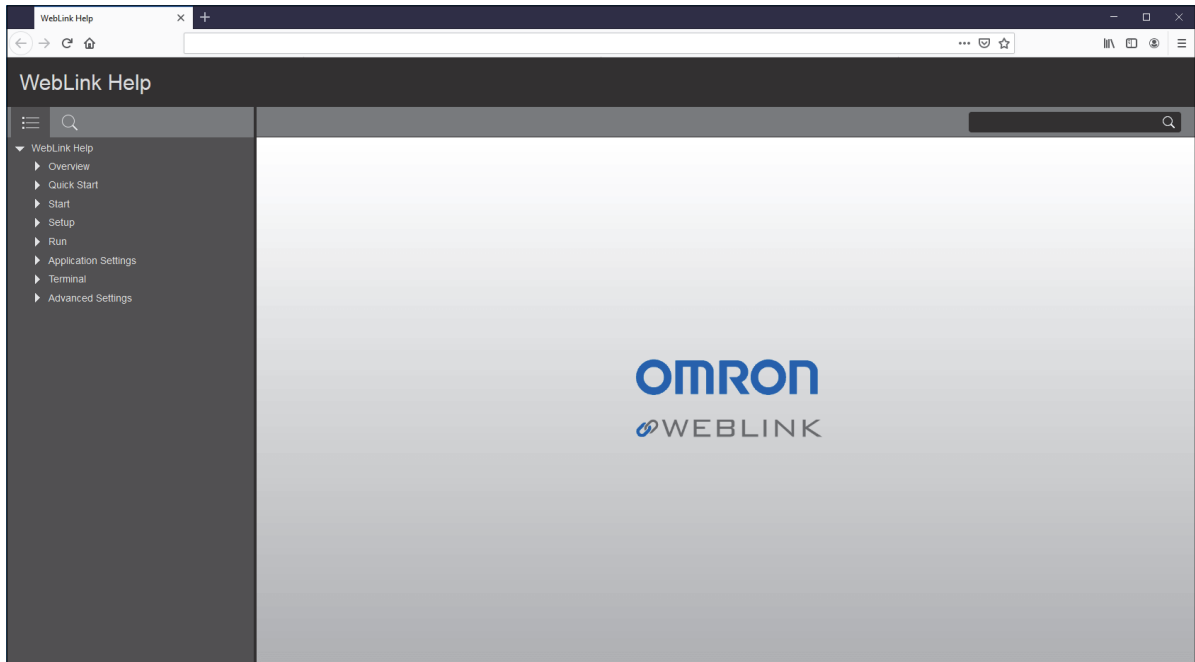

1-6 Application Settings Icon

Click the **gear icon** to the right of the help icon to open the **Application Settings** menu.



1-6-1 Application Settings Menu

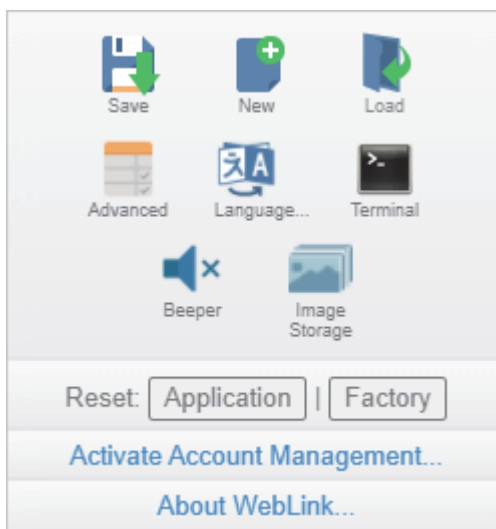

1-7 Left Panel

The area to the left of the **Image Area** is different depending on whether you are in the **Start** or **Setup** view. In the **Run** view, the Image Area expands and the left panel is not present.

1-7-1 Left Panel in Start View

In the **Start** view, the left panel shows your reader's **user-defined name**, **IP address**, **Reader Model**, **Serial Number**, **MAC ID**, **Firmware version**, **WebLink version**, **Sensor resolution**, and **Optics**.

Note: The **user-defined name** must be **19** characters or fewer.

The left panel in the **Start** view also contains buttons for **Assisted Setup**, **Create a New Setup**, and **Load a Setup**.

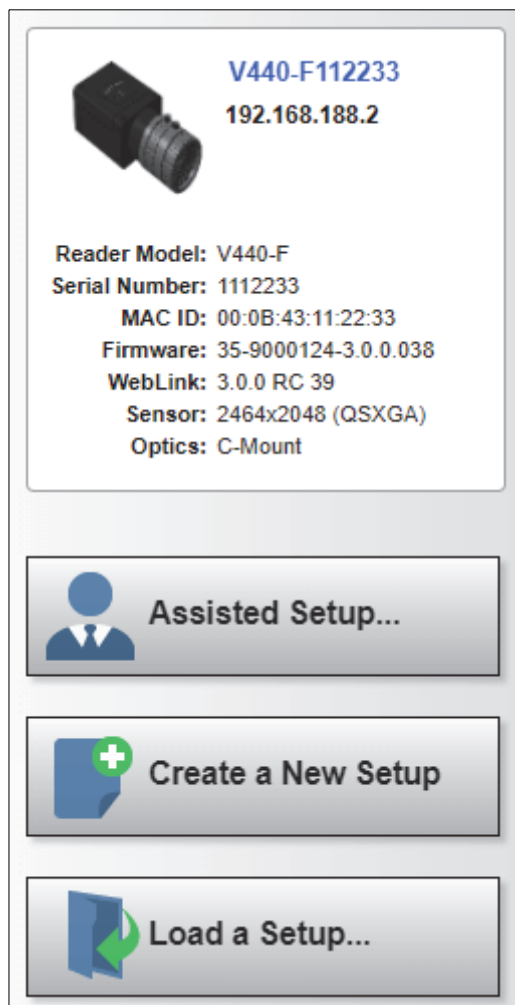

1-7-2 Left Panel in Setup View

In the **Setup** view, the left panel contains the majority of WebLink's configuration tools: **Cycle**, which allows you to set the trigger mode; **Acquire**, which allows you to set the camera's exposure and gain; **Decode**, which allows you to select which code types are required in your application; **Match String**, which allows you to set the match code mode, wildcard, text output, new master, and match string database; **Format Output**, which allows you to determine the ways in which barcode data can be formatted before it is output as a data string; **Outputs**, which allows you to determine output conditions, the output mode, the pulse width, and the output state (normally open or normally closed); and **Favorites**, which allows you to define the commands you use most frequently and gives you quick access to their command parameters.

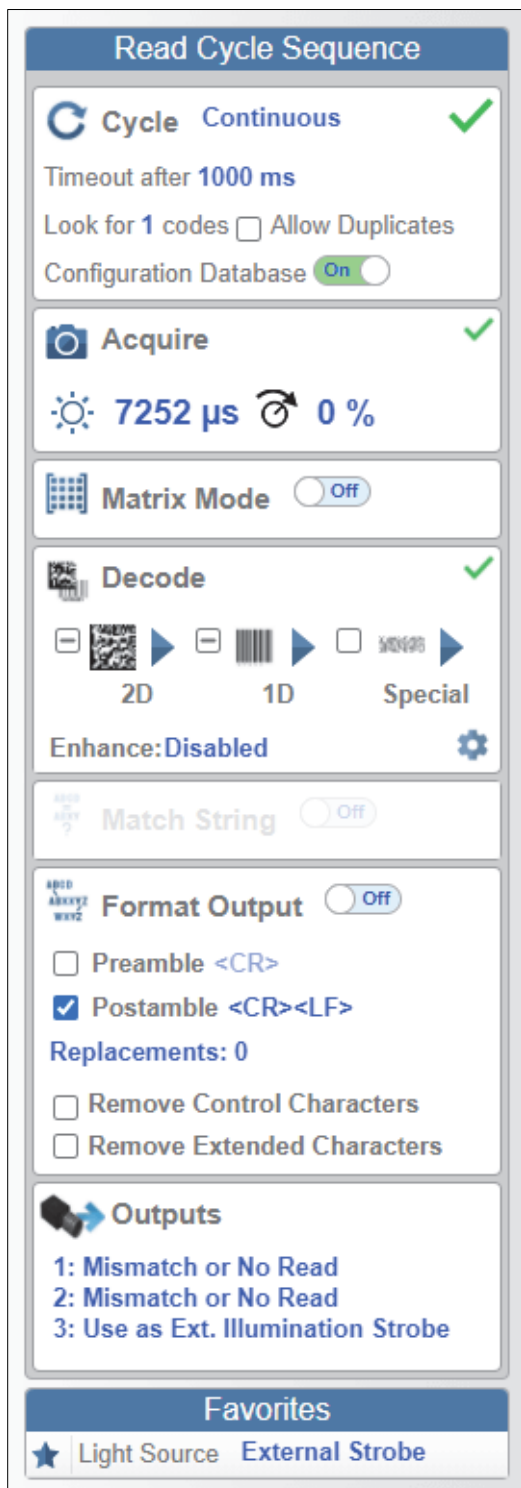

1-8 Right Panel

The area to the right of the **Image Area** shows counters for **Cycles**, **Reads**, **No Reads**, **Mismatches** (which only applies if you have defined a match string), and **Read %**; statistics for the rate of **Capture**, **Decode**, **Overhead**, **Total Read**, and **Trigger Rate**; a line graph representation of **Read Time**; and a display area for **Output Data**.

You may find the information displayed on this panel to be most useful in the **Run** view, but it appears in all three of WebLink's primary views.

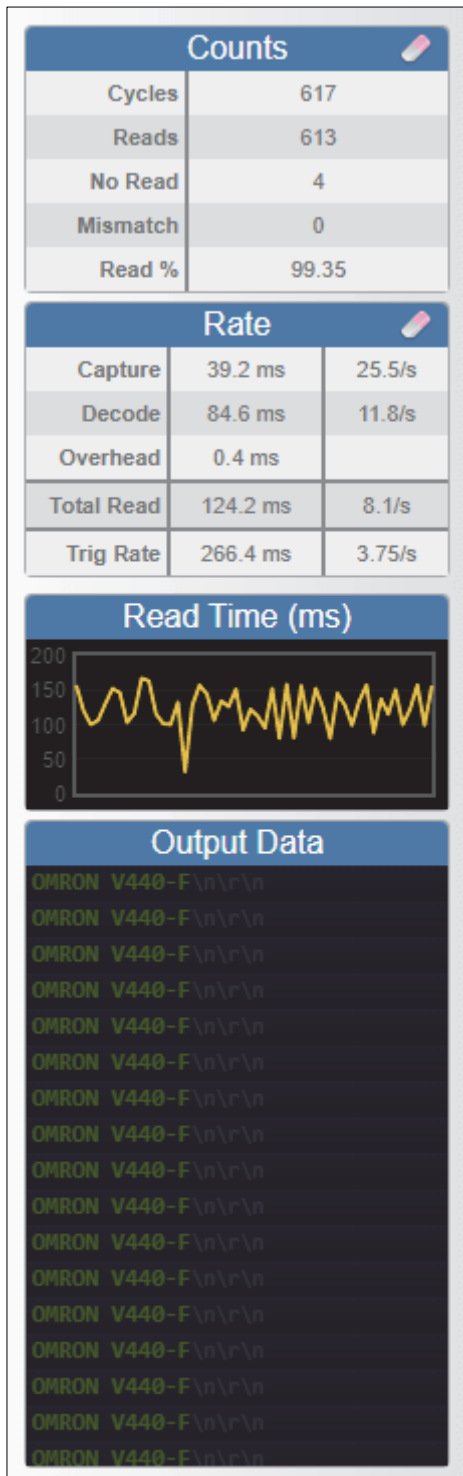

1-9 Image Area

The **Image Area** is the main focus of WebLink. This area allows you to see what currently falls within the reader's field of view, and offers several image control tools.



1-9 Image Area

1-9-1 Device Control Toolbar

1

1-9-1 Device Control Toolbar

The **Device Control** buttons are a convenient way to enable and disable multiple triggering methods and image processing settings in the camera directly from the **Image Area**.

Start the Reader

Starts the read cycle.



Stop the Reader

Stops the read cycle.



Send a Serial Trigger to the Reader

Sends a **Serial Trigger** to the reader.

Note: The **Serial Trigger** only works when the reader is in a **Triggered** mode. The icon is not visible when the reader is in **Continuous Mode**.



Send a Virtual Serial Trigger Stream to the Reader

Sends a continuous **Virtual Serial Trigger Stream** to the reader. The **Trigger Interval** can be set from the **Read Cycle** menu in **Advanced Settings**.

Note: The **Virtual Serial Trigger Stream** only works when the reader is in a **Triggered** mode. The icon is not visible when the reader is in **Continuous, Start/Stop, or Custom** modes.



Acquire Live Video

Allows you to toggle live, high-frame-rate video on and off to focus the reader. You can simultaneously zoom in to achieve optimal focus.



Set Window of Interest

Allows you to define the **Window of Interest** directly in the Image Area interface.

Note: When using an SXGA reader with Quick Photometry enabled, the Window of Interest cannot be set to a width less than **640**.



Quick Photometry

Performs a **Quick Photometry** function that sets the best **Exposure** and **Gain** settings for the current image.



Train

Train performs a full symbol calibration to determine the optimal **Exposure** and **Gain** to decode the target symbol. The Exposure and Gain settings are saved to enhance decode performance on similar symbols in subsequent read cycles.

You will see a progress bar along with a series of messages at each stage of the Train operation.

Note: The Train operation will un-optimize the system once an image is processed, but you can optimize the system again after a Train operation.

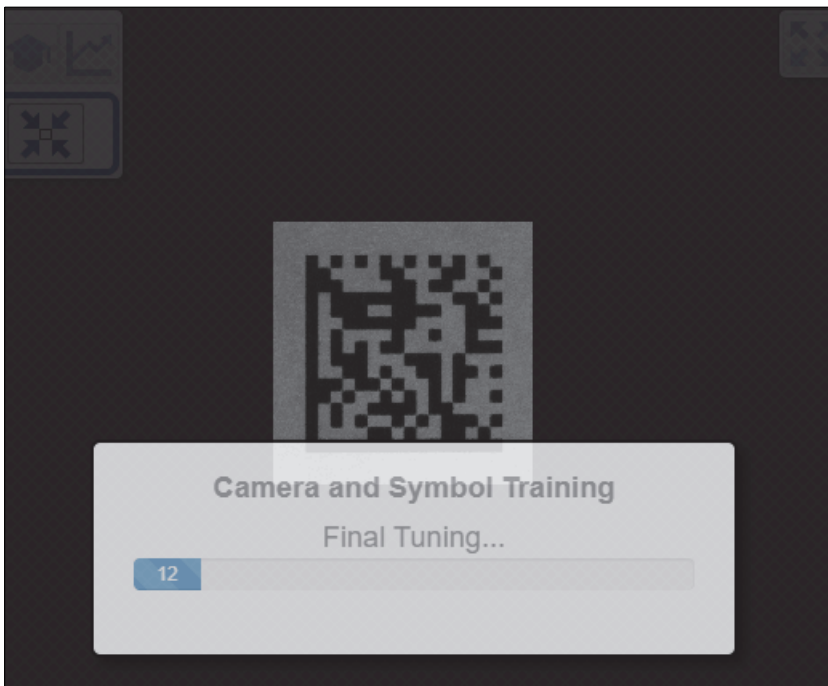

Note: The **Train** button only appears in the **Device Control Toolbar** when **Cycle** is configured to look for **only 1 symbol**. When configured to look for 2 or more symbols, the Train button disappears as shown in the example below.

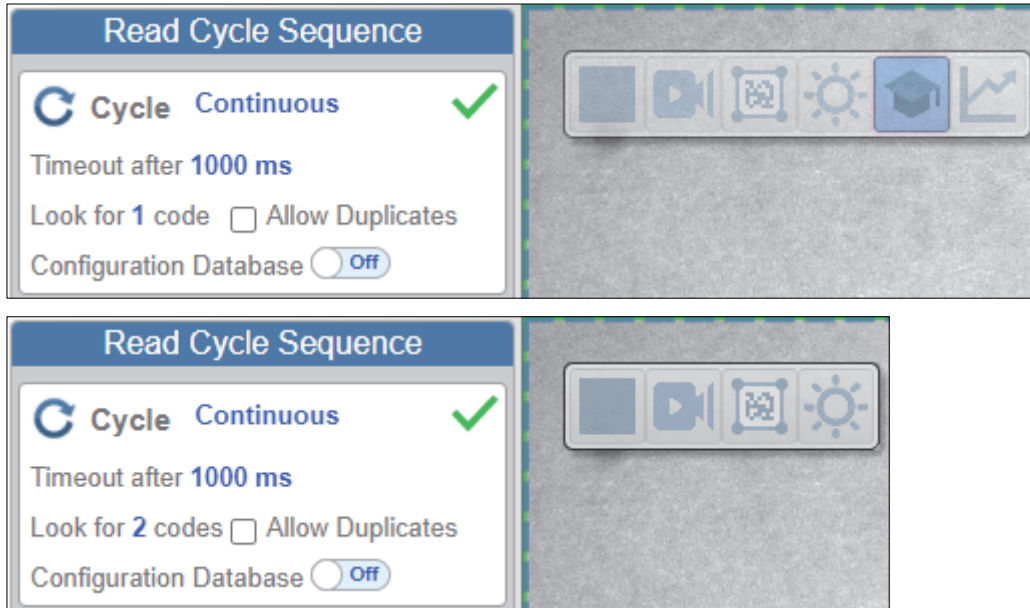

Optimize

Optimize saves relevant information about the target symbol, allowing the subsequent symbols to be processed more quickly and consistently.

The reader has three optimization states: **un-optimized**, **optimizing**, and **optimized**. When the reader is in the un-optimized state and the Optimize button is clicked, the reader enters the optimizing state until a symbol is decoded or until the Optimize button is clicked again to deactivate the optimizing state. When a symbol is decoded during the optimizing state, the reader enters the optimized state.

Note: Because the Train operation can impact symbol readability, it will un-optimize the system once an image is processed. You can optimize the system again after a Train operation.



1-9-2 Image Control Toolbar

Fit Image to Window

Fits the captured image to the Image Area window.



Zoom In

Zooms in on the desired area of the captured image.



Zoom Out

Zooms out and decreases the size of the captured image.



Note: You can also zoom in and out by scrolling up or down with your mouse, and you can move the image around by clicking and dragging.

Set User Interface Image Quality and WebLink Refresh Rate

By default, the image refresh rate is set to **Max** at a resolution and quality of **1:1** no decimation. The image format is **PNG** with no compression.

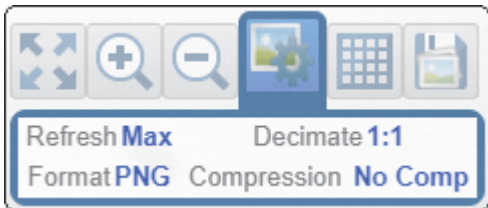

These settings affect the image update rate of the WebLink user interface, and also the processing burden on the reader to send images to the user interface. When configured to display the highest-quality images, the image refresh rate is about **1.5 frames per second** or **4 FPS** when in live video . This is most useful in **Setup** mode for evaluating images. In **Run** mode, you can display lower-quality images to achieve a higher image refresh rate approaching **14 FPS** at full image compression and decimation.

Show All Images Used in Read Cycle

Shows all the images that have been captured during the most recent read cycle.



Save Current Image

Allows you to save the current captured image to the location of your choice on your PC.



2

Quick Start

This section is designed to get your **V440-F** reader up and running quickly using **WebLink**. Following these steps will allow you to get a sense of the reader's capabilities and to test sample symbols. More detailed information for each topic is available in later sections of this manual.

2-1	Check Hardware	2-2
2-2	Position the Reader and Set Up Optics	2-3
2-3	Connect the System	2-7
2-4	Connect to WebLink	2-11
2-5	Explore the Start View	2-15
2-6	Create a New Setup or Load an Existing Setup	2-16
2-7	Explore the Setup View	2-17
2-8	Configure Read Cycle Settings	2-18
2-9	Configure Acquire Settings	2-19
2-10	Configure Symbology and Decode Settings	2-20
2-11	Format Output and Configure Match String	2-23
2-12	Configure Output 1, 2, 3 Settings	2-25
2-13	Run the Application	2-26

2-1 Check Hardware

2-1-1 Basic Hardware Table and Configuration Diagram

Important: The configuration shown below is just one example of how a V440-F can be configured in an application.

Item	Description	Part Number
1	V440-F, No Optics, 5 MP, Mono, No Light, Plus Mode	V440-FXXX50M-NNP
	V440-F, No Optics, 5 MP, Mono, No Light, X-Mode	V440-FXXX50M-NNX
2	Power Supply, 100-240VAC, +24VDC, M12 12-Pin Socket	97-000012-01
3	Cordset, Host, Ethernet	98-00013□-02

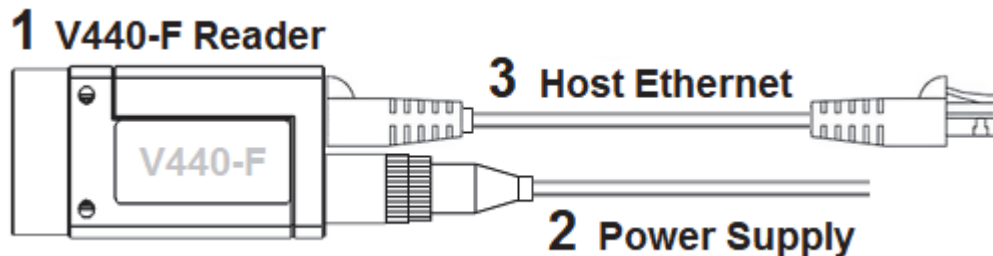

2-1-2 LED Indicators

The top of the V440-F Reader has two LEDs that indicate **Link** status and activity, and **Power** status.

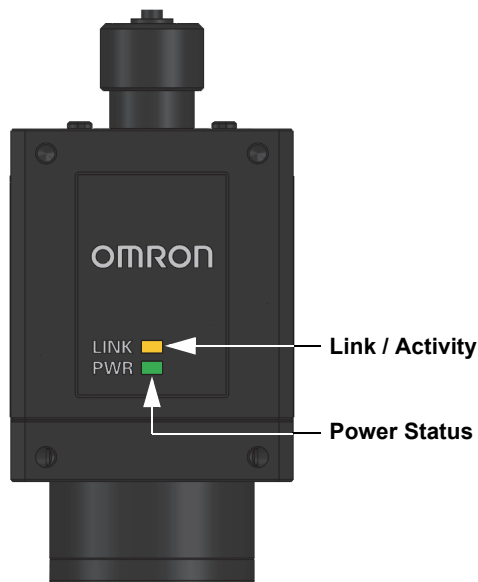

LED	Status	Description
LINK	On Steady (Amber)	Link Established
	Flashing On / Off (Amber)	Link Activity
	Off	No Link Established, No Link Activity
PWR	On Steady (Green)	Power On
	Off	No Power Applied to Unit

2-2 Position the Reader and Set Up Optics

- Use the **C-Mount Lens Options** tables in 2-2-1, **Determining the Optical Setup**, to find a C-Mount lens that achieves the camera standoff and field of view required for your application. Be sure that the resulting image resolution is adequate to decode the symbol sizes that will be used in your application.
- An external light will likely be needed to illuminate the work area where images will be captured and symbols will be decoded. You can choose lighting from any vendor, including NERLITE or FLV from Omron. NERLITE Smart Series Illuminators are an example of such lighting. The **NERLITE Smart Series Ring Illuminator** shown below left can be used with a **Bracket Kit** shown below right designed for mounting the Ring Light to the V440-F reader.

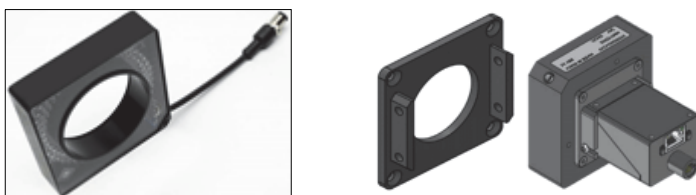

Note: Refer to the *V440-F Datasheet* for Ring Light and Bracket Kit options, dimensions, and part numbers.

- If possible, tip the reader relative to the symbol to avoid the glare of direct specular reflection.
- If your application requires the reader to be oriented perpendicular to the symbols it will be decoding, you can use a **Ring Light Polarizer** shown below left and a **Lens Polarizer** on the V440-F shown below right to avoid the glare of direct specular reflection.

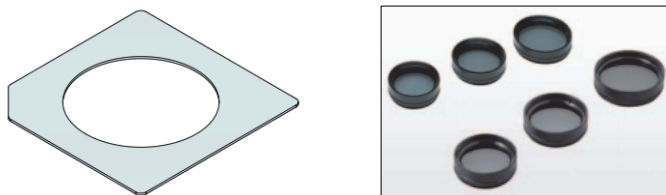

Note: Refer to the *V440-F Datasheet* for Polarizer Kit and Lens Polarizer options, dimensions, and part numbers.

- Symbols can be rotated tilted at any angle. However, for best results, symbols should be aligned with the field of view. In the case of linear symbols, aligning the bars in the direction of movement ladder orientation will minimize image blurring and will result in more consistent decodes.

Important: Avoid excessive skew or pitch. Maximum skew is $\pm 30^\circ$ and maximum pitch is $\pm 30^\circ$. The illustration below shows approximate skew axis, pitch axis, and tilt axis.

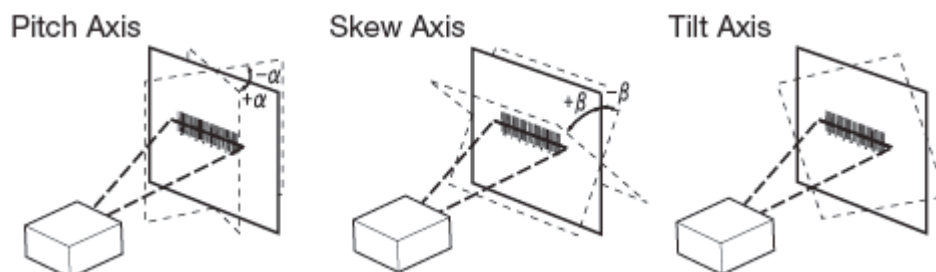

2-2-1 Determining the Optical Setup

The following four-step process determines the optimal lens focal length, field of view, and camera standoff to read the intended code successfully.

Step 1: Determine the minimum element size of the code (usually expressed in mils).

For a 1D barcode, this is the size of the thinnest bar of the code. For a 2D code, this is the size of a single square element in the code. The element size is usually known by the customer.



Step 2: Use the guidelines below to determine the approximate PPE (Pixels Per Element) required to read the code successfully.

Pixels Per Element (PPE) is defined as the number of pixels that span the smallest feature of the code. A certain minimum number of pixels is required to read successfully. For 1D codes, PPE refers to the number of image pixels across the narrowest bar in the barcode. For 2D codes, PPE refers to the number of image pixels across a single cell within the 2D code.

The following are general guidelines for typical PPE requirements based on the code type and application. It is acceptable to have too many Pixels Per Element. It can however slow down the read time.

Code Type	Minimum PPE	Preferred PPE	PPE for Code Grading
1D Code – High Contrast Label	1.6	2	5
1D Code – Direct Part Mark	2	2.5	5
2D Code – High Contrast Label	2.75	3.5 to 5	8 to 10
2D Code – Direct Part Mark	3.5	5	8 to 10

Step 3: Based on the suggested PPE from the above table, use the table below to determine the ideal field of view that delivers the required PPE.

The **Readability Table** below shows, for all common code sizes, the maximum field of view that will result in the required PPE. Results for **2, 3.5, 5, and 10** PPE are given.

FOV Size (mm) to Achieve a Specific PPE for all Common Code Sizes				
Thin Bar or 2D Cell Size	PPE = 2	PPE = 3.5	PPE = 5	PPE = 10
0.5 mil (0.0127 mm)	15.6	8.9	6.3	3.1
1 mil (0.0254 mm)	31.3	17.9	12.5	6.3
1.5 mil (0.0381 mm)	46.9	26.8	18.8	9.4
2 mil (0.0508 mm)	62.6	35.8	25.0	12.5
2.5 mil (0.0635 mm)	78.2	44.7	31.3	15.6
3.3 mil (0.084 mm)	103.5	59.1	41.4	20.7
5 mil (0.127 mm)	156.5	89.4	62.6	31.3
7.5 mil (0.19 mm)	234.1	133.8	93.6	46.8
10 mil (0.25 mm)	312.9	178.8	125.2	62.6
13 mil (0.33 mm)	406.6	232.3	162.6	81.3
15 mil (0.38 mm)	469.4	268.2	187.8	93.9
20 mil (0.5 mm)	625.9	357.6	250.3	125.2
30 mil (0.76 mm)	936.3	535.0	374.5	187.3
40 mil (1 mm)	1251.7	715.3	500.7	250.3
50 mil (1.25 mm)	1564.6	894.1	625.9	312.9

Step 4: Based on ideal field of view, use the Field of View / Working Distance charts below to choose the best lens and camera standoff distance combination that most closely matches the application requirements.

Example: Read a 2D, 7.5 mil code.

From the guidelines we can determine that **3.5 PPE** is a good starting point.

From the **PPE to FOV table** above, we see the ideal field of view for achieving a **PPE of 3.5** on a **7.5 mil code** is **133.8 mm**.

From the table below, we see there are multiple lens options and working distance options that come close*.

- **Option 1:** F = 9 mm, Working Distance = 150.
- **Option 2:** F = 12.5 mm, Working Distance = 200.
- **Option 3:** F = 16 mm, Working Distance = 250.

***Note:** Please note that it normal to interpolate between the set working distances in the chart to come up with the best answer. ALWAYS TEST the solution on your exact samples. You can always move the camera in to increase the resolution.

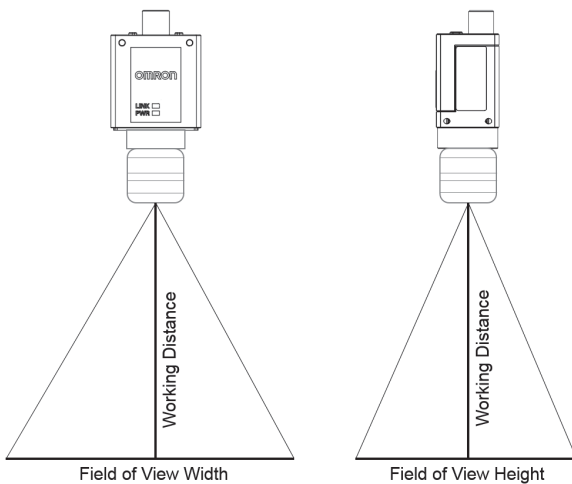

General lens formulas for any combination, given working distance, focal length, or field of view width:

Field of View Width = 8.5 x Working Distance / Focal Length

Field of View Height = 7.093 x Working Distance / Focal Length

Focal Length = 8.5 x Working Distance / Field of View Width

Working Distance = Field of View Width x Focal Length / 8.5

Field of View for 25* to 500 mm Working Distance

Field of View (mm x mm) at Specific Working Distances (mm)												
Lens FL	25	50	75	100	150	200	250	300	350	400	450	500
F = 6	35 x 30	71 x 59	106 x 89	142 x 118	213 x 177	283 x 236	354 x 296	425 x 355	496 x 414	567 x 473	638 x 532	708 x 591
F = 8	27 x 22	53 x 44	80 x 66	106 x 89	159 x 133	213 x 177	266 x 222	319 x 266	372 x 310	425 x 355	478 x 399	531 x 443
F = 9	24 x 20	47 x 39	71 x 59	94 x 79	142 x 118	189 x 158	236 x 197	283 x 236	331 x 276	378 x 315	425 x 355	472 x 394
F = 12.5	17 x 14	34 x 28	51 x 43	68 x 57	102 x 85	136 x 113	170 x 142	204 x 170	238 x 199	272 x 227	306 x 255	340 x 284
F = 16	13 x 11	27 x 22	40 x 33	53 x 44	80 x 66	106 x 89	133 x 111	159 x 133	186 x 155	213 x 177	239 x 199	266 x 222
F = 25	9 x 7	17 x 14	26 x 21	34 x 28	51 x 43	68 x 57	85 x 71	102 x 85	119 x 99	136 x 113	153 x 128	170 x 142
F = 35	6 x 5	12 x 10	18 x 15	24 x 20	36 x 30	49 x 41	61 x 51	73 x 61	85 x 71	97 x 81	109 x 91	121 x 101
F = 50	4 x 4	9 x 7	13 x 11	17 x 14	26 x 21	34 x 28	43 x 35	51 x 43	60 x 50	68 x 57	77 x 64	85 x 71
F = 75	3 x 2	6 x 5	9 x 7	11 x 9	17 x 14	23 x 19	28 x 24	34 x 28	40 x 33	45 x 38	51 x 43	57 x 47
F = 100	2 x 2	4 x 4	6 x 5	9 x 7	13 x 11	17 x 14	21 x 18	26 x 21	30 x 25	34 x 28	38 x 32	43 x 35

*For working distances shorter than the minimum working distance specified for the lens, an extension ring is required to focus the lens.

Field of View at 600 to 2500 mm Working Distance

Field of View (mm x mm) at Specific Working Distances (mm)										
Lens FL	600	700	800	900	1000	1250	1500	1750	2000	2500
F = 6	850 x 709	992 x 828	1133 x 946	1275 x 1064	1417 x 1182	1771 x 1478	2125 x 1773	2479 x 2069	2833 x 2364	3542 x 2956
F = 8	638 x 532	744 x 621	850 x 709	956 x 798	1063 x 887	1328 x 1108	1594 x 1330	1859 x 1552	2125 x 1773	2656 x 2217
F = 9	567 x 473	661 x 552	756 x 631	850 x 709	944 x 788	1181 x 985	1417 x 1182	1653 x 1379	1889 x 1576	2361 x 1970
F = 12.5	408 x 340	476 x 397	544 x 454	612 x 511	680 x 567	850 x 709	1020 x 851	1190 x 993	1360 x 1135	1700 x 1419
F = 16	319 x 266	372 x 310	425 x 355	478 x 399	531 x 443	664 x 554	797 x 665	930 x 776	1063 x 887	1328 x 1108
F = 25	204 x 170	238 x 199	272 x 227	306 x 255	340 x 284	425 x 355	510 x 426	595 x 497	680 x 567	850 x 709
F = 35	146 x 122	170 x 142	194 x 162	219 x 182	243 x 203	304 x 253	364 x 304	425 x 355	486 x 405	607 x 507
F = 50	102 x 85	119 x 99	136 x 113	153 x 128	170 x 142	213 x 177	255 x 213	298 x 248	340 x 284	425 x 355
F = 75	68 x 57	79 x 66	91 x 76	102 x 85	113 x 95	142 x 118	170 x 142	198 x 166	227 x 189	283 x 236
F = 100	51 x 43	60 x 50	68 x 57	77 x 64	85 x 71	106 x 89	128 x 106	149 x 124	170 x 142	213 x 177

Important: See [Connect the System](#).

V440-F Lens Selection Based on Focal Length

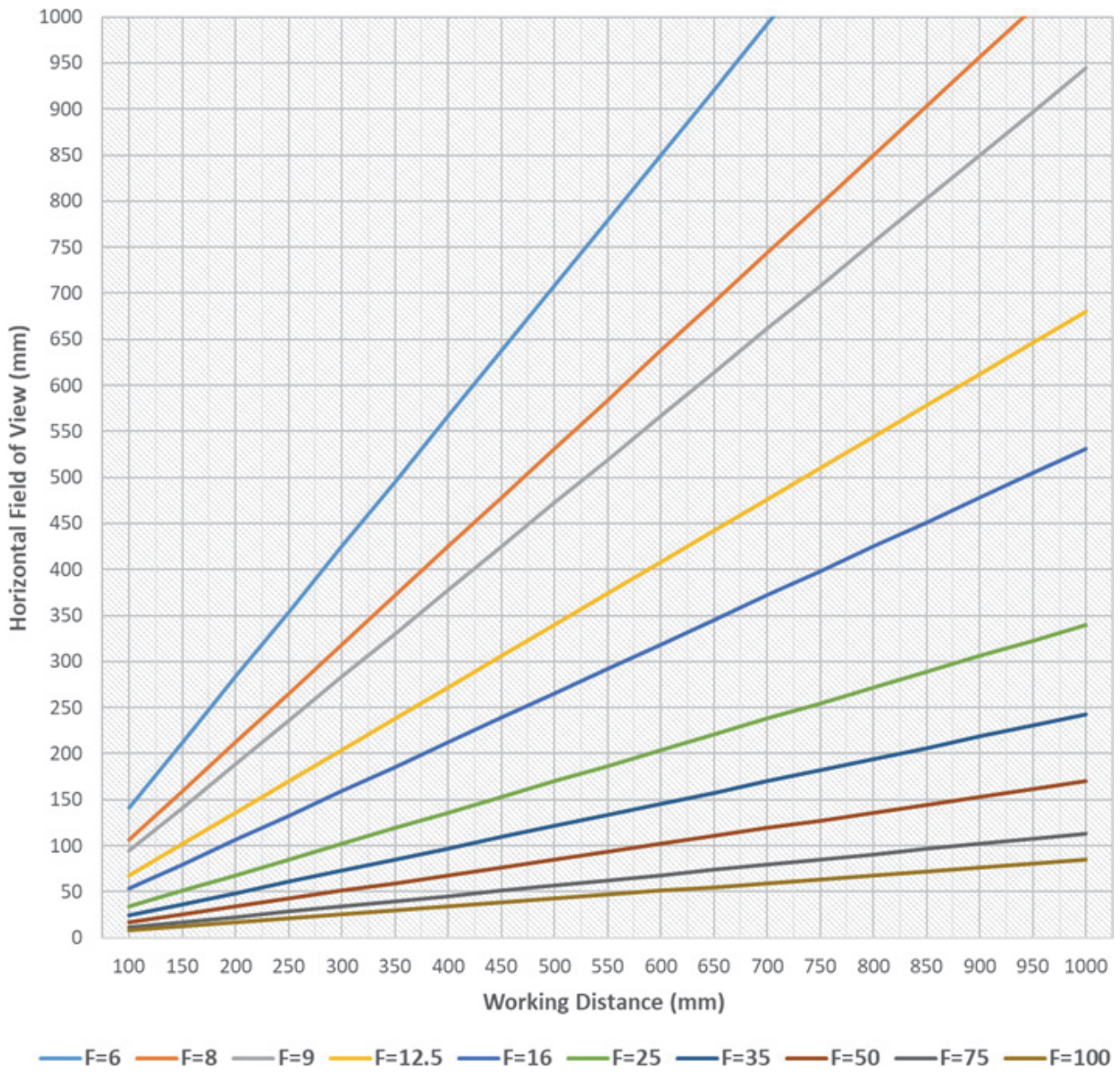

2-3 Connect the System

The following hardware configuration diagrams demonstrate some of the many ways the V440-F Reader can be deployed in an application. These configurations show Omron lenses and lighting. The V440-F can be used with any vendor's lenses and lighting. Lighting can be either directly powered, or can use Strobe Out pulse on DIO 3.

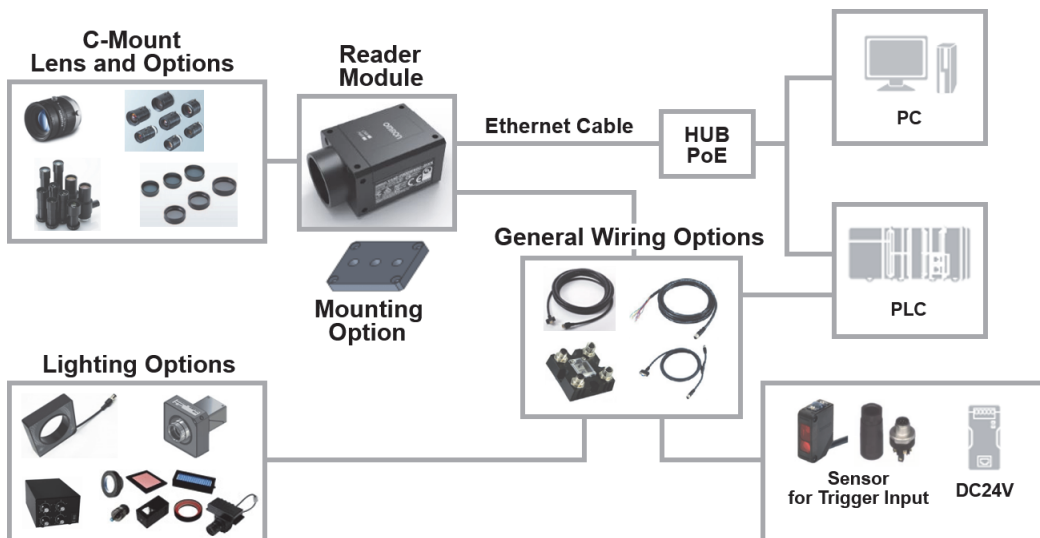

2-3-1 System Configuration Examples

Example 1: FLV Series or Other External Lighting

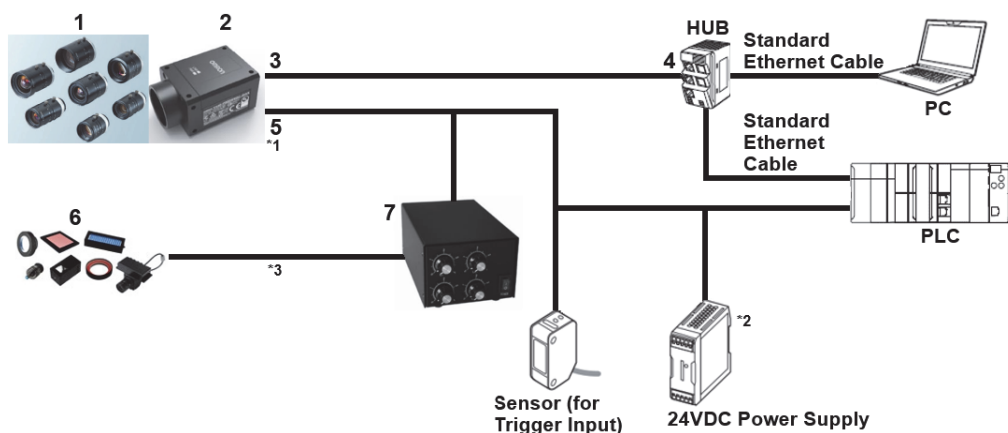

Dwg. Ref.	Category	Part Number
1	C-Mount Lens	3Z4S-□□, 98-9000□□□-01
2	V440-F C-Mount 5 MP Camera	V440-F□□□□50M-NN□
3	Industrial High-Flex GigE Ethernet Cable with Jack Screws and RJ45 Connector	98-00013□-0□
4	PoE (Power over Ethernet) Industrial Switching HUB	Select a cable that can supply power via Ethernet. Example: W4S1 Series
5	M12-to-Flying Leads Cable	V430-W8□□□-□M
6	FLV Lighting	FLV-□
7	Lighting Controller	FLV-ATC□, 3Z4S-LTIDGB□

*1. The V430-WQ cable (excluding V430-WQR / V430-WQK) can be used as an extension of the V430-W8 cable.

*2. A 24VDC power supply is not needed for the V440-F if a PoE switching HUB is used.

*3. Any vendor's lighting and power supply can be used with the V440-F. The I/O cable provides strobe signal to light power supply.

Example 2: NERLITE Smart Series Light with QX-1

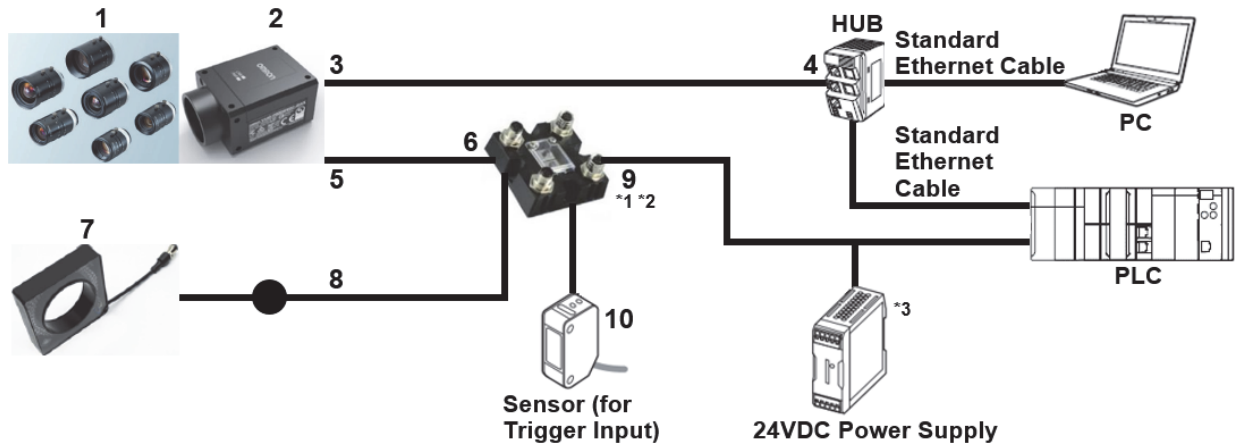

Dwg. Ref.	Category	Part Number
1	C-Mount Lens	3Z4S-□□, 98-9000□□□-01
2	V440-F C-Mount 5 MP Camera	V440-F□□□□50M-NN□
3	Industrial High-Flex GigE Ethernet Cable with Jack Screws and RJ45 Connector	98-00013□-0□
4	PoE (Power over Ethernet) Industrial Switching HUB	Select a cable that can supply power via Ethernet. Example: W4S1 Series
5	Reader-to-QX-1 Interconnect Cable	V430-WQ-1M
6	QX-1 Interface Device	98-000103-02
7	NERLITE Smart Series R-70 or R-100 Ring Light	NER-01166□□□□□G
8	Integrated Light Cable	61-0002□□-01
9	M12-to-Flying Leads Cable	V430-W8□□□-□M
10	QX-1 Photo Sensor	99-9000016-01
	QX-1 Field-Wireable M12 4-Pin Plug for Any Trigger Source or Photo Sensor	98-9000239-01

*1. The V430-WQ cable (excluding V430-WQR / V430-WQK) can be used as an extension of the V430-W8 cable.

*2. It is possible to connect a 97-000012-01 power supply instead of V430-W8. However, since there is no I/O line, you cannot connect to the sensor or PLC.

*3. A 24VDC power supply is not needed for the V440-F if a PoE switching HUB is used.

Example 3: NERLITE Smart Series Light without QX-1

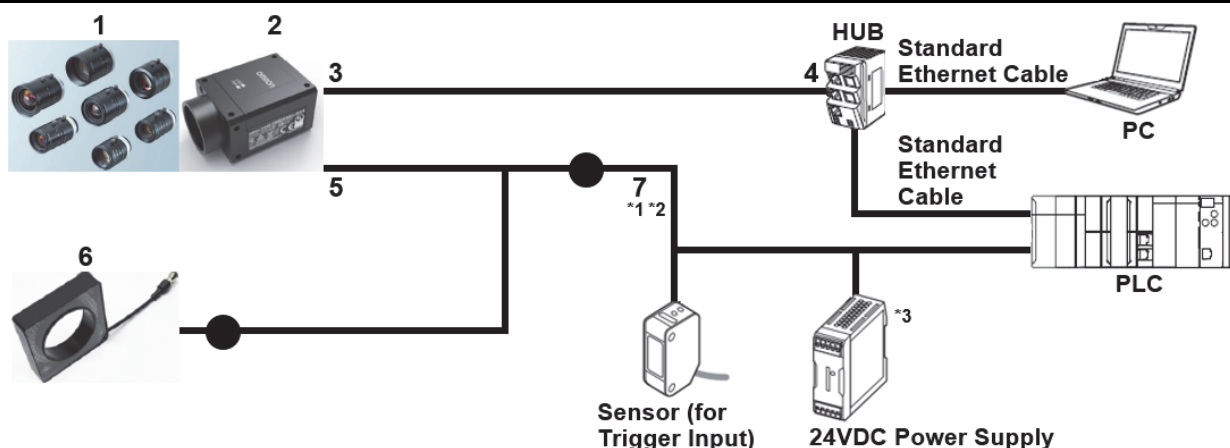

Dwg. Ref.	Category	Part Number
1	C-Mount Lens	3Z4S-□□, 98-9000□□□-01
2	V440-F C-Mount 5 MP Camera	V440-F□□□□50M-NN□
3	Industrial High-Flex GigE Ethernet Cable with Jack Screws and RJ45 Connector	98-00013□-0□
4	PoE (Power over Ethernet) Industrial Switching HUB	Select a cable that can supply power via Ethernet. Example: W4S1 Series
5	Integrated Light Y Cable	61-900013□-01
6	NERLITE Smart Series R-70 or R-100 Ring Light	NER-01166□□□□G
7	M12-to-Flying Leads Cable	V430-W8□□□-□M

*1. The V430-WQ cable (excluding V430-WQR / V430-WQK) can be used as an extension of the V430-W8 cable.

*2. It is possible to connect a 97-000012-01 power supply instead of V430-W8. However, since there is no I/O line, you cannot connect to the sensor or PLC.

*3. A 24VDC power supply is not needed for V440-F if a PoE switching HUB is used.

Example 4: Minimum Power over Ethernet (PoE) Configuration

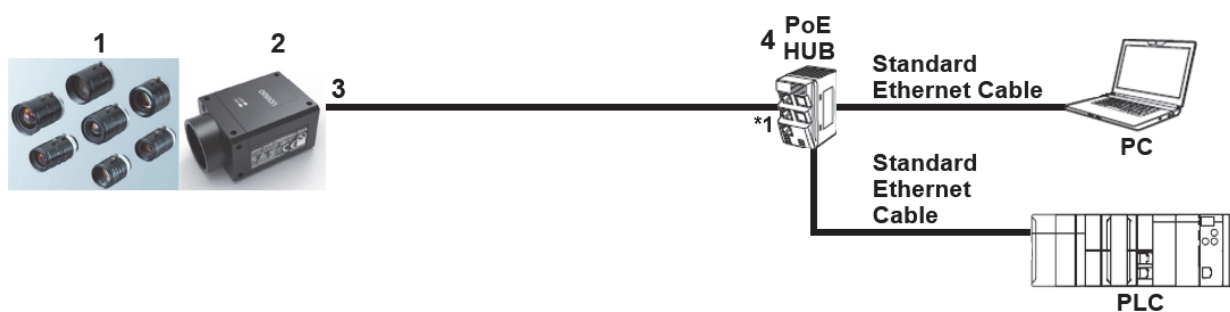

Dwg. Ref.	Category	Part Number
1	C-Mount Lens	3Z4S-□□, 98-9000□□□-01
2	V440-F C-Mount 5 MP Camera	V440-F□□□□50M-NN□
3	Industrial High-Flex GigE Ethernet Cable with Jack Screws and RJ45 Connector	98-00013□-0□
4	PoE (Power over Ethernet) HUB	Select a cable that can supply power via Ethernet.

*1. A 24VDC power supply is not needed for the V440-F if a PoE switching HUB is used.

Example 5: Minimum External Power Configuration

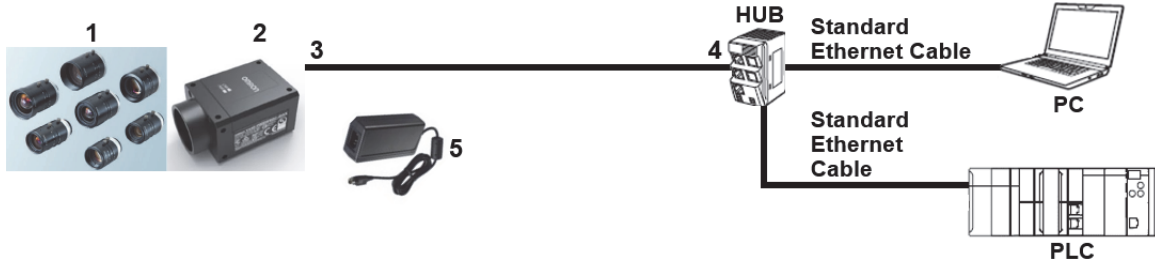

Dwg. Ref.	Category	Part Number
1	C-Mount Lens	3Z4S-□□, 98-9000□□□-01
2	V440-F C-Mount 5 MP Camera	V440-F□□□□50M-NN□
3	Industrial High-Flex GigE Ethernet Cable with Jack Screws and RJ45 Connector	98-00013□-0□
4	Industrial Switching HUB	Example: W4S1 Series
5	Power Supply, 100-240VAC, +24VDC, M12 12-Pin Socket	97-000012-01

Example 6: USB Configuration

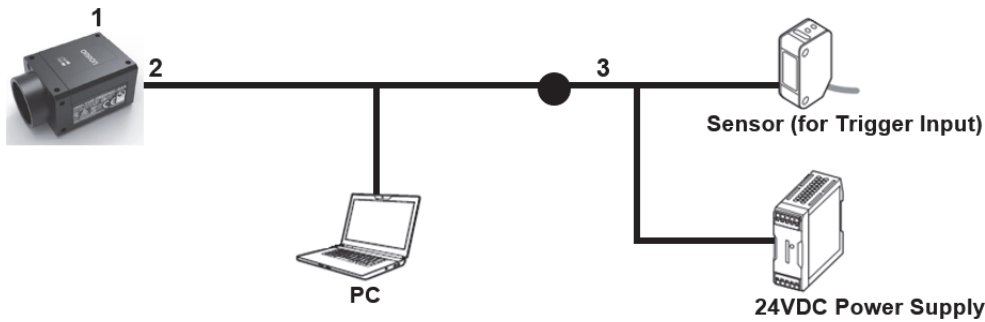

Dwg. Ref.	Category	Part Number
1	V440-F C-Mount 5 MP Camera	V440-F□□□□50M-NN□
2	Reader-to-QX-1 Interconnect Cable with USB Keyboard Wedge Breakout	V430-WQK-3M*
3	M12-to-Flying Leads Cable	V430-W8□□□□-□M

*Insert the V430-WQK-3M cable between the V440-F and the V430-W8□□□□-□M cable.

Example 7: RS-232C Configuration

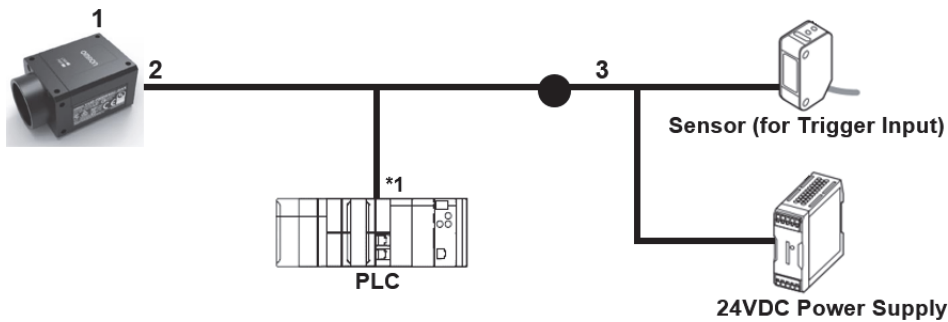

Dwg. Ref.	Category	Part Number
1	V440-F C-Mount 5 MP Camera	V440-F□□□□50M-NN□
2	Reader-to-QX-1 Interconnect Cable with RS-232 Breakout	V430-WQR-3M*
3	M12-to-Flying Leads Cable	V430-W8□□□□-□M

*Insert the V430-WQR-3M cable between the V440-F and the V430-W8 cable.

*1. If connecting Omron's CS/CJ/NJ Controller, check the connector shape and signal lines (pin assignments) and prepare the additional RS-232C conversion cable. If connecting to Omron's NX Machine Automation Controller, no additional RS-232C cable is required.

2-4 Connect to WebLink

2-4-1 WebLink System Requirements

Operating System Requirements

- Microsoft Windows 10 64-Bit or Microsoft Windows 7 64-Bit

Note: Using an Embedded OS Windows CE and / or an underpowered machine limited RAM or limited disk space is not recommended.

Hardware and Performance Requirements

- Intel Core i3 Duo Processor
- 2 GB RAM / 128 MB Video RAM
- 1 GB Hard Drive Space
- 32-Bit Color Display
- 4.0 Windows Experience Index

Browser Requirements

- Google Chrome Recommended
- Firefox
- Microsoft Edge
- Opera
- Safari Mac-Only

Browser Feature Requirements

WebLink requires certain features to be supported by the hosting browser. Support for these features is verified before WebLink loads, and if the features are not supported, an error message is displayed.

The following features are required by WebLink and are checked at startup:

- Web Sockets
- HTML5 Canvas
- HTML5 Audio

2-4-2 V440-F Static Connection

- 1 Navigate to **Control Panel > Network and Sharing Center** on your PC.
- 2 Click **Local Area Connection 4**. In the **Status** dialog, click **Properties**.
- 3 In the **Local Area Connection Properties** dialog, select **Internet Protocol Version 4 (TCP/IPv4)** and click **Properties** again.
- 4 Set your PC to a **192.168.188.X** IP address (**192.168.188.5**, for example).
- 5 Click **OK**.
- 6 Open a web browser and type the reader's default IP address (**http://192.168.188.2**) in the web browser's address bar. Note that the IP address may have been set to a different address by another user. Use the **Device Discovery Utility (DDU)** – described in **section 2-3-4** – to determine the exact IP address of the reader.
- 7 The reader will connect to WebLink.

2-4-3 V440-F DHCP Network Connection

- 1** If your PC is set to DHCP, you should set the reader to DCHP as well.
- 2** Plug your reader into your network adapter.
- 3** Run the **Omron Device Discovery Utility (DDU)**.
- 4** Click **Search** to find the reader. When the reader appears, click on it to set parameters.
- 5** Turn **DHCP On**. Click **Update Settings** and **Exit**. The reader will reset and come up in DHCP mode. The reader will then reboot and the DDU will search for the reader again.
- 6** When the reader is found, note the new IP address that is generated.
- 7** Open a browser and type the new IP address. WebLink will load.

Important: The reader does not work in APIPA mode. A DHCP server must be running on the network to hand out IP addresses for this to function correctly. If a DHCP server is not running on the network, the reader will continue to search for an IP address every 30 seconds.

2-4-4 Use the Device Discovery Utility (DDU) to Connect to WebLink

Omron provides the Device Discovery Utility (DDU) to enable automatic discovery and display of all readers on the local network. You can use this utility to change reader settings, download software updates to the camera, or launch the WebLink user interface.

You can establish a connection between WebLink and the reader with the **Device Discovery Utility (DDU)**, available at <https://automation.omron.com> or on your regional Omron website.

Once you have downloaded the Device Discovery Utility **.exe** file from the website and installed it, select Device Discovery Utility from your Start Menu.

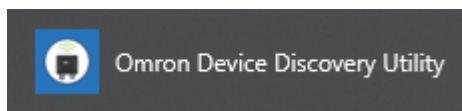

The following screen will appear.

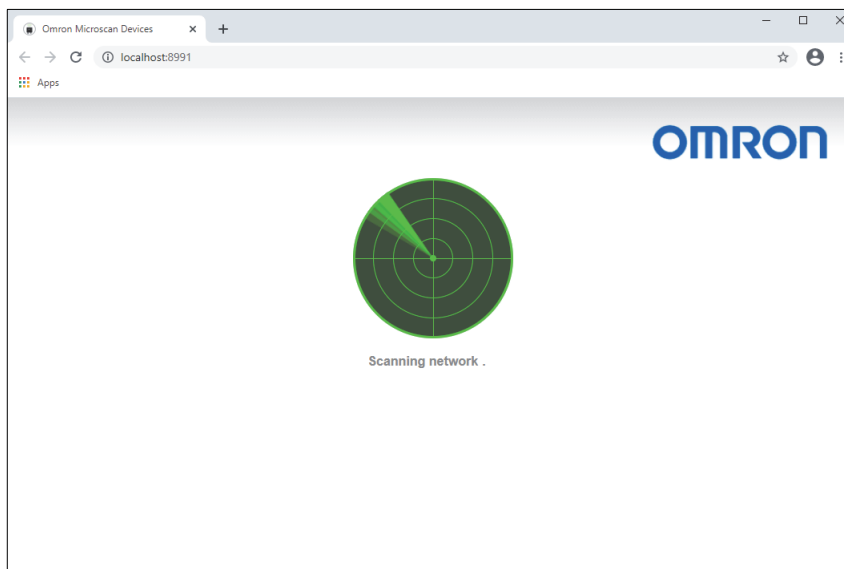

When the DDU locates your reader on the network, its identifying information will be shown as in the example indicated below. The DDU will also locate and display other V440-F Code Readers, MicroHAWK V-Series Code Readers, MicroHAWK F-Series Smart Cameras, and HAWK MV-4000 Smart Cameras on the network.

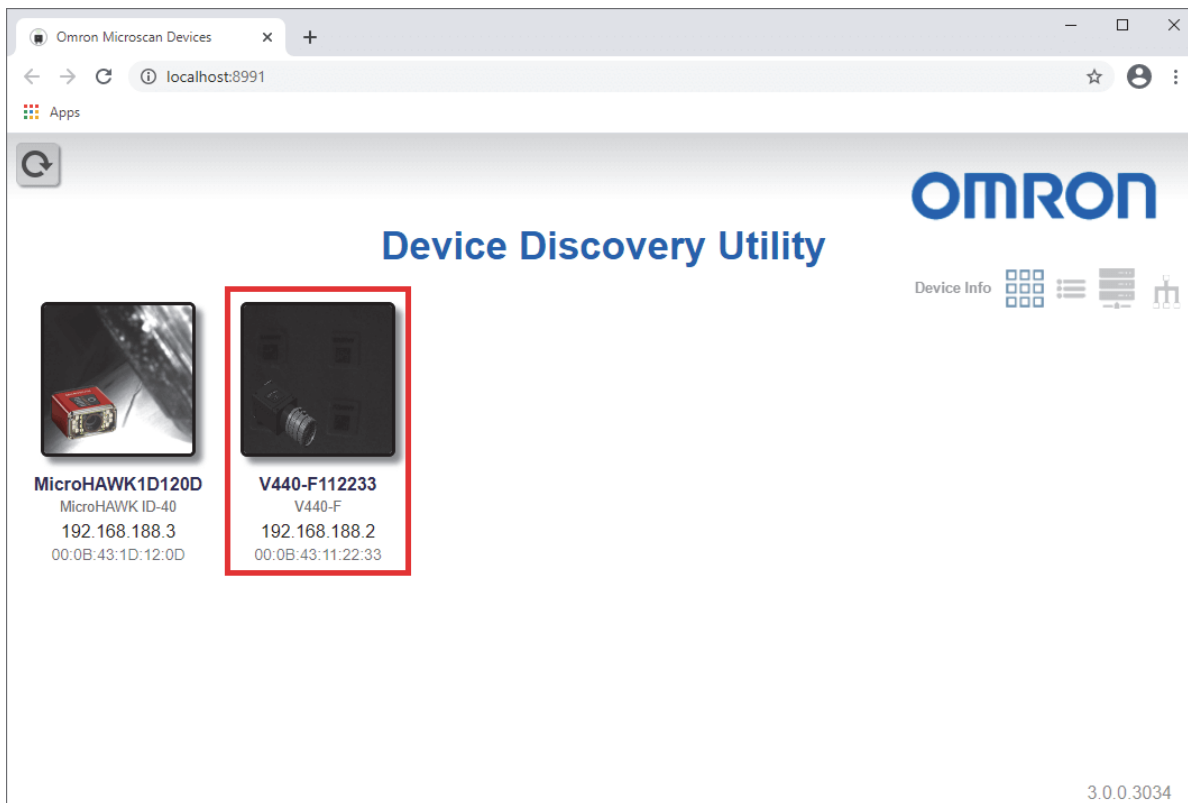

Click on the image of your reader to bring up the **Information** and **Settings** views.

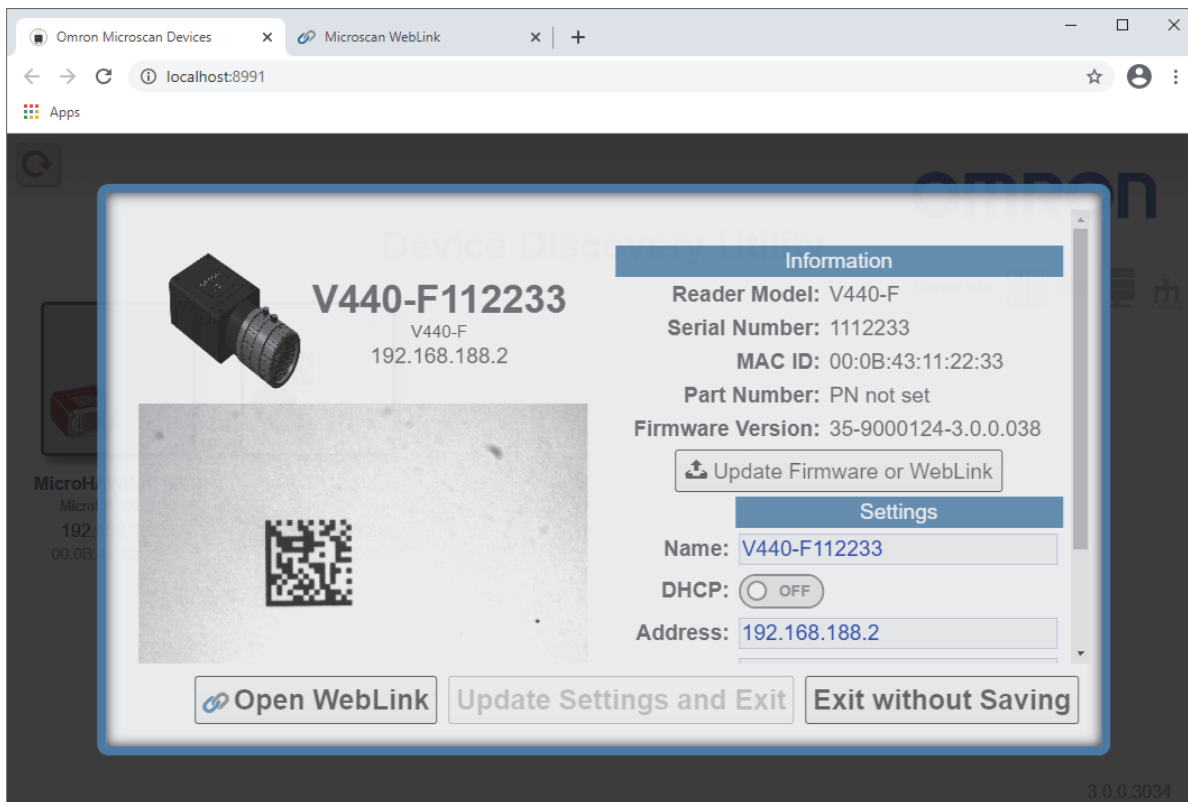

Click **Open WebLink**. The WebLink splash screen will appear as the program opens.

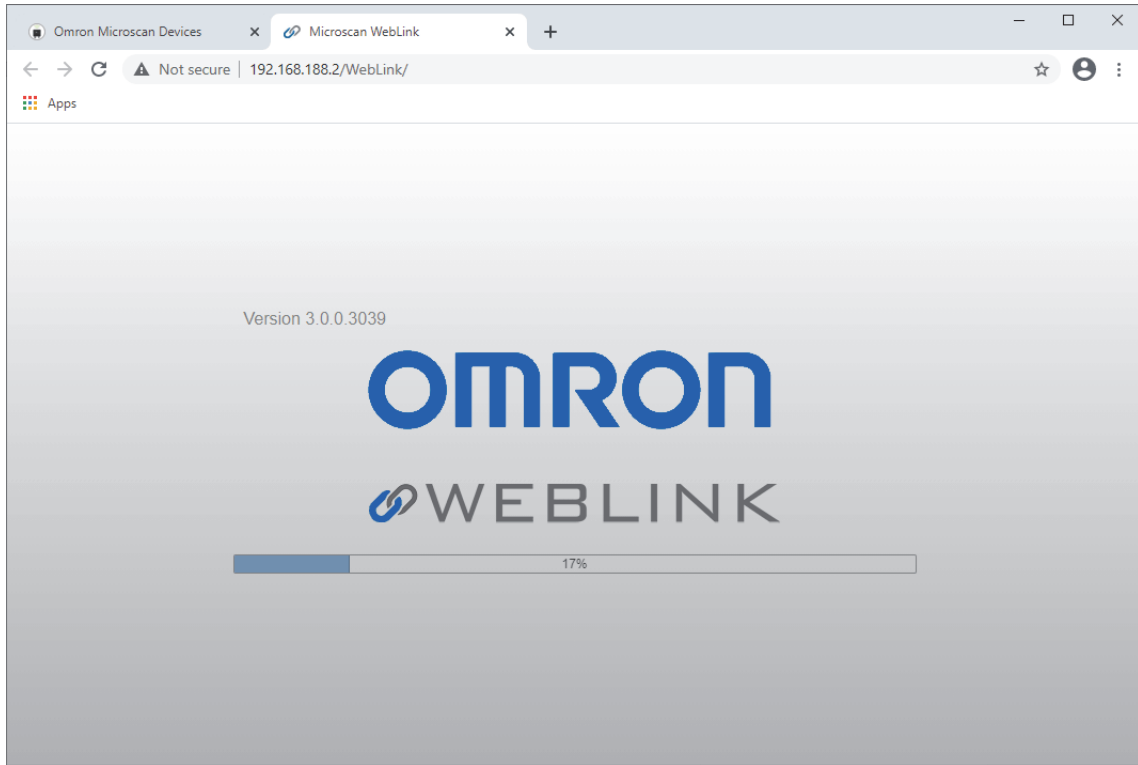

2-5 Explore the Start View

The **Start** view is the initial view you will see when the WebLink session begins. The connected reader is shown, along with its **user-defined name**, **IP address**, **Reader Model**, **Serial Number**, **MAC ID**, **Firmware version**, **WebLink version**, **Sensor resolution**, and **Optics**.

This view allows you to choose **Assisted Setup**, to **Create a New Setup**, or to **Load a Setup**.

The screenshot displays the OMRON WebLink Start View. The interface is divided into several sections:

- Top Navigation:** 'Start', 'Setup', and 'Run' buttons.
- OMRON Logo:** Located in the top right corner.
- Left Sidebar:**
 - Reader information for V440-F112233 (IP: 192.168.188.2).
 - Buttons for 'Assisted Setup...', 'Create a New Setup', and 'Load a Setup...'.
- Central View:** A camera feed showing a QR code with the text 'OMRON V440-F' overlaid.
- Right Sidebar:**
 - Counts:**

Counts	
Cycles	69862
Reads	N/A
No Read	N/A
Mismatch	N/A
Read %	N/A
 - Rate:**

Rate		
Capture	42.6 ms	23.4/s
Decode	56.1 ms	17.8/s
Overhead	0.4 ms	
Total Read	99.1 ms	10.1/s
Trig Rate	97.9 ms	10.21/s
 - Read Time (ms):** A line graph showing read time fluctuations.
 - Output Data:** A list of read events, each showing 'OMRON V440-F' and a status indicator.
- Bottom Status Bar:**
 - Refresh Rate: 0.640 Hz
 - Device Info: V440-F112233 | V440-F | 192.168.188.2 | 1122233

2-6 Create a New Setup or Load an Existing Setup

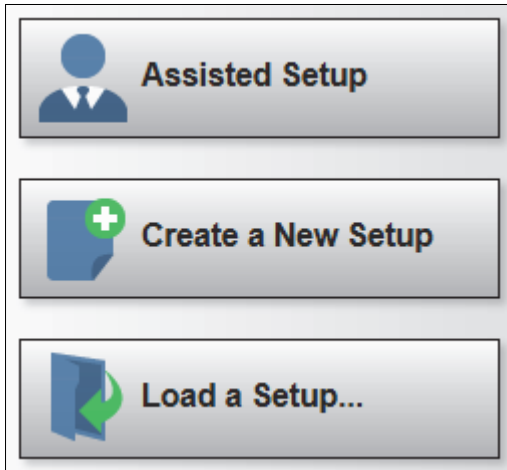

2-6-1 Assisted Setup

When you click the **Assisted Setup** button in the **Start** view, a dialog will appear asking you a series of application-based questions. Based on your answers, WebLink generates your initial setup automatically. Once the setup is created, you can fine-tune its parameters in the **Setup** view.

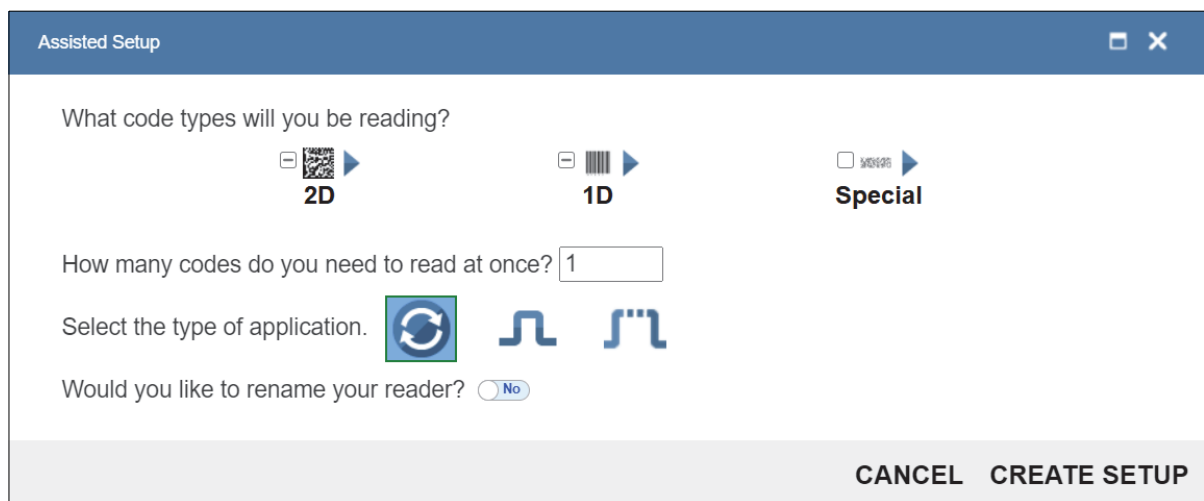

2-6-2 Create a New Setup

Clicking **Create a New Setup** allows you to create a setup without using **Assisted Setup**. Create a New Setup will perform a software reset and will recall default parameters except Communication settings. The New Setup should not save to flash, so you should be able to cycle power to the reader and see the settings that were last saved to flash.

2-6-3 Load a Setup

Select **Load a Setup** to load an existing **.wls** WebLink setup file. The **.wls** file contains all current reader settings.

2-7 Explore the Setup View

The **Setup** view allows you to configure all aspects of the **Read Cycle Sequence** on the left side of the user interface: **Autocalibration**, **Cycle**, **Acquire**, **Matrix Mode**, **Decode**, **Match String**, **Format Output**, **Outputs**, and **Favorites**.

Clicking the **flash icon** at the upper right saves current settings to the reader's flash memory so the settings will be available when the reader is rebooted.

The **question mark icon** at the upper right opens **WebLink Help**.

The **gear icon** at the upper right brings up the **Application Settings** menu.

Note: The **1, 2, and 3 output indicators** at the lower right of the screen display the results of the last read cycle.



2-8 Configure Read Cycle Settings

The reader can be configured to operate in free-running **Continuous** mode or **Triggered** mode. This is defined in the **Cycle** section of the **Read Cycle Sequence** on the **left side** of the user interface in **Setup** view. All cycle modes are described in detail in the **Section 4 – Setup**.

2-8-1 Continuous

In **Continuous** mode, the reader is in a continuous free-running state. Symbols can be presented to the reader at will. During the read cycle, the reader continuously acquires and processes images until all symbols are found or until the timeout is reached. Continuous mode is useful during reader setup because you don't have to send a trigger to see the immediate results of your configuration changes.

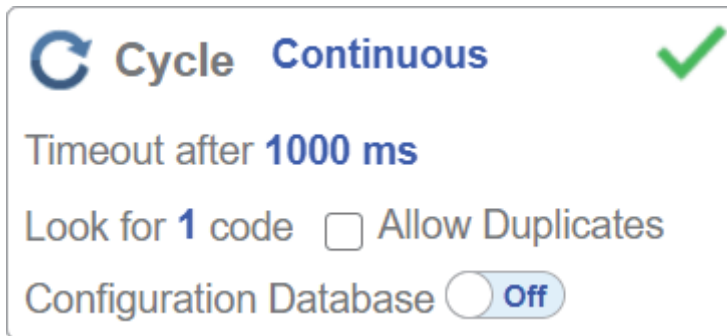

2-8-2 Triggered

In **Triggered** mode, the read cycle starts with a trigger and ends with a good read or a timeout. The trigger can come either from a physical or serial input, or it can be initiated with one of two trigger buttons on the screen. One of the buttons sends a single trigger to the reader, and the other button sends a continuous stream of triggers to the reader.

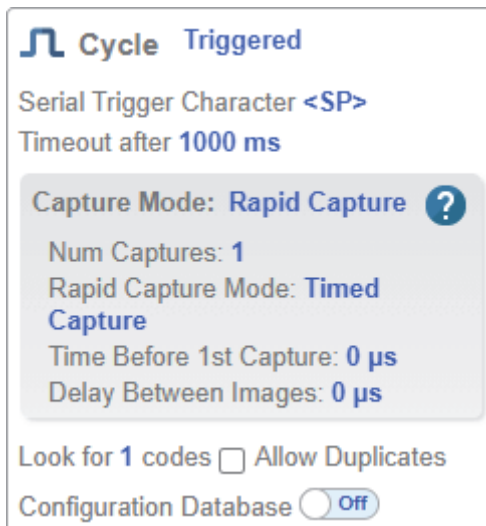

2-9 Configure Acquire Settings

Acquire allows you to set **Exposure** signified by the sun icon and **Gain** signified by the dial and right-pointing arrow icon in real time. Clicking any of these settings will cause a control to appear, allowing you to modify that setting. Settings take effect immediately. Exposure can be set from **16 μ s** to **400 msec**. Gain can be set from **0%** to **100%**.

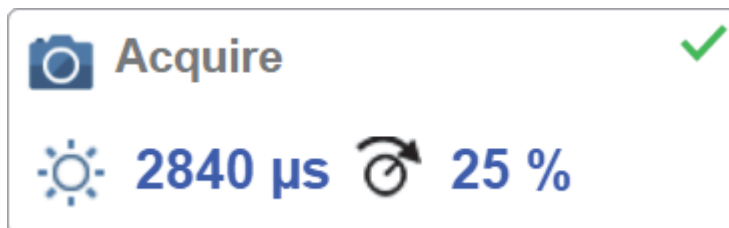

2-9-1 Quick Photometry

Clicking the **Quick Photometry** button will automatically set the optimal **Exposure** and **Gain** settings for the current image. This is a recommended first step when setting up an image. You can also adjust the values manually. Manual adjustment is useful when a short Exposure time is required to freeze the image in dynamic moving applications.



2-10 Configure Symbology and Decode Settings

The **Decode** area of the **Setup** view allows you to choose which symbologies code types you want to enable, and allows you to configure the parameters for those symbologies.

See **Symbologies** for **Advanced Decoding Parameters**.

The **Decode** area shown below allows you to select which symbologies the system will search for during the read cycle. Clicking the check boxes highlighted in the image below to the left of the **2D**, **1D**, and **Special** symbology categories turns on all symbologies within that category simultaneously.

You can also turn off all symbologies within a category simultaneously by unchecking its corresponding check box. In the image below, for example, the check box for the **Special** category is unchecked, meaning that none of the code types in that category are enabled.

If only some symbologies within a category have been enabled, the check box displays a dash. In the image below, for example, the check boxes for the **2D** and **1D** categories display a dash, meaning that only some of the code types in those categories are enabled.

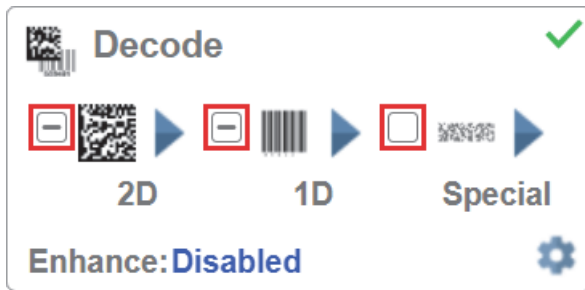

Click the symbols themselves highlighted in the image below to bring up a list of all the code types available in that symbology category.

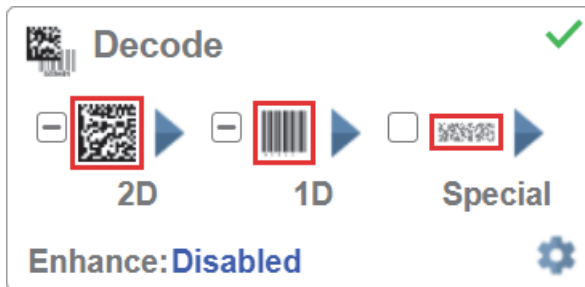

For example, if you click the Data Matrix symbol above **2D** in the Decode area, you will see a list of all supported 2D code types. Enable or disable specific code types from the list by clicking them on or off. In the example below, the green-highlighted code types are enabled and Aztec Code is disabled.

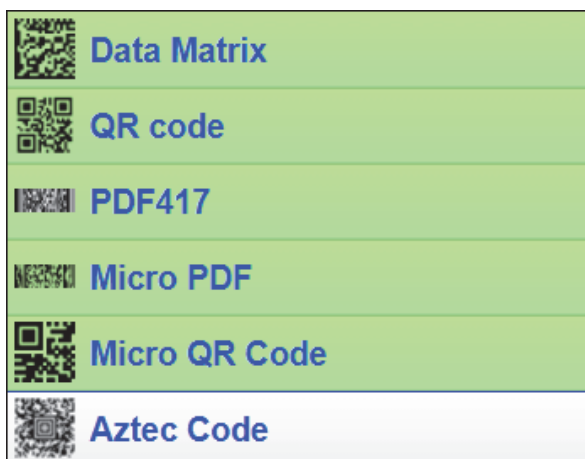

2-10-1 Symbology Settings

Clicking the **gear** icon at the bottom of the **Decode** area brings up **Symbology Settings**.

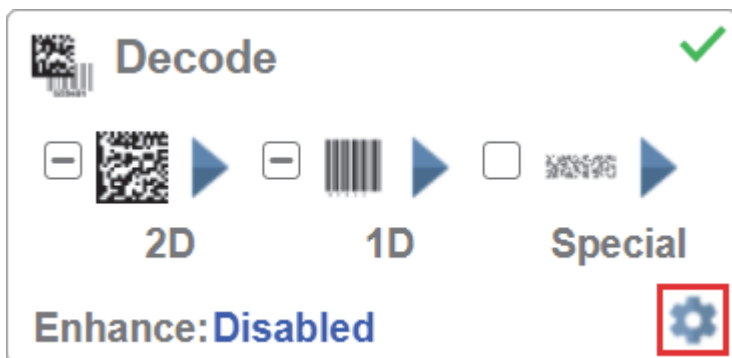

Symbology Settings allows you to configure every parameter of every code type supported by WebLink. All parameter changes take effect immediately.

Symbology Settings Example 1 - Data Matrix Parameters

Symbology Settings	
Data Matrix	▼ Data Matrix
QR code	☆ ECC 200 Status Enabled
Code 128	☆ DMRE Disabled
Code 39	☆ Use Alignment Pattern Disabled
Codabar	▼ Data Matrix Legacy
Code 93	☆ ECC 000 Status Disabled
I2of5	☆ ECC 050 Status Disabled
UPC	☆ ECC 080 Status Disabled
PDF417	☆ ECC 100 Status Disabled
Micro PDF	☆ ECC 140 Status Disabled
BC412	☆ ECC 120 Status Disabled
	☆ ECC 130 Status Disabled

Symbology Settings Example 2 - DotCode Parameters

Symbology Settings	
Dot Code	☆ DotCode Enabled
	☆ Rotation Mode No Rotation
	☆ Expected Rows 0
	☆ Expected Columns 0

2-10-2 Enhance

The **Enhance** drop-down menu at the bottom of the **Decode** area allows you to select the pre-processing method for codes within an image using morphology.

Note: When running in normal mode, the image pre-processing enhancement function applies to all codes within the image. When using the **Configuration Database** function, pre-processing only affects codes within a specific region of interest ROI or window of interest WOI.

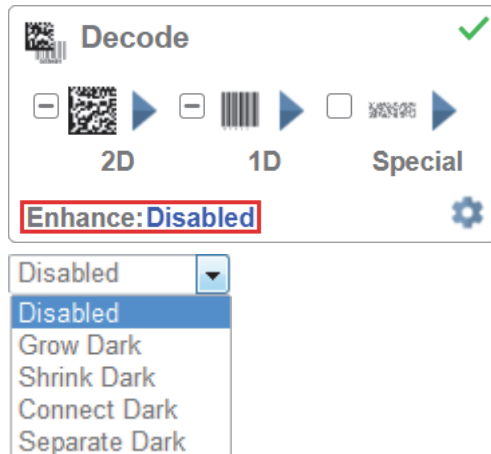

Grow Dark

Grow Dark increases the dark cell size of a symbol. It is useful for increasing the dark cell size of a dark-on-light Data Matrix symbol.

Shrink Dark

Shrink Dark increases the light cell size of a symbol. It is useful for increasing the light cell size of a light-on-dark Data Matrix symbol.

Connect Dark

Connect Dark removes minor light defects of dark cells.

Separate Dark

Separate Dark removes minor dark defects of light cells.

Operator Size

The **Operator Size** dropdown menu determines the size of the area or “pixel neighborhood” in which the enhance operation is being performed. The larger the operator, the larger the effect of the filter.

For example, using a **Connect Dark** enhancement with a **Large (7 x 7 pixel)** operator size will close 7-pixel-wide holes within a cell.

A **Small 3 x 3** operator size is sufficient for most applications.

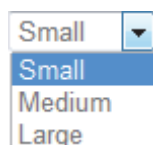

Small

Small corresponds to an area of **3 pixels by 3 pixels**.

Medium

Medium corresponds to an area of **5 pixels by 5 pixels**.

Large

Large corresponds to an area of **7 pixels by 7 pixels**.

2-11 Format Output and Configure Match String

2-11-1 Output Formatting Editor

The **Output Formatting Editor** provides many ways in which barcode data can be formatted and parsed before it is output as a data string. You can use the Output Formatting Editor to add a **Preamble** and **Postamble** of your choice to the beginning and end of the data output string. The Output Formatting Editor also allows you to control the order in which data is output, either by creating an explicit output string or by choosing one of the **Global Sorting Options** at the bottom of the Output Formatting Editor.

You can access Format Output in the left panel of the **Setup** view by setting **Format Output** to **On**, and then by clicking on the **blue Format String** example.

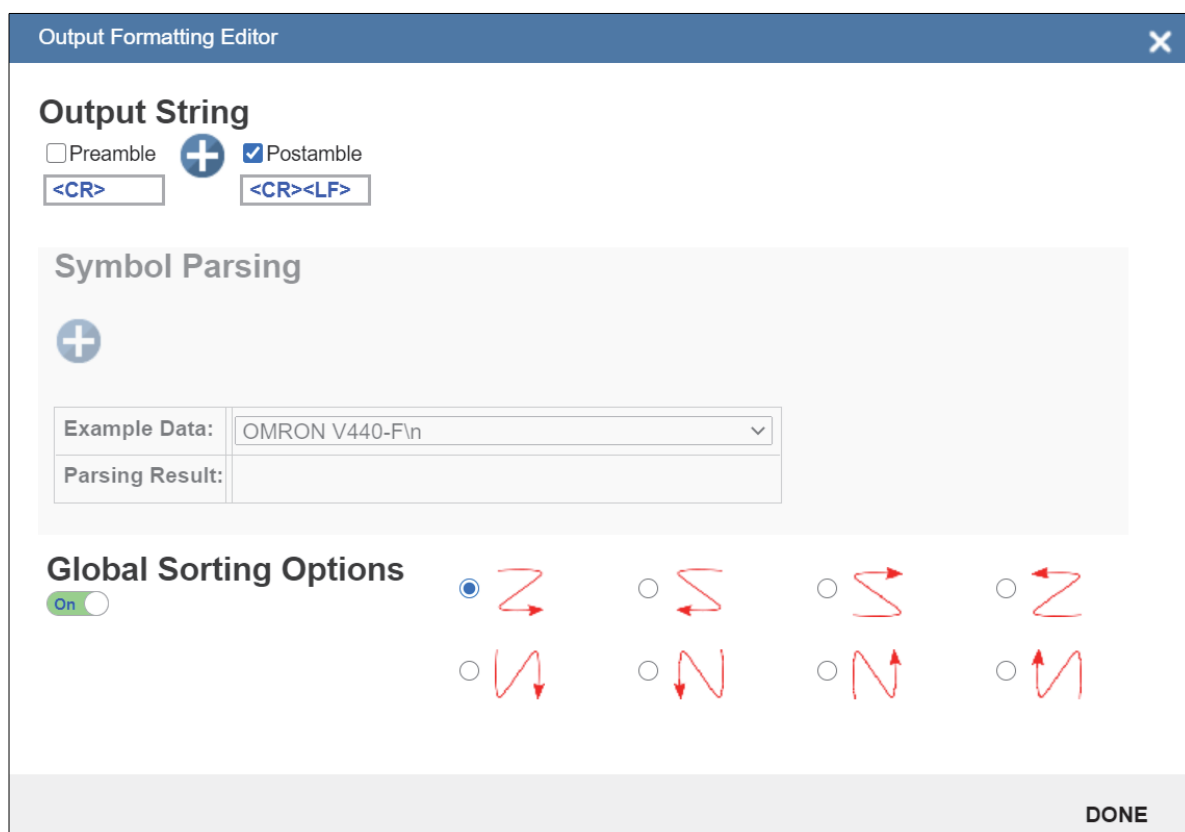
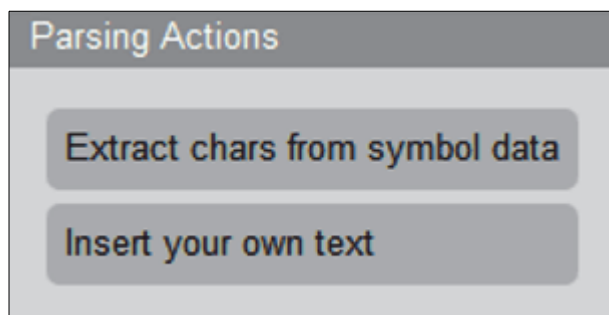

Match String Editor

Match Options and **Match String Database**, accessible by clicking the **Match String** section in the **Setup** view, allow you to set the match code mode, text output, new master, and match string database.

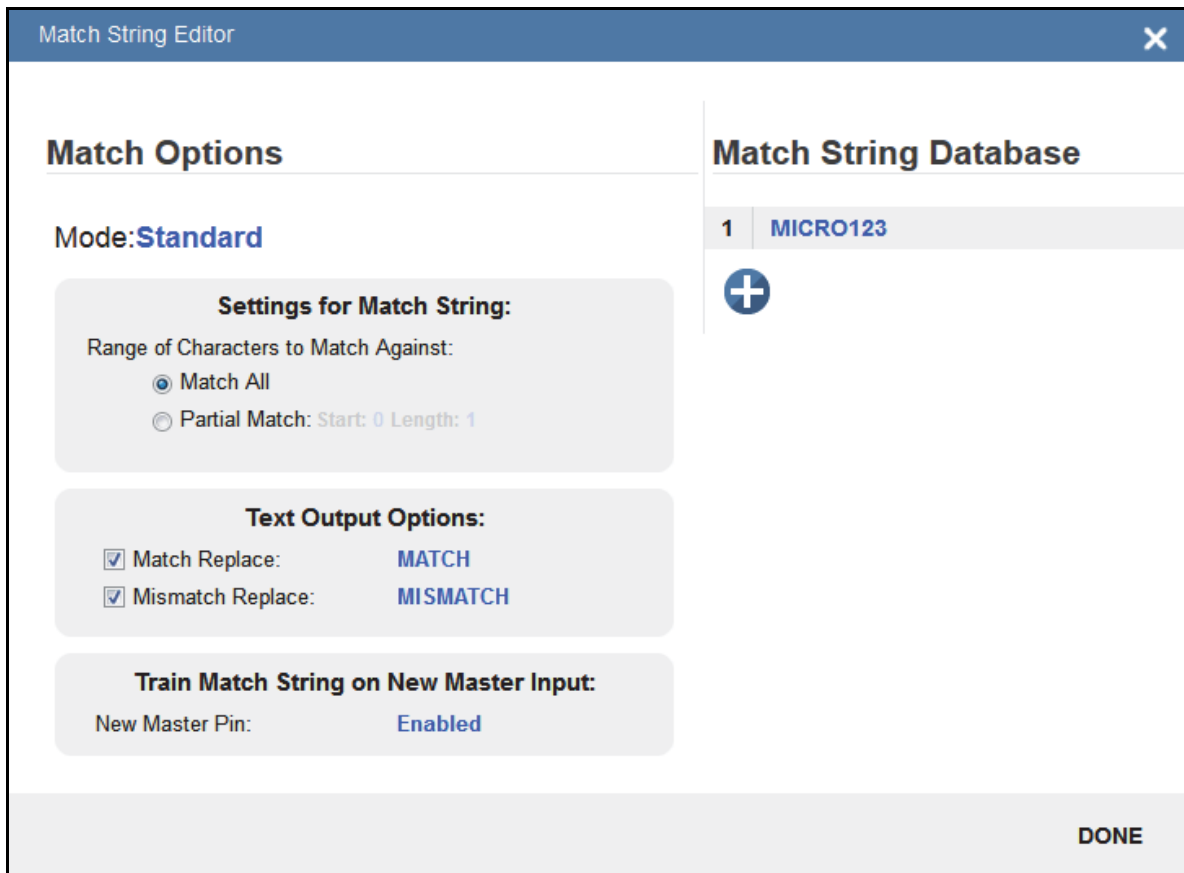

2-12 Configure Output 1, 2, 3 Settings

Bring up the **Output 1**, **Output 2**, and **Output 3** dialogs by clicking on the **Outputs** section at the lower left of the **Setup** view. For each output you can determine the **Output On** behavior, **Mode**, **Pulse Width**, and **State**. Outputs 2 and 3 also allow you to determine output behavior based on **Trend Options** parameters or **Verification Options** parameters.

This example shows the dialog that appears when you click **Symbol Quality Options**. A similar dialog would also appear for **Trend Options** under **Output 2**.

Note: The **1, 2, and 3 output indicators** at the lower right of the screen display the results of the last read cycle.

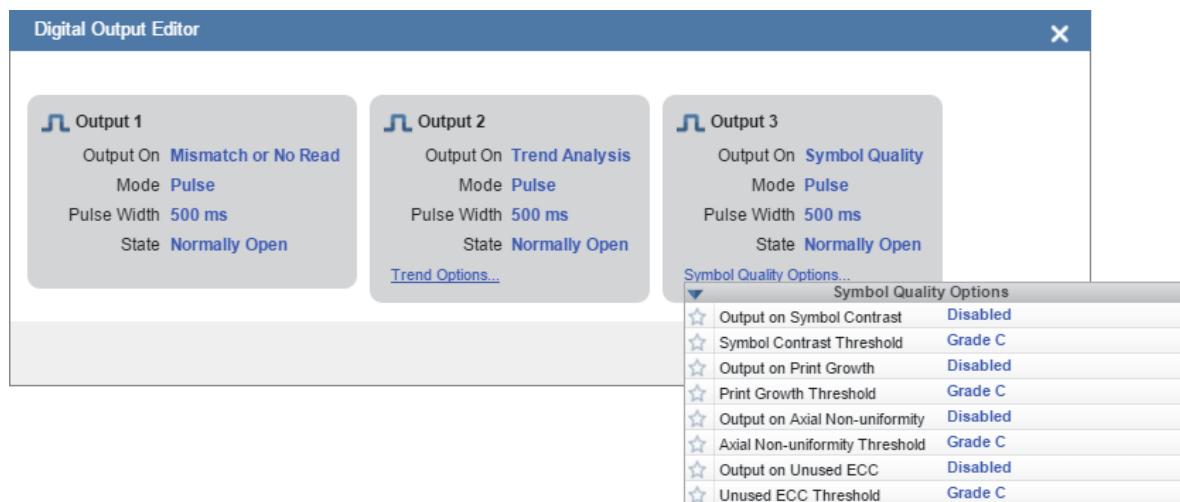

2-13 Run the Application

In the **Run** view, you can observe the progress of the setup as it follows the parameters you have defined. The right panel of the Run view shows **Counts** data for **Cycles**, **Reads**, **No Reads**, **Mismatches**, and **Read %**.

The right panel of the Run view also displays **Rate** data for **Capture**, **Decode**, **Overhead**, **Total Read**, and **Trigger Rate**, followed by a **Read Time** graph and the **Output Data** area at the lower right of the interface.

The "filmstrip" at the bottom of the Run view shows the sequence of image captures with a **green check mark** for each **Good Read** and a **red x** for each **No Read**.

Refer to **Section 5 – Run** for a more detailed description of the Run interface.

Increase the magnification of this page to read the descriptions in the image below.



The frequency with which the image is refreshed, expressed in hertz.

Reader part number.

Reader model name.

Reader IP address.

Reader serial number.

Triggered Outputs 1, 2, and 3 function both as indicators and buttons. They show when outputs are triggered, and they allow you to trigger outputs manually by clicking them. See Setup > Outputs for additional details.



Start



The **Start** view is the initial view you will see when the **WebLink** session begins.

3-1	Start	3-2
3-2	Assisted Setup	3-4
3-3	Reader Information	3-5
3-4	Setup Button	3-6

3-1 Start

The **Start** view is the initial view you will see when the WebLink session begins. The connected reader is shown, along with its **user-defined name**, **IP address**, **Reader Model**, **Serial Number**, **MAC ID**, **Firmware version**, **WebLink version**, **Sensor resolution**, and **Optics**.

Note: The **user-defined name** must be **19** characters or fewer.

This view also allows you to choose **Assisted Setup**, to **Create a New Setup**, or to **Load a Setup**.

Click the gear icon at the upper right to bring up the **Application Settings** menu. This menu includes several functions: **Save**, **New**, **Load**, **Advanced**, **Language**, **Terminal**, **Beeper**, **Image Storage**, **Reset Application or Factory Settings**, **Active Account Management**, and **About WebLink**.

Clicking **About WebLink** opens the dialog shown below, which shows the current **WebLink version**, **Reader Model**, **Serial Number**, **Part Number**, **MAC ID**, **Sensor resolution**, **Firmware version**, **Boot code version**, **Browser**, **Operating System**, and **Screen Resolution**.

Clicking **Contact us...** takes you to <https://automation.omron.com>.

Note: The information in this dialog is selectable so that you can copy it to a clipboard.

About WebLink



Reader Model V440-F
Serial Number 1112233
Part Number V440-FXXXY50M-NNX
MAC ID 00:0B:43:11:22:33
Sensor 2464x2048 (QSXGA)
Firmware 35-9000124-3.0.0
Boot 35-9000125-1.0.0-2011
Browser Chrome 87.0.4280.141
Operating System Windows 10
Screen Resolution 1920x1040

[Contact Us](#)

Done

3-2 Assisted Setup

When you click the **Assisted Setup** button in the **Start** view, a dialog will appear asking you a series of application-based questions. Based on your answers, WebLink generates your initial setup automatically. Once the setup is created, you can fine-tune its parameters in the **Setup** view.

The Assisted Setup dialog is designed to be logical and intuitive, and follows this sequence:

- You are asked which code types you will be reading in your application. Code types can be added by clicking directly in the code type field and selecting them from a drop-down menu.
- Then you are asked how many codes you need to read at once in a single read cycle. Type the number of codes you need to read directly in the text field or select a number using the up and down arrows.
- You are then given a selection of four application types, which represent the available selections in the **Cycle** area of the **left panel** in the Setup view. The icons represent the **Presentation**, **Continuous**, **Triggered**, and **Start / Stop** Cycle Types.
- The next question is whether or not you need the decoded data to match an existing string of data. This enables or disables **Match String**.
- If the answer to the previous question is **Yes**, a follow-up question appears asking for the exact output string that the decoded data must match. If the answer to the previous question is **No**, the follow-up question does not appear.
- Finally, you are asked if you want to rename the reader. If **Yes**, a text field appears in which you can type the reader's new name. The reader's MAC ID is also shown to the right of the text field.
- Click **Create Setup** to configure your WebLink setup automatically based on your answers to the Assisted Setup questions.

Note: Reader settings are defaulted when Assisted Setup settings take effect.

Assisted Setup

What code types will you be reading?

2D 1D Special

How many codes do you need to read at once? 1

Select the type of application.

Would you like to rename your reader? No

CANCEL CREATE SETUP

3-3 Reader Information

The **Reader Information** section of the **left panel** of the **Start** view shows your reader's **user-defined name**, **IP address**, **Reader Model**, **Serial Number**, **MAC ID**, **Firmware version**, **WebLink version**, **Sensor resolution**, and **Optics**.

Note: The **user-defined name** must be **19** characters or fewer.



V440-F112233
192.168.188.2

Reader Model: V440-F
Serial Number: 1112233
MAC ID: 00:0B:43:11:22:33
Firmware: 35-9000124-3.0.0.038
WebLink: 3.0.0
Sensor: 2464x2048 (QSXGA)
Optics: C-Mount

3-4 Setup Buttons

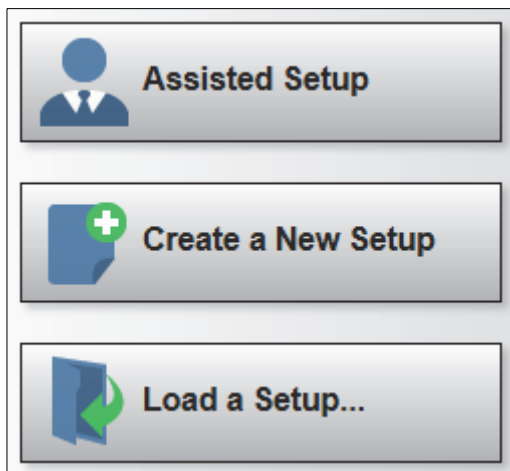

3-4-1 Assisted Setup

When you click the **Assisted Setup** button in the **Start** view, a dialog with a **series of questions** about your application will appear. Answering these simple questions allows WebLink to configure your setup for you.

3-4-2 Create a New Setup

Clicking **Create New Setup** allows you to create a new setup without using Assisted Setup. Create a New Setup will perform a software reset and will recall default parameters except Communication settings. The New Setup should not save to flash, so you should be able to cycle power to the reader and see the settings that were last saved to flash.

3-4-3 Load a Setup

Select **Load a Setup** to load an existing **.wls** WebLink setup file. The **.wls** file contains all current reader settings.

4

Setup

The **Setup** view allows you to configure all aspects of a setup. Multiple discrete sections of the **WebLink** interface give you the ability to set **Autocalibration**, **Cycle**, **Acquire**, **Decode**, **Matrix Mode**, **Match String**, **Format Output**, **Outputs**, **Configuration Database**, and **Favorites**.

4-1	Setup	4-2
4-2	Traing using Autocalibration.	4-4
4-3	Cycle	4-9
4-4	Acquire	4-18
4-5	Decode	4-19
4-6	Matrix Mode	4-22
4-7	Match String	4-30
4-8	Format Output	4-34
4-9	Outputs	4-43
4-10	Configuration Database.....	4-45
4-11	Configure Daisy Chain (If Required by Application).....	4-67
4-12	Favorites	4-75

4-1 Setup

The **Setup** view allows you to configure all aspects of the **Read Cycle Sequence** on the left side of the user interface: **Autocalibration**, **Cycle**, **Acquire**, **Matrix Mode**, **Decode**, **Match String**, **Format Output**, **Outputs**, and **Favorites**.

Clicking the **flash icon** at the upper right saves current settings to the reader's flash memory so the settings will be available when the reader is rebooted.

The **question mark icon** at the upper right opens **WebLink Help**.

The **gear icon** at the upper right brings up the **Application Settings** menu.

Note: The **1, 2, and 3 output indicators** at the lower right of the screen display the results of the last read cycle.

The screenshot shows the OMRON V440-F C-Mount Code Reader Setup interface. The top navigation bar includes 'Start', 'Setup', and 'Run' buttons. The left sidebar, titled 'Read Cycle Sequence', contains the following settings:

- Cycle:** Continuous (checked), Timeout after 1000 ms, Look for 1 codes (unchecked), Allow Duplicates (unchecked), Configuration Database (Off).
- Acquire:** 2840 μs, 25% (checked).
- Matrix Mode:** Off.
- Decode:** 2D (checked), 1D (unchecked), Special (unchecked), Enhance: Disabled.
- Match String:** Off.
- Format Output:** Off, Preamble <CR> (unchecked), Postamble <CR><LF> (checked), Replacements: 0, Remove Control Characters (unchecked), Remove Extended Characters (unchecked).
- Outputs:** 1: Mismatch or No Read, 2: Mismatch or No Read, 3: Use as Ext. Illumination Strobe.
- Favorites:** Light Source, External Strobe.

The central camera view shows a QR code being scanned. The right sidebar displays performance metrics:

Counts	
Cycles	5595
Reads	N/A
No Read	N/A
Mismatch	N/A
Read %	N/A

Rate	
Capture	36.1 ms 27.7%
Decode	51.7 ms 19.3%
Overhead	0.4 ms
Total Read	88.2 ms 11.3%
Trig Rate	88.5 ms 11.29/s

Below the rate table is a 'Read Time (ms)' graph and an 'Output Data' list showing multiple successful reads of 'OMRON V440-F'. The bottom status bar shows 'Refresh Rate: 1.040 Hz' and 'V440-F112233 | V440-F | 192.168.188.2 | 1112233'.

The **gear icon** at the upper right brings up the **Application Settings** menu. This menu includes several functions: **Save**, **New**, **Load**, **Advanced**, **Language**, **Terminal**, **Beeper**, **Image Storage**, **Reset Application** or **Factory Settings**, **Activate Account Management**, and **About WebLink**.

The Application Settings menu is displayed with the following options:

- Save
- New
- Load
- Advanced
- Language...
- Terminal
- Beeper
- Image Storage

At the bottom, there are buttons for 'Reset: Application | Factory', 'Activate Account Management...', and 'About WebLink...'.

Click **About WebLink** to display your current **WebLink version**, **Reader Model**, **Serial Number**, **Part Number**, **MAC ID**, **Sensor resolution**, **Firmware version**, **Boot code version**, **Browser**, **Operating System**, and **Screen Resolution**.

Clicking **Contact Us...** takes you to <https://automation.omron.com>.

About WebLink



Reader Model V440-F
Serial Number 1112233
Part Number V440-FXXXY50M-NNX
MAC ID 00:0B:43:11:22:33
Sensor 2464x2048 (QSXGA)
Firmware 35-9000124-3.0.0
Boot 35-9000125-1.0.0-2011
Browser Chrome 87.0.4280.141
Operating System Windows 10
Screen Resolution 1920x1040

[Contact Us](#) Done

4-2 Train using Autocalibration

This section describes how to perform **Autocalibration** in the WebLink user interface.

The Autocalibration function is used to automatically determine the best combination of image acquisition and image preprocessing parameters that will result in optimum decoder performance on a single difficult to read symbol in the field of view.

The following settings are optimized during Autocalibration:

- **Exposure**
- **Gain**
- **Morphology**
- **Morphology Size**
- **Binning**

The calibration algorithm performs an exhaustive search for the optimum combination of the above parameters that will result in the highest decode success rate, with the lowest decoding time variance between successive read cycles. Decode speed is also optimized, but is secondary to high success rate and low read time variance. Decode success and decode time repeatability are critical to real time production line performance.

4-2-1 Steps to Take Before Autocalibration

Ensure Adequate Resolution

You should choose the correct lens and reader standoff to ensure the adequate resolution for either 1D or 2D code reading. Two pixels per thin bar on a 1D code, or 5 pixels per cell on a 2D code are considered a good starting place. Refer to **2-2-1, Determining the Optical Setup**, to determine exact resolution and optical setup for customer applications.

Optimize Lighting

You must position the reader, and choose the best type of lighting to create the highest contrast image possible, with the lowest amount of background noise.

Set Good Focus

Set the aperture of the C-Mount lens to F5.6 or F8 to ensure good depth of field. Use a lower F# if fast exposure times are more important than Depth of Field. Focus the lens using live video mode so that the code is in good focus.

Perform Quick Photometry

Perform a Quick Photometry operation with the code in the center of the field of view.



4-2-2 Perform Training

Click the **Train** button and select the **Target** icon as shown below.

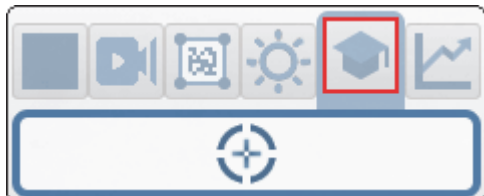

Set the crosshairs on the center of the code and click the mouse again to activate the **Autocalibration** routine. Autocalibration progress will be shown in WebLink's **Image Area**.

Labels normally do not need to be trained, but if so will take about 15-30 seconds with Window of Interest Framing on, and 30-45 seconds without.

DPM codes will often benefit from training. Training can take up to 60 seconds with Window of Interest Framing on, and 90 seconds without. The better the initial image, the faster calibration will be.

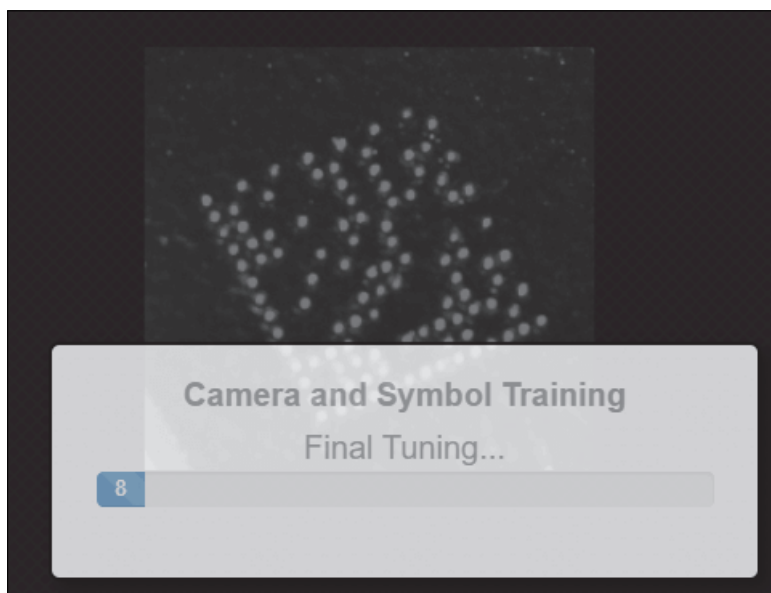

When Autocalibration is complete, you will see a message stating whether it has passed or failed. If it passes, the reader's settings will be optimized to decode the symbol on which it has just been calibrated.

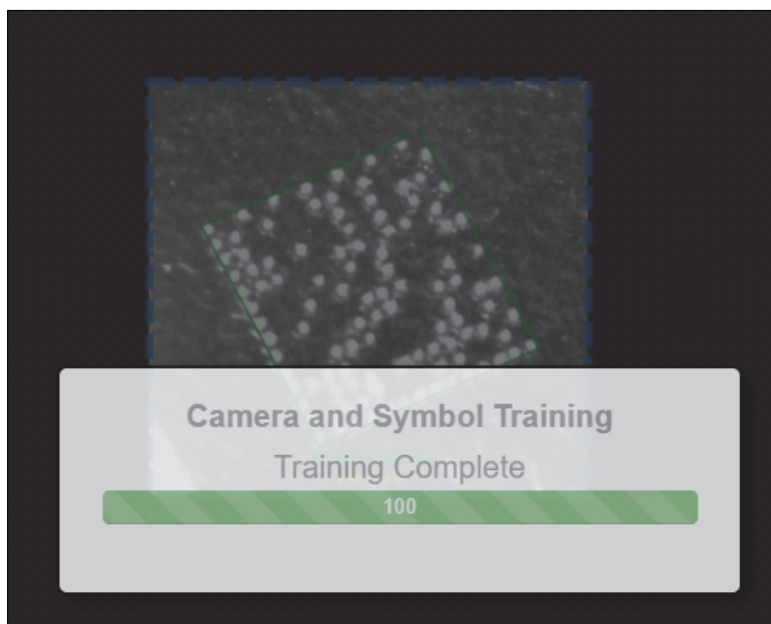

4-2-3 Steps to Take After Autocalibration

You can also use the **Optimize** button to enhance the decode capability further. Optimization will set the type of code, as well as the number of rows and columns within the code. Decode time can be significantly reduced using this feature, but only codes with the same number of rows and columns can be read.



4-2-4 Autocalibration Performance Improvements

Typical Autocalibration performance improvements are shown below. In this example, **pre-Autocalibration** decode time is **110.2 msec**, **post-Autocalibration** is **14.3 msec**, and **post-Optimization** is **9.8 msec**.

	Rate	
Capture	124.8 ms	8.0/s
Decode	110.2 ms	9.1/s
Overhead	0.0 ms	
Total Read	172.7 ms	5.8/s
Trig Rate	424.8 ms	2.35/s

	Rate	
Capture	34.1 ms	29.3/s
Decode	14.3 ms	70.0/s
Overhead	0.1 ms	
Total Read	48.5 ms	20.6/s
Trig Rate	298.4 ms	3.35/s

	Rate	
Capture	34.1 ms	29.3/s
Decode	9.8 ms	101.7/s
Overhead	0.3 ms	
Total Read	44.1 ms	22.7/s
Trig Rate	293.9 ms	3.40/s

4-2-5 Additional Calibration Options

The following settings can be configured in the **Calibration Options** section of the **I/O Menu**, located in **Advanced Settings > I/O**.

- **Window of Interest Framing** can be set to reduce the area of the image that is analyzed during Autocalibration. The area is reduced to the code size plus twice the Window Margin and Linescan height (width and height). Autocalibration will be approximately 30 seconds faster when the function is enabled, and will generally produce a better result. The reduced window size is maintained and used thereafter for both Setup and Runtime processing of the code, but can be resized with the ROI / WOI button.
- **Window of Interest Margin / Linescan Height** – These values dictate the size of the **Window of Interest WOI** used during the calibration operation as well as post-calibration during runtime. The **Margin** is the amount added to left and right of the code. **Linescan Height** is the amount added to the top and bottom of the code. By reducing the pixel area, Autocalibration operates much faster, as does runtime.

Calibration Options		
☆	Window of Interest Framing	Row and Column
☆	Window of Interest Margin	75
☆	Linescan Height	64

4-2-6 Autocalibration Theory

1 During Autocalibration, the system methodically cycles combinations of **Exposure**, **Gain**, **Morphology**, and **Pixel Binning**. For each combination, the system takes **5** pictures and then makes the following measurements, which it combines into an overall score for that attempt.

Signal Strength is defined as how many times the supplied image was **decoded successfully** with a frequency of **5Hz**, or every **5** images.

Interference is defined as any interference that will cause the X-Mode **object search algorithm** to have a high deviation between inspections.

Noise is defined as any interference that will cause the X-Mode 1D or 2D **detection algorithm** to have high deviation between inspections.

Propagation Disturbance is defined as any disturbance or noise in the image that will cause the **overall inspection time** to have a high deviation between inspections. This disturbance can be caused by:

- Background environment;
- Glare from the lighting;
- Reflections from the object on which the symbol is located;
- Anything that causes the **Interference** and **Noise** parameters to have a high deviation.

2 Scores for each measurement are based on this table:

SCORE	SIGNAL STRENGTH	INTERFERENCE	NOISE	PROPAGATION DISTURBANCE
5	Excellent	Nil	Nil	Nil
4	Good	Slight	Slight	Slight
3	Moderate	Moderate	Moderate	Moderate
2	Severe	Severe	Severe	Severe
1	Extreme	Extreme	Extreme	Extreme
0	Does not exist	N/A	N/A	N/A

- The overall score for the parameter set is calculated as a **weighted sum** of all the individual measurements:

VALUE	DESCRIPTION
EXCELLENT	The weighted sum of: Signal Strength + Interference + Noise + Propagation Disturbance = 5.0
GOOD	The weighted sum of: Signal Strength + Interference + Noise + Propagation Disturbance = 4.0
MODERATE	The weighted sum of: Signal Strength + Interference + Noise + Propagation Disturbance = 3.0
SEVERE	The weighted sum of: Signal Strength + Interference + Noise + Propagation Disturbance = 2.1
EXTREME	The weighted sum of: Signal Strength + Interference + Noise + Propagation Disturbance = 1.0

3 The system then chooses the highest overall scoring parameter set.

Note: The overall score value is calculated to four decimal places.

It is completely normal for there to be multiple sets of parameters that produce images evaluated as **Excellent** with high scores varying by just **0.0001**. **The algorithm is designed to choose the highest value for all of the scores.** This means that the algorithm might first choose an **Exposure** of **2000** and a **Gain** of **25**. The second time, it might choose an **Exposure** of **1000** and a **Gain** of **50**, based on slight changes in conditions when the Autocalibrations were performed. These two settings produce nearly identical images, however. The system chooses the one with the highest value. An example of this is shown below.

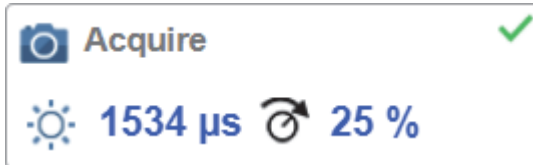
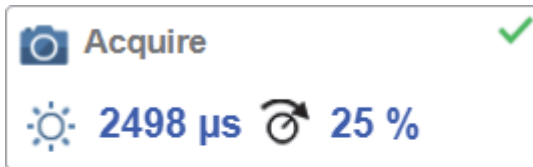

4-3 Cycle

4-3-1 Introduction

The reader can operate in a number of modes from a continuous reader to a triggered reader. The **Cycle** determines how the reader will operate. Setting up the read cycle type and parameters will involve a series of decisions based on your particular application:

- 1** Select the cycle type. The choices are either the free-running **Continuous Mode** or one of the various triggered modes: **Triggered**, **Start/Stop**, or **Custom**.
- 2** Select the **number of symbols (either 1D or 2D codes, depending on your application)** to be decoded in a single cycle. The reader can satisfy this condition by reading one or more symbols in a single image frame or across multiple image frames. The reader will communicate **pass** if it finds all symbols, and **fail** if it does not. Note that the reader will not read and count a symbol if it is the same code type and contains the same data as a previous code.
- 3** Choose whether or not to allow the reader to **read duplicate codes** and to include them as symbols found and as part of the output data.
- 4** Decide how the cycle will start by choosing the trigger type to be used. If free-running, the reader will start automatically. If triggered, you must select **Serial Trigger** and choose a serial character for the trigger, or if through I/O, you must choose either the **External Level** or **External Edge Trigger Mode**.
Note: Use **Cycle > Custom** or **Advanced Settings > Read Cycle** to set the **Trigger Mode**.
- 5** Designate how the read cycle should end: **Good Read**, **Timeout**, **New Trigger**, or **Last Frame**.
- 6** Select the **Capture Mode** – either **Continuous** or **Rapid Capture**.
- 7** If in Rapid Capture, select the **Number of Captures**, and the modes **Timed Capture** or **Triggered Capture**.
- 8** If Timed Capture, set the **Time Before First Capture** and **Time Between Captures**, if any.

4-3-2 Common Settings for all Cycle Modes

The following four settings are common settings for all read cycle modes:

Look for # Codes – This is the number of codes that the reader should find in each decode cycle. If the reader finds all codes, the decode cycle will pass. If it does not find all codes, the cycle will fail and only the codes it finds will be output. The remaining codes will be listed as No Read. This value can be set from **1** to **400**, but **70** is typically a practical limit in an average complex scene. This is because the algorithm is limited by the overall number of edge candidates that it can process. In this case it is recommended that you use **Matrix Mode** or multiple ROIs to surpass this practical limit.

Timeout After – This is the amount of time the reader is allowed to spend for the entire read cycle, acquiring and processing images until all codes are read. You should set this value long enough to be able to decode in all circumstances, but short enough to prevent the reader from taking longer than the allowed cycle time of the production line. This value can be set from **10 milliseconds** to **65 seconds (655,350 ms)**.

Allow Duplicates – The check box tells the reader what to do if it finds codes with the same content. By default, the reader will ignore duplicate codes. It will not count them as one of the codes it is set to find, and it will not include them in the output string data. If Allow Duplicates is checked, duplicate codes will be counted and included as part of the output string.

Configuration Database – Enable or disable the Configuration Database as part of the read cycle. The Configuration Database is described in detail in **Setup > Configuration Database**.

The different cycle modes are explained in detail below.

4-3-3 Continuous Mode

In **Continuous Mode**, the reader is in a continuous free-running state. Parts can be presented to reader at will. During the cycle, the reader will continuously acquire and process images until all symbols are found or until a user-defined **timeout** is reached. If the timeout is reached, “**Nothing was output**” will be displayed in the **Output Data**.

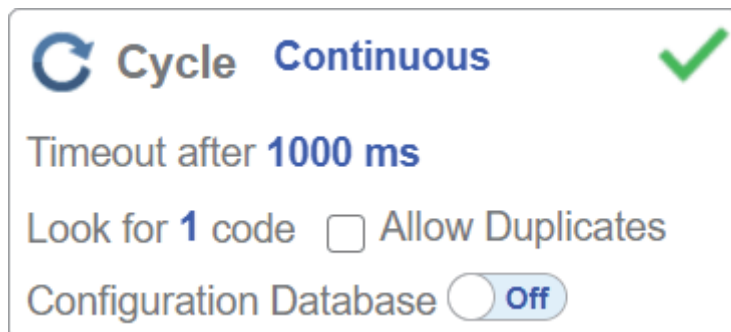

4-3-4 Triggered Modes

Introduction

In the various triggered modes, the read cycle starts with a trigger. The cycle will end and the reader will output data after decoding the expected number of codes, or after reaching the end of read cycle condition. The cycle time includes one or more Capture Times and Decode Times depending on the setup.

Triggers

In all modes, the units are set respond to both Serial Triggers through RS-232 or TCP, and to physical input triggers. You are able to set the Serial Trigger characters. The physical trigger is typically set to edge-based, searching for a transition, but in some cases it's level-based, either high or low. Detailed physical trigger parameters can be set in the **Trigger** section of the **Advanced Settings > Read Cycle** menu.

Image Buffering and Pipeline Processing

In all of the triggered modes, acquisition and image processing can occur in parallel. As images are acquired, they are put into a buffer pool. When processing is ready, it takes the image out of the buffer pool and analyzes it. This allows faster overall processing.

It also allows for an **initial burst mode** where the reader can capture all required images from a fast moving part and then analyze each in turn as it has time. This is accomplished by setting the **Delay Between Images** to 0.

The size of the buffer pool is finite, however. If all required images for the read cycle cannot fit in the buffer pool, the **Delay Between Images** must be set to a value high enough that processing can keep up, with **Acquire** typically set to slightly longer than the average processing time.

Note: The maximum size of this buffer is dependent on the maximum image size in the system. It can contain twenty 5MP images before reusing. If a **Window of Interest WOI** is used to get even smaller images, the maximum number of captures that can be contained in the buffer pool before overwriting is 254.

Clicking the **question mark** icon next to the **Capture Mode** displays a diagram showing how the read cycle sequence will operate in the **Trigger Mode** to which it is currently set. The examples below are from the **Read Cycle Sequence's Cycle** editor in the **Setup** view's left panel, and from **Advanced Settings > Read Cycle**.

Cycle Triggered ✓
 Serial Trigger Character <SP>
 Trigger Delay 0 μs
 Timeout after 1000 ms
Capture Mode: Continuous ?
 Look for 1 code Allow Duplicates
 Configuration Database Off

Advanced Settings [X]
 Camera Setup | Communications | **Read Cycle** | Symbolologies | I/O | Symbol Quality | Match String | >
 Search for settings [] ★ ■ ▼
Capture Mode

☆	Capture Mode	<i>Continuous</i>	?
☆	Number of Burst Captures	1	

4-3-4-1 – Triggered with Capture Mode = Continuous

Continuous Capture

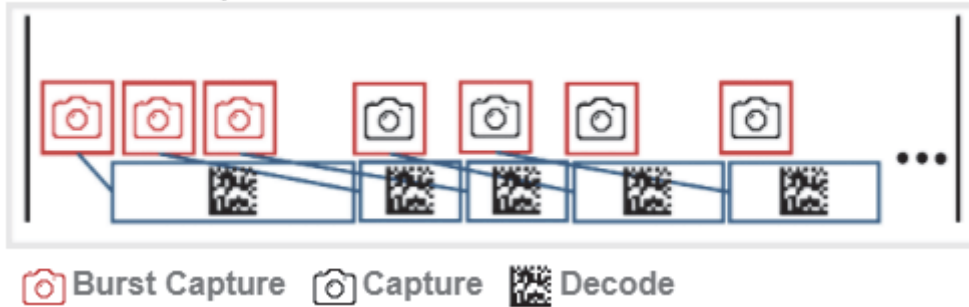

Triggered with Capture Mode = Continuous is useful in motion applications with slower line speeds or where symbol position or spacing may be random or not time-dependent. The read cycle starts with a trigger. An initial **Burst of Captures** is taken. The reader begins processing the first captured image and extracts a **decode** while at the same time it captures the second image. The reader will then continuously take another capture after every decode until all symbols are found, until the timeout is reached, or until a new trigger is received.

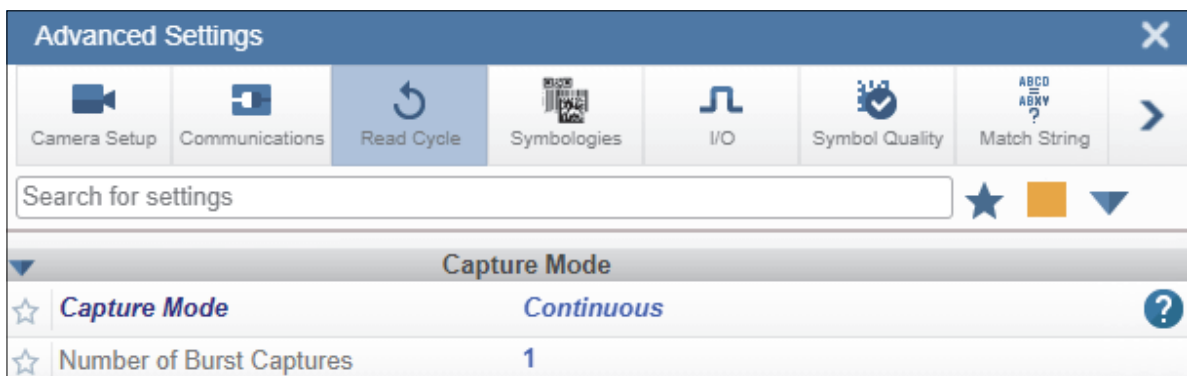
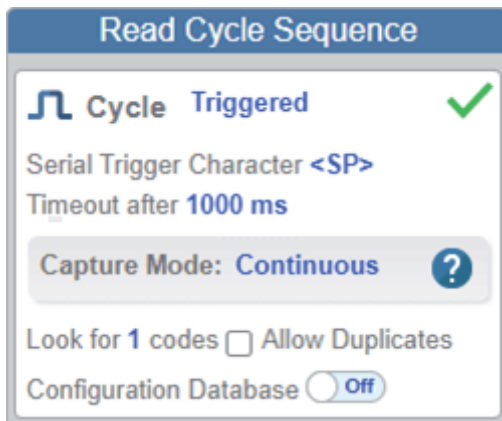

- **Serial Trigger Character** – Sets the serial input trigger character. The reader will also respond to an edge change on the physical trigger input.
- **Trigger Before 1st Capture**– This is the amount of time between when the trigger is received and when the reader takes the first picture. This is useful for adjusting code position on a moving line.
- **Capture Mode = Continuous** – The reader will continuously acquire and process images. Acquisition and processing are overlapped.
- **Number of Burst Captures** – This is the number of initial captures the reader will take at the start of the read cycle before waiting for a decode, at which time the reader will take another capture. **Number of Burst Captures** can be found in **Advanced Settings > Read Cycle**.

4-3-4-2 – Triggered with Capture Mode = Rapid Capture; Rapid Capture Mode = Timed Capture

Rapid Capture (Timed Capture)

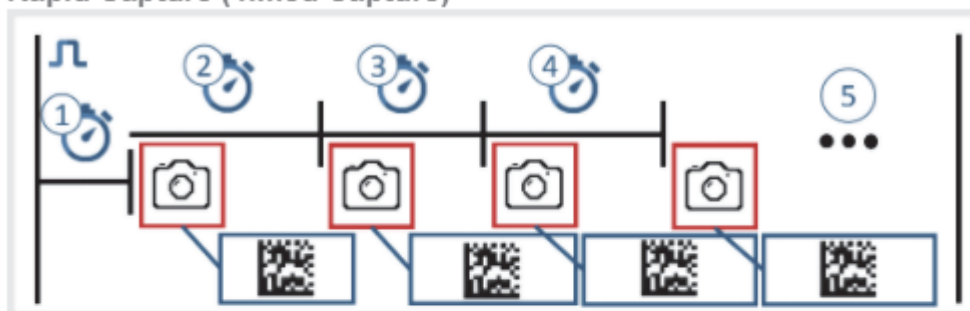

Capture Decode Trigger

Time Before 1st Capture Time Between Captures 1-2

Time Between Captures 2-3

Time Between Captures 3-4

Number of Captures or No Limit

Timed Rapid Capture is useful in fast-moving applications in which codes are only in the field of view for a short time and precise timing is required to read all the codes. In this mode the read cycle starts with an initial trigger. During the cycle, the reader will continuously acquire new captures based on the **time between captures** and place them in a buffer. Each buffered image will be processed in turn until all symbols are found, all captures are processed, or the **timeout** is reached.

The **time between captures** can be set to very small intervals, such that the reader can capture all images on a small or very fast-moving part. It is typically set to a longer interval to be able to catch all the codes on larger parts, or on slower-moving lines. Refer to **Image Buffering and Pipeline Processing** above.

Cycle Triggered

Serial Trigger Character <SP>

Timeout after 1000 ms

Capture Mode: Rapid Capture

Num Captures: 1

Rapid Capture Mode: Timed Capture

Time Before 1st Capture: 0 μ s

Delay Between Images: 200000 μ s

Look for 1 codes Allow Duplicates

Configuration Database Off

Serial Trigger Character – Sets the serial input trigger character. The reader will also respond to an edge change on the physical trigger input.

Trigger Before 1st Capture– This is the amount of time between when the trigger is received and when the unit takes the first picture. This is useful for adjusting code position on a moving line.

Capture Mode = Rapid Capture – The reader will continuously acquire and process images. Acquisition and processing are overlapped.

Num Captures – This is set to the number of captures required to see the codes after the initial trigger. Set the number of captures to **no limit** and it will take captures continuously.

Rapid Capture Mode = Timed Capture – The reader will acquire images on a timed basis.

Delay Between Images Time Between Captures in Advanced Settings – **0** for burst mode. Set slightly longer than the processing time for normal operation.

Advanced Settings		
Camera Setup	Communications	Read Cycle
Symbologies	I/O	Symbol Quality
Match String		
Search for settings		
☆	Decodes Before Output	1
▼ Capture Mode		
☆	Capture Mode	Rapid Capture
☆	Number of Captures	1
☆	Rapid Capture Mode	Timed Capture
▼ Capture Time		
☆	Time Before 1st Capture	0 μs
☆	Time Between Captures 1-2	200000 μs
☆	Time Between Captures 2-3	200000 μs
☆	Time Between Captures 3-4	200000 μs
☆	Time Between Captures 4-5	200000 μs
☆	Time Between Captures 5-6	200000 μs
☆	Time Between Captures 6-7	200000 μs
☆	Time Between Captures 7-8	200000 μs

4-3-4-3 – Triggered with Capture Mode = Rapid Capture; Rapid Capture Mode = Triggered Capture

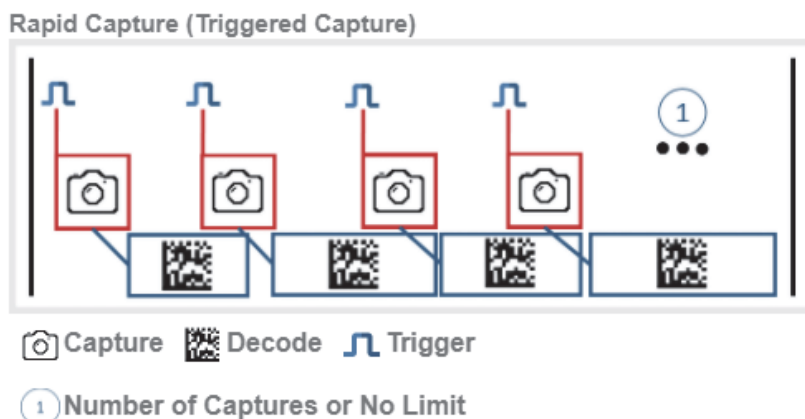

Triggered Rapid Capture is useful in applications where each decode must be treated as a discrete event, regardless of symbol data. In this mode the read cycle starts with an initial trigger. During the cycle, the reader will continuously acquire new captures based on subsequent triggers and place them in a buffer. Each buffered image will be processed in turn until all symbols are found, all frames are processed, or the **timeout** is reached.

Each new trigger should be sent when the code is expected to be in the field of view. The trigger spacing should be set so the processing can keep up with the acquisition in order not to overrun and overwrite the buffer pool. Typically this is set slightly longer than the processing time.

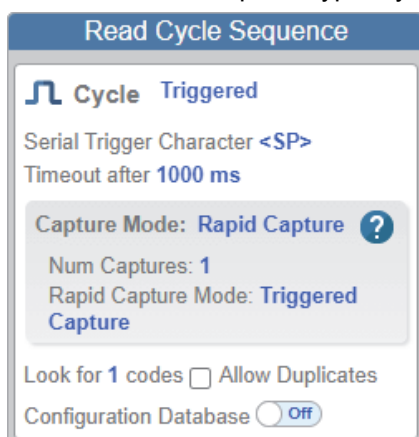

- **Serial Trigger Character** – Sets the serial input trigger character. The reader will also respond to an edge change on the physical trigger input.
- **Capture Mode: Rapid Capture** – The reader will continuously acquire and process images. Acquisition and processing are overlapped.
- **Num Captures** – This is set to the number of captures required to see the codes after the initial trigger.
- **Rapid Capture Mode = Triggered Capture** – The reader will acquire images on a triggered basis.

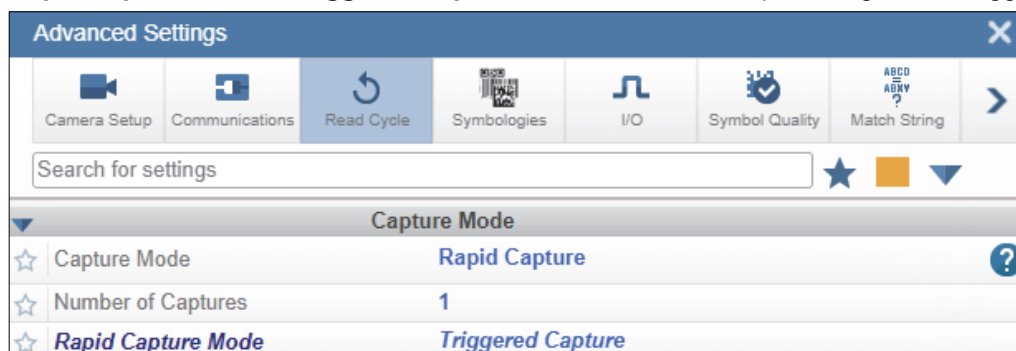

4-3-5 Start/Stop

In **Start / Stop mode**, the reader will enter **Continuous Read** mode when the start trigger is received, and exit when the stop trigger is received or when the timeout is reached. Even if the timeout stops the cycle, the stop trigger must be sent in order to close out the cycle completely. Data is output as soon as possible, but can be set to output only at the end of the read cycle. This can be configured in **Advanced Settings > Read Cycle**.

Serial Trigger Non-Delimited Off – When **Serial Trigger** is set to **Off**, the reader will respond to the I/O trigger **External Level. High** will start the read cycle and **Low** will end it.

Serial Trigger Non-Delimited On – When **Serial Trigger** is set to **On**, the reader will respond to **Serial Triggers**. It will also respond to the I/O trigger **External Level**. By default, the start and stop characters are set to **S** and **E**.

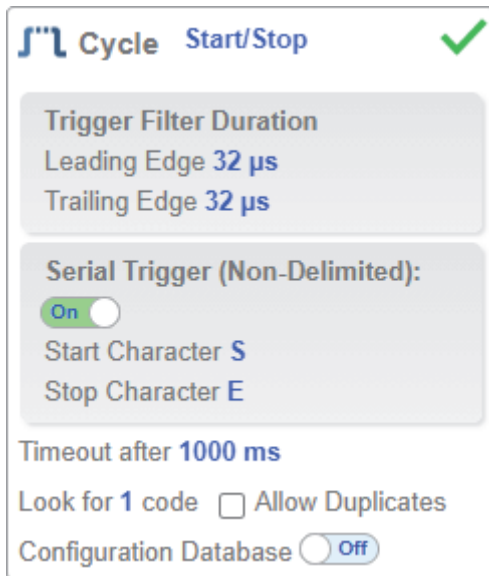

- **Trigger Filter Duration Leading / Trailing** – The amount of time the trigger must be present to be detected.
- **Serial Trigger Delimited** – Sets if I/O or Serial Trigger and I/O mode are used.
- **Start / Stop Characters** – Characters used for Serial Trigger.

4-3-6 Custom

This mode allows you a wider variety of read cycle scenarios, including **Continuous Read**. Use **Custom** to select **Trigger mode**, **Serial Trigger Character**, and **Trigger Delay**; to select **Capture Mode** and set **Number of Captures**, **Rapid Capture Mode**, and **Delay Between Images**; and to select the **End Cycle On** setting as well as **Timeout**, **Number of Codes**, **Allow Duplicates**, and **Enable / Disable Configuration Database**.

Clicking the **question mark** icon next to the **Capture Mode** displays a diagram showing how the read cycle sequence will operate in the **Trigger Mode** to which it is currently set.



Note: You can configure one of the cycle modes described above and then set **Cycle** to **Custom**. This will show the exact settings for that mode.

 **Cycle** Custom

Trigger: Serial Data and Edge
Serial Trigger Character <SP>

Capture Mode: Rapid Capture ?

Num Captures: 1
Rapid Capture Mode: **Timed Capture**
Time Before 1st Capture: 0 μ s
Delay Between Images: 200000 μ s

End cycle on
Timeout or New Trigger
Timeout after 1000 ms

Look for 1 codes Allow Duplicates
Configuration Database Off

Trigger:

Serial Data and Edge v

Continuous Read

Continuous Read 1 Output

External Level

External Edge

Serial Data

Serial Data and Edge

End cycle on

Timeout or New Trigger v

Timeout

New Trigger

Timeout or New Trigger

Last Frame

Last Frame or New Trigger

4-4 Acquire

Acquire settings allow you to set **Exposure** signified by the sun icon, and **Gain** signified by the dial and right-pointing arrow icon in real time. Clicking any of these settings will cause a control to appear, allowing you to modify that setting. Settings take effect immediately.

Exposure can be set from **16 μ s** to **400 msec**. Gain can be set from **0%** to **100%**.

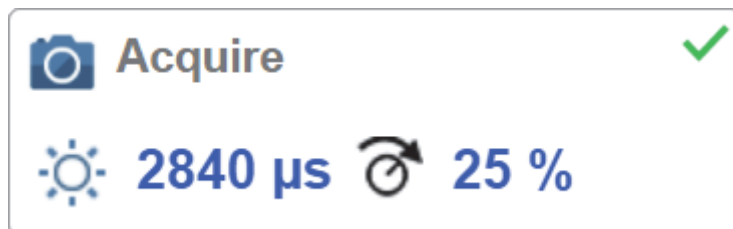

4-4-1 Quick Photometry

Clicking the **Quick Photometry** button will automatically set the optimal **Exposure** and **Gain** settings for the current image. This is a recommended first step when setting up an image. You can also adjust the values manually. Manual adjustment is useful when a short Exposure time is required to freeze the image in dynamic moving applications.



4-5 Decode

The **Decode** area of the **Setup** view allows you to choose which symbologies code types you want to enable, and allows you to configure the parameters for those symbologies.

See **Symbologies** for **Advanced Decoding Parameters**.

The **Decode** area shown below allows you to select which symbologies the system will search for during the read cycle. Clicking the check boxes highlighted in the image below to the left of the **2D**, **1D**, and **Special** symbology categories turns on all symbologies within that category simultaneously.

You can also turn off all symbologies within a category simultaneously by unchecking its corresponding check box. In the image below, for example, the check box for the **Special** category is unchecked, meaning that none of the code types in that category are enabled.

If only some symbologies within a category have been enabled, the check box displays a dash. In the image below, for example, the check boxes for the **2D** and **1D** categories display a dash, meaning that only some of the code types in those categories are enabled.

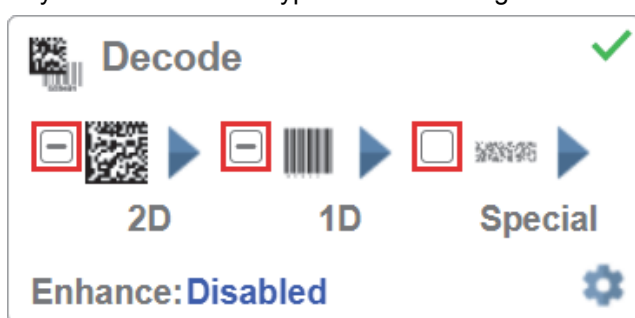

Click the symbols themselves highlighted in the image below to bring up a list of all the code types available in that symbology category.

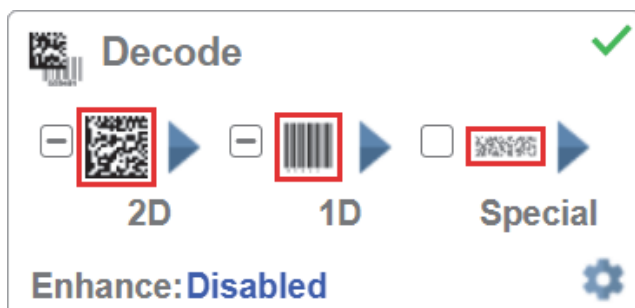

For example, if you click the Data Matrix symbol above **2D** in the Decode area, you will see a list of all supported 2D code types. You can enable or disable specific code types from the list by clicking them on or off. In the example below, the green-highlighted code types are enabled and Aztec Code is disabled.

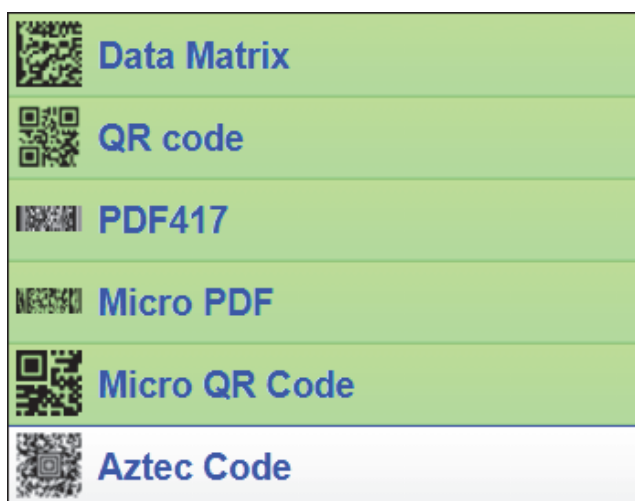

4-5-1 Symbology Settings

Clicking the **gear** icon at the bottom of the **Decode** area brings up **Symbology Settings**.

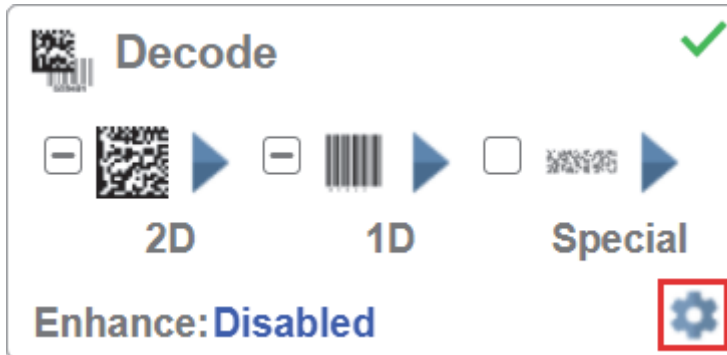

Symbology Settings allows you to configure every parameter of every code type supported by WebLink. All parameter changes take effect immediately.

Symbology Settings Example 1 - Data Matrix Parameters

Symbology Settings		
Data Matrix	Data Matrix	
QR code	☆ ECC 200 Status	Enabled
Code 128	☆ DMRE	Disabled
Code 39	☆ Use Alignment Pattern	Disabled
Codabar	Data Matrix Legacy	
Code 93	☆ ECC 000 Status	Disabled
I2of5	☆ ECC 050 Status	Disabled
UPC	☆ ECC 080 Status	Disabled
PDF417	☆ ECC 100 Status	Disabled
Micro PDF	☆ ECC 140 Status	Disabled
BC412	☆ ECC 120 Status	Disabled
	☆ ECC 130 Status	Disabled

Symbology Settings Example 2 - DotCode Parameters

Symbology Settings		
Dot Code	☆ <i>DotCode</i>	<i>Enabled</i>
	☆ Rotation Mode	No Rotation
	☆ Expected Rows	0
	☆ Expected Columns	0

4-5-2 Enhance

The **Enhance** dropdown menu at the bottom of the **Decode** area allows you to select the pre-processing method for codes within an image using morphology.

Note: When running in normal mode, the image pre-processing enhancement function applies to all codes within the image. When using the **Configuration Database** function, pre-processing only affects codes within a specific region of interest ROI or window of interest WOI.

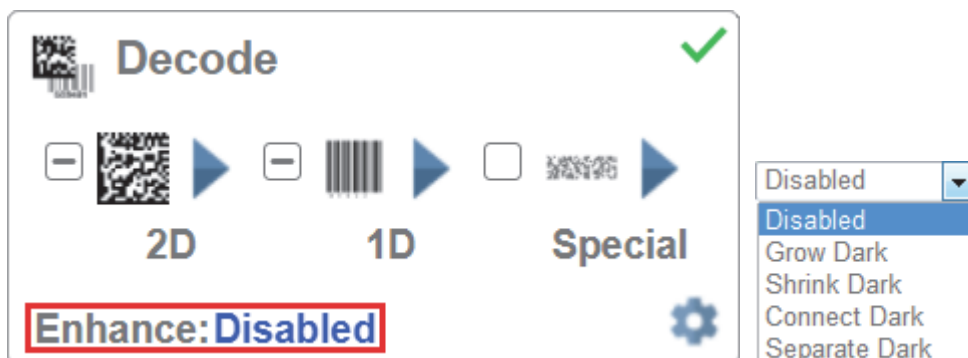

Grow Dark

Grow Dark increases the dark cell size of a symbol. It is useful for increasing the dark cell size of a dark-on-light Data Matrix symbol.

Shrink Dark

Shrink Dark increases the light cell size of a symbol. It is useful for increasing the light cell size of a light-on-dark Data Matrix symbol.

Connect Dark

Connect Dark removes minor light defects of dark cells.

Separate Dark

Separate Dark removes minor dark defects of light cells.

Operator Size

The **Operator Size** dropdown menu determines the size of the area or "pixel neighborhood" in which the enhance operation is being performed. The larger the operator, the larger the effect of the filter.

For example, using a **Connect Dark** enhancement with a **Large (7 x 7 pixel)** operator size will close 7-pixel-wide holes within a cell.

A **Small 3 x 3** operator size is sufficient for most applications.

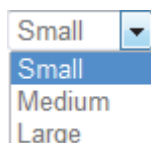

Small

Small corresponds to an area of **3 pixels by 3 pixels**.

Medium

Medium corresponds to an area of **5 pixels by 5 pixels**.

Large

Large corresponds to an area of **7 pixels by 7 pixels**.

4-6 Matrix Mode

Matrix Mode allows you to set up the system to read an array of symbols within a matrix using individual **Regions of Interest ROIs** for each code. This results in higher speed and higher decoding reliability than using a single region of interest for all symbols. Additionally, Matrix Mode can be set to decode from **1** to **400** individual symbols, while a single ROI is limited to **100** symbols. Finally, Matrix Mode simplifies sorting and output of data in user-specified order.

A 5 x 6 array is shown below.



Recommendation for Successful Use of Matrix Mode: When setting up Matrix Mode, you can initially set the **Cycle** to **Continuous Mode** so the system constantly reads and updates. This provides real-time feedback on how ROI or imaging adjustments affect decoding. Cycle can also be set to **Trigger**, in which case you can enable virtual triggers to send a constant stream of triggers to the system.

Note: When setting up a matrix to look for a large number of symbols, you may want to increase the **Cycle Timeout** to a high value while setting up the grid to ensure the reader has sufficient time to decode all cells. The overall cycle time is shown in the reports on the right side of the screen so you can determine the actual amount of time the matrix will require.

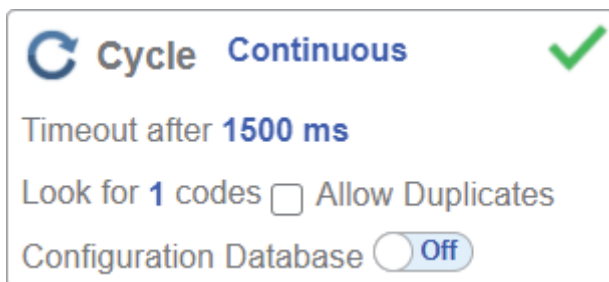

4-6-1 Setting Up a Matrix

Begin by setting **Matrix Mode** to **On**. Matrix Mode opens with a single row / single column matrix, and in **Position** adjustment mode.

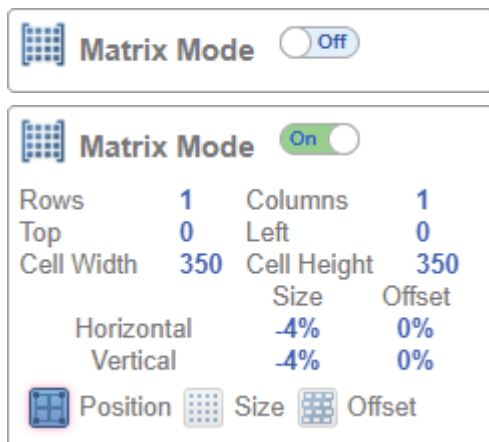

You will see a blue ROI in the upper left corner of the image. Drag the ROI into position, center it on the top left symbol, and size it to the approximate grid spacing.



Next, set the number of rows and columns to match the entire matrix.

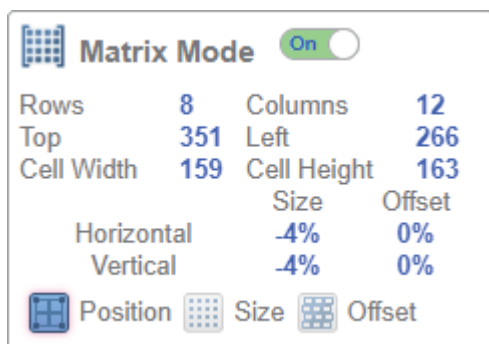

Note that **Look for n codes** in the **Cycle** editor is the correct value matching the matrix, which in this example is **96**. Setting a **Look for n codes** value is required for the system to perform all decodes.

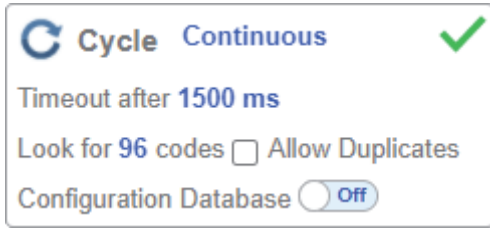

Next, drag and resize the entire grid so that all codes are centered in their own search areas. The entire grid area can be moved easily by clicking on it with the mouse and dragging it. The grid area can also be resized by clicking on any of the ROI anchor points and dragging them to the desired position.

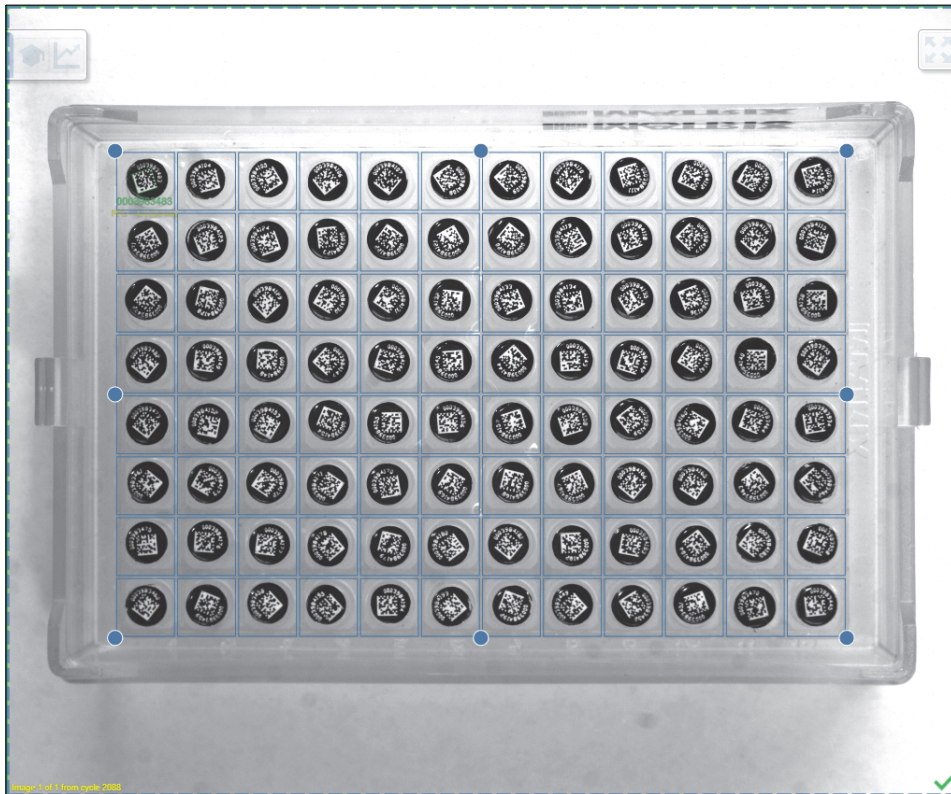

You can switch modes in the dialog box between adjusting the **Position**, **Size**, and **Offset** of the individual ROI search areas.

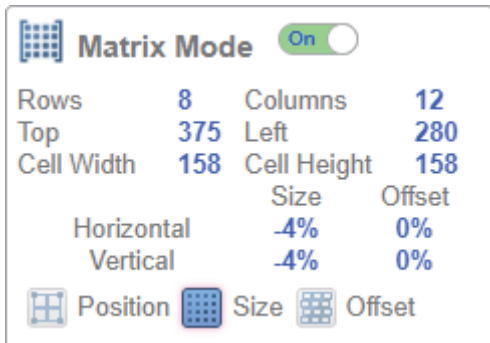

You can also switch between Position, Size, and Offset modes by clicking the appropriate icon on the screen. Clicking the icon will toggle from one setting to the next.



Adjustments to the horizontal and vertical size of the search areas, or offsets, are made using the sliders on the left and bottom of the matrix area. Slide up or to the right to make ROIs bigger with overlap. Slide down or to the left to make ROIs smaller around each code.

The same control is used to configure **Offset**. Offset shifts every other row or column to the right or left, or up or down. This is useful when setting up interstitial grid types. An example of Offset is shown in **Section 4-6-5 – Advanced Control – Offset**.

Clicking the **Reset** icon at the bottom left of the two axes will reset the **Size** or **Offset** to zero.

In the image below, the ROIs have been made smaller around each code to optimize decode time.

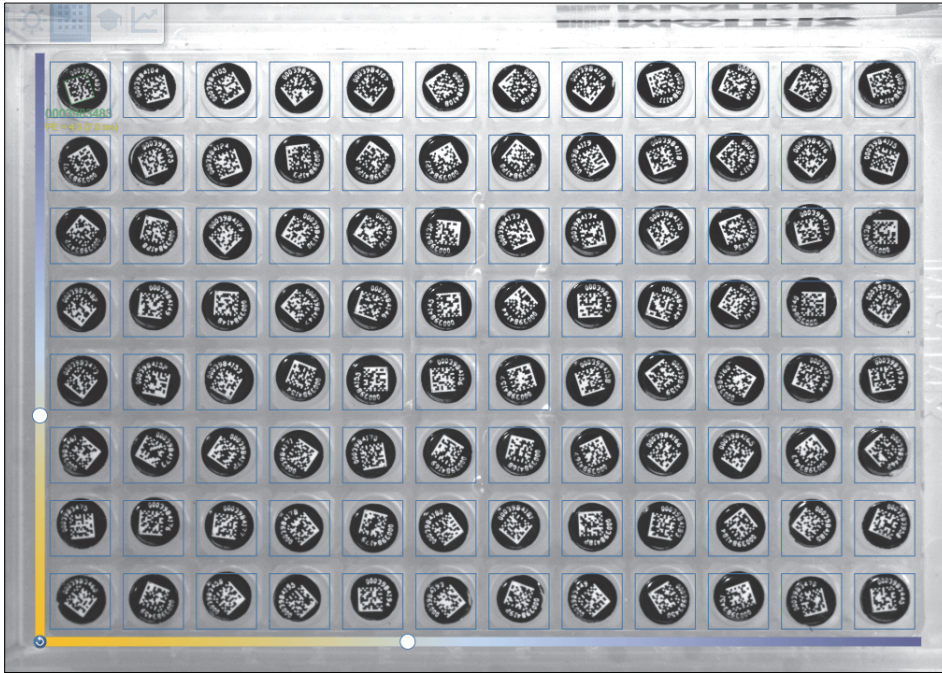

When setup of the ROIs is complete, all items should decode successfully. Setting triggering to **On** allows you to see adjustments in real time.

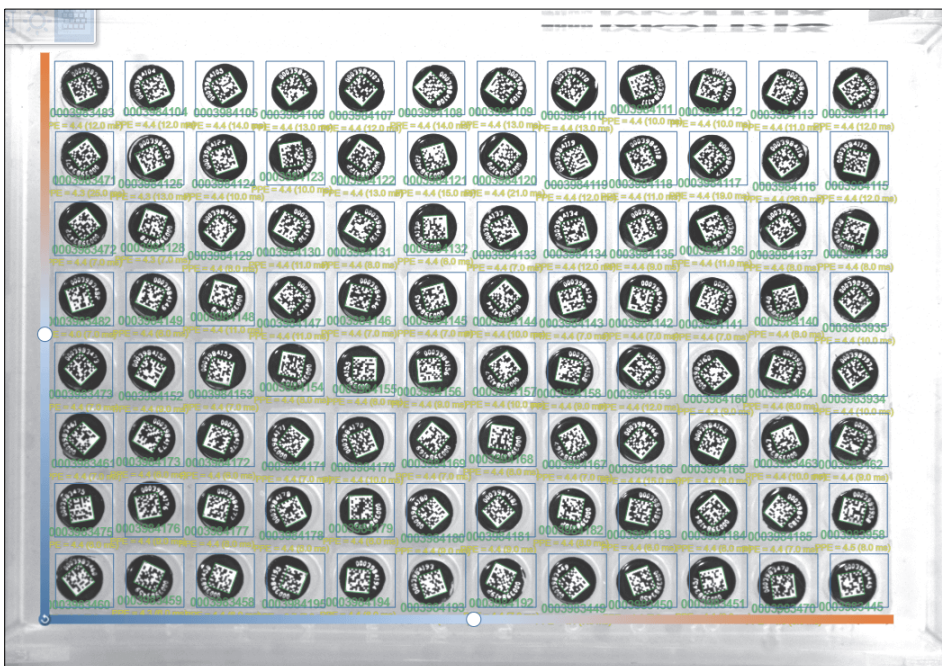

4-6-2 On-Screen Reporting

The decoded data and decode time is shown for each code. The decoded data shows if decodes are successful for each cell. The decode time allows you to determine if there are any issues with uniformity of lighting across the image. Each code should have roughly the same decode time in a well-illuminated image.



The **Rate** report window on the right side of the screen displays image **Capture** time, as well as the **Decode** time and **Total Read** time for all search areas. The Rate view also displays the **Overhead** and **Trigger Rate** values.

The **Matrix Info** window shows decode timing statistics for reading all symbols within the grid, including how many codes were found.

The sorted string which is **top-left** to **bottom-right** by default is shown in the **Output Data** window.

Rate		
Capture	152.5 ms	5.2/s
Decode	1334.5 ms	0.6/s
Overhead	9.4 ms	
Total Read	1496.4 ms	0.6/s
Trig Rate	1438.7 ms	0.70/s

Matrix Info	
Min Time	5.0 ms
Max Time	29.0 ms
Avg. Time	13.0 ms
Success	96 / 96

Output Data
0003983483,0003984104,0003984105,0003984106,0003984107,0003984108,0003984109,0003984110,0003984111,0003984112,0003984113,0003984114,0003983471,0003984125,0003984124,0003984123,0003984122,0003984121,0003984120,0003984119,0003984118,0003984117,0003984116,0003984115,0003983472,0003984128,0003984129,0003984130,0003984131,0003984132,0003984133,0003984134,0003984135,0003984136,0003984137,0003984138,0003983482,0003984149,0003984148,0003984147,0003984146,0003984145,0003984144,0003984143,0003984142,0003984141,0003984140,0003983935,0003983473,0003984152,0003984153,0003984154,0003984155,0003984156,0003984157,0003984158,0003984159,0003984160,0003983464,0003983465,0003983466,0003983467

4-6-3 Data Output

Matrix data is output from top-left to bottom-right by default. If you need the data to be output in a different order, turn on **Format Output**, add a symbol to the **Output Formatting Editor**, and then change the type to **Matrix** by clicking on the type above the added symbol. Then turn on **Global Sorting Options** at the bottom of the Output Formatting Editor and select the desired output order for the decoded data.

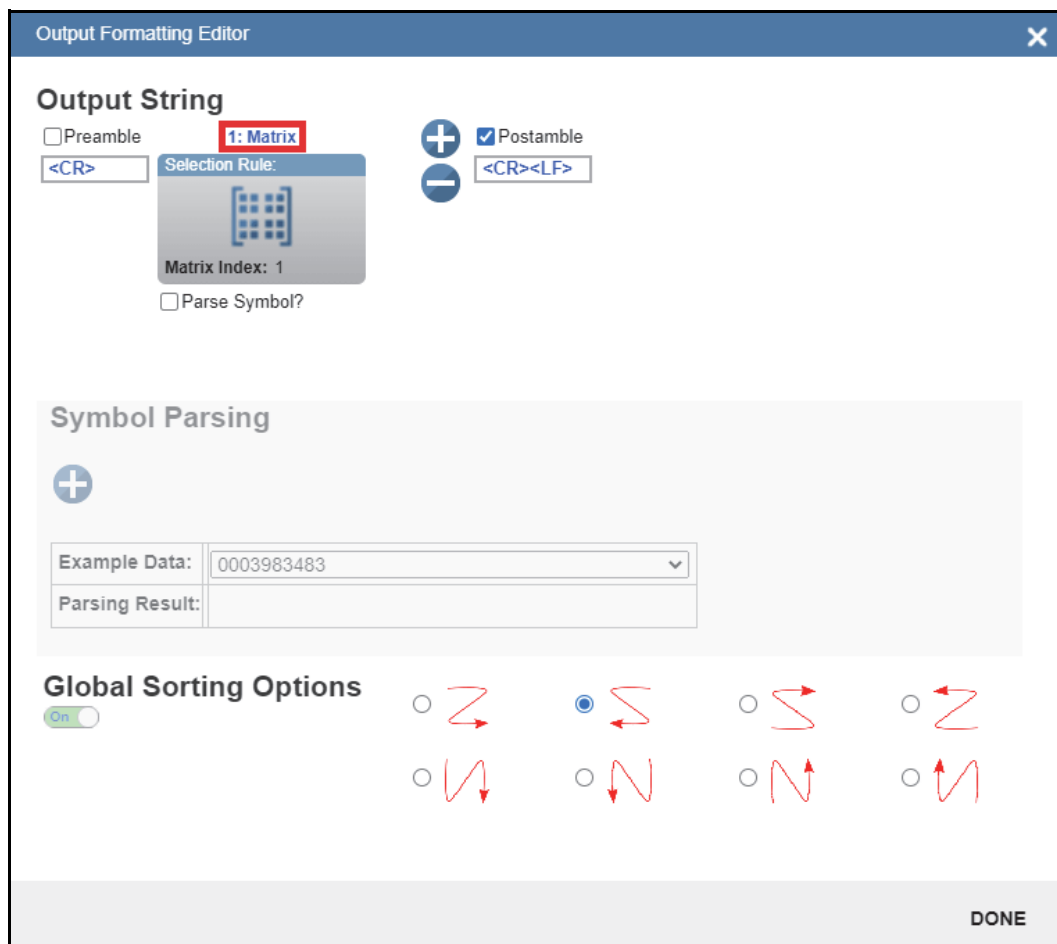

4-6-4 Run Mode

Set **Cycle** to the appropriate **Trigger Mode** for your application and move from the **Setup** view to the **Run** view.

Note: When multiple captures are enabled for **Rapid Capture** or **Timed Capture**, the system is able to find all the codes in the matrix over a series of images.

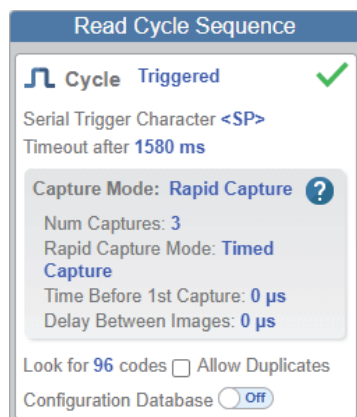

Below is an example of the matrix being decoded with a single capture in the **Run** view.

Below is an example of the matrix being decoded with multiple captures. In this example, most symbols are decoded in the first image, and the remaining symbols in the second image. Results are compiled and output in a single group and in the correct order upon conclusion of the read cycle.

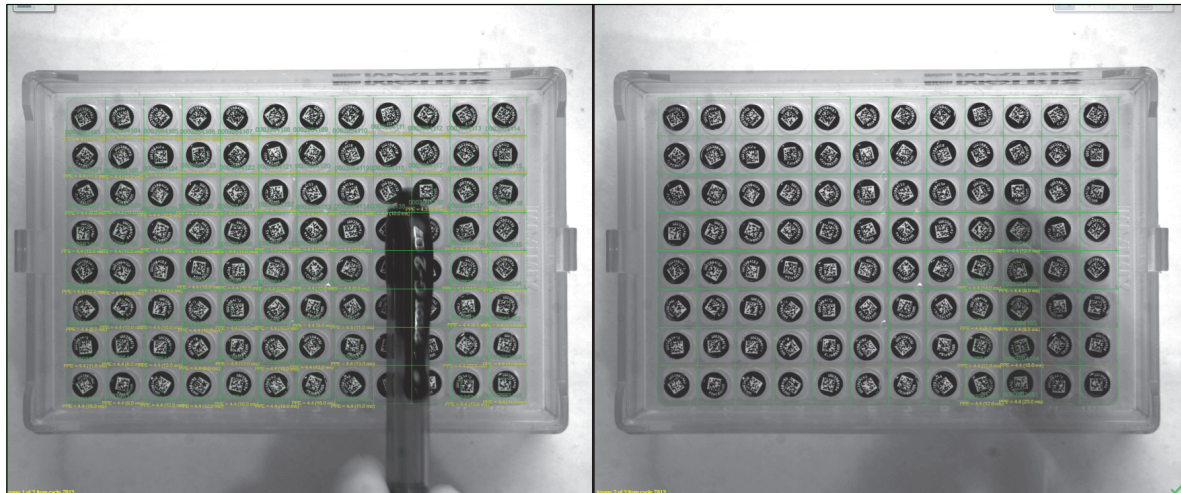



4-6-5 Advanced Control - Offset

There is an additional control that allows you to adjust the horizontal and vertical offset of the even-numbered rows and columns. In the example below, the bottom slider is used to adjust the horizontal offset of the even rows. This is useful for interstitial array types.

 **Matrix Mode**

Rows	8	Columns	12
Top	375	Left	280
Cell Width	158	Cell Height	158
		Size	Offset
Horizontal		-18%	0%
Vertical		-24%	0%

 Position  Size  Offset

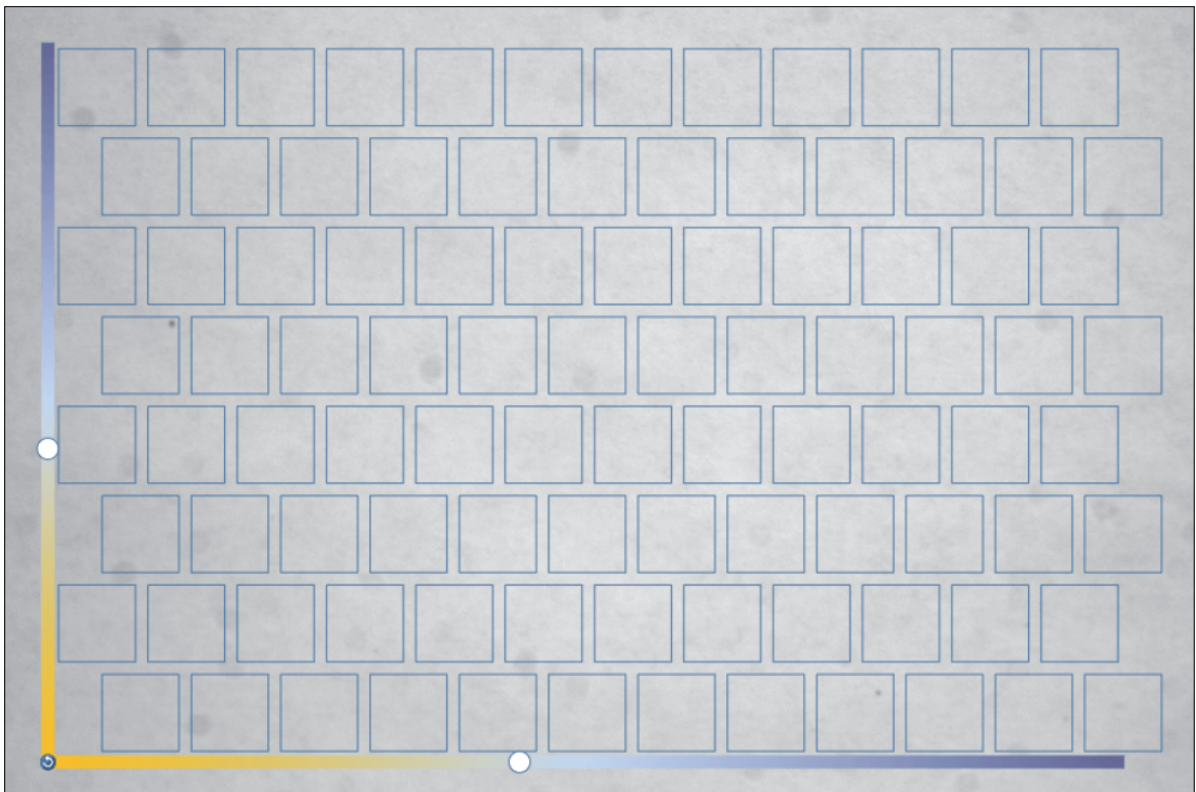

4-7 Match String

Match String will attempt to match to the decoded data. It will not attempt to match to the Formatted Output Data.

Note: Match String can only be used in **Triggered**, **Start/Stop**, and **Custom** modes. It cannot be used in Presentation or Continuous modes.

To open the **Match String Editor**, go to the **Setup** view and turn Match String **ON** as shown below.

Then click on the **Mode** link (shown as **Standard** in the example below) to open the **Match String Editor**.

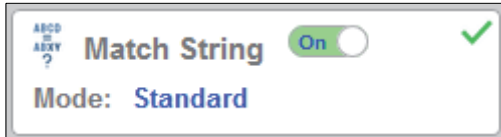

In the **Match String Editor**, click on the **Mode** link under **Match Options** to select your **Match String Mode** – **Standard**, **Wildcard**, or **Sequential**.

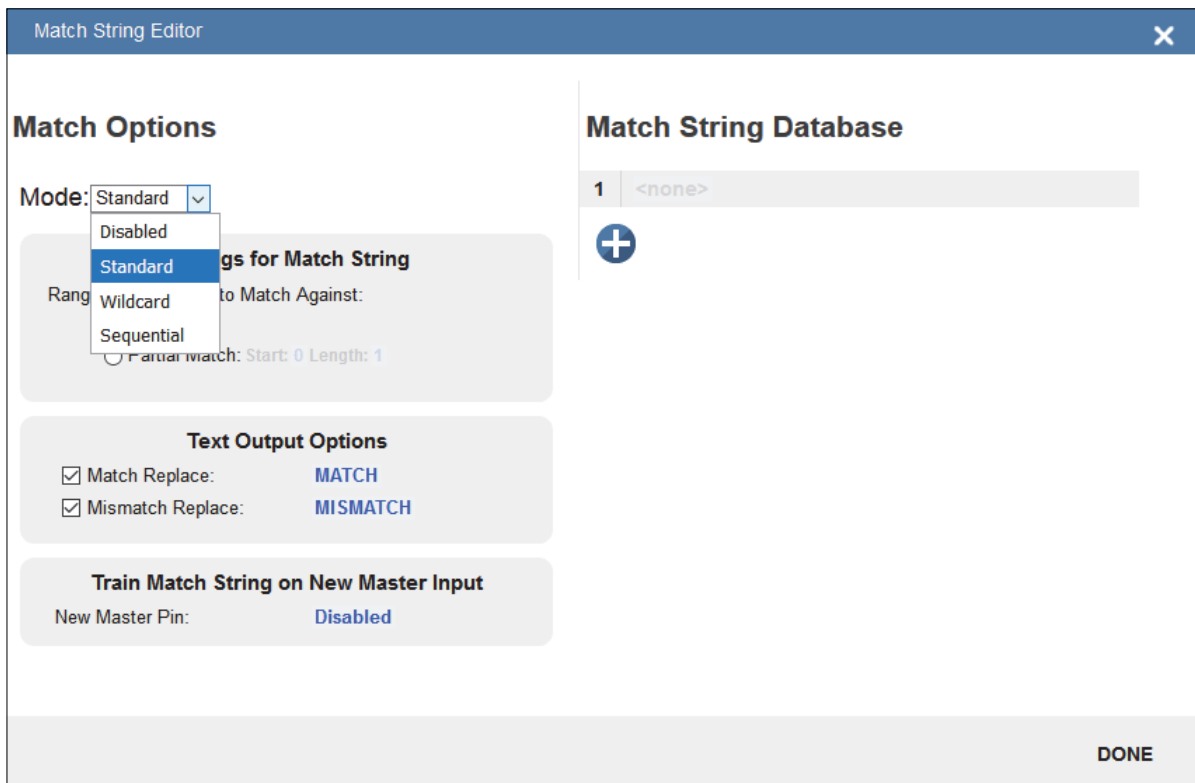

4-7-1 Standard and Wildcard Modes

Standard mode allows you to match total or partial barcodes by defining strings in the **Match String Database**.

Wildcard mode allows you to create custom matches using wildcards and placeholders.

A **wildcard** is a single character that can act as one or more character. A **placeholder** is a character that can substitute for exactly one character.

Standard Mode

Select **Match All** under **Settings for Match String**.

Under **Match String Database**, input the exact decoded data as it appears when you scan the barcode. Match All is working correctly if it successfully matches a barcode of the same length and character sequence that you input in the Match String Database.

Now select **Partial Match** under **Settings for Match String**. Choose a start position and length based on the barcode you're scanning. Partial Match works by using the Start and Length fields and attempting to match the exact portion of text defined in the Match String Database in that location.

For example, if the decoded symbol data is **1234567**, Start=**1**, Length=**2**, and the input in the Match String Database is **12**, the match would be successful because characters **12** are in the portion of the barcode data defined by the Start and Length fields.

Try achieving several of your own Partial Matches on several portions of your barcode data, changing the Start and Length fields each time.

In both **Match All** and **Partial Match**, you can output custom text upon a successful or unsuccessful match. These fields can be activated and edited by clicking on **Match Replace** and **Mismatch Replace**.

If you enter several inputs into the **Match String Database**, the application will attempt to match all of them. If one match is successful, then the other failures are ignored, and the match is considered successful.

Wildcard Mode

The screenshot shows the 'Match String Editor' window. On the left, under 'Match Options', the mode is set to 'Wildcard'. Below this are three sections: 'Settings for Wildcard Mode' with Wildcard: * and Placeholder: ?; 'Text Output Options' with checkboxes for Match Replace (MATCH) and Mismatch Replace (MISMATCH); and 'Train Match String on New Master Input' with New Master Pin: Disabled. On the right, the 'Match String Database' has one entry: '1 <none>' with a plus icon below it. A 'DONE' button is at the bottom right.

Wildcard mode gives you the ability to use wildcards and placeholders to search for matches. By default the Wildcard is * and the Placeholder is ?

You can use these wildcard and placeholder definitions when they input text into the **Match String Database**.

A **wildcard** represents one or more characters of any type. For instance, ***TEST*** looks for the text "TEST" in barcode data with any amount of characters before or after it.

***TEST** looks for the text "TEST" in barcode data with any number of characters before it, but "TEST" at the end.

TEST* looks for the text "TEST" at the beginning of the barcode data, with any number of characters after it.

If you had a barcode with data **1234567** and tried to match to the entire data string using **123***, you would have a successful match.

If you tried to match that same barcode data using ***123**, you would be unsuccessful because **123** appears at the beginning of the barcode. It's important to remember that the wildcard character * always stands for one or more unknown characters.

Now try to match a portion of the barcode you're scanning by using ***YOURTEXT***. If the text "YOURTEXT" appears somewhere in the middle of the barcode, the match will be successful.

A **placeholder** represents one character of any type. For example, **???TEST** tries to match a barcode that contains three characters of any type followed by the text "TEST". **???TE?T** attempts to match a barcode that contains an unknown character where the 'S' previously appeared.

Placeholders and wildcards can also be used together in the **Match String Database** input fields. The concepts of both are still the same: a wildcard represents one or more unknown character, and a placeholder represents exactly one unknown character.

An example of a complex match using wildcards is shown below. Recall that wildcards and placeholders are * and ? by default, but they can be redefined.

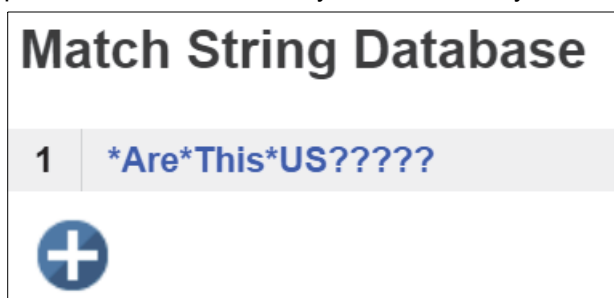

The barcode data the example above was attempting to match was **EN-1234_AreYouReadingThis en_US 1234**.

The logic of this match is diagrammed below.

[ANY AMOUNT OF CHARACTERS][ARE][ANY AMOUNT OF CHARACTERS][THIS][ANY AMOUNT OF CHARACTERS][US][5 CHARACTERS]

* = Any amount of characters (**EN-1234_** in this case)

Are

* = Any amount of characters (**YouReading** in this case)

This

* = Any amount of characters (**en_** in this case)

US

????? = **5 Characters** (**1234** in this case)

Sequential Mode

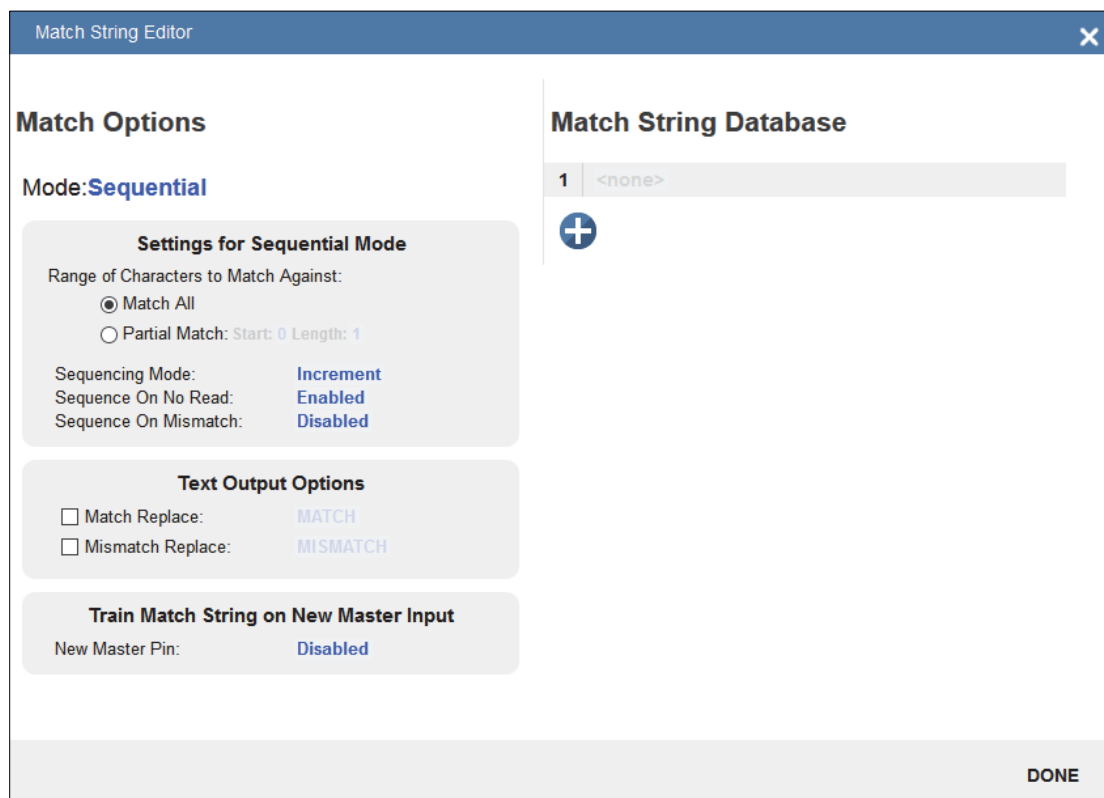

Sequential mode instructs the reader to sequence after each match and to compare symbols or portions of symbols for sequential numbers.

Note: If **Matchcode Type** is set to **Sequential**, the reader will behave as if **Number of Symbols** were set to **1**, regardless of the user-defined configuration.

4-8 Format Output

4-8-1 Generating the Output Result String

Standard Output String

By default, the system generates an **output string** containing data from all of the decoded symbols. The number of symbols, and whether or not to allow duplicates into the string, is controlled from the **Cycle** dialog.

Look for 4 codes Allow Duplicates
 Configuration Database Off

The **default output order** is not controlled. Symbol data is output in the order that the decode algorithm finds each code in the image.

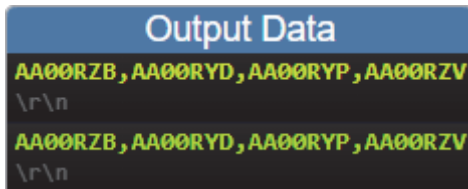

Basic Output String Formatting

The output dialog in the left panel of the user interface allows the user to make formatting changes to the output string. The user may do the following operations:

Format Output Off

Preamble <CR>
 Postamble <CR><LF>
 Replacements: 0

Remove Control Characters
 Separator
 Remove Extended Characters

Add Standard or Custom Preamble – Adds standard, or user defined text to the beginning of the output string when the checkbox is selected.

Select Custom Separator – Appends user defined text between the individual symbol data.

Add Standard or Custom Postamble – Appends standard, or user defined text to the end of the output string if the checkbox is selected.

All three of the above features work in the same way. The user turns on the checkbox, and then select the field. They may type in standard text, and or insert ASCII characters using the special dialog.

Preamble

ASCII...

SOH	STX	ETX	EOT	ENQ	ACK	BEL	BS
TAB	LF	VT	FF	CR	BSO	SI	DLE
DC1	DC2	DC3	DC4	NAK	SYN	ETB	CAN
EM	SUB	ESC	FS	GS	RS	US	SP

Remove Control Characters and Remove Extended Characters – These are used to remove all ASCII control characters and ASCII extended characters from decoded barcode data. A complete ASCII table is available for reference [here](#). Control characters are defined as [1-31](#), and extended characters are defined as [127-255](#).

Define Replacements – Replaces normal or ASCII characters in the string with user defined characters. To use, click on the Replacements in the dialog and it will bring up the following dialog.

Replace Character			
	Character	Replace Count	Replacement
1	<ACK>	1 character	<CR>
2	A	2 characters	PN

– +

Begin by clicking on the + to add a row for each character to be replaced. Complete the table using the following fields.

- **Character:** The standard or ASCII character that you want to replace.
- **Replacement Count:** How many characters to insert in its place. Valid options are 0, 1, and 2.
- **Replacement:** The character, or characters that you want to replace the character with. These can be standard or ASCII.

When you replace a character with one or more different characters, the results will be displayed in the **Output Data** window in the lower right panel of the WebLink user interface.

Up to **25** character replacements can be defined. If duplicates are defined, an error message will appear, and only the first definition will be applied.

You can enter ASCII control characters by selecting the link below the input box. You can also enter extended ASCII characters by entering **\xHexadecimal**. For example: **\xFF**.

The number of replacements that you've defined are displayed in the Format Output editor.

Basic Data Output Ordering

By default, the order the symbol data is inserted into the output string is the order in which they are decoded. The output order can be controlled using the **Global Sorting** option from within the Format Output dialog. This option must be turned on, and then the output order must be selected.

Global Sorting will apply to all codes found within a single image and ROI, as well as when using the Configuration Database with multiple Images and ROIs, and with a Matrix.

Note 1: Global Sorting is turned on by default if the user has defined a Matrix.

Note 2: Global Sorting will be overridden when using custom sorting within the Format Output dialog. Customer sorting will be described in the next section.

Global Sorting Options

On



4-8-2 Fully Customizing Output String with Format Output

The **Format Output** dialog allows the user to further customize the output string. It offers three very powerful functions:

- **Filtering** – Select just a subgroup of codes from within a larger group for output.
- **Ordering** – Output the selected codes in user defined order.
- **Parsing / Insertion** – Change content of selected codes based on parsing and insertion rules.

You can access Format Output in the left panel of the Setup view by setting Format Output on, and then by clicking on the blue Format String example.



Filtering Using Selection Rules

Inserting Selection Rules

The user begins creating the custom sorted string using **Selection Rules**. This is done by clicking on the + sign to insert the first entry. The Selection Rule is used to select a certain code, or set of codes from all of those that have been decoded. This is done based on characteristics of the code, such as code type. Once all matching codes have been identified, they will be inserted into the output string in this position.

Multiple selection rules can be inserted. Again, the position of the Selection Rule determines the position of the selected decodes in the output string.



Setting up Selection Criteria

Next, the user should click on the Selection Rule. All of the selection criteria will be displayed. For a symbol, the selection criteria is **Symbology Type**, **Data** content, data **Length**, and **Configuration Database Index**.

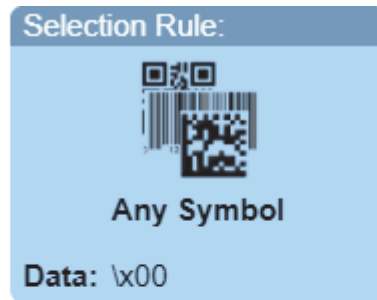

☆	Symbology Type	Any Type
☆	Data	<NUL>
☆	Length	0
☆	Database Index	None

For the image below, without any selection filter and with the number of codes set to six, all codes will be decoded and output.

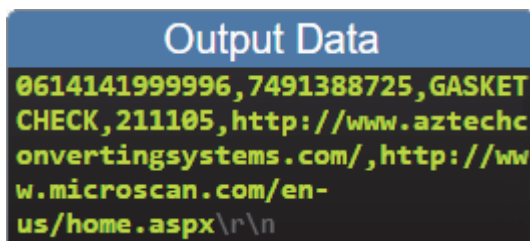

If the user wants to select and output just the QR Codes, they will set the Symbology type to QR Code and set the number codes to two. Only the QR Codes will be shown as green in the image, and the string will change from displaying all codes to just the QR Code.



Setting up Multiple Criteria with a Single Selection Rule

The user can further refine the selection criteria for which code to choose by setting additional fields. For this example, if we want to differentiate between the two barcode tools, we can select Data to do so. Whichever code contains the set data will be the one selected. Here we set it to find the QR Code containing the substring “microscan”.

The rules for entering characters in the Data field are similar to those for entering characters in the Match String Database. You simply use a combination of text, wildcards (*), and placeholders (?) to denote the string.

Note: Wildcard (*) rules. If the string is in the middle of the code, it must be set with wild cards at either end (*microscan*). If the string is at the beginning, or is at the end of the decode data, we need to leave off the leading or trailing *.

☆	Symbology Type	QR Code
☆	Data	*microscan*
☆	Length	0
☆	Database Index	None

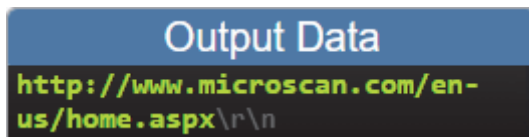

Ordering Using Multiple Selection Rules

The user can insert as many selection rules as there are codes to set the exact order of each and every code if desired. Below we will show two examples for how to output all 6 codes in a defined order.

Note: Ordering using **Selection Rules** override the **Global Sorting Option**.

Example 1: For this example, the two QR Codes come out first followed by the other four codes. Here we do not care about the order or the last four.

For this case we simply need to add a second Selection Rule with **no selection criteria** set. This will match to all of the other codes and allow them to be printed out after the two QR Codes.

Preamble

<CR>

1: Symbol

Selection Rule:



QR Code

Data: *microscan*

Separator

,

2: Symbol

Selection Rule:



Any Symbol

Data: \x00

Output Data

```
http://www.microscan.com/en-us/home.aspx,http://www.aztechconverting.com/,0614141999996,7491388725,GASKET CHECK,211105\r\n
```

Example 2: For this example, want to output two QR Codes followed by two Data Matrix codes and then the 1D barcodes. Here we simply use three selection rules.

Preamble

<CR>

1: Symbol

Selection Rule:



QR Code

Data: \x00

Separator

,

2: Symbol

Selection Rule:



Data Matrix

Data: \x00

,

3: Symbol

Selection Rule:



Code 39



Data: \x00

Selection Rules for Matrix and Unique IDs

The examples above show the **Symbol** type of **Selection Rule**. Symbol is the mode in which the decode tool is set to find one or more codes. There are two other types that can be set: **Matrix** and **Unique ID**.

1: Symbol

Selection Rule:

-  Symbol
-  Matrix
-  Unique ID

Any Symbol

Data: \x00

Selection Rules for Matrix

For a Matrix, there is no **Selection** criteria. There is always only one Matrix allowed.

2: Matrix

Selection Rule:



Matrix Index: 1

The order of the Selection Rules define order the data will be output. In the example below, all the QR codes will be output, then the Unique ID that is labeled as 1 will be output. Then all the codes within the Matrix. It is important to note that while the start position for the Matrix output is defined by the Selection Rule, the actual output order for the individual codes within the Matrix will follow the **Global Sorting** option that is set.

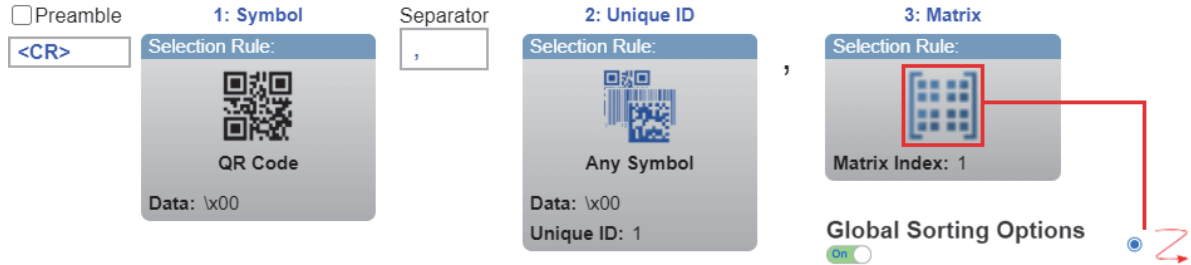

Selection Rules for Unique ID

For a **Unique ID**, the **Selection** criteria is **Symbology Type**, **Data** content, data **Length** or **Unique ID** label number. The only important criteria in this case is Unique ID number. When you select that label number, the decode data from that **single code** which is set up using the **Configuration Database** is inserted into the output string at the set location.

Note: A Unique ID always refers to a single labeled code.

Note: A Unique ID number must appear only once in the output builder. The Unique ID must not be used on more than one **Selection Rule**.

2: Unique ID

Selection Rule:

Any Symbol

Data: \x00

Unique ID: 1

☆	Symbology Type	Any Type
☆	Data	<NUL>
☆	Length	0
☆	Unique ID	1

4-8-3 Symbol Parsing and Insertion

Symbol Parsing allows the user to modify the contents of the decode data strings before they are put into the output string. There are two functions or rules that can be applied.

- **Parse** – Extract parse multiple substrings from the original symbol data and insert them in the new output string.
- **Insert** – Insert custom text into the output string.

Note: Only one parsing sequence can be set up. It will be applied to all groups where Symbol Parsing is checked on. All codes within a checked group will be affected.

Example: Setting the Format of Output Data

- 1 Acquire Image and determine output requirements. Here we want to extract the last two characters in the strings beginning with AA.



- 2 Parsing is enabled by clicking on the check box below any or all of the Selection Rules. When checked, all the codes associated with that Selection Rule will be modified by the Symbol Parsing rules.

1: Symbol

Selection Rule:

Any Symbol

Data: AA*

Parse Symbol?

Separator

,

2: Symbol

Selection Rule:

Any Symbol

Data: 21*

Parse Symbol?

- 3 Click the **+** to add Parsing Actions. Choose either **Extract chars from symbol data**, or **insert your own text**.

Symbol Parsing

Example Data:	AA00RZV ▼
Parsing Result:	

Parsing Actions

Extract chars from symbol data

Insert your own text

- 4** To insert text, type the text and hit return inside the text box. You will see the full ASCII characters that will go into the output string.

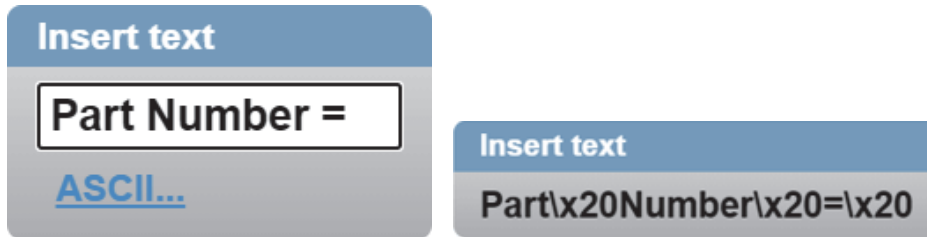

- 5** Hit + again to add the new rule. Choose Extract chars from symbol data. Set first char and last char position. Hit the check for **OK**.



- 6** Review the sample result that is actively displayed in the **Parsing Result** box as you build the string.

Insert text	Extract chars	+	+
Part\x20Number\x20=\x20	[6 - 7]		
Example Data:	AA00RZB v		
Parsing Result:	Part\x20Number\x20=\x20ZB		

- 7** Up to **30 rules** can be inserted. Rules can be deleted by hovering over them and typing **X**.

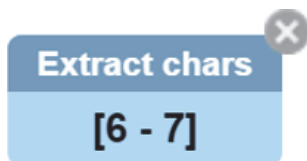

- 8** When complete, the results can be seen in the Output Data window.

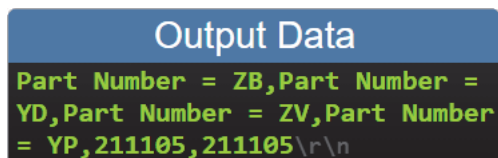

4-9 Outputs

Bring up the **Output 1**, **Output 2**, and **Output 3** dialogs by clicking on the **Outputs** section at the lower left of the **Setup** view. For each output you can determine the **Output On** behavior, **Mode**, **Pulse Width**, and **State**. **Outputs 2** and **3** also allow you to determine output behavior based on **Trend Options** parameters or **Symbol Quality Options** parameters.

This example shows the dialog that appears when you click **Symbol Quality Options**. A similar dialog would also appear for **Trend Options** under **Output 2**.

Note: The **1**, **2**, and **3** output indicators at the lower right of the screen display the results of the last read cycle.

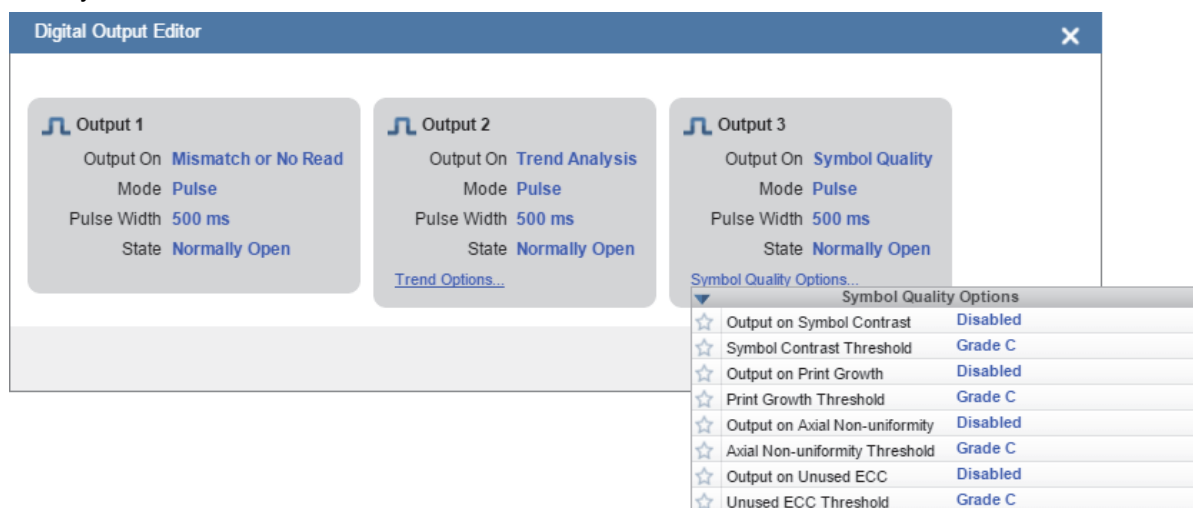

4-9-1 Output On

Output On provides discrete signaling to host software to control external devices such as PLCs and relays. It is useful for routing, sorting, and to prevent mis-packaging and mis-routing. This option allows you to set the conditions under which an output (or outputs) will be activated.

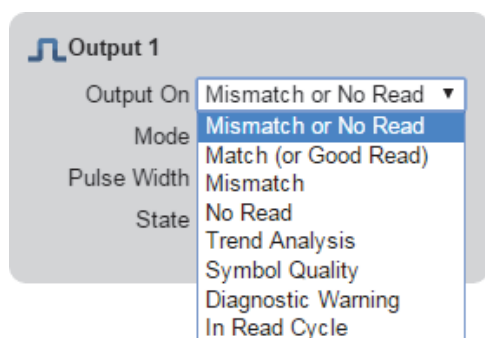

4-9-2 Mode

Output Mode sets the condition in which the discrete output is deactivated.

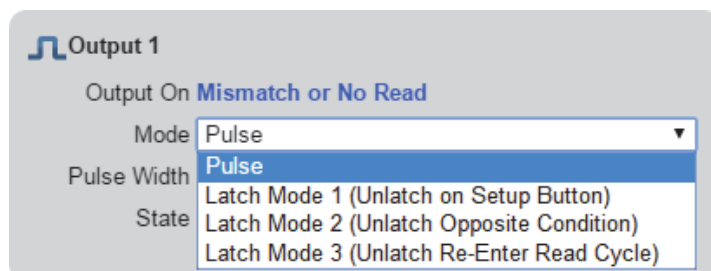

4-9-3 Pulse Width

Pulse Width sets the time in milliseconds that the discrete output remains active.

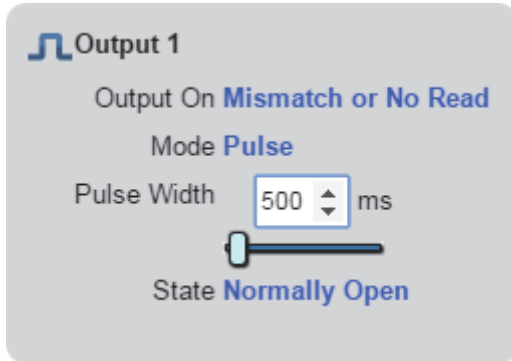

4-9-4 State

Output State allows you to set the active electrical state of the discrete output to **Normally Open** or **Normally Closed**.

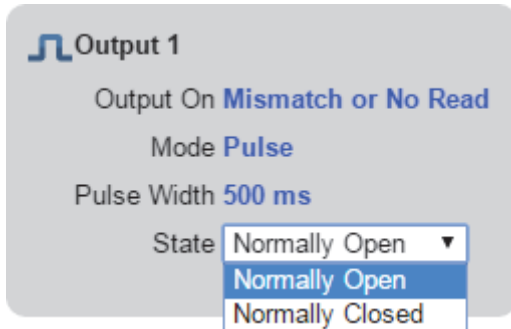

4-9-5 Triggered Outputs

Triggered Outputs show when outputs are triggered and give you the ability to trigger outputs manually.

Outputs 1 - 3 are located in the lower right corner of the user interface. They function both as buttons that trigger whichever output you click, and as a display that shows which output is currently being triggered. In the example below, output 2 is being triggered.

Note: The three output indicators shown below display the results of the last read cycle.

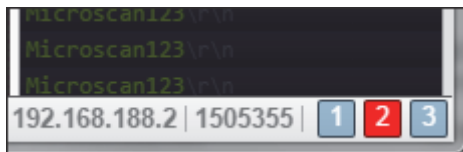

4-10 Configuration Database

When setting up a read cycle, you can specify the number of symbols that must be found and decoded for each trigger.

There may be instances in which not all the symbols can be read within a single image or with one set of decode parameters. This is the purpose of the **Configuration Database**. With the Configuration Database, upon receiving a trigger, the system cycles through multiple sets of imaging, image enhancement, and decode parameters stored in the database until it reads the required number of codes.

Example: A manufacturing line where the single code to be read may be either very bright or very dark, but where there is no single exposure setting that can read both. To solve this, the user can set up the Configuration Database with two entries to take two images with two different exposures. When the system is triggered, it will take the first image with the exposure in Configuration Database entry 1. If the symbol is not read, the system automatically takes a second image with the exposure in Configuration Database entry 2 and tries the decode again. In this way, it is guaranteed that the system will be able to read both the very bright and very dark instances of the symbol.

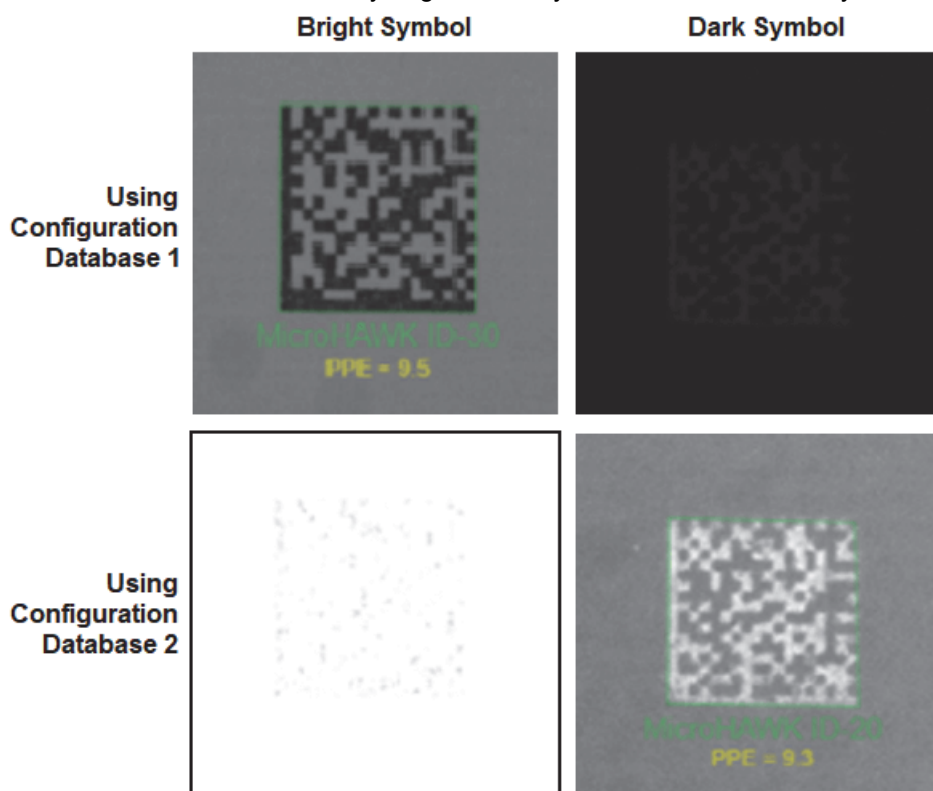

Configuration Database Parameters

The Configuration Database has 20 slots allowing for up to 20 decode attempts. The following parameters can be set uniquely for each entry. These settings are related to either Image Acquisition, or to the Decode tool.

Image Settings – Applies to all decode tools within an image.

- Exposure Time
- Gain
- Pixel Binning – Acquires image at half size by sub-sampling every other pixel.

Decode Tool Settings – Applies to the specific decode tool for that particular database entry.

- Region of Interest ROI or Window of Interest WOI Location and Size
- Symbol Type
- Image Enhancement Applied within the ROI

Configuration Database Programming Modes

There are two modes that can be used to setup the Configuration Database.

The first is **Simple Mode**, which is extremely powerful but easy to use. Simple Mode is explained below.

The second is **Advanced Mode**, and is the classic mode from previous versions of WebLink. Advanced Mode is described later in **Configuration Database** (lower down in this same topic).

4-10-1 Simple Mode

The **Simple Mode** Configuration Database is designed so the user can create as many images as are necessary to be able to see all the symbols. Then within each image, the user can insert the number of decode tools required to read all the symbols. As detailed above, each image and each decode tool have their own unique settings.

The Simple Mode Configuration Dialog allows the user to easily set up the Configuration Database with multiple images, and with multiple decode tools within each image to attempt to read all codes. Again, **20** is the limit for the number of Configuration Database entries.

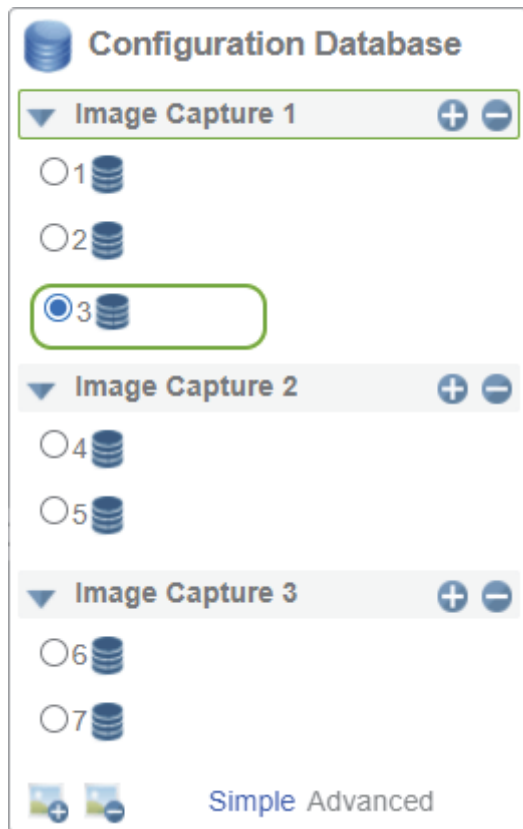

Simple Mode Quick Start Example

In the following example, you will see how to set up the Configuration Database to read two different code types that require two different image exposure settings to be seen.

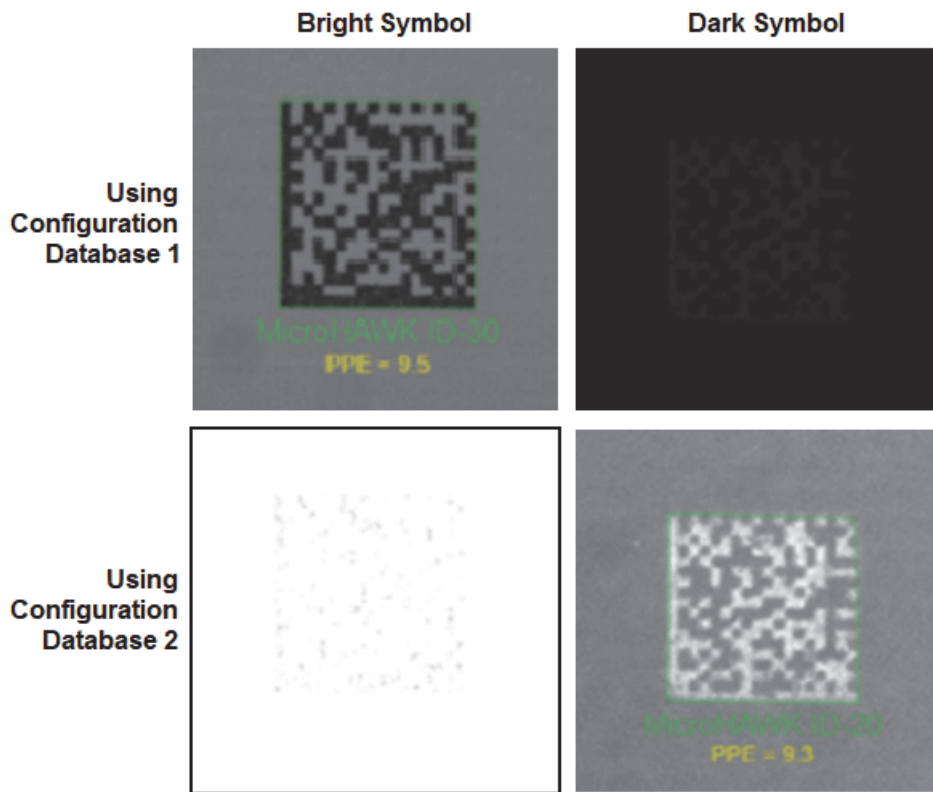

The Configuration Database is enabled from the Cycle dialog box. The total number of codes you want to find is set at this time. For this example, the system is set to find **1** code.

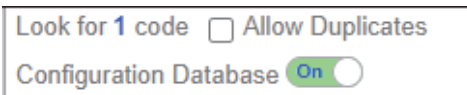

When switched on, the Configuration Database dialog becomes active with a single Image entry, and with one Decode tool entry in that image. Clicking on the Add Image button at the bottom of the dialog adds another image with an additional decode tool inside of it.

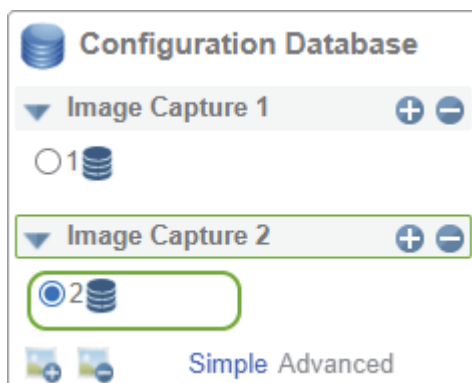

The next step is to set up the two different images with the correct exposure settings to be able to find the light colored code in one image, and the dark colored code in the second image. Each image is selected by clicking on it, or by clicking on the decode tool radio button. Exposure and gain are set through the image dialog shown below.

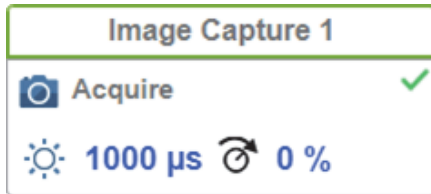

Within each image are the individual decode tools. When the user clicks on either radio button, the system will take an image with the recently applied image settings, and the ROI for the decode tool will become active. The user can grab, size and position the ROI around the code at this time.

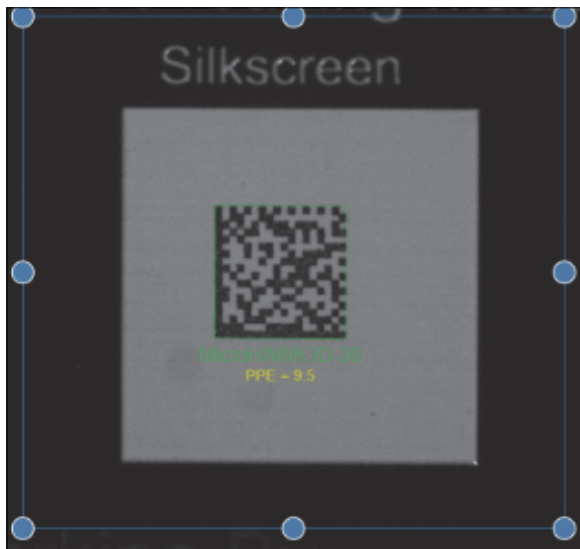

Finally, using the Decoder Dialog, the user can direct the system to read just a particular set of code types, as well to employ specific image enhancement settings to aid in reading the code.

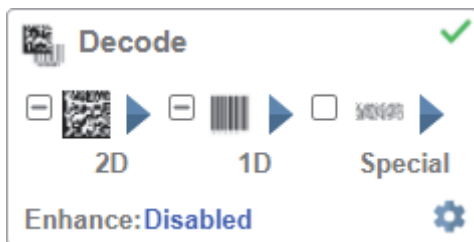

At runtime, when the system is triggered, it will take the first image with the exposure in Configuration Database entry 1, and if the symbol is not read, the system automatically takes a second image with the exposure in Configuration Database entry 2 and tries the decode again.

The overall Simple Configuration Database setup is displayed for the user within a single grouping outlined in blue for ease of use.

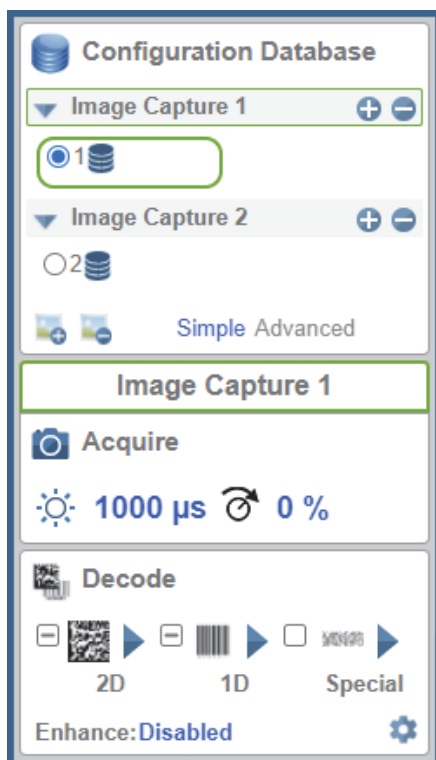

Details for Using Simple Mode

● Cycle

The Cycle dialog is set up first. The Configuration Database should be turned on. The number of captures should be set to match the number of images that will be used in the Configuration Database setup. The number of codes or symbols to be found should be set here as well.

The Timeout should be set long enough to guarantee that all codes can be found. Feedback on decode time can be seen the timing dialog on the right side of the screen.

Note: The Cycle Timeout is for the entire read cycle and should account for all acquisition of all images, running all decode tools, and inter-trigger delays. The Image Processing Timeout, which sets the timeout for each individual decode tool is set through Advanced Settings.

Finally, the user should set the appropriate triggering mode for the application. If one of the triggered modes is used, the user can enable virtual triggering to generate a constant stream of triggers to the system so it will run continuously while setting it up. Conversely, trigger mode can be kept at continuous until ready to go into run mode, at which time the trigger mode can be set up.

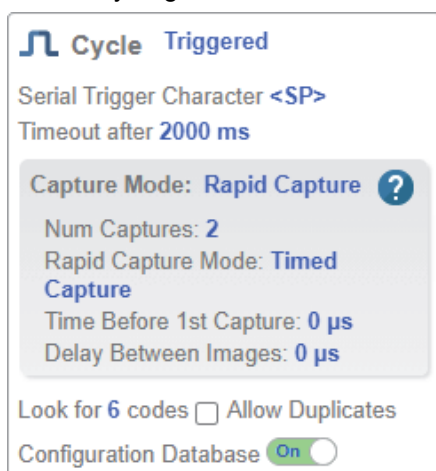

Images

Adding and Deleting Images – Add or delete images using the buttons at the bottom of the dialog box. When a new image is added, it will inherit the settings from the previous image. Also, a single database entry is automatically inserted into it as well.



Setting Image Parameters – Each Image can be set up with unique Exposure and Gain values through the Image Capture dialog. These settings will apply to all the decode tools within that image. Note that the Image label is visible in this dialog.

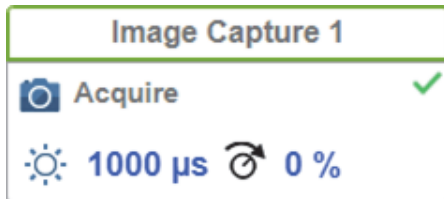

Binning is an advanced parameter, and can be found in the **Advanced Settings > Camera Setup** section. Binning mode acquires an image sub-sampled with every other pixel. Binned acquisition is 2x faster than normal acquisition. The smaller pixel area will also result in decreased decode times provided that there is adequate PPE to decode the symbols. This setting applies to all decode tools within that image.

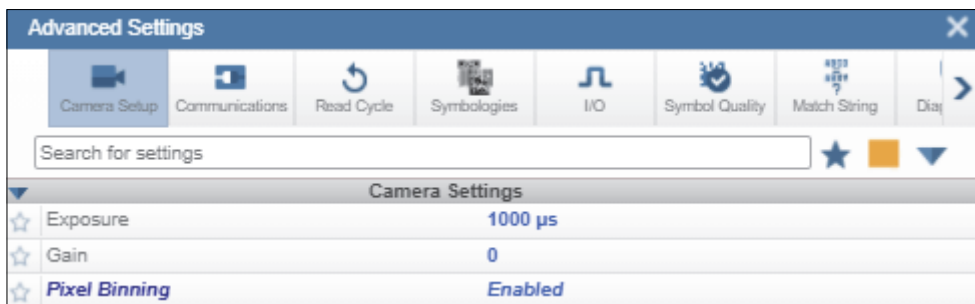

Decode Tools

Adding and Deleting Decode Tools – The user can add decode tools to an existing image entry by selecting an existing decode tool Radio button within that image, and then by hitting the + button next to the Image Capture. The new decode tool will be inserted directly after the currently selected one.



All settings from the selected tool will be copied into the new decode tool, including the ROI position and size. After insertion, focus will shift to the newly inserted tool. The user can move the new ROI into place over the next symbol or set of symbols at this time.

The user can delete decode tools as well by selecting one and then hitting the – button. Focus will shift to the previous decode tool within that image, or within the previous image.

Setting Decode Tool Parameters – Each Decode Tool can be set to look for only certain Code Types. Additionally each decode tool can be set to run with specific image enhancement settings, as well as with a unique Region of Interest ROI.

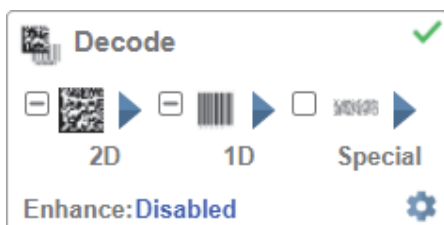

The region of interest appears on the screen in an active state with anchor points on the sides and corners. The ROI can be grabbed using the mouse and can be moved and resized as required.

Sizing the ROI reduces the amount of pixel area the decode tool has to search in. This makes the tool much faster and robust since it does not have to consider all of the other possible code positions within the whole image. This is key, especially when using the V440-F 5MP sensor, to optimize decode times.

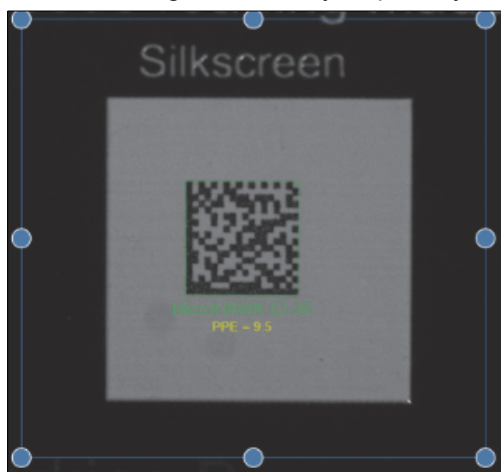

Note: The individual decode tools can be selected either by clicking on the Radio button in the dialog box, or by clicking on their Region of Interest within the image. When selected, the system will start decoding within that ROI. If the selection is inside of another image, that image will be first be acquired automatically, and then decoding will start.

Mode Types

Clicking the database entry icon for any given database entry allows you to change the **Configuration Database** mode.

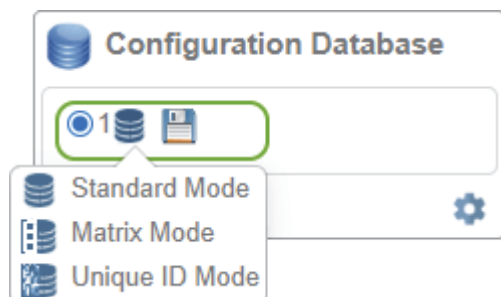

There are three **Configuration Database** modes:

- **Standard Mode** – This is a general symbology tool. It can be used to decode any number of symbols within the ROI.
- **Matrix Mode** – In this mode, the Configuration Database entry is decoding a matrix as defined by the **Matrix Mode** setup tool. There can only be one matrix defined for the system, but multiple database entries can be used for the the one matrix so you can vary all the standard image and decode variables as you would for an individual symbol. The system works its way through all entries until all codes in all cells are decoded. The system then compiles these into a single result.
- **Unique ID Mode** – This is also a general symbology tool, but is typically used to label one particular symbol with a unique identifier. Labeling individual codes is a very useful tool when setting up **Formatted Output** with a particular output order.

Note: **Unique ID** labels must not be included in other **Window of Interest (WOI)** or **Matrix Mode** cells.

Example Use Cases

The following use cases demonstrate some ways Configuration Database can be used, although the possible scenarios and combinations are virtually endless.

Example 1 – Using the Configuration Database to try multiple sets of decoding parameters to read all target codes in an application.

Problem: Some codes are overprinted, some are normal, and some are underprinted, as shown below. The system must decode them with 100% accuracy and success.

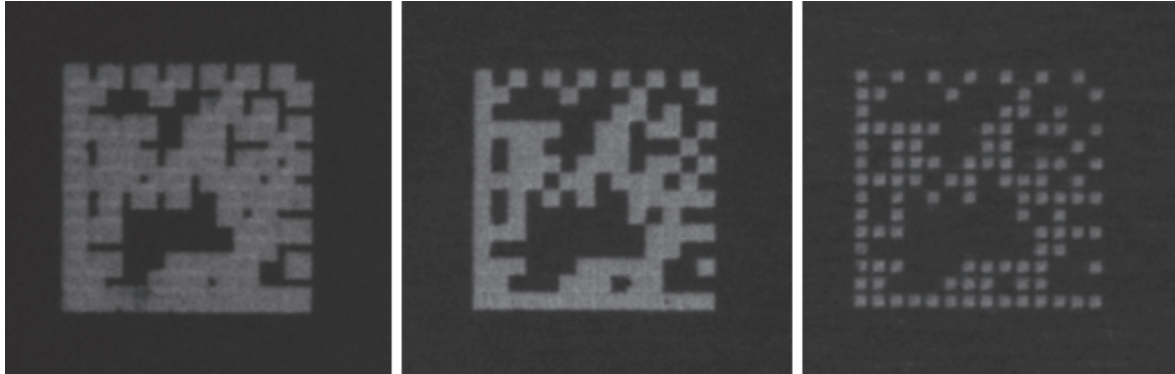

Solution Steps:

- 1** Set **Cycle** to look for 1 code.
- 2** Set up Configuration Database with **1 image** and with **3 database entries**.
- 3** Change enhancement parameters on all three entries to handle printing or marking variation.

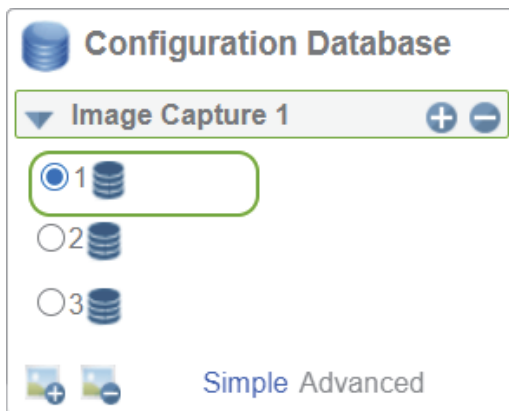

For each entry, change image enhancement morphology to do nothing, to grow, or to shrink the white cells prior to reading.



Result: The system will try all database entries until a symbol, whether overprinted, normal, or underprinted, is decoded.



Example 2 – Using the Configuration Database with ROI to specific areas containing barcodes.

Problem: Decode all symbols in field of view. Limit the reading area for each tool to reduce confusion and to enhance speed. Output decoded symbol data in user-specified order.

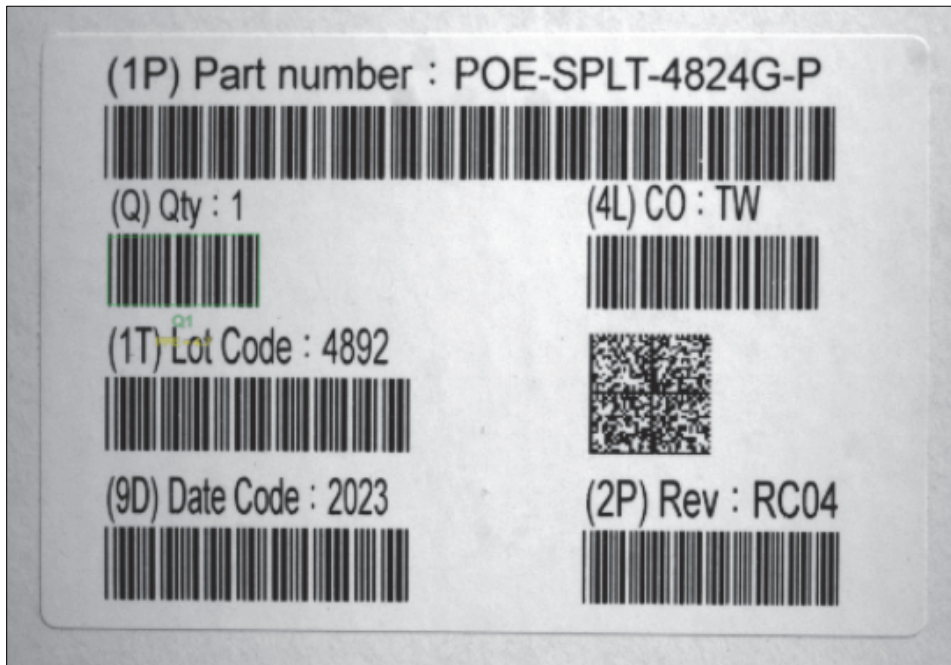

Solution Steps:

- 1** Set **Cycle** to look for 7 codes.
- 2** Set up Configuration Database with 1 **image** and 1 **database entry**.
- 3** Set the type of entry to **UID**. Label this code as 1.
- 4** Set ROI up around first code.
- 5** Add an additional database entry. Move the ROI around the second code. Change the UID label to 2.
- 6** Repeat for all 7 codes. Note that you can limit the code type for each entry.

7 Set up **Formatted Output Step** to output codes in the desired output order. For example, codes can be output in the order **1, 4, 3, 6, 5, 7, 2**.

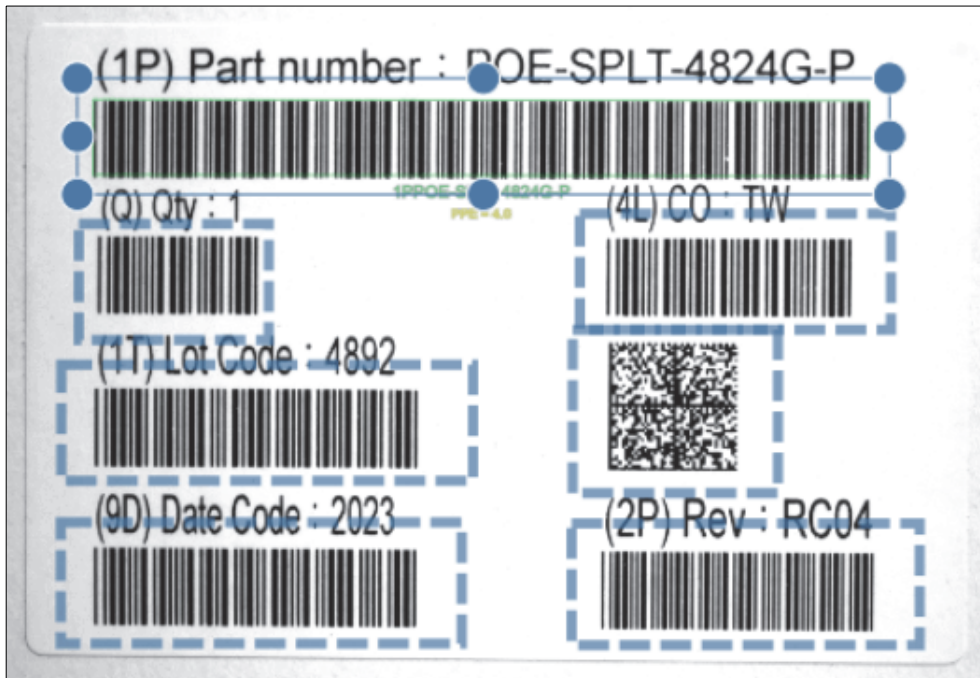
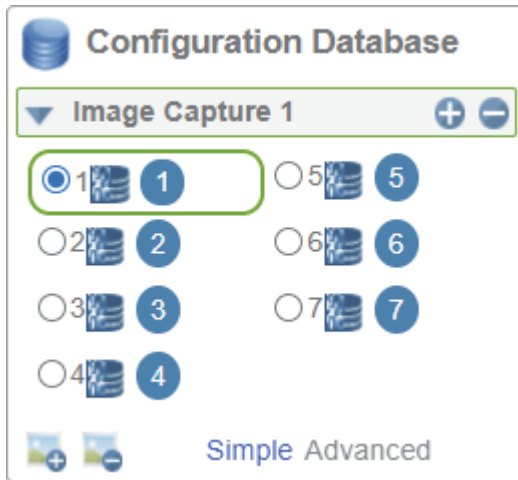

Output String

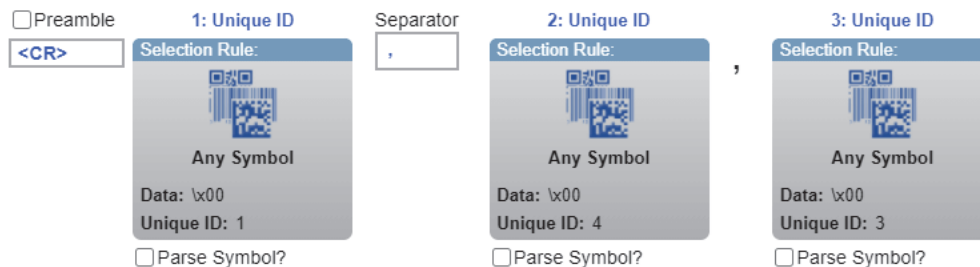

Result: The system will try all database entries to find all 7 symbols. The resulting string will be in the user-defined order.

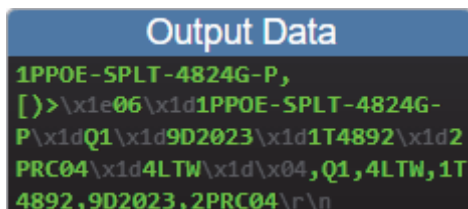

Example 3 – Using the Configuration Database with **UID** and **Matrix Mode** under conditions of widely varying tray orientation and symbol quality.

Problem:

- 1** Read the label on the well plate in either of two orientations.
- 2** Read all the codes in the matrix. Do this over 3 images, varying lighting and image enhancements to make sure all codes are read.
- 3** Output the data in the order of well plate label followed by matrix data.

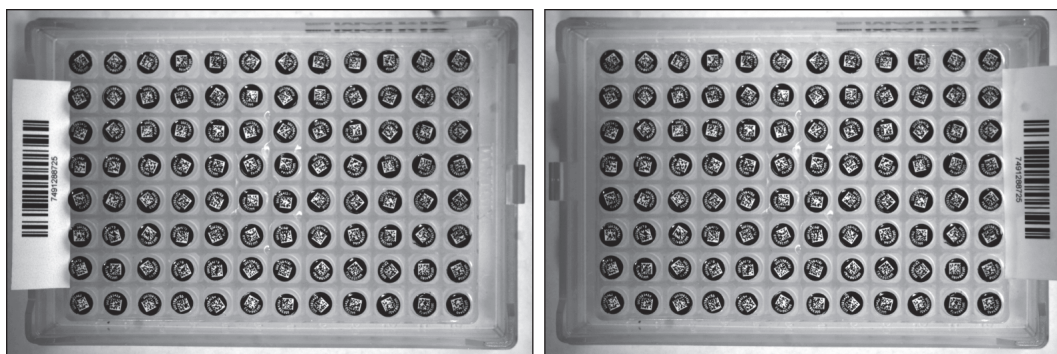

Solution Steps:

- 1** Set up Cycle to read **97** codes (**96** from the well plate and **1** from the label). Set number of images to 3.
- 2** Insert **1** image.
- 3** Insert the first entry and change it to **UID 1**. Put ROI around label in left hand orientation.
- 4** Insert the second entry and change it to **UID 1** as well. Put an ROI around the label in the right-hand orientation.
- 5** Insert the third entry and change it to **Matrix**.
- 6** Insert second and third image, insert entry into each, and change it to **Matrix**.

7 Set up **Formatted Output Step** to output label with **UID 1** first, and then **Matrix**.

Cycle Triggered ✔

Serial Trigger Character **<SP>**
 Trigger Delay **0 μs**
 Timeout after **1840 ms**

Capture Mode: Rapid Capture

Num Captures: **3**
 Rapid Capture Mode: **Timed Capture**
 Delay Between Images: **0 μs**

Look for **97** codes Allow Duplicates
 Configuration Database **On**

Configuration Database

▼ **Image Capture 1** + -

1 **1**

2 **1**

3

▼ **Image Capture 2** + -

4

▼ **Image Capture 3** + -

5

Simple Advanced

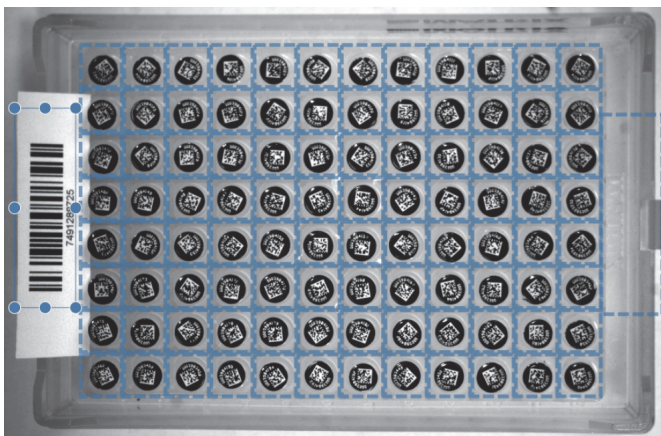

Output String

Preamble

1: Unique ID

Separator

2: Matrix

Postamble

<CR> **<CR><LF>**

Selection Rule:

Any Symbol

Selection Rule:

Matrix Index: 1

Data: \x00

Unique ID: 1

Parse Symbol?

Parse Symbol?

Result: The system will try all database entries to find the label in either position. The system will also try the matrix using all entries across the three images until it reads all codes within the matrix. See the images below.

Five No Read Areas in Image 1

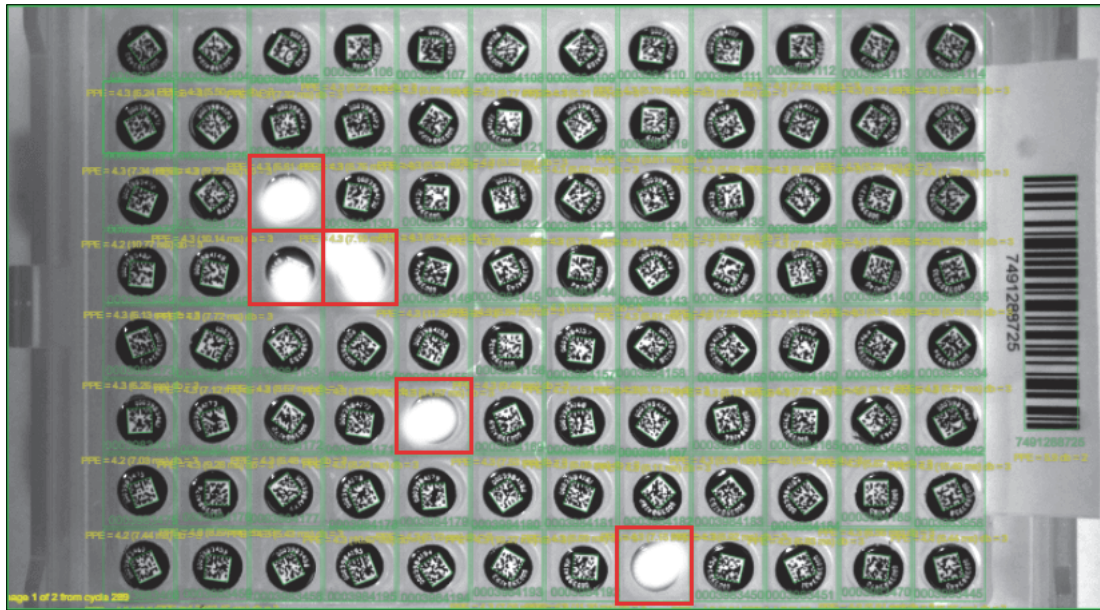

All Symbols Decoded in Image 2

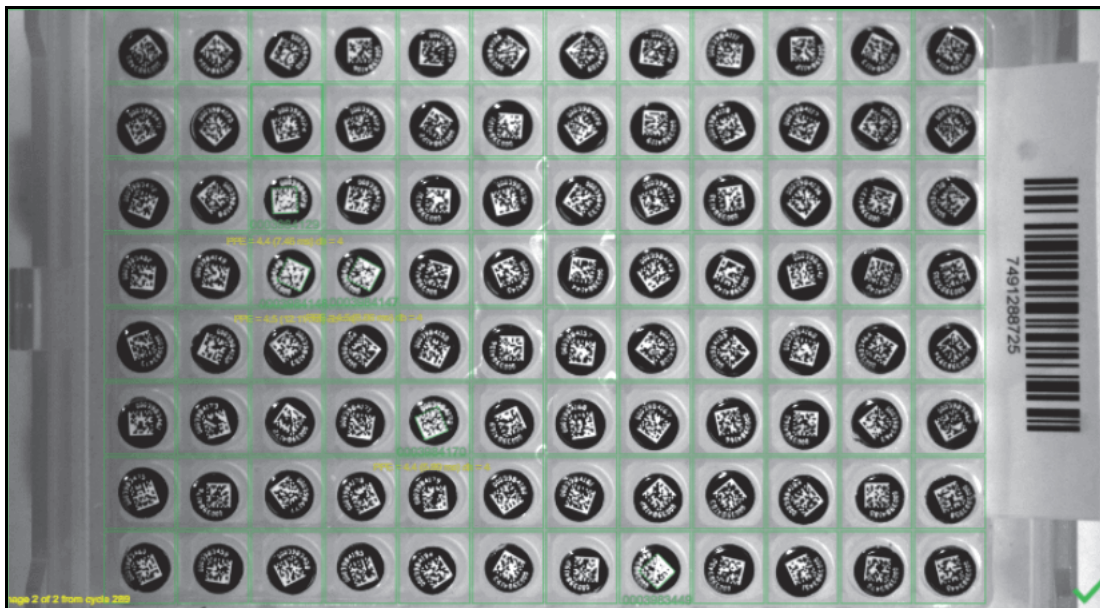

4-10-2 Advanced Mode

WebLink's Configuration Database Advanced Mode uses two or more unique reader configurations that are automatically attempted during a read cycle. It allows for multiple reader changes to be made without user interaction. WebLink is used to configure the database settings and verify that all the database indexes are working correctly.

The Configuration Database can be used to fine-tune the reader's performance in your application. It can run multiple decode options in a single read cycle. You can enable Configuration Database by using the Cycle editor in the Read Cycle Sequence that comprises the left panel in the Setup view of WebLink's user interface. Configurations are set up individually and saved individually. Configuration Database is set up in the Setup tab and tested in the Run tab. Virtually all Acquire and Decode settings can be individualized per database entry. Clicking the gear icon in the Configuration Database editors shows a view of all database settings. Settings can be based on Window of Interest (WOIs), meaning a new picture is taken for each decode. Settings can also be based on Regions of Interest (ROIs), meaning decodes are attempted on a single image.

Important: Quick Photometry should be disabled while using the Configuration Database.

The Configuration Database Advanced Mode is useful in applications where:

- More than one symbol type is present;
- A symbol may require different photometry settings to decode;
- Symbols are presented at different depths;
- Multiple symbols with the same data need to be decoded;
- Multiple symbols need to be read in a specific order.

Overview of Setup Process

Use the **Cycle** editor in the **left panel** in the **Setup** view to enable Configuration Database.

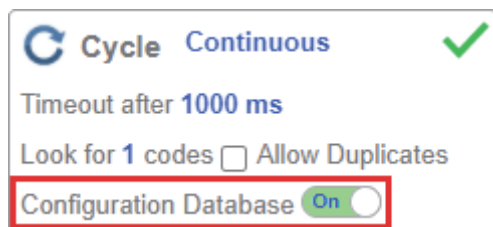

Use Weblink to configure each of the database indexes by selecting them in the **Setup** view.

● Tips

- Database indexes are not cycled in **Setup** mode. Switch to **Run** mode for read cycle testing.
- Set the "**Look for n codes**" value to match the number of barcodes you need to decode.
- If decoding multiple barcodes in the same image, make the following changes in **Advanced Settings > Configuration Database**:
 - **Image Process Looping**: Set to **Enabled**
 - **Image Dimensions**: Set to **Region of Interest**
- Save each index configuration by clicking on the **Save** icon when done.
- Remember that the Index number is only output in **Run** mode if it is **Enabled**.
- Save settings to the reader's flash memory when all the indexes in the Configuration Database have been defined for the application.

Start and Run Views

You can use **Assisted Setup**, **Create a New Setup**, and **Load a Setup**, along with **Advanced Settings**, to manipulate reader settings.

Note: Assisted Setup and **Create a New Setup** will both default the reader.

Note: Advanced Settings, while in the **Start** and **Run** views, allows you to manipulate all reader settings except the individual Configuration Database index settings. The settings that are shared between the global and Configuration Database index are ignored by the reader. While in the **Setup** view, the reader pauses the Configuration Database, and any changes to the shared settings can be saved into any of the available Configuration Database indexes.

While in the **Start** and **Run** views, you can see which database decoded the symbol:



Setup View

Set the position of the **Configuration Database** switch to **On** in the **Setup** view's **Cycle** editor to enable Configuration Database functionality. Configuration Database allows you to add, remove, and modify specific active indexes from the database.

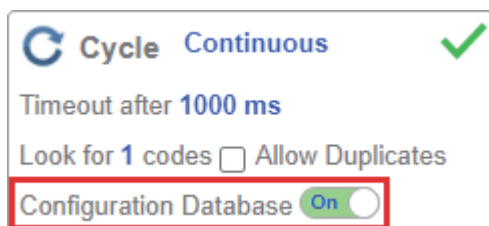

The Configuration Database editors shown below are only displayed when Configuration Database is switched to **On** in the **Cycle** editor as shown above.

The **Add** button creates a new database index and shifts all other indexes down by one.

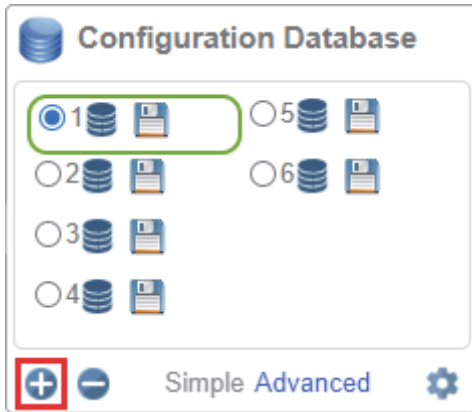

The **Remove** button removes the current selected database index 1 and shifts all other indexes up by one. The index that had previously been index 2 is now automatically selected as the new index 1.

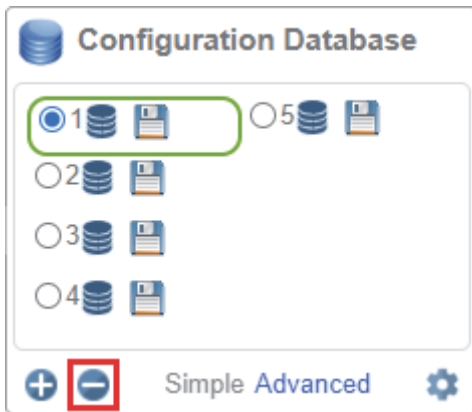

Once you change database index settings, the current index's **flash icon** will turn red. Clicking the red flash icon will save the new settings, and the flash icon will turn back to blue.

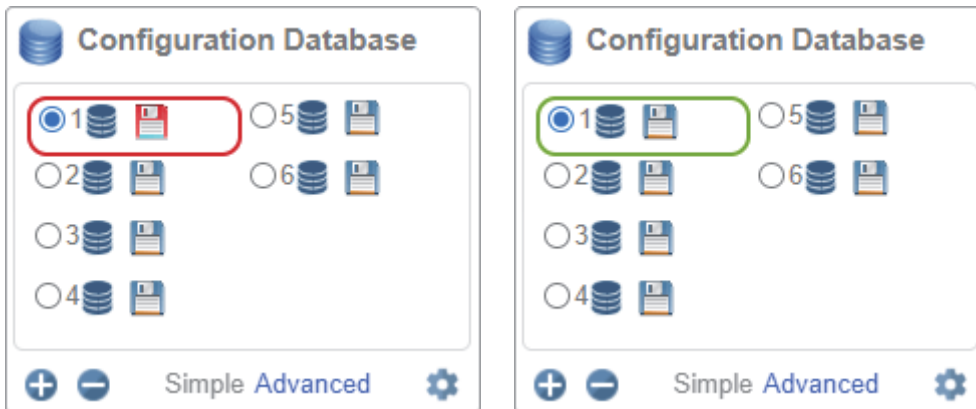

You can save the current settings to a non-current database icon by clicking the blue icon for indexes that are not selected. This will turn the flash icon green.

In the example below, the current settings were saved to the 6th index. The flash icon will continue to appear green until another database is saved.

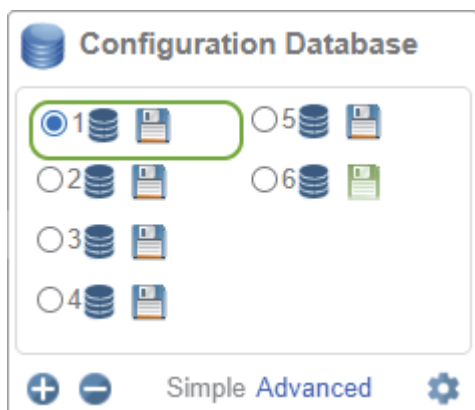

Example:

Suppose you want to switch from database index 1 to database index 3. You can click the radio button to the left of database index 3 to switch to that database index. However, since database index 1 is still not saved, you will see the following dialog:

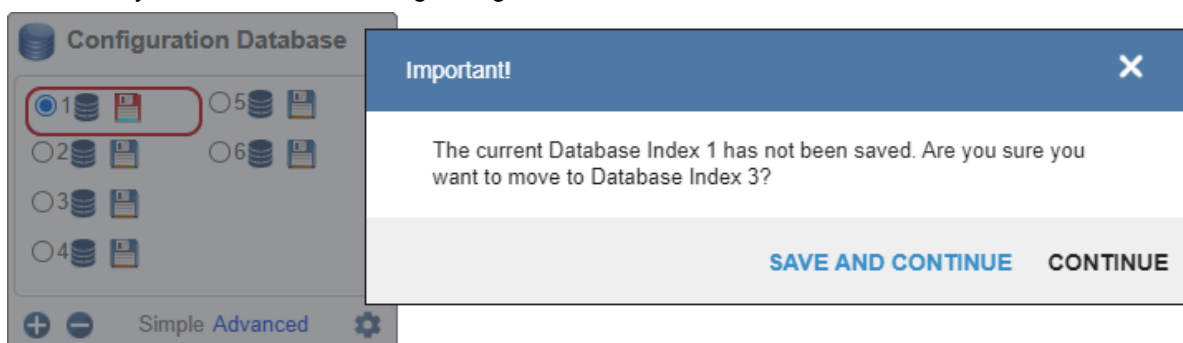

If you want to switch from database index 1 to database index 3 without saving database index 1 settings, click **CONTINUE**. If you want to save database index 1 settings and then switch to database index 3, click **SAVE AND CONTINUE**. You can also click the **X** at the upper-right of the dialog to remain at index 1.

If you click the **Run** view tab in WebLink's **Navigation Bar** before the current database is saved, you will see a dialog similar to the one below asking if you want to save the current index you were configuring. If you want to switch from your current database index to the Run view without saving current database index settings, click **CONTINUE**. If you want to save your current database index settings and then switch to the Run view, click **SAVE AND CONTINUE**. You can also click the **X** at the upper-right of the dialog to remain at the current database index.

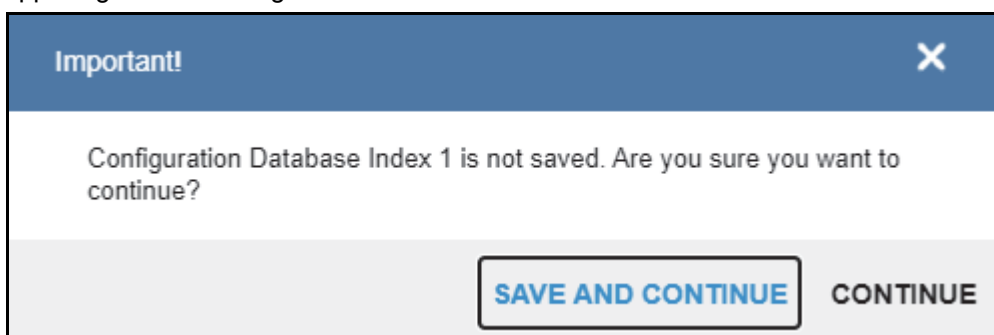

Mode Types

Clicking the database entry icon for any given database entry allows you to change the Configuration Database mode.

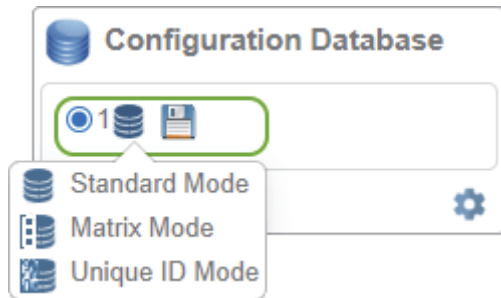

There are three **Configuration Database** modes:

- **Standard Mode** – This mode is a general symbology tool. It can be used to decode any number of symbols within the region of interest.
- **Matrix Mode** – In this mode, the Configuration Database entry is decoding a matrix as defined by the **Matrix Mode** setup tool. There can only be one matrix defined for the system, but multiple database entries can be used for the one matrix so you can vary all the standard image and decode variables as you would for an individual symbol. The system works its way through all entries until all codes in all cells are decoded. The system then compiles these into a single result.
- **Unique ID Mode** – This is also a general symbology tool, but is typically used to label one particular symbol with a unique identifier. Labeling individual codes is a very useful tool when setting up Formatted Output with a particular output order.

Note: **Unique ID** labels must not be included in other **Window of Interest WOI** or **Matrix Mode** cells.

Switching to **Simple Mode** will do the following:

- Force the system to Region of Interest ROI Mode;
- Attempt to group Database Indexes into image captures;
- Turn every Capture Index off;
- Prompt you to click **CONTINUE** or **CANCEL**.

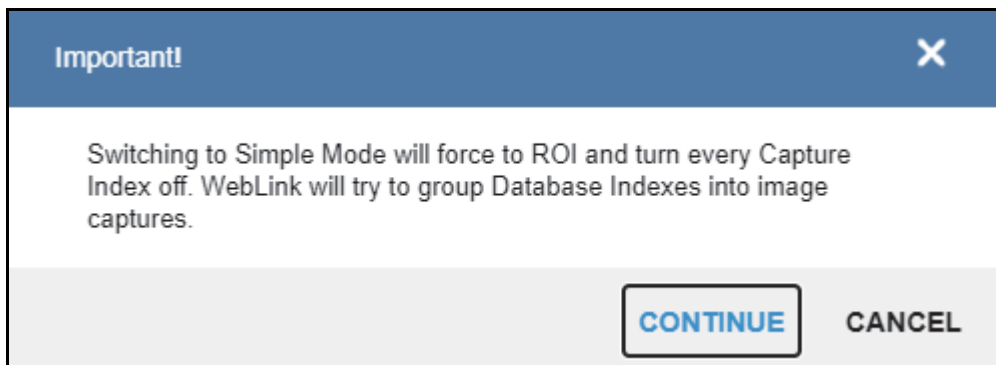

Extra Settings

You can access extra Configuration Database settings in a popup dialog by clicking the **Extra Settings** gear icon. This provides a read-only view of the Configuration Database showing all available settings. It also includes the Advanced Settings that are available in the Advanced Settings dialog.

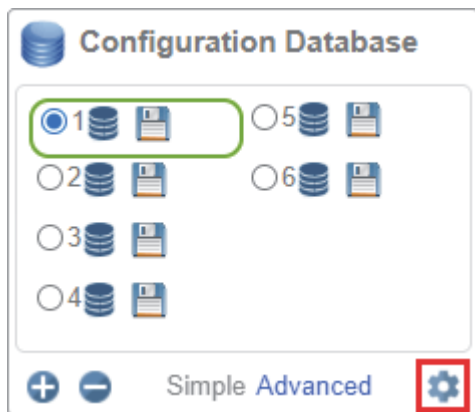

WOI / ROI

When you click **WOI**, the Configuration Database uses the **Top**, **Left**, **Width**, and **Height** values as **Window of Interest** values. When you click **ROI**, the Configuration Database will use **Top**, **Left**, **Width**, and **Height** values as **Region of Interest** values.

	Capture Settings				Processing Settings				Identifiers			
	Expos...	Gai...	Pixel B...	To...	Le...	Wid...	Hei...	Symbol Type	Morph...	Morph...	Unique...	Matrix I...
1	1000	0	Disabled	0	0	2464	2048	124894	Disabled	Small	None	None
2	1000	0	Disabled	0	0	2464	2048	0	Disabled	Small	None	None
3	1000	0	Disabled	0	0	2464	2048	0	Disabled	Small	None	None
4	1000	0	Disabled	0	0	2464	2048	0	Disabled	Small	None	None
5	1000	0	Disabled	0	0	2464	2048	0	Disabled	Small	None	None
6	1000	0	Disabled	0	0	2464	2048	0	Disabled	Small	None	None
7	1000	0	Disabled	0	0	2464	2048	0	Disabled	Small	None	None

Configuration Database Advanced Settings

The **Advanced Settings > Configuration Database** dialog shows the extra configuration settings not present in the Configuration Database in the left panel of the WebLink's **Setup** user interface.

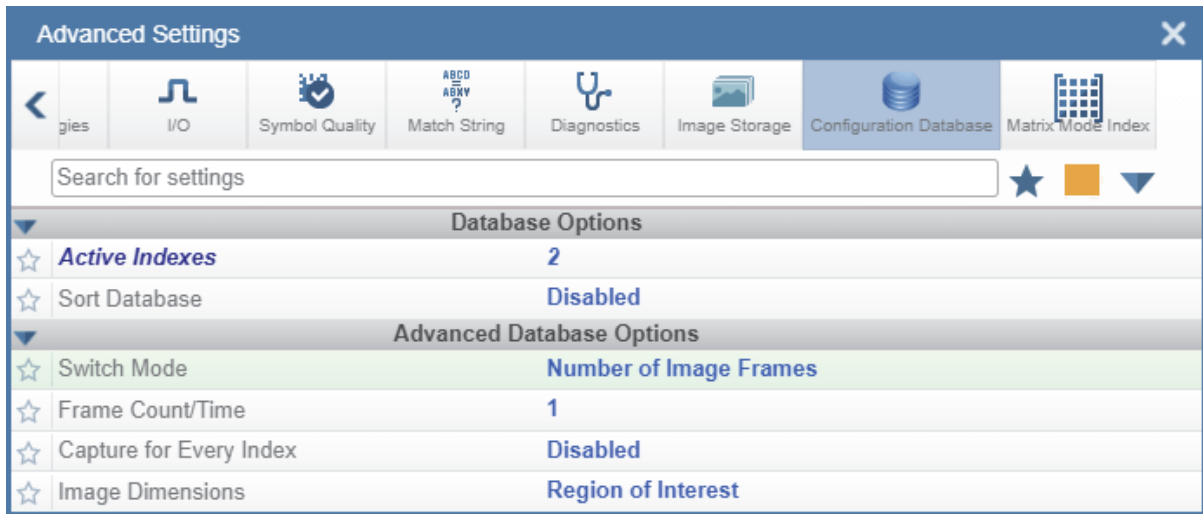

If you enable **Sort Database**, a warning will appear in the Configuration Database section of the left panel.

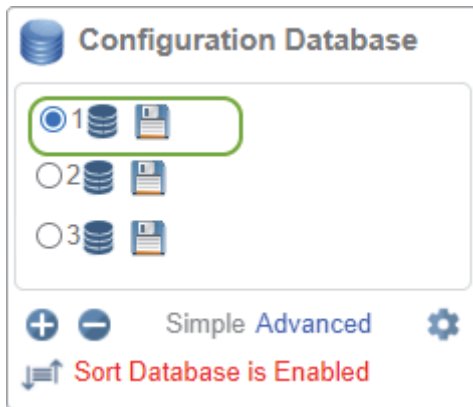

If you disable the Configuration Database with multiple database indexes, the following warning dialog will appear:

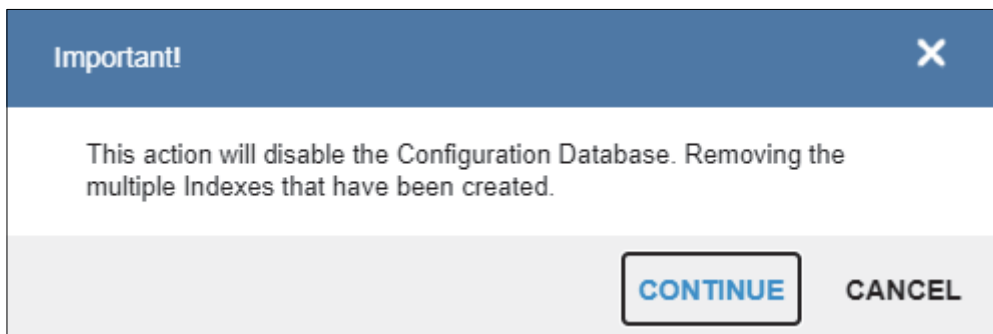

The user interface shows which settings are affected by the **Configuration Database** using dark blue highlighting around the Acquire and Decode steps.

The screenshot displays the Configuration Database interface with several sections:

- Configuration Database:** Includes three radio button options (1, 2, 3), a 'Simple Advanced' toggle, and a 'Sort Database is Enabled' status indicator.
- Acquire:** Shows a camera icon, a green checkmark, a sun icon with '1000 μs', a refresh icon with '0%', and 'Enhance: Disabled'.
- Matrix Mode:** A table showing grid parameters:

	1	Columns	1
Rows	1	Columns	1
Top	0	Left	0
Cell Width	350	Cell Height	350
		Size	Offset
Horizontal		-4%	0%
Vertical		-4%	0%

 Below the table are icons for 'Position', 'Size', and 'Offset'.
- Decode:** Shows a document icon, a green checkmark, and three buttons labeled '2D', '1D', and 'Special' with corresponding icons and a gear icon.
- Match String:** A toggle switch currently set to 'Off'.
- Format Output:** A toggle switch currently set to 'Off', with checkboxes for 'Preamble <CR>' (unchecked), 'Postamble <CR><LF>' (checked), and 'Replacements: 0'. Below are checkboxes for 'Remove Control Characters' and 'Remove Extended Characters'.

Advanced Features

If you are in **Rapid Capture** and **ROI** mode and have fewer captures than the Configuration Database has groups of indexes with the same capture settings, a warning icon like the one below will appear.

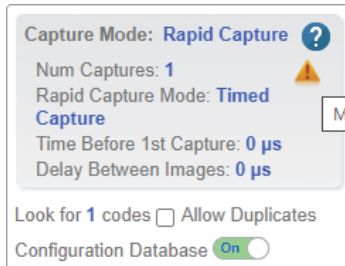

Capture Mode: **Rapid Capture** ?

Num Captures: **1** ⚠

Rapid Capture Mode: **Timed Capture**

Time Before 1st Capture: **0 μs**

Delay Between Images: **0 μs**

Look for **1** codes Allow Duplicates

Configuration Database On

Make sure the capture count is equal to the number of groups of Database Indexes with the same capture settings.

If you are in **Rapid Capture** and **WOI** mode and have fewer captures than the Configuration Database has database indexes, a warning icon like the one below will appear.

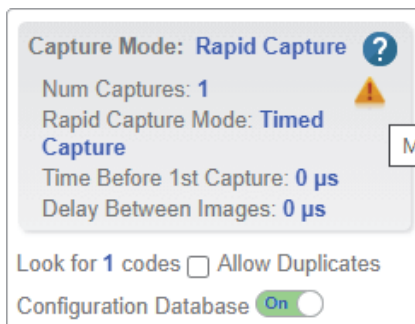

Capture Mode: **Rapid Capture** ?

Num Captures: **1** ⚠

Rapid Capture Mode: **Timed Capture**

Time Before 1st Capture: **0 μs**

Delay Between Images: **0 μs**

Look for **1** codes Allow Duplicates

Configuration Database On

Make sure the capture count is equal to the Configuration Database active Index count.

4-11 Configure Daisy Chain (If Required by Application)

Daisy Chain is useful in applications where:

- More than one symbol type is present;
- A symbol may be present on multiple sides of a package;
- Symbols are presented at different depths;
- Multiple readers are required to cover a large field of view;
- There is a need to find a symbol on a circular object in any orientation.

A Daisy Chain consists of one **parent** and one or more **child** devices. The child devices report their data to the parent, which then reports the data to the network, effectively allowing all readers to act as one. In other words, the outside world interacts with one unit – the parent reader.

The **Device Discovery Utility DDU** is used to configure the Daisy Chain group where the parent reader and the child readers are defined. The parent reader interacts with a host computer or PLC. A parent reader that receives a trigger will send a trigger to each of the child readers. Any symbol decoded by the child readers will be communicated to the parent, which collects all of the decodes from the children and will communicate them to the host. The Daisy Chain uses one UDP packet for the decoded data from all readers. Combined data from all readers larger than 3800 bytes will not be reported.

4-11-1 Overview of Setup Process

Use the Device Discovery Utility to define the Daisy Chain group, the parent reader, and the child readers.

Use WebLink to configure each of the readers in the Daisy Chain group as desired for the application.

Tips

The parent reader should:

- Configure for application requirements: Match String, Format Output, Trigger, Digital Outputs, etc.

The child readers should:

- Use a Triggered cycle, such as External Edge.
- Use a timeout that occurs before the end of read cycle on the parent reader.

Parent and child readers should:

- Save settings to the flash memory of the readers.

4-11-2 Setting Up a Daisy Chain Configuration with the Device Discovery Utility (DDU)

If your application requires readers to be deployed in a Daisy Chain configuration, the **DDU** can help you create such a configuration.

A Daisy Chain is a grouping of **2 to 8** readers that function as one. The DDU interface allows you to manage Daisy Chains, including their creation, monitoring, and deletion.

Connect 2 to 8 V440-F or V430-F readers that have Daisy Chain-compatible firmware. From the DDU home page, click on the group icon located near the top-right.



On the **Groups** page, assign a **Group Name** and click **Create**. This opens the interface that allows you to create a new Daisy Chain.

Important: Only Daisy Chain-enabled readers will appear in this view.

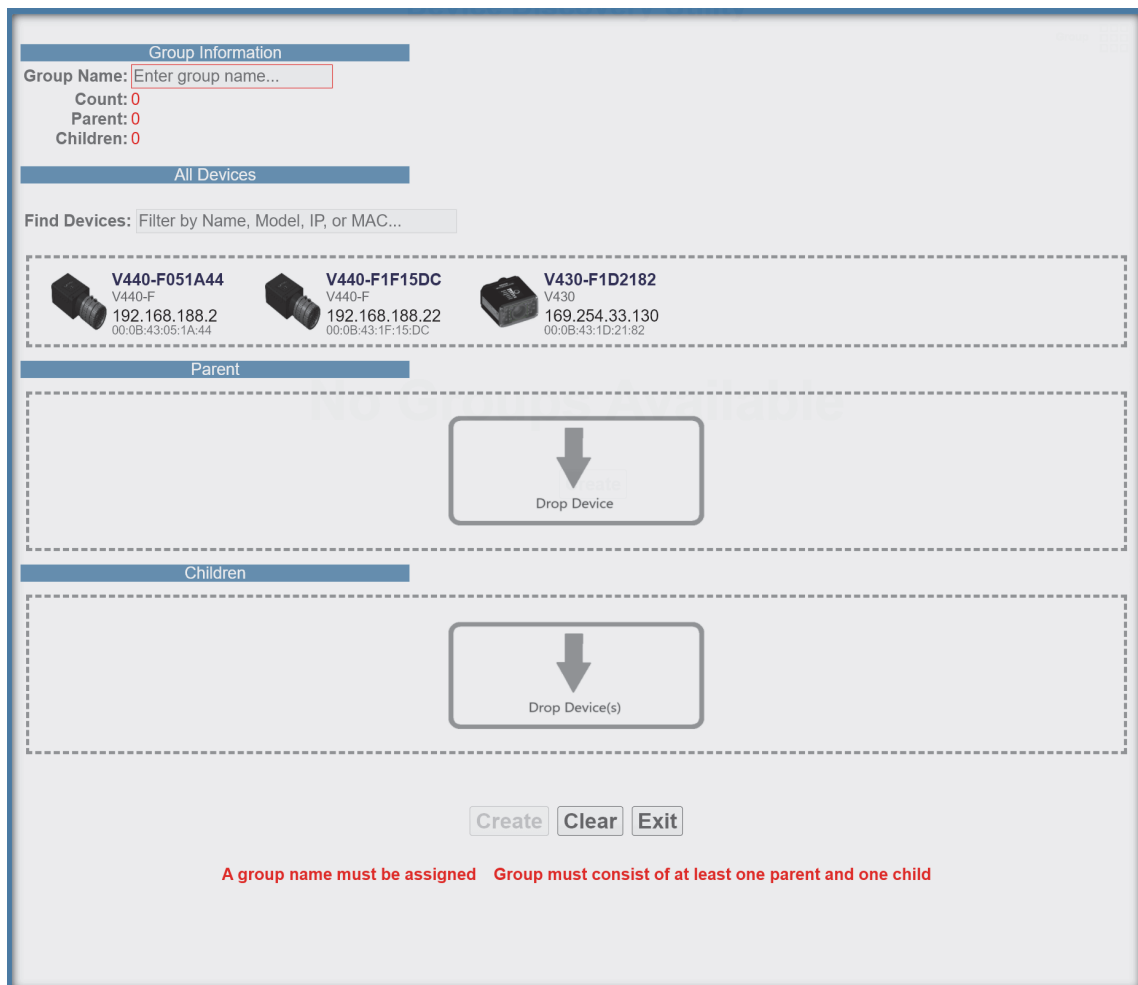

The five most important areas in the Daisy Chain creation interface are:

- **Group Information:** Contains the **Group Name**, Total **Count**, **Parent** Count, and **Children** Count of the Daisy Chain being created. This information is dynamically updated as you make changes. The Group Name text box is editable, and a group name must be provided to create a new Daisy Chain.

- **All Devices:** Contains all Daisy Chain-enabled devices that appear on the network. Devices are represented by an image, a model, and an IP address. Each device is clickable. You can search for specific devices using the **Filter Devices** search box.

- **Parent:** The **Parent** container is empty upon opening the interface. This container is used to store the **Parent** reader in the Daisy Chain. A maximum of one device can be placed in the Parent container. A minimum of one device must be placed here to create the Daisy Chain.
- **Children:** The **Children** container is empty upon opening the interface. This container is used to store the **Children** readers in the Daisy Chain. A minimum of one device must be placed here to create a Daisy Chain, and a maximum of seven devices may be placed here.

- **Buttons:** This section of the interface includes the **Create**, **Clear**, and **Exit** buttons.
 - **Create** creates a new Daisy Chain if all the necessary conditions are met.
 - Note:** The **Create** function does not delete a Daisy Chain and only resets the interface.
 - **Clear** resets the interface to its original state.
 - **Exit** closes the window.

Below these buttons, messages will appear that indicate any errors in the potential Daisy Chain being created. These errors appear and disappear based on dynamic validation of user input.

The Daisy Chain creation interface is drag-and-drop, meaning you can move devices around the page to build your Daisy Chain.

The **All Devices**, **Parent**, and **Children** containers are drop zones for readers. To move a device, place the cursor over a device, left-click, and hold down. Then drag the device in another drop zone by moving the cursor / reader over it and releasing your mouse's left-click button. Valid reader drop zone areas are designated by the dotted grey line surrounding them.

Drag and drop a reader into the **Parent** drop zone. Drag and drop one or more other Daisy-Chain-enabled readers into the **Children** drop zone. Assign a name to the group.

If errors occur (**A group name must be assigned** or **Group must consist of at least one parent and one child**), resolve them as needed, and then you will see that the **Create** button will be active. A valid Daisy Chain configuration should resemble the example below.

The screenshot displays the Daisy Chain configuration interface. At the top, the 'Group Information' section shows the group name 'MY_FIRST_GROUP', a count of 3 devices, 1 parent, and 2 children. Below this is the 'All Devices' section with a search filter. The 'Parent' section contains one device: V440-F051A44 (V440-F) with IP 192.168.188.2 and MAC 00:0B:43:05:1A:44. The 'Children' section contains two devices: V440-F1F15DC (V440-F) with IP 192.168.188.22 and MAC 00:0B:43:1F:15:DC, and V430-F1D2182 (V430) with IP 169.254.33.130 and MAC 00:0B:43:1D:21:82. A 'No Groups Available' message is visible in the background. At the bottom, there are 'Create', 'Clear', and 'Exit' buttons.

If the Daisy Chain was created successfully, the popup will close, and the newly established Daisy Chain will be displayed as a diagram or map. This diagram is generated based on the number of devices in the Daisy Chain. Whichever number of devices in the Daisy Chain, the Parent always appears above and all Children devices below.

Sample Daisy Chain with One Parent and Two Children



Sample Daisy Chain with One Parent and One Child

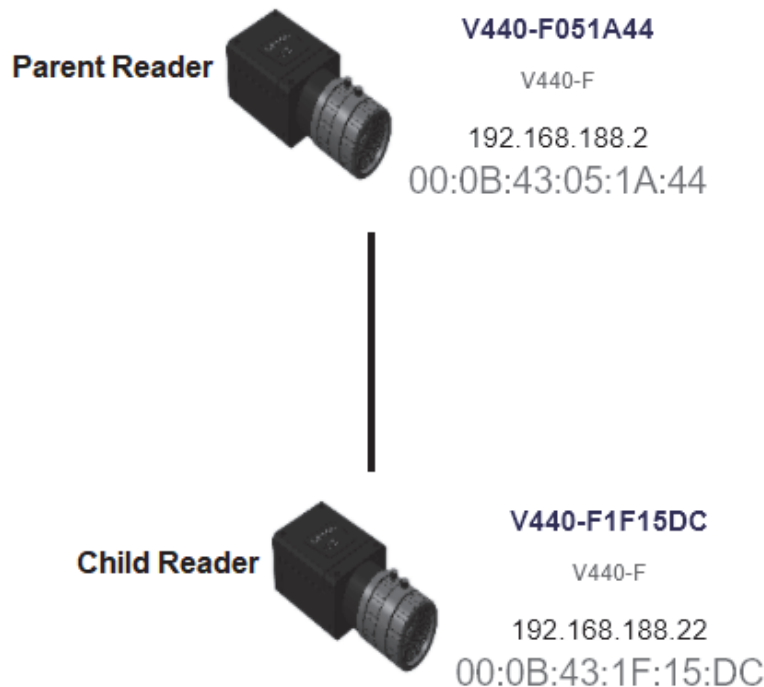

There is no limit on the number of Daisy Chains that can be created. All current, active Daisy Chains will appear on the Daisy Chain page in the DDU. Click on any Daisy Chain to open its information popup. This popup contains information about the Daisy Chain configuration, including Group Information, Parent reader identity, and Children reader identities. The Daisy Chain information popup also contains a Delete button, which deletes the entire Daisy Chain configuration – Parent and Children.

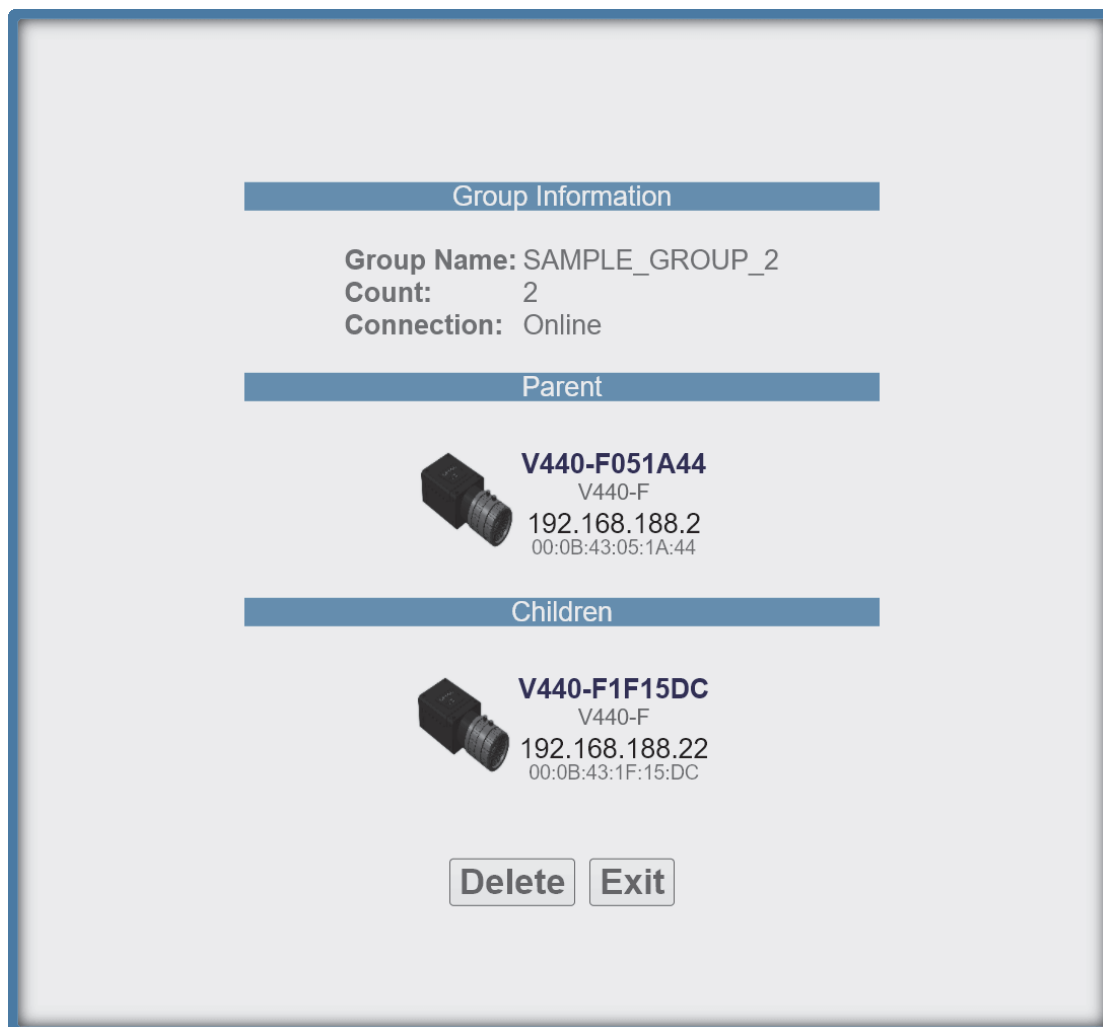

4-11-3 Daisy Chain Fundamentals

Important: It is recommended that Daisy Chain readers of the same group should be positioned in such a way that their fields of view do not overlap. Should their fields of view overlap, label data may be output twice from the Parent device.

Parent: The master device in the group. Responsible for establishing the group on the firmware side and reporting the Daisy Chain to the DDU. There can be only one Parent in a Daisy Chain. The parent is responsible for receiving **create** and **delete** commands from the DDU.

Children: Any reader that is currently a part of a Daisy Chain that is not the Parent device is a Child device. Child readers report data to the Parent reader.

A Valid Daisy Chain:

- Must have at least two readers;
- Must contain one Parent reader;
- Must contain one or more Child readers (up to 8);
- Must have a group name less than 25 characters in length;
- Must have a valid group name [a-z, A-Z, 0-9, _, -]

The creation and deletion of Daisy Chains occurs via UDP messages that are sent from the DDU user interface to the readers. If a parent device recognizes that it has been configured in a Daisy Chain, it creates the firmware connection, and then broadcasts UDP messages that contain all the information needed by the user interface to produce a functional Daisy Chain configuration. The user interface will only create a new Daisy Chain if it receives a broadcast from the Parent device with the Daisy Chain information. The core communication between the user interface and the device(s) is via the Parent device. The firmware is responsible for connecting the Parent device to the Children devices and then reporting the status.

A Daisy Chain consists of one Parent and one or more Children devices. The Children devices report their data to the Parent, which then reports the data to the network, effectively allowing all readers to act as one.

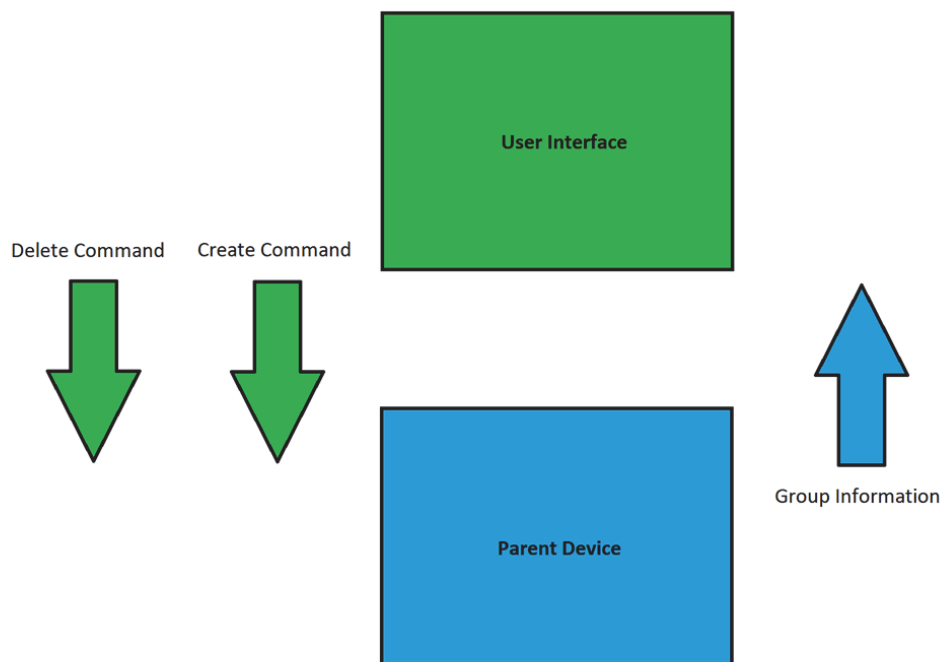

4-11-4 Error Handling

If the **Parent** reader in a Daisy Chain is turned off for more than one minute, a **Disconnected** notice will appear in the dialog. This notice will disappear once the Parent reader is turned back on.



If a **Child** reader in a Daisy Chain is turned off, even temporarily, an **Offline** notice will appear below the respective Child on the reader map. Once turned back on, the Offline notice will disappear.

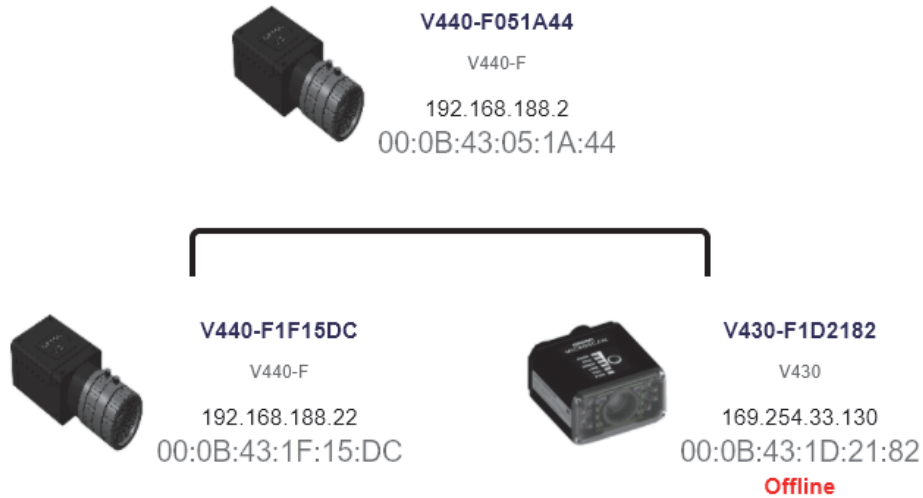

Some errors can occur when you have already established a Daisy Chain and confirmed that it's working.

In this hypothetical error scenario, the Parent reader = **P**, the first Child reader = **C1**, the second Child reader = **C2**, and the third Child reader = **C3**.

The user shuts down the application and completely turns off power on **P**, **C1**, **C2**, and **C3**. The user comes in the following day and turns on all the devices except C3 and then starts the application.

The complete Daisy Chain can't be re-initiated because it is missing a unit. To account for this, the application will place a "dummy device" in place of the missing **C3**. The dummy device will display an error icon, the missing device's MAC address, and an **Offline** status message. It will continue show this status if the browser is restarted. This offline device can't be clicked in the Daisy Chain info page. It is only there to alert the user of the missing device.

DAISY_ONE

An error occurred in this group



If the user turns on **C3** when seeing the status shown in the diagram above, the application will automatically resolve the issue and a new, fully-formed Daisy Chain with **C3** as a full device will be created. There is no need to restart the browser or Parent device.

4-12 Favorites

The **Favorites** dropdown menu displays commands that you have selected as favorites by clicking the star icons next to command names in the **Advanced Settings** menus. This is useful because it allows you to change the parameters of frequently-used commands without returning to the Advanced Settings menus.

In the example below, notice that the star icon next to the **Light Source** command in the **Camera Setup** menu is selected. This causes that command to appear in the Favorites editor in the **left panel** of WebLink's **Setup** view. Commands that are displayed in Favorites can be configured in the same way as commands in Advanced Settings.

The image shows two screenshots from the WebLink software interface. The top screenshot is a 'Favorites' dropdown menu. It has a blue header with the word 'Favorites'. Below the header, there is a star icon followed by the text 'Pixel Binning'. To the right of this text is a dropdown menu currently showing 'Disabled'. The dropdown menu is open, showing three options: 'Disabled' (highlighted in blue), 'Disabled', and 'Enabled'. The bottom screenshot is the 'Advanced Settings' window. It has a blue header with the text 'Advanced Settings' and a close button. Below the header is a navigation bar with several icons and labels: 'Camera Setup', 'Communications', 'Read Cycle', 'Symbolologies', 'I/O', 'Symbol Quality', 'Match String', 'Diagnostics', 'Image Storage', and 'Configurati'. Below the navigation bar is a search bar with the text 'Search for settings'. The main content area is divided into several sections: 'Camera Settings', 'Illumination', 'Window of Interest', 'Morphological Preprocessing', and 'Simulation Images'. Each section contains a list of settings with star icons next to their names. In the 'Camera Settings' section, 'Pixel Binning' is highlighted with a red box and has a star icon next to it. Other settings in this section include 'Exposure' (2578 μs) and 'Gain' (25 %). In the 'Illumination' section, settings include 'Illumination Brightness' (Off), 'Light Source' (External Strobe), 'Fixed Light On Time' (0 μs), and 'Fixed Light Delay Time' (0 μs). In the 'Window of Interest' section, settings include 'Top' (1195), 'Left' (1461), 'Height' (624), and 'Width' (696). In the 'Morphological Preprocessing' section, settings include 'Morphological Preprocessing' (Enabled), 'Operation' (Separate Dark), and 'Size' (Small). The 'Simulation Images' section is currently empty.

5

Run

In the **Run** view, you can observe the progress of the application as it follows the parameters you have defined.

5-1	Run	5-2
5-2	Counts.....	5-3
5-3	Rate	5-4
5-4	Matrix Info.....	5-5
5-5	Read Time.....	5-6
5-6	Output Data.....	5-7
5-7	Image History	5-8

5-1 Run

The **right panel** of the UI shows **Counts** for **Cycles**, **Reads**, **No Reads**, and **Mismatches**, as well as **Rate** information for **Capture**, **Decode**, **Overhead**, **Total Read**, and **Trigger Rate**, as well as **Output Data**. A **"filmstrip"** below the **Image Area** shows each image capture with a **green check mark** for a good read and a **red x** for a no read.

Increase the magnification of this page to read the descriptions in the image below.

The frequency with which the image is refreshed, expressed in hertz.

Reader part number.

Reader model name.

Reader IP address.

Reader serial number.

Triggered Outputs 1, 2, and 3 function both as indicators and buttons. They show when outputs are triggered, and they allow you to trigger outputs manually by clicking them. See Setup > Outputs for additional details.

5-2 Counts

The **Counts** area of the **right panel** provides five data points:

- **Cycles** shows the total number of captures that have occurred.
- **Reads** shows how many decode attempts have been successful.
- **No Read** shows how many decode attempts have been unsuccessful.
- **Mismatch** shows how many times decoded symbol data has not matched a user-defined character string if a **Match String** is defined.
- **Read %** shows the percentage of decode attempts that have been successful.

Counts 	
Cycles	174
Reads	174
No Read	0
Mismatch	0
Read %	100.00

You can reset all Counts by clicking the **eraser** icon.

5-3 Rate

The **Rate** area of the **right panel** provides five data points:

- **Capture** shows the average image capture rate per second.
- **Decode** shows the average decode rate per second.
- **Overhead** shows the average of excess processing time required to achieve captures and decodes.
- **Total Read** shows the total average time required for image capture, decoding, and overhead per second.
- **Trig Rate** shows the average number of triggers per second.

Rate 		
Capture	244.6 ms	4.1/s
Decode	405.1 ms	2.5/s
Overhead	1.0 ms	
Total Read	650.6 ms	1.5/s
Trig Rate	1688.0 ms	0.59/s

You can reset all Rate data by clicking the **eraser** icon.

5-4 Matrix Info

The **Rate** area of the **right panel** provides four data points:

- **Min Time** shows the fastest decode time from among all the symbols in the matrix.
- **Max Time** shows the slowest decode time from among all the symbols in the matrix.
- **Avg. Time** shows the average decode time for all the symbols in the matrix.
- **Success** shows the number of symbols decoded successfully.

Matrix Info 	
Min Time	7.37 ms
Max Time	28.48 ms
Avg. Time	18.59 ms
Success	4 / 4

You can reset all Matrix Info data by clicking the **eraser** icon.

5-5 Read Time

Read Time (ms) is a real-time line graph representation of the read time data point in the **Rate** area of the **right panel**.

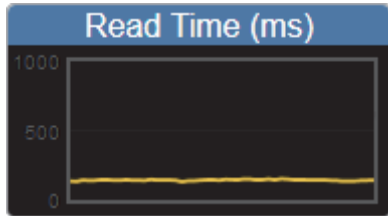

5-6 Output Data

The **Output Data** area of the **right panel** shows the data from each symbol decoded in a read cycle. The preamble and postamble are also shown here if enabled and configured. New data scrolls down from the top.



The screenshot shows a vertical list of 16 lines of text in a dark-themed interface. The title 'Output Data' is at the top in a blue header. Each line contains the text 'OMRON V440-F\n\r\n' in a light green font, representing a decoded symbol.

```
Output Data
OMRON V440-F\n\r\n
OMRON V440-F\n\r\n
OMRON V440-F\n\r\n
OMRON V440-F\n\r\n
OMRON V440-F\n\r\n
OMRON V440-F\n\r\n
OMRON V440-F\n\r\n
OMRON V440-F\n\r\n
OMRON V440-F\n\r\n
OMRON V440-F\n\r\n
OMRON V440-F\n\r\n
OMRON V440-F\n\r\n
OMRON V440-F\n\r\n
OMRON V440-F\n\r\n
OMRON V440-F\n\r\n
OMRON V440-F\n\r\n
```

5-7 Image History

Image History is a series of thumbnail representations of each image capture. The Image History appears below the **Image Area** in the **Run** view. Each image capture thumbnail shows a **green check mark** for a good read and a **red x** for a no read.

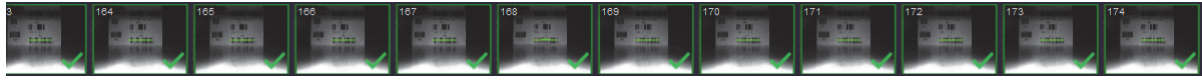



Application Settings

This section describes the **Application Settings** menu, which enables you to control a wide array of **WebLink** functions.

6-1	Application Settings Menu	6-2
6-2	Save.....	6-3
6-3	New	6-4
6-4	Load	6-5
6-5	Advanced	6-6
6-6	Language	6-7
6-7	Terminal	6-8
6-8	Beeper.....	6-9
6-9	Image Storage	6-10
6-10	Reset Application or Factory Settings	6-21
6-11	Activate Account Management	6-22
6-12	About WebLink.....	6-30

6-1 Application Settings Menu

Click the **gear icon** to the right of the **help icon** to open the **Application Settings** menu.



The **Application Settings** menu includes several functions: **Save, New, Load, Advanced, Language, Terminal, Beeper, Image Storage, Reset Application or Factory Settings, Active Account Management, and About Weblink.**

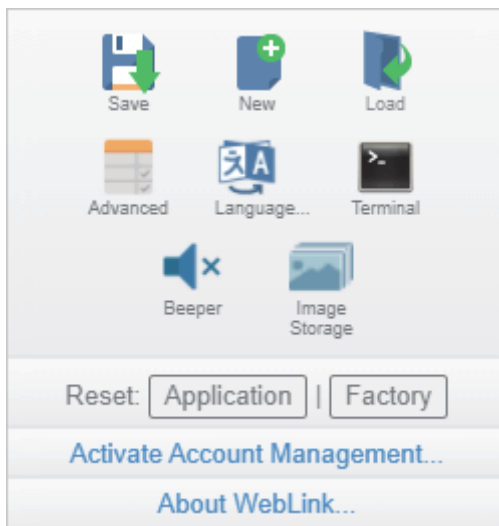

6-2 Save

Save saves the current configuration.

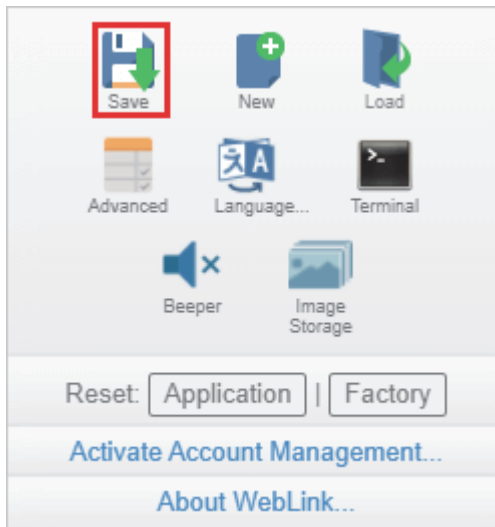

6-3 New

New opens a new WebLink session.

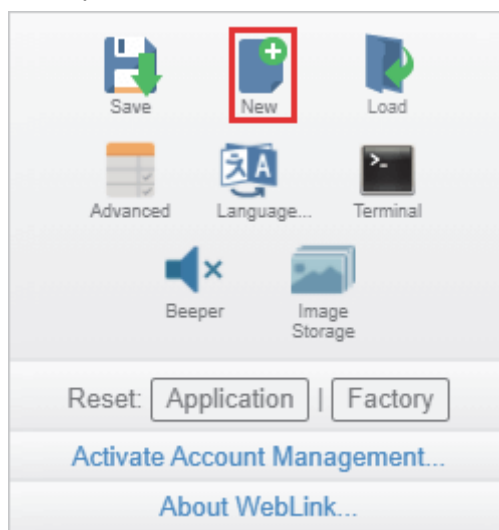

6-4 Load

Load allows you to open an existing configuration.

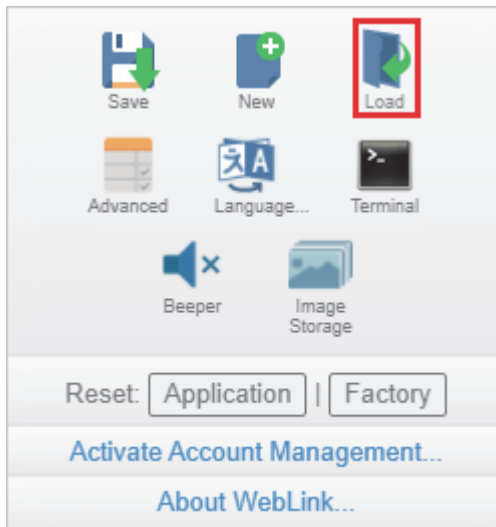

6-5 Advanced

Advanced allows you to make precise adjustments to every area of reader functionality: **Camera Setup, Communications, Read Cycle, Symbologies, I/O, Symbol Quality, Match String, Diagnostics, Image Storage, Configuration Database, and Differences from Default.**

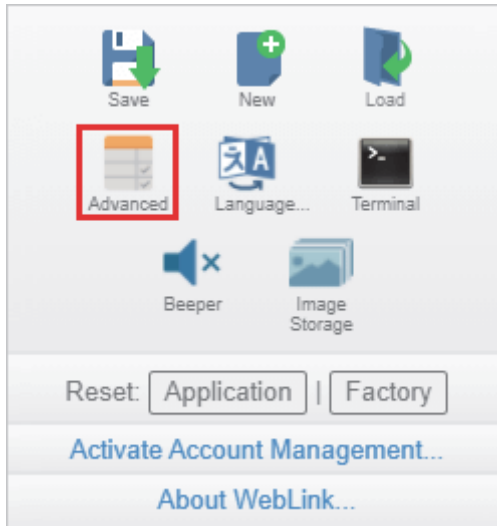

6-6 Language

Language allows you to select the language of the WebLink interface.

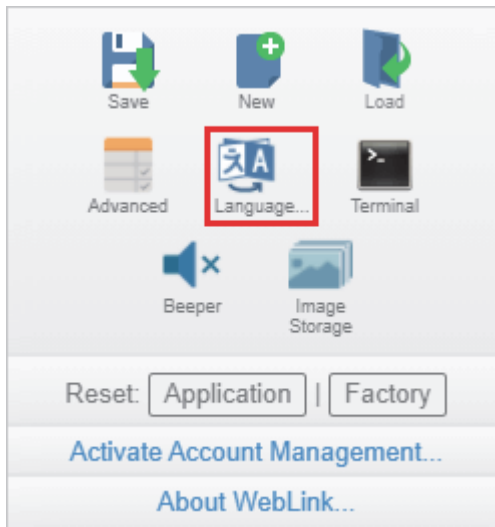

Important: The reader will restart when a different language is selected.

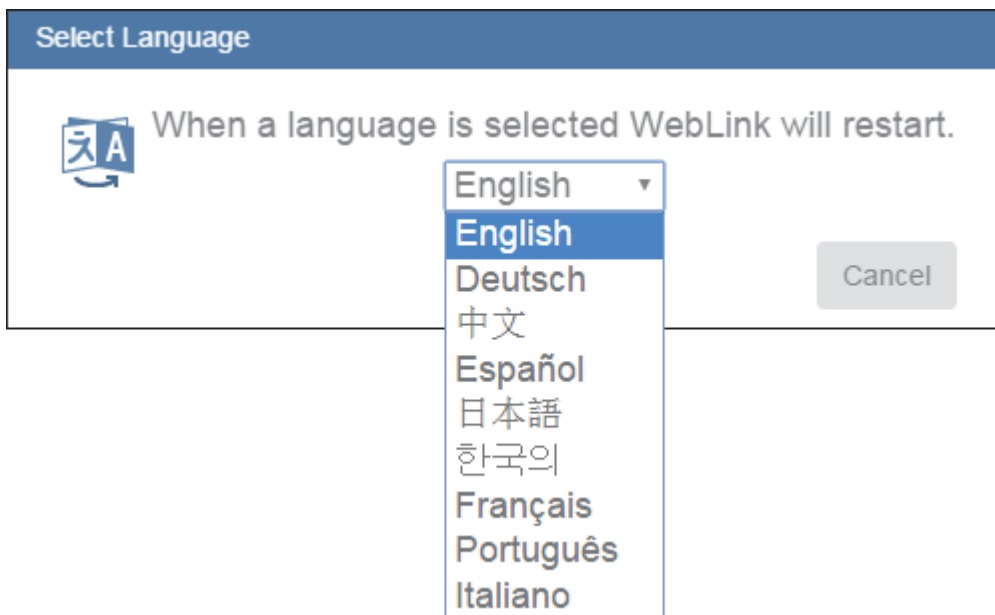

Available Languages:

- English
- German
- Chinese (Simplified and Traditional)
- Spanish
- Japanese
- Korean
- French
- Portuguese
- Italian

6-7 Terminal

Terminal opens WebLink's **Terminal** interface, where serial commands can be sent, responses from the reader can be shown, and reader output can be displayed.

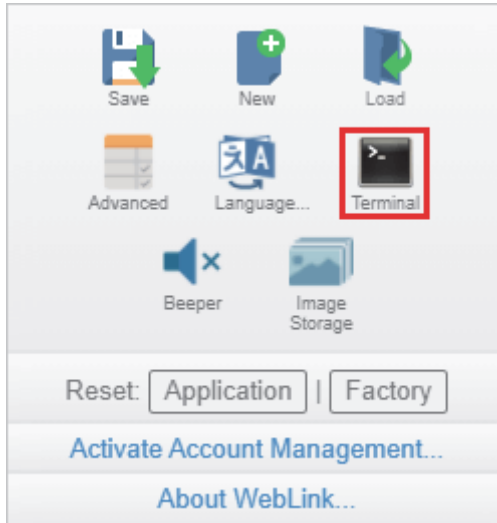

6-8 Beeper

Enabling **Beeper** causes your PC to beep when WebLink receives a valid decode from the reader.

Note: There is no beeper in the reader's hardware.

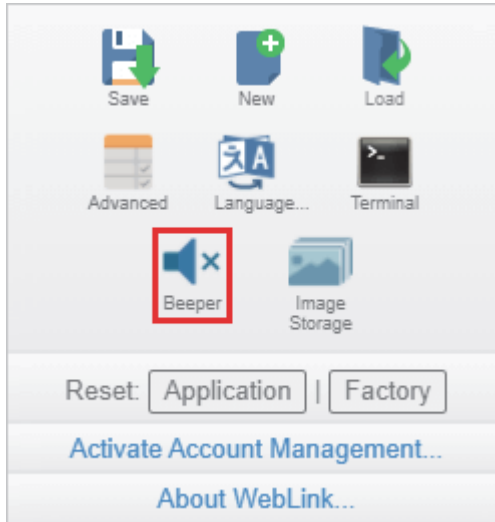

6-9 Image Storage

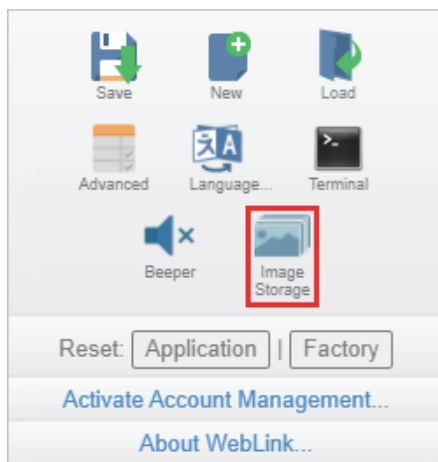

When you click the **Image Storage** icon in the **Application Settings** menu, you will see this dialog:

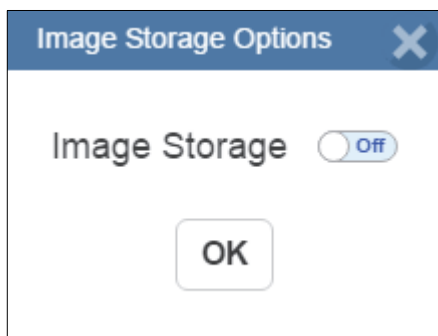

When you turn **Image Storage on** and click **OK**, the dialog will expand as shown below. The **Image Storage Options** commands allow you to control how, when, and where images captured by the reader are stored. Those commands are described on the following pages.

The commands in the **Image Storage Options** dialog are described on the following pages. These commands are only visible when the **Image Storage** switch is set to **On**.

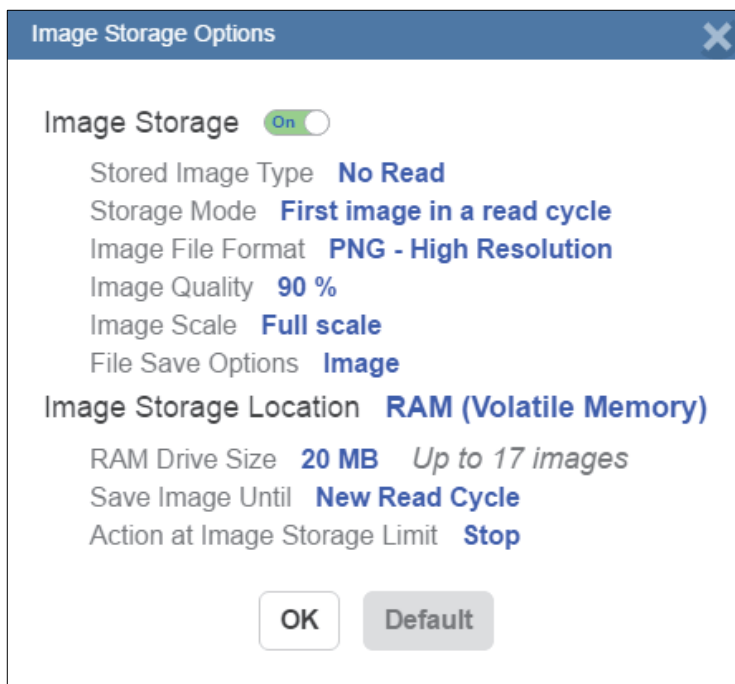

Image Storage (Continued from Previous Page)

Stored Image Type allows you to configure which images are stored to the destination device. Options are:

- **Good Read:** Saves image(s) where the decoder reports a good read.
- **No Read:** Saves image(s) where the decoder does not report a good read (default).
- **Good Read and No Read:** Save both Good Read and No Read decoder reports.
- **Match:** Save reports satisfying Match criteria.
- **Mismatch:** Save reports satisfying Mismatch criteria.
- **Match and Mismatch:** Save reports satisfying both Match and Mismatch criteria.
- **All:** Save All reports.

Storage Mode represents which image or images are stored. Options are:

- **First Image in a Read Cycle:** Save first image that qualifies the **Stored Image Type (default)**.
- **All Images in a Read Cycle:** Save all images that qualify the **Stored Image Type**.

Image File Format allows you to select which file format to apply to the saved image. Options are:

- **PNG – High Resolution:** Save images using .png format (**default**).
- **JPG – Low Resolution:** Save images using .jpg format.
- **BMP – Direct Raw:** Save images using .bmp format.

Image Quality is a sliding scale between **1%** and **100%**, where the higher the image quality, the more space is required to store the image. The default setting is **90%**.

Image Scale represents the amount of data compression applied to the stored image. Images with a lower compression ratio require more storage space. Options are:

- **1:1** – No data compression applied. Full image (**default**).
- **2:1** – Image compressed by 50%.
- **4:1** – Image compressed by 75%.
- **8:1** – Image compressed by 88%.

File Save Options allow you to decide which type of report to save. Options are:

- **Image:** Saves images (**default**).
- **Read Cycle Report:** Saves cycle reports.
- **Image and Read Cycle Report:** Saves images and cycle reports.

Image Storage Location is where images and reports are stored. Options are:

- **RAM (Volatile Memory):** Images and cycle reports are saved to internal RAM drive (**default**).
- **Remote (FTP):** Images and cycle reports are saved to a remote FTP-connected device.

When the **Image Storage Location** setting is configured as RAM, all information is saved to a RAM drive onboard the camera. This drive is volatile and all data is lost when the unit resets.

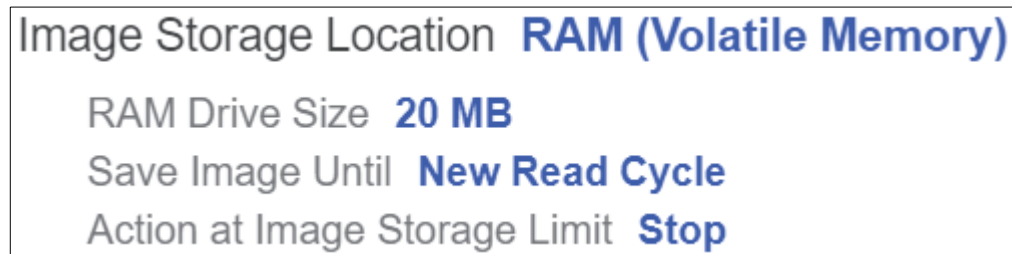
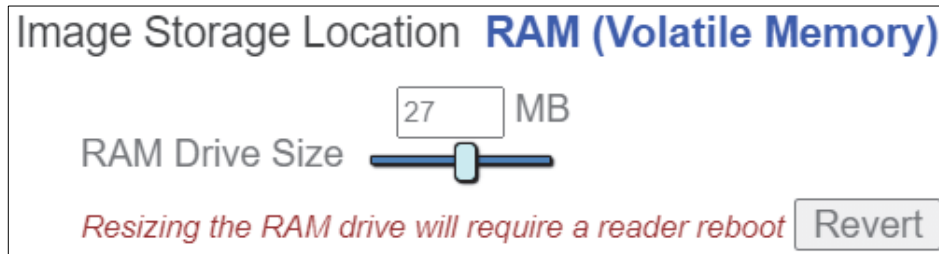

Image Storage (Continued from Previous Page)

RAM Drive Size allows you to create a RAM drive between **1 MB** and **50 MB** using a slider. The default is **20 MB**. Resizing the RAM drive requires a reboot of the camera, resulting in the loss of any data currently on the drive. If the **RAM Drive Size** value changes, a message will appear in the **Image Storage Location** dialog stating “Resizing the RAM drive will require a reader reboot”. If you click **Revert**, the RAM drive size will return to its previous size.



Save Image Until determines how long stored data is to be saved. Options are:

- **New Read Cycle:** Saves a cycle of data until the next read cycle (**default**).
- **System Reset:** Saves data until the system is reset. When maximum storage capacity is reached, the **Action at Image Storage Limit** parameter determines whether or not data is overwritten.

Action at Image Storage Limit allows you to decide what action is taken once the storage limit is reached. Options are:

- **Stop:** Stop saving images and cycle reports when maximum storage reached (**default**).
- **Erase Oldest:** Overwrite oldest image and cycle report when maximum storage reached.

If **Image Storage Location** is set to **Remote FTP**, the **FTP Address** will appear, which allows you to input your user ID, password, and the address of the applicable FTP server.

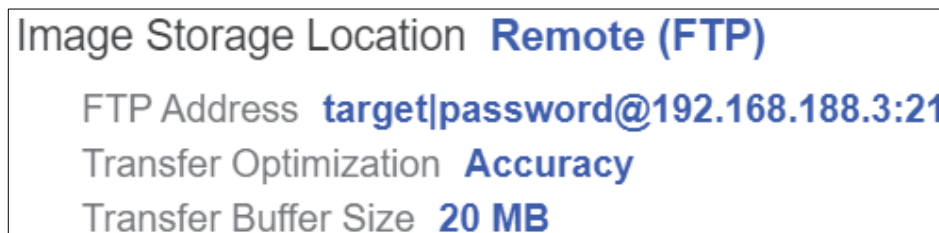

FTP Address represents the the FTP host settings on the device where images and reports are saved. The device must be running an FTP server.

- **target (userid):** The user ID configured on the FTP host server.
- **password:** The password associated with the user ID of the FTP host server.
- **xxx.xxx.xxx.x:** IP address of the FTP host device. The default is **192.168.188.3**.
- **port:** Which host port to use. The default is **21**.

Transfer Optimization configures how images and reports are sent to the FTP host.

- **Speed:** Images and reports are sent via a lossy mechanism. This method focuses on maintaining trigger integrity (**default**).
- **Accuracy:** Images and reports are sent via a lossless mechanism. This method transmits all images and reports that could possibly result in triggers being delayed or read cycles being ended prematurely.

Transfer Buffer Size defines the maximum buffer size used per cycle. If the **Transfer Buffer Size** parameter changes, the message shown below will appear in the **Image Storage Location** dialog. If you click **Revert**, the RAM drive returns to its previous size. The default size is **20 MB**.

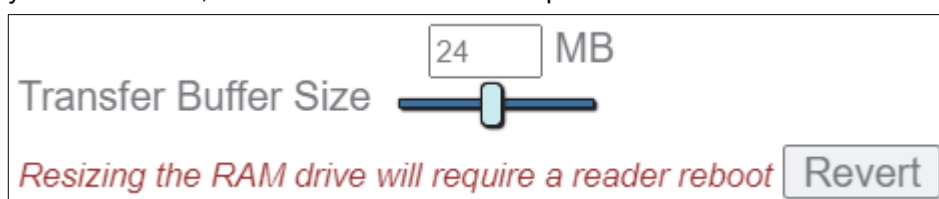

Image Storage settings can also be configured in **Section 8 – Advanced Settings**.

6-9-1 Image Storage by External FTP Server

An external FTP server can be used to store images captured by the reader. The reader can connect to an FTP server and can send images and cycle reports to that server for storage. The following procedure describes how to set up an external FTP server.

The example procedure shown here uses **FileZilla Server**, which can be downloaded at <https://filezilla-project.org/>. Note that FileZilla is a Windows-only utility.

- Download and install FileZilla Server.

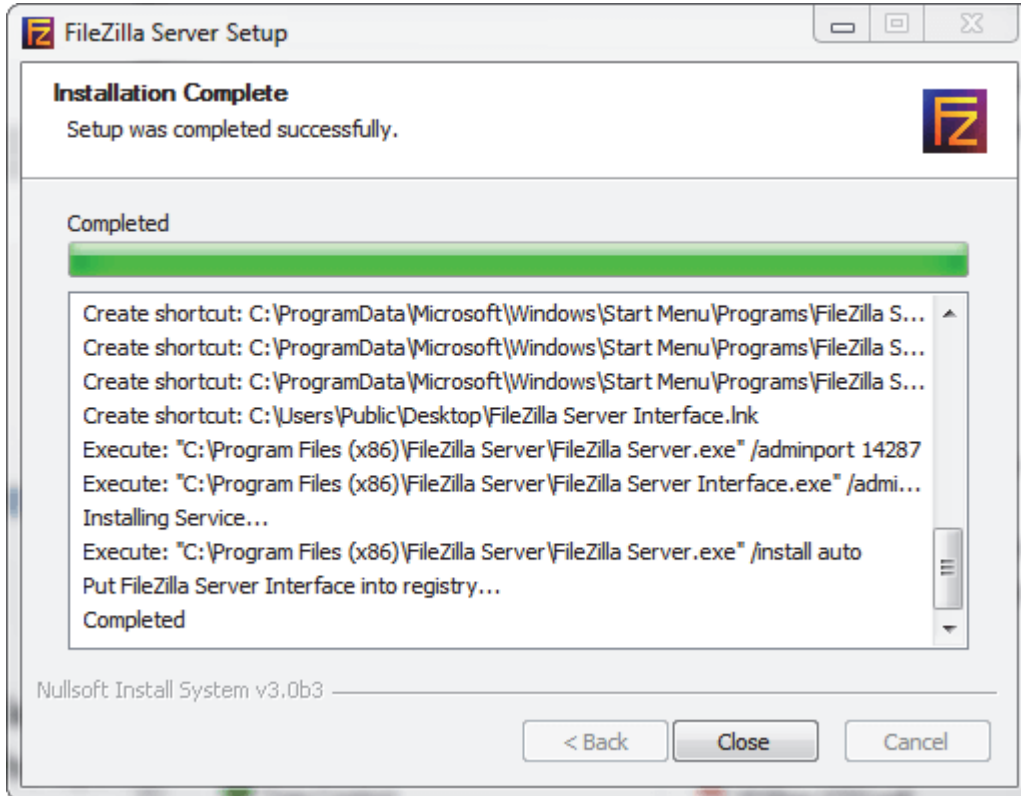

- Connect to the server. Use the **127.0.0.1** server address if you are setting up the server on your PC. Note the port that you use – **14147** in the example shown here – as the port number will be required when you log back into the server.

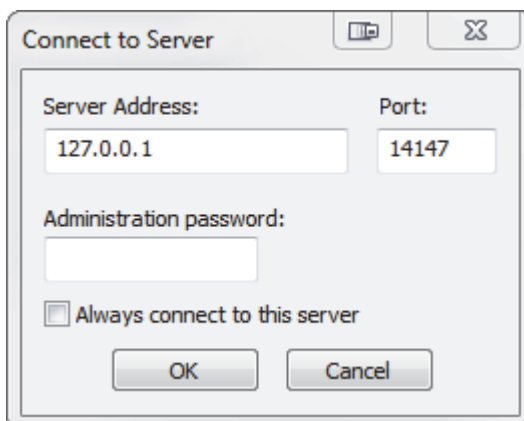

- Configure the settings on the **General** page of the **Users** dialog.

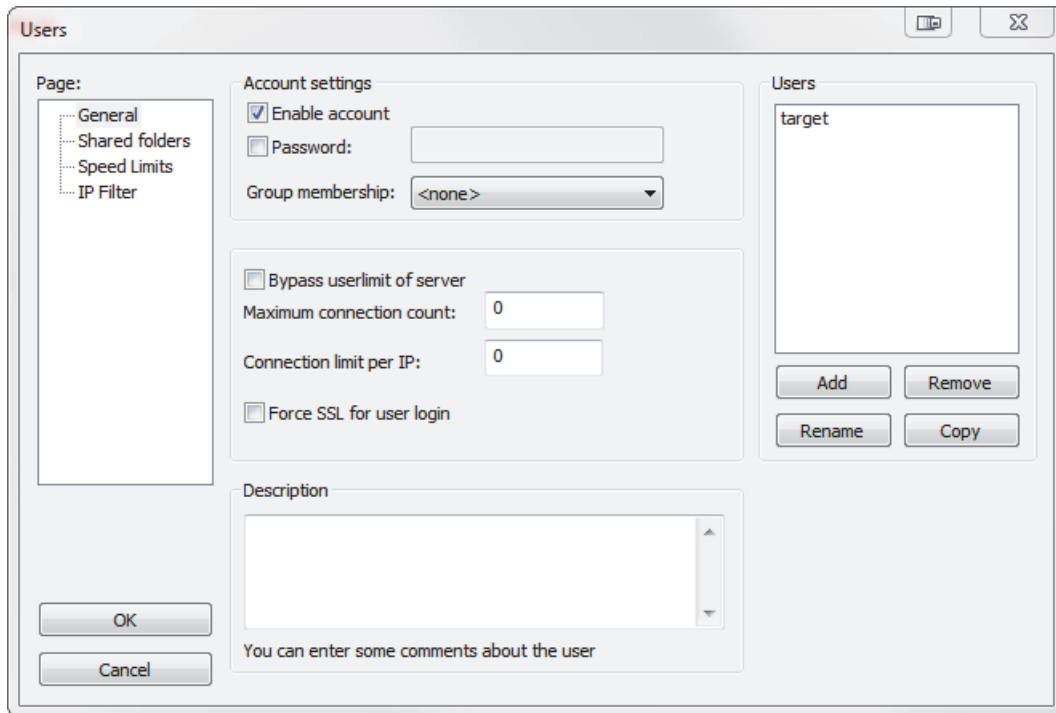

- Navigate to **Shared folders** under **Page:** in the left panel. Be sure that **Write** under **Files** is checked and that **Create** under **Directories** is checked. Add a new user group.

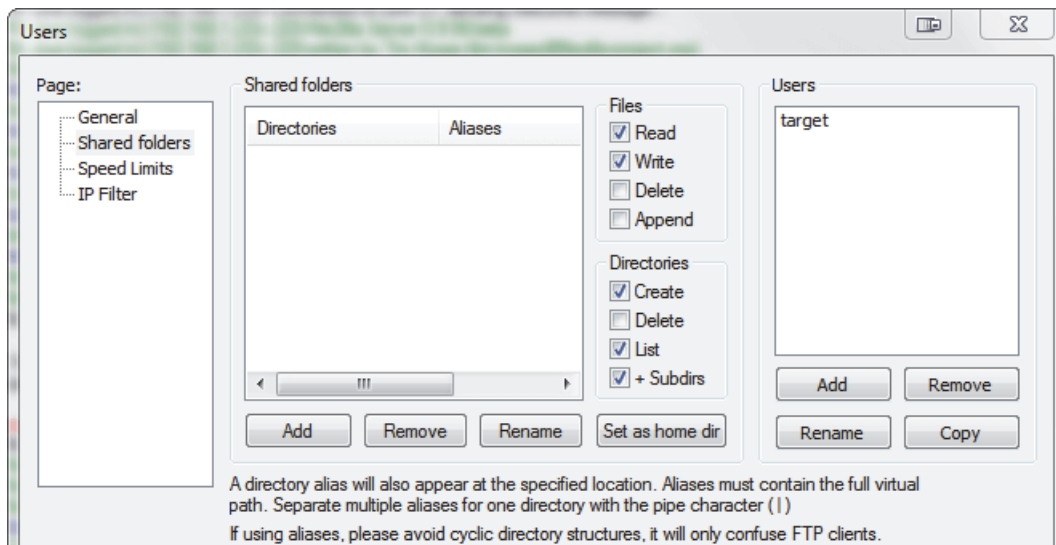

- Browse for the folder on your PC where you want to store images. In this example, the folder is called **C:\Users\el\Desktop\images**.

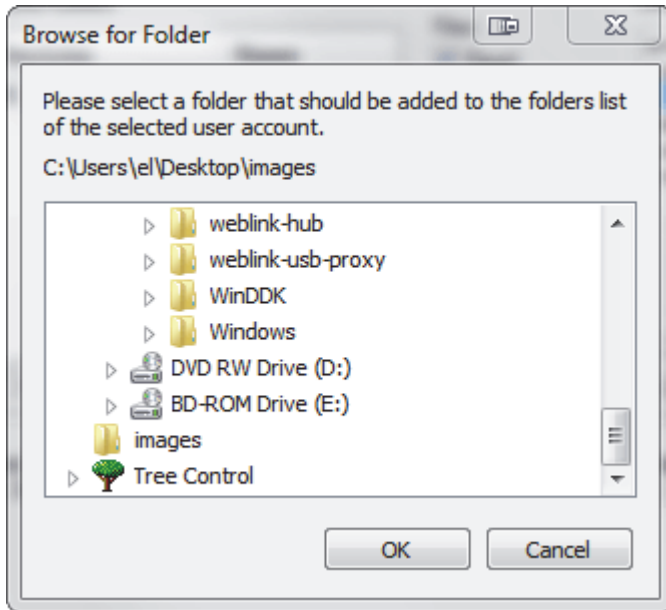

- Return to the **General** page and set a password.

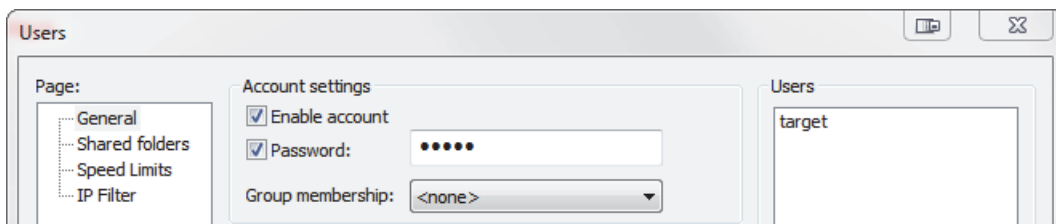

- Click **OK** and connect to your reader.
- Open **Application Settings** and click the **Image Storage** icon.

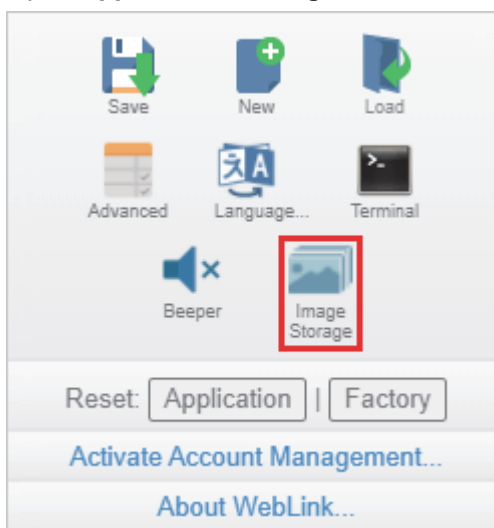

- Update your **Image Storage Options**, including your FTP Address.

Note: `pwd` represents the password you set on the **General** page of the FileZilla Server interface.

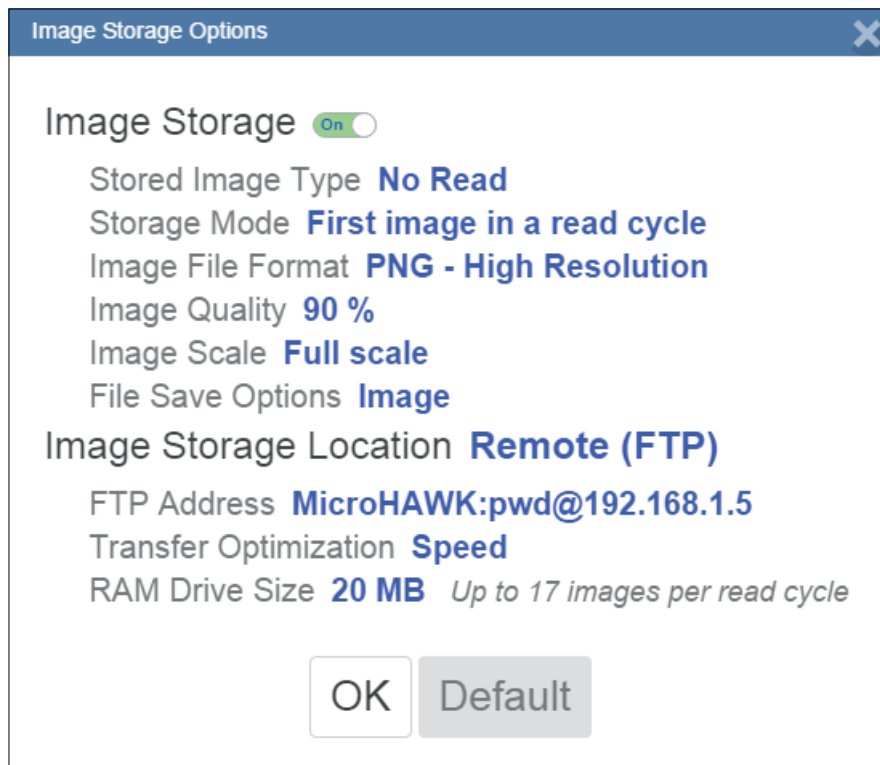

6-9-2 Starting and Stopping FileZilla Server

During FileZilla installation, you have the option of configuring FileZilla Server to auto-start each time the reader is powered on. You can also start and stop the server manually via the **Start FileZilla Server** and **Stop FileZilla Server** shortcuts shown here.



To disable FileZilla Server's auto-start feature:

- Press the **Windows button + the 'R' key** to bring up the **Run** dialog.
- In the Run dialog's **Open:** field, type **msconfig** and then **Enter**.
- Click the **Startup** tab as shown below.
- Uncheck **FileZilla Server** so it won't launch on startup.

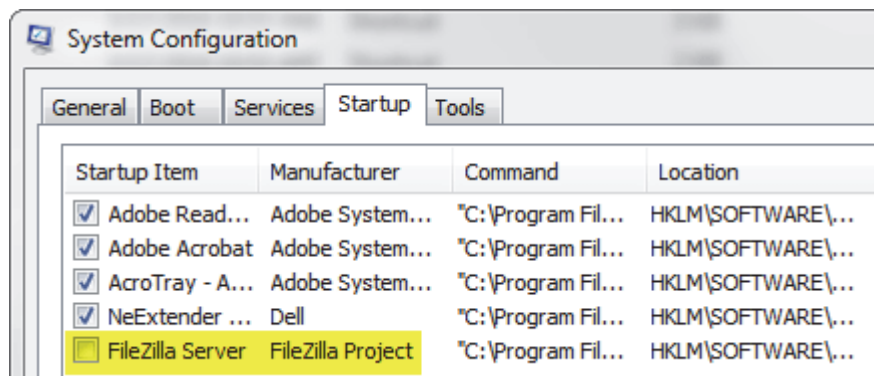

- Click **OK**.
- When prompted, **restart** your computer.

6-9-3 Saving and Downloading Images with V440-F RAM Drive

You can save captured images and read cycle reports to the V440-F reader's RAM drive and then download them to a PC or other local device.

The following example shows the RAM drive procedure using **FileZilla** (<https://filezilla-project.org/>).

Note: FileZilla is a Windows-only utility.

- Download and run FileZilla.
- To connect to the V440-F reader, enter the following information in the fields shown below and click the Quickconnect button.
 - **Host:** 192.168.188.2 (IP address of the V440-F reader)
 - **Username:** target
 - **Password:** password
 - **Port:** 21

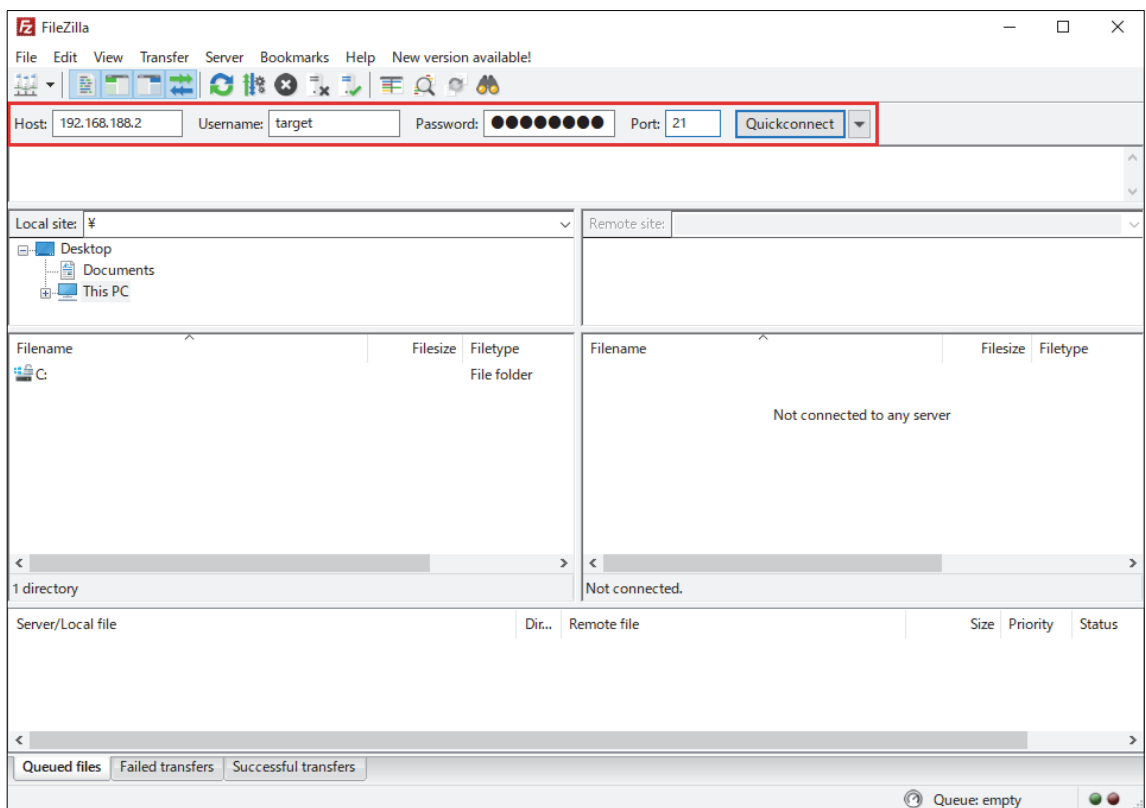

- After connecting to the V440-F reader, you will its file directory in the **Remote Site** section of the FileZilla interface.

Important: The V440-F reader's file directory contains files needed to operate the reader. Do not make any changes to files or folders in the directory other than those specified in this procedure. Incorrect organization of the file directory can damage the V440-F reader's internal configuration and prevent it from booting.

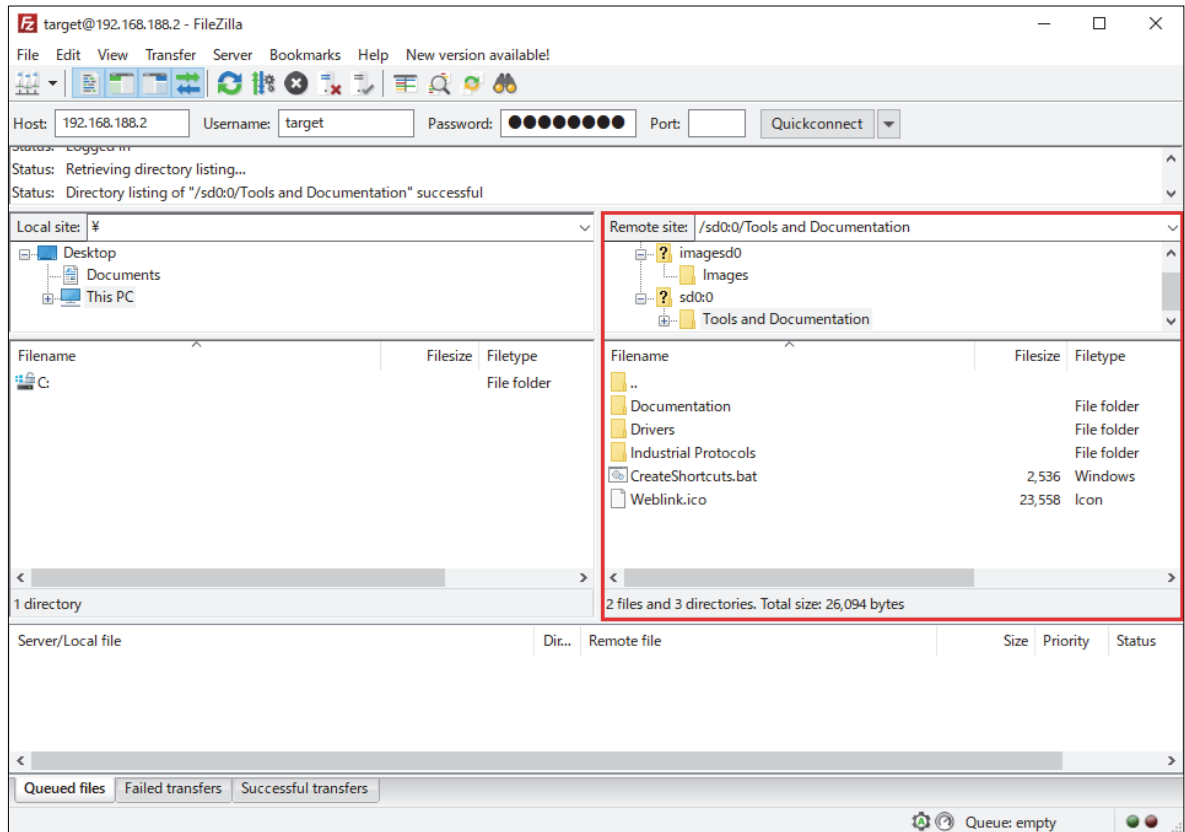

- Enter **/imagesd0/Images** in the **Remote Site** field. In the **Filename** section, you will see the captured images and read cycle reports that are stored on the V440-F reader's RAM drive.

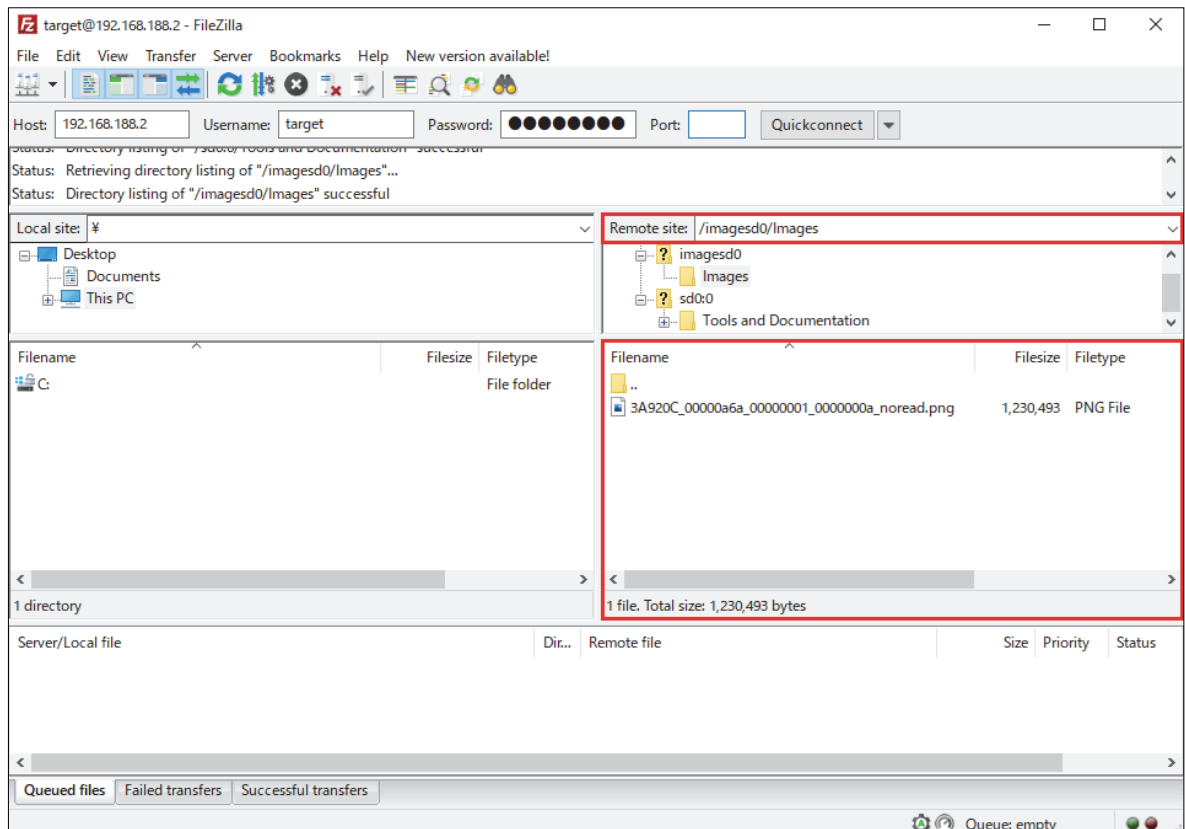

- In the **Local Site** section of the interface, navigate to the folder where you want to save the downloaded image. The folder location will be displayed in the **Local Site** field shown below.

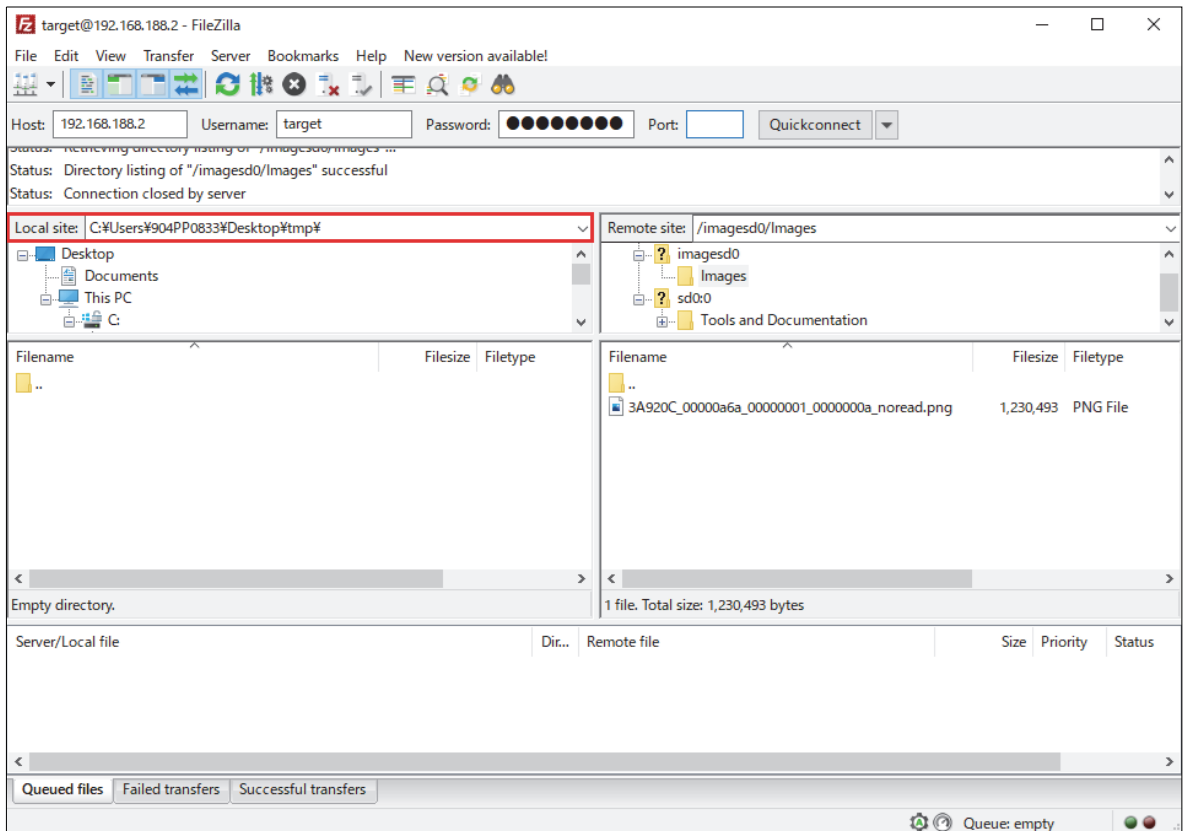

- In the **Filename** section, right-click the image you want to download from the V440-F reader and select **Download**. In the example below, the image filename is **3A920C_00000a6a_00000001_0000000a_noread.png**.

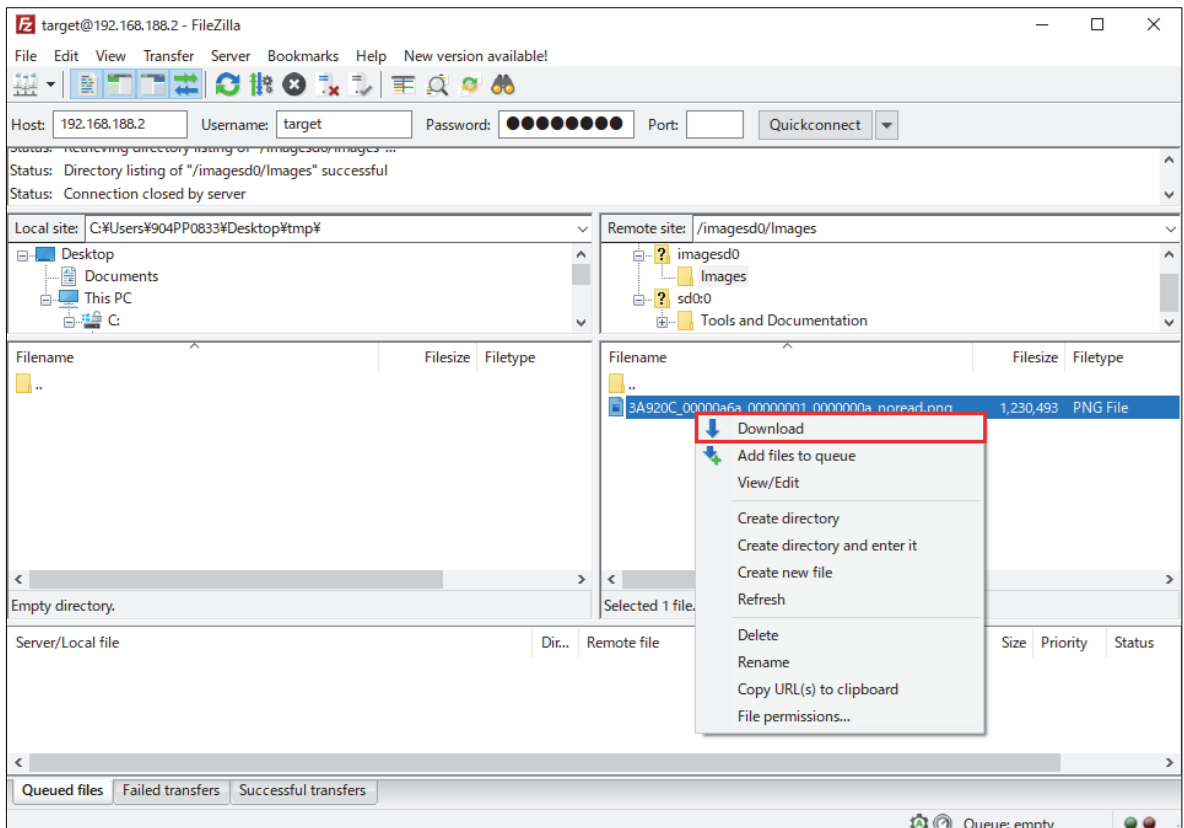

- The image file will be downloaded from the V440-F reader's RAM drive to the Local Site folder you selected. This completes the image acquisition.

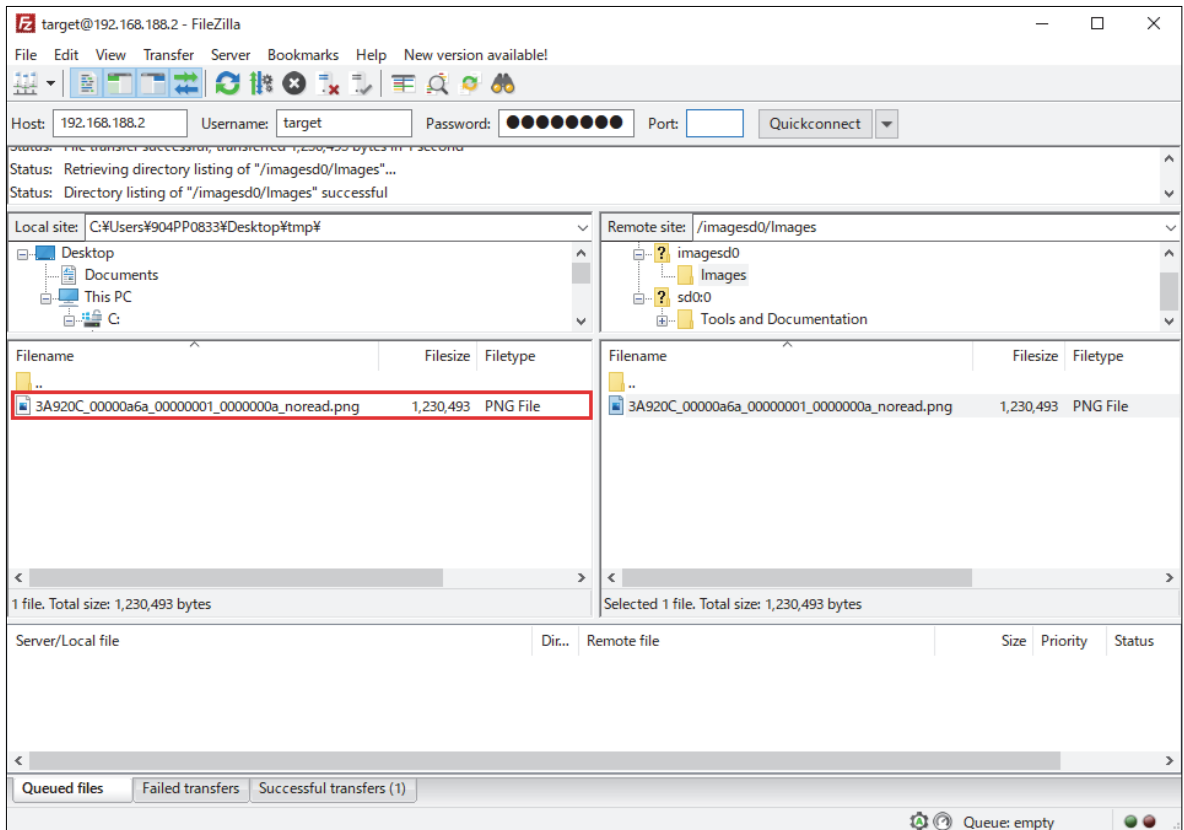

V440-F Reader Image Storage Options Settings

For the **RAM drive** procedure to function, **Image Storage Options** must be configured as shown below.

- Click the **gear icon** at the upper right of the WebLink interface to open the **Application Settings** menu.
- Click the **Image Storage** icon in the Application Settings menu.
- In the **Image Storage Options** dialog, set **Image Storage** to **On**.
- Set **Image Storage Location** to **RAM (Volatile Memory)** and configure **RAM Drive Size**, **Save Image Until**, and **Action at Image Storage Limit** as required for your application.

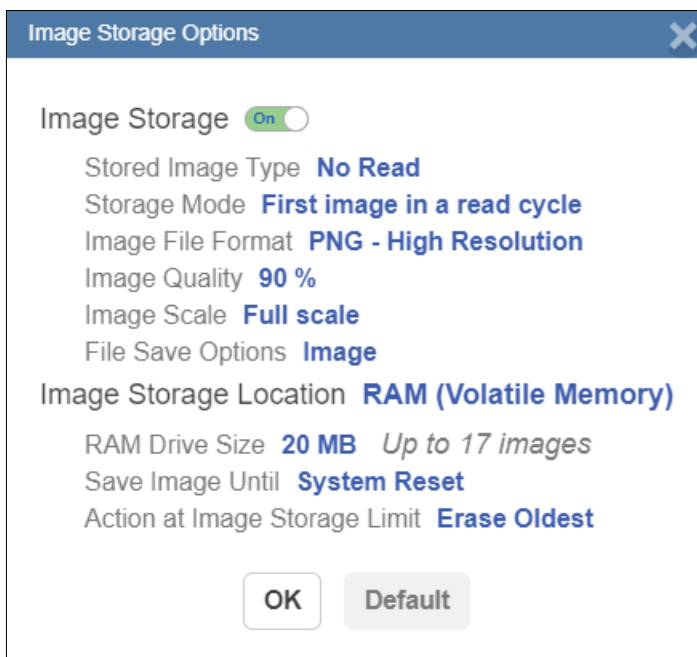

6-10 Reset Application or Factory Settings

6-10-1 Reset Options

Reset Application Settings

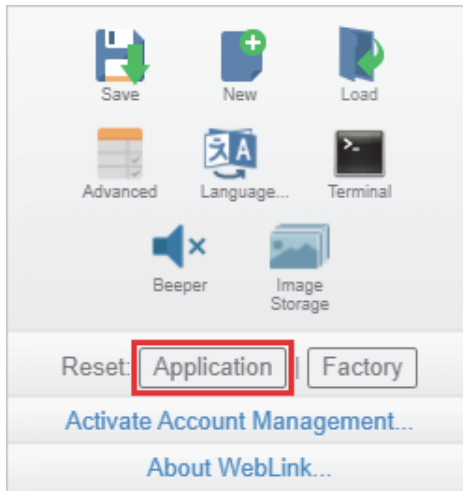

Clicking the **Application** button returns the reader to default settings, not including Communications settings. The reset is saved to flash memory.

Reset Application Settings

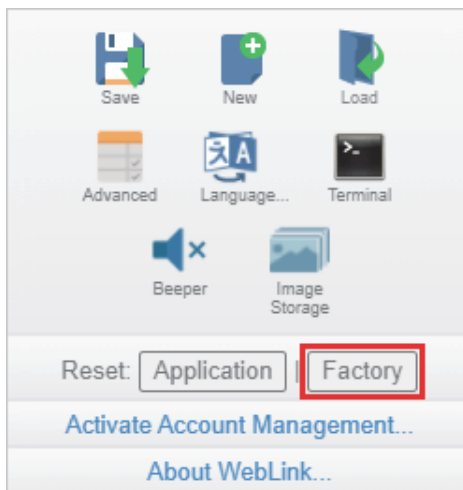

Clicking the **Factory** button returns the reader to default settings, including Communications settings. The reset is saved to flash memory. Because all settings will be defaulted to their factory configuration, the following warning will appear:

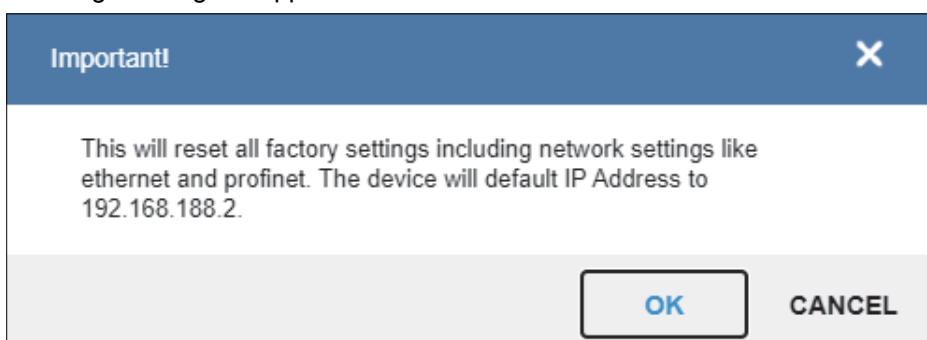

6-11 Activate Account Management

Activate Account Management allows you to set a password that will be required to open any session of WebLink. An **Administrator** can create, update, and delete users from an Administrator user interface. While **Account Management** is active, every user must log in with a username and password established by the Administrator. There are three different user types, each with a different privilege level that determines their access:

- **Administrator:** Full Access as well as the ability to manage user accounts and enable or disable Account Management
- **Controller:** Full Access
- **Monitor:** View-Only Access

Click the **gear** icon at the upper right of the WebLink user interface to open the **Application Settings** menu.

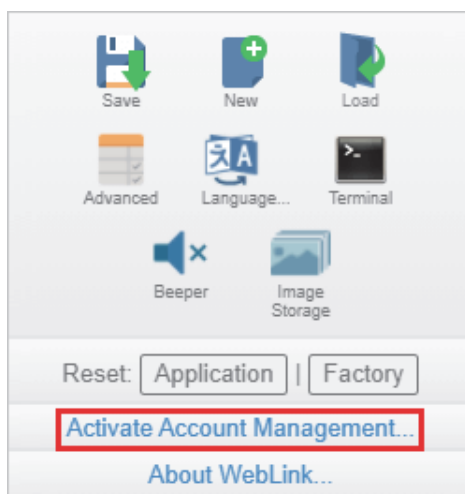

Then click **Activate Account Management** to open the dialog shown below.

Enter and verify a new username and password and then click **Activate Account Management** to password-protect the WebLink configuration.

The Activate Account Management button brings up a dialog allowing you to create an Administrator account and to Activate Account Management. This is the same account information that you will use to log in to the application later, so be sure to remember it. After entering valid credentials, click the blue **Activate Account Management** button. Clicking this button will create the Administrator account and will restart the application.

Activate Account Management

Activating account management will restart the application and require login ?

Note: When **Account Management** is active, **Activate Account Management** will not appear in the Application Settings menu.

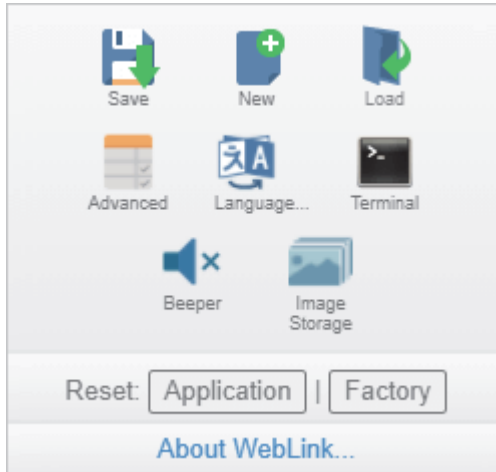

After you've clicked **Activate Account Management**, the WebLink application will be refreshed and you will see the login screen shown below. Since you haven't created other users yet, you must enter your own newly-created Administrator credentials.

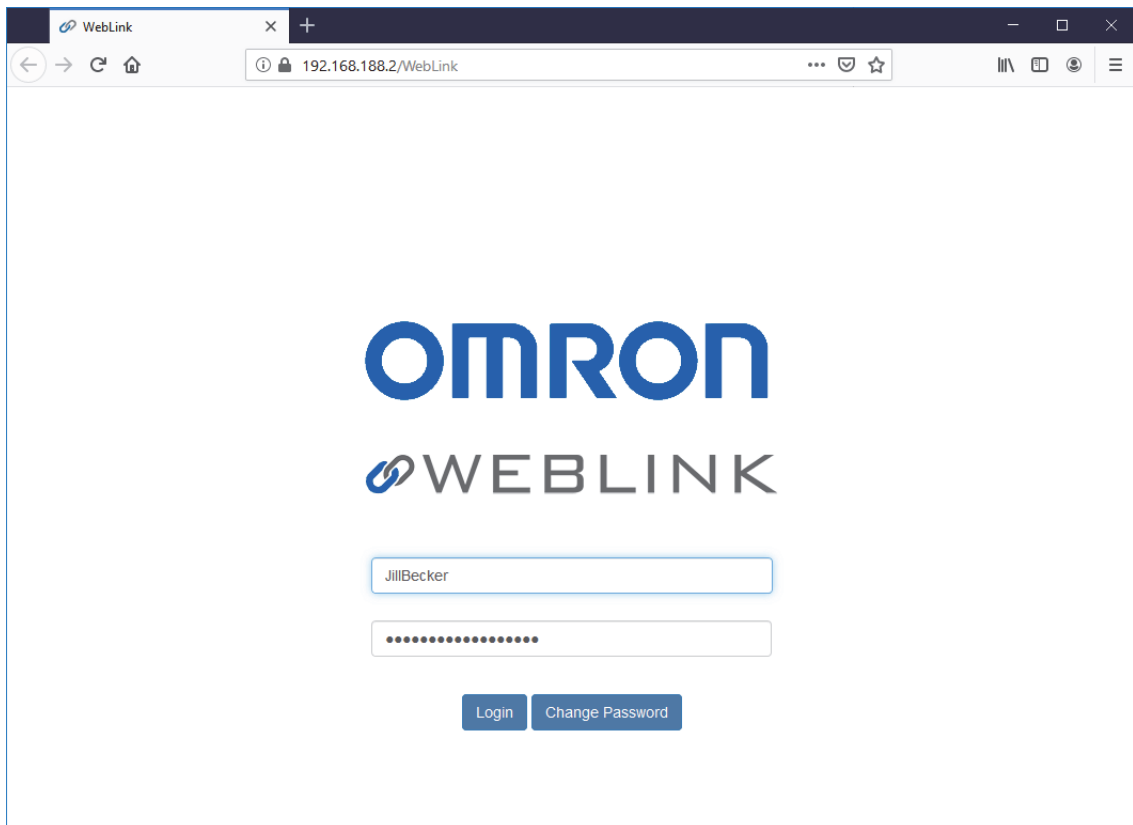

6-11-1 Admin View

After successfully logging in, you will see an **Admin** tab to the right of the **Start**, **Setup**, and **Run** tabs. Click the **Admin** tab to view the **Account Management** interface. This interface is only visible to the Administrator.

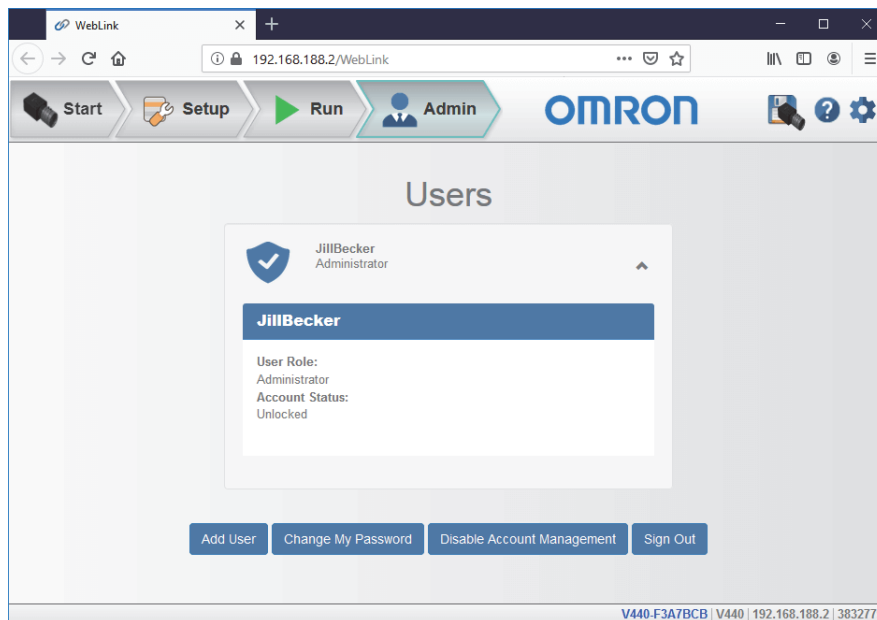

There are four primary buttons in the **Admin** view:

- **Add User:** Create a new user by establishing a username, password, and account type.
- **Change My Password:** Change Administrator password.
- **Disable Account Management:** Turn off Account Management with the option to reactivate it with existing users, or to turn off account management and delete all current users including Administrator.
- **Sign Out:** Sign out of this account and return to the login screen.

When multiple user accounts have been created, all users are shown in the list above the four primary buttons. Initially only the Administrator will be shown, but the list will grow as you create more users. Each user tab can be expanded by clicking on the chevron icon on the far right. Before expanding, notice the basic layout of the user panel. It contains user information on account type, username, and an icon that represents the account type.

6-11-2 Managing User Accounts

When you select **Add User**, you will see the **Create New User** dialog, which allows you to set the username, password, and account type **Controller** or **Monitor**.

You can create users of either account type.

Each time you add a user, that user's information is added to the Admin view, as shown below.

Clicking on the down arrow to the right of each user opens a view similar to the one shown below. This view allows you to update the **User Role** and **Account Status**.

You can also delete a user from this view.

In the example shown here, the Administrator has changed the user's account from **Unlocked** to **Locked**.

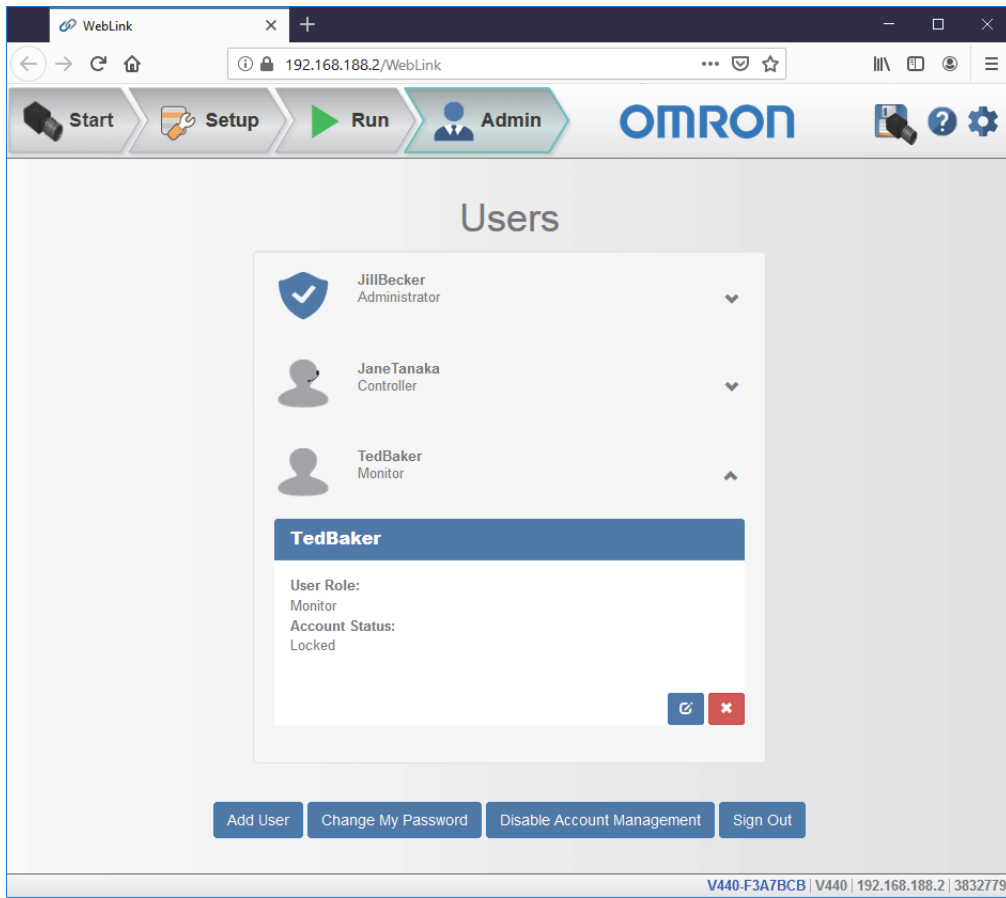

When a user's account is locked, a lock icon will appear to the right of the user's name.

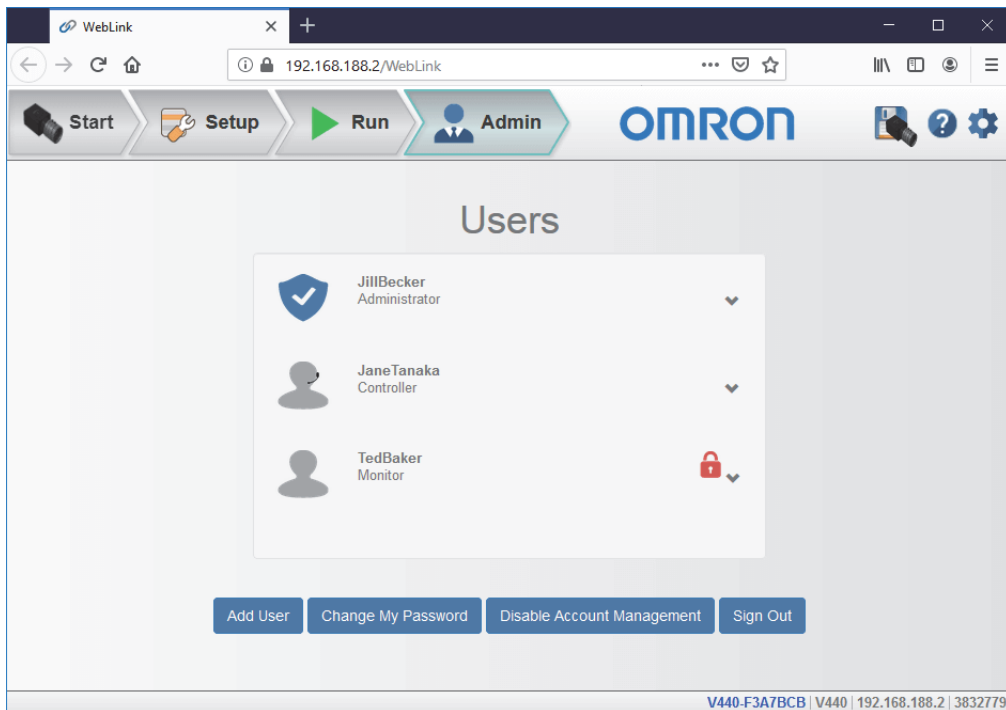

Two buttons appear in the lower right of each user profile when it is expanded. These buttons allow the Administrator to make changes to user accounts.

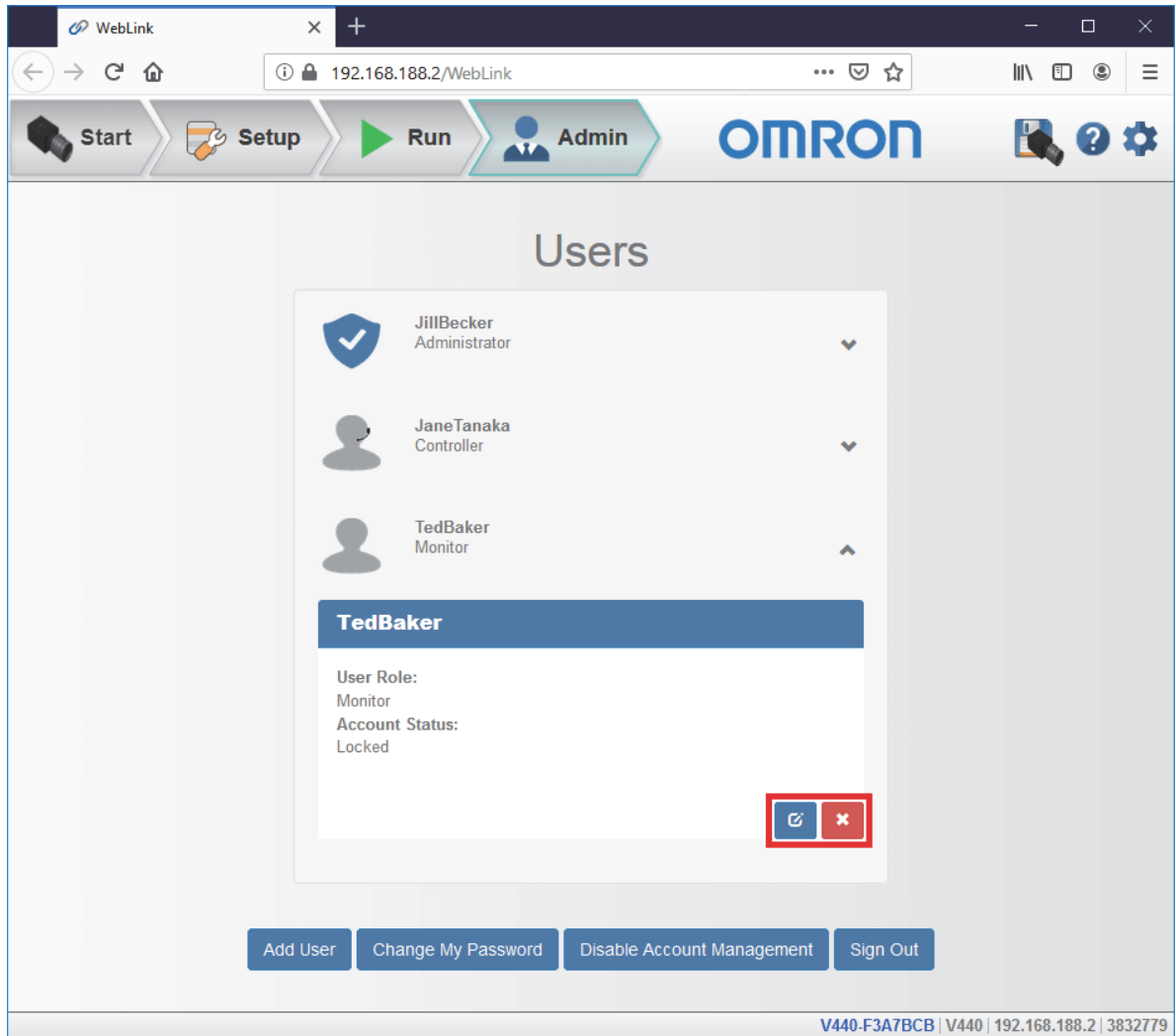

The blue button allows the Administrator to modify user information, such as password, account type, or account status.



The red button allows the Administrator to delete the user.

6-11-3 Account Status

There are four types of User Account Status: **Unlocked**, **Locked**, **Wait**, and **Continue**. Each status is described below.

Account Status Information	
Status	Description
Unlocked	User can access WebLink by logging in with their username and password.
Locked	User failed multiple login attempts and must have their account unlocked by the administrator to access WebLink.
Wait	User is temporarily locked out of WebLink for repeatedly providing an invalid password.
Continue	User can access WebLink by logging in with their username and password, but will be Locked if they repeatedly provide an invalid password.

6-11-4 Changing Your Password

Clicking **Change My Password** causes the following dialog to appear, allowing you to enter and verify a new password of your choice.

Update Password

6-11-5 Disabling Account Management

If you are the Administrator, you can either **Disable** Account Management and retain your account information and that of the other users, or you can **Disable and Delete Users**, which will erase your account information and that of the other users.

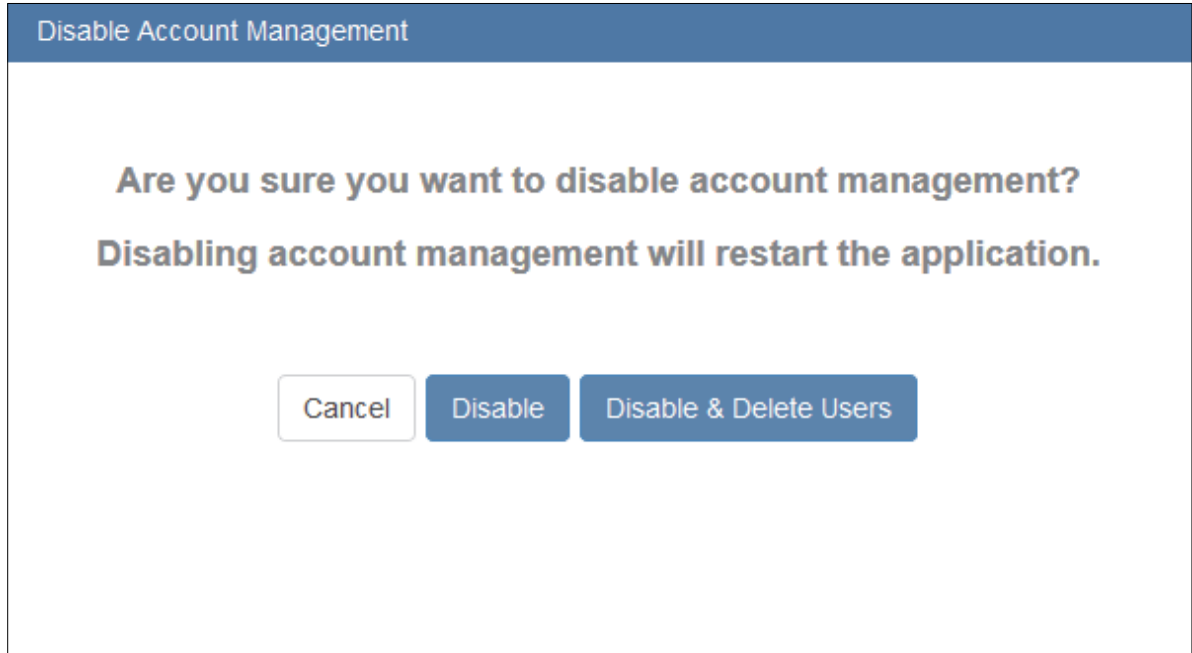

6-12 About WebLink

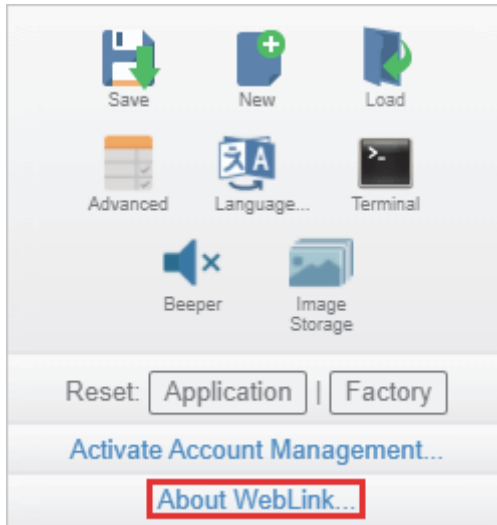

About WebLink opens the dialog shown below, which shows the current **WebLink version, Reader Model, Serial Number, Part Number, MAC ID, Sensor resolution, Firmware version, Boot code version, Browser, Operating System, and Screen Resolution.**

Note: The information in this dialog is selectable so that you can copy it to a clipboard.

Clicking **Contact us...** takes you to <https://automation.omron.com>.





Terminal

The **Terminal** provides immediate visibility of decode output, allows you to send serial commands to the reader, and allows you to find specific strings within large amounts of data.

7-1	Send	7-2
7-2	Find	7-3
7-3	Filters	7-4

7-1 Send

The Terminal features an auto-complete function that shows several common serial command options as soon as you start typing in the **command to send** field.

The Terminal automatically adds the < and > characters to commands entered in the **command to send** field.

Serial commands sent from the Terminal appear in yellow text and reader output is returned in white text.

Click the **eraser** icon to clear the Terminal screen of all commands, reader responses, and decode output.

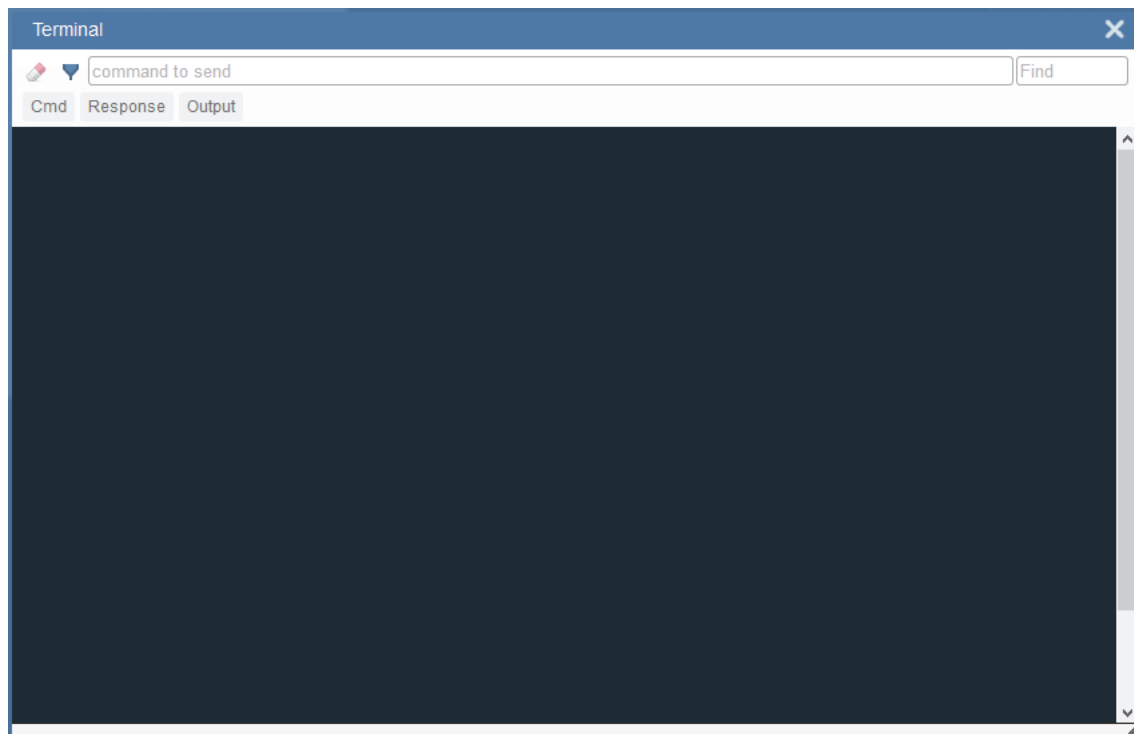

7-2 Find

The **Find** field in the top right of the window allows you to enter a specific character string to locate within the data on the Terminal screen.

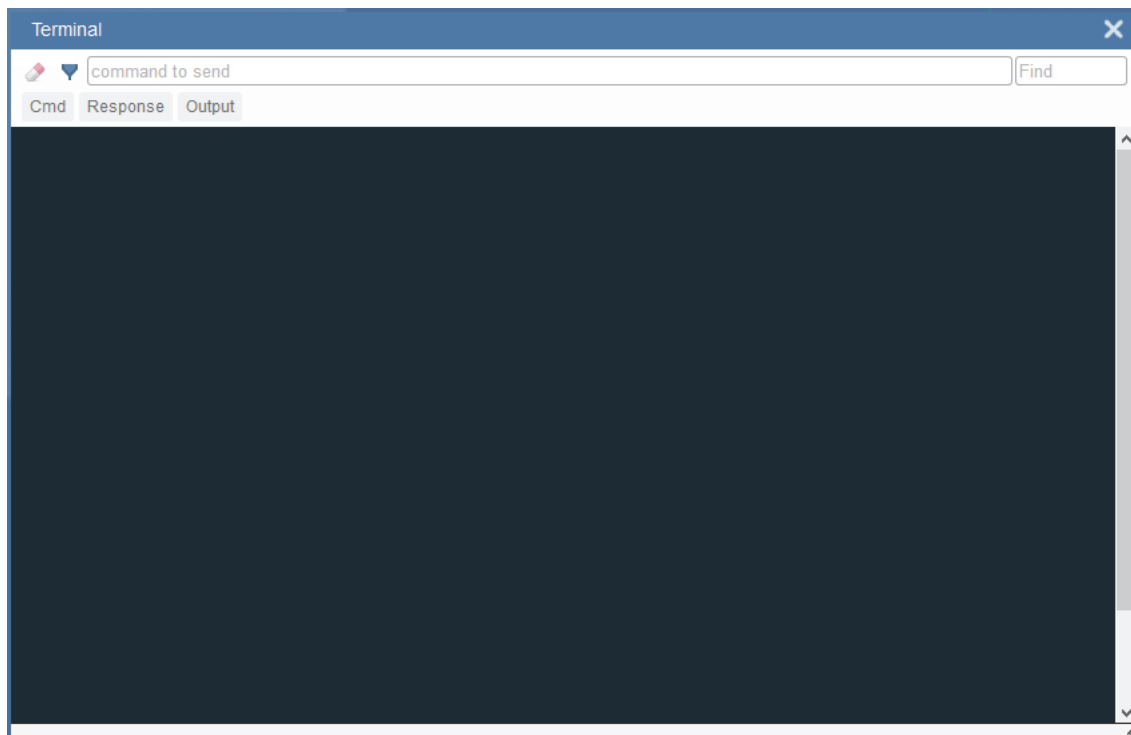

7-3 Filters

Click the **filter** icon to the right of the erase icon to display the three filter buttons.

7-3-1 Cmd

When the **Cmd** filter button is selected, serial commands sent from the Terminal are shown. When only the Cmd button is selected, only serial commands are shown.

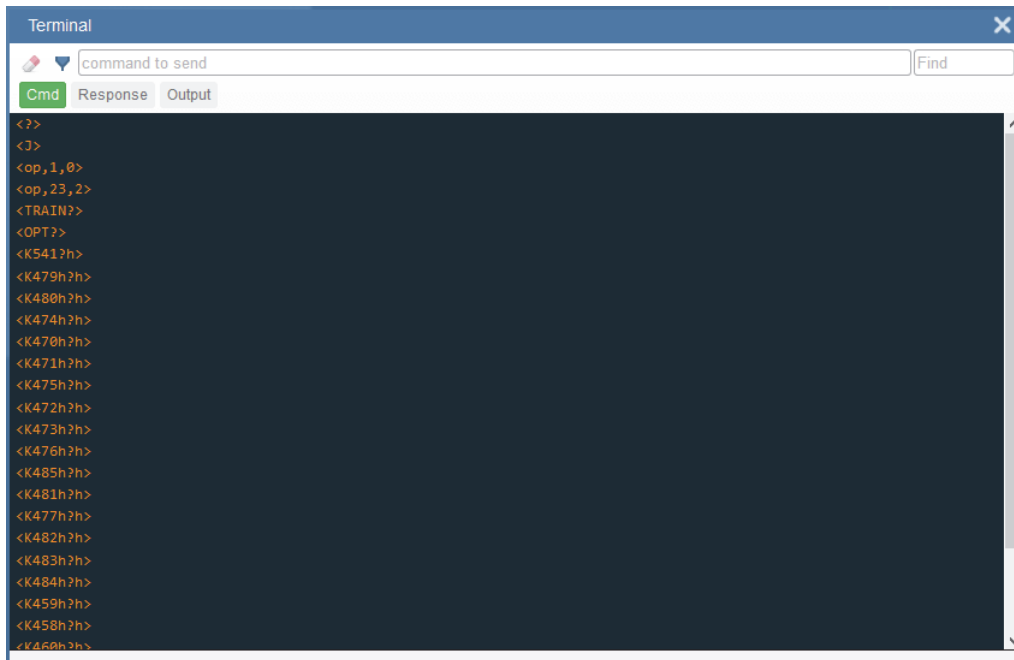

```

Terminal
command to send Find
Cmd Response Output
<?>
<C>
<op,1,0>
<op,23,2>
<TRAIN?>
<OPT?>
<K541?h>
<K479h?h>
<K480h?h>
<K474h?h>
<K470h?h>
<K471h?h>
<K475h?h>
<K472h?h>
<K473h?h>
<K476h?h>
<K485h?h>
<K481h?h>
<K477h?h>
<K482h?h>
<K483h?h>
<K484h?h>
<K459h?h>
<K458h?h>
<K460h?h>

```

7-3-2 Response

When the **Response** filter button is selected, responses sent back from the reader are shown. When only the Response button is selected, only responses sent back from the reader are shown.

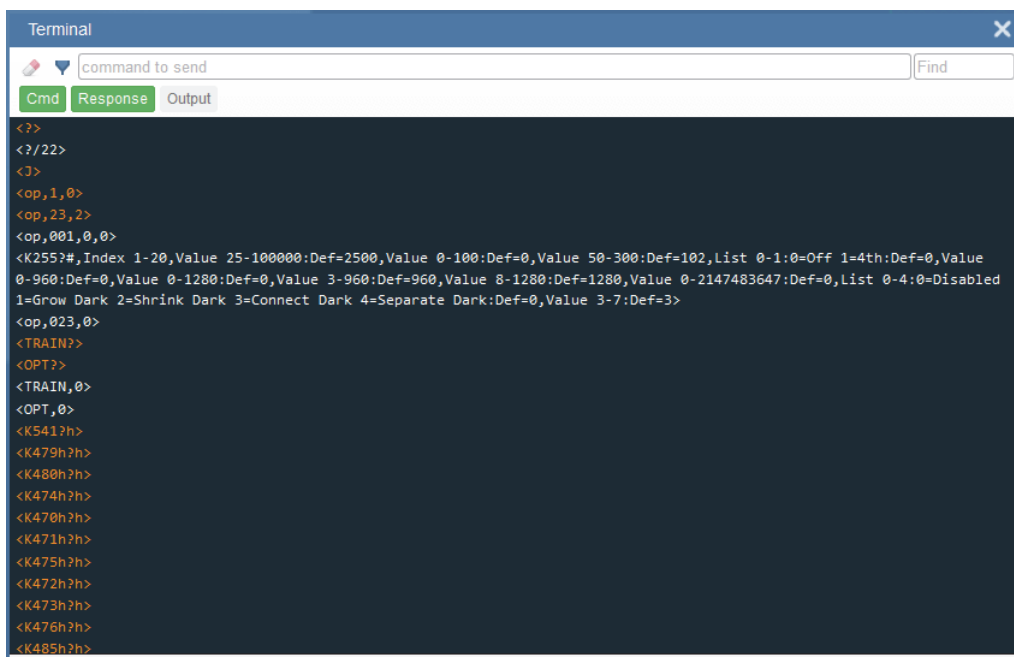

```

Terminal
command to send Find
Cmd Response Output
<?/?22>
<?>
<op,1,0>
<op,23,2>
<op,001,0,0>
<K255?#,Index 1-20,Value 25-10000:Def=2500,Value 0-100:Def=0,Value 50-300:Def=102,List 0-1:0=Off 1=4th:Def=0,Value
0-960:Def=0,Value 0-1280:Def=0,Value 3-960:Def=960,Value 8-1280:Def=1280,Value 0-2147483647:Def=0,List 0-4:0=Disabled
1=Grow Dark 2=Shrink Dark 3=Connect Dark 4=Separate Dark:Def=0,Value 3-7:Def=3>
<op,023,0>
<TRAIN?>
<OPT?>
<TRAIN,0>
<OPT,0>
<K541?h>
<K479h?h>
<K480h?h>
<K474h?h>
<K470h?h>
<K471h?h>
<K475h?h>
<K472h?h>
<K473h?h>
<K476h?h>
<K485h?h>

```

7-3-3 Output

When the **Output** filter button is selected, decode output from the reader is shown. When only the Output button is selected, only decode output from the reader is shown.

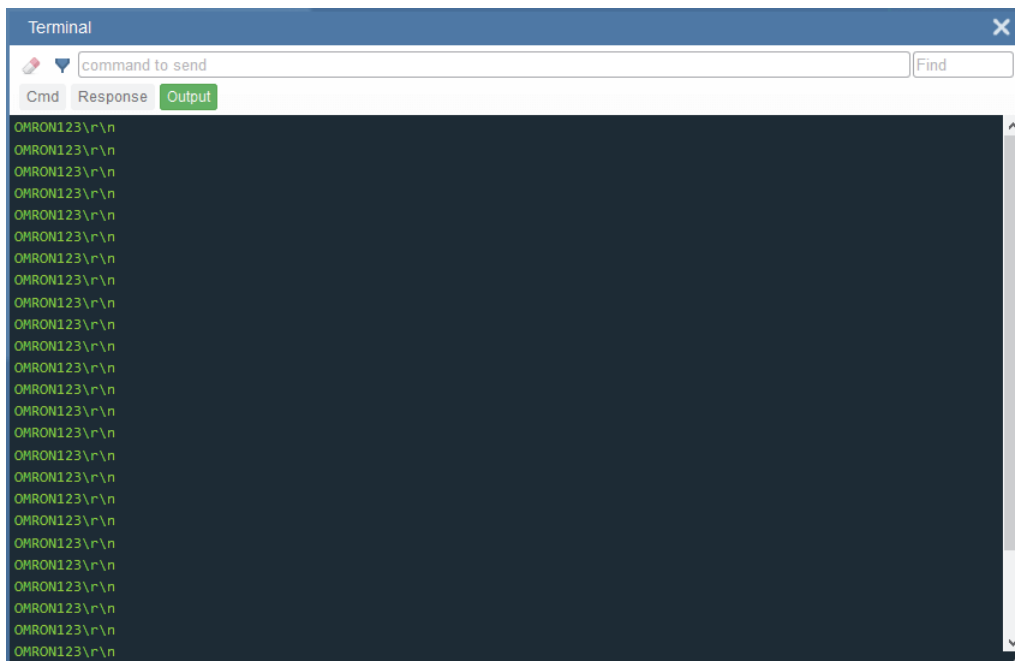



Advanced Settings

This section describes WebLink's **Advanced Settings** menus. Some commands aren't accessible in WebLink's graphical user interface and can only be configured via these advanced menus.

8-1	Introduction	8-2
8-2	Camera Setup	8-3
8-3	Communications	8-5
8-4	Read Cycle	8-13
8-5	Symbologies	8-14
8-6	I/O	8-23
8-7	Symbol Quality	8-33
8-8	Match String	8-34
8-9	Diagnostics	8-35
8-10	Image Storage	8-36
8-11	Configuration Database	8-37
8-12	Differences from Default	8-38

8-1 Introduction

Click the **gear** icon to the right of the **help** icon open the **Application Settings** menu. One of the options you will see is **Advanced**.

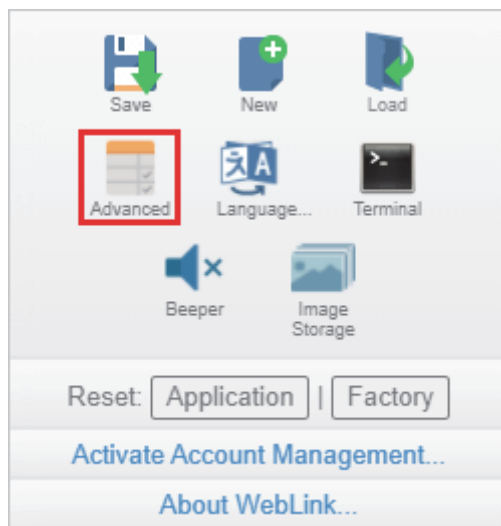

WebLink's **Advanced Settings** allow you to make fine adjustments to individual command parameters in all areas of your reader's functionality: **Camera Setup, Communications, Read Cycle, Symbologies, I/O, Symbol Quality, Match String, Diagnostics, Image Storage, and Configuration Database**. Many of these commands can be configured directly in the WebLink user interface, but all parameters can be configured and examined in Advanced Settings.

Advanced Settings are an efficient way to send complex, multi-parameter commands to the reader.

Each menu of Advanced Settings commands is shown in the following nine sections, and an additional section is included that shows an example of the **Differences from Default** menu, which shows only commands that are different from WebLink defaults.

8-2 Camera Setup

The **Camera Setup** menu shows all the commands that control the function of the reader's camera. Many of these command settings can also be controlled from the WebLink user interface. For example, the **Exposure** and **Gain** settings in the **Camera Settings** command can be configured in the **Acquire** section located in the left panel of the **Setup** view.

Command parameters can be changed directly from this menu.

8-2-1 Camera Setup Menu

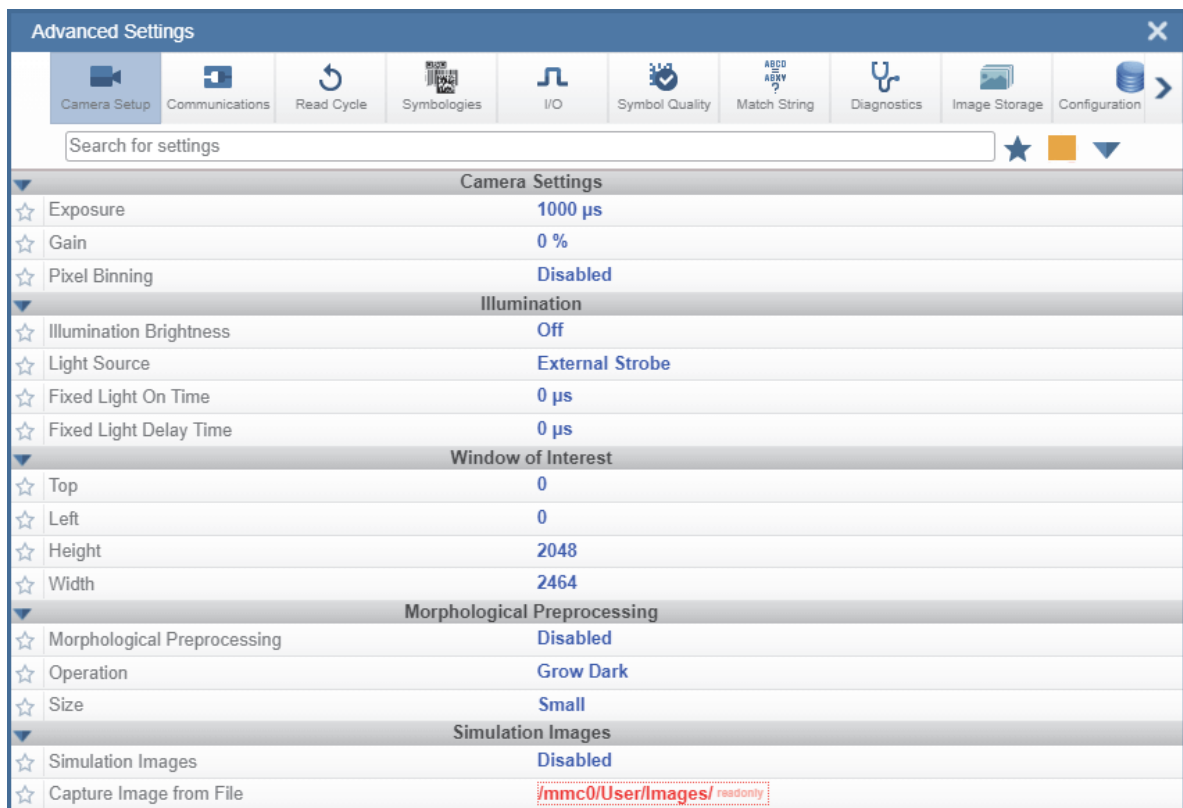

Note: When **Illumination Brightness** is set to **Constant**, the illumination brightness is the same power level as the **High** setting. However, the LEDs are continuously on once Brightness is set to Constant, and they will remain on during and after the read cycle to eliminate perceptible flashing.

Exposure – This is the amount of time in microseconds that the sensor will actively expose for. The minimum setting is 16 μ s. The maximum is 400 msec. 16 μ s is very short and can be used in lieu of a very fast strobe to stop motion for moving applications. In this case, you only need to set up a bright, constant illumination source.

Pixel Binning – When pixel binning is enabled, the image is reduced to half resolution by using sub-sampling every other pixel. The resulting image is 1232 x 1024 pixels, but the field of view remains the same as it was in full resolution mode.

- The **PPE** of codes in the image are thus reduced in half as well, allowing for faster processing.
- The **Frame Rate** in binning mode doubles to **72 frames per second**.
- **Autocalibration** may turn on **Pixel Binning** automatically.
- When using the **Configuration Database**, Pixel Binning can be turned on or off on an image by image basis. Any decodes within that image will work on reduced-resolution symbols.

Illumination Brightness – This value is set to off for the V440-F. This function does not apply to this unit because it does not have built-in lighting.

Light Source – Light source is always set to **External Strobe**. By default, the reader sends an external strobe signal out on **Output 3**. The external strobe output signal follows the exact Exposure signal sent to the sensor unless modified by the next two values. Output 3 can be used to trigger any external light.

Fixed Light On Time – By default, the external strobe trigger signal sent from the reader to an external strobe controller follows the exact time the sensor is exposing. For example, if the exposure time is 1 msec, then the external strobe output pulse will also be 1 msec.

The actual external strobe output pulse can be set longer or shorter than the exposure time based on the **Fixed Light On Time** setting. This value can, for instance, be used to create a strobe pulse that is even faster than the 16 μ s minimum exposure time by setting it to something less.

Fixed Light Delay Time – This allows you to actively align their external strobe source with the V440-F acquisition exposure time. If the external strobe controller and light is known to have a delay between when it receives a trigger and when it turns the light on, you can set this setting to that known delay value, and the camera will delay for that amount of time before it takes the picture, thus ensuring it is aligned with when the light comes on.

Simulation Images – The V440-F can be run on stored images for debugging purposes. When this setting is enabled, images will be captured from files rather than from the camera. The file location is set with the next parameter.

Capture Image from File – This is the location for the files in the reader's memory. Images can be copied into this location using **FileZilla Client**. Log into the reader using the reader IP. The login is **target**. The password is **password**. Navigate to the **/mmc0/user/images/** folder and drag images into it. When the reader is triggered, it will cycle through these images. Disable **Simulation Images** to go back to acquiring images with the camera.

Use as External Illumination Strobe

Use as External Illumination Strobe is available in the **Output On** parameter of the **Output 3** command in **I/O Parameters**. **External Strobe** must be enabled for this parameter to function.

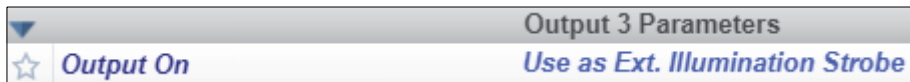

8-3 Communications

The **Communications** menu shows all the commands that control the reader's connectivity to the host and to your application's network. These commands also control **Preamble** and **Postamble** settings for decoded data output, **Response Timeout**, **LRC Status**, **ACK/NAK Options**, and **Polling Mode Options**.

Command parameters can be changed directly from this menu.

8-3-1 Communications Menu

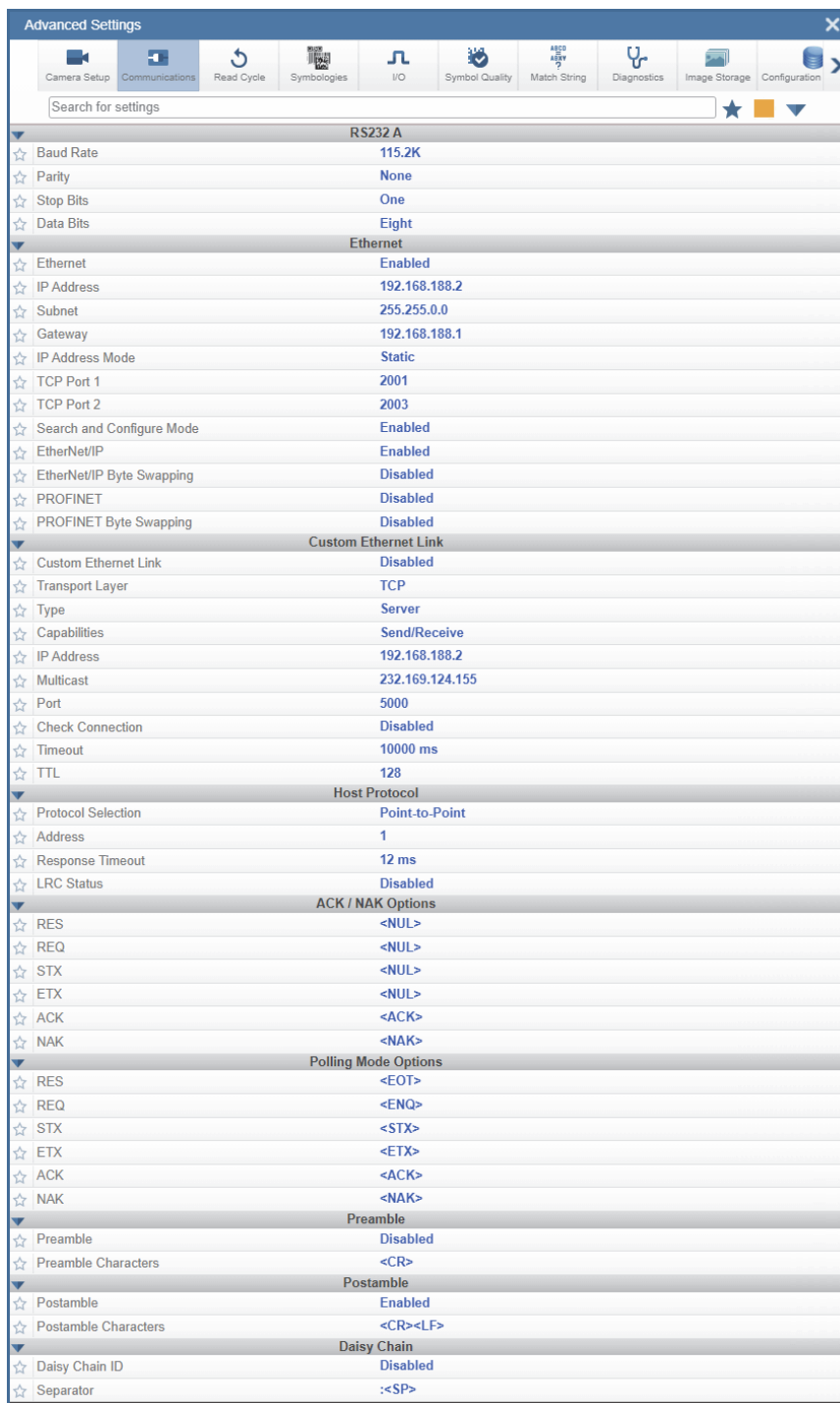

Daisy Chain

The **Daisy Chain** section, located beneath the **Postamble** section in the **Communications Menu** in **Advanced Settings**, allows you to enable or disable **Daisy Chain ID** functionality. Daisy Chain ID outputs the name of the reader that decoded the candidate symbol. It also allows you to determine the type of **Separator** you want to appear between the reader ID and the barcode data output.

In the example below, Daisy Chain ID is **Enabled** and the Separator is set to:

Daisy Chain	
☆ <i>Daisy Chain ID</i>	<i>Enabled</i>
☆ <i>Separator</i>	:

Those two settings cause the data output to look like the example below.

The reader ID is **V440-F112233**.

The : character is displayed between the reader ID and the symbol data output.

Output Data
V440-F112233: OMRON V440-F\n\r\n
V440-F112233: OMRON V440-F\n\r\n
V440-F112233: OMRON V440-F\n\r\n
V440-F112233: OMRON V440-F\n\r\n
V440-F112233: OMRON V440-F\n\r\n
V440-F112233: OMRON V440-F\n\r\n
V440-F112233: OMRON V440-F\n\r\n
V440-F112233: OMRON V440-F\n\r\n
V440-F112233: OMRON V440-F\n\r\n
V440-F112233: OMRON V440-F\n\r\n
V440-F112233: OMRON V440-F\n\r\n

See **Configure Daisy Chain** for more information about general Daisy Chain functionality.

EtherNet/IP and PROFINET Byte Swapping

EtherNet/IP Byte Swapping and PROFINET Byte Swapping allow you to switch the order in which bytes are transmitted big-endian or little-endian between the reader and the PLC. If enabled, the bytes are swapped for 2-byte words.

☆ EtherNet/IP	Enabled
☆ EtherNet/IP Byte Swapping	Disabled
☆ PROFINET	Disabled
☆ PROFINET Byte Swapping	Disabled

Custom Ethernet Link

By default, the V440-F reader operates as a server, and communicates with the host over TCP/IP for both commands and data.

Custom Ethernet Link gives you the ability to create an Ethernet interface that is bound to the command processor per your own requirements. You can set the **Transport Layer** to **UDP** or **TCP**, set the message **Type** to **Server** or **Client**, and set **Capabilities** to **Send Only**, **Receive Only**, or **Send/Receive**.

Custom Ethernet Link	
☆ Custom Ethernet Link	Disabled
☆ Transport Layer	TCP
☆ Type	Server
☆ Capabilities	Send/Receive
☆ IP Address	192.168.1.65
☆ Multicast	232.169.247.185
☆ Port	5000
☆ Check Connection	Disabled
☆ Timeout	10000 ms
☆ TTL	128

Custom Ethernet Link is intended for advanced users. This feature permits the establishment of a connection to the reader on any port, using the protocols UDP/IP, TCP, and Multicast on a specified port. A bi-directional communication configuration is available to send commands to the reader, obtain barcode output data, or form a single direction of communication, i.e. sending commands to the reader only, or receiving barcode data from reader only, without having both directions open.

In addition to the ability to move ports, you can also force the connection created by the Custom Ethernet Link to act as a client. Instead of "reaching out" to the reader, it is possible to configure the reader to "go out and connect to" a specified server. This increases flexibility when integrating readers into customer applications. Without this feature, users are limited to static communication into and out of the reader UDP=80, TCP1=2001, TCP2=2003.

The following section will cover the implementation of how the custom Ethernet object is implemented in an Ethernet-based reader. This additional Ethernet-based transport layer allows you to:

- Send "and/or" commands to the device from a specified endpoint;
- Send barcode data to a receiving endpoint i.e. a client or server;
- Handle more than one connecting endpoint connection.

With Custom Ethernet Link functionality, users can configure:

- Transport Layer;
- TCP, UDP, or Multicast;
- Message Type;
- Server or Client;
- The type of data sent and/or received from the device;
- The endpoint to send and receive data, send only barcode data, receive only commands.

Custom Ethernet Link functionality is bound to the reader's command processor as shown in the figure below. This enables an outside endpoint to still send commands to the device as well as receive data commands and barcode to the receiver.

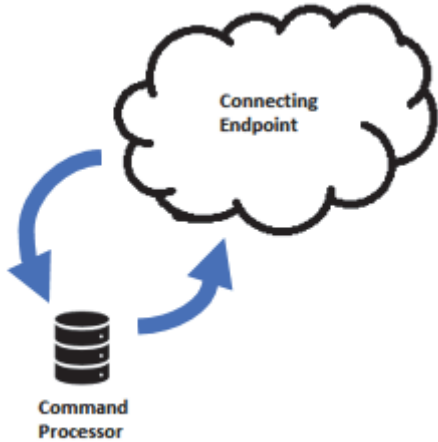

● **Server Implementation**

In cases where the endpoint is configured as a server, the reader is only able to handle 10 simultaneous connections for any transport layer. For TCP, the reader will refuse the connection. UDP and Multicast will simply ignore the connection request due to the connectionless nature of the transport layer.

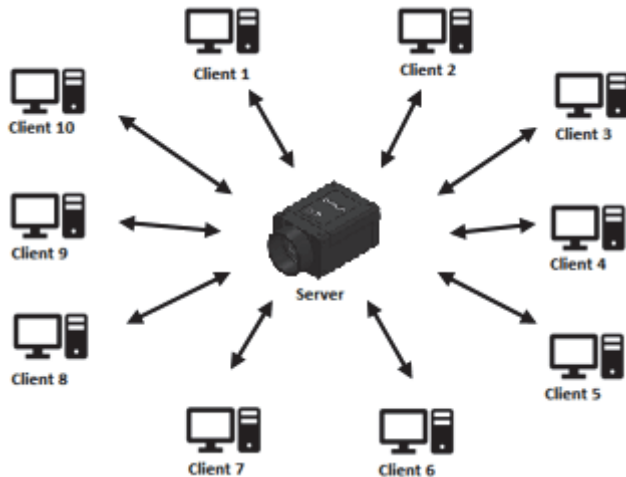

● **Client Implementation**

In cases where the endpoint is configured as a client, the reader is only able to handle one connection to a server. This means the following restrictions apply:

TCP: The reader can only connect to one server when configured as a client.

UDP and Multicast: The reader can only send data out on to one UDP port.



UDP is limited to UDP/IP in order to avoid broadcasting data on the network.

● Configuration

This section explains how to configure the custom Ethernet object in the reader. The Custom Ethernet Link K Command **<K166>** allows you to configure the custom Ethernet object in the reader.

The following section explains the command parameters that configure the custom Ethernet object. Note that each parameter described below corresponds with each parameter shown in the **Custom Ethernet Link** section of WebLink's **Communications** menu shown at the beginning of this topic.

K Command Format: *<K166,status,transport layer,type,capabilities,IP address,multicast address,port,check connection,timeout milliseconds,TTL>*

● Status

<K166,status,transport layer,type,capabilities,IP address,multicast address,port,check connection,timeout milliseconds,TTL>

Status of the custom Ethernet object in the device.

0 = Disabled Default – The custom Ethernet object is not started.

1 = Enabled – The custom Ethernet object has started with the parameters configured.

● Transport Layer

<K166,status,transport layer,type,capabilities,IP address,multicast address,port,check connection,timeout milliseconds,TTL>

The transport layer used by the custom Ethernet object to send/receive data. This transport layer obeys the OSI Model layer 4. The multicast implementation uses UDP User Datagram Protocol as the transport layer.

0 = TCP Default

1 = UDP

2 = Multicast

● Type

<K166,status,transport layer,type,capabilities,IP address,multicast address,port,check connection,timeout milliseconds,TTL>

This is the how the feature runs on the device and follows the server client model.

0 = Server Default – In server mode the device will be listening on the configured port number. The server can handle up to 10 different connections at one time independent of the transport layer selection. Once the limit has been reached the server will reject other connections.

For Multicast server configuration you can either use a specified Multicast address or leave the Multicast address to the configured Multicast APIPA Address. This Multicast address is safe to use according to RFC 4607 stating that Multicast ranges from 232.0.0.0 – 232.255.255.255 are okay to use for source specific applications. By default, the unit creates a unique Multicast address in the range of 232.169.xxx.xxx so it does not conflict with other multicast addresses.

1 = Client – In client mode the device will send data to the specified server. You must configure the IP Address or Multicast Address of the server and the port number that the specified server is listening on. Improper configuration will either yield an error on startup or result in no data being transmitted from the device to the outside world.

● Capabilities

<K166,status,transport layer,type,capabilities,IP address,multicast address,port,check connection,timeout milliseconds,TTL>

Capabilities is how you configure the custom Ethernet object's read/write settings.

1 = Receive – The device will only receive data from the connecting endpoint. The device will not send data out to any connecting endpoints.

2 = Send – The device will only send data to the connecting endpoint. Any data received is immediately disposed of and not processed.

3 = Send/Receive Default – The device will be able to send and receive data to the connecting endpoint.

● IP Address

<K166,status,transport layer,type,capabilities,IP address,multicast address,port,check connection,timeout milliseconds,TTL>

If the unit is configured as a client, the IP Address is determined by the Transport Layer.

TCP – This is the server's IP Address.

UDP – If the server uses UDP/IP, this is the IP Address of the server. Otherwise, it is ignored and the device will send data on the specified port.

Multicast – This parameter is the device's IP Address used to send out the Multicast message. You do not need to configure this parameter.

Default = Unit's IP Address

● Multicast Address

<K166,status,transport layer,type,capabilities,IP address,multicast address,port,check connection,timeout milliseconds,TTL>

In **Server mode**, this is the multicast address that clients can connect to in order to send/receive data. The port number is the port that the connecting endpoints will use.

In **Client mode**, this is the multicast address of the server that the device is sending data to.

The port number is the port the multicast server is listening on.

Default = 232.169.xxx.xxx Multicast APIPA Address

● Port

<K166,status,transport layer,type,capabilities,IP address,multicast address,port,check connection,timeout milliseconds,TTL>

In **Server mode**, this is the port number that the connecting endpoints will use to connect to the device.

In **Client mode**, this is the port number that the server is listening on.

5000 Default

● Check Connection

<K166,status,transport layer,type,capabilities,IP address,multicast address,port,check connection,timeout milliseconds,TTL>

This feature is only applicable for Transport Layer UDP in Client mode. The device will transmit 0 length UDP packets to the specified port that the server is listening on. If the device receives an ICMP Port Destination Not Found than it will continue to send 0 length packets in an exponential back-off delay until the device no longer receives ICMP packets. This feature is disabled by default.

0 = Disabled Default

1 = Enabled

● Timeout Milliseconds

<K166,status,transport layer,type,capabilities,IP address,multicast address,port,check connection,timeout milliseconds,TTL>

For TCP this is the timeout before the socket is forcibly closed. For UDP and Multicast this parameter has no effect.

Default = 10000

● TTL

<K166,status,transport layer,type,capabilities,IP address,multicast address,port,check connection,timeout milliseconds,TTL>

For Multicast this is the **Time To Live** counter, or how many hops before the message is discarded by the network. By default, the counter is set to 128 hops which is more than enough for a typical packet to reach its destination host but can be configured to last longer or shorter per network requirements.

Default = 128

Examples

The following section provides examples of how to configure the custom Ethernet object using the **Custom Ethernet Link K Command <K166>** described in the **Configuration** section earlier in this topic.

● TCP

Server Mode

Send/Receive Capabilities

<K166,1,0,0,3>

Interpretation of K Command Settings: Custom Ethernet Link Enabled Default, Transport Layer = TCP Default, Type = Server Default, Capabilities = Send/Receive Default

Send-Only Capabilities

<K166,1,0,0,2>

Interpretation of K Command Settings: Custom Ethernet Link Enabled Default, Transport Layer = TCP Default, Type = Server Default, Capabilities = Send

Client Mode

The following client modes will connect to a TCP Server with IP Address **192.168.188.5** listening on port **5050**.



IP: 192.168.188.2
Port: N/A



IP: 192.168.188.5
Port: 5050

Send/Receive Capabilities

<K166,1,0,1,3,192.168.188.5, ,5050>

Interpretation of K Command Settings: Custom Ethernet Link Enabled Default, Transport Layer = TCP Default, Type = Client, Capabilities = Send/Receive Default, IP Address = 192.168.188.5, Port = 5050.

Send-Only Capabilities

<K166,1,0,1,2,192.168.188.5, ,5050>

Interpretation of K Command Settings: Custom Ethernet Link Enabled Default, Transport Layer = TCP Default, Type = Client, Capabilities = Send, IP Address = 192.168.188.5, Port = 5050.

● UDP

Server Mode

Send/Receive Capabilities

<K166,1,1,0,3>

Interpretation of K Command Settings: Custom Ethernet Link Enabled Default, Transport Layer = UDP, Type = Server Default, Capabilities = Send/Receive Default.

Send-Only Capabilities

<K166,1,1,0,2>

Interpretation of K Command Settings: Custom Ethernet Link Enabled Default, Transport Layer = UDP, Type = Server Default, Capabilities = Send.

Client Mode

The following client modes will connect to a UDP Server with IP Address **192.168.188.5** listening on port **5050**.

***Send/Receive Capabilities***

<K166,1,1,1,3,192.168.188.5, ,5050>

Interpretation of K Command Settings: Custom Ethernet Link Enabled Default, Transport Layer = UDP, Type = Client, Capabilities = Send/Receive Default, IP Address = 192.168.188.5, Port = 5050.

Send-Only Capabilities

<K166,1,1,1,2,192.168.188.5, ,5050>

Interpretation of K Command Settings: Custom Ethernet Link Enabled Default, Transport Layer = UDP, Type = Client, Capabilities = Send, IP Address = 192.168.188.5, Port = 5050.

● Multicast**Server Mode**

The following uses the default Multicast IP Address generated in the device.

Send/Receive Capabilities

<K166,1,2,0,3>

Interpretation of K Command Settings: Custom Ethernet Link Enabled Default, Transport Layer = Multicast, Type = Server Default, Capabilities = Send/Receive Default.

Send-Only Capabilities

<K166,1,2,0,2>

Interpretation of K Command Settings: Custom Ethernet Link Enabled Default, Transport Layer = Multicast, Type = Server Default, Capabilities = Send.

Client Mode

The following client modes will connect to a Multicast server with IP Address **224.0.1.90** listening on port **5050**.

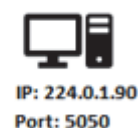
***Send/Receive Capabilities***

<K166,1,2,1,3, ,224.0.1.90,5050>

Interpretation of K Command Settings: Custom Ethernet Link Enabled Default, Transport Layer = Multicast, Type = Client, Capabilities = Send/Receive Default, IP Address = 224.0.1.90, Port = 5050.

Send-Only Capabilities

<K166,1,2,1,2, ,224.0.1.90, ,5050>

Interpretation of K Command Settings: Custom Ethernet Link Enabled Default, Transport Layer = Multicast, Type = Client, Capabilities = Send, IP Address = 224.0.1.90, Port = 5050.

8-4 Read Cycle

The **Read Cycle** menu shows all the commands that control all aspects of read cycle, including triggering, read cycle timing, and image processing.

Command parameters can be changed directly from this menu.

8-4-1 Read Cycle Menu

Advanced Settings	
Search for settings	
Multisymbol	
☆ Number of Symbols	1
☆ Multisymbol Separator	,
☆ Allow Duplicate Symbols	Disabled
Trigger	
☆ Mode	Continuous Read
☆ Leading Edge	32 μ s
☆ Trailing Edge	32 μ s
☆ External Trigger State	Active Closed
Serial Trigger	
☆ Character (Delimited)	<SP>
☆ Start Character (Non-Delimited)	<NUL>
☆ Stop Character (Non-Delimited)	<NUL>
End of Read Cycle	
☆ Mode	Timeout
☆ Read Cycle Timeout	1000 ms
☆ Decodes Before Output	1
Capture Mode	
☆ Capture Mode	Continuous ?
☆ Number of Burst Captures	1
Capture Time	
☆ Time Before 1st Capture	0 μ s
☆ Time Between Captures 1-2	0 μ s
☆ Time Between Captures 2-3	0 μ s
☆ Time Between Captures 3-4	0 μ s
☆ Time Between Captures 4-5	0 μ s
☆ Time Between Captures 5-6	0 μ s
☆ Time Between Captures 6-7	0 μ s
☆ Time Between Captures 7-8	0 μ s
Store No Read Image	
☆ Image Storage Type	Disabled
☆ Image Storage Mode	First Image
Image Processing Settings	
☆ Image Processing Timeout	5000 ms

8-5 Symbologies

The **Symbologies** menu shows all the commands that allow you precise control of the parameters of all enabled code types. Parameters differ depending on the unique standards of each code type. Command parameters can be changed directly from this menu.

8-5-1 Symbologies Menu

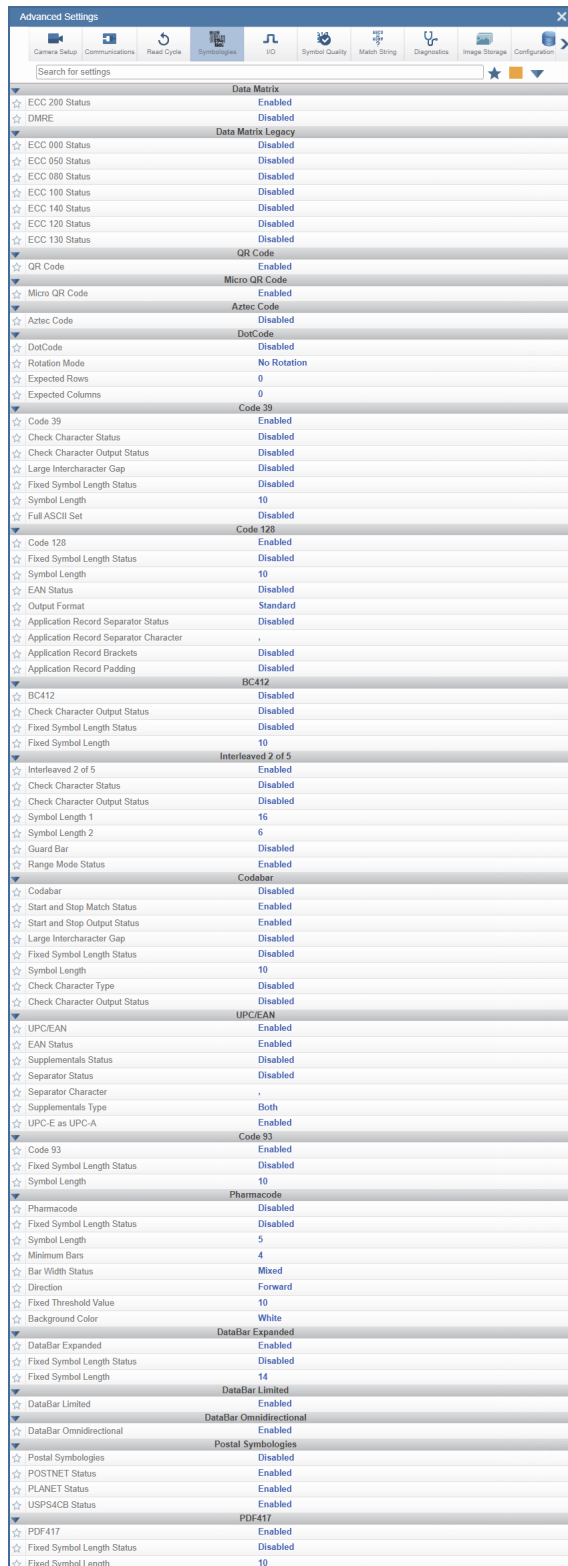

Dot Code

DotCode is a special code type that can be enabled using the standard Code Type dialog box or using Advanced Settings.

Important: When DotCode is enabled, no other symbologies will be decodable. You must disable DotCode to decode symbols of any other type.

DotCode	
☆ DotCode	Disabled
☆ Rotation Mode	No Rotation
☆ Expected Rows	0
☆ Expected Columns	0

DotCode parameters can be found in the Symbologies menu located in WebLink's Advanced Settings.

Rotation – DotCode will look for either horizontal or vertical codes with no rotation plus or minus 3 degrees. You can set **Rotation Mode** to **Low Rotation** plus or minus 10 degrees or to **Omnidirectional**.

Rows and Columns – When using DotCode, you can specify the exact number of rows and columns in the code to minimize the possibility of decoding errors and no reads. If you specify the exact row and column dimensions, only DotCode symbols of the same dimension are decoded.

To do this, you must enter the row and column values using a **K command** via the **Terminal** under **Settings**, or via another serial link.



Important: DotCode must be enabled for the column and row settings to take effect.

Serial K Command: <K561,Custom Feature Command String>

Default Setting: “ ”

Options: **DOTCODE_COL_ROW=?##?**

The ? character in **DOTCODE_COL_ROW=?##?** should be changed to the expected number of columns and rows in the DotCode symbol.

In the example below, **40** is the number of columns, and **7** is the number of rows.

<K561,DOTCODE_COL_ROW=**40#7#**>



Swap columns and rows when the same symbol is oriented vertically.

<K561,DOTCODE_COL_ROW=**7#40#**>



Advanced Decoding Parameters

Advanced Decoding Parameters can help you read difficult and damaged symbols, and are optimized for direct part marks DPM.

	Advanced
☆ Optimize using DM Internal Alignment Pattern	Disabled
☆ Fast Linear Mode	Disabled
☆ Curved 2D	Disabled
☆ Convert Shift-JIS to UTF-8	Disabled
☆ 1D Quiet Zone Violation	Disabled
☆ Scale Image	Disabled
☆ 2D Damaged Mode	Disabled
☆ Attempt Morphology Manipulation	Disabled
☆ Extend Image Boundary Pixels	0

Optimize Using DM Internal Alignment Pattern

Alignment Pattern Mode AP Mode directs the algorithm to use the internal clock pattern of Data Matrix symbols with multiple data regions.

When enabled, it improves both decode time and decreases the read timing variance, guaranteeing that the code will be read on the first pass.

The decode time impact of this feature is low when there is no internal alignment pattern.

Data Matrix Symbol with Multiple Data Regions:



Serial Command: <K478,,0>

Default Setting: Disabled

Options:

0 = Disabled

1 = Enabled

Examples:

<K478,,0> = Disabled

<K478,,1> = Enabled

Fast Linear Mode

Fast Linear Mode optimizes 1D symbol decoding. Fast Linear Mode accelerates 1D decode speeds by restricting the orientation in which barcodes can be aligned, and only decoding barcodes in that orientation.

If you know the direction the application's symbols will be oriented relative to the reader horizontally or vertically, set Fast Linear Mode to match that direction. This will cause the reader to decode only symbols in that orientation, thereby reducing the processing needed and speeding up decode times.

If you prefer to use serial commands, the following command allows you to enter your settings via a Terminal.

Serial Command: **<K562,Fast Linear Mode>**

Default Setting: Disabled

Options:

0 = Disabled

1 = Horizontal

2 = Vertical

Examples:

<K562,0> = Disabled

<K562,1> = Horizontal

<K562,2> = Vertical

Horizontal requires that the entire symbol be oriented horizontally in the reader's field of view.



Vertical requires that the entire symbol be oriented vertically in the reader's field of view.



Curved 2D

Curved 2D is designed for **Data Matrix** and **QR Code** symbols on bottles and other cylinders.



Curved Data Matrix



Curved QR Code

Curvature in a captured image is usually created when the reader is pointing to the symbol at an angle. This algorithm, when enabled, will only be active when the curvature is great enough. If the length ratio between the red and green line shown in the example below is greater than **20:1**, the Curved 2D algorithm will be activated.

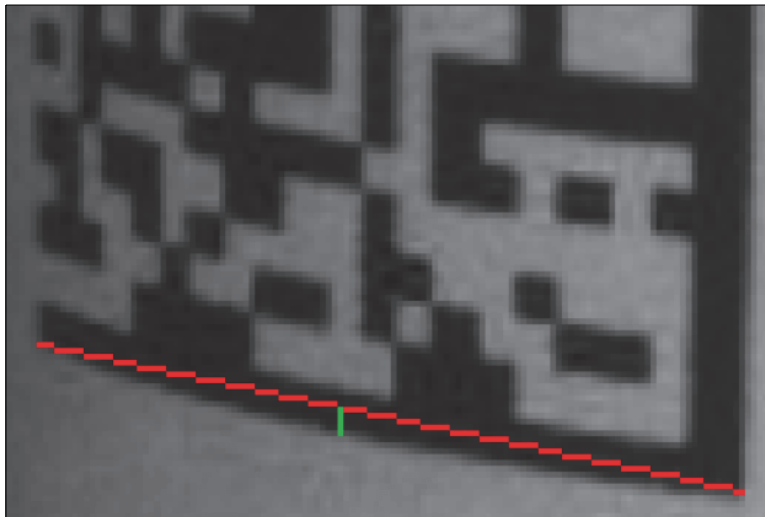

If you prefer to use serial commands, the following command allows you to enter your settings via a Terminal.

Serial Command: <K563,Curved 2D>

Default Setting: **Disabled**

Options:

0 = Disabled

1 = Enabled

Examples:

<K563,0> = Disabled

<K563,1> = Enabled

Convert Shift-JIS to UTF-8

For any symbol often QR Code but not always, this feature converts decoded **Shift-JIS** characters to **UTF-8** characters.

If you prefer to use serial commands, the following command allows you to enter your settings via a Terminal.

Serial Command: <K564,Convert Shift-JIS to UTF-8>

Default Setting: **Disabled**

Options:

0 = Disabled

1 = Enabled

Examples:

<K564,0> = Disabled

<K564,1> = Enabled

1D Quiet Zone Violation

This feature allows a symbol to be decoded even when there is noise in the quiet zone on one or both sides of a symbol. This command is specific to UPC, Code 128, Code 39, and Codabar.

If you prefer to use serial commands, the following command allows you to enter your settings via a Terminal.

Serial Command: <K565,1D Quiet Zone Violation>

Default Setting: **Disabled**

Options:

0 = Disabled

1 = Enabled

Examples:

<K565,0> = Disabled

<K565,1> = Enabled

Scale Image Up, Down, or Both

Scale Image allows you to scale the captured image up or down.

Scale Up is intended for symbols with low PPE pixels per element and small quiet zones. It scales up the image by 2x 4x by area. The maximum zoomed image size is 2600 x 2048. If the original image is greater than 1300 x 1024, it will be cropped to the center portion.

Scale Down scales the captured image to the ideal size for the reader's decoder 1/4 or 1/16 if necessary and filters out image noise.

There is also a **Both** option that allows you to scale the image up or down.

If you prefer to use serial commands, the following command allows you to enter your settings via a Terminal.

Serial Command: <K566,Scale Image>

Default Setting: **Disabled**

Options:

0 = Disabled

1 = Scale Up

2 = Scale Down

3 = Both

Examples:

<K566,0> = Disabled

<K566,1> = Scale Up

<K566,2> = Scale Down

<K566,3> = Both

2D Damaged Mode

2D Damaged Mode allows you to decode symbols with distorted grid alignment or bad cell registration.

If you prefer to use serial commands, the following command allows you to enter your settings via a Terminal.

Serial Command: <K567,2D Damaged Mode>

Default Setting: **Disabled**

Options:

0 = Disabled

1 = Enabled

Examples:

<K567,0> = Disabled

<K567,1> = Enabled

Attempt Morphology Manipulation

Attempt Morphology Manipulation applies morphology dilation and attempts to decode. If this isn't successful, it applies morphology erosion and attempts to decode.

If you prefer to use serial commands, the following command allows you to enter your settings via a Terminal.

Serial Command: <K568,Attempt Morphology Manipulation>

Default Setting: **Disabled**

Options:

0 = Disabled

1 = Enabled

Examples:

<K568,0> = Disabled

<K568,1> = Enabled

Extend Image Boundary Pixels

Extended Boundary EB Mode – Some applications benefit from have a window of interest WOI tight around the symbol. The benefit can come from having a smaller image to process, less "noise" around the symbol, or fewer L-patterns in the image.

When the Data Matrix symbol is too close to the WOI border it will compromise decoding, leading to No Reads. EB Mode increases the size of the image by creating an artificial low resolution border around the WOI prior to attempting to decoding it.

EB Mode is configured by setting the boundary to a value greater than 0. **8** is a typical value, and will add 8 pixels to the WOI, as in the example below.

New Image from WOI Plus 8 Pixels on Each Side:



EB Mode should not be enabled with the WOI at the size of the full image. The reader will stop decoding Data Matrix symbols.

Serial Command: <K569,0>

Default Setting: **Disabled**

Options:

0 = Disabled

Greater than 0 = Number of Boundary Pixels to Add

Examples:

<K569,0> = Disabled

<K569,8> = Eight-Pixel Boundary

Advanced Decoding Parameters Examples

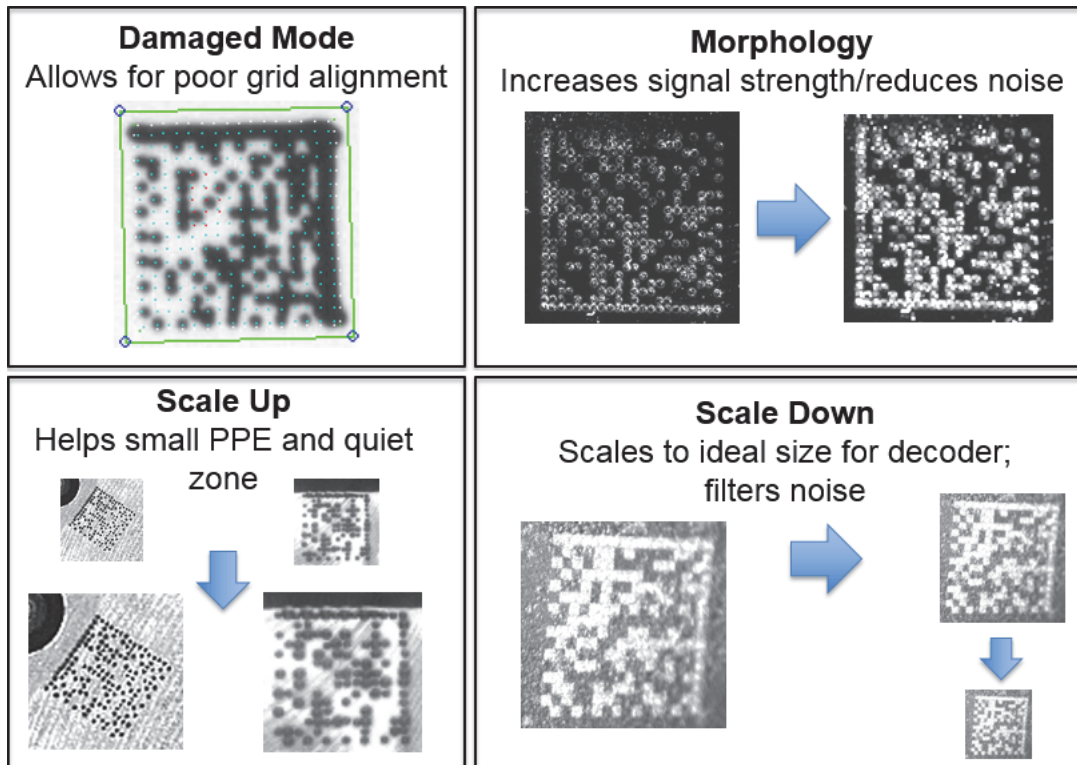

Examples of 2D Damaged Mode, Attempt Morphology Manipulation, Scale Image Up, and Scale Image Down

Notes on Using Advance Decode Parameters

Before setting advanced features, the following setup conditions should be considered in time-critical applications:

- Aim for around 4 pixels per element PPE . This is optimal for decoding performance. When the PPE is around 8 or higher, enable Pixel Binning in the **Camera Setup** section of **Advanced Settings**. Binning will reduce the resolution of the image. Prior to decoding, the number of PPE indicated should drop to 50% compared to the original image.
- In applications that use Data Matrix symbols of a fixed size and fixed number of elements, use the **Optimize** speed option. This will preset the decode algorithm to look only for Data Matrix symbols with the Optimized dimensions and PPE, leading to faster decode times.
- Enable **2D Damaged Mode** from the **Symbologies** section of **Advanced Settings**. This helps decode symbols with distorted grids in the reader's field of view.
- Consider using the **Curved 2D** feature. It can improve decode performance when the Data Matrix symbol covers a large part of a curved surface, such as a cylindrical surface. Large is considered to be about $\frac{1}{2}$ to a $\frac{1}{4}$ for the symbol-to-surface ratio in the image. Enabling the Curved 2D when the Data Matrix symbol is small compared to the curve will increase the time required to decode the symbol.

Time Impact of Advanced Features

- **2D Damaged Mode** can be used in all applications, not much extra decode time is expected where the damaged is not required.
 - **2D Curved Mode** should only be used on small-diameter curves. On large-diameter curves, the additional function of the algorithm is not used and the pre-selection will add extra time.
 - **AP Mode** has the biggest impact on Data Matrix symbols with multiple data regions. It improves the decode time required and improves consistency. Little extra decode time is expected where the AP Mode is not required.
 - **EB Mode** is for applications that require a window of interest that fits tightly around the symbol. No Reads caused by the edge of the symbol being close to the edge of the image are reduced.
- The modes listed above can be combined. Enabling them all will lead to longer decode times. In general, a combination of 2D Damaged Mode and AP Mode will not make the decode time noticeably longer, and it will make decode times shorter and more consistent in the applications for which it is intended.

Combining Advanced Decoding Parameters

Some Advanced Decoding Parameters can be combined and others cannot, as follows:

- **Curved 2D** and **Convert Shift-JIS to UTF-8** can be combined with each other, and both will be activated.
- **Scale Up, Scale Down, Attempt Morphology Manipulation, and 2D Damaged Mode** can be combined with each other.
- **Fast Linear Mode Horizontal** and **Fast Linear Mode Vertical** cannot be combined with other **Advanced Decoding Parameters** commands.
- **1D Quiet Zone Violation** cannot be combined with other Advanced Decoding Parameters commands.

8-6 I/O

The I/O menu shows all the commands that control a wide range of real-world reader behavior, including the enabling or disabling of messages about various reader states, the configuration of the LEDs, the enabling or disabling of messages about symbol quality, and the sending of signals to external systems such as conveyors and light stacks.

Command Parameters can be changed directly from this menu.

8-6-1 I/O Menu

The screenshot displays the 'Advanced Settings' window for the I/O menu. It is organized into several sections, each with a search bar and a list of settings. The settings are categorized into Decode Location, Symbol Data Output, Read Duration Output, Output Object Info, Output Indicators, LED Configuration, Serial Verification, Calibration Options, Database Identifier Output, Quality Output, and multiple Output Parameters sections (Output 1, Output 2, Output 3). Each setting includes a star icon for toggling, a label, and a value or status.

Section	Setting	Value/Status
Decode Location	Sort	Disabled
	Row Direction	Left to Right
	Column Direction	Top to Bottom
	Row Overlap	20 %
	Column Overlap	20 %
Symbol Data Output	Symbol Data Output	Any Good Read
	When to Output Symbol Data	As Soon As Possible
	Include Symbology Identifier	Disabled
	No Read Message	Enabled
Read Duration Output	Message	NOREAD
	Read Duration Output	Disabled
	Separator	<SP>
Output Object Info	Output Object Info	Disabled
	Output Coordinates	Disabled
	Output Indicators	Disabled
LED Configuration	Green Flash Mode	Disabled
	Targeting	Always Off
	Green Flash Duration	250 ms
	LED Mode	Standard
Serial Verification	ISO/IEC 16022 Grade	Final Grade
	Serial Command Echo Status	Disabled
	Control/Hex Output	Control
Calibration Options	Window of Interest Framing	Row and Column
	Window of Interest Margin	75
	Linescan Height	64
Database Identifier Output	Database Identifier Output	Disabled
	Separator Character	<SP>
	Quality Output Separator	-
Output 1 Parameters	Decodes/Trigger Status	Disabled
	Output On	Mismatch or No Read
	Output State	Normally Open
	Pulse Width	500 ms
Trend Analysis (Output 1)	Output Mode	Pulse
	Trend Analysis Mode	No Read
	Number of Triggers	0
	Number to Output On	0
	Decodes per Trigger	0
Symbol Quality (ISO/IEC 15415) - Output 1	Output on Overall Grade	Disabled
	Output on Symbol Contrast	Disabled
	Output on Modulation	Disabled
	Output on Reflectance Margin	Disabled
	Output on Fixed Pattern Damage	Disabled
	Output on Axial Non-Uniformity	Disabled
	Output on Grid Non-Uniformity	Disabled
	Output on Unused ECC	Disabled
	Output on Overall Grade	Disabled
	Output on Edge Determination	Disabled
Symbol Quality (ISO/IEC 15416) - Output 1	Output on Decode	Disabled
	Output on Contrast	Disabled
	Output on Min Reflectance	Disabled
	Output on Min Edge Contrast	Disabled
	Output on Modulation	Disabled
	Output on Defects	Disabled
	Output on Decodability	Disabled
	Output on Quiet Zone	Disabled
	Output on Symbol Contrast	Disabled
	Output on Print Growth	Disabled
Symbol Quality (ISO/IEC 16022) - Output 1	Output on Axial Non-Uniformity	Disabled
	Output on Unused ECC	Disabled
	Output on Overall Grade	Disabled
	Output on Cell Contrast	Disabled
	Output on Cell Modulation	Disabled
Symbol Quality (ISO/IEC 29158) - Output 1	Output on Fixed Pattern Damage	Disabled
	Output on Axial Non-Uniformity	Disabled
	Output on Grid Non-Uniformity	Disabled
	Output on Unused ECC	Disabled
	Output on Overall Grade	Disabled
Diagnostics (Output 1)	Service Unit	Disabled
	Output On	Mismatch or No Read
Output 2 Parameters	Output State	Normally Open
	Output Mode	Pulse
Trend Analysis (Output 2)	Trend Analysis Mode	No Read
	Number of Triggers	0
	Number to Output On	0
	Decodes per Trigger	0
	Output on Overall Grade	Disabled
Symbol Quality (ISO/IEC 15415) - Output 2	Output on Symbol Contrast	Disabled
	Output on Modulation	Disabled
	Output on Reflectance Margin	Disabled
	Output on Fixed Pattern Damage	Disabled
	Output on Axial Non-Uniformity	Disabled
	Output on Grid Non-Uniformity	Disabled
	Output on Unused ECC	Disabled
	Output on Overall Grade	Disabled
	Output on Edge Determination	Disabled
	Output on Decode	Disabled
Symbol Quality (ISO/IEC 15416) - Output 2	Output on Contrast	Disabled
	Output on Min Reflectance	Disabled
	Output on Min Edge Contrast	Disabled
	Output on Modulation	Disabled
	Output on Defects	Disabled
	Output on Decodability	Disabled
	Output on Quiet Zone	Disabled
	Output on Symbol Contrast	Disabled
	Output on Print Growth	Disabled
	Output on Axial Non-Uniformity	Disabled
Symbol Quality (ISO/IEC 16022) - Output 2	Output on Unused ECC	Disabled
	Output on Overall Grade	Disabled
	Output on Cell Contrast	Disabled
	Output on Cell Modulation	Disabled
	Output on Fixed Pattern Damage	Disabled
Symbol Quality (ISO/IEC 29158) - Output 2	Output on Axial Non-Uniformity	Disabled
	Output on Grid Non-Uniformity	Disabled
	Output on Unused ECC	Disabled
	Output on Overall Grade	Disabled
	Output on Cell Contrast	Disabled
Diagnostics (Output 2)	Service Unit	Disabled
	Output On	Use as Ext. Illumination Strobe
Output 3 Parameters	Output State	Normally Open
	Pulse Width	500 ms
Trend Analysis (Output 3)	Output Mode	Pulse
	Trend Analysis Mode	No Read
	Number of Triggers	0
	Number to Output On	0
	Decodes per Trigger	0
Symbol Quality (ISO/IEC 15415) - Output 3	Output on Overall Grade	Disabled
	Output on Symbol Contrast	Disabled
	Output on Modulation	Disabled
	Output on Reflectance Margin	Disabled
	Output on Fixed Pattern Damage	Disabled
	Output on Axial Non-Uniformity	Disabled
	Output on Grid Non-Uniformity	Disabled
	Output on Unused ECC	Disabled
	Output on Overall Grade	Disabled
	Output on Edge Determination	Disabled
Symbol Quality (ISO/IEC 15416) - Output 3	Output on Decode	Disabled
	Output on Contrast	Disabled
	Output on Min Reflectance	Disabled
	Output on Min Edge Contrast	Disabled
	Output on Modulation	Disabled
	Output on Defects	Disabled
	Output on Decodability	Disabled
	Output on Quiet Zone	Disabled
	Output on Symbol Contrast	Disabled
	Output on Print Growth	Disabled
Symbol Quality (ISO/IEC 16022) - Output 3	Output on Axial Non-Uniformity	Disabled
	Output on Unused ECC	Disabled
	Output on Overall Grade	Disabled
	Output on Cell Contrast	Disabled
	Output on Cell Modulation	Disabled
Symbol Quality (ISO/IEC 29158) - Output 3	Output on Fixed Pattern Damage	Disabled
	Output on Axial Non-Uniformity	Disabled
	Output on Grid Non-Uniformity	Disabled
	Output on Unused ECC	Disabled
	Output on Overall Grade	Disabled
Diagnostics (Output 3)	Service Unit	Disabled
	Output On	Use as Ext. Illumination Strobe
Output Cycle ID	Output Cycle ID	Disabled
	Separator	<SP>

8-6-2 Symbol Grading

Grading Overview

The symbol grading features presented here are not intended to be, and should not be confused with, barcode verification. The individual parameter measurements in symbol grading are implemented in accordance with verification standards. However, calibration and other methodologies needed for compliant verification are not feasible in a reader configuration. Compliant verification is beyond the scope of this help topic, but reviewing a few topics can help in understanding how to deploy the features and functionality provided.

Verifiers are integrated systems designed to meet the rigorous demands of the verification specifications. To provide compliant verification, verifier systems are designed with specific features and functionality. In addition to specific requirements that are explicitly defined in the standards themselves, verifiers also incorporate general design features to eliminate sources of variability that can have adverse effects on the accuracy and repeatability of measurements. Readers are designed to provide maximum product flexibility for integration into systems that require reading for traceability. Key reader design specifications such as size, cost, read range, and read rate are a few factors that drive fundamental differences between verifier and reader designs. Understanding these tradeoffs in design can help users to optimize their reader systems to provide better accuracy and repeatability when grading.

V440-F readers provide no calibration features. The image captured by the reader is processed as-is and the intensity values of the image 0 – 255 are directly mapped to 0 – 100% reflectance grading purposes. Additionally, grading requires applying a synthetic aperture. A verifier normally applies an aperture using application standard requirements in combination with dimensional calibration. Without calibration the aperture needs to be specified by the user as a percentage of the nominal symbol dimension. Finally, some metrics in verification such as Minimum Reflectance in ISO 29158 are calculated using data that can only be provided through a calibration process and have no means of representation without such a process.

Setup Considerations

Key setup objectives when grading standard printed marks are listed below. Note that grading certain DPM marks with ISO 29158, such as dot peen marks, may require different and/or axial lighting to get an appropriate response from the symbol.

- Select an optical configuration and distance that will achieve minimum pixel-per-element requirements for the target symbol. Select an optical configuration and illumination setup that achieves the requirements at a working distance greater than or equal to 6". Working distances shorter than 6" can be used, although this introduces optical distortions that may impact performance of certain measurements.
- Image the symbol as close to perpendicular as achievable in the application. Off-axis imaging introduces distortions that can be significant, even causing the symbol to fail to read during the grading process, resulting in all F grades.
- Achieve and maintain the best possible focus on the symbol when grading. Small variations in focus can have substantial impacts on grading.
- Provide even external illumination at or close to 45 degrees of incidence and disable the internal illuminating LEDs.

● Illumination Distribution

Evenly-distributed illumination over the inspection area is a key component for accurate and repeatable grading. In general, ISO 15416 grading will be the most sensitive of the grading methods provided with regard to variation in illumination. This is because 1D symbols generally span a larger range in the field of view and many of the grading measurements that rely on absolute measurements can be impacted noticeably over that range. It is important to take care in achieving as flat a response as possible of the inspection area. Uneven illumination will not only impact the grade of a given symbol, but can also have a very large impact on repeatability of measurements. For example, a given symbol may achieve a different result in the center of the field of the view then it does near the edges or corner. Illumination providing a perfectly flat response will remove locational variance but this is not always possible. Care in symbol presentation, location, and consistency will have a significant impact on grading consistency.

● Optical Distortion

Optical distortion of the symbol under test can also impact results. Optical distortion is introduced through a few different sources. The optics themselves will introduce non-linear distortions. These distortions will have a more significant impact on the symbol as the working distance is shortened. Lengthening the working distance reduces the variation in angle at which light traveling from the symbol enters the lensing system. Moving the symbol farther away also reduces the pixel per element resolution and changes illumination profiles, so care must be taken to optimize these parameters together. The symbol should be presented as close to 90 degrees to the imager as possible. Off-axis imaging will introduce distortion. Optical distortion mostly impacts 2D grading, particularly Axial and Grid Non-Uniformity, but will have cascading effects on other metrics.

● Digital Resolution

A minimum digital resolution in the image is required to allow the software to have enough data to accurately measure the grading parameters. For ISO 15416 grading, 4 pixels per nominal symbol dimension are required. For ISO 15415 and ISO 29158 grading, 6 pixels per nominal symbol element are required. Under the highest-quality imaging, good performance can be seen down to 3 pixels for 1D and 5 pixels for 2D. This is system-dependent and requires optimal illumination. Not having enough resolution will impact repeatability and introduce overall degradation in dependent parameters.

● Optical Resolution

Optical resolution is the ability of the optics to resolve detail in the image. High digital resolution of the symbol in the image does not equate to a high optical resolution. The system needs to resolve the detail of the image accurately. This requires making sure your lens is at optimal focus and that other considerations such as working distance and color of illumination have been evaluated to ensure they are not negatively impacting optical resolution in the system. When designing an optical setup you should evaluate and optimize to achieve the best possible modulation transfer function MTF for the imager. Poor optical resolution typically results in a degraded modulation score can have a cascading effect on other metrics.

General Grading Functionality

● The Grading Process

The three grading specifications described in this topic are independent of each other as an inspection process but are all dependent on the X-Mode decoder being properly set up to read the symbol type provided. The grading evaluation does not take place until a symbol has first been identified by the X-Mode decoder. Once a symbol supported by an enabled grading specification has been decoded by the decoder a separate grading evaluation will commence. Note this evaluation can potentially add significant processing time to the overall process and each specification requires independent evaluation. Furthermore, enabling any single parameter within a given specification requires the complete grading evaluation.

Grading ISO 15416

● Overview

This section outlines the grading implementation for ISO 15416 available in the reader firmware. Please refer to the free AIM guide titled *The Layman's Guide to ANSI, CEN, and ISO/IEC Linear Bar Code Print Quality Documents* or to the relevant ISO specification documents for additional detail related to print quality.

● Supported Symbologies

- Code 128 / GS1-128
- UPC-A / UPC-E / EAN-13 / EAN-8
- Interleaved 2 of 5 / ITF-14
- Code 39
- Code 93
- Codabar

● Minimum Resolution

- 4.0 Pixels Per Element Element = Nominal X Dimension

Usage / Notes

● Illumination and ISO 15416 Grading

The accuracy and consistency of ISO 15416 grading depends greatly upon the illumination in the field of view. ISO 15416 grading is evaluated by analyzing individual scan lines applied across the imaged symbol. These scan lines generate a signal called the scan reflectance profile which is the basis of the scan line grading methodology. This scan line grading methodology uses a fixed intensity threshold to determine whether the signal state represents a bar or space. In addition, this threshold is used as a reference for measuring the value for contrast, modulation, and defects. Simply reading a symbol with the X-Mode decoder can be achieved over a wide range of illumination profiles, but accurately grading a defect requires much tighter control of the environment. The level of accuracy required is not easily perceived by the human eye. To illustrate how variation that appears subtle to the eye can have a large impact on grading performance, consider the following image from a standard reader using internal illumination. The scan reflectance profile for the two line scans shown in the image is displayed to the right of the imaged symbols. The large symbol spanning the entire field of view shows dramatic differences in intensity. The spaces in the center of the symbol are providing 50% higher signal response than the quiet zones at either edge of the field of view. Similarly, the smaller symbol lower in the field of view provides a much lower overall response throughout its region. Scenarios like this will create low modulation scores and differences in defect scores depending on the physical location of the defect. If the symbol is moved within the field of view, it will receive a different score. It is recommended that external illumination is used and evaluated closely for response characteristics when performing ISO 15416 grading.

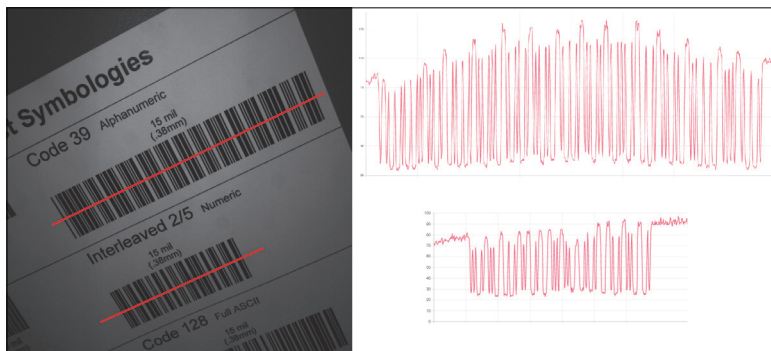

Figure 1: Uneven Illumination

● Synthetic Aperture

The synthetic aperture is a process in ISO 15416 that is applied to the image when extracting the scan line profile for grading. The aperture is an averaging process using a circular region along the scan line shown below in Figure 2.

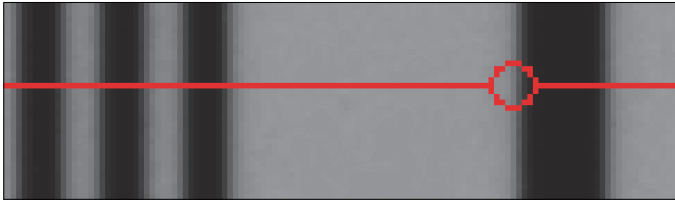

Figure 2: Scan Line Aperture

This averaging provides a generalization of the information in the image that is consistent with typical reading equipment acquisition techniques. Verification systems implement the aperture based on the physical dimension of the symbol under test and the application standard guidelines, such as GS1. In a reader that may have varying optical configurations and no calibration process, there is no means by which the process can determine the physical size of the symbol under inspection. For this reason the aperture is a configurable parameter as a percentage of the nominal dimension of the symbol under evaluation. The default value provides a general case that is close to most application standards. It is the user's responsibility to ensure this percentage matches the grading objectives. A representation of the effects of the aperture is provided in Figure 3. A larger aperture configuration creates more of an averaging effect that is less sensitive to defects but may lower modulation.

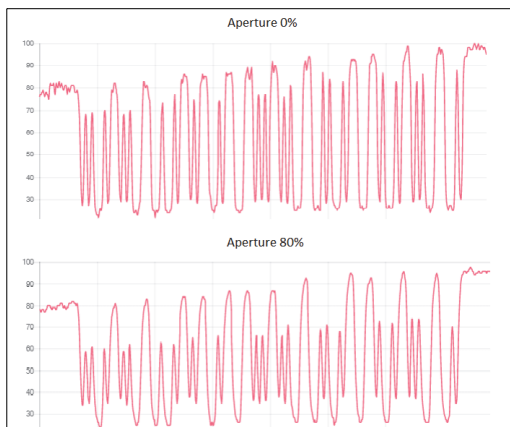

Figure 3: Aperture Effects

● Overall, Scan, and Individual Parameter Grades

The overall grade is calculated in accordance with the process defined in ISO 15416. This is often misunderstood, so a review is provided here. The overall grade is an average of the individual scan grades that are applied over the inspection region. The individual scan grades are not provided by the reader but are calculated internally. These individual scan grades are the lowest grade of any single parameter grade evaluated in that particular scan line or 0 / F if the scan line evaluation fails the edge determination or quiet zone requirements. The individual parameter grades that are provided by the reader are averages of the individual parameters grades from each scan evaluated. These individual average parameter grades are not themselves part of the overall grade calculation but can be helpful for diagnosing the cause of declining overall grades. This creates circumstances in which the overall grade can be lower than the lowest average grade, particularly when there are degrading features in the symbol from different parameters.

Configuration

● Aperture

This determines the size of aperture to use for grading configured as a percentage of the nominal narrow element width for the symbol under evaluation. For example, if you have a 13 mil UPC symbol and you wish to grade using a 6 mil aperture you would configure the aperture to 46% $6/13 = 0.46$.

● ISO 15416 Grading Serial Output

Each grade metric can be individually enabled for serial output. These outputs can be in one of three different formats configured by the global quality output mode parameter. The mode can be configured as a letter grade A-F, the actual measured metric values 0 – 100, or as a normalized grade value score where the grade A-F is mapped from 0-100. The enabled outputs are appended to the symbol data with the grading separator. They are appended in their order of appearance in the grade metric section.

● ISO 15416 Grading Logic Output and Threshold 1 – 3

Each of the three logic outputs available can be configured and driven by each of the individual grade metrics. Each output has a corresponding enable and threshold field for each metric used to control assertion of the output when the grade drops below the threshold value.

Grade Metrics

● Overall Grade

The **Overall Grade** is calculated in accordance with the ISO 15416 specification. The Overall Grade is the average of the individual scan line grades applied to the symbol. The individual scan line grades are the lowest individual parameter grade seen during the individual scan. These scan grades are not available for output. For additional detail, see **Overall, Scan, and Individual Parameter Grades** earlier in this help topic.

● Edge Determination

The **Edge Determination** check is done on each scan to ensure that element widths can be properly determined. Failing Edge Determination can occur with an uneven reflectance profile or with different types of damage. A failed Edge Determination scan results immediately as a failed decode scan.

● Decode

Decode is calculated and graded for each scan and provided for the overall grade calculation in accordance with the ISO 15416 specification. The parameter grade and value provided for output is an average value for each measured scan over the entire symbol.

● Symbol Contrast

Symbol Contrast measurements assume 8-bit 0 – 255 intensity in the captured image correlate directly to 0 – 100% reflectance. Symbol Contrast is calculated and graded for each scan and provided for the overall grade calculation in accordance with the ISO 15416 specification. The parameter grade and value provided for output is an average value for each measured scan over the entire symbol.

● Minimum Reflectance

Minimum Reflectance is a measurement that, if failing, can indicate that bars are not providing adequate response difference from the substrate, which may cause readability issues. Envision very light gray bars on a white background versus very dark bars on a grey background. Both symbols are low contrast but the latter has a better Minimum Reflectance score. Small relative changes to in the light grey bars can more easily turn into errors against a bright background than small relative changes in a very dark bar against a gray background. Minimum Reflectance is calculated and graded for each scan and provided for the overall grade calculation in accordance with the ISO 15416 specification. The Minimum Reflectance parameter grade and value provided for output is an average value for each measured scan over the entire symbol.

- **Minimum Edge Contrast**

Minimum Edge Contrast measurements assume 8-bit 0 – 255 intensity in the captured image correlate directly to 0 – 100% reflectance. Minimum Edge Contrast is an absolute measurement that ensures each element edge within the symbol achieves a minimum value. Uneven thermal or ink transfer, or printing on an inconsistent or uneven substrate, can result in areas where the edge of a bar is difficult to identify. The Minimum Edge Contrast is calculated and graded for each scan and provided for the overall grade calculation in accordance with the ISO 15416 specification. The parameter grade and value provided for output is an average value for each measured scan over the entire symbol.

- **Modulation**

Modulation is a relative measure of the edge contrast to symbol contrast. A good Modulation means the printing process is taking full advantage of the contrast available. Good Modulation becomes important particularly as other areas degrade allowing for relative margin in the reading process. Modulation is calculated and graded for each scan and provided for the overall grade calculation in accordance with the ISO 15416 specification. The parameter grade and value provided for output is an average value for each measured scan over the entire symbol.

- **Defects**

Defects are measurements of anomalies in the printed bars or spaces. These can be from a printing problem or from a variety of other sources such as scratches or problems with the substrate material. Defects, if large enough, can introduce spaces or bars that don't exist, causing a misread or failure. Defects are calculated and graded for each scan and provided for the overall grade calculation in accordance with the ISO 15416 specification. The parameter grade and value provided for output is an average value for each measured scan over the entire symbol.

- **Decodability**

Decodability measures the difference in dimension of the decoded symbol characters to the ideal. The further the characters are from the ideal, the more likely they are to fail to read or produce a misread. This can be caused by a variety of factors but can often indicate that equipment is not capable of printing at the resolution required or that the source data for the symbol has been improperly formed or degraded through transformation. Decodability is calculated and graded for each scan and provided for the overall grade calculation in accordance with the ISO 15416 specification. The parameter grade and value provided for output is an average value for each measured scan over the entire symbol.

- **Quiet Zone**

Quiet Zone is an evaluation of the scan line before and after the start and stop characters. Required Quiet Zones are dependent on the symbology and evaluated in accordance with symbol specifications. Note that Quiet Zone is not an individually processed parameter within the ISO 15416 specification but is evaluated as part of the ISO graded decode parameter. A failing Quiet Zone scan will result in a failed Decode scan, which then feeds into the overall grade. The Quiet Zone parameter is provided as an average scan result where a passing scan receives an A / 4.0 grade and a failing scan receives an F / 0.0. When the serial output for Quiet Zone is a letter grade, 95% of scans must pass. When the serial output is a numeric grade, the output shows the passing percentage.

Grading - ISO 15415

● Overview

This section outlines the grading implementation of ISO 15415 in the reader firmware.

● Supported Symbologies

- Data Matrix ECC 200 / GS1 Data Matrix
- QR Code

● Minimum Resolution

- 6.0 Pixels Per Element Element = Nominal Cell Dimension

Configuration

● ISO 15415 Grading Serial Output

Each grade metric can be individually enabled for serial output. These outputs can be in one of three different formats configured by the global quality output mode parameter. The mode can be configured as a letter grade A-F, the actual measured metric values 0 – 100, or as a normalized grade value score where the grade A-F is mapped from 0-100. The enabled outputs are appended to the symbol data with the grading separator. They are appended in their order of appearance in the grade metric section.

● ISO 15415 Grading Logic Output and Threshold 1 - 3

Each of the three logic outputs available can be configured and driven by each of the individual grade metrics. Each output has a corresponding configuration to enable and threshold each metric to control assertion of the output.

● Aperture

The size of the aperture to use for grading is configured as a percentage of the nominal dimension of the symbol under evaluation. ISO 15415 is typically applied using an 80% aperture, but for controlled applications a smaller aperture may be more effective for process control.

Grade Metrics

● Overall Grade

The **Overall Grade** is the lowest individual parameter grade. The is in accordance with the ISO 15415 specification.

● Symbol Contrast

The **Symbol Contrast** is the difference between the highest and lowest reflectance values over the symbol region as measured by the aperture. Symbol Contrast measurements assume 8-bit 0 – 255 image intensity correlate to 0 – 100% reflectance. Symbol Contrast is calculated in accordance with the ISO 15415 specification.

● Modulation

Modulation is a measure of how distinguishable dark cells are from light cells as it applies to properly decoding the codewords within the symbol. Modulation is calculated in accordance with the ISO 15415 specification.

● Reflectance Margin

Reflectance Margin is a calculation that follows the procedure of Modulation but also takes into account individual cell state errors. Reflectance Margin is calculated in accordance with the ISO 15415 specification.

- **Fixed Pattern Damage**

Fixed Pattern Damage is an evaluation of the elements in the fixed patterns of the symbol that are used for locating and extracting the data successfully. Fixed Pattern Damage is calculated in accordance with the ISO 15415 specification.

- **Axial Non-Uniformity**

Axial Non-Uniformity measures the relationship between the overall dimensions of the two axes of the symbol. Axial Non-Uniformity is calculated in accordance with the ISO 15415 specification.

- **Grid Non-Uniformity**

Grid Non-Uniformity measures the difference of the decoding grid in relation to the ideal grid formed from the four corners of the symbol. Grid Non-Uniformity is calculated in accordance with the ISO 15415 specification.

- **Unused Error Correction**

Unused Error Correction measures the remaining error correction available after correcting the errors within the decoded symbol and is calculated in accordance with the ISO 15415 specification.

Grading - ISO 29158

- **Overview**

This section outlines the grading implementation for ISO 29158 in the reader firmware.

- **Supported Symbologies**

- Data Matrix ECC 200 / GS1 Data Matrix

- **Minimum Resolution**

- 6.0 Pixels Per Element = Nominal Cell Dimension

Configuration

- **ISO 29158 Grading Serial Output**

Each grade metric can be individually enabled for serial output. These outputs can be in one of three different formats configured by the global quality output mode parameter. The mode can be configured as a letter grade A-F, the actual measured metric values 0 – 100, or as a normalized grade value score where the grade A-F is mapped from 0-100. The enabled outputs are appended to the symbol data with the grading separator. They are appended in their order of appearance in the grade metric section.

- **ISO 29158 Grading Logic Output and Threshold 1 - 3**

Each of the three logic outputs available can be configured and driven by each of the individual grade metrics. Each output has a corresponding configuration to enable and threshold each metric to control assertion of the output.

ISO 29158 Metrics

- **Overall Grade**

The **Overall Grade** is the minimum grade of all evaluated parameters, noting minimum reflectance is not evaluated.

- **Cell Contrast**

Cell Contrast is a measure of contrast that differs from ISO 15415 using a statistical value calculated from the measurements at the grid centers. Cell Contrast is calculated in accordance with the ISO 29158 specification.

- **Cell Modulation**

Like Cell Contrast, **Cell Modulation** is a modified version from ISO 15415. Cell Modulation is calculated in accordance with the ISO 29158 specification. Note that the difference in the calculation for Cell Modulation versus the Modulation parameter in ISO 15415 also eliminated the need for ISO 29158 to adopt Reflectance Margin, which was added to the ISO 15415 specification.

- **Fixed Pattern Damage**

Fixed Pattern Damage is an evaluation of the elements in the fixed patterns of the symbol that are used for locating and extracting the data successfully. Fixed Pattern Damage is calculated in accordance with the ISO 29158 specification.

- **Axial Non-Uniformity**

Axial Non-Uniformity measures the relationship between the overall dimensions of the two axes of the symbol. Axial Non-Uniformity is calculated in accordance with the ISO 29158 specification.

- **Grid Non-Uniformity**

Grid Non-Uniformity measures the difference of the decoding grid in relation to the ideal grid formed from the four corners of the symbol. Grid Non-Uniformity is calculated in accordance with the ISO 29158 specification.

- **Unused Error Correction**

Unused Error Correction measures the remaining error correction available after correcting the errors within the decoded symbol and is calculated in accordance with the ISO 29158 specification.

8-7 Symbol Quality

The **Symbol Quality** menu shows commands that allow you to define the evaluation of symbols per the ISO/IEC 16022 specification, or by a collection of commonly-used grading parameters. The two **Global** commands allow you to define the separator that will appear between instances of symbol quality output, and the format in which symbol quality evaluations will be output.

Command parameters can be changed directly from this menu.

8-7-1 Symbol Quality Menu

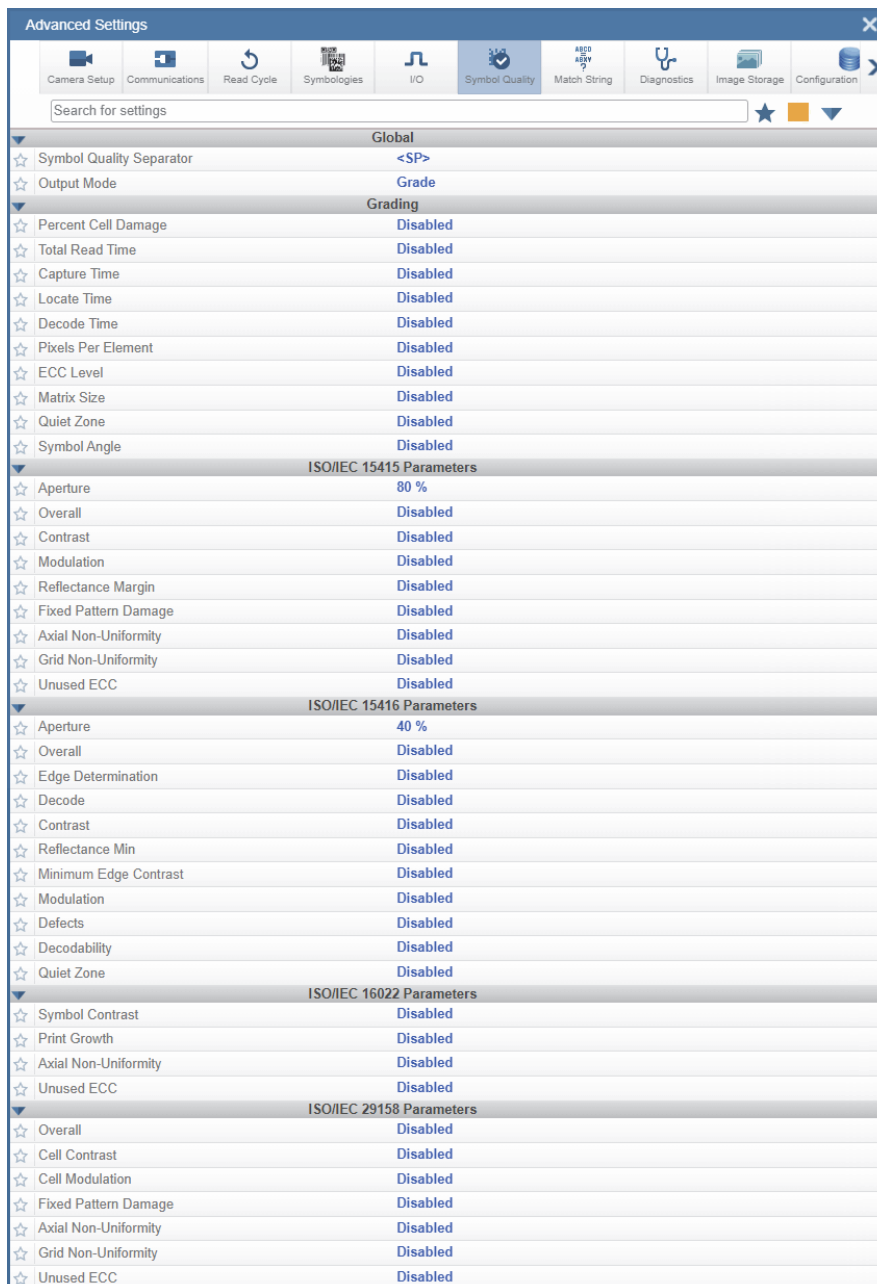

Important: For descriptions of symbol grading functionality, refer to the **Symbol Grading** section in **I/O**.

8-8 Match String

Note: **Match String** can only be used in **Triggered**, **Start/Stop**, and **Custom** modes. It cannot be used in **Continuous Mode**.

The **Match String** menu shows all the commands that allow you to determine the type of matching behavior required of the reader, as well as new master pin functionality enabled or disabled, and the character strings intended to replace a string of decoded data that is either a match or mismatch with the user-defined match string.

Command parameters can be changed directly from this menu.

8-8-1 Match String Menu

Matchcode Type	
Matchcode Type	Disabled
Sequential Matching	Increment
Match Start Position	0
Match Length	1
Wildcard	*
Sequence on No Read	Enabled
Sequence on Mismatch	Disabled
Placeholder	?
New Master Pin	Disabled
Sequence Step Interval	1
Match Replace	
Match Replace	Disabled
Replacement String	MATCH
Mismatch Replace	
Mismatch Replace	Disabled
Replacement String	MISMATCH

8-9 Diagnostics

The **Diagnostics** menu shows commands that allow you to change various service messages as well as the reader's name. It also allows you to examine the read-only count values for multiple reader functions and states.

Command parameters can be changed directly from this menu.

8-9-1 Diagnostics Menu

Counts	
Power-on	102 <i>readonly</i>
Resets	1 <i>readonly</i>
Power-on Saves	4 <i>readonly</i>
Custom Default Saves	3 <i>readonly</i>
Total Reset Count	1711 <i>readonly</i>
Flash Writes	2581 <i>readonly</i>
Hours Since Reset (Read-only)	
Hours	1 <i>readonly</i>
Minutes	33
Service Message	
Status	Disabled
Service Message	SERVICE
Threshold	300
Resolution	Seconds
User-Defined Name	V440-F1F0B87

8-10 Image Storage

The **Image Storage** menu shows commands that allow you to control how, when, and where images captured by the reader are stored.

The **Image Storage** and **Image Storage Location** commands shown below are functionally identical to those described in **Application Settings**. For example, when you configure the **FTP Address** command as shown below, the outcome is the same as it would have been had you used the graphic user interface accessible from the Application Settings menu.

Image Storage Location			
☆ Image Storage Location	<i>Remote (FTP)</i>		
☆ FTP Address	userid	pass	192.168.1.1 21
☆ Transfer Optimization	Speed		
☆ RAM Drive Size	20 MB		

Command parameters can be changed directly from this menu.

8-10-1 Image Storage Menu

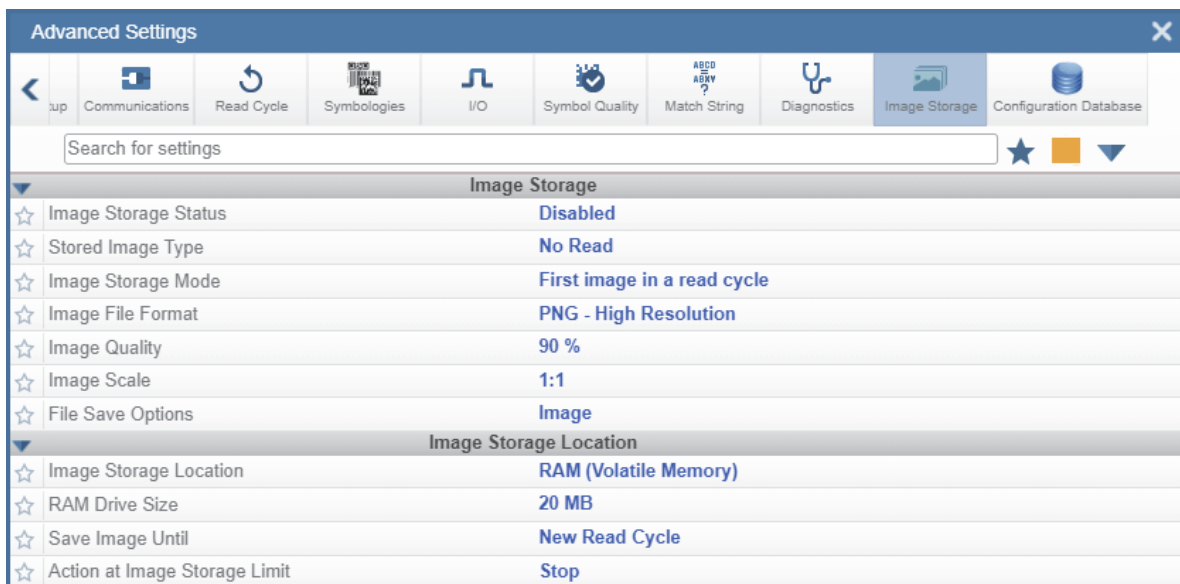

8-11 Configuration Database

The **Configuration Database** menu allows you to:

- Set the number of database record groups of settings that will be used automatically during the read cycle;
- Move the database entry that produced a successful decode to the first position in the list of database entries;
- Select the event that causes the reader to load the next database entry to current active settings;
- Determine the number of image frames that must be captured;
- Determine the amount of time that must transpire before the reader will load the next database index entry;
- Process a single captured image multiple times using different IP and decode parameters;
- Determine how the image dimension parameters will be implemented (Window of Interest or Region of Interest).

Command parameters can be changed directly from this menu.

8-11-1 Configuration Database Menu

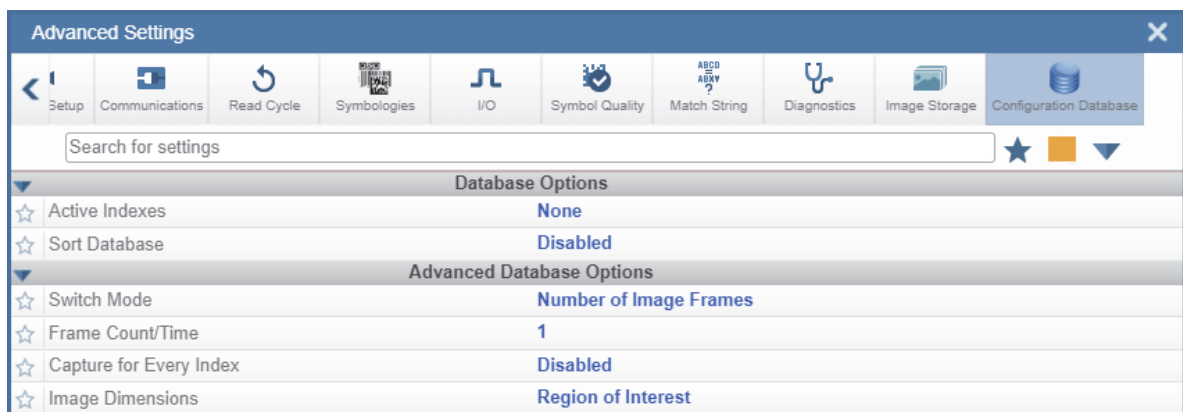

8-12 Differences from Default

The **Differences from Default** menu shows only commands whose parameters are not currently set to WebLink defaults. Commands from any of the eight categories may appear in this menu.

Command parameters can be changed directly from this menu.

8-12-1 Differences From Default Menu

Advanced Settings	
Camera Setup	Communications
Read Cycle	Symbologies
I/O	Symbol Quality
Match String	Diagnostics
Image Storage	Configuration
Search for settings	
Camera Settings	
☆ Exposure	40000 μ s
☆ Gain	40 %
Window of Interest	
☆ Top	358
☆ Left	191
☆ Height	1072
☆ Width	1664
Trigger	
☆ Mode	Serial Data and Edge
End of Read Cycle	
☆ Mode	Timeout or New Trigger
Service Message	
☆ User-Defined Name	V440-F1F0B87

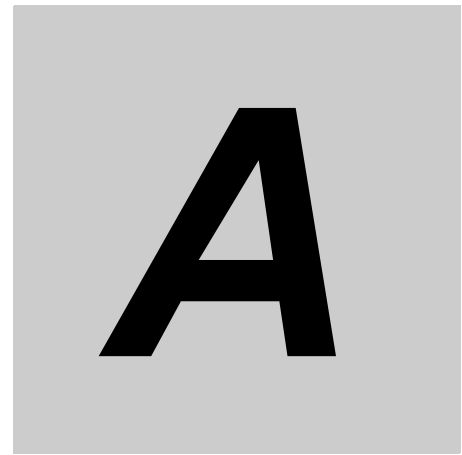

General Specifications



This section contains general information about V440-F readers.

A-1	General Specifications	A-2
A-2	Grounding and Power	A-5
A-3	Accessories and Cables	A-7

A-1 General Specifications

V440-F		
Symbologies *1	1D Symbologies	Code 39, Code 128, BC412, Interleaved 2 of 5, UPC/EAN, Codabar, Code 93, Pharmacode, PLANET, Postnet, Japanese Post, Australian Post, Royal Mail, Intelligent Mail, KIX
	2D Symbologies	Data Matrix (ECC 0-200), QR Code, Micro QR Code, Aztec Code, DotCode, DMRE
	Stacked Symbologies	PDF417, MicroPDF417, GS1 Databar (Composite and Stacked)
Reading Performance *2	Number of Reading Digits	No Upper Limit (depending on bar width and reading distance)
	Reading Distance / Field of View	Based on Lens Selection and Code Size
	Pitch Angle (α) *3	$\pm 30^\circ$
	Skew Angle (β) *3	$\pm 30^\circ$
Image	Tilt Angle (γ) *3	$\pm 180^\circ$
	Resolution, Pixel Size	2464 (H) x 2056 (V) – 3.45 μm Pixel Size
	Color / Monochrome	Monochrome CMOS
	Shutter	Global Shutter
	Frames per Second	35 FPS for 5 MP
Image Logging	Exposure	16 μs to 400 msec
	Image Logging	FTP
Trigger	External Trigger (Edge or Level), Communication Trigger (Ethernet, RS-232C)	
Trigger to Strobe Latency + Jitter	320 μs + 65 μs	
I/O Specifications	Input Signals	Trigger Input, New Master, and Default – Bi-Directional Inputs, Optoisolated, 4.5 – 28 V rated (10 mA @ 28 VDC)
	Output Signals	3 Signals: Bi-Directional, Optoisolated, 1 – 28 V rated, ($I_{CE} < 100$ mA at 24 VDC, current limited by user)
Communication	Connectivity	RS-232C, Ethernet TCP/IP, EtherNet/IP™, PROFINET
	Ethernet Specifications	1000BASE-T
Indicator LEDs	LINK (Amber), PWR (Green)	
Power Supply Voltage	Power over Ethernet (IEEE 802.3af) / 24 VDC +/- 20%, External Input via IO *4	
Current Consumption	PoE (44-57 VDC): 0.10 A or 24 VDC: 0.15 A	
Environmental Immunity *5	Ambient Temperature Range	Operating: 0 to 40° C; Storage: -25 to 65° C (No Icing or Condensation)
	Ambient Humidity Range	Operating and Storage: 25% to 85% (Non-Condensing)
	Ambient Atmosphere	No Corrosive Gases
	Vibration Tolerance	Oscillation Frequency: 10 to 150 Hz; Half Amplitude: 0.35 mm; Vibration Direction: X/Y/Z; Sweep Time: 8 Minutes / Count; Sweep Count: 10 Times
	Shock Resistance (Destructive)	Impact Force: 150 m/s ² , Test Direction: 6 Directions, 3 Times Each (Up / Down, Front / Behind, Left / Right)
	Degree of Protection	IEC 60529 – IP40
Weight	Main Body Only	103.4 g
	Packaging Weight	219.1 g
Dimensions	40 mm (W) x 61 mm (D) x 30 mm (H)	
Accessories	ReadMeFirst, CE Compliance Sheet, Protocol Support Table	
EMC / Safety	EN 55032:2012/AC:2013, EN 55035:2017, EN 62368-1:2014/AC FCC Part 15, Subpart B (Class B), UL 60950-1 RCM, KC	
Materials	Aluminum Diecast, Alumite (Black)	
Software	WebLink 3.0	

*1. These symbologies are supported based on Omron's read capability validation standard. Omron recommends that validation be performed for each application.

*2. Unless otherwise specified, reading performance is defined with center of field of view, angle R=∞.

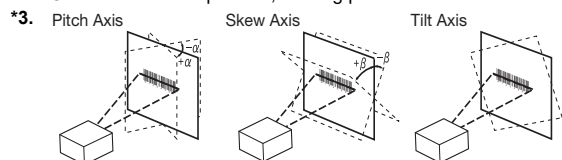

*4. Camera operates External Input at 24 VDC when supplied at the same time as PoE.

*5. In an electrically noisy environment, use only the V440-F in combination with a noise filter cable (V430-W□F-□M) to ensure proper operation.

V440-F Cable and Accessory Specifications

Item	V430-W8□□-_M	V430-W□□□F-_M	V430-WQ-_M
Cable Type	Robot cable	Robot cable. Overmolded filter must be protected from flexing	Robot cable
Connector Type	Straight	Straight	Straight
Category	I/O		
Size	AWG24		
Outer Diameter	7.11mm		
Min. Bending Radius	53mm		
Usage Environment	Ambient Temperature Range	Operating: 0-45C Storage: -50 to 75C (No Icing or Condensation)	
	Ambient Humidity Range	5-95% (Non-Condensing)	
	Ambient Atmosphere	No Corrosive Gases	
	Vibration Tolerance	Oscillation Frequency: 10 to 150Hz, Half Amplitude: 0.35 mm, Vibration Direction: X/Y/Z, Sweep Time: 8 minute/count, Sweep Count: 10 times	
	Shock Resistance	Impact Force: 150 m/s ² , Test Direction: 6 directions, three times each (up/down, front/back, left/right)	
Material	Connector Overmold: Thermoplastic Polyamide, Cable Jacket: Polyurethane		
Weight	V430-W8-3M: 259g V430-W8-5M: 422g	V430-WQF-1M: 79g V430-W8F-3M: 285g V430-W8F-5M: 447g	V430-WQ-1M: 109g V430-WQ-3M: 272g V430-WQ-5M: 351g

Item	61-000151-01	
Cable Type	Static use cable	
Connector Type	Straight	
Category	I/O	
Size	AWG22	
Outer Diameter	5.82mm	
Min. Bending Radius	63.5mm	
Usage Environment	Ambient Temperature Range	Operating: 0-45C Storage: -50 to 75C (No Icing or Condensation)
	Ambient Humidity Range	5-95% (Non-Condensing)
	Ambient Atmosphere	No Corrosive Gases
	Vibration Tolerance	Oscillation Frequency: 10 to 150Hz, Half Amplitude: 0.35 mm, Vibration Direction: X/Y/Z, Sweep Time: 8 minute/count, Sweep Count: 10 times
	Shock Resistance	Impact Force: 150 m/s ² , Test Direction: 6 directions, three times each (up/down, front/back, left/right)
Material	Connector Housing: Nylon, Cable Jacket: PVC	
Weight	67g	

A

V440-F Cable and Accessory Specifications (continued)

Item	V430-WQR-3M	V430-WR_ M	V430-WQK-3M
Cable Type	Robot cable. "Y" must be produced from flexing	Robot cable	Robot cable (2M long section only). Protect "Y" from flexing.
Connector Type	Straight		
Category	I/O and RS232		Keyboard Wedge
Size	AWG24		
Outer Diameter	7.11mm		
Min. Bending Radius	53mm		
Usage Environment	Ambient Temperature Range	Operating: 0-45C Storage: -50 to 75C (No Icing or Condensation)	
	Ambient Humidity Range	5-95% (Non-Condensing)	
	Ambient Atmosphere	No Corrosive Gases	
	Vibration Tolerance	Oscillation Frequency: 10 to 150Hz, Half Amplitude: 0.35 mm, Vibration Direction: X/Y/Z, Sweep Time: 8 minute/count, Sweep Count: 10 times	
	Shock Resistance	Impact Force: 150 m/s ² , Test Direction: 6 directions, three times each (up/down, front/back, left/right)	
Material	Connector Overmold: Thermoplastic Polyamide, Cable Jacket: Polyurethane		
Weight	273g	V430-WR-1M: 107g V430-WR-3M: 276g	270g

Item	97-000012-01	
Compatible models	V440/V430/F430	
Power Supply Type	5V Power Supply, 12 Pole M12 Socket	
AC Plug Shape	B/E	
Input Voltage	AC100V-240V	
Output Voltage	DC24V	
Maximum Output Current	2.1A	
Usage Environment	Ambient Temperature Range	Operating: 0-40C Storage: -20-80C (No Icing or Condensation)
	Ambient Humidity Range	20-80%
	Ambient Atmosphere	No Corrosive Gases
	Vibration Tolerance	Note 1
	Shock Tolerance	Note 1
Power Supply Manufacturer	Mega Electronics Inc.	
Safety Standards	UL, CCC, CE, RCM, PSE, KC, EAC, BSMI	
Weight	258g	

A-2 Grounding and Power

A-2-1 Ground and Shield Considerations

Proper grounding is necessary for operator safety, noise reduction, and the protection of equipment from voltage transients. Buildings, including any steelwork, all circuits, and all junction boxes must be grounded directly to an earth ground in compliance with local and national electrical codes.

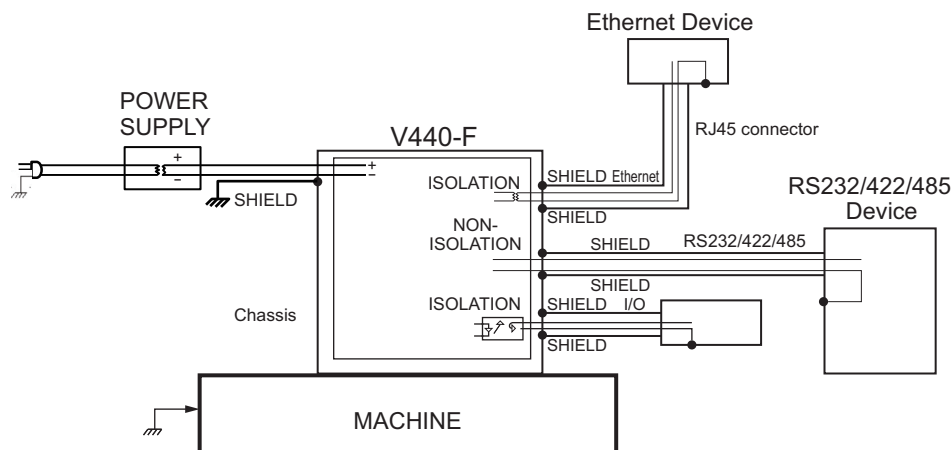

An earth ground is provided through the cable shields and chassis of the camera.

If the MicroHAWK malfunctions due to influence of the environment by shield cables grounded, try any of the ones below.

- Disconnect the chassis and the shield cable of the power supply from the earth.
- Ground the shield cable of the power supply to $-(0V)$.

Ground any of one part of the shield cable, chassis, or RJ-45 connector of Ethernet cable to earth with D class grounding. Use a Class 2 power supply for the DC source.

Note: In the case of this connection, must not ground the $+(24V)$ of the power supply. If connected, the device will break down due to a short circuit.

A-2-2 Ground Loops

Ground loops (signal degradation due to different ground potentials in communicating devices) can be eliminated or minimized by ensuring that both the host, imager, and their power supplies are connected to a common earth ground.

Note: If a malfunction occurred to your reader by noise, mount a noise filter (RSAL2001W manufactured by TDK-Lambda Corp.) close to the reader's power-supply terminals and ground the chassis of the filter.

A-2-3 Expected Power and Ground Connections for Proper Operation

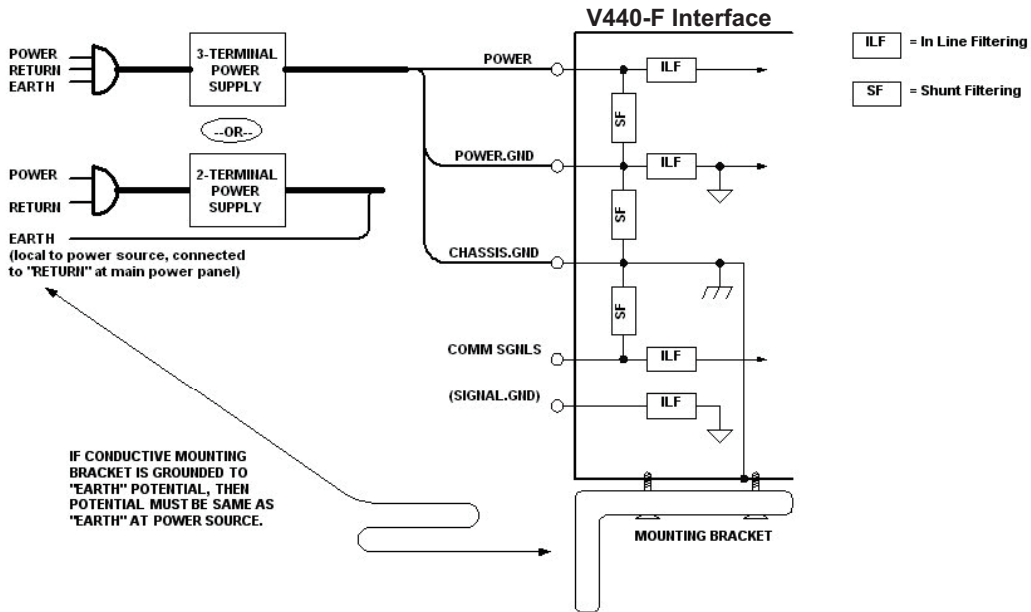

A-2-4 Grounding Notes

- Ensure that mounting bracket "Earth" is at the same potential as power source "Earth".
 - Supply "Return" and "Earth" ground must be stable, low-impedance reference points.
 - "2-Terminal Power Supply" must still provide an "Earth" connection to the imager.
- "Signal Ground" can be used for communications and/or discrete signal ground reference. It must **not** be used as Power Ground or Earth Ground.

A-3 Accessories and Cables

V440-F C-Mount Code Reader

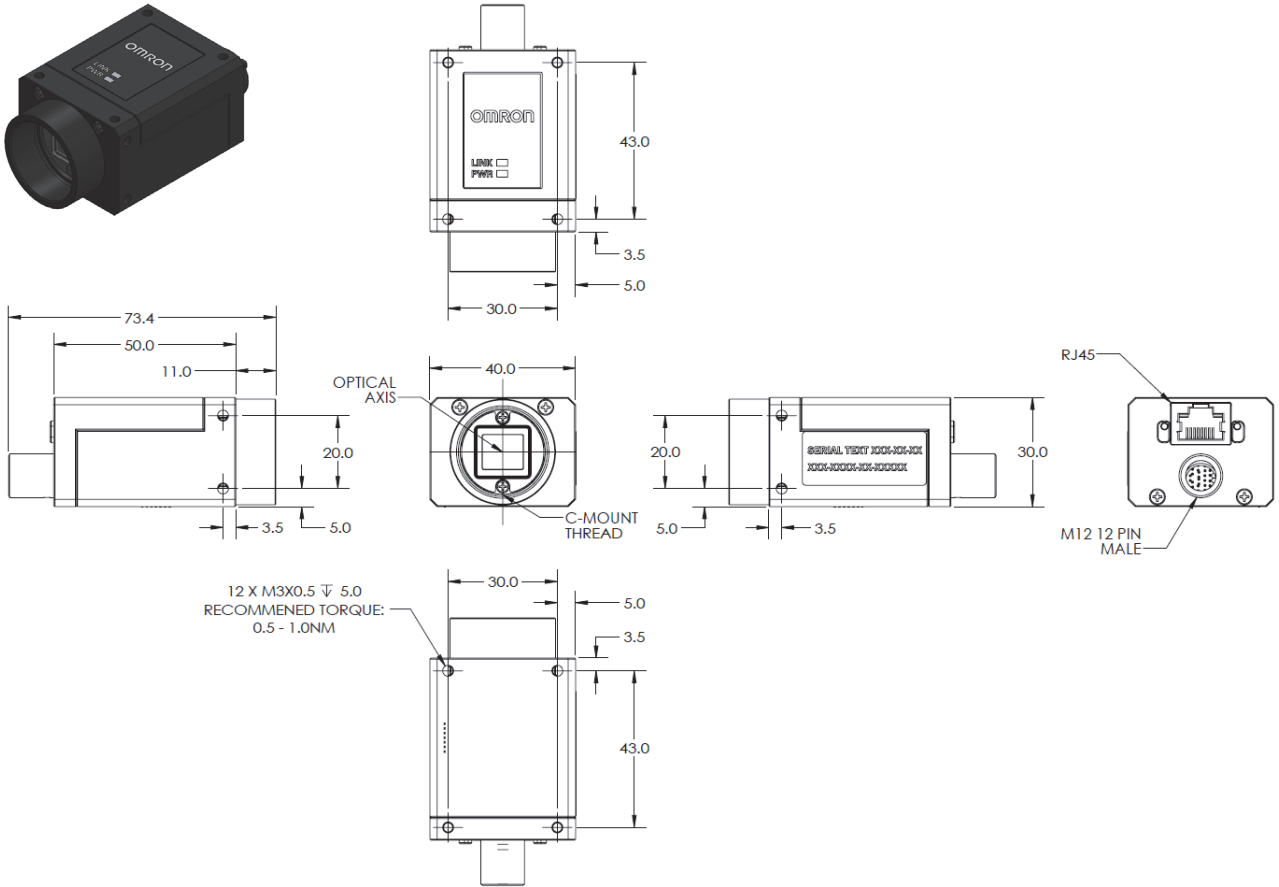

1/4-20 Reader Mounting Block Kit V440-AM0

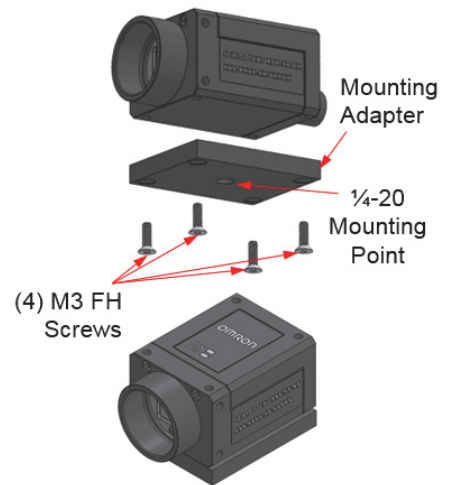
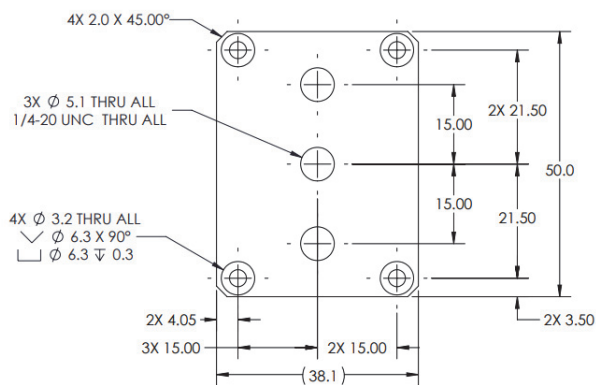
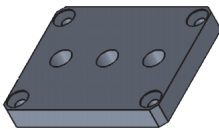

Smart Series R-70 Ring Light to V440-F Mounting Bracket Kit
V440-AM1

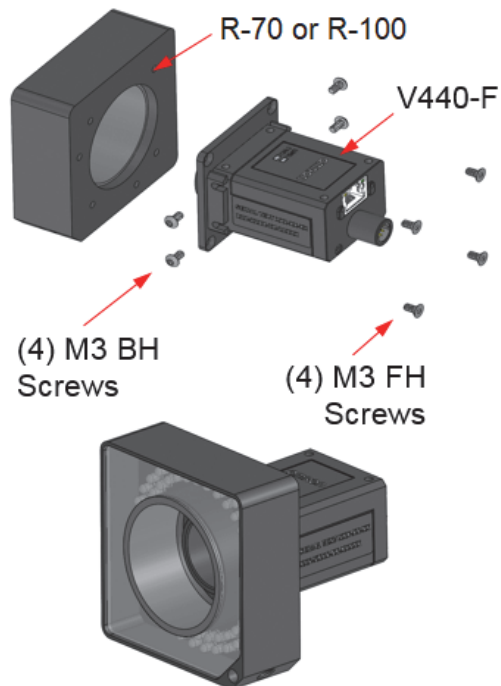
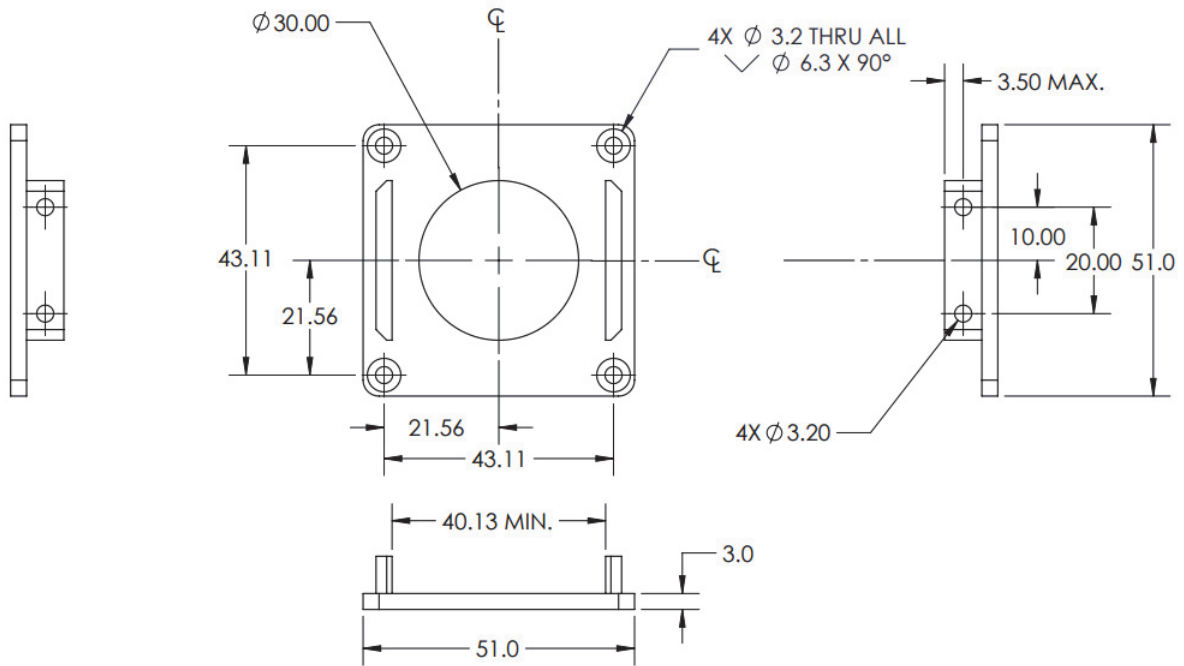
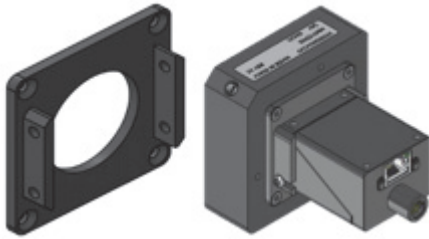

Smart Series R-100 Ring Light to V440-F Mounting Bracket Kit V440-AM2

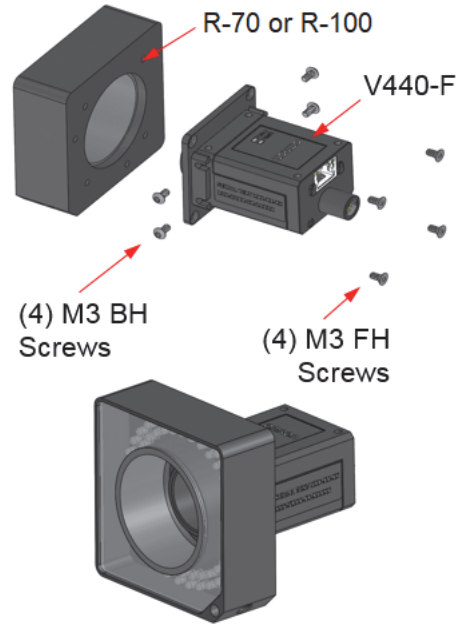
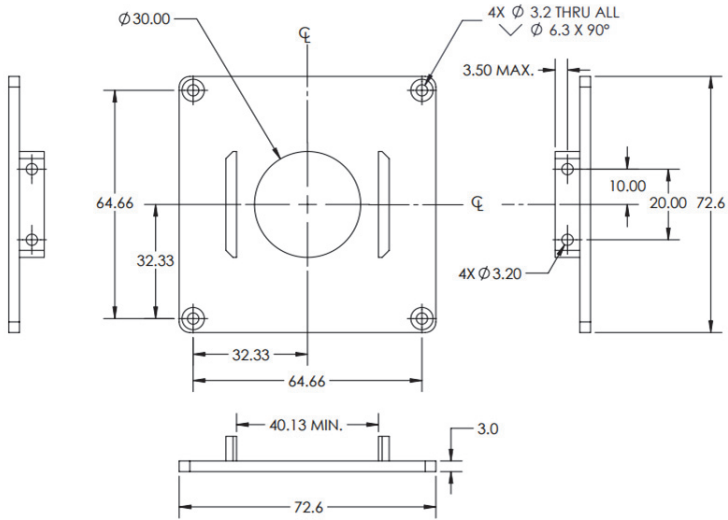
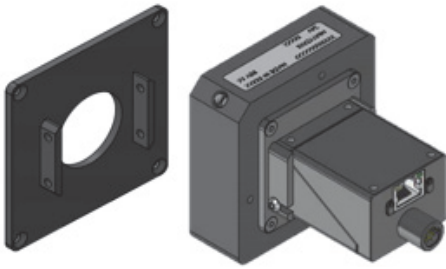

A

Smart Series R-70 Ring Light Polarizer Kit 98-9000301-01

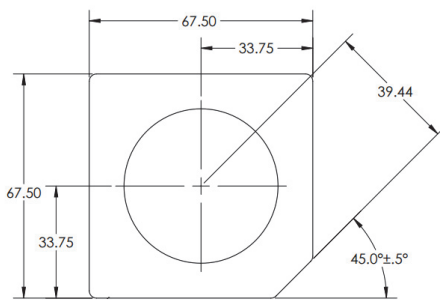
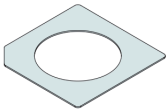

THE LINEAR POLARIZER MATERIAL'S TRANSMISSION AXIS MUST BE ORIENTATED PARALLEL TO THE ARROWS SHOWN BELOW RELATIVE TO THE PART

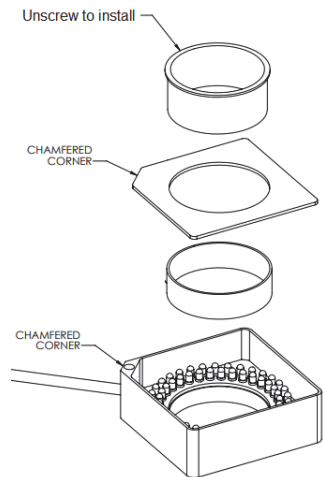
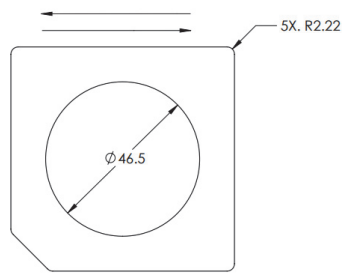

**Smart Series R-100 Ring Light Polarizer Kit
98-9000302-01**

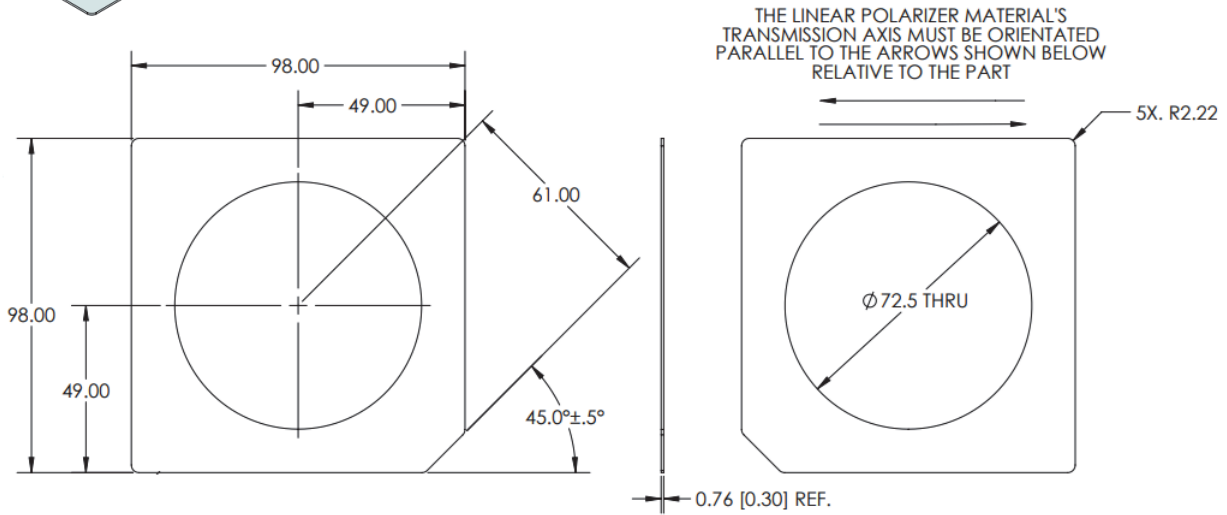
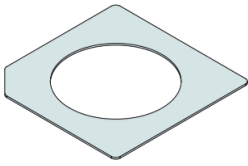

**QX-1 Photo Sensor, M12 4-Pin Plug, NPN – 2 Meters – Light ON / Dark ON
99-9000016-01**

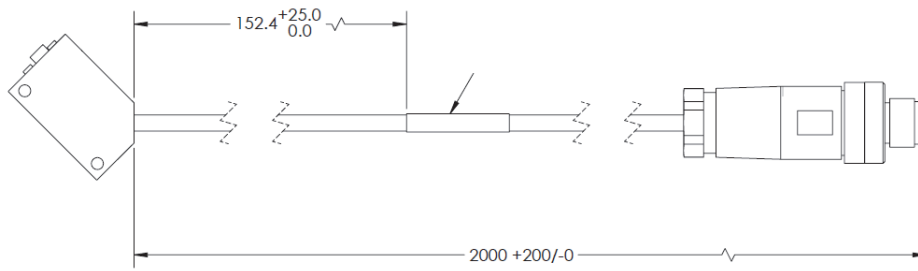

**QX-1 Interconnect Module – Power, Trigger, Smart Light Control Breakout
98-000103-02**

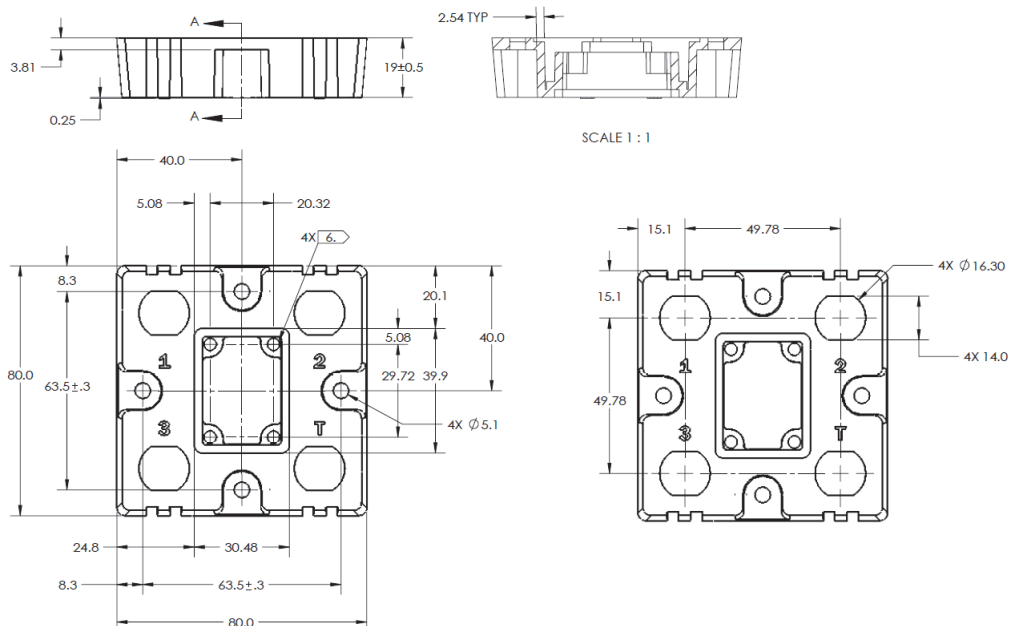

QX-1 Field-Wireable M12 4-Pin Plug for Any Trigger Source or Photo Sensor – Screw Terminals
98-9000239-01

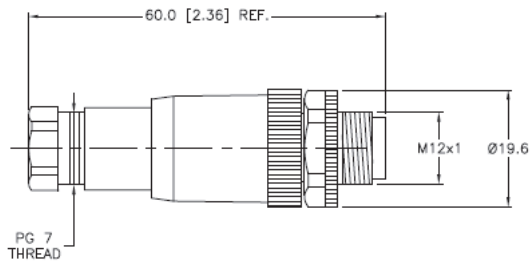

A

Power Supply, 100-240VAC, +24VDC, M12 12-Pin Socket – 1 Meter – U.S. / Euro Plug
97-000012-01

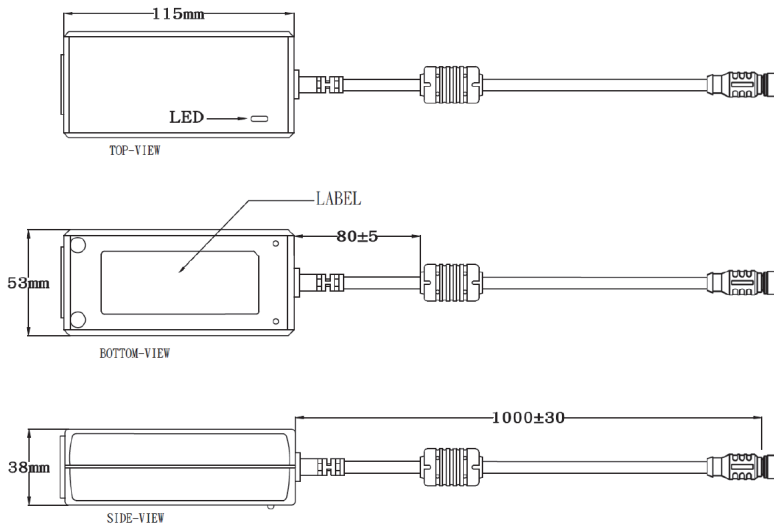

Omron Microscan Smart Light Series – Integrated Power and Strobe Control Module
See Omron Microscan Smart Light Offering – Ring, DOAL, Large Area Lighting

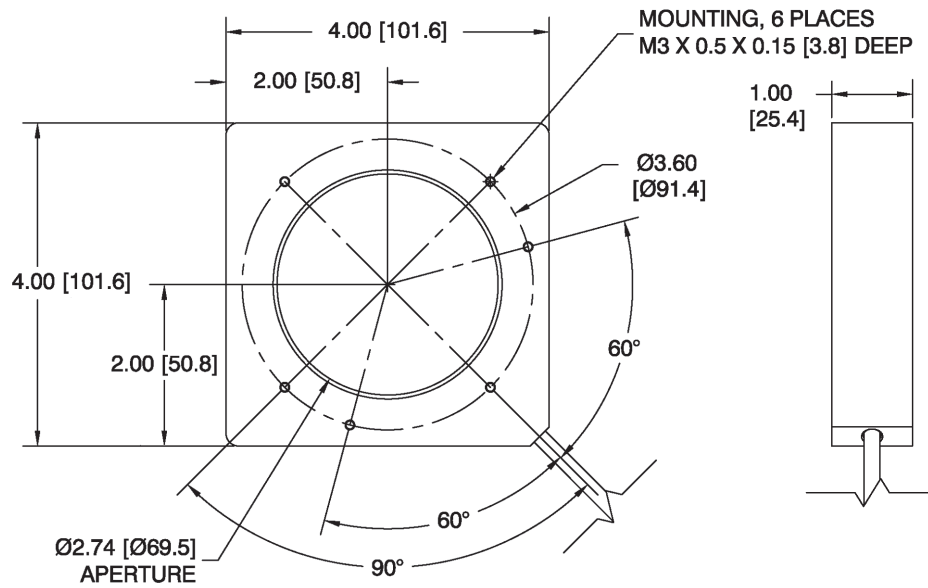
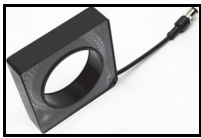

Reader to QX-1 Interconnect Cables – 1 Meter, 3 Meters, or 5 Meters
M12 Socket to M12 Plug
 QX-1 is used as breakout module for common IO signals and power.
V430-WQ-1M
V430-WQ-3M
V430-WQ-5M

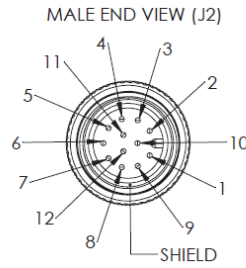
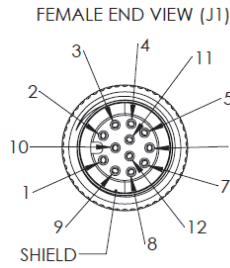
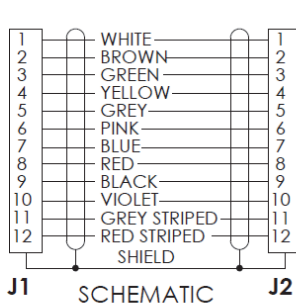

J1 SCHEMATIC J2

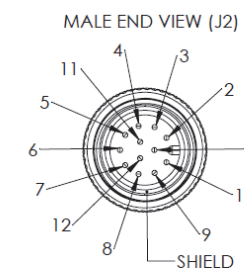
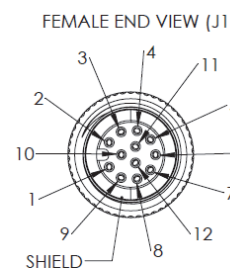
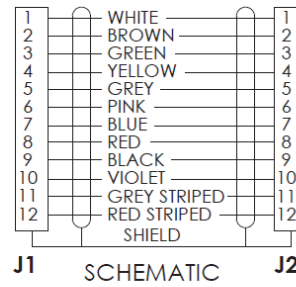
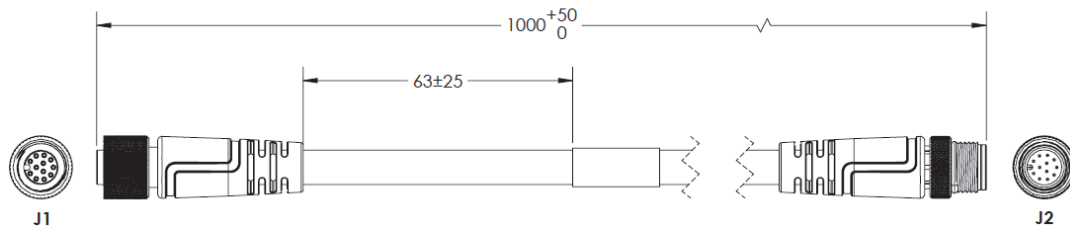

J1 SCHEMATIC J2

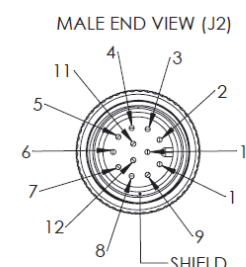
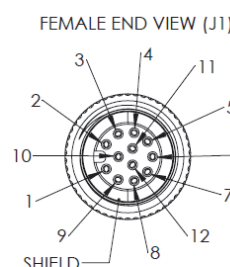
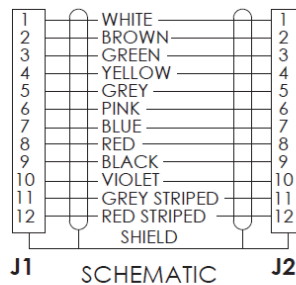
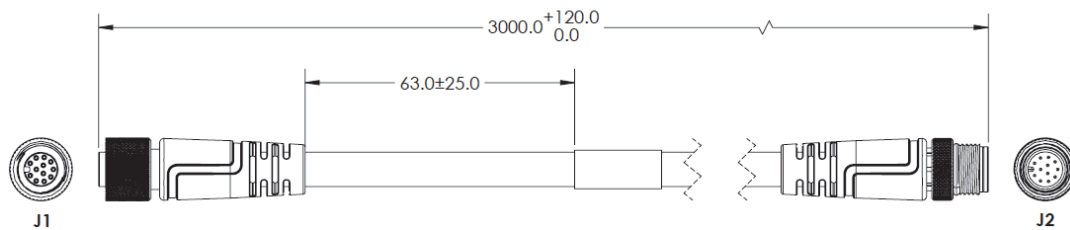

J1 SCHEMATIC J2

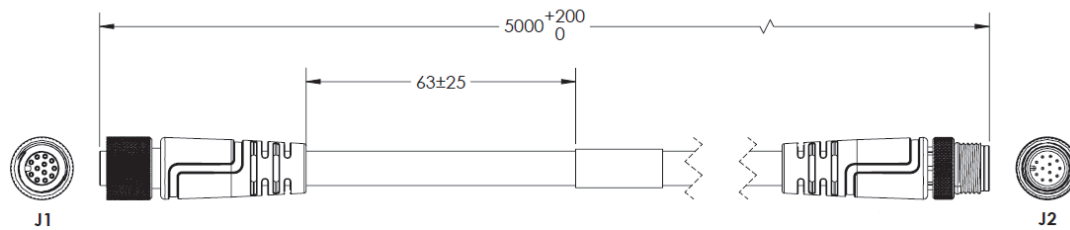

A

**M12 Socket to M12 Plug, with Power Filter – 300 mm
V430-WQF-1M**

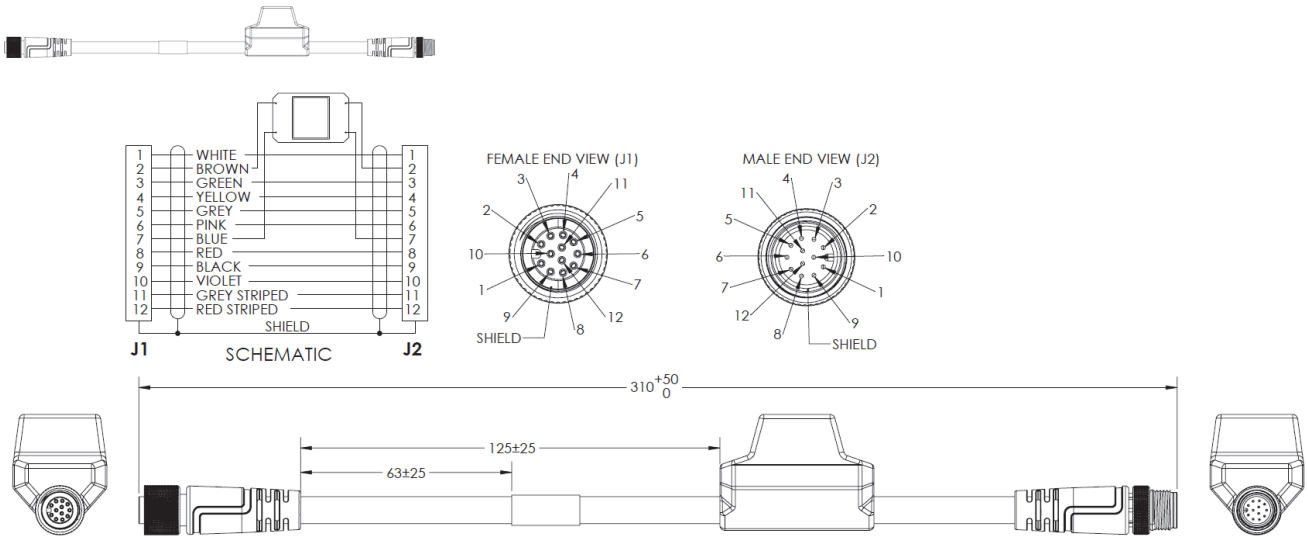

**QX-1 M12 to Smart Light Power and Strobe Control Cables – 3 Meters
M12 Plug on QX-1 to 5 Pin Socket on Light
61-000204-01 (Continuous Power)
61-000218-01 (Strobe Control)**

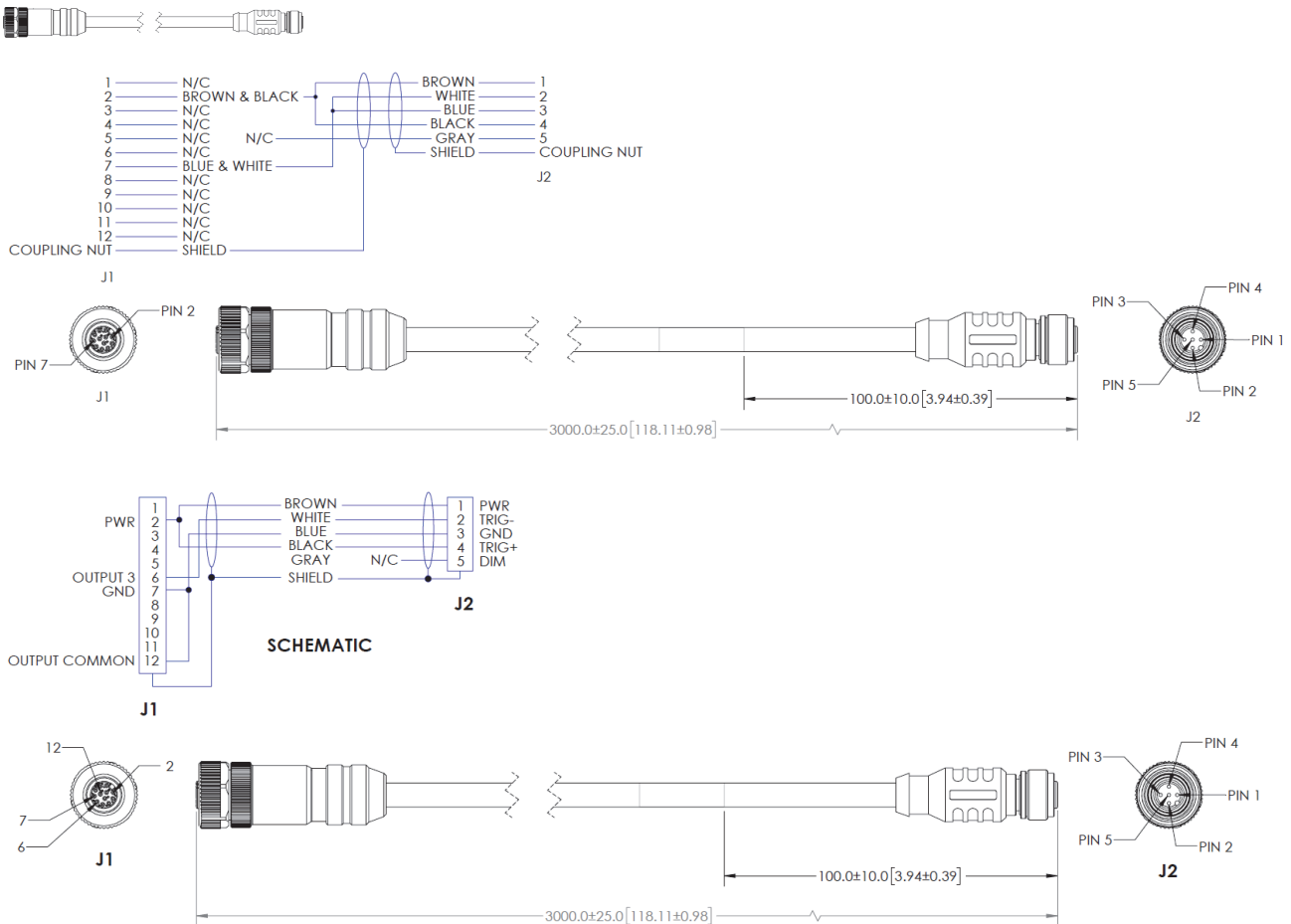

Y Cable, Reader/Power and Smart Light Power (Continuous On) – 1 Meter
61-9000135-01

Y Cable, Reader/Power and Smart Light Strobe Control – 1 Meter
61-9000137-01

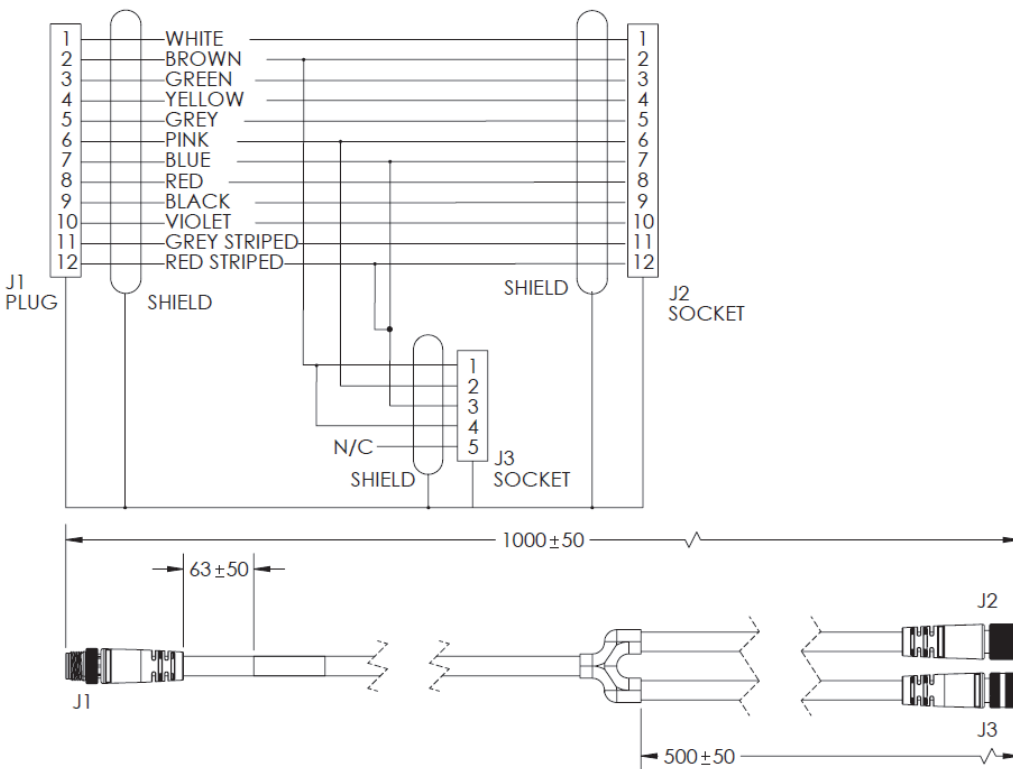
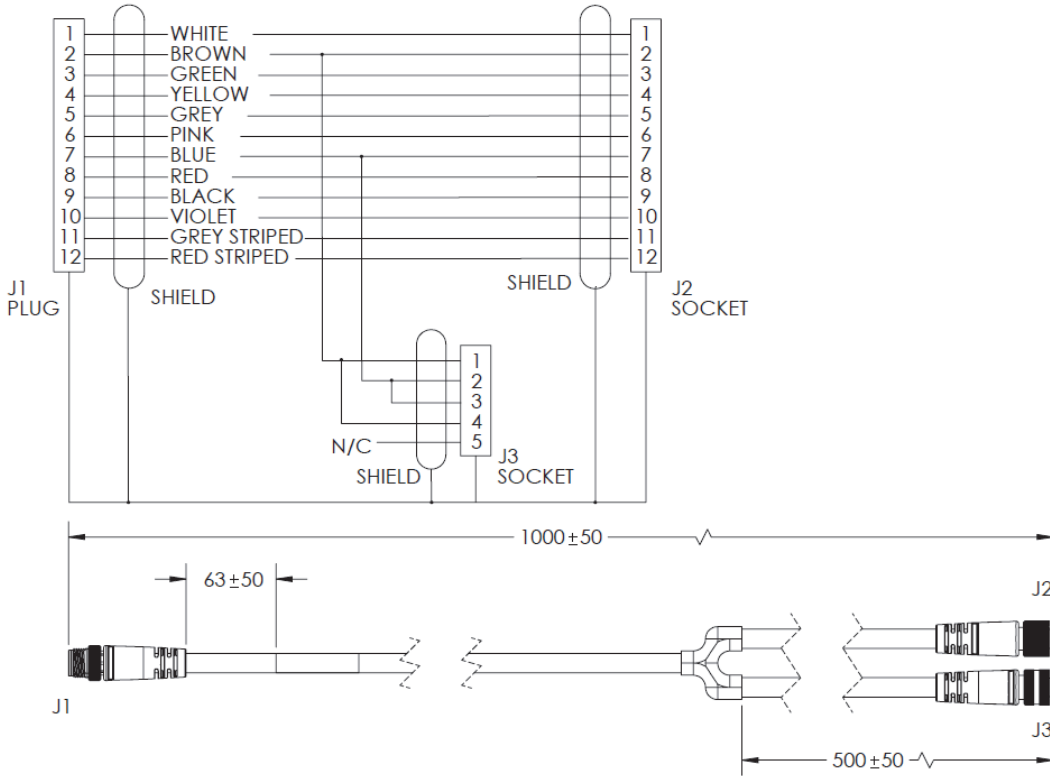
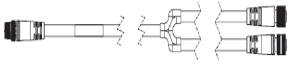

A

M12 to Flying Leads Cable, Straight Power, IO, RS-232, USB – 3 Meters or 5 Meters
V430-W8-3M
V430-W8-5M

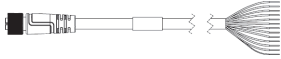

Pin	Function
1	Trigger
2	Power (+VIN)
3	Default
4	New Master
5	Output 1
6	Output 3
7	Ground (-VIN)
8	Input Common
9	RS-232 (Host) RxD
10	RS-232 (Host) TxD
11	Output 2
12	Output Common

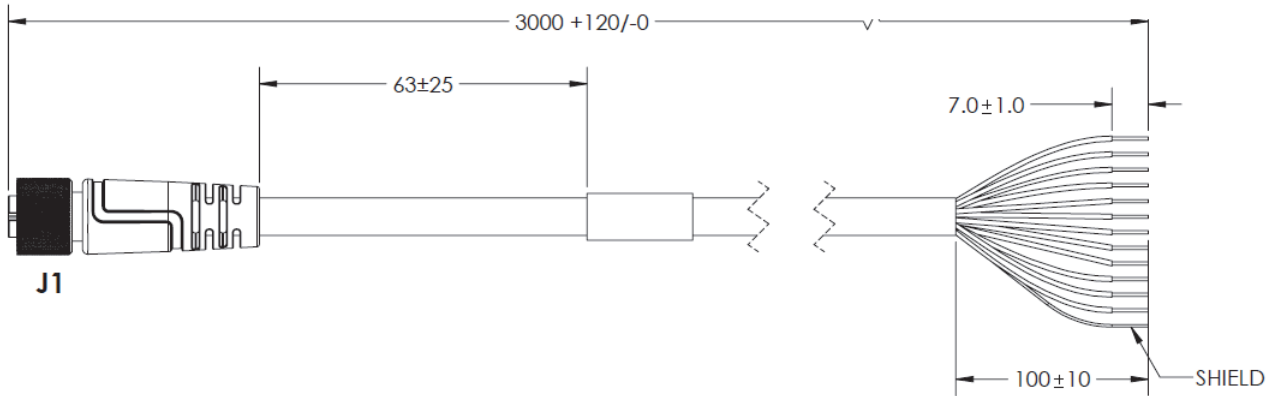
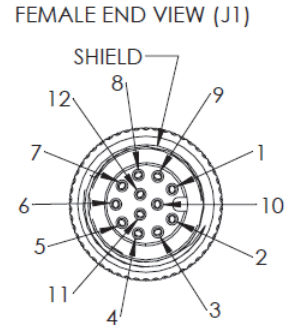
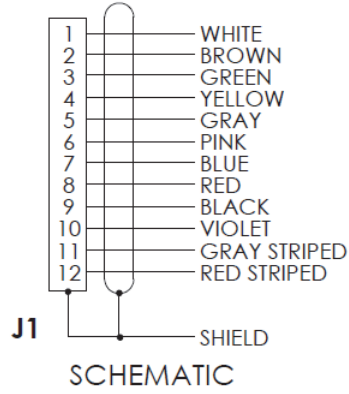

Pin	Function
1	Trigger
2	Power (+VIN)
3	Default
4	New Master
5	Output 1
6	Output 3
7	Ground (-VIN)
8	Input Common
9	RS-232 (Host) RxD
10	RS-232 (Host) TxD
11	Output 2
12	Output Common

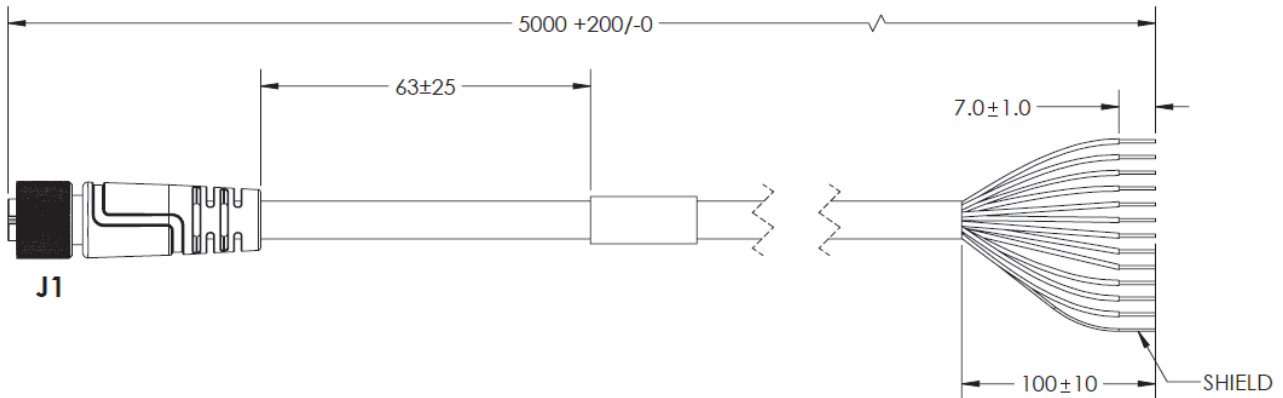
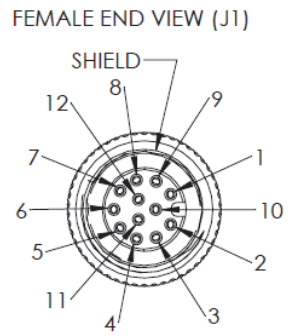
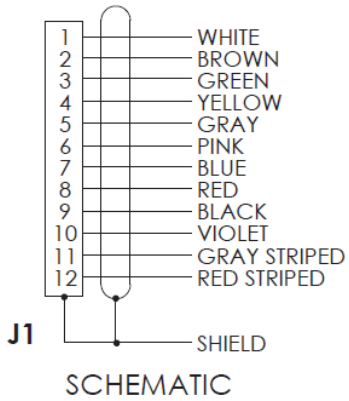

M12 to Flying Leads Cable, with Power Filter – 3 Meters or 5 Meters
V430-W8F-3M
V430-W8F-5M

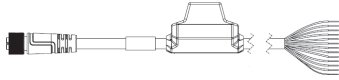

Pin	Function
1	Trigger
2	Power (+VIN)
3	Default
4	New Master
5	Output 1
6	Output 3
7	Ground (-VIN)
8	Input Common
9	RS-232 (Host) RxD
10	RS-232 (Host) TxD
11	Output 2
12	Output Common

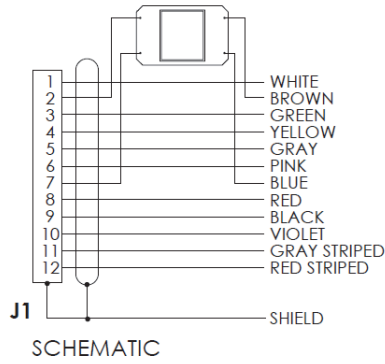

FEMALE END VIEW (J1)

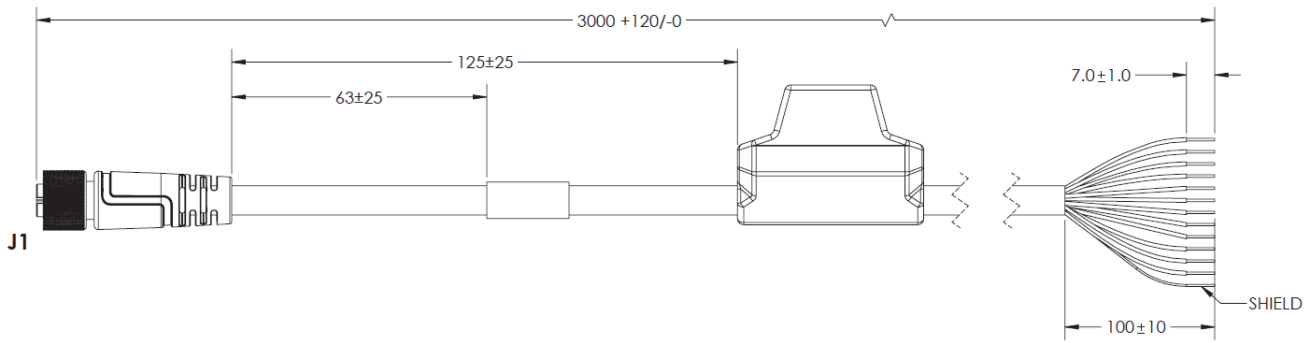
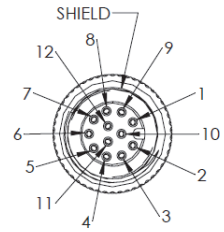

Pin	Function
1	Trigger
2	Power (+VIN)
3	Default
4	New Master
5	Output 1
6	Output 3
7	Ground (-VIN)
8	Input Common
9	RS-232 (Host) RxD
10	RS-232 (Host) TxD
11	Output 2
12	Output Common

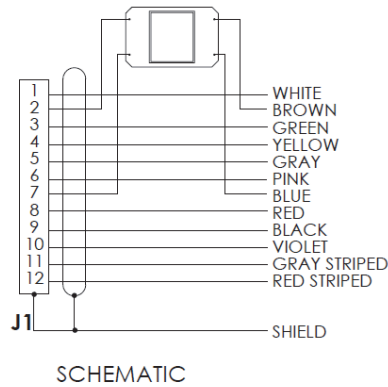

FEMALE END VIEW (J1)

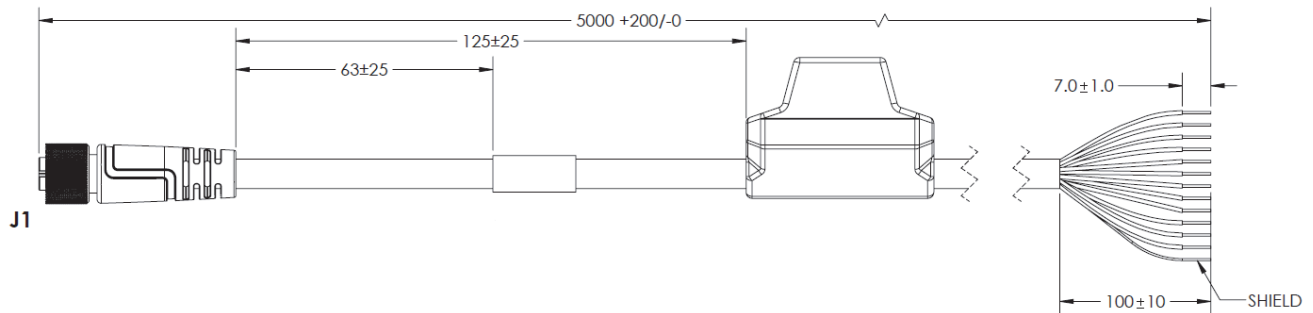
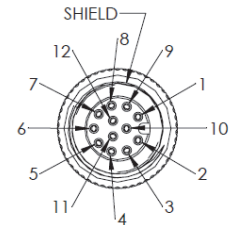

M12 to RS-232 Breakout – 1 Meter or 3 Meters
V430-WR-1M
V430-WR-3M

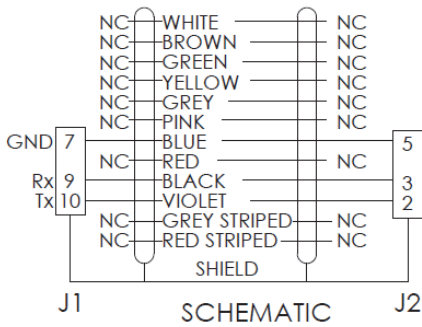

M12 END VIEW (J1)

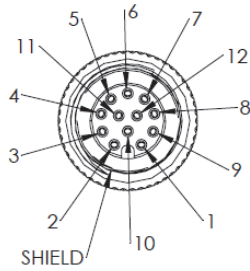

DB9 END VIEW (J2)

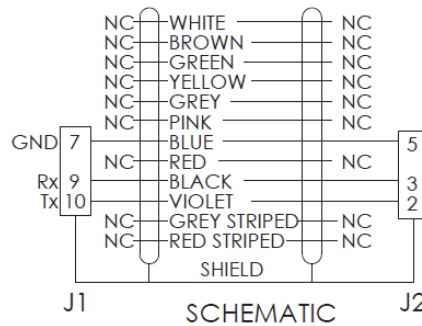
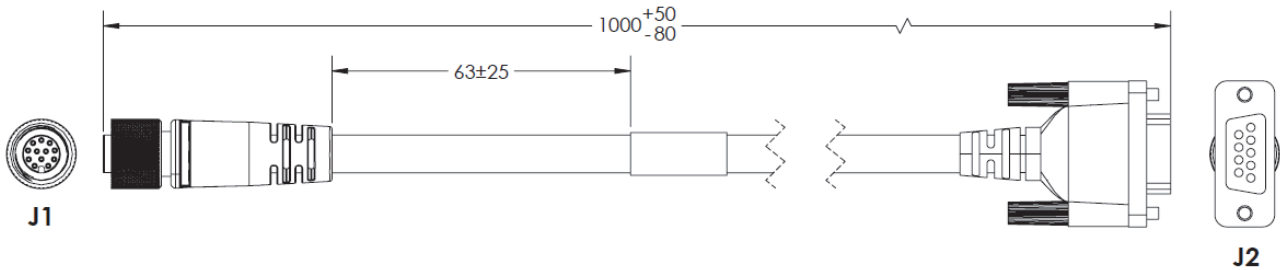
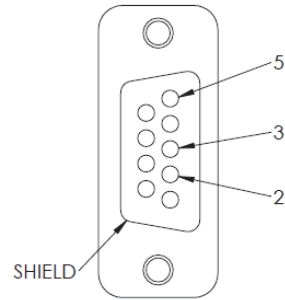

M12 END VIEW (J1)

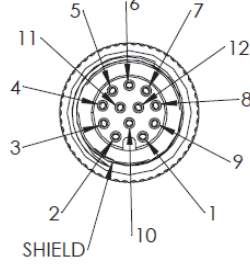

DB9 END VIEW (J2)

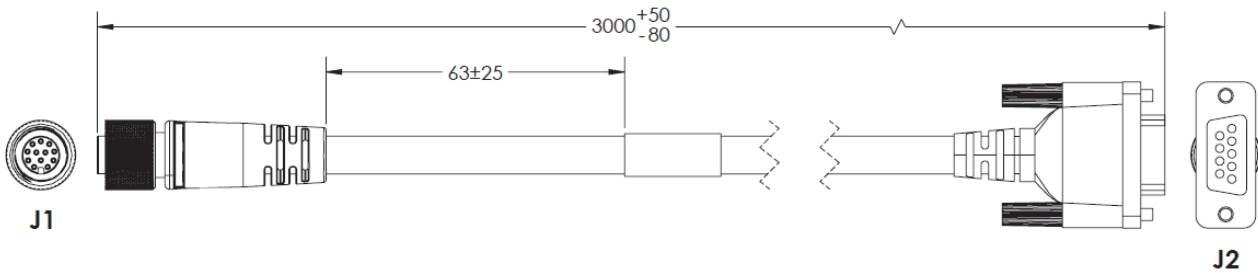
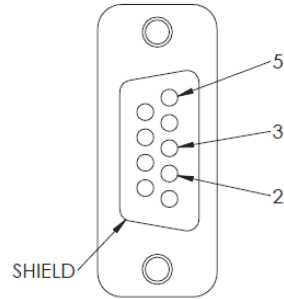

**Reader to QX-1 Interconnect Cables with RS-232 Breakout – 2.7 Meters
V430-WQR-3M**

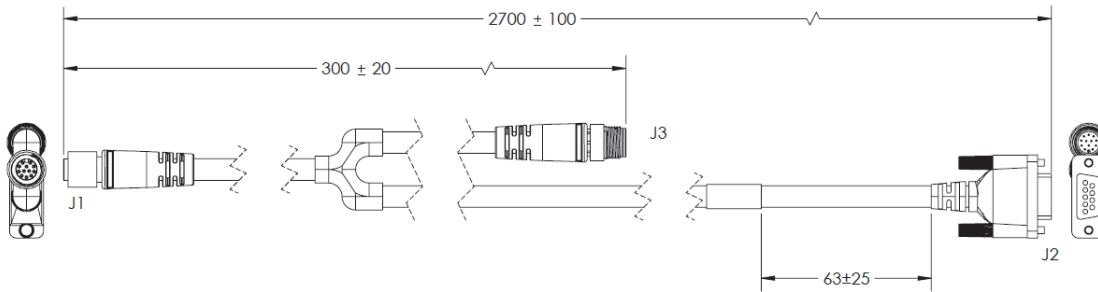
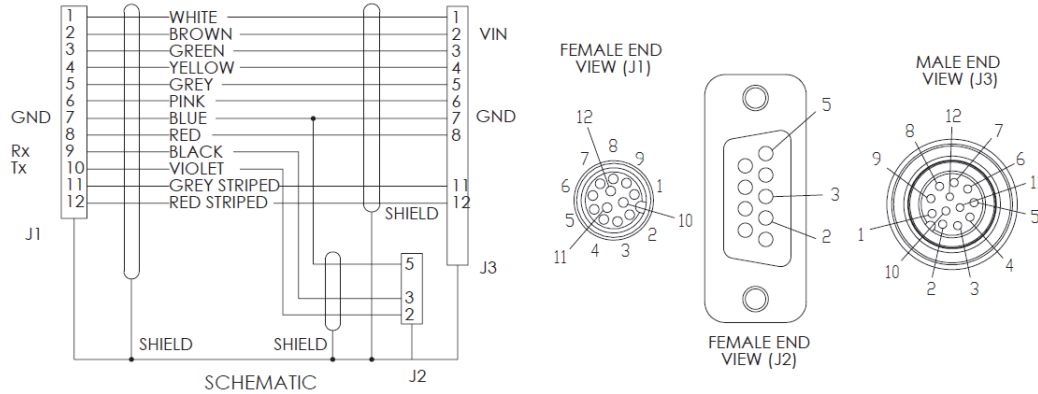
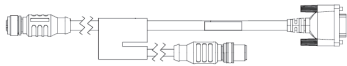

**Reader to QX-1 Interconnect Cables with USB Keyboard Wedge Breakout – 2.7 Meters
V430-WQK-3M**

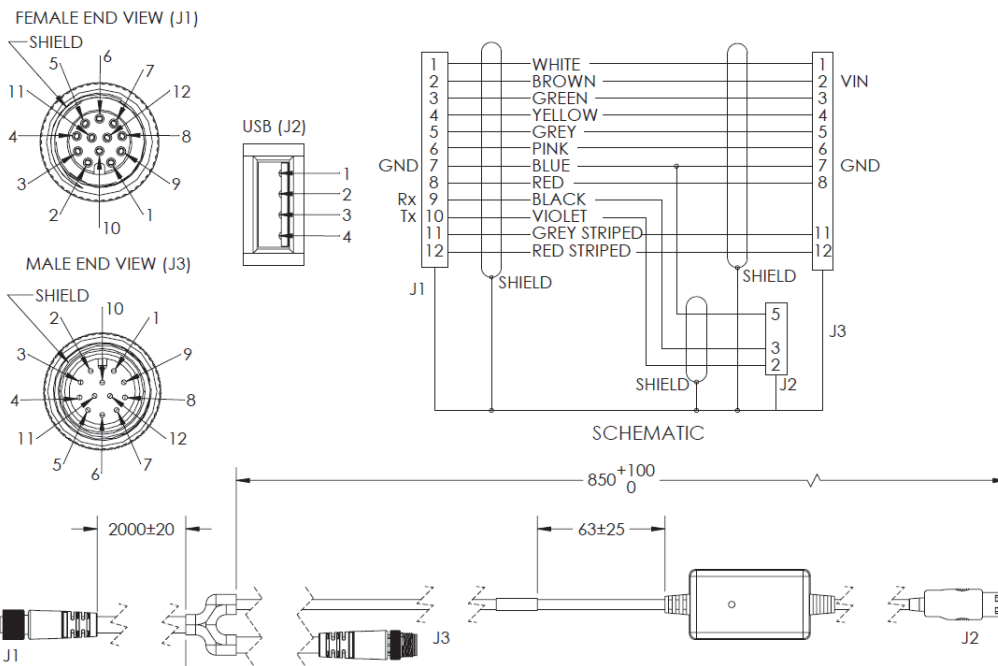

A

Smart Series Light Cable 5 Pin M12 Female to Flying Leads, 3 Meters and 5 Meters
61-000186-01
61-000187-01

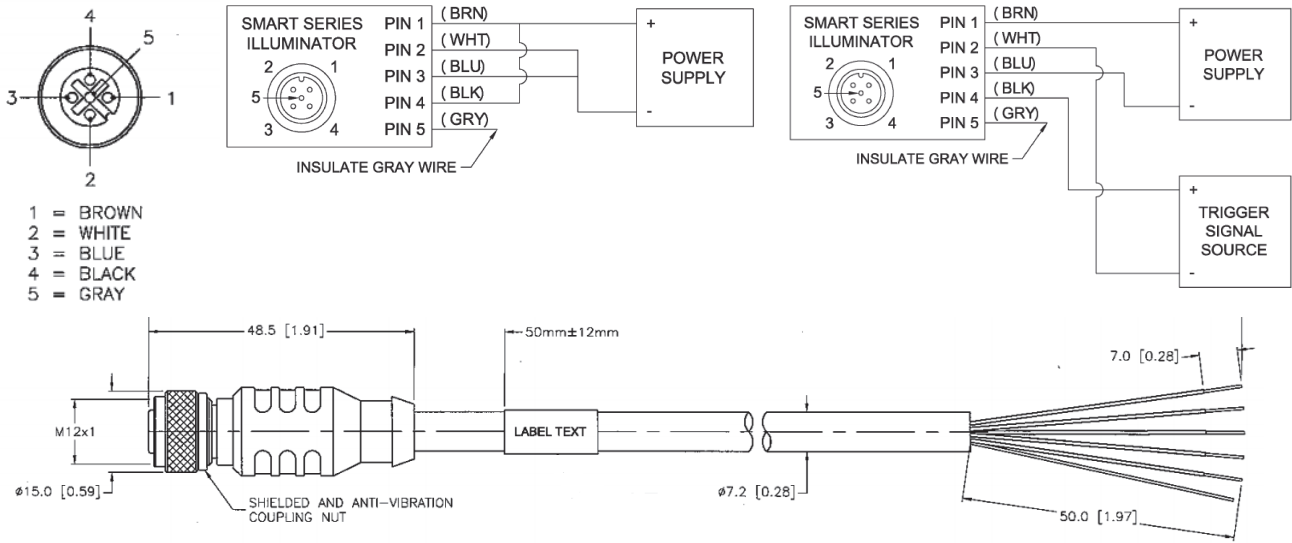

DSP60 24VDC 2.5A DIN Mount Power Supply
NER-011504100

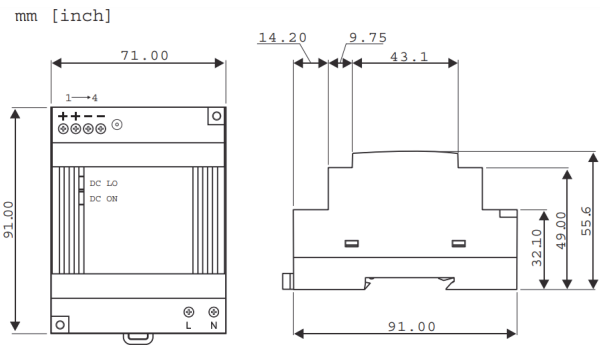

Kit, Spot Light, Blue, Telecentric Lens with Flying Leads Extension Cable
98-9000304-01

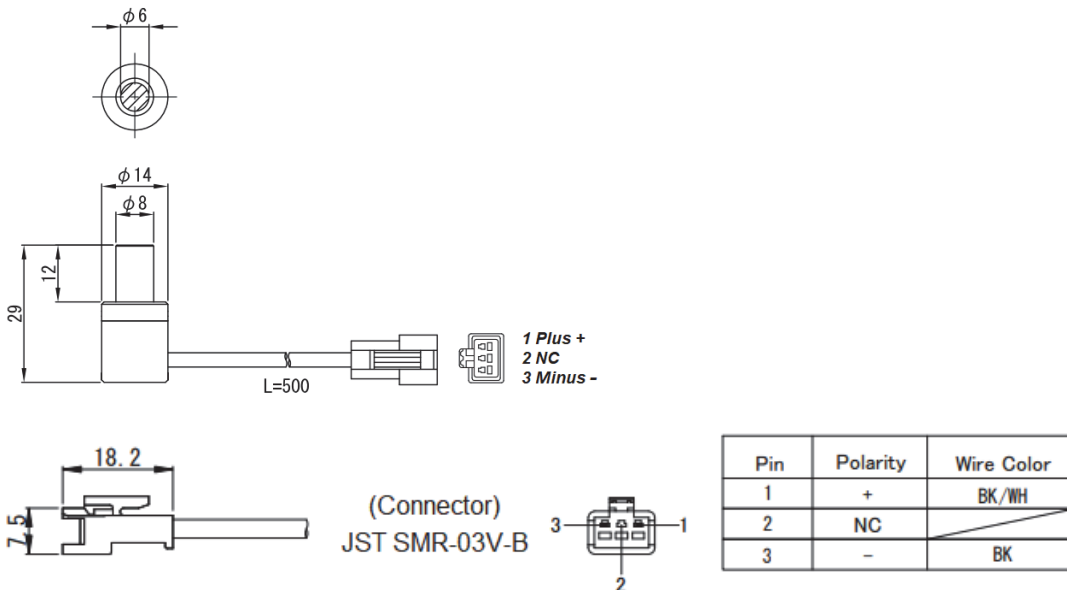

Spot Light Extension Cable, Flying Leads, 5M

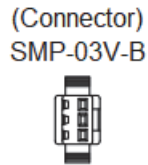
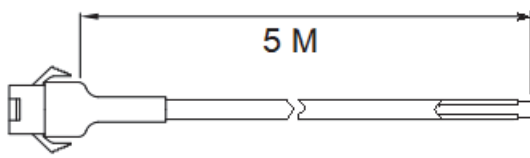

Polarity	Wire Color
+	BK/WH
NC	
-	BK

Industrial High-Flex Ethernet Cables with Jack Screws and RJ45, 2 Meters, 5 Meters, and 7 Meters

- 98-000133-01
- 98-000134-01
- 98-000134-02

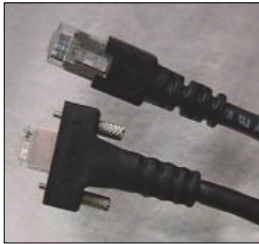

Industrial High-Flex Ethernet Cables

Industrial High-Flex cables provide an interface between V440-F readers and other devices.

These cables are designed for harsh environments that could damage a traditional CAT 5 cable. The overmold design provides increased strain relief. Thumbscrew locking keeps the connection secure despite shock and vibration. The double-shielded design provides extra protection in industrial applications.

High-Flex cables are designed to withstand 12 million+ flex cycles. The TPE jacket provides additional protection from elements such as oil, water, and abrasion.

Cable Specifications	
Overall Diameter	.245 Inches
Max. Temperature	80 Degrees C
Jacket Color	Black
UL/CSA Rated	Yes
Min. Bend Radius	2.45 Inches
Flame Rating	FT-1

Primary Components	
Cable	4 Twisted Pairs
Connector A	Standard RJ45
Connector B	Standard RJ45



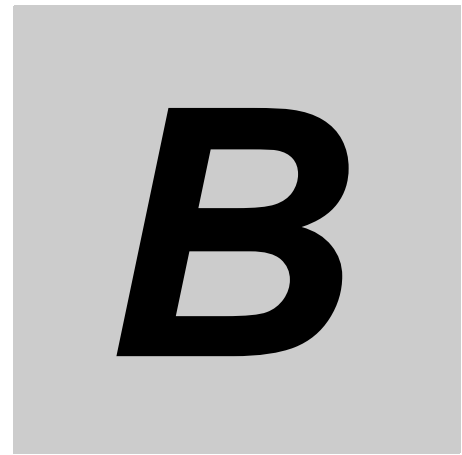

Electrical Specifications

B

This section shows the V440-F reader's connectors and pin assignments.

B-1	V440-F Connectors	B-2
------------	--------------------------------	------------

B-1 V440-F Connectors

RJ45 Connector

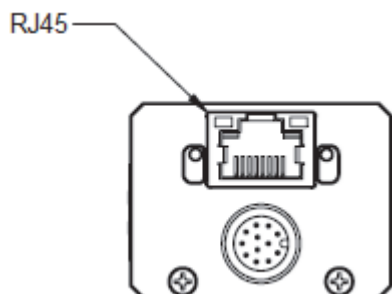

Pin	Function
1	TA+
2	TA-
3	TB+
4	TC+
5	TC-
6	TB-
7	TD+
8	TD-

M12 12-Pin Socket Connector

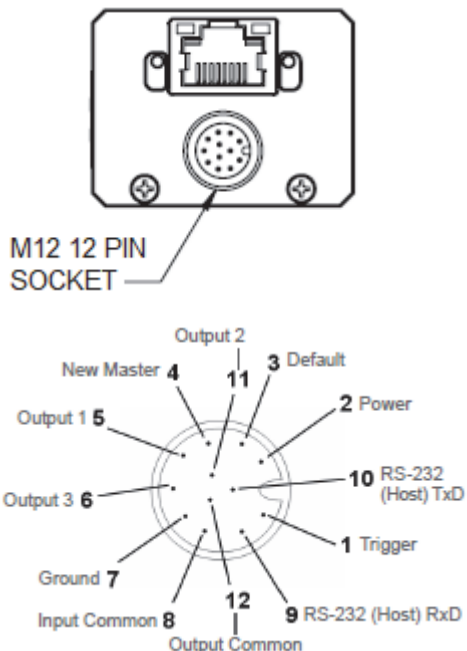

M12 12-Pin Socket

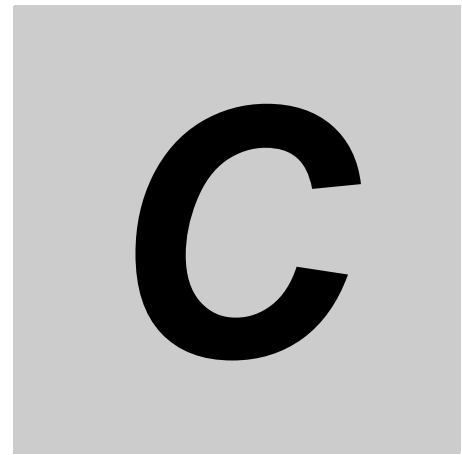

Serial Command Usage



This section contains an explanation of how serial configuration commands (K commands) are constructed. K commands can be used to configure all aspects of the V440-F Reader. All V440-F K commands are available in Appendices D through N.

C-1	Serial Command Syntax	C-2
------------	------------------------------------	------------

C-1 Serial Command Syntax

This section explains the structure and syntax of Omron Microscan's proprietary serial commands – K commands. K commands are used to configure the V440-F Reader. All K commands are described in Appendices D through N.

Serial Command Format

Omron Microscan readers are controlled by two types of serial commands: configuration commands and utility commands.

● Rules that apply to both configuration and utility commands

- Less than '<' and greater than '>' angle bracket characters enclose the commands.
- Commands and data are case sensitive. Characters must be entered as upper or lower case, as specified.

Serial Utility Commands

Serial Utility Commands are sent during operations and are not followed by <A> or <Z>.

Serial Configuration Commands (K Commands)

Omron Microscan's serial configuration commands begin with a single "K" character followed by a 3-digit numeric character, comma-separated command fields, and an initializing command, as follows:

<Knumeric character,data,data,...etc.><initializing command>

An initializing command <Z> or <A> may follow the command.

- <Z> initializes the memory and saves for power-on.
- <A> initializes the memory but does not save for power-on, with the exception of Communications parameters.

For example, to enable **UPC** and save the change for power-on, send <K473,1><Z>.

To change **Baud Rate** and reset without saving changes for power-on, send <K100,3><A>.

● Serial Configuration Command Conventions

- All command fields (except the last) must be followed by a comma (without a space).
- NULL cannot be used. The characters <, >, and , can be used, but only if entered as hex values.
- All fields preceding a modified field must be included.
- If there is no change in preceding fields, then commas alone can be entered in these fields. For example, if only the last field in the following command is changing, <K100,4,1,0,0> can be entered as <K100,,,,0>.
- All fields *following* a modified field can be omitted. For example, to change Baud Rate only, send <K100,3>.

Concatenating Configuration Commands

Commands can be concatenated (added together) in a single string. For example, <K145,1><K220,1><A> enables **LRC**, sets **End of Read Cycle** mode to **New Trigger**, and resets the data buffers without saving the changes for power-on.

Serial Command Status Request

To ensure that any command was received and accepted, send the **Show Reader Status** command: `<?>`.

The status of a specific serial command can be requested by entering the command followed by a question mark. For example, send `<K142?>` to request the status of **Postamble**.

Entering Control Characters in Serial Commands

To enter control characters within a serial command, hold down the **Ctrl** key while typing the desired character.

Example: To enter a carriage return and line feed (**^M^J**), enter `<K141,1,CNTL-m CNTL-j>`



Communications

This section explains how to set up communications with a host.

D-1 Introduction	D-2
D-2 Communications Serial Commands	D-3
D-3 Custom Ethernet Link	D-4
D-4 Host Port Connections	D-11
D-5 Host Port Protocol	D-12
D-6 ACK/NAK Options	D-13
D-7 Polling Mode Options	D-14
D-8 Ethernet	D-15
D-9 Response Timeout	D-16
D-10 LRC (Longitudinal Redundancy Check) Status	D-17
D-11 Protocol Configuration Examples	D-18
D-12 Preamble	D-19
D-13 Postamble	D-20
D-14 USB HID/Keyboard	D-21
D-15 EtherNet/IP Byte Swapping Enabled	D-22
D-16 PROFINET	D-23
D-17 Entering ASCII Characters as Hex Values	D-24

D-1 Introduction

With WebLink, configuration changes can be made in the menus and then sent and saved to the reader. The user can also send serial commands to the reader via Terminal.

The following describes the basic flow of the serial (RS-232C) communications.

- Match RS-232C communication parameters (baud rate, parity, data bits, and stop bits) between the reader and the host.
- Send the read command “< >” from the host to reader.
- Send the “read result” from the reader to the host.

The serial (RS-232C) communications use serial commands stated in this manual.

For example, “Read” commands are described in Chapter 5 **Read Cycle**.

The following describes the basic flow of the serial (TCP) communications.

- The reader opens a port (default: 2001) as TCP server at startup.
- The higher connects to the reader as a TCP client.
- The host sends the “read command” “< >” to the reader .
- The reader sends the “read results” to the host.

The serial (TCP) communications use serial commands stated in this manual.

For example, “Read” commands are described in Chapter 5 **Read Cycle**.

The following describes the output format of serial (RS-232C, TCP) communications.

<Header> Read strings <Footer>

In default, the header is “None” and the footer is “CR+LF”. The header and footer can be changed with WebLink. (Gear icon - **Advanced - Communications - Preamble/Postamble**)

For example, When reading a code of 12345, the default output data is below.

Output format of serial communications	Output data						
ASCII character notation:	1	2	3	4	5	CR	LF
Hex notation:	31	32	33	34	35	0D	0A

Addition to read strings, coordinate information of a read code and the print quality evaluation information can be added.

D-2 Communications Serial Commands

Host Port Connections	<K100,baud rate,parity,stop bits,data bits>
Ethernet	<K126,status,IP address,subnet,gateway,IP address mode>
Ethernet TCP Ports	<K127,TCP Port 1,TCP Port 2>
Search and Configure Mode	<K128,status,timed window>
EtherNet/IP	<K129,status>
Host Protocol	<K140,protocol,address>
Preamble	<K141,status,preamble characters>
Postamble	<K142,status,postamble characters>
Response Timeout	<K143,response timeout>
LRC Status	<K145,status>
ACK/NAK Options	<K147,RES,REQ,STX,ETX,ACK,NAK>
Polling Mode Options	<K148,RES,REQ,STX,ETX,ACK,NAK>
EtherNet/IP Byte Swapping Enabled	<K163,status>
PROFINET	<K164,status>
Custom Ethernet Link	<K166,status,transport layer,type,capabilities,IP address,multicast address,port,check connection, timeout (milliseconds),TTL>

D-3 Custom Ethernet Link

By default, the V440-F reader operates as a server, and communicates with the host over TCP/IP for both commands and data.

Custom Ethernet Link functionality gives you the ability to create an Ethernet interface that is bound to the command processor per your own requirements. You can set the **Transport Layer** to **UDP** or **TCP**, set the message **Type** to **Server** or **Client**, and set **Capabilities** to **Send Only**, **Receive Only**, or **Send/Receive**.

Custom Ethernet Link	
☆ Custom Ethernet Link	Disabled
☆ Transport Layer	TCP
☆ Type	Server
☆ Capabilities	Send/Receive
☆ IP Address	192.168.1.65
☆ Multicast	232.169.247.185
☆ Port	5000
☆ Check Connection	Disabled
☆ Timeout	10000 ms
☆ TTL	128

Custom Ethernet Link is intended for advanced users. This feature permits the establishment of a connection to the reader on any port, using the protocols UDP/IP, TCP, and Multicast on a specified port. A bi-directional communication configuration is available to send commands to the reader, obtain barcode output data, or form a single direction of communication, i.e. sending commands to the reader only, or receiving barcode data from reader only, without having both directions open.

In addition to the ability to move ports, you can also force the connection created by the Custom Ethernet Link to act as a client. Instead of "reaching out" to the reader, it is possible to configure the reader to "go out and connect to" a specified server. This increases flexibility when integrating readers into customer applications. Without this feature, users are limited to static communication into and out of the reader – UDP=80, TCP1=2001, TCP2=2003.

The following section will cover the implementation of how the Custom Ethernet Object is implemented in an Ethernet-based reader. This additional Ethernet-based transport layer allows you to:

- Send "and/or" commands to the device from a specified endpoint;
- Send barcode data to a receiving endpoint i.e. a client or server;
- Handle more than one connecting endpoint connection.

With Custom Ethernet Link functionality, users can configure:

- Transport Layer;
- TCP, UDP, or Multicast;
- Message Type;
- Server or Client;
- The type of data sent and/or received from the device;
- The endpoint to send and receive data, send only barcode data, or receive only commands.

Custom Ethernet Link functionality is bound to the reader's command processor as shown in the figure below. This enables an outside endpoint to still send commands to the device as well as receive data commands and barcode to the receiver.

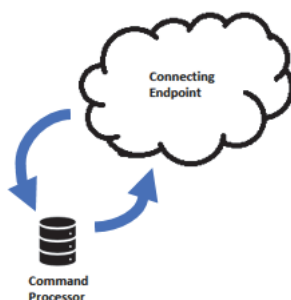

D-3-1 Server Implementation

In cases where the endpoint is configured as a server, the reader is only able to handle 10 simultaneous connections for any transport layer. For TCP, the reader will refuse the connection. UDP and Multicast will simply ignore the connection request due to the connectionless nature of the transport layer.

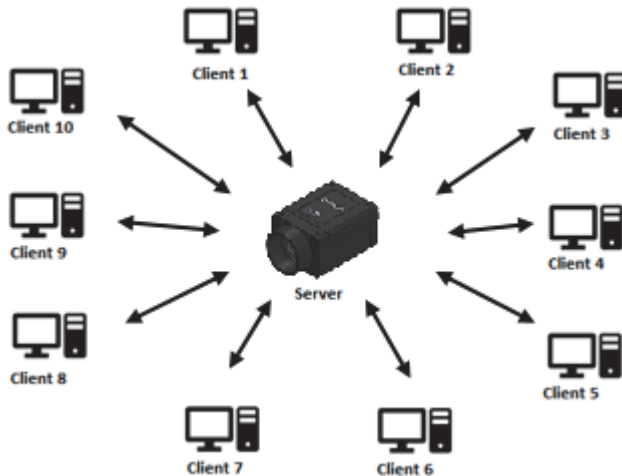

D-3-2 Client Implementation

In cases where the endpoint is configured as a client, the reader is only able to handle one connection to a server. This means the following restrictions apply:

TCP: The reader can only connect to one server when configured as a client.

UDP and Multicast: The reader can only send data out on to one UDP port.



UDP is limited to UDP/IP in order to avoid broadcasting data on the network.

D-3-3 Configuration

This section explains how to configure the Custom Ethernet Object in the reader. The **Custom Ethernet Link K Command <K166>** allows you to configure the Custom Ethernet Object in the reader.

Important: For information about Omron Microscan's proprietary **K Command** syntax, see [Appendix C](#) through [Appendix N](#).

The following section explains the command parameters that configure the Custom Ethernet Object. Note that each parameter described below corresponds with each parameter shown in the **Custom Ethernet Link** section of WebLink's **Communications** menu.

K Command Format: *<K166,status,transport layer,type,capabilities,IP address,multicast address,port,check connection,timeout (milliseconds),TTL>*

Status

<K166,status,transport layer,type,capabilities,IP address,multicast address,port,check connection, timeout (milliseconds),TTL>

Status of the Custom Ethernet Object on the device.

0 = Disabled Default – The Custom Ethernet Object is not started.

1 = Enabled – The Custom Ethernet Object has started with the parameters configured.

Transport Layer

<K166,status,transport layer,type,capabilities,IP address,multicast address,port,check connection, timeout (milliseconds),TTL>

The transport layer used by the Custom Ethernet Object to send/receive data. This transport layer obeys the **OSI Model layer 4**. The multicast implementation uses **UDP User Datagram Protocol** as the transport layer.

0 = TCP Default

1 = UDP

2 = Multicast

Type

<K166,status,transport layer,type,capabilities,IP address,multicast address,port,check connection, timeout (milliseconds),TTL>

This is the how the feature runs on the device and follows the server client model.

0 = Server Default – In server mode the device will be listening on the configured port number. The server can handle up to 10 different connections at one time independent of the transport layer selection. Once the limit has been reached the server will reject other connections.

For Multicast server configuration the user can either use a specified Multicast address or leave the Multicast address to the configured Multicast APIPA Address. This Multicast address is safe to use according to RFC 4607 stating that Multicast ranges from 232.0.0.0 – 232.255.255.255 are okay to use for source specific applications. By default, the unit creates a unique Multicast address in the range of 232.169.xxx.xxx so it does not conflict with other multicast addresses.

1 = Client – In client mode the device will send data to the specified server. The user must configure the IP Address or Multicast Address of the server and the port number that the specified server is listening on. Improper configuration will either yield an error on startup or result in no data being transmitted from the device to the outside world.

Capabilities

<K166,status,transport layer,type,capabilities,IP address,multicast address,port,check connection, timeout (milliseconds),TTL>

Capabilities is how the user configures the Custom Ethernet Object's read/write settings.

1 = Receive – The device will only receive data from the connecting endpoint. The device will not send data out to any connecting endpoints.

2 = Send – The device will only send data to the connecting endpoint. Any data received is immediately disposed of and not processed.

3 = Send/Receive Default – The device will be able to send and receive data to the connecting endpoint.

IP Address

<K166,status,transport layer,type,capabilities,IP address,multicast address,port,check connection,timeout (milliseconds),TTL>

If the unit is configured as a client, the **IP Address** is determined by the **Transport Layer**.

TCP – This is the server's IP Address.

UDP – If the server uses UDP/IP, this is the IP Address of the server. Otherwise, it is ignored and the device will send data on the specified port.

Multicast – This parameter is the device's IP Address used to send out the Multicast message. You do not need to configure this parameter.

Default = Unit's IP Address

Multicast Address

<K166,status,transport layer,type,capabilities,IP address,multicast address,port,check connection,timeout (milliseconds),TTL>

In **Server Mode**, this is the multicast address that clients can connect to in order to send/receive data. The port number is the port that the connecting endpoints will use.

In **Client Mode**, this is the multicast address of the server that the device is sending data to.

The port number is the port the multicast server is listening on.

Default = 232.169.xxx.xxx Multicast APIPA Address

Port

<K166,status,transport layer,type,capabilities,IP address,multicast address,port,check connection,timeout (milliseconds),TTL>

In **Server Mode**, this is the port number that the connecting endpoints will use to connect to the device.

In **Client Mode**, this is the port number that the server is listening on.

5000 (Default)

Check Connection

<K166,status,transport layer,type,capabilities,IP address,multicast address,port,check connection,timeout (milliseconds),TTL>

This feature is only applicable for **Transport Layer UDP** in **Client Mode**. The device will transmit **0** length UDP packets to the specified port that the server is listening on. If the device receives an **ICMP Port Destination Not Found**, then it will continue to send **0** length packets in an exponential back-off delay until the device no longer receives ICMP packets. This feature is disabled by default.

0 = Disabled Default

1 = Enabled

Timeout (Milliseconds)

<K166,status,transport layer,type,capabilities,IP address,multicast address,port,check connection,timeout (milliseconds),TTL>

For TCP, this is the timeout before the socket is forcibly closed. For UDP and Multicast, this parameter has no effect.

Default = 10,000

TTL

<K166,status,transport layer,type,capabilities,IP address,multicast address,port,check connection,timeout (milliseconds),TTL>

For Multicast, this is the Time-To-Live counter, or how many hops before the message is discarded by the network. By default, the counter is set to 128 hops, which is more than enough for a typical packet to reach its destination host. It can, however, be configured to last longer or shorter per network requirements.

Default = 128

D-3-4 Configuration Examples

The following examples demonstrate how to configure the Custom Ethernet Object using the **Custom Ethernet Link K Command <K166>** described in the **Configuration** section earlier in this section.

TCP

● Server Mode

Send/Receive Capabilities

<K166,1,0,0,3>

Interpretation of K Command Settings:

- **Custom Ethernet Link Enabled Default, Transport Layer = TCP Default;**
- **Type = Server Default;**
- **Capabilities = Send/Receive Default**

Send-Only Capabilities

<K166,1,0,0,2>

Interpretation of K Command Settings:

- **Custom Ethernet Link Enabled Default, Transport Layer = TCP Default;**
- **Type = Server Default;**
- **Capabilities = Send**

● Client Mode

The following client modes will connect to a **TCP Server** with **IP Address 192.168.188.5** listening on **port 5050**.



IP: 192.168.188.2
Port: N/A



IP: 192.168.188.5
Port: 5050

Send/Receive Capabilities

<K166,1,0,1,3,192.168.188.5,5050>

Interpretation of K Command Settings:

- **Custom Ethernet Link Enabled Default, Transport Layer = TCP Default;**
- **Type = Client;**
- **Capabilities = Send/Receive Default;**
- **IP Address = 192.168.188.5;**
- **Port = 5050**

Send-Only Capabilities

<K166,1,0,1,2,192.168.188.5, 5050>

Interpretation of K Command Settings:

- **Custom Ethernet Link Enabled Default, Transport Layer = TCP Default;**
- **Type = Client;**
- **Capabilities = Send;**
- **IP Address = 192.168.188.5, Port = 5050**

UDP

● Server Mode

Send/Receive Capabilities

<K166,1,1,0,3>

Interpretation of K Command Settings:

- **Custom Ethernet Link Enabled Default, Transport Layer = UDP;**
- **Type = Server Default;**
- **Capabilities = Send/Receive Default**

Send-Only Capabilities

<K166,1,1,0,2>

Interpretation of K Command Settings:

- **Custom Ethernet Link Enabled Default, Transport Layer = UDP;**
- **Type = Server Default;**
- **Capabilities = Send**

● Client Mode

The following client modes will connect to a **UDP Server with IP Address 192.168.188.5** listening on **port 5050**.



IP: 192.168.188.2
Port: 5050



IP: 192.168.188.5
Port: 5050

Send/Receive Capabilities

<K166,1,1,1,3,192.168.188.5, 5050>

Interpretation of K Command Settings:

- **Custom Ethernet Link Enabled Default, Transport Layer = UDP;**
- **Type = Client;**
- **Capabilities = Send/Receive Default;**
- **IP Address = 192.168.188.5;**
- **Port = 5050**

Send-Only Capabilities

<K166,1,1,1,2,192.168.188.5, 5050>

Interpretation of K Command Settings:

- **Custom Ethernet Link Enabled Default, Transport Layer = UDP;**
- **Type = Client;**
- **Capabilities = Send;**
- **IP Address = 192.168.188.5;**
- **Port = 5050**

Multicast

● Server Mode

The following uses the default **Multicast IP Address** generated in the device.

Send/Receive Capabilities

<K166,1,2,0,3>

Interpretation of K Command Settings:

- **Custom Ethernet Link Enabled Default, Transport Layer = Multicast;**
- **Type = Server Default;**
- **Capabilities = Send/Receive Default**

Send-Only Capabilities

<K166,1,2,0,2>

Interpretation of K Command Settings:

- **Custom Ethernet Link Enabled Default, Transport Layer = Multicast;**
- **Type = Server Default;**
- **Capabilities = Send**

● Client Mode

The following client modes will connect to a **Multicast** server with **IP Address 224.0.1.90** listening on **port 5050**.



IP: N/A
Port: 5050



IP: 224.0.1.90
Port: 5050

Send/Receive Capabilities

<K166,1,2,1,3, ,224.0.1.90,5050>

Interpretation of K Command Settings:

- **Custom Ethernet Link Enabled Default, Transport Layer = Multicast;**
- **Type = Client;**
- **Capabilities = Send/Receive Default;**
- **IP Address = 224.0.1.90;**
- **Port = 5050**

Send-Only Capabilities

<K166,1,2,1,2, ,224.0.1.90, ,5050>

Interpretation of K Command Settings:

- **Custom Ethernet Link Enabled Default, Transport Layer = Multicast;**
- **Type = Client;**
- **Capabilities = Send;**
- **IP Address = 224.0.1.90;**
- **Port = 5050**

D-4 Host Port Connections

The host port can be configured with RS-232 connections.

The following settings define the basic transmission speeds and digital standards that ensure common formatting.

D-4-1 Baud Rate, Host Port

Usage: Can be used to transfer data faster or to match host port settings.

Definition: The rate at which the reader and host transfer data back and forth.

Serial Cmd: <**K100**,*baud rate*,*parity*,*stop bits*,*data bits*>

Default: **115.2K**

Options:

0 = 600	1 = 1200	2 = 2400
3 = 4800	4 = 9600	5 = 19.2K
6 = 38.4K	7 = 57.6K	8 = 115.2K

D-4-2 Parity, Host Port

Usage: Only changed if necessary to match host setting.

Definition: An error detection routine in which one data bit per character is set to 1 or 0 so that the total number of bits in the data field is either even or odd.

Serial Cmd: <**K100**,*baud rate*,**parity**,*stop bits*,*data bits*>

Default: **None**

Options: **0 = None** 1 = Even 2 = Odd

D-4-3 Stop Bits, Host Port

Usage: Only changed if necessary to match host setting.

Definition: One or two bits added to the end of each character to indicate the end of the character.

Serial Cmd: <**K100**,*baud rate*,*parity*,**stop bits**,*data bits*>

Default: **One**

Options: **0 = One** 1 = Two

D-4-4 Data Bits, Host Port

Usage: Only changed if necessary to match host setting.

Serial Cmd: <**K100**,*baud rate*,*parity*,*stop bits*,**data bits**>

Default: **Eight**

Options: 0 = Seven 1 = **Eight**

D-5 Host Port Protocol

- Usage:* In general, the point-to-point protocols will work well in most applications. They require no address and must use RS-232 communications standards.
- Definition:* Protocols define the sequence and format in which information is transferred between the reader and the host.
- Serial Cmd:* <K140,protocol,address>
- Default:* **Point-to-Point**
- Options:* **0 = Point-to-Point**
 2 = Point-to-Point with XON/XOFF
 4 = ACK/NAK
 5 = Polling Mode

- **Note:** In all protocol modes, the preamble <K141> and postamble <K142> character strings can be used to frame the decode data, and both are included in calculating the **LRC** (Longitudinal Redundancy Check).

D-5-1 Point-to-Point (Standard)

- Usage:* Used only with RS-232.
- Definition:* Standard **Point-to-Point** requires no address and sends the data to the host whenever it is available, without a request or handshake from the host.
- Serial Cmd:* <K140,0>

D-5-2 Point-to-Point (Point-to-Point with XON/XOFF)

- Usage:* Used only with RS-232.
- Definition:* This option enables the host to send the XON and XOFF command as a single byte transmission command of start (^Q) or stop (^S). Requests a handshake from the host. If an XOFF has been received from the host, data will not be sent to the host until the host sends an XON. During the XOFF phase, the host is free to carry on other chores and accept data from other devices.
- Serial Cmd:* <K140,2>

D-5-3 ACK/NAK

- Definition:* See the **ACK/NAK Options** command <K147>.
- Serial Cmd:* <K140,4>

D-5-4 Polling Mode

- Definition:* See the **Polling Mode Options** command <K148>.
- Serial Cmd:* <K140,5>

Poll Address

- Serial Cmd:* <K140,protocol,address>
- Default:* **1**
- Options:* 1 to 50
 1 = Poll address 0x1C, Select address 0x1D
 2 = Poll address 0x1E, Select address 0x1F
 ...
 50 = Poll address 0x7E, Select address 0x7F

D-6 ACK/NAK Options

Definition: These parameters take effect for **ACK/NAK <K140,4>** on the main RS-232 port and are completely independent of the **Polling Mode Options <K148>**. The reader always follows the protocol in both directions (to and from the host). There is no option to disable it from either direction.

Serial Cmd: <K147,RES,REQ,STX,ETX,ACK,NAK>

D-6-1 RES-NAK Defaults

<i>RES: (Reset)</i>	00 (disabled)
<i>REQ: (Request)</i>	00 (disabled)
<i>STX: (Start of Text)</i>	00 (disabled)
<i>ETX: (End of Text)</i>	00 (disabled)
<i>ACK: (Acknowledge)</i>	06
<i>NAK: (Negative Acknowledge)</i>	15

The following are general outlines of the **ACK/NAK** protocol. Items that are framed by brackets ([]) can either be disabled or enabled. LRC does not include STX, but it does include preamble, postamble, and ETX.

Symbol Data Output

TX to host: [STX] [preamble] SYMBOL DATA [postamble] [ETX] [LRC]

Response from host: ACK/NAK. Sent when LRC, ETX, postamble, or timeout (waiting for more data) are detected (if REQ is disabled) depending on what is enabled.

Commands from Host to Reader

TX to Reader: [STX] <command> [ETX] [LRC]

Response from Reader: ACK/NAK. Sent when LRC, ETX, or command-ending angle bracket '>' are received, depending on what is enabled.

Command Response from Reader to Host

TX to host: [STX] [preamble] COMMAND RESPONSE DATA [postamble] [ETX] [LRC]

Response from host: ACK/NAK. Sent when LRC, ETX, postamble, command-ending angle bracket '>', or timeout (waiting for more data) are detected, depending on what is enabled.

As with **Polling Mode <K140,5>**, the reader can optionally perform the REQ and RES event sequences in ACK/NAK mode. If the sender does not receive an ACK or NAK, it will send REQ to request such a response (if enabled). When the sender receives an ACK, too many NAKs, or times out (if already enabled), it will send a RES (if enabled) to terminate the transaction.

Note: See **ACK/NAK Data Flow Examples** for sample ACK/NAK communication scenarios.

D-7 Polling Mode Options

Definition: These parameters only take effect for **Polling Mode <K140,5>** on the main RS-232 port and are completely independent of the **ACK/NAK Options <K147>**.

The values of protocol characters can be changed, but the protocol events cannot be disabled. The polling mode address is configured in the **<K140>** command (see **Poll Address**).

Serial Cmd: **<K148,RES,REQ,STX,ETX,ACK,NAK>**

D-7-1 RES-NAK Defaults

<i>RES: (Reset)</i>	04
<i>REQ: (Request)</i>	05
<i>STX: (Start of Text)</i>	02
<i>ETX: (End of Text)</i>	03
<i>ACK: (Acknowledge)</i>	06
<i>NAK: (Negative Acknowledge)</i>	15

Note: See **Polling Mode Data Flow Examples** for sample **Polling Mode** communication scenarios.

D-8 Ethernet

Enables or disables Ethernet connectivity in the reader. In V440-F readers, Ethernet cannot be disabled and always returns **1**. This corresponds to the **<K126>** command. It requires a **<Zrdall>** to return to default settings.

D-8-1 IP Address

This is the IP address of the reader when it is in Static IP Address Mode.

D-8-2 Subnet

This is the subnet of the reader when it is in Static IP Address Mode.

D-8-3 Gateway

This is the gateway IP address of the reader when it is in Static IP Address Mode.

D-8-4 IP Address Mode

Determines how the reader's IP address will be defined.

Static

In **Static Mode**, the reader uses the user-defined IP address. This is the default state for the V440-F.

DHCP

In **DHCP Mode**, the reader automatically acquires the IP address, Subnet, and Gateway addresses from a DHCP or BOOTP server.

D-8-5 TCP Port 1

One of two TCP ports for Ethernet communication with the reader. The default setting is **2001**.

D-8-6 TCP Port 2

One of two TCP ports for Ethernet communication with the reader. The default setting is **2003**.

Changes to this parameter are saved to NOVRAM and are set to default on power on.

A Reset **<A>** is required for settings to take effect.

Important: Once this setting is Disabled, you will only be able to connect to the reader if you know the IP address and enter it in the IP Address field of the Ethernet TCP/IP connect dialog.

When enabled, **Search and Configure Mode** will find the reader and settings can be changed.

Timed Window

When **Timed Window** is selected, Search and Configure Mode will find the reader and settings can be changed, but only 60 seconds from the last reset. After 60 seconds, Search and Configure Mode will be disabled.

D-9 Response Timeout

- Usage:* Only used when a response is required from the host. The reader can be set to wait indefinitely by setting **Response Timeout** to zero.
- Definition:* The time that the reader will wait before timing out if **ACK**, **NAK**, and **ETX** are enabled, and a host response is expected.
- Serial Cmd:* **<K143,response timeout>**
- Default:* **12** (in 1 ms increments)
- Options:* 0 to 255 (A zero (0) setting causes an indefinite wait.)

D-10 LRC (Longitudinal Redundancy Check) Status

- Usage:* Used when extra data integrity is required.
- Definition:* An error-checking routine that verifies the accuracy of transmissions. It is the exclusive OR of all characters following the **STX** (start of text) up to and including the **ETX** (end of text). What this means is that the binary representation of all the characters in a transmission are cumulatively added in a column and each resulting odd integer is assigned a 1 and each even integer a 0 (two 1s = 0, two 0s = 0, a 1 and a 0 = 1). The extra LRC character is then appended to the transmission, and the receiver (usually the host) performs the same addition and compares the results.
- Serial Cmd:* <K145,status>
- Default:* **Disabled**
- Options:* **0 = Disabled** 1 = Enabled

D-11 Protocol Configuration Examples

D-11-1 Point-to-Point (Main Port)

<K100,8,0,1,1> Baud Rate: **115.2K**; Parity: **None**; Stop Bits: **2**; Data Bits: **8**
 <K140,0> Point-to-Point
 <K102,0> RS-232 enabled

D-11-2 Polling Mode (Main Port)

<K100,4,0,1,1> Baud Rate: **9600**; Parity: **None**; Stop Bits: **2**; Data Bits: **8**
 <K140,5,23> Polling Mode; Address: **23**
 <K102,0> RS-232 Point-to-Point polling
 <K143,30> 30 ms Response Timeout

D-11-3 “User-Defined” Polling Mode (Main Port)

<K100,4,0,1,1> Baud Rate: **9600**; Parity: **None**; Stop Bits: **2**; Data Bits: **8**
 <K140,5,12> Polling Mode; Address: **12**
 <K148,,08,09,18,0B,0C,0D> Default RES (0x04), REQ=0x08; EOT=0x09; STX=0x18;
 ETX=0x0B; ACK=0x0C; NAK=0x0D
 <K102,0> RS-232 Point-to-Point polling
 <K143,40> 40 ms Response Timeout

D-11-4 ACK/NAK (Main Port)

<K100,9,0,1,1> Baud Rate: **230K**; Parity: **None**; Stop Bits: **2**; Data Bits: **8**
 <K140,4> ACK/NAK
 <K147,,,01,1B,2E,1F> Default RES and REQ (00, disabled); STX=0x01; ETX=0x1B;
 ACK=0x2E; NAK=0x1F
 <K102,0> RS-232 enabled
 <K143,50> 50 ms Response Timeout

D-12 Preamble

D-12-1 Preamble Status

- Usage:* Useful for identifying and controlling incoming data. For example, defining the preamble as a carriage return and a line feed causes each decoded message to be displayed on its own line.
- Definition:* Defines a one to four character data string that can be added to the front of the decoded data.
- Serial Cmd:* <**K141**,*status*,*preamble character(s)*>
- Default:* **Disabled**
- Options:* **0 = Disabled** 1 = Enabled (within any protocol)

D-12-2 Preamble Characters

- Serial Cmd:* <**K141**,*status*,*preamble character(s)*>
- Default:* **^M** corresponds to: **carriage return**.
- Options:* To enter control characters within a serial command, hold down the **Ctrl** key while typing the desired character.

Example: <**K141**,**1**,**CNTL-m**> to enter the control character **^M**.

D-13 Postamble

D-13-1 Postamble Status

Usage: Useful for identifying and controlling incoming data. For example, defining the postamble as a carriage return and a line feed causes each decoded message to be displayed on its own line.

Definition: Allows the user to enable or disable up to four postamble characters that can be added to the end of the decoded data.

Serial Cmd: <**K142,status,postamble character(s)**>

Default: **Enabled**

Options: 0 = Disabled 1 = **Enabled (within any protocol)**

D-13-2 Postamble Characters

Serial Cmd: <**K142,status,postamble character(s)**>

Default: **^M^J** corresponds to: **carriage return/line feed**.

Options: To enter control characters within a serial command, hold down the control key while typing the desired character.

Example: <**K142,1,CNTL-m CNTL-j**> to enter **^M^J**.

D-14 USB HID / Keyboard

Note: The V440-F is an Ethernet-only device. HID requires a USB interface and is not supported.

D-15 EtherNet/IP Byte Swapping Enabled

Definition: Enables or disables EtherNet/IP byte swapping for decode data.

Serial Cmd: <**K163,status**>

Default: **Disabled**

Options: **0 = Disabled**
1 = Enabled

D-16 PROFINET

Definition: Enables or disables the PROFINET communications protocol.
Serial Cmd: <**K164,status**>
Default: **Disabled**
Options: **0 = Disabled**
1 = Enabled

D-17 Entering ASCII Characters as Hex Values

Commands that require ASCII text fields, such as **Preamble** and **Postamble** commands, can be sent to the reader as hex values.

Serial Cmd Format: <**Knnnh,00-FF**>

To enter ASCII fields as hex values (00 to FF), add a lower-case **h** directly after the command's **K** number, and then enter the hex value that corresponds with the desired ASCII character.

Example:

Consider the **Postamble** command:

Serial Cmd: <**K142,status,postamble character(s)**>

Imagine that your application requires the ASCII character **>** to be the postamble in your symbol decode output.

The ASCII characters **<**, **>**, and **,** can only be entered as hex values. So, to make **>** the postamble in your symbol decode output, enter the **Postamble** command as follows:

<**K142h,,3E**>

Note that the "status" field contains only a **,**. This is because the only field that is being changed is the "postamble character(s)" field. (See **Serial Configuration Command Conventions** for a more detailed explanation of this command shortcut.)

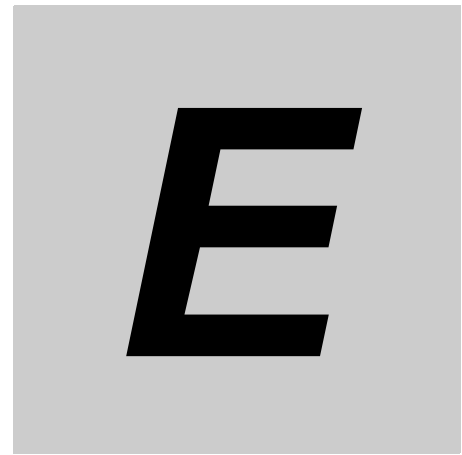

Calibration

This section shows the calibration options and explains the different ways that those options can be configured.



E-1 Calibration Serial Command	E-2
E-2 Calibration Overview	E-3
E-3 Calibration Options	E-4
E-4 Additional Notes about Calibration	E-9

E-1 Calibration Serial Command

Calibration Options	< K529 , <i>gain, exposure, symbol type, WOI framing, WOI margin, line scan height, processing, calibration manager</i> >
---------------------	--

E-2 Calibration Overview

Calibration is one of the most powerful features of the V440-F. The calibration process can be initiated by serial command or in the WebLink user interface.

When the reader enters calibration, it runs through an optimization cycle that sets the ideal parameters for reading symbols at the highest possible level of performance. Calibration can be specially configured to optimize specific parameters, such as gain, exposure, and symbol type.

E-3 Calibration Options

This command specifies the operation of the calibration feature. The default configuration performs calibration on gain and symbol type. The calibration process optimizes the gain setting for the configured exposure.

E-3-1 Gain

<i>Definition:</i>	When enabled, gain is calibrated to provide the best available image quality and performance. When disabled, gain is fixed and is not part of the calibration process.
<i>Serial Cmd:</i>	<code><K529,gain,exposure,symbol type,WOI framing,WOI margin,line scan height,processing,calibration manager></code>
<i>Default:</i>	Quick Calibrate
<i>Options:</i>	0 = Disabled 1 = Enabled (Decode Required) 2 = Quick Calibrate

Note: If you choose to calibrate the reader by sending a `<@CAL>` command, a decode is also required for the calibration process to be completed successfully.

Disabled

When disabled, gain is fixed and is not part of the calibration process.

Enabled

When enabled, gain is calibrated to provide the best image quality and performance for the symbol present in the field of view. Calibration requires that a decodable symbol be placed in the field of view, as feedback from the symbol decoding process is used to select the best gain setting. If a symbol is not decoded the process will result in a fail condition. Gain is enabled by default.

Quick Calibrate

Quick Calibrate uses the automatic gain control (AGC) feature of the image sensor to adjust the gain value such that the current image falls into a desirable region of the image sensor's sensitivity range, ensuring optimal image luminance. The image sensor converges on the optimal gain value within a few image frames.

E-3-2 Exposure

Definition: Unless the application is static, exposure should be configured based on the application's line speed. The table below is a general guideline for exposure configurations at various line speeds.

Serial Cmd: <K529,gain,exposure,symbol type,WOI framing,WOI margin,line scan height,processing,calibration manager>

Default: **Quick Calibrate**

Options: 0 = Disabled
 1 = Enabled (Decode Required)
 2 = **Quick Calibrate**

Note: If you choose to calibrate the reader by sending a <@CAL> command, a decode is also required for the calibration process to be completed successfully.

Note: This table shows guidelines for exposure settings based on various line speeds. The settings shown depend on the reader's optical configuration and on symbol element size.

Exposure	Line Speed
100,000 – 4,000	Static
4,000 – 1,250	5" / sec
1,250 – 700	10" / sec
700 – 500	15" / sec
500 – 400	20" / sec

Disabled

When disabled, exposure is fixed and is not part of the calibration process.

Enabled

When enabled, exposure is calibrated to provide the best image quality and performance for the symbol present in the field of view. Calibration requires that a decodable symbol be placed in the field of view, as feedback from the symbol decoding process is used to select the best exposure setting. If a symbol is not decoded the process will result in a fail condition. Exposure is enabled by default.

Quick Calibrate

Quick Calibrate uses a basic histogram profile to bring the image into an acceptable dynamic range that will provide good contrast for decoding symbols in most environments. This routine is optimized for a fast process to execute in under 1 second.

E-3-3 Symbol Type

<i>Serial Cmd:</i>	< K529 ,gain,exposure, symbol type ,WOI framing,WOI margin,line scan height,processing,calibration manager>	
<i>Default:</i>	Enabled	
<i>Options:</i>	0 = Disabled	1 = Enabled

Disabled

When this feature is disabled, only the current enabled symbologies will be considered during the calibration process.

Enabled

When this feature is enabled, autodiscrimination is in effect during the calibration process. All supported symbologies except PDF417 and Pharmacode will be attempted during calibration. Any new symbologies successfully decoded during calibration will remain enabled at the end of the process. All enabled symbologies will remain enabled. For example, assume that only Code 39 is enabled at the beginning of calibration. If a Code 128 symbol is decoded during calibration, then Code 128 as well as Code 39 will be enabled.

E-3-4 Window of Interest (WOI) Framing

<i>Definition:</i>	If WOI Framing is enabled, the camera's Window of Interest will be set to a full size image when calibration begins. Once a symbol is decoded, the camera WOI will be zoomed in both vertically and horizontally (regardless of which WOI mode is enabled) to include the symbol plus an additional margin. This is done to speed up the calibration process. When a successful calibration is complete, the camera WOI will be adjusted according to the mode enabled. Otherwise, the original WOI configuration will be retained.
<i>Serial Cmd:</i>	< K529 ,gain,exposure,symbol type, WOI framing ,WOI margin,line scan height,processing,calibration manager>
<i>Default:</i>	Disabled
<i>Options:</i>	0 = Disabled 1 = Row and Column 2 = Row 3 = Column 4 = Straight Line 5 = Straight Line Framed

If WOI framing is not enabled, the current WOI configuration will be used until a symbol has been decoded. After a symbol is decoded, the WOI is framed exactly as it would be if a WOI framing mode was enabled. When calibration completes, the original WOI configuration is restored.

Disabled

When this feature is disabled, the Window of Interest is not modified after the calibration process is complete.

Row and Column

If the calibration process is successful, the Window of Interest will be modified to frame the symbol as well as an additional margin area around the symbol, determined by the **WOI Margin** parameter.

Row

If the calibration process is successful, the Window of Interest rows will be modified to horizontally frame the symbol, plus an additional margin area around the symbol, determined by the WOI Margin parameter.

Column

If the calibration process is successful, the Window of Interest columns will be modified to vertically frame the symbol, plus an additional margin area around the symbol, determined by the WOI Margin parameter.

Straight Line

This feature is intended for use with linear symbologies. If the calibration process is successful, the orientation of the symbol is determined and the Window of Interest is modified according to the symbol orientation. The scan line orientation is determined to be vertical if the symbol tilt is between 225° and 315°, or between 45° and 135°. Otherwise, the scan line will be horizontal.

If the symbol is vertical, the image column size will be set by the scan height parameter, and will be configured for full row resolution. If the symbol is horizontal, the image row size will be set by the scan height parameter, and will be configured for full column resolution. The scan line will be centered in the middle of the symbol. If the symbol is tilted such that the scan line will not pass completely through the symbol, the scan width will be adjusted to include the entire symbol. Refer to the diagram below:



Straight Line Framed

This parameter is the same as “Straight Line”, except that the Window of Interest will also frame the scan line on the symbol length as well. The scan line includes the symbol plus an additional margin area determined by the WOI Margin parameter.

E-3-5 Window of Interest (WOI) Margin

<i>Definition:</i>	Sets the margin size that is applied to the calibrated symbol. This parameter is expressed in number of pixels. If the margin causes the image to exceed the maximum image size, it will be reduced accordingly.
<i>Serial Cmd:</i>	<K529,gain,exposure,symbol type,WOI framing,WOI margin,line scan height,processing,calibration manager>
<i>Default:</i>	75 (pixels)
<i>Options:</i>	20 to 1280

E-3-6 Line Scan Height

Definition: This parameter is only used with the Straight Line modes. It sets the scan height of the straight-line image, and it is expressed in number of pixels.

Serial Cmd: <K529,gain,exposure,symbol type,WOI framing,WOI margin,**line scan height**,processing,calibration manager>

Default: **64 (pixels)**

Options: 3 to 1280

E-3-7 Processing

Definition: This setting defines the amount of time and effort the reader will spend attempting to decode a symbol for each parameter configuration.

Serial Cmd: <K529,gain,exposure,symbol type,WOI framing,WOI margin,line scan height,**processing**,calibration manager>

Default: **Medium**

Options: 0 = Low **1 = Medium**
2 = High 3 = Definable

Low

The reader will spend a low amount of effort attempting to decode the given symbol for each parameter configuration.

Medium

The reader will spend a medium amount of effort attempting to decode the given symbol for each parameter configuration.

High

The reader will spend a high amount of effort attempting to decode the given symbol for each parameter configuration.

Definable

The processing time for each image frame is defined by **Image Processing Timeout**.

E-3-8 Calibration Manager

Definition: <@CAL> will follow the core algorithm supplied for its approach if it is not set to **Quick Calibrate** in **Gain** and **Exposure**. This will control all image and preprocessing settings to generate optimal decoding, if decoding is possible.

Serial Cmd: <K529,gain,exposure,symbol type,WOI framing,WOI margin,line scan height,processing,**calibration manager**>

Default: **Complex**

Options: 0 = Disabled
1 = Quick
2 = Fast
3 = Moderate
4 = **Complex**

Complex

Complex allows full image analysis and processing settings to optimize the stability and speed of the decoder. It can be used on DPM symbols and other difficult symbols, but processing time will increase.

E-4 Additional Notes about Calibration

The following conditions apply to the reader's calibration process. Some of these items are noted at various points throughout this section, or in other sections of the reader's documentation.

- 1** If **Window of Interest Framing** is enabled, the WOI will be set to full frame when calibration begins. If **WOI Framing** is disabled, the current WOI configuration will be used for the **Search Pass**.
- 2** **Image Processing Mode** will not be altered during calibration.
- 3** If **Symbol Type** is enabled for calibration (**Autodiscriminate**), then Interleaved 2 of 5 **Range Mode Status (Interleaved 2 of 5) <K472>** will be enabled. This allows variable-length Interleaved 2 of 5 symbols to be decoded. If an Interleaved 2 of 5 symbol is decoded during calibration, then code length # 1 will be set to the decoded symbol length at the end of calibration. Otherwise, the symbol lengths will be restored to their original configurations.
- 4** **Pharmacode** is not calibrated.
- 5** All symbol types that were enabled before calibration will still be enabled after calibration. For example, if Data Matrix ECC 200 was enabled before calibration, and the calibration routine was performed on a Code 128 symbol, then after calibration is completed both Data Matrix ECC 200 and Code 128 will be enabled.
- 6** Calibration does not modify the global **Composite** status **<K453>**. The global Composite status must be configured properly before calibration.
- 7** If the user requires calibration of a **stacked** symbology **<K482>**, **<K483>**, or **<K484>**, that symbology must be enabled and configured appropriately before calibration.
- 8** The **Search** process will use the configurable Window of Interest for image captures. However, when the search process is completed, the WOI will be reduced to include only the symbol of interest and some additional boundary area.



Read Cycle

After you've established communications and completed basic read rate testing, you will need to address the spatial and timing parameters associated with your application. This section explains those parameters.

F-1 Read Cycle Serial Commands	F-2
F-2 Read Cycle Setup	F-3
F-3 Multisymbol	F-4
F-4 Trigger Mode and Filter Duration	F-5
F-5 External Trigger State	F-9
F-6 Serial Trigger	F-10
F-7 Start Trigger Character (Non-Delimited)	F-11
F-8 Stop Trigger Character (Non-Delimited)	F-12
F-9 End of Read Cycle	F-13
F-10 Capture Mode	F-15
F-11 Capture Timing	F-18
F-12 Image Processing Timeout	F-19
F-13 Image Storage	F-20
F-14 Decodes Before Output	F-22

F-1 Read Cycle Serial Commands

Trigger Mode/Filter Duration	<K200,trigger mode,leading edge trigger filter,trailing edge trigger filter>
Serial Trigger Character	<K201,serial trigger character>
External Trigger State	<K202,external trigger state>
End of Read Cycle	<K220,end of read cycle mode,read cycle timeout>
Decodes Before Output	<K221,good decode(s) needed>
Multisymbol	<K222,number of symbols,multisymbol separator,allow duplicates>
Start Trigger Character	<K229,start character>
Stop Trigger Character	<K230,stop character>
Capture Mode	<K241,capture mode,number of rapid captures,rapid capture mode,number of continuous captures,images per read cycle limit,read cycle history limit>
Capture Time	<K242,time before first capture,time between captures 1 and 2,time between captures 2 and 3,time between captures 3 and 4,time between captures 4 and 5,time between captures 5 and 6,time between captures 6 and 7,time between captures 7 and 8>
Image Storage	<K244,image storage type,image store mode>
Image Processing Timeout	<K245,image processing timeout>

F-2 Read Cycle Setup

Setting up read cycle and triggering parameters will involve a series of decisions based on your particular application, as follows:

- 1** Select the number of symbols to be read in a single cycle. The reader can read multiple symbols in a single image frame and/or spread over multiple frames.
- 2** Decide on the trigger type to be used: if serial, choose a serial character; if external, choose either **Level** or **Edge**.
- 3** Designate how the read cycle should end (**Timeout**, **New Trigger**, **Last Frame**).
- 4** Select **Capture Mode** between **Continuous Mode** or **Rapid Mode**.
- 5** Select **Number of Captures** (if in **Rapid Capture Mode**).
- 6** Set the **Time Before First Capture** and **Time Between Captures** if **Rapid Mode** is used. This is to maintain processing backlog (**tuning** – depending on total read cycle time and object rate of motion).

Note: The capture rate increases as the frame size decreases.

F-3 Multisymbol

- Usage:** Multisymbol is commonly used in shipping applications where a shipping symbol contains individual symbols for part number, quantity, etc. This feature allows on trigger to pick up all the symbols.
- Definition:** **Multisymbol** allows the user to define up to 100 symbols that can be read in a single read cycle.
- Conditions:** The following conditions apply:
- Each symbol must be different to be read, unless in **Rapid Capture Mode**, configured for “triggered capture”.
 - The maximum number of characters in a read cycle is 3,000 for all symbols.
 - All No-Read messages are posted at the end of the data string, unless output filtering is enabled.
 - If more than one symbol is within the field of view at the same time, symbol data may not be displayed in the order of appearance.
 - If **Matchcode Type** is set to **Sequential** or if **Trigger** is set to **Continuous Read 1 Output**, the reader will behave as if **Number of Symbols** were set to **1**, regardless of the user-defined configuration.

F-3-1 Number of Symbols

- Definition:** **Number of Symbols** is the number of different symbols that can be read in a single read cycle.
- Serial Cmd:** <K222,number of symbols,multisymbol separator,allow duplicates>
- Default:** 1
- Options:** 1 to 400

F-3-2 Multisymbol Separator

- Usage:** Used to delimit or separate data fields with a user defined character.
- Definition:** Any valid ASCII character, inserted between each symbol read when Multisymbol is set to any number greater than 1.
- Serial Cmd:** <K222,number of symbols,multisymbol separator,allow duplicates>
- Default:** , (comma)
- Options:** Any available ASCII character.

Note: If No-Read messages are disabled and there are No-Reads occurring, separators will only be inserted between symbol data outputs.

F-3-3 Allow Duplicates

- Definition:** When enabled, **Allow Duplicates** allows two strings of identical decoded data to be output when the data is from two separate 2D symbols of the same code type.
- Serial Cmd:** <K222,number of symbols,multisymbol separator,allow duplicates>
- Default:** 0
- Options:** 0 = Disabled 1 = Enabled

F-4 Trigger Mode and Filter Duration

F-4-1 Trigger Mode

<i>Definition:</i>	The Trigger is the event that initiates a read cycle. Note: When calibrating the reader or testing read rate, the current trigger setting will be disregarded.
<i>Serial Cmd:</i>	<K200, trigger mode , <i>leading edge trigger filter</i> , <i>trailing edge trigger filter</i> >
<i>Default:</i>	Continuous Read
<i>Options:</i>	0 = Continuous Read 1 = Continuous Read 1 Output 2 = External Level 3 = External Edge 4 = Serial Data 5 = Serial Data and Edge

Continuous Read

<i>Usage:</i>	Continuous Read is useful in testing symbol readability or reader functions. It is not recommended for normal operations.
<i>Definition:</i>	In Continuous Read , trigger input options are disabled, the reader is always in the read cycle, and it will attempt to decode and transmit every capture. If a single symbol stays within read range for multiple read cycles, its data will be transmitted repeatedly until it leaves the read range. The reader sends replies to serial commands that require responses when symbol data is transmitted, or read cycle timeout is enabled and a timeout occurs <i>and</i> at least one captured image has been processed. Depending on the combination of enabled symbologies, the reader may take longer than the timeout to process a captured image. Note: When to Output and No-Read options have no affect on Continuous Read.
<i>Serial Cmd:</i>	<K200,0>

Continuous Read 1 Output

<i>Usage:</i>	Continuous Read 1 Output can be useful in applications where it is not feasible to use a trigger and all succeeding symbols contain different information. It is also effective in applications where the objects are presented by hand.
<i>Definition:</i>	In Continuous Read 1 Output the reader self-triggers whenever it decodes a new symbol or a timeout occurs. If End of Read Cycle is set to Timeout and the symbol doesn't change, the output is repeated at the end of each timeout period. For example, if Timeout is set to one second, the reader sends the symbol data immediately and repeats the output at intervals of one second for as long as it continues to capture the symbol. If End of Read Cycle is set to New Trigger , the reader will send the current symbol data immediately, <i>but only once</i> . A new symbol appearing in the reader's range will be read and sent immediately, provided it is not identical to the previous symbol.
<i>Serial Cmd:</i>	<K200,1>

Caution: In automated environments, **Continuous Read 1 Output** is not recommended because there is typically no reliable way to verify that a symbol was missed.

Note: If **Trigger Mode** is set to **Continuous Read 1 Output**, the reader will behave as if **Number of Symbols** were set to 1, regardless of the user-defined configuration.

External Level

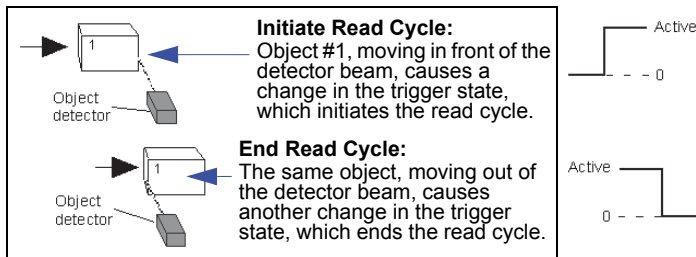

Usage: This mode is effective in an application where the speeds of the conveying apparatus are variable and the time the reader spends reading each object is not predictable. It also allows the user to determine if a No-Read has occurred.

Definition: **External Level** allows the read cycle (active state) to begin when a trigger (change of state) from an external sensing device is received. The read cycle persists until the object moves out of the sensor range and the active trigger state changes again.

Serial Cmd: <K200,2>

Important: **Level** and **Edge** apply to the active logic state (**Active Open** or **Active Closed**) that exists while the object is in a read cycle, between the rising edge and the falling edge. *Rising edge* is the trigger signal associated with the appearance of an object. *Falling edge* is the trigger signal associated with the subsequent disappearance of the object. This applies both to **External Level** and **External Edge**.

External Edge

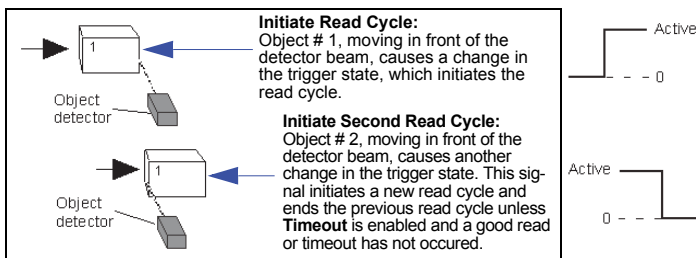

Usage: This mode is highly recommended in any application where conveying speed is constant, or if spacing, object size, or read cycle timeouts are consistent.

Definition: **External Edge**, as with **Level**, allows the read cycle (active state) to begin when a trigger (change of state) from an external sensing device is received. However, the passing of an object out of sensor range does not end the read cycle. The read cycle ends with a good read output, or, depending on the **End of Read Cycle** setting, a timeout or new trigger occurs.

Serial Cmd: <K200,3>

Serial Data

Usage: **Serial Data** is effective in a highly controlled environment where the host knows precisely when the object is in the field of view. It is also useful in determining if a No-Read has occurred.

Definition: In **Serial Data**, the reader accepts an ASCII character from the host or controlling device as a trigger to start a read cycle. A **Serial Data** trigger behaves the same as an **External Edge** trigger.

Serial commands are entered inside angle brackets, as shown here: <t>.

Serial Cmd: <K200,4>

Note: In **Serial Data**, sending a non-delimited start serial character will start a read cycle; however, a non-delimited stop serial character has no effect.

Serial Data and Edge

Usage: **Serial Data or External Edge** is seldom used but can be useful in an application that primarily uses an external sensing device but occasionally needs to be triggered manually.

Definition: In this mode the reader accepts either a serial ASCII character or an external trigger pulse to start the read cycle.

Serial Cmd: <K200,5>

Note: In **Serial Data**, sending a non-delimited start serial character will start a read cycle; however, a non-delimited stop serial character has no effect.

F-4-2 Leading Edge Trigger Filter

- Usage:* Used to ignore spurious triggers when **Trigger Mode** is set to External Edge or External Level.
- Definition:* To consider a change in state on the trigger input, the level must be stable for the trigger filter duration. In an edge mode, the reader will trigger a read cycle if the active state has been uninterrupted for the entire trigger filter duration. In a level mode, the leading edge is filtered such that on an active edge, the state must be held interrupted for the trigger filter duration before a trigger will occur.
- Serial Cmd:* <**K200**,*trigger mode*,**leading edge trigger filter**,*trailing edge trigger filter*>
- Default:* **1**
- Options:* 0 to 65535 (Trigger filter range: 32.0 μ s to 2.10 seconds.)
When **Leading Edge Trigger Filter** is set to **0**, no filtering is performed.

F-4-3 Trailing Edge Trigger Filter

- Usage:* Used to ignore spurious triggers when **Trigger Mode** is set to External Edge or External Level.
- Definition:* To consider a change in state on the trigger input, the level must be stable for the trigger filter duration. In an edge mode, the reader will trigger a read cycle if the active state has been uninterrupted for the entire trigger filter duration. In a level mode, the trailing edge is filtered such that on the falling edge, the state must be held for the trigger filter duration before the trigger will be deemed inactive.
- Serial Cmd:* <**K200**,*trigger mode*,*leading edge trigger filter*,**trailing edge trigger filter**>
- Default:* **1**
- Options:* 1 to 65535 (Trigger filter range: 32.0 μ s to 2.10 seconds.)
When **Trailing Edge Trigger Filter** is set to **0**, no filtering is performed.

F-5 External Trigger State

<i>Usage:</i>	Allows users to select the trigger polarity that will be used in their application.
<i>Definition:</i>	Determines the active state of the trigger signal applied to the cable input of the reader.
<i>Serial Cmd:</i>	< K202,active state >
<i>Default:</i>	Active Closed
<i>Options:</i>	0 = Active Open 1 = Active Closed

F-6 Serial Trigger

- Usage:* Allows the user to define the trigger character and delimiters that start and stop the read cycle.
- Definition:* A serial trigger is considered an online host command and requires the same command format as all host commands. It must be entered within angle bracket delimiters < > or, in the case of non-delimited triggers, it must define individual start and stop characters.

F-6-1 Serial Trigger Character (Delimited)

- Usage:* Allows the user to define the trigger character that initiates the read cycle.
- Definition:* A single ASCII host serial trigger character that initiates the read cycle. A delimited trigger character is one that either starts or ends the read cycle and is enclosed by delimiters such as < >.
- Serial Cmd:* <**K201,serial trigger character**>
- Default:* **Space bar**
- Options:* Any single ASCII character, including control characters, except NUL (0x00 in hex), an existing host command character, or an on-line protocol character. Control characters entered on the command line are displayed in the menu as mnemonic characters.

Note: **Serial Data** or **Serial Data or External Edge** triggering mode must be enabled for **Serial Trigger Character** to take effect.

F-7 Start Trigger Character (Non-Delimited)

- Usage:** Useful in applications where different characters are required to start a read cycle.
- Definition:** A single ASCII host serial trigger character that starts the read cycle and is not enclosed by delimiters such as < and >. Non-delimited **Start** characters can be defined and will function according to the trigger event. When defining **Start** trigger characters, the following rules apply:
- In **External Edge** the reader looks only for the **Start** trigger character and ignores any **Stop** trigger character that may be defined.
 - In **External Level** the **Start** trigger character begins the read cycle and the **Stop** trigger character ends it. Note that even after a symbol has been decoded and the symbol data transmitted, the reader remains in **External Level** trigger read cycle until a **Stop** character is received.
 - In **Serial Data or External Edge** trigger mode, either a **Start** trigger character or a hardware trigger can start an edge trigger read cycle.
- Serial Cmd:** <K229,start character>
- Default:** **NUL** (00 in hex) (disabled)
- Options:** Two hex digits representing any ASCII character except **XON** and **XOFF**.

F-8 Stop Trigger Character (Non-Delimited)

- Usage:* Useful in applications where different characters are required to end a read cycle.
- Definition:* A single ASCII host serial trigger character that ends the read cycle and is not enclosed by delimiters such as < and >.
Non-delimited **Stop** characters can be defined and will function according to the trigger event.
When defining **Stop** trigger characters, the following rules apply:
- In **External Edge** the reader looks only for the **Start** trigger character and ignores any **Stop** trigger character that may be defined.
 - In **External Level** the **Start** trigger character begins the read cycle and the **Stop** trigger character ends it. Note that even after a symbol has been decoded and the symbol data transmitted, the reader remains in **External Level** trigger read cycle until a **Stop** character is received.
 - In **Serial Data or External Edge** trigger mode, either a **Start** trigger character or a hardware trigger can start an edge trigger read cycle.
- Serial Cmd:* <**K230,stop character**>
- Default:* **NUL** (00 in hex) (disabled)
- Options:* Two hex digits representing an ASCII character.

F-9 End of Read Cycle

Definition: The read cycle is the time during which the reader will attempt to capture and decode a symbol. A read cycle can be ended by a timeout, a new trigger, or by the last frame in a capture sequence or a combination of the above.

F-9-1 End of Read Cycle Mode

Note: When operating in Continuous Read or Continuous Read 1 Output, the reader is always in the read cycle.

Serial Cmd: <K220,end of read cycle,read cycle timeout>

Default: Timeout

Options:

- 0 = Timeout
- 1 = New Trigger
- 2 = Timeout and new Trigger
- 3 = Last Frame
- 4 = Last Frame / New Trigger

Timeout

Usage: Typically used with **Serial Data or External Edge** and **Continuous Read 1 Output**.

It is effective in highly controlled applications when the maximum length of time between objects can be predicted. It assures that a read cycle ends before the next symbol appears, giving the system extra time to decode and transmit the data to the host.

Definition: **Timeout** ends the read cycle, causing the reader to stop reading symbols and send the symbol data or No-Read message when the time set in **Timeout** elapses (times out), *if* **When to Output** is set to **End of Read Cycle**.

If in **Continuous Read 1 Output**, a timeout initiates a new read cycle and allows the same symbol to be read again.

With **External Edge**, **Serial Data**, or **Serial Data or External Edge** enabled, a timeout ends the read cycle and symbol data or a No-Read message is sent to the host.

With **External Level** enabled, the read cycle does not end until the falling edge trigger occurs or a timeout occurs. The next read cycle does not begin until the next rising edge trigger.

New Trigger

Usage: **New Trigger** is an effective way to end a read cycle when objects move past the reader at irregular intervals (not timing-dependent).

Definition: **New Trigger** ends the current read cycle and initiates a new one when a new trigger occurs. **New Trigger** refers only to a rising edge trigger.

With **External Edge**, **Serial Data**, or **Serial Data or External Edge** enabled, an edge or serial trigger ends a read cycle and initiates the next read cycle.

In the case of **External Level**, a falling edge trigger ends the read cycle but the next read cycle does not begin until the occurrence of the next rising edge trigger.

Timeout and New Trigger

- Usage:* Useful in applications that require an alternative way to end the read cycle. For example, if an assembly line should stop completely or the intervals between objects are highly irregular.
- Definition:* **Timeout or New Trigger** is identical to **Timeout** except that a timeout *or* a new trigger (whichever occurs first) ends the read cycle.

Last Frame

- Usage:* Useful in applications in which the number of captures needed can be defined but the timeout duration varies.
- Definition:* **Last Frame** only applies to **Rapid Capture Mode**.

Last Frame / New Trigger

- Usage:* Useful in applications in which line speeds are irregular and a new labelled object could appear before the last frame in a **Rapid Capture** sequence.
- Definition:* **Last Frame or New Trigger** is identical to **New Trigger** except that a new trigger *or* last frame (whichever occurs first) ends the read cycle.

F-9-2 Read Cycle Timeout

- Definition:* **Read Cycle Timeout** is the duration of the read cycle.
- Serial Cmd:* <K220,end of read cycle,read cycle timeout>
- Default:* **100** (x10 ms)
- Options:* 1 to 65535

F-10 Capture Mode

- Definition:** **Capture Mode** relates to the way in which images are captured and processed.
- Serial Cmd:** <K241,capture mode,number of captures,rapid capture mode,continuous capture burst count,images per read cycle limit,read cycle history>
- Default:** **Continuous Capture**
- Options:** 0 = Rapid Capture 1 = **Continuous Capture**

Rapid Capture

- Definition:** In a rapid capture mode, one or multiple captures can be taken at an interval specified by the time-between-captures parameter. In this mode, the only limiting time factor is integration and transfer timing.

Continuous Capture

- Usage:** **Continuous Capture** is useful in applications with slower line speeds or where symbol spacing may be random or not time-dependent.
- Definition:** In **Continuous Capture Mode**, image captures are taken throughout the read cycle in a multi-buffered format (see diagram below). The reader begins processing the first captured image at the same time that it captures the second image. Captures will continue occurring throughout the read cycle until an end condition occurs, such as a timeout, a new trigger, the last frame in a capture sequence, or a combination of the above.

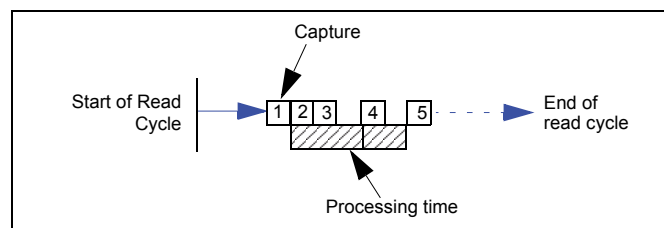

F-10-1 Number of Captures

- Usage:** **Number of Captures** is used to specify the number of captures to be processed in **Rapid Capture Mode**.
- Definition:** Sets the total number of captures that are processed during a read cycle in **Rapid Capture Mode**. This feature is used in conjunction with **Capture Timing** parameters to specify the capture sequence of a rapid capture read cycle. This may be more than the total buffers available and may require tuning to optimize large capture counts, especially when more than the buffer count is requested. It may not be possible to capture all images when such a large capture count is requested.
- Serial Cmd:** <K241,capture mode,number of captures,rapid capture mode,continuous capture burst count,images per read cycle limit,read cycle history>
- Default:** 1
- Options:** 1 to 255 (No limit)

F-10-2 Rapid Capture Mode

Definition: In **Rapid Capture Mode**, one or multiple captures (as many as 32) can be taken at an interval specified by the time-between-captures parameter. In this mode, the only limiting time factor is integration and transfer timing.

Serial Cmd: <K241,capture mode,number of captures,rapid capture mode,continuous capture burst count,images per read cycle limit,read cycle history>

Default: **Timed Capture**

Options: **0 = Timed Capture** **1 = Triggered Capture**

Timed Capture

Usage: **Timed Rapid Capture** is useful in fast-moving applications in which symbols are only in the field of view for a short time and precise timing is required.

Definition: In **Timed Rapid Capture**, decoding occurs independent of and simultaneous with capturing, thus allowing precise timing or no delay at all between captures.

Also, consecutive captures are regarded as the same symbol if the output data is the same.

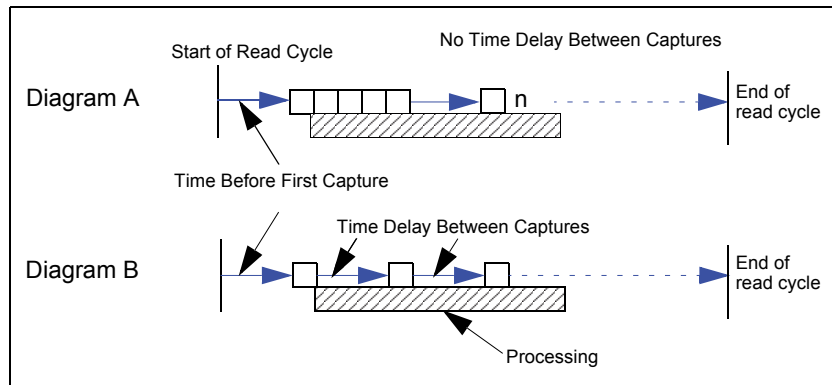

Triggered Capture

Usage: Useful in applications where each decode must be treated as a discrete event, regardless of symbol data.

Definition: The first trigger event starts the read cycle, and subsequent triggers will continue until the predetermined **Number of Captures** is met, or until the predetermined **End of Read Cycle** condition is met-- whichever occurs first.

Note: If **End of Read Cycle** is set for **New Trigger** and the read cycle qualifications have not been met, the read cycle will only end *once it receives the first trigger after reaching the predetermined **Number of Captures** setting.*

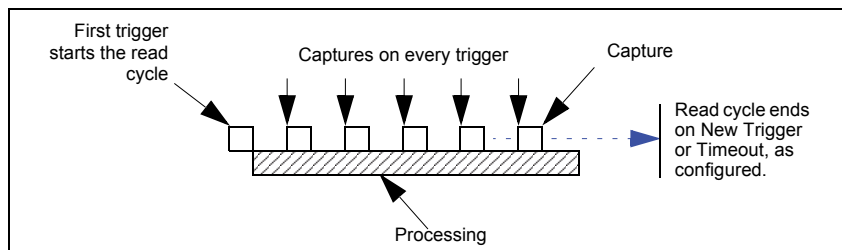

F-10-3 Continuous Mode Burst Count

- Definition:** Specifies the number of captures immediately issued to the reader when in **Continuous Capture Mode**. This is often set to between 1 and 3, and represents how much buffering to have waiting for the decoder to process at any given moment. Because this is Continuous Capture Mode, it will not have a last frame, so End of Read Cycle cannot be set to Last Frame for an exit condition. The expected setting for most users would be **1 = No Buffering**, **2 = Double-Buffered**, or **3 = Triple-Buffered**.
- Serial Cmd:** <K241,capture mode,number of captures,rapid capture mode,continuous capture burst count,images per read cycle limit,read cycle history>
- Default:** 1
- Options:** 1 to 254

F-10-4 Images per Read Cycle Limit

- Definition:** **Important: Images per Read Cycle Limit** is available as a K command only. It is not part of the WebLink user interface. Specifies the number of buffers before attempting to reuse them again. This number is not a hard limit but is a soft limit for the quantity of historical images maintained. Setting it too low may cause you to lose historical information. Setting it too high can also limit the number of read cycles too look back in the image history. Values rarely have any effect on the operation of the unit within a read cycle, but may affect WebLink's ability to show images.
- Serial Cmd:** <K241,capture mode,number of captures,rapid capture mode,continuous capture burst count,images per read cycle limit,read cycle history>
- Default:** 10
- Options:** 3 to 254

F-10-5 Read Cycle History

- Definition:** **Important: Read Cycle History** is available as a K command only. It is not part of the WebLink user interface. Specifies the number of images that can be stored in read cycle history.
- Serial Cmd:** <K241,capture mode,number of captures,rapid continuous capture burst count,images per read cycle limit,read cycle history>
- Default:** 10
- Options:** 0 to 254

F-11 Capture Timing

Note: Capture Timing applies only to **Rapid Capture Mode**.

F-11-1 Time Before First Capture

Usage: In almost any moving line application, a time delay is needed to ensure that a symbol will be in the reader's field of view at the beginning of the capture sequence. Using **Rapid Capture Mode** allows the delay system to take effect and tune capture timing. For most read cycle setup, the first is used for trigger framing, and all the rest will be set to the same time to create a measured spacing between captures until the last capture.

Definition: **Time Before First Capture** in a moving line application is the time between an external trigger event and the occurrence of the first capture.

Serial Cmd: <K242,time before 1st capture,time between capture 1 and capture 2,,,,,,time between capture 7 and capture 8>

Default: 0

Options: 0 to 65535 (2.097 seconds, in 32 μS increments)

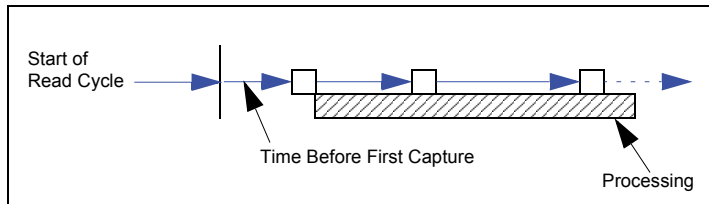

F-11-2 Time Between Captures

Usage: This is useful in applications where more than one symbol can appear during a single read cycle (multisymbol), or where line speeds are slow enough that captured frames might overlap or miss a symbol.

Definition: A time delay can be inserted between individual frame captures in **Rapid Capture Mode**.

Serial Cmd: <K242,time before 1st capture,time between captures [time 1,time 2,...time7]>

Entering 0s will result in no time between captures.

Entering a different value in each field will vary the time delays accordingly.

Note: You must enter time values along with comma separators for each field you want to change. If you omit fields, or enter only commas, the fields will remain as previously set.

Important: If the reader is configured to capture more than 8 images, the last (or 8th) delay value will be repeated for the remaining captures.

Default: 0

Options: 0 to 65535 (2.097 seconds, in 32 μS increments)

Note: **Number of Captures** and number of frame delays (**Time Between Captures**) must be the same.

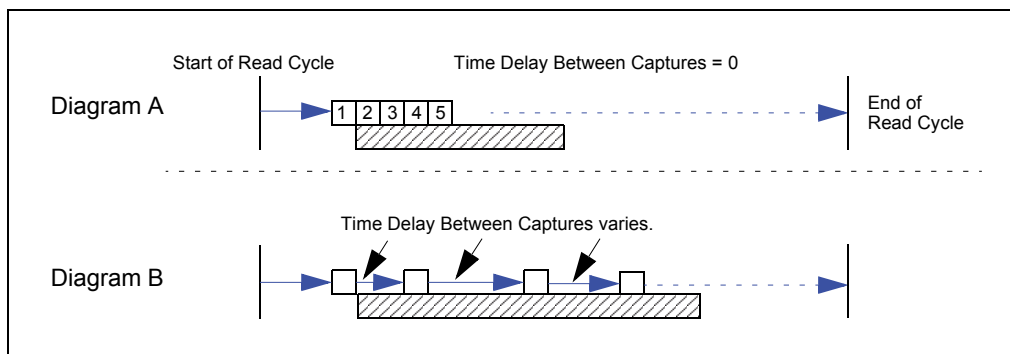

F-12 Image Processing Timeout

<i>Usage:</i>	Useful in higher speed applications where image processing time is long enough that not all captures have an opportunity to be processed.
<i>Definition:</i>	Specifies the maximum amount of time to process a captured image. When the timeout expires, the image processing is aborted. This timeout works in both Rapid Capture and Continuous Capture modes, as well as with the Configuration Database.
<i>Serial Cmd:</i>	< K245,image processing timeout >
<i>Default:</i>	5000 ms (5 sec.)
<i>Options:</i>	0 to 65535 (in 1 ms increments)

Notes:

- The timeout period does not include capture time.
- If a timeout occurs during processing and no symbols in the field of view have been decoded, the image will be recorded as a No-Read. For this reason, a longer timeout should be tried to ensure that the symbol is decoded successfully.

F-13 Image Storage

F-13-1 Image Storage Type

Definition: Allows the user to store images from separate read cycles and to retrieve them later. The number of available slots for storage depends on the mode of operation. If the reader is in **Rapid Capture Mode**, the number of images that can be stored is equivalent to the maximum number of the rapid count (the current rapid count setting). If the reader is in **Continuous Capture Mode**, a number of images equivalent to the maximum number of the rapid count minus 3.

Serial Cmd: <K244,*image storage type,image storage mode*>

Default: **Disabled/Clear**

Options: **0 = Disabled/Clear** 1 = Store on No-Read

Disabled/Clear

Upon selection of this option, all saved images will be cleared and the reader will not store images for later viewing.

Store on No Read

This option will cause the reader to store an image upon exiting the read cycle for retrieval at a later time. If multiple captures are present during the duration of a read cycle, the stored image will be the last image processed for that read cycle. This image is stored in RAM and can be retrieved as long as power is cycled to the reader, and as long as the reader has not been reset via a reset/save sequence. Other commands that can initialize storage in RAM are ones that change capture modes or put the reader in a test capture mode.

F-13-2 Image Storage Mode

Serial Cmd: <K244,*image storage type,image storage mode*>

Default: **First Mode**

Options: **0 = First Mode** 1 = Last Mode

First Mode

This mode allows the reader to store images until the available image memory has been filled. At that point the reader will stop saving additional images. In this mode, you will always have the first image captured, because the saving process stops once memory has been filled.

Last Mode

In this mode, image storage continues after available memory limits are reached. The oldest image in memory is overwritten, so you will always have the most recent stored image.

Image Storage Example

The following example assumes that the reader is in a **Rapid Capture Mode** set to **3 captures**.

Number of Symbols	1
Frame # 1	No Read
Frame # 2	No Read
Frame # 3	Good Read, Symbol # 1
Read Cycle Result	Good Read
Stored Frame	None

Number of Symbols	1
Frame # 1	No Read
Frame # 2	No Read
Frame # 3	No Read
Read Cycle Result	No Read
Stored Frame	Frame # 3

Number of Symbols	2
Frame # 1	No Read
Frame # 2	No Read
Frame # 3	Good Read, Symbol # 1
Read Cycle Result	No Read
Stored Frame	Frame # 2

F-14 Decodes Before Output

F-14-1 Good Decode(s) Needed

<i>Definition:</i>	This value specifies the number of times a symbol needs to be read to qualify as a good read.
<i>Serial Cmd:</i>	< K221,good decode(s) needed >
<i>Default:</i>	1
<i>Options:</i>	1 to 255



Symbologies

This section describes the various symbol types that can be decoded by V440-F readers.

G-1 Symbologies Serial Commands	G-2
G-2 Data Matrix	G-3
G-3 Aztec	G-5
G-4 QR Code	G-6
G-5 Micro QR Code	G-7
G-6 Code 39	G-8
G-7 Code 128/EAN 128	G-10
G-8 BC412	G-12
G-9 Interleaved 2 of 5	G-13
G-10 Code 93	G-15
G-11 Codabar	G-16
G-12 UPC/EAN	G-18
G-13 Pharmacode	G-21
G-14 Postal Symbologies	G-23
G-15 GS1 DataBar	G-26
G-16 PDF417	G-27
G-17 MicroPDF417	G-28
G-18 Composite	G-29
G-19 DotCode	G-30

G-1 Symbologies Serial Command

Composite	<K453,symbology status,separator status,separator character>
Aztec	<K458,status>
Micro QR Code	<K459,status>
Postal Symbologies	<K460,postal symbology type,POSTNET status,PLANET status,USPS4CB status>
Code 39	<K470,status,check character status,check character output status,large intercharacter gap,fixed symbol length status,fixed symbol length,full ASCII set>
Codabar	<K471,status,start/stop match,start/stop output,large intercharacter gap,fixed symbol length status,symbol length,check character type,check character output>
Interleaved 2 of 5	<K472,status,check character status,check character output status,symbol length #1,symbol length #2,guard bar status,range mode status>
UPC/EAN	<K473,UPC status,EAN status,supplemental status,separator status,separator character,supplemental type,format UPC-E as UPC-A>
Code 128/EAN 128	<K474,status,fixed symbol length status,fixed symbol length,EAN 128 status,output format,application record separator status,application record separator character,application record brackets,application record padding>
Code 93	<K475,status,fixed symbol length status,symbol length>
PDF417	<K476,status,unused,fixed symbol length status,symbol length>
Pharmacode	<K477,status,fixed bar count status,fixed bar count,minimum bar count,bar width mode,direction,fixed threshold value,background color>
Data Matrix Option	<K478,DMRE status,use alignment pattern status>
Data Matrix	<K479,ECC 200 status,ECC 000 status,ECC 050 status,ECC 080 status,ECC 100 status,ECC 140 status,ECC 120 status,ECC 130 status>
QR Code	<K480,status>
BC412	<K481,status,check character output,fixed symbol length status,fixed symbol length>
DataBar-14	<K482,status>
DataBar Limited	<K483,status>
DataBar Expanded	<K484,status,fixed symbol length status,fixed symbol length>
MicroPDF417	<K485,status,unused,fixed symbol length status,fixed symbol length>
DotCode	<K497,status,rotation mode,expected rows,expected columns>

G-2 Data Matrix

- Usage:* Very useful where information needs to be packed into a small area, and/or where symbols need to be applied directly to the substrate with laser etching, chemical etching, dot peen, or other methods.
- Definition:* Data Matrix is a type of Matrix symbology and has subsets ECC 000 - ECC 200. ECC 200 symbols have an even number of rows and an even number of columns. Most of the symbols are square with sizes from 10x10 to 144x144. Some symbols, however, are rectangular, with sizes from 8x18 to 16x48. All ECC 200 symbols can be recognized by the upper right corner module being light (binary 0) instead of dark.

G-2-1 ECC 200

- Definition:* When enabled, will decode ECC 200 Data Matrix symbols.
- Serial Cmd:* <**K479,ECC 200 status,ECC 000 status,ECC 050 status,ECC 080 status,ECC 100 status,ECC 140 status,ECC 120 status,ECC 130 status**>
- Default:* **Enabled**
- Note:** This is the only symbol type enabled by default.
- Options:* 0 = Disabled **1 = Enabled**

G-2-2 ECC 000

- Definition:* When enabled, will decode ECC 000 symbols.
- Serial Cmd:* <**K479,ECC 200 status,ECC 000 status,ECC 050 status,ECC 080 status,ECC 100 status,ECC 140 status,ECC 120 status,ECC 130 status**>
- Default:* **Disabled**
- Options:* **0 = Disabled** 1 = Enabled

G-2-3 ECC 050

- Definition:* When enabled, will decode ECC 050 symbols.
- Serial Cmd:* <**K479,ECC 200 status,ECC 000 status,ECC 050 status,ECC 080 status,ECC 100 status,ECC 140 status,ECC 120 status,ECC 130 status**>
- Default:* **Disabled**
- Options:* **0 = Disabled** 1 = Enabled

G-2-4 ECC 080

- Definition:* When enabled, will decode ECC 080 symbols.
- Serial Cmd:* <**K479,ECC 200 status,ECC 000 status,ECC 050 status,ECC 080 status,ECC 100 status,ECC 140 status,ECC 120 status,ECC 130 status**>
- Default:* **Disabled**
- Options:* **0 = Disabled** 1 = Enabled

G-2-5 ECC 100

- Definition:* When enabled, will decode ECC 100 symbols.
- Serial Cmd:* <**K479,ECC 200 status,ECC 000 status,ECC 050 status,ECC 080 status,ECC 100 status,ECC 140 status,ECC 120 status,ECC 130 status**>
- Default:* **Disabled**
- Options:* **0 = Disabled** 1 = Enabled

G-2-6 ECC 140

Definition: When enabled, will decode ECC 140 symbols.

Serial Cmd: <**K479**,ECC 200 status,ECC 000 status,ECC 050 status,ECC 080 status,ECC 100 status,**ECC 140 status**,ECC 120 status,ECC 130 status>

Default: **Disabled**

Options: **0 = Disabled** 1 = Enabled

G-2-7 ECC 120

Definition: When enabled, will decode ECC 120 symbols.

Serial Cmd: <**K479**,ECC 200 status,ECC 000 status,ECC 050 status,ECC 080 status,ECC 100 status,ECC 140 status,**ECC 120 status**,ECC 130 status>

Default: **Disabled**

Options: **0 = Disabled** 1 = Enabled

G-2-8 ECC 130

Definition: When enabled, will decode ECC 130 symbols.

Serial Cmd: <**K479**,ECC 200 status,ECC 000 status,ECC 050 status,ECC 080 status,ECC 100 status,ECC 140 status,ECC 120 status,**ECC 130 status**>

Default: **Disabled**

Options: **0 = Disabled** 1 = Enabled

G-2-9 DMRE (Data Matrix Rectangular Extensions)

Definition: When enabled, this option will decode the DMRE subtype of Data Matrix symbols with all allowed row / column combinations. "DMRE" stands for "Data Matrix Rectangular Extensions." This feature should be enabled to read all rectangular code types.

Serial Cmd: <**K478**,**DMRE status**,optimize using DM internal alignment pattern>

Default: **Disabled**

Options: **0 = Disabled** 1 = Enabled

G-2-10 Optimize using DM Internal Alignment Pattern

Definition: When enabled, this option will add extra processing for larger Data Matrix symbols that have added alignments.

Serial Cmd: <**K478**,DMRE status,**optimize using DM internal alignment pattern**>

Default: **Disabled**

Options: **0 = Disabled** 1 = Enabled

G-3 Aztec

- Usage:* Used in document imaging, railway ticket validation, and some postal applications.
- Definition:* A 2D matrix symbology built on a square grid with a square “bull’s-eye” pattern at the center. **Aztec** can encode up to 3,832 numeric or 3,067 alphabetical characters, or 1,914 bytes of data.
The level of Reed-Solomon error correction used with Aztec is configurable, from 5% to 95% of the total data region. The recommended error correction level is 23% of symbol capacity plus codewords.
- Serial Cmd:* <**K458,status**>
- Default:* **Disabled**
- Options:* **0 = Disabled** 1 = Enabled

G-4 QR Code

Usage: Widely implemented in the automotive industry in Japan and throughout their worldwide supply chain.

Definition: QR Code is capable of handling numeric, alphanumeric, and byte data as well as kanji and kana characters. Up to 7,366 characters (numeric data) can be encoded using this symbol. Therefore, less space is required to encode the same amount of data in a QR Code symbol than in a conventional symbol, lowering the cost of labelling.

Three Position Detection Patterns in the symbol make omnidirectional, ultra-fast reading possible.

QR Code has error protection capability. Data can often be restored even if a part of the symbol has become dirty or damaged.

Serial Cmd: <**K480,status**>

Default: **Enabled**

Options: 0 = Disabled **1 = Enabled**

G-5 Micro QR Code

- Usage:* Used in various applications that require higher data density than that provided by standard QR Code. Some application examples are automotive inventory, vehicle ID, and mobile phone URL encoding.
- Definition:* **Micro QR Code** is a 2D matrix symbology that comes in 4 different symbol sizes, the largest capable of encoding 35 numeric characters.
- Serial Cmd:* **<K459,status>**
- Default:* **Enabled**
- Options:* 0 = Disabled 1 = **Enabled**

G-6 Code 39

Usage: **Code 39** is considered the standard for non-retail 1D symbology.

Definition: An alphanumeric symbology with unique start/stop code patterns, composed of 9 black and white elements per character, of which 3 are wide.

Serial Cmd: *<K470,status,check character status,check character output status,large intercharacter gap,fixed symbol length status,fixed symbol length,full ASCII set>*

Default: **Enabled**

Options: 0 = Disabled 1 = Enabled

G-6-1 Check Character Status (Code 39)

Serial Cmd: *<K470,status,check character status,check character output status,large intercharacter gap,fixed symbol length status,fixed symbol length,full ASCII set>*

Default: **Disabled**

Options: **0 = Disabled** 1 = Enabled

G-6-2 Check Character Output Status (Code 39)

Usage: **Check Character Output Status**, added to the symbol, provides additional data security.

Definition: When enabled, the check character character is read and compared along with the symbol data. When disabled, symbol data is sent without the check character.

Note: With **Check Character Output Status** and an **External** or **Serial** trigger option enabled, an invalid check character calculation will cause a No-Read message to be transmitted at the end of the read cycle.

Serial Cmd: *<K470,status,check character status,check character output status,large intercharacter gap,fixed symbol length status,fixed symbol length,full ASCII set>*

Default: **Disabled**

Options: **0 = Disabled** 1 = Enabled

G-6-3 Large Intercharacter Gap (Code 39)

Usage: **Large Intercharacter Gap** is helpful for reading symbols that are printed out of specification.

Definition: When enabled, the reader can read symbols with gaps between symbol characters that exceed three times (3x) the narrow element width.

Serial Cmd: *<K470,status,check character status,check character output status,large intercharacter gap,fixed symbol length status,fixed symbol length,full ASCII set>*

Default: **Disabled**

Options: **0 = Disabled** 1 = Enabled

G-6-4 Fixed Symbol Length Status (Code 39)

- Definition:* When enabled, the reader will check the symbol length against the symbol length field. If disabled, any length will be considered valid.
- Serial Cmd:* <K470,status,check character status,check character output status,large intercharacter gap,fixed symbol length status,fixed symbol length,full ASCII set>
- Default:* **Disabled**
- Options:* **0 = Disabled** 1 = Enabled

G-6-5 Fixed Symbol Length (Code 39)

- Usage:* **Fixed Symbol Length** helps prevent truncations and increases data integrity by ensuring that only one symbol length will be accepted.
- Definition:* Specifies the exact number of characters that the reader will recognize (this does not include start and stop and check characters). The reader ignores any symbology that does not match the specified length.
- Serial Cmd:* <K470,status,check character status,check character output status,large intercharacter gap,fixed symbol length status,fixed symbol length,full ASCII set>
- Default:* **10**
- Options:* 1 to 64

G-6-6 Full ASCII Set (Code 39)

- Usage:* Must be enabled when reading characters outside the standard character set (0-9, A-Z, etc.)
The user must know in advance whether or not to use the **Full ASCII Set** option. Since **Full ASCII Set** requires two code words to encode one character, it is less efficient.
- Definition:* Standard Code 39 encodes 43 characters; zero through nine, capital "A" through capital "Z", minus symbol, plus symbol, forward slash, space, decimal point, dollar sign, and percent symbol. When **Full ASCII Set** is enabled, the reader can read the full ASCII character set, from 0 to 255.
- Serial Cmd:* <K470,status,check character status,check character output status,large intercharacter gap,fixed symbol length status,fixed symbol length,full ASCII set>
- Default:* **Disabled**
- Options:* **0 = Disabled** 1 = Enabled

G-7 Code 128/EAN 128

- Usage:** **Code 128** is a smaller symbology useful in applications with tight spots and high security needs.
- Definition:** A very dense alphanumeric symbology. It encodes all 128 ASCII characters, it is continuous, has variable length, and uses multiple element widths measured edge to edge.
- Serial Cmd:** *<K474,status,fixed symbol length status,fixed symbol length,EAN 128 status,output format,application record separator status,application record separator character,application record brackets,application record padding>*
- Default:** **Disabled**
- Options:** **0 = Disabled** 1 = Enabled

G-7-1 Fixed Symbol Length Status (Code 128/EAN 128)

- Definition:** When enabled, the reader will check the symbol length against the symbol length field. If disabled, any length will be considered a valid symbol.
- Serial Cmd:** *<K474,status,fixed symbol length status,fixed symbol length,EAN 128 status,output format,application record separator status,application record separator character,application record brackets,application record padding>*
- Default:** **Disabled**
- Options:** **0 = Disabled** 1 = Enabled

G-7-2 Fixed Symbol Length (Code 128/EAN 128)

- Usage:** **Fixed Symbol Length** helps prevent truncations and increases data integrity by ensuring that only one symbol length will be accepted.
- Definition:** This specifies the exact number of characters that the reader will recognize (this does not include start, stop, and check characters). The reader ignores any symbol not having the specified length.
- Serial Cmd:** *<K474,status,fixed symbol length status,fixed symbol length,EAN 128 status,output format,application record separator status,application record separator character,application record brackets,application record padding>*
- Default:** **10**
- Options:** 1 to 64

G-7-3 EAN 128 Status (Code 128/EAN 128)

- Definition:** When this field is disabled, the reader will not check any Code 128 labels for conformance to EAN requirements, or perform any special formatting. When enabled, the reader can read symbols with or without a function 1 character in the first position. If a symbol has a function 1 character in the first position, it must conform to EAN format. Symbols that conform to EAN format will also be subject to the special output formatting options available in this command. If EAN status is required, the reader will only decode symbols that have a function 1 character in the first position and that conform to EAN format. All symbols read will be subject to the special output formatting options available in this command.
- Note:** Code 128 status must be enabled for EAN status to be active.
- Serial Cmd:** *<K474,status,fixed symbol length status,fixed symbol length,EAN 128 status,output format,application record separator status,application record separator character,application record brackets,application record padding>*
- Default:** **Disabled**
- Options:** **0 = Disabled** 1 = Enabled 2 = Required

G-7-4 Output Format (Code 128/EAN 128)

- Definition:** In **Standard**, the reader will not apply special EAN output formatting options.
In **Application**, the reader will apply the special EAN output formatting options to decoded EAN-conforming symbols.
- Serial Cmd:** <**K474**,status,fixed symbol length status,fixed symbol length,EAN 128 status,**output format**,application record separator status,application record separator character,application record brackets,application record padding>
- Default:** **Standard**
- Options:** **0 = Standard** 1 = Application

G-7-5 Application Record Separator Status (Code 128/EAN 128)

- Definition:** When enabled, an EAN separator will be inserted into the output between fields whenever an EAN-conforming symbol is decoded and EAN output formatting applies.
- Serial Cmd:** <**K474**,status,fixed symbol length status,fixed symbol length,EAN 128 status,output format,**application record separator status**,application record separator character,application record brackets,application record padding>
- Default:** **Disabled**
- Options:** **0 = Disabled** 1 = Enabled

G-7-6 Application Record Separator Character (Code 128/EAN 128)

- Definition:** This is an ASCII character that serves as an EAN separator in formatted EAN output.
- Serial Cmd:** <**K474**,status,fixed symbol length status,fixed symbol length,EAN 128 status,output format,application record separator status,**application record separator character**,application record brackets,application record padding>
- Default:** ,
- Options:** Any ASCII character (7 bit)

G-7-7 Application Record Brackets (Code 128/EAN 128)

- Definition:** If an EAN-conforming symbol is decoded and EAN formatting applies, this feature places bracket characters around the application identifiers in the formatted output.
- Serial Cmd:** <**K474**,status,fixed symbol length status,fixed symbol length,EAN 128 status,output format,application record separator status,application record separator character,**application record brackets**,application record padding>
- Default:** **Disabled**
- Options:** **0 = Disabled** 1 = Enabled

G-7-8 Application Record Padding (Code 128/EAN 128)

- Definition:** This feature causes the reader to pad variable-length application fields with leading zeroes. This is not done for the last field of a symbol.
- Serial Cmd:** <**K474**,status,fixed symbol length status,fixed symbol length,EAN 128 status,output format,application record separator status,application record separator character,application record brackets,**application record padding**>
- Default:** **Disabled**
- Options:** **0 = Disabled** 1 = Enabled

G-8 BC412

- Usage:** Widely used in semiconductor manufacturing. Particularly useful where speed, accuracy, and ease of printing are required.
- Definition:** BC412 (Binary Code 412), a proprietary IBM symbology since 1988, is an alphanumeric symbol with a set of 35 characters, each encoded by a set of 4 bars in 12 module positions. All bars have a single width; it is the presence (1) or absence (0) of bars in each of the twelve module positions that make BC412 binary.
This symbology is also bi-directional and self-clocking, with a start character and a stop character.
- Serial Cmd:** <**K481,status,check character output,fixed symbol length status,fixed symbol length**>
- Default:** **Disabled**
- Options:** **0 = Disabled** 1 = Enabled

G-8-1 Check Character Output (BC412)

- Usage:** **Check Character Output**, added to the symbol, provides additional security.
- Definition:** When enabled, the check character is read and compared along with the symbol data. When disabled, symbol data is sent without the check character.
- Serial Cmd:** <**K481,status,check character output,fixed symbol length status,fixed symbol length**>
- Default:** **Disabled**
- Options:** **0 = Disabled** 1 = Enabled

G-8-2 Fixed Symbol Length Status (BC412)

- Definition:** When enabled, the reader will check the symbol length against the symbol length field. If disabled, any length will be considered valid.
- Serial Cmd:** <**K481,status,check character output,fixed symbol length status,fixed symbol length**>
- Default:** **Disabled**
- Options:** **0 = Disabled** 1 = Enabled

G-8-3 Fixed Symbol Length (BC412)

- Definition:** When enabled, the check character is read and compared along with the symbol data. When disabled, symbol data is sent without the check character.
- Serial Cmd:** <**K481,status,check character output,fixed symbol length status,fixed symbol length**>
- Default:** **10**
- Options:** 1 to 64

G-9 Interleaved 2 of 5

<i>Usage:</i>	I-2/5 has been popular because it is the most dense symbology for printing numeric characters less than 10 characters in length; however, Omron Microscan does not recommend this symbology for any new applications because of inherent problems such as truncation.
<i>Definition:</i>	A dense, continuous, self-checking, numeric symbology. Characters are paired together so that each character has five elements, two wide and three narrow, representing numbers 0 through 9, with the bars representing the first character and the interleaved spaces representing the second character. (A check character is highly recommended). Important: You must set Symbol Length in order to decode I-2/5 symbols, unless Range Mode is enabled.
<i>Serial Cmd:</i>	< K472,status,check character status,check character output status,symbol length #1,symbol length #2,guard bar status,range mode status >
<i>Default:</i>	Enabled
<i>Options:</i>	0 = Disabled 1 = Enabled

G-9-1 Check Character Status (Interleaved 2 of 5)

<i>Usage:</i>	This option is not typically used, but it can be enabled for additional security in applications where the host requires redundant check character verification.
<i>Definition:</i>	An error correcting routine in which the check character is added.
<i>Serial Cmd:</i>	< K472,status,check character status,check character output status,symbol length #1,symbol length #2,guard bar status,range mode status >
<i>Default:</i>	Disabled
<i>Options:</i>	0 = Disabled 1 = Enabled

G-9-2 Check Output Status (Interleaved 2 of 5)

<i>Definition:</i>	When enabled, a check character is sent along with the symbol data for added data security.
<i>Serial Cmd:</i>	< K472,status,check character status,check character output status,symbol length #1,symbol length #2,guard bar status,range mode status >
<i>Default:</i>	Disabled
<i>Options:</i>	0 = Disabled 1 = Enabled

G-9-3 Symbol Length #1 (Interleaved 2 of 5)

<i>Usage:</i>	Useful in applications where I 2/5 symbols of a specific length are required.
<i>Definition:</i>	The Symbol Length # 1 field is one of two fields against which the decoded symbol is compared before accepting it as valid or rejecting it.
<i>Serial Cmd:</i>	< K472,status,check character status,check character output,symbol length #1,symbol length #2,guard bar status,range mode status >
<i>Default:</i>	16
<i>Options:</i>	0 to 64, even only Important: If Range Mode is disabled, the length of the symbol must match either Symbol Length # 1 or Symbol Length # 2 to be considered a valid symbol. If Range Mode is enabled, Symbol Length # 1 and Symbol Length # 2 form a range into which the length of the symbol must fall to be considered valid.

G-9-4 Symbol Length #2 (Interleaved 2 of 5)

- Usage:* Useful in applications where I 2/5 symbols of a specific length are required.
- Definition:* The **Symbol Length # 2** field is one of two fields against which the decoded symbol is compared before accepting it as valid or rejecting it.
- Serial Cmd:* <**K472,status,check character status,check character output,symbol length #1,symbol length #2,guard bar status,range mode status**>
- Default:* **6**
- Options:* 0 to 64, even only
- Important:** If **Range Mode** is disabled, the length of the symbol must match either **Symbol Length # 2** or **Symbol Length # 1** to be considered a valid symbol.
- If **Range Mode** is enabled, **Symbol Length # 2** and **Symbol Length # 1** form a range into which the length of the symbol must fall to be considered valid.

G-9-5 Guard Bar Status (Interleaved 2 of 5)

- **Note:** Whenever **Guard Bar** is enabled, the presence of guard bars (also called “bearer bars”) is required for decoding to take place.

- Usage:* Useful when I-2/5 multisymbols are enabled to prevent false data output. This typically occurs with highly tilted or skewed symbols.
- Definition:* A guard bar is a heavy bar, at least twice the width of the wide bar, surrounding the printed I-2/5 symbol and helping to prevent false reads.
- Serial Cmd:* <**K472,status,check character status,check character output,symbol length #1,symbol length #2,guard bar status,range mode status**>
- Default:* **Disabled**
- Options:* **0 = Disabled** **1 = Enabled**

G-9-6 Range Mode Status (Interleaved 2 of 5)

- Usage:* Useful in applications where I 2/5 symbols of a specific length are required.
- Definition:* When **Range Mode** is disabled, the reader checks the value of the symbol length against the values set in **Symbol Length # 1** and **Symbol Length # 2**. If the symbol length does not match either of the preset values, then it is rejected as invalid.
- When **Range Mode** is enabled, **Symbol Length # 1** and **Symbol Length # 2** are combined to form a range of valid symbol lengths. Any symbol length that does not fall into this range is rejected as an invalid symbol. Either of the preset symbol length values in the **Symbol Length # 1** and **Symbol Length # 2** fields can form the start or end of the range.
- Serial Cmd:* <**K472,status,check character status,check character output,symbol length #1,symbol length #2,guard bar status,range mode status**>
- Default:* **Enabled**
- Options:* **0 = Disabled** **1 = Enabled**

G-10 Code 93

<i>Usage:</i>	Sometimes used in clinical applications.	
<i>Definition:</i>	Code 93 is a variable-length, continuous symbology employing four element widths. Each Code 93 character has nine modules that may be either black or white. Each character contains three bars and three spaces.	
<i>Serial Cmd:</i>	< K475 , <i>status</i> , <i>fixed symbol length status</i> , <i>symbol length</i> >	
<i>Default:</i>	Enabled	
<i>Options:</i>	0 = Disabled	1 = Enabled

G-10-1 Fixed Symbol Length Status (Code 93)

<i>Definition:</i>	When disabled, the reader will accept any Code 93 symbol provided is doesn't exceed the system's maximum capabilities. When enabled, the reader will reject any Code 93 symbol that doesn't match the fixed symbol length.	
<i>Serial Cmd:</i>	< K475 , <i>status</i> , <i>fixed symbol length status</i> , <i>symbol length</i> >	
<i>Default:</i>	Disabled	
<i>Options:</i>	0 = Disabled	1 = Enabled

G-10-2 Symbol Length (Code 93)

<i>Definition:</i>	This is the symbol length value against which all Code 93 symbols will be compared.	
<i>Serial Cmd:</i>	< K475 , <i>status</i> , <i>fixed symbol length status</i> , <i>symbol length</i> >	
<i>Default:</i>	10	
<i>Options:</i>	1 to 64	

G-11 Codabar

- Usage:** Used in photo-finishing and library applications. Previously used in medical applications, but not typically used in newer medical applications.
- Definition:** Codabar is a 16-bit character set (0 through 9, and the characters \$, :, /, ., +, and -) with start/stop codes and at least two distinctly different bar widths.
- Serial Cmd:** <**K471**,*status*,*start/stop match*,*start/stop output*,*large intercharacter gap*,*fixed symbol length status*,*symbol length*,*check character type*,*check character output*>
- Default:** **Disabled**
- Options:** **0 = Disabled** 1 = Enabled

G-11-1 Start/Stop Match (Codabar)

- Definition:** When disabled, the reader will decode Codabar symbols whether or not the start and stop characters are the same.
When enabled, the reader will not decode Codabar symbols unless the start and stop characters are the same.
- Serial Cmd:** <**K471**,*status*,**start/stop match**,*start/stop output*,*large intercharacter gap*,*fixed symbol length status*,*symbol length*,*check character type*,*check character output*>
- Default:** **Enabled**
- Options:** 0 = Disabled 1 = Enabled

G-11-2 Start/Stop Output (Codabar)

- Definition:** When disabled, the start and stop characters will *not* be present in the data output of the decoded symbol.
When enabled, the start and stop characters *will* be present in the data output of the decoded symbol.
Note: Because the start and stop characters are included as part of the data, the characters must be included as part of the length in a fixed length mode of operation.
- Serial Cmd:** <**K471**,*status*,*start/stop match*,**start/stop output**,*large intercharacter gap*,*fixed symbol length status*,*symbol length*,*check character type*,*check character output*>
- Default:** **Enabled**
- Options:** 0 = Disabled 1 = Enabled

G-11-3 Large intercharacter Gap (Codabar)

- Definition:** When disabled, the spaces between characters, or the “intercharacter gap”, are ignored during the decode process.
Note: If the intercharacter space is large enough to be considered a margin, the symbol will not decode, regardless of this parameter’s setting.
- Serial Cmd:** <**K471**,*status*,*start/stop match*,*start/stop output*,**large intercharacter gap**,*fixed symbol length status*,*symbol length*,*check character type*,*check character output*>
- Default:** **Disabled**
- Options:** **0 = Disabled** 1 = Enabled

G-11-4 Fixed Symbol Length Status (Codabar)

- Definition:** When disabled, the reader will accept any Codabar symbol provided it doesn't exceed the system's maximum capabilities.
When enabled, the reader will reject any Codabar symbol that doesn't match the fixed length.
- Serial Cmd:** <**K471**,status,start/stop match,start/stop output,large intercharacter gap,**fixed symbol length status**,symbol length,check character type,check character output>
- Default:** **Enabled**
- Options:** **0 = Disabled** 1 = Enabled

G-11-5 Symbol Length (Codabar)

- Definition:** This is the value against which all Codabar symbol lengths will be compared.
- Serial Cmd:** <**K471**,status,start/stop match,start/stop output,large intercharacter gap,**fixed symbol length status**,**symbol length**,check character type,check character output>
- Default:** **10**
- Options:** 1 to 64

G-11-6 Check Character Type (Codabar)

- Definition:** When disabled, the reader will not perform any character checking calculations on decoded Codabar symbols.
When set to **Mod 16**, the reader will perform a modulus 16 check character calculation on the symbol. If the symbol does not pass this calculation, it will not be decoded.
When set to **NW7**, The reader will perform an NW7 modulus 11 check character calculation on the symbol. If the symbol does not pass this calculation, it will not be decoded.
When set to **Both**, the reader will perform both the Mod 16 and NW7 modulus 11 check character calculations on the symbol. If the symbol does not pass either calculation, it will not be decoded.
- Serial Cmd:** <**K471**,status,start/stop match,start/stop output,large intercharacter gap,**fixed symbol length status**,symbol length,**check character type**,check character output>
- Default:** **Disabled**
- Options:** **0 = Disabled** 1 = Mod 16 2 = NW7 (Mod 11)
3 = Mod 16 and NW7

G-11-7 Check Character Output (Codabar)

- Definition:** When this field is disabled and a check character calculation is enabled, the reader will strip the verified check character from the symbol data output. This condition must be accounted for if a fixed length is also being used.
When enabled, the reader will output the check character as part of the symbol data. This condition must be accounted for if a fixed length is also being used.
- Serial Cmd:** <**K471**,status,start/stop match,start/stop output,large intercharacter gap,**fixed symbol length status**,symbol length,check character type,**check character output**>
- Default:** **Disabled**
- Options:** **0 = Disabled** 1 = Enabled

G-12 UPC/EAN

<i>Usage:</i>	Used primarily in point-of-sale applications in the retail industry. It is commonly used with the readers in applications in combination with Matchcode when there is a need to verify that the right product is being placed in the right packaging.	
<i>Definition:</i>	UPC (Universal Product Code) is a fixed length, numeric, continuous symbology. UPC can have two- or five-digit supplemental bar code data following the normal code. The UPC Version A (UPC, A) symbol is used to encode a 12 digit number. The first digit is the number system character, the next five are the manufacturer number, the next five are the product number, and the last digit is the checksum character. When enabled, the reader will read UPC Version A and UPC Version E only.	
<i>Serial Cmd:</i>	< K473 , UPC status , EAN status , supplementals status , separator status , separator character , supplemental type , format UPC-E as UPC-A >	
<i>Default:</i>	Enabled	
<i>Options:</i>	0 = Disabled	1 = Enabled

G-12-1 EAN Status

<i>Usage:</i>	EAN is the European version of the UPC symbology and is used in European market applications. Note: UPC must be enabled for EAN to take effect.	
<i>Definition:</i>	EAN is a subset of UPC. When enabled, the reader will read UPC Version A, UPC Version E, EAN 13, and EAN 8. It also appends a leading zero to UPC Version A symbol information and transmits 13 digits. If transmitting 13 digits when reading UPC Version A symbols is not desired, disable EAN. Note: The extra character identifies the country of origin.	
<i>Serial Cmd:</i>	< K473 , UPC status , EAN status , supplementals status , separator status , separator character , supplemental type , format UPC-E as UPC-A >	
<i>Default:</i>	Enabled	
<i>Options:</i>	0 = Disabled	1 = Enabled

G-12-2 Supplemental Status (UPC/EAN)

<i>Usage:</i>	Reads Supplementals typically used in publications and documentation.		
<i>Definition:</i>	A supplemental is a 2 to 5 digit symbol appended to the main symbol. When set to Enabled or Required , the reader reads supplemental code data that has been appended to the standard UPC or EAN codes.		
<i>Serial Cmd:</i>	< K473 , UPC status , EAN status , supplementals status , separator status , separator character , supplemental type , format UPC-E as UPC-A >		
<i>Default:</i>	Disabled		
<i>Options:</i>	0 = Disabled	1 = Enabled	2 = Required

Disabled

UPC **Supplementals** will not be decoded.

Enabled

When enabled, the reader will try to decode a main and a supplemental.

Required

When set to **Required**, both the main and the supplemental symbols must be read.

For example, if **Supplementals** is set to **Required**, **Separator** is enabled, and an asterisk is defined as the UPC separator character. Then the data is displayed as:

MAIN * SUPPLEMENTAL.

- **Note:** Under no circumstances will the supplemental symbol data be sent without a main symbol.
- **Note:** If additional symbols—other than the main or supplemental—will be read in the same read cycle, **Number of Symbols** should be set accordingly.

G-12-3 Separator Status (UPC/EAN)

<i>Usage:</i>	Allows users to distinguish between the main and Supplemental symbols.	
<i>Definition:</i>	A character can be inserted between the standard UPC or EAN symbology and the supplemental symbology when Supplementals is set to Enabled or Required .	
<i>Serial Cmd:</i>	< K473 ,UPC status,EAN status,supplementals status,separator status, separator character,supplemental type,format UPC-E as UPC-A>	
<i>Default:</i>	Disabled	
<i>Options:</i>	0 = Disabled	1 = Enabled

G-12-4 Separator Character (UPC/EAN)

<i>Usage:</i>	As required by the application.
<i>Definition:</i>	Allows the user to change the separator character from a comma to a new character.
<i>Serial Cmd:</i>	< K473 ,UPC status,EAN status,supplementals status,separator status, separator character,supplemental type,format UPC-E as UPC-A>
<i>Default:</i>	, (comma)
<i>Options:</i>	Any ASCII character.

- **Note:** Whenever **Separator Character** is defined as a comma (,) sending a <**K473,s?**> command will return the current settings, including the separator character comma which appears after the separator status comma.

G-12-5 Supplemental Type (UPC/EAN)

<i>Usage:</i>	As required by symbology used in application.		
<i>Definition:</i>	Allows the user to select 2 character or 5 character supplements, or both.		
<i>Serial Cmd:</i>	< K473 ,UPC status,EAN status,supplementals status,separator status, separator character,supplemental type,format UPC-E as UPC-A>		
<i>Default:</i>	Both		
<i>Options:</i>	0 = Both	1 = 2 characters only	2 = 5 characters only

Both

Either 2 character or 5 character supplementals will be considered valid.

2 Characters Only

Only two character supplementals will be considered valid.

5 Characters Only

Only five character supplementals will be considered valid.

G-12-6 Format UPC-E as UPC-A (UPC/EAN)

- Definition:* When disabled, the reader will output the version E symbols in their encoded 6-character format.
When enabled, the reader will format the symbol as either a 12-character UPC-A symbol or an EAN-13 symbol, depending on the state of the EAN status parameter. This formatting reverses the zero suppression that is used to generate the symbol in the UPC specification.
- Serial Cmd:* <**K473**,*UPC status,EAN status, supplementals status, separator status, separator character, supplemental type, **format UPC-E as UPC-A***>
- Default:* **Enabled**
- Options:* **0 = Disabled** 1 = Enabled

G-13 Pharmacode

<i>Usage:</i>	Used mostly with packaging for the pharmaceuticals industry.	
<i>Definition:</i>	Encodes up to five different numbers, each with its own color, which may be entered in decimal or "binary" format with a 1 represented by a thick bar and a 0 represented by a thin bar. Bar width is independent of height. In decimal format, each part can be up to 999,999. In binary format, each input can have up to 19 ones and zeros. Important: When Pharmacode is enabled, other linear symbologies will not decode properly. Disable Pharmacode before reading other linear symbologies.	
<i>Serial Cmd:</i>	< K477 , <i>status</i> , <i>fixed symbol length status</i> , <i>fixed symbol length</i> , <i>minimum number of bars</i> , <i>bar width status</i> , <i>direction</i> , <i>fixed threshold value</i> , <i>background color</i> >	
<i>Default:</i>	Disabled	
<i>Options:</i>	0 = Disabled	1 = Enabled

G-13-1 Fixed Symbol Length Status (Pharmacode)

<i>Definition:</i>	When enabled, the reader will check the symbol length against the symbol length field. If disabled, any length will be considered valid.	
<i>Serial Cmd:</i>	< K477 , <i>status</i> , fixed symbol length status , <i>fixed symbol length</i> , <i>minimum number of bars</i> , <i>bar width status</i> , <i>direction</i> , <i>fixed threshold value</i> , <i>background color</i> >	
<i>Default:</i>	Disabled	
<i>Options:</i>	0 = Disabled	1 = Enabled

G-13-2 Fixed Symbol Length (Pharmacode)

<i>Definition:</i>	Specifies the exact number of bars that must be present for the reader to recognize and decode the Pharmacode symbol.	
<i>Serial Cmd:</i>	< K477 , <i>status</i> , <i>fixed symbol length status</i> , fixed symbol length , <i>minimum number of bars</i> , <i>bar width status</i> , <i>direction</i> , <i>fixed threshold value</i> , <i>background color</i> >	
<i>Default:</i>	5	
<i>Options:</i>	1 to 16	

G-13-3 Minimum Number of Bars (Pharmacode)

<i>Definition:</i>	Sets the minimum number of bars that a Pharmacode symbol must have to be considered valid.	
<i>Serial Cmd:</i>	< K477 , <i>status</i> , <i>fixed symbol length status</i> , <i>fixed symbol length</i> , minimum number of bars , <i>bar width status</i> , <i>direction</i> , <i>fixed threshold value</i> , <i>background color</i> >	
<i>Default:</i>	4	
<i>Options:</i>	1 to 16	

G-13-4 Bar Width Status (Pharmacode)

Definition: If set to **Mixed**, the reader will autodiscriminate between narrow bars and wide bars. If set to **All Narrow**, all bars will be considered as narrow bars. If set to **All Wide**, all bars will be considered as wide bars. If set to **Fixed Threshold**, it will use the fixed threshold value to determine whether the bars are narrow or wide. The **Bar Width Status** setting will be ignored when the reader is able to tell the difference between the narrow and the wide bars.

Serial Cmd: <**K477**,*status, fixed symbol length status, fixed symbol length, minimum number of bars, bar width status, direction, fixed threshold value, background color*>

Default: **Mixed**

Options: **0 = Mixed**
 1 = All Narrow
 2 = All Wide
 3 = Fixed Threshold

G-13-5 Direction (Pharmacode)

Definition: Specifies the direction in which a symbol can be read.

Serial Cmd: <**K477**,*status, fixed symbol length status, fixed symbol length, minimum number of bars, bar width status, direction, fixed threshold value, background color*>

Default: **Forward**

Options: **0 = Forward** 1 = Reverse

G-13-6 Fixed Threshold Value (Pharmacode)

Definition: Used when **Bar Width Status** is set to **Fixed Threshold**. Defines the minimum difference in pixels that will distinguish a narrow bar from a wide bar.

Serial Cmd: <**K477**,*status, fixed symbol length status, fixed symbol length, minimum number of bars, bar width status, direction, fixed threshold value, background color*>

Default: **10**

Options: 1 to 65535

G-13-7 Background Color (Pharmacode)

Definition: Used when the color of bars is reversed. Sets the background color that a Pharmacode symbol must have to be considered valid.

Serial Cmd: <**K477**,*status, fixed symbol length status, fixed symbol length, minimum number of bars, bar width status, direction, fixed threshold value, background color*>

Default: **White**

Options: 0 = Black 1 = White

G-14 Postal Symbologies

Important: Postal Symbologies must have a minimum pixels-per-element value of **4** to be decoded reliably by the reader.

The reader must be configured to specific read range, field of view, and reader parameters before decoding Postal Symbologies.

For optimal decode results, position the symbol as close to the center of the reader's field of view as possible.

G-14-1 Postal Symbology Type

<i>Usage:</i>	The following 1D Postal Symbologies are used in mail sortation, auditing, certified mail, registered mail, metered mail, and point-of-sale (POS) applications.
<i>Definition:</i>	Determines the postal symbology that will be decoded by the reader.
<i>Serial Cmd:</i>	<code><K460,postal symbology type,POSTNET status,PLANET status,USPS4CB status></code>
<i>Default:</i>	Disabled
<i>Options:</i>	0 = Disabled 1 = U.S. Post (POSTNET, PLANET, USPS4CB) 2 = Australia Post 3 = Japan Post 4 = Royal Mail 5 = KIX 6 = UPU

U.S. Post (POSTNET, PLANET, USPS4CB)

When **U.S. Post** is enabled (`<K460,1>`), the reader will only decode **POSTNET**, **PLANET**, and **USPS4CB** symbols.

Important: POSTNET Status, PLANET Status, and USPS4CB Status are enabled by default. However, if any of the three U.S. Post symbologies is set to **disabled** individually, symbols of that type will not be decoded by the reader even when U.S. Post is enabled.

For example, if **U.S. Post** is enabled but **POSTNET Status** is disabled (`<K460,1,0>`), **POSTNET** symbols will not be decoded by the reader.

See **POSTNET Status, PLANET Status, and GS1 DataBar** for more detail about U.S. Post symbologies.

Australian Post

When **Australia Post** is enabled (`<K460,2>`), the reader will only decode Australia Post symbols.

Japan Post

When **Japan Post** is enabled (`<K460,3>`), the reader will only decode Japan Post symbols.

Royal Mail

When **Royal Mail** is enabled (`<K460,4>`), the reader will only decode Royal Mail symbols.

KIX

When **KIX** is enabled (<**K460,5**>), the reader will only decode KIX symbols.

UPU

When **UPU** is enabled, the reader will decode UPU symbols.

For example, if **Postal Symbology Type** is set to **UPU** and **POSTNET Status** is enabled and (<**K460,6,1**>), the reader will attempt to decode both UPU and POSTNET symbols.

G-14-2 POSTNET Status

Usage: **POSTNET** is used by the United States Postal Service to direct mail. The ZIP Code or ZIP+4 Code is encoded in the symbol. Data is encoded in half-height and full-height bars, making POSTNET a “2-state” symbology. The delivery point (usually the last two digits of the address or post office box number) is also typically encoded in POSTNET symbols.

Definition: If **U.S. Post** and **POSTNET Status** are both enabled, the reader will decode POSTNET symbols.

Serial Cmd: <**K460,postal symbology type,POSTNET status,PLANET status,USPS4CB status**>

Default: **Enabled**

Options: 0 = Disabled
1 = **Enabled**

G-14-3 PLANET Status

Usage: **PLANET (Postal Alphanumeric Encoding Technique)** is a symbology used by the United States Postal Service to track and identify items during delivery. Each PLANET symbol is either 12 or 14 digits long, and encodes data in half-height and full-height bars, making PLANET a “2-state” symbology. The symbol always starts and ends with a full-height bar, or “guard rail”, and each individual digit is represented by a set of five bars in which two of the bars are always short.

Definition: If **U.S. Post** and **PLANET Status** are both enabled, the reader will decode PLANET symbols.

Serial Cmd: <**K460,postal symbology type,POSTNET status,PLANET status,USPS4CB status**>

Default: **Enabled**

Options: 0 = Disabled
1 = **Enabled**

G-14-4 USPS4CB Status

- Usage:** **USPS4CB**, also called **Intelligent Mail**, is used by the United States Postal Service to sort and track individual items as well as flats of mail. USPS4CB combines the capabilities of POSTNET and PLANET, and can encode 31 digits (65 bars). USPS4CB symbols are slightly longer than POSTNET symbols, and offer additional flexibility in choosing symbol height and width. Data is encoded in four types of bars ("states"), each of which is identified by a name and a value. This type of postal symbol is known as "4-state". Each bar has a "tracker", or middle section, to which an "ascender" (top section) or "descender" (bottom section) may be added. The 4-state format allows the symbol to contain more information, and makes it easier to decode. 4-state symbols can also be printed easily in a variety of media, including dot matrix, inkjet, and laser.
- Definition:** If **U.S. Post** and **USPS4CB Status** are both enabled, the reader will decode USPS4CB symbols.
- Serial Cmd:** <**K460**,postal symbology type,POSTNET status,PLANET status,**USPS4CB status**>
- Default:** **Enabled**
- Options:** 0 = Disabled
1 = **Enabled**

G-15 GS1 DataBar

G-15-1 DataBar Expanded

Usage: Used to encode primary and supplementary data in retail point-of-sale and other applications.

Definition: DataBar Expanded is a variable length symbology that can encode supplementary information in addition to the 14-digit EAN item identification number and is capable of encoding up to 74 numeric or 41 alphabetic characters.

Serial Cmd: <**K484,status,fixed symbol length status,fixed symbol length**>

Default: **Enabled**

Options: 0 = Disabled 1 = Enabled

G-15-2 Fixed Symbol Length Status (DataBar Expanded)

Definition: When enabled, the reader will check the symbol length against the symbol length field, minus the embedded check character. If disabled, any length would be considered valid.

Serial Cmd: <**K484,status,fixed symbol length status,fixed symbol length**>

Default: **Disabled**

Options: **0 = Disabled** 1 = Enabled

G-15-3 Fixed Symbol Length (DataBar Expanded)

Usage: **Fixed Symbol Length** helps prevent truncations and increases data integrity by ensuring that only one symbol length will be accepted.

Definition: Specifies the exact number of characters that the reader will recognize (this does not include start, stop, and check character characters). The reader ignores any symbol not having the specified length.

Serial Cmd: <**K484,status,fixed symbol length status,fixed symbol length**>

Default: **14**

Options: 1 to 74

G-15-4 DataBar Limited

Usage: DataBar Limited is designed to be read by laser and CCD readers. It is not recommended for omnidirectional slot scanners.

Definition: Encodes a smaller 14-digit symbol (74 modules wide) that is not omnidirectional.

Serial Cmd: <**K483,status**>

Default: **Enabled**

Options: 0 = Disabled 1 = Enabled

G-15-5 DataBar-14

Usage: Used in the grocery, retail, and prescription drug industries where 14-digit EAN item identification may be needed.

Definition: DataBar-14 is a fixed symbol length symbology that encodes 14 digits, including a 1-digit indicator. DataBar-14 is 96 modules wide. It can be stacked in two rows, it can read omnidirectionally if printed in full height, or horizontally if height-truncated for small marking.

Serial Cmd: <**K482,status**>

Default: **Enabled**

Options: 0 = Disabled 1 = Enabled

G-16 PDF417

<i>Usage:</i>	Used in applications where a large amount of information (over 32 characters) needs to be encoded within a symbol, typically where the symbol is transported from one facility to another. For example, an automobile assembly line might use a single symbol with multiple fields of information that will be read at several stations along the way, without reference to a database.	
<i>Definition:</i>	A two-dimensional, multi-row (3 to 90), continuous, variable length symbology that has high data capacity for storing up to 2,700 numeric characters, 1,800 printable ASCII characters, or 1,100 binary characters per symbol. Each symbol character consists of 4 bars and 4 spaces in a 17-module structure.	
<i>Serial Cmd:</i>	< K476 , <i>status</i> , <i>unused</i> , <i>fixed symbol length status</i> , <i>fixed symbol length</i> >	
<i>Default:</i>	Enabled	
<i>Options:</i>	0 = Disabled	1 = Enabled

- **Note:** Sending <a1> will cause PDF417 data to be prefaced with information consisting of error correction level (ECC Level *n*), number of rows (*n* Rows), number of columns (*n* Columns), number of informative code words (*n* Info Code Words) and the number of data characters (*n* Data Characters). This feature can be disabled by re-sending <a1>.

G-16-1 Fixed Symbol Length Status (PDF417)

<i>Serial Cmd:</i>	< K476 , <i>status</i> , <i>unused</i> , <i>fixed symbol length status</i> , <i>fixed symbol length</i> >	
<i>Default:</i>	Disabled	
<i>Options:</i>	0 = Disabled	1 = Enabled

G-16-2 Fixed Symbol Length (PDF417)

<i>Usage:</i>	Used to increase data integrity by ensuring that only one symbol length will be accepted.	
<i>Definition:</i>	When enabled, the PDF symbol must contain the same number of characters as the symbol length setting before it can be considered a good read. The reader will ignore any symbol not having the specified length.	
<i>Serial Cmd:</i>	< K476 , <i>status</i> , <i>unused</i> , <i>fixed symbol length status</i> , <i>fixed symbol length</i> >	
<i>Default:</i>	10	
<i>Options:</i>	1 to 2710	

- **Note:** **Fixed Symbol Length Status** must be enabled for **Fixed Symbol Length** to take effect.

G-17 MicroPDF417

<i>Usage:</i>	Used for labelling small items that need large data capacity.	
<i>Definition:</i>	A variant of PDF417, a very efficient and compact stacked symbology that can encode up to 250 alphanumeric characters or 366 numeric characters per symbol.	
<i>Serial Cmd:</i>	< K485 , <i>status</i> , <i>unused</i> , <i>fixed symbol length status</i> , <i>fixed symbol length</i> >	
<i>Default:</i>	Enabled	
<i>Options:</i>	0 = Disabled	1 = Enabled

G-17-1 Fixed Symbol Length Status (MicroPDF417)

<i>Serial Cmd:</i>	< K485 , <i>status</i> , <i>unused</i> , <i>fixed symbol length status</i> , <i>fixed symbol length</i> >	
<i>Default:</i>	Enabled	
<i>Options:</i>	0 = Disabled	1 = Enabled

G-17-2 Fixed Symbol Length (MicroPDF417)

<i>Usage:</i>	Used to increase data integrity by ensuring that only one symbol length will be accepted.
<i>Definition:</i>	When enabled, the MicroPDF417 symbol must contain the same number of characters as the symbol length setting before it can be considered a good read. The reader will ignore any symbol not having the specified length.
<i>Serial Cmd:</i>	< K485 , <i>status</i> , <i>unused</i> , <i>fixed symbol length status</i> , <i>fixed symbol length</i> >
<i>Default:</i>	10
<i>Options:</i>	1 to 366

Note: Fixed Symbol Length Status must be enabled for Fixed Symbol Length to take effect.

G-18 Composite

When set to **Enabled** or **Required**, will decode the 2D composite component of a linear symbol. The linear symbol can be DataBar-14, DataBar Expanded, DataBar Limited, EAN-128, UPC-A, EAN-13, EAN-8, and UPC-E.

<i>Usage:</i>	Allows reading by both linear and 2D readers.		
<i>Definition:</i>	Combines 2D and linear width-modulated symbology on the same symbol where different messages can be read by each reader type.		
<i>Serial Cmd:</i>	<K453,mode,separator status,separator>		
<i>Default:</i>	Disabled		
<i>Options:</i>	0 = Disabled	1 = Enabled	2 = Required

Enabled

If **Composite** is set to **Enabled**, the reader will decode both the 2D composite and linear components. However, if the 2D composite component is not decoded, the linear data will be sent by itself at the end of the read cycle.

Required

If set to **Required**, the reader must decode both components, or a No-Read will occur.

G-18-1 Separator Status (Composite)

<i>Usage:</i>	Allows the user to distinguish between the main and Supplemental symbols.		
<i>Definition:</i>	Separates the linear and the composite component.		
<i>Serial Cmd:</i>	<K453,mode,separator status,separator>		
<i>Default:</i>	Disabled		
<i>Options:</i>	0 = Disabled	1 = Enabled	

G-18-2 Separator Character (Composite)

- **Note:** The Separator Character will be the same as the character defined in the **Multisymbol Separator** field of the <K222> command.

<i>Usage:</i>	As required by the application.		
<i>Definition:</i>	Allows the user to change the separator character from a comma to a new character.		
<i>Serial Cmd:</i>	<K453,mode,separator status,separator>		
<i>Default:</i>	, (comma)		
<i>Options:</i>	Any ASCII character.		

G-19 DotCode

Important: When **DotCode** is enabled, no other symbologies will be decodable. You must disable DotCode to decode symbols of any other type.

G-19-1 DotCode Status

Serial Cmd: <**K497**,*status*,*rotation mode*,*expected rows*,*expected columns*>

Default: **0 = Disabled**

Options: **0 = Disabled**
1 = Enabled

Disabled

The reader will not attempt to decode DotCode symbols.

Enabled

The reader will attempt to decode DotCode symbols.

G-19-2 Rotation Mode

Serial Cmd: <**K497**,*status*,**rotation mode**,*expected rows*,*expected columns*>

Default: **0 = No Rotation**

Options: **0 = No Rotation**
1 = Low Rotation
2 = Omnidirectional

No Rotation

The reader will decode horizontal and vertical symbols (**+/- approximately 3 degrees**).

Low Rotation

The reader will decode **+/- approximately 10 degrees** from the horizontal or vertical symbols. It is slightly slower than the No Rotation option.

Omnidirectional

The reader will support **360 degree** reading. Omnidirectional is significantly slower than the other two options.

G-19-3 Expected Rows

Definition: **Expected Rows** allows you to specify the exact number of rows in the code to minimize the possibility of decoding errors and no reads. If you specify the exact row dimensions, only DotCode symbols of the same dimensions are decoded.

Serial Cmd: <**K497**,*status*,*rotation mode*,**expected rows**,*expected columns*>

Default: **0**

Options: 0 to 256

G-19-4 Expected Columns

Definition: **Expected Columns** allows you to specify the exact number of columns in the code to minimize the possibility of decoding errors and no reads. If you specify the exact column dimensions, only DotCode symbols of the same dimensions are decoded.

Serial Cmd: <**K497**,*status*,*rotation mode*,*expected rows*,**expected columns**>

Default: **0**

Options: 0 to 256



I/O Parameters

This section includes instructions on setting up conditions for changing input/output electrical transitions for control of the reader's internal and external devices. A discrete I/O (in/out) signal is an electrical transition from one voltage level to another so that digital switching can occur.

H-1	I/O Parameters Serial Commands	H-2
H-2	Symbol Data Output	H-4
H-3	No-Read Message	H-6
H-4	Read Duration Output	H-7
H-5	Serial Verification	H-8
H-6	Configurable Output 1	H-9
H-7	Trend Analysis Output 1	H-11
H-8	ISO/IEC 16022 Symbol Quality Output 1	H-13
H-9	ISO/IEC 15415 Symbol Quality Output 1	H-15
H-10	ISO/IEC 15416 Symbol Quality Output 1	H-20
H-11	ISO/IEC 29158 Symbol Quality Output 1	H-26
H-12	Diagnostics Output 1	H-30
H-13	Other Outputs	H-31
H-14	Power On/Reset Counts	H-35
H-15	Time Since Reset	H-36
H-16	Service Message	H-37
H-17	User-Assigned Name	H-38
H-18	Output Object Info	H-39
H-19	Database Identifier Output	H-40
H-20	Quality Output	H-41
H-21	Image Push to Host	H-42
H-22	Image Push to Host Detailed Setup	H-44



H-1 I/O Parameters Serial Commands

Power On/Reset Counts	<K406,power-on,resets,power-on saves,customer default saves>
Time Since Reset (Read-Only)	<K407,hours,minutes>
Service Message	<K409,status,service message,threshold,resolution>
User-Defined Name	<K412,user-defined name>
Serial Verification	<K701,serial command echo status,control/hex output>
Quality Output	<K704,quality output separator,decodes per trigger status>
Symbol Data Output	<K705,status,when to output,symbology identifier status>
Read Duration Output	<K706,status,separator>
No-Read Message	<K714,status,message>
Output Object Info	<K734,output frame number status,output coordinates status>
Database Identifier Output	<K759,status,separator character>
Image Push to Host	<K764,Image Storage Status,Stored Image Type,Image Storage, Image File Format,Image Quality,Image Scale,File Save Options>
Image Push to Host Detail Setup	<K763,Image Storage Location,FTP Host Info,Transfer Optimization, RAM Drive Size in MB,Save Image Until,Action at Image Storage Limit>
Trend Analysis Output 1	<K780,trend analysis mode,number of triggers,number to output on,decodes per trigger>
Trend Analysis Output 2	<K781,trend analysis mode,number of triggers,number to output on,decodes per trigger>
Trend Analysis Output 3	<K782,trend analysis mode,number of triggers,number to output on,decodes per trigger>
Diagnostic Output 1	<K790,service unit message status>
Diagnostic Output 2	<K791,service unit message status>
Diagnostic Output 3	<K792,service unit message status>
ISO/IEC 16022 Symbol Quality Output 1	<K800,output on symbol contrast,symbol contrast threshold,output on print growth,print growth threshold,output on axial non-uniformity, axial non-uniformity threshold,output on Unused ECC,Unused ECC threshold>
ISO/IEC 16022 Symbol Quality Output 2	<K801,output on symbol contrast,symbol contrast threshold,output on print growth,print growth threshold,output on axial non-uniformity, axial non-uniformity threshold,output on Unused ECC,Unused ECC threshold>
ISO/IEC 16022 Symbol Quality Output 3	<K802,output on symbol contrast,symbol contrast threshold,output on print growth,print growth threshold,output on axial non-uniformity, axial non-uniformity threshold,output on Unused ECC,Unused ECC threshold>
Output 1 Parameters	<K810,output on,output state,pulse width,output mode>
Output 2 Parameters	<K811,output on,output state,pulse width,output mode>
Output 3 Parameters	<K812,output on,output state,pulse width,output mode>
ISO/IEC 15415 Symbol Quality Output 1	<K870,Output on Overall Grade, Overall Grade Threshold, Symbol Contrast, Symbol Contrast Threshold, Modulation, Modulation Threshold, Reflectance Margin, Reflectance Margin Threshold, Fixed Pattern Damage, Fixed Pattern Damage Threshold, Axial Nonuniformity, Axial Nonuniformity Threshold, Grid Nonuniformity, Grid Nonuniformity Threshold, Unused ECC,Unused ECC Threshold>

ISO/IEC 15415 Symbol Quality Output 2	< K871 , Output on Overall Grade, Overall Grade Threshold, Symbol Contrast, Symbol Contrast Threshold, Modulation, Modulation Threshold, Reflectance Margin, Reflectance Margin Threshold, Fixed Pattern Damage, Fixed Pattern Damage Threshold, Axial Nonuniformity, Axial Nonuniformity Threshold, Grid Nonuniformity, Grid Nonuniformity Threshold, Unused ECC, Unused ECC Threshold>
ISO/IEC 15415 Symbol Quality Output 3	< K872 , Output on Overall Grade, Overall Grade Threshold, Symbol Contrast, Symbol Contrast Threshold, Modulation, Modulation Threshold, Reflectance Margin, Reflectance Margin Threshold, Fixed Pattern Damage, Fixed Pattern Damage Threshold, Axial Nonuniformity, Axial Nonuniformity Threshold, Grid Nonuniformity, Grid Nonuniformity Threshold, Unused ECC, Unused ECC Threshold>
ISO/IEC 15416 Symbol Quality Output 1	< K880 , Output on Overall Grade, Overall Grade Threshold, Edge Determination, Edge Determination Threshold, Decode, Decode Threshold, Contrast, Contrast Threshold, Min Reflectance, Min Reflectance Threshold, Min Edge Contrast, Min Edge Contrast Threshold, Modulation, Modulation Threshold, Defects, Defects Threshold, Decodability, Decodability Threshold, Quiet Zone, Quiet Zone Threshold >
ISO/IEC 15416 Symbol Quality Output 2	< K881 , Output on Overall Grade, Overall Grade Threshold, Edge Determination, Edge Determination Threshold, Decode, Decode Threshold, Contrast, Contrast Threshold, Min Reflectance, Min Reflectance Threshold, Min Edge Contrast, Min Edge Contrast Threshold, Modulation, Modulation Threshold, Defects, Defects Threshold, Decodability, Decodability Threshold, Quiet Zone, Quiet Zone Threshold >
ISO/IEC 15416 Symbol Quality Output 3	< K882 , Output on Overall Grade, Overall Grade Threshold, Edge Determination, Edge Determination Threshold, Decode, Decode Threshold, Contrast, Contrast Threshold, Min Reflectance, Min Reflectance Threshold, Min Edge Contrast, Min Edge Contrast Threshold, Modulation, Modulation Threshold, Defects, Defects Threshold, Decodability, Decodability Threshold, Quiet Zone, Quiet Zone Threshold >
ISO/IEC 29158 Symbol Quality Output 1	< K890 , Output on Overall Grade, Overall Grade Threshold, Cell Contrast, Cell Contrast Threshold, Cell Modulation, Cell Modulation Threshold, Fixed Pattern Damage, Fixed Pattern Damage Threshold, Axial Nonuniformity, Axial Nonuniformity Threshold, Grid Nonuniformity, Grid Nonuniformity Threshold, Unused ECC, Unused ECC Threshold>
ISO/IEC 29158 Symbol Quality Output 2	< K891 , Output on Overall Grade, Overall Grade Threshold, Cell Contrast, Cell Contrast Threshold, Cell Modulation, Cell Modulation Threshold, Fixed Pattern Damage, Fixed Pattern Damage Threshold, Axial Nonuniformity, Axial Nonuniformity Threshold, Grid Nonuniformity, Grid Nonuniformity Threshold, Unused ECC, Unused ECC Threshold>
ISO/IEC 29158 Symbol Quality Output 3	< K892 , Output on Overall Grade, Overall Grade Threshold, Cell Contrast, Cell Contrast Threshold, Cell Modulation, Cell Modulation Threshold, Fixed Pattern Damage, Fixed Pattern Damage Threshold, Axial Nonuniformity, Axial Nonuniformity Threshold, Grid Nonuniformity, Grid Nonuniformity Threshold, Unused ECC, Unused ECC Threshold>

H-2 Symbol Data Output

H-2-1 Symbol Data Output Status

- **Note:** **Symbol Data Output** relates to data and should not be confused with **Outputs 1, 2, and 3** listed in the **Output Parameters** which describe output states and functions.

Usage:	Useful when the host needs symbol data only under certain conditions.
Definition:	Defines the conditions under which decoded symbol data is transmitted to the host.
Serial Cmd:	<code><K705,symbol data output status,when to output,symbology identifier status></code>
Default:	Good Read
Options:	0 = Disabled 1 = Match 2 = Mismatch 3 = Any Good Read 4 = Only If All Good Reads

Note: **Symbol Data Output Status**, if set to **Match** or **Mismatch**, will not take effect unless **Matchcode Type** is enabled and a master symbol is loaded into memory.

Disabled

Usage:	It is useful when an application only needs to use the discrete outputs and can allow the reader to do the decision-making. When Disabled , the host does not need the symbol data and the communication lines are used only for setup and status checks.
Definition:	When set to Disabled , the reader will not transmit any data that is generated during a read cycle (symbols, No-Reads, etc.)

Match

Usage:	Match is used in an application that requires specific symbol information and needs to sort, route, or verify based on matching the specific symbol data.
Definition:	When set to Match , the reader transmits symbol data whenever a symbol matches a master symbol. However, if Matchcode Type is Disabled , it transmits on any good read.

Note: A No-Read can still be transmitted if **Enabled**.

Mismatch

Usage:	Mismatch is typically used as a flag within the host system to prevent an item from being routed in the wrong container.
Definition:	With Mismatch enabled, the reader transmits symbol data whenever the symbol data information does NOT match the master symbol.

Note: A No-Read can still be transmitted if **Enabled**.

Any Good Read

Usage:	Any Good Read is used when an application requires all symbol data to be transmitted. It's typically used in tracking applications in which each object is uniquely identified.
Definition:	With Any Good Read enabled, the reader outputs symbol data for any qualified symbol in the read cycle regardless of Matchcode Type setting. No Read is output if no symbols are qualified.

Only If All Good Reads

Definition: With **Only If All Good Reads** enabled, the reader outputs symbol data only when all symbols in the read cycle are qualified. **No Read** is output if no symbols are qualified.

H-2-2 When to Output Symbol Data

Definition: This command allows the user to choose when symbol data can be sent to the host.

Serial Cmd: <K705,symbol data output status,when to output,symbology identifier status>

Default: As Soon As Possible

Options: 0 = ASAP 1 = End of Read Cycle

As Soon As Possible

Usage: As Soon As Possible is useful in applications in which symbol data needs to be moved quickly to the host, typically when the host is making decisions based on symbol data.

Definition: Enabling **As Soon As Possible** causes symbol data to be sent to the host immediately after a symbol has been successfully decoded.

- **Note:** More than one decode might in fact be required to qualify as a good read, depending on how **Decodes Before Output** is set.

End of Read Cycle

Usage: **End of Read Cycle** is useful in timing-based systems in which the host is not ready to accept data at the time that it is decoded.

Definition: Enabling **End of Read Cycle** means that symbol data does not get sent to the host until the read cycle ends with a timeout or new trigger.

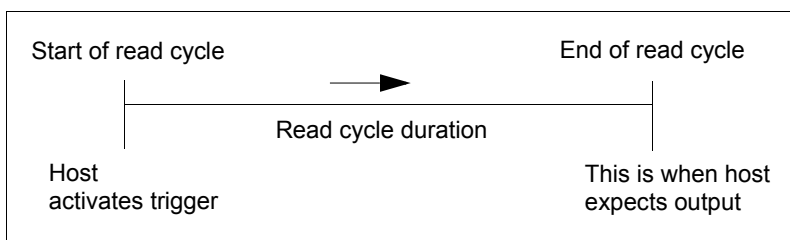

H-2-3 Symbology Identifier Status

Serial Cmd: <K705,symbol data output status,when to output,symbology identifier status>

Default: Disabled

Options: 0 = Disabled 1 = Enabled

Disabled

When set to **Disabled**, the symbol data output does not contain symbology information.

Enabled

When set to **Enabled**, the symbol data output contains a three-character symbology identifier sequence.

H-3 No-Read Message

- Usage: Used in applications where the host needs serial verification that a symbol has not been read and especially useful in new print verification.
- Definition: When enabled, and if no symbol has been decoded before timeout or the end of the read cycle, the No-Read message will be transmitted to the host.

H-3-1 No-Read Message Mode

- Serial Cmd: <**K714**,*No-Read message status*,*No-Read message*>
- Default: Enabled
- Options: 0 = Disabled 1 = Enabled

Disabled

Only symbol data is output after a read cycle.

Enabled

When the reader is in a triggered mode, a No-Read message will be appended for each failed read attempt.

H-3-2 No-Read Message

- Definition: Any combination of ASCII characters can be defined as the No-Read message.
- Serial Cmd: <**K714**,*No-Read message status*,*No-Read message*>
- Default: NOREAD
- Options: A string of up to 64 characters.

Note: No-Read Message will only be transmitted if **Symbol Data Output** is set to **Match**, **Mismatch**, or **Good Read**.

No-Read Message can be set to any ASCII character.

H-4 Read Duration Output

- Usage: Useful in evaluating actual read cycle timing results, especially when initially setting up an application to determine maximum line speed (obtainable based on spacing between symbols.)
- Definition: When enabled the duration of the read cycle (in milliseconds) is appended to the symbol data.
The read duration is the time from the beginning of the read cycle until data is output.

H-4-1 Read Duration Output Mode

- Serial Cmd: <K706,status,separator>
Default: Disabled
Options: 0 = Disabled 1 = Enabled

- **Important:** To measure the entire read cycle when in **External Level** trigger mode, set **When to Output Symbol Data** to **End of Read Cycle**.

This output can measure over 49 days' worth of duration; if exceeded, the "OVERFLOW" message will be output in place of the duration.

H-4-2 Read Duration Output Separator

- Definition: User defined character that separates the symbol information from the **Read Duration Output**.
- Serial Cmd: <K706,status,separator>
Default: [space character]
Options: Any ASCII character.

H-5 Serial Verification

Allows the user to verify configuration command status.

H-5-1 Serial Command Echo Status

Usage: This command is useful in removing any doubt about the reader's interpretation of any configuration command.

For example, if the current preamble is "SOM" and **<K701,1, ,START>** is entered, the reader will echo back **<K701,SOM>** since the attempted entry "START" exceeds the four character limit for that command. Therefore, it is rejected and the existing "SOM" message is echoed back and remains the preamble message.

Definition: When enabled, a configuration command received from the host is echoed back to the host with the resultant settings.

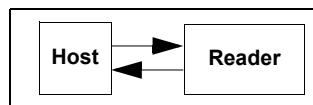

Function: If a command with multiple fields is processed, some of the fields may have been processed properly while others were not. The changes will appear in the string echoed back so that the user will know which fields did or did not change.

Serial Cmd: **<K701,serial command echo status, unused, control/hex output>**

Default: Disabled

Options: 0 = Disabled 1 = Enabled

H-5-2 Control/Hex Output

Usage: Useful for viewing settings with binary characters when using serial commands on a terminal.

Definition: Determines the response to a **Serial Command Echo** or status request command.

When set to **Control**, two characters are transmitted to represent a non-displayable character. For example, a carriage return will be shown as: **^M**.

Serial Cmd: **<K701,serial command echo status, unused, control/hex output>**

Default: Control

Options: 0 = Control 1 = Hex

H-6 Configurable Output 1

Usage:	This option provides discrete signalling to host software to control external devices such as PLCs and relays. It is useful for routing, sorting, and to prevent mis-packaging and mis-routing.
Definition:	Sets the discrete output functions for specific user-selected conditions. Allows the user to set the conditions under which an output (or outputs) will be activated.
Serial Cmd:	<K810,output on,output state,pulse width,output mode>
Default:	Mismatch or No-Read
Options:	0 = Mismatch or No-Read 1 = Match (or Good Read) 2 = Mismatch 3 = No-Read 4 = Trend Analysis 5 = Symbol Quality 6 = Diagnostic Warning 7 = In Read Cycle

Note: If **Output On** is set to **Match** or **Mismatch**, a transition (switching) will not occur unless **Matchcode Type** is enabled and a master symbol is loaded into memory.

Mismatch or No-Read

Activates discrete output when the data does not match that of the master symbol or the symbol has not been decoded before the end of the read cycle.

Match (or Good Read)

Activates a discrete output when the symbol data matches the master symbol.

Note: If you want to output for a good read and **Matchcode** is not enabled, you can enable any output for **Match**.

Mismatch

Activates a discrete output whenever the symbol data does not match that of the master symbol.

No-Read

Activates a discrete output whenever the symbol data is not decoded before the end of the read cycle.

Trend Analysis

Usage:	Typically used when successful decodes are occurring but a discrete output is needed to flag a trend in quality issues.
Definition:	Activates discrete output when a trend analysis condition is met, depending on the trend analysis option enabled.

Symbol Quality

Usage:	Typically used when a discrete indication is needed to flag a symbol quality condition.
Definition:	Activates discrete output when a symbol quality condition is met, depending on the symbol quality option enabled.

Diagnostic Warning

Usage: Typically used when a discrete indication of a diagnostic condition is needed.
 Definition: Activates discrete output when a diagnostic warning condition is met, depending on the diagnostic option enabled.

In Read Cycle

Definition: Activates a discrete output when the reader is in a read cycle.

H-6-1 Output State

Definition: Sets the active electrical state of the discrete output.
 Serial Cmd: <K810,output on,output state,pulse width,output mode>
 Default: Normally Open
 Options: 0 = Normally Open 1 = Normally Closed

H-6-2 Pulse Width

Definition: Sets the time in 1 ms increments that the discrete output remains active.
 Serial Cmd: <K810,output on,output state,pulse width,output mode>
 Default: 500ms
 Options: 0 to 65535(in 1 ms increments)

H-6-3 Output Mode

Definition: Sets the condition in which the discrete output is de-activated.
 Serial Cmd: <K810,output on,output state,pulse width,output mode>
 Default: Pulse
 Options: 0 = Pulse
 2 = Latch Mode 2
 3 = Latch Mode 3

Pulse

This is the default mode of operation in which the programmable output is activated when the **Output On** condition has been met and held active for the duration of the selected pulse width.

Latch Mode 2 (*Unlatch Opposite Condition*)

The programmable output is activated when the **Output On** condition has been met and held active until the opposite condition selected under **Output On** has been met.

For example, if **No-Read** is enabled under **Output On**, the programmable output will go active on a No-Read and remain active until the opposite condition, a good read, occurs.

Latch Mode 3 (*Unlatch Re-enter Read Cycle*)

The programmable output is active when the Output On condition has been met and is held active until a new read cycle begins.

- **Note:** All of the **Output On** modes are inhibited when any **Output on Warning** is active for **Output 1**.

H-7 Trend Analysis Output 1

Usage:	Useful in cases where the user doesn't want to shut down for one condition but wants to monitor quality and read conditions.
Definition:	Applies Trend Analysis settings to Output 1 . With Trend Analysis , the user can track the occurrences and frequency of mismatches, No-Reads, and the number of reads per trigger, and output the results to any of three outputs.
Example:	Trend Analysis Mode = No-Read Trigger Evaluation Period= 25 triggers (read cycles) Number to Output On = 4 In this example, the reader will activate an output when 4 No-Reads occur within a period of 25 triggers (read cycles).

H-7-1 Trend Analysis Mode

Definition:	Sets the trend condition (Mismatch , No-Read , or Decodes per Trigger) that will activate the output.
Serial Cmd:	<code><K780,trend analysis mode,trigger evaluation period,number to output on,decodes per trigger threshold></code>
Default:	No-Read
Options:	0 = Mismatch 1 = No-Read 2 = Decodes per Trigger

Mismatch

Output will be activated when the number of mismatches equals the value entered for **Number to Output On** within the trigger window selected in **Number of Triggers**.

No-Read

Output will be activated when the number of No-Reads equals the value entered for **Number to Output On** within the trigger window selected in **Number of Triggers**.

Decodes per Trigger

Output will be activated when the number of decodes equals the value entered for **Number to Output On** within the trigger window selected in **Number of Triggers**.

H-7-2 Trigger Evaluation Period

Definition:	The number of triggers to examine for the trend analysis condition.
Serial Cmd:	<code><K780,trend analysis mode,trigger evaluation period,number to output on,decodes per trigger threshold></code>
Default:	0
Options:	0 to 255

H-7-3 Number to Output On

- Usage: *Example:* If **Number to Output On** is set to 3 and **Trend Analysis Mode** is set to **No-Read**, then the output will not be activated until 3 No-Reads have occurred.
- Definition: Sets the number of **Trend Analysis Mode** events (mismatches, No-Reads, or reads/trigger as configured by Trend Analysis Mode) to occur within the trigger evaluation period before activating the associated output.
- Serial Cmd: *<K780,trend analysis mode,trigger evaluation period,number to output on,decodes per trigger threshold>*
- Default: 0
- Options: 0 to 255

H-7-4 Decodes per Trigger Threshold

- Definition: The appropriate output will be activated if, at the end of the read cycle, the symbol decode count is below this setting.
- Note:** To activate this feature the reader must be in Decodes per Trigger mode. To put the reader in this mode during the read cycle and the Trend Analysis operation, the Decodes per Trigger status in the quality settings must be enabled. Enabling this setting will also append the decode count to the symbol data.
- Serial Cmd: *<K780,trend analysis mode,trigger evaluation period,number to output on,decodes per trigger threshold>*
- Default: 0
- Options: 0 to 65535

H-8 ISO/IEC 16022 Symbol Quality Output 1

● Output on Symbol Contrast

Usage:	Lets the user know if symbol quality is less than acceptable.	
Definition:	If enabled, toggles Output 1 to an active state when Symbol Contrast Threshold is met.	
Serial Cmd:	<i><K800,output on symbol contrast,symbol contrast threshold,output on print growth,print growth threshold,output on axial non-uniformity,axial non-uniformity threshold,output on UEC,UEC threshold></i>	
Default:	Disabled	
Options:	0 = Disabled	1 = Enabled

● Output on Print Growth

Usage:	Lets the user know if symbol quality is less than acceptable.	
Definition:	If enabled, toggles Output 1 to an active state when Print Growth Threshold is met.	
Serial Cmd:	<i><K800,output on symbol contrast,symbol contrast threshold,output on print growth,print growth threshold,output on axial non-uniformity,axial non-uniformity threshold,output on UEC,UEC threshold></i>	
Default:	Disabled	
Options:	0 = Disabled	1 = Enabled

● Output on Axial Non-Uniformity

Usage:	Lets the user know if symbol quality is less than acceptable.	
Definition:	If enabled, toggles Output 1 to an active state when Axial Non-Uniformity Threshold is met.	
Serial Cmd:	<i><K800,output on symbol contrast,symbol contrast threshold,output on print growth,print growth threshold,output on axial non-uniformity,axial non-uniformity threshold,output on UEC,UEC threshold></i>	
Default:	Disabled	
Options:	0 = Disabled	1 = Enabled

● Output on Unused Error Correction

Usage:	Lets the user know if symbol quality is less than acceptable.	
Definition:	If enabled, toggles Output 1 to an active state when UEC Threshold is met.	
Serial Cmd:	<i><K800,output on symbol contrast,symbol contrast threshold,output on print growth,print growth threshold,output on axial non-uniformity,axial non-uniformity threshold,output on UEC,UEC threshold></i>	
Default:	Disabled	
Options:	0 = Disabled	1 = Enabled

● Symbol Contrast Threshold

Usage:	Lets the user set the acceptable level of symbol quality.
Definition:	Conforms to ISO/IEC 16022 symbol quality grading (A,B,C,D).
Serial Cmd:	< K800 , <i>output on symbol contrast</i> , symbol contrast threshold , <i>output on print growth</i> , <i>print growth threshold</i> , <i>output on axial non-uniformity</i> , <i>axial non-uniformity threshold</i> , <i>output on UEC</i> , <i>UEC threshold</i> >
Default:	Grade C
Options:	0 = Grade A 1 = Grade B 2 = Grade C 3 = Grade D

● Print Growth Threshold

Usage:	Lets the user set the acceptable level of symbol quality.
Definition:	Conforms to ISO/IEC 16022 symbol quality grading (A,B,C,D).
Serial Cmd:	< K800 , <i>output on symbol contrast</i> , <i>symbol contrast threshold</i> , <i>output on print growth</i> , print growth threshold , <i>output on axial non-uniformity</i> , <i>axial non-uniformity threshold</i> , <i>output on UEC</i> , <i>UEC threshold</i> >
Default:	Grade C
Options:	0 = Grade A 1 = Grade B 2 = Grade C 3 = Grade D

● Axial Non-Uniformity Threshold

Usage:	Lets the user set the acceptable level of symbol quality.
Definition:	Conforms to ISO/IEC 16022 symbol quality grading (A,B,C,D).
Serial Cmd:	< K800 , <i>output on symbol contrast</i> , <i>symbol contrast threshold</i> , <i>output on print growth</i> , <i>print growth threshold</i> , <i>output on axial non-uniformity</i> , axial non-uniformity threshold , <i>output on UEC</i> , <i>UEC threshold</i> >
Default:	Grade C
Options:	0 = Grade A 1 = Grade B 2 = Grade C 3 = Grade D

● Unused Error Correction Threshold

Usage:	Lets the user set the acceptable level of symbol quality.
Definition:	Conforms to ISO/IEC 16022 symbol quality grading (A,B,C,D).
Serial Cmd:	< K800 , <i>output on symbol contrast</i> , <i>symbol contrast threshold</i> , <i>output on print growth</i> , <i>print growth threshold</i> , <i>output on axial non-uniformity</i> , <i>axial non-uniformity threshold</i> , <i>output on UEC</i> , UEC threshold >
Default:	Grade C
Options:	0 = Grade A 1 = Grade B 2 = Grade C 3 = Grade D

H-9 ISO/IEC 15415 Symbol Quality Output 1

Barcode Symbol Print Quality Test Specification – 2D Symbols

Supported symbologies:

- Data Matrix ECC200
- QR Code
- Micro QR Code

Minimum Resolution: 6.0 Pixels Per Element

● **Output on Overall Grade**

Usage: Lets the user know if symbol quality is less than acceptable.
 Definition: If enabled, drives **Output** if grade is under **Overall Grade Threshold**.
 Serial Cmd: <**K870, output on overall grade**, overall grade threshold, symbol contrast, symbol contrast threshold, modulation, modulation threshold, reflectance margin, reflectance margin threshold, fixed pattern damage, fixed pattern damage threshold, axial non-uniformity, axial non-uniformity threshold, grid non-uniformity, grid non-uniformity threshold, unused ECC, unused ECC threshold>
 Default: Disabled
 Options: 0 = Disabled 1 = Enabled

● **Overall Grade Threshold**

Usage: Sets the threshold for driving the output.
 Definition: Conforms to ISO/IEC 15415 symbol quality grading (A,B,C,D).
 Serial Cmd: <**K870, output on overall grade, overall grade threshold**, symbol contrast, symbol contrast threshold, modulation, modulation threshold, reflectance margin, reflectance margin threshold, fixed pattern damage, fixed pattern damage threshold, axial non-uniformity, axial non-uniformity threshold, grid non-uniformity, grid non-uniformity threshold, unused ECC, unused ECC threshold>
 Default: Grade B
 Options: 0 = Grade D
 1 = Grade C
 2 = Grade B
 3 = Grade A



● Symbol Contrast

Usage: Lets the user know if symbol quality is less than acceptable.
 Definition: If enabled, drives **Output** if grade is under **Symbol Contrast Threshold**.
 Serial Cmd: <**K870**, output on overall grade, overall grade threshold, **symbol contrast**, symbol contrast threshold, modulation, modulation threshold, reflectance margin, reflectance margin threshold, fixed pattern damage, fixed pattern damage threshold, axial non-uniformity, axial non-uniformity threshold, grid non-uniformity, grid non-uniformity threshold, unused ECC, unused ECC threshold>
 Default: Disabled
 Options: 0 = Disabled 1 = Enabled

● Symbol Contrast Threshold

Usage: Sets the threshold for driving the output.
 Definition: Conforms to ISO/IEC 15415 symbol quality grading (A,B,C,D).
 Serial Cmd: <**K870**, output on overall grade, overall grade threshold, symbol contrast, **symbol contrast threshold**, modulation, modulation threshold, reflectance margin, reflectance margin threshold, fixed pattern damage, fixed pattern damage threshold, axial non-uniformity, axial non-uniformity threshold, grid non-uniformity, grid non-uniformity threshold, unused ECC, unused ECC threshold>
 Default: Grade B
 Options: 0 = Grade D
 1 = Grade C
 2 = Grade B
 3 = Grade A

● Modulation

Usage: Lets the user know if symbol quality is less than acceptable.
 Definition: If enabled, drives **Output** if grade is under **Modulation Threshold**.
 Serial Cmd: <**K870**, output on overall grade, overall grade threshold, symbol contrast, symbol contrast threshold, **modulation**, modulation threshold, reflectance margin, reflectance margin threshold, fixed pattern damage, fixed pattern damage threshold, axial non-uniformity, axial non-uniformity threshold, grid non-uniformity, grid non-uniformity threshold, unused ECC, unused ECC threshold>
 Default: Disabled
 Options: 0 = Disabled 1 = Enabled

● Modulation Threshold

Usage: Sets the threshold for driving the output.
 Definition: Conforms to ISO/IEC 15415 symbol quality grading (A,B,C,D).
 Serial Cmd: <**K870**, output on overall grade, overall grade threshold, symbol contrast, symbol contrast threshold, modulation, **modulation threshold**, reflectance margin, reflectance margin threshold, fixed pattern damage, fixed pattern damage threshold, axial non-uniformity, axial non-uniformity threshold, grid non-uniformity, grid non-uniformity threshold, unused ECC, unused ECC threshold>
 Default: Grade B
 Options: 0 = Grade D
 1 = Grade C
 2 = Grade B
 3 = Grade A

● Reflectance Margin

Usage:	Lets the user know if symbol quality is less than acceptable.	
Definition:	If enabled, drives Output if grade is under Reflectance Margin Threshold .	
Serial Cmd:	< K870 , output on overall grade, overall grade threshold, symbol contrast, symbol contrast threshold, modulation, modulation threshold, reflectance margin , reflectance margin threshold, fixed pattern damage, fixed pattern damage threshold, axial non-uniformity, axial non-uniformity threshold, grid non-uniformity, grid non-uniformity threshold, unused ECC, unused ECC threshold>	
Default:	Disabled	
Options:	0 = Disabled	1 = Enabled

● Reflectance Margin Threshold

Usage:	Sets the threshold for driving the output.	
Definition:	Conforms to ISO/IEC 15415 symbol quality grading (A,B,C,D).	
Serial Cmd:	< K870 , output on overall grade, overall grade threshold, symbol contrast, symbol contrast threshold, modulation, modulation threshold, reflectance margin, reflectance margin threshold , fixed pattern damage, fixed pattern damage threshold, axial non-uniformity, axial non-uniformity threshold, grid non-uniformity, grid non-uniformity threshold, unused ECC, unused ECC threshold>	
Default:	Grade B	
Options:	0 = Grade D	
	1 = Grade C	
	2 = Grade B	
	3 = Grade A	

● Fixed Pattern Damage

Usage:	Lets the user know if symbol quality is less than acceptable.	
Definition:	If enabled, drives Output if grade is under Fixed Pattern Damage Threshold .	
Serial Cmd:	< K870 , output on overall grade, overall grade threshold, symbol contrast, symbol contrast threshold, modulation, modulation threshold, reflectance margin, reflectance margin threshold, fixed pattern damage , fixed pattern damage threshold, axial non-uniformity, axial non-uniformity threshold, grid non-uniformity, grid non-uniformity threshold, unused ECC, unused ECC threshold>	
Default:	Disabled	
Options:	0 = Disabled	1 = Enabled

● Fixed Pattern Damage Threshold

Usage:	Sets the threshold for driving the output.	
Definition:	Conforms to ISO/IEC 15415 symbol quality grading (A,B,C,D).	
Serial Cmd:	< K870 , output on overall grade, overall grade threshold, symbol contrast, symbol contrast threshold, modulation, modulation threshold, reflectance margin, reflectance margin threshold, fixed pattern damage, fixed pattern damage threshold , axial non-uniformity, axial non-uniformity threshold, grid non-uniformity, grid non-uniformity threshold, unused ECC, unused ECC threshold>	
Default:	Grade B	
Options:	0 = Grade D	
	1 = Grade C	
	2 = Grade B	
	3 = Grade A	

● **Axial Non-uniformity**

Usage: Lets the user know if symbol quality is less than acceptable.
 Definition: If enabled, drives **Output** if grade is under **Axial Non-uniformity Threshold**.
 Serial Cmd: <**K870**, output on overall grade, overall grade threshold, symbol contrast, symbol contrast threshold, modulation, modulation threshold, reflectance margin, reflectance margin threshold, fixed pattern damage, fixed pattern damage threshold, **axial non-uniformity**, axial non-uniformity threshold, grid non-uniformity, grid non-uniformity threshold, unused ECC, unused ECC threshold>
 Default: Disabled
 Options: 0 = Disabled 1 = Enabled

● **Axial Non-uniformity Threshold**

Usage: Sets the threshold for driving the output.
 Definition: Conforms to ISO/IEC 15415 symbol quality grading (A,B,C,D).
 Serial Cmd: <**K870**, output on overall grade, overall grade threshold, symbol contrast, symbol contrast threshold, modulation, modulation threshold, reflectance margin, reflectance margin threshold, fixed pattern damage, fixed pattern damage threshold, axial non-uniformity, **axial non-uniformity threshold**, grid non-uniformity, grid non-uniformity threshold, unused ECC, unused ECC threshold>
 Default: Grade B
 Options: 0 = Grade D
 1 = Grade C
 2 = Grade B
 3 = Grade A

● **Grid Non-uniformity**

Usage: Lets the user know if symbol quality is less than acceptable.
 Definition: If enabled, drives **Output** if grade is under **Grid Non-uniformity Threshold**.
 Serial Cmd: <**K870**, output on overall grade, overall grade threshold, symbol contrast, symbol contrast threshold, modulation, modulation threshold, reflectance margin, reflectance margin threshold, fixed pattern damage, fixed pattern damage threshold, axial non-uniformity, axial non-uniformity threshold, **grid non-uniformity**, grid non-uniformity threshold, unused ECC, unused ECC threshold>
 Default: Disabled
 Options: 0 = Disabled 1 = Enabled

● **Grid Non-uniformity Threshold**

Usage: Sets the threshold for driving the output.
 Definition: Conforms to ISO/IEC 15415 symbol quality grading (A,B,C,D).
 Serial Cmd: <**K870**, output on overall grade, overall grade threshold, symbol contrast, symbol contrast threshold, modulation, modulation threshold, reflectance margin, reflectance margin threshold, fixed pattern damage, fixed pattern damage threshold, axial non-uniformity, axial non-uniformity threshold, grid non-uniformity, **grid non-uniformity threshold**, unused ECC, unused ECC threshold>
 Default: Grade B
 Options: 0 = Grade D
 1 = Grade C
 2 = Grade B
 3 = Grade A

● Unused ECC

Usage:	Lets the user know if symbol quality is less than acceptable.	
Definition:	If enabled, drives Output if grade is under Unused ECC Threshold .	
Serial Cmd:	< K870 , output on overall grade, overall grade threshold, symbol contrast, symbol contrast threshold, modulation, modulation threshold, reflectance margin, reflectance margin threshold, fixed pattern damage, fixed pattern damage threshold, axial non-uniformity, axial non-uniformity threshold, grid non-uniformity, grid non-uniformity threshold, unused ECC , unused ECC threshold>	
Default:	Disabled	
Options:	0 = Disabled	1 = Enabled

● Unused ECC Threshold

Usage:	Sets the threshold for driving the output.	
Definition:	Conforms to ISO/IEC 15415 symbol quality grading (A,B,C,D).	
Serial Cmd:	< K870 , output on overall grade, overall grade threshold, symbol contrast, symbol contrast threshold, modulation, modulation threshold, reflectance margin, reflectance margin threshold, fixed pattern damage, fixed pattern damage threshold, axial non-uniformity, axial non-uniformity threshold, grid non-uniformity, grid non-uniformity threshold, unused ECC, unused ECC threshold >	
Default:	Grade B	
Options:	0 = Grade D	
	1 = Grade C	
	2 = Grade B	
	3 = Grade A	

H-10 ISO/IEC 15416 Symbol Quality Output 1

Barcode Print Quality Guideline

Supported Symbologies:

- Code 128 / GS1-128
- UPC-A / UPC-E / EAN-13 / EAN-8
- Interleaved 2 of 5 / ITF-14
- Code 39
- Code 93
- Codabar

Minimum Resolution: 4.0 Pixels Per Element

● Output on Overall Grade

Usage: Lets the user know if symbol quality is less than acceptable.
 Definition: If enabled, drives **Output** if grade is under **Overall Grade Threshold**.
 Serial Cmd: <**K880, output on overall grade**, overall grade threshold, edge determination, edge determination threshold, decode, decode threshold, contrast, contrast threshold, min reflectance, min reflectance threshold, min edge contrast, min edge contrast threshold, modulation, modulation threshold, defects, defects threshold, decodability, decodability threshold, quiet Zone, quiet zone threshold >
 Default: Disabled
 Options: 0 = Disabled 1 = Enabled

● Overall Grade Threshold

Usage: Sets the threshold for driving the output.
 Definition: Conforms to ISO/IEC 15416 symbol quality grading (A,B,C,D).
 Serial Cmd: <**K880, output on overall grade, overall grade threshold**, edge determination, edge determination threshold, decode, decode threshold, contrast, contrast threshold, min reflectance, min reflectance threshold, min edge contrast, min edge contrast threshold, modulation, modulation threshold, defects, defects threshold, decodability, decodability threshold, quiet Zone, quiet zone threshold >
 Default: Grade B
 Options: 0 = Grade D
 1 = Grade C
 2 = Grade B
 3 = Grade A

● Edge Determination

Usage:	Lets the user know if symbol quality is less than acceptable.	
Definition:	If enabled, drives Output if grade is under Edge Determination Threshold .	
Serial Cmd:	< K880 , output on overall grade, overall grade threshold, edge determination , edge determination threshold, decode, decode threshold, contrast, contrast threshold, min reflectance, min reflectance threshold, min edge contrast, min edge contrast threshold, modulation, modulation threshold, defects, defects threshold, decodability, decodability threshold, quiet Zone, quiet zone threshold >	
Default:	Disabled	
Options:	0 = Disabled	1 = Enabled

● Edge Determination Threshold

Usage:	Sets the threshold for driving the output.	
Definition:	Conforms to ISO/IEC 15416 symbol quality grading (A,B,C,D).	
Serial Cmd:	< K880 , output on overall grade, overall grade threshold, edge determination, edge determination threshold , decode, decode threshold, contrast, contrast threshold, min reflectance, min reflectance threshold, min edge contrast, min edge contrast threshold, modulation, modulation threshold, defects, defects threshold, decodability, decodability threshold, quiet Zone, quiet zone threshold >	
Default:	Grade B	
Options:	0 = Grade D	1 = Grade C
	2 = Grade B	3 = Grade A

● Decode

Usage:	Lets the user know if symbol quality is less than acceptable.	
Definition:	If enabled, drives Output if grade is under Decode Threshold .	
Serial Cmd:	< K880 , output on overall grade, overall grade threshold, edge determination, edge determination threshold, decode , decode threshold, contrast, contrast threshold, min reflectance, min reflectance threshold, min edge contrast, min edge contrast threshold, modulation, modulation threshold, defects, defects threshold, decodability, decodability threshold, quiet Zone, quiet zone threshold >	
Default:	Disabled	
Options:	0 = Disabled	1 = Enabled

● Decode Threshold

Usage:	Sets the threshold for driving the output.	
Definition:	Conforms to ISO/IEC 15416 symbol quality grading (A,B,C,D).	
Serial Cmd:	< K880 , output on overall grade, overall grade threshold, edge determination, edge determination threshold, decode, decode threshold , contrast, contrast threshold, min reflectance, min reflectance threshold, min edge contrast, min edge contrast threshold, modulation, modulation threshold, defects, defects threshold, decodability, decodability threshold, quiet Zone, quiet zone threshold >	
Default:	Grade B	
Options:	0 = Grade D	1 = Grade C
	2 = Grade B	3 = Grade A

● **Contrast**

Usage: Lets the user know if symbol quality is less than acceptable.
 Definition: If enabled, drives **Output** if grade is under **Contrast Threshold**.
 Serial Cmd: <**K880**, output on overall grade, overall grade threshold, edge determination, edge determination threshold, decode, decode threshold, **contrast**, contrast threshold, min reflectance, min reflectance threshold, min edge contrast, min edge contrast threshold, modulation, modulation threshold, defects, defects threshold, decodability, decodability threshold, quiet Zone, quiet zone threshold >
 Default: Disabled
 Options: 0 = Disabled 1 = Enabled

● **Contrast Threshold**

Usage: Sets the threshold for driving the output.
 Definition: Conforms to ISO/IEC 15416 symbol quality grading (A,B,C,D).
 Serial Cmd: <**K880**, output on overall grade, overall grade threshold, edge determination, edge determination threshold, decode, decode threshold, contrast, **contrast threshold**, min reflectance, min reflectance threshold, min edge contrast, min edge contrast threshold, modulation, modulation threshold, defects, defects threshold, decodability, decodability threshold, quiet Zone, quiet zone threshold >
 Default: Grade B
 Options: 0 = Grade D
 1 = Grade C
 2 = Grade B
 3 = Grade A

● **Min Reflectance**

Usage: Lets the user know if symbol quality is less than acceptable.
 Definition: If enabled, drives **Output** if grade is under **Min Reflectance Threshold**.
 Serial Cmd: <**K880**, output on overall grade, overall grade threshold, edge determination, edge determination threshold, decode, decode threshold, contrast, contrast threshold, **min reflectance**, min reflectance threshold, min edge contrast, min edge contrast threshold, modulation, modulation threshold, defects, defects threshold, decodability, decodability threshold, quiet Zone, quiet zone threshold >
 Default: Disabled
 Options: 0 = Disabled 1 = Enabled

● **Min Reflectance Threshold**

Usage: Sets the threshold for driving the output.
 Definition: Conforms to ISO/IEC 15416 symbol quality grading (A,B,C,D).
 Serial Cmd: <**K880**, output on overall grade, overall grade threshold, edge determination, edge determination threshold, decode, decode threshold, contrast, contrast threshold, min reflectance, **min reflectance threshold**, min edge contrast, min edge contrast threshold, modulation, modulation threshold, defects, defects threshold, decodability, decodability threshold, quiet Zone, quiet zone threshold >
 Default: Grade B
 Options: 0 = Grade D
 1 = Grade C
 2 = Grade B
 3 = Grade A

● Min Edge Contrast

Usage:	Lets the user know if symbol quality is less than acceptable.	
Definition:	If enabled, drives Output if grade is under Min Edge Contrast Threshold .	
Serial Cmd:	< K880 , output on overall grade, overall grade threshold, edge determination, edge determination threshold, decode, decode threshold, contrast, contrast threshold, min reflectance, min reflectance threshold, min edge contrast , min edge contrast threshold, modulation, modulation threshold, defects, defects threshold, decodability, decodability threshold, quiet Zone, quiet zone threshold >	
Default:	Disabled	
Options:	0 = Disabled	1 = Enabled

● Min Edge Contrast Threshold

Usage:	Sets the threshold for driving the output.	
Definition:	Conforms to ISO/IEC 15416 symbol quality grading (A,B,C,D).	
Serial Cmd:	< K880 , output on overall grade, overall grade threshold, edge determination, edge determination threshold, decode, decode threshold, contrast, contrast threshold, min reflectance, min reflectance threshold, min edge contrast, min edge contrast threshold , modulation, modulation threshold, defects, defects threshold, decodability, decodability threshold, quiet Zone, quiet zone threshold >	
Default:	Grade B	
Options:	0 = Grade D	1 = Grade C
	2 = Grade B	3 = Grade A

● Modulation

Usage:	Lets the user know if symbol quality is less than acceptable.	
Definition:	If enabled, drives Output if grade is under Modulation Threshold .	
Serial Cmd:	< K880 , output on overall grade, overall grade threshold, edge determination, edge determination threshold, decode, decode threshold, contrast, contrast threshold, min reflectance, min reflectance threshold, min edge contrast, min edge contrast threshold, modulation , modulation threshold, defects, defects threshold, decodability, decodability threshold, quiet Zone, quiet zone threshold >	
Default:	Disabled	
Options:	0 = Disabled	1 = Enabled

● Modulation Threshold

Usage:	Sets the threshold for driving the output.	
Definition:	Conforms to ISO/IEC 15416 symbol quality grading (A,B,C,D).	
Serial Cmd:	< K880 , output on overall grade, overall grade threshold, edge determination, edge determination threshold, decode, decode threshold, contrast, contrast threshold, min reflectance, min reflectance threshold, min edge contrast, min edge contrast threshold, modulation, modulation threshold , defects, defects threshold, decodability, decodability threshold, quiet Zone, quiet zone threshold >	
Default:	Grade B	
Options:	0 = Grade D	1 = Grade C
	2 = Grade B	3 = Grade A

● **Defects**

Usage: Lets the user know if symbol quality is less than acceptable.
 Definition: If enabled, drives **Output** if grade is under **Defects Threshold**.
 Serial Cmd: <**K880**, output on overall grade, overall grade threshold, edge determination, edge determination threshold, decode, decode threshold, contrast, contrast threshold, min reflectance, min reflectance threshold, min edge contrast, min edge contrast threshold, modulation, modulation threshold, **defects**, defects threshold, decodability, decodability threshold, quiet Zone, quiet zone threshold >
 Default: Disabled
 Options: 0 = Disabled 1 = Enabled

● **Defects Threshold**

Usage: Sets the threshold for driving the output.
 Definition: Conforms to ISO/IEC 15416 symbol quality grading (A,B,C,D).
 Serial Cmd: <**K880**, output on overall grade, overall grade threshold, edge determination, edge determination threshold, decode, decode threshold, contrast, contrast threshold, min reflectance, min reflectance threshold, min edge contrast, min edge contrast threshold, modulation, modulation threshold, defects, **defects threshold**, decodability, decodability threshold, quiet Zone, quiet zone threshold >
 Default: Grade B
 Options: 0 = Grade D
 1 = Grade C
 2 = Grade B
 3 = Grade A

● **Decodability**

Usage: Lets the user know if symbol quality is less than acceptable.
 Definition: If enabled, drives **Output** if grade is under **Decodability Threshold**.
 Serial Cmd: <**K880**, output on overall grade, overall grade threshold, edge determination, edge determination threshold, decode, decode threshold, contrast, contrast threshold, min reflectance, min reflectance threshold, min edge contrast, min edge contrast threshold, modulation, modulation threshold, defects, defects threshold, **decodability**, decodability threshold, quiet Zone, quiet zone threshold >
 Default: Disabled
 Options: 0 = Disabled 1 = Enabled

● **Decodability Threshold**

Usage: Sets the threshold for driving the output.
 Definition: Conforms to ISO/IEC 15416 symbol quality grading (A,B,C,D).
 Serial Cmd: <**K880**, output on overall grade, overall grade threshold, edge determination, edge determination threshold, decode, decode threshold, contrast, contrast threshold, min reflectance, min reflectance threshold, min edge contrast, min edge contrast threshold, modulation, modulation threshold, defects, defects threshold, decodability, **decodability threshold**, quiet Zone, quiet zone threshold >
 Default: Grade B
 Options: 0 = Grade D
 1 = Grade C
 2 = Grade B
 3 = Grade A

● **Quiet Zone**

Usage: Lets the user know if symbol quality is less than acceptable.
 Definition: If enabled, drives **Output** if grade is under **Quiet Zone Threshold**.
 Serial Cmd: <**K880**, output on overall grade, overall grade threshold, edge determination, edge determination threshold, decode, decode threshold, contrast, contrast threshold, min reflectance, min reflectance threshold, min edge contrast, min edge contrast threshold, modulation, modulation threshold, defects, defects threshold, decodability, decodability threshold, **quiet Zone**, quiet zone threshold >
 Default: Disabled
 Options: 0 = Disabled 1 = Enabled

● **Quiet Zone Threshold**

Usage: Sets the threshold for driving the output.
 Definition: Conforms to ISO/IEC 15416 symbol quality grading (A,B,C,D).
 Serial Cmd: <**K880**, output on overall grade, overall grade threshold, edge determination, edge determination threshold, decode, decode threshold, contrast, contrast threshold, min reflectance, min reflectance threshold, min edge contrast, min edge contrast threshold, modulation, modulation threshold, defects, defects threshold, decodability, decodability threshold, quiet Zone, **quiet zone threshold** >
 Default: Grade B
 Options: 0 = Grade D
 1 = Grade C
 2 = Grade B
 3 = Grade A

H-11 ISO/IEC 29158 Symbol Quality Output 1

Automatic Identification and data capture – Direct Part Mark (DMP) Quality

Supported symbologies:

- Data Matrix ECC200

Minimum Resolution: 6.0 Pixels Per Element

● Output on Overall Grade

Usage: Lets the user know if symbol quality is less than acceptable.
 Definition: If enabled, drives Output if grade is under Overall Grade Threshold.
 Serial Cmd: <**K890**, output on overall grade, overall grade threshold, cell contrast, cell contrast threshold, cell modulation, cell modulation threshold, fixed pattern damage, fixed pattern damage threshold, axial non-uniformity, axial non-uniformity threshold, grid non-uniformity, grid non-uniformity threshold, unused ECC, unused ECC threshold>
 Default: Disabled
 Options: 0 = Disabled 1 = Enabled

● Overall Grade Threshold

Usage: Sets the threshold for driving the output.
 Definition: Conforms to ISO/IEC 29158 symbol quality grading (A,B,C,D).
 Serial Cmd: <**K890**, output on overall grade, **overall grade threshold**, cell contrast, cell contrast threshold, cell modulation, cell modulation threshold, fixed pattern damage, fixed pattern damage threshold, axial non-uniformity, axial non-uniformity threshold, grid non-uniformity, grid non-uniformity threshold, unused ECC, unused ECC threshold>
 Default: Grade B
 Options: 0 = Grade D
 1 = Grade C
 2 = Grade B
 3 = Grade A

● Cell Contrast

Usage: Lets the user know if symbol quality is less than acceptable.
 Definition: If enabled, drives **Output** if grade is under **Symbol Contrast Threshold**.
 Serial Cmd: <**K890**, output on overall grade, overall grade threshold, **cell contrast**, cell contrast threshold, cell modulation, cell modulation threshold, fixed pattern damage, fixed pattern damage threshold, axial non-uniformity, axial non-uniformity threshold, grid non-uniformity, grid non-uniformity threshold, unused ECC, unused ECC threshold>
 Default: Disabled
 Options: 0 = Disabled 1 = Enabled

● Cell Contrast Threshold

Usage:	Sets the threshold for driving the output.	
Definition:	Conforms to ISO/IEC 29158 symbol quality grading (A,B,C,D).	
Serial Cmd:	< K890 , output on overall grade, overall grade threshold, cell contrast, cell contrast threshold , cell modulation, cell modulation threshold, fixed pattern damage, fixed pattern damage threshold, axial non-uniformity, axial non-uniformity threshold, grid non-uniformity, grid non-uniformity threshold, unused ECC, unused ECC threshold>	
Default:	Grade B	
Options:	0 = Grade D 1 = Grade C 2 = Grade B 3 = Grade A	

● Cell Moduration

Usage:	Lets the user know if symbol quality is less than acceptable.	
Definition:	If enabled, drives Output if grade is under Cell Moduration Threshold .	
Serial Cmd:	< K890 , output on overall grade, overall grade threshold, cell contrast, cell contrast threshold, cell modulation , cell modulation threshold, fixed pattern damage, fixed pattern damage threshold, axial non-uniformity, axial non-uniformity threshold, grid non-uniformity, grid non-uniformity threshold, unused ECC, unused ECC threshold>	
Default:	Disabled	
Options:	0 = Disabled	1 = Enabled

● Cell Moduration Threshold

Usage:	Sets the threshold for driving the output.	
Definition:	Conforms to ISO/IEC 29158 symbol quality grading (A,B,C,D).	
Serial Cmd:	< K890 , output on overall grade, overall grade threshold, cell contrast, cell contrast threshold, cell modulation, cell modulation threshold , fixed pattern damage, fixed pattern damage threshold, axial non-uniformity, axial non-uniformity threshold, grid non-uniformity, grid non-uniformity threshold, unused ECC, unused ECC threshold>	
Default:	Grade B	
Options:	0 = Grade D 1 = Grade C 2 = Grade B 3 = Grade A	

● Fixed Pattern Damage

Usage:	Lets the user know if symbol quality is less than acceptable.	
Definition:	If enabled, drives Output if grade is under Fixed Pattern Damage Threshold .	
Serial Cmd:	< K890 , output on overall grade, overall grade threshold, cell contrast, cell contrast threshold, cell modulation, cell modulation threshold , fixed pattern damage, fixed pattern damage threshold, axial non-uniformity, axial non-uniformity threshold, grid non-uniformity, grid non-uniformity threshold, unused ECC, unused ECC threshold>	
Default:	Disabled	
Options:	0 = Disabled	1 = Enabled

● Fixed Pattern Damage Threshold

Usage: Sets the threshold for driving the output.
 Definition: Conforms to ISO/IEC 29158 symbol quality grading (A,B,C,D).
 Serial Cmd: <**K890**, output on overall grade, overall grade threshold, cell contrast, cell contrast threshold, cell modulation, cell modulation threshold, fixed pattern damage, **fixed pattern damage threshold**, axial non-uniformity, axial non-uniformity threshold, grid non-uniformity, grid non-uniformity threshold, unused ECC, unused ECC threshold>
 Default: Grade B
 Options: 0 = Grade D
 1 = Grade C
 2 = Grade B
 3 = Grade A

● Axial Non-uniformity

Usage: Lets the user know if symbol quality is less than acceptable.
 Definition: If enabled, drives **Output** if grade is under **Axial Non-uniformity Threshold**.
 Serial Cmd: <**K890**, output on overall grade, overall grade threshold, cell contrast, cell contrast threshold, cell modulation, cell modulation threshold, fixed pattern damage, fixed pattern damage threshold, **axial non-uniformity**, axial non-uniformity threshold, grid non-uniformity, grid non-uniformity threshold, unused ECC, unused ECC threshold>
 Default: Disabled
 Options: 0 = Disabled 1 = Enabled

● Axial Non-uniformity Threshold

Usage: Sets the threshold for driving the output.
 Serial Cmd: <**K890**, output on overall grade, overall grade threshold, cell contrast, cell contrast threshold, cell modulation, cell modulation threshold, fixed pattern damage, fixed pattern damage threshold, axial non-uniformity, **axial non-uniformity threshold**, grid non-uniformity, grid non-uniformity threshold, unused ECC, unused ECC threshold>
 Definition: Conforms to ISO/IEC 29158 symbol quality grading (A,B,C,D).
 Default: Grade B
 Options: 0 = Grade D
 1 = Grade C
 2 = Grade B
 3 = Grade A

● Grid Non-uniformity

Usage: Lets the user know if symbol quality is less than acceptable.
 Definition: If enabled, drives **Output** if grade is under **Grid Non-uniformity Threshold**.
 Serial Cmd: <**K890**, output on overall grade, overall grade threshold, cell contrast, cell contrast threshold, cell modulation, cell modulation threshold, fixed pattern damage, fixed pattern damage threshold, axial non-uniformity, axial non-uniformity threshold, **grid non-uniformity**, grid non-uniformity threshold, unused ECC, unused ECC threshold>
 Default: Disabled
 Options: 0 = Disabled 1 = Enabled

● Grid Non-uniformity Threshold

Usage:	Sets the threshold for driving the output.	
Definition:	Conforms to ISO/IEC 29158 symbol quality grading (A,B,C,D).	
Serial Cmd:	<K890, output on overall grade, overall grade threshold, cell contrast, cell contrast threshold, cell modulation, cell modulation threshold, fixed pattern damage, fixed pattern damage threshold, axial non-uniformity, axial non-uniformity threshold, grid non-uniformity, grid non-uniformity threshold , unused ECC, unused ECC threshold>	
Default:	Grade B	
Options:	0 = Grade D	
	1 = Grade C	
	2 = Grade B	
	3 = Grade A	

● Unused ECC

Usage:	Lets the user know if symbol quality is less than acceptable.	
Definition:	If enabled, drives Output if grade is under Unused ECC Threshold .	
Serial Cmd:	<K890, output on overall grade, overall grade threshold, cell contrast, cell contrast threshold, cell modulation, cell modulation threshold, fixed pattern damage, fixed pattern damage threshold, axial non-uniformity, axial non-uniformity threshold, grid non-uniformity, grid non-uniformity threshold, unused ECC , unused ECC threshold>	
Default:	Disabled	
Options:	0 = Disabled	1 = Enabled

● Unused ECC Threshold

Usage:	Sets the threshold for driving the output.	
Definition:	Conforms to ISO/IEC 29158 symbol quality grading (A,B,C,D).	
Serial Cmd:	<K890, output on overall grade, overall grade threshold, cell contrast, cell contrast threshold, cell modulation, cell modulation threshold, fixed pattern damage, fixed pattern damage threshold, axial non-uniformity, axial non-uniformity threshold, grid non-uniformity, grid non-uniformity threshold, unused ECC, unused ECC threshold >	
Default:	Grade B	
Options:	0 = Grade D	
	1 = Grade C	
	2 = Grade B	
	3 = Grade A	

H-12 Diagnostics Output 1

Serial Cmd: <K790,*unused 1,service unit*>
Default: 0
Options: 0 = Disabled

H-12-1 Service Unit

When **Diagnostic Warning** is enabled, the **Output On** configuration has no effect. The output will remain active as long as one of the diagnostic warning conditions is met. The output will become inactive once it detects that there are no diagnostic warning conditions.

Definition: Allows the user to set up the output to toggle to active when the service timer has expired. This condition will only be held for one service timer click.

Note: This feature cannot be used if the reader is in a **Continuous Read** mode.

Serial Cmd: <K790,*unused 1,service unit*>
Default: 0
Options: 0 = Disabled 1 = Enabled

H-13 Other Outputs

H-13-1 Configurable Output 2

Serial Cmd: <K811,output on,output state,pulse width,output mode>

H-13-2 Trend Analysis Output 2

Serial Cmd: <K781,trend analysis mode,trigger evaluation period,number to output on>

H-13-3 ISO/IEC 16022 Symbol Quality Output 2

Serial Cmd: <K801,output on symbol contrast,symbol contrast threshold,output on print growth,print growth threshold,output on axial non-uniformity,axial non-uniformity threshold,output on UEC,UEC threshold>

H-13-4 ISO/IEC 15415 Symbol Quality Output 2

Serial Cmd: <K871, output on overall grade, overall grade threshold, symbol contrast, symbol contrast threshold, modulation, modulation threshold, reflectance margin, reflectance margin threshold, fixed pattern damage, fixed pattern damage threshold, axial non-uniformity, axial non-uniformity threshold, grid non-uniformity, grid non-uniformity threshold, unused ECC, unused ECC threshold>

H-13-5 ISO/IEC 15416 Symbol Quality Output 2

Serial Cmd: <K881, output on overall grade, overall grade threshold, edge determination, edge determination threshold, decode, decode threshold, contrast, contrast threshold, min reflectance, min reflectance threshold, min edge contrast, min edge contrast threshold, modulation, modulation threshold, defects, defects threshold, decodability, decodability threshold, quiet Zone, quiet zone threshold >

H-13-6 ISO/IEC 29158 Symbol Quality Output 2

Serial Cmd: <K891, output on overall grade, overall grade threshold, cell contrast, cell contrast threshold, cell modulation, cell modulation threshold, fixed pattern damage, fixed pattern damage threshold, axial non-uniformity, axial non-uniformity threshold, grid non-uniformity, grid non-uniformity threshold, unused ECC, unused ECC threshold>

H-13-7 Diagnostics Output 2

Serial Cmd: <K791,unused 1,service unit>

H-13-8 Configurable Output 3

Serial Cmd: <K812,output on,output state,pulse width,output mode>

Output On Output 3

Usage:	This option provides discrete signalling to host software to control external devices such as PLCs and relays. It is useful for routing, sorting, and preventing mis-packaging and mis-routing.
Definition:	Sets the discrete output functions for specific user-selected conditions. Allows the user to determine when an output (or outputs) will be activated.
Serial Cmd:	< K812 , <i>output on,output state,pulse width,output mode</i> >
Default:	8 = Use as External Illumination Strobe
Options:	0 = Mismatch or No-Read 1 = Match (or Good Read) 2 = Mismatch 3 = No-Read 4 = Trend Analysis 5 = Symbol Quality 6 = Diagnostic Warning 7 = In Read Cycle 8 = Use as External Illumination Strobe

● Use as External Illumination Strobe

Definition: Asserts the external illumination strobe output during image capture.

H-13-9 Trend Analysis Output 3

Serial Cmd: <**K782**,*trend analysis mode,trigger evaluation period,number to output on*>

H-13-10 ISO/IEC 16022 Symbol Quality Output 3

Serial Cmd: <**K802**,*output on symbol contrast,symbol contrast threshold,output on print growth,print growth threshold,output on axial non-uniformity,axial non-uniformity threshold,output on UEC,UEC threshold*>

H-13-11 ISO/IEC 15415 Symbol Quality Output 3

Serial Cmd: <**K872**, *output on overall grade, overall grade threshold, symbol contrast, symbol contrast threshold, modulation, modulation threshold, reflectance margin, reflectance margin threshold, fixed pattern damage, fixed pattern damage threshold, axial non-uniformity, axial non-uniformity threshold, grid non-uniformity, grid non-uniformity threshold, unused ECC, unused ECC threshold*>

H-13-12 ISO/IEC 15416 Symbol Quality Output 3

Serial Cmd: <K882, output on overall grade, overall grade threshold, edge determination, edge determination threshold, decode, decode threshold, contrast, contrast threshold, min reflectance, min reflectance threshold, min edge contrast, min edge contrast threshold, modulation, modulation threshold, defects, defects threshold, decodability, decodability threshold, quiet Zone, quiet zone threshold >

H-13-13 ISO/IEC 29158 Symbol Quality Output 3

Serial Cmd: <K892, output on overall grade, overall grade threshold, cell contrast, cell contrast threshold, cell modulation, cell modulation threshold, fixed pattern damage, fixed pattern damage threshold, axial non-uniformity, axial non-uniformity threshold, grid non-uniformity, grid non-uniformity threshold, unused ECC, unused ECC threshold>

H-13-14 Diagnostics Output 3

Serial Cmd: <K792,unused 1,service unit>

H-14 Power On/Reset Counts

Note: **Power On/Reset Counts** is a read-only command.

Power-On

Serial Cmd: <K406,*power-on*,*resets*,*power-on saves*,*power-on flash saves*>

Power-On uses a 16-bit counter that increments each time the reader is powered-on.

Resets

Serial Cmd: <K406,*power-on*,*resets*,*power-on saves*,*power-on flash saves*>

Resets uses a 16-bit counter that increments each time the reader is reset. This value is reset at power-on.

Power-On Saves

Serial Cmd: <K406,*power-on*,*resets*,*power-on saves*,*power-on flash saves*>

Power-On Saves uses a 16-bit counter that increments each time an reader setting is saved for power-on with a <Z> command.

Power-On Flash Saves

Serial Cmd: <K406,*power-on*,*resets*,*power-on saves*,*power-on flash saves*>

Power-On Flash Saves uses a 16-bit counter that increments each time an reader setting is saved to the customer parameter section of flash memory with a <Zc> command.

H-15 Time Since Reset

Note: **Time Since Reset** is a read-only command.

Hours

Serial Cmd: <**K407**,*hours,minutes*>
Default: 16-bit counter (0 to 65535)

Hours uses a 16-bit counter that increments every 60 minutes.

Minutes

Serial Cmd: <**K407**,*hours,minutes*>
Default: 16-bit counter (0 to 60)

Minutes uses a 16-bit counter that increments every 60 seconds.

Note: Time counts are reset at power-on, but not with an <**A**> or <**Z**> command.

H-16 Service Message

When **Service Message** is enabled, a message of up to 10 ASCII characters is sent whenever the system detects that the service timer's limit has been reached. The service timer is reset at power-on, meaning that the service timer's limit is the amount of time since last reset. Service timer increments can be set in seconds or minutes.

Serial Cmd: <**K409,status,service message,threshold,resolution**>
 Default: 0
 Options: 0 = Disabled 1 = Enabled

Service Message

Serial Cmd: <**K409,status,service message,threshold,resolution**>
 Default: SERVICE
 Options: An ASCII string between 1 and 10 characters.

Threshold

Serial Cmd: <**K409,status,service message,threshold,resolution**>
 Default: 300 (5 minutes)
 Options: 1 to 65535

Resolution

Serial Cmd: <**K409,status,service message,threshold,resolution**>
 Default: Seconds
 Options: 0 = Seconds 1 = Minutes

H-17 User-Assigned Name

- Definition: **User-Assigned Name** allows you to enter any string of ASCII characters to help you identify your reader. The user-assigned name is saved at power-on and custom defaults, and is stored as a “sticky” parameter so it cannot be defaulted without a **<Zrdall>** or **<K412d>** command.
- Serial Cmd: **<K412,user-assigned name>**
- Options: ASCII string, up to 19 characters

H-18 Output Object Info

H-18-1 Output Frame Number

Serial Cmd: <K734,output frame number,output coordinates>

Default: Disabled

Options: 0 = Disabled 1 = Enabled

Disabled

When **Output Frame Number** is set to **Disabled**, the frame number is not output as part of the symbol data.

Enabled

When **Output Frame Number** is set to **Enabled**, the number of the frame in which the symbol was first decoded is attached to the symbol output information. The output format is “Fnnn”, where “nnn” is a 3-digit decimal value from 0 to 255. The frame number rolls over to 0 once it passes 255.

If this feature is enabled, the frame information will follow the symbol data, and it will precede any symbol quality data (if symbol quality settings are enabled—see **Symbol Quality Separator**). The symbol quality separator is located between the end of the already-formatted data and the “F” that precedes the frame number.

H-18-2 Output Coordinates

Serial Cmd: <K734,output frame number,output coordinates>

Default: Disabled

Options: 0 = Disabled 1 = Enabled

Disabled

When **Output Coordinates** is set to **Disabled**, the coordinates are not output as part of the symbol data.

Enabled

When **Output Coordinates** is set to **Enabled**, the four sets of object coordinates for the first successfully decoded symbol are attached to the symbol data output in the following format:

“(nnn,mmm)”, where “nnn” is a 3-digit X-coordinate and “mmm” is a 3-digit Y-coordinate. The validation separator is located between the end of the already formatted data and the first coordinate point. The point with the lowest X + Y sum will be output first, followed by the next three points in a clockwise direction.

Example:

(032,040)(287,056)(287,279)(048,271)

H-19 Database Identifier Output

Usage:	Useful in keeping track of which database entries read which symbols.	
Serial Cmd:	<K759,status,separator>	
Default:	0	
Options:	0 = Disabled	1 = Enabled

H-19-1 Output Status

Disabled

When this command is disabled, no database identifier information will be output.

Enabled

When this command is enabled, the reader will append a two-digit number and the characters "DB" to the data output following the separator for each symbol decoded using **Configuration Database**. For example, if the separator is an underscore character and the second database entry reads a symbol encoded with "data capture" during the read cycle, the symbol data output will be "data capture_DB02". If the database is not active, no identifiers will be attached to output.

H-19-2 Separator

Usage:	The separator character separates the symbol data from the database identifier.
Serial Cmd:	<K759,status,separator>
Default:	<space>
Options:	Any ASCII character.

H-20 Quality Output

H-20-1 Separator

Definition: The separator character separates quality output data from symbol data.
Serial Cmd: **<K704,separator,decodes per trigger status>**
Default: ,
Options: Any ASCII character.

H-20-2 Decodes per Trigger Status

Definition: When this feature is enabled, the reader enters a state where it processes frames as configured until the end of a read cycle, with or without a successful symbol decode. When the read cycle ends, the reader outputs any decoded symbol data along with the decodes per trigger count.
Serial Cmd: **<K704,separator,decodes per trigger status>**
Default: 0
Options: 0 = Disabled 1 = Enabled

H-21 Image Push to Host

Definition:	Image Storage Status determines whether or not Image Logging is active. Note: Only images that have been processed by the decoder will be saved. If Image Storage Status and RAM Drive Size in MB in <K764> are switched from Disable to Enable , a cold boot of the reader will be required in order to create the required RAM Drive, and it will take additional time for the reader to re-initialize. Switching from Enable to Disable does not require a cold boot.
Serial Cmd:	<K763, image storage status , <i>stored image type,image storage,image file format,image quality,image scale,file save options</i> >
Default:	Disabled
Options:	0 = Disabled 1 = Enabled

H-21-1 Stored Image Type

Definition:	Stored Image Type defines what kind of image you want to log in a read cycle.
Serial Cmd:	<K763, <i>image storage status</i> , stored image type , <i>image storage,image file format,image quality,image scale,file save options</i> >
Default:	No Read
Options:	1 = Good Read 2 = No Read 3 = Good Read + No Read 4 = Match 8 = Mismatch 12 = Match + Mismatch 15 = Good Read + No Read + Match + Mismatch

H-21-2 Image Storage

Definition:	Image Storage defines which image will be stored within a read cycle. <ul style="list-style-type: none"> • Good Read/Match/Mismatch: First qualified image or all qualified images. • No Read: First image or all images that have an IP report.
Serial Cmd:	<K763, <i>image storage status</i> , <i>stored image type</i> , image storage , <i>image file format,image quality,image scale,file save options</i> >
Default:	First Image in a Read Cycle
Options:	0 = First Image in a Read Cycle 1 = All Images in a Read Cycle

H-21-3 Image File Format

Definition:	Image File Format defines the image format you want to use.
Serial Cmd:	<K763, <i>image storage status</i> , <i>stored image type</i> , <i>image storage</i> , image file format , <i>image quality,image scale,file save options</i> >
Default:	PNG
Options:	0 = PNG 1 = JPG 2 = BMP

H-21-4 Image Quality

Definition:	Image Quality defines the amount of image compression you want the image to have.
Serial Cmd:	< K763 , <i>image storage status</i> , <i>stored image type</i> , <i>image storage</i> , <i>image file format</i> , image quality , <i>image scale</i> , <i>file save options</i> >
Default:	90
Options:	1 to 100

H-21-5 Image Scale

Definition:	Image Scale defines the size you want the image to be.
Serial Cmd:	< K763 , <i>image storage status</i> , <i>stored image type</i> , <i>image storage</i> , <i>image file format</i> , <i>image quality</i> , image scale , <i>file save options</i> >
Default:	0 = Full
Options:	0 = Full 1 = 1/2 2 = 1/4 3 = 1/8

H-21-6 File Save Options

Definition:	File Save Options determines which files you want to save.
Serial Cmd:	< K763 , <i>image storage status</i> , <i>stored image type</i> , <i>image storage</i> , <i>image file format</i> , <i>image quality</i> , <i>image scale</i> , file save options >
Default:	Image
Options:	1 = Image 2 = Read Cycle Report 3 = Image + Read Cycle Report

H-22 Image Push to Host Detailed Setup

H-22-1 Image Storage Location

Definition:	<p>Defines where the saved image is going to be stored.</p> <p>Note: When saving images to RAM, the system is limited to the actual RAM space available in the system. The number of images that can be saved depends on the Max RAM Drive Size. The actual system path is /imagesd0/Images/. When saving images to FTP, the path is <last 6 digits of device's MAC Address>_Images/ on the host FTP director. Note that the FTP server needs to grant the user with create directory rights as the system will need to create a directory on the FTP server to store all uploaded images.</p> <p>File save scheme: The image file will be posted with its system reset count, followed by its read cycle i.d., followed by its image i.d., followed by its stored image type defined in <K763>, as follows:</p> <p><last 6 digits of device's MAC Address>_<system total reset count>_<read cycle id>_<image id>_<save image type>.{png, jpg}</p> <p><last 6 digits of device's MAC Address>_<system total reset count>_<read cycle id>_<image id>_readreport.xml</p>
Serial Cmd:	<K764,image storage location,FTP host info,transfer optimization,RAM drive size in MB,save image until,action at image storage limit>
Default:	RAM
Options:	0 = RAM 1 = FTP

H-22-2 FTP Host Info

Definition:	<p>mscan pass@192.168.188.1:21 signifies a the user with mscan at 192.168.188.1 FTP server on port 21 with pass as the FTP login password.</p> <p>Note: If port is not defined with the FTP server address, it will default to port 21.</p>
Serial Cmd:	<K764,image storage location,FTP host info,transfer optimization,RAM drive size in MB,save image until,action at image storage limit>
Default:	"user pass@xxx.xxx.xxx.xxx:21"
Options:	Maximum 255 characters including the characters " ", "@", and ":".

H-22-3 Transfer Optimization

Definition:	Transfer Optimization defines how the image is going to be stored in triggered captured modes.
Serial Cmd:	<K764,image storage location,FTP host info,transfer optimization,RAM drive size in MB,save image until,action at image storage limit>
Default:	Speed
Options:	0 = Speed (Lossy) 1 = Accuracy (Lossless)

Speed (Lossy)

Images will be saved when possible. Some images may be dropped.

SOR = Start of Read Cycle

EOR = End of Read Cycle

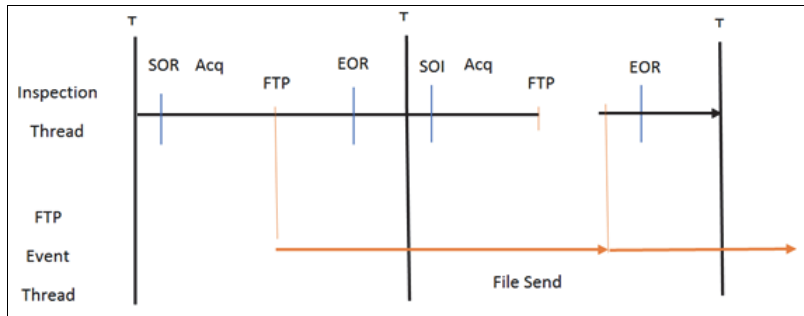

Accuracy (Lossless)

Every image in read cycle is transferred. The read cycle may be delayed due to image saving since each transfer will need to be finished before the end of the read cycle.

SOR = Start of Read Cycle

EOR = End of Read Cycle

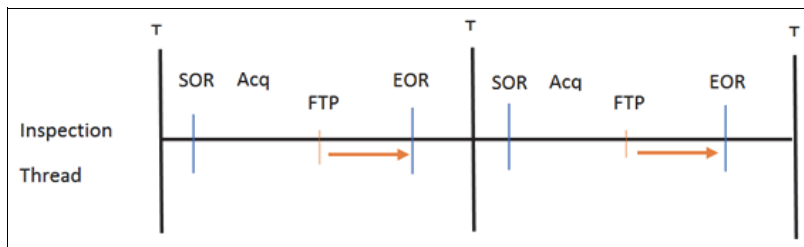

H-22-4 RAM Drive Size in MB

Definition: This defines the maximum RAM Drive size on the system. It is also limited to the memory available on the system and affects the max. rapid image count in **<K241>** since the onboard memory may be taken up by the RAM Drive. Images may not be saved if the RAM Drive is not large enough to store all the images in the current read cycle and if **Image Storage Location** is set to **FTP** with **Image Save Mode** set to **Speed**. If Image Storage Location is set to FTP with Image Save Mode set to **Accuracy**, all images in the read cycle will be transferred to the FTP host but the read cycle may be delayed.

Serial Cmd: **<K764,image storage location,FTP host info,transfer optimization,RAM drive size in MB,save image until,action at image storage limit>**

Default: 20

Options: 1 to 50

- Note: The number of images that can be save in the RAM drive vary depending on model, RAM drive size setting, image file format.

The following is a list of the number of images to be saved when the **Image File Format** is **PNG** and, the **Image Scale** is **Full**.

Resolution	No. of images to be saved	
	default: 20MB	Max.: 50MB
0.3 Mpix	57	143
1.2 Mpix	16	42
5 Mpix	4	10

H-22-5 Save Image Until

Definition: This defines how long the image will be stored in the system when the **Image Storage Location** is **RAM**.

If set to **New Read Cycle**, the saved image will be erased upon entering the next read cycle.

If set to **System Reset**, the saved image will be erased upon the next system reset.

Serial Cmd: <**K764**,*image storage location,FTP host info,transfer optimization,RAM drive size in MB,save image until,action at image storage limit*>

Default: New Read Cycle

Options: 1 = New Read Cycle

2 = System Reset

H-22-6 Action at Image Storage Limit

Definition: This defines what to do when **Action at Storage Full** is reached and when images are saved on **RAM**. When this setting is set to **Erase Oldest First**, the oldest images in the current read cycle will be erased.

Serial Cmd: <**K764**,*image storage location,FTP host info,transfer optimization,RAM drive size in MB,save image until,action at image storage limit*>

Default: Stop

Options: 0 = Stop

1 = Erase Oldest First



Symbol Quality

This section describes parameters that, when enabled, will output detailed symbol quality evaluations.

I-1	Symbol Quality Serial Commands	I-2
I-2	Overview of Symbol Quality	I-3
I-3	Symbol Quality Separator/Output Mode	I-4
I-4	ISO/IEC 16022 Symbol Quality Output	I-5
I-5	Omron Microscan Symbol Quality Output	I-7
I-6	ISO/IEC 15415 Symbol Quality Output	I-9
I-7	ISO/IEC 15416 Symbol Quality Output	I-12
I-8	ISO/IEC 29158 Symbol Quality Output	I-16

I-1 Symbol Quality Serial Commands

Symbol Quality Separator / Output Mode	<K708,symbol quality separator, output mode>
ISO/IEC 16022 Symbol Quality Output	<K709,symbol contrast,print growth,axial non-uniformity, unused ECC>
Omron Microscan Symbol Quality Output	<K710,percent cell damage,total read time,capture time,locate time,decode time,pixels per element,ECC level,matrix size,quiet zone,symbol angle>
ISO/IEC 15415 Symbol Quality Output	<K725,aperture,overall,contrast, modulation,reflectance margin, fixed pattern damage,axial nonuniformity,grid nonuniformity, unused ECC>
ISO/IEC 15416 Symbol Quality Output	<K726,aperture,overall,edge determination,decode,contrast, minimum reflectance,minimum edge contrast,modulation, defects,decodability,quiet zone>
ISO/IEC 29158 Symbol Quality Output	<K727,overall,cell contrast,cell modulation,fixed pattern damage,axial nonuniformity,grid nonuniformity,unused ECC>

I-2 Overview of Symbol Quality

V440-F readers support the following standards.

ISO code pint quality grading	Supported code
ISO/IEC 15415	DataMatrix (ECC200, GS1)
	QR Code *1
	Micro QR
ISO/IEC TR 29158	DataMatrix (ECC200, GS1)
ISO/IEC 15416	Code 128/GS1-12
	UPC/EAN(JAN)
	ITF
	Code 39
	Code 93
	Codabar
ISO/IEC 16022 *2	DataMatrix (ECC200, GS1)

(1) QR Code unique grading, VID/FID, are not supported.

(2) The evaluation standard of ISO/IEC 16022 is presently integrated to ISO/IEC 15415.

Information about symbol quality and timing can be appended to symbol data by enabling specific evaluation parameters. The order in which these values are appended corresponds to the order in ISO/IEC 16022 Parameters, Omron Microscan Grading Parameters, ISO/IEC 15415 Parameters, ISO/IEC 15416 Parameters, and ISO/IEC 29158 Parameters.

Symbol Quality parameters are separated into ISO/IEC 16022 Symbol Quality Output, Omron Microscan Symbol Quality Output, ISO/IEC 15415 Symbol Quality Output, ISO/IEC 15416 Symbol Quality Output, and ISO/IEC 29158 Symbol Quality Output.

Total Read Time, Symbol Quality Separator, and Output Mode are common parameters.

I-3 Symbol Quality Separator/Output Mode

Symbol Quality Separator applies to all Symbol Quality groups: ISO/IEC 16022 Symbol Quality Output, ISO/IEC 15415 Symbol Quality Output, ISO/IEC 15416 Symbol Quality Output, ISO/IEC 29158 Symbol Quality Output, and Omron Microscan Symbol Quality Output.

I-3-1 Symbol Quality Separator

Definition: Inserts a separator between each enabled field of the symbol quality output.

Serial Cmd: <**K708**,*symbol quality separator,output mode*>

Default: <**SP**> (space character)

Options: Any ASCII character.

I-3-2 Output Mode

Output Mode applies to ISO/IEC 16022 symbol quality parameters, ISO/IEC 15415 symbol quality parameters, ISO/IEC 15416 symbol quality parameters, and ISO/IEC 29158 symbol quality parameters.

Definition: Output Mode specifies how the output parameters, if enabled, are formatted.

Serial Cmd: <**K708**,*symbol quality separator,output mode*>

Default: **Grade**

Options: **0 = Grade** 1 = Value 2 = Score

Grade

If in **Grade Mode**, a grade (A,B,C,D,F) is appended to the symbol data.

Value

If in **Value Mode**, the calculated value for the given parameter is appended to the symbol data.

Score

If in **Score Mode**, a percentage of passing lines for that parameter is appended to the symbol data.

I-4 ISO/IEC 16022 Symbol Quality Output

Symbol Quality Parameters for Data Matrix symbols specified by ISO/IEC 16022.

I-4-1 Symbol Contrast

<i>Usage:</i>	Lets the user know if contrast settings are less than acceptable.	
<i>Definition:</i>	All the pixels that fall within the area of the test symbol, including its required zone, will be sorted by their reflectance values to select the darkest 10% and the lightest 10% of the pixels. The arithmetic mean of the darkest and the lightest pixels is calculated and the difference of the two means is the Symbol Contrast. (ANSI) Symbol Contrast grading is defined this way: A (4.0) if SC > 70% B (3.0) if SC > 55% C (2.0) if SC > 40% D (1.0) if SC > 20% F (0.0) if SC < 20%	
	If enabled, the symbol contrast is appended to the symbol data according to the ISO/IEC 16022 Symbol Quality Output Mode setting.	
<i>Serial Cmd:</i>	<K709,symbol contrast,print growth,axial non-uniformity,UEC>	
<i>Default:</i>	Disabled	
<i>Options:</i>	0 = Disabled	1 = Enabled

I-4-2 Print Growth

<i>Definition:</i>	The extent to which dark or light markings appropriately fill or exceed their module boundaries. These values are determined by counting pixels in the clock pattern of the binary digitized image, then comparing it to a nominal value and minimum and maximum values. The print growth grade is defined in this way: A (4.0) if $-0.50 < PG < 0.50$ B (3.0) if $-0.70 < PG < 0.70$ C (2.0) if $-0.85 < PG < 0.85$ D (1.0) if $-1.00 < PG < 1.00$ F (0.0) if $PG < -1.00$ or $PG > 1.00$	
	If enabled, the print growth is appended to the symbol data according to the ISO/IEC 16022 Symbol Quality Output Mode setting.	
<i>Serial Cmd:</i>	<K709,symbol contrast,print growth,axial non-uniformity,UEC>	
<i>Default:</i>	Disabled	
<i>Options:</i>	0 = Disabled	1 = Enabled

I-4-3 Axial Non-Uniformity (Data Matrix Only)

Definition: Axial non-uniformity is a measure of how much the sampling point spacing differs from one axis to another, namely $AN = \text{abs}(XAVG - YAVG) / ((XAVG + YAVG)/2)$ where $\text{abs}()$ yields the absolute value. If a symbology has more than two major axes, then AN is computed for those two average spacings which differ the most. (ANSI) axial non-uniformity grading is defined this way:

- A (4.0) if AN < .06
- B (2.0) if AN < .08
- C (2.0) if AN < .10
- D (1.0) if AN < .12
- F (0.0) if AN > .12

If enabled, the axial non-uniformity is appended to the symbol data according to the **ISO/IEC 16022 Symbol Quality Output Mode** setting.

Serial Cmd: <K709,symbol contrast,print growth,axial non-uniformity,UEC>

Default: Disabled

Options: 0 = Disabled 1 = Enabled

I-4-4 Unused ECC (Data Matrix Only)

Definition: The correction capacity of Reed-Solomon decoding is expressed in the equation: $e + 2d < d - p$, where e is the number of erasures, d is the number of error correction code words, and p is the number of code words reserved for error detection.

- A (4.0) if UEC > .62
- B (3.0) if UEC > .50
- C (2.0) if UEC > .37
- D (1.0) if UEC > .25
- F (0.0) if UEC < .25

If enabled, the UEC is appended to the symbol data according to the **ISO/IEC 16022 Symbol Quality Output Mode** setting.

Serial Cmd: <K709,symbol contrast,print growth,axial non-uniformity,UEC>

Default: Disabled

Options: 0 = Disabled 1 = Enabled

I-5 Omron Microscan Symbol Quality Output

I-5-1 Percent Cell Damage (Data Matrix Only)

<i>Definition:</i>	When this feature is enabled, the cell damage percentage is appended to data output.	
<i>Serial Cmd:</i>	<K710, percent cell damage ,total read time,capture time,locate time,decode time,pixels per element,ECC level,matrix size,quiet zone,symbol angle>	
<i>Default:</i>	Disabled	
<i>Options:</i>	0 = Disabled	1 = Enabled

I-5-2 Total Read Time

<i>Definition:</i>	The time that transpires between the image capture and the output of the decoded data, including locate time. When enabled, the total read time is appended to the symbol data.	
<i>Serial Cmd:</i>	<K710,percent cell damage, total read time ,capture time,locate time,decode time,pixels per element,ECC level,matrix size,quiet zone,symbol angle>	
<i>Default:</i>	Disabled	
<i>Options:</i>	0 = Disabled	1 = Enabled

I-5-3 Capture Time

<i>Definition:</i>	Capture time (in milliseconds) is a fixed “overhead” that includes the time of capture and transfer of the image. When enabled, the capture time is appended to the symbol data.	
<i>Serial Cmd:</i>	<K710,percent cell damage,total read time, capture time ,locate time,decode time,pixels per element,ECC level,matrix size,quiet zone,symbol angle>	
<i>Default:</i>	Disabled	
<i>Options:</i>	0 = Disabled	1 = Enabled

I-5-4 Locate Time

<i>Definition:</i>	The time in milliseconds from the start of image processing until the symbol has been located and is ready to be decoded. When enabled, the locate time is appended to the symbol data.	
<i>Serial Cmd:</i>	<K710,percent cell damage,total read time,capture time, locate time ,decode time,pixels per element,ECC level,matrix size,quiet zone,symbol angle>	
<i>Default:</i>	Disabled	
<i>Options:</i>	0 = Disabled	1 = Enabled

I-5-5 Decode Time

<i>Definition:</i>	The time in milliseconds required to decode a symbol. When enabled, the decode time is appended to the symbol data.	
<i>Serial Cmd:</i>	<K710,percent cell damage,total read time,capture time,locate time, decode time ,pixels per element,ECC level,matrix size,quiet zone,symbol angle>	
<i>Default:</i>	Disabled	
<i>Options:</i>	0 = Disabled	1 = Enabled

I-5-6 Pixel Per Element (Data Matrix Only)

<i>Definition:</i>	The number of pixels for each element, either dark or light for both x and y directions. When enabled, the pixels per element value is appended to the symbol data.	
<i>Serial Cmd:</i>	< K710 ,percent cell damage,total read time,capture time,locate time,decode time, pixels per element ,ECC level,matrix size,quiet zone,symbol angle>	
<i>Default:</i>	Disabled	
<i>Options:</i>	0 = Disabled	1 = Enabled

I-5-7 ECC Level (Data Matrix Only)

<i>Definition:</i>	Outputs the Data Matrix ECC level. When enabled, the ECC level is appended to the symbol data.	
<i>Serial Cmd:</i>	< K710 ,percent cell damage,total read time,capture time,locate time,decode time, pixels per element , ECC level ,matrix size,quiet zone,symbol angle>	
<i>Default:</i>	Disabled	
<i>Options:</i>	0 = Disabled	1 = Enabled

I-5-8 Matrix Size (Data Matrix Only)

<i>Definition:</i>	Defines the symbol matrix size, in number of pixels in both the x and y axis. When enabled, the matrix size value is appended to the symbol data.	
<i>Serial Cmd:</i>	< K710 ,percent cell damage,total read time,capture time,locate time,decode time, pixels per element ,ECC level, matrix size ,quiet zone,symbol angle>	
<i>Default:</i>	Disabled	
<i>Options:</i>	0 = Disabled	1 = Enabled

I-5-9 Quiet Zone (Data Matrix Only)

<i>Definition:</i>	When this feature is enabled, the size of the quiet zone is evaluated and a PASS or FAIL message is appended to the symbol data.	
<i>Serial Cmd:</i>	< K710 ,percent cell damage,total read time,capture time,locate time,decode time, pixels per element ,ECC level,matrix size, quiet zone ,symbol angle>	
<i>Default:</i>	Disabled	
<i>Options:</i>	0 = Disabled	1 = Enabled

I-5-10 Symbol Angle (Data Matrix Only)

<i>Definition:</i>	When this feature is enabled, the symbol orientation is appended to data output as a degree value representing the angle of the Data Matrix symbol's L-shaped finder pattern relative to the reader.	
<i>Serial Cmd:</i>	< K710 ,percent cell damage,total read time,capture time,locate time,decode time, pixels per element ,ECC level,matrix size,quiet zone, symbol angle >	
<i>Default:</i>	Disabled	
<i>Options:</i>	0 = Disabled	1 = Enabled

I-6 ISO/IEC 15415 Symbol Quality Output

Symbol Quality Parameters for 2D Symbols Specified by ISO/IEC 15415

Supported Symbologies:

- Data Matrix ECC 200
- QR Code
- Micro QR Code

Minimum Resolution: 6.0 Pixels Per Element

I-6-1 Aperture

<i>Definition:</i>	The size of aperture to use for grading configured as a percentage of the nominal narrow element width for the symbol under evaluation. For example, if you have a 15 mil symbol and you wish to grade using a 10 mil aperture you would configure the aperture to 67% ($10/15 = 0.67$).
<i>Serial Cmd:</i>	<K725,aperture,overall,contrast,modulation,reflectance margin,fixed pattern damage,axial non-uniformity,grid non-uniformity,unused ECC>
<i>Default:</i>	80%
<i>Options:</i>	Any number between 0 to 100%

I-6-2 Overall

<i>Definition:</i>	Overall is calculated in accordance with the ISO 15415 specification. The overall grade is the lowest individual parameter grade seen during the individual scan. When enabled, the Overall is attached to the symbol output data as a value.
<i>Serial Cmd:</i>	<K725,aperture,overall,contrast, modulation,reflectance margin,fixed pattern damage,axial non-uniformity,grid non-uniformity,unused ECC>
<i>Default:</i>	Disabled
<i>Options:</i>	0 = Disabled 1 = Enabled

I-6-3 Contrast

<i>Definition:</i>	Contrast measurements assume 8-bit 0 to 255 grey correlate to 0 to 100% reflectance. Contrast is calculated in accordance with the ISO 15415 specification. The Contrast grading is defined as follows. A (4.0) if $C \geq 70\%$ B (3.0) if $C \geq 55\%$ C (2.0) if $C \geq 40\%$ D (1.0) if $C \geq 20\%$ F (0.0) if $C < 20\%$ When enabled, the Contrast is attached to the symbol output data as a value.
<i>Serial Cmd:</i>	<K725,aperture,overall,contrast,modulation,reflectance margin,fixed pattern damage,axial non-uniformity,grid non-uniformity,unused ECC>
<i>Default:</i>	Disabled
<i>Options:</i>	0 = Disabled 1 = Enabled

I-6-4 Modulation

- Definition:** Modulation is calculated in accordance with the ISO 15415 specification. The Modulation grading is defined as follows.
 A (4.0) if $MOD \geq 0.50$
 B (3.0) if $MOD \geq 0.40$
 C (2.0) if $MOD \geq 0.30$
 D (1.0) if $MOD \geq 0.20$
 F (0.0) if $MOD < 0.20$
 When enabled, the Modulation is attached to the symbol output data as a value.
- Serial Cmd:** <K725,aperture,overall,contrast,**modulation**,reflectance margin,fixed pattern damage,axial non-uniformity,grid non-uniformity,unused ECC>
- Default:** **Disabled**
- Options:** **0 = Disabled** 1 = Enabled

I-6-5 Reflectance Margin

- Definition:** Reflectance Margin is calculated in accordance with the ISO 15415 specification. When enabled, the Reflectance Margin is attached to the symbol output data as a value.
- Serial Cmd:** <K725,aperture,overall,contrast,modulation,**reflectance margin**,fixed pattern damage,axial non-uniformity,grid non-uniformity,unused ECC>
- Default:** **Disabled**
- Options:** **0 = Disabled** 1 = Enabled

I-6-6 Fixed Pattern Damage

- Definition:** Fixed Pattern Damage is calculated in accordance with the ISO 15415 specification. When enabled, the Fixed Pattern Damage is attached to the symbol output data as a value.
- Serial Cmd:** <K725,aperture,overall,contrast,modulation,reflectance margin,**fixed pattern damage**,axial non-uniformity,grid non-uniformity,unused ECC>
- Default:** **Disabled**
- Options:** **0 = Disabled** 1 = Enabled

I-6-7 Axial Non-Uniformity

- Definition:** Axial Non-Uniformity is calculated in accordance with the ISO 15415 specification. The Axial Non-Uniformity grading is defined as follows.
 A (4.0) if $AN \leq 0.06$
 B (3.0) if $AN \leq 0.08$
 C (2.0) if $AN \leq 0.10$
 D (1.0) if $AN \leq 0.12$
 F (0.0) if $AN > 0.12$
 When enabled, the Axial Non-Uniformity is attached to the symbol output data as a value.
- Serial Cmd:** <K725,aperture,overall,contrast,modulation,reflectance margin,fixed pattern damage,**axial non-uniformity**,grid non-uniformity,unused ECC>
- Default:** **Disabled**
- Options:** **0 = Disabled** 1 = Enabled

I-6-8 Grid Non-Uniformity

Definition: Grid Non-Uniformity is calculated in accordance with the ISO 15415 specification. The Grid Non-Uniformity grading is defined as follows.

- A (4.0) if $GN \leq 0.38$
- B (3.0) if $GN \leq 0.50$
- C (2.0) if $GN \leq 0.63$
- D (1.0) if $GN \leq 0.75$
- F (0.0) if $GN > 0.75$

When enabled, the Grid Non-Uniformity is attached to the symbol output data as a value.

Serial Cmd: `<K725,aperture,overall,contrast,modulation,reflectance margin,fixed pattern damage,axial non-uniformity,grid non-uniformity,unused ECC>`

Default: **Disabled**

Options: **0 = Disabled** 1 = Enabled

I-6-9 Unused ECC

Definition: Unused ECC is calculated in accordance with the ISO 15415 specification. The Unused ECC grading is defined as follows.

- A (4.0) if $UEC \geq 0.62$
- B (3.0) if $UEC \geq 0.50$
- C (2.0) if $UEC \geq 0.37$
- D (1.0) if $UEC \geq 0.25$
- F (0.0) if $UEC < 0.25$

When enabled, the Unused ECC is attached to the symbol output data as a value.

Serial Cmd: `<K725,aperture,overall,contrast,modulation,reflectance margin,fixed pattern damage,axial non-uniformity,grid non-uniformity,unused ECC>`

Default: **Disabled**

Options: **0 = Disabled** 1 = Enabled

I-6-10 Grading Report

<VAL3>: Responds with a text report that summarized the grading of ISO/IEC15415. This command will return the evaluation results, in a format similar to the one shown below.

```

-----
                           15415 Validation Report
-----
ISO/IEC   Overall           = 0
15415:    Symbol Contrast   = 30
         Modulation         = 0
         Reflectance Margin = 0
         Fixed Pattern Damage = 50
         Axial Nonuniformity = 100
         Grid Nonuniformity  = 100
         Unused ECC         = 45
         Aperture           =  80 %
SYMBOL
DATA:    6000000006
TYPE:    Datamatrix
-----
                                  :GRADE
                                  :
                                  F
                                  D
                                  F
                                  F
                                  C
                                  A
                                  A
                                  C

```

I-7 ISO/IEC 15416 Symbol Quality Output

Symbol Quality Parameters for Barcodes Specified by ISO/IEC 15416

Supported Symbologies:

- Code 128/GS1-128
- UPC-A/UPC-E/EAN-13/EAN-8
- Interleaved 2 of 5/ITF-14
- Code 39
- Code 93
- Codabar

Minimum Resolution: 4.0 Pixels Per Element

I-7-1 Aperture

- Definition:** The size of aperture to use for grading configured as a percentage of the nominal narrow element width for the symbol under evaluation. For example, if you have a 13 mil UPC symbol and you wish to grade using a 6 mil aperture you would configure the aperture to 46% ($6/13 = 0.46$).
- Serial Cmd:** `<K726,aperture,overall,edge determination,decode,contrast,minimum reflectance,minimum edge contrast,modulation,defects,decodability,quiet zone>`
- Default:** 40%
- Options:** Any number between 0 to 100%

I-7-2 Overall

- Definition:** Overall is calculated in accordance with the ISO 15416 specification. The overall grade is the average of the individual scan grades applied to the symbol. The individual scan grades are the lowest individual parameter grade seen during the individual scan. These individual scan grades are not available for output. When enabled, the Overall is attached to the symbol output data as a value.
- Serial Cmd:** `<K726,aperture,overall,edge determination,decode,contrast,minimum reflectance,minimum edge contrast,modulation,defects,decodability,quiet zone>`
- Default:** **Disabled**
- Options:** **0 = Disabled** **1 = Enabled**

I-7-3 Edge Determination

- Definition:** Edge Determination is calculated and graded for each scan and provided for the overall grade calculation in accordance with the ISO 15416 specification. The parameter grade and value provided for output is an average value for each measured scan over the entire symbol. When enabled, the Edge Determination is attached to the symbol output data as a value.
- Serial Cmd:** `<K726,aperture,overall,edge determination,decode,contrast,minimum reflectance,minimum edge contrast,modulation,defects,decodability,quiet zone>`
- Default:** **Disabled**
- Options:** **0 = Disabled** **1 = Enabled**

I-7-4 Decode

Definition: Decode is calculated and graded for each scan and provided for the overall grade calculation in accordance with the ISO 15416 specification. The parameter grade and value provided for output is an average value for each measured scan over the entire symbol.
 When enabled, the Decode is attached to the symbol output data as a value.

Serial Cmd: <**K726**,aperture,overall,edge determination,decode,contrast,minimum reflectance,minimum edge contrast,modulation,defects,decodability,quiet zone>

Default: Disabled

Options: 0 = Disabled 1 = Enabled

I-7-5 Contrast

Definition: Contrast measurements assume 8-bit, 0 to 255 grey correlate to 0 to 100% reflectance. Contrast is calculated and graded for each scan and provided for the overall grade calculation in accordance with the ISO 15416 specification. The parameter grade and value provided for output is an average value for each measured scan over the entire symbol.
 When enabled, the Contrast is attached to the symbol output data as a value.

Serial Cmd: <**K726**,aperture,overall,edge determination,decode,contrast,minimum reflectance,minimum edge contrast,modulation,defects,decodability,quiet zone>

Default: Disabled

Options: 0 = Disabled 1 = Enabled

I-7-6 Minimum Reflectance (Reflectance Min)

Definition: The Minimum Reflectance (Reflectance Min) is calculated and graded for each scan and provided for the overall grade calculation in accordance with the ISO 15416 specification. The parameter grade and value provided for output is an average value for each measured scan over the entire symbol.
 When enabled, the Minimum Reflectance is attached to the symbol output data as a value.

Serial Cmd: <**K726**,aperture,overall,edge determination,decode,contrast,minimum reflectance,minimum edge contrast,modulation,defects,decodability,quiet zone>

Default: Disabled

Options: 0 = Disabled 1 = Enabled

I-7-7 Minimum Edge Contrast

Definition: Contrast measurement assume 8-bit 0 to 255 grey correlate 0 to 100% reflectance The Minimum Edge Contrast is calculated and graded for each scan and provided for the overall grade calculation in accordance with the ISO 15416 specification. The parameter grade and value provided for output is an average value for each measured scan over the entire symbol.
 When enabled, the Minimum Edge Contrast is attached to the symbol output data as a value.

Serial Cmd: <**K726**,aperture,overall,edge determination,decode,contrast,minimum reflectance,minimum edge contrast,modulation,defects,decodability,quiet zone>

Default: Disabled

Options: 0 = Disabled 1 = Enabled

I-7-8 Modulation

<i>Definition:</i>	Modulation is calculated and graded for each scan and provided for the overall grade calculation in accordance with the ISO 15416 specification. The parameter grade and value provided for output is an average value for each measured scan over the entire symbol. When enabled, the Modulation is attached to the symbol output data as a value.	
<i>Serial Cmd:</i>	< K726 ,aperture,overall,edge determination,decode,contrast,minimum reflectance,minimum edge contrast, modulation ,defects,decodability,quiet zone>	
<i>Default:</i>	Disabled	
<i>Options:</i>	0 = Disabled	1 = Enabled

I-7-9 Defects

<i>Definition:</i>	Defects are calculated and graded for each scan and provided for the overall grade calculation in accordance with the ISO 15416 specification. The parameter grade and value provided for output is an average value for each measured scan over the entire symbol. When enabled, the Defects are attached to the symbol output data as a value.	
<i>Serial Cmd:</i>	< K726 ,aperture,overall,edge determination,decode,contrast,minimum reflectance,minimum edge contrast,modulation, defects ,decodability,quiet zone>	
<i>Default:</i>	Disabled	
<i>Options:</i>	0 = Disabled	1 = Enabled

I-7-10 Decodability

<i>Definition:</i>	Decodability is calculated and graded for each scan and provided for the overall grade calculation in accordance with the ISO 15416 specification. The parameter grade and value provided for output is an average value for each measured scan over the entire symbol. When enabled, the Decodability is attached to the symbol output data as a value.	
<i>Serial Cmd:</i>	< K726 ,aperture,overall,edge determination,decode,contrast,minimum reflectance,minimum edge contrast,modulation,defects, decodability ,quiet zone>	
<i>Default:</i>	Disabled	
<i>Options:</i>	0 = Disabled	1 = Enabled

I-7-11 Quiet Zone

<i>Definition:</i>	Quiet Zone is not an individually processed parameter within the ISO 15416 specification, but it is evaluated as a part of the ISO graded decode parameters feeding into the overall grade. Quiet Zone is provided here as average scan result where a passing scan receives an A/4.0 grade and a fail receives an F/0.0. When enabled, the Quiet Zone is attached to the symbol output data as a value.	
<i>Serial Cmd:</i>	< K726 ,aperture,overall,edge determination,decode,contrast,minimum reflectance,minimum edge contrast,modulation,defects,decodability, quiet zone >	
<i>Default:</i>	Disabled	
<i>Options:</i>	0 = Disabled	1 = Enabled

I-7-12 Grading Report

<VAL4>: Responds with a text report that summarized the grading of ISO/IEC15416.

This command will return the evaluation results, in a format similar to the one shown below.

```

-----
                          15416 Validation Report
-----
ISO/IEC 15416: Overall = 0
                Edge Determination = 0
                Decode = 100
                Contrast = 35
                Min Reflectance = 100
                Min Edge Contrast = 0
                Modulation = 0
                Defects = 100
                Decodability = 1
                Quiz Zone = 100
                Aperture = 40 %
                GRADE
                F
                F
                D
                A
                F
                F
                F
                F
                F
                A
SYMBOL
DATA: code128
TYPE: Code128
    
```

I-8 ISO/IEC 29158 Symbol Quality Output

Symbol Quality Parameters for direct part marking specified by ISO/IEC 29158

Supported Symbologies:

- DataMatrix ECC200

Minimum Resolution: 6.0 Pixels Per Element

I-8-1 Overall

<i>Definition:</i>	The overall grade is the minimum grade of all evaluated parameters, noting minimum reflectance is not evaluated. When enabled, the overall grade is attached to the symbol output data as a value.	
<i>Serial Cmd:</i>	< K727 , <i>overall</i> , <i>cell contrast</i> , <i>cell modulation</i> , <i>fixed pattern damage</i> , <i>axial non-uniformity</i> , <i>grid non-uniformity</i> , <i>unused ECC</i> >	
<i>Default:</i>	Disabled	
<i>Options:</i>	0 = Disabled	1 = Enabled

I-8-2 Cell Contrast

<i>Definition:</i>	Cell Contrast is calculated in accordance with the ISO 29158 specification. When enabled, the Cell Contrast is attached to the symbol output data as a value.	
<i>Serial Cmd:</i>	< K727 , <i>overall</i> , cell contrast , <i>cell modulation</i> , <i>fixed pattern damage</i> , <i>axial non-uniformity</i> , <i>grid non-uniformity</i> , <i>unused ECC</i> >	
<i>Default:</i>	Disabled	
<i>Options:</i>	0 = Disabled	1 = Enabled

I-8-3 Cell Modulation

<i>Definition:</i>	Cell Modulation is calculated in accordance with the ISO 29158 specification. Note the difference in the calculation for Cell Modulation versus Modulation in ISO 15415 eliminated the need for the parameter Reflectance Margin which was added to ISO 15415. When enabled, the Cell Modulation is attached to the symbol output data as a value.	
<i>Serial Cmd:</i>	< K727 , <i>overall</i> , <i>cell contrast</i> , cell modulation , <i>fixed pattern damage</i> , <i>axial non-uniformity</i> , <i>grid non-uniformity</i> , <i>unused ECC</i> >	
<i>Default:</i>	Disabled	
<i>Options:</i>	0 = Disabled	1 = Enabled

I-8-4 Fixed Pattern Damage

<i>Definition:</i>	Fixed Pattern Damage is calculated in accordance with the ISO 29158 specification. When enabled, the Fixed Pattern Damage is attached to the symbol output data as a value.	
<i>Serial Cmd:</i>	< K727 , <i>overall</i> , <i>cell contrast</i> , <i>cell modulation</i> , fixed pattern damage , <i>axial non-uniformity</i> , <i>grid non-uniformity</i> , <i>unused ECC</i> >	
<i>Default:</i>	Disabled	
<i>Options:</i>	0 = Disabled	1 = Enabled

I-8-5 Axial Non-Uniformity

Definition: Axial Non-Uniformity is calculated in accordance with the ISO 29158 specification.
When enabled, the Axial Non-Uniformity is attached to the symbol output data as a value.

Serial Cmd: <K727,overall,cell contrast,cell modulation,fixed pattern damage,**axial non-uniformity**,grid non-uniformity,unused ECC>

Default: Disabled

Options: 0 = Disabled 1 = Enabled

I-8-6 Grid Non-Uniformity

Definition: Grid Non-Uniformity is calculated in accordance with the ISO 29158 specification.
When enabled, the Grid Non-Uniformity is attached to the symbol output data as a value.

Serial Cmd: <K727,overall,cell contrast,cell modulation,fixed pattern damage,axial non-uniformity,**grid non-uniformity**,unused ECC>

Default: Disabled

Options: 0 = Disabled 1 = Enabled

I-8-7 Unused ECC

Definition: Unused ECC is calculated in accordance with the ISO 29158 specification.
When enabled, the Unused ECC is attached to the symbol output data as a value.

Serial Cmd: <K727,overall,cell contrast,cell modulation,fixed pattern damage,axial non-uniformity,grid non-uniformity,**unused ECC**>

Default: Disabled

Options: 0 = Disabled 1 = Enabled

I-8-8 Grading Report

<VAL5>: Responds with a text report that summarized the grading of ISO/IEC29158.
This command will return the evaluation results, in a format similar to the one shown below.

```

-----
                          29158 Validation Report
-----
ISO/IEC 29158:  Overall          = 75
                  Cell Contrast    = 100
                  Cell Modulation   = 75
                  Fixed Pattern Damage = 100
                  Axial Nonuniformity = 100
                  Grid Nonuniformity = 100
                  Unused ECC        = 100
SYMBOL:
DATA:   6000000006
TYPE:   Datamatrix
-----
GRADE
-----
B
A
B
A
A
A
A

```

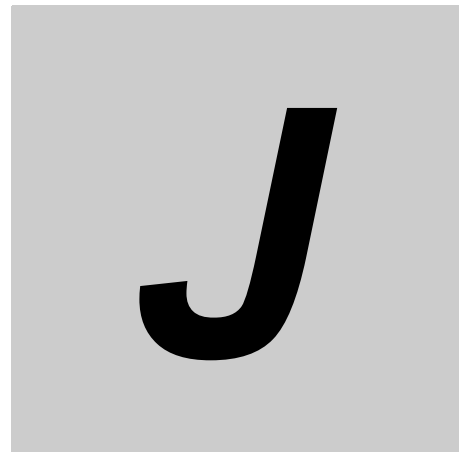
Matchcode

This section explains the matchcode output functions and the master symbol database setup.

J-1 Matchcode Serial Commands	J-2
J-2 Overview of Matchcode	J-3
J-3 Matchcode	J-4
J-4 Sequence Step Interval	J-7
J-5 Match Replace	J-8
J-6 Mismatch Replace	J-9
J-7 New Master Pin	J-10

J-1 Matchcode Serial Commands

Matchcode	<K223,matchcode,sequential matching,match start position,match length,wildcard character,sequence on No Read,sequence on mismatch,placeholder character>
Number of Master Symbols	<K224,number of master symbols>
New Master Pin	<K225,status>
Sequence Step Interval	<K228,sequence step interval>
Master Symbol Data	<K231,index,master symbol data>
Match Replace	<K735,status,match replacement string>
Mismatch Replace	<K736,status,mismatch replacement string>

J-2 Overview of Matchcode

- Definition:** **Matchcode** allows the user to store master symbol data in the reader's memory, compare that data against other symbol data, and define how symbol data and/or discrete signal output will be directed. A master symbol database can be set up for up to 10 master symbols. **Note:** **Matchcode** will function with multiple symbols; however, if **Matchcode Type** is set to **Sequential** or if **Triggering Mode** is set to **Continuous Read 1 Output**, the reader will behave as if **Number of Symbols** were set to 1, regardless of the user-defined configuration.
- Usage:** Matchcode is used in applications to sort, route, or verify data based on matching the specific symbol in a variety of ways as defined in this section. For example, a manufacturer might sort a product based on dates that are embedded in the symbol.

Steps for Entering and Using Master Symbols

- 1** Set **Triggering Mode** to **External** or **Serial**.
- 2** Choose the method of symbol comparison that fits your application.
- 3** Define the output you want to achieve with your matchcode setup:
 - (a) **Symbol data output**
 - (b) **Discrete output**
- 4** Select the number of master symbols you want to create.
- 5** Decide which way you want to enter your master symbol(s):
 - (a) **Send a serial command with symbol data in the form of <M231, master symbol#, data>.**
 - (b) **Send a <G> (Read Next Symbol as Master Symbol) command.**
 - (c) **Enable the New Master Pin command and activate the discrete input to store the next symbol read as the master symbol.**

J-3 Matchcode

<i>Definition:</i>	Allows you to choose the way that master symbols will be compared with subsequently read symbols. Note: First set Triggering Mode to External or Serial .
<i>Serial Cmd:</i>	< K223 , <i>matchcode</i> , <i>sequential matching</i> , <i>match start position</i> , <i>match length</i> , <i>wildcard</i> , <i>sequence on No Read</i> , <i>sequence on mismatch</i> , <i>placeholder character</i> >
<i>Default:</i>	Disabled
<i>Options:</i>	0 = Disabled 1 = Enabled 2 = Wildcard 3 = Sequential
<i>Disabled:</i>	Has no effect on operations.
<i>Enabled:</i>	Instructs the reader to compare symbols or portions of symbols with the master symbol.
<i>Wildcard:</i>	Allows the user to enter user-defined wildcard characters in the master symbol.
<i>Sequential:</i>	Instructs the reader to sequence after each match (numeric only) and compare symbols or portions of symbols for sequential numbers. Note: If Matchcode Type is set to Sequential , the reader will behave as if Number of Symbols were set to 1 , regardless of the user-defined configuration.

J-3-1 Sequential Matching

<i>Usage:</i>	Useful in tracking product serial numbers that increment or decrement sequentially.
<i>Definition:</i>	With Sequential enabled, Sequential Matching determines if a count is in ascending (incremental) or descending (decremental) order.
<i>Serial Cmd:</i>	< K223 , <i>matchcode</i> , sequential matching , <i>match start position</i> , <i>match length</i> , <i>wildcard</i> , <i>sequence on No Read</i> , <i>sequence on mismatch</i> , <i>placeholder character</i> >
<i>Default:</i>	Increment
<i>Options:</i>	0 = Increment 1 = Decrement

J-3-2 Match Start Position

<i>Usage:</i>	Match Start Position is useful in defining specific portions of a symbol for comparison. For example, if a symbol contains a part number, manufacturing date, and lot code info, but you are only interested in the part number information, you can set the reader to sort only the part number and ignore the other characters.
<i>Definition:</i>	Match Start Position determines the portions of symbols that will be matched by defining the first character in the symbol (from left to right) that will be compared with those of the master symbol, when Matchcode Type is set to Enabled or Sequential .
<i>Function:</i>	For example, if Match Start Position is set to 3 , the first 2 characters read in the symbol will be ignored and only the 3rd and subsequent characters to the right will be compared, up to the number of characters specified by Match Length .
<i>Serial Cmd:</i>	< K223 , <i>matchcode</i> , <i>sequential matching</i> , match start position , <i>match length</i> , <i>wildcard</i> , <i>sequence on No Read</i> , <i>sequence on mismatch</i> , <i>placeholder character</i> >
<i>Default:</i>	0
<i>Options:</i>	0 to 3000

Note: **Match Start Position** must be set to **1** or greater to enable this feature. **0** disables this feature.

J-3-3 Match Length

- Usage:* *Example:* If **Match Length** is set to **6** in a 10-character symbol, and **Match Start Position** is set to **2**, only the 2nd through 7th characters (from left to right) will be compared.
- Definition:* Defines the length of the character string that will be compared with that of the master symbol when **Match Start Position** is set to **1** or greater. When **Match Start Position** is set to **0**, no comparison will occur.
- Serial Cmd:* **<K223,matchcode,sequential matching,match start position,match length,wildcard,sequence on No Read,sequence on mismatch,placeholder character>**
- Default:* **1**
- Options:* 1 to 3000

J-3-4 Wildcard

- Usage:* *Example:* When the **Wildcard** character is defined as the default asterisk, defining **CR*34** as the master symbol will result in matches for CR134 and CR234, but not CR2345. Entering URGENT** as your master symbol will result in matches for URGENT, URGENT1, and URGENT12 but not for URGENT123. This means any wildcards appended to the master symbol data will result in matches of symbols in variable lengths up to the master symbol lengths but not over. However, wildcards in the beginning or center of a symbol (e.g., UR**NT) do not allow for variable symbol lengths.
- Definition:* Wildcard Character allows a user to define a wildcard character as part of the master symbol.
- Serial Cmd:* **<K223,matchcode,sequential matching,match start position,match length,wildcard,sequence on No Read,sequence on mismatch,placeholder character>**
- Default:* * (asterisk)
- Options:* Any ASCII character.

J-3-5 Sequence on No Read

- Usage:* **Sequence on No Read** is useful when the reader needs to stay in sequence even if no decode occurs.
- Definition:* When **Sequence on No Read** is **Enabled** and **Matchcode** is set to **Sequential**, the reader sequences the master symbol on every match or No Read. When disabled, it does not sequence on a No Read.
- Serial Cmd:* **<K223,matchcode,sequential matching,match start position,match length,wildcard,sequence on No Read,sequence on mismatch, placeholder character>**
- Default:* **Enabled**
- Options:* 0 = Disabled **1 = Enabled**

As an example of **Sequence on No Read Enabled**, consider the following decodes:

Master Symbol	Decoded Symbol	Master Symbol after Decode
001	001	002
002	002	003
003	No Read	004 (sequenced on No Read)
004	004	005
005	No Read	006 (sequenced on No Read)
006	No Read	007 (sequenced on No Read)
007	007	008

As an example of **Sequence on No Read Disabled**, consider the following series of decodes:

Master Symbol	Decoded Symbol	Master Symbol after Decode
001	001	002
002	002	003
003	No Read	003 (not sequenced)
003	003	004
004	No Read	004 (not sequenced)
004	No Read	004 (not sequenced)
004	004	005

J-4 Sequence Step Interval

- Usage:* Useful in applications in which it is desirable to count by intervals other than 1.
- Definition:* Sequencing in Matchcode operations can occur in steps from 1 to 32,768.
Sequencing performs like a mechanical counter by displaying positive integers and a specific number of digits after roll-overs. For example, 000 – 3 = 997 (not -3) and 999 + 3 = 002 (not 1002).
- Serial Cmd:* <K228,sequence step interval>
- Default:* 1
- Options:* Any number from 1 to 32768.

Example: If **Sequence Step** is set to **3** and **Sequential Matching** is set to **Increment**:

<i>Master Symbol</i>	<i>Decoded Symbol</i>	<i>Master Symbol after Decode</i>
003	001	003
003	002	003
003	003	006
006	004	006
006	005	006
006	006	009

J-5 Match Replace

<i>Usage:</i>	Provides a convenient shortcut for applications that need to output a predefined text string whenever a symbol matches a master symbol.	
<i>Definition:</i>	Outputs a user-defined data string whenever a match occurs and Matchcode is enabled.	
<i>Serial Cmd:</i>	< K735 , <i>status</i> , <i>replacement string</i> >	
<i>Default:</i>	Disabled	
<i>Options:</i>	0 = Disabled	1 = Enabled

J-5-1 Replacement String

<i>Definition:</i>	User-defined data string that, when enabled, replaces symbol data whenever a match occurs.
<i>Serial Cmd:</i>	< K735 , <i>status</i> , <i>replacement string</i> >
<i>Default:</i>	MATCH
<i>Options:</i>	An ASCII string up to 64 characters.

J-6 Mismatch Replace

<i>Usage:</i>	Provides a convenient shortcut for applications that need to output a predefined text string whenever a symbol does not match a master symbol.	
<i>Definition:</i>	Outputs a user-defined data string whenever a mismatch occurs and Matchcode is enabled.	
<i>Serial Cmd:</i>	< K736 , <i>status</i> , <i>replacement string</i> >	
<i>Default:</i>	Disabled	
<i>Options:</i>	0 = Disabled	1 = Enabled

J-6-1 Replacement String

<i>Definition:</i>	User-defined data string that, when enabled, replaces symbol data whenever a mismatch occurs.
<i>Serial Cmd:</i>	< K736 , <i>status</i> , <i>replacement string</i> >
<i>Default:</i>	MISMATCH
<i>Options:</i>	An ASCII string up to 64 characters.

J-7 New Master Pin

- Definition:* If **Matchcode** and **New Master Pin** are enabled and the new master pin is momentarily activated (must be active for a minimum of 10 ms) master symbol information will be loaded into the database based on the next read cycle that achieves a Good Read, starting with **Index 1**.
Note: For the V440-F, Input 1 (pin 3) is Default and Input 2 (pin 4) is New Master.
- Serial Cmd:* <K225,status>
- Default:* Disabled
- Options:* 0 = Disabled 1 = Enabled

J-7-1 New Master Load Status

- Definition:* The new master status responds with the number of the next master position to be loaded, where 0 represents "idle" or "no master to be loaded."
Example: If the user has the **Number of Master Symbols** set to 1, and then either sends a <G> or toggles an active **New Master Pin**, the state will be 1, and prior to reading and effectively loading position 1, the response to <NEWM> would be <NEWM/1>. Once a symbol has been read and loaded, the status will be cleared: <NEWM/0>.
- Serial Cmd:* <NEWM>

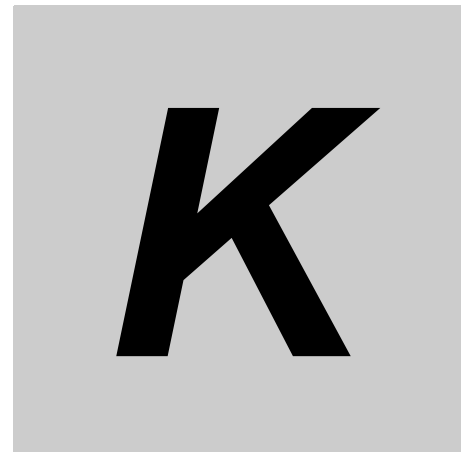

Camera and IP Setup

This section provides adjustment parameters for the physical controls of the camera, image acquisition, database settings, and image diagnostics.

K-1 Camera and IP Setup Serial Commands	K-2
K-2 Window of Interest	K-3
K-3 Pixel Binning	K-5
K-4 Camera Settings	K-6
K-5 Illumination	K-7
K-6 Morphological Pre-Processing	K-8
K-7 Morphological Operation and Operator Size	K-9
K-8 1D Damaged Symbol	K-11
K-9 Linear Security Level	K-12
K-10 Fast Linear Mode	K-13

K-1 Camera and IP Setup Serial Commands

Window of Interest	<K516,row pointer,column pointer,row depth,column width>
1D Damaged Symbol	<K519,1D Damaged Symbol>
Illumination	<K536,unused,unused,fixed light on time,fixed light on delay time>
Camera Settings	<K541,exposure,gain>
Pixel Binning	<K542,pixel binning status>
Morphological Pre-Processing	<K550,status>
Morphological Operation	<K551,morphological operation,operator size>
Set License	<K556,license file name,license key>
Linear Security Level	<K560,linear security level>
Fast Linear Mode	<K561,fast linear mode>
Curved 2D	<K563,Curved 2D>
Shift-JIS to UTF-8	<K564,Shift-JIS to UTF-8>
1D Quiet Zone Violation	<K565,1D Quiet Zone Violation>
Scale Image	<K566,Scale Image>
2D Damaged Mode	<K567,2D Damaged Mode>
Attempt Morphology Manipulation	<K568,Attempt Morphology Manipulation>

K-2 Window of Interest

The active pixel area of the image sensor is called the **Window of Interest (WOI)**. The WOI allows the user to select an area of the field of view in which the desired symbol is located.

The programmable window of interest increases decode speed, improves threshold, and makes it easy to select specific symbols from among several in the field of view. The user provides the upper-left pixel location and the size of the window in rows and columns to define the Window of Interest.

K-2-1 Window of Interest by Serial Command

The figure shows where to locate the start position of the row and column pointers and how to measure the column depth and row width dimensions.

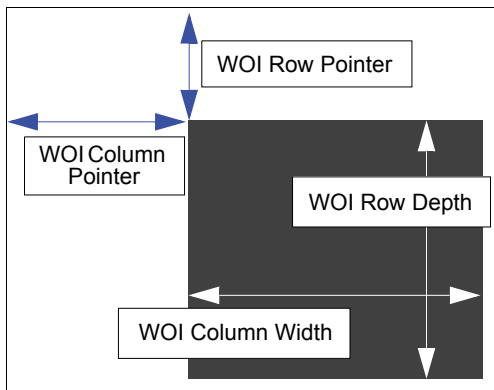

Note: The names of K commands, parameters, and options are occasionally different from the names of commands, parameters, and options in the WebLink user interface. For example, the terms in the diagram shown at left correspond to the values **Top**, **Left**, **Height**, and **Width** in the WebLink user interface.

Row Pointer

Definition: Defines the row position of the upper-left starting point of the image window.
Serial Cmd: <K516,row pointer,column pointer,row depth,column width>
Default: All models: 0
Options: V440-F □50C QSXGA: 0 to (2048 – row depth)

Column Pointer

Definition: Defines the column position of the upper-left starting point of the image window.
Serial Cmd: <K516,row pointer,column pointer,row depth,column width>
Default: All models: 0
Options: V440-F □50C QSXGA: 0 to (2464 – column width)

Row Depth

- Definition:* Defines the size, in rows, of the image window. Maximum value is defined as the maximum row size of the image sensor minus the Row Pointer value.
- Serial Cmd:* <**K516**,row pointer,column pointer,row **depth**,column width>
- Default:* **V440-F** □ **50C QSXGA: 2048**
- Options:* **V440-F** □ **50C QSXGA: 3 to (2048 – row pointer)**

Column Width

- Definition:* Defines the size, in columns, of the image window. Maximum value is defined as the maximum column size of the image sensor minus the Column Pointer value.
- Serial Cmd:* <**K516**,row pointer,column pointer,row depth,**column width**>
- Default:* **V440-F** □ **50C QSXGA: 2592**
- Options:* **V440-F** □ **50C QSXGA: 8 to (2464 – column pointer)**

Important Notes

The column width value must be a modulus 8 value. Regardless of the column width setting that is configured, the actual column width will be decreased if necessary to a modulus 8 value. For example, a column width value of **639** would actually be **632**. A user query for the value of this setting would still return **639**.

The column pointer must be an even value. Regardless of the column pointer setting that is configured, the actual column pointer will be decreased if necessary to an even value. For example, a column pointer value of **101** would actually be **100**. A user query for the value of this setting would still return **101**.

K-3 Pixel Binning

Definition: In addition to windowing the image sensor, smaller resolutions can be obtained by down sampling the entire captured image by using pixel binning. Pixel binning can increase the signal to noise ratio and produce a more pleasing output image with reduced artifacts. It will also improve low-light performance. It is important to note that enabling pixel binning does not affect the sensor frame rate as the pixels still need to be processed in order to be averaged and binned.

Usage: <K542,pixel binning>

Default: Disabled

Options: 0 = Disabled 1 = Enabled

Disabled

Pixel-binning is disabled.

Enabled

Two column pixels and two row pixels are averaged to create a single pixel value providing a 2:1 reduction in the vertical pixels and a 2:1 reduction in the horizontal pixels for a combined 4:1 reduction. An image with a dimension of 640 x 480 will be scaled to 320 x 240.

K-4 Camera Settings

Camera Settings are typically obtained during the calibration process, and do not necessarily need to be modified directly by the user.

K-4-1 QSXGA, SXGA, and WVGA

● Exposure

- Usage:* Faster exposures reduce blurring in faster applications. Slower exposures are useful in slower applications and lower contrast applications.
- Definition:* This value sets the exposure or integration time (in microseconds) for the image sensor pixels. The exposure setting in relation to the speed of the object is critical. If an object is moving rapidly and too long an exposure value is selected, blurring or smearing of the object will occur. As exposure time is decreased the movement of the object becomes less of a factor but, with the duration of light collection by the pixels reduced, the image sensor gain will need to be increased to compensate.
- Serial Cmd:* **<K541,exposure,gain>**
- Default:* **All versions: 1000 µs**
- Options:* Any number between 16 – 400,000

● Gain

- Usage:* Can be used to adjust the brightness of the image.
- Definition:* Sets the gain value for the image sensor and is a percentage value from 0 (lowest gain) to 100% (highest gain). This setting can be configured through autocalibration. A higher gain value will increase the brightness of the image, but the noise performance of the system will be reduced. Before configuring the gain, the required exposure should be set, and the gain should be configured to optimize the exposure setting.
- Serial Cmd:* **<K541,exposure,gain>**
- Default:* **0**
- Options:* Any number between 0 – 100, representing 0% to 100%
Gain is set in 1% increments.

K-5 Illumination

Definition: This feature allows you to set the timing of external illumination hardware to coordinate it with the V440-F image sensor.

Serial Cmd: <K536,unused,unused,fixed light on time,fixed light on delay time>

K-5-1 Fixed Light On Time

Note: Entering **0** disables **Fixed Light On Time**.

Definition: **Fixed Light On Time** is the amount of delay after the external lighting is turned on before the reader captures an image. This allows the external lighting time to reach full power.

Serial Cmd: <K536,unused,unused,fixed light on time,fixed light on delay time>

Options: 0 - 100,000 μ s

Default: **0 (Disabled)**

K-5-2 Fixed Light On Delay Time

Definition: **Fixed Light On Delay Time** is the amount of time the external light should be on after the sensor starts an image capture. If set to a value other than 0, this time interval should be shorter than the sensor's exposure/integration period. The light is always forced off after the sensor's exposure/integration time is up. Fixed Light On Delay Time allows you to configure a light pulse that is shorter than the sensor's integration time.

The V440-F's image sensor is very fast (the V440-F sensor supports 16 μ s shutter exposure times), and this delay accounts for any potential lag time in external lighting hardware. It allows slower lights to reach full illumination in a shorter time than the sensor's exposure/integration period.

Serial Cmd: <K536,unused,unused,fixed light on time,fixed light on delay time>

Options: 0 - 100,000 μ s

Default: **0**

K-7 Morphological Operation and Operator Size

K-7-1 Morphological Operation

Definition: **Morphological Operation** allows the user to select the method for processing captured images.

Serial Cmd: <K551,0,morphological operation,operator size>

Default: **Grow Dark**

Options: **0 = Grow Dark**
1 = Shrink Dark
2 = Connect Dark
3 = Separate Dark

Erode (Grow Dark)

Erode increases the dark cell size of a symbol. Useful for increasing the dark cell size of a dark-on-light Data Matrix symbol.

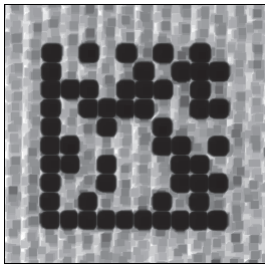

Dilate (Shrink Dark)

Dilate increases the light cell size of a symbol. Useful for increasing the light cell size of a light-on-dark Data Matrix symbol.

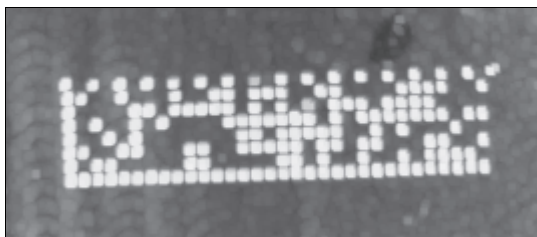

Open (Connect Dark)

Open removes minor light defects of dark cells by performing a **Dilate** function followed by an **Erode** function.

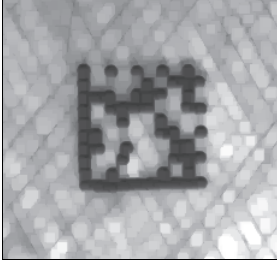

Close (Separate Dark)

Close removed minor dark defects of light cells by performing an **Erode** function followed by a **Dilate** function.

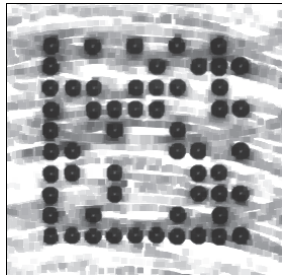

K-7-2 Operator Size

Definition: **Operator Size** determines the size of the area or "pixel neighborhood" (measured in pixels) in which the morphological operation is being performed.

Serial Cmd: <K551,0,morphological operation,**operator size**>

Default: **Small**

Options: **3 = Small (3 pixels by 3 pixels)**
5 = Medium (5 pixels by 5 pixels)
7 = Large (7 pixels by 7 pixels)

K-8 1D Damaged Symbol

Definition: When **1D Damaged Symbol** is enabled, the reader will make additional attempts to decode damaged Code 128 and Code 39 symbols. It is effective on symbols with high noise and partial bar missing. Enabling Damaged Symbol may significantly increase decode time.

Serial Cmd: <**K519,1D damaged symbol status**>

Default: **Disabled**

Options: **0 = Disabled**

1 = Enabled

K-9 Linear Security Level

Definition: **Linear Security Level** is intended to prevent misreads. When it is set to a higher level, it requires more scan lines to decode the same result, making it more secure.

Serial Cmd: **<K560,linear security level>**

Default: **Aggressive**

Options: **0 = Aggressive**

1 = Normal

2 = Secure

K-10 Fast Linear Mode

Definition: **Fast Linear Mode** optimizes 1D symbol decoding. If you know the direction the application's symbols will be oriented, set Fast Linear Mode to match that direction.

Serial Cmd: <K562,fast linear mode>

Options: **XMODE_FLM=DIS** (or any other string) = No Fast Linear Mode
XMODE_FLM=HORIZ=STD = Standard horizontal Fast Linear Mode
XMODE_FLM=VERT=STD = Standard vertical Fast Linear Mode

Note: **XMODE_FLM_HORIZ=STD** cannot decode vertical symbols, and **XMODE_FLM_VERT=STD** cannot decode horizontal symbols.

If you know the direction the application's symbols will be oriented relative to the reader, set Fast Linear Mode to match that direction.

Horizontal requires that the entire symbol be oriented horizontally in the reader's field of view.

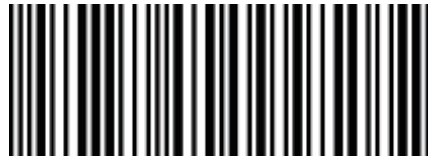

Vertical requires that the entire symbol be oriented vertically in the reader's field of view.

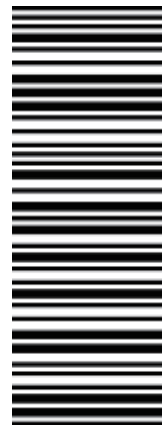

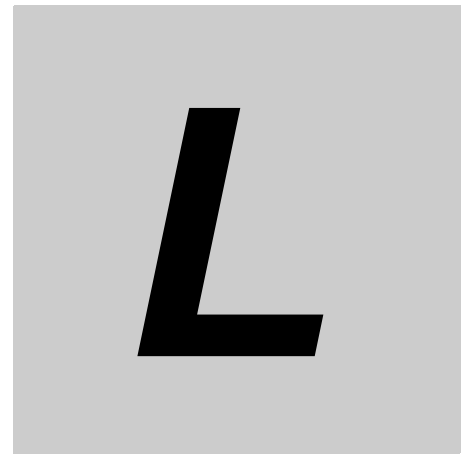

Configuration Database

This section concerns the various capture settings and processing settings that can be used to fine-tune the reader's performance in your application.

L-1 Introduction	L-2
L-2 Configuration Database Serial Commands	L-3
L-3 Number of Active Indexes	L-4
L-4 Configuration Database Status	L-5
L-5 Database Mode	L-10
L-6 Save Current Settings to Configuration Database	L-13
L-7 Load Current Settings from Configuration Database	L-13
L-8 Request Selected Index Settings	L-13
L-9 Request All Configuration Database Settings	L-13
L-10 Remove Database Index	L-13
L-11 Shift Database Indexes Up by One	L-13

L-1 Introduction

For the Configuration Database, the following functions as the bank switching function are possible to achieve.

- Up to **20** settings can be held.
- Settable parameters: Exposure, Gain, Focal Distance, Pixel Binning, Window of Interest / Region of Interest, Symbology, Morphology Operator, Morphology Size, Tray ID, and Matrix ID.
- Switch command of the database: `<K255-,index>`
- Automatic switching function of the database: `<K252,number of active indexes.sort database>`

L-2 Configuration Database Serial Commands

Number of Active Indexes	<K252,number of active indexes,sort database>
Configuration Database Status	<K255,index,exposure,gain,focal distance,pixel binning,row pointer,column pointer,row depth,column width,symbology,morphology operator, morphology size,tray id,matrix id,group id>
Save Current Settings to Database	<K255+,index>
Load Current Settings from Database	<K255-,index>
Request Selected Index Settings	<K255?,index>
Request All Database Settings	<K255?>
Remove Database Index	<K255r#>
Shift Database Indexes Up by One	<K255i#>
Database Mode	<K256,switch mode,frame count/time,image process looping,image dimensions>

L-3 Number of Active Indexes

- Usage:* Useful for applications that require several different complex reader configurations to be applied sequentially. Multiple database indexes allow you to concatenate configuration profiles, and to perform more complex operations than would be possible with only one set of configuration parameters.
- Definition:* This feature allows you to set the number of database records (groups of settings) that will be used automatically during the read cycle. If **Number of Active Indexes** is set to 0, only the current reader settings will be used, not database entry settings.
- Serial Cmd:* <**K252,number of active indexes,sort database**>
- Default:* **0 (Disabled)**
- Options:* 0 to 20

L-3-1 Sort Database

- Definition:* **Sort Database** moves the database entry that produced a successful decode to the first position in the list of database entries.
- Serial Cmd:* <**K252,number of active indexes,sort database**>
- Default:* **Disabled**
- Options:* **0 = Disabled** 1 = Enabled

L-4 Configuration Database Status

L-4-1 Index

Usage: Useful for applications that require several different complex reader configurations to be applied sequentially. Multiple database indexes allow you to concatenate configuration profiles, and to perform more complex operations than would be possible with only one set of configuration parameters.

Definition: Determines the specific database index that will be used.

Serial Cmd: <K255,index,exposure,gain,focal distance,pixel binning,row pointer,column pointer,row depth,column width,symbology,morphology operator,morphology size,tray id,matrix id>

Options: 1 to 10

L-4-2 Exposure

Serial Cmd: <K255,index,exposure,gain,focal distance,pixel binning,row pointer,column pointer,row depth,column width,symbology,morphology operator,morphology size,tray id,matrix id>

Default: 2500

Options: 50 to 100,000

Note: The Exposure parameter is read-only when the reader is in **Continuous Read** mode.

L-4-3 Gain

Serial Cmd: <K255,index,exposure,gain,focal distance,pixel binning,row pointer,column pointer,row depth,column width,symbology,morphology operator,morphology size,tray id,matrix id>

Default: 0

Options: 0 to 100

L-4-4 Focal Distance

Definition: Provides the focal distance adjustment for the reader.
Any value outside this range will be rejected.

If you attempt to set the Focal distance as the out of range value of your model, the parameter will be left as-is.

Serial Cmd: <K255,index,exposure,gain,focal distance,pixel binning,row pointer,column pointer,row depth,column width,symbology,morphology operator,morphology size,tray id,matrix id>

Default: 102

Options: 25 to 4,000 (mm)
100 to 4,000 (1/100 inch)

L-4-5 Pixel Binning

Serial Cmd: <K255,index,exposure,gain,focal distance,pixel binning,row pointer,column pointer,row depth,column width,symbology,morphology operator,morphology size,tray id,matrix id>

Default: Disabled

Options: 0 = Disabled 1 = Enabled

Important: Pixel Binning has no effect when the **Image Dimension** mode is configured as **Region of Interest** in the **Database Mode** command. This is because the **Window of Interest** reader settings are determined by the software based on the **Region of Interest** setup. There is no benefit to Pixel Binning to increase processing speed when ROI is configured, because the frame size would need to be increased to make Pixel Binning possible.

L-4-6 Row Pointer

Definition: The image dimension settings can be applied as a Window of Interest or a Region of Interest, depending on the image dimension mode selected in the **Database Mode** command.

Serial Cmd: <K255,index,exposure,gain,focal distance,pixel binning,**row pointer**,column pointer,row depth,column width,symbology,morphology operator,morphology size,tray id,matrix id>

Default: All models: 0

Options: V440-F 50C QSXGA: 0 to (2048 – row depth)

L-4-7 Column Pointer

Definition: The image dimension settings can be applied as a Window of Interest or a Region of Interest, depending on the image dimension mode selected in the **Database Mode** command.

Serial Cmd: <K255,index,exposure,gain,focal distance,pixel binning,row pointer,**column pointer**,row depth,column width,symbology,morphology operator,morphology size,tray id,matrix id>

Default: All models: 0

Options: V440-F 50C QSXGA: 0 to (2464 – column width)

L-4-8 Row Depth

Definition: The image dimension settings can be applied as a Window of Interest or a Region of Interest, depending on the image dimension mode selected in the **Database Mode** command.

Serial Cmd: <K255,index,exposure,gain,focal distance,pixel binning,row pointer,column pointer,**row depth**,column width,symbology,morphology operator,morphology size,tray id,matrix id>

Default: V440-F 50C QSXGA: 2048

Options: V440-F 50C QSXGA: 3 to (2048 – row pointer)

L-4-9 Column Width

Definition: The image dimension settings can be applied as a Window of Interest or a Region of Interest, depending on the image dimension mode selected in the **Database Mode** command.

Serial Cmd: <K255,index,exposure,gain,focal distance,pixel binning,row pointer,column pointer,row depth,**column width**,symbology,morphology operator,morphology size,tray id,matrix id>

Default: V440-F 50C QSXGA: 2592

Options: V440-F 50C QSXGA: 8 to (2464 – column pointer)

L-4-10 Symbology

Definition: This field allows the user to configure the database to enable specific symbologies for selected database indexes. Symbology-specific parameters must be configured with the appropriate symbology command.

For example, if fixed length Code 128 is required, it must first be set up with the Code 128 command: **<K474>**.

To select a particular symbology, add the number value associated with that symbology.

Examples:

If Data Matrix and Code 39 are required, the parameter would be: $2 + 16 = 18$.

If I 2/5, BC412, and DataBar Limited are required, the parameter would be: $128 + 2048 + 16384 = 18560$.

Serial Cmd: **<K255,index,exposure,gain,focal distance,pixel binning,row pointer,column pointer,row depth,column width,symbology,morphology operator,morphology size,tray id,matrix id>**

Default: **Disabled**

Notes on Symbol Type

- The **current** DataBar Expanded status does not change if it is configured as Enabled (Stacked) and the **database** DataBar Expanded status is Enabled.
- The **current** DataBar-14 status does not change if it is configured as Enabled (Stacked) and the **database** DataBar Expanded status is Enabled.

Data Matrix ECC level is determined by the **current** settings and not by **database** settings. Therefore, the database does not know which ECC level to enable, and has no effect on current Data Matrix ECC settings.

Disabled

When **Symbology** is disabled, the database uses the current **Symbology** setup to determine active symbologies.

Any Symbology (Add 1)

All symbologies except Pharmacode are enabled when this database index is being used.

Data Matrix (Add 2)

If enabled, Data Matrix will be active for this database index.

Important: The ECC level must be configured using the Data Matrix command **<K479>**. If no ECC level has been configured, the reader will not decode Data Matrix symbols.

QR Code (Add 4)

If enabled, QR Code will be active for this database index.

Code 128 (Add 8)

If enabled, Code 128 will be active for this database index.

Code 39 (Add 16)

If enabled, Code 39 will be active for this database index.

Codabar (Add 32)

If enabled, Codabar will be active for this database index.

Code 93 (Add 64)

If enabled, Code 93 will be active for this database index.

Interleaved 2 of 5 (Add 128)

If enabled, Interleaved 2 of 5 will be active for this database index.

UPC/EAN (Add 256)

If enabled, UPC/EAN will be active for this database index.

PDF417 (Add 512)

If enabled, PDF417 will be active for this database index.

MicroPDF417 (Add 1024)

If enabled, MicroPDF417 will be active for this database index.

BC412 (Add 2048)

If enabled, BC412 will be active for this database index.

Pharmacode (Add 4096)

If enabled, Pharmacode will be active for this database index.

DataBar-14 (Add 8192)

If enabled, DataBar-14 will be active for this database index.

Important: If the stacked and non-stacked operation is required, the DataBar-14 command must be configured as follows: <K482,2>. If the DataBar-14 status parameter in the <K482> command is set to either Disabled or Enabled, the reader will only read non-stacked DataBar-14 symbols.

DataBar Limited (Add 16384)

If enabled, DataBar Limited will be active for this database index.

DataBar Expanded (Add 32768)

If enabled, DataBar Expanded will be active for this database index.

Important: If the stacked and non-stacked operation is required, the DataBar Expanded command must be configured as follows: <K484,2>. If the DataBar Expanded status parameter in the <K484> command is set to either Disabled or Enabled, the reader will only read non-stacked DataBar Expanded symbols.

Micro QR Code (Add 65536)

If enabled, Micro QR Code will be active for this database index.

Aztec (Add 131072)

If enabled, Aztec will be active for this database index.

Postal Symbolologies (Add 262144)

If enabled, Postal Symbolologies will be active for this database index.



L-4-11 Morphology Operator

- Definition:* Specifies the morphology operation (**erode, dilate, open, close**) used to pre-process the WOI.
- Serial Cmd:* <**K255**,*index,exposure,gain,focal distance,pixel binning,row pointer,column pointer,row depth,column width,symbology,morphology operator,morphology size,tray id,matrix id*>
- Default:* **Disabled**

L-4-12 Morphology Size

- Definition:* Specifies the morphology operator size to apply: **Small (3 x 3)**, **Medium (5 x 5)**, and **Large (7 x 7)**.
- Serial Cmd:* <**K255**,*index,exposure,gain,focal distance,pixel binning,row pointer,column pointer,row depth,column width,symbology,morphology operator,morphology size,tray id,matrix id*>
- Default:* **Small (3 x 3)**

L-4-13 Tray ID

- Definition:* **Tray ID** is a value, such as a test tube rack ID, representing a single code that identifies a matrix. Typically, each test tube cap would be in a matrix in a different slot.
- Serial Cmd:* <**K255**,*index,exposure,gain,focal distance,pixel binning,row pointer,column pointer,row depth,column width,symbology,morphology operator,morphology size,tray id,matrix id*>
- Default:* **0**
- Options:* **0** or 20

L-4-14 Matrix ID

- Definition:* **Matrix ID** refers to each matrix setup.
If there are multiple matrix setups with different grids, like 4 x 3, or 6 x 6, they can be assigned multiple database indexes in a user-defined sequence.
- Serial Cmd:* <**K255**,*index,exposure,gain,focal distance,pixel binning,row pointer,column pointer,row depth,column width,symbology,morphology operator,morphology size,tray id,matrix id*>
- Default:* **0**
- Options:* **0** or 1

L-5 Database Mode

L-5-1 Switch Mode

Definition: Selects the event that causes the reader to load the next database entry to current, active settings. When **Frame Count/Time** expires and **Image Process Looping** is enabled, the next database entry with modifications to reader settings will be used.

Note: The image capture event always occurs when the first database entry is used.

Note: The **Switch Mode** setting has no effect on **Rapid Capture Mode**, which always operates in **Number of Image Frames** mode with a frame count of 1.

Serial Cmd: <K256,switch mode,frame count/time,image process looping,image dimensions>

Default: 1

Options: 0 = Time 1 = Number of Image Frames

Time

When **Switch Mode** is set to **Time**, the reader will load the next database entry to current, active settings after a predefined time interval. The timer will start upon use of a database entry. If the timer expires during an image capture event, the timer will not start again until that database entry has been incremented and the new database entry has been loaded to current, active settings.

Number of Image Frames

When **Switch Mode** is set to **Number of Image Frames**, the database entry is incremented after the predetermined number of image capture events has occurred.

L-5-2 Frame Count/Time

Definition: Indicates the **Number of Image Frames** that must be captured or the amount of **Time** that must transpire before the reader will load the next database index entry.

Serial Cmd: <K256,switch mode,frame count/time,image process looping,image dimensions>

Default: 1 (frames or ms)

Options: 1 to 65535

L-5-3 Image Process Looping

Usage: Useful in applications where it is necessary to process a single captured image multiple times using different IP and decode parameters.

Serial Cmd: <K256,switch mode,frame count/time,image process looping,image dimensions>

Default: 1

Options: 0 = Disabled 1 = Enabled

Disabled

When **Image Process Looping** is set to **Disabled**, an image is captured for every database configuration, whether or not any reader settings have been modified.

Enabled

When **Image Process Looping** is set to **Enabled**, the last captured image frame is re-processed with the new IP and decode parameters. If reader settings have not been changed from the last capture event, and when a database configuration is loaded to current, active settings, no new image is captured.

Note: An exception to this is the first database index: a new image is always captured when the first database index is used. When a reader setting has been modified from one database setting to the next, a new image is captured. For example, if all database entries contained the same reader setting values but had different IP and decode parameters, an image frame would only be captured when the first database configuration was used.

L-5-4 Image Dimensions

Definition: Determines how the image dimension parameters will be implemented.

Serial Cmd: <**K256**,switch mode,frame count/time,image process looping,**image dimensions**>

Default: **1 (ROI)**

Options: 0 = Window of Interest (WOI) **1 = Region of Interest (ROI)**

Region of Interest (ROI)

When **Image Dimensions** is set to Region of Interest, the database image dimension parameters are *IP and decode settings*, and they determine the region or area of the captured image to be processed.

ROI coordinate data is based on the full image size. The **WOI** of the captured image will be configured to cover all the ROI settings in the current, active database entry. In the following example, there are three active database settings, each with a different ROI configuration. Their coordinates are based at point 0,0 of the full scale image. In this example, **DB1** and **DB3** determine the size of the captured image WOI, while **DB2** has no impact. The image WOI is not configurable. It is automatically set up by the database according to the ROI settings.

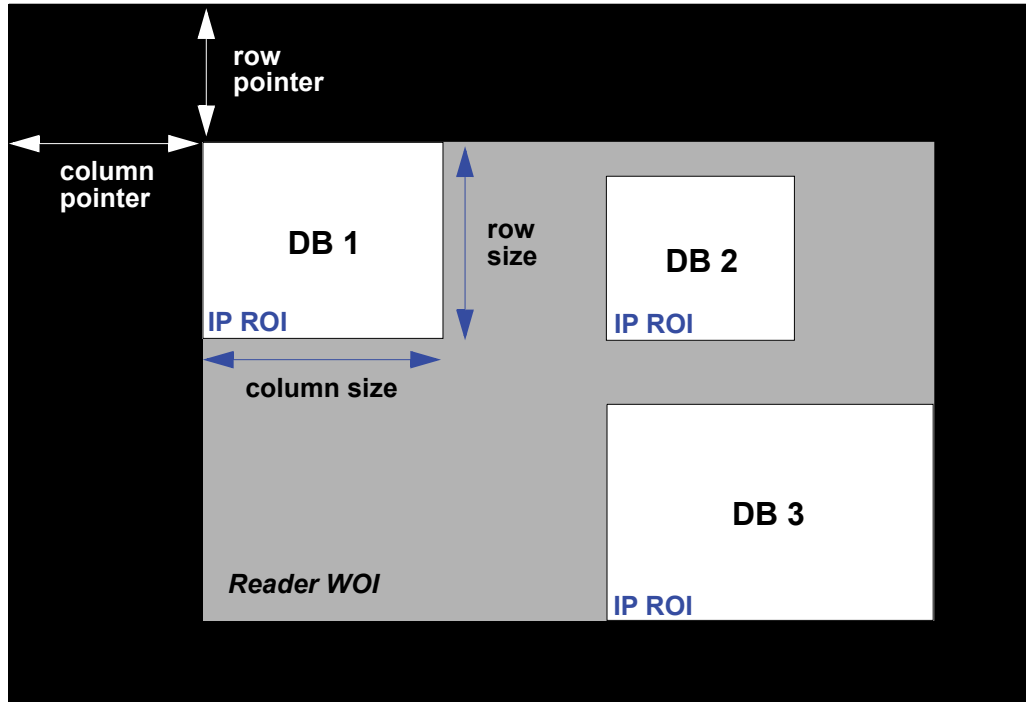

Full Image Size (QSXGA Reader: 2464 x 2048)

Note: Since the **ROI** parameters are not a reader setting, a change in **ROI** parameters from one index to another does *not* indicate an image capture event.

This feature is intended to be used in conjunction with **Image Process Looping**, to allow different regions of a captured image to be processed using different IP and decode settings.

Also, if this feature is used in conjunction with **Output Filtering**, multiple decoded symbols in a captured image frame can be output according to their location in the field of view.

L-6 Save Current Settings to Config DB

Definition: Allows current, active configuration settings to be saved to a selected database index.

Serial Cmd: <K255+,index>

Example: <K255+,5>

This command phrase saves the reader's current, active configuration settings to database index 5.

L-7 Load Current Settings from Config DB

Definition: Allows the configuration settings contained in a selected database index to be loaded to current, active configuration settings.

Serial Cmd: <K255-,index>

Example: <K255-,5>

This command phrase loads the configuration settings contained in database index 5 to current, active configuration settings.

L-8 Request Selected Index Settings

Definition: Returns configuration settings for the selected database index.

Serial Cmd: <K255?,index>

Example: <K255?,5>

This command phrase returns the configuration settings for database index 5.

L-9 Request All Config DB Settings

Definition: Returns configuration settings for all indexes in the Configuration Database.

Serial Cmd: <K255?>

Example: <K255?>

This command phrase returns the configuration settings for all 10 database indexes.

L-10 Remove Database Index

Definition: Removes the user-defined database index number and shifts all other indexes down by one.

Serial Cmd: <K255r,#>

Example: <K255r,3>

When database 3 is removed, database 4's settings become database 3's settings; database 5's settings become database 4's settings, etc.

L-11 Shift Database Indexes Up by One

Definition: Shifts every database index up by one and re-numbers the database indexes.

Serial Cmd: <K255i,#>

Example: <K255i,3>

The current settings are assigned to database 3. The previous database 3's settings become database 4's settings; database 4's settings become database 5's settings, etc.



Utilities

Utility commands are generally commands that are performed during reader operations to check or determine read rates, or to perform miscellaneous operations on reader hardware. Serial utility commands are not prefaced with a “K” and a numeric code, nor do they require an initialization command (<A> and <Z>). They can be entered from within any terminal program or from **WebLink’s Terminal** window.

M-1 Operational Commands	M-2
M-2 Read Rate	M-4
M-3 Counters	M-5
M-4 Device Control	M-6
M-5 Master Database	M-7
M-6 Firmware	M-9
M-7 Default/Reset/Save	M-10
M-8 Reader Status Request	M-12
M-9 Other Operational Serial Commands	M-14

M-1 Operational Commands

Type	Command	Name
Counter Request/Clear	<q>	No-Reads Per Read Cycle Counter
	<q0>	No-Reads Per Read Cycle Counter Reset
	<\$>	Mismatch Per Read Cycle Counter
	<\$0>	Mismatch Per Read Cycle Counter Reset
	<N>	No-Read Counter
	<O>	No-Read Counter Reset
	<T>	Trigger Counter
	<U>	Trigger Counter Reset
	<V>	Match Code Counter
	<W>	Match Code Counter Reset
	<X>	Mismatch Counter
Firmware Verification	<#>	Request All Part Numbers
	<#a>	Request Application Firmware Part Number
	<#b>	Request Boot Code Firmware Part Number
	<!>	Request All Firmware Checksums
	<!a>	Request Application Firmware Checksum
	<!b>	Request Boot Code Firmware Checksum
	<!s>	Request Current Parameter Settings Checksum
Read Rate	<C>	Decodes Per Second Test
	<Cp>	Decode Percent Test
	<J>	Exit Read Rate Tests
	<a1>	Preface PDF417 Output with Data Attributes
Device Control	<L1>	Pulse Programmable Output 1
	<L2>	Pulse Programmable Output 2
	<L3>	Pulse Programmable Output 3
Read Cycle Enable/Disable	<I>	End Current Read Cycle until <H>
	<H>	Enable Read Cycle after <I>
	<I1> ¹	Activate Targeting System
	<I0> ²	Deactivate Targeting System
Parameter Reset/Save	<A?/1>	Complete Reset when Resets or Save for Power-On Command Has Been Issued
	<A?/0>	Warm Reset if Power-On Command Has Been Issued
Resets	<A>	Software Reset, Current Parameters Retained
	<Ard>	Software Reset, Recall Default Parameters except Communication and Custom Unit Name Parameters
	<Arp>	Software Reset, Recall Power-On Default Parameters
	<Arc>	Software Reset, Recall Customer Default Parameters

¹<I1> = lowercase 'L', one
²<I0> = lowercase 'L', zero

Save for Power-On	<Z>	Software Reset, Save Current Settings for Power-On
	<Zc>	Software Reset, Save Current Settings as Customer Default Parameters
	<Zrc>	Software Reset, Recall Customer Default Parameters and Save for Power-On
	<Zrd>	Software Reset, Recall Microscan Default Parameters Except Communication and Custom Unit Name Parameters and Save for Power-On
	<Zrdall>	Software Reset, Recall Microscan Default Parameters Including Communication and Custom Unit Name Parameters and Save for Power-On
Master Database	<G>	Store Next Symbol Read to Database Index 1
	<Gn>	Store Next Symbol Read to Database Index <i>n</i>
	<NEWM>	New Master Load Status
Reader Status	<?>	Reader Status Request
Train/Optimize	<TRAIN>	Initiate Train Operation
	<UNTRAIN>	Initiate Untrain Operation
	<TRAIN?>	Train Status Request
	<OPT>	Initiate Optimize Operation
	<UNOPT>	Initiate Un-Optimize Operation
Barcode Configuration	<OPT?>	Display Optimize Status
Symbol Quality	<BCCFG>	Enter Barcode Configuration
	<VAL3>	ISO/IEC 15415 Grading Report
	<VAL4>	ISO/IEC 15416 Grading Report
	<VAL5>	ISO/IEC 29158 Grading Report

M-2 Read Rate

M-2-1 Read Rate Serial Utility Commands

Enter Decodes/Second Test

Sending <C> instructs the reader to transmit the decodes per second and symbol data (if any). The decode rate can vary dramatically due to the angle and location of the symbol in relation to the field of view. This test is very useful in aligning and positioning the reader during setup.

Enter Percent Test

Sending <Cp> instructs the reader to transmit the percentage of decodes and any decoded symbol data.

End Read Rate Test

Sending <J> ends both the Percent test and the Decodes/Second test.

M-3 Counters

M-3-1 Counters by Serial Command

No-Read Counter

Sending <N> displays the total number of No-Reads that have occurred since the last reset.

No-Read Counter Reset

Sending <O> sets the No-Read Counter to 0.

Trigger Counter

Sending <T> displays the total number of triggers since the last reset.

Trigger Counter Reset

Sending <U> sets the trigger counter to 0.

Good Read/Match Counter (or Good Read Counter)

Sending <V> displays the total number of good reads matching the master symbol, or, if **Master Symbol** is not enabled, the number of good reads since the last reset. This counter is always enabled, but will only work as a match count when **Master Symbol** is enabled. If **Master Symbol** is not enabled, this counter records the number of good reads. This count can be requested at any time.

Good Read/Match Counter Reset

Sending <W> sets the Match Counter to 0.

Mismatch Counter

Sending <X> displays the number of decoded symbols since the last reset that do not match the master symbol.

Mismatch Counter Reset

Sending <Y> sets the Mismatch Counter to 0.

M-4 Device Control

M-4-1 Device Control by Serial Command

Output 1 Pulse

Sending <L1> activates the link between Output 1 (+) and Output 1 (–) of the host connector (regardless of Master Symbol or Output 1 status).

Output 2 Pulse

Sending <L2> activates the link between Output 2 (+) and Output 2 (–) of the host connector (regardless of Master Symbol or Output 2 status).

Output 3 Pulse

Sending <L3> activates the link between Output 3 (+) and Output 3 (–) of the host connector (regardless of Master Symbol or Output 3 status).

Disable Reader

Sending <I> will turn the reader OFF, end the current read cycle, and will not allow the reader to enter another read cycle until turned ON. This feature is useful during extended periods of time when no symbols are being decoded, or the reader is being configured. Disabling the reader will not affect any commands that have already been downloaded.

Enable Reader

Sending <H> will turn the reader ON and allow it to enter read cycles.

M-5 Master Database

M-5-1 Master Symbol Database Size

Definition: **Number of Master Symbols** allows you to select **1 to 30** master symbols for the master symbol database.

Serial Cmd: **<K231,master symbol number,master symbol data>**
Note: You must follow this command with a save command **<A>** or **<Z>**.

Default: **1**

Options: **1 to 30**

Caution: Since the total number of characters available for the master symbol database is **3000**, changes to the **Master Symbol Database Size** will re-allocate the number of characters available for each master symbol and could cause existing master symbols to be deleted (except master symbol #1, unless it also exceeds the size limitation).

The table below specifies the maximum number of characters available to each symbol according to the number of master symbols defined, from 1 to 30.

Master Symbol Number	Maximum Characters	Master Symbol Number	Maximum Characters
# 1	3000	# 6	500
# 2	1500	# 7	428
# 3	1000	# 8	375
# 4	750	# 9	333
# 5	600	# 10	300

M-5-2 Enter Master Symbol Data

Usage: Allows you to enter master symbol data for any enabled master symbol index number (1 to 10), provided the total number of characters does not exceed the maximum allowed.

Serial Cmd: **<K231,master symbol number,master symbol data>**

Options: Enter data for 1 to 10 symbols (any combination of ASCII text up to the maximum allowed).

For example, to enter data for master symbol 9, after making certain that master symbol database size is enabled for 9 or more symbols, send **<K231,9,data>**.

Important: The ASCII characters **<**, **>**, and **,** can only be entered as hex values.

Caution: If no data is entered, the existing data will be deleted.

M-5-3 Request Master Symbol Data

Definition: Returns master symbol data for any enabled master symbols from 1 to 10. For example, to request master symbol # 5, enter **<K231?,5>**. The reader transmits master symbol # 5 data in brackets in the following format: **<5/>**. If no master symbol data is available, the output will be: **<5/>**.

Serial Cmd: **<K231?,master symbol number>**

Caution: Be sure to add the **?** or you will delete the master symbol.

Note: This command returns the number of master symbols if no number is included.

M-5-4 Request All Master Symbol Data

Definition: This command will return master symbol data for all symbols enabled (up to 10).
 Serial Cmd: <K231?>

M-5-5 Read Next Symbol as Master Symbol

Definition: After you've set the size in the database, you can order the reader to read the next symbol as the master symbol for any given master symbol number.

Serial Cmd: <G*master symbol number*>

To store the next symbol decoded as master symbol # 1, send:

<G> or <G1>.

To store the next symbol decoded as the master symbol for any other master symbol database number, send:

<G*master symbol number [1-30]*>.

For example, <G5> will cause the next symbol read to be entered as master symbol # 5.

M-5-6 Request New Master Status

Usage: Informs the user when a new master symbol is pending and which position it is in.

Definition: Returns the position in the master symbol database that will be loaded on the next read.

Serial Cmd: <NEWM>

The reader returns: <NEWM/*next master to load*>

Once a symbol has been read and loaded, the status will be cleared and the response will be <NEWM/0>.

(See also **New Master Pin** in **Matchcode**.)

M-5-7 Delete Master Symbol Data

Definition: You can directly delete the master symbol data by serial command.

Serial Cmd: <K231,*master symbol number*,>

To delete a master symbol, enter the database number and a comma, but leave the data field empty. For example, to delete master symbol # 5, send the following: <K231,5,>. The command is entered with a blank master symbol data field, which tells the reader to delete the selected master symbol from the database.

M-6 Firmware

M-6-1 Firmware Update

Application code versions are specific to your reader. Consult with your sales representative before downloading application code. If needed, an application code file will be sent to you.

Firmware Verification

● Request Part Number by Serial Command

- When you send `<#>` (a request for all product part numbers), the reader returns:
 - `<#b/BOOT_P/N><#a/APP_P/N><#p/PROFILE_P/N>`.
- When you send `<#a>` (a request for the application code part number), the reader returns:
 - `<#a/APP_P/N>`.
- When you send `<#b>` (a request for the boot code part number), the reader returns:
 - `<#b/BOOT_P/N>`.
- When you send `<#p>` (a request for profile module part numbers), the reader returns:
 - `<#p/PROFILE_P/N>`.

● Request Checksum by Serial Command

- When you send `<!>` (a request for all available firmware checksums), the reader returns:
 - `<!b/BOOT_CHECKSUM><!a/APP_CHECKSUM><!p/PROFILE_CHECKSUM>`
- When you send `<!a>` (a request for the application code checksum), the reader returns:
 - `<!a/APP_CHECKSUM>`
- When you send `<!b>` (a request for the boot code checksum), the reader returns:
 - `<!b/BOOT_CHECKSUM>`
- When you send `<!p>` (a request for profile module checksum), the reader returns:
 - `<!p/PROFILE_CHECKSUM>`

M-7 Default/Reset/Save

Understanding and controlling your reader's active, saved, and default settings is critical to its successful operation.

	<i>Function</i>	<i>Serial Cmd</i>
Resets (not saved for power-on)	Reset	<A>
	Reset and Recall Omron Microscan Defaults	<Ard>
	Reset and Recall Power-On Parameters	<Arp>
	Reset and Recall Customer Default Parameters	<Arc>
Saved for Power-on	Save Current Settings for Power-On	<Z>
	Save Current Settings as Customer Default Parameters for Power-On	<Zc>
	Recall Microscan Default Parameters and Save for Power-On	<Zrd>
	Recall Customer Default Parameters and Save for Power-On	<Zrc>

M-7-1 Resets

Resets ("A" commands) affect only the current settings (active memory) and are not saved for power-on.

M-7-2 Saved for Power-On

Power-on parameters ("Z" commands) are saved to NOVRAM and recalled and loaded into current parameters when power is cycled to the reader or the <Arp> command is issued.

M-7-3 Defaults

Defaults are Omron Microscan firmware settings or saved customer settings that can be recalled, either by software or hardware reset.

M-7-4 Customer Default Parameters

Customer default parameters (saved by <Zc>) are the same set of parameters as power-on parameters but are saved in a different, isolated section of NOVRAM. This allows a user essentially to create a backup set of parameters that can be recalled in the event that the current parameters or power-on parameters have been accidentally changed or are no longer desired.

It is important to note that a hardware default does not affect customer default parameters. For example, a user that has inadvertently changed communication settings and saved them with a <Z> command, may not know the correct settings or have the capability to communicate within those settings. By first doing a hardware default to restore the known Omron Microscan defaults, the user can then recall the previous customer saved settings with an <Arc> or <Zrc> command.

M-7-5 Omron Microscan Default Parameters

Omron Microscan default parameters are contained in the firmware and cannot be changed.

Software Defaults

Omron Microscan default parameters can be recalled (loaded into current settings) with **<Ard>** command or recalled and saved for power-on with the **<Zrd>** command.

Hardware Default

In cases where a software or hardware reset is not possible, it may be necessary to reset the code reader to factory settings by connecting the unit's **DEFAULT** pin to either **GROUND** or **VIN**, depending on how the **INPUT COMMON** pin is connected. Resetting the code reader in this manner is functionally equivalent to sending the **<Zrdall>** command.

Pin No.	Signal
2	VIN
3	DEFAULT
7	GROUND
8	INPUT COMMON

● Precautions for Correct Use

To perform a hardware reset in this manner, the pin sequencing described below must be executed within 60 seconds of the reader application being started by either its power supply being turned on or the reader being reset via software. Connecting incorrect pins can cause serious damage to the equipment.

● INPUT COMMON Tied to GROUND (0V)

- 1.) Verify the location of Pin 3 (DEFAULT) and Pin 2 (VIN).
- 2.) Power on or reset the unit and wait approximately 20 seconds for the application to load.
- 3.) Once the default sequence has been initiated, it must be completed within three seconds.
 - a.) Connect Pin 3 (DEFAULT) to Pin 2 (VIN).
 - b.) Remove the connection.
 - c.) Connect Pin 3 (DEFAULT) to Pin 2 (VIN).
 - d.) Remove the connection.
 - e.) The unit will automatically restart using factory default settings.

● INPUT COMMON Tied to VIN

- 1.) Verify the location of Pin 3 (DEFAULT) and Pin 7 (GROUND).
- 2.) Power on or reset the unit and wait approximately 20 seconds for the application to load.
- 3.) Once the default sequence has been initiated, it must be completed within three seconds.
 - a.) Connect Pin 3 (DEFAULT) to Pin 7 (GROUND).
 - b.) Remove the connection.
 - c.) Connect Pin 3 (DEFAULT) to Pin 7 (GROUND).
 - d.) Remove the connection.
 - e.) The unit will automatically restart using factory default settings.

M-8 Reader Status Requests

M-8-1 <?> Status Byte

The reader responds to a status request <?> with a two character hex value, such as <?/22>. To determine status:

- 1** Look up the binary conversion in the table below.
For example, the first hex **2** would be **0 0 1 0** in binary, as read from binary digits **3** through **0**; the second hex **2** is also **0 0 1 0** as read from binary digits **7** through **4**.
- 2** Next, enter your binary values from the table below in the “Binary” column next to the appropriate bit.

Hex Value	Binary Bit Digits			
	7	6	5	4
	3	2	1	0
0	0	0	0	0
1	0	0	0	1
2	0	0	1	0
3	0	0	1	1
4	0	1	0	0
5	0	1	0	1
6	0	1	1	0
7	0	1	1	1
8	1	0	0	0
9	1	0	0	1
A	1	0	1	0
B	1	0	1	1
C	1	1	0	0
D	1	1	0	1
E	1	1	1	0
F	1	1	1	1

Bit	Binary	Reader Status
0	0	Command error detected
1	1	Command received
2	0	Communication error detected
3	0	Reserved
4	0	Host port buffer overflow
5	1	Reader is in a read cycle

- 3** Under “Binary,” interpret **1s** as true and **0s** as not true. For example, bit 1 has a **1** in the “Binary” column, indicating “Command Received”. Bit 5 is also a **1**, indicating that the “Reader is in a read cycle”.

M-8-2 <K?> All Status Request

This is the fastest way to learn the reader’s current configuration. Sending this request will return the current settings of all commands, starting with the lowest K command value and ending with the highest K command value.

M-8-3 <K??> All Descriptor Status Request

This request will return all current descriptors for every K command, starting with the lowest K command value and ending with the highest K command value.

M-8-4 <K?#> All Range Status Request

This request will return the current settings of all commands within the user-defined range, starting with the lowest user-defined K command value and ending with the highest user-defined K command value.

M-8-5 <Knnn?> Single Status Request

This request will return the value of the variables associated with the requested K command. The request of a single entry of a database command cannot exceed the number of database slots for the specific command.

M-8-6 <Knnn??> Single Descriptor Status Request

This request returns the basic functional description of all fields in the requested K command.

M-8-7 <Knnn?#> Single Range Status Request

This request will return the value range and storage type description of all fields in the requested K command.

M-8-8 <Knnn?*> Display Command Wildcard

This request will return the individual K command status, description, and range for each parameter.

M-9 Other Operational Serial Commands

The following serial utility commands can be entered from **Terminal** or a PLC:

M-9-1 Train and Optimize

Train Symbol

Format: **<TRAIN>**: Initiates a Train operation.

This command will put the product into a mode of operation that will cause it to “train” the next symbol decoded. This mode of operation will remain active until either a symbol is decoded or the call is made to disable the mode and revert back to normal operation. Upon decoding a symbol, the image processing will save pertinent information regarding the target symbol to allow higher readability for the similar symbols.

The data collected by the Train operation can be saved for a power-on condition, using the **<Z>** command.

Un-Train Symbol

Format: **<UNTRAIN>**: Initiates an Un-Train operation.

This command will cause the product to discard any information acquired during a Train operation. The Untrained state can be saved for a power-on condition, using the **<Z>** command.

Train Status

Format: **<TRAIN?>**: Responds with Train Status

This command will return the current status of the TRAIN operation.

Response: **< TRAIN,0>**: Default, not trained

<TRAIN,1>: Train operation in process

<TRAIN,2>: Symbol trained

Train Persistence

The train state and parameters persist the same as ordinary parameters. Examples:

- A unit in the trained state has not been saved. A power cycle will remove any trained state information and the unit will come up in its configured state.
- A unit is saved in a training state. The unit will come from power up in the training state and train the first symbol read.
- A unit is saved in a trained state. The unit will come from power up in the trained state and only read the trained symbol type.
- A trained unit is issued a reset default command **<Ard>**. The unit will return to an untrained state but if power is cycled will return to its saved state.

Optimize Symbol

Format: **<OPT>** Initiates an Optimize operation.

This command will put the product into a mode of operation that will cause it to “optimize” the next symbol decoded. This mode of operation will remain active until either a symbol is decoded or the call is made to disable the mode and revert back to normal operation. Upon decoding a symbol, the image processing will save pertinent information regarding the target symbol to allow it to be processed quicker and more consistently.

The data collected by the Optimize operation can be saved for a power-on condition, using the **<Z>** command.

Un-Optimize Symbol

Format: **<UNOPT>**: Initiates an Un-Optimize operation.

This command will cause the product to discard any information acquired during a Optimize operation. The Un-Optimized state can be saved for a power-on condition, using the **<Z>** command.

Optimize Status

Format: **<OPT?>**: Responds with Optimize Status

This command will return the current status of the OPT operation.

Response: **<OPT,0>**: Default, not optimized

<OPT,1>: Optimize operation in-process

<OPT,2>: Symbol optimized

Optimize Persistence

The Optimize state and parameters persist the same as ordinary parameters. Examples:

- A unit in the optimized state has not been saved. A power cycle will remove any optimized state information and the unit will come up in its configured state.
- A unit is saved in a optimizing state. The unit will come from power up in the optimizing state and optimize the first symbol read.
- A unit is saved in a optimized state. The unit will come from power up in the optimized state and only read the optimized symbol type.
- A optimized unit is issued a reset default command **<Ard>**. The unit will return to an un-optimized state but if power is cycled will return to its saved state.

M-9-2 Y-Modem Upload Transfer Options

<uy,path,filename>

M-9-3 Y-Modem Download Transfer Options

<dy,path,filename>

M-9-4 Image Library Request

<op,9> Manages files in a selected directory.

<i>File Source</i>	<i>Explanation</i>
(Nothing)	All files in "root" directory
/	All files in "root" directory
/saved	All files in "saved" directory
.	All files in all directories
/del	Deletes all files in the root directory
/saved/del	Deletes all files in the saved directory
del*.*	Deletes files in all directories

M-9-5 Bar Code Configuration Mode

Definition: **Bar Code Configuration Mode** is a way of programming the reader by using ECC 200 Data Matrix symbols.

Serial Cmd: **<BCCFG>**

Bar Code Configuration Mode can be entered in two different ways:

- 1** By forcing the reader into **Bar Code Configuration Mode** by serial command **<BCCFG>**.
- 2** By reading a Data Matrix symbol with a special code word used by ISO/IEC 16022 to signify reader programming. This can be either in a regular read cycle or during a read rate test. Reading this symbol in the calibration routine will have no effect.¹

Once **Bar Code Configuration Mode** has been entered, the Data Matrix symbols can be thought of as serial data. You can configure the reader by printing labels in Omron Microscan's serial command format. Commands are processed as if the data were streamed in through the serial port. The reader will acknowledge the symbol with a green flash, and echo the serial data to the host. If the command causes the reader to produce more serial output, such as serial verification or counter requests, the data will be routed to the host port.

Bar Code Configuration Mode can be exited by any reset **<A>**, **<Z>** or **<J>** command.

The command to exit **Bar Code Configuration Mode** can be included as part of the Data Matrix symbol. For example, try encoding **<K200,4><K220,1><J>** into a Data Matrix symbol. This configures the reader to enable **Serial Trigger Mode**, to program a new trigger to end the read cycle, and to exit **Bar Code Configuration Mode** with **<J>**.

Note: When the system is in barcode configuration mode, 2D symbols are allowed to pass through even if the reader only has a 1D license. The system outputs a Config Code Received message when the configuration symbol is decoded instead of showing the configuration symbol's actual symbol data. A > character is output to the Terminal to indicate that the system is ready for bar code configuration mode.

1. In normal reading modes, it is required to read a special Data Matrix symbol with a special codeword used by ISO/IEC 16022 to signify reader programming.



Output Format

This section explains how to control the formatting and filtering of decoded symbol data for output.

N-1 Output Format Serial Commands	N-2
N-2 Output Format Status	N-3
N-3 Format Assign	N-4
N-4 Format Extract	N-5
N-5 Format Insert	N-6
N-6 Output Filter Configuration	N-7
N-7 Number of Filters	N-9
N-8 Global Sorting Options	N-10
N-9 Matrix Mode	N-13
N-10 Matrix Mode Template Attributes	N-14
N-11 Unique ID	N-17

N-1 Output Format Serial Commands

Format Extract	<K740,output index,start location,length>
Format Insert	<K741,output index,length,hex string>
Format Assign	<K742,symbol number,status>
Format Status	<K743,output format status>
Output Filter Configuration	<K744,filter number,symbology,length,wildcard,placeholder,data,unused,database index,tray ID,matrix index>
Output Format Count	<K745,number of filters>
Global Sorting Options	<K748,sort output,row direction,column direction,minimum same-row symbol overlap height percentage,minimum same-column symbol overlap width percentage>
Matrix Mode	<K765,active matrices,active index>
Matrix Mode Template Attributes	<K766,index,x0,y0,cell width,cell height,columns,rows,horizontal offset,vertical offset,horizontal overlap/underlap,vertical overlap/underlap>
Unique ID	<K767,active unique IDs,active index>

N-2 Output Format Status

Definition: This is a global enable/disable parameter. In order to use formatting you must set up the format using the insert and extract commands, and you must also assign a symbol to format using the **Format Assign** command.

Serial Cmd: <K743, **output format status**>

Default: **0 = Disabled**

Options: **0 = Disabled** 1 = Enabled

N-2-1 Output Format Status Disabled

When **Output Format Status** is set to **Disabled**, output formatting is globally disabled.

N-2-2 Output Format Status Enabled

When **Output Format Status** is set to **Enabled**, output formatting is enabled. However, **Format Assign**, **Format Insert**, and **Format Extract** must be properly set up as well.

N-3 Format Assign

N-3-1 Symbol Number

Definition: **Symbol Number** refers to the number of the symbol to which output formatting will apply. For example, if you wish to enable user-defined formatting to symbol # 2 in a multisymbol read cycle, you would send the command **<K742,2,1>**.
Note that the number of symbols may exceed the format capabilities.

Serial Cmd: **<K742, symbol number, status>**

Options: 1 to 400

1 = Formatted output status for symbol # 1.

2 = Formatted output status for symbol # 2.

...(Cont.)

400 = Formatted output status for symbol # 400.

N-3-2 Status

Definition: **Status** refers to the user-defined formatting of a selected symbol position in the read cycle result. Note that there is also a global formatting "enable" command that must be set for the formatting to be applied.

Serial Cmd: **<K742, symbol number, status>**

Default: **Disabled**

Options: **0 = Disabled**

1 = Enabled (Assigns parameters to specified symbol.)

N-4 Format Extract

N-4-1 Output Index

Definition: **Output Index** refers to the database entry you wish to modify with this command. A formatted output is built by *extracting data from a symbol's original data output* and/or inserting user-defined characters.

It may be helpful to think of individual indexes as positions in the final formatted output you wish to build. Starting with index # 1, enter either an extract or insert command to begin building your desired output string. Then, with the next index number, enter either an extract or insert command to continue building the output string. Continue this process until you are finished building the string.

Serial Cmd: <**K740,output index,start location,length**>

Options: 1 to 100

N-4-2 Start Location

Definition: Defines the location within the symbol data where the character extraction will begin. The first character extracted will also be the first character in the sequence displayed in user-defined output.

Serial Cmd: <**K740,output index,start location,length**>

Default: **0 (Disabled)**

Options: **0** to *n* (maximum number of characters in the symbol data).

N-4-3 Length

Definition: Defines the length (in consecutive characters) that will be extracted and placed in user-defined output.

Serial Cmd: <**K740,output index,start location,length**>

Default: **0** (Disabled; end of format cell array)

Options: **0** to *n* (maximum number of characters in the symbol data).

N-5 Format Insert

N-5-1 Output Index

Definition: **Output Index** refers to the database entry you wish to modify with this command. A formatted output is built by extracting data from a symbol's original data output and/or *inserting user-defined characters*.

It may be helpful to think of individual indexes as positions in the final formatted output you wish to build. Starting with index # 1, enter either an extract or insert command to begin building your desired output string. Then, with the next index number, enter either an extract or insert command to continue building the output string. Continue this process until you are finished building the string.

Serial Cmd: <**K741,output index,length,hex string**>

Options: 1 to 100

N-5-2 Length

Definition: Specifies the length of the user-defined character string that will be inserted. This function is limited to 4 characters per output index, so multiple indexes must be entered in order to insert longer character sequences.

For example, if you wish to insert a 10 character sequence in user-defined output, you would need three commands with consecutive index numbers, where the first two character sequence lengths were 4 and the third was 2.

Serial Cmd: <**K741,output index,length,hex string**>

Default: 0 (Disabled; end of format cell array)

Options: 0 to 4

N-5-3 Hex String

Definition: Specifies a character string that represents ASCII characters to be inserted in the database entry. Two hex characters are required for every ASCII character to be inserted in the user-defined output string. These two characters comprise the hex (base 16) value of the ASCII character.

For example, if you wanted to enter the three-character sequence "Hi!" you would enter 3 for the length of the string, and a hex sequence of **486921** for the ASCII sequence to be inserted. (48 = H; 69 = i; 21 = !)

Important: Each pair of hex characters represents one ASCII character. Hex character pairs range from 00 to FF. Since you are limited to 4 ASCII characters per insertion per database entry, you are also limited to 8 hex characters per insertion per database entry.

Serial Cmd: <**K741,output index,length,hex string**>

Default: NUL (00 in hex)

Options: 00 to FF (As many as 4 bytes, or hex values.)

N-6 Output Filter Configuration

Definition: Output filtering is a method of providing a set of good read qualifiers and also providing ordered output. There is a filter for up to the first 10 positions in a multisymbol output. The first filter corresponds to the first symbol output at the end of the read cycle. Each filter has settings for the following four parameters: **Symbology**, **Symbol Length**, **Data**, and **Configuration Database Number**.

Serial Cmd: <**K744**,*filter number,symbology,length,wildcard,placeholder,data,unused,database index,tray ID,matrix index*>

N-6-1 Rules for Output Filter Configuration

Output Filter Configuration Rule # 1

Each symbol that is decoded must match one of the filters before it can be saved to a read cycle record. There is an exception to this rule, however, when the number of symbols required for a read cycle exceeds the number of active filters. In such a case, unfiltered symbols can be placed into unfiltered output positions.

For example, if the number of symbols required is 6 but there are only 4 active filters, the last 2 positions can be filled by any (unfiltered) qualified symbol.

Output Filter Configuration Rule # 2

The same filter setup can be used multiple times.

For example, filters 1, 2, and 3 can be set up to filter Data Matrix symbols, and the output will occur in the order the symbols are decoded.

Output Filter Configuration Rule # 3

All qualified symbols will be sorted and output in the matching filter position. If a symbol matches filter 3, it will be output as the third symbol. If a filter does not have a matching qualified symbol, a No-Read message will be output in place of the symbol (assuming the No-Read message is enabled).

For example, if there is not a symbol that meets filter 3's requirements, then a No-Read message will be output in the third output position.

N-6-2 Filter Number

Definition: This is the filter index number that represents the position of the symbol in the data output at the end of the read cycle. This index number should be entered along with the following filter settings for the predetermined symbol position.

Serial Cmd: <**K744**,*filter number,symbology,length,wildcard,placeholder,data,unused,database index,tray ID,matrix index*>

Options: 1 to 400

N-6-3 Placeholder

Definition: The placeholder character requires a character to be present, but does not compare the data value.

Serial Cmd: <**K744**,*filter number,symbology,length,wildcard,placeholder,data,unused,database index,tray ID,matrix index*>

Default: " ? " = 3F (hex)

Options: Any ASCII input in the form of a pair of hex characters.

Example:

3F = ?

00 = disabled

N-6-4 Data

Definition: This is the data string to be used when comparing symbol data for output filtering and ordering. This data string may also contain wildcard and placeholder characters to facilitate matching. Remember that in order to filter or order symbol data, it must meet all the requirements of the selected filter index.

Examples:

- Filter data = "123*". This will match data strings of "123", "123456", and "123ABC", but not "12".
- Filter data = "123*AB?C". This will be interpreted as "123*".
- Filter data = "123?". This will match "1234" and "123A", but not "123", "12345", or "1234C".
- Filter data = "123?A". This will match "1234A" and "123BA", but not "123", "1234C", or "1234ABCD".
- Filter data = "123?A?". This will match "1234AB" and "123BAT", but not "1234A" or "123BATS".
- Filter data = "12??*". This will match "1234", "123456", and "123ABC", but not "12" or "123".
- Filter data = "123?A*". This will match "1234A", "123BA", and "123BATS", but not "1234" or "1234C".

Serial Cmd: <K744,filter number,symbology,length,wildcard,placeholder,data,unused,database index,tray ID,matrix index>

Default: 00 (NUL)

Options: Any ASCII input in the form of a pair of hex characters.
Maximum length: 63 bytes defined.

Examples:

41422A = AB*

Data [0] = NUL represents string matching disabled.

N-6-5 Database Index

Definition: The index of the database entry that decodes a given symbol must equal this setting for filtering to occur. A setting of 0 allows any database index for this filter entry.

Serial Cmd: <K744,filter number,symbology,length,wildcard,placeholder,data,unused,database index,tray ID,matrix index>

Default: 0 (Any index)

Options: 0 to 20

N-6-6 Tray ID

Definition: When **Tray ID** is enabled, the ID of the tray index entry that decodes the symbol must equal this value.

Serial Cmd: <K744,filter number,symbology,length,wildcard,placeholder,data,unused,database index,tray ID,matrix index>

Default: 0 = (Disable tray output)

Options: 0 to 20

N-6-7 Matrix Index

Definition: The **Matrix Index** is the matrix entry used for output. A setting of 0 disables **Matrix Mode**. When the index is greater than 0, all other parameters in the command are ignored except the filter number.

Serial Cmd: <K744,filter number,symbology,length,wildcard,placeholder,data,unused,database index,tray ID,matrix index>

Default: 0 = (Disable matrix output)

Options: 0 to 1

N-7 Number of Filters

Definition: **Number of Filters** refers to the number of active output filters. **0** disables all output filters. Any non-zero numeral will enable filtering to be performed using the filter indexes covered by this value.

For example, if the number of filters is **1**, then only filter index # 1 will be applied. If the number of filters is **2**, then only filter index # 1 and filter index # 2 will be applied, etc.

Serial Cmd: **<K745,number of filters>**

Default: **0**

Options: **0 to 400**

N-8 Global Sorting Options

Note: Regular **Output Filter**, <K743>, will take precedence over this option if it is enabled. Decode output will follow Output Filter rules.

Note: Although this feature has built in tolerance when one symbol not exactly line up with other symbols on the image to consider as same row or column, it is best to be used when the image has single row or column of symbol to decode or output.

Definition: **Global Sorting Options** specifies the sorting that a user wants to apply to the global matrix or to decoded symbol output.

Serial Cmd: <K748,sort output,row direction,column direction,minimum same-row symbol overlap height percentage,minimum same-column symbol overlap width percentage>

N-8-1 Sort Output

Definition: Allows you to order symbol data output by row or by column.

Serial Cmd: <K748,sort output,row direction,column direction,minimum same-row symbol overlap height percentage,minimum same-column symbol overlap width percentage>

Default: 0 = Disabled

Options: 0 = Disabled 1 = By Row 2 = By Column

N-8-2 Row Direction

Definition: Allows you to determine which direction decoded symbol data should be output in a row setup.

Serial Cmd: <K748,sort output,row direction,column direction,minimum same-row symbol overlap height percentage,minimum same-column symbol overlap width percentage>

Default: 0 = Left to Right

Options: 0 = Left to Right 1 = Right to Left

N-8-3 Column Direction

Definition: Allows you to determine which direction decoded symbol data should be output in a column setup.

Serial Cmd: <K748,sort output,row direction,column direction,minimum same-row symbol overlap height percentage,minimum same-column symbol overlap width percentage>

Default: 0 = Top to Bottom

Options: 0 = Top to Bottom 1 = Bottom to Top

N-8-4 Minimum Same-Row Symbol Overlap Height Percentage

Definition: Allows you to determine the minimum percentage of overlap at which two symbols are considered to be on the same row.

Serial Cmd: <K748,sort output,row direction,column direction,minimum same-row symbol overlap height percentage,minimum same-column symbol overlap width percentage>

Default: 20

Options: Any number from 0 to 100 (0 = 0% and 100 = 100%)



Symbol B is part of R1 if **Minimum Same-Row Symbol Overlap Height Percentage** is set to 20.

N-8-5 Minimum Same-Column Symbol Overlap Width Percentage

Definition: Allows you to determine the minimum percentage of overlap at which two symbols are considered to be in the same column.

Serial Cmd: <K748,sort output,row direction,column direction,minimum same-row symbol overlap height percentage,minimum same-column symbol overlap width percentage>

Default: 20

Options: Any number from 0 to 100 (0 = 0% and 100 = 100%)

Example:



Symbol A is part of C2 if Minimum Same-Column Symbol Overlap Width Percentage is set to 20.

N-8-6 Output Sorting Examples

The following examples demonstrate label setup functionality.

Note: "NR" = No Read – not output with symbol data.



```

A      B      C
D      NR1    F
NR2    H      I      J
      K
    
```

<p>Case 1: Sort = By Row Row Direction = Left to Right Column Direction = Top to Bottom ■ Ascending Order Using Y Center Coordinate</p> <p>Expected Output: (Decoder Separator = ",") A,B,C,D,NR1,F,NR2,H,I,J,K</p>	<p>Case 5: Sort = By Column Row Direction = Left to Right Column Direction = Top to Bottom ■ Descending Order Using X Center Coordinate</p> <p>Expected Output: (Decoder Separator = ",") A,D,NR2,B,NR1,H,K,C,F,I,J</p>
<p>Case 2: Sort = By Row Row Direction = Right to Left Column Direction = Top to Bottom Expected Output: (Decoder Separator = ",") C,B,A,F,NR1,D,J,I,H,NR2,K</p>	<p>Case 6: Sort = By Column Row Direction = Left to Right Column Direction = Bottom to Top Expected Output: (Decoder Separator = ",") NR2,D,A,K,H,NR1,B,I,F,C,J</p>

(Continued on next page.)

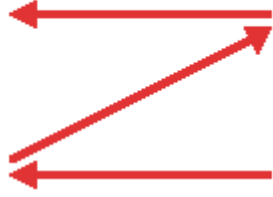
Output Sorting Examples (Continued from previous page.)

<p>Case 3: Sort = By Row Row Direction = Right to Left Column Direction = Bottom to Top</p> <p>■ Descending Order Using Y Center Coordinate</p>  <p>Expected Output: (Decoder Separator = ",") K,J,I,H,NR2,F,NR1,D,C,B,A</p>	<p>Case 7: Sort = By Column Row Direction = Right to Left Column Direction = Bottom to Top</p> <p>■ Descending Order Using X Center Coordinate</p>  <p>Expected Output: (Decoder Separator = ",") J,I,F,C,K,H,NR1,B,NR2,D,A</p>
<p>Case 4: Sort = by Row Row Direction = Left to Right Column Direction = Bottom to Top Expected Output: (Decoder Separator = ",") K,NR2,H,I,J,D,NR1,F,A,B,C</p>	<p>Case 8: Sort = By Column Row Direction = Right to Left Column Direction = Top to Bottom Expected Output: (Decoder Separator = ",") J,C,F,I,B,NR1,H,K,A,D,NR2</p>

N-9 Matrix Mode

Definition: **Matrix Mode** sets up the number of active matrices and the matrix that is currently active.

Serial Cmd: <K765,active matrices,active index>

N-9-1 Active Matrices

Definition: **Active Matrices** specifies how many Matrix Mode templates are available to define (position, rows, columns, cell sizes, overlap, underlap, etc.).

Serial Cmd: <K765,active matrices,active index>

Default: 1

Options: 0 to 1

N-9-2 Active Index

Definition: **Active Index** specifies which single matrix is currently active from among the available matrix templates.

Serial Cmd: <K765,active matrices,active index>

Default: 0 = Disabled

Options: 0 = Disabled

1 = Enabled

N-10 Matrix Mode Template Attributes

Definition: **Matrix Mode Template Attributes** specifies the attributes of a particular matrix.

Serial Cmd: <**K766**,*index,x0,y0,cell width,cell height,columns,rows,horizontal offset,vertical offset,horizontal overlap/underlap,vertical overlap/underlap*>

N-10-1 Index

Definition: The **Index** field specifies which matrix is going to be updated by this command.

Serial Cmd: <**K766**,*index,x0,y0,cell width,cell height,columns,rows,horizontal offset,vertical offset,horizontal overlap/underlap,vertical overlap/underlap*>

Default: 0

Options: 0 to 1

N-10-2 x0

Definition: The **x0** field specifies the location of the left-most side of the matrix template (in pixels).

Serial Cmd: <**K766**,*index,x0,y0,cell width,cell height,columns,rows,horizontal offset,vertical offset,horizontal overlap/underlap,vertical overlap/underlap*>

Default: 0

Options: 0 to 2592 (in pixels)

N-10-3 y0

Definition: The **y0** field specifies the location of the top-most side of the matrix template (in pixels).

Serial Cmd: <**K766**,*index,x0,y0,cell width,cell height,columns,rows,horizontal offset,vertical offset,horizontal overlap/underlap,vertical overlap/underlap*>

Default: 0

Options: 0 to 1944 (in pixels)

N-10-4 Cell Width

Definition: The **Cell Width** field specifies the horizontal width of each cell (in pixels).

Serial Cmd: <**K766**,*index,x0,y0,cell width,cell height,columns,rows,horizontal offset,vertical offset,horizontal overlap/underlap,vertical overlap/underlap*>

Default: 350

Options: 8 to 2592 (in pixels)

N-10-5 Cell Height

Definition: The **Cell Height** field specifies the vertical height of each cell (in pixels).

Serial Cmd: <**K766**,*index,x0,y0,cell width,cell height,columns,rows,horizontal offset,vertical offset,horizontal overlap/underlap,vertical overlap/underlap*>

Default: 350

Options: 8 to 2066 (in pixels)

N-10-6 Columns

Definition: The **Columns** field specifies the number of columns in the matrix template.

Serial Cmd: <**K766**,*index,x0,y0,cell width,cell height,columns,rows,horizontal offset,vertical offset,horizontal overlap/underlap,vertical overlap/underlap*>

Default: 1

Options: 1 to 400 (Rows and columns multiplied together must not exceed the number of codes, which is 400.)

N-10-7 Rows

Definition: The **Rows** field specifies the number of rows in the matrix template.

Serial Cmd: <**K766**,index,x0,y0,cell width,cell height,columns,rows,horizontal offset,vertical offset, horizontal overlap/underlap,vertical overlap/underlap>

Default: **1**

Options: **1** to 400 (Rows and columns multiplied together must be less than the number of codes, which is 400.)

N-10-8 Horizontal Offset

Definition: The **Horizontal Offset** field specifies the amount (in 2% increments with regard to Cell Width) by which every other row (starting with the second row) is offset. The default is **50 (0% Horizontal Offset)**.

Serial Cmd: <**K766**,index,x0,y0,cell width,cell height,columns,rows,**horizontal offset**,vertical offset, horizontal overlap/underlap,vertical overlap/underlap>

Default: **50 = 0% Horizontal Offset**

Options: 10 = -80% Horizontal Offset

...(continued)

48 = -4% Horizontal Offset

49 = -2% Horizontal Offset

50 = 0% Horizontal Offset

51 = +2% Horizontal Offset

52 = +4% Horizontal Offset

...(continued)

100 = 100% Horizontal Offset

N-10-9 Vertical Offset

Definition: The **Vertical Offset** field specifies the amount (in 2% increments with regard to Cell Height) by which every other column (starting with the second column) is offset. The default is **50 (0% Vertical Offset)**.

Serial Cmd: <**K766**,index,x0,y0,cell width,cell height,columns,rows,horizontal offset,**vertical offset**, horizontal overlap/underlap,vertical overlap/underlap>

Default: **50 = 0% Vertical Offset**

Options: 10 = -80% Vertical Offset

...(continued)

48 = -4% Vertical Offset

49 = -2% Vertical Offset

50 = 0% Vertical Offset

51 = +2% Vertical Offset

52 = +4% Vertical Offset

...(continued)

100 = 100% Vertical Offset

N-10-10 Horizontal Overlap / Underlap

Definition: The **Horizontal Overlap / Underlap** field specifies the amount (in 2% percent increments with regard to Cell Width) to add to or subtract from Cell Width and Cell Height. The default is **48 (-4% Horizontal Underlap)**.

Serial Cmd: <**K766**,*index,x0,y0,cell width,cell height,columns,rows,horizontal offset,vertical offset, horizontal overlap/underlap,vertical overlap/underlap*>

Default: **48 = -4% Horizontal Underlap**

Options: 10 = -80% Horizontal Underlap

...(continued)

48 = -4% Horizontal Underlap

49 = -2% Horizontal Underlap

50 = 0% Horizontal Overlap / Underlap

51 = +2% Horizontal Overlap

52 = +4% Horizontal Overlap

...(continued)

100 = 100% Horizontal Overlap

N-10-11 Vertical Overlap / Underlap

Definition: The **Vertical Overlap / Underlap** field specifies the amount (in 2% increments with regard to Cell Height) to add to or subtract from Cell Width and Cell Height. The default is **48 (-4% Vertical Underlap)**.

Serial Cmd: <**K766**,*index,x0,y0,cell width,cell height,columns,rows,horizontal offset,vertical offset, horizontal overlap/underlap,vertical overlap/underlap*>

Default: **48 = -4% Vertical Underlap**

Options: 10 = -80% Vertical Underlap

...(continued)

48 = -4% Vertical Underlap

49 = -2% Vertical Underlap

50 = 0% Vertical Overlap / Underlap

51 = +2% Vertical Overlap

52 = +4% Vertical Overlap

...(continued)

100 = 100% Vertical Overlap

N-11 Unique ID

Definition: **Unique ID** specifies which current unique identifier is currently active.

Serial Cmd: <**K767**,*active unique IDs*,*active index*>

N-11-1 Active Unique IDs

Definition: **Active Unique IDs** specifies how many unique IDs are available to define.

Serial Cmd: <**K767**,*active unique IDs*,*active index*>

Default: **0**

Options: **0** to 20

N-11-2 Active Index

Definition: **Active Index** specifies which single unique ID is currently active from among the available unique IDs.

Serial Cmd: <**K767**,*active unique IDs*,*active index*>

Default: **0**

Options: **0** to 20

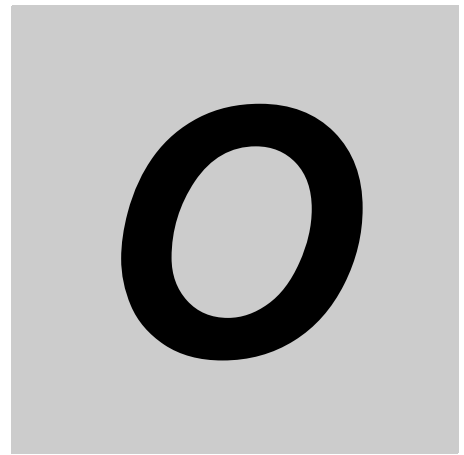

Firmware Update

This section describes how to update V440-F C-Mount Code Reader firmware using the Device Discovery Utility (DDU).

O-1 Introduction	O-2
O-2 Preparation	O-3
O-3 Firmware Update Procedure using the Device Discovery Utility (DDU) ..	O-4

O-1 Introduction

This section describes how to update V440-F firmware.

You can update the following V440-F firmware versions by following the steps described.

- Firmware
- WebLink

V440-F firmware version example:

Type	Version
Firmware	3.0.0
WebLink	3.0.0

O-1-1 Precautions

- The **Device Discovery Utility (DDU)** is required to update V440-F firmware.
- When you update the firmware version, the settings saved on the V440-F will be initialized. Be sure to connect to WebLink and back up the setting file before updating.
- Do not turn off the V440-F during the update.
- Be careful not to disconnect the cable that connects the V440-F to your computer during the update.
- The updated firmware cannot be downgraded.

If you accidentally apply old firmware, you may not be able to connect to the V440-F. Be sure not to apply an older firmware version.

O-2 Preparation

- Be sure Google Chrome is installed on your computer.
- V440-F hardware requirements for firmware update:
 - V440-F Main Unit;
 - Ethernet Cable;
 - I/O Cable;
 - 24V Power Supply.
- Download the **Omron Microscan DDU Installer** from the Omron website and install it. The DDU is available at: <https://automation.omron.com/en/us/products/families/barcode-readers> in the V440-F's **Software** section on the **Downloads** tab.
- The latest V440-F firmware files can be acquired from your regional Omron website or sales representative.

Example of firmware update .zip file:

 30-9000079-3.0.0_3013-http-35-9000097-3.0.0.3031-pkg.zip

O-2-1 How to Back Up the V440-F Setting File using WebLink

- 1 Save the current settings to the V440-F by clicking the **flash icon** at the upper right of the WebLink interface.

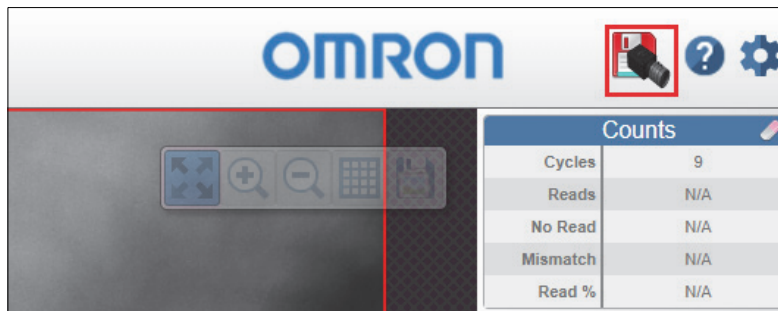

- 2 Click the **gear icon** at the upper right of the WebLink screen and then click the **Save** icon in the **Application Settings** menu that appears.

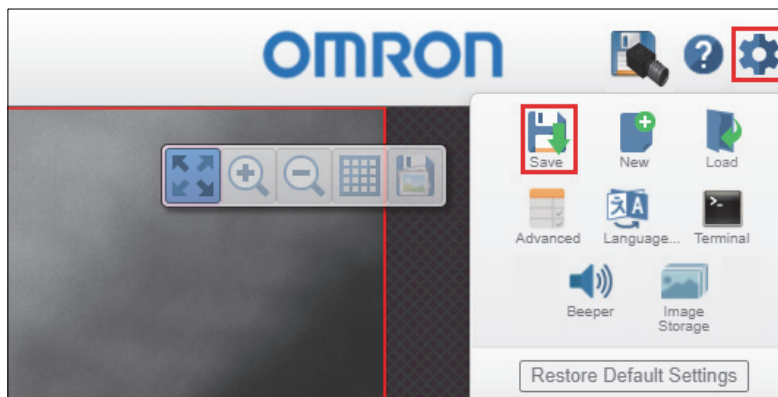

- 3 The location where the **.wls** configuration file is stored depends on the browser settings. Example: **C:\Users\username\Downloads**.



O-3 Firmware Update Procedure using the Device Discovery Utility (DDU)

The following procedure describes how to update firmware with the Device Discovery Utility (DDU).

- 1** Connect the PC and V440-F via Ethernet.
- 2** Start the Device Discovery Utility (DDU).



- 3** The browser will launch and automatically search for the connected V440-F.

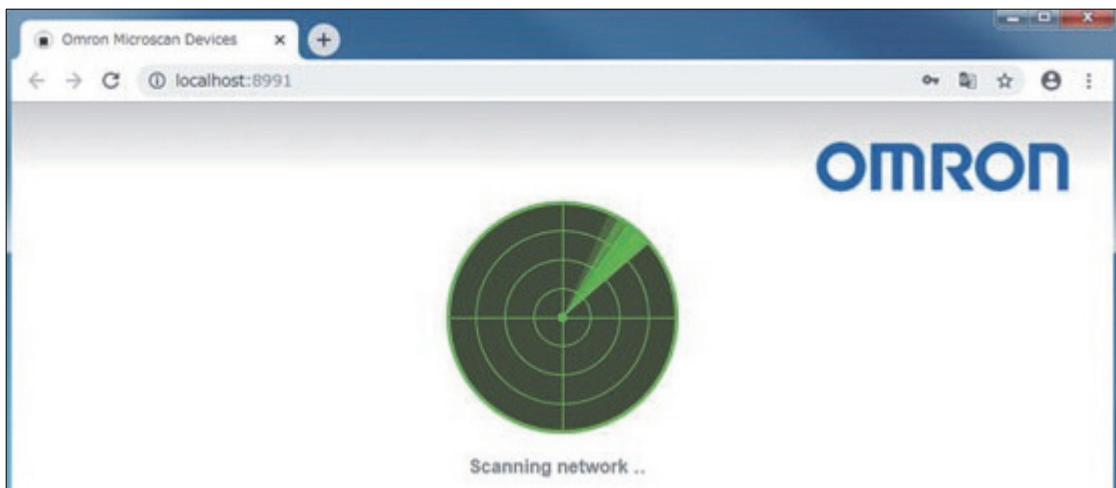

- 4** When the connected V440-F is detected, an image of the detected reader and its identifying information will be displayed. Click the image of the V440-F.

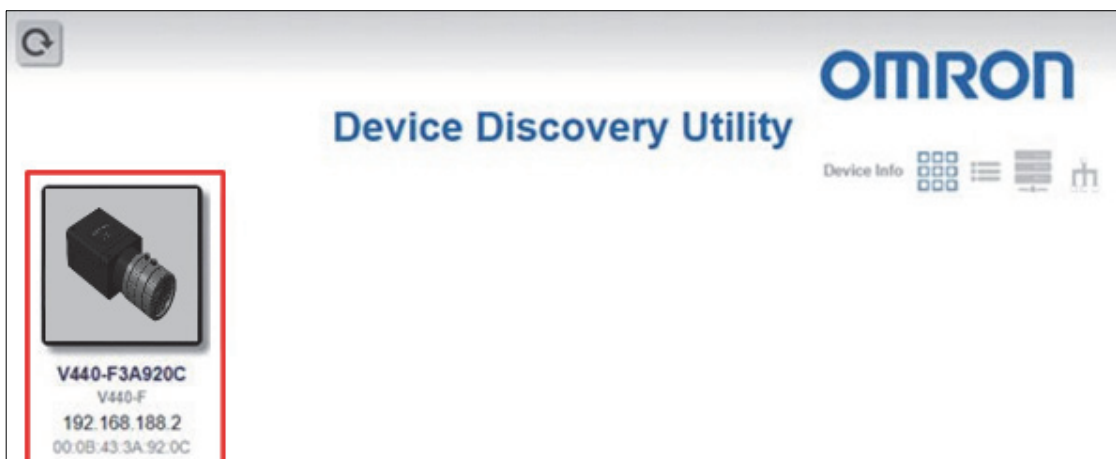



- 5 Be sure that the **Serial Number** matches the V440-F main unit. If they match, click **Update Firmware or WebLink**.

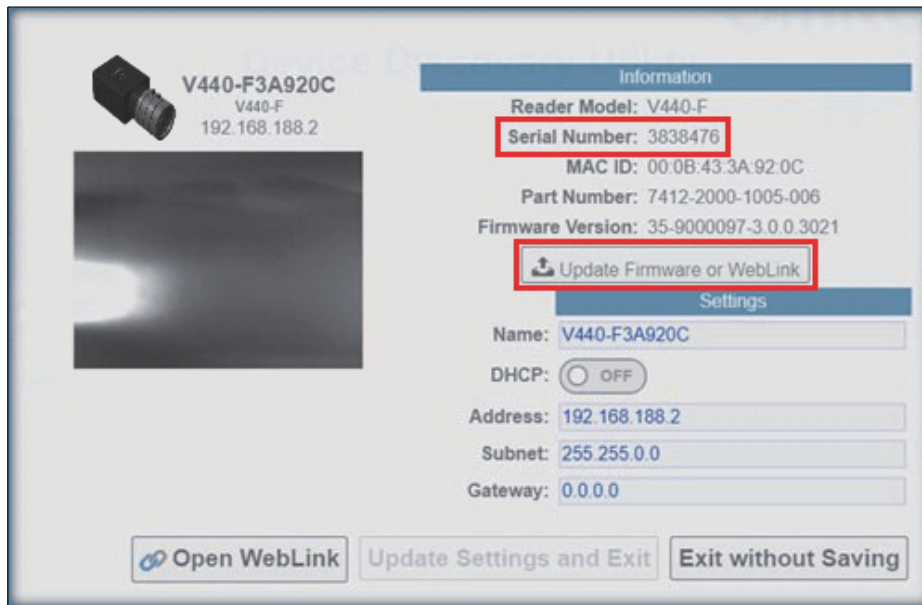

- 6 The message below will be displayed. Click **OK**.

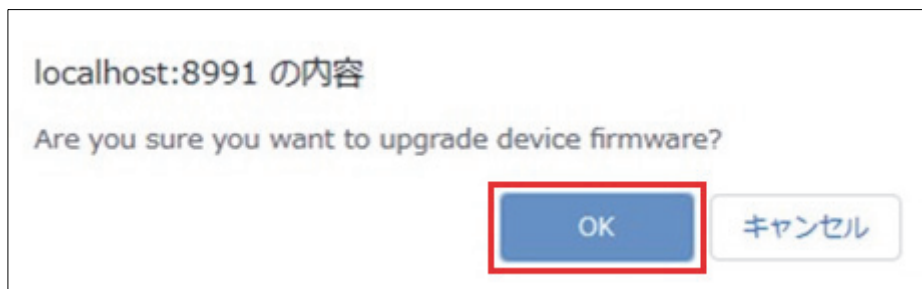

- 7 You will then see the password entry screen. Leave the password field blank and click **OK**.

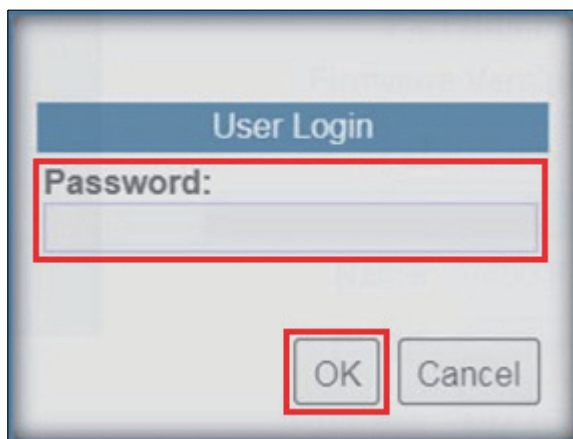

8 Select the .zip file and click **Open**.

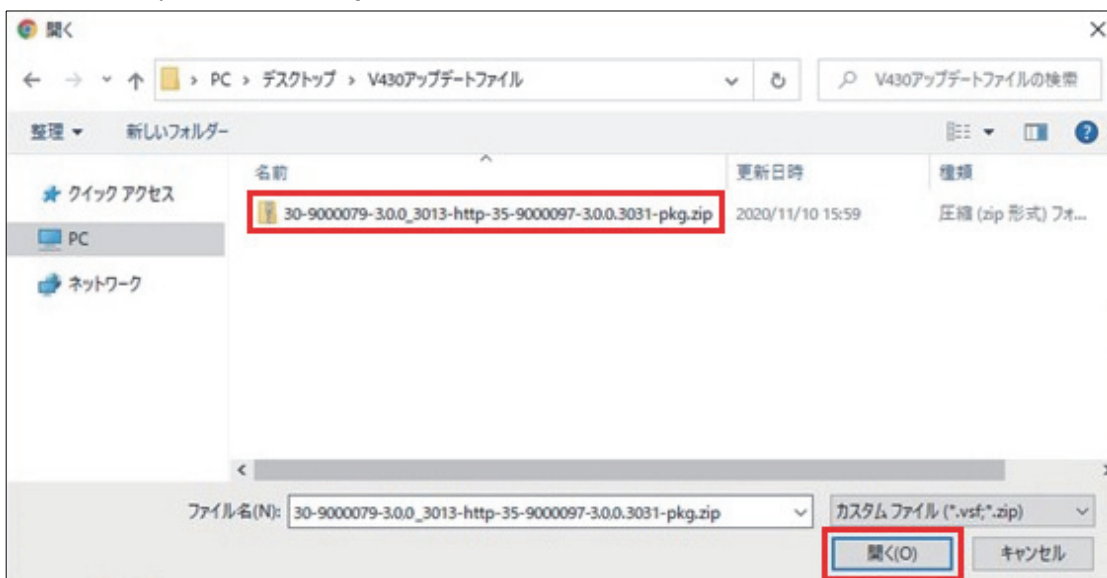

9 A progress bar will appear as the V440-F update begins. The update may take several seconds.



10 You will see the following message displayed on the DDU screen. The reader reboot may take several seconds.

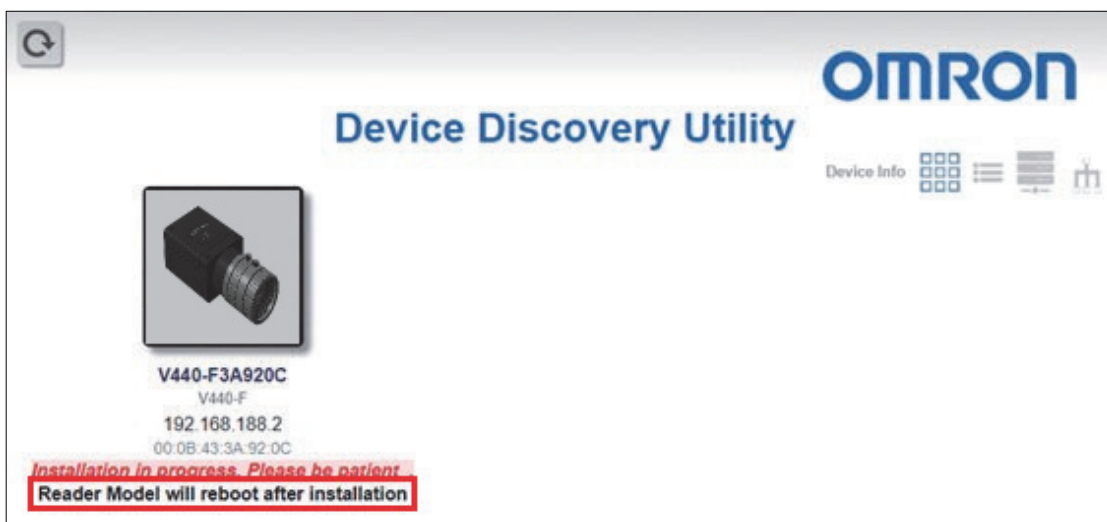

- 11** During or after the reboot, you may see the message below. Simply wait until the V440-F reappears on the DDU screen.

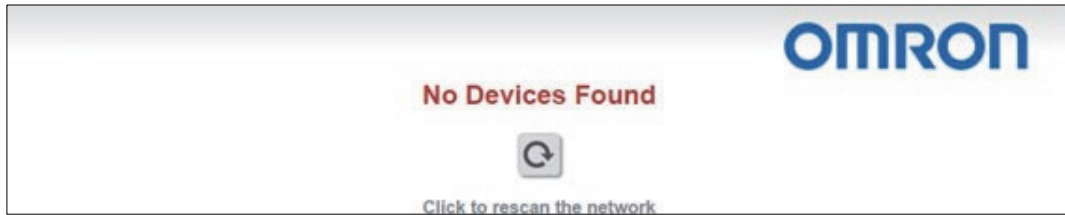

- 12** The following screen will be displayed when the firmware update is finished.

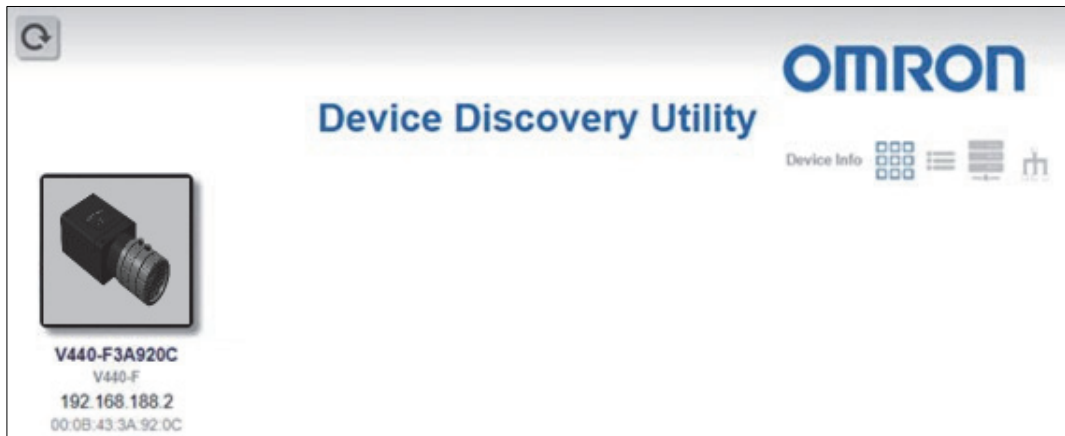

- 13** Select the detected V440-F.

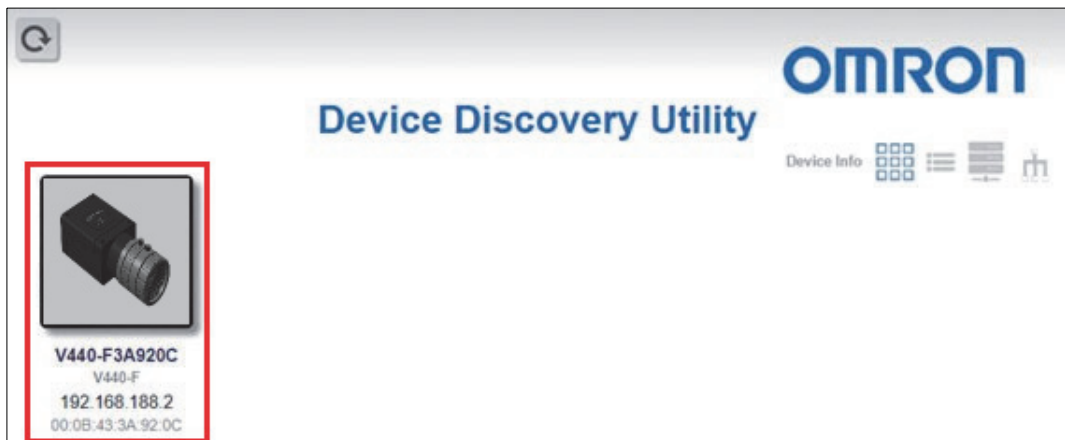

- 14** Click **Open WebLink**.

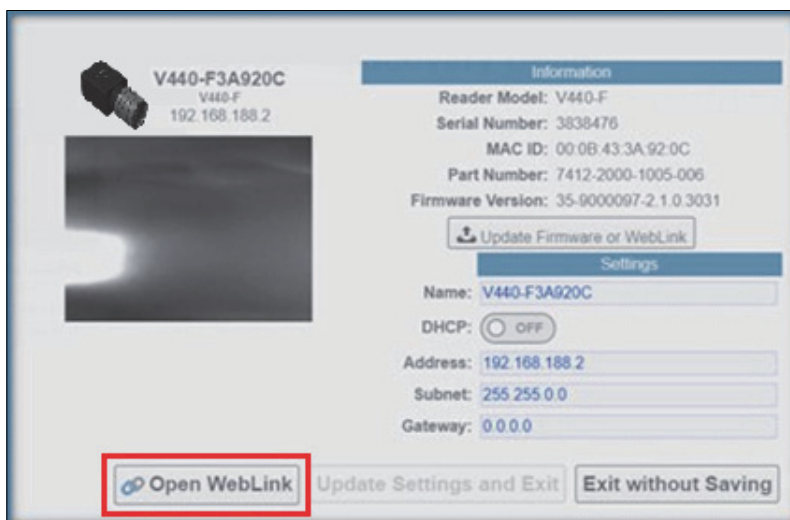

- 15** The following message will be displayed. Click **OK**.



- 16** WebLink will open.



- 17** Check the firmware version to be sure it is correct. When the WebLink user interface is displayed, click the **gear icon** at the upper right of the screen and then click **About WebLink** button in the **Application Settings** menu that appears.

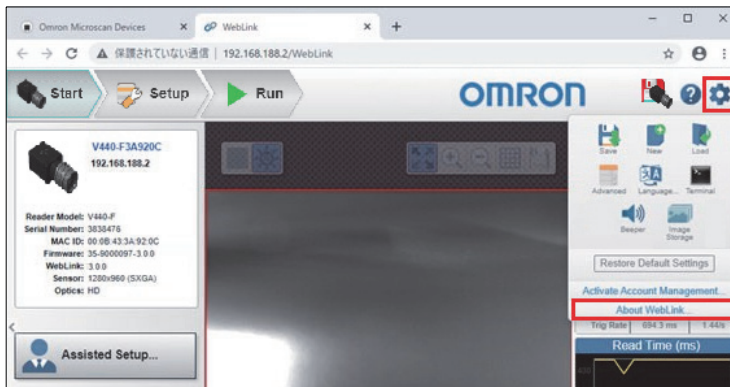

- 18** Make sure the V440-F update has been applied.



This completes the V440-F firmware update procedure using the Device Discovery Utility (DDU).



O-3-1 Apply the Saved Configuration File to the V440-F

- 1 Apply the pre-saved settings to the V440-F. Open WebLink and press [Gear Icon]-[Load] at the top right of the screen.

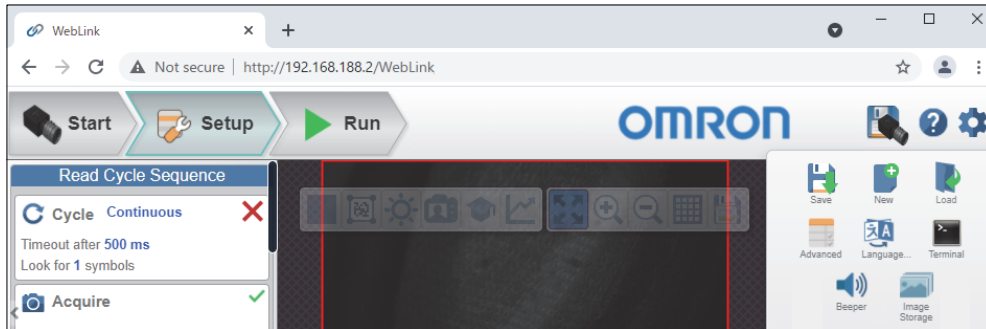

- 2 Select the saved setting file (.wls) and click [Open].

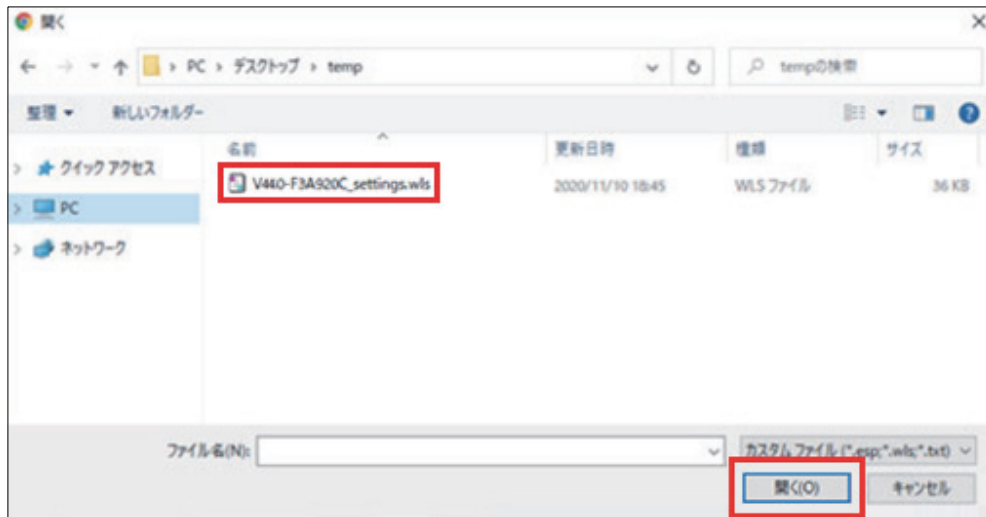

- 3 The configuration file is expanded.

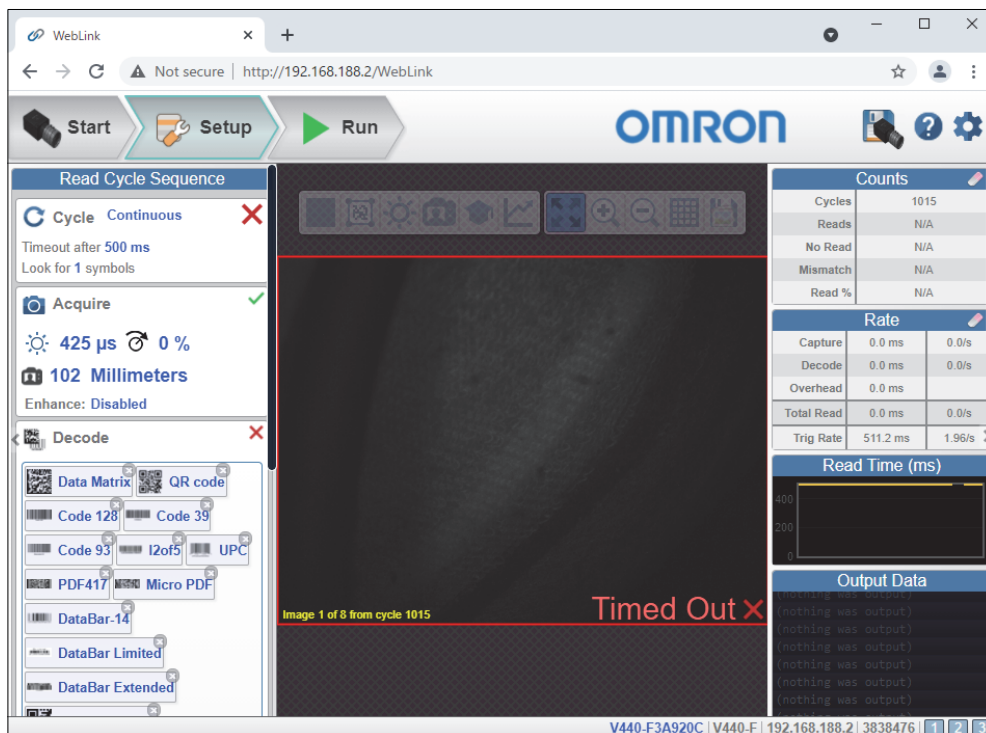



Communications Protocol



This section contains a protocol command table for your reference.

P-1	Protocol Command Table.....	P-2
------------	------------------------------------	------------

P-1 Protocol Command Table

Protocol Command (Mnemonic Displayed in Menu)	Control Characters (Entered in Menu or by Serial Command)	Hex Value	Effect of Command
RES	^D	04	Reset
REQ	^E	05	Request
EOT	^D	04	Reset
STX	^B	02	Start of Text
ETX	^C	03	End of Text
ACK	^F	06	Acknowledge
NAK	^U	15	Negative Acknowledge
XON	^Q	11	Begin Transmission
XOFF	^S	13	Stop Transmission



ASCII Table

This section contains an ASCII table for your reference.

P-1 ASCII Table P-2

Q-1 ASCII Table

Dec	Hex	Mne	Ctrl	Dec	Hex	Ch	Dec	Hex	Ch	Dec	Hex	Ch
00	00	NUL	^@	32	20	SP	64	40	@	96	60	`
01	01	SOH	^A	33	21	!	65	41	A	97	61	a
02	02	STX	^B	34	22	"	66	42	B	98	62	b
03	03	ETX	^C	35	23	#	67	43	C	99	63	c
04	04	EOT	^D	36	24	\$	68	44	D	100	64	d
05	05	ENQ	^E	37	25	%	69	45	E	101	65	e
06	06	ACK	^F	38	26	&	70	46	F	102	66	f
07	07	BEL	^G	39	27	'	71	47	G	103	67	g
08	08	BS	^H	40	28	(72	48	H	104	68	h
09	09	HT	^I	41	29)	73	49	I	105	69	i
10	0A	LF	^J	42	2A	*	74	4A	J	106	6A	j
11	0B	VT	^K	43	2B	+	75	4B	K	107	6B	k
12	0C	FF	^L	44	2C	,	76	4C	L	108	6C	l
13	0D	CR	^M	45	2D	-	77	4D	M	109	6D	m
14	0E	SO	^N	46	2E	.	78	4E	N	110	6E	n
15	0F	SI	^O	47	2F	/	79	4F	O	111	6F	o
16	10	DLE	^P	48	30	0	80	50	P	112	70	p
17	11	DC1	^Q	49	31	1	81	51	Q	113	71	q
18	12	DC2	^R	50	32	2	82	52	R	114	72	r
19	13	DC3	^S	51	33	3	83	53	S	115	73	s
20	14	DC4	^T	52	34	4	84	54	T	116	74	t
21	15	NAK	^U	53	35	5	85	55	U	117	75	u
22	16	SYN	^V	54	36	6	86	56	V	118	76	v
23	17	ETB	^W	55	37	7	87	57	W	119	77	w
24	18	CAN	^X	56	38	8	88	58	X	120	78	x
25	19	EM	^Y	57	39	9	89	59	Y	121	79	y
26	1A	SUB	^Z	58	3A	:	90	5A	Z	122	7A	z
27	1B	ESC	^[59	3B	;	91	5B	[123	7B	{
28	1C	FS	^\	60	3C	<	92	5C	\	124	7C	
29	1D	GS	^]	61	3D	=	93	5D]	125	7D	}
30	1E	RS	^^	62	3E	>	94	5E	^	126	7E	~
31	1F	US	^_	63	3F	?	95	5F	_	127	7F	D



Q & A



This section answers some common questions about V440-F functionality.

R-1 Q & A R-2

R-1 Q & A

Question	Answer
What is PPE?	PPE stands for Pixel Per Element . For 2D code, it is one cell size on a captured image. For 1D code (barcode), it is the minimum bar width on a captured image. e.g. When [PPE=4.0] is displayed on WebLink at DataMatrix read, the DataMatrix cell size is four pixels on the captured image.
When magnifying an image on WebLink, it blurs.	In WebLink, compressed images are displayed. Since such images have lower resolution than measured images, they might be blurred when magnifying them. Important: The image will not blur if magnified at 1-to-1. When magnifying a measured image with an actual resolution, use saved images. For the image saving method, refer to Q&A: <i>How to save read images</i> .
How to react when being unable to WebLink.	<ul style="list-style-type: none"> • For Internet Explorer, check the following settings. Uncheck the upper right Tool icon - Compatibility View settings - Display Intranet sites in Compatibility View. Or use Google Chrome. • Turn off the VPN function. Turn off the VPN function. When the VPN function is turned on, local LAN connections other than the VPN are disabled all. • Check the IP address using DDU. DDU (Discovery Device Utility) is a tool to search a reader whose IP address is lost. When the search was succeeded, its IP address also can be changed. Download the DDU from Omron Microscan Web site. • Initialize V440-F if the above measures does not help. Related Q&A: <i>How to initialize the settings?</i>
About WebLink	The merits of WebLink are that does not require the installation and is easily operated to set with a Web browser. Use WebLink basically. Most of the functions are settable except for some functions. The following shows a list of comparison. WebLink Merits: <ul style="list-style-type: none"> • No installation software (Web browser) • Japanese supported • Visually easy to understand UI
Can the position information of a code be output?	Enable Advanced - I/O - Output Object Info - Output Coordinates . Following the captured string, every four vertexes of the code are output. • Output example: When a code of 123456 was captured 123456.(0032,0040)(0287,0056)(0287,0279)(0048,0271)
Can serial commands calibrate brightness or focus?	It is possible to adjust with a serial command <@CAL> executing the calibration. Which parameter should be adjusted at Calibration, it is selectable with the following parameter on WebLink. Advanced - I/O tab - Calibration Options When executing the <@CAL> command, V440-F outputs numeric values indicating trial results in some rows and then Calibration PASSED . When failed, Calibration FAILED is output. Example of a response when <@CAL> was succeeded.: Prog Exposure Gain Brightness 2 5764 33 24 100 6011 33 37 Calibration PASSED.
How is a trigger inputted in serial communications?	The following describes a serial command to input a trigger in default. • Serial Trigger command ASCII character notation < > Hex notation 3C 20 3E Although space is a default in the center (Hex notation: 20), it can be changed to any ASCII character from the menu below. WebLink - Gear icon - Advanced - Read Cycle - Serial Trigger - Serial Trigger Character (Delimited) Additionally, from the menu below, any ASCII character can be set up to two characters for Start Trigger Character/Stop Trigger Character that do not need < >. WebLink - Gear icon - Advanced - Read Cycle - Serial Trigger - Start Trigger Character (Non-Delimited)/Stop Trigger Character (Non-Delimited)
What kind of effect is in Teaching?	When Teaching (Hat icon on WebLink) was executed, judgment of code type and the detection algorithm optimization are performed. When reading codes with the same conditions, the reading will be more stable just to execute Teaching. However, Teaching is not a function that always needs be executed.

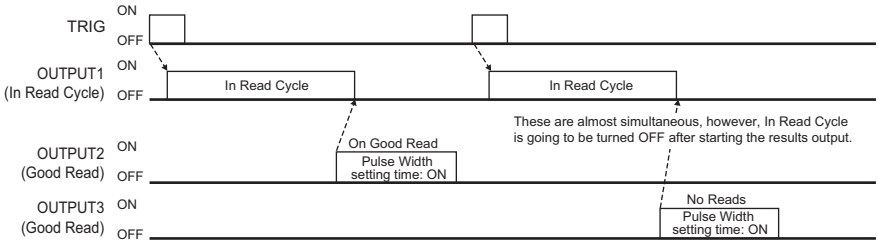
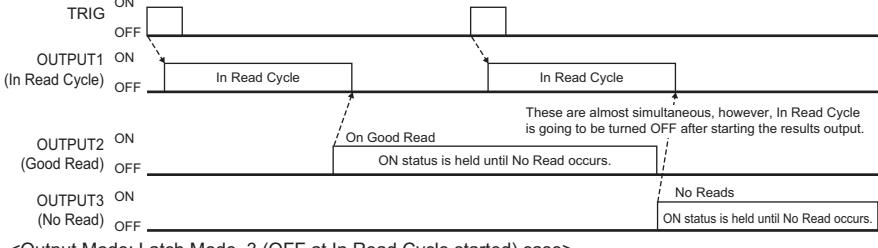
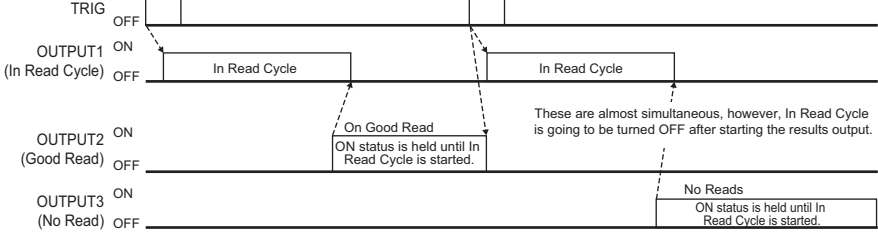
<p>How to access a RAM drive from a PC?</p>	<p>A PC can access a RAM drive using the FTP client tool. The initial values of V440-F are as follows.</p> <table border="1" data-bbox="384 271 842 412"> <thead> <tr> <th>Settings</th> <th>Value</th> </tr> </thead> <tbody> <tr> <td>IP address</td> <td>192.168.188.2</td> </tr> <tr> <td>Path</td> <td>imagesd0/images/</td> </tr> <tr> <td>Account</td> <td>target</td> </tr> <tr> <td>Password</td> <td>password</td> </tr> </tbody> </table> <p>Example: When using Internet Explorer to access. 1. If the IP address is the default, enter <i>ftp://192.168.188.2/imagesd 0/images/</i> in the address bar to connect. 2. Enter your account and password. 3. Download the file saved in the RAM drive to your PC.</p>	Settings	Value	IP address	192.168.188.2	Path	imagesd0/images/	Account	target	Password	password
Settings	Value										
IP address	192.168.188.2										
Path	imagesd0/images/										
Account	target										
Password	password										
<p>Parallel communications timing chart</p>	<p>The parallel output signals, OUTPUT1/OUTPUT2/OUTPUT3, can change those roles by the output condition settings. The default is that those are turned on when all are No-Read. WebLink - Gear icon - Advanced - I/O - OUTPUT1 parameters - Output On Additionally, a timing to turn off can also be adjusted using the following setting. WebLink - Gear icon - Advanced - I/O - OUTPUT1parameters - Output Mode</p> <p>When you want to detect a timing that the output is changed, set the output condition for one of OUTPUT1/OUTPUT2/OUTPUT3 to In Read Cycle. According to the setting, it turns on in a period from detecting a trigger, reading, and end of output.</p> <p>For example, the following describes a timing chart in a case of a setting below.</p> <ul style="list-style-type: none"> • Output On • OUTPUT1 In Read Cycle • OUTPUT2 Match or Good Read • OUTPUT3 Mismatch or No-Read • Timing chart <p><Output Mode: Pulse case></p>  <p><Output Mode: Latch Mode 2 (Status held) case></p>  <p><Output Mode: Latch Mode 3 (OFF at In Read Cycle started) case></p> 										
<p>How to estimate an exposure time when reading a moving symbol?</p>	<p>A moving amount of a symbol during exposure should be 1/10 or less of the cell size (for barcode, narrow bar width). When a cell size is C [mm] and a line speed is L [mm/s], use the following formula to get the exposure time S. $S \leq 0.1 \times C/L$ For example, When a cell size is 0.3 [mm] and a line speed is 300 [mm/s], the exposure time should be 100 [μs] or less. $0.1 \times 0.3 \text{ [mm]} / 300 \text{ [mm/s]} = 100 \text{ [μs]}$</p>										



<p>Read Rate of Counts on the right panel is not available.</p>	<p>Read Rate of Counts on the right panel is sometimes not available depending on the setting of Read Cycle.</p> <table border="1" data-bbox="363 241 970 414"> <thead> <tr> <th>Read Cycle</th> <th>Read Rate</th> </tr> </thead> <tbody> <tr> <td>Presentation</td> <td>Unavailable</td> </tr> <tr> <td>Continuous Read</td> <td>Unavailable</td> </tr> <tr> <td>Triggered</td> <td>Available</td> </tr> <tr> <td>Start/Stop</td> <td>Available</td> </tr> <tr> <td>Custom</td> <td>Refer to below</td> </tr> </tbody> </table> <p>When Read Cycle is Custom, it sometimes is unavailable depending on the setting of Trigger Mode.</p> <table border="1" data-bbox="363 472 970 667"> <thead> <tr> <th>Trigger Mode</th> <th>Read Rate</th> </tr> </thead> <tbody> <tr> <td>Continuous Read</td> <td>Unavailable</td> </tr> <tr> <td>Continuous Read 1 Output</td> <td>Unavailable</td> </tr> <tr> <td>External Level</td> <td>Available</td> </tr> <tr> <td>External Edge</td> <td>Available</td> </tr> <tr> <td>Serial Data</td> <td>Available</td> </tr> <tr> <td>Serial Data and Edge</td> <td>Available</td> </tr> </tbody> </table>	Read Cycle	Read Rate	Presentation	Unavailable	Continuous Read	Unavailable	Triggered	Available	Start/Stop	Available	Custom	Refer to below	Trigger Mode	Read Rate	Continuous Read	Unavailable	Continuous Read 1 Output	Unavailable	External Level	Available	External Edge	Available	Serial Data	Available	Serial Data and Edge	Available
Read Cycle	Read Rate																										
Presentation	Unavailable																										
Continuous Read	Unavailable																										
Triggered	Available																										
Start/Stop	Available																										
Custom	Refer to below																										
Trigger Mode	Read Rate																										
Continuous Read	Unavailable																										
Continuous Read 1 Output	Unavailable																										
External Level	Available																										
External Edge	Available																										
Serial Data	Available																										
Serial Data and Edge	Available																										
<p>Only one image can save.</p>	<p>When Save Image Until is set to New Read Cycle, only last one image is saved. When saving multiple images, set WebLink - Gear icon - Advanced - Image Storage - Save Image Until to System Reset. Additionally, when Image Storage Location was set to FTP, images might not be saved due to the shorter read interval if Transfer Optimization is set to Speed (Lossy). When you want to prioritize the image storage over the read, set WebLink - Gear icon - Advanced - Image Storage - Transfer Optimization to Accuracy (Lossless).</p>																										
<p>How to acquire or change the settings from external?</p>	<p>With the serial communications, it is possible to do so using a serial command so called K command. For each K command, refer to Chapter 3 or later. Example: Set the exposure time to 1,000 [μs]. Command: <K541,1000> Response: None</p> <p>As adding "?" to a K command, the setting value will be returned. Example: Acquire the current exposure time and gain. Command: <K541?> Response: <K541,1000,30> Presently, the exposure time is set to 1,000 [μs] and the gain is set to 30 [%].</p>																										
<p>How can I read multiple codes in the field of view?</p>	<p>When the string of codes are different from each other, multiple codes in the field of view can be read.</p> <ul style="list-style-type: none"> • Settings To enable multiple reads, change the value of default <i>Look for 1 Symbols</i> in Read Cycle at the left on the setup screen. Or, change the settings below. WebLink - Gear icon - Advanced - Read Cycle - Multisymbol - Number of Symbols • Output order The output order is practically random because of the order of completed read. Using the Configuration Database or Order Output Filter functions with serial commands, up to 10 output order can be controlled (when symbols satisfy the output conditions). • Cautions Multiple reads are not available in codes with the same string. 																										
<p>Is it possible to specify the output range for output string?</p>	<p>Turn on Output Format at the left on the WebLink setup screen. With clicking format strings, Output Formatting Editor screen opens. With enabling Parse Symbol, the output range can be specified.</p>																										
<p>How to output the same code only once in Constant Read state?</p>	<p>To output the same code only once in Constant Read state with V440-F, set the following.</p> <ul style="list-style-type: none"> • Gear icon - Advanced - Read Cycle - Trigger - Mode: Continuous Read 1 Output • Gear icon - Advanced - Read Cycle - End of Read Cycle - Mode: New Trigger <p>With the above setting, V440-4 in Constant Read state reads the same code only once and only output it when a code different from the previous code is read. When you want to set V440-F so that it can read the same code again after some time passed, set End of Read Cycle Mode to Timeout and adjust Read Cycle Timeout.</p>																										

<p>How to initialize the settings?</p>	<p>Initialization methods:</p> <ul style="list-style-type: none"> • Initialization by operating the menu in WebLink. <ol style="list-style-type: none"> 1. Click the Gear icon at the right of WebLink. 2. Click the Restore Default Settings button. <p>*This performs an initialization processing as same as a serial command <Zrd>.</p> <p>In cases where a software or hardware reset is not possible, it may be necessary to reset the code reader to factory settings by connecting the unit's DEFAULT pin to either GROUND or VIN, depending on how the INPUT COMMON pin is connected. Resetting the code reader in this manner is functionally equivalent to sending the <Zrdall> command.</p> <table border="1" data-bbox="384 405 695 544"> <thead> <tr> <th>Pin</th> <th>Signal</th> </tr> </thead> <tbody> <tr> <td>2</td> <td>VIN</td> </tr> <tr> <td>3</td> <td>DEFAULT</td> </tr> <tr> <td>7</td> <td>GROUND</td> </tr> <tr> <td>8</td> <td>INPUT COMMON</td> </tr> </tbody> </table> <p>Precautions for Correct Use</p> <p>To perform a hardware reset in this manner, the pin sequencing described below must be executed within 60 seconds of the reader application being started by either its power supply being turned on or the reader being reset via software. Connecting incorrect pins can cause serious damage to the equipment.</p> <p>INPUT COMMON Tied to GROUND (0V)</p> <ol style="list-style-type: none"> 1.) Verify the location of Pin 3 (DEFAULT) and Pin 2 (VIN). 2.) Power on or reset the unit and wait approximately 20 seconds for the application to load. 3.) Once the default sequence has been initiated, it must be completed within three seconds. <ol style="list-style-type: none"> a.) Connect Pin 3 (DEFAULT) to Pin 2 (VIN). b.) Remove the connection. c.) Connect Pin 3 (DEFAULT) to Pin 2 (VIN). d.) Remove the connection. e.) The unit will automatically restart using factory default settings. <p>INPUT COMMON Tied to VIN</p> <ol style="list-style-type: none"> 1.) Verify the location of Pin 3 (DEFAULT) and Pin 7 (GROUND). 2.) Power on or reset the unit and wait approximately 20 seconds for the application to load. 3.) Once the default sequence has been initiated, it must be completed within three seconds. <ol style="list-style-type: none"> a.) Connect Pin 3 (DEFAULT) to Pin 7 (GROUND). b.) Remove the connection. c.) Connect Pin 3 (DEFAULT) to Pin 7 (GROUND). d.) Remove the connection. e.) The unit will automatically restart using factory default settings. 	Pin	Signal	2	VIN	3	DEFAULT	7	GROUND	8	INPUT COMMON
Pin	Signal										
2	VIN										
3	DEFAULT										
7	GROUND										
8	INPUT COMMON										
<p>How to save read images?</p>	<p>The read images are possible to save with the following procedures.</p> <ul style="list-style-type: none"> • Save images on WebLink. <p>Click Save Current Image button at the right end on the Image Control Toolbar at the upper right on the image area to save the read image to your PC. The file is download to a destination you set with a browser.</p> <ul style="list-style-type: none"> • Save images to the RAM drive. <p>Images read according to Read Cycle can be saved in the RAM drive on V440-F. Click Gear icon at the upper right - Image Storage to open Image Save Options, and set the conditions to save images. Click the Advanced button to set other parameters such as Save Image Until. Such saved images can be saved in a PC via FTP. Regarding the method to save images via FTP, refer to "How to access a RAM drive from a PC?". Regarding No. of images savable to the RAM drive, refer to "How many sheets of images can be saved in the RAM drive?". It is initialized when turning off the power because of RAM drive.</p> <ul style="list-style-type: none"> • Save images to a FTP server. <p>Images read according to Read Cycle can be saved to an FTP server on the network. Click Gear icon at the upper right - Image Storage to open Image Save Options, and set the conditions to save images. Select FTP for the Image Storage Location. By setting the FTP address of the FTP server after that, images can be saved in it.</p> <p>* Re-reading is not available by using the saved images.</p>										
<p>How to check read characters?</p>	<p>When checking character strings, turn on Matchcode at the left panel on WebLink.</p> <p>Click Mode of Matchcode and register character strings you want to check to Match String Database.</p> <p>Up to 10 strings are registrable to Match String Database.</p>										
<p>What is the smallest size of the readable 2D code?</p>	<p>A 2D code with 2x2 pixels or more in the cell size on an image is readable.</p> <p>This figure is a theoretical value. In practice, test it for the judgment.</p>										
<p>What is the smallest size of the readable barcode?</p>	<p>In ideal, a barcode with the size below is readable.</p> <p>Barcode width: 1 pixel or more Barcode height: 16 pixels or more</p> <p>These figures are theoretical values. In practice, test it for the judgment.</p>										
<p>What is the method to evaluate the reading stability?</p>	<p>There are two methods.</p> <ul style="list-style-type: none"> • ISO print quality evaluation <p>The ISO print quality evaluation is a function to evaluate the read stability compatible for the ISO standards. For example, use ISO 29158 to evaluate DataMatrix of DPM.</p> <p>Enable Gear icon - Advanced - Symbol Quality - ISO/IEC 29158 Parameters, which add an evaluation results to the end of a read character strings.</p> <ul style="list-style-type: none"> • Read Rate Mode <p>Operating the Setup Button or performing the Read Rate command makes the device to Rear Rate mode. The operation display LED on the body becomes to indicate the Read Rate and the body is set to a state to output the rate via the serial (RS-232C) communications or TCP communications.</p>										
<p>What is the number of the maximum readable characters?</p>	<p>V440-F can read up to the maximum numbers defined each code standard.</p> <p>For example, although up to 7,089 characters can be input to QR code based on the standard, V440-F can read the code.</p>										

<p>What is the readable installation distance?</p>	<p>That of V440-F depends on the cell size (bar width) of a target code too.</p> <p>The reference values are described on page A-5 to A-6, refer to them.</p> <p>The read range is described, which was possible to read with typical cell size examples for the design readable focal distance per format.</p> <p>* For barcode, a half size of the bar width for readable values of 2D code cell size is a guide.</p>														
<p>How to shorten the read time?</p>	<p>Please consider below.</p> <ul style="list-style-type: none"> • Construct appropriate optical conditions like an image is in focus or having sufficient contrast. Mount distance, Mount angle, Exposure time) • Limit symbol types for the read target. • Enable the optimization. (Graph icon on the setup screen) • Perform the Window of Interest. 														
<p>What parameters need to be adjusted when a symbol is unable to read?</p>	<p>Adjust the following parameters.</p> <table border="1" data-bbox="363 546 1225 869"> <thead> <tr> <th>Symbol state</th> <th>Adjustment</th> </tr> </thead> <tbody> <tr> <td>An image is dark.</td> <td>Adjust Exposure or Gain to bright the image.</td> </tr> <tr> <td>Out of focus.</td> <td>Adjust Focus to make the symbol in focus.</td> </tr> <tr> <td>A cell size is small.</td> <td>Change the mount distance or use a high pixel density and narrow field of view type.</td> </tr> <tr> <td>Noisy background</td> <td>Remove noise with the Morphological Preprocessing. When 5 M type is used, adjust the color filter.</td> </tr> <tr> <td>The read time takes much time.</td> <td>Set Timeout longer.</td> </tr> <tr> <td>The lighting is reflected.</td> <td>Tilt the lighting by approx. 15 degrees to reduce the reflection. Or, try to use the optional Polarizer (V430-AF12) and the Diffuser (V430-AF11).</td> </tr> </tbody> </table>	Symbol state	Adjustment	An image is dark.	Adjust Exposure or Gain to bright the image.	Out of focus.	Adjust Focus to make the symbol in focus.	A cell size is small.	Change the mount distance or use a high pixel density and narrow field of view type.	Noisy background	Remove noise with the Morphological Preprocessing. When 5 M type is used, adjust the color filter.	The read time takes much time.	Set Timeout longer.	The lighting is reflected.	Tilt the lighting by approx. 15 degrees to reduce the reflection. Or, try to use the optional Polarizer (V430-AF12) and the Diffuser (V430-AF11).
Symbol state	Adjustment														
An image is dark.	Adjust Exposure or Gain to bright the image.														
Out of focus.	Adjust Focus to make the symbol in focus.														
A cell size is small.	Change the mount distance or use a high pixel density and narrow field of view type.														
Noisy background	Remove noise with the Morphological Preprocessing. When 5 M type is used, adjust the color filter.														
The read time takes much time.	Set Timeout longer.														
The lighting is reflected.	Tilt the lighting by approx. 15 degrees to reduce the reflection. Or, try to use the optional Polarizer (V430-AF12) and the Diffuser (V430-AF11).														
<p>What is the number of the maximum characters for Match String Database?</p>	<p>It is 3,000 characters.</p> <p>It is divided by the number of registrations, so it varies depending on the number of registrations.</p> <p>When the number of registrations is one, it can register up to 3,000 characters.</p> <p>When the number of registrations is ten, each registration can register up to 300 characters.</p> <p>Related Q&A: <i>What is the number of the maximum readable characters?</i></p>														
<p>How to change Match String externally?</p>	<p>Use <K231> command.</p> <p>Command format: <K231, index, master symbol data></p> <p>Example: When setting ABC to the first Match String Database: <K231, 1, ABC></p>														
<p>How to enable the External Trigger rather than Continuous Read?</p>	<p>Set the Trigger Mode except for Continuous Read. Refer to the following instruction.</p> <p>Select Gear icon - Advanced - Read Cycle - Trigger - Mode - External Edge or Serial Data and Edge.</p>														
<p>How can I confirm the OK/NG Read result over EtherNet/IP?</p>	<p>The method differs according to the selected input assembly.</p> <ul style="list-style-type: none"> • When using a Small (100) assembly; First determine whether the Output String (DECODE DATA STRING) is NOREAD (default). • When using a Big (101) assembly; There is a way to verify the External Output Status OUTPUT bit. Please note that the External Output Status is dependent on the Output condition setting for the Parallel I/O OUTPUT signal. The default setting is ON when there is a Read Fail. • When an assembly after MXL/SLC (102) is selected; You can verify the Read Cycle Pass, Read Cycle Fail bit status in Device Status. The Read Cycle Pass, Read Cycle Fail bit is OFF during a READ cycle and is updated when Data Is Ready is ON. 														

EtherNet/IP data output timing

The timing signal indicating when the output data is stored in the data memory of the PLC varies depending on the selected assembly.

- When using the Small (100) assembly, there is no applicable data output timing signal
- When using the Big (101) assembly, the timing of data output is when **Device Status - In Read Cycle** bit changes from ON to OFF.
- When MXL/SLC (102) or later assembly is selected, Output is at the timing when the **Data Status Ready** bit of **Device Status** turns ON.

· When using the Small (100) assembly, there is no applicable data output timing signal.

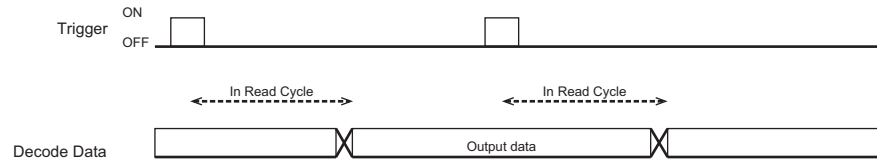

· When using the Big (101) assembly, the timing of data output is when **Device Status - In Read Cycle** bit changes from ON to OFF.

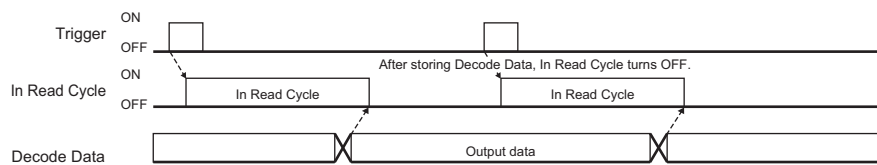

· When MXL/SLC (102) or later assembly is selected, Output is at the timing when the **Data Status Ready** bit of **Device Status** turns ON.

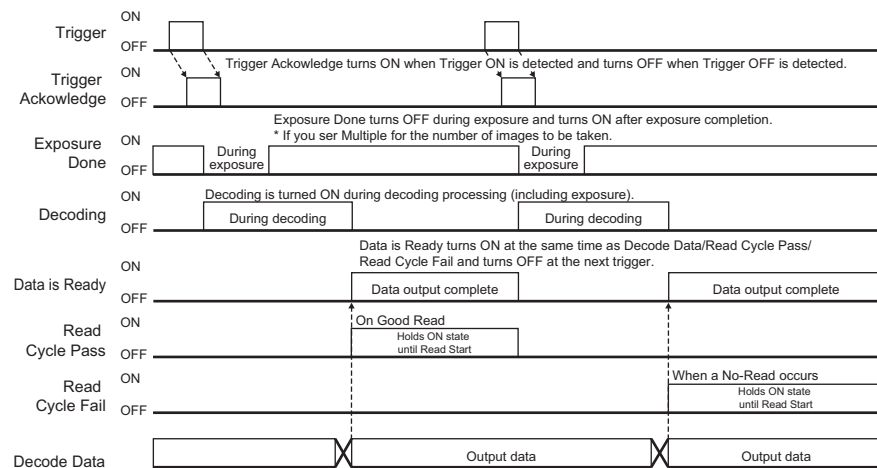

R

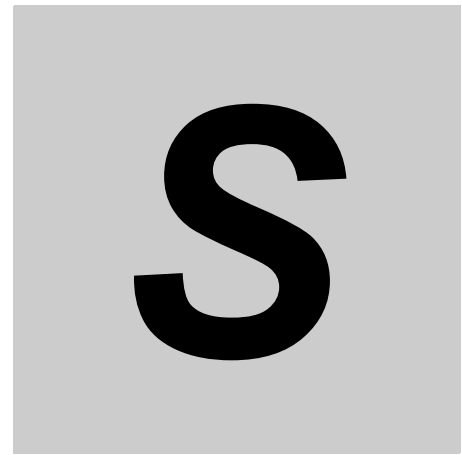

Glossary of Terms



This section contains a glossary of terms relevant to barcode reading and machine vision inspection in industrial automation applications.

S-1	Glossary of Terms	S-2
------------	--------------------------------	------------

S-1 Glossary of Terms

Aberration — The failure of an optical lens to produce an exact point-to-point correspondence between the object and its resulting image. Various types are chromatic, spherical, coma, astigmatism, and distortion.

Absorption — The loss of light of certain wavelengths as it passes through a material and is converted to heat or other forms of energy.

Active Illumination — Lighting an area with a light source coordinated with the acquisition of an image. Strobed flash tubes and pulsed lasers are examples.

Ambient Light — Light which is present in the environment of the imaging front end of a vision system and generated from outside sources. This light, unless used for actual illumination, will be treated as background **Noise** by the vision system.

Analog — A smooth, continuous voltage or current signal or function whose magnitude (value) is the information.

Analog-to-Digital Converter (A/D Converter or ADC) — A device that converts an analog voltage or current signal to a discrete series of digitally encoded numbers (signal) for computer processing.

Application-Specific Integrated Circuit (ASIC) — An integrated circuit that is customized for a particular kind of use, rather than general use. All vision system elements including firmware can be integrated into one ASIC.

Architecture — The hardware organization of a vision system designed for high speed image analysis.

Aspect Ratio — The ratio between the height and width of a sensor or display. Found by dividing the vertical number of pixels (height) by the horizontal number of pixels (width) leaving it in fractional format.

Automatic Gain Control (AGC) — Adjustment to signal strength that seeks to maintain a constant level regardless of the distance between a reader and symbol.

Auxiliary Port — RS-232 connection to an auxiliary terminal or device for remote viewing.

Blooming — A situation in which too many photons are being produced to be received by a pixel. The pixel overflows and causes the photons to go to adjacent pixels. Blooming is similar to overexposure in film photography, except that in digital imaging, the result is a number of vertical and/or horizontal streaks appearing from the light source in the picture.

Baud Rate — The number of discrete signal events per second; bits per second.

Capture — The act of acquiring and storing video images in an imager or host computer. Also, the image captured.

Charge-Coupled Device (CCD) — A semiconductor device with an array of light-sensitive elements that converts light images into electrical signals.

Check Character — A Modulus 43 or Modulus 10 character that is added to encoded symbol data for additional data integrity.

Complementary Metal Oxide Semiconductor (CMOS) — Like CCDs, CMOS imagers include an array of photo-sensitive diodes, one diode within each pixel. Unlike CCDs, however, each pixel in a CMOS imager has its own individual amplifier integrated inside.

Connector — A plug or socket on a device or cable providing in/out connectivity for various circuits and pins.

Concentrator — Intermediary device that relays data from imagers to a host and commands from the host to the imagers or other devices.

Counter — Memory space allocated to keep track of imager events.

Daisy Chain — Linkage of primary and secondary imagers allowing data to be relayed up to the host via auxiliary port connections.

Decode — A Good Read. The successful interpretation and output of the information encoded in a symbol.

Default — Restores **ROM** or flash settings, initializes serial commands and resets all counters.

Delimited — A delimited command or field is bracketed by predefined characters.

Decode Rate — The number of good reads per second achieved by an imager.

Dark Field Illumination — Lighting of objects, surfaces, or particles at very shallow or low angles, so that light does not directly enter a reader's optical hardware.

Depth-of-Field — The in-focus range of an imaging system. Measured from the distance behind an object to the distance in front of the object with all objects appearing in focus.

Diffused Lighting — Scattered soft lighting from a wide variety of angles used to eliminate shadows and specular glints from profiled, highly reflective surfaces.

Digital-to-Analog Converter (DAC) — A **VLSI** circuit used to convert digitally processed images to analog for display on a monitor.

Digital Imaging — Conversion of an image into pixels by means of an **Analog-to-Digital Converter** where the level of each pixel can be stored digitally.

Digital Signal Processor (DSP) — A **VLSI** chip designed for ultra-high-speed arithmetic processing. Often imbedded in a vision engine.

Discrete I/O — Inputs and outputs characterized by discrete signal transitions from one voltage level to another so that digital switching can occur.

Direct Memory Access (DMA) — A capability provided by some computer bus architectures that allows data to be sent directly to memory from an attached device.

Dynamic Range — The difference between the minimum and maximum thresholds of discernible images; the amount of usable signal.

Edge Enhancement — Image processing method to strengthen high-spatial frequencies in the image.

Embedded Memory — Onboard memory device such as **EPROM** or flash.

End of Read Cycle — The time or condition at which the imager stops expecting symbol information to decode.

Erasable Programmable Read-Only Memory (EPROM) — A memory chip that retains data when its power supply is turned off; "non-volatile memory".

External Edge — Allows a read cycle to be initiated by a trigger signal from an object detector when it detects the appearance of an object (rising edge). The read cycle ends with a good read, a timeout, or a new trigger.

External Level — Allows a read cycle to be initiated by a trigger signal from an object detector. The read cycle ends when the object moves out of the detector's range.

Falling Edge — A change of state (to inactive) associated with a level trigger.

Field-Programmable Gate Array (FPGA) — A semiconductor device containing programmable interconnects and logic components.

Fill Factor — Percentage of pixel area used for light collection.

Firmware — Software hard-coded in non-volatile memory (**ROM**), and closely tied to specific pieces of hardware.

Fixed Symbol Length — Increases data integrity by ensuring that only one symbol length will be accepted.

Focal Distance — In camera-based vision, the distance from the front of the camera to the object being viewed. (In optics, the distance from the lens to the focal plane.)

Focal Plane — Usually found at the image sensor, it is a plane perpendicular to the lens axis at the point of focus.

Focus — Any given point in an image at which light converges; the focal point.

Frame — The total area captured in an image sensor while the video signal is not blanked.

Frame Grabber — A device that interfaces with a camera and, on command, samples the video, converts the sample to a digital value and stores that in a computer's memory.

Front-End System — The object, illumination, optics and imager blocks of a vision system. Includes all components useful to acquire a good image for subsequent processing.

Full-Duplex — A communications system in which signals can travel simultaneously between devices.

Gain — The amount of energy applied to pixel gray scale values prior to output, expressed in dB; optimal signal strength.

Good Read — A **Decode**. The successful scanning and decoding of the information encoded in a symbol.

Gradient — The rate of change of pixel intensity (first derivative).

Gray Scale — Variations of values from white, through shades of gray, to black in a digitized image with black assigned the value of zero and white the value of one.

Half-Duplex — A communications system in which signals can travel between devices in both directions, but not simultaneously.

Histogram — A graphical representation of the frequency of occurrence of each intensity or range of intensities (gray levels) of pixels in an image. The height represents the number of observations occurring in each interval.

Host — A computer, **PLC**, or other device that is used to execute commands and process data and discrete signals.

Image — Projection of an object or scene onto a plane (i.e. screen or image sensor).

Image Processing (IP) — Transformation of an input image into an output image with desired properties.

Image Resolution — The number of rows and columns of pixels in an image. A higher resolution means that more pixels are available per element of the symbol being read. Examples: 640 x 480 (VGA); 854 x 480 (WVGA); 1280 x 1024 (SXGA); 2048 x 1536 (QXGA).

Image Sensor — A device that converts a visual image to an electrical signal; a **CCD** or **CMOS** array.

Initialize — Implement serial configuration commands into the imager's active memory.

Input — A channel or communications line. Decoded data or a discrete signal that is received by a device.

Integration — Exposure of pixels on a **CMOS** sensor.

Ladder Orientation — A linear symbol orientation in which the bars are parallel to the symbol's direction of travel.

Light-Emitting Diode (LED) — A semiconductor device that emits light when conducting current.

Lens — A transparent piece of material with curved surfaces which either converge or diverge light rays.

Machine Vision — The automatic acquisition and analysis of images to obtain desired data for controlling a specific activity.

Multidrop — A communications protocol for networking two or more imagers or other devices with a concentrator (or controller) and characterized by the use of individual device addresses and the RS-485 standard.

Noise — The same as static in a phone line or "snow" in a television picture, noise is any unwanted electrical signal that interferes with the image being read and transferred by the imager.

Normally Closed — A discrete output state that is only active when open.

Normally Open — A discrete output state that is only active when closed.

Object Plane — An imaginary plane in the field of view, focused by an imager's optical system at the corresponding image plane on the sensor.

Output — A channel or communications line. Data or discrete signals that are transmitted or displayed by a device.

- Parity** — An error detection routine in which one data bit in each character is set to **1** or **0** so that the total number of **1** bit in the data field is even or odd.
- Picket Fence Orientation** — A linear symbol orientation in which the bars are perpendicular to the symbol's direction of travel.
- Pitch** — Rotation of a linear or 2D symbol around an axis parallel to the symbol length on the Substrate.
- Pixel** — An individual element in a digitized image array; "picture element".
- Port** — Logical circuit for data entry and exit. (One or more ports may be included within a single connector.)
- Processing Time** — The time used by a vision system to receive, analyze and interpret image information. Often expressed in "parts per minute".
- Programmable Logic Controller (PLC)** — An electronic device used in industrial automation environments such as factory assembly lines and automotive manufacturing facilities.
- Progressive Scan** — A non-interlaced scan that doubles the number of visible picture lines per field by displaying all picture lines at once.
- Protocol** — The rules for communication between devices, providing a means to control the orderly flow of information between linked devices.
- Random Access Memory (RAM)** — A data storage system used in computers, composed of integrated circuits that allow access to stored data in any sequence without movement of physical parts.
- Read Cycle** — A programmed period of time or condition during which a reader will accept symbol input.
- Read-Only Memory (ROM)** — A data storage medium used in computers and other electronics, primarily used to distribute **Firmware**.
- Real-Time Processing** — In machine vision, the ability of a system to perform a complete analysis and take action on one part before the next one arrives for inspection.
- Region** — Area of an image. Also called a region of interest for image processing operations.
- Saturation** — The degree to which a color is free of white. One of the three properties of color perception, along with hue and value.
- Scattering** — Redirection of light reflecting off a surface or through an object.
- Skew** — Rotation of a linear or 2D symbol around an axis parallel to the symbol height on the substrate.
- Substrate** — The surface upon which a linear or 2D symbol is printed, stamped, or etched.
- Symbol Transitions** — The transition of bars and spaces on a symbol, used to detect the presence of a symbol on an object.
- Symbology** — A symbol type, such as Code 39 or Code 128, with special rules to define the widths and positions of bars and spaces to represent specific numeric or alphanumeric information.
- Tilt** — Rotation of a linear or 2D symbol around an axis perpendicular to the substrate.
- Trigger** — A signal, transition, or character string that initiates a read cycle.
- Very Large-Scale Integration (VLSI)** — The creation of integrated circuits by combining thousands of transistor-based circuits on a single chip.
- Watchdog Timer** — A security device that detects system crashes and attempts to reset the imager.

OMRON Corporation Industrial Automation Company

Kyoto, JAPAN

Contact : www.ia.omron.com

Regional Headquarters

OMRON EUROPE B.V.

Wegalaan 67-69, 2132 JD Hoofddorp
The Netherlands
Tel: (31) 2356-81-300 Fax: (31) 2356-81-388

OMRON ELECTRONICS LLC

2895 Greenspoint Parkway, Suite 200
Hoffman Estates, IL 60169 U.S.A.
Tel: (1) 847-843-7900 Fax: (1) 847-843-7787

OMRON ASIA PACIFIC PTE. LTD.

438B Alexandra Road, #08-01/02 Alexandra
Technopark, Singapore 119968
Tel: (65) 6835-3011 Fax: (65) 6835-3011

OMRON (CHINA) CO., LTD.

Room 2211, Bank of China Tower,
200 Yin Cheng Zhong Road,
PuDong New Area, Shanghai, 200120, China
Tel: (86) 21-6023-0333 Fax: (86) 21-5037-2388

Authorized Distributor:

©OMRON Corporation 2023 All Rights Reserved.
In the interest of product improvement, specifications
are subject to change without notice.

Z452-E-05 (84-9000440-02-E)

0523 (0621)