



**Vision Sensor**

**FH Series**

**Vision System**

**3D Robot Vision Application Construction Guide**

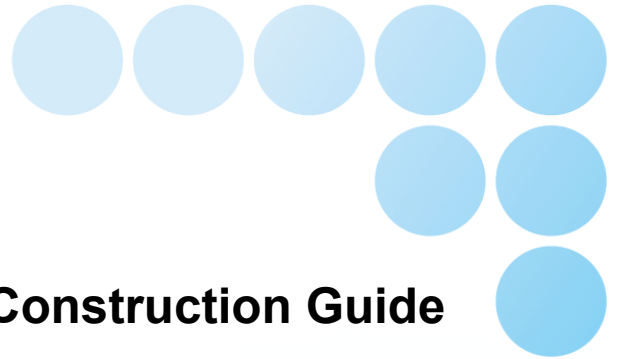

**FH-5050**

**FH-SMDA-GS050B**

## NOTE

- All rights reserved.
- No part of this publication may be reproduced, stored in a retrieval system, or transmitted, in any form, or by any means, mechanical, electronic, photocopying, recording, or otherwise, without the prior written permission of OMRON.
- No patent liability is assumed with respect to the use of the information contained herein. Moreover, because OMRON is constantly striving to improve its high-quality products, the information contained in this manual is subject to change without notice. Every precaution has been taken in the preparation of this manual. Nevertheless, OMRON assumes no responsibility for errors or omissions.

Neither is any liability assumed for damages resulting from the use of the information contained in this publication.

## Trademarks

- Sysmac and SYSMAC are trademarks or registered trademarks of OMRON Corporation in Japan and other countries for OMRON factory automation products.
- This software is based in part on the work of the Independent JPEG Group.
- Microsoft, Windows, Windows Vista, Excel, and Visual Basic are either registered trademarks or trademarks of Microsoft Corporation in the United States and other countries.
- Intel, Core and Pentium are trademarks of Intel Corporation in the U.S. and/or other countries.
- EtherCAT® is registered trademark and patented technology, licensed by Beckhoff Automation GmbH, Germany.
- ODVA, CIP, CompoNet, DeviceNet, and EtherNet/IP are trademarks of ODVA.
- The SD, SDHC, microSD, and microSDHC logos are trademarks of SD-3C, LLC.



- QR Code is a registered trademark of DENSO WAVE INCORPORATED.
- MELSEC is a registered trademarks of Mitsubishi Electric Corporation.

Other company names and product names in this document are the trademarks or registered trademarks of their respective companies.

## Copyrights

Microsoft product screen shots reprinted with permission from Microsoft.

## CONTENTS

<b>Introduction</b> .....	<b>5</b>
<b>Terms and Conditions Agreement</b> .....	<b>6</b>
<b>Safety Precautions</b> .....	<b>8</b>
<b>Warning</b> .....	<b>10</b>
<b>Precautions for Safe Use</b> .....	<b>15</b>
<b>Precautions for Correct Use</b> .....	<b>20</b>
<b>Regulations and Standards</b> .....	<b>25</b>
<b>Related Manuals</b> .....	<b>28</b>
<b>Revision History</b> .....	<b>30</b>
<b>1. Overview</b> .....	<b>31</b>
1.1. Overview .....	31
1.2. Target Audience .....	31
1.3. Work Flow .....	32
<b>2. System Configuration</b> .....	<b>33</b>
2.1. System Configuration .....	33
2.2. Applicable Devices .....	33
<b>3. Configuration of the Application</b> .....	<b>36</b>
3.1. Specification of the Sensor .....	36
3.2. Workpiece .....	37
3.3. Container .....	38
3.4. Supported Robots .....	38
<b>4. Equipment Installation Overview</b> .....	<b>39</b>
4.1. Mounting .....	39
4.2. Wiring .....	39
4.3. Connecting .....	39
4.4. Camera Cable Mounting .....	39
4.5. Start and Stop Sequence .....	39
<b>5. Startup Procedure</b> .....	<b>40</b>
5.1. Preconditions .....	40
5.2. What You Can Do by This Startup Procedure .....	41
<b>6. Creating Data Set for the Robot Vision</b> .....	<b>45</b>
6.1. Creating Data Sets .....	45
<b>7. 3D Sensor Software Installation</b> .....	<b>47</b>
7.1. Installing and Uninstalling the 3D Robot Vision Software 47	
7.2. Loading the Sensor Controller Project .....	60
7.3. Configuring the Network (Ethernet Communications) .	61
<b>8. Vision Sensor Setting for Robot Vision</b> .....	<b>65</b>
8.1. Overview .....	65
8.2. Coordinate Systems and Angle Types .....	66
8.3. Scene Data Configuration .....	68
8.4. User Dialogs .....	71
8.5. Hand-eye Calibration Configuration Using the Wizard	81
8.6. Hand-eye Camera Pick Application Configuration Using the Wizard .....	84
8.7. Hand-eye Calibration .....	87
8.8. Pick Application Flow for the Hand-Eye Camera System 116	
<b>9. Appendix</b> .....	<b>172</b>
9.1. Making Hand (Tow finger Gripper) and Grasp Point Registration .....	172
9.2. Robot Error .....	186





# Introduction

Thank you for purchasing the FH Series.

This manual contains information that is necessary to use the FH Series.

Please read this manual and make sure you understand the functionality and performance of the FH Series before you attempt to use it in a control system.

Keep this manual in a safe place where it will be available for reference during operation.

# Terms and Conditions Agreement

## Warranty, Limitations of Liability

### Warranties

#### • Exclusive Warranty

Omron's exclusive warranty is that the Products will be free from defects in materials and workmanship for a period of twelve months from the date of sale by Omron (or such other period expressed in writing by Omron). Omron disclaims all other warranties, express or implied.

#### • Limitations

OMRON MAKES NO WARRANTY OR REPRESENTATION, EXPRESS OR IMPLIED, ABOUT NON-INFRINGEMENT, MERCHANTABILITY OR FITNESS FOR A PARTICULAR PURPOSE OF THE PRODUCTS. BUYER ACKNOWLEDGES THAT IT ALONE HAS DETERMINED THAT THE PRODUCTS WILL SUITABLY MEET THE REQUIREMENTS OF THEIR INTENDED USE.

Omron further disclaims all warranties and responsibility of any type for claims or expenses based on infringement by the Products or otherwise of any intellectual property right.

#### • Buyer Remedy

Omron's sole obligation hereunder shall be, at Omron's election, to (i) replace (in the form originally shipped with Buyer responsible for labor charges for removal or replacement thereof) the non-complying Product, (ii) repair the non-complying Product, or (iii) repay or credit Buyer an amount equal to the purchase price of the non-complying Product; provided that in no event shall Omron be responsible for warranty, repair, indemnity or any other claims or expenses regarding the Products unless Omron's analysis confirms that the Products were properly handled, stored, installed and maintained and not subject to contamination, abuse, misuse or inappropriate modification. Return of any Products by Buyer must be approved in writing by Omron before shipment. Omron Companies shall not be liable for the suitability or unsuitability or the results from the use of Products in combination with any electrical or electronic components, circuits, system assemblies or any other materials or substances or environments. Any advice, recommendations or information given orally or in writing, are not to be construed as an amendment or addition to the above warranty.

See <http://www.omron.com/global/> or contact your Omron representative for published information.

#### Limitation on Liability; Etc

OMRON COMPANIES SHALL NOT BE LIABLE FOR SPECIAL, INDIRECT, INCIDENTAL, OR CONSEQUENTIAL DAMAGES, LOSS OF PROFITS OR PRODUCTION OR COMMERCIAL LOSS IN ANYWAY CONNECTED WITH THE PRODUCTS, WHETHER SUCH CLAIM IS BASED IN CONTRACT, WARRANTY, NEGLIGENCE OR STRICT LIABILITY.

Further, in no event shall liability of Omron Companies exceed the individual price of the Product on which liability is asserted.

## **Application Considerations**

### **Suitability of Use**

Omron Companies shall not be responsible for conformity with any standards, codes or regulations which apply to the combination of the Product in the Buyer's application or use of the Product. At Buyer's request, Omron will provide applicable third party certification documents identifying ratings and limitations of use which apply to the Product. This information by itself is not sufficient for a complete determination of the suitability of the Product in combination with the end product, machine, system, or other application or use. Buyer shall be solely responsible for determining appropriateness of the particular Product with respect to Buyer's application, product or system. Buyer shall take application responsibility in all cases.

NEVER USE THE PRODUCT FOR AN APPLICATION INVOLVING SERIOUS RISK TO LIFE OR PROPERTY OR IN LARGE QUANTITIES WITHOUT ENSURING THAT THE SYSTEM AS A WHOLE HAS BEEN DESIGNED TO ADDRESS THE RISKS, AND THAT THE OMRON PRODUCT(S) IS PROPERLY RATED AND INSTALLED FOR THE INTENDED USE WITHIN THE OVERALL EQUIPMENT OR SYSTEM.

### **Programmable Products**

Omron Companies shall not be responsible for the user's programming of a programmable Product, or any consequence thereof.

## **Disclaimers**

### **Performance Data**

Data presented in Omron Company websites, catalogs and other materials is provided as a guide for the user in determining suitability and does not constitute a warranty. It may represent the result of Omron's test conditions, and the user must correlate it to actual application requirements. Actual performance is subject to the Omron's Warranty and Limitations of Liability.

### **Change in Specifications**

Product specifications and accessories may be changed at any time based on improvements and other reasons. It is our practice to change part numbers when published ratings or features are changed, or when significant construction changes are made. However, some specifications of the Product may be changed without any notice. When in doubt, special part numbers may be assigned to fix or establish key specifications for your application. Please consult with your Omron's representative at any time to confirm actual specifications of purchased Product.



### **Errors and Omissions**

Information presented by Omron Companies has been checked and is believed to be accurate; however, no responsibility is assumed for clerical, typographical or proofreading errors or omissions.







# Safety Precautions

## Symbols and the Meanings for Safety Precautions Described in This Manual

The following notation is used in this manual to provide precautions required to ensure safe usage of a Sensor Controller. The safety precautions that are provided are extremely important to safety. Always read and heed the information provided in all safety precautions. The following notation is used.

 <b>WARNING</b>	<p>Indicates a potentially hazardous situation which, if not avoided, will result in minor or moderate injury, or may result in serious injury or death. Additionally there may be significant property damage.</p>
 <b>Caution</b>	<p>Indicates a potentially hazardous situation which, if not avoided, may result in minor or moderate injury or in property damage.</p>

## Meanings of Alert Symbols

	<p>General Prohibition Indicates general prohibitions, including warnings, for which there is no specific symbol</p>
	<p>General Caution Indicates general cautions, including warnings, for which there is no specific symbol.</p>
	<p>The filled circle symbol indicates operations that you must do. The specific operation is shown in the circle and explained in text. This example shows a general precaution for something that you must do.</p>
	<p>Electrical Hazard Indicates the possible danger of electric shock under specific conditions.</p>
	<p>Explosion Hazard Indicates the possible danger of explosion under specific conditions.</p>
	<p>LED light Hazard Indicates the possible danger of LED radiation or light.</p>
	<p>High Temperature Caution Indicates the possible danger of injury by high temperature under specific conditions.</p>



### **Precautions for Correct Use**

---

Precautions on what to do and what not to do to ensure proper operation and performance.

---



### **Additional Information**

---

Additional information to read as required.

This information is provided to increase understanding or make operation easier.

---

## Warning

# WARNING

This product must be used according to this manual and Instruction Sheet. Failure to observe this may result in the impairment of functions and performance of the product.



This product is not designed or rated for ensuring the safety of persons. Do not use it for such purposes.



Never connect the AC power supply with this product. When the AC power supply is connected, it causes the electric shock and a fire.



A lithium battery is built into the Controller and may occasionally combust, explode, or burn if not treated properly. Dispose of the Controller as industrial waste, and never disassemble, apply pressure that would deform, heat to 100°C or higher, or incinerate the Controller.



If you keep watching the LED light, it may have an adverse effect on the eyes, do not stare directly into the light emitted from the LED. If a specular object is used, take care not to allow reflected light to enter your eyes.



Do not touch the terminals while the power supply is ON. Doing so may result in electrical shock.



Please take external safety measures so that the system as a whole should be on the safe side even if a failure of a Sensor Controller, a failure of a 3D Vision Sensor, or an error due to an external factor occurred. An abnormal operation may result in serious accident.



Please take fail-safe measures on your side in preparation for an abnormal signal due to signal conductor disconnection and/or momentary power interruption.



An abnormal operation may result in a serious accident.









FH series must be handled by those who have the expertise in electricity. Read the reference manuals carefully to understand the contents well, and make the proper use of this product accordingly. Keep this document safely for ready reference at any time.











Note that this document does not include detailed information on the use of this product, including safety precautions. Please obtain manuals and instructions of the devices and equipment that constitute the system, and thoroughly read precautions such as "Safety Precautions", "Precautions for Safe Use", and "Precautions for Correct Use" before using the system.



According to Article 36, 31 and 32 of the Occupational Health and Safety Regulations, work to teach, inspect, repair and adjust industrial robots falls under "dangerous or harmful work" as defined in the Occupational Health and Safety Act. Under Article 59 of the Occupational Safety and Health Act, operators are obliged to provide workers with "special training for safety or health".



<p>Check the measurement results before operating the robot. Otherwise the robot may act in an unintended manner. Change the workpiece position and angle of picking/placing and check the operation thoroughly.</p>	
<p>The scene variables and system variables that are set in advance for the scene loaded with the environment copy function are automatically set using operations on the dialog box. Do not directly set them using the processing item setting screen or the TDM editor.</p>	
<p>FH series does not comply with the laws and regulations for industrial robot safety. When using the FH series in a robot system that includes an industrial robot, be sure to check for compliance with laws and regulations regarding the safety of industrial robots. Take steps to ensure safety as needed.</p>	
<p>It is your responsibility to implement appropriate safety measures based on the results of risk assessment. Compliance with the Robot Safety Guide and all of the information contained in our Robotic System Product Information does not guarantee that personal injury or damage to equipment caused by an industrial robot will be avoided.</p>	
<p>During maintenance, disconnect the robot's AC power supply and lock out or tag out the power supply to prevent powering up. If the following safety measures are not taken, the subject robot may cause death or serious injury or damage to the robot itself or its peripheral equipment.</p> <ul style="list-style-type: none"> <li>• Workers who install, operate, teach, program, or maintain the system should read the "Robot Connection Guide (Cat. No. Z448, Z447)" and "Robot Safety Guide (Cat. No. I590)" and take a training course on their responsibilities with the robot.</li> <li>• Those who design a robot system must read this document and the Robot Safety Guide, and follow the safety regulations and laws in the area where the robot will be installed.</li> <li>• Do not use the subject robot for any purpose other than those described in this document and the manuals referred to in the Robot Connection Guide. If you are not sure whether your application is compatible, please contact us.</li> <li>• The user is responsible for installing safety barriers around the robot to prevent workers from entering the work area and coming into contact with it while it is in operation.</li> <li>• During maintenance, the power to the robot and the main power supply must be locked out and tagged out (measures and indication of prohibition from being turned on) to prevent them from being turned on.</li> </ul>	
<p>If you proceed to the next step before registering the HandEye calibration start position, the robot may operate unintentionally. Be sure to register the start position.</p>	
<p>The robot is driven by pressing the Jog Move button and the Robot Move button. The operation must be done by shoes who have completed special health and safety training. The system must be operated so that it can be stopped at any time by an emergency stop button.</p>	
<p>Check the measurement results before operating the robot. Otherwise the robot may act in an unintended manner. Change the workpiece position and angle and check the operation thoroughly.</p>	
<p>If the robot is operated with an incorrectly shaped hand, the robot may pick and hold the workpiece in an unintended position and/or posture, damaging the workpiece, container, or hand and causing it to fly out into the environment. Check the dimensions of the drawing and</p>	

<p>the actual product, and make registration securely. Change the workpiece position and angle of picking/placing and check the operation thoroughly. The system must be operated so that it can be stopped at any time by an emergency stop button.</p>	
<p>Registering the grasp point that interferes with the workpiece may damage the hand or the workpiece. Register the gripping position that does not interfere with the work.</p>	
<p>If the robot is operated with an incorrectly selected picking and holding DB or hand data, the robot may pick and hold the workpiece in an unintended position and/or posture, damaging the workpiece, container, or hand and causing it to fly out into the environment. Select the proper picking and holding DB in the picking and holding plan setting. Make sure to perform offline measurement before operating the robot to confirm that the proper hand is selected.</p>	
<p>If the robot is operated with incorrect sensor controller project data, it may act in an unintended manner, resulting in contact with humans, scattering of workpieces, and contact with surrounding objects. Make sure that the proper environment file for the robot is loaded.</p>	
<p>If the robot is operated after changing the floor or container height, it may collide with the floor. If the container position or floor level is changed, register the floor level and container again.</p>	
<p>If the 3D Vision Sensor shape is not registered, the 3D Vision Sensor may collide with the container and be damaged. Please register the 3D Vision Sensor shape when you register the hand data.</p>	
<p>Do not perform camera calibration during the warm-up operation of the 3D Vision Sensor.</p>	
<p>Measurement errors occur when the geometric positional relationship between the lighting section and imaging section of the 3D Vision Sensor changes due to factors such as aging, temperature changes, or impact on the 3D Vision Sensor. Perform a camera calibration check on a regular basis and calibrate the camera if necessary.</p>	
<p>Do not perform hand-eye calibration during the warm-up operation of the 3D Vision Sensor.</p>	
<p>Complete sensor calibration before performing hand-eye calibration.</p>	
<p><b>Anti-virus protection</b></p>	
<p>Install the latest commercial-quality antivirus software on the computer connected to the control system and maintain to keep the software up-to-date.</p>	
<p><b>Security measures to prevent unauthorized access</b></p>	
<p>Take the following measures to prevent unauthorized access to our products.</p> <ul style="list-style-type: none"> <li>• Install physical controls so that only authorized personnel can access control systems and equipment.</li> <li>• Reduce connections to control systems and equipment via networks to prevent access from untrusted devices.</li> <li>• Set strong passwords and change them frequently.</li> </ul>	



- 
- Scan virus to ensure safety of USB drives or other external storages before connecting them to control systems and equipment.
- 

#### **Data input and output protection**

Validate backups and ranges to cope with unintentional modification of input/output data to control systems and equipment.

- Checking the scope of data
- Checking validity of backups and preparing data for restore in case of falsification and abnormalities
- Safety design, such as emergency shutdown and fail-soft operation in case of data tampering and abnormalities



---

#### **Data recovery**

Backup data and keep the data up-to-date periodically to prepare for data loss.



When using an intranet environment through a global address, connecting to an unauthorized terminal such as a SCADA, HMI or to an unauthorized server may result in network security issues such as spoofing and tampering. You must take sufficient measures such as restricting access to the terminal, using a terminal equipped with a secure function, and locking the installation area by yourself.



When constructing an intranet, communication failure may occur due to cable disconnection or the influence of unauthorized network equipment. Take adequate measures, such as restricting physical access to network devices, by means such as locking the installation area.



When using a device equipped with the USB flash drive or SD Memory Card function, there is a security risk that a third party may acquire, alter, or replace the files and data in the removable media by removing the removable media or unmounting the removable media.

Please take sufficient measures, such as restricting physical access to the Controller or taking appropriate management measures for removable media, by means of locking the installation area, entrance management, etc., by yourself.



---

## **Caution**

---

Danger of burns. Do not touch the case while the power is ON or just after power is turned OFF, since it remains extremely hot.



---

If the camera calibration is performed with the target tilted, the measurement error may deteriorate. Ensure that the calibration target is placed in a stable position on a flat floor.



---

If the camera calibration is performed while the target is dirty, the measurement error may deteriorate. If the camera calibration target is dirty, wring out a wet towel, wipe it clean, and dry it with a soft cloth before performing the calibration.



---

If the camera calibration is performed while the 3D Vision Sensor is dirty, the measurement error may deteriorate. If the 3D Vision Sensor window surface is dirty, wring out a wet towel, wipe the dirt off, and dry with a dry cloth.



---

When placing the camera calibration target, place it slowly so that your hands do not get caught on the floor.

---



# Precautions for Safe Use

Be sure to respect following items for safety.

## Condition of the Fitness of OMRON Products

• Omron products are designed and manufactured as general-purpose products for use in general industrial applications. They are not intended to be used in the following critical applications. If you are using Omron products in the following applications, Omron shall not provide any warranty for such Omron products, unless otherwise specifically agreed or unless the specific applications are intended by Omron.

a) Applications with stringent safety requirements, including but not limited to nuclear power control equipment, combustion equipment, aerospace equipment, railway equipment, elevator/lift equipment, amusement park equipment, medical equipment, safety devices and other applications that could cause danger/harm to people's body and life.

b) Applications that require high reliability, including but not limited to supply systems for gas, water and electricity, etc., 24 hour continuous operating systems, financial settlement systems and other applications that handle rights and property.

c) Applications under severe condition or in severe environment, including but not limited to outdoor equipment, equipment exposed to chemical contamination, equipment exposed to electromagnetic interference and equipment exposed to vibration and shocks.

d) Applications under conditions and environment not described in specifications.

1. In addition to the applications listed from (a) to (d) above, Omron products (see definition) are not intended for use in vehicles designed human transport (including two wheel vehicles). Please do NOT use Omron products for vehicles designed human transport. Please contact the Omron sales staff for information on our automotive line of products.

2. The above is part of the Terms and Conditions Agreement. Please use carefully read the contents of the guarantee and disclaimers described in our latest version of the catalog, data sheets and manuals.

## Installation Environment (FH-5050)

- Do not use the product in the environment with flammable or explosive gases.
- Install the product so that the air can flow freely through its cooling vents.
- Regularly clean the vent holes or fan outlet to prevent dust or particles blocking them. Internal temperature increases when those are blocked, it causes malfunction.
- To secure safety for operation and maintenance, install the product apart from high-voltage devices and power devices.
- Make sure to tighten all screws in mounting.
- When mounting the product, be sure to tighten all screws.

## Power Supply and Wiring (FH-5050)

- Make sure to use the product within the power voltage specified by catalog, manual, or instruction sheet.
- Never connect the product to AC power. If connected, it causes malfunction.
- Select and use the appropriate wire size based on consumption current.
- Keep the power supply wires as short as possible.

- Provide the power from a DC power supply (safety extra-low voltage circuits) that has been taken measures not to generate high-voltage.
- Check the following again before turning on the power.
  - Is the voltage and polarity of the power supply correct? (24 VDC)
  - Is not the load of the output signal short-circuited?
  - Is the load current of the output signal appropriate?
  - Is not the mistake found in wiring?
  - Is the voltage and polarity of the encoder power (ENC0\_VDD/GND ENC1\_VDD/GND) supply? (5VDC)

## **Grounding (FH-5050)**

- Since the power supply circuit for the Sensor Controller is described in the manual and instruction sheet, please check it.
  - When a base is packed in a camera that will be connected to the Sensor Controller, make sure to mount the camera using the base. Since the enclosure of the camera body is connected to the internal circuits, the circuits may cause short-circuit with FG if the base is not used to mount the camera and result in malfunction or damage.
  - Apply Class D grounding (grounding resistance: 100 [ $\Omega$ ] or less) Wire the grounding wire for the Sensor Controller independently. If the grounding wire is shared with other devices or connected to a building beam, the Sensor Controller may be adversely affected.
  - Do not ground the plus (+) terminal when the Sensor Controller is connected to the FH-SC12/FH- SM12. The internal circuits may cause a short-circuit and result in malfunction.
  - When using the Sensor Controller and the peripheral devices such as a monitor, USB connection devices, RS-232C connection devices, there should be no potential difference in ground level. If not, it may cause malfunction.
- Take measures that the potential difference does not occur between the grounds for the Sensor Controller and the peripheral devices.

## **Others (FH-5050)**

- Use only the camera and cables designed specifically for the product. Use of other products may result in malfunction or damage of the product.
- Always turn OFF the power of the Sensor Controller and peripheral devices before connecting or disconnecting a camera or cable. Connecting the cable with power supplied may result in damage of the camera or peripheral devices.
- For the cable that is flexed repeatedly, use the robotic cable type (Bend resistant camera cable) to prevent damages.
- Do not apply torsion stress to the cable. It may damage the cable.
- Secure the minimum bending radius of the cable. Otherwise the cable may be damaged.
- Do not apply stress to the connector by pulling or bending the cable. It may damage the connector.
- Do not attempt to dismantle, repair, or modify the product.
- Should you notice any abnormalities, immediately stop use, turn OFF the power supply, and contact your OMRON representative.

- Do not drop the product nor apply excessive vibration or shock to the product. Doing so may cause malfunction or burning.
- This product is heavy. Be careful not to drop it while handling.
- Be sure to take fail-safe measures externally when controlling stages and robots by using the measurement results of the Sensor Controller (axis movement output by calibration and alignment measurement).

### **Installation Environment (FH-SMDA-GS050B)**

- Do not use the product in the environment with flammable or explosive gases.
- To secure safety for operation and maintenance, install the product apart from high-voltage devices and power devices.
- Avoid installing the product in places with vibration as much as possible.

### **Power Supply and Wiring (FH-SMDA-GS050B)**

- Make sure to use the product with the power supply voltage specified. If a DC voltage exceeding the rating or an AC voltage is applied, the circuit parts may be burnt or exploded.
- Do not connect the power supply with polarity reversed.
- Use a DC power supply with safety measures against high-voltage spikes (safety extra low-voltage circuits on the secondary side).
- Use an independent power source for this product. Do not use a shared power source.
- Never apply more than the rated voltage or AC power supply to this product. It may cause malfunction.
- The recommended power supplies are as follows:
  - When not attaching the lighting module, use S8VK-G06024 (OMRON) or S8VS-06024 (OMRON).
- Wire high-voltage cables or power cables are separated from the cables of this product. If the same cable or duct is used, the product may receive induction and it may cause malfunctioning or breakage.
- Do not short-circuit the load on the open collector output.
- Apply load not exceeding the rating.
- Before wiring an I/O cable, attach a crimping terminal. Do not connect cables just twisted together to the power supply or terminal block directly.
- Insulate unnecessary signal cables so that they do not contact any other signal cables.
- After wiring the cables, confirm if the power supply is appropriate, if there is miswiring such as short-circuit of load, if the load current is appropriate, and if FG is connected appropriately. Otherwise, the product may be broken due to miswiring etc.
- Take enough safety measures such as a failsafe circuit before using the product.
- Be sure to apply Class D grounding (100Ω or lower grounding resistance) to the ground wire of the I/O cable.
- Do not share the ground wire with some other devices or connect it to the beam of the building. The product may be adversely affected.
- Determine the contact point as near as possible to shorten the ground wire as much as possible. The product may be adversely affected.
- For positive ground, please refer to cautions described in the setup manual.

- Do not touch the optical surface of the camera or the lighting section during wiring or installation. It may affect the characteristics.

### **Mounting (FH-SMDA-GS050B)**

- When doing the following, be sure to turn OFF the power of the 3D vision sensor or connected peripheral devices. Not doing so leads to a product failure.
  - Cable connection and wiring
  - Connector mounting/removal
- Tighten the mounting screws securely using the defined torque. (Screw: M4 x 4 , Tightening torque: 1.2 N•m)
- Do not apply torsional stress to the cable. Doing so may cause cable breakage.
- Secure the minimum bending radius of the cable. If it cannot be secured, the cable may be broken.

### **Others (FH-SMDA-GS050B)**

- Use only the dedicated cable (FHV-VNBX2 / FHV-VNLBX2 / FHV-VNBX / FHV-VNLBX and FHV-VSDX-BX / FHV-VSDX-LBX). Otherwise, the product may malfunction or be broken.
- If anything abnormal occurs, for example, strange smell/sound is detected, the main unit gets very hot, or a smoke comes, stop using the product, turn OFF the product, and consult OMRON's branch or sales office.
- Do not disassemble, deform by pressurizing, incinerate, repair, or alter this product.
- When disposing of the product, treat as industrial waste.
- Do not use the product for atomic power or safety circuits endangering human lives.
- Do not drop the product or expose it to abnormal vibration or impact. Doing so may lead to product failure.
- When operating the robot by using the vision sensor measurement results, be sure to check the measurement result data on the robot side and take fail-safe measures, such as operating the robot only after confirming that the data is within the robot's range of motion.
- When operating the jog, check the actual robot visually instead of the camera image.
- The robot is driven when using the motion sample program. The operation must be done by shoes who have completed special health and safety training. The system must be operated so that it can be stopped at any time by an emergency stop button.
- If the operation range of hand-eye calibration is not set correctly, the robot may act in an unexpected position and/or posture that may result in contact with surrounding objects. Make sure that the calibration trajectory is clear and that there are no obstacles or people in the vicinity. The system must be operated so that it can be stopped at any time by an emergency stop button.
- 3D Vision Sensor measurements are relative, not absolute. It cannot be used as a measurement sensor.

### **Camera Calibration Target (FH-XCAL-S)**

- Install and store the product in a location that meets the following conditions:
  - Ambient temperature and relative humidity do not exceed the range of specifications
  - No rapid changes in temperature (place where dew does not form)
  - No presence of corrosive or flammable gases

- Place free of dust, salts and iron particles
- Place free of vibration and shock
- Place out of direct sunlight
- Place where it will not come into contact with oils or chemicals
- Do not drop the product nor apply excessive vibration or shock to the product. Doing so may cause malfunction or burning.
- Place the camera calibration target in a stable position on a flat floor.
- Set the camera calibration target within the measurement distance and measurement range of the 3D Vision Sensor to calibrate the camera.
- Before performing camera calibration automatically, make sure that the robot is in a coordinate position that does not collide with the target.

### **HandEye Calibration Target (FH-XCAL-R)**

- Install and store the product in a location that meets the following conditions:
  - No rapid changes in temperature (place where dew does not form)
  - No presence of corrosive or flammable gases
  - Place free of dust, salts and iron particles
  - Place free of vibration and shock
  - Place out of direct sunlight
  - Place where it will not come into contact with oils or chemicals
- Do not drop the product nor apply excessive vibration or shock to the product. Doing so may cause malfunction or burning.
- Set the hand-eye calibration target within the measurement distance and measurement range of the 3D Vision Sensor to performing hand-eye calibration.
- When performing hand-eye calibration, make sure that there is no workpiece around the hand-eye calibration target.
- Install the hand-eye calibration target on a flat floor in a stable condition without vibration.
- If the hand-eye calibration target is dirty, wring out a wet towel, wipe off the dirt, and dry with a soft cloth.
- If the 3D Vision Sensor window surface is dirty, wring out a wet towel, wipe the dirt off, and dry with a dry cloth.
- Check that the hand-eye calibration result shows an error of approximately 1.0 or less.

# Precautions for Correct Use

Please observe the following precautions to prevent failure to operate, malfunction, or undesirable effect.

## Installation and Storage Sites (FH-5050)

Install and store the product in a location that meets the following conditions:

- Surrounding temperature of 0 to +45°C (-20 to +65°C in storage)
- No rapid changes in temperature (place where dew does not form)
- Relative humidity of between 35 to 85%
- No presence of corrosive or flammable gases
- Place free of dust, salts and iron particles
- Place free of vibration and shock
- Place out of direct sunlight
- Place where it will not come into contact with water, oils or chemicals
- Place not affected by strong electro-magnetic waves
- Place not near to high-voltage, or high-power equipment

## Orientation of Product (FH-5050)

• For efficient heat dissipation, install the product only with the orientation written in the manual or the Instruction Sheet. Install the product so that the air can flow freely through its cooling vents.

## Ambient Temperature (FH-5050)

- To secure good ventilation, install the product with clearance written in the manual or the Instruction Sheet.
- Do not install the product immediately above significant heat sources, such as heaters, transformers, or large-capacity resistors.
- Use the product within the operating temperature range based on the specifications of it.
- Install a forced cooling fan or air conditioner not to exceed the operating temperature range when the ambient temperature is close to the upper limit of its range.

## Component Installation and Handling (FH-5050)

- When touching a terminal part or a signal wire in a connector, take anti-static measures using a wrist strap or another device to prevent damage from static electricity.
- Handling a USB flash drive/SD memory card: (Refer to Using External Storage Device in the Vision System FH/FHV Series User's Manual (Cat. No. Z365).

Do not insert an SD memory card in the reverse orientation, at an angle, or in a twisting manner. Before removing a USB flash drive, make sure that data is not being read or written to them. Before removing a SD memory card, make sure that data is not being read or written to them.

For a USB flash drive, the memory device's LED flashes or lights while data is being read or written, so make sure that it is turned OFF before removing the device.

For SD memory card, the SD BUSY LED flashes or lights while data is being read or written, so make sure that it is turned OFF before removing the memory.



- Turning OFF the Power:

When a message is displayed indicating that a task is in progress, do not turn OFF the power. Doing so causes the data in the memory to be corrupted, resulting in the product not operating properly upon the next start-up.

Do not turn OFF during saving data to Sensor Controller.

When turns OFF, conform the followings proceedings have completed. and then operate again.

- When saves using Sensor Controller: Confirm the save processing is completed and next operation is possible.
  - When saves using communication command: Intended command is completed. BUSY signal is turned OFF.
- After turning off the power, wait at least 1 second before restarting.

## **Maintenance (FH-5050)**

- Turn OFF the power and ensure the safety before maintenance.
- Clean the lens with a lens-cleaning cloth or air brush.
- Lightly wipe off dirt with a soft cloth.
- Dirt on the image element must be removed using an air brush.
- Do not use thinners or benzine.
- To secure safety for operation and maintenance, install the product apart from high-voltage devices and power devices.

## **Communications with Upper Device (FH-5050)**

- After confirming that this product is started up, communicate with the high-order device. During start-up, an indefinite signal may be output to the high-order interface. To avoid this problem, clear the receiving buffer of your device at initial operations.

## **Failsafe Measures (FH-5050)**

- Be sure to take fail-safe measures externally when controlling stages and robots by using the measurement results of the Sensor Controller (axis movement output by calibration and alignment measurement).
- On a Sensor Controller side, supplementary use operations and branches of the Sensor Controller to configure a check flow such as “data should not be externally provide if the data is in a range from -XXXXX to XXXXX” based on the stage/robots range of movement.

## **Connecting the Sensor Controller and Monitor with a Switcher and Splitter**

- Do not use devices that may require re-recognition of the monitor by the Sensor Controller when a switching operation was performed. If such re-recognition processing happens at switching operation, it may cause measurement time to be longer.

## **Installation Location (FH-SMDA-GS050B)**

In order to prevent the product from becoming inoperable or malfunction, and to prevent other adverse effects to the performance or equipment, please observe the following.

- A location where the ambient temperature does not exceed the rated range.
- A location where the temperature does not vary sharply (condensation occurs).
- A location where relative temperature does not exceed a range of 35-85%.
- A location not exposed to corrosive gases or combustible gases.
- A location not exposed to dust, salt, or metal powder.
- A location not exposed to direct vibration or impact.
- A location not exposed to strong disturbance light (laser light, arc welding light, or ultraviolet light).
- A location not near a heating appliance or exposed to direct sunlight.
- A location not exposed to mist of water, oil, or chemicals or misty atmosphere.
- A location not exposed to strong magnetic/electric fields.
- A location not near a high-voltage device or power device

## **Power Supply, Connection, and Wiring (FH-SMDA-GS050B)**

- If using a commercially available switching regulator, earth the frame ground terminal.
- If the power supply line has surge, connect a surge absorber according to the operational environment to use the product.
- After wiring the cables, confirm if the power supply is appropriate, if there is miswiring such as short-circuit of load, or if the load current is appropriate. Otherwise, the product may be broken due to miswiring etc.
- Do not put load on the cables and connectors before wiring them.
- Turn on the power of the 3D Vision Sensor at the same time as or before turning on the power of the FH sensor controller.
- When turning OFF the power, confirm that data have been saved completely before starting operations.
  - When data are saved by operating the 3D vision sensor, the saving process must have been completed and the following user operations must be possible.
  - When data are saved using communication commands, processing of the applicable commands must have been completed and the busy state is OFF.
- Attach the cable straight with the terminal correctly aligned. Forcibly attaching the cable may bend the terminal, resulting in failure or communication error.
- Insulate the unused signal lines of the I/O cable so that the signal lines do not come into contact with other signal lines.

## **Maintenance (FH-SMDA-GS050B)**

- Turn OFF the power and confirm safety before starting maintenance.
- Remove dirt on the window using the special cloth for lens or an air brush.
- Do not use thinner, alcohol, benzene, acetone, or kerosene to clean his product.

## **Optical axis (FH-SMDA-GS050B)**

- The field of view may vary product by product. When mounting this product, be sure to confirm video using the sensor controller.

## **Image Sensor (FH-SMDA-GS050B)**

- For this product, a line may appear depending on the measurement condition or sensitivity because of the specification of the image sensor.

However, this is not a fault or failure of the product. In addition, although there may be multiple defective pixels, this is not a fault or failure of the product. Use the product as confirming the actual image.

## **Failsafe Measures (FH-SMDA-GS050B)**

- When operating the robot by using the vision sensor measurement results, be sure to check the measurement result data on the robot side and take fail-safe measures, such as operating the robot only after confirming that the data is within the robot's range of motion.

## **Warm-up (FH-SMDA-GS050B)**

- The correct brightness and focus may not be achieved or may fluctuate until the product function is stabilized (approximately 15 minutes) after power-on. Check the WARM UP indicator LED or the warm-up completion flag in the camera image input processing item on the FH software before using the product.

## **Camera Installation (FH-SMDA-GS050B)**

- In an environment exposed to high humidity and sharp temperature fluctuation, the window may become cloudy in rare cases.

## **Connection and Operation with the Robot (FH-SMDA-GS050B)**

- For an example design of a robot program to build an application, see the sample program (fhsample\_main()) of the Robot Connection Guide.
- For the processing to move the robot to the imaging position, refer to the Robot Connection Guide.
- If you proceed to the next step before registering the workpiece reference position, the robot may operate unintentionally. Be sure to register the start position.
- If you proceed to the next step before registering the robot's picking and holding position, the robot may operate unintentionally. Be sure to register the start position.

## LED Safety (FH-SMDA-GS050B)

This product is classified into the following risk groups by IEC62471.

LED safety	Display
Risk group 2	

## Camera Calibration Target (FH-XCAL-S)

- Do not use thinner, alcohol, benzene, acetone, or kerosene to clean his product.
- Before calibrating the camera, make a backup of the AOS camera information file.
- After calibrating the camera, check the results to confirm that the calibration was successful. When an abnormal AOS camera information file is read, the measurement error increases and the wrong coordinate position is output.
- When disposing of this product, treat it as industrial waste and never heat or incinerate it at 100 °C or higher.

## HandEye Calibration Target (FH-XCAL-R)

- Do not use thinner, alcohol, benzene, acetone, or kerosene to clean his product.
- When disposing of this product, treat it as industrial waste and never heat or incinerate it at 100 °C or higher.

# Regulations and Standards

## FH-5050

### Using Product Outside Japan

---

If you export (or provide a non-resident with) this product or a part of this product that falls under the category of goods (or technologies) specified by the Foreign Exchange and Foreign Trade Control Law as those which require permission or approval for export, you must obtain permission or approval or service transaction permission) pursuant to the law.

### U.S. California Notice:

---

This product contains a lithium battery for which the following notice applies: Perchlorate Material - special handling may apply.

See "[www.dtsc.ca.gov/hazardouswaste/perchlorate](http://www.dtsc.ca.gov/hazardouswaste/perchlorate)".

### Conformance to KC Standards

---

Observe the following precaution if you use this product in Korea.

사 용 자 안 내 문

이 기기는 업무용 환경에서 사용할 목적으로 적합성평가를 받은 기기로서

가정용 환경에서 사용하는 경우 전파간섭의 우려가 있습니다.

- Guidance for users

This product meets the electromagnetic compatibility requirements for business use. There is a risk of radio interference when this product is used in home.

### WEEE Directive

---



Dispose of in accordance with WEEE Directive

### Conformance to EC/EU Directives and UK Legislation

---

The product is compliant with the standards below:

- EC Directive 2004/108/EC (Until April 19 2016) / EU Directive 2014/30/EU (After April 20 2016) / UK legislation 2016 No 1091 Electromagnetic Compatibility Regulations 2016 EN61326-1 Electromagnetic environment: Industrial electromagnetic environment (EN/IEC 61326-1 Table 2)

- Also, the following condition is applied to the immunity test of this product.
  - If the level of disturbance of the video is such that characters on the monitor are readable, the test is a pass.
- This product complies with EC/EU Directives. EMC-related performance of the OMRON devices that comply with EC/EU Directives will vary depending on the configuration, wiring, and other conditions of the equipment or control panel on which the OMRON devices are installed.
- The customer must, therefore, perform the final check to confirm that devices and the overall machine conform to EMC standards.
- If there is a need to respond to the EC/EU directive and UK legislations, please use by an analog RGB output.

## Conformance to UL Standards

---

This product complies with UL Standards.

- UL61010-2-201

## FH-SMDA-GS050B

## Using Product Outside Japan

---

If you export (or provide a non-resident with) this product or a part of this product that falls under the category of goods (or technologies) specified by the Foreign Exchange and Foreign Trade Control Law as those which require permission or approval for export, you must obtain permission or approval or service transaction permission) pursuant to the law.

## Conformance to KC Standards

---

Observe the following precaution if you use this product in Korea.

사 용 자 안 내 문

이 기기는 업무용 환경에서 사용할 목적으로 적합성평가를 받은 기기로서  
가정용 환경에서 사용하는 경우 전파간섭의 우려가 있습니다.

- Guidance for users

This product meets the electromagnetic compatibility requirements for business use. There is a risk of radio interference when this product is used in home.

## Conformance to EU Directives and UK Legislation

---

The product is compliant with the standards below:

- EU Directive 2014/30/EU/UK legislation 2016 No 1091 Electromagnetic Compatibility Regulations 2016 EN61326-1 Electromagnetic environment: Industrial electromagnetic environment (EN/IEC 61326-1 Table 2)

- This product complies with EC/EU Directives. EMC-related performance of the OMRON devices that comply with EC/EU Directives will vary depending on the configuration, wiring, and other conditions of the equipment or control panel on which the OMRON devices are installed.
- The customer must, therefore, perform the final check to confirm that devices and the overall machine conform to EMC standards.

# Related Manuals

The followings are the manuals related to this manual. Use these manuals for reference.

Name of Manual	Cat. No.	Model	Purpose	Contents
Vision System FH Instruction Sheet	3615791-1	FH-2□□□ FH-2□□□-□□ FH-5□□□ FH-5□□□-□□	To confirm the safety and usage precautions of the Vision System FH series Sensor Controller.	Describes the definitions of basic terms, meaning of signal words, and precautions for correct use of FH series in the manual.
3D Vision Sensor FH-SMDA Instruction Sheet	3290410-0	FH-SMDA-GS050B	To confirm the safety and usage precautions of the 3D Vision Sensor FH-SMDA.	Describes the definitions of basic terms, the meaning of signal words, and precautions for correct use of 3D Vision Sensor FH-SMDA in the manual.
FH Application Software FH-UM3D1 Instruction Sheet	5665477-6	FH-UM3D1	To confirm the safety and usage precautions of the FH Application Software FH-UM3D1. When User want to know about the hardware specifications or to setup the FH Application Software FH-UM3D1.	Describes the definitions of basic terms, product specifications, how to use, meaning of signal words, and precautions for correct use of FH Application Software FH-UM3D1 in the manual.
Vision System FH series 3D Robot Vision Application Construction Guide	Z446	FH-5050 FH-SMDA-GS050B	When User want to know about the FH series 3D robot vision system.	Describes the soft functions, setup, and operations to use FH series 3D robot vision system.
Vision System FH series Hardware Setup Manual for 3D Robot Vision	Z436		When User want to know about the Hardware specifications or to setup the Sensor Controller of the FH series 3D robot vision system.	Describes FH series 3D robot vision system specifications, dimensions, part names, I/O information, installation information, and wiring information.
Vision System FH series Processing Item Function Reference Manual for 3D Robot Vision	Z445		When User confirm the details of each processing items at the create the measurement flow or operate it.	Describes the software functions, settings, and operations for using FH series 3D robot vision system.
Vision Sensor FH Series 3D Robot Vision AOS Camera Calibration Operation Guide	Z451		When User calibrate 3D vision sensor itself.	Describes 3D vision sensor AOS camera calibration operation by using camera calibration target.
Vision System FH/FHV series Robot Connection Guide OMRON TM Series Edition	Z447		When connecting FH series 3D robot vision system to the robot	Describes communication settings and sample programs for picking applications that connect FH series 3D robot vision system to the robot.
Vision System FH/FHV series Robot Connection Guide OMRON Viper Series Edition	Z448			



Vision System FH/FHV series Robot Connection Guide FANUC Corporation Edition	Z449			
Vision System FH/FHV series Robot Connection Guide DENSO WAVE INCORPORATED Edition	Z458			
Vision System FH/FHV series Robot Connection Guide ABB Corporation Edition	Z459			
Vision System FH/FHV series Robot Connection Guide YASKAWA Corporation Edition	Z460			
Vision System FH/FHV series Robot Connection Guide UNIVERSAL ROBOTS Edition	Z463			
Vision System FH/FHV series Robot Connection Guide NACHI-FUJIKOSHI Corporation Edition	Z464			
Vision System FH/FHV Series User's Manual	Z365	FH-2□□□ FH-2□□□-□□ FH-5□□□	When User want to know about the FH/FHV series.	Describes the soft functions, setup, and operations to use FH/FHV series.
Vision System FH/FHV series Processing Item Function Reference Manual	Z341	FH-5□□□-□□ FH-L□□□-□□ FH-L□□□ FHV7□-□□□□□-□□□-□□	When User confirm the details of each processing items at the create the measurement flow or operate it.	Describes the software functions, settings, and operations for using FH/FHV series.
Vision System FH/FHV Series User's manual for Communications Settings	Z342		When User confirm the setting of communication functions.	Describes the functions, settings, and communications methods for communication between FH/FHV series and PLCs. The following communications protocol are described. Parallel, PLC Link, EtherNet/IP, EtherCAT, and Non-procedure.
Vision System FH series Macro Customize Functions Programming Manual	Z367	FH-2□□□ FH-2□□□-□□ FH-5□□□ FH-5□□□-□□ FH-L□□□ FH-L□□□-□□	When User operate or programming using Macro Customize functions.	Describes the functions, settings, and operations for using Macro Customize function of the FH series.

# Revision History

A manual revision code appears as a suffix to the catalog number on the front and back covers of the manual.

<b>Cat. No.</b>	<b>Z436-E1-05</b>
-----------------	-------------------

↑ Revision code

Rev. Code	Rev. Date	Revision Contents
01	Feb. 2021	Original product
02	Jun. 2021	Corrected mistakes.
03	Jan. 2022	Added to "Related Manuals".
04	Sep. 2022	Revisions for adding safety precautions regarding security. Added to "Related Manuals".
05	Feb. 2023	Revisions for update "Precautions for Safe Use", "Precautions for Correct Use", "Regulations and Standards", "Related Manuals". Revisions for update camera cables model. Added FZ-MEM16G

# 1. Overview

## 1.1. Overview

This document describes procedures for settings required for constructing 3D robot vision applications by connecting the Vision Sensor FH (hereafter referred to as Vision Sensor) to the robot controller.

Utilizing this document and the “Vision System FH/FHV series Robot Connection Guide” listed in the “Related Manuals” at startup, you can reduce the man-hours required to connect the Vision Sensor to your robot controller, set the Vision Sensor, and create robot programs.

Robot Vision applications described in this document are as follows.

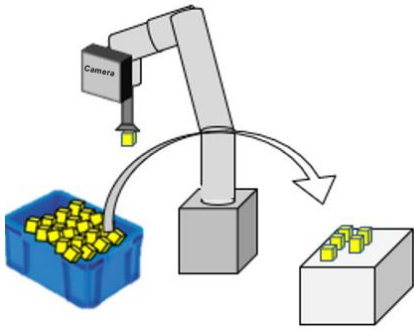
Application	Description
Picking application with on-hand camera	<p>Robot vision system with a camera mounted on the robot arm. The robot can pick and place randomly placed workpieces.</p>  <p>The diagram illustrates a robot arm with a camera mounted on its end effector. The camera is labeled 'Camera'. The robot arm is positioned over a blue bin filled with yellow workpieces. An arrow points from the bin to the robot arm, indicating the picking action. Another arrow points from the robot arm to a white surface where the workpieces are being placed, indicating the placing action.</p>

## 1.2. Target Audience

The target reader for this document are persons responsible for developing 3D Robot Vision Applications by connecting a vision sensor and a robot controller. Additionally, the reader needs to have the capability to operate and program robots.

### 1.3. Work Flow

---

Please follow the flow below for constructing robot vision applications.

For the robot settings, please refer to the *Vision System FH/FHV series Robot Connection Guide* listed in the *Related Manuals* according to the robot to be connected.

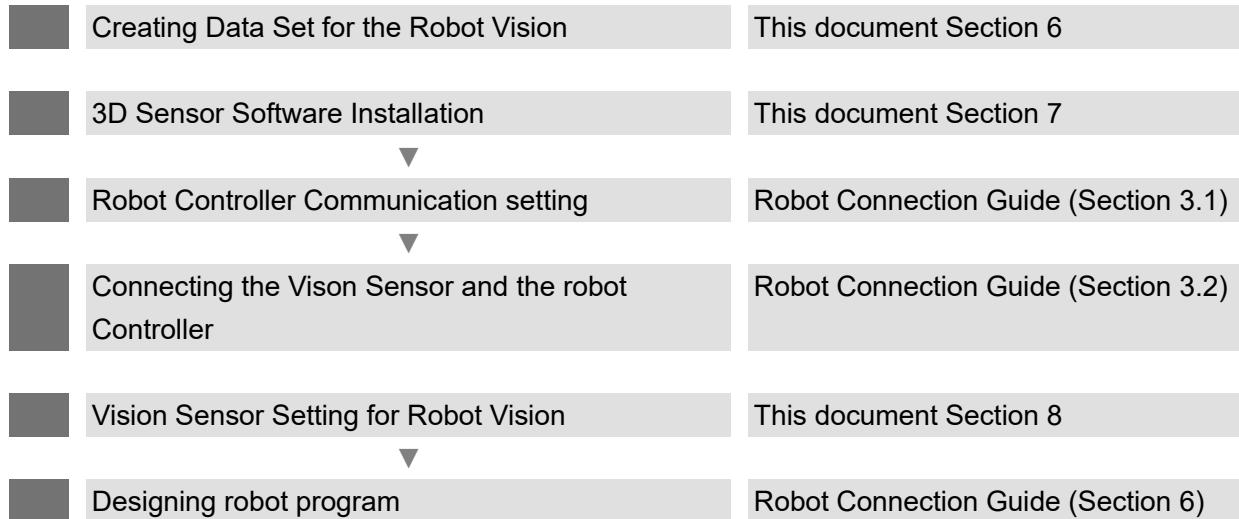

## 2. System Configuration

This section describes the system configuration and target devices to construct robot vision applications. Please refer to the *Vision System FH/FHV series Robot Connection Guide* listed in the *Related Manuals* for detail system configuration for each robot system.

### 2.1. System Configuration

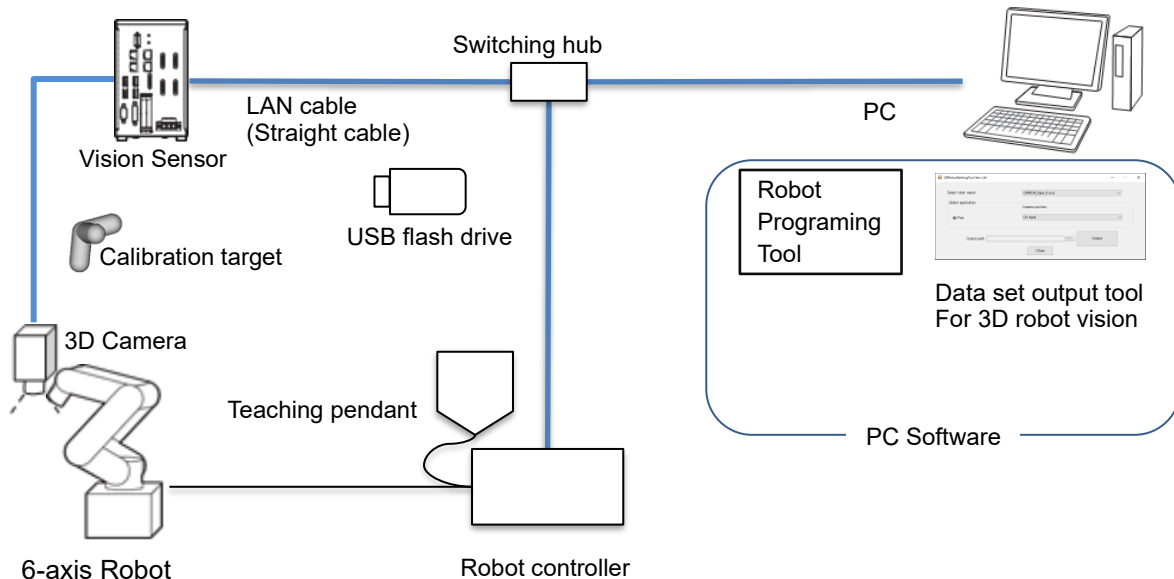

### 2.2. Applicable Devices

The following is a list of target devices.

For details on robot-related items, refer to the *Vision System FH/FHV series Robot Connection Guide* (hereinafter also referred to as the *Robot Connection Guide*) corresponding to each robot listed in the *Related Manuals* pages.

Device name	Manufacture	Name	Model	Remarks
Vision Sensor	OMRON	Vision Sensor FH Series	FH-5050	Ver. 6.40 or higher Controllers other than the FH-5050 are not supported.
3D Camera	OMRON	3D vision sensor	FH-SMDA-GS050B	---
Camera cable	OMRON	Ethernet cable super bending resistance	FHV-VNBX2□M FHV-VNLBX2□M	---
Camera I/O cable	OMRON	I/O cable super bending resistance	FH-VSDX-BX□M FH-VSDX-LBX□M	---

Calibration target	OMRON	Handeye Calibration Target	FH-XCAL-R	---
		Camera Calibration Target	FH-XCAL-S	---
3D software	OMRON	3D Robot Vision Software Installer	FH-UM3D1	3D robot vision application and 3D camera driver
Robot controller	OMRON	collaborative robot TM5-700	RT6-0□□70□□	For details, refer to the <i>Robot Connection Guide</i> listed in <i>Related Manuals</i> .
		TM5-900	RT6-0□□90□□	
		Vertical multi-joint robot Viper 650	1720□-36000 1720□-36020 1720□-36010	For details, refer to the <i>Robot Connection Guide</i> listed in <i>Related Manuals</i> .
	Viper 850	1720□-38000 1720□-38020 1720□-38010		
	FANUC Corp.	Vertical multi-joint robot LR Mate 200iD/4S	R-30iB Mate	For details, refer to the <i>Robot Connection Guide</i> listed in <i>Related Manuals</i> .
PC software	OMRON	Data set output tool for 3D robot vision	---	Ver.1.0.0 You can download it from the purchaser limited service. Please contact our branch or sales office.
	OMRON	Robot programming environment	---	Refer to the <i>Robot Connection Guide</i> for each robot.
	FANUC Corp.	Robot programming environment	---	Refer to the <i>Robot Connection Guide</i> for each robot.
Switching hub	OMRON	Industrial switching hub	W4S1-□□□	Recommended product
USB flash drive	OMRON	USB flash drive	FZ-MEM16G	Recommended product



### **Precautions for Correct Use**

---

---

**Do not use any device except those mentioned above for each device of the system configuration.**

---

---



### **Additional Information**

---

This document does not cover operations, installation, and wiring methods for each device. For details, refer to manuals noted in *Reference Manual*.

---

## 3. Configuration of the Application

### 3.1. Specification of the Sensor

#### ●Specification

Refer to the section 3-2-1 in the *Vision System FH Series Hardware Setup Manual for 3D Robot Vision* (Cat. No. Z436).

#### ●Component Names and Functions

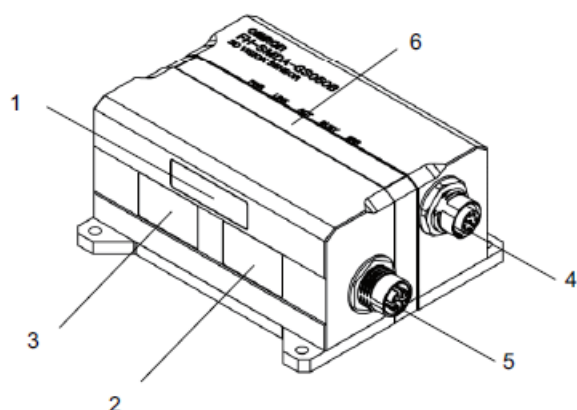

	Name	Description	
1	2D lighting unit	Lighting for 2D measurement is arranged to illuminate the light.	
2	3D lighting unit	Pattern lighting for 3D measurement is arranged to illuminate the light.	
3	Imaging unit	Captures images.	
4	Connector for camera I/O cable	Use this connector when connecting the camera with a power supply or an external device using a camera I/O cable. Dedicated camera I/O cable: FH-VSDX-BX / FH-VSDX-LBX)	
5	Connector for camera cable (Ethernet cable)	Use this connector when connecting the camera with a FH sensor controller using an camera cable (Ethernet cable). Dedicated camera cable (Ethernet cable): FHV-VNBX2 / FHV-VNLBX2)	
6	Operation indicator	PWR (Green)	Lights while power is supplied.
		LINK (Green)	Lights when connected with Ethernet equipment.
		ACT (Yellow)	Blinks while communicating with an Ethernet device.
		WARM UP (Yellow)	Lights from startup to completion of warming up. Turns off after warming up.
		ERR (Red)	Lights when an error occurs. For the error (system error), refer to the <i>Camera Image Input AOS</i> in the <i>Vision System FH series Processing Item Function Reference Manual for 3D Robot Vision</i> (Cat. No. Z445).



## ●Measurement Range and Field of View

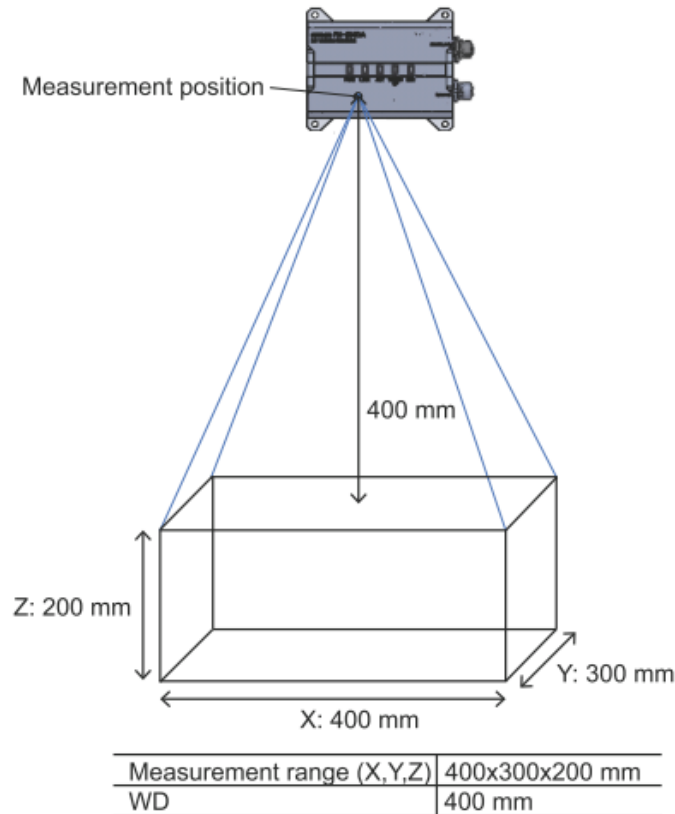

## ●Dimensions

Refer to the section 3-2-1 in the *Vision System FH Series Hardware Setup Manual for 3D Robot Vision* (Cat. No. Z436).

### 3.2. Workpiece

Use the following information as a guide to determine whether a part is measurable. Note that this guide is not a guarantee. Test thoroughly to make sure that it is measurable.

Characteristics	Measurable	Unmeasurable
Surface characteristics	Matte to weak luster Pattern reflects moderately from all surface	Mirror surface, strong gloss, transparent, translucent Pattern is completely reflected or absorbed
Surface shape	Narrowest width of the surface is more than 10 mm Shapes on which pattern light does not break or warp	Holes and steep unevenness, dominant width is less than 10 mm. Pattern light is interrupted
Exterior size	Dimensions $\geq 40 \times 40$ mm Thickness $\geq 5$ mm Area and height required to obtain sufficient 3D features for recognition	Dimensions $< 40 \times 40$ mm Thickness $< 5$ mm Surface area and height for which 3D features required for recognition cannot be obtained

### 3.3. Container

Examples of containers that are supported or not supported by the 3D robot vision software are shown below.

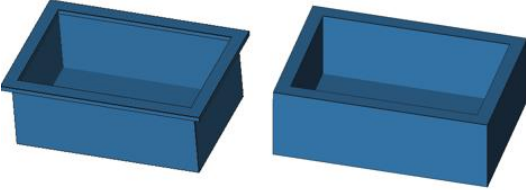
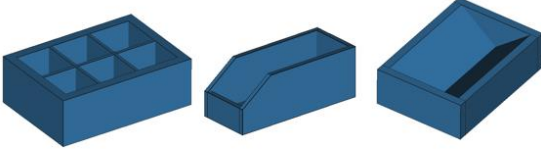
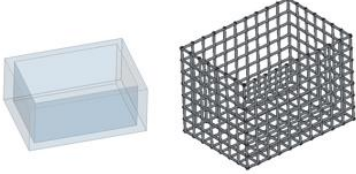
	Container shape examples	Conditions
Supported	Box container 	Edge thickness: 10 mm or more Maximum size: Approx. 400 × 300 mm Size that fits in the field of view of the 3D Vision Sensor Minimum size: Edge width: 10 mm or more Container inner dimensions: 10 × 10 mm or more Container color: Colors that can be detected by 2D search
Not supported	Partitioned    Part rack    Mortar-shaped 	Container shapes with internal partitions or gradients cannot be registered. For information on whether you can customize the software to support these shapes, please contact your sales representative.
	Transparent or translucent    Mesh rack 	Container shapes as seen from directly above the opening or with colors that cannot be detected by 2D search are not supported.

### 3.4. Supported Robots

Refer to the *Robot Connection Guides* in “Related Manuals”. For connection to other robots, please contact your sales representative.

## 4. Equipment Installation Overview

### 4.1. Mounting

---

Attach the camera to the 6th axis of the 6-axis articulated robot using a jig. Refer to the section 5-5-2 in the *Vision System FH Series Hardware Setup Manual for 3D Robot Vision* (Cat. No. Z436).

### 4.2. Wiring

---

Wire the signal line of the camera I/O cable (FH-VSDX-BX / FH-VSDX-LBX: sold separately) with a crimp terminal. Insulate unnecessary signal lines and avoid contact with other signal lines. Refer to the section 5-5-2 in the *Vision System FH Series Hardware Setup Manual for 3D Robot Vision* (Cat. No. Z436).

### 4.3. Connecting

---

Connect the camera cable (Ethernet cable FHV-VNBX2 / FHV-VNLBX2: sold separately) to the Ethernet connector on the 3D vision sensor. Then connect it to the top of the two Ethernet connectors on the sensor controller. Refer to the section 5-5-2 in the *Vision System FH Series Hardware Setup Manual for 3D Robot Vision* (Cat. No. Z436).

### 4.4. Camera Cable Mounting

---

To prevent the cables from being caught in the rotating robot, connect them with a sufficient clearance, taking into account the minimum bending radius.

To prevent the connectors from interfering with the robot, adjust the rotation angle of the robot.

Refer to the section 5-5-2 in the *Vision System FH Series Hardware Setup Manual for 3D Robot Vision* (Cat. No. Z436).

### 4.5. Start and Stop Sequence

---

Turn ON the power of the 3D Vision Sensor at the same time as or before you turn ON the power of the FH Controller. If the FH Controller starts up first, it will not be able to communicate with the 3D Vision Sensor.

Also, because scene data is large, confirm that saving of the data is completed before you turn OFF the Controller.

## 5. Startup Procedure

This section describes the work flow, preconditions, and what can be achieved by Startup Procedures in each section.

### 5.1. Preconditions

---

The following conditions shall be satisfied.

- The installation, wiring, and operation verification for each device have been finished.
- Warmup of 3D vision sensor is completed.
- Robot is operated in the robot base coordinate and no tool offset is set.



#### Additional Information

---

- This document does not provide operations, installation, and wiring methods for each device. For details, refer to manuals noted in *Related Manuals*.
  - As a guide, the warmup time of the 3D Vision Sensor is about 15 minutes after power ON. For details, refer to *Precautions for Correct Use* in the following manual. *Vision System FH series Hardware Setup Manual for 3D Robot Vision* (Cat. No. Z436)
  - For the setup of the robot, refer to the *Vision System FH/FHV series Robot Connection Guide* for the robot to connect.
-

## 5.2. What You Can Do by This Startup Procedure

### 5.2.1. 3D Robot Vision Software Installation

Factory default Vision Sensor doesn't have software for 3D measurement. Please follow the procedure in section 7 to install a 3D Software and camera driver to the Vision Sensor.

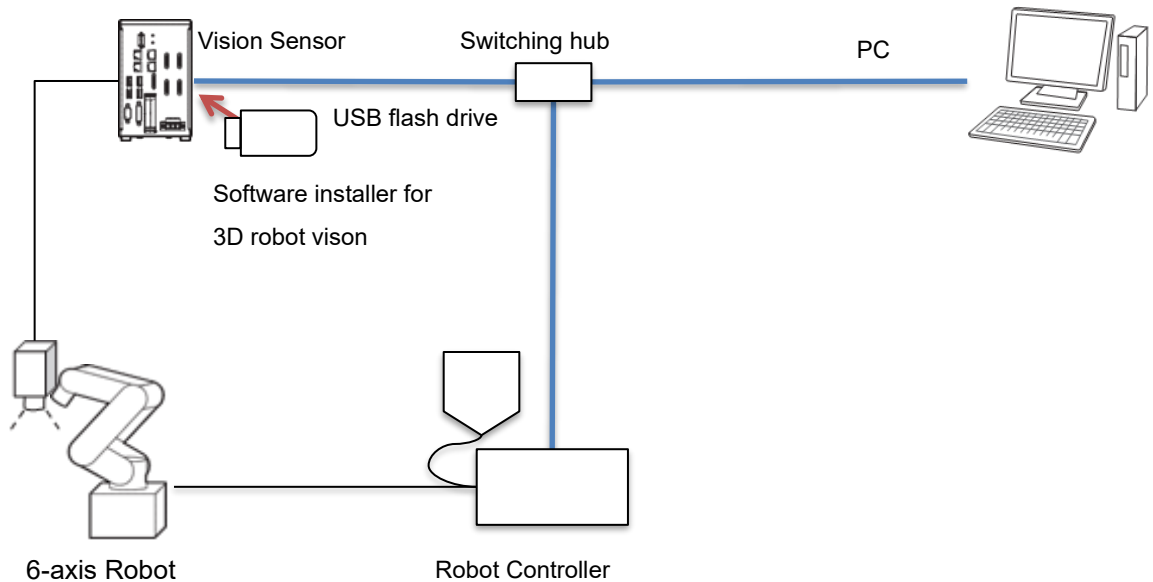

### 5.2.2. Connecting the Vision Sensor to the Robot Controller

The procedures to load the sensor controller project data (including scene data) into the Vision Sensor and configure the network are described in the 7.2 and 7.3, respectively. For the setup and connection to the robot controller, refer to the *Vision System FH/FHV series Robot Connection Guide* for the robot to connect listed in the *Related Manuals* in this manual.

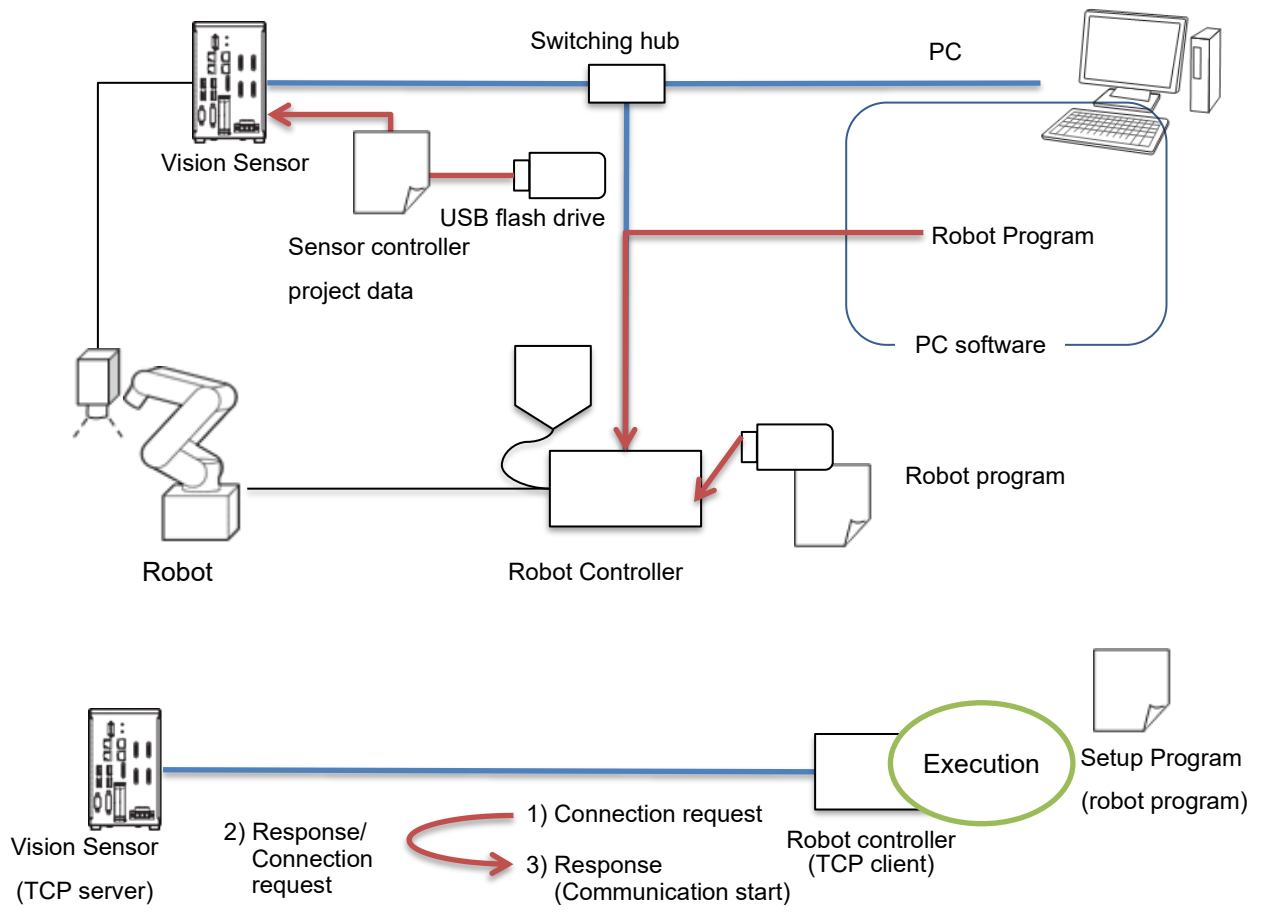

### 5.2.3. Setting Vision Sensor

When following the procedures in section 8 you can complete settings for the Vision Sensor required for applications that are calibration between camera and robot, and controlling the robot from the Vision Sensor's operation.

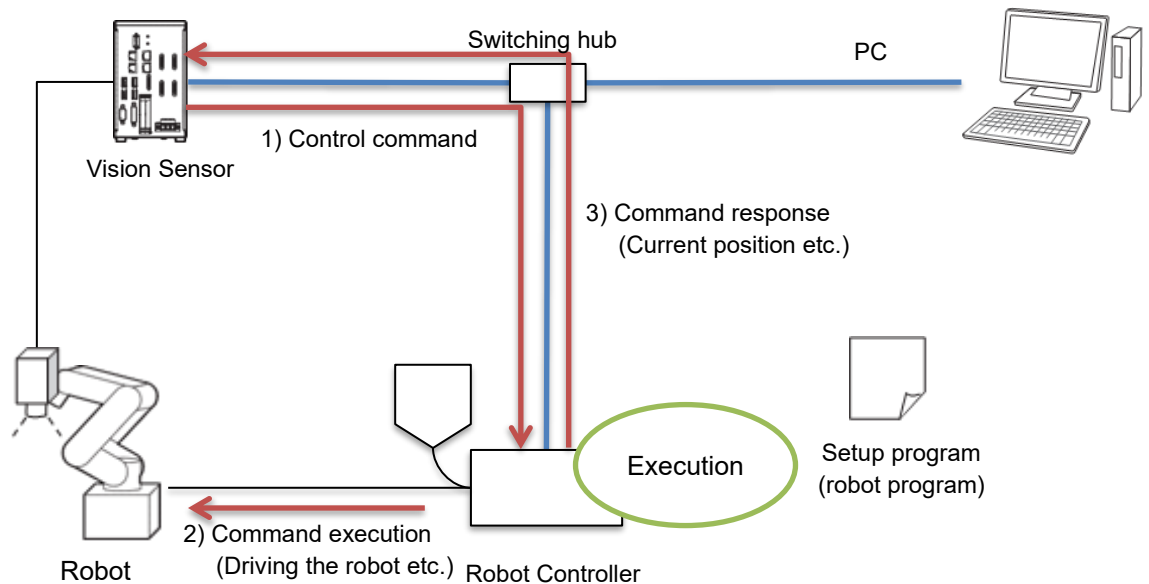

## 5.2.4. Designing Robot Program

The robot program implementation procedure for controlling the Vision sensor (changing scenes, executing measurement) is described in the section 6 of 'Vision System FH/FHV series Robot Connection Guide'.

Refer to the document corresponding to each robot.

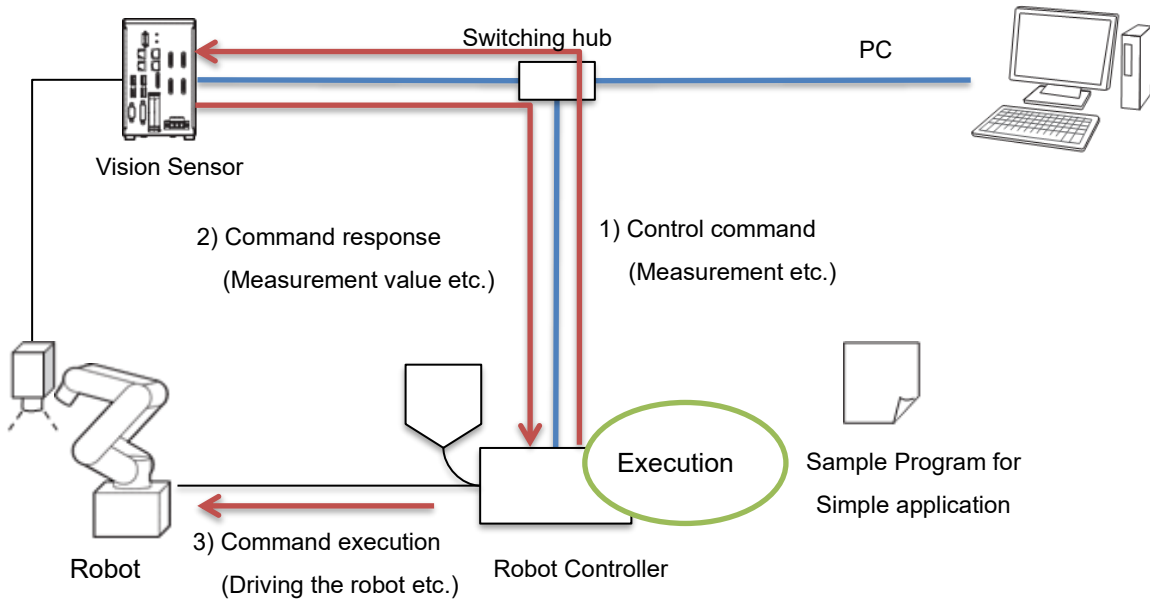

### Precautions for Correct Use

The implementation procedures for robot programs noted in the 'Vision System FH/FHV series Robot Connection Guide' are for reference only. You must design, implement, and test actual robot program operation based on the used environment and robot applications.



## 6. Creating Data Set for the Robot Vision

This section describes the work flow for creating a data for the vision sensor (sensor controller project data) and a robot program (sample program) for the robot controller.

### 6.1. Creating Data Sets

Use the Data set output tool for 3D robot vision to output the following data sets.

You will use the sensor controller project data that you create here in 7.2. For details on the scene data included in the sensor controller project, refer to 8.3.

For details on the robot program, refer to the *Vision System FH/FHV series Robot Connection Guide* corresponding to the robot listed in *Related Manuals* in this manual.

	Output data	Description
1	Sensor controller project data	Scene templates, communication command macros, user dialogs, etc., that are required to construct the 3D robot vision application
2	Robot program	Setup programs for setting up the application, sample programs for executing the application



Follow the steps below to create the data sets for robot vision.



#### Precautions for Correct Use

- The operating environment of the Data set output tool for 3D robot vision is Windows 10 64-bit.

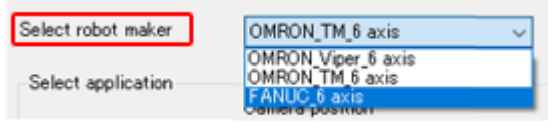
Step	Description	Window image, diagram
1	<p>Open the folder on your PC where the Data set output tool for 3D robot vision is stored.</p> <p>Launch the dataset output tool for 3D robot vision by double clicking RobotSettingTool.exe .</p>	

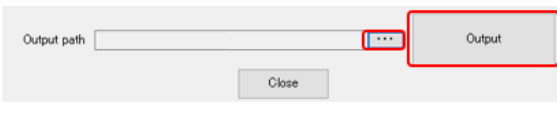
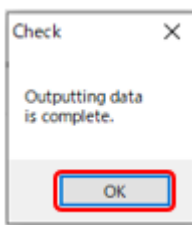
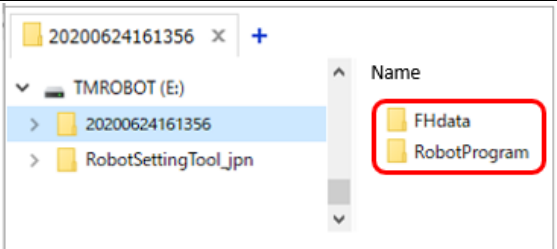
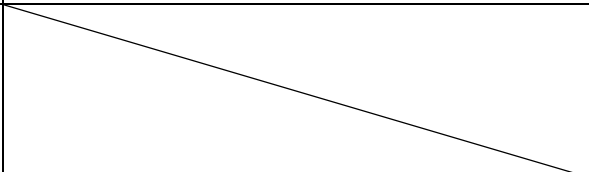
2	<p>Select a robot manufacturer to connect from the combo box.</p>	
<div style="background-color: black; color: white; padding: 10px; text-align: center;">  <h2 style="margin: 0;">Caution</h2> </div> <p>Select the actual robot to connect. Selecting a wrong robot causes the Vision Sensor to output incorrect command values to the connected robot, which may result in unexpected robot movement. Sensor controller projects that the tool outputs cannot be used commonly between different robots.</p>		
3	<p>Click [Output] after selecting the output path for the data set.</p>	
4	<p>Click [OK] when the “Check” Dialog is displayed after the data set was output.</p>	
5	<p>Check that a folder was created with a name of “year, month, day, hour, minute, and second” in the specified output path and there are “FHdata” and “RobotProgram” in it.</p> <p>The FHdata folder stores the sensor controller project files for 3D robot vision.</p> <p>The RobotProgram folder stores the robot program.</p>	
6	<p>Copy the folder that contains the output FHdata and RobotProgram to a USB flash drive or other media.</p>	

## 7. 3D Sensor Software Installation

This section describes procedures to install 3D Sensor Software to the Vision Sensor. Before installation, please disconnect the 3S sensor head from the Vision sensor.

Please follow the flow below for the installation.

7.1	Installing and Uninstalling the 3D Robot Vision Software	Installing the 3D Robot vision software that include 3D processing item functions and installing the camera driver for 3D Vision sensor.
7.2	Loading the Sensor Controller Project	Load the sensor controller project data which generated by the Data set output tool for robot vision.
7.3	Configuring the Network (Ethernet Communications)	Vision sensor network setting for connect it to the robot controller.

### 7.1. Installing and Uninstalling the 3D Robot Vision Software

This section describes the procedures for upgrading the software of the FH sensor controller with the FH-UM3D1.

Please perform the software version upgrade only after confirming the operating procedures and cautions. After upgrading, if you want to return to the previous version, use the Version upgrade tool (Ver. 6.11 or higher) and install the applicable FH sensor controller software.

For troubleshooting for Installing and Uninstalling, refer to 7.1.4.



#### Precautions for Correct Use

- Keep a backup of the scenes and other data created with older versions before you update the software. They may become unusable due to incompatibility.
- For how to back up the data, refer to *Backing up Sensor Controller setting data* in the following manual. *Vision System FH/FHV Series User's Manual* (Cat. No. Z365)



#### Precautions for Correct Use

- FH-UM3D1 can be used for version upgrade of one FH Sensor Controller.
- Keep the FH-UM3D1 device in a safe place as it will be needed when using again or repairing a controller.

- Do not make any modifications to the files or file structure of the FH-UM3D1. It may cause the device to no longer function correctly.

### 7.1.1. Applicable Devices and Device Configuration

The devices for which there is FH-UM3D1 support are as follows.

Manufacturer	Name	Model	Version
OMRON	FH sensor controller	FH-5050	Ver. 6.40 or higher

Connect each device as follows.

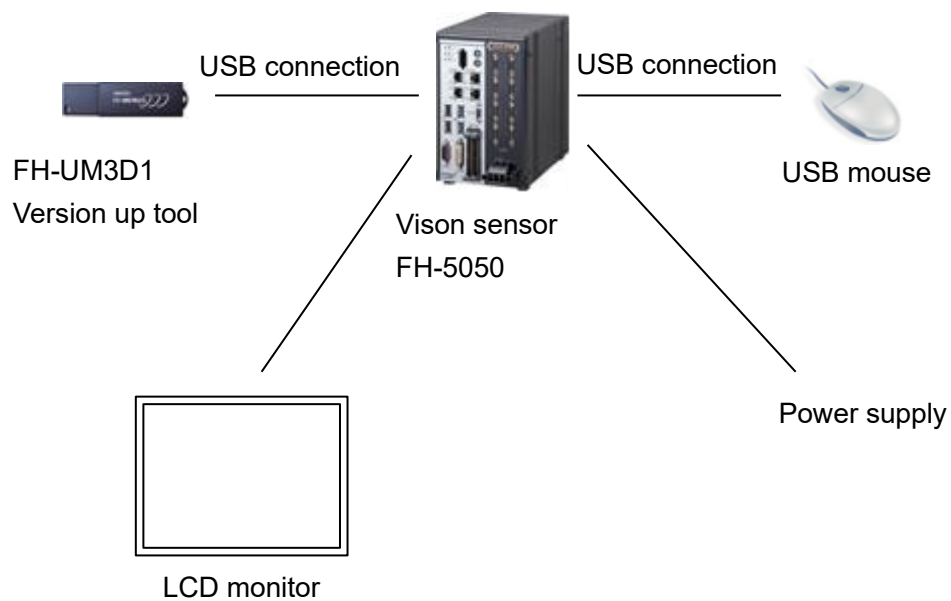

Manufacturer	Name	Model	Version
OMRON	FH-UMAI version up tool	FH-UM3D1	---
OMRON	Vision sensor	FH-5050	Ver. 6.40 or higher
---	USB mouse	---	---
---	LCD monitor	---	---
---	Power supply	---	---



#### Precautions for Correct Use

- Do not connect anything other than those included in the above configuration to the FH sensor controller during version upgrade. If a USB switch, etc. is connected, the FH sensor controller may not operate properly after the version upgrade.

- Do not insert any external storage device other than USB flash drive or SD card that contains the Version update tool software in the FH Sensor controller. The version upgrade may not be completed normally.

## 7.1.2. Software Installation





### Precautions for Correct Use

- Do not remove the FH-UM3D1 from the FH sensor controller during the version upgrade. It may cause the version upgrade to fail.
- Do not turn off the power to the FH Sensor Controller during the version upgrade. It may cause the version upgrade to fail.

Follow the steps below to install the software.

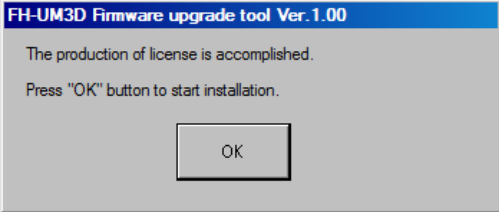
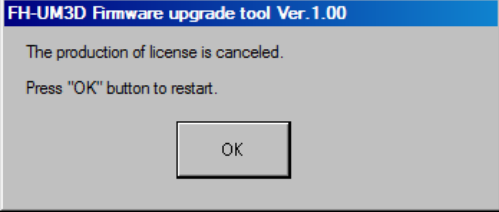
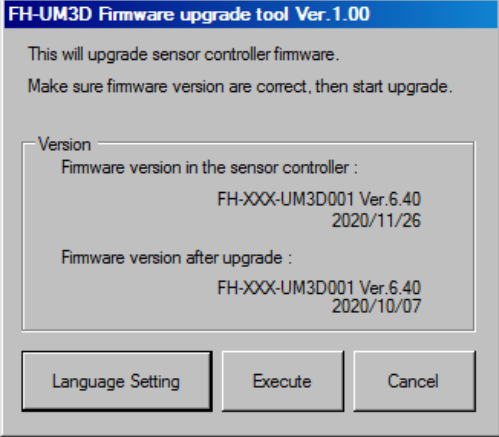
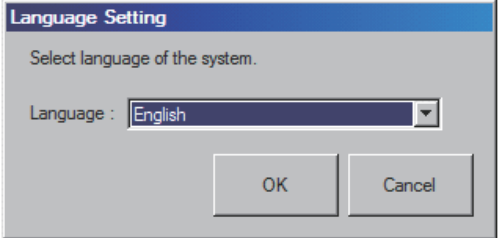
Step	Description	Window image, diagram
1	<p>Make sure the FH-UM3D1 is inserted in the FH Sensor Controller when it is started up.</p> <p>The <b>Language Setting</b> dialog will be displayed the first time the FH-UM3D1 is used.</p> <p>In the <b>Language Setting</b> dialog, select the language and click <b>OK</b>.</p>	
2	<p>If the license file has already been generated, the following dialog will be displayed. Click <b>OK</b>.</p> <p>If the license file has not already been generated, the following dialog will be displayed. Click <b>OK</b>.</p>	

	<p>The following dialog will be displayed. Click <b>OK</b>.</p> <p>If you click <b>Cancel</b>, the following dialog will be displayed. Click <b>OK</b>. The license file creation will be canceled and the FH Sensor Controller will be restarted.</p>	 
<p><b>3</b></p>	<p>The following dialog will be displayed. Click <b>Execute</b>. The Version upgrade will be started.</p> <p>If you click <b>Cancel</b>, the Version upgrade is cancelled and the FH Sensor Controller will be restarted.</p> <p>If you click <b>Language Setting</b>, the <b>Language Setting</b> dialog will open. Select your desired language and click <b>OK</b>. The dialog will change to the selected language. If you click <b>Cancel</b> it will revert to the previous language.</p>	 
<p><b>4</b></p>	<p>When upgrading, the FH sensor controller may restart more than once.</p> <p> <b>Precautions for Correct Use</b></p> <hr/> <p>Do not remove the FH-UM3D1 until the version upgrade is completely finished.</p> <hr/>	

- 5 If the following dialog appears, select **Install this driver software anyway**. If the dialog below does not appear, proceed to the next step.

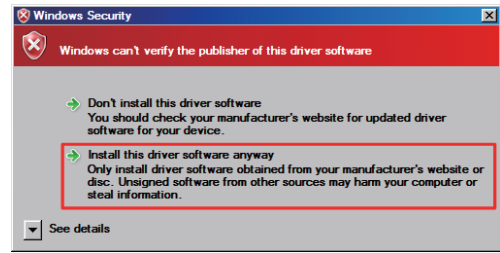

### Precautions for Correct Use

If you select **Don't install this driver software**, the process will proceed without updating the driver. If you mistakenly select this, the following dialog will appear. Click **OK** to display the same dialog screen will appear again during the process. In which case select **Install this driver software anyway**.

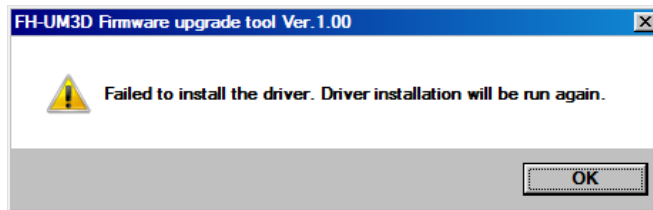



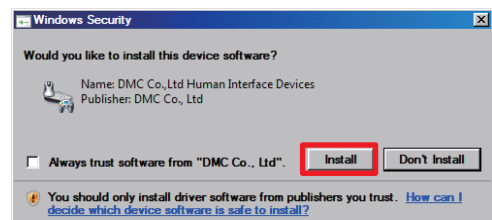
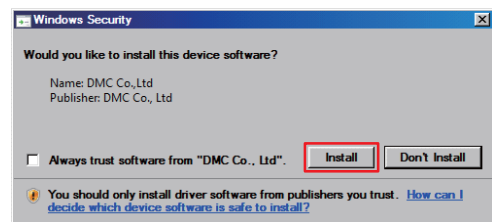

- 6 Depending on the configuration of the FH sensor controller, Touch panel drivers may also be installed. If the following dialog appears, select **Install**. If the dialog below does not appear, proceed to the next step.

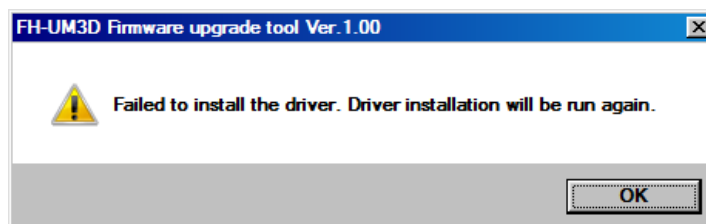

### Precautions for Correct Use

If you select **Don't install**, the process will proceed without updating the driver. If you mistakenly select this, the following dialog will appear several times. Click **OK**. After that, please proceed to step 9 and execute the version upgrade procedure again.

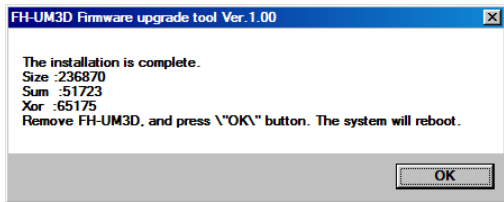

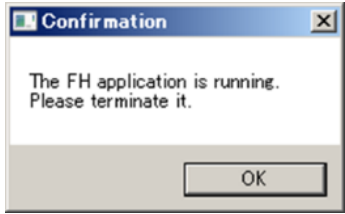
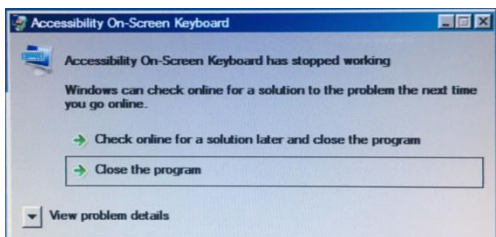
7	<p>When upgrading, the FH sensor controller may restart more than once.</p> <p> <b>Precautions for Correct Use</b></p> <hr/> <p>Do not remove the FH-UM3D1 until the version upgrade is completely finished.</p> <hr/>	
8	<p>The following dialog will appear. Remove the FH-UM3D1 from the FH sensor controller and click <b>OK</b>.</p>	
9	<p>The FH controller will restart.</p>	
10	<p>When the FH sensor controller starts, a dialog as shown on the right will appear to confirm that you are about to perform network configuration for the 3D Vision Sensor. Click <b>OK</b>.</p> <p>When you click <b>OK</b>, if the application software for the FH sensor controller is running, a dialog as shown on the right will appear to prompt you to close the FH application.</p> <p>In the FH application software, click <b>End</b> from the <b>File</b> menu to close the FH application software, and then click <b>OK</b> in the dialog.</p> <p> <b>Precautions for Correct Use</b></p> <hr/> <p>If other processing such as firmware update is running, wait until it completes before you close the FH application software.</p> <hr/> <p>When you close the FH sensor controller application software, the window keyboard may terminate abnormally. If the window keyboard terminates abnormally, there will be a delay in response to your mouse operation, along with an abnormal termination notification as shown on the right. Close the abnormal termination notification to recover from the symptom.</p>	  

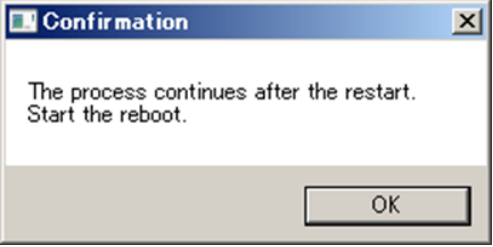
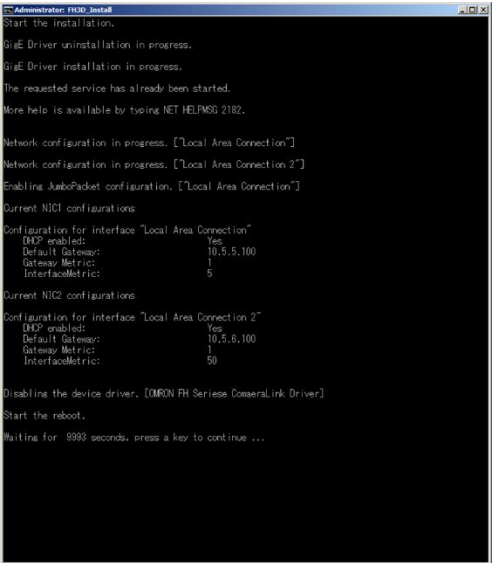

11	When a dialog as shown on the right appears to notify that you are about to restart the sensor controller, click <b>OK</b> .	 <p>A dialog box titled "Confirmation" with a close button (X) in the top right corner. The text inside reads: "The process continues after the restart. Start the reboot." At the bottom right, there is an "OK" button.</p>
12	A command prompt as shown on the right appears, which shows the progress of automatic camera driver installation and Ethernet communications configuration. When the processing is completed, the sensor controller will restart automatically.	 <p>A command prompt window titled "Administrator: CMD - Install" showing the progress of installation. The text includes: "Start the installation.", "GigE Driver uninstallation in progress.", "GigE Driver installation in progress.", "The requested service has already been started.", "More help is available by typing NET HELPMSG 2182.", "Network configuration in progress. [Local Area Connection]", "Network configuration in progress. [Local Area Connection 2]", "Enabling JumboPacket configuration. [Local Area Connection]", "Current NIC1 configurations", "Configuration for interface 'Local Area Connection'", "DHCP enabled: Yes", "Default Gateway: 10.5.5.100", "Gateway Metric: 1", "InterfaceMetric: 5", "Current NIC2 configurations", "Configuration for interface 'Local Area Connection 2'", "DHCP enabled: Yes", "Default Gateway: 10.5.6.100", "Gateway Metric: 1", "InterfaceMetric: 50", "Disable the device driver. [OMRON FH Seriese CameraLink Driver]", "Start the reboot.", "Waiting for 9993 seconds, press a key to continue ..."</p>



### Precautions for Correct Use

- Since this processing initializes the Ethernet communications settings, the FH sensor controller may fail to communicate with the 3D Vision Sensor after the restart. If it fails to communicate with the 3D Vision Sensor, restart the system again.
- Since this processing initializes the Ethernet communications settings, the FH sensor controller may not be able to communicate with external devices. If so, you need to reconfigure the Ethernet communications settings. For details on setting the conditions for Ethernet communications, refer to the *Vision System FH/FHV Series User's Manual for Communications Settings* (Cat. No. Z342).

If the dialog shown on the right is displayed for installation of the driver in the middle of step 12, select **Install**. If the following dialog does not appear, no operation is required.





### Precautions for Correct Use

---

- Select **Don't install** to proceed without updating the driver. If this is not the case, from the Windows start menu, select **OMRON – FH-UM3D1** and click **Reinstal** after restarting in step 12.
- 

This will complete the Version upgrade.

Connect the 3D vision sensor and restart FH Sensor Controller.

---

### 7.1.3. Software Uninstallation

This section describes the procedure to uninstall the 3D robot vision functions from the FH sensor controller and restore the standard FH sensor controller Ver. 6.4.0. Performing the uninstallation operation disables the dedicated processing items for the 3D Vision Sensor and 3D robot vision. To reinstall the 3D robot vision functions in this state, follow the version upgrade procedure again.



### Precautions for Correct Use

---

- Performing uninstallation disables the scene group data, scene data, and window layout that you have used. Before you perform uninstallation, back up the settings of the FH sensor controller. For how to back up the data, refer to *Backing up Sensor Controller setting data* in the following manual. *Vision System FH/FHV Series User's Manual* (Cat. No. Z365)
- 

- 1 From the Windows Start menu, select **OMRON - FH-UM3D1** and click **Uninstall**. A dialog as shown on the right appears to confirm that you are about to start uninstallation. Click **OK** to start uninstallation. Click **Cancel** to cancel the uninstallation and end the processing.

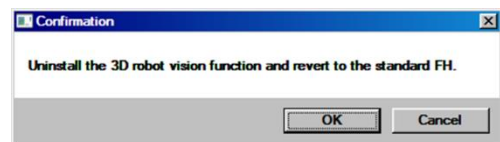

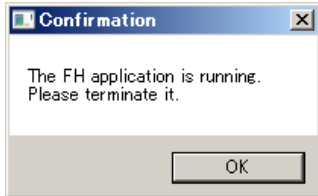
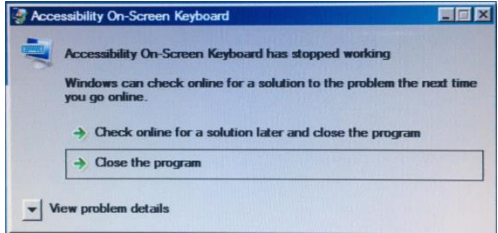
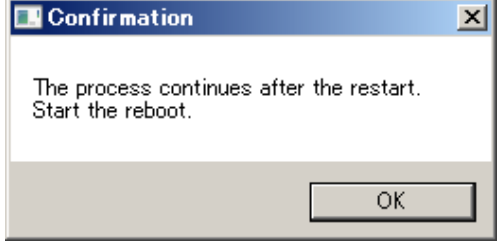
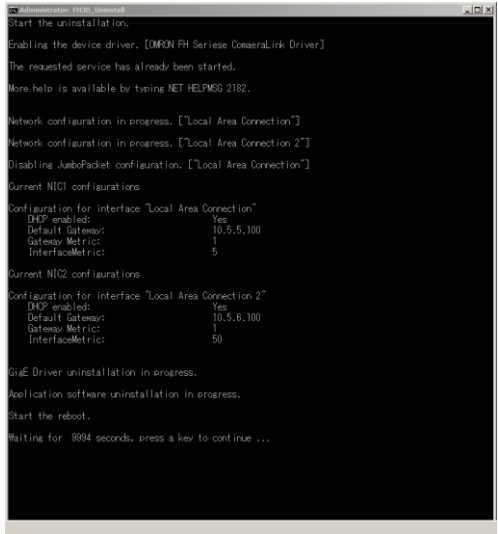
	<p>When you click <b>OK</b>, if the application software for the FH sensor controller is running, a dialog as shown on the right will appear to prompt you to close the FH application.</p> <p>In the FH application software, click <b>End</b> from the <b>File</b> menu to close the FH application software, and then click <b>OK</b> in the dialog.</p> <p>When you close the FH sensor controller application software, the window keyboard may terminate abnormally. If the window keyboard terminates abnormally, there will be a delay in response to your mouse operation, along with an abnormal termination notification as shown on the right. Close the abnormal termination notification to recover from the symptom.</p>	 
2	<p>When a dialog as shown on the right appears to notify that you are about to restart the sensor controller, click <b>OK</b>.</p>	
3	<p>A command prompt as shown on the right appears, which shows the progress of automatic uninstallation of the camera driver, deletion of dedicated processing items for 3D robot vision, installation of FH application software Ver. 6.40, etc. When the processing is completed, the sensor controller will restart automatically.</p> <p>This will complete the uninstallation.</p>	



## Precautions for Correct Use

- Performing uninstallation disables the scene group data, scene data, and window layout that you have used. After you perform uninstallation, initialize the settings of the FH sensor controller before use. For how to initialize the FH sensor controller, refer to *Initializing the Controller* in the following manual. *Vision System FH/FHV Series User's Manual* (Cat. No. Z365)

### 7.1.4. Troubleshooting

When this occurs	Possible cause	Corrective action
The Version upgrade tool does not start.	The files in the FH-UM3D1 may be corrupted. At startup, there may be a delay in recognizing FH-UM3D1, and the Version upgrade tool may have failed to load.	Perform the Version upgrade procedure again. If it does not start after the above actions, please contact us.
The FH controller does not restart.	A power failure may have occurred during installation, and the hardware of the FH Sensor Controller may be damaged.	Turn off the power of the FH sensor controller and restart it. If the above does not work, the file or hardware may be damaged. Please contact Omron.
	The files in the FH Sensor Controller may be corrupted. The version upgrade may have failed due to the insertion / extraction of FH-UM3D1.	Perform the Version upgrade procedure again. If the above does not work, the file or hardware may be damaged. Please contact Omron.
The camera or I/O do not work properly after the version upgrade.	Some files may not have been updated due to FH-UM3D1 insertion / removal while the FH sensor controller was restarting.	Perform the Version upgrade procedure again. If the above does not work, the file or hardware may be damaged. Please contact Omron.

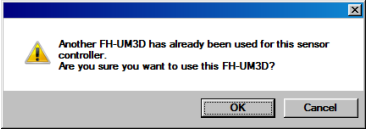
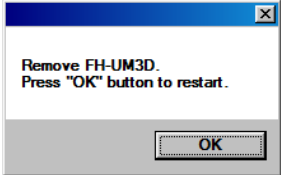
When this occurs	Possible cause	Corrective action
<p>After version upgrade, the FH sensor controller does not start normally.</p>	<p>You may have selected <b>Do not install</b> in the driver installation confirmation dialog during the version upgrade. Some files may not have gotten updated.</p> <p>It is possible that the power was turned off without pressing the <b>OK</b> button when the version upgrade complete message was displayed. Some files may not have gotten updated.</p> <p>There was a delay in recognizing the FH-UM3D1 while restarting the FH sensor controller, and some files may not have gotten updated.</p>	<p>Perform the Version upgrade procedure again.</p> <p>If the above does not work, the file or hardware may be damaged.</p> <p>Please contact Omron.</p>
<p>The following dialog is displayed.</p>  <p>(Another FH-UM3D has already been used for this sensor controller. Are you sure you want to use this FH-UM3D?)</p>	<p>If an FH-UM3D1 of the same format was previously used for the same FH sensor controller in the past.</p>	<p>To execute, click <b>OK</b>.</p> <p>To cancel, click <b>Cancel</b>.</p> <p>If you click <b>Cancel</b>, the following dialog is displayed.</p>  <p>(Remove the FH-UM3D1 and then click <b>OK</b>. The FH controller will restart.)</p>

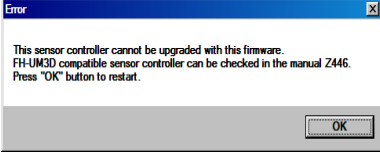
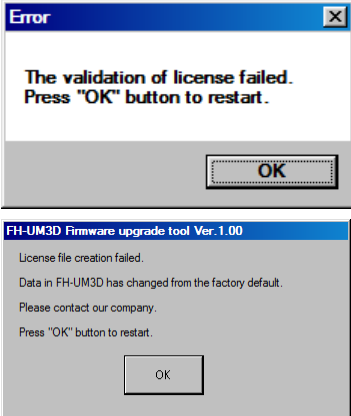
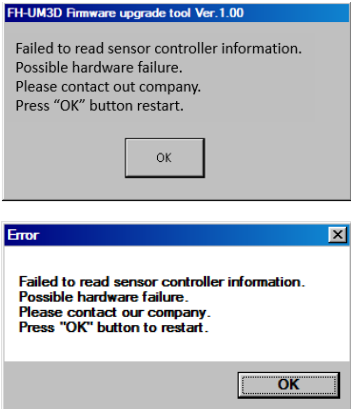

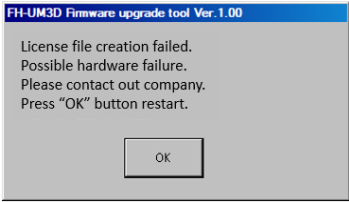
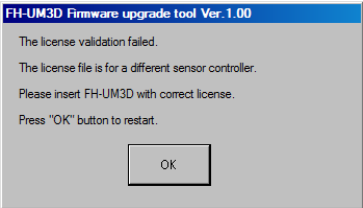
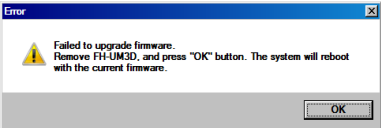
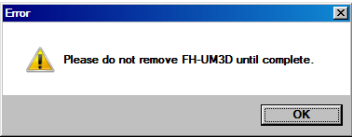
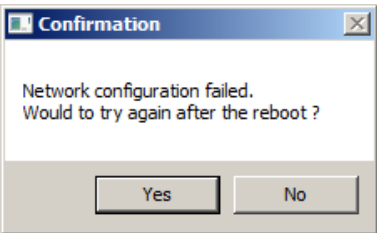

When this occurs	Possible cause	Corrective action
<p>The following dialog is displayed.</p>  <p>(This sensor controller cannot be upgraded with this firmware. FH-UM3D compatible sensor controller can be checked in the manual Z446. Press "OK" button to restart.)</p>	<p>If the FH-UM3D1 is executed on a non-supported FH sensor controller model, the dialog will be displayed.</p>	<p>Check that the device is a supported model and perform the version upgrade procedure again.</p>
<p>The following dialog is displayed.</p> 	<p>The file structure of FH-UM3D1 may be changed.</p>	<p>Please contact Omron.</p>
<p>The following dialog is displayed.</p> 	<p>If an error occurs in the controller, the dialog will be displayed.</p>	<p>Please contact Omron.</p>

When this occurs	Possible cause	Corrective action
<p>The following dialog is displayed.</p> 	<p>If an error occurs in FH-UM3D1, the dialog will be displayed.</p>	<p>Please contact Omron.</p>
<p>The following dialog is displayed.</p> 	<p>If you use a licensed FH-UM3D1 with an FH sensor controller that is different from the one used when the license was created, the dialog will be displayed.</p>	<p>Use FH-UM3D1 with the correct license file.</p>
<p>The following dialog is displayed.</p>  <p>(Failed to Update firmware. Remove FH-UM3D, and press “OK” button. The System will reboot with the current firmware)</p>	<p>If the version upgrade fails, the dialog will be displayed.</p>	<p>Perform the Version upgrade procedure again. If the dialog is displayed every time, please contact Omron.</p>
<p>The following dialog is displayed.</p>  <p>(Please do not remove FH-UM3D until complete)</p>	<p>If you remove the FH-UM3D1 while updating the driver, the dialog will be displayed.</p>	<p>Connect FH-UM3D1 again and press the <b>OK</b> button. The Version upgrade will continue.</p>
<p>The following dialog is displayed.</p> 	<p>If the Ethernet communications configuration fails, the following dialog will be displayed.</p>	<p>To start the configuration again from the beginning, click the <b>Yes</b> button. To leave the settings as they are, click the <b>No</b> button. Whichever you choose, the sensor controller will restart.</p>

## 7.2. Loading the Sensor Controller Project

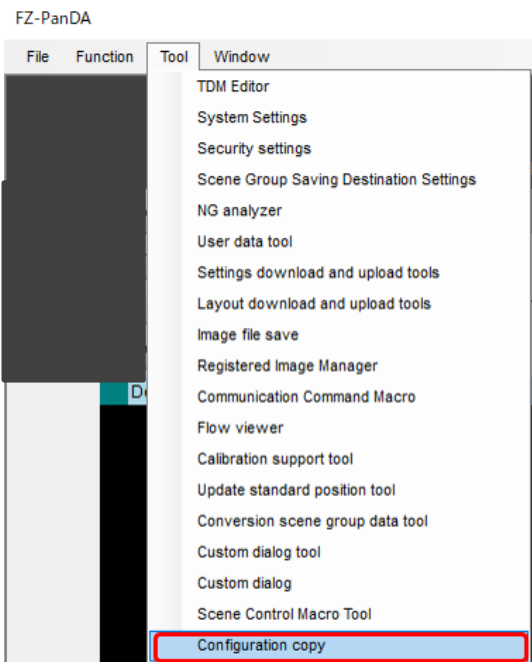
An application template that include scene data, environment variables and macros is loaded from the sensor controller project data. The sensor controller project data is being prepared separately according to each robot. Use a sensor controller project that matches the robot type.

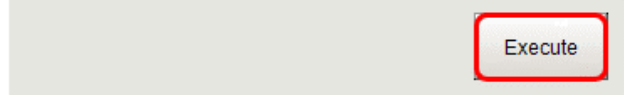
Please follow the procedures below to load the configuration data.

Step	Description	Window image, diagram
1	<p>Insert USB flash drive which stores the sensor controller project data into USB port. Select [Tool] - [Configuration copy] in the menu bar.</p>	 <p>The screenshot shows the 'FZ-PanDA' application window. The 'Tool' menu is open, displaying a list of options. The 'Configuration copy' option at the bottom of the list is highlighted with a red rectangular box.</p>
2	<p>Select "Select a sensor controller project" from the [Load] tab.</p> <p>Select the sensor controller project folder (FHdata) that create in section 6.1.</p>	 <p>The screenshot shows a dialog box titled 'Configuration copy'. It has two buttons: 'Save' and 'Load'. The 'Load' button is highlighted with a red rectangular box. Below the buttons is a text field labeled 'Select a sensor controller project' with a dropdown arrow on the right side.</p>
3	<p>Click <b>Execute</b> button to restart it.</p>	 <p>The screenshot shows a single button labeled 'Execute' with a red rectangular box around it.</p>
 <b>WARNING</b>		
<p>Please be sure to use the sensor controller project data appropriate for your robot.</p> <p>Mismatch of configuration file cause unexpected robot motion.</p>		



### 7.3. Configuring the Network (Ethernet Communications)

The IP address of Vision sensor and 3D sensor head is as shown below.

Please connect 3D vision sensor to Ethernet1.

Then, connect the robot controller and other communication equipment to Ethernet2. For how to check the network settings of the robot controller and the connection with the FH sensor controller, refer to the *Vision System FH/FHV series Robot Connection Guide* for each robot listed in the *Related Manuals* in this manual. You can set any IP address for the FH sensor controller Ethernet2.



	IP Address	Net mask	Connect to
Vision Sensor Ethernet1	10.5.5.100	255.255.255.0	3D Sensor head
Vision Sensor Ethernet2	10.5.6.100	255.255.255.0	Other equipment
3D Vision Sensor	10.5.5.XXX (auto assigned )	255.255.255.0	Vision Sensor Ethernet1



#### Precautions for Correct Use

- Do not change the settings of the FH sensor controller Ethernet1 as it prevents communications with the 3D Vision Sensor. If you change the communication settings by mistake and find that the sensor controller is not communicating with the 3D Vision Sensor, restore the default settings above.
- Set the settings in section 3 of *Vision System FH/FHV series Robot Connection Guide* using the above examples of IP addresses.
- Change the IP address and subnet mask settings of the FH sensor controllers Ethernet1 and Ethernet2 as necessary so that they have different IP addresses. Setting the same IP address may prevent the sensor controllers from communicating correctly.

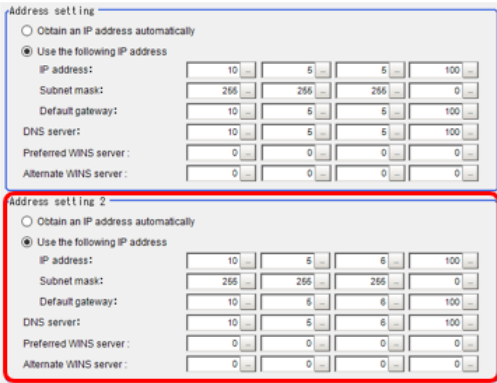
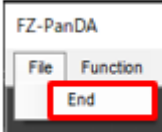
Setting only the IP address of the FH sensor controller Ethernet2 in the System settings (**Tools - System settings - Communications**) does not reflect the change in the system. To have it reflected in the system, perform the following procedure. If the IP address of Ethernet2 is changed, be sure to follow the procedure below. For details on setting the conditions for Ethernet communications, refer to the *Vision System FH/FHV Series User's Manual* (Cat. No. Z365).

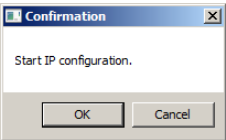
Step	Description	Window image, diagram
1	<p>Configure the Communications Module settings of the FH sensor controller. For details, refer to the following information.</p> <p><i>2-5 Non-procedure Communications in Vision System FH/FHV Series User's Manual for Communications Settings (Cat. No. Z342)</i></p>	
2	<p>Set the communication specifications of the FH sensor controller for communications with external devices. Configure the settings in <b>Address setting 2</b> only.</p> <p>After setting, click <b>Data Save</b> button of Vision Sensor Main window.</p>	
3	<p>Close the FH application software. In the FH application software, click <b>End</b> from the <b>File</b> menu.</p>	
4	<p>Have the Ethernet communications settings that you configured in the FH sensor controller reflected in the system. From the Windows Start menu, select <b>OMRON - FH-UM3D1</b> and click <b>NICconfig</b>. A dialog as shown on the right appears to confirm that you are about to start IP address setting.</p> <p>Click <b>OK</b> to start the IP setting. Click <b>Cancel</b> to cancel the IP setting and end the processing.</p> <p> <b>Precautions for Correct Use</b></p> <p>If you cancel the IP setting, the Ethernet communications settings will not be reflected in the system. Start again from Step 4.</p>	

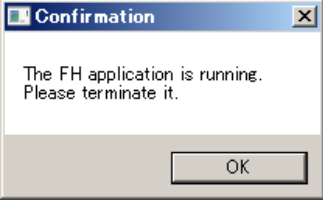
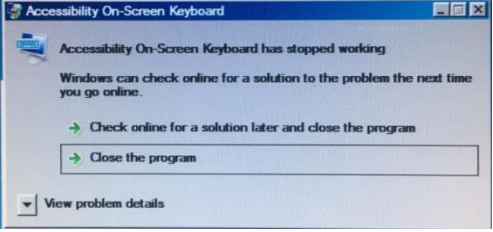
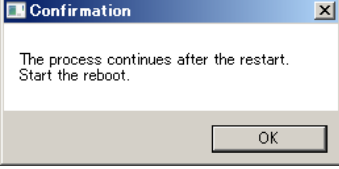
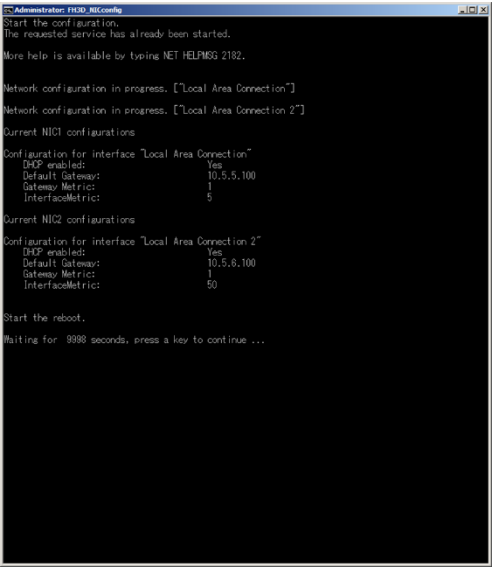
	<p>When you click <b>OK</b>, if the application software for the FH sensor controller is running, a dialog as shown on the right will appear to prompt you to close the FH application.</p> <p>In the FH application software, click <b>End</b> from the <b>File</b> menu to close the FH application software, and then click <b>OK</b> in the dialog.</p> <p>When you close the FH sensor controller application software, the window keyboard may terminate abnormally. If the window keyboard terminates abnormally, there will be a delay in response to your mouse operation, along with an abnormal termination notification as shown on the right. Close the abnormal termination notification to recover from the symptom.</p>	 <p>The FH application is running. Please terminate it.</p> <p>OK</p>  <p>Accessibility On-Screen Keyboard has stopped working</p> <p>Windows can check online for a solution to the problem the next time you go online.</p> <p>→ Check online for a solution later and close the program</p> <p>→ Close the program</p> <p>View problem details</p>
5	<p>When a dialog as shown on the right appears to notify that you are about to restart the sensor controller, click <b>OK</b>.</p>	 <p>The process continues after the restart. Start the reboot.</p> <p>OK</p>
6	<p>A command prompt as shown below appears, which shows the progress of automatic configuration of the Ethernet communications settings. When the processing is completed, the sensor controller will restart automatically.</p> <p>The Ethernet communications settings are now reflected in the system.</p>	 <pre> Administrator: CMD - Microsoft Windows [Version 6.0.6002.18000] Start the configuration. The requested service has already been started. More help is available by typing NET_HELPING 2182.  Network configuration in progress. ["Local Area Connection"] Network configuration in progress. ["Local Area Connection 2"]  Current NIC1 configurations Configuration for interface "Local Area Connection"   DHCP enabled: Yes   Default Gateway: 10.5.5.100   Gateway Metric: 1   InterfaceMetric: 5  Current NIC2 configurations Configuration for interface "Local Area Connection 2"   DHCP enabled: Yes   Default Gateway: 10.5.5.100   Gateway Metric: 1   InterfaceMetric: 50  Start the reboot. Waiting for 9998 seconds, press a key to continue ... </pre>

If the network configuration fails, the following dialog will be displayed.

To start the configuration again from the beginning, click the **Yes** button.

To leave the settings as they are, click the **No** button.

Whichever you choose, the FH sensor controller will restart.

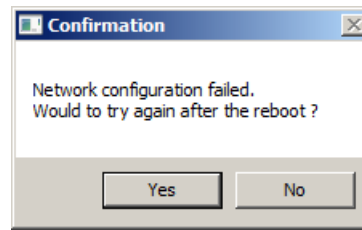

After completing the configuration, follow the instructions in the *Vision System FH/FHV Series User's manual for Communications Settings* (Cat. No. Z342) to check the communications status.

## 8. Vision Sensor Setting for Robot Vision

This section describes the setting procedures for the Vision Sensor required for constructing robot vision applications.

### 8.1. Overview

---

The settings for the Vision Sensor use a special data set for robot vision applications. By loading the sensor controller project according to the procedures in section 6, scene group data and user dialog data are loaded. Thereby, you can start the setting without designing a measurement flow from scratch. Additionally, the Vision Sensor user dialogs equip robot controlling functions such as jog operation and auto-calibration. It contributes to reduce man-hour of constructing an application.



#### **Precautions for Correct Use**

---

This section covers the operation to output the grasp points of the detected workpieces in the robot coordinate system. It does not cover the path control (path plan) of the robot, and the grasp error control, placement position recognition, and placement position control of the grasped workpieces.

---

## 8.2. Coordinate Systems and Angle Types

This section describes the coordinate system and angle representation used in the processing items to set the sensor settings.

### 1) Robot coordinate system

This coordinate system deals with the coordinates of the robot. The terms used in the robot coordinate system are shown in the table and figure below.

Coordinate system name	Description
Robot base coordinate system	Origin is based on the robot base.
Local coordinate system	User defined coordinate system
Flange coordinate system	Origin is based on the robot flange center.
Tool coordinate system	Origin is based on the end effector or tool that attached on robot flange.
Camera coordinate system	Origin is based on cameras optical center.

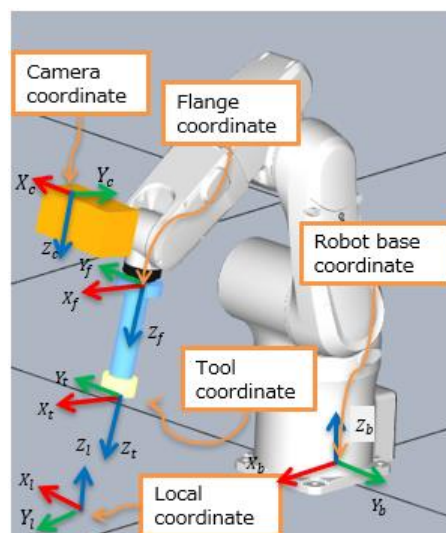

For each coordinate system, the orientation of each axis differs depending on the robot manufacturer and axis configuration. For the detailed definition of the coordinate systems, please refer to the manual for your robot.

## 2) Camera coordinate system

The coordinate system used by the 3D Vision Sensor. The center of the left-side window of the 3D Vision Sensor is the origin of the camera coordinate system. On the display, X represents the direction toward the right side; Y represents the direction toward the lower side; and Z represents the direction from the front to the back of the paper.

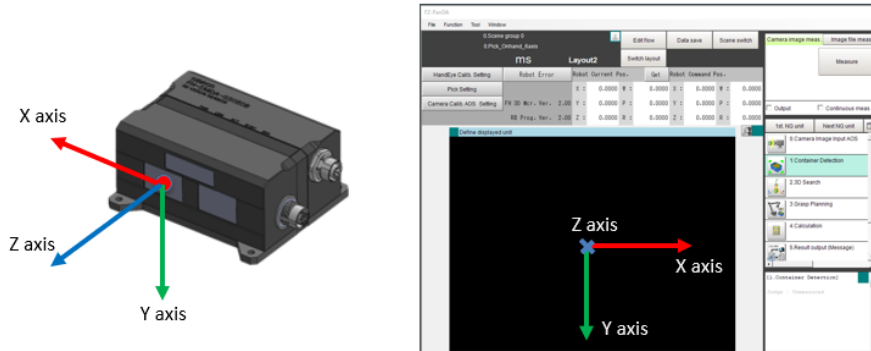

## 3) CAD coordinate system

The coordinate system of CAD data. It has the origin and directions set in the CAD software, which are defined in individual CAD data. The center of gravity of the CAD data is not necessarily the origin.

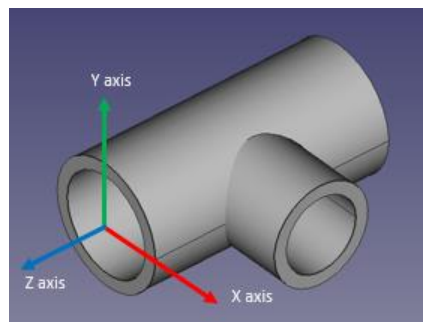

## 4) Latitude and Longitude

The registration range of a 3D Search model can be specified as latitude range and Longitude range. When a model is displayed in the window, the directions of the latitude range and longitude range are defined as shown below.

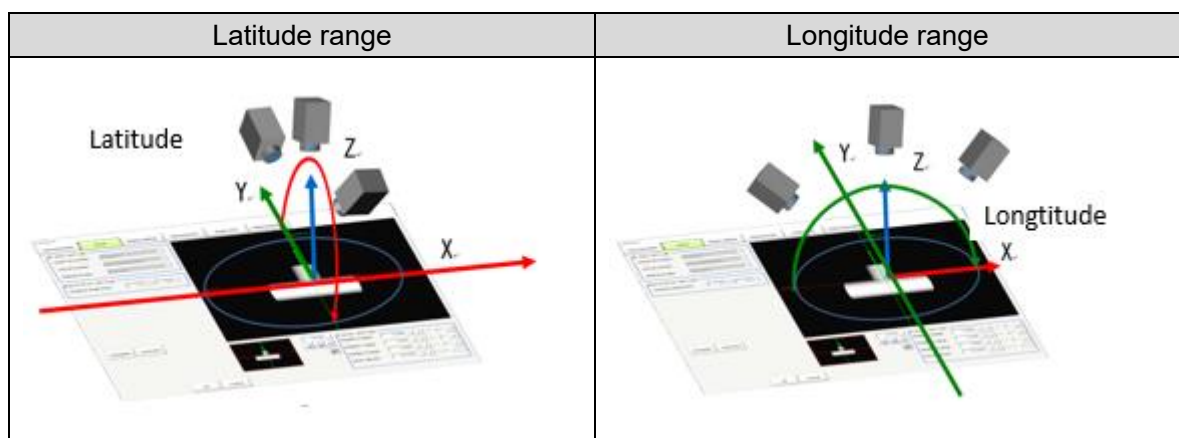

### 8.3. Scene Data Configuration

Scene data is assigned to fixed scene per application. When setting it, switch scenes with reference to the following.

No.	Scene name	Description
0	Place_Onhand_6axis	Perform Pick application.
:	:	
125	Calibration _Place_Onhand_6axis_XXX (XXX: Identifier of robot type)	Perform hand-eye calibration.
126	3D_Data_Manager	Register workpiece CAD data, hand(gripper) model data and grasp point data. The registered data will be referenced by other scenes in the same scene group.
127	Camera Calibration AOS	This scene is used to calibrate the camera (3D Vision Sensor) using a dedicated calibration plate.



#### Precautions for Correct Use

When you make new scene data for new workpiece or new hand-eye calibration condition, please copy scene No.0 or scene No.125 by using [Function]-> [Scene maintenance]. These two scenes use internal variables to link processing items to enable communications with the robot. If you individually add or delete the processing items, they will not operate properly.



#### 1) No.0 Pick\_Onhand\_6axis

This scene is for the Picking application.





This scene consist of image input(3D), container detection, work pieces search(3D Search), finding grasp point of work piece and output to the robot.

An output of this scene is sent to the robot and the robot moves to the grasp point.

Copy this scene to adding the new scene for new kind of workpiece.

No.	Processing Unit	Function
0	 0.Camera Image Input AOS	Capture an image from 3D camera and reconstruct 3D data (depth map). It also obtains 2D image (gray scale).
1	 1.Container Detection	Register the container size (setting mode) and detect the container (run mode).







2	 2.3D Search	Searches the work piece in depth image and outputs its 3D coordinate values (X,Y,Z,RX,RY,RZ) in camera coordinate system.
3	 3.Grasp Planning	Selecting preferable grasp point (no conflict with container) from searched wok piece. Output grasp point(X,Y,Z,RX,RY,RZ) in robot coordinate.
4	 4.Calculation	This unit is used for reflecting total judge of the flow. There is no need to set/modify this unit.
5	 5.Result output (Message)	Transmitting the grasp point3D coordinate values (X,Y,Z,RX,RY,RZ) to the robot.
6	 6.Robot Info. Log	Log the coordinates of the robot to scene variables to be used for trouble analysis.

2) No.125 Calibtartio\_Pick\_Onhand\_6axis\_XXX



This scene is intended to use for the hand-eye calibration between the robot and the Vision sensor. The HandEye calibration unit calculates the hand-eye calibration parameters. The camera coordinate system is converted in the robot coordinate system by using the hand-eye calibration parameters.

To set several different calibration conditions, make copies of this scene.

No.	Processing Unit	Function
0	 0.Camera Image Input AOS	Capture an image from 3D camera and reconstruct 3D data (depth image). It also obtains 2D image (gray scale).
1	 1.Robot Data	Select a robot type to be connected to the Vision sensor. The information set in this unit is referenced form other units (HandEye Calibration, Container detection unit).
2	 2.3D Search	Searches a location and posture of the calibration target object in 3D space.
3	 3.HandEye Calibration	Calculate the hand-eye calibration parameter with results of 3D Search and robot points and postures. The hand-eye calibration parameters are referenced from the container detection unit

3) No.127 3D\_Data\_Manager

This scene is used to register/manage the work pieces CAD data, grippers (end effector) data and grasp points of the work pieces. The 3D Data Manager unit is referenced from processing units (3D Search, Grasp Planning) In another scene in same scene group. It is possible to manage all workpiece data, gripper data and grasp point data belongs to same scene group in one 3D Data Manager unit.

No.	Processing Unit	Function
0	 0.Camera Image Input AOS	Dummy unit. There is no need for setting this unit in this scene.
1	 1.3D Data Manager	<ol style="list-style-type: none"> <li>1) Load the work piece CAD data from file and register the CAD data.</li> <li>2) Register shape of the gripper (end effector)</li> <li>3) Register the grasp points of the work pieces.</li> </ol>

4) No.127 Camera Calibration AOS

This scene is used to correct the geometric parameters of the 3D vision camera (FH-SMDA-GS050B) depending on changes over time or temperature changes. For details, refer to the *Vision System FH Series AOS Camera Calibration Operation Guide* (Cat. No. Z451) listed in *Related Manuals* in this manual.

## 8.4. User Dialogs

The main window of the Vision Sensor has buttons to launch user dialogs to assist the user to configure settings. Layout 2, which is the default window displayed when you load a sensor controller project for 3D robot vision as described in 7.2, has buttons to start configuration wizards for novice users; Layout 0 has buttons to start configuration without using wizards for experienced users. You can also display the buttons of Layout 0 from the wizard that you start from Layout 2.

For how to switch between the layouts, refer to *Arranging Windows [Layout Functions]* in the *Vision System FH/FHV Series User's Manual* (Cat. No. Z365) listed in *Related Manuals* in this manual.

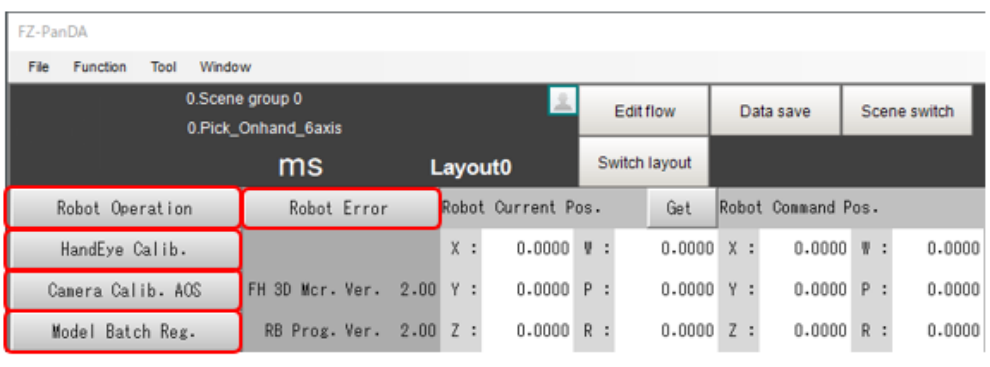
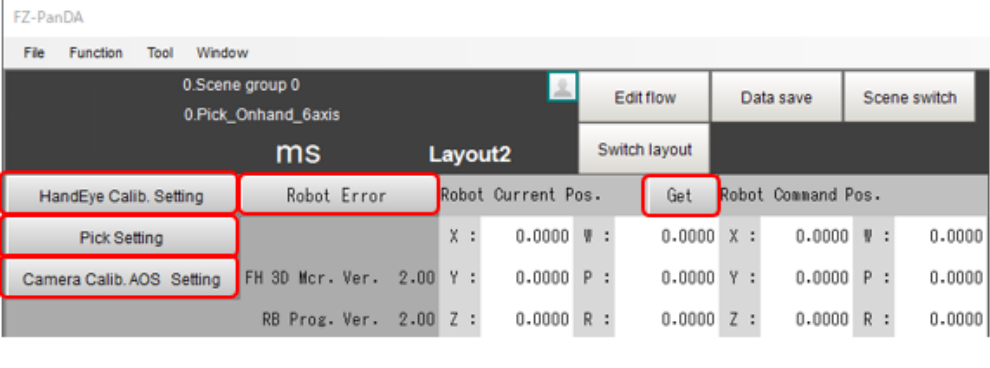
Layout	Main window image
1	
2	 <p data-bbox="571 1451 1287 1487" style="text-align: center;">Default window after loading the sensor controller project</p>

### 8.4.1. Layout 0 Window

The main window of the Vision Sensor has buttons to launch user dialogs as shown in the figure below. This section describes buttons that are displayed in the Layout 0 window.

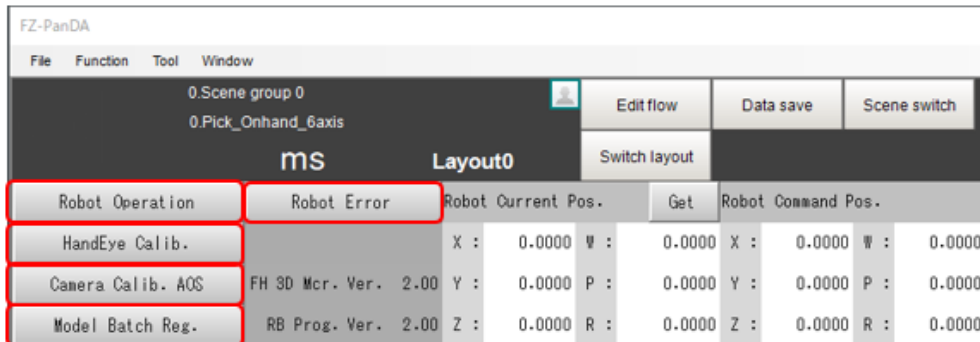

Dialog name	Description
Robot Operation	Sets the jog operation, target position movement, operation speed, etc.
HandEye Calib.	Execute the hand-eye calibration (Calibrates a camera and the robot) automatically with operations of the Vision Sensor. The functions and settings of the dialog are described in 8.7.
Camera Calib AOS	You can operate the Vision Sensor to automatically execute the geometric correction of the 3D Vision Sensor. For details on the functions of the dialog, refer to the <i>Vision System FH Series AOS Camera Calibration Operation Guide</i> (Cat. No. Z451).
Model Batch Reg.	You can execute or cancel the batch registration of the 3D Search processing item. Use this dialog when you back up or restore scene data.
Get	When the Vision Sensor can communicate with the robot, you can click the <b>Get</b> button to obtain the current position of the robot. The obtained results are displayed in the <b>Current Robot Pos.</b> column. They are displayed in the X, Y, Z, W, P, and R cells. However, the indication of W, P, and R changes depending on the <b>Representation of pose</b> setting of the connected robot. When <b>Representation of pose</b> is set to ZYX system: W → RX, P → RY, R → RZ When <b>Representation of pose</b> is set to ZYZ system: W → RZ, P → RY, R → RZ
Robot Error	If an error occurs in the connected robot, or in communications between robots, this button turns red. Detailed information of an error displayed. Please refer to section 9.2 for detail.



## Precautions for Correct Use

- If a robot error occurs, selecting **Clear** from the **Function** menu does not clear the error indication. The error will be cleared when the Vision Sensor successfully communicates with the robot that caused the error, after normal robot status or communications status is recovered.

### Robot Operation

Terms used in this dialog are defined as follows.

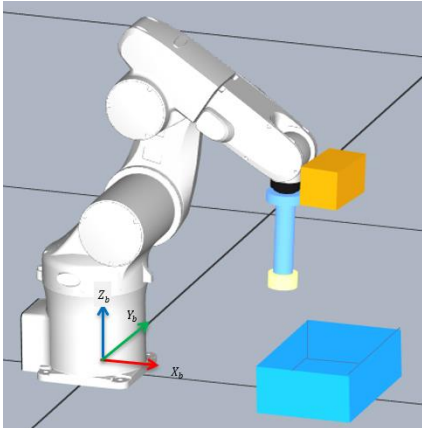
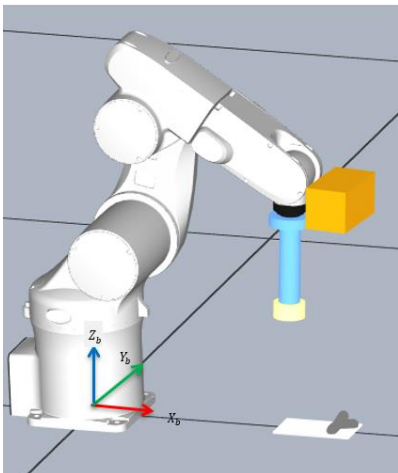
Dialog name	Description
Robot Imaging Position	<p>This is the robot position when imaging (measuring) workpieces. This position is described in the robot base coordinate system.</p> 
Calib. Start Position	<p>Hand-eye calibration base position where the calibration target object is captured around center of the camera view. This position is described in the robot base coordinate system.</p> 

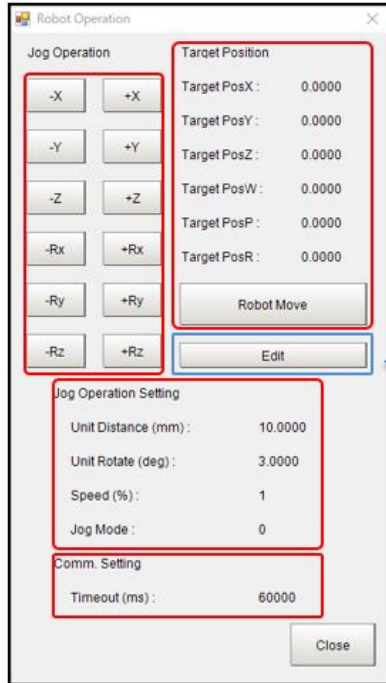

Robot Operation Dialog

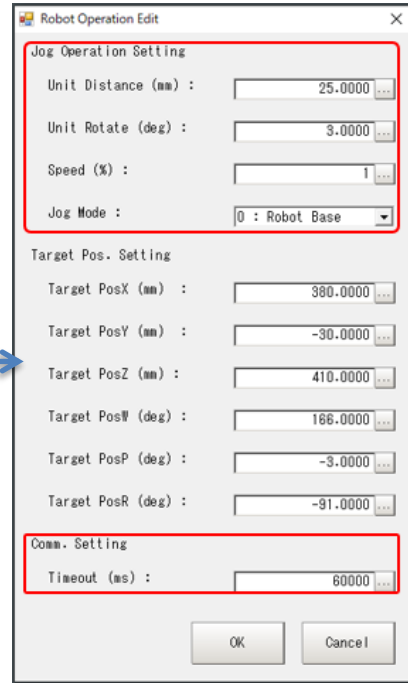

Robot Operation Setting Dialog

In the Robot Operation dialog, the following items are provided for basic robot operation from the Vision sensor.

Function	Description
Jog operation	<p>Execute the jog operation of the robot. By clicking [Jog operation], the robot is operated according to the settings in the jog operation setting.</p> <p>* The robot will not operate even if you are holding down the [Jog operation].</p>
Target position movement	<p>The robot performs the jog operation to the position set as a target position. The movement amount with one-click action follows the setting value of the jog operation setting.</p>
Jog operation setting	<p>Settings of jog movement such as single click jog move distance, single click jog rotation angle, robot speed ( not enable TM robot) and base coordinate switch.</p> <p>You can choose either “Robot base coordinate” or “ Tool coordinate” for Jog Mode.</p> <p><b>[Robot base] coordinate</b>            The coordinate system with reference to the base of the robot. Clicking the <b>Jog Operation</b> buttons Rx, Ry, and Rz causes the robot to rotate around the X, Y, and Z axes, respectively.</p> <div data-bbox="576 1144 1318 1615" data-label="Image"> </div> <p><b>[Tool ] coordinate</b>            The coordinate system with reference to the position and posture of the robot flange. Clicking the <b>Jog Operation</b> buttons Rx, Ry, and Rz causes the robot to rotate around the X, Y, and Z axes, respectively.</p>

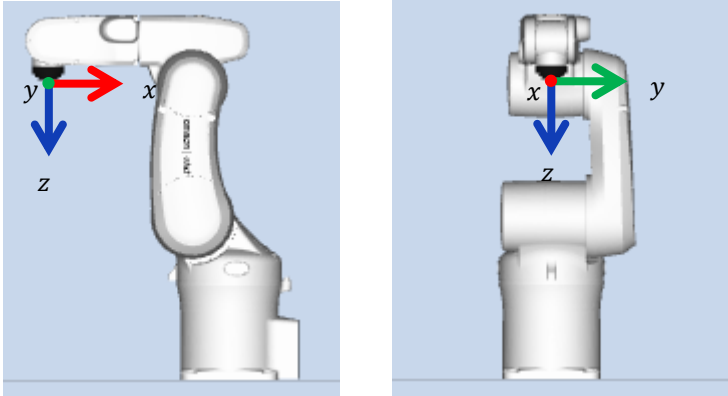
	 <p>*Initial setting of the Robot Speed is 1% Depending on the robot, a timeout may occur. Set an appropriate operation speed in consideration of safety.</p>
Comm Setting	Time out between Vision Sensor and Robot Controller is set here. The setting range for <b>Timeout</b> is 1,000 to 60,000 ms.

## ⚠ WARNING

- Clicking [Jog operation] or [Robot move] drives the robot. Operate the robot in the state whereby pressing the [Emergency stop] button can stop its motion anytime.
- Please set safety robot operation speed on the robot controller. Robot speed setting from Vision Sensor is not reflected to robot controller.
- Depending on the model of the robot, you cannot change the robot speed setting in **Speed (%)** in the Robot Operation Edit window. On the robot side, set the speed to the minimum and check the operation in advance.



## ⚠ Caution

- When the robot moves in the Z-axis direction, check its motion by visual observation and not by camera image.







### **Precautions for Correct Use**

---

- These features are only available in a connection status that is established between the Vision Sensor and the robot controller with TCP no-procedure protocol invoked by steps in the Robot connection guide listed in section 7 and the Setup program is running in the robot controller.
  - Even if the robot controller changes the reference position from the flange of the tool coordinate system, it will not be reflected to the jog operation setting of the Vision Sensor.
  - External trigger inputs or communications with outside the system will be disabled when operating the robot.
  - Operations except for the Main Window of the Vision Sensor such as opening setting screens for processing units is not executed.
  - If communication was disconnected during operations of the user dialog, operations of the Vision Sensor may be unavailable for the time period set for communication timeout (Default: 60,000 [ms]) in Communication settings. Please change the value as necessary.
- 



### **Precautions for Correct Use**

---

- The operations of the user dialogs described here are effective only when the Vision Sensor is connected to the robot according to the procedures described in the *Robot Connection Guide* for each robot listed in Related Manuals in this manual, and when the setup program is running on the robot side.
-

### ■ Model Batch Registration

You can use batch model registration to register and unregister all 3D Search unit models that you set in 8.8.5. Since the 3D Search unit consumes 300 to 600 Mbytes of memory, it takes time to back up data to external media if there are many 3D Search units in a scene group. You can unregister it before backing up data to save the capacity of the backup media and the backup time.

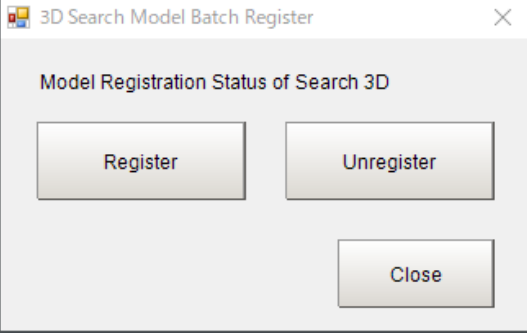
Name	Description
Model Batch Reg.	 <p>Start a dialog in which you can register and unregister models at once.</p>
Register	Register all the 3D Search models in the currently selected scene groups. If the number of 3D Search models in a scene group is N, the processing time will be about $90 \times N$ seconds.
Unregister	Unregister all the 3D Search models in the currently selected scene groups.



### Precautions for Correct Use

- If you load a scene or scene group with unregistered 3D Search models, the models will not be registered automatically. If you perform measurement in this state, the 3D Search unit will be NG. Perform model registration for the 3D Search models in each individual scene, or click **Register** in the above dialog to register the models again.

## 8.4.2. Layout 2 Window

The main window of the Vision Sensor has buttons to launch user dialogs as shown in the figure below. This section describes buttons that are displayed in the Layout 2 window.

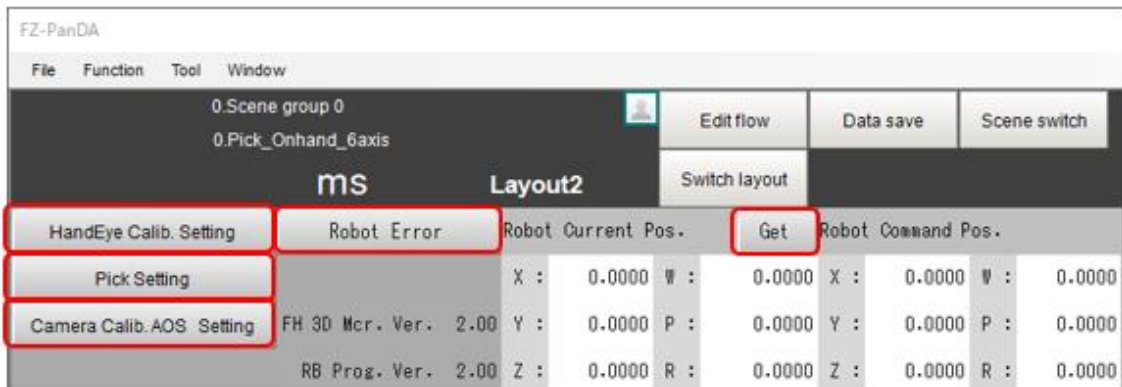

Dialog name	Description
HandEye Calib. Setting	Start a wizard for setting and executing hand-eye calibration (calibration between the camera and a robot). Details on configuring settings using the wizard are described in 8.5.
Pick Setting	Start a wizard for setting scenes for the picking application. Details on configuring settings using the wizard are described in 8.6.
Camera Calib. AOS Setting	Start a wizard for setting and executing geometric correction for the 3D Vision Sensor. For details on configuring the settings using the wizard, refer to the <i>Vision System FH Series AOS Camera Calibration Operation Guide</i> (Cat. No. Z451).
Get	Refer to 8.4.1
Robot Error	Refer to 8.4.1.

The structure and functions of the wizard window are shown in the figure below.

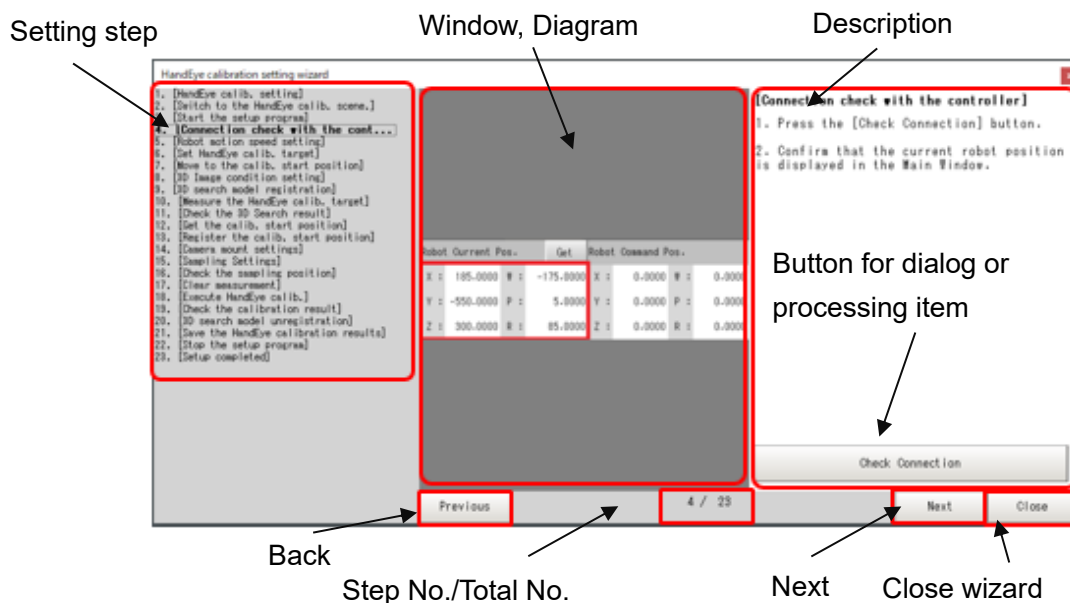



### **Precautions for Correct Use**

---

- When you click a processing item setting window, etc., the wizard may be hidden behind the main window. In this case, click the button that started the wizard again.
-

## 8.5. Hand-eye Calibration Configuration Using the Wizard

Configure the hand-eye calibration settings for the on-hand camera and execute a hand-eye calibration. Executing a hand-eye calibration allows you to establish the positional relationship between the camera coordinate system of the 3D Vision Sensor and the flange coordinate system of the robot and then convert the position of the workpiece detected by the 3D Vision Sensor into the position in the robot coordinate system. Hand-eye calibration parameters can be referenced by the Container Detection or Grasp Planning processing item. The description here assumes that the Layout 2 window is displayed.

### WARNING

- Make sure that you always use a sensor controller project that matches the robot type. If the type is mismatched, the robot may operate in an unexpected manner.
- Make sure that the robot is operated by personnel who have completed special training for safety and health.
- Make sure that you can stop the operation of the robot at any time by pressing the emergency stop button.



#### Precautions for Correct Use

- For robot-related settings, refer to the *Vision System FH/FHV series Robot Connection Guide* corresponding to each robot in *Related Manuals*.
- This wizard configures only the minimum required settings. To configure advanced settings, refer to the relevant topics in 8.7, or the following document listed in *Related Manuals* in this manual. *Vision System FH series Processing Item Function Reference Manual for 3D Robot Vision* (Cat. No. Z445)



#### Note

- If the wizard does not work as described, you may have skipped some step in the middle of the procedure. In this case, redo from the beginning of the wizard.

Before proceeding to the following step, please check the network connection to the robot as described in section 3 of the *Vision System FH/FHV series Robot Connection Guide* corresponding to each robot in *Related Manuals* for the robot to be connected.

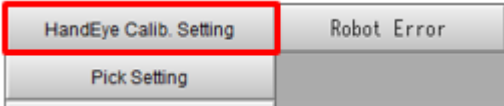
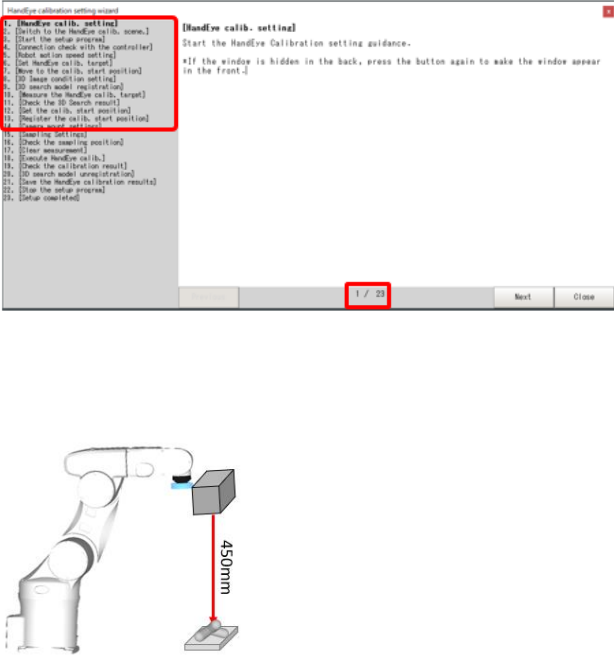
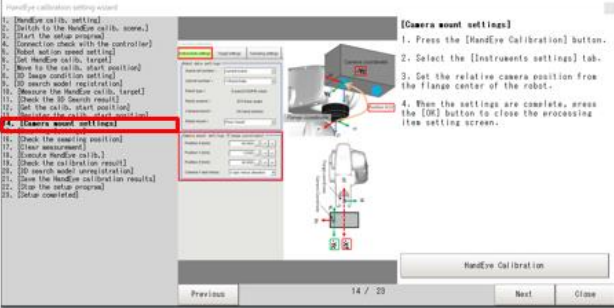
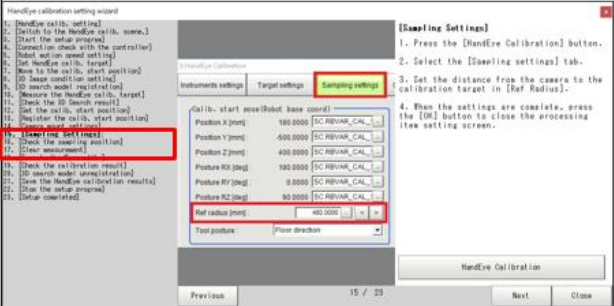
Step	Description	Window image, diagram
1	<p>In the main window of the Vision Sensor, click the <b>HandEye Calib. Setting</b> button to start the wizard.</p>	
2	<p>According to the wizard instructions, configure the settings on pages 1/23 to 14/23 of the wizard.</p> <p>To configure the settings on the next page, click the <b>Next</b> button.</p> <p>To return to the settings on the previous page, click the <b>Previous</b> button.</p> <p>To close the wizard, click the <b>Close</b> button.</p> <p>For 7/23 [<b>Move to Calibration Start Position</b>], set the calibration start position so that the distance between the 3D vision sensor and the hand eye calibration target is approximately 450mm.</p>	
3	<p>For details on how to configure the camera installation settings for hand-eye calibration that you will set on 14/23 and later pages of the wizard, refer to the setting procedure in 8.7.6</p>	
4	<p>Configure the settings on pages 15/23 to 17/23 of the wizard.</p>	

5 On page 18/23 of the wizard, click **Calibration** and, in the dialog displayed, execute a hand-eye calibration.

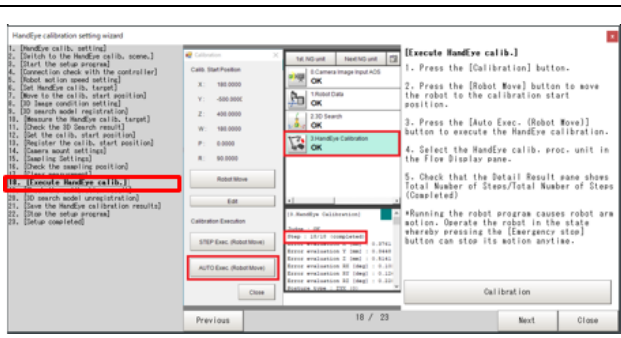

6 According to the wizard instructions, configure the settings on pages 19/23 to 23/23 of the wizard.

This completes the configuration and execution of hand-eye calibration. Click the **OK** button to close the wizard.

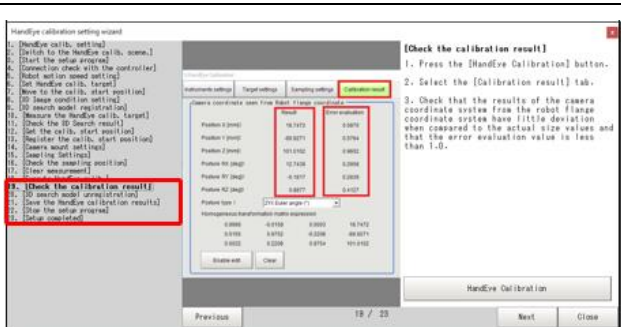

If 3D Search or calibration fails, refer to *Key Points for Measurement and Adjustment* in the *Vision System FH series Processing Item Function Reference Manual for 3D Robot Vision* (Cat. No. Z445).

## 8.6. Hand-eye Camera Pick Application Configuration Using the Wizard

Configure the application to pick workpieces with the hand-eye camera. Specifically, register the target workpiece model, hand, and container, and then perform a 3D Search, detect the grasped workpiece, and output the command position to grasp workpieces to the robot controller.

Before you start the following setting procedure, complete the settings described in 8.5. The description here assumes that the Layout 2 window is displayed.

### ⚠ WARNING

- Make sure that you always use a sensor controller project that matches the robot type. If the type is mismatched, the robot may operate in an unexpected manner.
- Make sure that the robot is operated by personnel who have completed special training for safety and health.
- Make sure that you can stop the operation of the robot at any time by pressing the emergency stop button.



#### Precautions for Correct Use

- For robot-related settings, refer to the *Vision System FH/FHV series Robot Connection Guide* corresponding to the robot listed in *Related Manuals*.
- This wizard configures only the minimum required settings. To configure advanced settings, refer to the relevant topics in 8.8, or the following document listed in *Related Manuals* in this manual. *Vision System FH series Processing Item Function Reference Manual for 3D Robot Vision* (Cat. No. Z445)



#### Note

- If the wizard does not work as described, you may have skipped some step in the middle of the procedure. In this case, redo from the beginning of the wizard.

Step	Description	Window image, diagram
1	In the main window of the Vision Sensor, click the <b>Pick Setting</b> button to start the wizard.	



2 According to the wizard instructions, configure the settings on pages 1/35 to 24/35 of the wizard. To configure the settings on the next page, click the **Next** button. To return to the settings on the previous page, click the **Previous** button. To close the wizard, click the **Close** button.

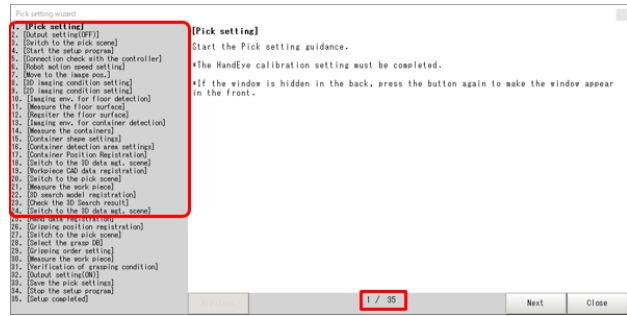

In 7/35 **[Move to Imaging Position]**, Set the imaging position so that the distance to the imaging target is 400to 600mm.

In 11/35 **[Register Floor Surface]**, the floor area can be registered by dividing it into several area. Register the area on the same plane and do not include surfaces that differ in height or inclination.

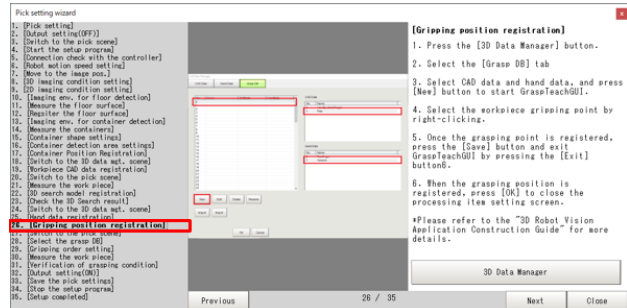
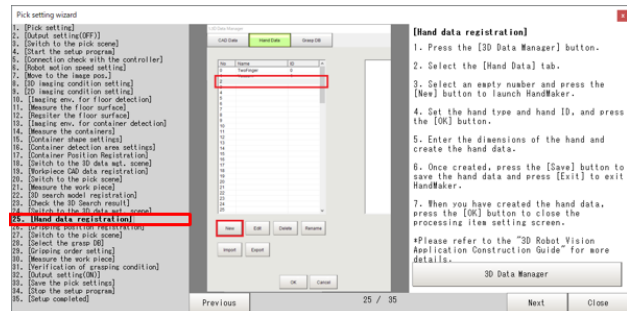

3 For details on how to register the hand data and grasp point in the 3D Data Manager window from pages 25/35 and 26/35 of the wizard, refer to 8.8.6 in this manual.

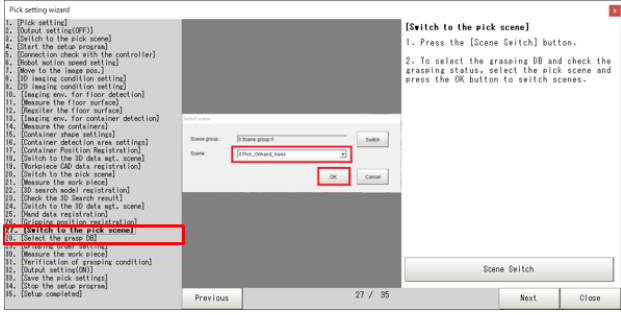
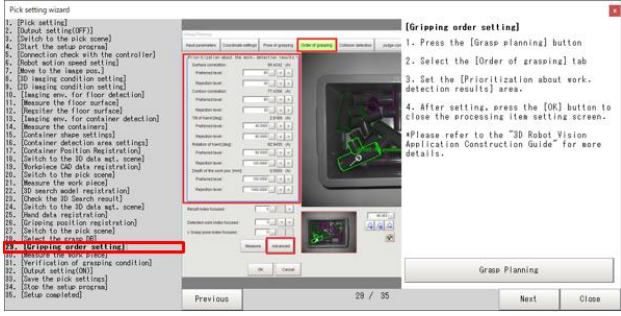
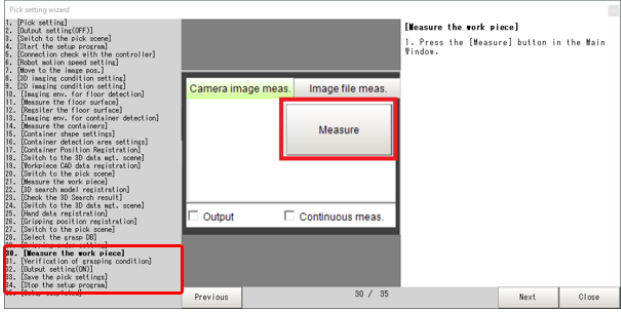

<p>4 Configure the settings according to the instructions on pages 27/35 to 28/35 of the wizard.</p>	
<p>5 For details on configuring the order of grasping settings on page 29/35 of the wizard, refer to 8.8.7 step 7 of this manual.</p>	
<p>6 According to the wizard instructions, configure the settings on pages 30/35 to 35/35 of the wizard.</p> <p>This completes the configuration of the picking application settings.</p> <p>Click the <b>Close</b> button to close the wizard.</p>	 

For troubleshooting for each processing item in the picking application, refer to Key Points for Test Measurement and Adjustment for each processing item in the *Vision System FH series Processing Item Function Reference Manual for 3D Robot Vision* (Cat. No. Z445).

For how to operate the robot to pick a workpiece based on the settings in this manual, refer to section 6 of the *Vision System FH/FHV series Robot Connection Guide* corresponding to the robot listed in *Related Manuals* in this manual.

## 8.7. Hand-eye Calibration

This section describes hand-eye calibration settings and procedure.

Calibration parameters describes geometrical relation between camera optical center and robot flange center. This allows you to convert the position of the workpiece detected by the 3D Vision Sensor into the position in the robot coordinate system.

The calibration parameters are referenced from Container Detection unit and Grasp Planning unit.

The description here assumes that the Layout 0 window is displayed.

### WARNING

- When hand-eye calibration executing the robot moves variety of positions and postures, but it does not consider surrounding obstacles. Please remove obstacles around robot in case of collision.
- During calibration, the move command values to the robot are output in the base coordinate system of the robot. Set the robot to the base coordinate system before calibration.



#### Precautions for Correct Use

- Do not change the default values of system variables and scene variables. If you change them, the robot will not operate correctly.
- For robot-related settings, refer to the *Vision System FH/FHV series Robot Connection Guide* corresponding to the robot listed in *Related Manuals*. It is also referred to as Robot Connection Guide in this manual.

Use the following work flow to configure the settings.

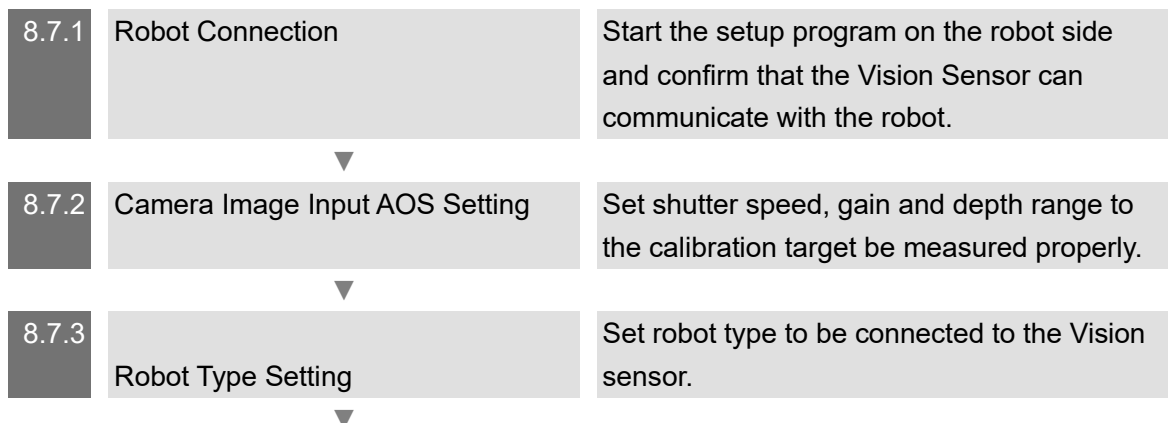

8.7.4	3D Search Setting	Generate 3D search model from calibration target CAD file and set/adjust 3D search parameters.
8.7.5	Hand-eye Calibration Start Position Registration	Set robot move range parameters which enable capture of the calibration target in many points and postures.
8.7.6	Hand-eye Calibration Setting	Set robot move range parameters which enable capture of the calibration target in many points (sampling point) and postures.
8.7.7	Hand-Eye Calibration Execution	Execute hand-eye calibration and calculate the calibration parameters.

### 8.7.1. Robot Connection

During hand-eye calibration, the Vision Sensor communicates with the robot to perform robot operation. Before proceeding to the following step, please check the network connection to the robot as described in section 3 of the Vision System FH/FHV series Robot Connection Guide corresponding to each robot in Related Manuals for the robot to be connected.

Step	Description	Window image, diagram
1	<p>Click <b>Scene switch</b> button on the main Window of the Vision Sensor.</p> <p>Select the No.125 scene that contains the hand-eye calibration scene.</p> <p>Click <b>OK</b> to switch scene.</p>	
2	<p>Start the robot setup program according to the procedure described in section 5 of the <i>Robot Connection Guide</i>.</p>	

# ⚠ WARNING

Running the robot program causes robot arm motion.  
Operate the robot in the state whereby pressing the [Emergency stop] button can stop its motion anytime.



3 Click the **Get** button. Confirm that the current position of the robot is displayed correctly.

Robot Error	Robot Current Pos.	Get	Robot Command Pos.
	X : 208.4306 W : -174.3759		X : 0.0000 W : 0.0000
FH Macro Ver.	Y : -573.9842 P : 1.3117		Y : 0.0000 P : 0.0000
RB Prog. Ver.	Z : 358.3550 R : 90.2261		Z : 0.0000 R : 0.0000

4 In the main window, click the **Robot Operation** button. Then, in the Robot Operation dialog displayed, click the **Edit** button and set the operation speed of the robot. The operation speed of the robot depends on the robot model.

Jog Operation Setting

Unit Distance (mm) :

Unit Rotate (deg) :

Speed (%) :

5 Place the calibration target object in the center of the field of view as shown on the figure on the right. At this time, with the hand-eye calibration target set in the center of the field of view, secure a hemispherical trajectory with a radius of about 450 mm for the robot.



6 Adjust the position of the robot so that the hand-eye calibration target to capture is near the center of the field of view. Click the **Robot Operation** button in the main window and use the **Jog Operation** buttons to operate the robot. You may use the robot pendant to perform jog operation.

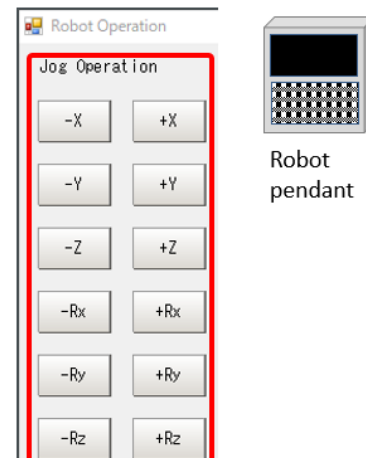

# ⚠ WARNING

- Running the robot program causes robot arm motion.
- Operate the robot in the state whereby pressing the [Emergency stop] button can stop its motion anytime.



## 8.7.2. Camera Image Input AOS Setting

Set the imaging position, shutter speed, gain, and measurement range so that the hand-eye calibration target can be measured properly.

Step	Description	Window image, diagram
1	Click the “0.Camera Image Input AOS” icon on the Main window of the Vision Sensor to open its setting screen.	
2	<p>Open the Camera setting (3D) tab.</p> <p>The Through image from the camera can be displayed by clicking the <b>Change display</b> button.</p> <p>Adjust shutter speed, camera gain and Light gain so that the 3D depth image can be captured properly.</p>	

If the exposure is appropriate, the distance image of the hand-eye calibration target as shown in the figure on the right will be displayed.

If you see only black in the image window, check the box for “Captured image” in the “Display setting” at the bottom right of the screen and confirm whether or not you can observe the projected mesh image on the target object. Set the camera settings so that the projector pattern has high contrast, as shown in the figure on the right.

Also confirm whether of the target object form the 3D Vision sensor is in the range of “measurement range of Z”.

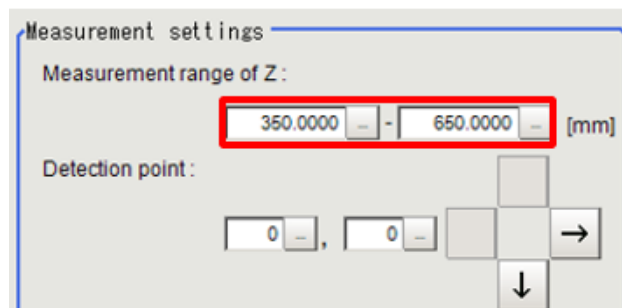
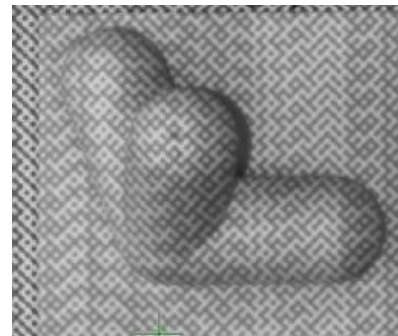
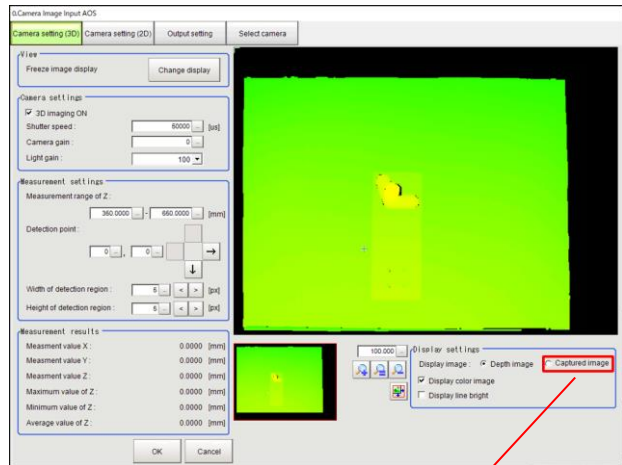

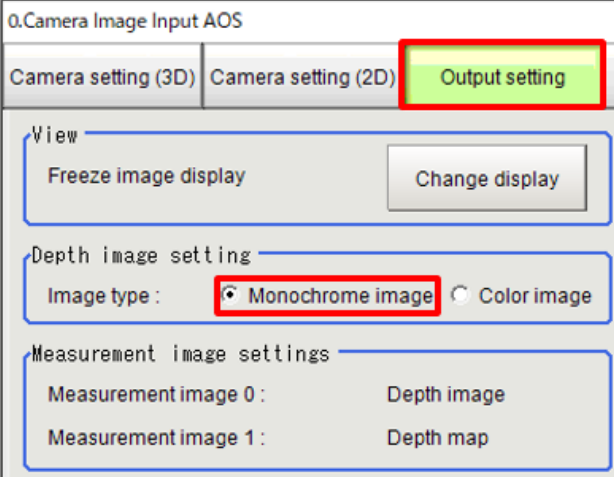
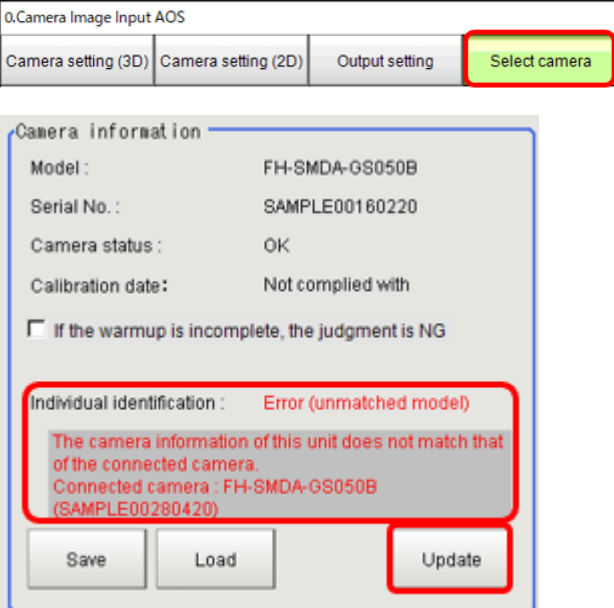
<p>3</p>	<p>Open "Output setting" tab. Select <b>Monochrome image</b>.</p>	
<p>4</p>	<p>If the connected 3D Vision Sensor has been changed, a model mismatch error is displayed in the Select camera tab. Click the <b>Update</b> button to update the camera information to that of the connected camera.</p> <p>If the 3D Vision Sensor has not been changed, click the <b>OK</b> button to close the setting window.</p>	



### 8.7.3. Robot Type Setting

Follow the procedures below to set the robot type and robot coordinate system which connect to the Vision sensor.

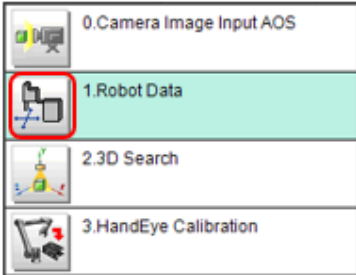
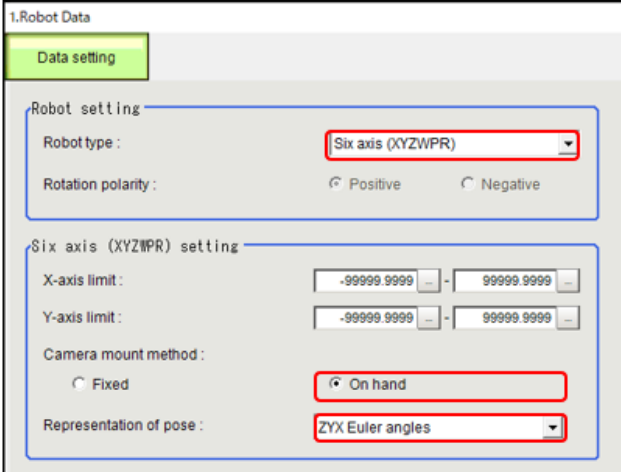
Step	Description	Window image, diagram
1	<p>Click the “1.Robot Data” icon on the Main window of the vision sensor to open its setting screen.</p> <p>Confirm that the selections for “Robot type”, “Camera mount method” and “Representation of pose” are appropriate for the robot being used for this application.</p> <p>Select [<b>ZYX Euler angles</b>] pose representation to TM5-XXX series.</p> <p>Select [<b>ZYZ Euler angles</b>] pose representation to Viper series.</p> <p>The <b>Representation of pose</b> setting varies depending on the robot manufacturer and model. Please check the instruction manual for each robot.</p> <p>Click <b>OK</b> to complete Robot Data setting and close the screen.</p>	 <p>The screenshot shows a menu with four items: '0.Camera Image Input AOS', '1.Robot Data' (highlighted in green and circled in red), '2.3D Search', and '3.HandEye Calibration'.</p>  <p>The screenshot shows the '1.Robot Data' window with a 'Data setting' tab. It contains two main sections: 'Robot setting' and 'Six axis (XYZWPR) setting'. In the 'Robot setting' section, 'Robot type' is set to 'Six axis (XYZWPR)', and 'Rotation polarity' has 'Positive' selected. In the 'Six axis (XYZWPR) setting' section, 'X-axis limit' and 'Y-axis limit' are both set to '-99999.9999' to '99999.9999'. 'Camera mount method' has 'On hand' selected, and 'Representation of pose' is set to 'ZYX Euler angles'. Red boxes highlight the 'Robot type', 'Representation of pose', and 'On hand' settings.</p>

### 8.7.4. 3D Search Setting

Follow the steps below to configure and adjust the 3D Search settings for the calibration target.

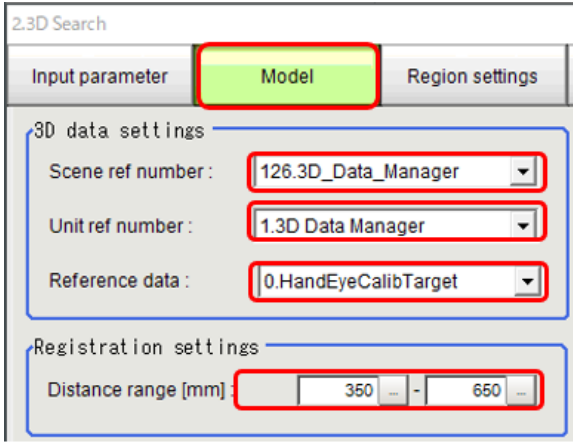
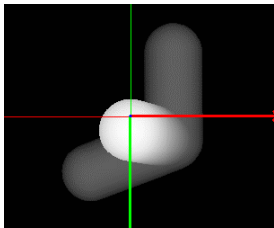
Step	Description	Window image, diagram
1	Click “2. 3D Search” icon on the Main window of the Vision Sensor to open its setting screen.	
2	<p>Open the “Model” tab to select the calibration target file.</p> <p>In “3D data settings”, set “Reference data” to the calibration target CAD data (HandEyeCalibTarget) which is in the 3D Data Manager.</p> <p>Set “Distance range [mm]” to range that same range as 3D camera Image Input AOS (350 to 650 ).</p>	
3	<p>Click <b>Advanced</b> to open the advanced setting dialog.</p> <p>Set Reference posture so that the model’s front side to camera posture is as shown in the figure to the right.</p> <p>Check the box for “Having front and back symmetry about current view”. In the calibration scene, there is no need for the back side of the calibration target. Checking this box here suppresses the creation of the back side of a 3D search model.</p>	

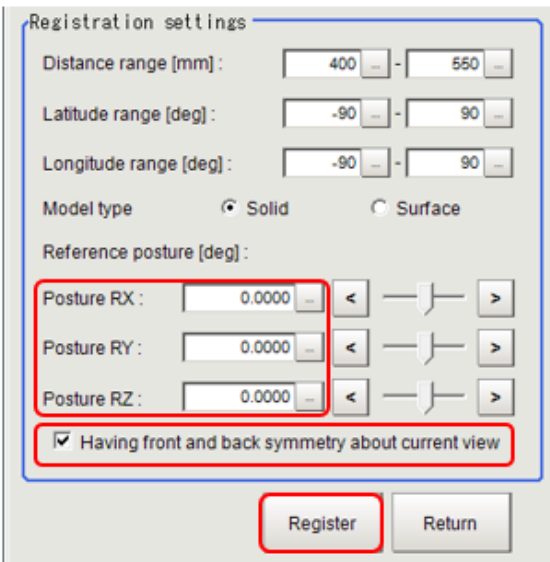
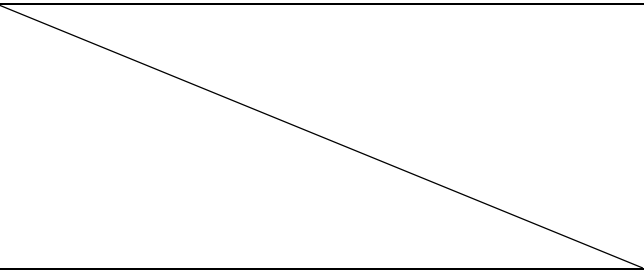
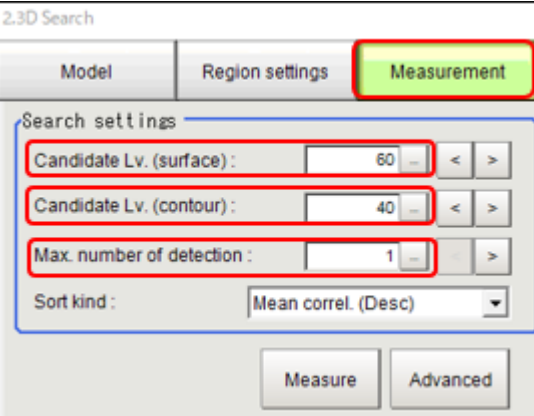
	<p>Click the <b>Register</b> button to register the CAD data. The process generates 3D Search model data. The <i>Under registering</i> message blinks during the registration process. It takes about 60 to 90 seconds to complete.</p> 
<p>4 Open the “Region settings” tab. Set the region so that the measurement FOV covers the calibration range.</p>	
<p>5 Open the “Measurement” tab.</p> <p>Set “Candidate Lv.(surface)” and “Candidate LV.(contour)” to detect the calibration target. Normally, there is no need to change the default values of 60 and 40.</p> <p>Set the “Max. number of detection” to “1”.</p> <p>If it fails to recognize the calibration target, adjust the Candidate levels.</p>	

6 Open "Judge cond." tab to set the judgement condition.

Set the lower threshold for "Contour correlation" to be lower than that for "Surface correlation". Normally, there is no need to change the default value.

Click **OK** to complete settings

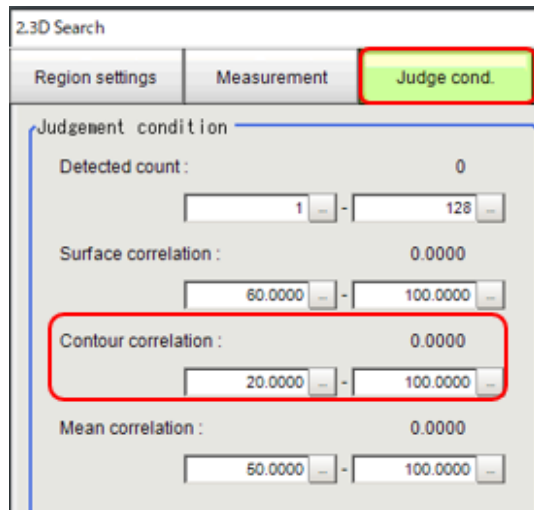

7 Click the Measure button of the Main Window and confirm 3D Search succeeded to detect the calibration target.

Open the 3D Search processing item and check that the hand-eye calibration target is detected.

Click the **Draw with 3D** button at the lower right of the Measurement tab of the 3D Search processing item. You can now check that the points measured with the 3D Visualizer correctly match the CAD data for hand-eye calibration. If the target is not detected, adjust the candidate level settings in the Measurement tab.

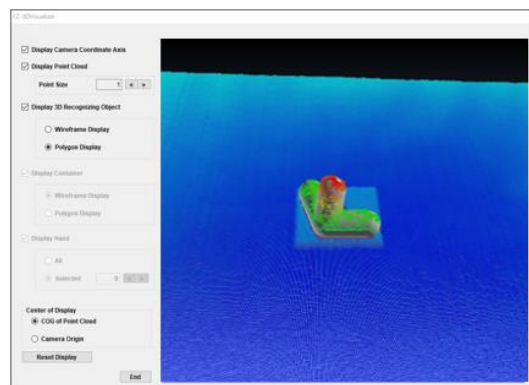
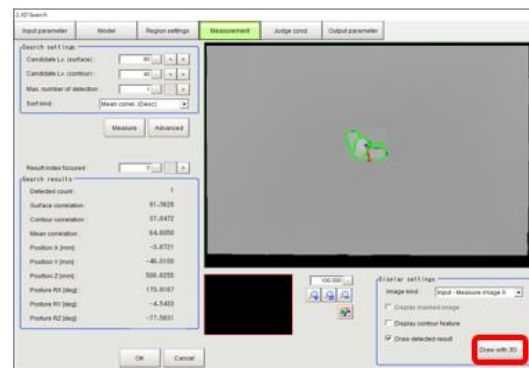
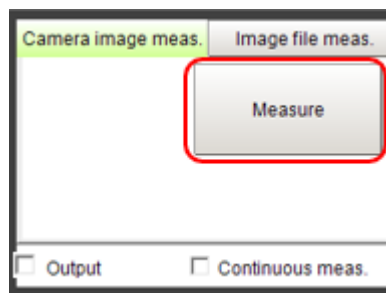

### 8.7.5. Hand-eye Calibration Start Position Registration

Follow the steps below to register the start pose of hand-eye calibration. Calibration will start from the position that you register here, and the robot will stop at this position after the calibration is completed. Perform the procedure described in 8.7.1 when the robot is running.

Step	Description	Window image, diagram
1	<p>Operate the robot to the calibration start point. Click the <b>Get</b> button to acquire position and posture of the calibration start point.</p> <p>Click the <b>HandEye Calib.</b> button in the main window of the Vision sensor to open the Calibration setting dialog.</p>	
2	<p>Click the <b>Edit</b> button on the Calibration dialog and then click <b>Reg. Calib. Start Pos</b> button to register the robot position and posture to the system variables.</p> <p>These values are referenced in the HandEye Calibration unit.</p> <p>Click the <b>Close</b> button to close the dialog.</p>	

### 8.7.6. Hand-eye Calibration Setting

Set the conditions of the 3D vision camera installed on the robot and the movement range of the robot during hand-eye calibration, which are required to execute hand-eye calibration.

Follow the steps below to set and execute hand-eye calibration.

To set hand-eye calibration, you need to get the position and posture of the robot according to the procedure described in 0.

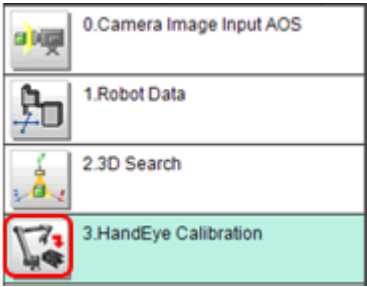
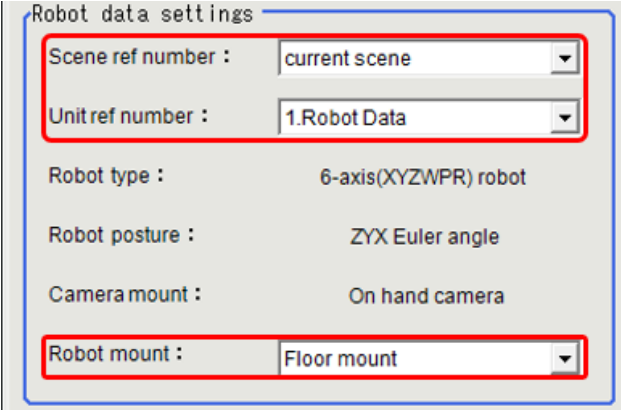
Step	Description	Window image, diagram
1	Click the “HandEye Calibration” icon on the Main window of the vision sensor to open its setting screen.	
2	<p>Open “Instruments settings” tab to set the robot type.</p> <p>Select the “Robot Data” unit which was set in section 8.7.3.</p> <p>Confirm the Robot mount type is “Floor mount”.</p>	

3 Set the offset position (X,Y,Z) of the 3D vision camera's camera coordinate origin in flange coordinate system from the robot flange center.

The directions of Position X, Position Y, and Position Z are determined by the direction of the robot flange on which you install the 3D Vision Sensor. Check the direction of the flange coordinate system of the robot before you set them.

This positioning need not be so precise ( $\pm 5\text{mm}$  tolerance).

In **Camera Y-axis minus**, set the direction in which the 3D vision camera is mounted.

Select Robot flange axis that same direction to the 3D camera's Y axis minus direction.

Specific examples are given in *Supplementary Information on Camera Installation Settings 1* at the end of this section.

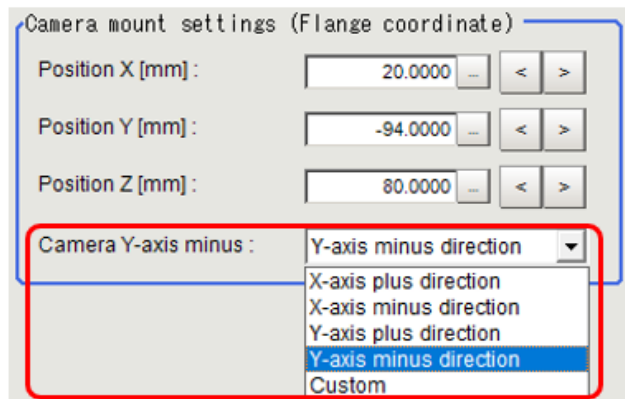
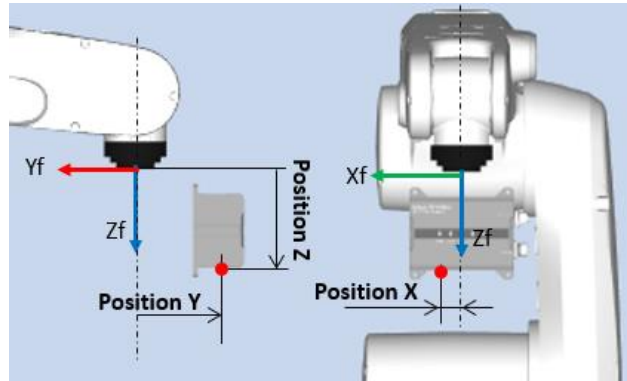
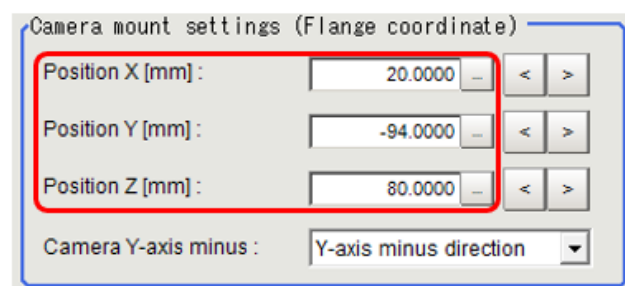

In the example figure shown on the right, the -Y axis (Y-axis minus direction) of the camera coordinate system coincides with the -Y axis of the flange coordinate system. For the direction, an error of  $\pm 5$  degrees is allowed.

To set a different angle intentionally, select **Custom** and set the angle. For how to set an angle, refer to *Supplementary Information on Camera Installation Settings 2* at the end of this section.

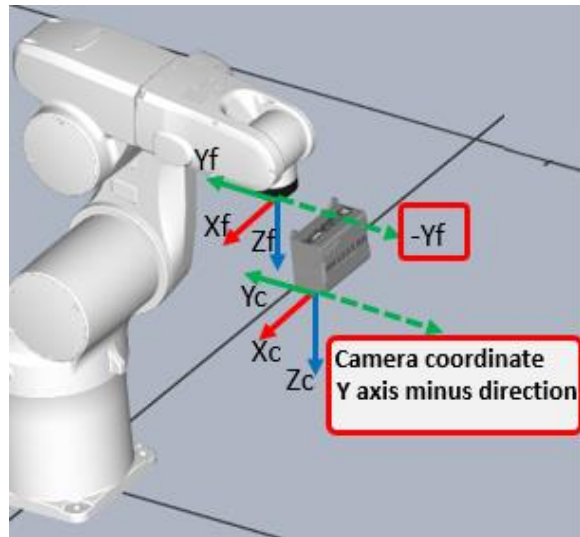

- 4 Open "Target settings" tab to set the calibration target pose and posture which are search result of the "3D Search" unit result. If you load a sensor controller project corresponding to the robot type, there is no need to enter or change the settings because the system variables (SY.XXX) are already set.

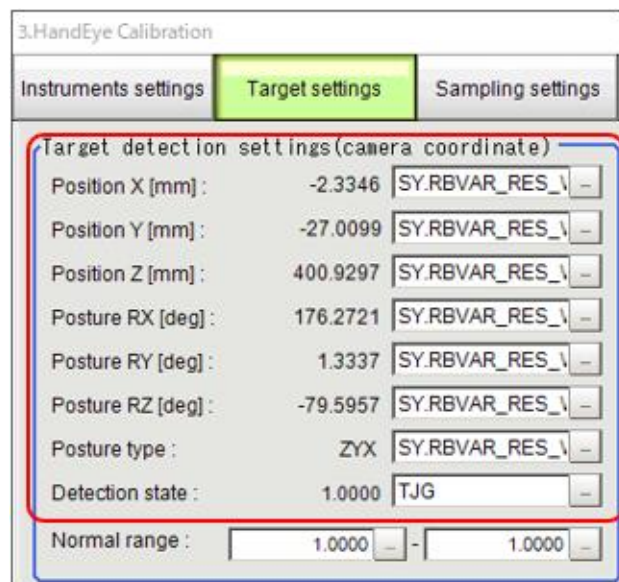



5 Open “Sampling settings” tab to set Calibration start point. Confirm the “Calib. Start pose” values (System variables) are same position and posture which registered section 8.7.5. If you load a sensor controller project corresponding to the robot type, there is no need to set or change the settings because the scene variables (SC.XXX) is already set.

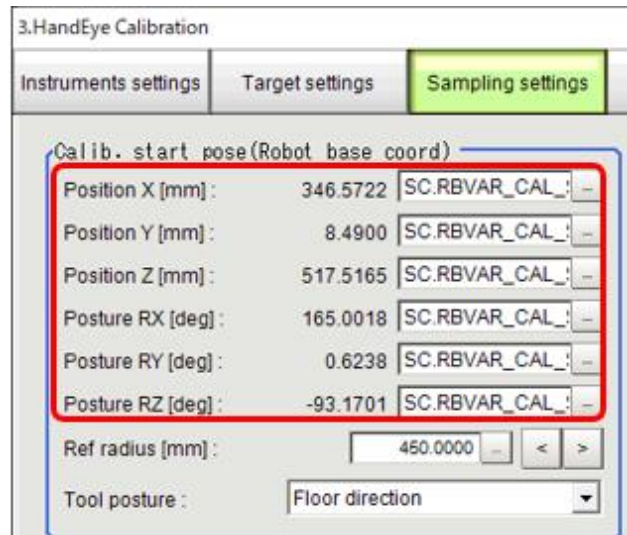

6 During the Hand-eye calibration procedure the robot moves half sphere trajectory from “Calib. Start pose” with keeping the calibration target in center of the 3D camera view. The camera measures the calibration target from many directions and calculate camera location from the robot flange center.

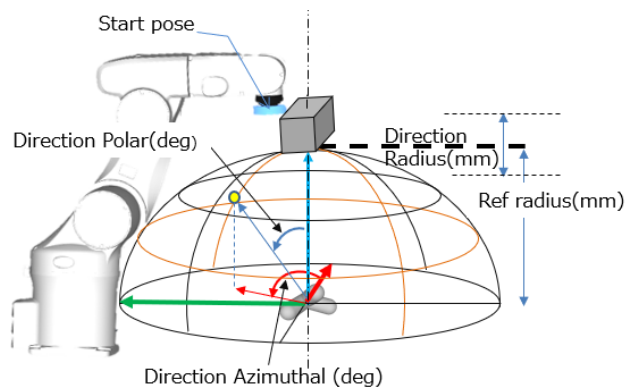

For the working range of the robot based on each parameter, refer to *Supplementary Information on Sampling Settings* at the end of this section.

Set distance from 3D vision camera to the handeye calibration target in “Ref radius”

Set a Working range (radius transfer range) and Divisions (transfer step num  $\geq 2$ ) to the “Direction Radius”.

Set polar direction inner angle of the flange trajectory and transfer step num to “Direction Polar (Polar coord)”. Division must be greater or equal 2.

Set Azimuth direction inner angle of the flange trajectory and transfer step num to “Direction Azimuthal (Polar coord)”. Division must be greater or equal 2.

Polar and Azimuth angle is applied to plus and minus side.

Set Perturbation angle 2-5.0 degree. Too much perturbation angle cause loss of the calibration target object from 3D camera view.

Normally, there is no need to change the default values. If the values are too large, the calibration target will be out of the field of view.

3.HandEye Calibration

Instruments settings Target settings **Sampling settings**

Calib. start pose (Robot base coord)

Position X [mm]: 346.5722 SC.RBVAR\_CAL\_ --

Position Y [mm]: 8.4900 SC.RBVAR\_CAL\_ --

Position Z [mm]: 517.5165 SC.RBVAR\_CAL\_ --

Posture RX [deg]: 165.0018 SC.RBVAR\_CAL\_ --

Posture RY [deg]: 0.6238 SC.RBVAR\_CAL\_ --

Posture RZ [deg]: -93.1701 SC.RBVAR\_CAL\_ --

**Ref radius [mm]: 450.0000 -- < >**

Tool posture: Floor direction

Direction Radius (Polar coord)

Working range [mm]: 45.0000 -- < >

Divisions: 2 -- >

Direction Polar (Polar coord)

Working range [deg]: 40.0000 -- < >

Divisions: 4 -- < >

Direction Azimuthal (Polar coord)

Working range [deg]: 45.0000 -- < >

Divisions: 4 -- < >

Perturbation (Sphere center coord)

Working range X [deg]: 2.0000 -- < >

Working range Y [deg]: 2.0000 -- < >

Working range Z [deg]: 4.0000 -- < >

Sampling points are generated and shown on “Robot move pose list for sampling” as shown on the figure in right.

The number of sampling points is product of transfer step (Divisions) of “Direction radius”, “Direction Polar” and “Direction Azimuthal”. The hand-eye calibration target will be captured at the position specified by these coordinates.

No.	Robot position X	Robot position Y	Robot position Z	Robot po ^
0.	346.5722	8.4900	517.5165	165.0
1.	277.3218	176.3017	447.6972	175.0
2.	329.1021	190.9072	457.6612	166.0
3.	376.5276	198.5674	459.1024	162.0
4.	415.0559	186.6293	461.2183	160.0
5.	321.1734	69.0463	484.8544	169.0
6.	343.4995	73.4434	491.3585	164.0
7.	359.6419	80.4628	491.0244	162.0
8.	367.9586	75.8907	486.8067	165.0
9.	320.0393	-43.2057	488.3442	168.0
10.	342.2670	-48.5481	495.0461	163.0
11.	358.4083	-41.6427	496.3634	161.0
12.	366.8143	-37.3737	493.7674	164.0
13.	274.0189	-150.6192	458.2058	173.0
14.	325.4835	-167.2609	468.5800	163.0
15.	372.8808	-162.3964	474.8862	159.0
16.	411.6464	-150.8415	476.0602	158.0
17.	417.3168	-172.5913	517.2759	158.0
18.	374.6509	-185.0599	515.9806	158.0
19.	323.3915	-176.4746	511.9479	164.0
20.	268.0492	-158.4928	501.1636	173.0
21.	368.6923	-49.3882	539.0639	163.0
22.	358.9636	-54.1755	541.5837	161.0
23.	341.6057	-46.5029	539.2022	163.0
24.	318.0596	-41.2660	532.3936	169.0
25.	369.9371	73.8222	535.6197	164.0
26.	360.3050	78.6031	537.9111	162.0
27.	342.9396	85.5324	533.8782	164.0
28.	319.2883	80.3450	527.4785	170.0
29.	421.0224	194.1880	507.1662	160.0
30.	378.6254	207.3486	505.1718	161.0
31.	327.3080	212.2825	496.2941	167.0

The figure on the right shows an image of the imaging position seen from directly above and from the side of the robot in accordance with the robot move pose list for sampling.

If you find any abnormal value as a coordinate of the robot, review the settings in the Target settings and Sampling settings tabs. An abnormal value refers to a position that the robot cannot reach, or a position where it is obvious that a collision will occur. However, it depends on the model and orientation of the robot. Check the working range of your robot.

This completes the setting for hand-eye calibration.

Click the **OK** button to close the setting window.

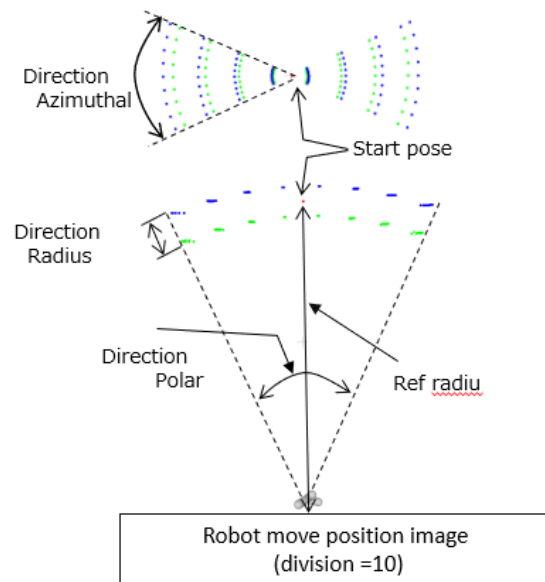

## WARNING

- The scene loaded by configuration copy in section 7.2 has predefined scene variables and system variables. You may not edit these variables manually (with TDM or setting windows). These variables are set automatically by the operations of the dialogs described in this section.
- Proceeding with the subsequent steps without setting [Reg. Calib. Start Pos] (Calibration start position) can cause unexpected robot motion. Do not forget setting the calibration start position.



### **Precautions for Correct Use**

---

- If you click the **Measure** button in the main window after configuring the hand-eye calibration settings, be sure to execute **Clear measurement** from the **Function** menu in the main window before you execute hand-eye calibration.  
To perform hand-eye calibration, click the **HandEye Calib.** button in the main window.
-

■Supplementary Information on Camera Installation Settings 1:

The **Position X**, **Position Y**, **Position Z**, and **Camera Y-axis minus** settings in **Camera mount settings** differ depending on the orientation of the robot flange in which the 3D vision camera is installed. The following shows examples of setting different flange conditions when the positional relationship between the center of the flange and the 3D Vision Sensor is as shown in the figure below.

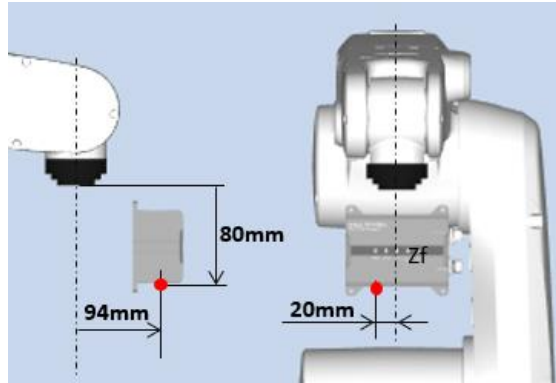

Example 1	Example 2
<p>Camera mount settings (Flange coordinate)</p> <p>Position X [mm]: <input type="text" value="20.0000"/></p> <p>Position Y [mm]: <input type="text" value="-94.0000"/></p> <p>Position Z [mm]: <input type="text" value="80.0000"/></p> <p>Camera Y-axis minus: <input type="text" value="Y-axis minus direction"/></p>	<p>Camera mount settings (Flange coordinate)</p> <p>Position X [mm]: <input type="text" value="-94.0000"/></p> <p>Position Y [mm]: <input type="text" value="-20.0000"/></p> <p>Position Z [mm]: <input type="text" value="80.0000"/></p> <p>Camera Y-axis minus: <input type="text" value="X-axis minus direction"/></p>

■Supplementary Information on Camera Installation Settings 2:

When you install the 3D Vision Sensor at a tilt relative to the flange coordinate system, select **Custom** and enter the pose of the 3D Vision Sensor in the Euler angle representation. As the representation of pose in Euler angle, you can select ZYX, ZYZ, or XYZ. If you are not familiar with the representation of pose, it makes easy to set the ZYX representation.

When **Representation of pose** is ZYX, with the flange coordinate system and the camera coordinate system set in the same orientation, rotate the Z axis, Y axis, and X axis of the camera coordinate system in this order to set the pose of the 3D Vision Sensor in an installed state.

The following explains the ZYX representation of pose with examples, where the camera is installed at a tilt relative to the robot flange Z axis. In this manual, coordinates are right-handed, and the direction of rotation is right-handed screw.

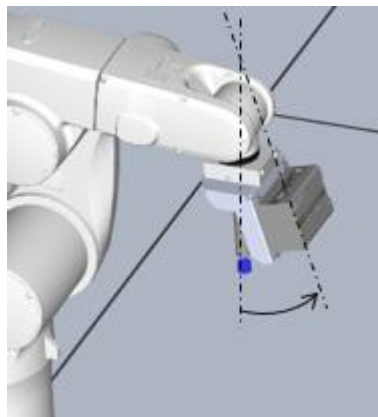

	Example 1	Example 2
Z axis rotation	<p>Z axis rotation=0deg</p>	<p>Z axis rotation=-90deg</p>
Y axis rotation	<p>Y axis rotation=0deg</p>	<p>Y axis rotation=0deg</p>

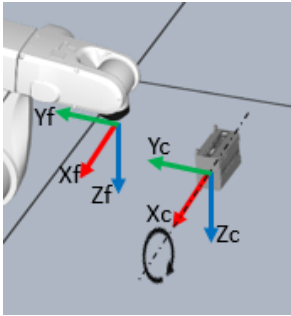
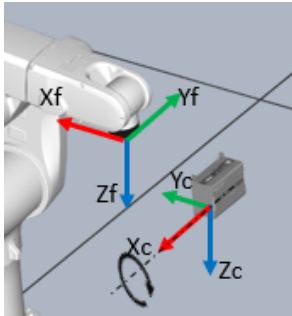
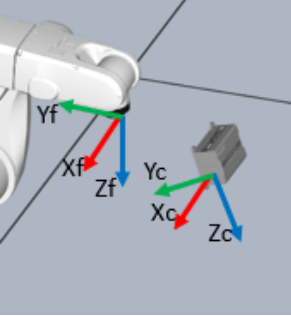
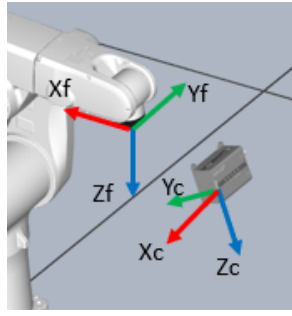
<p>X axis rotation</p>	 <p>X axis rotation=15deg</p>	 <p>X axis rotation=15deg</p>
<p>Settings</p>	 <p>Camera Y-axis minus : <input type="text" value="Custom"/></p> <p>Posture RX [deg] : <input type="text" value="15.0000"/> <input type="button" value="..."/> <input type="button" value="&lt;"/> <input type="button" value="&gt;"/></p> <p>Posture RY [deg] : <input type="text" value="0.0000"/> <input type="button" value="..."/> <input type="button" value="&lt;"/> <input type="button" value="&gt;"/></p> <p>Posture RZ [deg] : <input type="text" value="0.0000"/> <input type="button" value="..."/> <input type="button" value="&lt;"/> <input type="button" value="&gt;"/></p> <p>Posture type : <input type="text" value="ZYX Euler angle"/></p>	 <p>Camera Y-axis minus : <input type="text" value="Custom"/></p> <p>Posture RX [deg] : <input type="text" value="15.0000"/> <input type="button" value="..."/> <input type="button" value="&lt;"/> <input type="button" value="&gt;"/></p> <p>Posture RY [deg] : <input type="text" value="0.0000"/> <input type="button" value="..."/> <input type="button" value="&lt;"/> <input type="button" value="&gt;"/></p> <p>Posture RZ [deg] : <input type="text" value="-90.0000"/> <input type="button" value="..."/> <input type="button" value="&lt;"/> <input type="button" value="&gt;"/></p> <p>Posture type : <input type="text" value="ZYX Euler angle"/></p>

Note: For convenience of explanation, the positions of the flange and 3D Vision Sensor are drawn apart.



■ Supplementary Information on Sampling Settings:

The following shows sampling setting parameters with an image of the working range of the robot.

For details on each parameter, refer to the *Vision System FH series Processing Item Function Reference Manual for 3D Robot Vision* (Cat. No. Z445).

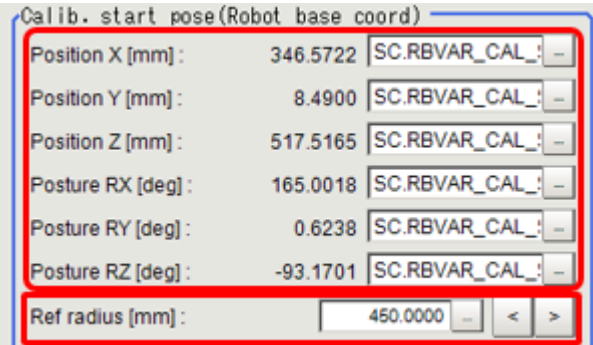
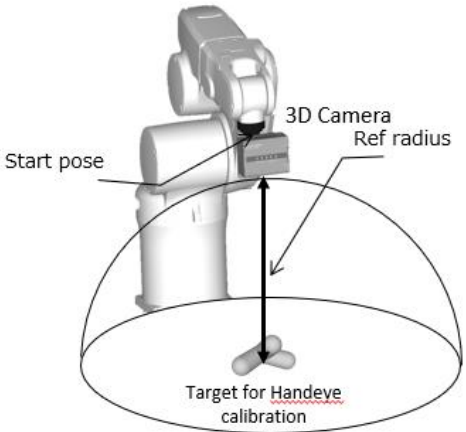
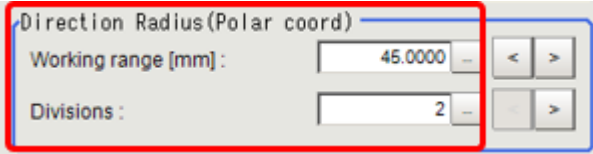
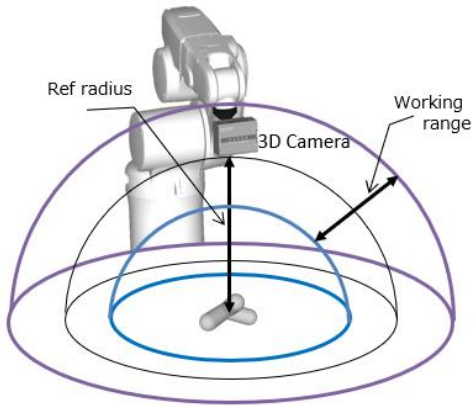
Sampling setting	Working range
 <p>Note: <b>Calib. start pose</b> is the position that you registered in <b>Calib. Start Position</b>.</p>	 <p><b>[Calib. Start pose and Ref radius]</b></p>
 <p>The movement range of the robot in the radial direction relative to the calibration target.          If Ref radius is 450 mm and Working range is 45 mm, a hemispherical trajectory with a minimum of 427.5 mm and a maximum of 472.5 mm will be created.          If the number of divisions is 2, the target will be captured from hemispherical trajectories with radii of 427.5 and 472.5.          If the number of divisions is 3, the target will be captured from three-layered hemispherical trajectories with radii of 427.5, 450.0, and 472.5 mm.</p>	 <p><b>[Direction Radius( Polar coord)]</b></p>



Direction Polar (Polar coord)

Working range [deg]:  < >

Divisions:  < >

The angle range in which the hand-eye calibration target is seen with the Calib. start pose as the starting point. If Working range is 40 deg and the number of divisions is 4, the target will be captured at angles obtained by dividing the angle range from -20 to +20 deg by 4.

If Working range is too large, the robot may collide with the camera or move out of its movement range, which makes it impossible to capture the target. Be sure to set a safe range.

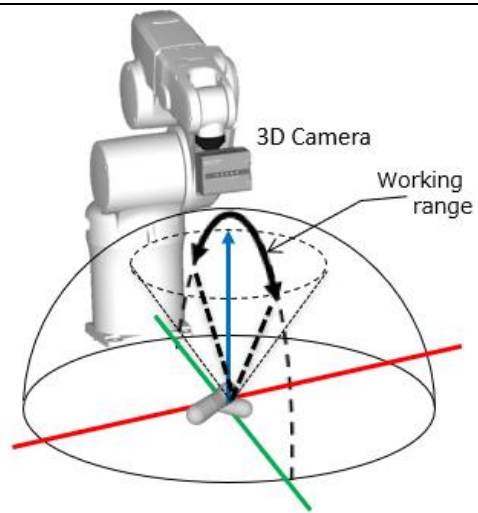

**[Direction Polar (Polar coord)]**

Direction Azimuthal (Polar coord)

Working range [deg]:  < >

Divisions:  < >

The angle range centered on the hand-eye calibration target. The set range will be symmetrical when seen from the robot.

If Working range is 40 deg and the number of divisions is 4, the target will be captured at angles obtained by dividing the angle range from -20 to +20 deg by 4.

If Working range is too large, the robot may collide with the camera or move out of its movement range, which makes it impossible to capture the target. Set the angle in a safe range depending on the robot and environment.

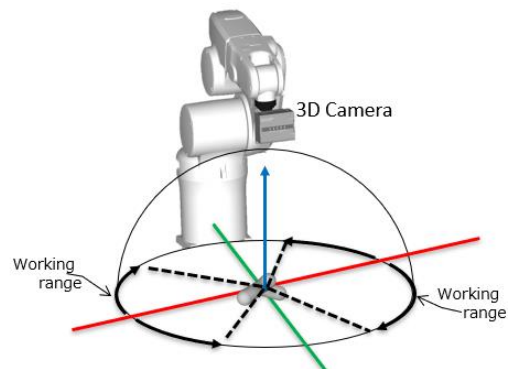

**[Direction Azimuthal (Polar coord)]**

Perturbation(Sphere center coord)

Working range X [deg] :	<input type="text" value="2.0000"/>	-	<	>
Working range Y [deg] :	<input type="text" value="2.0000"/>	-	<	>
Working range Z [deg] :	<input type="text" value="4.0000"/>	-	<	>

Set the angles at which the imaging direction of the 3D Vision Sensor is shifted from the imaging position determined by radial, polar angular, and azimuthal movements. Setting these angles is effective to stabilize the calculation for hand-eye calibration. If the values are too large, target for hand-eye calibration may be out of the field of view. Normally, there is no need to change the default settings.

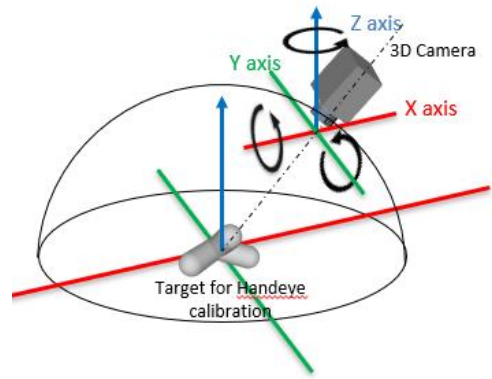

**[Perturbation (Sphere center cord)]**

### 8.7.7. Hand-Eye Calibration Execution

Execute hand-eye calibration based on the settings described in the previous sections. Make sure that the warmup of the 3D Vision Sensor is completed before you execute hand-eye calibration.

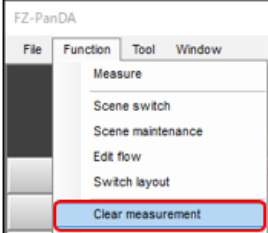
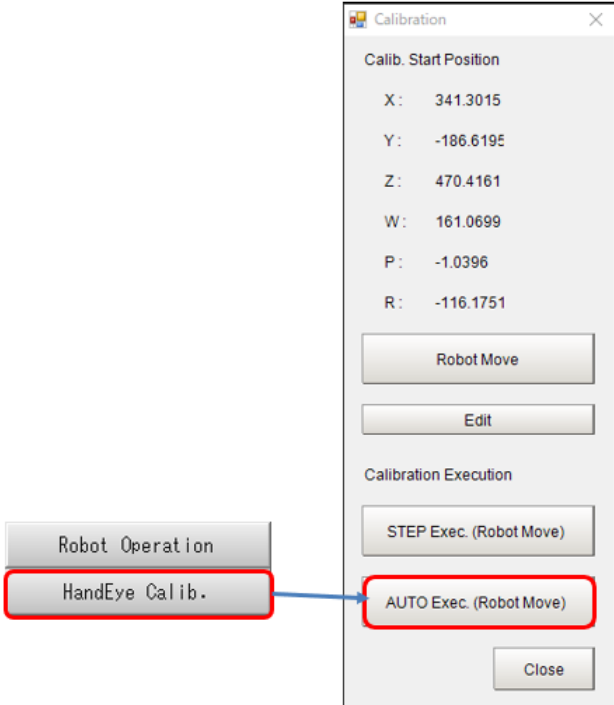
Step	Description	Window image, diagram
1	<p>From the <b>Function</b> menu of the main window of the vision sensor, select [Clear measurement]. This must be done every time before executing Hand-eye calibration.</p>	
2	<p>Click the <b>HandEye Calib.</b> button on the main window of the vision sensor. Then click the <b>Auto Exec (Robot Move)</b> button or <b>Step Exec.(Robot Move)</b> to start auto calibration operation.</p> <p><b>Auto Exec (Robot Move):</b> Click this button to execute automatic hand-eye calibration in which the robot automatically moves to all sampling coordinates and captures images. The execution time of the hand-eye calibration depends on the settings in the Sampling settings tab and the speed setting of the robot.</p> <p><b>Step Exec.(Robot Move):</b> Every time you click this button, the robot moves sequentially to the set sampling coordinates and captures an image. Click the button as many as the number of the set sampling coordinates to complete the hand-eye calibration.</p>	

The progress of the hand-eye calibration is indicated as *Number of executed steps/Total number of steps* in **Step** in the detailed result display window.

When the hand-eye calibration is completed, (*Completed*) will appear next to **Step**.



## WARNING

- Clicking [Auto Exec(Robot Move)]or [Step Exec.(Robot Move)] drives the robot.
- Operate the robot in the state whereby pressing the [Emergency stop] button can stop its motion anytime.



## Caution

- Make sure that an appropriate robot speed is set according to the procedure described in 8.7.1 before you execute calibration.
- Make sure to confirm the robot movement by actually observing it instead of relying on the camera image.
- If you click the **AUTO Exec.** or **STEP Exec.** button when the warmup of the 3D Vision Sensor is not completed, the measurement will be NG and the hand-eye calibration will not complete. Try again after the warmup is completed.



3 When Hand-eye calibration is complete, the robot moves back to the calibration start point. Click the “Hand-Eye Calibration” processing item icon and then open its “Calibration result” tab.

The results for Positions X, Y, Z and Posture RX, RY, RZ indicate the offset between the optical origin of the camera coordinate system and the origin of the flange coordinate system obtained as a result of hand-eye calibration.

If they do not deviate significantly (a few centimeters or more, or 5 degrees or more) from the settings in the Instruments settings tab, and the error evaluation values are less than 1.0, the calibration will be completed.



Camera coordinate seen from Robot frange coordinate

	Result	Error evaluation
Position X [mm]:	19.1093	0.1643
Position Y [mm]:	-92.9169	0.1512
Position Z [mm]:	13.2291	0.2446
Posture RX [deg]:	14.1970	0.2329
Posture RY [deg]:	0.2340	0.1198
Posture RZ [deg]:	0.2550	0.2736

Posture type : ZYX euler angle (\*)

Homogeneous transformation matrix expression

1.0000	-0.0033	0.0051	19.1093
0.0044	0.9695	-0.2452	-92.9169
-0.0041	0.2453	0.9695	13.2291

Enable edit Clear

The origin of the actual camera coordinate system is located inside at about a few more than 10 mm from the surface of the 3D vision camera. Therefore, the indicated result for Position Z will be 10 and a few mm smaller than the setting.

If there is a large error, change the value of the setting in the Sampling settings tab and execute hand-eye calibration again.

The calculation of the hand-eye calibration is now completed. Click the **OK** button to close the setting window.

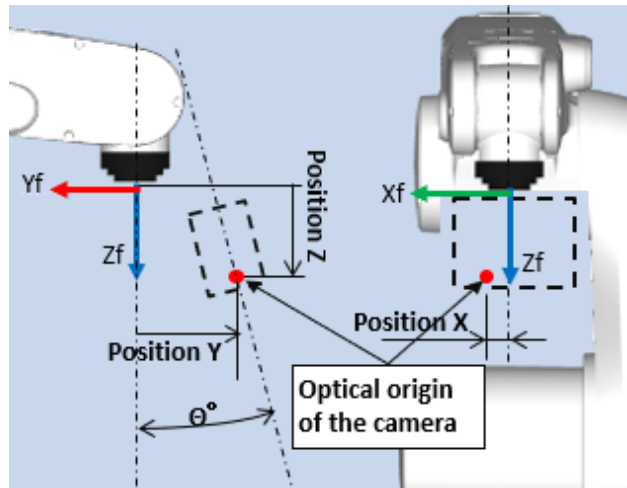

#### **Precautions for Correct Use**

- If the calibration results show an error evaluation value of 1.0 mm or 1.0 deg or larger, the sampled data may contain undesirable values (measurement errors, robot movement errors, etc.), or the sampling points may not be appropriate. The errors may become larger when the position and posture in the camera coordinate system detected by the 3D Vision Sensor is converted into those in the robot coordinate system.
- For how to adjust the settings when the calibration results show an error evaluation value of 1.0 mm or 1.0 deg or larger, refer to *Key Points for Measurement and Adjustment in Hand-eye Calibration processing item* in the *Vision System FH series Processing Item Function Reference Manual for 3D Robot Vision* (Cat. No. Z445).

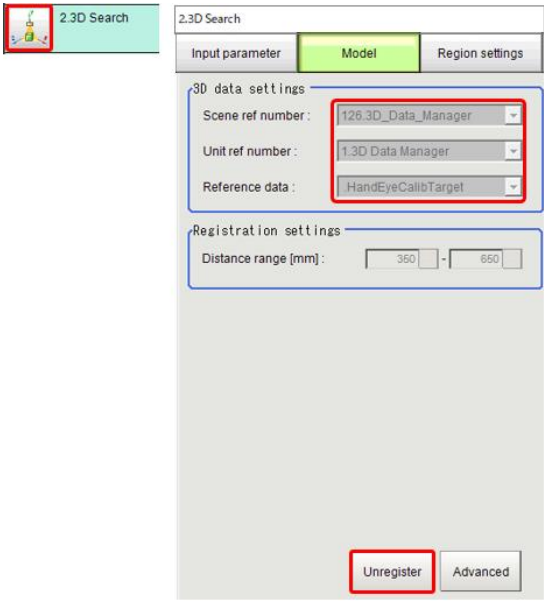
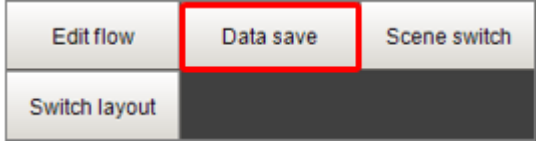
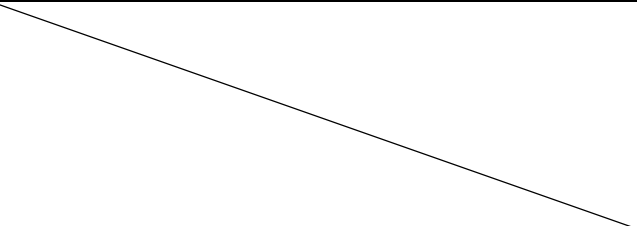
<p><b>4</b></p>	<p>Open the 3D Search processing item and click the <b>Unregister</b> button in the Model tab to unregister the model.</p> <p>After the hand-eye calibration is completed, the 3D Search model of the hand-eye calibration target is no longer needed.</p> <p>You can unregister it to reduce the scene size.</p> <p>Click the <b>OK</b> button to close the setting window.</p>	
<p><b>5</b></p>	<p>In the main window, click the <b>Data save</b> button to save the results of the hand-eye calibration.</p>	
<p><b>6</b></p>	<p>Stop the robot program that you started in 8.7.1.</p> <p>For how to stop the program, refer to the <i>Robot Connection Guide</i> for each robot.</p>	

### 8.7.8. Troubleshooting for Hand-eye Calibration

If 3D Search or calibration fails, refer to *Key Points for Measurement and Adjustment* in the *Vision System FH series Processing Item Function Reference Manual for 3D Robot Vision* (Cat. No. Z445).

## 8.8. Pick Application Flow for the Hand-Eye Camera System

This section describes sample flow building procedure for Pick & Place application.

The procedure consists of 3D camera setting, Container and floor registration, Search model registration and 3D Search setting, Hand and Grasp point registration, Grasp plan setting and Output destination position and posture to the robot.

Before proceeding with the steps in this section, please complete the settings described in section 8.7.

The description here assumes that the Layout 0 window is displayed.



### Precautions for Correct Use

- The Pose and posture output of Grasp Planning unit in section 8.8.7 is expressed in the robot base coordinate. Please set the robot to the robot base coordinate system.
- Do not change the default values of system variables and scene variables. If you change them, the robot will not operate correctly.
- For robot-related settings, refer to the *Vision System FH/FHV series Robot Connection Guide* corresponding to the robot listed in *Related Manuals*. In this manual, it is referred to as *Robot Connection Guide*.

Use the following work flow to configure the settings.

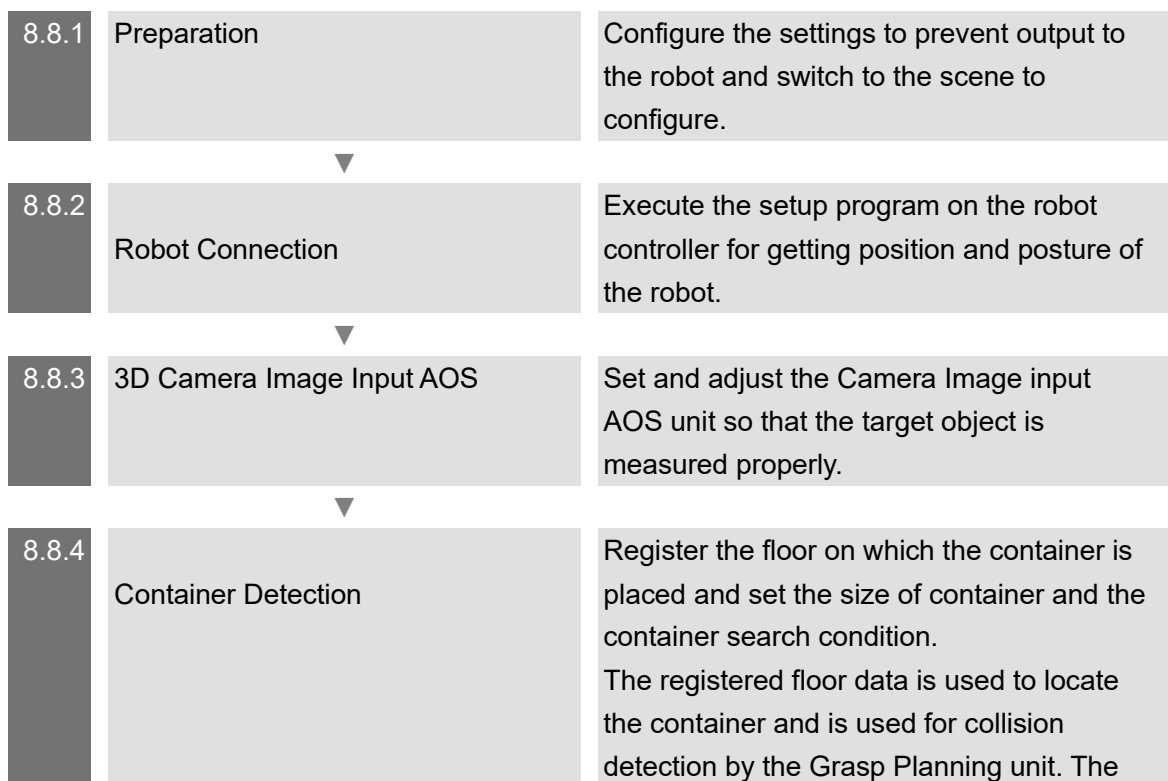



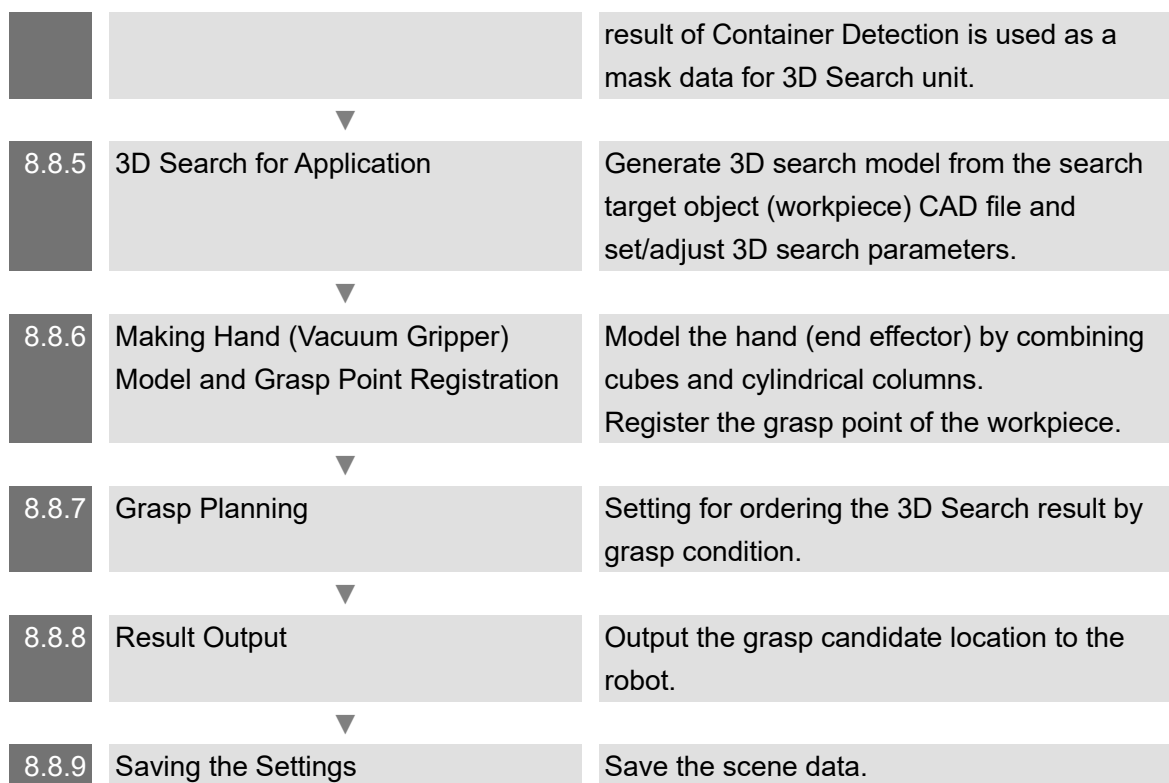

### 8.8.1. Preparation

Switch to the scene to configure.

Loading a sensor controller project sets the scene named “Pick on hand\_6 axis” for Scene No. 0 as a sample scene for the picking application.





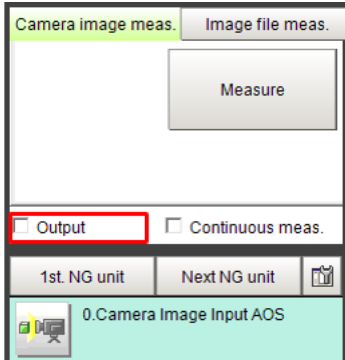
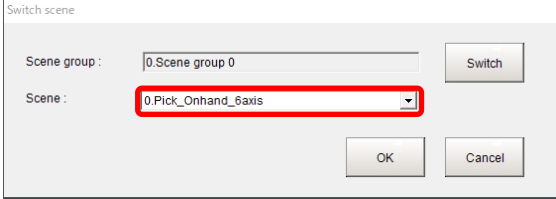

#### Precautions for Correct Use

- When you create a new scene for picking, be sure to copy the “Pick\_Onhand\_6axes” of Scene No as a template. 0. And use the scene maintenance copy function to copy the scene. The application will not operate normally if you combine individual processing items. The sample scene is configured with system variables and scene variables that are required to construct an application.

Step	Description	Window image, diagram
1	On the main screen of the vision sensor, uncheck the <b>Output</b> checkbox to avoid unexpected robot motion while doing the setting procedures	
2	Switch to the scene for picking. The scene “0.Pick_Onhand_6axis” that you copied by using the scene maintenance copy function.	

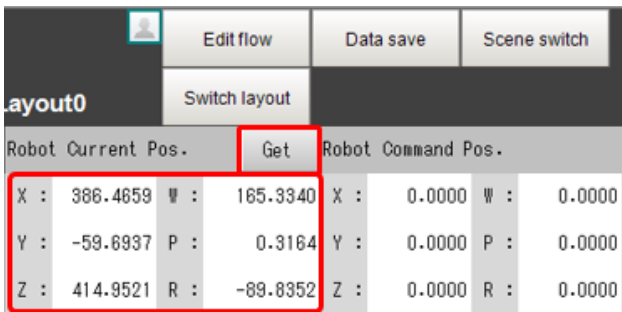
## 8.8.2. Robot Connection

Check the network connection between the Vision Sensor and the robot, and move the robot to the imaging position.

Step	Description	Window image, diagram
1	<p>Run the setup program on the robot controller according to the "Robot Connection Guide section 5".</p>	<div style="text-align: center; background-color: black; color: white; padding: 10px;">  <b>WARNING</b> </div> <ul style="list-style-type: none"> <li>• The setup program drives the robot.</li> <li>• Operate the robot in the state whereby pressing the [Emergency stop] button can stop its motion anytime</li> </ul> <div style="text-align: right; padding-right: 20px;">  </div>
2	<p>Click the <b>Get</b> button. Confirm that the current position of the robot is displayed.</p>	
3	<p>Set the operation speed of the robot to perform jog operation of the robot.</p> <p>In the main window, click the <b>Robot Operation</b> button. Then, in the Robot Operation dialog displayed, click the <b>Edit</b> button and set the operation speed of the robot.</p>	
<div style="text-align: center; background-color: black; color: white; padding: 10px;">  <b>Caution</b> </div> <ul style="list-style-type: none"> <li>• The operation speed of the robot depends on the robot model and settings. Set a safe speed depending on each robot.</li> </ul> <div style="text-align: right; padding-right: 20px;">  </div>		

4 Operate the robot to the measurement position.  
Set the distance between the target workpiece and the 3D Vision Sensor in the Z direction to 400 to 600 mm.  
Click the **Robot Operation** button in the main window and use the **Jog Operation** buttons to operate the robot. You may use the robot pendant to perform jog operation. Here, move to an approximate position and finely adjust it later while checking the field of view.

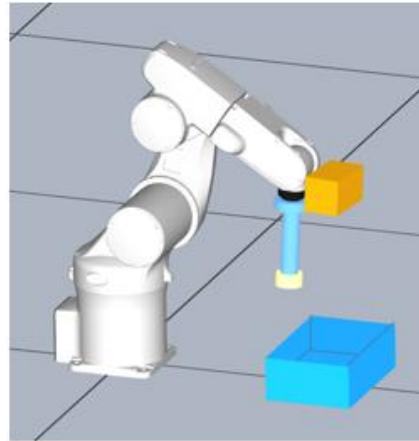



### 8.8.3. 3D Camera Image Input AOS

Follow the procedures below to set shutter speed, gain and depth range so that the target object be measured properly.

For details on each parameter of the Camera Image Input AOS processing item, refer to *Camera Image Input AOS* in the following manual.

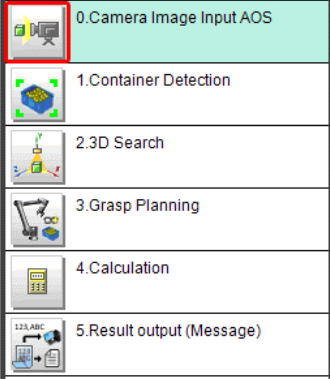
*Vision System FH series Processing Item Function Reference Manual for 3D Robot Vision* (Cat. No. Z445)

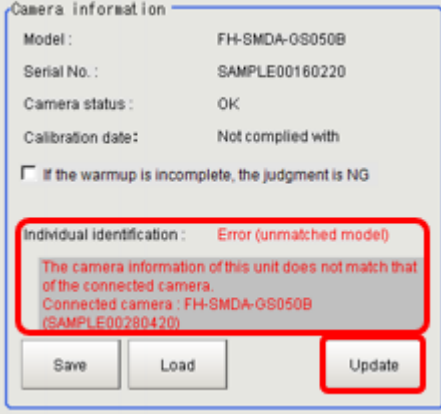
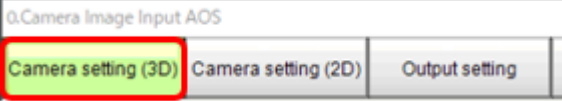
Step	Description	Window image, diagram
1	<p>Click the “0.Camera Image Input AOS” icon on the Main window of the Vision Sensor to open the setting screen.</p> <p>If you change the connected 3D Vision Sensor, an error will be displayed for <b>Individual identification</b> in the Select camera tab.</p> <p><b>Update</b> button to import camera parameters from the connected 3D camera.</p> <p>Without doing this procedure, the Camera Image Input AOS will not execute 3D image measurement.</p>	 <p>0.Camera Image Input AOS</p> <p>1.Container Detection</p> <p>2.3D Search</p> <p>3.Grasp Planning</p> <p>4.Calculation</p> <p>5.Result output (Message)</p>  <p>0.Camera Image Input AOS</p> <p>Camera setting (3D) Camera setting (2D) Output setting <b>Select camera</b></p>  <p>Camera information</p> <p>Model : FH-SMDA-GS050B</p> <p>Serial No. : SAMPLE00160220</p> <p>Camera status : OK</p> <p>Calibration date : Not complied with</p> <p><input type="checkbox"/> if the warmup is incomplete, the judgment is NG</p> <p><b>Individual identification : Error (unmatched model)</b></p> <p>The camera information of this unit does not match that of the connected camera.</p> <p>Connected camera : FH-SMDA-GS050B (SAMPLE00280420)</p> <p>Save Load <b>Update</b></p>
2	<p>Open the Camera setting (3D) tab.</p>	 <p>0.Camera Image Input AOS</p> <p><b>Camera setting (3D)</b> Camera setting (2D) Output setting</p>

Set an appropriate “Measurement range of Z” between 400-600mm. “Measurement range of Z” is the distance from the 3D camera to target object.

The camera Through image will be displayed by clicking the **Change display** button.

Adjust shutter speed, camera gain and Light gain so that the 3D depth image be captured properly.

When adjusted properly, you will see the target object 3D depth image similar to that shown in the figure on the right. Black color denotes unmeasurable or out of range area.

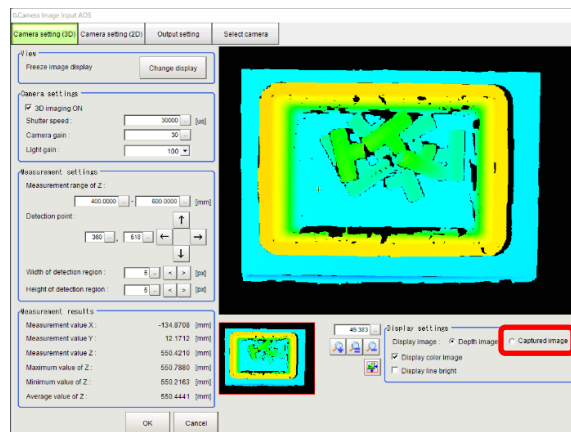
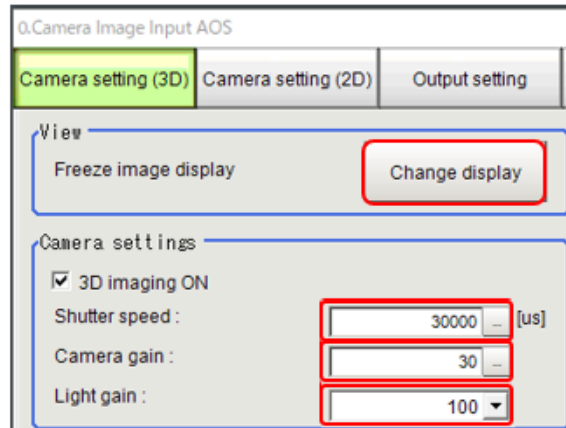
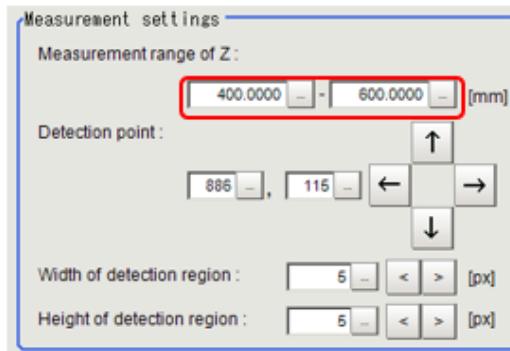

If you see only a black image in the window, check the box for “Captured Image” in the “Display setting” at the bottom right of the screen and confirm whether you can observe the projected mesh pattern image on the target object.

After you configure the camera settings, click the **Change display** button again to freeze the image display.

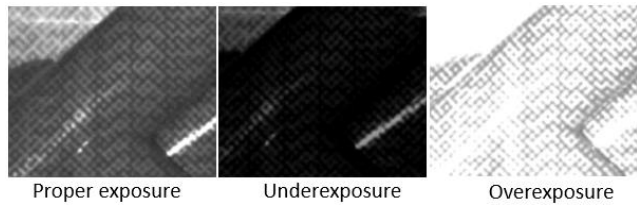

3 Open the Camera setting (3D) tab for 2D image capture setting.

The camera Through image will be displayed by clicking the **Change display** button.

Adjust shutter speed, camera gain and Light gain so that the 3D depth image be captured properly.

As with the settings for processing item such as Shape Search III that uses the edges of images, set the conditions to achieve good contrast of the target workpiece and container.

After you configure the camera settings, click the **Change display** button again to freeze the image display.

Click **OK** to complete setting and close the setting screen.

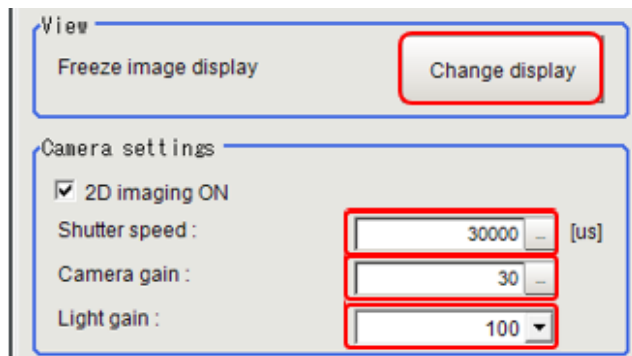
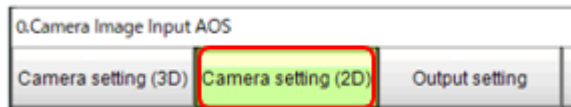



### **Precautions for Correct Use**

---

- Setting different shutter speeds in the Camera setting (3D) and Camera setting (2D) tabs results in an overhead of about 50 ms in the imaging time. Set the same value as much as possible. If you cannot set the same value, adjust the shutter speeds by the camera gain and light gain.  
Increasing the camera gain in Camera setting (3D) tab does not have significant effect on the detection accuracy of 3D Search.
-



### 8.8.4. Container Detection

Follow the procedures below to register the floor where the container is placed and set the size of container and container search condition. The registered floor data is used to locate the container and used for collision detection by the Grasp Planning unit. The Container Detection unit uses 2D image, so change Camera Image Input AOS setting enables to capture 2D image.

Detectable containers are limited to those listed in 3.3. There is also a limitation in size that they must fit entirely in the field of view of the 3D vision camera.

Registering and detecting a container allows for container detection between the container and the hand (8.8.7).

For details on each parameter of the Container Detection processing item, refer to *Container Detection* in the following manual. *Vision System FH series Processing Item Function Reference Manual for 3D Robot Vision* (Cat. No. Z445)

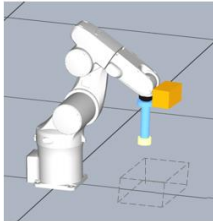
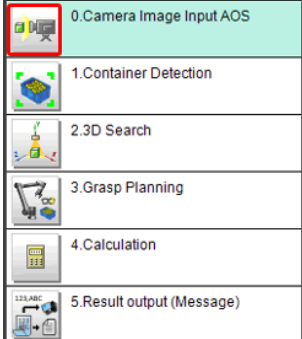
Step	Description	Window image, diagram
1	<p>Operate robot to the measurement position. Make sure the floor is clear (no container, no workpiece).</p> <p>Click the “0.Camera Image Input AOS” icon on the Main window of the Vision Sensor to open the setting screen.</p>	 

Open “Camera Setting 3D” tab and click **Display Change**.

Then Confirm that the floor is measured correctly.

If the depth image is not captured stably due to glossy or uneven surface, place a piece of thin, white paper on the floor.

After confirming the above, place the container on the floor.

Open “Camera Setting 2D” tab

Confirm that the container is in appropriate imaging conditions (detectable by Shape Search III) with the condition settings in the Camera setting (2D) tab in 8.8.3.

By doing the above, 3D setting for the floor measurement and 2D setting for the container measurement are completed. Click [OK] to close the setting screen.

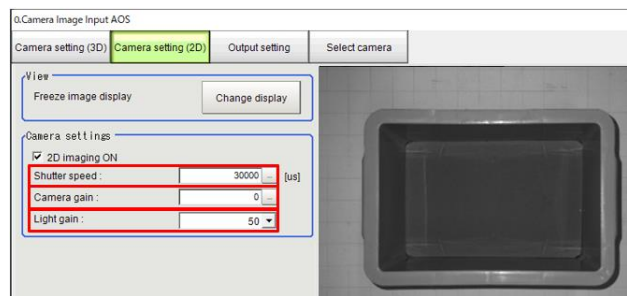
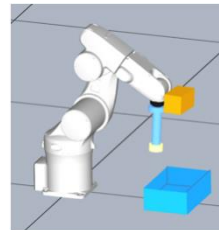
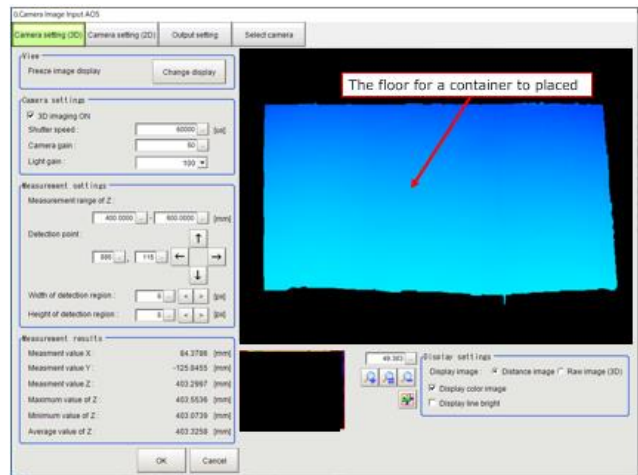



## Precautions for Correct Use

- If the container position is fixed and the condition settings in 8.8.3 are inappropriate for detection, once adjust the imaging condition settings to achieve appropriate conditions for container detection and then perform container detection. After completion of the container, return to the condition settings in 8.8.3 .
- If you need to detect the container position every time, return to the Camera setting (2D) tab in 8.8.3 and configure the condition settings so that both the workpiece and the container can be appropriately measured.

2 If you have adjusted the robot position after the connection check with the robot in 0, click the **Get** button in the main window to reacquire the current position of the robot.

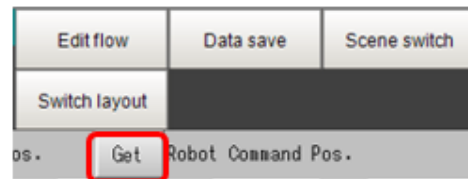

3 Make sure the floor is clear (no container, no workpieces) and click [Measure] to measure the floor plane without the container.

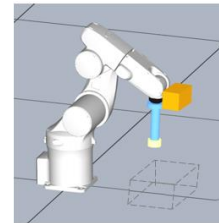
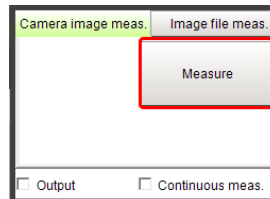

4 Click the “1.Container Detection” icon on the Main windows of the Vision Sensor to open setting screen.

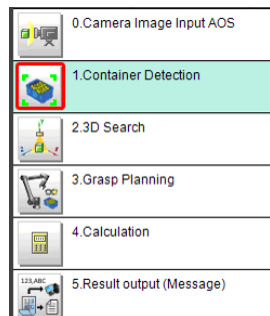

Open “Input parameters” tab and confirm that the Input settings are as shown in the right figure.

Usually no change from the initial settings is needed.

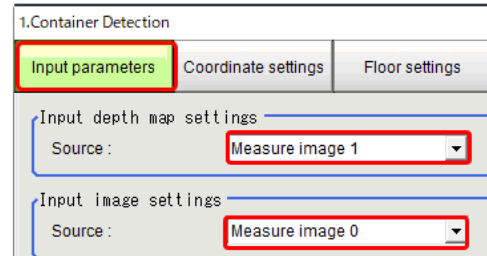

5 Open “Coordinate settings” tab. Confirm that the processing unit set in section 8.7 “Hand-Eye Calibration Execution” is present.

Confirm that “Flange coord. seen from robot base coord” values are same as the robot current position.  
The robot current position represents the position that you obtained by pressing the **Get** button in the main window.

The screenshot shows the 'Coordinate settings' tab selected. It contains three main sections:

- Output coordinate settings:** 'Coordinate kind' is set to 'Robot coordinate'.
- Hand-Eye data unit settings:** 'Scene ref number' is '125.Handeye\_Calibration\_P' and 'Unit ref number' is '3.HandEye Calibration'. Below these are fields for 'Robot type' (6-axis(XYZWPR) robot), 'Robot posture' (ZYX Euler angle), 'Camera mount' (On hand camera), and 'Robot mount' (Floor mount).
- Flange coord. seen from robot base coord:** A table of values:
 

Position X [mm] :	386.4659	SY.RBVAR_CUR_I
Position Y [mm] :	-59.6937	SY.RBVAR_CUR_I
Position Z [mm] :	414.9521	SY.RBVAR_CUR_I
Posture RX [deg] :	165.3340	SY.RBVAR_CUR_I
Posture RY [deg] :	0.0000	SY.RBVAR_DST_F
Posture RZ [deg] :	-89.8352	SY.RBVAR_CUR_I

 The posture type is 'ZYX'.

6 Open the “Floor Settings” tab and then Click the **Edit** button to specify the floor region for measurement.

The position of the container is based on the floor set here. Register only the floor on which the container will be placed.

The screenshot shows the 'Floor settings' tab selected. It features a 'Plane region' section with a 'Registered figure' input field and an 'Edit' button.

You can also register the region by dividing it into up to four multiple areas. Register area that are on the same plane.

Do not include surfaces with different heights or gradients.

If the registered areas are too small, the registration will fail, or error will be large.

If the area is small in one area, set up four arbitrary area on the same plane.

Click **OK** to finish floor region setting.

Click the **Measure** button and register the floor on which the container will be placed.

The information on the detected floor surface will be displayed in **Floor detection result**.

Confirm that the value of **Position Z [mm]** does not deviate significantly from the distance between the 3D Vision Sensor and the floor surface.

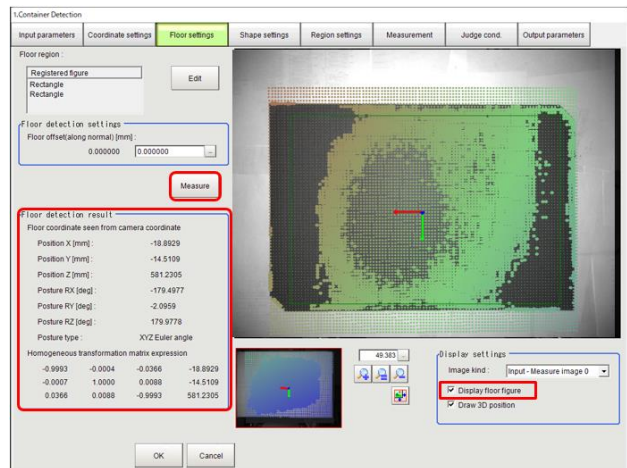
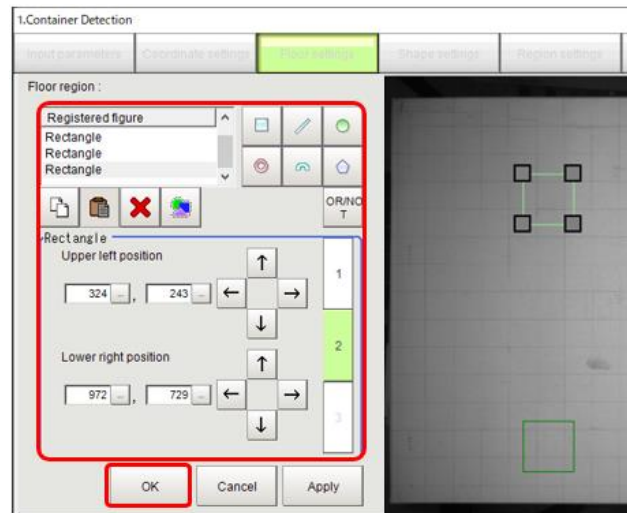

Checking **Display floor figure** in **Display settings** displays 100 by 100 dots in the pane.

The color of the dots indicates the distance from the camera, which is the same as the distance image display in the Camera Image Input AOS processing item.

The diameter of points with a smaller error in the measured value than the value of the registered plane will be displayed larger. Confirm that points with large diameters are distributed over the entire measurement region that you set.

If the points with large diameters are biased to either side or in parts of the measurement region, check

Example of an image that is distributed throughout

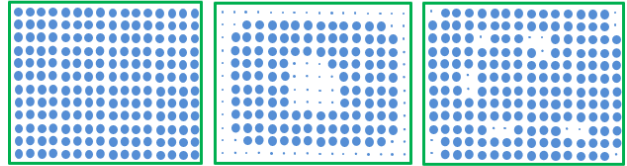

Example of an unevenly distributed image

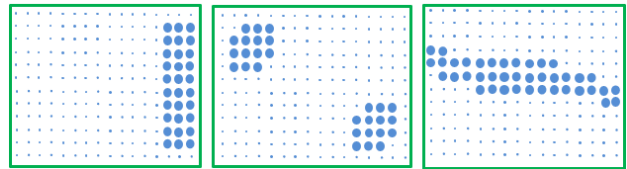

## Caution

- If you have changed the height or gradient of the floor surface on which the container is placed, the imaging position, or the position or posture of the robot after you clicked the **Measure** button in the Floor setting tab, redo the floor registration from Step 2 (reacquisition of the current position of the robot) of this procedure. Otherwise, the robot hand may collide with the floor.



7 Place the container on the floor of measurement position.

Click **Measure** button on the Main Window and capture a 2D image of the container.

The container is registered at the imaging position. If you have corrected the position, click the **Measure** button and capture the image again.

Click "1,Container Detection" icon again and open setting screen again.

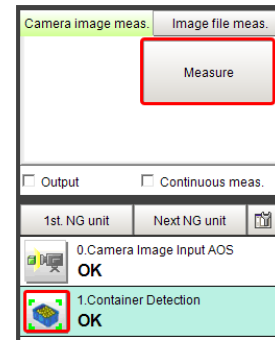
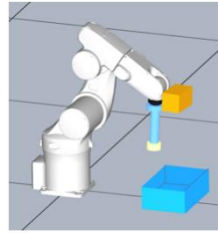

8 Open "Shape settings" tab to set size of the container.

You can register only the supported containers shown in 3.3.

The width is the horizontal direction of the camera image (X axis), and the depth is the vertical direction of the camera image (Y axis).

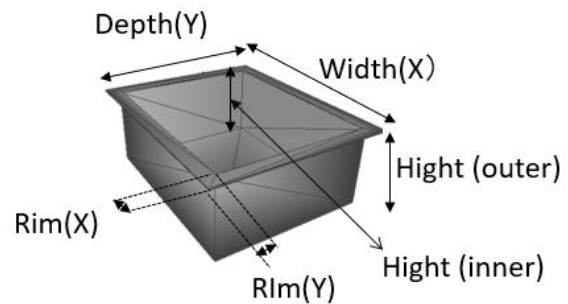
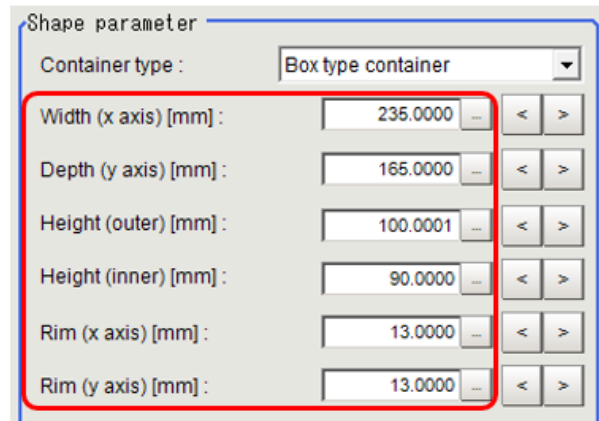
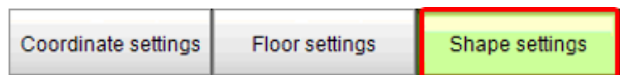

After you enter the shape parameters, green lines that represent the rims of the container seen from directly above are displayed in the center of the pane.

Check that there is no deviation in size.

Note that the position of the lines appears to be misaligned with the container image because the container is not detected yet.

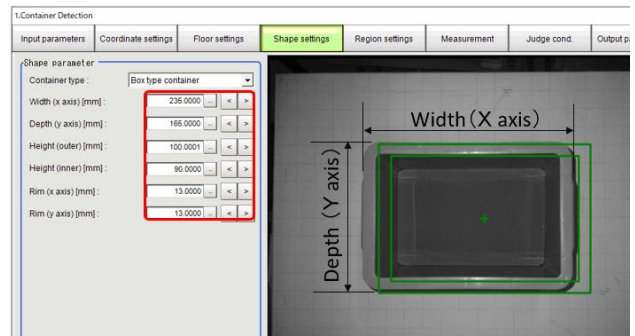

- 9 Open "Region settings" tab and click **Edit** to set search region of the container.

Specify the container search region.

Click the **OK** button to complete region setting.

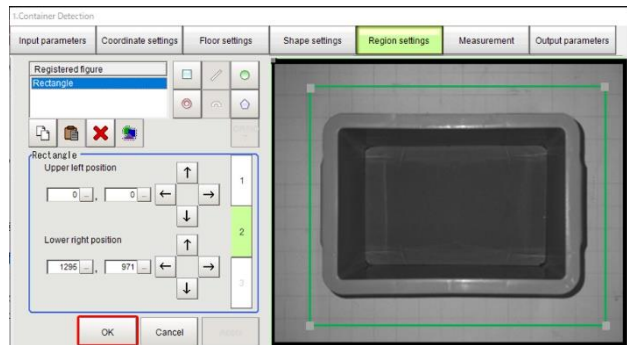
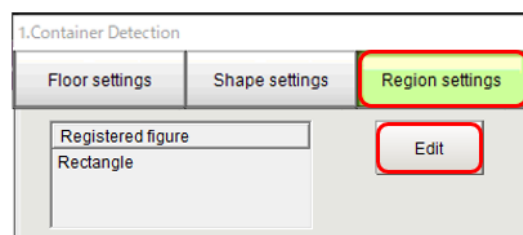



10 Open “Measurement” tab and detect the container by setting above.  
Confirm that the box for [Measure once] is checked.

Click the **Measure** button once.  
The container will be displayed with a green frame as shown in the figure on the right indicating that container detection was successful.

If the detection failed, click the **Advanced** button and adjust edge level. The container will be detected based on the edges of the 2D image.

Clicking the **Draw with 3D** button displays the set container in wireframe with the measurement results overlaid on it.  
Click the **End** button to close the 3D Visualizer window.

Click the **OK** button to close the container detection settings.

The container detection procedure stores the shape and position of the container in the robot base coordinate system.  
If you have changed the position of the container, redo the procedure from Step 7 (measurement of the container image).

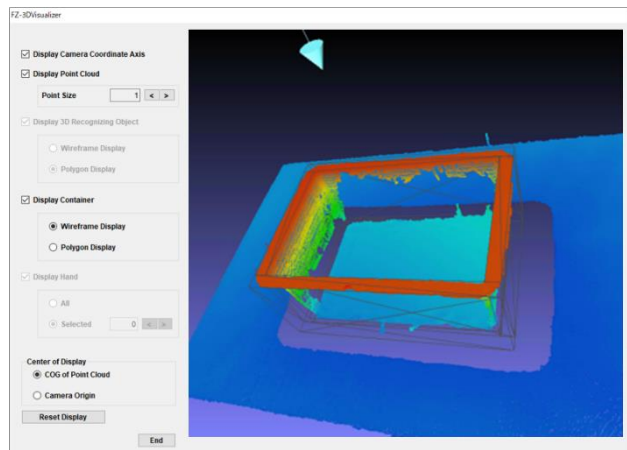
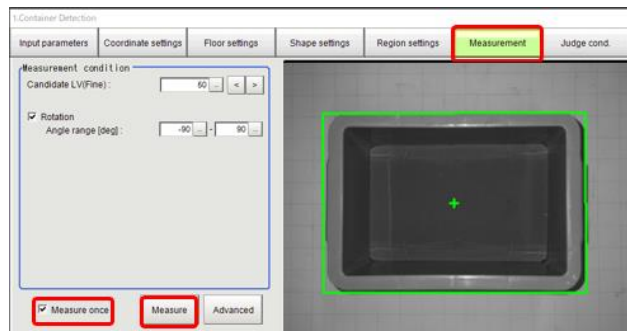

## Caution

- If you uncheck **Measure once** in the Measurement tab to measure the position of the container in every measurement, set the container position so that it is not out of the region that you set in the Region settings tab. In addition, make sure that the container can be detected with the workpiece actually contained in the container.



### 8.8.5. 3D Search for Application

Configuring the 3D Search settings consists of loading the CAD data for the search target model, registering the model, and setting search parameters. You can use the setting procedure below to get the 3D position and posture of the search-target workpiece (in the camera coordinate system) from the measurement results of the 3D Vision Sensor.

For details on each parameter of the 3D Search processing item, refer to *3D Search* in the following manual. *Vision System FH series Processing Item Function Reference Manual for 3D Robot Vision* (Cat. No. Z445)



#### Precautions for Correct Use

You can load CAD data in the STL format. For details, refer to *3D Data Manager* in the following manual. *Vision System FH series Processing Item Function Reference Manual for 3D Robot Vision* (Cat. No. Z445)

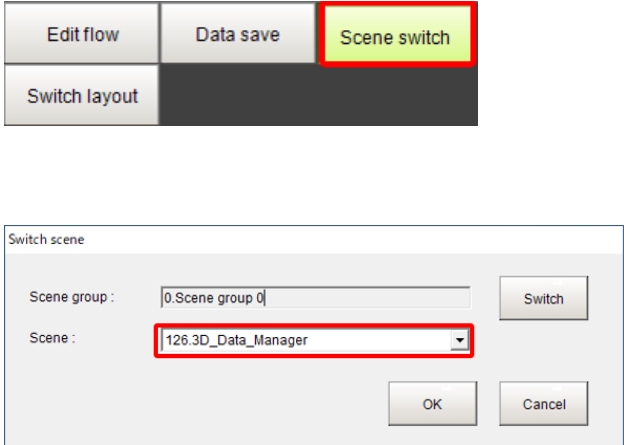
Step	Description	Window image, diagram
1	<p>Click <b>Scene switch</b> button on the main Window of the Vision Sensor.</p> <p>Select scene “126.3D_Data_Manager” which contains the 3D Data Manager unit.</p> <p>Click the <b>OK</b> button to switch the scene.</p>	 <p>The screenshot shows the main window of the Vision Sensor with buttons for 'Edit flow', 'Data save', 'Scene switch', and 'Switch layout'. The 'Scene switch' button is highlighted with a red box. Below this is a 'Switch scene' dialog box. In the dialog, the 'Scene group' is '0.Scene group 0' and the 'Scene' dropdown menu is set to '126.3D_Data_Manager', which is also highlighted with a red box. There are 'Switch', 'OK', and 'Cancel' buttons in the dialog.</p>

2 Insert USB flash drive which stores the target object CAD file into USB port.

Click the “1. 3D Data Manager” icon on the Main window of the Vision Sensor to open the setting screen.

Open the “CAD Data” tab.

Select a number in the list that is not registered.

Click the **Import** button on the bottom left to open File Explorer.

Select the target object CAD file in the USB flash drive and then click the **OK** button to load the file.

The loaded CAD data will be displayed as shown in the figure on the right.

You can use the slider at the bottom right of the window to rotate the loaded CAD data. Confirm the target object is correct. Then click the **OK** button to close the setting screen.

At this point the target object CAD data loading is completed.

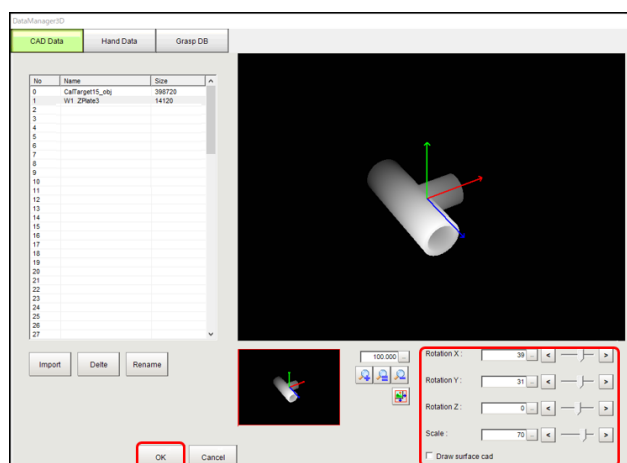
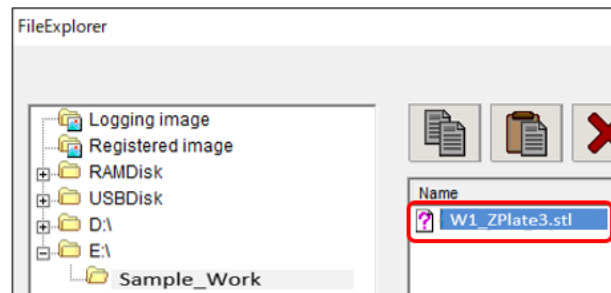
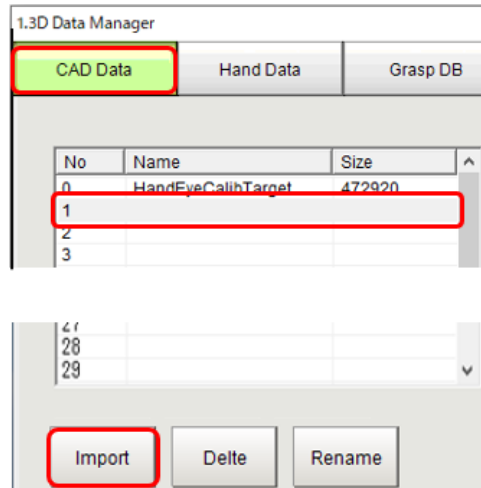
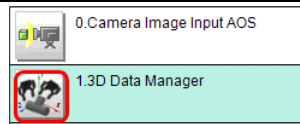



### Precautions for Correct Use

If the size of the CAD data is too large, the display may become very slow. If the display is slow, adjust the granularity of the CAD data output from the CAD software.

- 3 Click **Scene switch** button on the main Window of the Vision Sensor.

Select the sample scene (scene No.0) and Click **OK** button to switch scene.

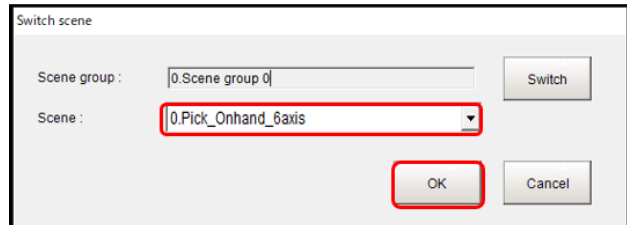

- 4 Put the target workpiece in the container and set the registered container in place.



- 5 In the main window, click the **Measure** button to capture an image according to the camera condition settings in 8.8.3. Although the measurement result will be NG since the settings are not yet complete, proceed to the next step.

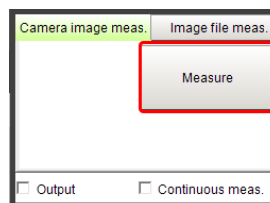

- 6 Click the "2. 3D Search" icon on the Main windows of the Vision Sensor to open its setting screen.

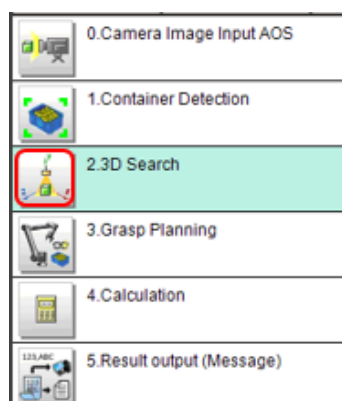

Open the “Input parameter” tab and confirm that Input settings are as shown in the figure on the right. Usually there is no need to change from the initial settings.

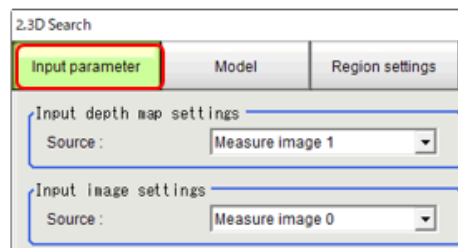

7 Open the “Model” tab to select the target object file.

In “3D data settings”, set the “Reference data” to the target object loaded to 3D Data Manager in STEP 2.

Set the distance range from the 3D camera (camera coordinate system) in which the target objects will be placed. The narrower the range, the shorter the detection time.

If the shape of the model is symmetrical from front to back (i.e., identical even when it is rotated 180 degrees around the X or Y axis from the state displayed in the window) as shown in the figure on the right, adjust the reference posture RX, RY, and RZ values to achieve front to back symmetry and check the **Having front and back symmetry about current view** check box. This will reduce the size of the 3D Search model and speed up the processing time.

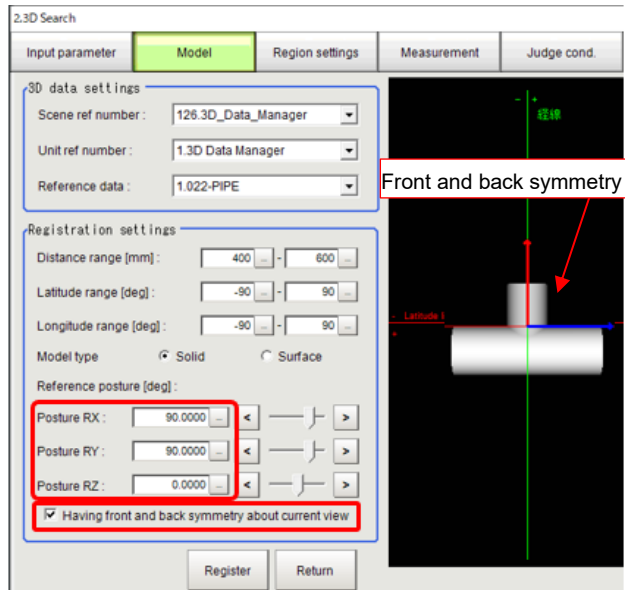
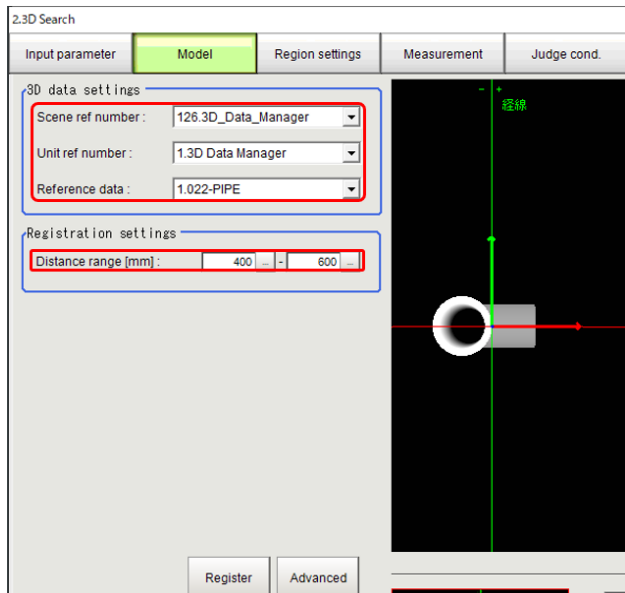

If the model is not symmetrical from front to back, set it to an orientation that secures the largest area in the setting window, or a workpiece posture that frequently appears on the captured image of the actual package.

Click the **Register** button to register the CAD data. This process generates 3D Search model data. “Under registration” message blinks during the registration process. When completed, the label will change to [Unregister].

The registration takes about 90 seconds.



#### Precautions for Correct Use

- Changing the posture in **Display settings** at the lower right of the window does not affect the **Reference posture** settings in the advanced settings. To change the **Reference posture** settings, click the **Advanced** button.

- 8 Open the “Region settings” tab to Set the region so that the measurement FOV covers the container.  
Click the **Edit** button to set the measurement region.

When using result of container detection as a mask, place a check on **Enable masking** and set the container detection unit to Unit ref number of Masking settings.

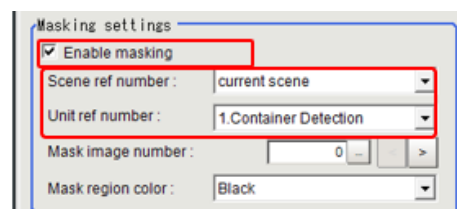
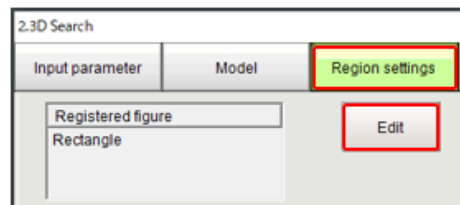

If the container detection is successful, a mask region will appear in the window. If the mask region is colored “black” as shown in the figure on the right, the black region will be excluded from the target of measurement.

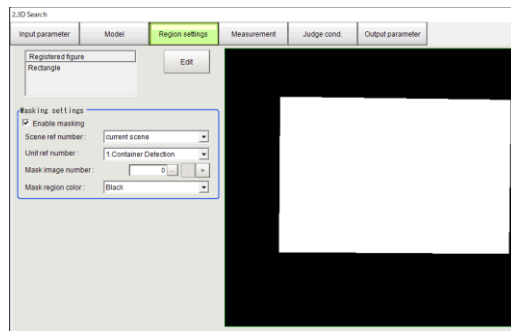

9 Open “Measurement” tab to set measurement condition of 3D search.

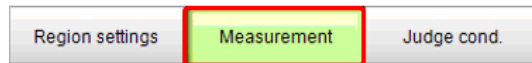

Open “Measurement” tab to set measurement condition of 3D search.

In 3D Search, candidates will be selected at the following two candidate levels.

Candidate Lv.(surface): The match level for curved surfaces between CAD data and measurement result.

Candidate Lv.(contour): The match level for contours between CAD and measurement results.

There is an “OR” relationship between the two candidate levels. Candidates beyond one of the candidate levels will be included in search results.

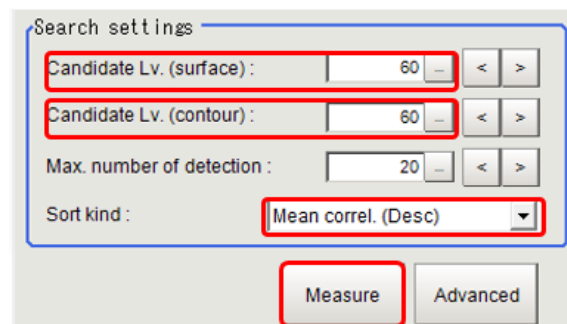

Select “Sort kind” for sort order of searched results

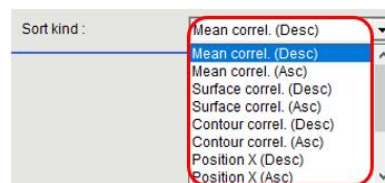



When you want to limit searched candidate posture or distance (from camera), adjust the ranges of Latitude, Longitude, Roll and/or Distance. Click **Return** button to close advanced setting.

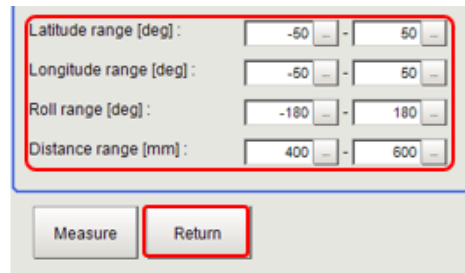

Click the **Draw with 3D** button at the bottom right of the window to start the 3DVisualizer. The searched CAD data will be overlaid on the 3D data. You can check the search results on the 3D display.

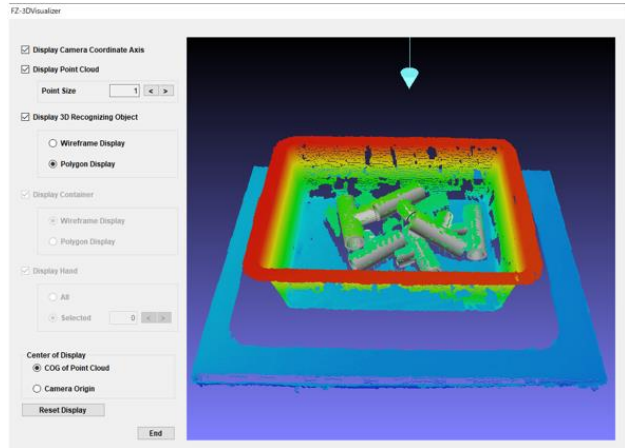

After you check the results, click the **End** button to close the window.

10 If the workpiece cannot be detected with the default parameters, adjust or change any of the following three settings.

- Adjusting the candidate level settings

Decrease the **Candidate Lv. (surface)** and **Candidate Lv. (contour)** values from the default value of 60 to about 40.

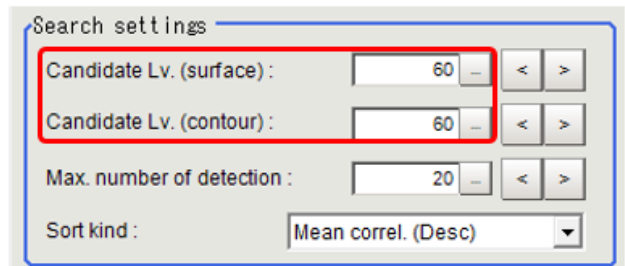

If the search results are displayed, check the surface correlation and contour correlation values and adjust the candidate level settings to a slightly lower value than the detected correlation value.

Candidate Lv. (Surface) < Surface correlation  
Candidate Lv. (contour) < Contour correlation

■ Changing the edge information to use  
 Check **Display contour feature** in **Display settings** to display the contour features.  
 Click the **Advanced** button to open the advanced setting window.

In Edge info used, switch the setting between Depth and Image to compare the contour features.  
 Select the setting with clearer contours and less noise.

■ Adjusting the edge level  
 If the contours are unclear or there is too much noise when the contour features are displayed, uncheck **Auto** for the edge level setting. Adjust the edge level to make the edges clearer with less noise.

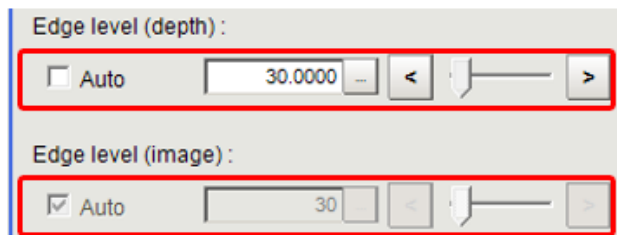
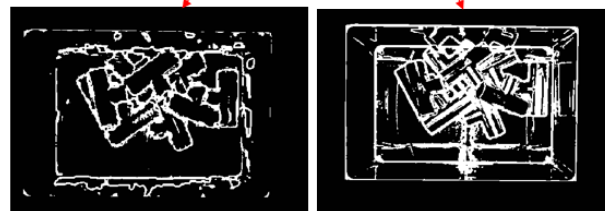
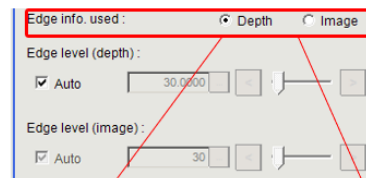
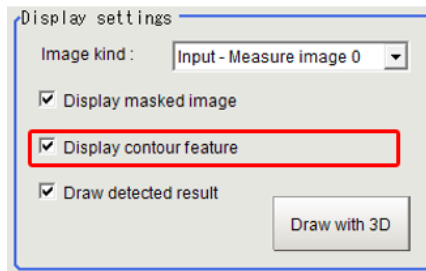

11 Open "Judge Cond" tab to set judge condition.

If judge by position and posture (in camera coordinate) needed, Click [Advanced] button and set range.

Click **Return** button to close advanced setting.

Click **OK** to complete 3D search settings and close the setting window.

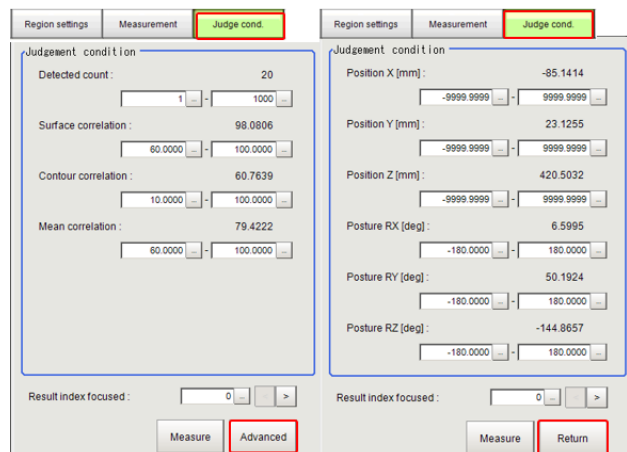

12 In the main window, click the **Measure** button and confirm that the 3D Search results are displayed.

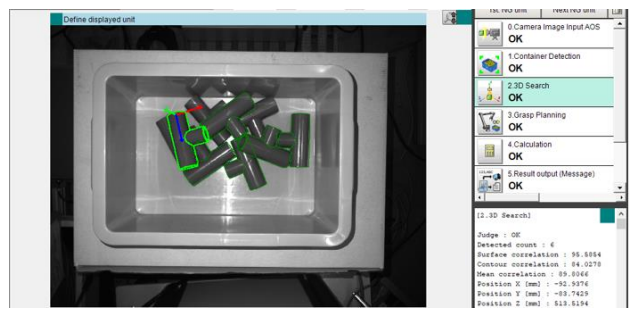

### 8.8.6. Making Hand (Vacuum Gripper) Model and Grasp Point Registration

Create and register the shape of the hand (gripper) used to grasp workpieces. To create a hand shape, combine cylinders and cubes. You can create one-point vacuum and two-finger parallel open-close hands. You can also register a camera as part of the hand to detect a collision with the container.

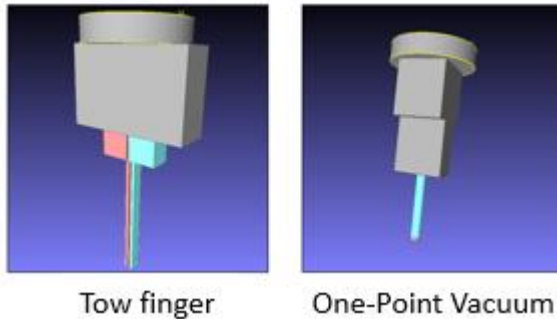

#### Precautions for Correct Use

You cannot register hand shapes directly from CAD data.

Prepare a drawing that describes the dimensions of each element of the hand.

This section explains how to register the hand by using example shown in below figure. This section describes the model registration procedure for a single-point vacuum hand (including the 3D Vision Sensor) as shown in the figure below. For the procedure for a two-finger hand, refer to 9.1 Making Hand (Two finger Gripper) and Grasp Point Registration.

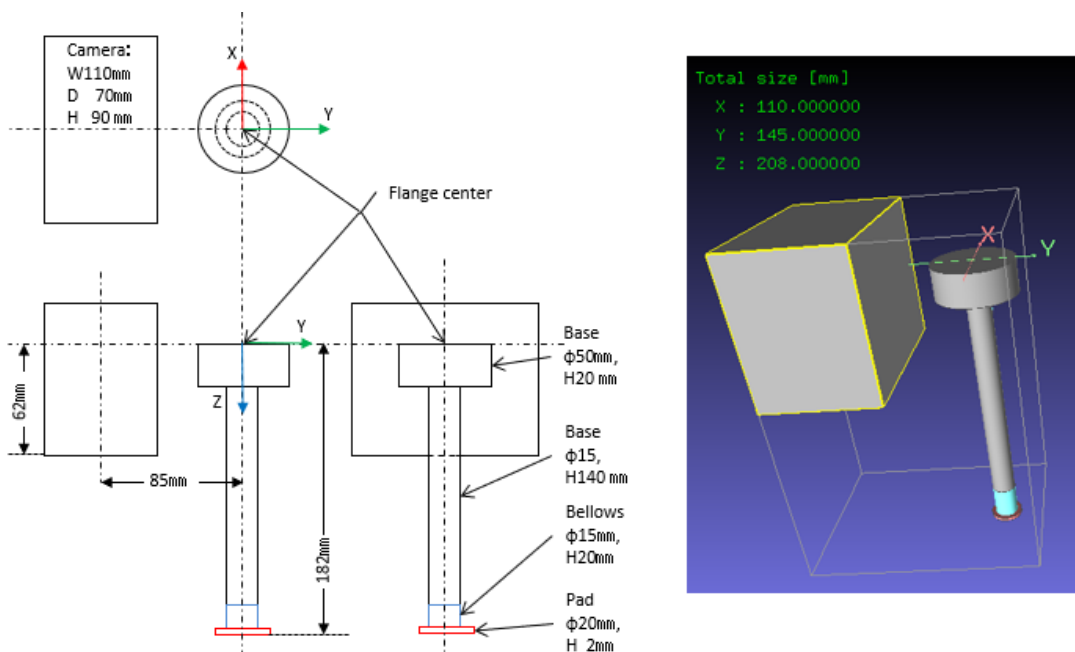

■Hand coordinate

Hand data uses the robot flange coordinate system. Check the orientation of the robot flange coordinate system when you install the gripper.

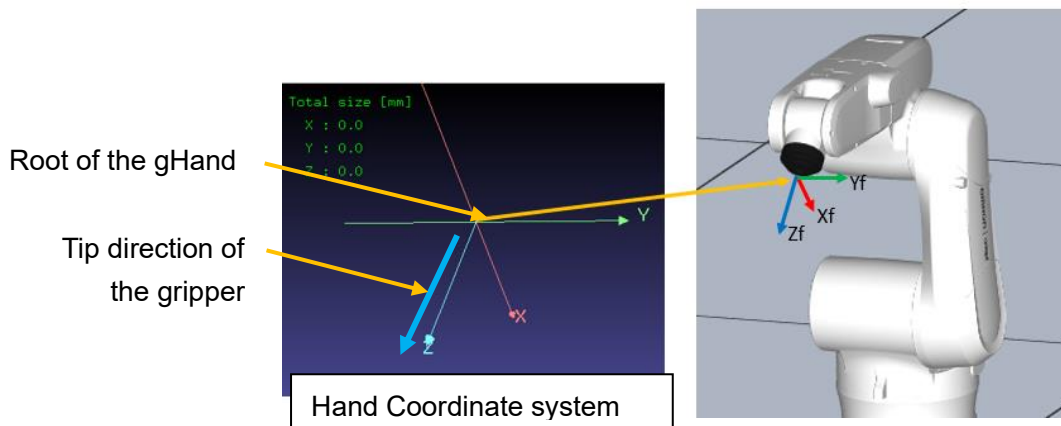

■Components of the hand

Example of a vacuum hand consist of following element.

Part	Description
Pad	Vacuum pad that makes contact with the target object.
Bellows	Expanding and contracting part of vacuum pad.
Base	All element other than Pad and Bellows. Jigs to connect the robot's flange, pipe, camera and other element moves with the hand.

■Location and dimensions of components

Position and posture of elements are described in the flange coordinate. The position of the element is center of roof plane or cross section of diagonal line. Height/ Width Z is minus Z direction in flange coordinate system.

The root of the hand is located at the origin of the flange coordinate system. Create the tip of the gripper in the Z-axis plus direction of the flange coordinate system.

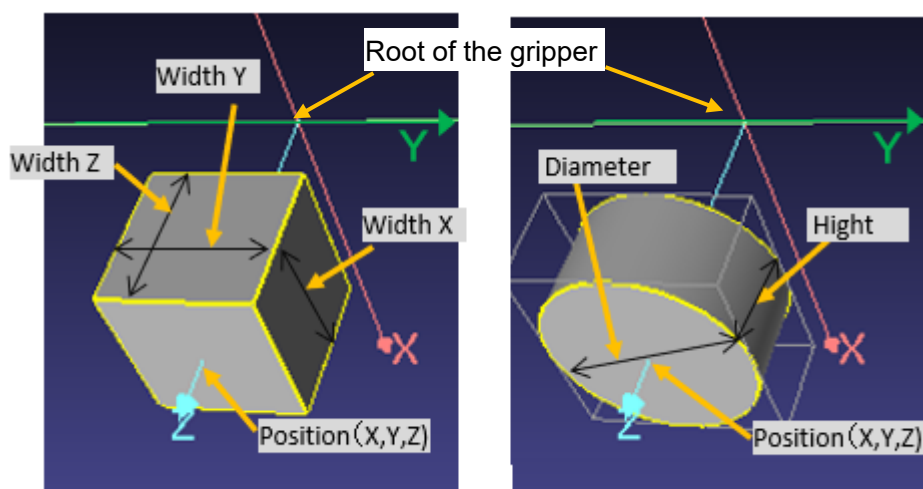

■Accuracy of the hand

Accurately set the position and dimensions of the tip that makes contact with workpieces (shown in a red outline in the figure below). In particular, set the dimensions in the Z-axis direction of the flange coordinate system correctly. For other elements, you can use approximate shapes such as circumscribed cubes and cylinders without problems.

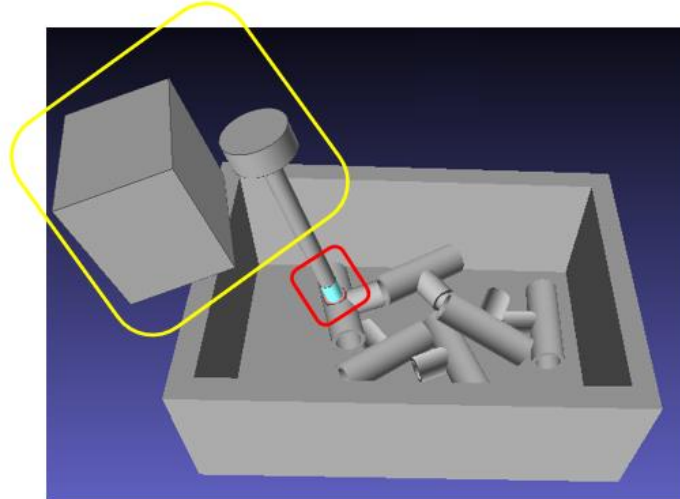

**Precautions for Correct Use**

- Output of the Vision Sensor is calculated based on the hand shape specified here. Position and size of the element which contact to the target object must be set precisely.
- Register the elements attached to the hand (camera, connectors, jigs attached to the hand, etc.) that require collision judgement with the container together with the hand.

Follow the steps below to register the hand data, and then register the grasp point.  
For details on each parameter of the processing item, refer to *3D Data Manager* in the following manual. *Vision System FH series Processing Item Function Reference Manual for 3D Robot Vision* (Cat. No. Z445)

Step	Description	Window image, diagram
1	Click <b>Scene switch</b> button on the main window to switch to Scene No. "126. 3D Data Manager". Click the "1. 3D Data Manager" icon on the Main windows of the Vision Sensor to open its setting screen.	

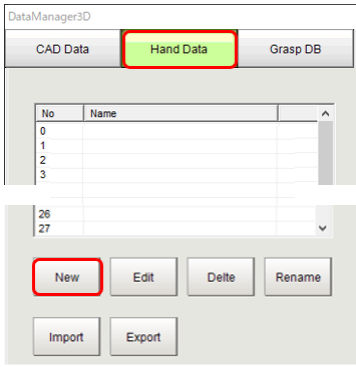
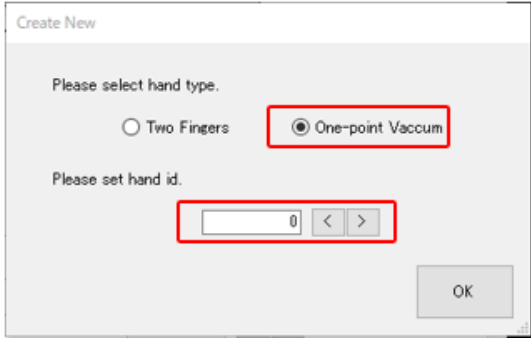
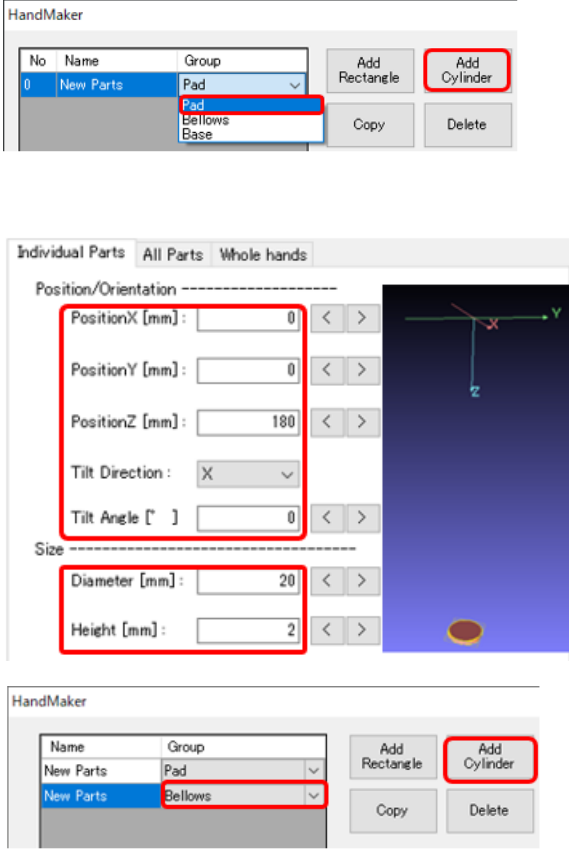
<p>2 Open the “Hand Data” tab.</p> <p>Select a vacant No. and click <b>New</b> button.</p>	
<p>3 The dialog shown in the figure to the right will pop up. Select [<b>One-point Vacuum</b>] and set a unique hand ID.</p> <p>Click the <b>OK</b> button to open the HandMaker tool.</p>	
<p>4 ■Registering Pad and Bellows.</p> <p>Click <b>Add Cylinder</b> button and then select <b>Pad</b> from the pull down list.</p> <p>Open the “Individual Parts” tab. Set Position, Orientation and dimension of each element (Pad).</p> <p>Again, click <b>Add Cylinder</b> button and select <b>Bellows</b> from the pull down list.</p>	

Open the “Individual parts” tab.  
Set Position, Orientation and dimension of each element (Bellows).

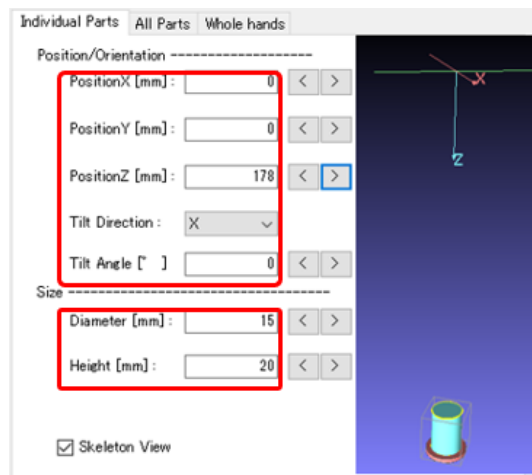

If there is no bellows element, set the difference in length between the non-adsorbed state and the adsorbed state of the pad (deformation of the tip).

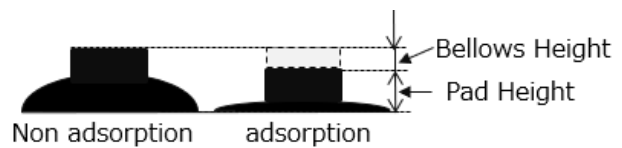

The length of the Bellows changes when vacuum pressure is applied so open the [Whole hands] tab and set Max Bellows Contraction (unit is mm).

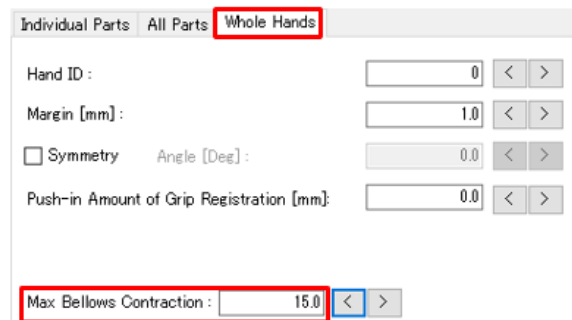

### Precautions for Correct Use

- The vacuum hand assumes that the pad is pressed against the workpiece within the range of **Max Bellows Contraction** and grasps it. If there is no bellows element, set the difference in length between the non-adsorbed state and the adsorbed state of the adsorbed rubber (deformation of the tip) as a bellows. When the bellows are not set, or the **Max Bellows Contraction** is 0 mm, it is determined that the work piece and the hand interfere with the grasp point registration.

- 5 ■ Pipe and Flange connection jig  
Click **Add Cylinder** and then select **Base** from the pulldown list.

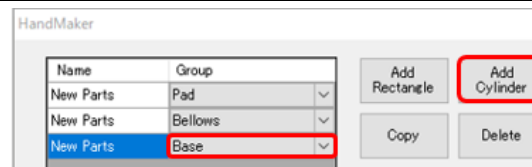



Open the “Individual parts” tab.  
Set Position, Orientation and dimension of each element (pipe).

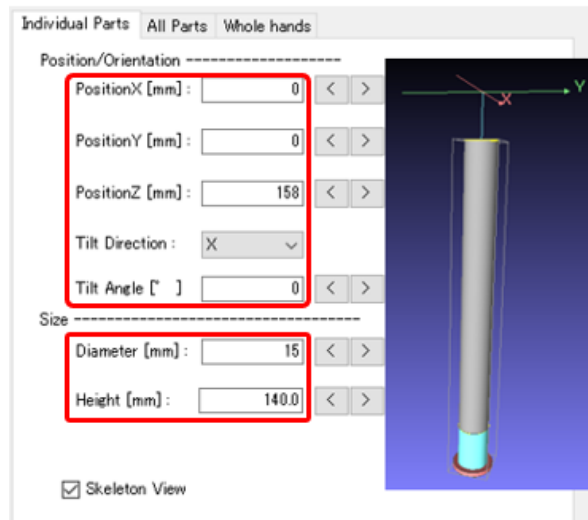

Click **Add Cylinder** and then select **Base** from the pulldown list.

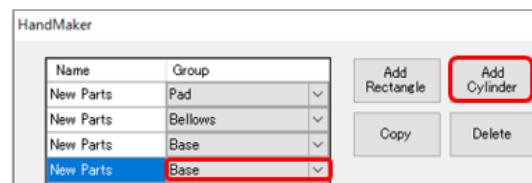

Open “Individual parts” tab.  
Set Position, Orientation and dimension of each element (flange connection jig).

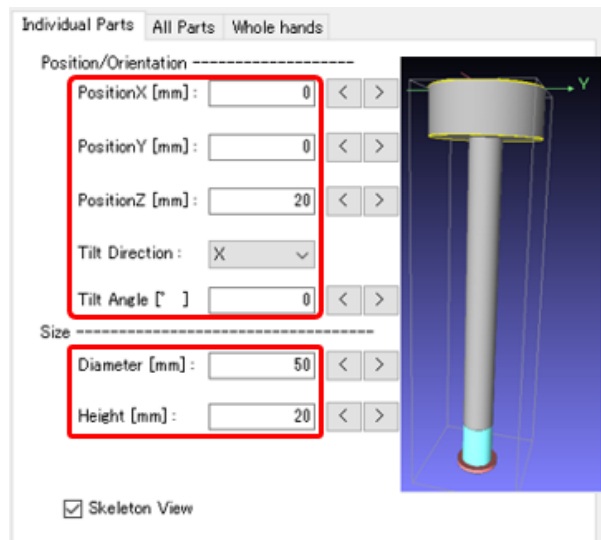

- 6 ■ On-Hand Camera  
Assume the size of the On-Hand Camera to be 110x70x90mm.  
Click **Add Rectangle** button and select **Base** from the pulldown list.

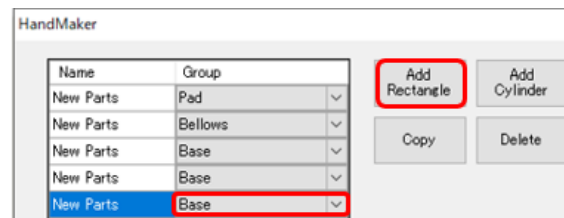



Open the “Individual parts” tab.  
Set Position, Orientation and dimension of each element (On-Hand camera).

To tilt the camera, set **Tilt Direction** and **Tilt Angle [deg]**.

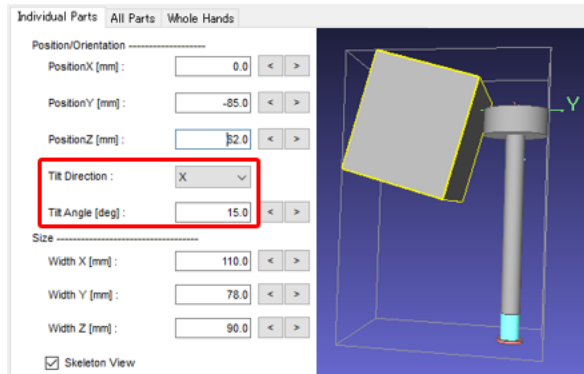
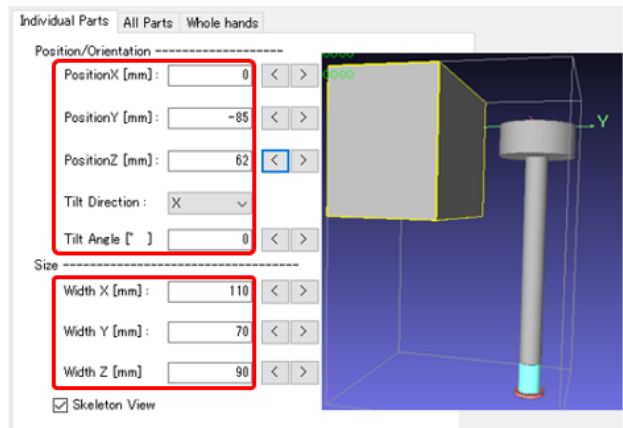
This hand model does not have rotational symmetry because of the camera, so open “Whole hands” tab and remove the check from the **Symmetry** check box.

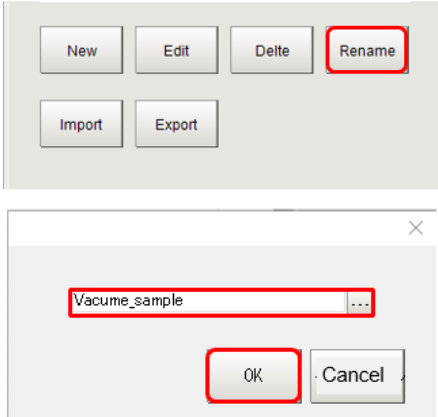

<p><b>7</b></p>	<p>Open the “Whole hands” tab and set the margin for collision check. The Hand model size “Margin mm” is enlarged at the collision check calculation. The amount of depth that Pad face pushed in to the workpiece surface can be set in “Push-in Amount of Grip Registration”.</p> <p>Sucking a workpiece with the suction pad pressed against it ensures reliable suction performance.</p> <p>You can also register parts individually at the time of grasp point registration.</p>	
<p><b>8</b></p>	<p>Click <b>Save</b> to save designed hand and then click <b>Exit</b> button to close HandMaker tool.</p>	
<p><b>9</b></p>	<p>Click <b>Rename</b> button to change hand name from the system default name.</p> <p>Input arbitrary name in dialog box and then Click <b>OK</b> to apply change.</p> <p>Hand design and registration process is done by above operations.</p>	

10 Open "Grasp DB" to make a Grasp DB and register grasp points.

Select a target object from CAD Data list and select a hand from Hand Data list.

Click the **New** button to open the GraspTeachGUI tool.

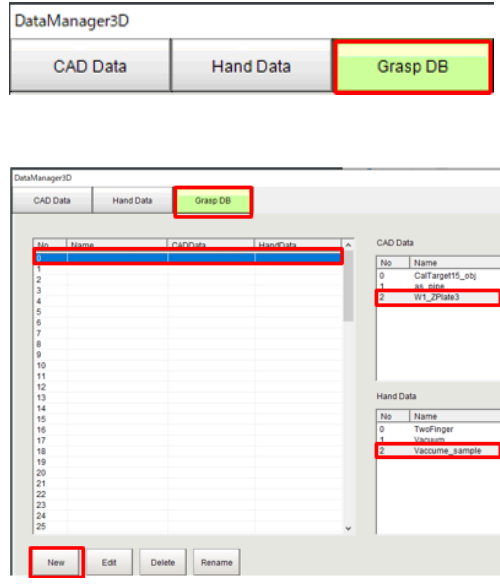

11 With the left button of the mouse pressed, drag the target object CAD on the screen to rotate and make its grasp side visible on the screen.

Move mouse on the grasp point and right click. The hand will be displayed on the grasp point like the figure shown on the right.

When **Push-in Amount of Grip Teach [mm]** is set, the suction pad will be automatically pushed into workpieces.

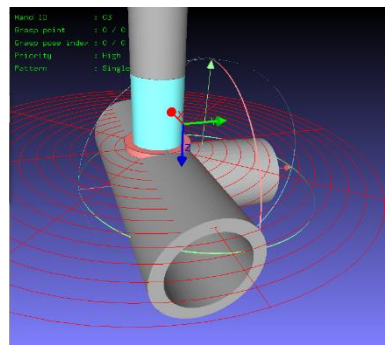
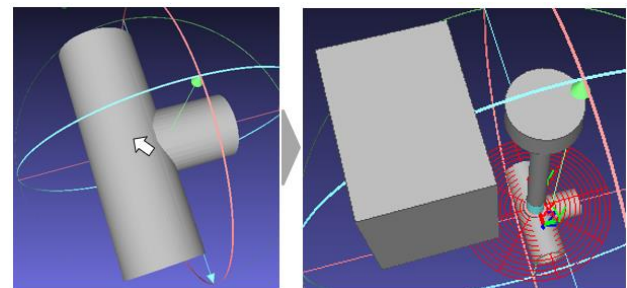
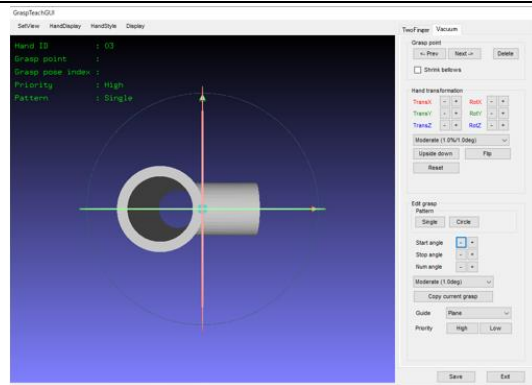

The Grasp point location and posture is adjusted by using “Hand transformation” buttons. The function of the button are as follows.

Adjust the position of the hand by clicking the + or - button for each axis.

The amount of movement can be selected from the pull-down list.

The bellows shrink (contraction) condition can be seen by placing check on the “Shrink bellows” check box.

Consider shrink and no shrink condition of the bellows and adjust proper grasp point.

The Grasp point placed by right mouse button click is just surface of the target object. If it is not the right place for vacuum grasping, move the hand lower by clicking **Trans Z +/-** button.

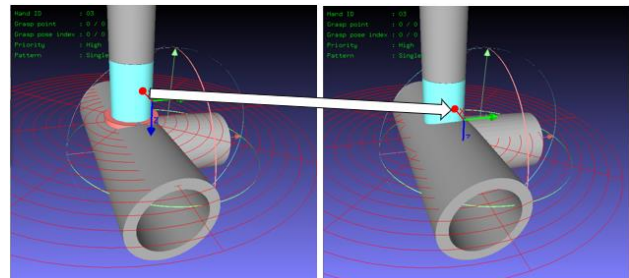
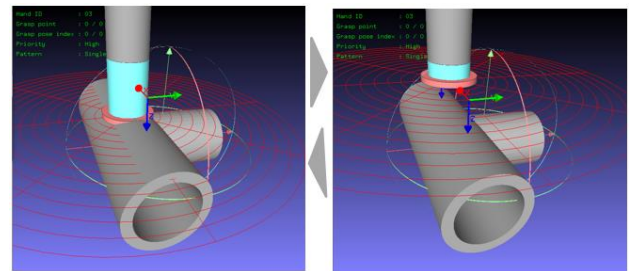
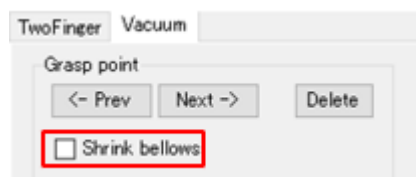
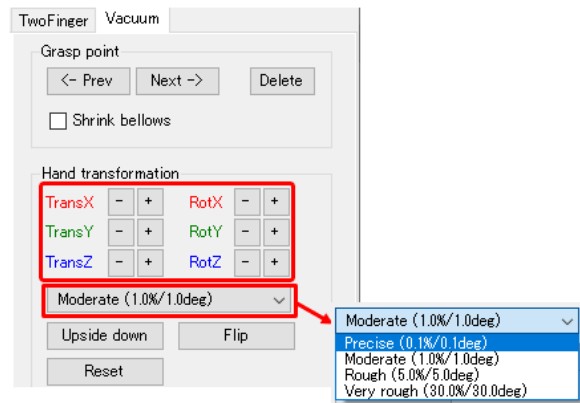

- 12 Some type of grasp points can be generated automatically. Multiple point around Z axis is generated by **Circle** button. Number of multiple point and angle is adjustable by using [+]/[-] button shown in right figure.

Move mouse to other point and right click adds next grasp point.

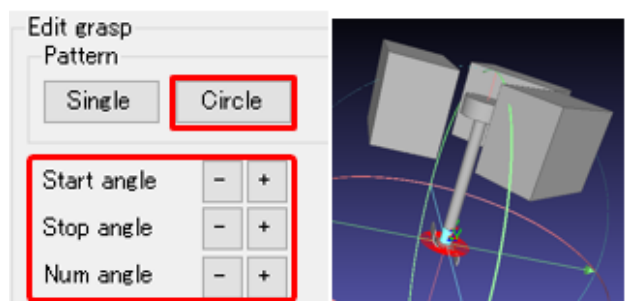

In some condition, the robot may not reach the set grasp point. Add grasp points considering the workpiece's orientation and the robot's rotational range limit. [**<-Prev**] button displays previous grasp point, [**Next->**] button displays next grasp point.

**Delete** button deletes current grasp point.

After setting all grasp points, click [Save] button at right lower side of the window.

When the dialog "Grasp DB has been saved successfully" pops up, click the **OK** button.

If a warning dialog appears, please review grasp points that do not touch, or collide with the workpiece. For detail, refer to *Key Points for Adjustment(3D Data Manager) or 3D Data manager in the Vision System FH series Processing Item Function Reference Manual for 3D Robot Vision (Cat. No. Z445)*

Then click the [Exit] button.

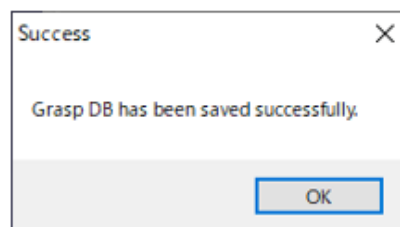
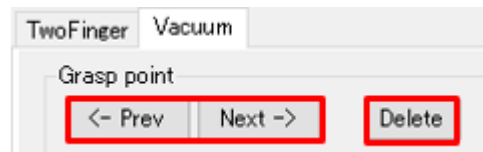

**13** Click the **Rename** button to change the Grasp DB name from the system default name.

Input any name in the dialog box and then click **OK** to apply the change.

The Grasp point registration process is completed by the above operations.

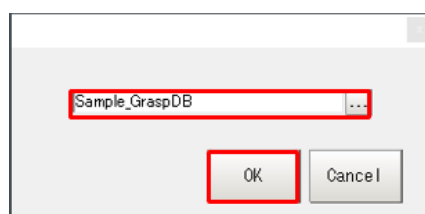
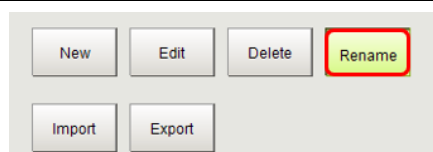

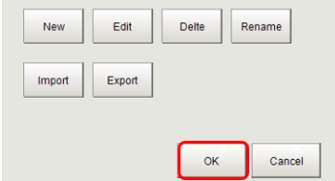
14	Click the <b>OK</b> button to complete the setting and close Hand and Grasp point registration, and 3D Data Manager unit.	
15	Click the <b>Scene switch</b> button in the main window. And switch scene to sample scene (No.0 scene).	



### Precautions for Correct Use

- Set the grasp point based on the actual posture of workpieces, the movement range of the robot, and the shape and placement of the hand.
- If you need to set more than one grasp point and consider how to place the hand for each grasp point, design the robot program depending on the grasp point.

#### ■ Supplementary Information on Grasp Point.

The figure below illustrates why multiple grasp point registrations are necessary.

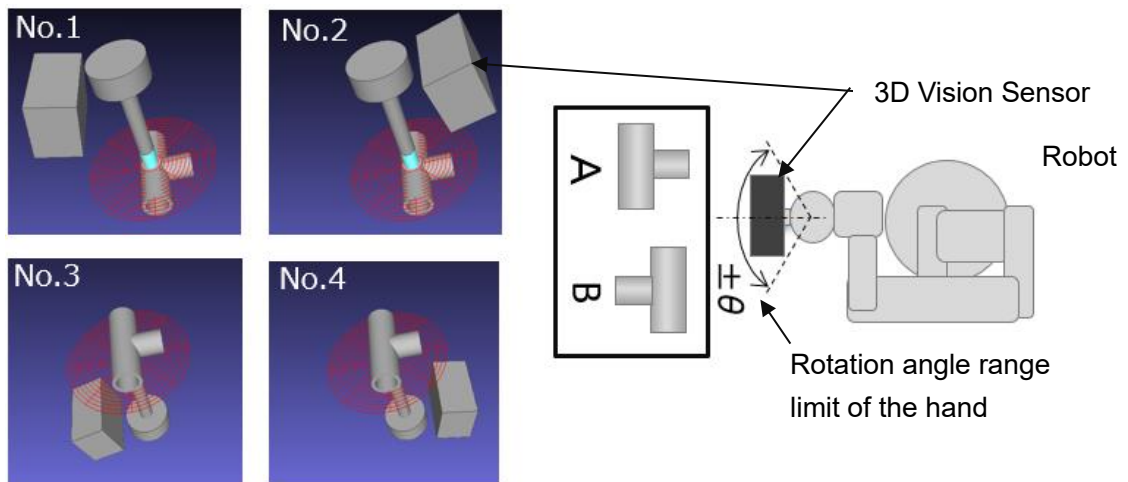

Grasp points No.1 to No. 4 are defined as follows.

No. 1	Grasp point on the front side of the workpiece	No. 2	Grasp point with the hand rotated 180 deg from grasp point No. 1
No. 3	Grasp point on the back side of grasp point No. 1	No. 4	Grasp point with the hand rotated 180 deg from grasp point No. 3

#### 1) Consideration for the rotation angle range of the robot

If the robot cannot reach the registered grasp point due to the limited rotation angle of the robot or the shape of the container or hand, add grasp points to locations where the robot can reach. As shown in the above figure where the rotation angle of the robot hand is limited to  $\pm\theta$  deg, the robot can grasp workpiece A but cannot grasp workpiece B at grasp point No.1 due to the limited rotation angle. Therefore, grasp point No.2 is added. In the Grasp Planning procedure in the next section, it will compare grasp points No. 1 and No. 2 for workpiece B and select grasp point No. 2 where the robot does not reach the rotation limit.

#### 2) Consideration for symmetry of the workpiece

When the workpiece has a front to back symmetry, it may be recognized as the front or back side even in the same posture in the result of 3D Search. Therefore, registering only grasp points No. 1 and No. 2 on the front side is not sufficient, if it is recognized as the back side. Therefore, grasp points No. 3 and No. 4 are added. However, when the *Having front and back symmetry about current view* check box is selected in 3D Search model registration, grasp points No. 3 and No. 4 need not be registered.

In addition, when the workpiece has a horizontal (or vertical) symmetry, even in the same view, it may be recognized as being rotated 0 or 180 deg to the Z axis of the camera coordinate system in the result of 3D Search. Therefore, grasp points are registered in 180-deg symmetrical locations as in the relationship between grasp points No. 1 and No. 2.



### 8.8.7. Grasp Planning

Follow the setting procedure below for priority ordering of the target object and collision checking. The Grasp planning unit refers HandEye Calibration unit, Container Detection unit and 3D Search unit. Confirm those units are correctly working.

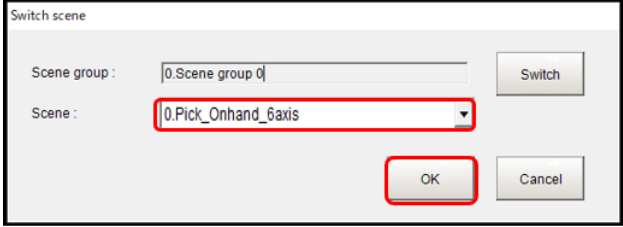
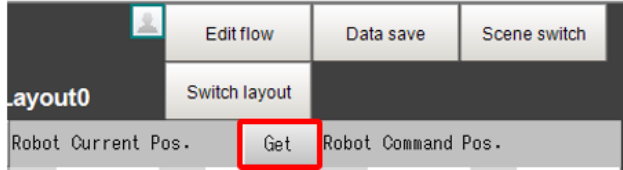
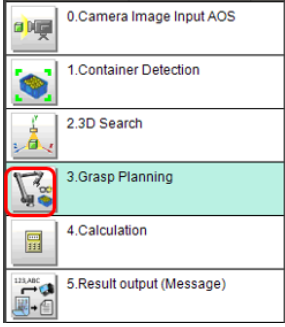
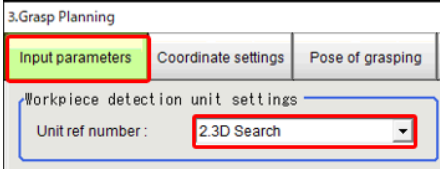
Step	Description	Window image, diagram
1	<p>In the main window of the Vision Sensor, click the <b>Scene switch</b> button.</p> <p>You now return to the scene to set.</p>	
2	<p>Operate the robot to the Measurement point.</p> <p>Click <b>Get</b> button to acquire position and posture of the Measurement point.</p> <p>If this was already done in section 8.8.4 Container Detection, you can skip this.</p>	
3	<p>Click the “3.Grasp Planning” icon on the Main window of the Vision Sensor to open the setting screen.</p>	
4	<p>Open “Input parameters” tab to confirm that “2.3D Search” is selected to “Workpiece detection unit settings”.</p>	

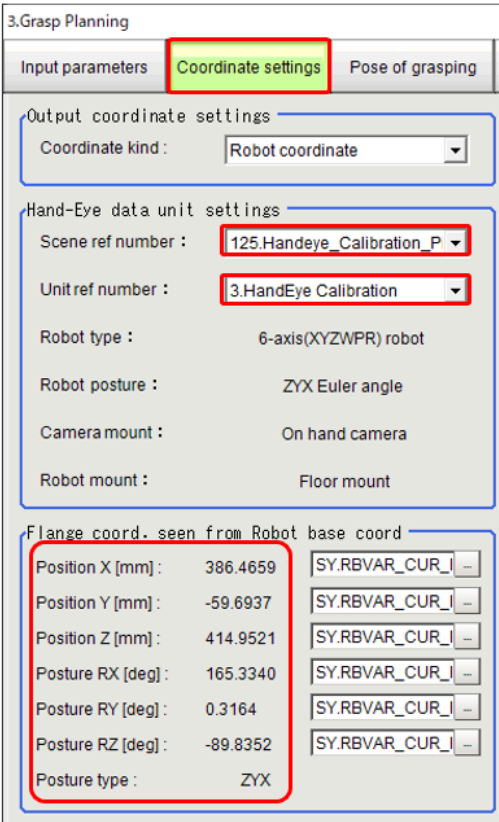
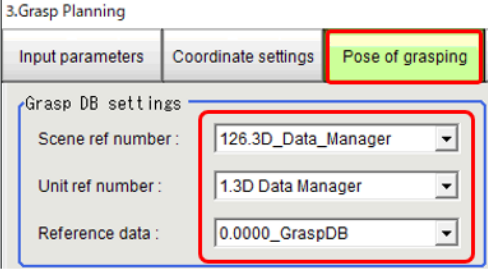
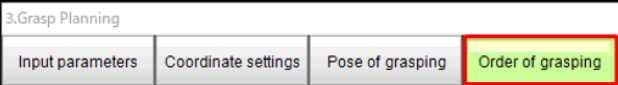
<p><b>5</b></p> <p>Open “Coordinate settings” tab to confirm that Hand-Eye data unit of section 8.7.6 is selected.</p> <p>Confirm that “Flange coord seen from Robot base coord” reflects the robot pose and posture acquired in STEP 2.</p> <p>If you load a sensor controller project corresponding to the robot type, there is no need to enter or change the settings because the system variables (SY.XXX) are already set.</p> <p>The Grasp Planning unit considers this as base position and posture for determining priority order.</p>	
<p><b>6</b></p> <p>Open “Pose of grasping” tab and set the Grasp DB which was created in section 8.8.6 for “Grasp DB settings”.</p>	
<p><b>7</b></p> <p>Open “Order of grasping” to set priority order of the 3D Search unit results (grasp candidates).</p>	

Priority order is divided into 3 levels (High/Low/Reject) by 2 parameters (Preferred /Reject) as shown in the figure on the right. The final priority will be determined based on the overall evaluation of each evaluation value. Candidates with more items that are at “Preferred level” or higher will be given higher priority.

Items with no condition selected will be set to “Rejection level” and excluded.

#### ■3D Search result

Threshold of 3D Search (section 8.8.5) matching level is set to Surface correlation and Contour correlation.

All candidates detected in 3D Search are the target of evaluation. Candidates that are rejected due to the judgment conditions will also be included.

#### ■Tilt and Rotation angle

The priority will be set based on the tilt and rotation of the hand tip when the workpiece is grasped.

**Tilt of hand and Rotation of hand** provide the allowable limits for the amount of tilt and rotation (rotation angle) of the hand at the time of grasping workpieces. The condition is whether candidates fall in the range above or below the set value. Set a safe range for each item, considering the collision with the environment and the cable length.

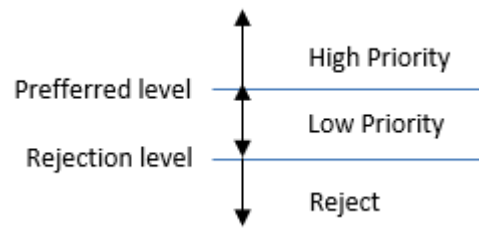

Surface correlation :	97.9129 (A)
Preferred level :	<input type="text" value="60"/> ... < >
Rejection level :	<input type="text" value="30"/> ... < >
Contour correlation :	81.5872 (A)
Preferred level :	<input type="text" value="60"/> ... < >
Rejection level :	<input type="text" value="30"/> ... < >

Tilt of hand [deg] :	8.8037 (A)
Preferred level :	<input type="text" value="40.0000"/> ... < >
Rejection level :	<input type="text" value="90.0000"/> ... < >
Rotation of hand [deg] :	29.9322 (A)
Preferred level :	<input type="text" value="90.0000"/> ... < >
Rejection level :	<input type="text" value="120.0000"/> ... < >

For **Tilt of hand**, the angle reference varies depending on whether or not **Target object** is set to *None* in the Collision detection tab.

When **Target object** is *Floor + container*, the normal to the floor is the reference.

When **Target object** is *None*, the optical axis of the camera is the reference.

To limit the tilt angle, set **Rejection level** to the limit angle.

For **Rotation of hand**, set the reference by clicking the **Advanced** button. The angle formed between the two reference vectors selected in the Advanced window represents the amount of rotation.

Select a robot base coordinate axis in measurement pose and select a flange coordinate axis for rotation object.

The angle of “Rotation of hand” is angle between selected vectors. Select two vectors that are same direction when the robot is in measurement position.

Setting examples are given in *Supplementary Information on the Amount of Hand Rotation* at the end of this section.

If there is no applicable direction, select *Custom* and set an appropriate angle.

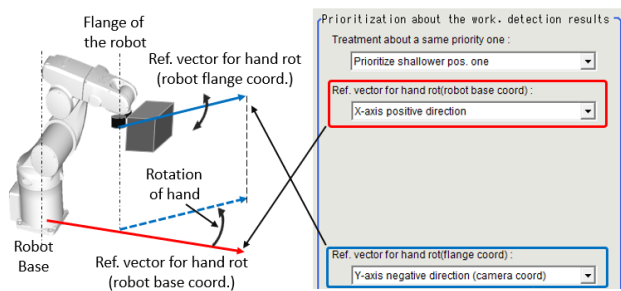
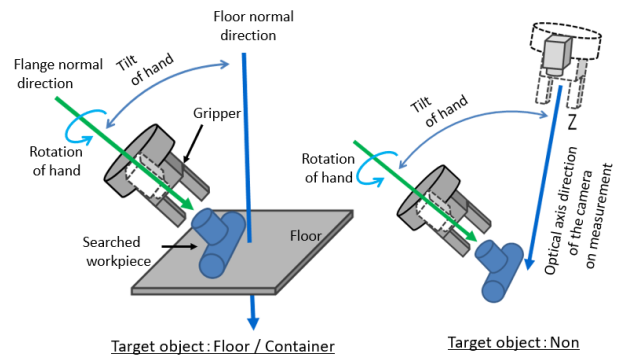

■Depth of the work pos.

The priority will be set based on the depth of the target. Use these settings to give priority to workpieces placed in shallower (upper) depth.

In **Depth of work pos.**, set the candidate selection range in the direction of depth with reference to the workpiece detected at the highest position.

The direction in which the depth is measured differs depending on whether or not **Target object** is set to *None* in the Collision detection tab.

If Target object is set to Floor or Container, the depth will be judged by the distance along the normal to the floor.

In cases other than the above, the depth will be judged by the distance along the optical axis of the camera.

■Same priority

Able to set priority for same score candidates.

Click [Advanced] button to set "Treatment about a same priority one" for same score candidates.

Click the [Return] button to close advanced setting.

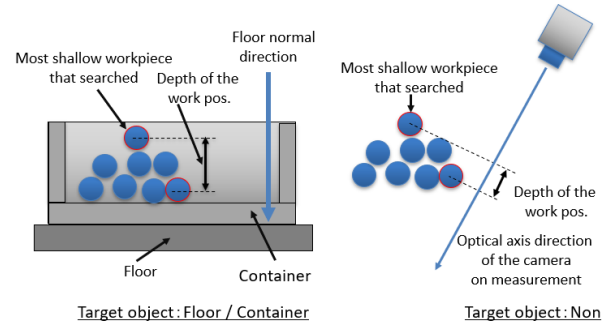

**Precautions for Correct Use**

The candidates detected as a result of 3D Search will be input to the Grasp Planning processing item regardless of the judgment result OK/NG. To use only the 3D Search judgment result OK, set the threshold of the 3D Search judgment condition in **Rejection level** for **Surface correlation** or **Contour correlation**.

8 Open "Collision detection" to set collision detection condition.

■ Collision with hand

Set collision margin of hand in "Collision with hand". The hand model size is enlarged by the "Margin mm" at collision check calculation.

■ Collision with surrounding environment

Select the target objects that collide with the hand. Objects are **Floor, Container, Container + Floor or None**. Specifying the "Container Detection" unit that set in the section 8.8.4 is necessary for Collision detection.

Set the margin by which to extend the container and/or floor during collision detection.

■ Collision with point cloud

Set "Outlier height" for ignoring outlier point cloud which must be noise. The height is measured from the floor plane.

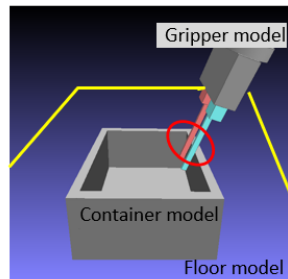
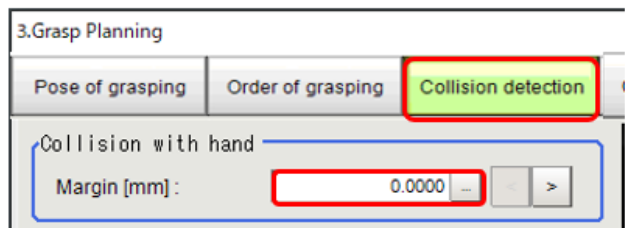

Container and gripper

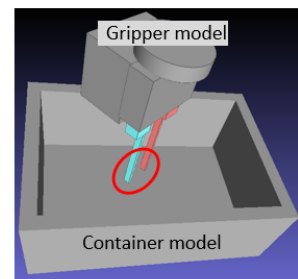

Gripper and floor container

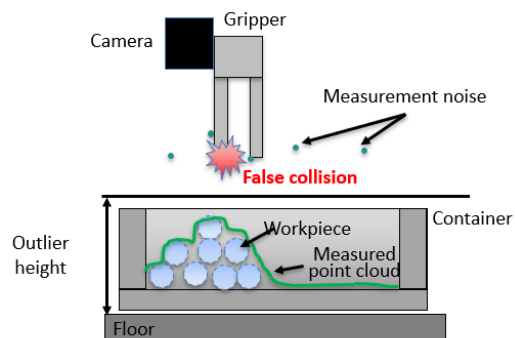
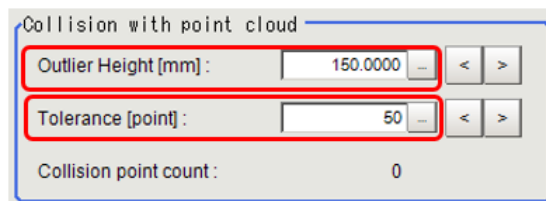
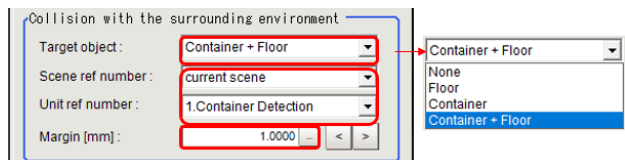

Set "Tolerance" for ignoring point cloud collision with hand caused by measurement noise.

Click **OK** button to close the setting window.

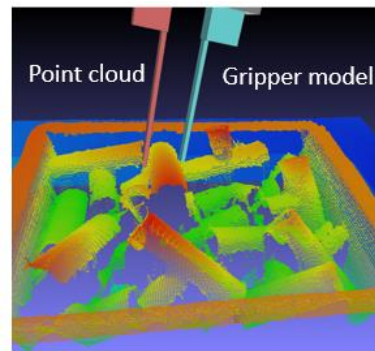

Gripper and point cloud



### **Precautions for Correct Use**

- Setting a margin in **Collision with hand** reduces the risk of contact with the container or other workpieces. However, for two-finger hands, the setting reduces the actual opening width. Consider the size of the workpieces and the opening width when you set the margin.
- Setting a margin in **Collision with the surrounding environment** reduces the risk of a collision between the hand and the container. However, setting it too large may result in detecting a collision at workpiece grasp points near the wall of the container.

9 Click the **Measure** button to execute measurement.

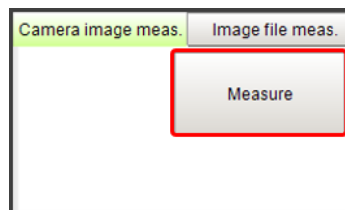

10 Open Grasp Planning "Collision detection" tab.

If the measurement is successful, green outline will be overlaid on the 2D workpiece image.

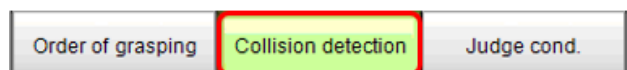

Click **Draw with 3D** button to run the 3D Visualizer.

Grasp candidates and pose and posture is displayed on screen.

Following mouse operation is available to check grasp condition.

Left down + drag : Rotation

Shift+Left down+drag: Translation

Rotate Wheel : Scaling

Visible/Invisible of each element can switch by radio button.

Click [End] to close 3D Visualiz.

In **Display settings**, check **Draw rejected work** and **Draw rejected reason**. A purple outline will be overlaid on the rejected workpiece image.

In **Detected work index focused**, use the > button to go through the work numbers to display the rejection reason for the rejected workpiece in red text.

The figure on the right is an example of how the rejection reason is displayed on the rejected workpiece image.

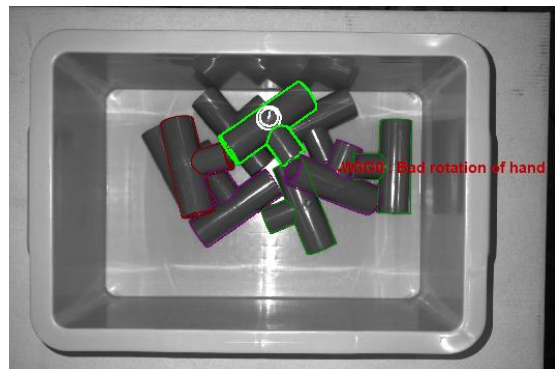
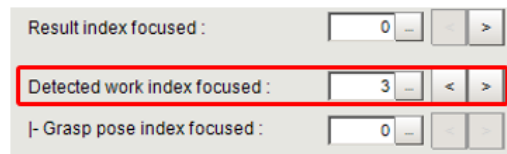
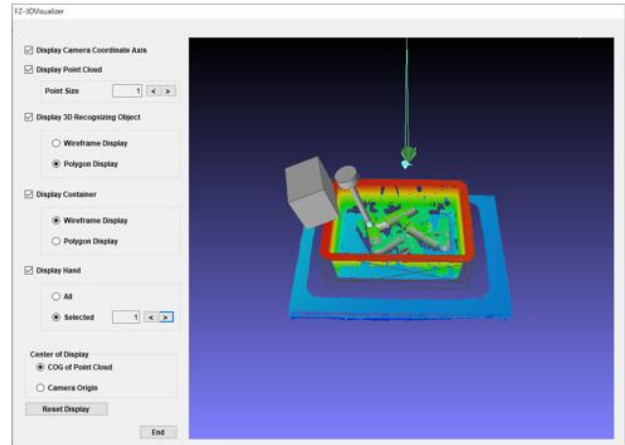
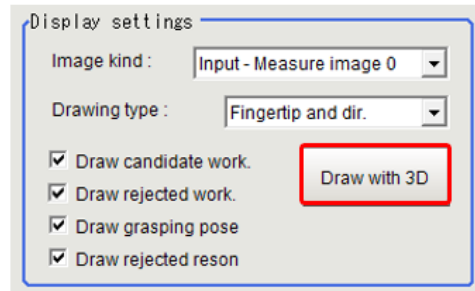



If the number of grasp candidates is 0 even though a workpiece is detected in 3D Search, check the following to narrow down the causes.

1) Current position of the robot, hand-eye calibration unit

Confirm that the **Hand-Eye data unit settings** in the Coordinate settings tab are correct. In addition, confirm that the coordinate values of the flange coordinate system viewed from the robot base coordinate system are correct and correctly reflect the posture of the robot when the image is captured.

2) Collision with the surrounding environment

In **Collision with the surrounding environment** in the Collision detection tab, set **Target object** to *None* and measure again. A collision with the container and/or floor may occur due to the condition setting.

3) Tilt and Rotation

Check if the "Ref. vector for hand" vector is set correctly. Refer to the setting examples at the end of this section. Also, in **Tilt of hand [deg]** and **Rotation of hand [deg]** in the Order of grasping tab, increase the angle values and measure again. The condition settings may be too strict, or the number of registered grasp points that meet the conditions may be insufficient.

4) Collision with point cloud

In Collision with point cloud in the Collision detection tab, increase the **Tolerance [point]** value and measure again. The tolerance may be too strict.

5) Margin settings

In the Collision detection tab, decrease the set **margin** values for **Collision with hand** and **Collision with the surrounding environment**, and measure again. The set margin values may be too large.

11 Open the Judge cond. tab. For each judgment condition, set the range in which the unit is to be judged as OK.

3. Grasp Planning

Order of grasping | Collision detection | **Judge cond.**

Judgement condition

Graspable candidate count : 15  
0 - 512

Grasping grade : 0 (A)  
0 - 9

Collision point count : 0  
0 - 9999

Surface correlation : 90.4031  
60.0000 - 100.0000

Contour correlation : 51.3889  
35.0000 - 100.0000

Tilt of hand [deg] : 25.0983  
0.0000 - 60.0000

Rotation of hand [deg] : 43.2238  
0.0000 - 150.0000

Depth of the work pos. [mm] : 0.0000  
0.0000 - 50.0000

Result index focused : 0 >

Measure Advanced

This completes the Grasp Planning setting procedure. At the time of measurement, the grasp point selected based on the condition settings configured in the **Order of grasping** tab in this section will be output in the robot coordinate system.

12 Click **OK** to complete Grasp Planning and close the setting screen.

## WARNING

The movement of each axis and each arm of the robot with respect to the grasp point output in the Grasp Planning processing item depends on the operation algorithm of the robot. Thoroughly test that the movement of the robot arm does not cause the 3D vision sensor or hand to collide with the robot or apply a greater load than the specified value to the cable.



■Supplementary Information on the Amount of Hand Rotation

Examples of setting the amount of hand rotation are shown below. The subscript b, f, or c next to each coordinate axis name in the figure represents the base coordinate system, flange coordinate system, or camera coordinate system, respectively.

A 3D vision camera (the camera in the figure) is fixed to the flange of the robot. In this setting, two examples are shown, where the Y-axis minus direction of the flange coordinate system and the Y-axis minus direction of the camera coordinate system are used under one installation condition.

Setting example			Layout (top view)	
1		Ref. vector for hand rot(robot base coord)		
	(1)	X-axis plus direction		Y-axis minus direction (Camera coordinate system)
	(2)	X-axis plus direction		Y-axis minus direction
<p>Since the Y axis of camera coordinate system and the Y axis of the flange coordinate system have the same direction, setting examples (1) and (2) produce the same result.</p>				
2		Ref. vector for hand rot(robot base coord)		
	(1)	X-axis plus direction		Y-axis minus direction (Camera coordinate system)
	(2)	X-axis plus direction		X-axis minus direction
<p>Since the Y axis of camera coordinate system and the X axis of the flange coordinate system have the same direction, setting examples (1) and (2) produce the same result.</p>				

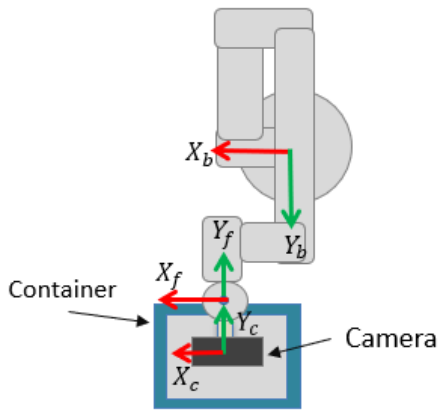
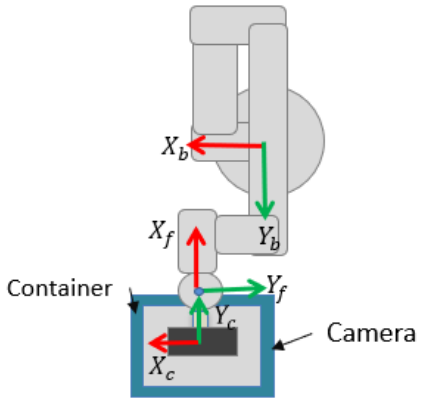
3		Ref. vector for hand rot(robot base coord)	Ref. vector for hand rot(frang coord)	
	(1)	Y-axis plus direction	Y-axis minus direction (Camera coordinate system)	
	(2)	Y-axis plus direction	Y-axis minus direction	
<p>Since the Y axis of camera coordinate system and the Y axis of the flange coordinate system have the same direction, setting examples (1) and (2) produce the same result.</p>				
4		Ref. vector for hand rot(robot base coord)	Ref. vector for hand rot(frang coord)	
	(1)	Y-axis plus direction	Y-axis minus direction (Camera coordinate system)	
	(2)	Y-axis plus direction	X-axis minus direction	
<p>Since the Y axis of camera coordinate system and the X axis of the flange coordinate system have the same direction, setting examples (1) and (2) produce the same result.</p>				

### 8.8.8. Result Output

Result of Grasp Planning is sent to the robot through Ethernet serial communication. If you load a sensor controller project corresponding to the robot type, there is no need to enter or change the settings because the system variables (SY.XXX) are already set.

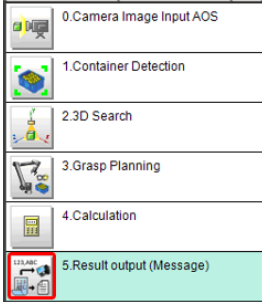
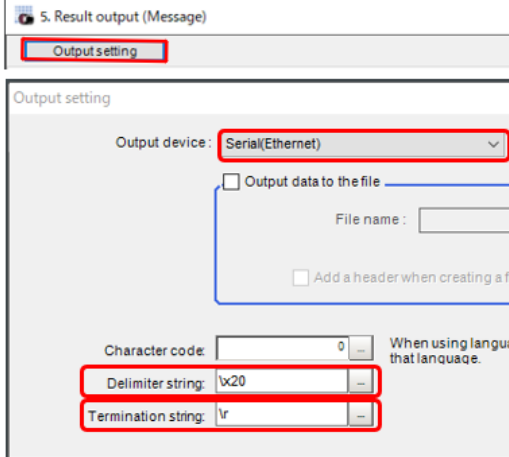
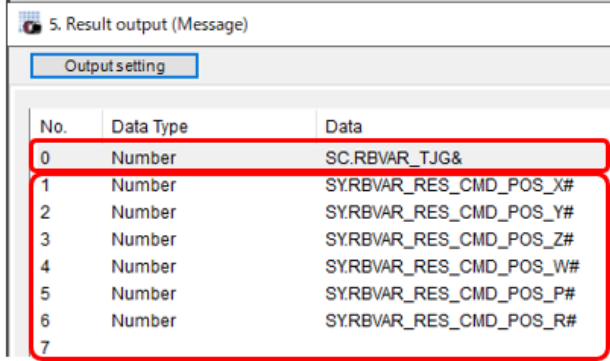
Step	Description	Window image, diagram																											
1	Click the “5.Result output(Message) icon on the Main window of the Vision Sensor to open its setting screen.																												
2	<p>Open “Output setting” tab to confirm the settings are as figure shown in right.</p> <p>Output : Serial (Ethernet)            Delimiter string:\x20 (Space)            Terminate string:\r (CR)</p>																												
3	<p>Open the “Output data” tab to confirm the settings are as figure shown in right.</p> <p>SY.RBVAR_RES_CMD_POS_X#            SY.RBVAR_RES_CMD_POS_Y#            SY.RBVAR_RES_CMD_POS_Z#            SY.RBVAR_RES_CMD_POS_W#            SY.RBVAR_RES_CMD_POS_P#            SY.RBVAR_RES_CMD_POS_R#</p> <p>Click [OK] to close the setting screen.</p>	 <table border="1" data-bbox="815 1346 1417 1597"> <thead> <tr> <th>No.</th> <th>Data Type</th> <th>Data</th> </tr> </thead> <tbody> <tr> <td>0</td> <td>Number</td> <td>SC.RBVAR_TJG&amp;</td> </tr> <tr> <td>1</td> <td>Number</td> <td>SY.RBVAR_RES_CMD_POS_X#</td> </tr> <tr> <td>2</td> <td>Number</td> <td>SY.RBVAR_RES_CMD_POS_Y#</td> </tr> <tr> <td>3</td> <td>Number</td> <td>SY.RBVAR_RES_CMD_POS_Z#</td> </tr> <tr> <td>4</td> <td>Number</td> <td>SY.RBVAR_RES_CMD_POS_W#</td> </tr> <tr> <td>5</td> <td>Number</td> <td>SY.RBVAR_RES_CMD_POS_P#</td> </tr> <tr> <td>6</td> <td>Number</td> <td>SY.RBVAR_RES_CMD_POS_R#</td> </tr> <tr> <td>7</td> <td></td> <td></td> </tr> </tbody> </table>	No.	Data Type	Data	0	Number	SC.RBVAR_TJG&	1	Number	SY.RBVAR_RES_CMD_POS_X#	2	Number	SY.RBVAR_RES_CMD_POS_Y#	3	Number	SY.RBVAR_RES_CMD_POS_Z#	4	Number	SY.RBVAR_RES_CMD_POS_W#	5	Number	SY.RBVAR_RES_CMD_POS_P#	6	Number	SY.RBVAR_RES_CMD_POS_R#	7		
No.	Data Type	Data																											
0	Number	SC.RBVAR_TJG&																											
1	Number	SY.RBVAR_RES_CMD_POS_X#																											
2	Number	SY.RBVAR_RES_CMD_POS_Y#																											
3	Number	SY.RBVAR_RES_CMD_POS_Z#																											
4	Number	SY.RBVAR_RES_CMD_POS_W#																											
5	Number	SY.RBVAR_RES_CMD_POS_P#																											
6	Number	SY.RBVAR_RES_CMD_POS_R#																											
7																													



## ⚠ WARNING

- If you add, delete, or change the order of items in the result output, the robot will perform an unexpected operation. Do not change the settings.

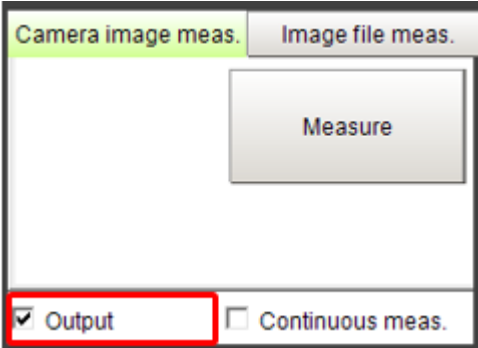

### 8.8.9. Saving the Settings

You have completed the settings on the Vision Sensor side in the previous section. In this section, enable the output of the measurement results to external devices and save the settings.

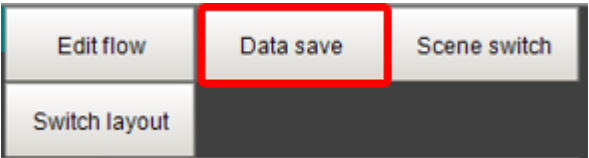
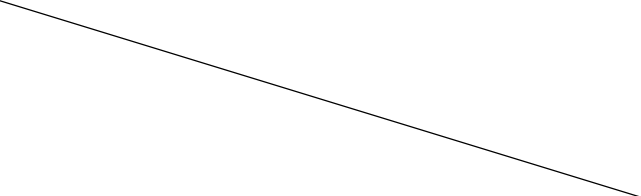
Step	Description	Window image, diagram
1	Place check in the box for Output.	
<h2 style="margin: 0;">⚠ WARNING</h2>		
<p>After this operation, executing a measurement causes the Vision Sensor to output a movement command to the robot.</p>		
2	Click <b>Data save</b> button of Vision Sensor Main window and save settings.	
3	<p>Stop the robot program that you started in 0.</p> <p>For how to stop the program, refer to the <i>Robot Connection Guide</i>.</p>	

For how to operate the robot to pick a workpiece based on the settings in this manual, refer to section 6 of the *Vision System FH/FHV series Robot Connection Guide* corresponding to the robot listed in *Related Manuals* in this manual.

#### **8.8.10. Troubleshooting**

For troubleshooting for each processing item in the picking application, refer to *Key Points for Test Measurement and Adjustment* for each processing item in the *Vision System FH series Processing Item Function Reference Manual for 3D Robot Vision* (Cat. No. Z445).

## 9. Appendix

### 9.1. Making Hand (Two finger Gripper) and Grasp Point Registration

Register the shape of the hand used to grasp workpieces. You can also register a camera as part of the hand to include in collision detection with the container.

You can create one-point vacuum and two-finger hands.

For details on each parameter of the processing item, refer to *3D Data Manager* in the following manual. *Vision System FH series Processing Item Function Reference Manual for 3D Robot Vision* (Cat. No. Z445)

This section explains how to register the tow finger hand by using example shown in below figure. The unit is mm.

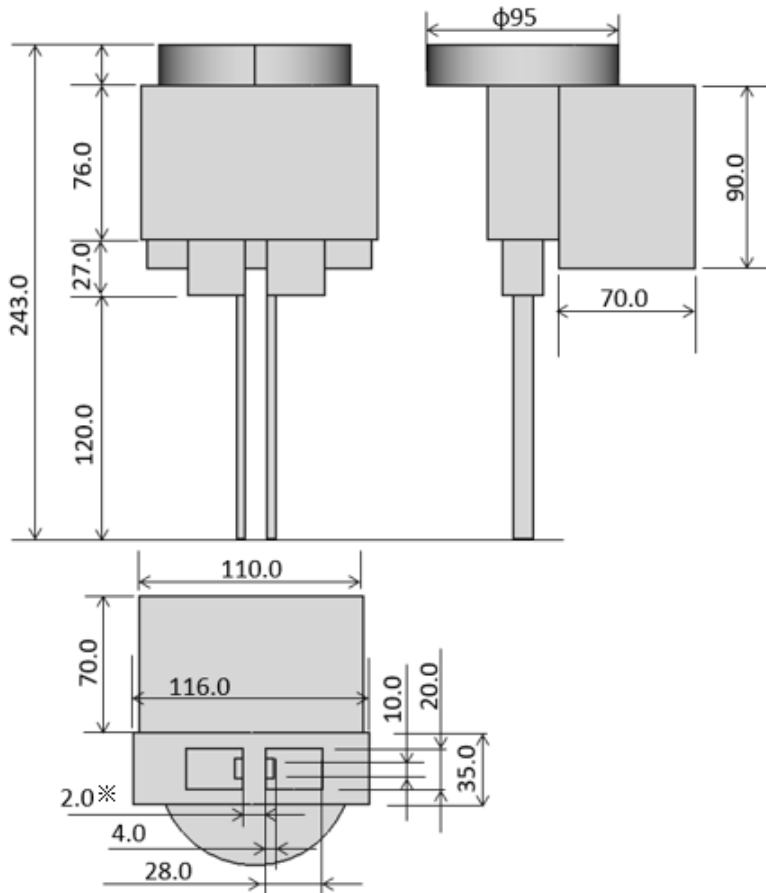

\* Hand fully closed (mm)

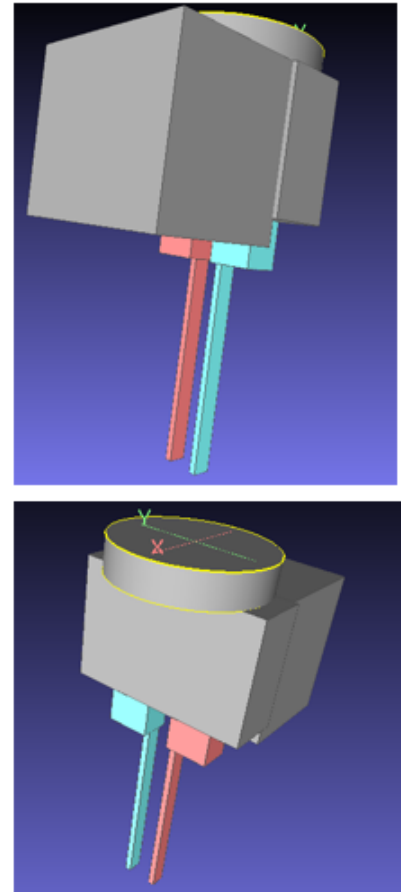

#### ■ Hand coordinate

Hand data uses the robot flange coordinate system. Check the orientation of the robot flange coordinate system when you install the hand.



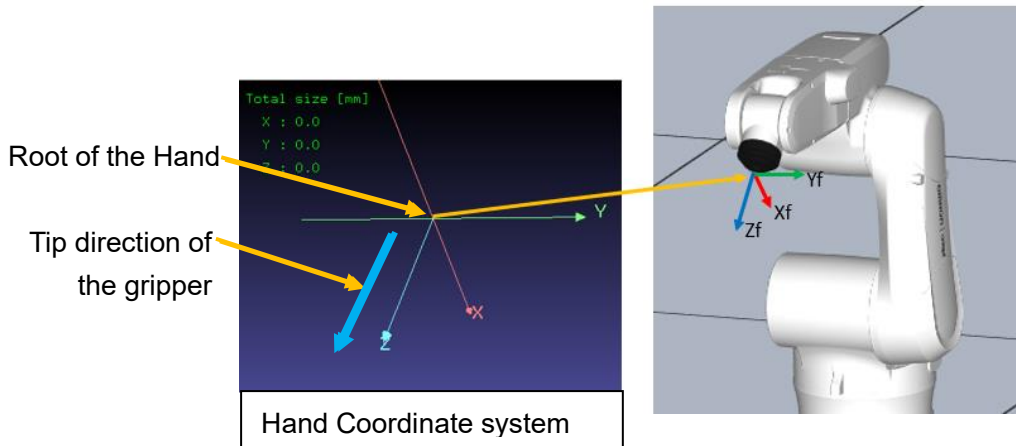

■ Components of the hand

The two-finger hand consists of the following elements.

Element	Description
Left finger	Left finger part. This is movable.
Left tip finger	The left finger tip part that grasps workpieces. This is movable. You must register only one part.
Right finger	Right finger part. This is movable.
Right tip finger	The right finger tip part that grasps workpieces. This is movable. You must register only one part.
Base	Structural elements other than the above. Elements such as flange mounting bracket, hand actuator, camera, and jig that are linked to the 6th axis of the robot and required for collision detection are registered as Base.

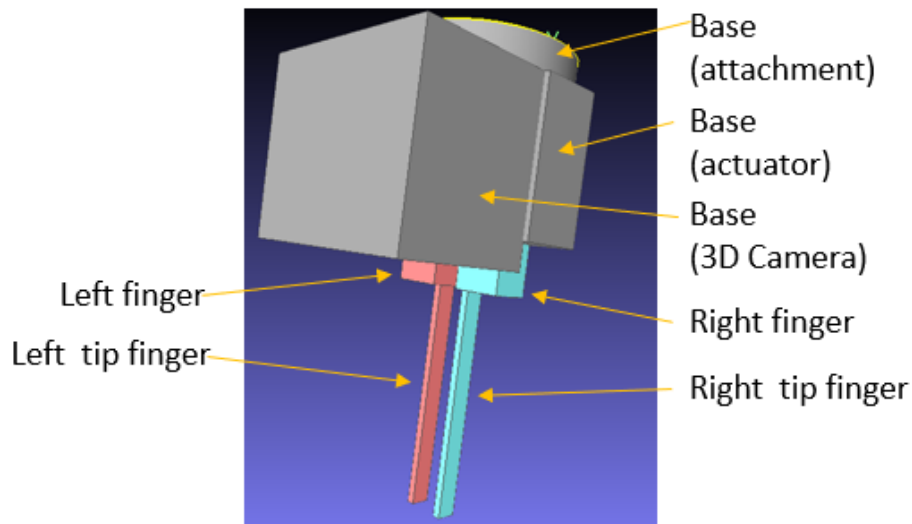

■ Location and dimensions of components

Position and posture of elements are described in the flange coordinate. The position of the element is center of roof plane or cross section of diagonal line. Height/ Width Z is minus Z direction in flange coordinate system.

The root of the hand is located at the origin of the flange coordinate system. Create the tip of the hand in the Z-axis plus direction of the flange coordinate system.

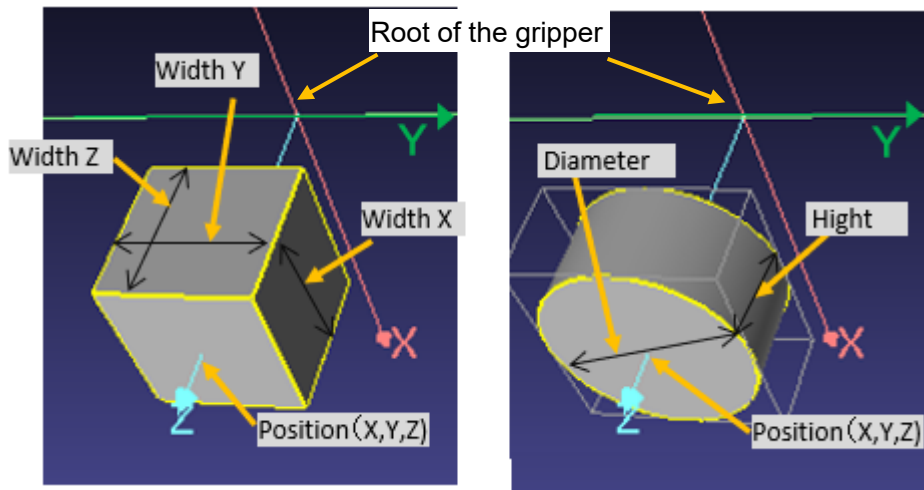

■ Accuracy of the hand

Accurately set the positions and dimensions of the left and right tip fingers that make contact with workpieces (shown in a red outline in the figure below). In particular, set the dimensions in the Z-axis direction of the flange coordinate system correctly. For other elements that may collide with the container (shown in a yellow outline in the figure below), you can use approximate shapes such as circumscribed cubes and cylinders without problems.

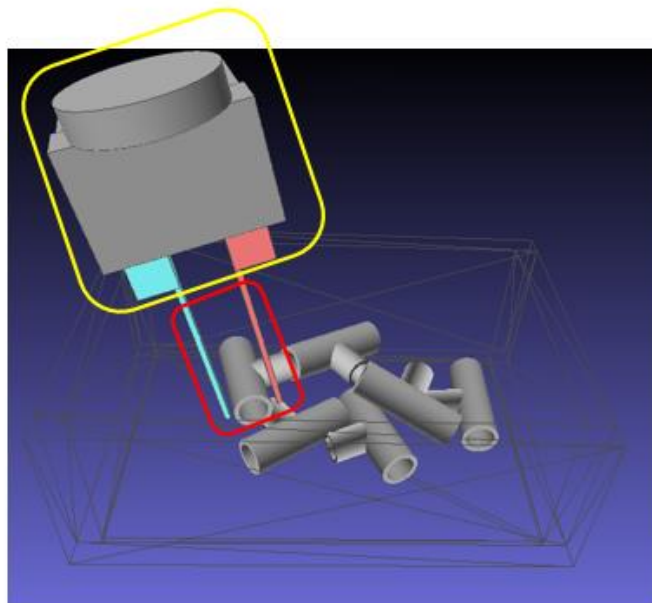



## Precautions for Correct Use

- Output of the Vision Sensor is calculated based on the hand shape specified here. Position and size of the element which contact to the target object must be set precisely.
- Register the elements attached to the hand (camera, connectors, jigs attached to the hand, etc.) that require collision judgement with the container together with the hand.

Follow the steps below to register the hand data, and then register the grasp point.

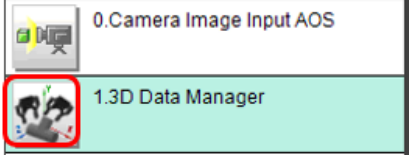
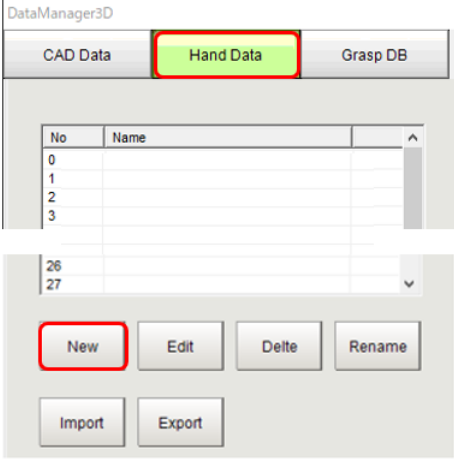
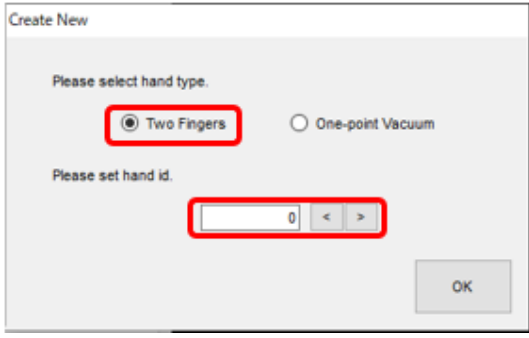
1	Click the “1. 3D Data Manager” icon on the Main windows of the Vision Sensor to open its setting screen.	
2	Open the “Hand Data” tab.  Select a vacant No. and click <b>New</b> button.	
3	The dialog shown in the figure to the right will pop up. Select [ <b>Two Finger</b> ] and set a unique hand ID. Click the <b>OK</b> button to open the HandMaker tool.	

4 ■ Flange connection jig  
 Click **Add Cylinder** button and then select **Base** from the pulldown list.  
  
 Open the “Individual parts” tab.  
 Set Position, Orientation and dimension of each element (pipe).

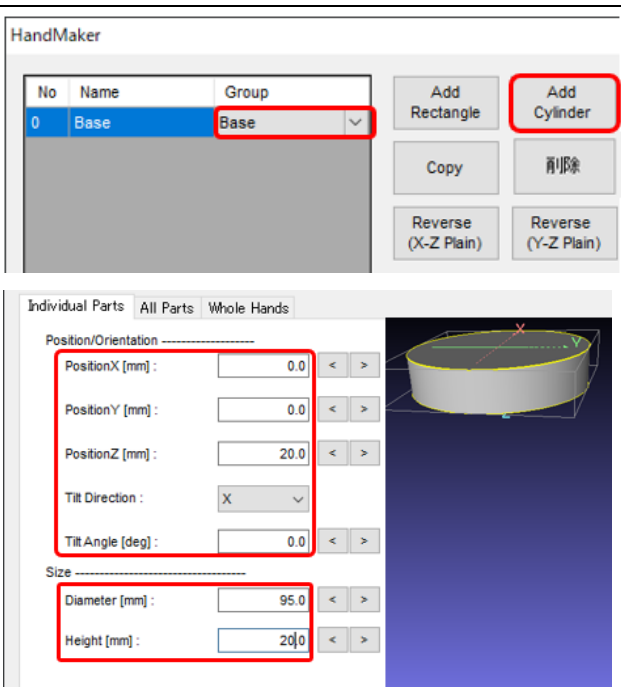

5 ■ Actuator  
 Click **Add Rectangle** and then select **Base** from the pulldown list.  
  
 Open the “Individual parts” tab.  
 Set Position, Orientation and dimension of each element (Rectangle)

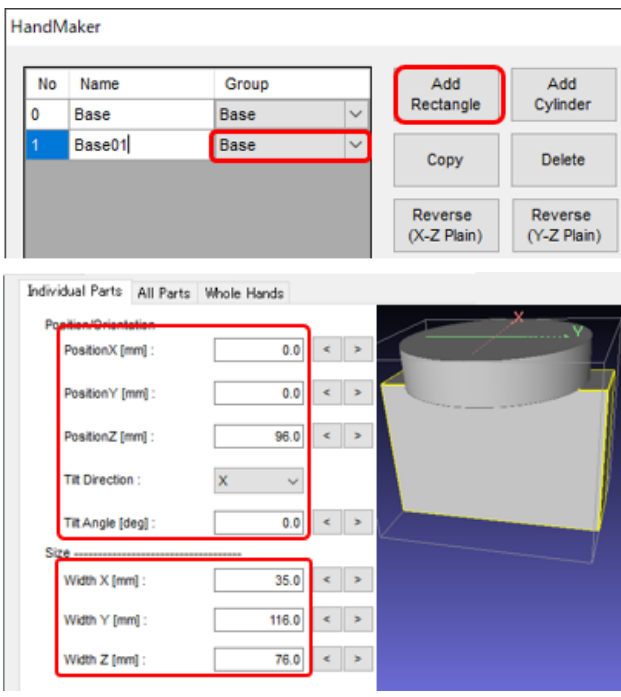

6 ■ Right finger  
 Click **Add Rectangle** and then select **Right finger** from the pulldown list.

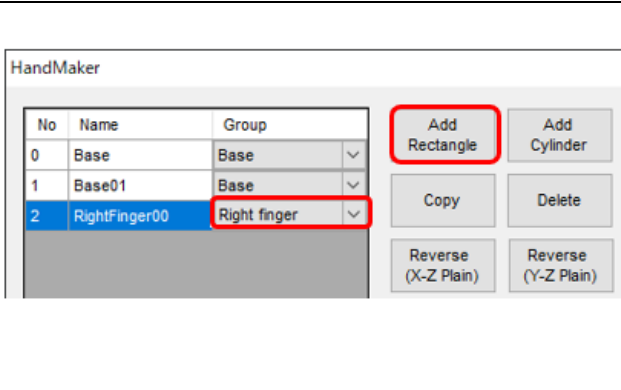

Open the “Individual parts” tab.  
Set Position, Orientation and dimension of each element (Rectangle)

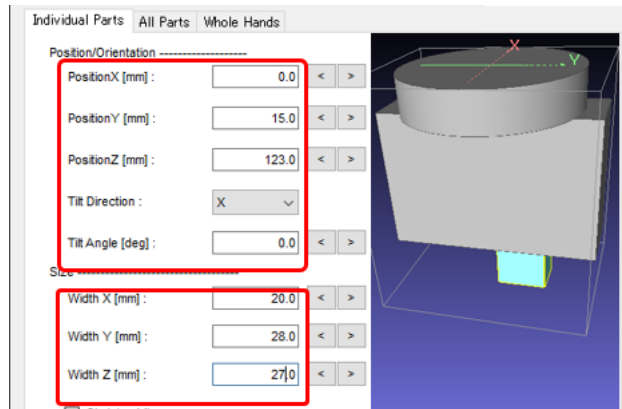

7 ■ Right tip finger  
Click **Add Rectangle** and then select **Right tip finger** from the pulldown list.

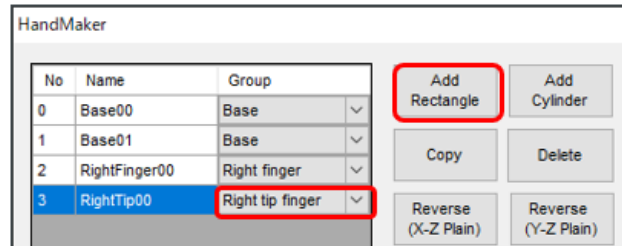

Open the “Individual parts” tab.  
Set Position, Orientation and dimension of each element (Rectangle)

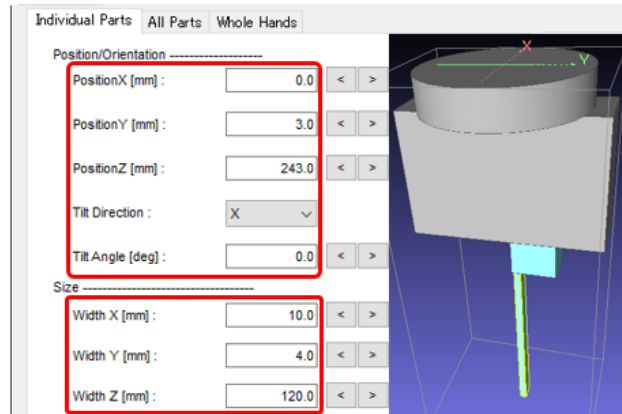

## ⚠ Caution

- Accurately set the positions, postures and dimensions of the left and right tip fingers. If they differ from the actual dimensions or positions, the hand may collide with workpieces or the container.



## 8 ■Left finger

Copy the right finger part to make the left finger part.

In the right hand part, select the element that you set to *Right finger* and click the **Copy** button.

Since the hand is symmetrical to the XZ plane of the flange coordinate system, click the **Reverse (X-Z Plane)** button to reverse the position.

Change the group of the reversed element to *Left finger*.

In the Individual Parts tab, check that the position/orientation and size settings are correct.

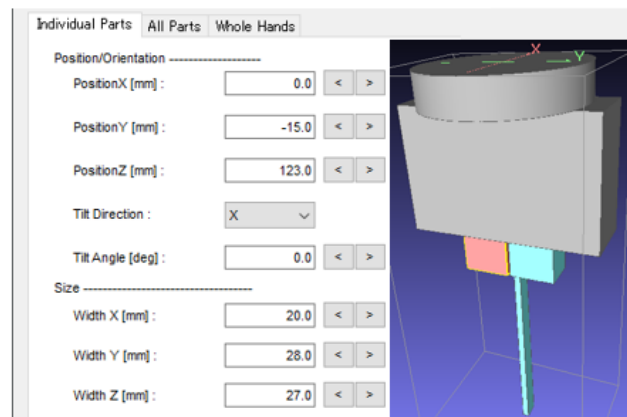
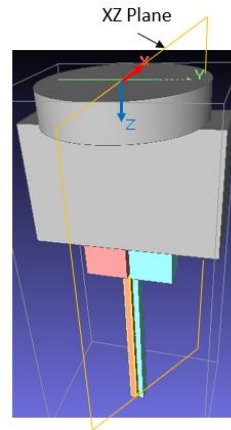
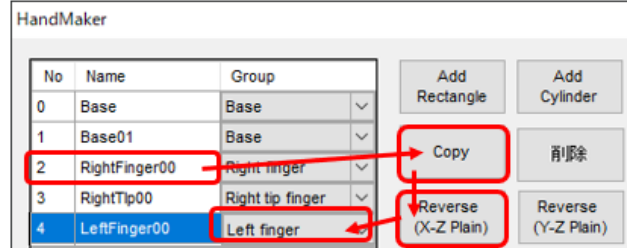

9

■Left finger tip

Copy the right finger tip part to make the left finger tip.

In the right finger tip part, select the element that you set to *Right tip finger* and click the **Copy** button.

Since the hand is symmetrical to the XZ plane of the flange coordinate system, click the **Reverse (X-Z Plane)** button to reverse the position.

Change the group of the reversed element to *Left tip finger*.

If necessary, rename it.

In the Individual Parts tab, check that the position/orientation and size settings are correct.

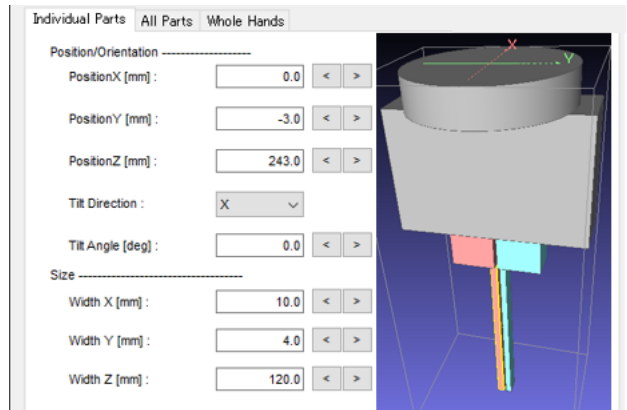
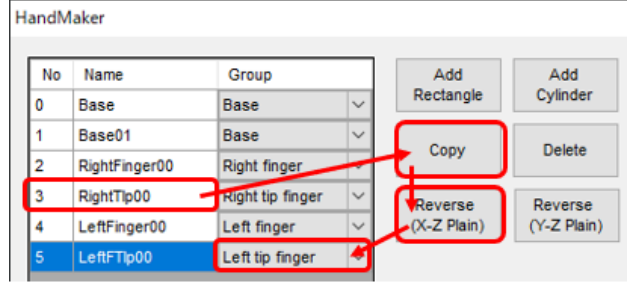





10

■On-Hand Camera

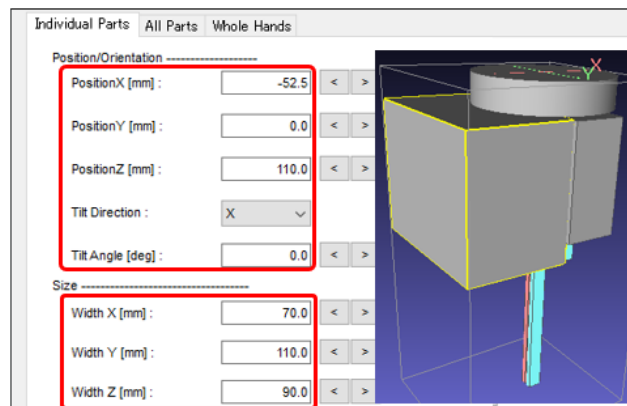
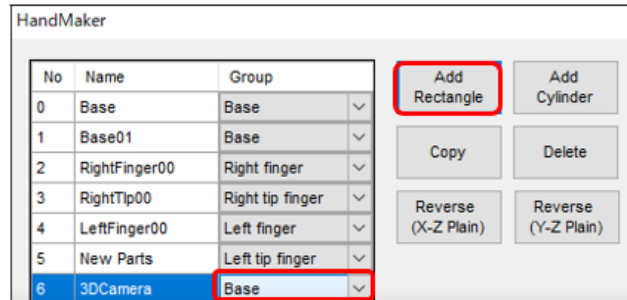
Assume the size of the On-Hand Camera to be 110x70x90mm. Click [Add Rectangle] button and select "Base" from the pulldown list.

Open the "Individual parts" tab. Set Position, Orientation and dimension of each element (On-Hand camera).

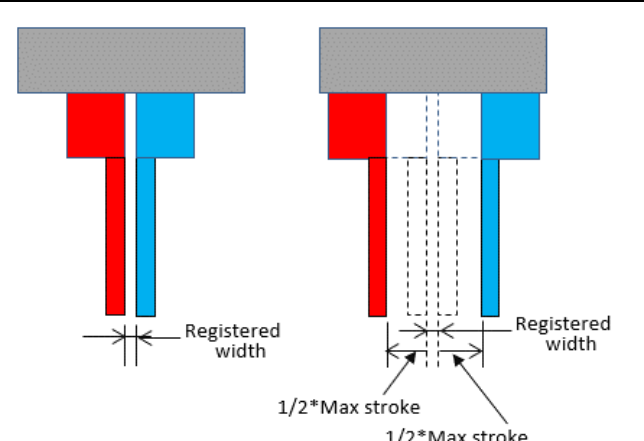
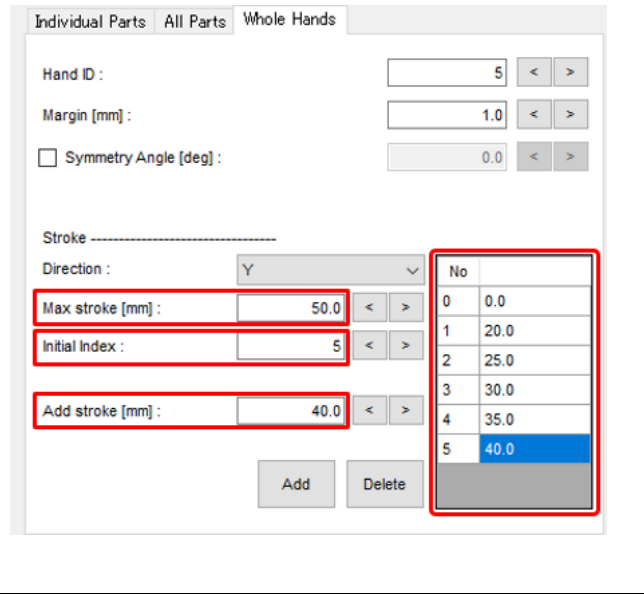

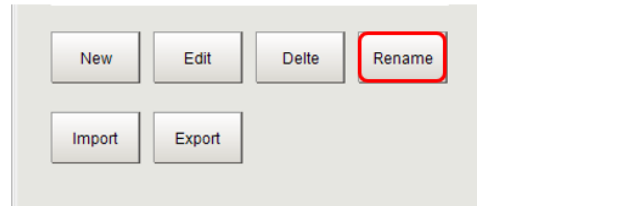
	<p>This hand model does not have rotational symmetry because of the camera so open “Whole hands” tab and remove the check from the <b>Symmetry</b> check box.</p> 														
<p><b>11</b> In the Whole Hands tab, set the stroke of the hand.</p> <p>The maximum stroke is the opening width between the two fingers. The actual opening width is the sum of the width at the initial position where the element was registered and the maximum stroke that you set here.</p> <p>With an actuator that supports multiple hand opening width settings, you can set multiple hand opening widths.</p> <p>In <b>Initial index</b>, set the opening width of the hand when workpieces are grasped.</p>	  <table border="1" data-bbox="1228 1097 1396 1355"> <thead> <tr> <th>No</th> <th>Value</th> </tr> </thead> <tbody> <tr> <td>0</td> <td>0.0</td> </tr> <tr> <td>1</td> <td>20.0</td> </tr> <tr> <td>2</td> <td>25.0</td> </tr> <tr> <td>3</td> <td>30.0</td> </tr> <tr> <td>4</td> <td>35.0</td> </tr> <tr> <td>5</td> <td>40.0</td> </tr> </tbody> </table>	No	Value	0	0.0	1	20.0	2	25.0	3	30.0	4	35.0	5	40.0
No	Value														
0	0.0														
1	20.0														
2	25.0														
3	30.0														
4	35.0														
5	40.0														
<p><b>12</b> Click <b>Save</b> button to save designed hand and then click <b>Exit</b> button to close HandMaker tool.</p>															
<p><b>13</b> Click <b>Rename</b> button to change hand name from the system default name.</p>															

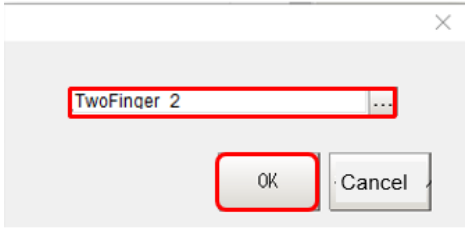
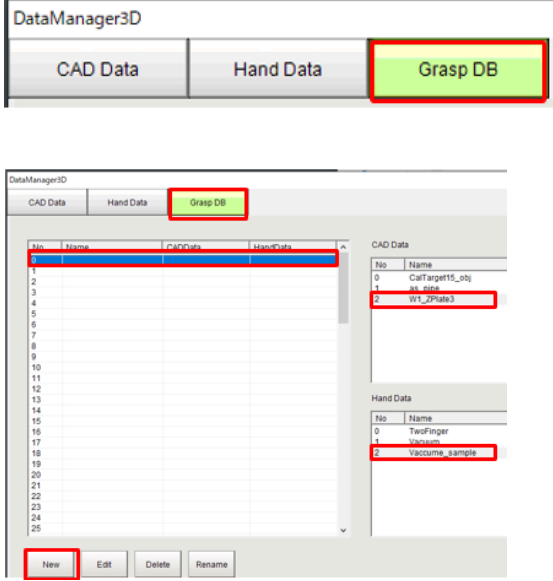
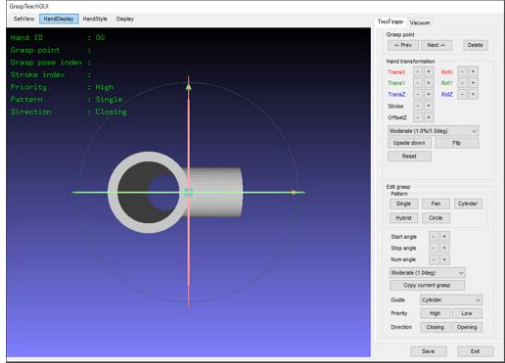
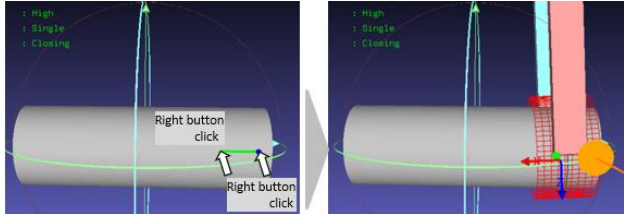

	<p>Input arbitrary name in dialog box and then Click <b>OK</b> to apply change.</p> <p>Hand design and registration process is done by above operations.</p>	
<p>14</p>	<p>Open “Grasp DB” to make a Grasp DB and register grasp points.</p> <p>Select a target object from CAD Data list and select a hand from Hand Data list.</p> <p>Click the <b>New</b> button to open the GraspTeachGUI tool.</p>	
<p>15</p>	<p>Move mouse on the grasp point and right click. The hand will be displayed on the grasp point like the figure shown on the right.</p> <p>Right-click any two points on the workpiece to specify the line where the left finger tip (Left tip finger) makes contact.</p>	 

Use the **Hand transformation** buttons to finely adjust the grasp point. Use each button as follows. Click the **+ or -** button for each axis to adjust the position of the hand.

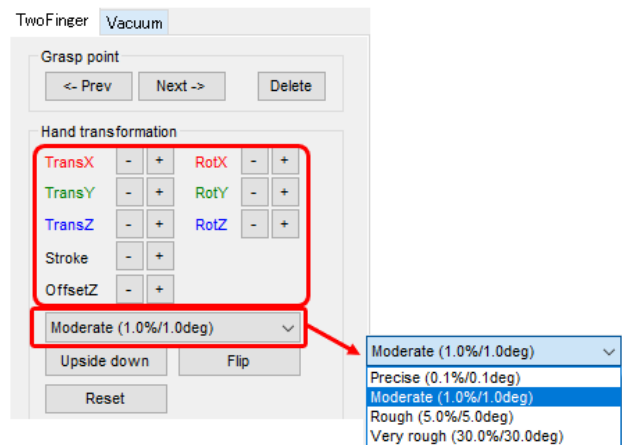

Use the guide on display to adjust the position so that the left and right fingers are equidistant from the workpiece.

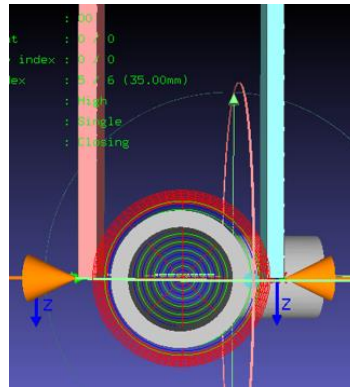

If the position of the hand causes a collision with the workpiece as shown in the figure on the right, the fingers will be shown in yellow. In this case, adjust the position to prevent collisions.

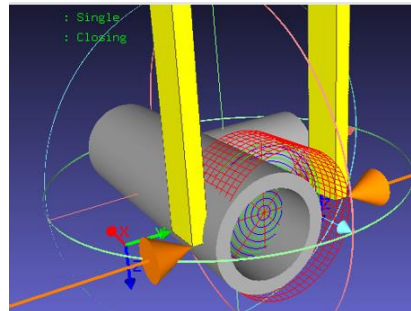

You can add a grasp point by right-clicking another place on the workpiece.

16 If the object is a cylinder, etc., you can use the **OffsetZ** buttons to push in and move the grasp point to a stable place.

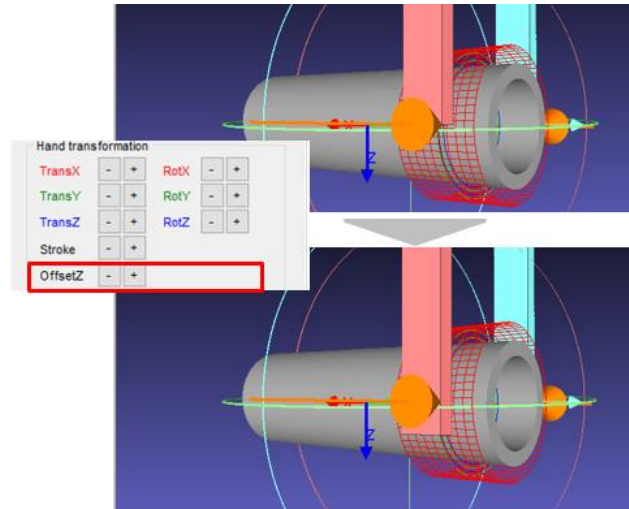

17 Some type of grasp points can be generated automatically. Multiple point around axis are generated by **Fan** or **Circle** button. Number of multiple point and angle is adjustable by using **[+]/[-]** button shown in right figure. Start angle Stop angle Click the **Single** button to cancel the **Fan** or **Cylinder** setting mode.

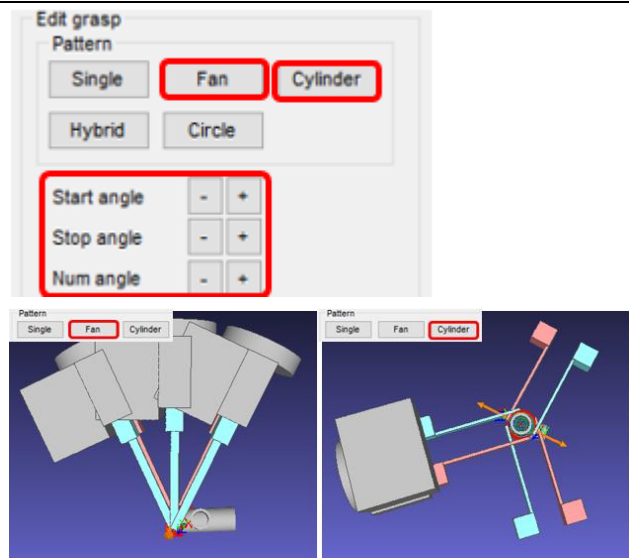

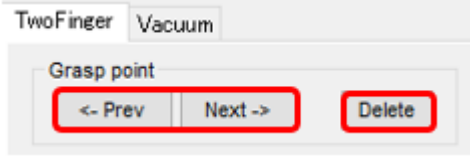
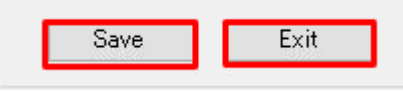
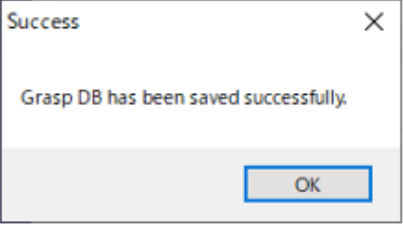
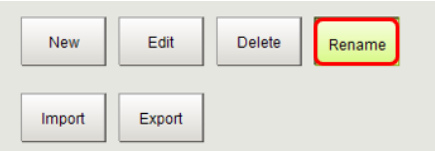
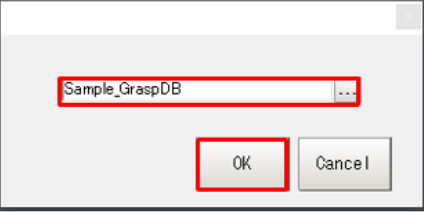
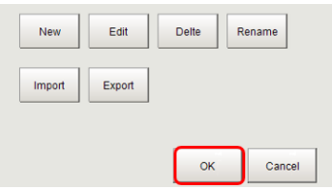
<p>18</p>	<p>[-Prev] button displays previous grasp point, [Next-&gt;] button displays next grasp point.</p> <p><b>Delete</b> button deletes current grasp point.</p> <p>After setting all grasp points, click <b>Save</b> button at right lower side of the window.</p> <p>When the dialog “Grasp DB has been saved successfully” pops up, click the <b>OK</b> button.</p> <p>If a warning dialog appears, please review grasp points that do not touch, or collide with the workpiece.</p> <p>Then click the <b>Exit</b> button.</p>	  
<p>19</p>	<p>Click the <b>Rename</b> button to change the Grasp DB name from the system default name.</p> <p>Input any name in the dialog box and then click <b>OK</b> to apply the change.</p> <p>The Grasp point registration process is completed by the above operations.</p>	 
<p>20</p>	<p>Click the <b>OK</b> button to complete the setting and close Hand and Grasp point registration, and 3D Data Manager unit.</p>	

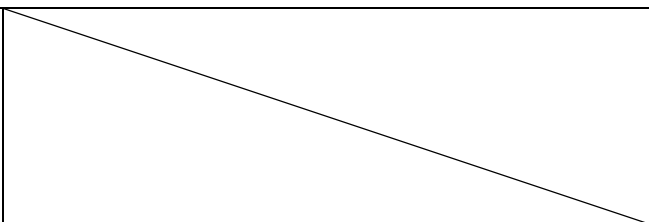
21	Click the <b>Scene switch</b> button in the main window. And switch scene to sample scene (No.0 scene).	
----	---	--



### **Precautions for Correct Use**

---

- Set the grasp point based on the actual posture of workpieces, the movement range of the robot, and the shape and placement of the hand.
  - If you need to set more than one grasp point and consider how to place the hand for each grasp point, design the robot program depending on the grasp point.
-

## 9.2. Robot Error

When an error occurs during communication with a robot, click the **Robot Error** button to display the following screen.

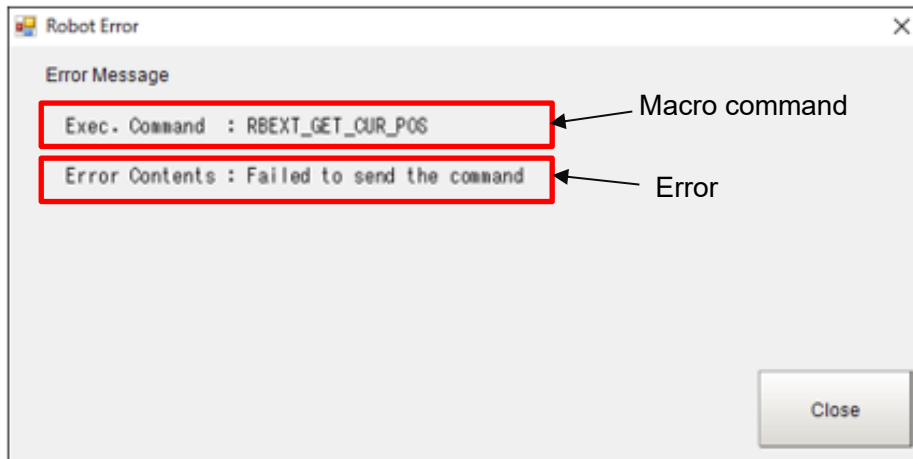

The following table shows the error messages and corrective actions that may be displayed.

Error	Possible cause / Corrective action
Failed to send the command	<ul style="list-style-type: none"> <li>Robots and/or Vision Sensor may have incorrect communication settings. Adjust the settings of the IP address and port number of the robot controller and Vision Sensor.</li> <li>The setup program may not have been started on the robot side. Operate with the setup program activated on the robot.</li> </ul>
The Connection had timed out	<ul style="list-style-type: none"> <li>The robots did not respond to Vision Sensor commands within a certain time period. Due to the slow robot operation speed, the robot may not complete its movement within the set communication timeout period. Increase the communication timeout time. Or increase the operation speed of the robot.</li> </ul>
Measure failed	<ul style="list-style-type: none"> <li>Measurement trigger may have been sent when the Processing Item or System Setting window is open. Do not send measurement trigger when the process unit or the system setting window is open.</li> </ul>
Failed to move robot	<ul style="list-style-type: none"> <li>The destination robot position sent from the Vision Sensor may be out of movement range. Adjust the parameters of the robot operation range so that the robot position of the destination is within the movement range. Alternatively, adjust the settings of the Hand-eye Calibration unit and Grasp Planning unit.</li> </ul>
Measurement result is NG	<ul style="list-style-type: none"> <li>The measurement result is NG. Adjust the setting of the processing unit with the result of NG.</li> </ul>

**OMRON Corporation Industrial Automation Company**

**Kyoto, JAPAN**

**Contact : [www.ia.omron.com](http://www.ia.omron.com)**

**Regional Headquarters**

**OMRON EUROPE B.V.**

Wegalaan 67-69, 2132 JD Hoofddorp  
The Netherlands  
Tel: (31) 2356-81-300 Fax: (31) 2356-81-388

**OMRON ELECTRONICS LLC**

2895 Greenspoint Parkway, Suite 200  
Hoffman Estates, IL 60169 U.S.A.  
Tel: (1) 847-843-7900 Fax: (1) 847-843-7787

**OMRON ASIA PACIFIC PTE. LTD.**

438B Alexandra Road, #08-01/02 Alexandra  
Technopark, Singapore 119968  
Tel: (65) 6835-3011 Fax: (65) 6835-2711

**OMRON (CHINA) CO., LTD.**

Room 2211, Bank of China Tower,  
200 Yin Cheng Zhong Road,  
PuDong New Area, Shanghai, 200120, China  
Tel: (86) 21-5037-2222 Fax: (86) 21-5037-2200

**Authorized Distributor:**

©OMRON Corporation 2021-2023 All Rights Reserved.  
In the interest of product improvement,  
specifications are subject to change without notice.

**Cat. No. Z446-E1-05** 0223  
Printed in Japan