

**Machine Automation Controller
NX Series**

EtherNet/IP™ Connection Guide

**Smart camera
F430-F Series**

A teal gradient rectangular box with a thin dark teal border is positioned on the right side of the page. It contains the text "Network Connection Guide" in white, centered vertically and horizontally.

**Network
Connection
Guide**

About Copyrights and Trademarks

Screen shots of elements of Microsoft products are used with permission from Microsoft Corporation.

Windows is a registered trademark of Microsoft Corporation in the USA and other countries.

ODVA, EtherNet/IP™ are trademarks of ODVA.

Sysmac and SYSMAC are trademarks or registered trademarks of OMRON Corporation in Japan and other countries for OMRON factory automation products.

Company names and product names in this document are the trademarks or registered trademarks of their respective companies.

Contents

1. Related Manuals	3
2. Terms and Definitions.....	4
3. Restrictions and Precautions.....	5
4. Overview	6
5. Applicable Devices and Device Configuration	7
5.1. Applicable Devices	7
5.2. Device Configuration	8
6. EtherNet/IP Settings.....	10
6.1. Parameters	10
6.2. Data Types to Use for Tag Data Links.....	10
6.3. Global Variables	12
6.4. Tag Set.....	16
6.5. Tag Data Link Table	16
7. EtherNet/IP Connection Procedure.....	17
7.1. Operation Flow	17
7.2. Smart Camera Setup.....	18
7.3. Controller Setup.....	23
7.4. Confirm EtherNet/IP Communications	43
8. Initializing the System.....	46
8.1. Initializing the Controller	47
8.2. Initializing the Smart camera	47
9. Appendices: How to Use the Project File.....	48
9.1. Operation Flow	48
9.2. Controller Setup.....	49
10. Revision History	51

1. Related Manuals

To ensure system safety, make sure to always read and follow the information provided in all Safety Precautions and Precautions for Safe Use in the manuals for each device which is used in the system.

The following Omron Corporation (hereinafter referred to as "Omron") manuals are related to this document:

Manual No.	Model	Manual Name
W535	NX Series	NX Series CPU Unit User's Hardware Manual
W593	NX Series	NX Series NX102 CPU Unit Hardware User's Manual
W578	NX Series	NX Series NX1P2 CPU Unit Hardware User's Manual
W501	NJ/NX Series	NJ/NX Series CPU Unit Software User's Manual
W506	NJ/NX Series	NJ/NX Series CPU Unit Built-in EtherNet/IP Port User's Manual
W504	SYSMAC-SE2□□□	Sysmac Studio Version 1 Operation Manual
W502	NJ/NX Series	NJ/NX Series Instructions Reference Manual
Z433	F430-F Series	Smart Camera F430-F Series User Manual
Z444	F430-F Series	Smart Camera F430-F Series User Manual for Communications Settings

2. Terms and Definitions

Below is a list of terms used in this manual and their definitions.

Term	Description / Definition
Node	It refers to a relay point, a branch point or a terminal on an EtherNet/IP network comprised of equipment having an EtherNet/IP port. Devices with one EtherNet/IP port are recognized as one node on the EtherNet/IP network, and devices with two EtherNet/IP ports are recognized as two nodes.
Tag	A tag is a unit that is used to exchange data with tag data links. Data is exchanged between the network variable specified in "Tag" and the partner device network variable or the specified I/O memory area.
Tag Set	When a connection is established, from 1 to 8 tags (including Controller status) is configured as a set. This is referred to as a Tag Set. Each tag set represents the unit of data that is linked for a tag data link connection. A Tag data link is established by connecting individual tag sets. A Tag set name must be given to each tag set.
Tag Data Link	The Implicit communication of the EtherNet/IP standard is called a Tag Data Link. A Tag data link is a function to exchange data for each tag cyclically between controllers or between a controller and other device type on an EtherNet/IP network.
Connection	A connection is a unit of data exchange that ensures data synchronization.
Connection type	You can select a multi-cast connection or unicast (point-to-point) connection as the connection type in the tag data link connection settings. The multi-cast connection sends an output tag set in one packet to more than one node. The unicast connection separately sends one output tag set to each node. Therefore, multi-cast connections can decrease the communications load if one output tag set is sent to multiple nodes.
Originator and Target	In order to perform tag data linking, it is necessary to first establish a connection between the nodes that perform tag data linking. The node that requests the connection is called the Originator and the node that receives the request is called the Target.
Tag Data Link Parameters	In tag data link setting, "tag setting", "tag set setting" and "connection setting" are collectively called "tag data link parameters".
EDS file	It is a file describing device-specific information such as the number of input/output points for an EtherNet/IP device.

3. Restrictions and Precautions

- (1) Understand the specifications of devices which are used in the system. Allow some margin for ratings and performance.
- (2) Provide safety measures, such as installing a safety circuit, in order to ensure safety and minimize the risk of abnormal occurrence.
- (3) To ensure system safety, make sure to always read and follow the information provided in all Safety Precautions and Precautions for Safe Use in the manuals for each device which is used in the system. The user is encouraged to confirm the standards and regulations that the system must conform to.
- (4) It is prohibited to copy, to reproduce, and to distribute a part or the whole of this document without the permission of OMRON Corporation.
- (5) The information contained in this document is current as of January 2020.
It is subject to change for improvement without notice.

The following notations are used in this document.

 WARNING	Indicates a potentially hazardous situation which, if not avoided, may result in minor or moderate injury, or may result in serious injury or death. Additionally, there may be severe property damage.
---	---

 CAUTION	Indicates a potentially hazardous situation which, if not avoided, may result in minor or moderate injury, or property damage.
--	--



Precautions for Correct Use

Precautions on what to do and what to avoid doing to ensure proper operation and performance.



Note

Additional information to read as required.

This information is provided to increase understanding and make operation easier.

Symbols



- This indicates operations that you must do.

The specific operation is shown in the circle and explained in text.

This example shows a general precaution for something that you must do.

4. Overview

This document describes the procedures for connecting the Omron Smart Camera product (F430-F Series) to the NX Series Machine Automation Controller (hereinafter referred to as Controller) via EtherNet/IP, and for verifying their connections.

Refer to Section 6. EtherNet/IP Settings and Section 7. EtherNet/IP Connection Procedure to understand setting methods and key points to operate EtherNet/IP tag data links.



Note

Settings described in 7.3. Controller Setup are made in advance in the Sysmac Studio project file (hereinafter referred to as project file) listed below. For how to use this project file, see "9. Appendices: How to use the Project File". Obtain the latest version of the project file from OMRON Corporation.

Name	Filename	Version
Sysmac Studio Compact Project File (Extension: SMC2)	OMRON_F430_NX_EIP_V100.SMC2	Ver.1.00

5. Applicable Devices and Device Configuration

5.1. Applicable Devices

The applicable devices that can be connected are as follows:

Manufacturer	Name	Model	Version
OMRON	NX Series CPU Unit	NX701-□□□□ NX102-□□□□ NX1P2-□□□□	Same or higher version as indicated in section 5.2.
OMRON	Smart camera	F430-F□□□□□□□-□□□	



Note

This document describes the procedure for establishing the communication connection of the device, and does not describe the operation, installation and wiring method of the device. For detailed information on the above products (other than communication connection procedure), please refer to the instruction manual of the product or contact OMRON.



Note

In this document, from among the above target devices, connection confirmation is performed using the devices listed in section 5.2. When using a device that is not described in section 5.2. Among the above target devices, check the connection referring to the contents of this document.



Precautions for Correct Use

In this document, the devices with models and versions listed in section 5.2. You cannot use devices with versions lower than the versions listed in section 5.2. To use the above devices with models not listed in 5.2. or versions higher than those listed in 5.2., check the differences in the specifications by referring to the manuals before operating the devices.

5.2. Device Configuration

The system components required for reproducing the connection procedures described in this document are as follows.

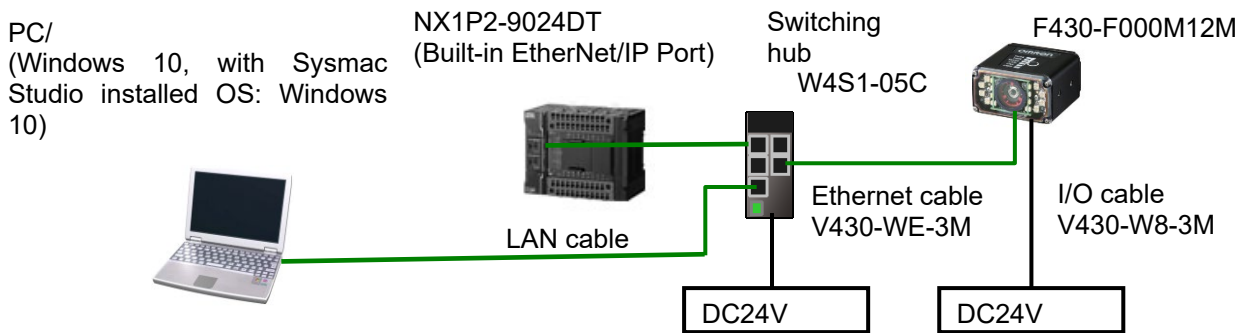

Manufacturer	Name	Model	Version
OMRON	NX Series CPU Unit (Built-in EtherNet/IP Port)	NX1P2-9024DT	Ver.1.16
OMRON	Switching hub	W4S1-05C	
OMRON	Sysmac Studio	SYSMAC-SE2□□□	Ver.1.29
OMRON	Sysmac Studio Project File	OMRON_F430_NX_EIP_V100.csm2	Ver.1.00
	Computer (OS: Windows 10)		
	LAN cable (STP (shielded, twisted-pair) cable of Ethernet category 5 or higher)		
OMRON	Smart camera	F430-F000M12M	Ver.5.2.0
OMRON	I/O cable	V430-W8-3M	
OMRON	Ethernet cable	V430-WE-3M	
-	DC24V Power supply (Smart camera)	-	



Precautions for Correct Use

Ensure that Sysmac Studio is updated to at least the version specified in this documentation, or to a higher version.

If you use a version other than the version specified in this section, there may be differences in the procedures in chapter 7 and after. In that case, use the equivalent procedures described in this document by referring to the Sysmac Studio Version 1 Operation Manual (Cat. No. W504).



Note

Refer to "Industrial Switching Hub W4S1 Series User Manual" (0969584-7) for power supply specifications that can be used for 24 VDC power supply (for switching hub).



Note

Refer to the "Smart Camera F430-F Series User Manual" (Z433) for the power supply specifications that can be used for DC24V power supply (for Smart camera).

6. EtherNet/IP Settings

The specifications for the parameters, global variables, tag sets, and tag data link table are shown.

In subsequent chapters, the smart camera may also be referred to as the "Partner device", depending on the description.

6.1. Parameters

The parameters that are set in this document are shown below.

6.1.1. EtherNet/IP Communication Settings

The parameters used for connecting the controller and smart camera via EtherNet/IP are as follows.

Setting item	Controller	Smart camera
Ethernet	-	Enabled
IP Address	192.168.188.200	192.168.188.2
Subnet mask	255.255.0.0	255.255.0.0 (default)
Gateway	-	0.0.0.0 (Default: As needed)
IP Address Mode	-	Fixed
EtherNet/IP	-	Enabled
KeepAlive	Enabled (default)	-

* For the use cases in this document, setting the gateway is unnecessary because the devices are connected within the same segment of the network.

Set the Smart camera gateway setting to any value other than blank.

6.2. Data Types to Use for Tag Data Links

For the data of the tag data link of the smart camera, an example of using the data type is described.

- Define the Data type (common format) for signal access.
Data type for handling control signals and status signals.

Data type name	Data type
U_EIPFlag16	STRUCT
F	BOOL[16]
W	WORD
U_EIPFlag32	STRUCT
F	BOOL[32]
W	DWORD

- Data type definition (structure) for Command Area access
Data type for accessing the Command Area.

Data type name	Data type	Smart camera data
S_EIPOutput	STRUCT	-
CONTROL	U_EIPFlag16	Control signal (16bit)
ECHO	WORD	Echo
CmdCode	DWORD	Command code
CmdArg	DWORD	Command parameters
reserved1	U_EIPFlag32	Reserved for future use
VIO	U_EIPFlag16	Virtual IO
reserved2	U_EIPFlag16	Reserved for future use
bool_val	BOOL[64]	Global Data Service (GDS*1) bool101 to bool164
int_val	INT[10]	GDS int101 to int110
long_val	DINT[10]	GDS long101 to long110
float_val	REAL[10]	GDS float101 to float110
string101_length	DINT	GDS string101 String length
string101	STRING[92]	GDS string101
string102_length	DINT	GDS string102 String length
string102	STRING[28]	GDS string102
string103_length	DINT	GDS string103 String length
string103	STRING[28]	GDS string103
string104_length	DINT	GDS string104 String length
string104	STRING[28]	GDS string104

*1: For more detailed GDS information, please click on the [Omron Microscan] link that can be found in the Help menu of the AutoVision software.

■ Data type definition (Structure) for Response / Output Area access

Data type for accessing the Response / Output Area.

Data type name	Data type	Smart camera data
S_EIPInput	STRUCT	-
STATUS	U_EIPFlag16	Control signal (16bit)
ECHO	WORD	Echo
CmdCodeRslt	DWORD	The result of executing CmdCode
CmdRet	DWORD	Value returned for CmdCode
reserved1	U_EIPFlag16	Reserved for future use
State	U_EIPFlag16	State
VIO	U_EIPFlag16	Virtual IO
reserved2	U_EIPFlag16	Reserved for future use
bool_val	BOOL[64]	GDS bool1 to bool64
int_val	INT[10]	GDS int1 to int10
long_val	DINT[10]	GDS long1 to long10
float_val	REAL[10]	GDS float1 to float10

string1_length	DINT	GDS string1 String length
string1	STRING[92]	GDS string1
string2_length	DINT	GDS string2 String length
string2	STRING[28]	GDS string2
string3_length	DINT	GDS string3 String length
string3	STRING[28]	GDS string3
string4_length	DINT	GDS string4 String length
string4	STRING[28]	GDS string4



Note

For a description of how to use each bit, see "Chapter 2 Using EtherNet/IP" in "Smart Camera F430-F Series AutoVISION Industrial Protocol Manual" (SDNC-752).

6.3. Global Variables

The Controller treats the data in tag data links as global variables. The settings for Global variables are shown below.

The global variable below is set to "Project file".

Variable	Network Publish	Data type	Usage
EIOutput	Output	S_EIOutput	For Output Area data links
EIInput	Input	S_EIInput	For Input Area data links

■ EIOutput Structure

Smart camera data	Variable name	Data type
Control signal (32bit)		U_EIPFlag16
	EIOutput.CONTROL.F	BOOL[16]
	EIOutput.CONTROL.W	DWORD
Echo	EIOutput.ECHO	WORD
Command code	EIOutput.CmdCode	DWORD
Command parameters	EIOutput.CmdArg	DWORD
Reserved for future use	EIOutput.reserved1	U_EIPFlag32
Virtual IO	EIOutput.VIO	U_EIPFlag16
Reserved for future use	EIOutput.reserved2	U_EIPFlag16
Global Data Service (GDS*) bool101 to bool164	EIOutput.bool_val	BOOL[64]
GDS int101 to int110	EIOutput.int_val	INT[10]
GDS long101 to long110	EIOutput.long_val	DINT[10]
GDS float101 to float110	EIOutput.float_val	REAL[10]

GDS string101 String length	EIOutput.string101_length	DINT
GDS string101	EIOutput.string101	STRING[92]
GDS string102 String length	EIOutput.string102_length	DINT
GDS string102	EIOutput.string102	STRING[28]
GDS string103 String length	EIOutput.string103_length	DINT
GDS string103	EIOutput.string103	STRING[28]
GDS string104 String length	EIOutput.string104_length	DINT
GDS string104	EIOutput.string104	STRING[28]

*1: Control Signal Assignment

Variable: The EIOutput.CONTROL assignment

15	14	13	12	11	10	9	8	7	6	5	4	3	2	1	0
				RESET DATA VALID			TRIGGER	EXE CMD		RESET COUNT	RESET ERR			GO OFFLINE	GO ONLINE

Name	Description
GO ONLINE	Starts all executed Inspections
GO OFFLINE	Stops all inspections
RESET ERROR	Reset Status Register ERROR
RESET COUNT	Resets the Count for all inspections
EXE CMD	Executes the command specified by Control.cmdCode
TRIGGER	Triggered inspection. The inspection is performed on the images acquired by the trigger.
RESET DATA VALID	Reset the Valid Status Register Data

■ EIInput Structure

*1: Control Signal Assignment

Variable: EIInput.STATUS assignment

15	14	13	12	11	10	9	8	7	6	5	4	3	2	1	0
				DATA VALID	INSP STAT	INSP BUSY	TRIGGER ACK	EXE CMD ACK		RESET COUNT ACK	ERROR	TRIGGER READY	ACQ BUSY	EXP BUSY	ONLINE

Name	Description
ONLINE	The inspection is being executed.
EXP BUSY	The camera is busy capturing images. Make sure the camera is not triggered and the object under inspection is not moved during this time.

ACQ BUSY	The camera is busy acquiring images. A trigger cannot be received while the camera is in the Busy state.
TRIGGER READY	The camera is ready to receive a trigger. This is equivalent to ONLINE == 1 and ACQBUSY == 0.
ERROR	An error occurred. Clear the RESET ERROR control bit by setting it to High.
RESET COUNT ACK	This bit mirrors the RESET COUNT control bit. The PLC can confirm that the camera has received a reset command when this goes High. The PLC can then return the RESET COUNT control signal to Low.
EXE CMD ACK	This bit mirrors the EXE CMD control bit. This bit mirrors the TRIGGER control bit.
TRIGGER ACK	This bit mirrors the TRIGGER control bit.
INSP BUSY	When Inspection 1 is processing an image, this bit is High.
INSP STAT	This bit indicates the Result Status of Inspection 1. If the inspection passed, it will be 1. It is valid only when DataValid becomes High.
DATA VALID	When Inspection 1 completes, this bit becomes High. The PLC should set RESET DV to High to clear this signal when a Read result is available.



Note

For more detailed information on Commands and their Responses, please refer to "Chapter 2 Using EtherNet/IP" in ["Smart Camera F430-F Series AutoVISION Industrial Protocol Manual" \(SDNC-752\)](#).



Precautions for Correct Use

If the number of bytes of data for the smart camera Tag data link is an odd byte number, declare it as BYTE type instead of declaring it as BOOL type.



Note

With Sysmac Studio, two methods can be used to specify an array for a data type. After specifying, (1) is converted to (2), and the data type is always displayed as (2).

① BOOL[16] / ② ARRAY[0..15] OF BOOL

In this document, the data type is simplified by displaying BOOL[16].

(The example above means a BOOL data type with sixteen array elements.)

6.4. Tag Set

The Tag set settings to perform Tag data links is shown below.

The data within the Tag set is in ascending order with the following OUT No. and IN No.

■ Output Area (Controller → Smart Camera)

Originator Variable (Tag set name)		Data size (byte)
EIPOutput		320
OUT No.	Global Variable Name (Tag Name)	Data size (byte)
1	EIPOutput	320

■ Input Area (Smart Camera → Controller)

Originator Variable (Tag set name)		Data size (byte)
EIPIInput		320
IN No.	Global Variable Name (Tag Name)	Data size (byte)
1	EIPIInput	320

6.5. Tag Data Link Table

The content of tag data link table settings (connection settings) is shown below.

The values shown in the red frame are those values defined in the EDS file of the smart camera.

Connection name	Connection I/O Type	RPI (ms)	Timeout
default_001	IO320	50.0	RPI x 4

Connection I/O Type	Input / Output	Target Variable	Size (Byte)	Originator Variable (Tag set name)	Size (Byte)	Connection type
IO320	Input	102	320	EIPIInput	320	Point to Point connection
	Output	114	320	EIPOutput	320	Point to Point connection

7. EtherNet/IP Connection Procedure

This section describes the procedures for connecting the Smart camera and Controller on an EtherNet/IP network.

The explanations of procedures for setting up the Controller and smart camera given in this document are based on the use of the factory default settings. For the initialization, refer to Section 8. Initialization Method.

7.1. Operation Flow

The procedures for setting up the EtherNet/IP Tag data links are as follows.

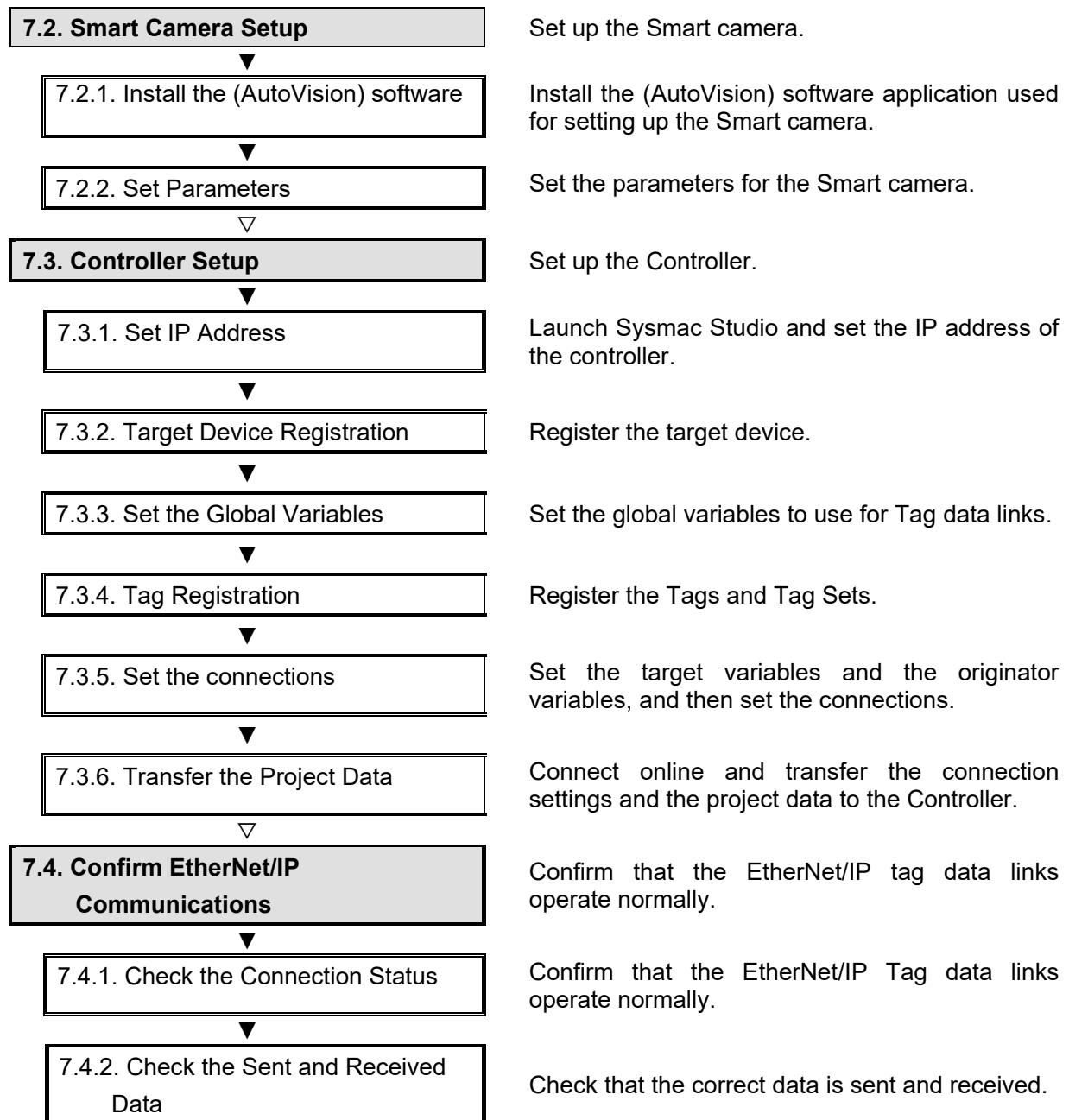

7.2. Smart Camera Setup

Setting up the Smart camera.

7.2.1. Install the (AutoVision) software

Install the (AutoVision) software application used for setting up the Smart camera. For more details on installing the AutoVision software, please refer to the "AutoVISION Quick Start Guide" (Z434).

7.2.2. Set Parameters

Set the parameters for the Smart camera.

Set the IP address of your computer to "192.168.188.100" and its subnet mask to "255.255.0.0".

- 1 Connect the [Ethernet connector] of the smart camera to the switching hub with the [Ethernet cable].

Connect the [I/O cable] to [I/O connector] and turn on the 24VDC power supply.

* This document is only for verification of the power supply wiring of the I/O cable connection. Be careful not to short-circuit any other wires.

* Ground the shielded wire as needed. For more information on Grounding, please refer to the "Smart Camera F430-F Series User Manual" (Z433) - "2-7 Grounding and Power"

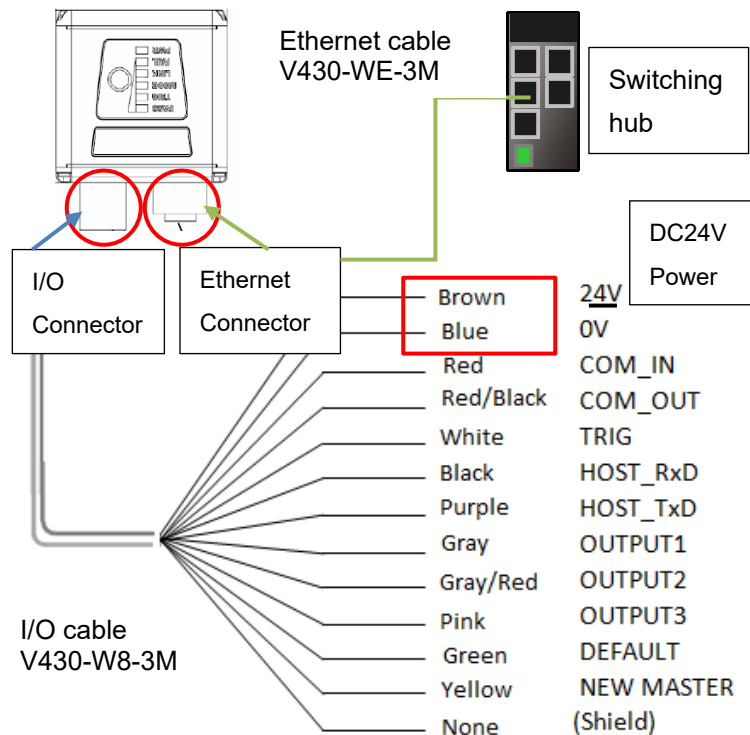

- 2 Connect the computer to the switching hub with the LAN cable.

Connect 24 VDC power supply (for Switching hub) to Switching hub.

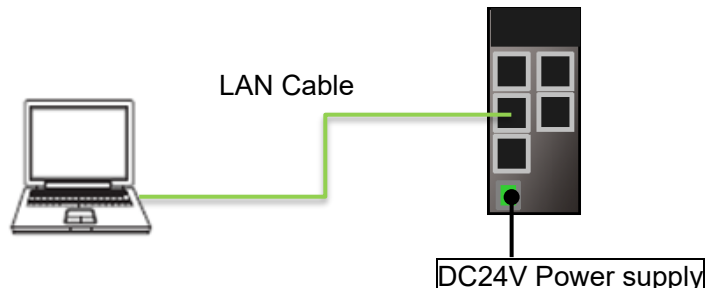

3 Set the IP Address of the computer.

For the IP address, "192.168.188.100", set the subnet mask to "255.255.0.0".

For the procedure to open the screen on the right, please refer to Step 4 below.

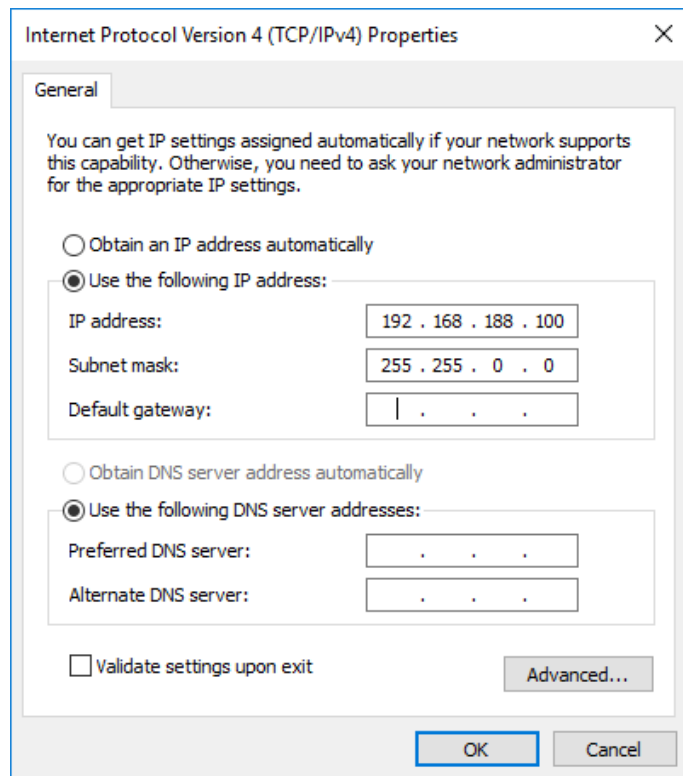

4 Static connection (fixed IP address)

(1) From the Windows Start menu, select Control Panel - Network and

Internet - Network and Sharing Center.

(2) Click on Local Area Connection. The Local Area Connection Status Dialog Box is displayed. Click Properties.

(3) In the [Local Area Connection Properties] dialog box, select [Internet Protocol Version 4 (TCP / IPv4)], and click the [Properties] button. Set the IP Address of the PC to 192.168.188.100.

(4) Click the "OK" button

5 Launch the AutoVision software.

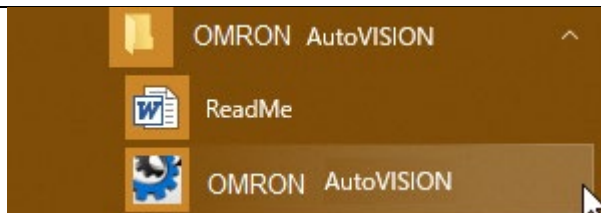

6 After starting AutoVision, if the smart camera is displayed in the device selection list, proceed to Step 8.

If the AutoVision startup screen does not appear, go to step 7.

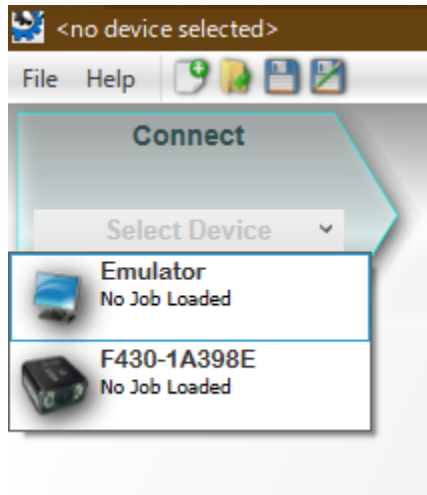

7 If the AutoVision startup screen does not appear, it means that communication between the smart camera and the PC has not been established so please check the following.

- Does the F430 and the PC have a proper physical (cable) connection?
- Are the respective IP Addresses on the PC and on the F430 smart camera set correctly?
→ Refer to 4. for setting the IP Address of the PC.
- Do a hardware reset of the F430.
→ When turning the power on, press and hold the setup button on the smart camera body until its light turns on.

8 After selecting the smart camera, the settings screen will display.

Check the settings indicated by the red boxes.

EtherNet/IP connection is Enabled by default, so you do not need to change the settings from its default.

If you need to change the IP address, for example when connecting multiple F430 devices, change the setting from [IP address] as necessary.

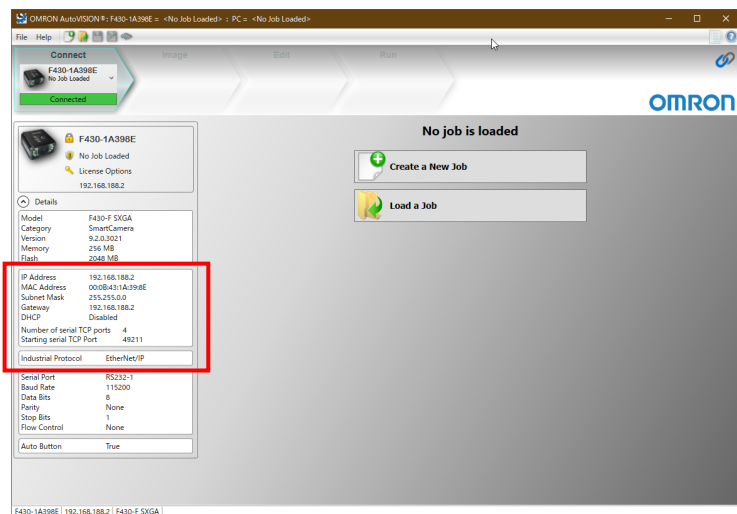

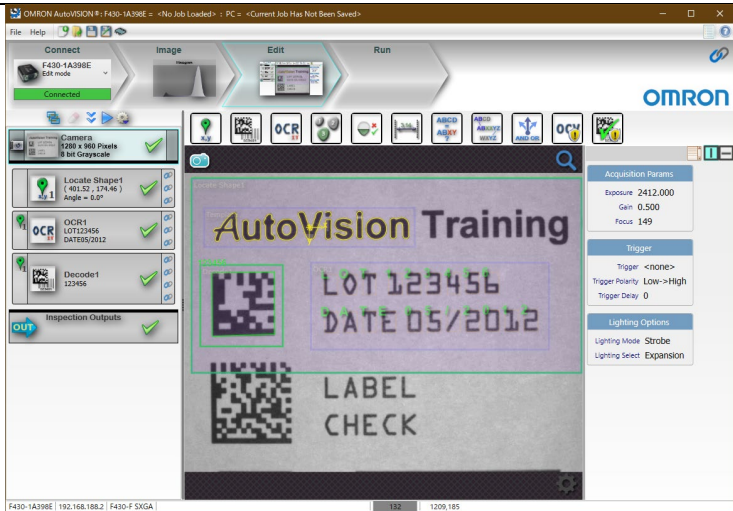

9 Create a new job and set the "Locate Shape", "OCR" and "Decode" tools.

* In this chapter, you will create a job to output the detection points from the Locate Shape tool, the text string read by the OCR tool and character text decoded from a 2D Code using Ethernet/IP communications.



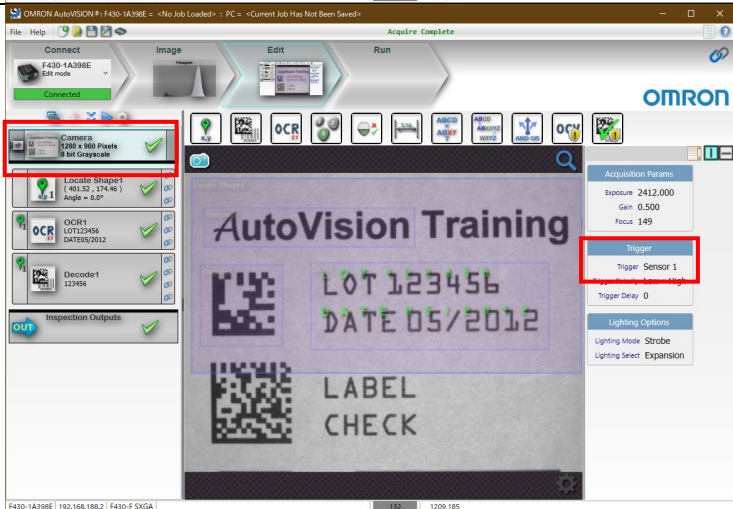

10 Select the Camera Tools and set the Trigger to "Sensor 1".



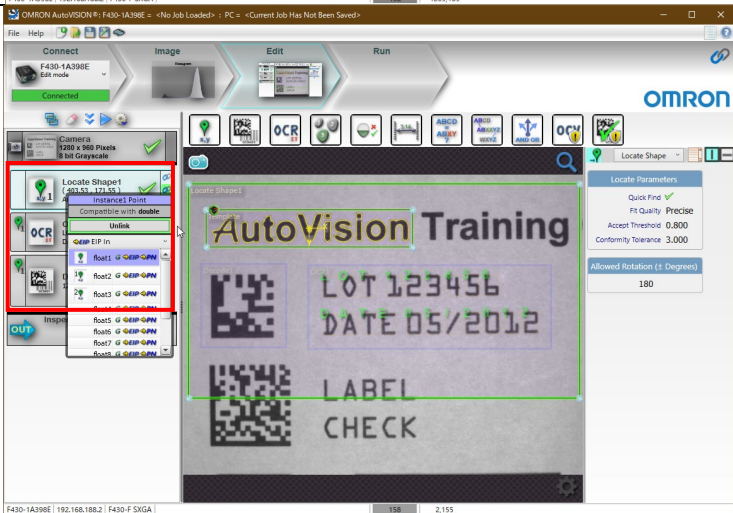

1 Select Locate Shape tool, click the second icon  (Instance1 Point), and set to EIP input float1 to float3.

* The icon will change to  to indicate when it is set.

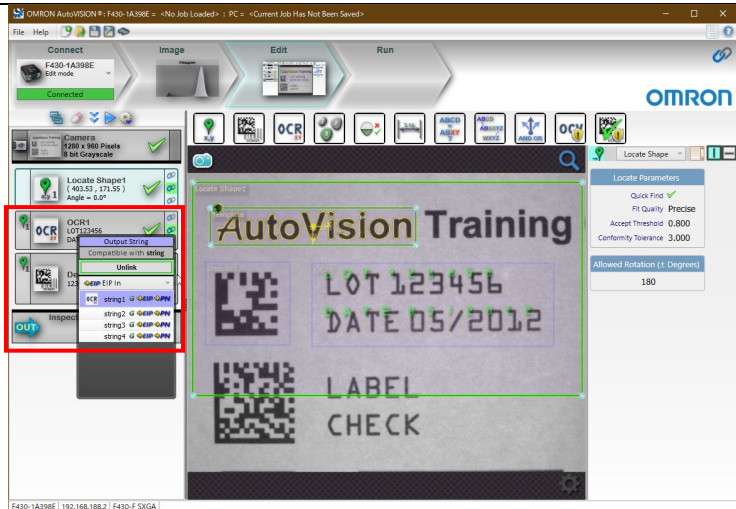

- 12 Select OCR, click the second icon  (Output String) and set it to EIP Input String 1.



- 13 Select Decode, click the first icon  (Status), and set it to bool1 of EIP input.

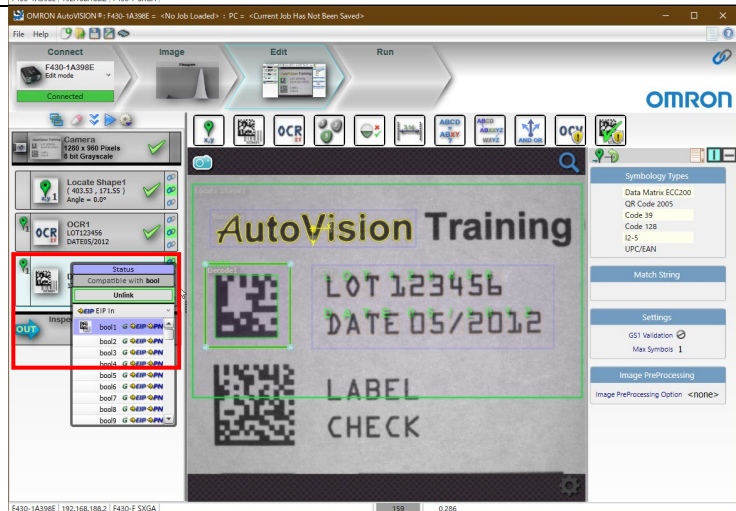

- 14 Select Decode, click the second icon  (Decoded Text) and set it to EIP Input String 2.

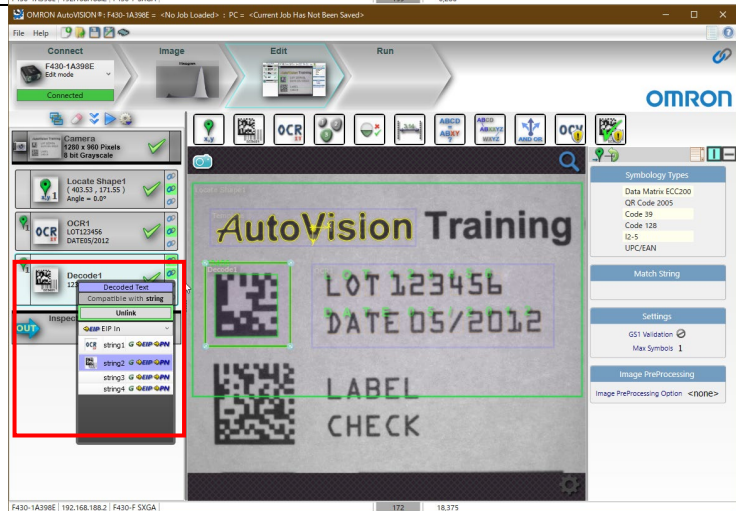

15 Click the icon shown by the red frame to display the Data Navigator Window.

If linked as is shown on the right, it is set correctly.

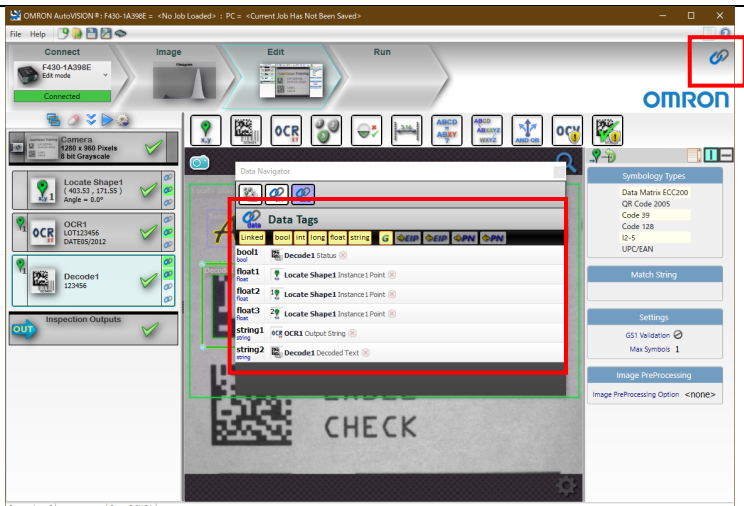

16 Go to Run view and download the job to smart camera.

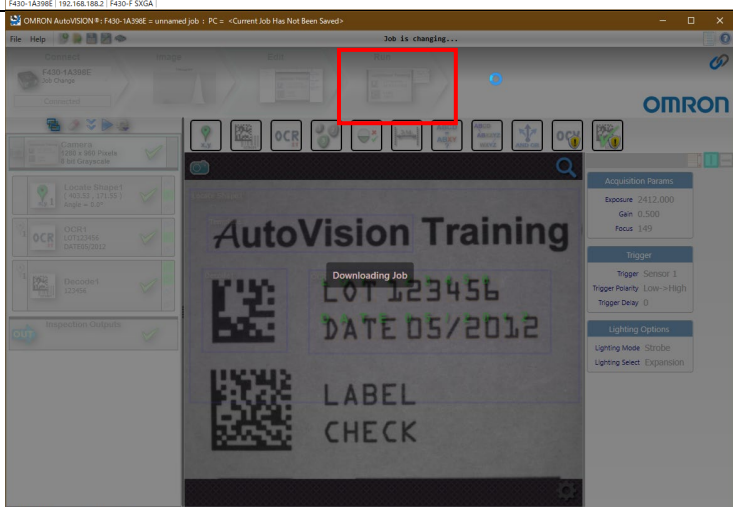

17 The download is complete when you can successfully transition to the Run screen.

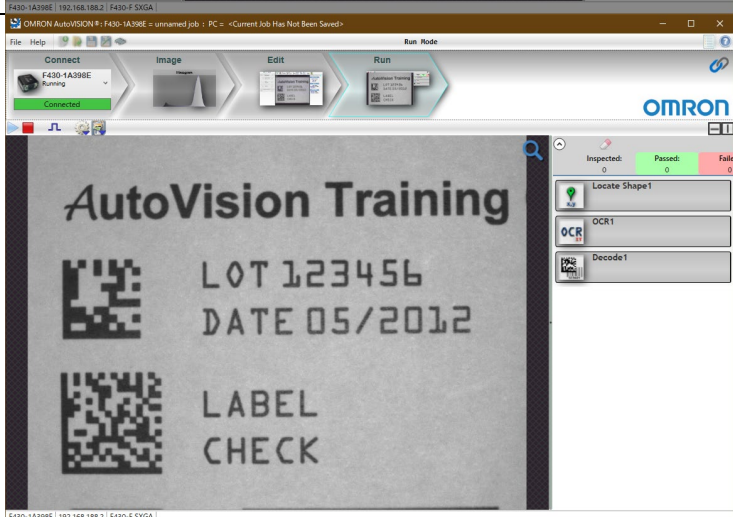

7.3. Controller Setup

Set up the Controller.

7.3.1. Set the IP address

Launch Sysmac Studio and set the IP address of the controller.

Install Sysmac Studio on PC beforehand.

- 1 Connect a LAN cable to Built-in EtherNet/IP Port (PORT1) of the controller and connect a PC and a switching hub to the controller as shown in "5.2. Device configuration".

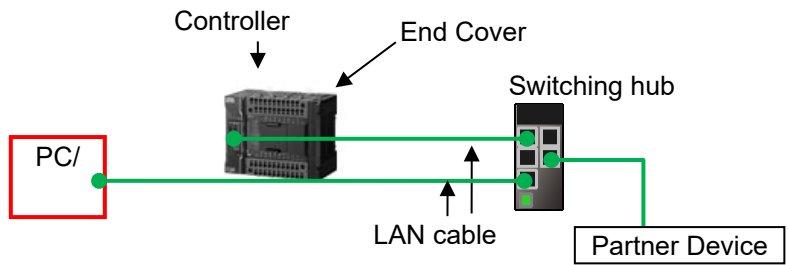

- 2 Start Sysmac Studio.

* If the User Account Control Dialog Box is displayed at startup, select the option to start.



- 3 Sysmac Studio starts. Click [New Project].

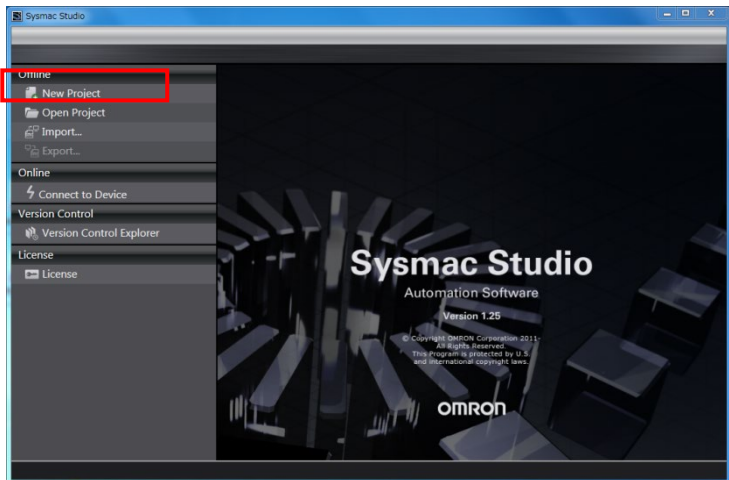

- 4 The Project Properties Screen is displayed.

* In this document, "New Project" is used as the project name.

Select the device to use from the pull-down list of Device.

Select an applicable version from the "Version" pull-down list.

* Although 1.16 is selected as an example in this document, select the version you actually use.

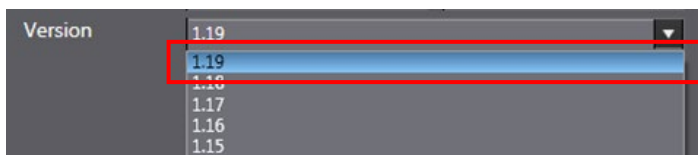
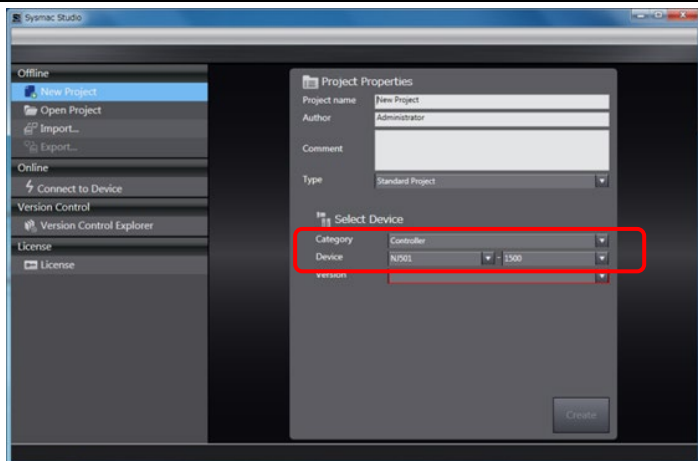

5 Click "Create".

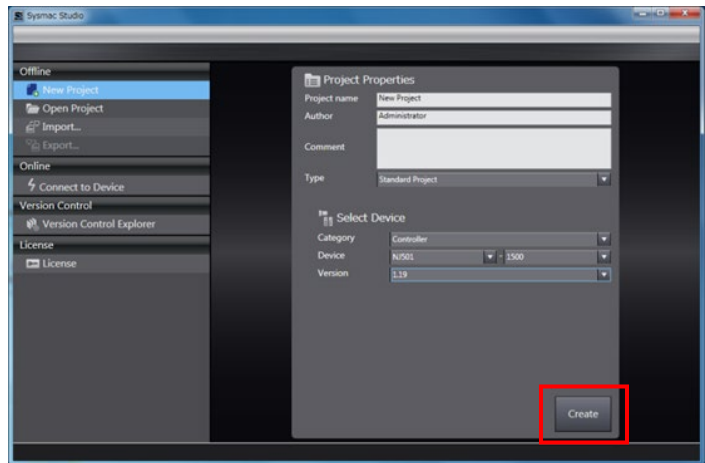

6 The New project screen is displayed.

The following panes are displayed in this window.

Left: Multiview Explorer

Upper right: Toolbox

Lower right: Controller Status Pane

Top middle: Edit Pane

The following tabs are in the lower center of the screen displayed.

Output Tab Page

Build Tab Page

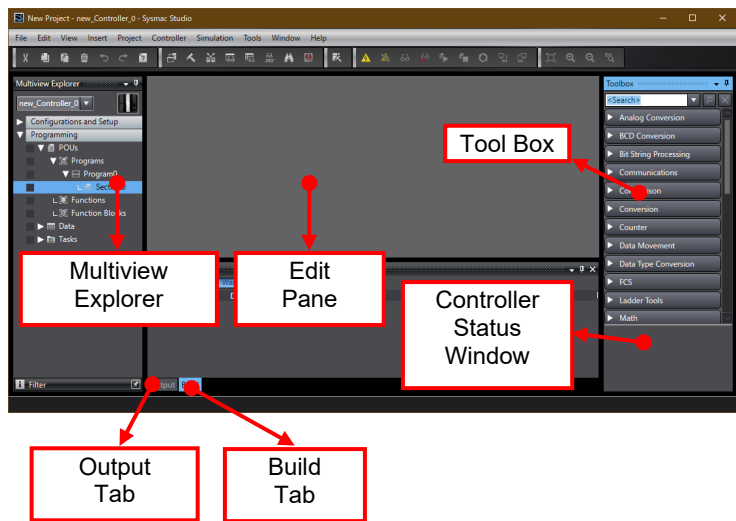

7 Double-click Built-in EtherNet/IP Port Settings under Configurations and Setup - Controller Setup in the Multiview Explorer.

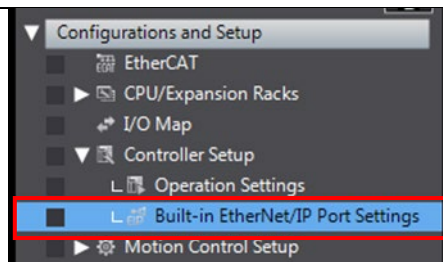

8 The Built-in EtherNet/IP Port Settings Tab Page is displayed in the Edit Pane.

Set the following for the "IP Address" settings.

IP Address: 192.168.188.200

Subnet mask:

255.255.0.0

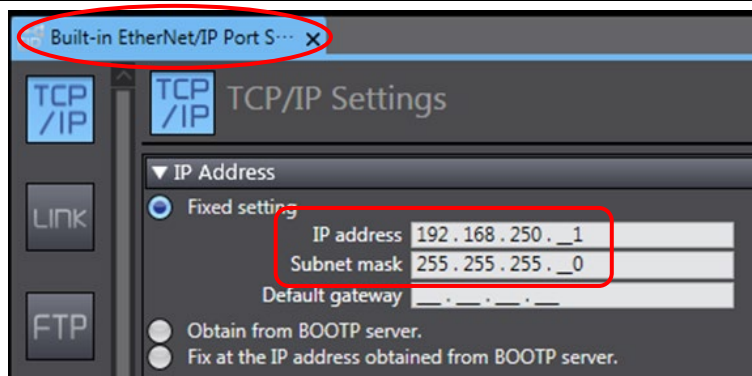

7.3.2. Install the EDS File

Install the F430-F EDS file.

After AutoVision software has been successfully installed, the EDS can be found in "C:\¥OMRON¥Vscope¥Firmware¥eds¥F430".

- 1 Select "EtherNet/IP Connection Settings" from the "Tools" Menu.

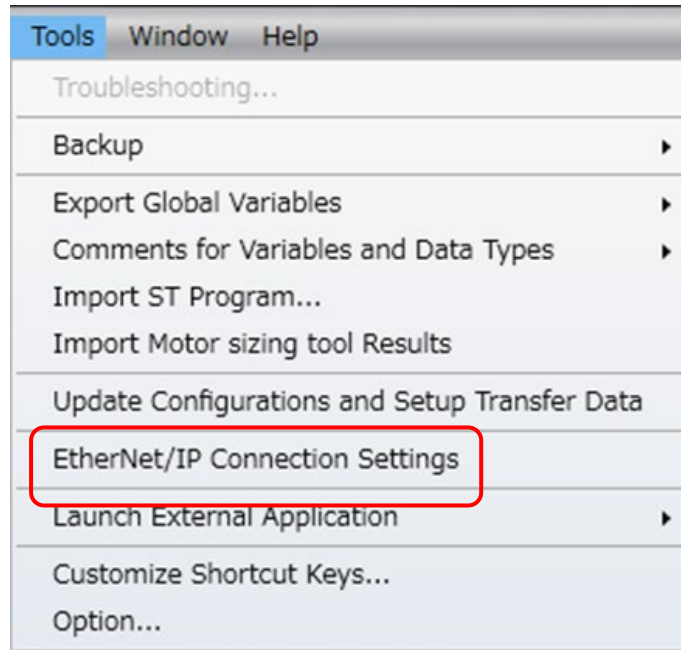

- 2 Double click "Built-in EtherNet/IP Port Settings".

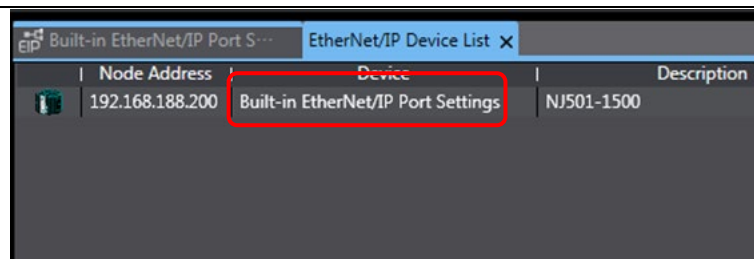

- 3 Right-click on the empty space below [Target Device] under [Toolbox], and select [Display EDS Library].

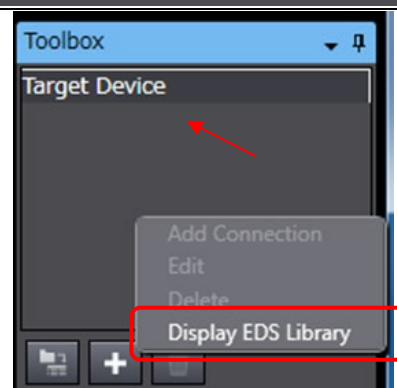

- 4 The EDS Library Dialog Box is displayed. Select [Install].

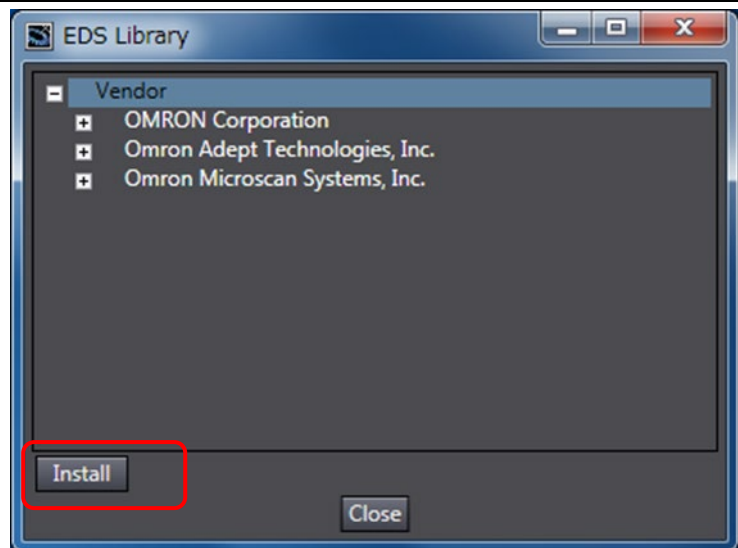

- 5 Select the EDS file you downloaded and then click on [Open (O)].

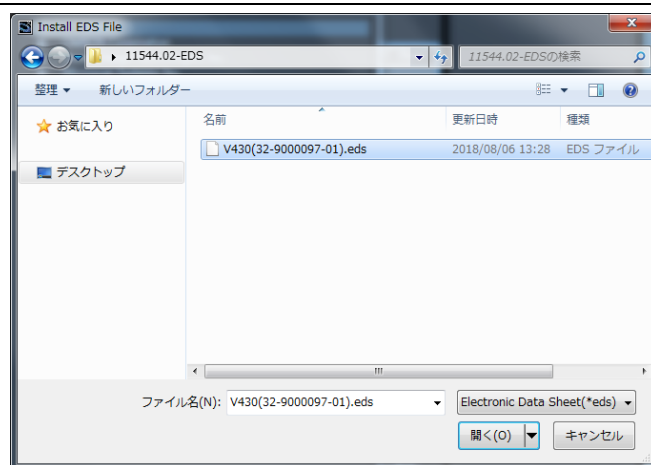

- 6 Verify that [Microscan Systems, Inc.]-[Vendor Specific, Machine Vision Smart Camera]-[F430-F] has been installed.



7.3.3. Target Device Registration

Register the target device.

- 1 From the Menu Bar, select [Tools] – [EtherNet/IP Connection Settings].

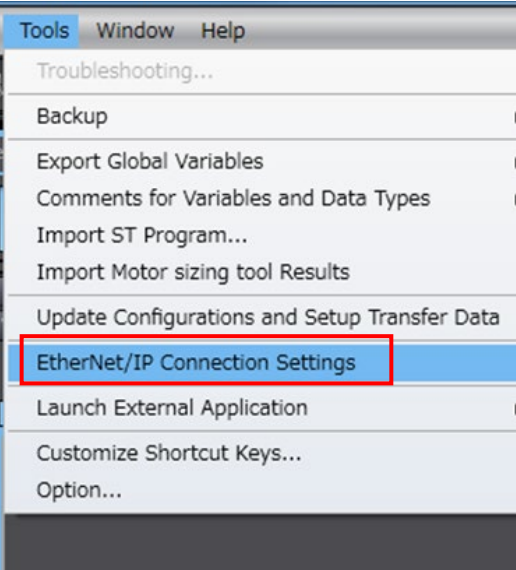

The screenshot shows the 'Tools' menu in a software application. The menu items are: Troubleshooting..., Backup, Export Global Variables, Comments for Variables and Data Types, Import ST Program..., Import Motor sizing tool Results, Update Configurations and Setup Transfer Data, EtherNet/IP Connection Settings (highlighted with a red box), Launch External Application, Customize Shortcut Keys..., and Option...
- 2 In the [Edit Pane], the [EtherNet/IP Device List] tab is displayed. With [Built-in EtherNet/IP Port Settings] selected, right-click the mouse and select [Edit] from the menu.

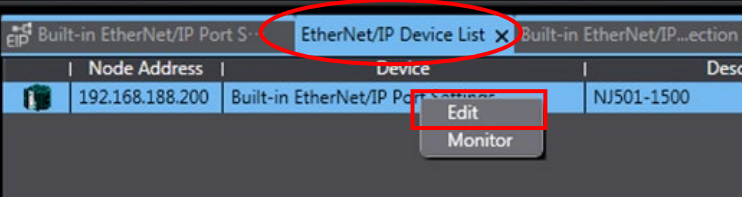

The screenshot shows a table titled 'EtherNet/IP Device List'. The table has columns for Node Address, Device, and Description. A row is selected with Node Address 192.168.188.200 and Device Built-in EtherNet/IP Port Settings. A context menu is open over the selected row, with the 'Edit' button highlighted by a red box.

Node Address	Device	Description
192.168.188.200	Built-in EtherNet/IP Port Settings	NJ501-1500
- 3 The [Built-in EtherNet/IP Port Settings - Connection] Tab appears in the Edit Pane.

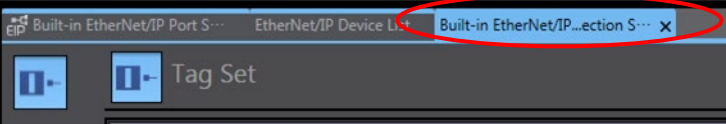

The screenshot shows the 'Edit Pane' with a tab titled 'Built-in EtherNet/IP Port Settings - Connection' selected. The pane also shows a 'Tag Set' section.
- 4 Click on [+] in [Toolbox].

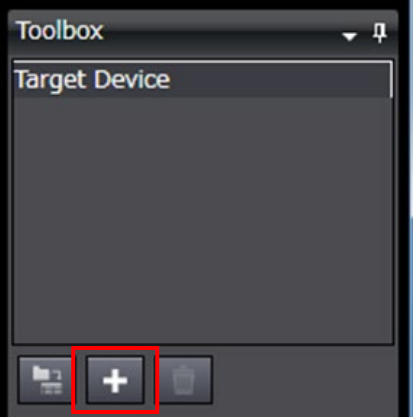

The screenshot shows the 'Toolbox' window with a 'Target Device' section. At the bottom of the toolbox, there is a '+' button highlighted with a red box.

5 The Add Target Device dialog appears.

In [Node Address] enter "192.168.188.2".

Click on the [Model Name] and [Revision] fields and select the following from their pulldown menus.

Model: F430-F

Revision: 1

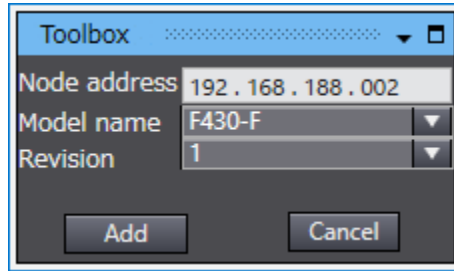

6 Confirm your selection and click [Add].

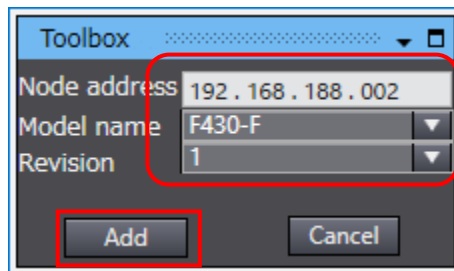

7 192.168.188.2 is registered in [Target Device] in the Toolbox.

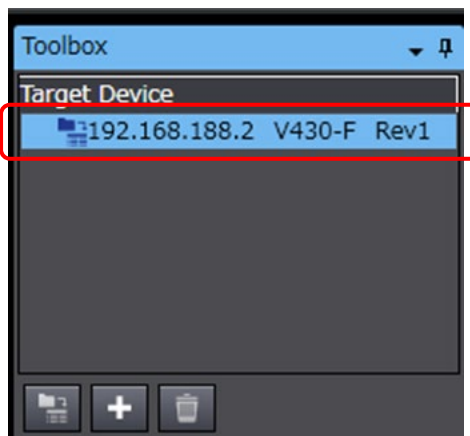

7.3.4. Set the Global Variables

Set the global variables to use for Tag data links.

The following Assemblies are used for this example flow.

- Input Assembly: Input Assembly (102)
- Output Assembly: Output Assembly (114)



Note

For information on input and output assemblies, refer to “Smart Camera F430-F Series User Manual for Communications Settings” (Z444).

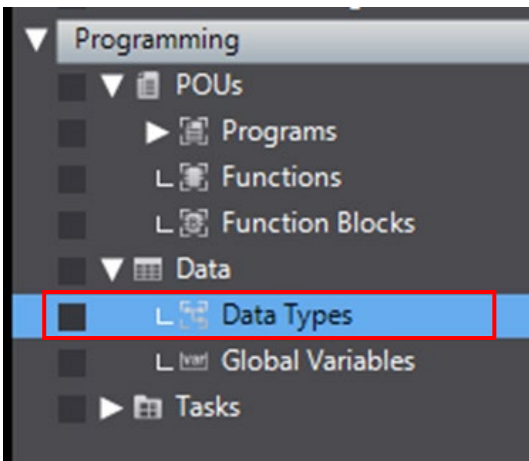
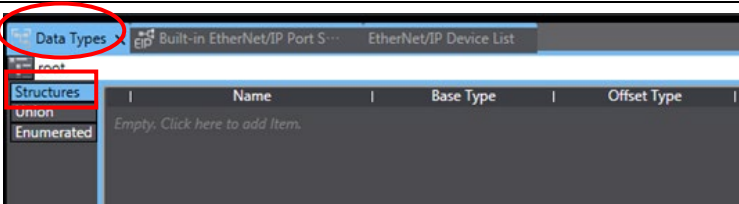
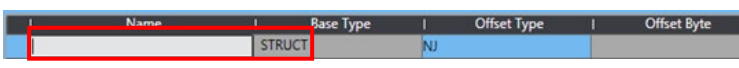
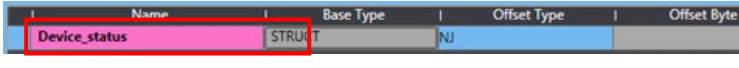
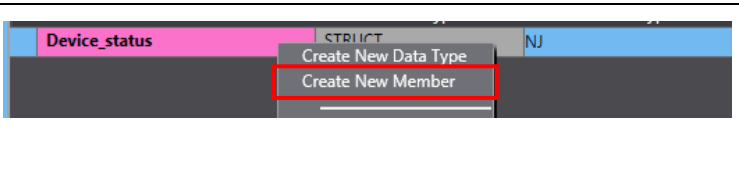
<p>1 Double-click Data Types under Programming - Data in the Multiview Explorer.</p>	
<p>2 The [Data type] tab is displayed. Click on [Structure]. The [Structure] tab appears.</p> <p>Click under [Name] to enter a new Data Type.</p> <p>Enter “S_EIPInput” as the name.</p>	 <p style="text-align: center;">↓</p>  <p style="text-align: center;">↓</p> 
<p>3 Confirm this is entered correctly and then right-click on the mouse to select [Create New Member] from the menu.</p>	

- 4 Enter the [Name] and [Data Type] as shown in the figure on the right.

For details of the content on the right, refer to "Smart Camera F430-F Series AutoVISION Industrial Protocol User Manual (SDNC-752)".

Name	Base Type
▼ S_EIPInput	STRUCT
STATUS	U_EIPFlag16
ECHO	U_EIPFlag16
CmdCodeRslt	U_EIPFlag32
CmdRet	U_EIPFlag32
reserved1	BOOL
State	U_EIPFlag16
VIO	U_EIPFlag16
reserved2	BOOL
bool_val	ARRAY[0..63] OF BOOL
int_val	ARRAY[0..9] OF INT
long_val	ARRAY[0..9] OF DINT
float_val	ARRAY[0..9] OF REAL
string1_Length	DINT
string1	STRING[92]
string2_Length	DINT
string2	STRING[28]
string3_Length	DINT
string3	STRING[28]
string4_Length	DINT
string4	STRING[28]

- 5 As described in steps 3 to 4, create new Data Types and Members.

Here we create Data types for the Output Assembly that controls the F430, such as bits for trigger input.

For details of the content on the right, refer to "Smart Camera F430-F Series AutoVISION Industrial Protocol User Manual (SDNC-752)".

Name	Base Type
▶ S_EIPInput	STRUCT
▼ S_EIPOutput	STRUCT
CONTROL	U_EIPFlag16
ECHO	U_EIPFlag16
CmdCode	U_EIPFlag32
CmdArg	U_EIPFlag32
reserved1	ARRAY[0..31] OF BOOL
VIO	U_EIPFlag16
reserved2	BOOL
bool_val	ARRAY[0..63] OF BOOL
int_val	ARRAY[0..9] OF INT
long_val	ARRAY[0..9] OF DINT
float_val	ARRAY[0..9] OF REAL
string_101_Length	DINT
string_101	STRING[92]
string_102_Length	DINT
string_102	STRING[28]
string_103_Length	DINT
string_103	STRING[28]
string_104_Length	DINT
string_104	STRING[28]

- 6 From the [Multiview Explorer], navigate to [Programming] - [Data] and double-click the "Global Variables" tab.

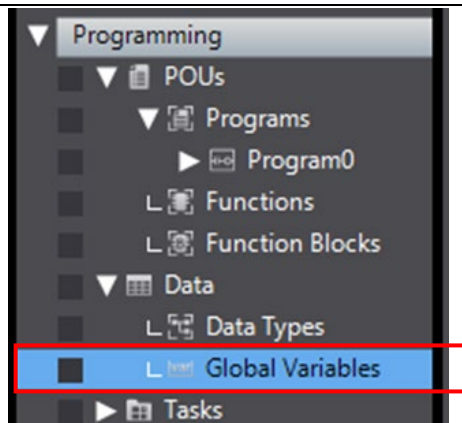

7 The [Global Variable] tab is displayed in the [Edit Pane].

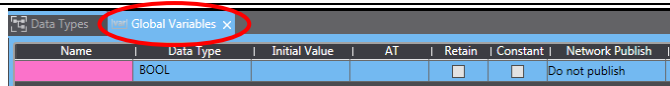

Click in [Name] to enter a new Variable.

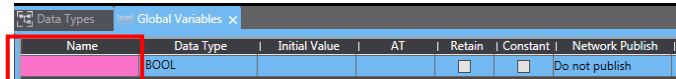

In the [Name] field, enter "EIPOutput".

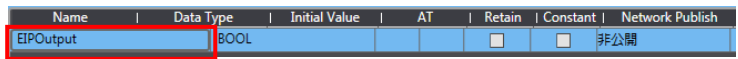

Enter [S_EIPOutput] as the "Data type".

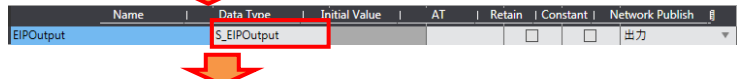

In the [Network Publish] menu select "Output".

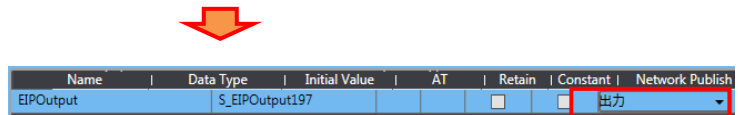
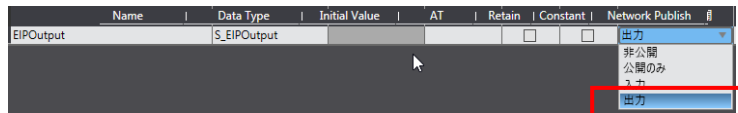

8 Confirm this is entered correctly and then right-click on the mouse to select [Create New] from the menu.

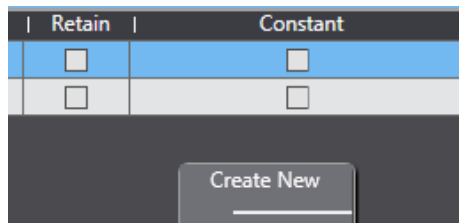

9 As in step 7, enter the following data in the Create New Area.

- Name: EIPIInput
- Data type: S_EIPIInput
- Network Publish: Input

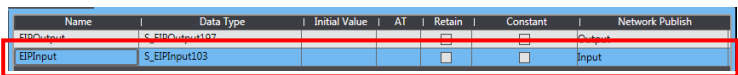

10 Double-click "Task Settings" under "Configurations and Setup" in the Multiview Explorer. The "Task Settings" Tab Page is displayed in the Edit Pane. Click on [VAR].

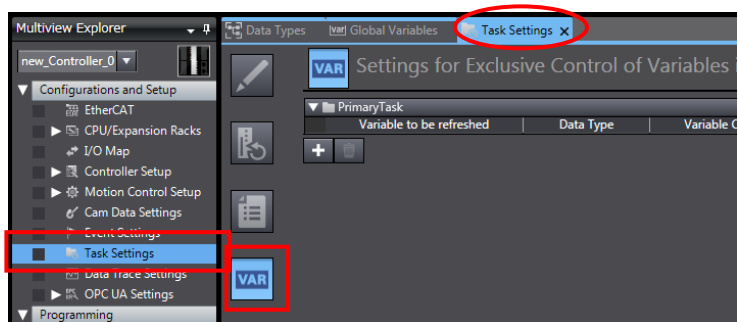

11 Click on [+].

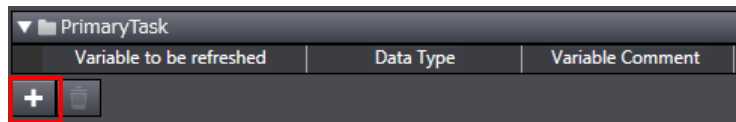

The new Area is added.
Click the down arrow on the "Variable to be refreshed" (left side of the screen) of the added area.

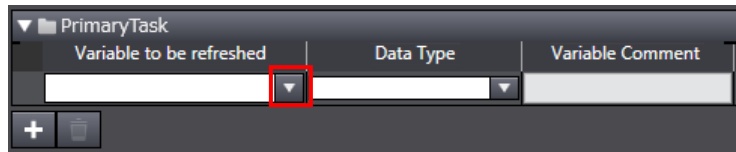

The variables set in this section are displayed.
Select [EIPOutput].

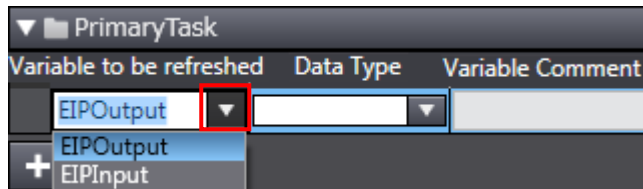

[S_EIPOutput] is added.

* Data Type is automatically set.
No value needs to be entered.

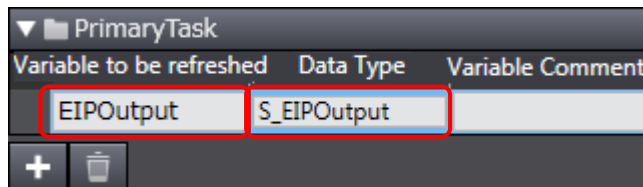

12 Using the same procedure as in step 11, add all the variables set in this section to [variable to be updated] (on the left side of the screen).

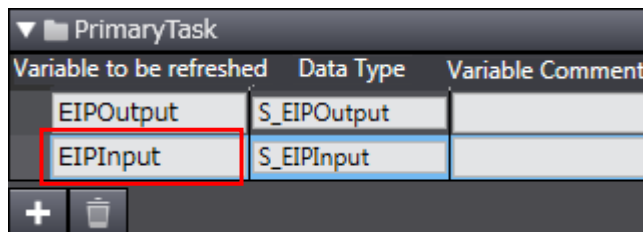

* Data Type is automatically set.
No value needs to be entered.

7.3.5. Tag Registration

Register the Tags and Tag Sets.

- 1 On the [Built in EtherNet/IP Port Connection Settings] tab, select [Tag Set].
In [Tag Set] select the [Input] tab.

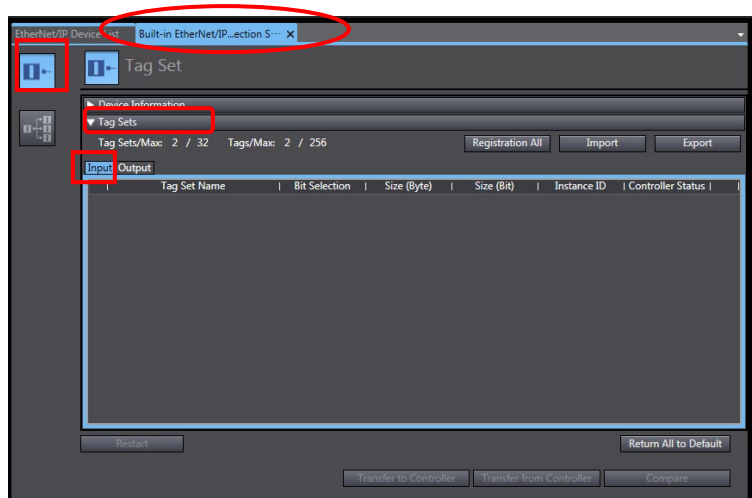

- 2 Right-click in the [Input] tab and select [Create New Tag Set] from the menu.

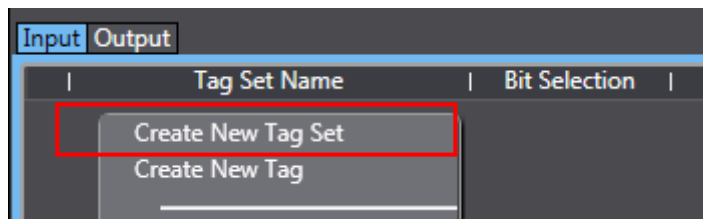

- 3 Here you can enter the [New Tag Set Name]. Select the newly added Input Area.

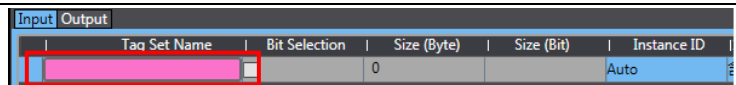

Enter [EIPInput].

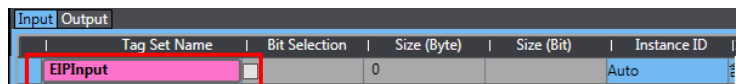

- 4 With [EIPInput] selected, right-click the mouse and select [Create New Tag] from the menu.

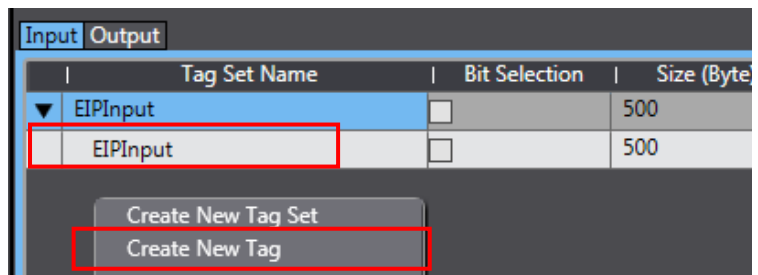

In [EIPInput] you can enter the [New Tag Name]. Select the newly added Input Area.

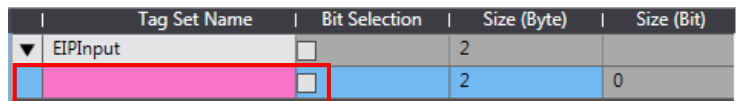

Enter [EIPInput] to set it as the Tag.

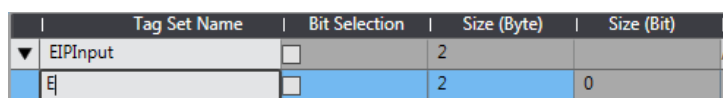

* When the first letter of the word is entered, the full word and additional fields will be populated as shown in the figure on the right.

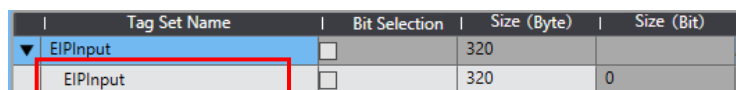

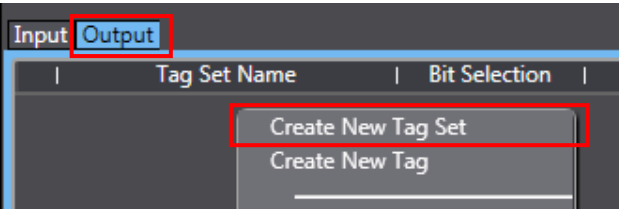
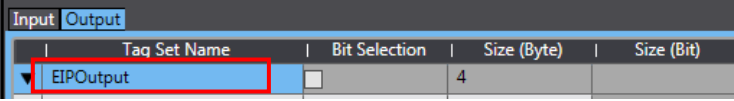
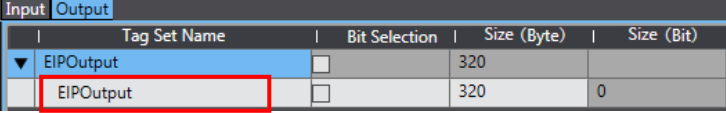
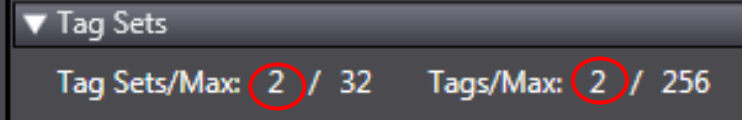
- 5 Select the [Output] tab. Right-click in the [Output] tab and select [Create New Tag Set] from the menu.
- 
- 6 Here you can enter the [New Tag Set Name]. Following the same procedure described in Step 3, enter [EIPOutput].
- 
- | Tag Set Name | Bit Selection | Size (Byte) | Size (Bit) |
|--------------|--------------------------|-------------|------------|
| EIPOutput | <input type="checkbox"/> | 4 | |
- 7 Using the same procedures described in Step 4, add the Global variables as Tags in the OUT No. order shown in [6.3. Tag Sets].
- 
- | Tag Set Name | Bit Selection | Size (Byte) | Size (Bit) |
|--------------|--------------------------|-------------|------------|
| EIPOutput | <input type="checkbox"/> | 320 | |
| EIPOutput | <input type="checkbox"/> | 320 | 0 |
- 8 Make sure that both [Tag Sets / Max] and [Tags / Max] are "2".
- 
- Tag Sets/Max: 2 / 32 Tags/Max: 2 / 256

7.3.6. Setting up a Connection

Set the Target Variable (the side on which the connection will be established) and the originator variable (the side for establishing the connection) and set up the connection (Tag Data Link Table).

- 1 On the [Built-in EtherNet/IP port Connection Settings] tab, select [Connection].

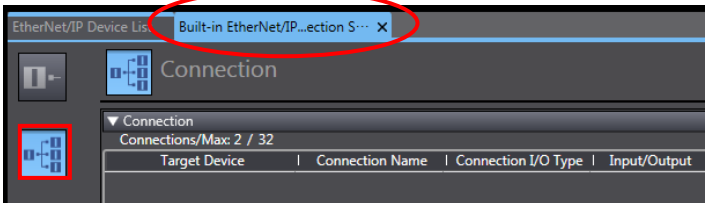

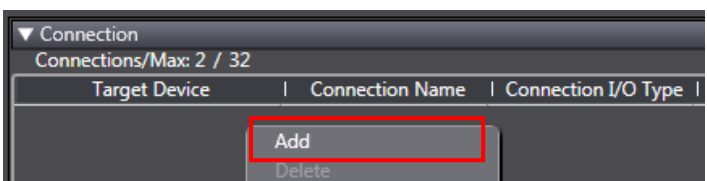
- 2 Right-click in [Connection] to select [Create New Connection] from the menu.

- 3 Here you can enter the new connection. Select the newly added Input area.

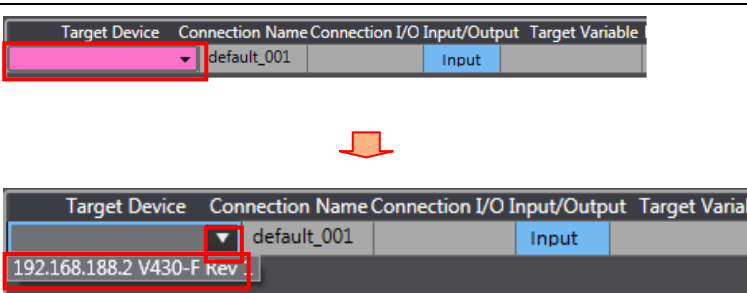
From the [Target device] pulldown menu, select [192.168.188.2 V430-F Rev 1].

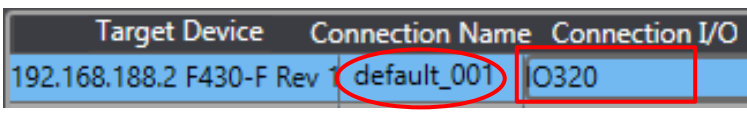
- 4 The Connection [default_001] is created. Select [IO320] for the [Connection I/O type].

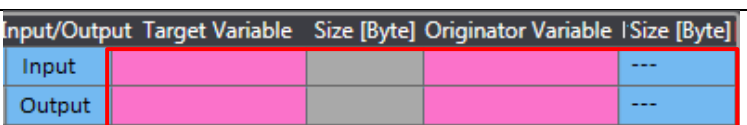
- 5 You will now be able to set the [Target Variable] and [Originator Variable].



6 Click on [Target Variable] for [Input]

Input/Output	Target Variable	Size [Byte]	Originator Variable	Size [Byte]
Input				---
Output				---

If you enter “[Ctrl] + [Space]” from the keyboard, the available “Assembly Numbers” for use will be displayed.

Input/Output	Target Variable	Size [Byte]	Originator Variable
Input	1		
Output	102		

* As shown in the example figure on the right, by typing [1] as the first digit of the “Assembly Number”, all the possible Assembly Numbers beginning with that digit will be displayed.

Input/Output	Target Variable	Size [Byte]	Originator Variable
Input	102	320	
Output			

Select the Assembly Number.

Input/Output	Target Variable	Size [Byte]	Originator Variable
Input	102	320	
Output	114	320	

In the same manner, set the [Target Variable] for [Output]

7 Now click on [Originator Variable] for [Input].

Input/Output	Target Variable	Size [Byte]	Originator Variable
Input	102	320	
Output	114	320	EIPInput

The available Tag Set Names will be displayed. Select the one to use.

Input/Output	Target Variable	Size [Byte]	Originator Variable	Size [Byte]
Input	102	320	EIPInput	320
Output	114	320	EIPOutput	320

In the same manner, set the [Originator Variable] for [Output]

8 Set the [Connection I/O] and [RPI[ms]] only as needed.

Originator Variable	Size [Byte]	Connection I/O	RPI[ms]	Timeout
EIPInput	320	Point to Point c	50.0	RPI x 4
EIPOutput	320	Point to Point c		

9 Verify that [Number of connections] shows [2].

▼ Connection
Connections/Max: 2 / 32

7.3.7. Transfer the Project Data

Connect online and transfer the connection settings and the project data to Controller.

WARNING

When transferring a user program, "configuration / setting" data, device variables, or memory values for the CX unit from Sysmac Studio, the device or machine may operate unexpectedly regardless of the operation mode of the CPU unit.

Before transferring project data, check the safety of the transfer destination slave.

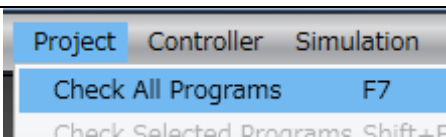
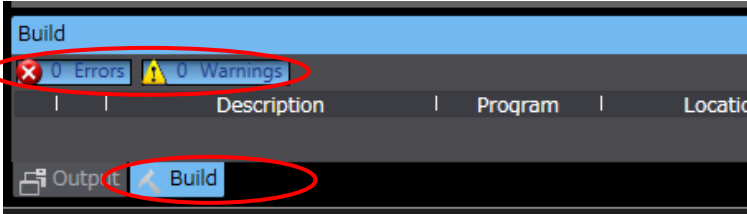
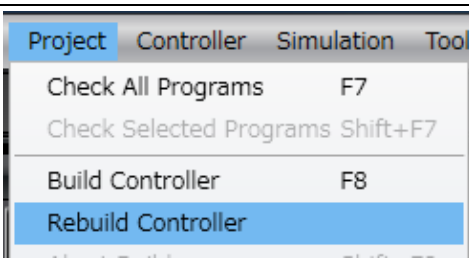
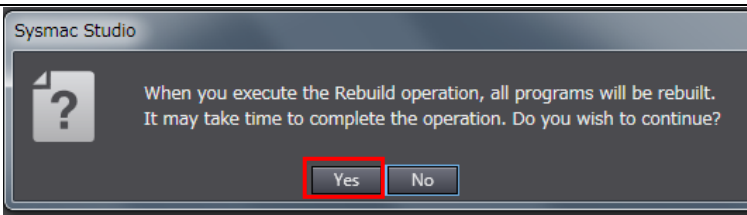
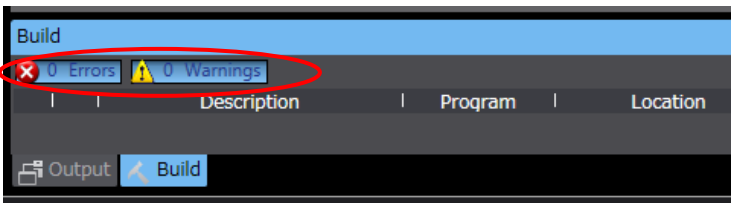

1	Turn power ON to the Controller, switching hub and smart camera.	
2	From the Main Menu in Sysmac Studio, select [Project] – [Check All Programs].	
3	The Build window is displayed. Confirm that [0] is shown for both Errors and Warnings	
4	From the Menu Bar, select [Project] – [Rebuild Controller].	
5	Confirm that the dialog that appears is the same, or like the figure on the right and press the [Yes] button.	
6	In the Build window, confirm that [0] is shown for both Errors and Warnings	

7 From the Menu Bar, select [Controller] – [Communications Setup].

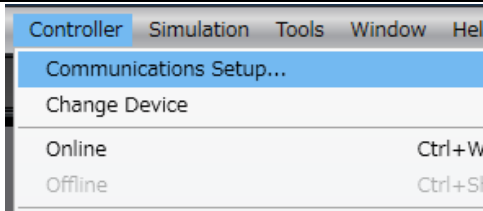

8 The [Communications Setup] dialog opens. Make sure that [Ethernet connection via a hub] is selected for the [Connection Type]. Also, enter [192.168.188.200] in [IP Address to connect to USB-Remote / Ethernet connection via a hub]. Press [Ethernet Communications Test] and confirm that [Communications test OK] is displayed. Click [OK].

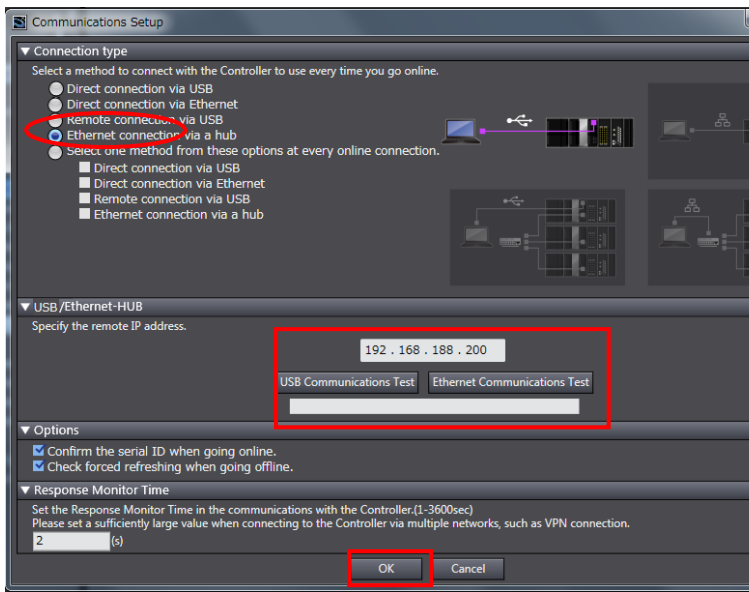

9 From the Menu Bar, select [Controller] – [Online]. A confirmation dialog will be displayed. Confirm the information and click [Yes].

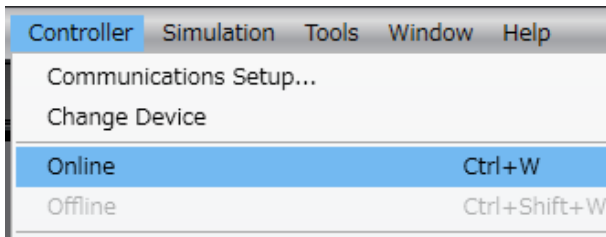

* The dialog that is displayed differs depending on the status of the controller you are using but make the selection to proceed with processing.

10 When you are online, a yellow frame will be displayed in the upper part of the [Edit window].



Note

Refer to Chapter 6 "Online Connections to a Controller" in the "Sysmac Studio Version 1.0 Operation Manual" (W504) for details on online connection to the controller.

11 From the Menu Bar, select [Controller] – [Synchronize].

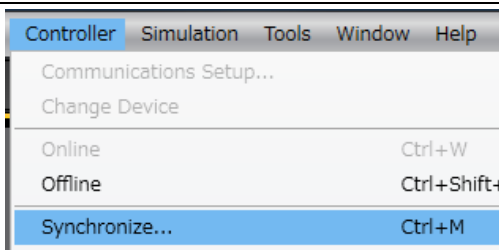

12 The [Synchronization] dialog opens.

Confirm that there is a check in the box for the data you wish to transfer. (In the example screen on the right, there is one data item [NX1P2] to transfer).

Since you want to transfer the EtherNet/IP connection settings, make sure that the box for “Do not transfer EtherNet/IP connection settings (built-in port and Unit) is unchecked. Click the [Transfer to Controller] Button.

* Executing [Transfer to Controller] transfers the data of Sysmac Studio to the controller and checks that the data was received.

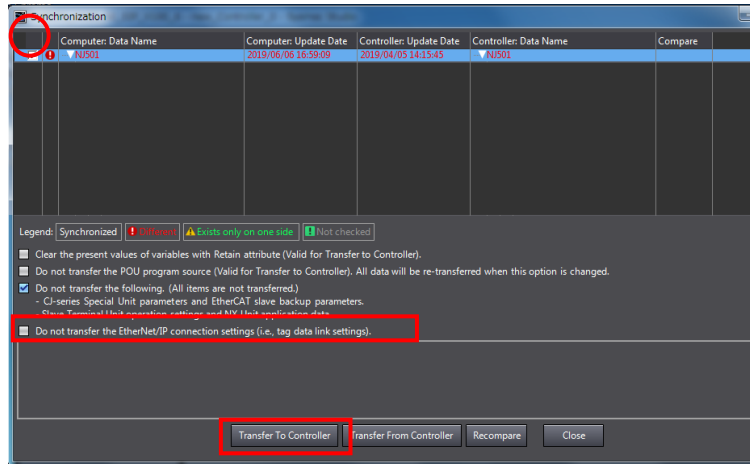

13 Confirm that the dialog settings are as shown in the figure on the right and press the [Yes] button.

The “Synchronizing” dialog appears.

Another Confirmation dialog appears when synchronization completes. Confirm there are no problems and click the [No] button.

* Do not return to “Run Mode” yet.

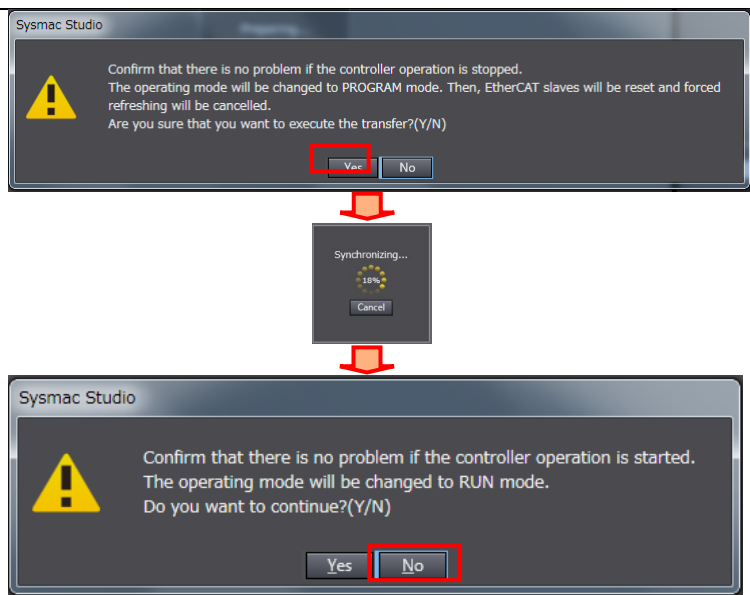

14 Confirm that the text color of the synchronized data becomes the color indicated for "Synchronized" and the "Synchronization Successful" is displayed. message is displayed. If there is no problem, click [Close].

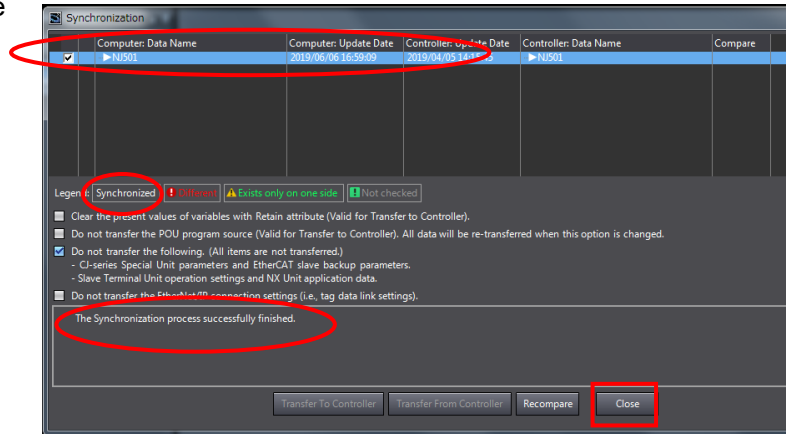

* The "Synchronization Successful" message indicates that the data in the controller matches the Project data in Sysmac Studio.

* If Synchronization fails, check the physical connections and perform the steps again from Step 1.

15 In [Controller Status], confirm that there is a Green light for [ERR/ALM] and that the Mode is [Program Mode].

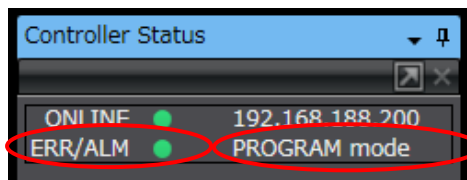

Precautions for Correct Use

If you change the connection settings (Tag data link table) after executing [Synchronization], the connection settings (Tag data link table) will not be transferred even if you execute [Synchronization] again.

When ready to transfer, please click [Transfer to Controller] in [Built-in EtherNet/IP Port Setting Connection Setting] tab as shown in the figure below.

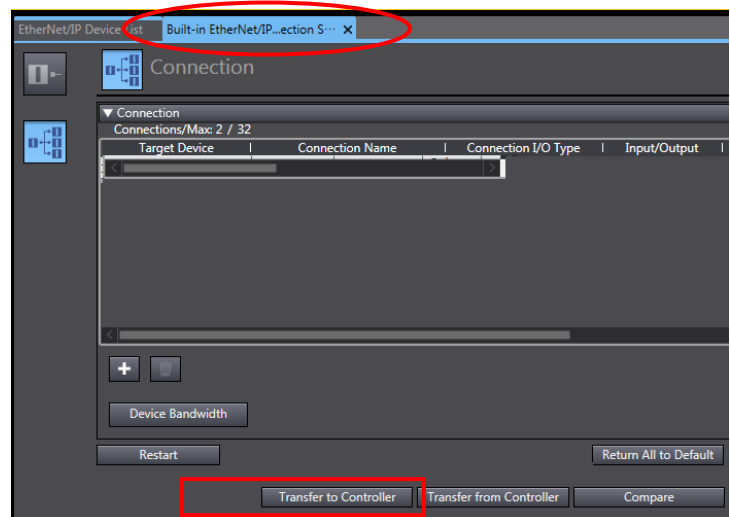

7.4. Confirm EtherNet/IP Communications

Confirm that the EtherNet/IP Tag Data Links function correctly.

7.4.1. Check the Connection Status

Verify the EtherNet/IP connection and connect to the smart camera with the AutoVision software.

- 1 Verify that the Tag Data Links are operating normally by observing the LEDs on the controller.

Below are the LED indicators for normal operation.

NET RUN: Lit Green

NET ERR: OFF

LINK/ACT: Blinking Yellow
(Blinking while sending and receiving packets)

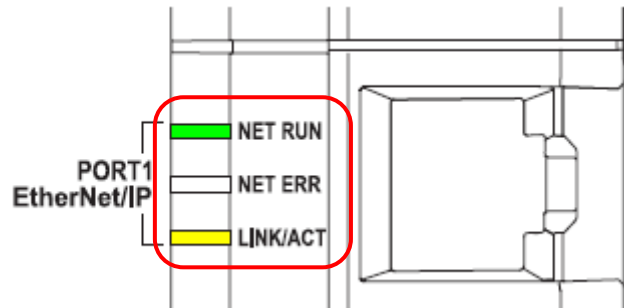

- 2 Verify the LEDs on the smart camera.

Below are the LED indicators for normal operation.

PASS: OFF

TRIG: OFF

MODE: OFF

LINK: Lit Orange

FAIL: OFF

PWR: Lit Green

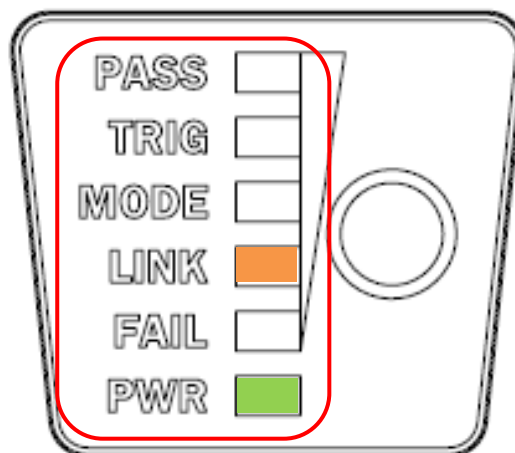

- 3 From the Menu Bar, select [Tools] - [EtherNet/IP Connection Settings] to display the EtherNet/IP Device List tab.

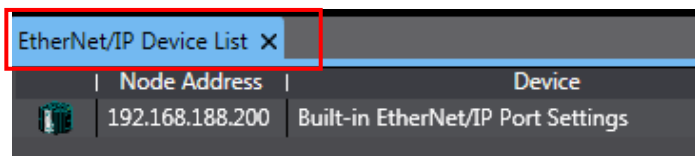

- 4 With [Built-in EtherNet/IP Port Settings] selected, right-click the mouse and select [Monitor] from the menu.

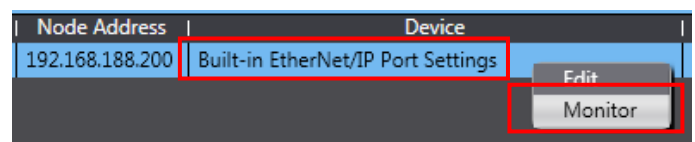

- 5 The dialog for monitoring the status of the [Built-in EtherNet/IP Port] opens

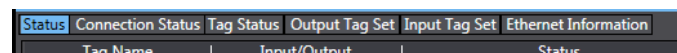

- 6 Select the [Connection status] tab.
Verify that the connection shown in [Connection Name] has a blue dot • beside it.
Verify that the [Status] column is displaying [00:0000].

Status	Connection Status	Tag Status	Output Tag Set	Input Tag Set	Ethernet Information	Status
•	192.168.188.2 (#002) default_001					00:0000

- 7 Select the [Tag Status] tab.
Verify that all the Tags are listed under [Tag Name] and that there is a blue dot • next to them, or depending on the version of software being used, that in their [Status] column, they all display "Normally resolved".

Status	Connection Status	Tag Status	Output Tag Set	Input Tag Set	Ethernet Information	Status
•		EIPInput	Input			Normally resolved
•		EIPOutput	Output			Normally resolved

- 8 Launch the AutoVision software and change to RUN View.

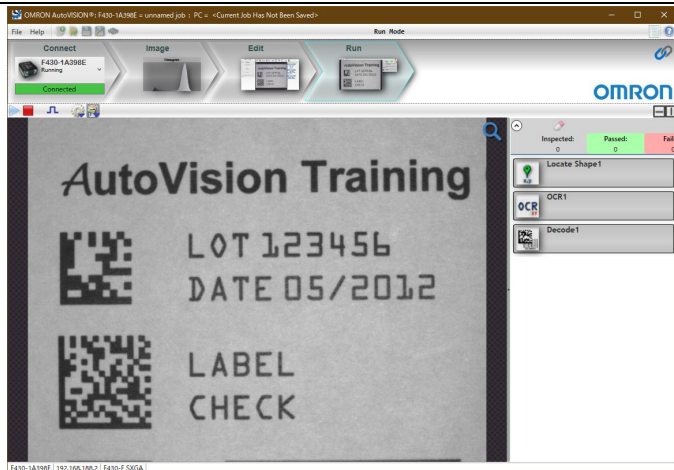

7.4.2. Check the Sent and Received Data

Check that the correct data is sent and received.

To confirm this, first place a readable code symbol in the smart camera's field of view.

CAUTION

If you change the value of the variable from the watch window online, the device connected to the output unit may operate regardless of the operation mode of the CPU unit.

Sufficiently confirm safety before you change the values of variables on a Watch Tab Page when the Sysmac Studio is online with the CPU Unit.

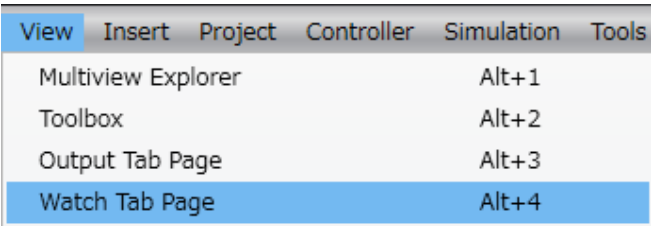
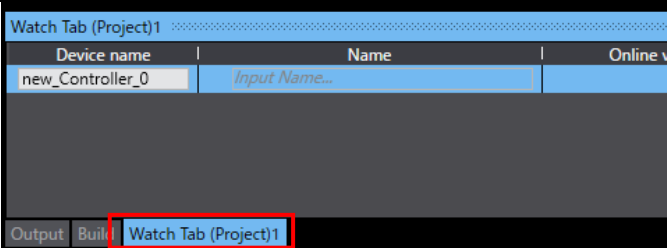
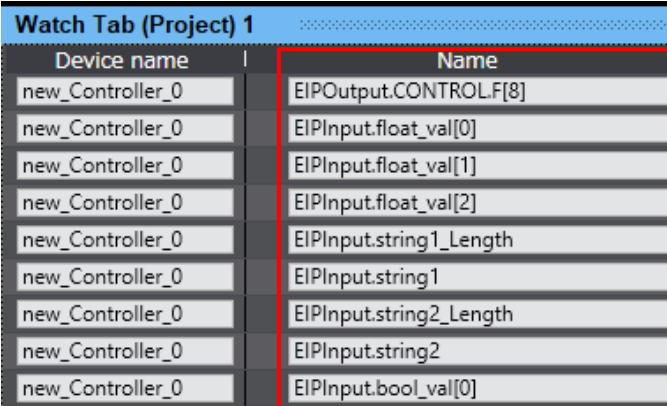

1	From Menu Bar in Sysmac Studio, select [View] - [Watch Tab Page].	
2	Select [Watch Tab Page 1].	
3	<p>Click on [Input Name] and enter the [Name] for the variable to monitor. If a new variable name needs to be entered, enter the following name for the variable.</p> <ul style="list-style-type: none"> EIOutput.CONTROL.F[8] EIInput.float_val[0] EIInput.float_val[1] EIInput.float_val[2] EIInput.string1_Length EIInput.string1 EIInput.string2_Length EIInput.string2 EIInput.bool_val[0] 	

- 4 Set the [Modify] column of EIPOutput.CONTROL.F[8] to "TRUE".

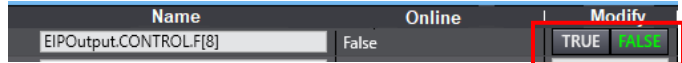

Press the Enter Key and confirm that [Monitor] for EIPOutput.CONTROL.F[8] shows "True".

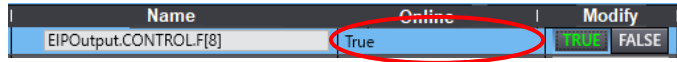

- 5 When the measurement processing completes, the result will be reflected on the AutoVision screen.

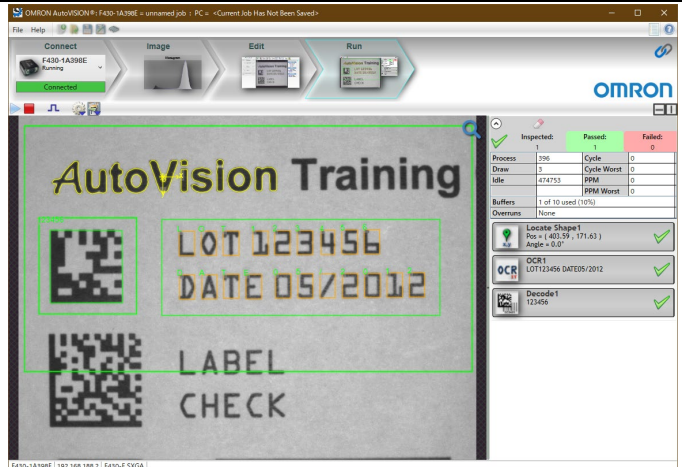

- 6 Launch Data Navigator and check the details of the measured values.

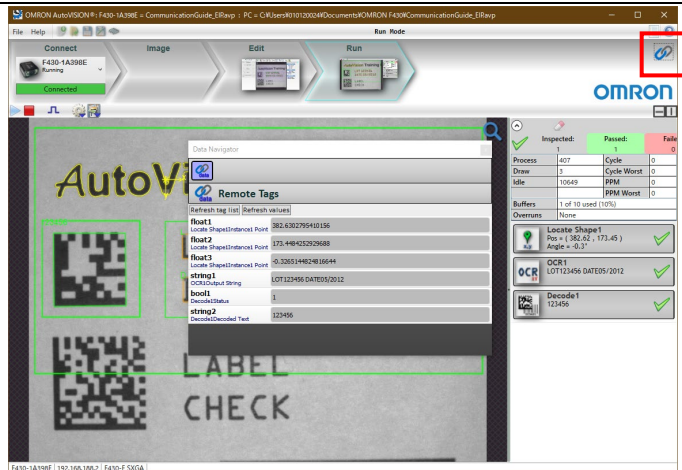

- 7 The measured values confirmed in Step 6 are reflected for each variable of EIPIInput.

Name	Online value	Modify
EIPOutput.CONTROL.F[8]	False	TRUE FALSE
EIPIInput.float_val[0]	382.61914	
EIPIInput.float_val[1]	173.45001	
EIPIInput.float_val[2]	-0.33424586	
EIPIInput.string1_Length	21	
EIPIInput.string1	LOT123456 DATE05/2012	
EIPIInput.string2_Length	6	
EIPIInput.string2	123456	
EIPIInput.bool_val[0]	True	TRUE FALSE

8. Initializing the System

The explanations of procedures given in this document are based on the use of the factory default settings.

When using a device that has been changed from the default settings, various settings may

not be able to proceed according to the procedures described.

8.1. Initializing the Controller

In order to initialize the controller, initialize the CPU Unit.

Before initialization, put the controller in Program Mode and select [Controller]-[Clear All Memory] from the Sysmac Studio menu bar. [Clear All Memory] dialog is displayed, confirm the contents and click [OK].

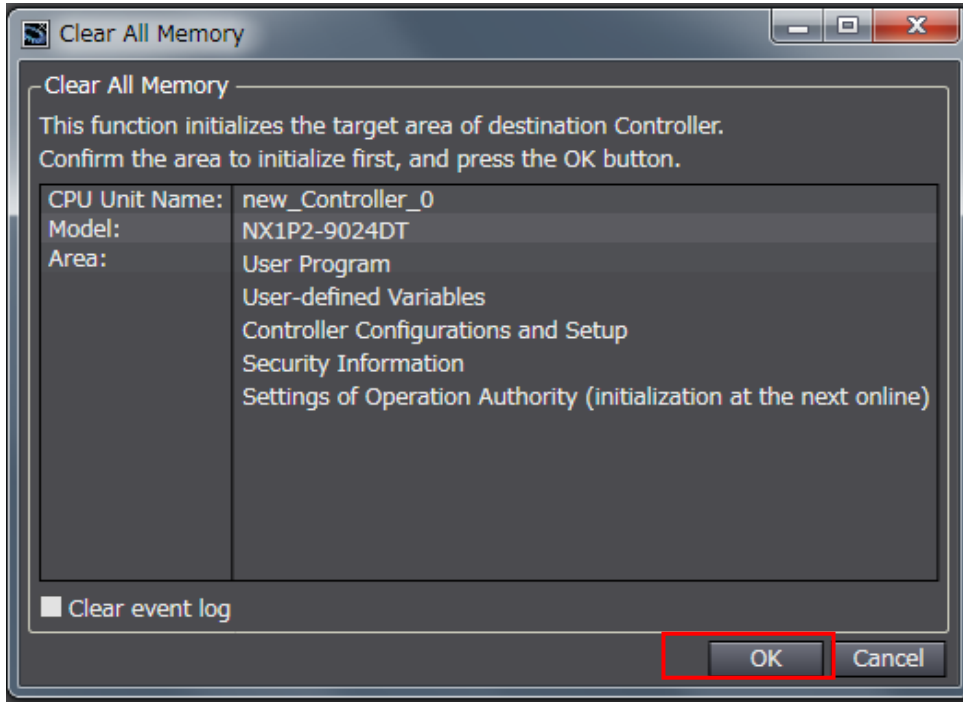

8.2. Initializing the Smart camera

For information on how to initialize a smart camera, consult our branch or sales office.

9. Appendices: How to Use the Project File

This section explains the procedure for using the following project file. The project file contains the contents described in "7.3. Controller Setup".

Obtain the latest version of the Project File from OMRON Corporation.

Name	Filename	Version
Sysmac Studio Compact Project File (Extension: csm2)	OMRON_F430_NX_EIP_V100.csm2	Ver.1.00

9.1. Operation Flow

The following steps are for how to use the project file to set up EtherNet/IP Tag Data Links. Refer to each section except "9.2.1. Load the Project File" enclosed in the red frame.

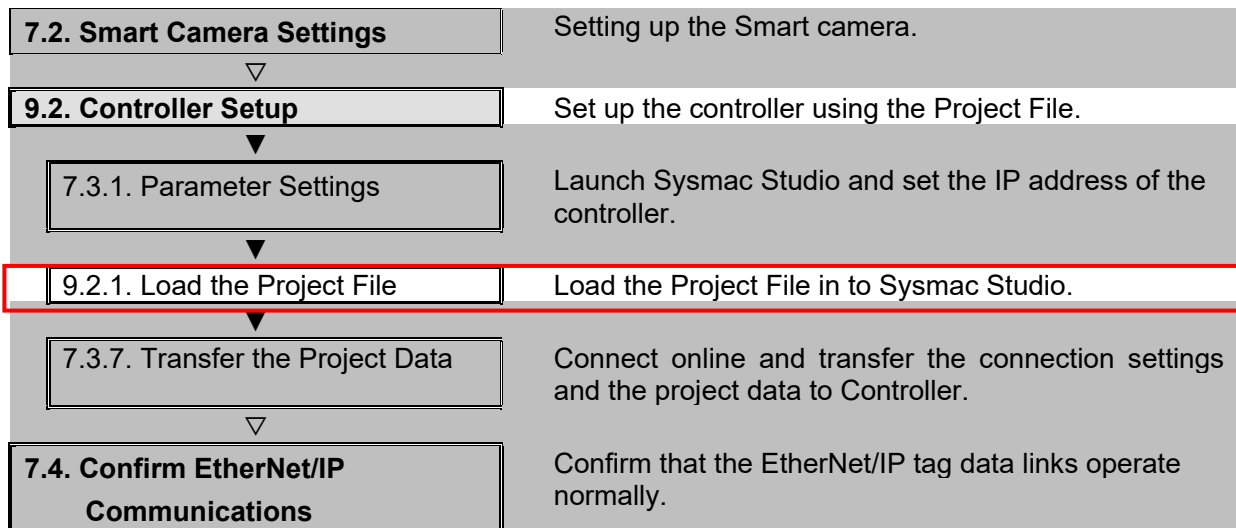

9.2. Controller Setup

Set up the controller using the Project File.

9.2.1. Load the Project File

Load the Project File in to Sysmac Studio.

- 1 From the Menu Bar, select [File] – [Import].

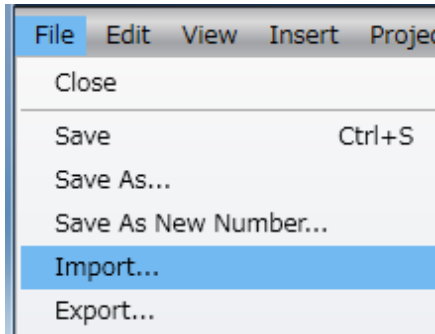

- 2 The [Import File] dialog is displayed. Select [OMRON_F430_NX_EIP_V100.csm2] (project file) and click [Open].

* Obtain the latest version of the project file from the OMRON Corporation website.

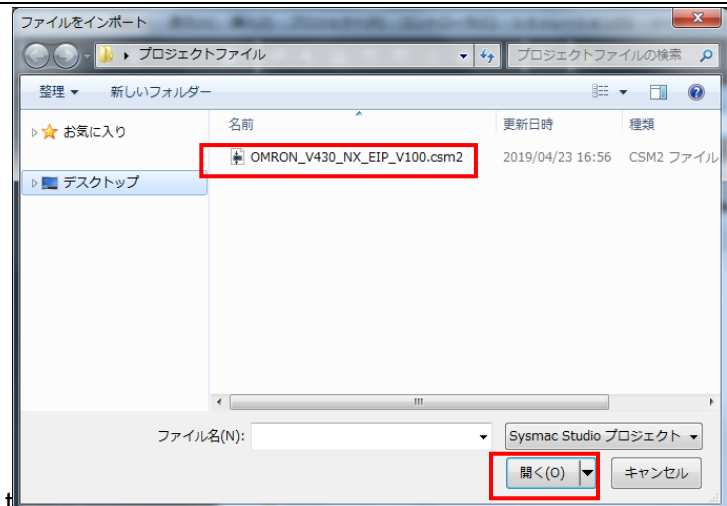

- 3 The [New Project] dialog will be displayed. Confirm the contents and click [No].

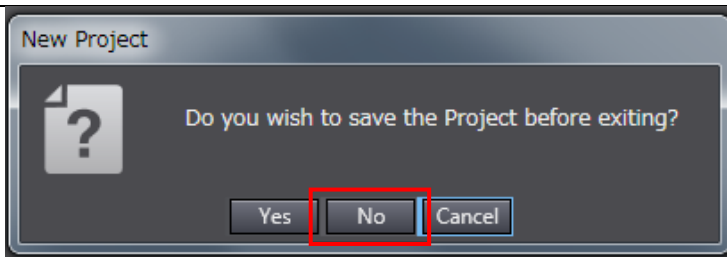

- 4 The [OMRON_F430_NX_EIP_V100] Project is displayed.

* If the error message "Cannot compare the repositories, the version on the target different from the source." is displayed, change the Sysmac Studio version to at least the version indicated in "5.2. Device Configuration" or higher.

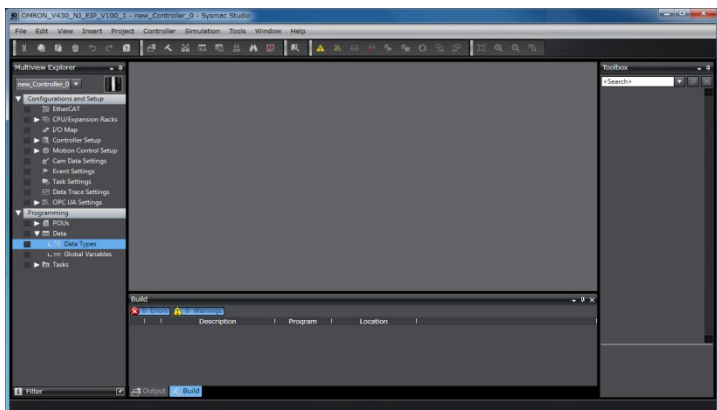

- 5 From the Menu Bar, select [Controller] – [Change Device].

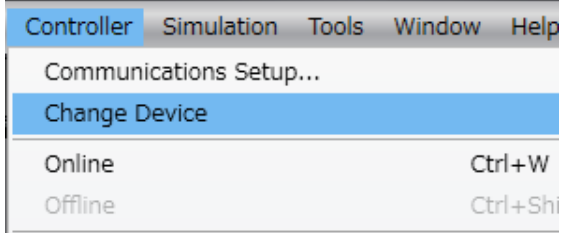

- 6 The Change Device Dialog Box is displayed.

Confirm that the [Device] and [Version] set to use are as shown in the figure on the right.

Click [Cancel].

* If the settings are different, select from the pull-down menu and click [OK].

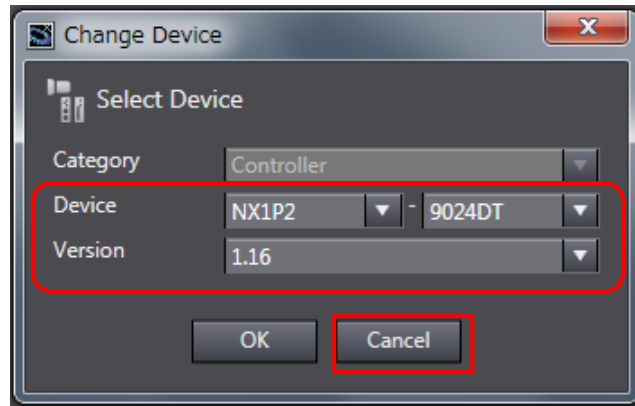

10. Revision History

Revision Symbol	Revised year and date	Revised Page and Reason
01	April 2022	First Publication

OMRON Corporation Industrial Automation Company
Kyoto, JAPAN

Contact: www.ia.omron.com

Regional Headquarters

OMRON EUROPE B.V.

Wegalaan 67-69, 2132 JD Hoofddorp
The Netherlands
Tel: (31)2356-81-300/Fax: (31)2356-81-388

OMRON ASIA PACIFIC PTE. LTD.

438B Alexandra Road, #08-01/02 Alexandra
Technopark, Singapore 119968
Tel: (65) 6835-3011/Fax: (65) 6835-2711

OMRON ELECTRONICS LLC

2895 Greenspoint Parkway, Suite 200
Hoffman Estates, IL 60169 U.S.A.
Tel: (1) 847-843-7900/Fax: (1) 847-843-7787

OMRON (CHINA) CO., LTD.

Room 2211, Bank of China Tower,
200 Yin Cheng Zhong Road,
PuDong New Area, Shanghai, 200120, China
Tel: (86) 21-5037-2222/Fax: (86) 21-5037-2200

Authorized Distributor:

© OMRON Corporation 2022 All Rights Reserved.
In the interest of product improvement,
specifications are subject to change without notice.

Cat. No. Z441-E-01

0622 (0422)