

Smart Sensors
ZS Series

CompoWay/F Communication

Command Reference

OMRON

Introduction

Thank you for purchasing the ZS Series. This manual provides information regarding operations and input/output formats for the communication between ZS Series controllers and external devices using the Omron proprietary protocol, CompoWay/F.

This manual provides information for the following models and versions.

Model	Firmware Version
ZS-LDC	v2.000 or later
ZS-HLDC	v1.000 or later
ZS-MDC	v2.000 or later
ZS-DSU	v2.000 or later

- * Different firmware versions may cause communication errors, unintended setting overwrite, and damages on the controller. Please make sure to use the controller with the correct software version.

If your software version is not listed in the table above, please update the software using the SmartMonitorZS firmware update software, such as WarpEngineZS, to match the software version.

When using the ZS Series, be sure to observe the following:

- The ZS Series must be operated by personnel knowledgeable in electrical engineering.
- To ensure correct use, please read this manual thoroughly to deepen your understanding of the product.
- Please keep this manual in a safe place so that it can be referred to whenever necessary.

Contents

Contents	1
Section 1 About Communication Commands	1-1
How Communication Works	1-2
Setting the Communication Specifications	1-3
Command Formats	1-4
Response Formats	1-6
Examples of Abnormal End	1-8
Section 2 Details of Commands	2-1
About General Information of Communication Commands	2-2
Reading Parameter Areas	2-3
List of Parameter Area Reading Commands	2-3
Commands and Responses	2-4
Writing Parameter Areas	2-6
List of Parameter Area Writing Commands	2-6
Commands and Responses	2-7
Reading Variable Areas	2-9
List of Variable Area Reading Commands	2-9
Commands and Responses	2-9
Reading Controller Information	2-11
Operation Instructions	2-12
List of Operation Instruction Commands	2-12
Commands and Responses	2-12
Section 3 Unit No. and Parameter No.	3-1
Measurement Result Obtaining Command	3-2
Setting Value Obtaining and Changing Command	3-4
Parameter List (ZS-LDC)	3-4
Parameter List (ZS-HLDC)	3-11
Parameter List (ZS-MDC)	3-18
Parameter List (ZS-DSU)	3-27

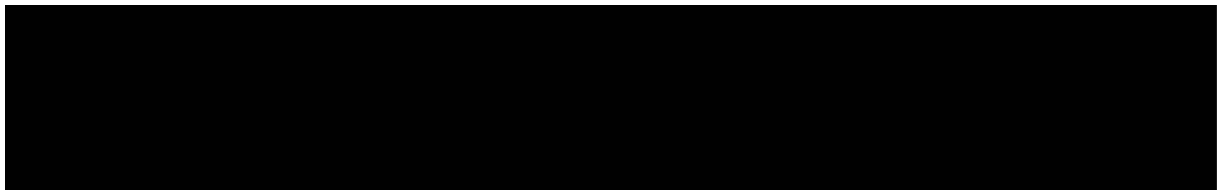

Section 4	How to Obtain Flow Data	4-1
	<u>About Obtaining Flow Data</u>	<u>4-2</u>
	<u>Setting Procedures for Data Obtaining Conditions</u>	<u>4-3</u>
	<u>Setting Parameters</u>	<u>4-8</u>
	<u>Buffer Size and Buffer Interval</u>	<u>4-8</u>
	<u>Logging Data Type</u>	<u>4-8</u>
	<u>Flow Data Response</u>	<u>4-11</u>
	<u>Format</u>	<u>4-11</u>
	<u>Composition of Response</u>	<u>4-11</u>

Section 1

About Communication Commands

▣ <u>How Communication Works</u>	<u>1-2</u>
▣ <u>Setting the Communication Specifications</u>	<u>1-3</u>
▣ <u>Command Formats</u>	<u>1-4</u>
▣ <u>Response Formats</u>	<u>1-6</u>
▣ <u>Examples of Abnormal End</u>	<u>1-8</u>

How Communication Works

ZS Series controllers have communication functions with external devices. Use this function to read the data in ZS Series controllers from the host and to write the setting data. Communication is achieved via the Command and Response Method based on the CompoWay/F, which is Omron's proprietary communication protocol. Controllers perform processing according to the command sent from the host, and then return the result to the host which sent the command as a response.

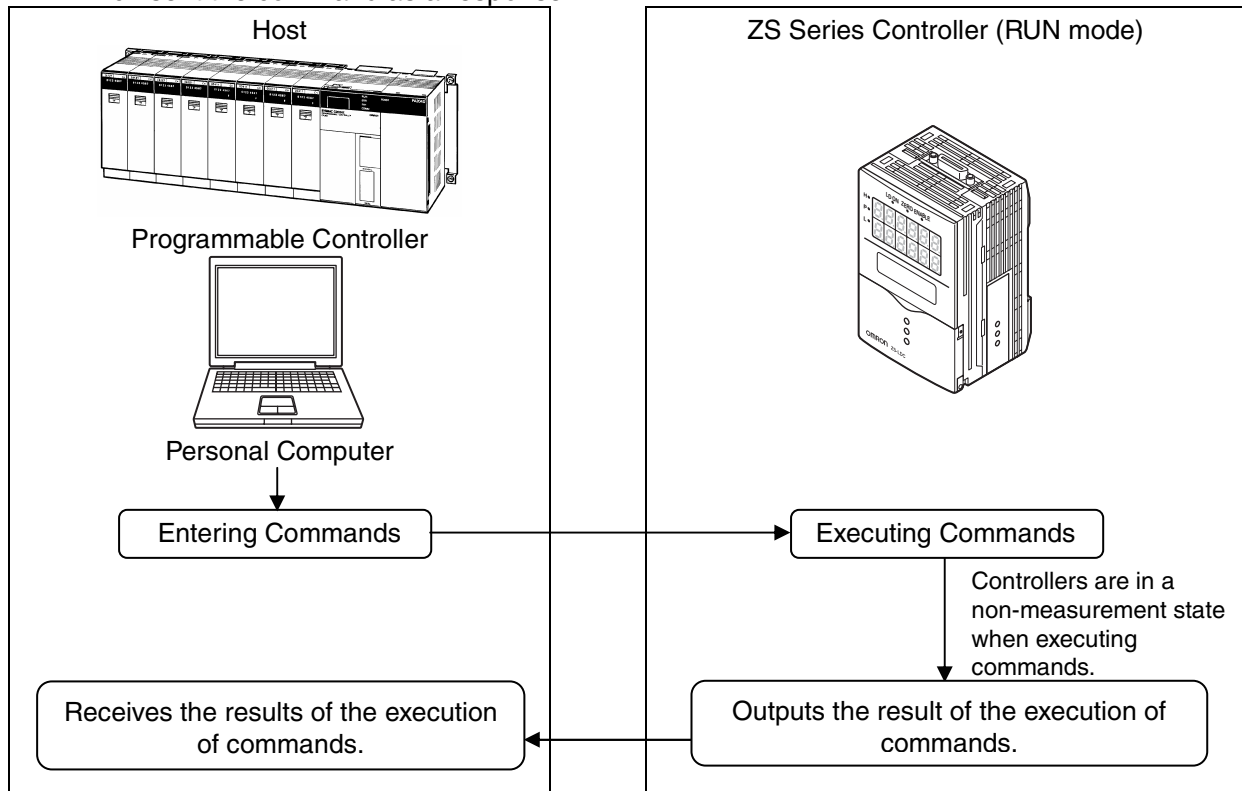

Setting the Communication Specifications

Change the settings of the controller communication specifications for communicating with the external device by CompoWay/F protocol.



Use USB cable or RS-232C cable to connect ZS Series controllers to external devices.

For USB cable connection, install Smart Monitor ZS and USB driver beforehand. After installing Smart Monitor ZS, USB ports are recognized as standard COM ports, and communication is achieved as with the RS-232C. (Setting the communication specifications including baud rate is not necessary.)

For details on how to connect cable, refer to the User's Manual for each controller.

- 1. Set the mode switch to "FUN"**
- 2. Select [System] - [Communication] - [Mode] menu.**
- 3. Select [CompoWay/F].**
- 4. For RS-232C cable connection, select [System] - [Communication] - [RS-232C] menu to set the appropriate communication specifications for the external device.**
- 5. Save the settings.**

Command Formats

The command format of the communication commands is shown below.
In the following section, items described with "Hex" after numerical values (ex. 02Hex) indicate hexadecimal numbers. Those described with " " or only with numeral values indicate ASCII characters.

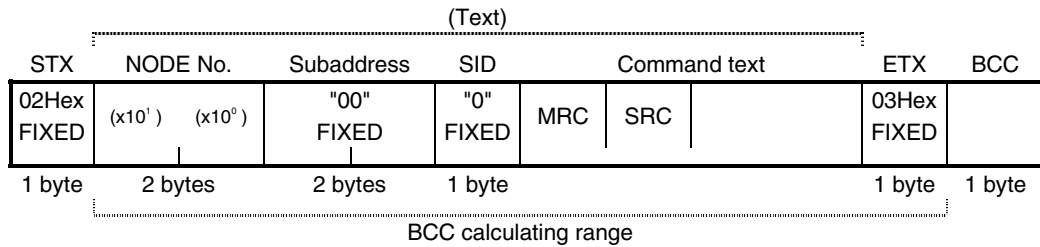

* In the example format, 1 byte = 1 ASCII character.

Elements	Details
STX	This is a code to indicate the first part of communication frames (02Hex). Make sure to set the first byte to 02Hex. When a controller receives STX while receiving a command, it receives the command again starting from where it received STX.
NODE No.	This is the Node No. for the identification of the destination. * About Node No. It refers to the connection group No. as seen from the host device (PLC). Not only the ZS Series but other multiple devices are connected to the PLC. The number assigned to devices connected to a PLC such as this is referred to as a Node No.
Subaddress	This should be fixed to "00."
SID (Service ID)	This should be fixed to "0."
Command text	This is the text part of the command. "Section 2 – Details of Commands" describes these parts by command.
ETX	This is a code to indicate the end of the text (03Hex).
BCC	This is a block check character. The exclusive OR (XOR) of values from Node No. to ETX per byte is BCC.

■ Example of BCC calculation

STX	NODE No.		Subaddress	SID	Command text	ETX	BCC
02Hex	"0" (30Hex)	"0" (30Hex)	"00" (3030Hex)	"0" (30Hex)	"30053001" (3330303533303031Hex)	03Hex	37Hex

Set the result of calculation, which is "37Hex," to BCC.

<Calculation>

$$\text{BCC} = 30\text{Hex} + 30\text{Hex} + 30\text{Hex} + 30\text{Hex} + 30\text{Hex} + 33\text{Hex} + 30\text{Hex} + 30\text{Hex} + 35\text{Hex} + 33\text{Hex} + 30\text{Hex} + 30\text{Hex} + 31\text{Hex} + 03\text{Hex} = 37\text{Hex}$$



"+" indicates the exclusive OR (XOR) operation.

Response Formats

The response format of the communication commands is shown below.

In the following section, items described with "Hex" after numerical values (ex. 02Hex) indicate hexadecimal numbers. Those described with " " or only with numeral values indicate ASCII characters.

STX	NODE No.	Subaddress	End code	Response text		ETX	BCC
02Hex Fixed	($\times 10^1$) ($\times 10^0$)	"00" Fixed		MRC	SRC	03Hex Fixed	
1 byte	2 bytes	2 bytes	2 bytes			1 byte	1 byte

Elements	Details
STX	 Command Formats - page 1 - 4
NODE No.	
Subaddress	
End code	Refer to the next page.
Response text	This is the response text part of the command. "Section 2 – Details of Commands" describes these parts by command.
ETX	 Command Formats - page 1 - 4
BCC	

End codes of responses are shown below.

End code	Name	Details
"00"	Normal end	Command ends successfully.
"0F"	Command error	Specified command is not executed. Refer to the response code for details of the non-execution.
"10"	Parity error	Parity error occurred with any character while receiving a command.
"11"	Framing error	Framing error occurred with any character while receiving a command.
"12"	Overrun error	Overrun error occurred with any character while receiving a command.
"13"	BCC error	Received an invalid BCC.
"14"	Format error	<ul style="list-style-type: none"> Occurs when characters other than 0 to 9 or A to F are used for command text parts. (Except during echo back tests) No SID and command texts exist. Or no command text exists. Either MRC or SRC is missing in the command text.
"16"	Subaddress error	<ul style="list-style-type: none"> Subaddress of the receiving frame is invalid (not supported). No subaddress, SID, and command texts exist. Subaddress is shorter than two characters, and no SID and command texts exist.
"18"	Frame length error	Receiving frame exceeds the supported number of bytes.

One end code is returned after receiving one complete command frame to the node.

No response is made when ETX or BCC characters are missing.



CHECK!

Noises may cause response errors or no response.
Make sure to retry from the host.

It may take three seconds at longest from sending a command to receiving a response. If no response is returned, make sure to send another command after waiting for more than three seconds.

Examples of Abnormal End

This section shows the examples of end codes for abnormal ends while receiving commands.

- **Invalid subaddress, and no SID and command text exist**

Command

STX	NODE No.	Subaddress		ETX	BCC
02Hex		"0"	"A"	03Hex	

Response

STX	NODE No.	Subaddress		End code	ETX	BCC
02Hex		"0"	"A"	"1" "6"	03Hex	

End code is "16" (Subaddress error).

- This response occurred because subaddress errors are prioritized over format errors.

- **No command text exists in the command**

Command

STX	NODE No.	Subaddress		SID	ETX	BCC
02Hex		"0"	"0"	"0"	03Hex	

Response

STX	NODE No.	Subaddress		End code	ETX	BCC
02Hex		"0"	"0"	"1" "4"	03Hex	

End code is "14" (Format error).

- **Node No. is missing**

Command

STX	ETX	BCC
02Hex	03Hex	

One character is missing for the Node No.

Response

No response is returned.

- **No subaddress exists, and an invalid BCC is used**

Command

STX	NODE No.	ETX	BCC
02Hex		03Hex	Err

Response

STX	NODE No.	Subaddress		End code	ETX	BCC
02Hex		"0"	"0"	"1" "3"	03Hex	

Subaddress is "00" and end code is "13" (BCC error).

Section 2

Details of Commands

▣	<u>About General Information of Communication Commands</u>	2-2
▣	<u>Reading Parameter Areas</u>	2-3
	List of Parameter Area Reading Commands	2-3
	Commands and Responses	2-4
▣	<u>Writing Parameter Areas</u>	2-6
	List of Parameter Area Writing Commands	2-6
	Commands and Responses	2-7
▣	<u>Reading Variable Areas</u>	2-9
	List of Variable Area Reading Commands	2-9
	Commands and Responses	2-9
▣	<u>Reading Controller Information</u>	2-11
▣	<u>Operation Instructions</u>	2-12
	List of Operation Instruction Commands	2-12
	Commands and Responses	2-12

About General Information of Communication Commands

Communication commands are categorized into the groups and meanings as in the following table:

Groups		Meanings	Pages for Reference
Reading parameter areas	System- related	Read setting values related to the target CH system.	Page 2-3
	Measurement- related	Read measurement-related setting values and results of measurements. Obtain data by specifying Unit No. and Data No.	(Refer to Section 3 for Unit No. and Data No.)
Writing parameter areas	System- related	Write setting values related to the target CH system.	-
	Measurement- related	Write measurement-related setting values and results of measurements. Write data by specifying Unit No. and Data No.	(Refer to Section 3 for Unit No. and Data No.)
Reading variable areas		Read particular kinds of data in the target CH system.	Page 2-9
Reading controller information		Read information on the models connected with a cable.	Page 2-11
Operation instructions		Operate data of each bank or all banks.	Page 2-12

[Notes on the exchange of communication data]

- Number of elements indicates the size of data to be exchanged. ASCII character length per element is determined depending on parameter type codes. Specifically,
8000h to BFFFh : 4 characters per element
From C000h: 8 characters per element
Number of elements = 1 for all commands in this manual. Please enter "8001h" to specify number of elements.
- Machine No. indicates channel No. of the destination controller.
- All data is exchanged in hexadecimal numbers. Therefore, "15" of the decimal number should be expressed as "0000000Eh." (*1)
- Distance values should be expressed in the unit of [nm]. Therefore, note that "100 (=00000064h)" indicates "100nm 0.1um" and not 100mm. (*1)
- Negative values are expressed as the complements of 2. For example, "-100" should be expressed as "FFFFFF9Ch." (*1)
- In the case that the measured values such as distance are abnormal values, data parts are expressed as "7FFFFFFXh" ("X" varies depending on the case.) (*1)

*1: This is an example for 8 characters per element.

Reading Parameter Areas

Read parameter areas.

List of Parameter Area Reading Commands

Data Name	MRC	SRC	Parameter Type	Reading start address	Specification of element numbers	Data to be read	Data Length *2
Bank switching	02h	01h	8000h	<Machine No.>	8001h	0 to 3	4
Keylock	02h	01h	A002h	<Machine No.>	8001h	0 : OFF, 1 : ON	4
Version Information	02h	01h	A021h	<Machine No.>	8001h	Software Version	4
Controller type Information	02h	01h	A022h	<Machine No.>	8001h	0 : ZS-LDC, 1 : ZS-MDC, 2 : ZS-DSU	4
RS-232C Data Length Setting	02h	01h	A030h	<Machine No.>	8001h	0 : 7 bits, 1 : 8 bits	4
RS-232C Parity Setting	02h	01h	A031h	<Machine No.>	8001h	0 : None, 1 : Odd Number, 2 : Even Number	4
Stop bits setting	02h	01h	A032h	<Machine No.>	8001h	0 : 1 bit, 1 : 2 bits	4
Communication node setting	02h	01h	A033h	<Machine No.>	8001h	0 to 64	4
Digits after decimal point	02h	01h	A040	<Machine No.>	8001h	0 : 1 digit, 1 : 2 digits, 2 : 3 digits, 3 : 4 digits, 4 : 5 digits	4
Digital "Eco" mode	02h	01h	A041h	<Machine No.>	8001h	0 : NORMAL, 1 : ECO1, 2 : OFF	4
LCD ON/OFF	02h	01h	A042h	<Machine No.>	8001h	0 : OFF, 1 : AUTOOFF, 2 : ON	4
LCD Backlight	02h	01h	A043h	<Machine No.>	8001h	0 : OFF, 1 : AUTOOFF, 2 : ON	4
Sensor Load	02h	01h	A050h	<Machine No.>	8001h	0 : LOAD every time, 1 : SAVE	4
Language	02h	01h	A051h	<Machine No.>	8001h	0 : Japanese, 1 : English	4
Reading processing unit data *1	02h	01h	C000h+ <Data No.>	XXYYh XX : Unit No. YY : Machine No.	8000h + <No. of Elements>	Data to be read	8

* 1 - All reading/writing operations on processing units are assigned by using this command.

* 2 - Indicates ASCII character length. Refer to page 2-2 for details.



Refer to "Section 3 - Unit No. and Parameter No." for Unit No. and Parameter No. for each processing unit.

Example 1: To read the "language" information from the 2CH controller, assign a command as follows:

[Machine No.]=0002h

MRC	SRC	Parameter Type	Reading start address	Number of elements
02h	01h	A051h	0002h	8001h

Example 2: To read the final measured value from the 1CH controller, assign a command as follows:



[Data No.]=20h, [Unit No.]=30h, [Machine No.]=01h

MRC	SRC	Parameter Type	Reading start address	Number of elements
02h	01h	C020h	3001	8001h

Commands and Responses

Command

MRC	SRC	Parameter Type	Reading start address	Number of elements
"02"	"01"			
2 bytes	2 bytes	4 bytes	4 bytes	4 bytes

Elements	Details
Parameter Type	Specify parameters depending on the data to be obtained.  List of Parameter Area Reading Commands page 2-3
Reading start address	Specify the Machine No. (=CH No.) of the controller to read data by using an ASCII code expressed in hexadecimal numbers. Please note that the format of "processing unit data reading" commands is XXYYh (XX : <Unit No.>, YY : <Machine No.>)  Unit No. and Parameter No. page 3-4
Number of elements	Specify number of elements depending on the Parameter Type.  List of Parameter Area Reading Commands page 2-3

Response

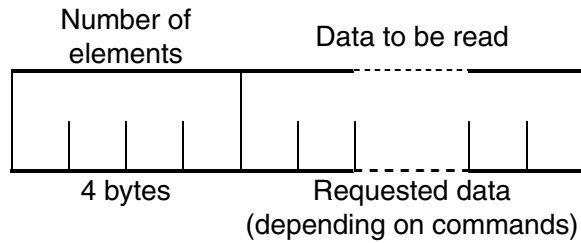
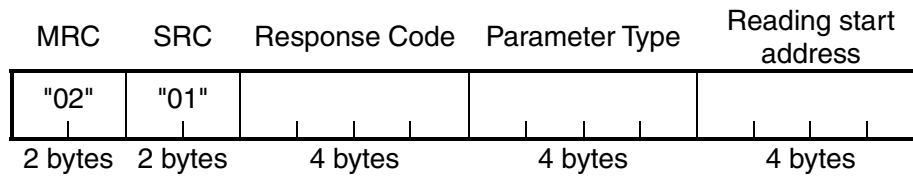

Elements	Details
Response Code	Indicates controller status for the command. Data to be read is not returned when an error occurs.
Data to be read	Data to be read is expressed by using an ASCII code in hexadecimal numbers. Data length varies depending on commands.  List of Parameter Area Reading Commands page 2-3

Response code for normal end

Response Code	Name	Details
"0000"	Normal end	No errors.

Response code when an error occurs

Response Code	Error name	Cause
"1001"	Long command length	Command length is too long.
"1002"	Short command length	Command length is too short.
"1003"	Inconsistent number of elements/data	Number of elements and data do not match.
"1101"	Area type error	Parameter type is wrong.
"1103"	Start address outside of range error	Reading start address is out of range. Reading start address specifies the sensor of the unconnected Machine No. Bit position is other than "00."
"1104"	End address outside of range error	Specified number of elements is out of range.
"2203"	Operating error	Reading error.
"2204"	Operating error	Operating mode of sensor is other than RUN.
"2205"	Operating error	Invalid command.

Writing Parameter Areas

Write parameter areas.

List of Parameter Area Writing Commands

Data Name	MRC	SRC	Parameter Type	Writing start address	Specification of element numbers	Data to be written	Data Length *2
Bank switching	02h	02h	8000h	<Machine No.>	8001h	0 to 3	4
KEYLOCK	02h	02h	A002h	<Machine No.>	8001h	0 : OFF, 1 : ON	4
RS-232C Data Length Setting	02h	02h	A030h	<Machine No.>	8001h	0 : 7 bits, 1 : 8 bits	4
RS-232C Parity Setting	02h	02h	A031h	<Machine No.>	8001h	0 : None, 1 : Odd Number, 2 : Even Number	4
Stop bits setting	02h	02h	A032h	<Machine No.>	8001h	0 : 1 bit, 1 : 2 bits	4
Communication node setting	02h	02h	A033h	<Machine No.>	8001h	0 to 64	4
Digits after decimal point	02h	02h	A040	<Machine No.>	8001h	0 : 1 digit, 1 : 2 digits, 2 : 3 digits, 3 : 4 digits, 4 : 5 digits	4
Digital "Eco" mode	02h	02h	A041h	<Machine No.>	8001h	0 : NORMAL, 1 : ECO1, 2 : OFF	4
LCD ON/OFF	02h	02h	A042h	<Machine No.>	8001h	0 : OFF, 1 : AUTOOFF, 2 : ON	4
LCD Backlight	02h	02h	A043h	<Machine No.>	8001h	0 : OFF, 1 : AUTOOFF, 2 : ON	4
Sensor Load	02h	02h	A050h	<Machine No.>	8001h	0 : LOAD, 1 : SAVE	4
Language	02h	02h	A051h	<Machine No.>	8001h	0 : Japanese, 1 : English	4
Writing processing unit data *1	02h	02h	C000h+ <Data No.>	XXYYh XX : Unit No. YY : Machine No.	8000h + <No. of Elements>	Data to be written	8

* 1 - All reading/writing operations on processing units are assigned by using this command.

* 2 - Indicates ASCII character length. Refer to page 2-2 for details.



Refer to "Section 3 - Unit No. and Parameter No." for Unit No. and Parameter No. for each processing unit.

Example 1: To turn on the "KEYLOCK" of the 2CH controller, assign a command as follows:

[Machine No.]=0002h, [Data to be written]=0001h

MRC	SRC	Parameter Type	Reading start address	Number of elements	Data to be written
02h	02h	A002h	0002h	8001h	0001h

Example 2: To set the peak hold mode for the 1CH controller, assign a command as follows:





[Data No.] = 02h, [Unit No.] = 2Dh, [Machine No.] = 01h, [Data to be written] = 00000001h

MRC	SRC	Parameter Type	Writing start address	Number of elements	Data to be written
02h	02h	C002h	2D01	8001h	00000001h

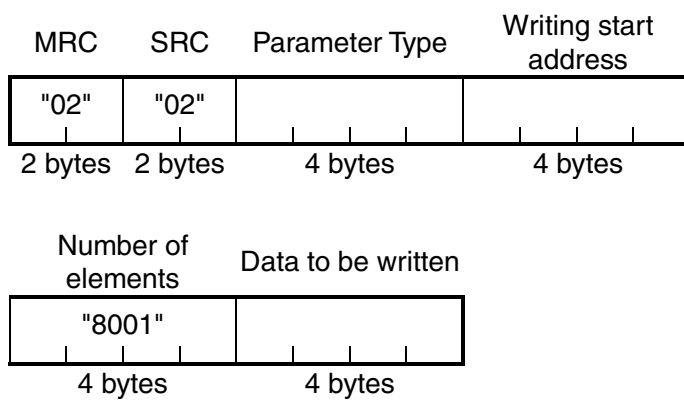
Commands and Responses

Command



Elements	Details
Parameter Type	Specify parameters depending on the data to be written.  List of Parameter Area Writing Commands page 2-6
Writing start address	Specify the Machine No. (=CH No.) of the controller to write data by using an ASCII code expressed in hexadecimal numbers. Please note that the format of "processing unit data writing" commands is XYYh (XX : <Unit No.>, YY : <Machine No.>)  Unit No. and Parameter No. page 3-4
Number of elements	Specify number of elements depending on the Parameter Type.  List of Parameter Area Writing Commands page 2-6
Data to be written	Data to be written is specified by using an ASCII code in hexadecimal numbers. Data length varies depending on commands. <ul style="list-style-type: none"> • List of Parameter Area Writing Commands page 2-6 • Do not issue commands other than specified parameter types. Issuing wrong commands may rewrite internal parameters. In the case that internal parameters of connected sensors are rewritten, execute "EEPROM initialization" of operation instruction commands. 

Response

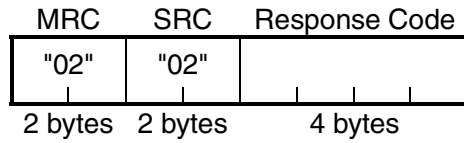

Elements	Details
Response Code	Indicates controller status for the command.

Response code for normal end

Response Code	Name	Details
"0000"	Normal end	No errors.

Response code when an error occurs

Response Code	Error name	Cause
"1001"	Long command length	Command length is too long.
"1002"	Short command length	Command length is too short.
"1003"	Inconsistent number of elements/data	Number of elements and data do not match.
"1100"	Parameter error	Data to be written is out of specified range.
"1101"	Area type error	Parameter type is wrong.
"1103"	Start address outside of range error	Writing start address is out of range. Writing start address specifies the sensor of the unconnected Machine No.
"1104"	End address outside of range error	Specified number of elements is other than "8001."
"2203"	Operating error	Setting is abnormal. Refer to the User's Manual of the ZS Series for setting error conditions of thresholds and the hysteresis width.
"2204"	Operating error	Operating mode of sensor is other than RUN.
"2205"	Operating error	Invalid command.

Reading Variable Areas

Read variable areas.

List of Variable Area Reading Commands

Data Name	MRC	SRC	Variable Type	Reading start address	Bit position	Number of elements
Flow data	01h	01h	E1h	0000h	00h	0001h
Measurement Cycle	01h	01h	81h	<Machine No.>	00h	0002h

Example: To read the measurement cycle information from the 2CH controller, assign a command as follows:



[Machine No.]=0002h

MRC	SRC	Variable Type	Reading start address	Bit position	Number of elements
01h	01h	81h	0002h	00h	0002h

Commands and Responses

Command

MRC	SRC	Variable Type	Reading start address	Bit position	Number of elements
"01"	"01"			"00"	
2 bytes	2 bytes	2 bytes	4 bytes	2 bytes	4 bytes

Elements	Details
Variable type	Specify variables depending on the data to be obtained.  List of Variable Area Reading Commands page 2-9
Reading start address	Specify the Machine No. (=CH No.) of the controller to read data by using an ASCII code expressed in hexadecimal numbers.  Unit No. and Parameter No. page 3-4
Bit position	ZS Series does not support bit access. It is fixed to "00."
Number of elements	Specify number of elements depending on the Variable Type.  List of Variable Area Reading Commands page 2-6

Response

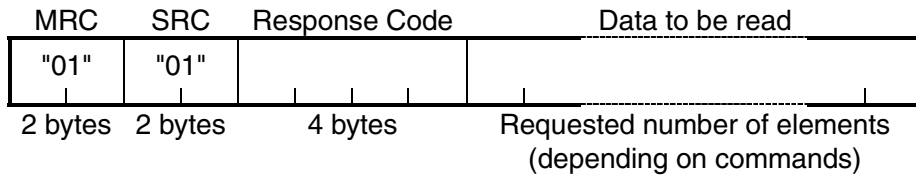

Elements	Details
Response Code	Indicates controller status for the command. Data to be read is not returned when an error occurs.
Data to be read	Data length is number of elements x 4 ASCII characters. Since the data reading part of the flow data obtaining commands use special formats, refer to "Section 4: How to Obtain Flow Data."  Composition of Flow Data Responses page 4-10

Response code for normal end

Response Code	Name	Details
"0000"	Normal end	No errors.

Response code when an error occurs

Response Code	Error name	Cause
"1001"	Long command length	Command length is too long.
"1002"	Short command length	Command length is too short.
"1003"	Inconsistent number of elements/data	Number of elements and data do not match.
"1101"	Area type error	Variable type is wrong.
"1103"	Start address outside of range error	Reading start address is out of range. Reading start address specifies the sensor of the unconnected Machine No. Bit position is other than "00."
"1104"	End address outside of range error	Specified number of elements is out of range.
"2203"	Operating error	Reading error.
"2204"	Operating error	Operating mode of sensor is other than RUN.
"2205"	Operating error	Invalid command.

Reading Controller Information

Read data about ZS Series types and so on.

Command

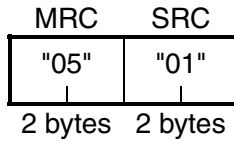

Response

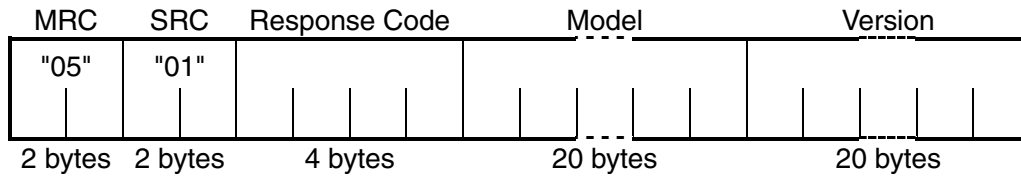

Elements	Details
Response Code	Indicates controller status for the command. Data to be read is not returned when an error occurs.
Model	Model is expressed with 20 ASCII characters.
Version	Version is expressed with 20 ASCII characters.

Response code for normal end

Response Code	Name	Details
"0000"	Normal end	No errors.

Response code when an error occurs

Response Code	Error Name	Cause
"1001"	Long command length	Command length is too long.
"1002"	Short command length	Command length is too short.

Operation Instructions

Provides operation instructions to controllers.

List of Operation Instruction Commands

Instruction Name	MRC	SRC	Instruction Code	Related Information 1	Related Information 2
Complete INIT	30h	05h	55h	<Machine No.>	0000h
DATA SAVE	30h	05h	57h	<Machine No.>	0000h
CLEAR	30h	05h	58h	<Machine No.>	0000h

CLEAR (which clears banks) initializes current banks' sensing settings and measurement settings. Settings of other banks and system settings are not initialized.
Complete INIT initializes all settings (settings of all banks and system settings).

Example: To execute Complete INIT of the 2CH controller, assign a command as follows:

[Related information1]=02h

MRC	SRC	Instruction Code	Related Information 1	Related Information 2
30h	05h	55h	02h	0001h

Commands and Responses

Command

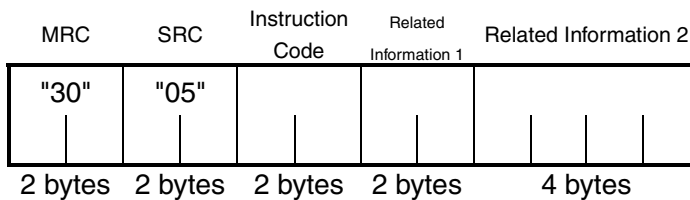

Elements	Details
Instruction Code	Specify commands depending on the instruction to be executed.
Related Information 1	Specify the channel No. of the controller related to the command. Example: In the case of 2CH, specify "02."
Related Information 2	Usually, setting other than "0000" is not accepted.

Response

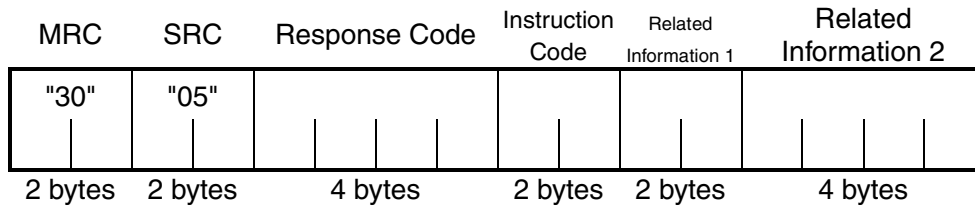

Elements	Details
Response Code	Indicates controller status for the command.
Instruction Code	The code which is the same as the transmitted will be returned.
Related Information 1	
Related Information 2	

Response code for normal end

Response Code	Name	Details
"0000"	Normal end	No errors.

Response code when an error occurs

Response Code	Error Name	Cause
"1001"	Long command length	Command length is too long.
"1002"	Short command length	Command length is too short.
"1101"	Area type error	Instruction code is invalid.
"1103"	Start address outside of range error	Related information specifies the sensor of the unconnected Machine No.
"2203"	Operating error	Setting is abnormal. Refer to the User's Manual of the ZS Series for error conditions.
"2204"	Operating error	Operating mode of sensor is other than RUN.
"2205"	Operating error	Invalid command.

MEMO

Section 3

Unit No. and Parameter No.

▣	<u>Measurement Result Obtaining Command</u>	3-2
▣	<u>Setting Value Obtaining and Changing Command</u>	3-4
	Parameter List (ZS-LDC)	3-4
	Parameter List (ZS-HLDC)	3-11
	Parameter List (ZS-MDC)	3-18
	Parameter List (ZS-DSU)	3-27

Measurement Result Obtaining Command

■ Parameter List (ZS-LDC)

When selecting a mode other than "THICK/GAP - FILM/OTHERS - TRANSFER" mode (when no 2-area measurement is performed):

Unit No.	Data No.	Parameter Description
30h	20h	Measurement result (=Main digital display value)

When selecting "THICK/GAP - FILM/OTHERS - TRANSFER" mode (when a 2-area measurement is performed):

Unit No.	Data No.	Parameter
30h	20h	Area 1 displacement value (TASK1)
44h		Area 2 displacement value (TASK2)
58h		Thickness and/or Gap results (=Main digital display value = TASK3 = Area1 – Area2)

■ Parameter List (ZS-HLDC)

For single task mode

When selecting a mode other than "GLASS/MODE 2" or "GLASS THICKNESS/MODE 2" mode

(when no 2-area measurement is performed):

Unit No.	Data No.	Parameter Description
30h	20h	Measurement result (=Main digital display value)

When selecting "GLASS/MODE 2" or "GLASS THICKNESS/MODE 2" mode

(when a 2-area measurement is performed):

Unit No.	Data No.	Parameter
30h	20h	Area 1 displacement value (TASK1)
44h		Area 2 displacement value (TASK2)
58h		Glass surface and/or Glass thickness results (=Main digital display value = TASK3 = Area1 – Area2)

For multi-task mode

Unit No.	Data No.	Parameter
30h	20h	TASK1 measurement result
44h		TASK2 measurement result
58h		TASK3 measurement result
6Ch		TASK4 measurement result

Parameter List (ZS-MDC)

Unit No.	Data No.	Parameter
30h	20h	TASK1 measurement result
44h		TASK2 measurement result
58h		TASK3 measurement result
6Ch		TASK4 measurement result

Example1: When obtaining a measurement result of ZS-LDC (2CH) (and when no 2-area measurement is performed):

02h 01h (C000h + 20h (Data No.)) 30h (Unit No.) 02h (CH No.) (8000h + 1h (Number of elements))

In the command section, the value is shown as below:

02h 01h C020h 3002h 8001h

To this command, if the response is shown as below:

02h 01h C020h 3002h 8001h 04CC5520h

It indicates as 80500000nm (= 80.5mm) because 04CC5520h = 80500000.

Example2: When obtaining a displacement value of a standalone ZS-LDC (0CH) Area2 (and a 2-area measurement is performed):

02h 01h (C000h + 20h (Data No.)) 44h (Unit No.) 00h (CH No.) (8000h + 1h (Number of elements))

In the command section, the value is shown as below:

02h 01h C020h 4400h 8001h

To this command, if the response is shown as below:

02h 01h C020h 4400h 8001h 02719C40h

It indicates as 41000000nm (= 41mm) because 02719C40h = 41000000.

Example3: When obtaining a measurement result of ZS-MDC (0CH) TASK3:

02h 01h (C000h + 20h (Data No.)) 58h (Unit No.) 00h (CH No.) (8000h + 1h (Number of elements))

In the command section, the value is shown as below:

02h 01h C020h 5800h 8001h

To this command, if the response is shown as below:

02h 01h C020h 5800h 8001h FFF0BDC0h

It indicates as -1000000nm (= -1mm) because FFF0BDC0h = -1000000.

(A negative value is expressed as a complement of two.)

Setting Value Obtaining and Changing Command Parameter List (ZS-LDC)

■ Sensing Setting (common for all TASKs)

Unit No.	Data No.	Parameter	Setting range/ output range	Remarks
00h	00h	Measurement mode	0: STANDARD 1: HI-RESO 2: HI-SPEED 3: HI-SENS 4: CUSTOM	
	12h	Exposure time	2 to 200 (1div:0.1ms)	Parameters when [Measurement mode]=[Custom]
	13h	Number of additional lines	1 to 200	
	14h	Line skipping	0: ON 1: OFF	
01h	00h	Head installation	0: DIFFUSE 1: REGULAR	
02h	00h	LD power mode	0: Auto 1: Auto range 2: Fixed	(Note 1)
	02h	Surface to be controlled for light amount	0: Peak 1: Surface 2: Second surface 3: Third surface	
	06h	LD power when fixed	0 to 1000 (1div:0.1%)	Parameters when [Emitted light amount setting]=[Fixed]
	0Dh	Lower limit of LD power	0 to 800 (1div:0.1%)	Parameters when [Emitted light amount setting]=[Auto range]
	0Eh	Upper limit of LD power	0 to 800 (1div:0.1%)	
	25h	Incident level (First surface)	0 to 4095 (tone)	
	26h	Incident level (Second surface)	0 to 4095 (tone)	
	27h	Incident level (Third surface)	0 to 4095 (tone)	
03h	00h	Measurement object	0: NORMAL 1: PCB 2: MIRROR 3: GLASS 4: THICKNESS 5: GAP	
	01h	Glass material	0: NORMAL 1: FILM/OTHERS	Parameters when [Measurement object]=[Thickness] or [Gap]
	02h	Glass thickness measurement mode	0: STOP 1: Moving	Parameters when [Glass material]=[FILM/ OTHERS]

Unit No.	Data No.	Parameter	Setting range/ output range	Remarks
03h	03h	Image smoothing level	0: None 1: Filter size 2 2: Filter size 4 3: Filter size 8 4: Filter size 16	
	04h	Background removing level before addition	0 to 255 (tone)	
	05h	Background removing level after addition	0 to 4095 (tone)	
	06h	Edge threshold	0: 0 % 1: 12.5 % 2: 25% 3: 37.5 % 4: 50% 5: 62.5 % 6: 75% 7: 87.5 %	
04h	00h	Mutual interference prevention mode	0: OFF 1: ON	
	01h	Timing setting	0: Timing A 1: Timing B	Parameters when [Mutual interference prevention mode]=[ON]
05h	00h	Gain setting	1 to 5	
07h	00h	LD power mode (Area 1)	0: Auto 1: Auto range 2: Fixed	(Note 1)
	02h	Surface to be controlled for light amount	0: Peak 1: Surface 2: Second surface 3: Third surface	
	06h	LD power when fixed	0 to 1000 (1div:0.1%)	Parameters when [Emitted light amount setting]=[Fixed]
	0Dh	Lower limit of LD power	0 to 800 (1div:0.1%)	Parameters when [Emitted light amount setting]=[Auto range]
	0Eh	Upper limit of LD power	0 to 800 (1div:0.1%)	
	11h	Measurement target area	0: Surface 1: Second surface 2: Third surface	
	25h	Incident level (First surface)	0 to 4095 (tone)	
	26h	Incident level (Second surface)	0 to 4095 (tone)	
	27h	Incident level (Third surface)	0 to 4095 (tone)	

Section 3 Setting Value Obtaining and Changing Command

Unit No.	Data No.	Parameter	Setting range/ output range	Remarks
08h	00h	LD power mode (Area 2)	0: Auto 1: Auto range 2: Fixed	(Note 1)
	02h	Surface to be controlled for light amount	0: Peak 1: Surface 2: Second surface 3: Third surface	
	06h	LD power when fixed	0 to 1000 (1div:0.1%)	Parameters when [Emitted light amount setting]=[Fixed]
	0Dh	Lower limit of LD power	0 to 800 (1div:0.1%)	Parameters when [Emitted light amount setting]=[Auto range]
	0Eh	Upper limit of LD power	0 to 800 (1div:0.1%)	
	11h	Measurement target area	0: Surface 1: Second surface 2: Third surface	
	25h	Incident level (First surface)	0 to 4095 (tone)	
	26h	Incident level (Second surface)	0 to 4095 (tone)	
	27h	Incident level (Third surface)	0 to 4095 (tone)	

Note 1: When no 2-area measurement is performed, Unit No. 2 is valid and Unit No. 7 and 8 are invalid.

When a 2-area measurement is performed, Unit No. 2 is invalid and Unit No. 7 and 8 are valid.

Example 1: When reading the setting values of edge threshold (when LDC is 1CH):

Since the edge threshold for Unit No. is 03h, and Data No. is 06h, values are shown as below:

02h 01h (C000h + 06h (Data No.)) 03h (Unit No.) 01h (CH No.) (8000h + 1h (Number of elements))

In the command section, the value is shown as below:

02h 01h C006h 0301h 8001h

To this command, if the response is shown as below:

02h 01h C006h 0301h 8001h 00000004h,

It indicates 50 % because the value is 4.

Example 2: When changing the gain setting to 3 (when ZS-LDC is 0CH):

Since the gain setting for Unit No. is 05h, and Data No. is 00h, values are shown as below:

02h 02h (C000h + 00h (Data No.)) 05h (Unit No.) 00h (CH No.)

and (8000h + 1h (Number of Elements)) 00000003h (Data to be written),

In the command section, the value is shown as below:

02h 02h C000h 0000h 8001h 00000003h

To this command, if the response is shown as below:

02h 02h 0000h

It indicates a normal end.

■ Measurement Setting 1 (Settings per TASK) (Note 2)

Unit No. (Note 3)	Data No.	Parameter	Setting range/output range	Remarks
29h	00h	Scaling mode	0: OFF 1: ON	
	01h	Span value	-20000 to 20000 (X0.0001)	
	02h	Offset value	-999999999 to 999999999 (nm)	
2Ah	02h	Smooth	0: OFF 1: ON	
2Bh	02h	Average number of times	0: 1 time 1: 2 times 2: 4 times 3: 8 times 4: 16 times 5: 32 times 6: 64 times 7: 128 times 8: 256 times 9: 512 times 10: 1024 times 11: 2048 times 12: 4096 times	
2Ch	02h	Differential mode	0: OFF 1: ON	
	03h	Differentiation cycles	1 to 5000 (ms)	
2Dh	02h	Hold type	0: OFF 1: PEAK 2: BOTTOM 3: P-P 4: AVERAGE 5: SAMPLE	
	03h	Trigger method	0: External 1: Self-up trigger 2: Self-down trigger	
	04h	Trigger level	-999999999 to 999999999 (nm)	
	05h	Trigger hysteresis	0 to 999999999 (nm)	
	06h	Trigger delay (ms)	0 to 5000 (ms)	
	07h	Sampling period (ms)	1 to 5000 (ms)	
	08h	Trigger delay mode	0: OFF 1: ON	
2Eh	05h	Offset value for zero reset	-999999999 to 999999999 (nm)	
	07h	Zero reset mode	0: REAL 1: HOLD	
30h	02h	LOW threshold value	-999999999 to 999999999 (nm)	
	03h	HIGH threshold value	-999999999 to 999999999 (nm)	

(Note 2)

The same task as MDC is performed as internal processing when selecting a “THICK/GAP - FILM/OTHERS - TRANSFER” mode (when a 2-area measurement is performed).

Processing is assigned to each task as below:

	When 2-area measurement is performed (*3)	When measurement other than 2-area measurement is performed
TASK1	Calculates Area 1 displacement value	Measurement result (*1)
TASK2	Calculates Area 2 displacement value	Unused (*2)
TASK3	Calculates the difference (=Thickness/gap) between TASK 1 and TASK 2	Unused (*2)
TASK4	Unused (*2)	Unused (*2)

*1: The result is a thickness distance value when the thickness measurement is set.

Other than the above, the result is a surface distance value.

*2: An error always occurs.

*3: Only TASK3 can be displayed or set on the controller.

(Note 3)

The Unit No. here indicates TASK 1 Unit No.

Unit No. other than the above, such as TASK2 or a later one, can be calculated by adding (TASK number -1) to the Unit No. and multiplying it by 14h for another reference or setting.

Example1: When reading the setting values of the average number of times (when ZS-LDC is 1CH, and no 2-area measurement is performed):

Since the average number of times is 2Bh for Unit No., and 02h for Data No., values are shown as below:

02h 01h (C000h + 02h (Data No.)) 2Bh (Unit No.) 01h (CH No.) (8000h + 1h (Number of elements))

In the command section, the value is shown as below:

02h 01h C002h 2B01h 8001h

To this command, if the response is shown as below:

02h 01h C002h 2B01h 8001h 00000004h

Since the value is 4, this indicates 16 times.

Example 2: When changing a high threshold value for the result of thickness to 100 mm (when ZS-LDC is 0CH, and a 2-area measurement is performed):

The thickness result is calculated by using TASK3 when performing a 2-area measurement.

Usually, the high threshold value is 30h for Unit No., and 03h for Data No.

However, Unit No. is 58h (= 30h + (3-1) x 14h) because TASK3 is set this time.

Besides, 100mm thickness is expressed as 05F5E100h in a hexadecimal number because 100 mm is 100,000,000nm.

02h 02h (C000h + 03h (Data No.)) 58h (Unit No.) 00h (CH No.)

and (8000h + 1h (Number of Elements)) 05F5E100h (Data to be written)

In the command section, the value is shown as below:

02h 02h C003h 5800h 8001h 05F5E100h

To this command, if the response is shown as below:

02h 02h 0000h

It indicates a normal end.

■ Measurement Setting 2 (common to all TASKs)

Unit No.	Data No.	Parameter	Setting range/output range	Remarks
78h	00h	Non-measurement settings	0: Keep 1: Clamp	
	01h	Output at CLAMP	0: MAX 1: 20mA 2: 12mA 3: 4mA 4: MIN	
79h	00h	Hysteresis width	0 to 999999999 (nm)	
	01h	Timer mode	0: OFF 1: OFF DELAY 2: ON DELAY 3: 1 shot	
	02h	Delay time	1 to 5000 (ms)	
7Ah	02h	Monitor focus mode	0: OFF, 1: ON	(Note 4)
	03h	Monitor focus distance value 1	-999999999 to 999999999 (nm)	
	04h	Monitor focus distance value 2	-999999999 to 999999999 (nm)	
	05h	Monitor focus current value 1	4 to 20 (mA)	
	06h	Monitor focus current value 2	4 to 20 (mA)	
	07h	Monitor focus voltage value 1	-10 to 10 (V)	
	08h	Monitor focus voltage value 2	-10 to 10 (V)	
7Eh	04h	Input polarity of external input 0	0: L active 1: H active	
	05h	Input polarity of external input 1		
	06h	Input polarity of external input 2		
	07h	Input polarity of external input 3		
7Fh	01h	External Input (IN) function mode	0: Standard 1: Bank	
	06h	Digital output target	0: OFF 1: ON	
	0Ah	External input 0 mode	0: Not used 1: Trigger 2: Hold reset 3: Laser OFF 4: Zero-reset	(Note 5)
	0Bh	External input 1 mode		
	0Ch	External input 2 mode		
	0Dh	External Input 3 mode		
F0h	08h	External input mode	0: STANDARD 2: Parallel input OFF mode	
	C0h	Timing input	0: OFF 1: ON	
	C1h	Reset input	0: OFF 1: ON	
	C2h	LD-OFF input	0: OFF 1: ON	
	C3h	Zero-reset execution	1: Execution	
	C4h	Zero-reset cancel	1: Cancel	

(Note 4)

To change the monitor focus setting, monitor focus mode must be ON.

For example, to change the current setting of the monitor focus, change parameters below:

- Monitor focus mode (ON)
- Monitor focus distance value 1
- Monitor focus distance value 2
- Monitor focus current value 1
- Monitor focus current value 2

In addition, set outputs (current and voltage), which are set by the analog output switch in the controller.

(Note 5)

External input 0 mode and External input 1 mode settings cannot be changed because they automatically function as bank inputs when the bank mode is used (when “external input (IN) function mode” is set to “bank”).

(Note 6)

When the external input mode is set to “STANDARD”, the controller enters into the status below:

- * External input of the controller is enabled,
- * Commands from timing input to zero-resetting are disabled.

When the external input mode is set to “Parallel input OFF”, the controller enters into the status below:

- * External input of the controller is enabled,
- * Commands from timing input to zero-resetting are disabled.

Therefore, to send a command related to inputs, the external input mode should be set to “Parallel input OFF.”

Once ON is written to the timing input, reset input, and LD-OFF input parameters, the ON state is kept until OFF is written next.

Controller operates in the same manner as the input state is kept ON.

However, special care shall be taken because the operation changes depending on the state of external input line to the controller when the external input mode is set back to the “standard mode.”

Operations are performed depending on the settings when “Execution” or “Cancel” is written to the parameter with respect to the zero-reset.

Example 1: To perform zero-reset (when ZS-LDC is 1CH):

The command sending sequence is as follows:

- (1) Write “parallel input OFF mode” to the “external input mode” parameter.
- (2) Write “execution” to the “zero-reset execution” parameter.
- (3) Write “STANDARD” to the “external input mode” parameter.

An actual example of a command procedure is shown below:

- (1) 02h 02h C008h F001h 8001h 00000002h
- (2) 02h 02h C0C3h F001h 8001h 00000001h
- (3) 02h 02h C008h F001h 8001h 00000000h

Writing commands (1) and (3) above before and after the input-related operation command, respectively, is recommended.

Parameter List (ZS-HLDC)

■ Sensing Setting (common for all TASKs)

Unit No.	Data No.	Parameter	Setting range/output range	Remarks
0h	0h	Measurement mode	0: STANDARD 1: HI-RESO 2: HI-SPEED 3: HI-SENS 4: CUSTOM	When multi-task mode is OFF
		Measurement mode	1: STANDARD 2: HI-RESO 3: HI-SENS 4: CUSTOM	When multi-task mode is ON
	Ch	Start position of area 1	0 to 639 (pix)	
	Eh	End position of area 1	0 to 639 (pix)	
	Dh	Start line of area 1	0 to (Number of additional lines - 1)	
	Fh	End line of area 1	0 to (Number of additional lines - 1)	
	18h	Start position of area 2	0 to 639 (pix)	
	1Ah	End position of area 2	0 to 639 (pix)	
	19h	Start line of area 2	0 to (Number of additional lines - 1)	
	1Ah	End line of area 2	0 to (Number of additional lines - 1)	
	12h	Exposure time	2 to 200 (1div:0.1ms) When multi-task mode is OFF	Parameters for CUSTOM mode
			5 to 200 (1div:0.1ms) When multi-task mode is ON	
	13h	Number of additional lines	1 to 200 When multi-task mode is OFF	
			8 to 200 When multi-task mode is ON	
	14h	Line skipping	0: OFF	
			1: ON	
	16h	2-area mode	0: OFF	
			1: ON	
	17h	Compensation mode	0: OFF 1: Start position compensation 2: End position compensation 3: Start/end position compensation	
20h	Measurement cycle	112 to 20000 (us)		
C0h	Reference point teach for compensation mode	1: Execute teach		
C1h	2-area teach	1: Execute teach		
1h	0h	Head installation	0: Diffuse 1: Regular	
2h	0h	LD power mode	0: Auto 1: Auto-scale 2: Fixed	

Section 3
Setting Value Obtaining and Changing Command

Unit No.	Data No.	Parameter	Setting range/output range	Remarks
	2h	Surface to be controlled for light amount	0: Peak 1: First surface 2: Second surface 3: Third surface	
	6h	LD power when fixed	0 to 800 (1div:0.1%)	
2h	Dh	Lower limit of LD power	0 to 800 (1div:0.1%)	
	Eh	Upper limit of LD power	0 to 800 (1div:0.1%)	
	20h	Incident level	0 to 4095 (1div:0.1%)	
	24h	LD power	0 to 800 (1div:0.1%)	
	25h	Incident level (First surface)	0 to 4095 (1div:0.1%)	
	26h	Incident level (Second surface)	0 to 4095 (1div:0.1%)	
	27h	Incident level (Third surface)	0 to 4095 (1div:0.1%)	
3h	0h	Measuring object	0: Normal 1: PCB 2: Mirror 3: Glass 4: Glass thickness	
	2h	GLASS/GLASS THICKNESS mode	0: Mode 1 1: Mode 2	
	3h	Image smoothing level	0: No filter 1: Filter size 2 2: Filter size 4 3: Filter size 8 4: Filter size 16	When the measurement object is changed, the settings are initialized according to the selected object.
	4h	Background removing level before addition	0 to 255 (tone)	
	6h	Edge threshold	0: 0% 1: 12.5% 2: 25% 3: 37.5% 4: 50% 5: 62.5% 6: 75% 7: 87.5%	
4h	0h	Mutual interference prevention mode	0: OFF 1: ON	
	1h	Mutual interference prevention timing	0: Timing A 1: Timing B	
5h	0h	Gain setting	1 to 5	
28h	0h	Measurement mode	0: OFF 1: Average 2: Peak 3: Bottom 4: Thickness 5: Gap 6: K+mX;+nY	TASK1 settings. The settings in Unit Number 28h are valid only for multi-task mode.

Unit No.	Data No.	Parameter	Setting range/output range	Remarks
	3h	Parameter X	0: None 1: TASK1 2: TASK2 3: TASK3 4: TASK4	
28h	4h	Parameter Y	0: None 1: TASK1 2: TASK2 3: TASK3 4: TASK4	
	5h	Parameter K	-999999999 to 999999999	
	8h	Parameter M	-100 to 100 (1div:0.1%)	
	9h	Parameter N	-100 to 100 (1div:0.1%)	
	1h	Surface for measurement (Area 1)	0: First surface 1: Second surface 2: Third surface	
	Ah	Surface for measurement (Area 2)	0: First surface 1: Second surface 2: Third surface	
	Bh	Measurement position 1 (for thickness measurement)	0: None 1: Average 2: Peak 3: Bottom	
	Ch	Measurement position 2 (for thickness measurement)	0: None 1: Average 2: Peak 3: Bottom	
	Dh	Measurement area	0: Area 1 1: Area 2	
	Eh	Width of peak bottom	0 to 255	
	20h	Measurement value (First surface)	- (nm)	
	21h	Measurement value (Second surface)	- (nm)	
	22h	Measurement value (Third surface)	- (nm)	
29h	0h	Scaling mode	0: OFF 1: ON	
	1h	Span value	-20000 to 20000 (1div:0.0001)	
	2h	Offset value	-999999999 to 999999999 (nm)	
2Ah	2h	Smooth	0: OFF 1: ON	TASK1 settings.

Section 3
Setting Value Obtaining and Changing Command

Unit No.	Data No.	Parameter	Setting range/output range	Remarks
2Bh	2h	Average	0: 1 time 1: 2 times 2: 4 times 3: 8 times 4: 16 times 5: 32 times 6: 64 times 7: 128 times 8: 256 times 9: 512 times 10: 1024 times 11: 2048 times 12: 4096 times	
2Ch	2h	Differential	0: OFF 1: ON	
	3h	Differentiation cycles	1 to 5000 (ms)	
2Dh	2h	Hold type	0: Through 1: Peak 2: Bottom 3: Peak to peak 4: Average 5: Sampling	
	3h	Trigger method	0: External input 1: Self up 2: Self down	
	4h	Trigger level	-999999999 to 999999999 (nm)	
	5h	Trigger hysteresis	0 to 999999999 (nm)	
	6h	Trigger delay (ms)	0 to 5000 (ms)	
	7h	Sampling time (ms)	1 to 5000 (ms)	
	8h	Trigger delay mode	0: OFF 1: ON	
	2Eh	5h	Offset at zero reset	-999999999 to 999999999 (nm)
7h		Zero reset mode	0: Real 1: Hold	
40h		Status	0: OFF 1: ON	

Section 3

Unit No. and Parameter No.

(*)

If GLASS/MODE 2 or GLASS THICKNESS/MODE 2 is selected, a process using multiple tasks will be performed, as in multi-task mode.

The following processes are assigned to the respective tasks:

TASK1	Calculates Area 1 displacement value
TASK2	Calculates Area 2 displacement value
TASK3	GLASS: Calculates the result of the NEAR side of TASK 1 and TASK 2.
	GALSS THICKNESS: Calculates the difference value between TASK1 and TASK2.
TASK4	Unused

The measurement conditions can be set for each task in this mode.

Unit No.	Data No.	Parameter	Setting range/output range	Remarks
78h	0h	Hysteresis width	0 to 999999999 (nm)	Setting judgment process
	1h	Timer mode	0: OFF 1: OFF-Delay 2: ON-Delay 3: One shot	
	2h	Delay time	1 to 5000 (ms)	
	3h	Judgment output TASK	0: TASK1 1: TASK2 2: TASK3 3: TASK4	
79h	0h	Non-measurement settings	0: Keep 1: Clamp	
7Ah	2h	Monitor focus mode	0: OFF, 1: ON	
	3h	Monitor focus distance value 1	-999999999 to 999999999 (nm)	
	4h	Monitor focus distance value 2	-999999999 to 999999999 (nm)	
	5h	Monitor focus current value 1	4 to 20 (mA)	
	6h	Monitor focus current value 2	4 to 20 (mA)	
	7h	Monitor focus voltage value 1	-10 to 10 (V)	
	8h	Monitor focus voltage value 2	-10 to 10 (V)	
	15h	Output mode TASK	When multi-task mode is OFF 0: OFF 1: ON When multi-task mode is ON 0: OFF 1: TASK1 2: TASK2 3: TASK3	

Section 3
Setting Value Obtaining and Changing Command

Unit No.	Data No.	Parameter	Setting range/output range	Remarks
7Ah	17h	Output at CLAMP	Voltage output 0: MAX 1: 10V 2: 9V 3: 8V 4: 7V 5: 6V 6: 5V 7: 4V 8: 3V 9: 2V 10: 1V 11: 0V 12: -1V 13: -2V 14: -3V 15: -4V 16: -5V 17: -6V 18: -7V 19: -8V 20: -9V 21: -10V 22: MIN	
			Current output 0: MAX 1: 20mA 2: 19mA 3: 18mA 4: 17mA 5: 16mA 6: 15mA 7: 14mA 8: 13mA 9: 12mA 10: 11mA 11: 10mA 12: 9mA 13: 8mA 14: 7mA 15: 6mA 16: 5mA 17: 4mA	
7Bh Digital Output	2h	Monitor focus mode	0: OFF, 1: ON	
	3h	Monitor focus distance value 1	-999999999 to 999999999 (nm)	
	4h	Monitor focus distance value 2	-999999999 to 999999999 (nm)	
	5h	Monitor focus current value 1	0 to 65535	
	6h	Monitor focus current value 2	0 to 65535	
	7h	Clear Monitor Focus	1: Clear	
	8h	Output at CLAMP	0 to 65535	

Section 3

Unit No. and Parameter No.

Unit No.	Data No.	Parameter	Setting range/output range	Remarks
7Bh Digital Output	Ah	Output TASK(When the measurement value is output)	0: TASK1 1: TASK2 2: TASK3 3: TASK4 4: Consecutively	
	Bh	Output mode	0: OFF 1: Measurement value 2: Judgment	
	Ch	Update cycle	1 to 100	
7Ch Logging	5h	Mode	0: OFF 1: ON	
	3h	Buffering period	1 to 65535	
	4h	Buffer size per item of data	1 to 1000	
	Eh	TASK1	0: OFF 1: ON	When multi-task mode is ON
	Fh	TASK2	0: OFF 1: ON	
	10h	TASK3	0: OFF 1: ON	
11h	TASK4	0: OFF 1: ON		
7Eh Link	0h	Output TASK	0: TASK1 1: TASK2 2: TASK3 3: TASK4	
	6h	Mode	0: OFF 1: ON	
F0h Parallel Input	4h	Input 0	0: Low Active 1: High Active	
	5h	Input 1		
	6h	Input 2		
	7h	Input 3		
	8h	External input mode	0: Normal mode 1: Bank switching mode 2: Parallel IN off mode	
	9h	Control TASK setting	0: TASK1 1: TASK2 2: TASK3 3: TASK4	

Parameter List (ZS-MDC)

■ Input Setting (common to all TASKs)

Unit No.	Data No.	Parameter	Setting range/output range	Remarks
00h	00h	Data A input destination CH	0 to 11 (CH)	
	01h	Data B input destination CH		
	02h	Data C input destination CH		
	03h	Data D input destination CH		
	04h	Data E input destination CH		
	05h	Data F input destination CH		
	06h	Data G input destination CH		
	07h	Data H input destination CH		
	08h	Data I input destination CH		
	09h	Data A input mode		0: OFF 1: ON
	0Ah	Data B input mode		
	0Bh	Data C input mode		
	0Ch	Data D input mode		
	0Dh	Data E input mode		
	0Eh	Data F input mode		
	0Fh	Data G input mode		
	10h	Data H input mode		
	11h	Data I input mode		
	20h	Obtained result A	-999999999 to 999999999 (nm)	
	21h	Obtained result B		
	22h	Obtained result C		
	23h	Obtained result D		
	24h	Obtained result E		
	25h	Obtained result F		
	26h	Obtained result G		
	27h	Obtained result H		
	28h	Obtained result I		

Example 1: When assigning (writing) input A to CH3:

To assign input A to CH3, input destination CH of data A should be set to 3CH and input mode of data A should be ON.

- (1) For input destination CH of data A, both Unit No. and Data No. are 00h.
- (2) For input mode of data A, Unit No. and Data No. are 00h and 09h, respectively.

Therefore, commands to be sent are shown as below:

- (1) When 02h 02h (C000h + 00h (Data No.)) 00h(Unit No.) 00h (CH No.),
and (8000h + 1h (Number of Elements)) 00000003h (Data to be written),
Command is: 02h 02h C000h 0000h 8001h 00000003h.

To this command, if the response is shown as below:

02h 02h 0000h

It indicates a normal end.

- (2) In the same manner as above,

When 02h 02h (C000h + 09h (Data No.)) 00h(Unit No.) 00h (CH No.),
and (8000h + 1h (Number of Elements)) 00000001h (Data to be written),
Command is: 02h 02h C009h 0000h 8001h 00000001h.

To this command, if the response is shown as below:

02h 02h 0000h

It indicates a normal end.

■ Measurement Setting 1 (Setting per TASK)

Unit No. (Note 1)	Data No.	Parameter	Setting range/output range	Remarks
28h	00h	Mode	0: OFF 1: INDIV 2: OPERATION	
	01h	Input selection	0: Input A 1: Input B 2: Input C 3: Input D 4: Input E 5: Input F 6: Input G 7: Input H 8: Input I	Parameters when [Mode]=[INDIV]
	02h	Expression	0: THICKNESS (K-(X+Y)) 1: STEP (X-Y) 2: K+mX+nY 3: AVE 4: MAX-MIN	Parameters when [Mode]=[Operation]
	03h	Calculation parameter X	0: Input A 1: Input B 2: Input C 3: Input D 4: Input E 5: Input F 6: Input G 7: Input H 8: Input I 9: TASK 1 10: TASK 2 11: TASK 3 12: TASK 4	Parameters when [Expression]= [Thickness], [STEP], and [K+mX+nY]
	04h	Calculation parameter Y		
	05h	Calculation parameter K	-999999999 to 999999999 (nm)	Parameters when [Expression]= [K+mX+nY]
	06h	Calculation parameter m	-100 to 100 (X0.1)	
	07h	Calculation parameter n	-100 to 100 (X0.1)	

Unit No. (Note 1)	Data No.	Parameter	Setting range/output range	Remarks
28h	08h	Input A setting (AVE, MAX-MIN)	0: OFF 1: ON	Parameters when [Expression]= [AVE] and [MAX-MIN]
	09h	Input B setting (AVE, MAX-MIN)		
	0Ah	Input C setting (AVE, MAX-MIN)		
	0Bh	Input D setting (AVE, MAX-MIN)		
	0Ch	Input E setting (AVE, MAX-MIN)		
	0Dh	Input F setting (AVE, MAX-MIN)		
	0Eh	Input G setting (AVE, MAX-MIN)		
	0Fh	Input H setting (AVE, MAX-MIN)		
	10h	Input I setting (AVE, MAX-MIN)		
	11h	TASK 1 setting (AVE, MAX-MIN)		
	12h	TASK 2 setting (AVE, MAX-MIN)		
	13h	TASK 3 setting (AVE, MAX-MIN)		
	14h	TASK 4 setting (AVE, MAX-MIN)		
	15h	Thickness		
29h	02h	Scaling mode	0: OFF 1: ON	
	03h	Span value	-20000 to 20000 (X0.0001)	
	04h	Offset value	-999999999 to 999999999 (nm)	
2Ah	02h	Smooth	0: OFF 1: ON	
2Bh	02h	Average number of times	0: 1 1: 2 2: 4 3: 8 4: 16 5: 32 6: 64 7: 128 8: 256 9: 512 10: 1024 11: 2048 12: 4096	

Section 3
Setting Value Obtaining and Changing Command

Unit No. (Note 1)	Data No.	Parameter	Setting range/output range	Remarks
2Ch	02h	Differential mode	0: OFF 1: ON	
	03h	Differentiation cycles	1 to 5000 (ms)	
2Dh	02h	Hold mode	0: OFF 1: PEAK 2: BOTTOM 3: P-P 4: AVERAGE 5: SAMPLE	
	03h	Trigger method	0: External 1: Self-up trigger 2: Self-down trigger	
	04h	Trigger level	-999999999 to 999999999 (nm)	
	05h	Trigger hysteresis	0 to 999999999 (nm)	
	06h	Trigger delay (ms)	0 to 5000 (ms)	
	07h	Sampling period (ms)	1 to 5000 (ms)	
	08h	Trigger delay mode	0: OFF 1: ON	
2Eh	05h	Offset value for zero reset	-999999999 to 999999999 (nm)	
	07h	Zero reset mode	0: REAL 1: HOLD	
30h	02h	LOW threshold value	-999999999 to 999999999 (nm)	
	03h	HIGH threshold value	-999999999 to 999999999 (nm)	

(Note 1)

The Unit No. here indicates TASK 1 Unit No.

Unit No. other than the above, such as TASK2 or a later one, can be calculated by adding (TASK number -1) to the Unit No. and multiplying it by 14h for another reference or setting.

Example 1: When reading the setting values of the average number of times for TASK 1:

Since the average number of times is 2Bh for Unit No., and 02h for Data No., values are shown as below:

02h 01h (C000h + 02h (Data No.)) 2Bh (Unit No.) 00h (CH No.) (8000h + 1h (Number of elements))

In the command section, the value is shown as below:

02h 01h C002h 2B00h 8001h

To this command, if the response is shown as below:

02h 01h C002h 2B01h 8001h 00000004h

Since the value is 4, this indicates 16 times.

Example 2: When changing the high threshold value of TASK 4 to 100 mm:

Usually, the high threshold value is 30h for Unit No., and 03h for Data No.

However, Unit No. is 6Ch (= 30h + (4-1) x 14h) because TASK4 is set this time.

Besides, 100mm thickness is expressed as 05F5E100h in a hexadecimal number because 100 mm is 100,000,000nm.

02h 02h (C000h + 03h (Data No.)) 6Ch (Unit No.) 00h (CH No.)

and (8000h + 1h (Number of Elements)) 05F5E100h (Data to be written)

In the command section, the value is shown as below:

02h 02h C003h 6C00h 8001h 05F5E100h

To this command, if the response is shown as below:

02h 02h 0000h

It indicates a normal end.

■ Measurement Setting 2 (common to all TASKs)

Unit No.	Data No.	Parameter	Setting range/ output range	Remarks
78h	00h	Non-measurement settings	0: Keep 1: Clamp	
	01h	Output upon clamp	0: MAX 1: 20mA 2: 12mA 3: 4mA 4: MIN	
79h	00h	HYS	0 to 999999999 (nm)	
	01h	Timer mode	0: OFF 1: OFF DELAY 2: ON DELAY 3: 1 shot	
	02h	Delay time	1 to 5000 (ms)	
7Ah	02h	Monitor focus mode	0: OFF, 1: ON	(Note 2)
	03h	Monitor focus distance value 1	-999999999 to 999999999 (nm)	
	04h	Monitor focus distance value 2	-999999999 to 999999999 (nm)	
	05h	Monitor focus current value 1	4 to 20 (mA)	
	06h	Monitor focus current value 2	4 to 20 (mA)	
	07h	Monitor focus voltage value 1	-10 to 10 (V)	
	08h	Monitor focus voltage value 2	-10 to 10 (V)	
7Dh	04h	Input polarity of external input 0	0: L active 1: H active	
	05h	Input polarity of external input 1		
	06h	Input polarity of external input 2		
	07h	Input polarity of external input 3		
7Eh	00h	External input (IN)	0: None 1: TASK 1 2: TASK 2 3: TASK 3 4: TASK 4 5: TASK ALL	
	01h	External Input (IN) function mode	0: Standard 1: Bank	
	02h	External output (OUT)	0: None 1: TASK 1 2: TASK 2 3: TASK 3 4: TASK 4	

Unit No.	Data No.	Parameter	Setting range/ output range	Remarks
7Eh	04h	Linear output (ANALOG)	0: None 1: TASK 1 2: TASK 2 3: TASK 3 4: TASK 4	
	06h	Digital output target 1	0: None 1: TASK 1 2: TASK 2 3: TASK 3 4: TASK 4 5: Input A 6: Input B 7: Input C 8: Input D 9: Input E 10: Input F 11: Input G 12: Input H 13: Input I	
	07h	Digital output target 2		
	08h	Digital output target 3		
	09h	Digital output target 4		
	0Ah	Digital output target 5		
	0Bh	Digital output target 6		
	0Ch	Digital output target 7		
	0Dh	Digital output target 8		
	0Eh	Digital output target 9		
	0Fh	External input 0 mode	0: Not used 1: Trigger 2: Hold reset 3: Laser OFF 4: Zero-reset	(Note 3)
	10h	External input 1 mode		
	11h	External input 2 mode		
	12h	External input 3 mode		
F0h	08h	External input mode	0: STANDARD 2: Parallel input OFF mode	(Note 4)
	C0h	Timing input	0: OFF 1: ON	
	C1h	Reset input	0: OFF 1: ON	
	C2h	LD-OFF input	0: OFF 1: ON	
	C3h	Zero-reset executed.	1: Execution	
	C4h	Zero-reset cancel.	1: Cancel	

(Note 2)

To change the monitor focus setting, monitor focus mode must be ON.

For example, to change the current setting of the monitor focus, change parameters below:

- Monitor focus mode (ON)
- Monitor focus distance value 1
- Monitor focus distance value 2
- Monitor focus current value 1
- Monitor focus current value 2

In addition, set outputs (current and voltage), which are set by the analog output switch in the controller.

(Note 3)

External input 0 mode and External input 1 mode settings cannot be changed because they automatically function as bank inputs when the bank mode is used (when “external input (IN) function mode” is set to “bank”).

(Note 4)

When the external input mode is set to “STANDARD”, the controller enters into the status below:

- * External input of the controller is enabled,
- * Commands from timing input to zero-resetting are disabled.

When the external input mode is set to “Parallel input OFF”, the controller enters into the status below:

- * External input of the controller is enabled,
- * Commands from timing input to zero-resetting are disabled.

Therefore, to send a command related to inputs, the external input mode should be set to “Parallel input OFF.”

Once ON is written to the timing input, reset input, and LD-OFF input parameters, the ON state is kept until OFF is written next.

Controller operates in the same manner as the input state is kept ON.

However, special care shall be taken because the operation changes depending on the state of external input line to the controller when the external input mode is set back to the “standard mode.”

Operations are performed depending on the settings when “Execution” or “Cancel” is written to the parameter with respect to the zero-reset.

Example 1: To perform zero-reset:

The command sending sequence is as follows:

- (1) Write “parallel input OFF mode” to the “external input mode” parameter.
- (2) Write “execution” to the “zero-reset execution” parameter.
- (3) Write “STANDARD” to the “external input mode” parameter.

An actual example of a command procedure is shown below:

- (1) 02h 02h C008h F000h 8001h 00000002h
- (2) 02h 02h C0C3h F000h 8001h 00000001h
- (3) 02h 02h C008h F000h 8001h 00000000h

Writing commands (1) and (3) above before and after the input-related operation command, respectively, is recommended.

Parameter List (ZS-DSU)

Unit No.	Data No.	Parameter	Setting range/ output range	Remarks
00h	00h	Source A Input CH	0: 1CH	
	01h	Source B Input CH	1: 2CH	
	02h	Source C Input CH	2: 3CH	
	03h	Source D Input CH	3: 4CH	
	04h	Source E Input CH	4: 5CH	
	05h	Source F Input CH	5: 6CH	
	06h	Source G Input CH	6: 7CH	
	07h	Source H Input CH	7: 8CH	
	08h	Source I Input CH	8: 9CH	
	09h	Source J Input CH	9: 10CH	
	0Ah	Source K Input CH	10: 11CH	
	0Bh	Source L Input CH	11: 12CH	
	0Ch	Source M Input CH	12: 13CH	
	0Dh	Source N Input CH	13: 14CH	
	0Eh	Source A selection TASK	0: TASK1	Settings are valid when the gang-mounted controller is MDC .
	0Fh	Source B selection TASK	1: TASK2	
	10h	Source C selection TASK	2: TASK3	
	11h	Source D selection TASK	3: TASK4	
	12h	Source E selection TASK	4: Input A	
	13h	Source F selection TASK	5: Input B	
	14h	Source G selection TASK	6: Input C	
	15h	Source H selection TASK	7: Input D	
	16h	Source I selection TASK	8: Input E	
	17h	Source J selection TASK	9: Input F	
	18h	Source K selection TASK	10: Input G	
	19h	Source L selection TASK	11: Input H	
	1Ah	Source M selection TASK	12: Input I	
	1Bh	Source N selection TASK		
	1Ch	Source A save mode	0: OFF	
	1Dh	Source B save mode	1: ON	
	1Eh	Source C save mode		
	1Fh	Source D save mode		
	20h	Source E save mode		
	21h	Source F save mode		
	22h	Source G save mode		
	23h	Source H save mode		
	24h	Source I save mode		
	25h	Source J save mode		
	26h	Source K save mode		
	27h	Source L save mode		
	28h	Source M save mode		
	29h	Source N save mode		

Section 3
Setting Value Obtaining and Changing Command

Unit No.	Data No.	Parameter	Setting range/output range	Remarks
00h	40h	Obtained result A	-999999999 to 999999999 (nm)	
	41h	Obtained result B		
	42h	Obtained result C		
	43h	Obtained result D		
	44h	Obtained result E		
	45h	Obtained result F		
	46h	Obtained result G		
	47h	Obtained result H		
	48h	Obtained result I		
	49h	Obtained result J		
	4Ah	Obtained result K		
	4Bh	Obtained result L		
	4Ch	Obtained result M		
	4Dh	Obtained result N		
01h	00h	Start trigger mode	0: Button 1: External input 2: Data 3: Window 4: I/O 5: Time	
	01h	Start trigger, trigger edge polarity	0: UP 1: DOWN	
	02h	Start trigger, data selection	0: Source A 1: Source B 2: Source C 3: Source D 4: Source E 5: Source F 6: Source G 7: Source H 8: Source I 9: Source J 10: Source K 11: Source L 12: Source M	
	03h	Start trigger, delay	-9999 to 9999 (ms) (*1) -127 to 127 (Number of images) (*2)	(*1) [Save image] is set to OFF. (*2) [Save image] is set to ON.
	04h	Start trigger, data threshold	-999999999 to 999999999 (nm)	
	06h	Start trigger, window mode	0: Window-in 1: Window-out	
	07h	Start trigger, window upper limit value	-999999999 to 999999999 (nm)	
	08h	Start trigger, window lower limit value	-999999999 to 999999999 (nm)	

Unit No.	Data No.	Parameter	Setting range/output range	Remarks
01h	0Ah	Start trigger, I/O result, I/O selection	0: IN 0 1: IN 1 2: IN 2 3: IN 3 4: OUT 0 5: OUT 1 6: OUT 2 7: OUT 3 8: OUT 4	
0Ch	0Ch	End trigger mode	0: Button 1: External input 2: Data 3: Window 4: I/O 5: Time 6: QUANT 7: Time	When [Save image] is set to ON, [TIME] is not available.
01h	0Dh	End trigger, trigger edge polarity	Same as start trigger	
	0Eh	End trigger, data selection		
	0Fh	End trigger, data threshold		
	11h	End trigger, window mode		
	12h	End trigger, window upper limit		
	13h	End trigger, window lower limit		
	15h	End trigger, I/O result, I/O selection		
	18h	End trigger, number of logging data items	1 to 999999 (*1) 1 to 128 (*2)	(*1) [Save image] is set to OFF. (*2) [Save image] is set to ON.
02h	00h	Save mode	0: 1 SHOT 1: REPEAT	When [Save image] is set to ON, [REPEAT] is not available.
	01h	Repeat mode	0: NEW 1: ADD 2: OVER WR	When [Save image] is set to ON, [ADD] is not available.
	02h	Repeat end condition	0: None 1: Number of triggers 2: Time (time-out)	
	03h	Repeat end condition, number of triggers	1 to 100000 (times)	
	06h	Interval of saving image	0: All 1: Save NG	It is available only if [Save image] is set to ON.
	07h	NG save mode	0: OR 1: AND	
	08h	Save image mode	0: Standard 1: Latest	

Section 3 Setting Value Obtaining and Changing Command

Unit No.	Data No.	Parameter	Setting range/output range	Remarks
03h	01h	I/O data	0: NONE 1: SAVE	
	02h	Save direction (ALIGN)	0: COLUMN 1: ROW	
	03h	Line feed input	0: Ignored 1: Enabled	

* About label input and time setting
The label input and time setting cannot be set or referred to.

■ Judgment-related

Unit No.	Data No.	Parameter	Setting range/output range	Remarks
28h	00h	Input source	0: Source A 1: Source B 2: Source C 3: Source D 4: Source E 5: Source F 6: Source G 7: Source H 8: Source I 9: Source J 10: Source K 11: Source L 12: Source M 13: Source N	
28h	01h	Threshold lower limit value	-999999999 to 999999999 (nm)	
28h	02h	Threshold upper limit value	-999999999 to 999999999 (nm)	

■ For Image Logging

Unit No.	Data No.	Parameter	Setting range/output range	Remarks
14h	00h	Align image	0: None 1: 1CH 2: 2CH 3: 3CH 4: 4CH 5: 5CH 6: 6CH 7: 7CH 8: 8CH 9: 9CH 10: 10CH 11: 11CH 12: 12CH 13: 13CH 14: 14CH	
14h	01h	Save image	0: OFF 1: ON	

Section 4

How to Obtain Flow Data

▣	<u>About Obtaining Flow Data</u>	4-2
▣	<u>Setting Procedures for Data Obtaining Conditions</u>	4-3
▣	<u>Setting Parameters</u>	4-8
	Buffer Size and Buffer Interval	4-8
	Logging Data Type	4-8
▣	<u>Flow Data Response</u>	4-11
	Format	4-11
	Composition of Response	4-11

About Obtaining Flow Data

■ What is flow data?

In the ZS series, a high-speed sampling measurement at a maximum of 110 microseconds is implemented. To handle the measurement data with external devices, it is necessary to obtain a large volume of data. The ZS series provides a system to handle measurement data as a bunch of any number of data items and to obtain data in units of bunches. A bunch of data is called flow data.

■ Process to obtain flow data

A data items bunch is transmitted as flow data output upon full data accumulation specified by buffer size (a maximum of 1000 data items) if a flow data obtaining command has been received. A data recipient (such as a personal computer) must issue a command in advance of full measurement data accumulation specified by buffer size to the ZS controller.

Commands and data items are exchanged between a data recipient and the ZS controller as shown in the flow chart below:

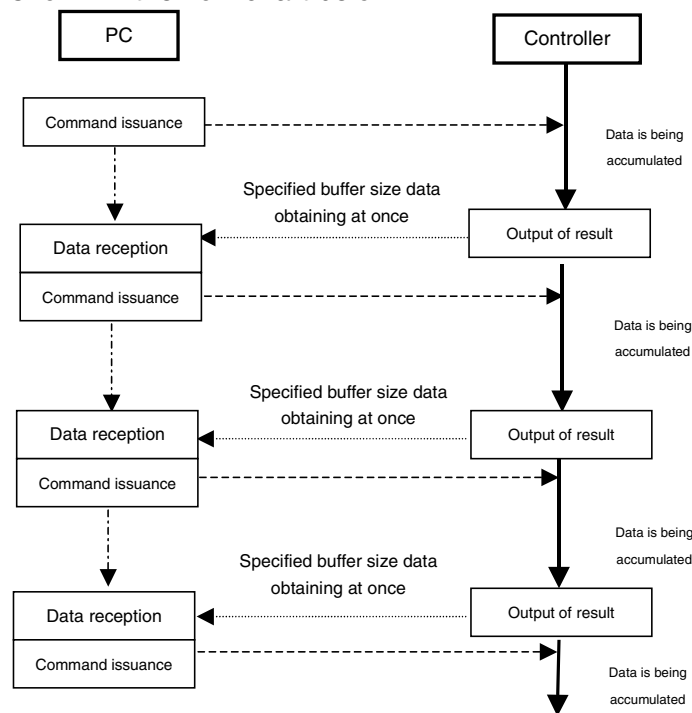

The previous data is overwritten upon full measurement data accumulation specified by buffer size in the ZS controller if no command has been received.

In this case, an error flag appears as buffer overflow occurs. A data recipient (such as a personal computer) must confirm whether or not a command is properly issued in time by observing this flag.

Setting Procedures for Data Obtaining Conditions

Follow the procedures below to set the data obtaining conditions:

Note that setting conditions described in this section are cleared upon turning OFF the power of the controller. (Set the threshold values again.)

The all data obtaining conditions set here are written using the parameter area write command. When setting, refer to the corresponding tables in "Unit No." and "Data No.", command examples described in Section 3, and the description of the parameter area write in Section 2.

1. Set the accumulation mode to ON.

Set the flow data accumulation mode to ON (=1). Make sure to set this value to ON (or write 1 to this value) in advance of obtaining data because flow data is not accumulated unless this setting is made. Specifically, write ON (=1) to Data No. 2 of Unit No.124 (=7Ch). (*)

Example: When writing the above command to ZS-MDC (0CH), a command to be sent is shown as below:

```
02h 02h C002h 7C00h 8001h 00000001
```

(*)

A measurement cycle changes from 112 microseconds to 142 microseconds upon setting the accumulation mode to ON when the ZS-LDC is used in the high speed mode. That is to say, the LDC itself as a single unit cannot obtain measurement data at every 112 microseconds via communications. To obtain the measurement data at every 112 microseconds, use a composition of ZS-LDC and ZS-MDC to obtain the measurement data from ZS-LDC via ZS-MDC.

2. Set the target data to be obtained.

Controllers have accumulation areas from “accumulation data 1” through “accumulation data 9” in the software. (*)

First, set the data to be accumulated in the respective area. Specifically, write the Parameter No., which corresponds to the data to be accumulated, to Data No. 5 through 13 of Unit No. 124 (=7Ch). (*)

(*)

The example here describes the case of ZS-MDC. In the case of ZS-LDC, Data No. 5 to 7 can be specified because only accumulate data areas from 1 to 3 exist.

Example: When writing data items: TASK1, TASK2, and input A to accumulate data 1, accumulate data 2, and accumulate data 3, respectively, for the ZS-MDC (0Ch), a command to be sent is shown as below:

```
02h 02h C005h 7C00h 8001h 00000001h } (Accumulate data 1=TASK1)
02h 02h C006h 7C00h 8001h 00000002h } (Accumulate data 2=TASK2)
02h 02h C007h 7C00h 8001h 00000005h } (Accumulate data 3=Input A)
02h 02h C008h 7C00h 8001h 00000000h }
02h 02h C009h 7C00h 8001h 00000000h }
: (Accumulate data 4 to 13 = no accumulation)
02h 02h C00Dh 7C00h 8001h 00000000h
```

3. Read a measurement cycle.

Read the current measurement cycle.

Measurement cycle information is necessary to execute step 4, “Specify the buffer interval.”

The measurement cycle information must be obtained again in this step because it may vary depending on the settings specified in the steps 1 and 2 above.

Example: When reading the measurement cycle to the ZS-MDC (0ch), a command to be sent is shown as below:

```
01h 01h 81h 0000h 00h 0002h
```

You will find that the measurement cycle is 269 microseconds (=010Dh) when the response is returned as below:

```
01h 01h 0000h 0000010Dh
```

4. Specify the buffer interval.

A number of skips, which is referred to as a “buffer interval”, can be set to the controller upon data accumulation. Calculate and set an optimal value according to the sampling interval to be obtained.

For example, to set the sampling interval to 100ms when the current measurement cycle is 269 μs, set the buffer interval to 371 (=372-1), which is calculated by the following formula:

$$100\text{ms}/269\mu\text{s}=371.747\dots (*)$$

(*)

Set the most approximate value to the sampling interval to be obtained because the sampling interval can be set only to the multiple number of measurement cycles as shown above.

The buffer interval value can be calculated by subtracting 1 from the value calculated using the formula above because the buffer interval must be the number of skips to be executed.

Example: When writing the buffer interval (=371) to ZS-MDC (0CH), a command to be sent is shown below:

02h 02h C003h 7C00h 8001h 00000173h (371(dec) = 1F4(hex))

5. Set the number of data items to be accumulated.

Set the number of data items to be batch-obtained.

Because the number of data items specified in this step is the one for the respective accumulation data area, the number of data items to be batch-obtained can be calculated as shown below when three types of data items are obtained as in the example above:

Number of data items specified in this step x 3

Example: When setting the number of data items to be accumulated (=500) to ZS-MDC (0CH), a command to be sent is shown below:

02h 02h C004h 7C00h 8001h 000001F4h (500(dec) = 1F4(hex))

6. Request and receive data.

Setting is completed.

All the data items are returned at once when the flow data request command is sent in the status above.

Example: When sending a request command to the ZS-MDC (0ch), the command is shown as below:

01h 01h E1h 0000h 00h 0001h

(No area is assigned for the specification of command send destination channel in the flow data request command. The CH of USB cable connection destination is the channel of command transmission destination.)

Because the flow data belongs to the “variable area reading” commands, the response follows their format. However, note that only the contents of the “data to be read” follow the format below:

(*)

In addition, whether or not the command ends cannot be judged by ETX specified based on the CompoWay/F because the data to be read is composed by binary data. Confirming the completion of data reception with the number obtained is recommended.

The number of data items to be received can be calculated using the formula specified in the step above: Data type (target data to be obtained) x Number of data items to be accumulated.

[About Continual Data Obtaining]

Note that sending a request command is necessary after starting the data reception until the next data accumulation is completed as described in “How to obtain flow data.”

Calculate the time for the completion of the accumulation using the formula specified in the step above: measurement cycle x number of data items to be accumulated, and send the next request command until the calculated time expires.

Example: When measurement cycle=269 μ s and the number of data items to be accumulated=500:

It will take 134.5 ms (=269 μ s x 500) until the accumulation is completed.

Sending the next request command before the time above expires is necessary.

The “flow data overflow bit,” which is described in Section, “Data Composition of Flow Data” and other sections, is enabled when sending a command is delayed due to the delay of processing at the master side of the communication devices, such as a personal computer.

(In this case, the continuity of data is lost.) Check the processing delay if the bit is enabled or not.

When the processing delay occurred due to the personal computer specification, adjustments below must be performed:

- Increase the buffer interval and decrease the number of data items per unit time.
- Increase the number of data items to be accumulated and lessen the frequency of communication processing.

Flow data is returned from controller upon completion of the data accumulation. Therefore, flow data is immediately returned after sending a command when data accumulation has already been completed upon sending a command. Response is not performed unless the data accumulation is completed upon sending a command.

Setting Parameters

This section describes buffer size, buffer interval, and logging data.

Buffer Size and Buffer Interval

Buffer size of the measurement data to be accumulated in the ZS controller and its buffer interval can be changed. To change buffer size and buffer interval, change the parameters below:

* Use DATAGET and DATASET commands to change and view the parameter.

Unit No.	Data No.	Parameter	Details
7Ch	2h	Flow data accumulation mode	0: OFF 1: ON
	3h	Buffer interval	1 to 65535
	4h	Buffer size	1 to 1000

Logging Data Type

Data to be accumulated in the ZS controller can be selected.

■ When using ZS-LDC

Up to 3 data types can be accumulated.

Unit No.	Data No.	Parameter	Details
7Ch	5h	Accumulation data 1	*
	6h	Accumulation data 2	
	7h	Accumulation data 3	

* Setting varies depending on the measurement mode.

- When "THICK/GAP - FILM/OTHERS - TRANSFER" mode is selected

Value	Details
0	No accumulation
1	Result of area 1
2	Result of area 2
3	Thickness/gap value

- When a mode other than above is selected

Value	Details
0	No accumulation
1	Distance value (measurement value)

■ When using ZS-HLDC

- When multi-task mode is OFF
 - When GLASS/MODE 2 or GLASS THICKNESS/MODE 2 is selected for the measurement object

Unit No.	Data No.	Parameter	Details
7Ch	5h	0	No accumulation
		1	Accumulation of result of area 1
		2	Accumulation of result of area 2
		3	Accumulation of result of glass surface or glass thickness

- When a mode other than the above is selected for the measurement object

Unit No.	Data No.	Parameter	Details
7Ch	5h	0	No accumulation
		1	Accumulation

- When multi-task mode is ON

Unit No.	Data No.	Parameter	Details
7Ch	Eh	0	Does not accumulate the result of TASK1.
		1	Accumulates the result of TASK1.
	Fh	0	Does not accumulate the result of TASK2.
		1	Accumulates the result of TASK2.
	10h	0	Does not accumulate the result of TASK3.
		1	Accumulates the result of TASK3.
	11h	0	Does not accumulate the result of TASK4.
		1	Accumulates the result of TASK4.

- When a mode other than the above is selected

Value	Details
0	No accumulation
1	Distance value (Measurement value)

■ When using ZS-MDC

Up to 9 data types can be accumulated.

Unit No.	Data No.	Parameter	Details
7Ch	5h	Accumulation data 1	0: No accumulation 1: Measurement result of TASK 1 2: TASK 2 3: TASK 3 4: TASK 4 5: Input A 6: Input B 7: Input C 8: Input D 9: Input E 10: Input F 11: Input G 12: Input H 13: Input I
	6h	Accumulation data 2	
	7h	Accumulation data 3	
	8h	Accumulation data 4	
	9h	Accumulation data 5	
	10Ah	Accumulation data 6	
	11Bh	Accumulation data 7	
	12Ch	Accumulation data 8	
	13Dh	Accumulation data 9	



Increasing the accumulation data lengthens the measurement cycle of the ZS controller.
Check the "System - Information - Cycle" after setting.

Flow Data Response

This section describes the format and composition of response of flow data.

Format

Binary data is output in the format below after outputting the flow data obtaining command.

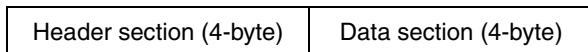

For details, refer to “Composition of Flow Data.”



Response data of the flow data is composed by binary data for the purpose of giving top priority to speed. Therefore, response data may not be received by generic communication tools, such as hyper terminal.

Composition of Response

FlowDATA 1 packet												
Header section												Data section
1st byte	2nd byte				3rd byte			4th byte				-
A	B	C	D	E	F	G	H	I	J	K	L	Data
8	1	1	2	4	5	1	2	1	1	1	5	32

Meaning of data
Number of bits

= Total
64 bits

■ Details of Header Section

Data	Name	Details
A	Not used	Reserved bit
B	FlowDATA Overflow bit	NORMAL, 0 : 1 is set when flow data accumulation overflows.
C	Decimal point information	NORMAL, 0 : 0: nm order, 1: μ m order
D	TASK No.	TASK1 to TASK4 (*1)
E	Channel No.	Channel No. of the data source
F	Unit status (input)	Indicates ON/OFF status of each input wire. (*2)
G	FlowData stop bit	<ul style="list-style-type: none"> All the data items are 1 when no flow data is sent afterward (or always 1 upon single request). All the data items are 0 when flow data is continuously sent afterward (after the continual flow data request until it is stopped).
H	TASK judgment result bit	Indicates the judgment result for the TASK of the data source. (*3)
I	Use prohibited	Reserved bit
J		
K		
L	Unit status (output)	Indicates output status (measurement result status) (*4)
Data	Measurement data	Signed 32-bit data When the decimal point information section is 0: data in the unit of nm When the decimal point information section is 1: data in the unit of μ m

*1 TASK No. = bit data + 1

Example: When bit data=10B=2(dec)

It indicates as TASK3 data.

*2 The input wires are assigned from the lower bit as:

When ZS is used;

- Input terminal 4 (Unused, always 0)
 - Input terminal 3
 - Input terminal 2
 - Input terminal 1
 - Input terminal 0
- (5 outputs in total)

*3 Data items and statuses to be received are shown below:

00b = unexecuted

01b = LOW

10b = PASS

11b = HIGH

*4 The output statuses are assigned from the lower bit as:

When ZS is used;

- Output terminal 4 (Busy output)
 - Output terminal 3 (Enable output)
 - Output terminal 2 (Low output)
 - Output terminal 1 (Pass output)
 - Output terminal 0 (High output)
- (5 outputs in total)

Standard status is described in the parentheses.

Revision History

Revision code	Date	Revised contents
A	Apr. 2004	Original production
B	Oct. 2004	Commands compatible with ZS-LDC (v2.000), ZS-MDC (v2.000), and ZS-DSU (v1.000) are added and matched.
C	Dec. 2004	"Section 4 How to Obtain Flow Data" is added.
D	June 2004	<ul style="list-style-type: none">• Commands and parameters compatible with ZS-DSU (v2.000) are added.• Multiple controllers connection with ZFV is added.
E	Oct. 2005	<ul style="list-style-type: none">• Commands and parameters compatible with ZS-HLDC are added.