

ZEN Programmable Relay

COMMUNICATIONS MANUAL



OMRON

Authorized Distributor:

The image shows three ZEN Programmable Relay units: a 20C1AR-A-V2 (AC100-240V, 50/60Hz, 11VA), a 10C1AR-A-V2 (AC100-240V, 50/60Hz, 8VA), and an 8E1AR (AC100-240V, 50/60Hz, 4VA). Each unit features a small LCD display and several control buttons (DEL, ALT, ESC, OK). The units are shown against a green background with white circuit diagrams and data tables.

Communication diagrams show STX and ETX signals with data fields. The 20C1AR-A-V2 unit has a data field of 00. The 10C1AR-A-V2 unit has a data field of 0004. The 8E1AR unit has a data field of 000. The diagrams also show various relay contacts (NO, NC) and their connections.

STX			0	0	ETX		
STX			0	0	0	0	ETX
STX			0	0	0	4	ETX
STX			0	0	0	ETX	

Preface

OMRON products are manufactured for use according to proper procedures by a qualified operator and only for the purposes described in this manual.

The ZEN is a compact and highly functional controller that can be used to easily automate small-scale applications. Its development has drawn on OMRON's advanced control technology and expertise in manufacturing various types of controllers.

Version 2 of the ZEN includes Economy-type CPU Units and Communications-type CPU Units. Twin timer operation and operation between days for weekly timers have been added. Pulse output operation and 8-digit counters with high-speed counting have also been added, and Expansion I/O Units have been downsized to half the width.

This manual describes the communications functions of Communications-type CPU Units. When using a Communications-type CPU Unit, read this manual and be sure to use the communications functions correctly. Keep the manual close at hand so that you can refer to it whenever necessary.

● Intended Audience

This manual is intended for the following readers.

- Persons in charge of introducing FA devices
- Persons who design FA systems
- Persons who install or connect FA devices
- Persons who manage working FA installations

Persons who use this product must have sufficient knowledge of electrical systems (i.e., an electrical engineer or the equivalent).

Warranty and Application Considerations

Read and Understand this Manual

Please read and understand this manual before using the product. Please consult your OMRON representative if you have any questions or comments.

Warranty and Limitations of Liability

Warranty and Limitations of Liability

WARRANTY

OMRON's exclusive warranty is that the products are free from defects in materials and workmanship for a period of one year (or other period if specified) from date of sale by OMRON. OMRON MAKES NO WARRANTY OR REPRESENTATION, EXPRESS OR IMPLIED, REGARDING NON-INFRINGEMENT, MERCHANTABILITY, OR FITNESS FOR PARTICULAR PURPOSE OF THE PRODUCTS. ANY BUYER OR USER ACKNOWLEDGES THAT THE BUYER OR USER ALONE HAS DETERMINED THAT THE PRODUCTS WILL SUITABLY MEET THE REQUIREMENTS OF THEIR INTENDED USE. OMRON DISCLAIMS ALL OTHER WARRANTIES, EXPRESS OR IMPLIED.

LIMITATIONS OF LIABILITY

OMRON SHALL NOT BE RESPONSIBLE FOR SPECIAL, INDIRECT, OR CONSEQUENTIAL DAMAGES, LOSS OF PROFITS OR COMMERCIAL LOSS IN ANY WAY CONNECTED WITH THE PRODUCTS, WHETHER SUCH CLAIM IS BASED ON CONTRACT, WARRANTY, NEGLIGENCE, OR STRICT LIABILITY.

In no event shall the responsibility of OMRON for any act exceed the individual price of the product on which liability is asserted.

IN NO EVENT SHALL OMRON BE RESPONSIBLE FOR WARRANTY, REPAIR, OR OTHER CLAIMS REGARDING THE PRODUCTS UNLESS OMRON'S ANALYSIS CONFIRMS THAT THE PRODUCTS WERE PROPERLY HANDLED, STORED, INSTALLED, AND MAINTAINED AND NOT SUBJECT TO CONTAMINATION, ABUSE, MISUSE, OR INAPPROPRIATE MODIFICATION OR REPAIR.

Application Consideration

SUITABILITY FOR USE

THE PRODUCTS CONTAINED IN THIS DOCUMENT ARE NOT SAFETY RATED. THEY ARE NOT DESIGNED OR RATED FOR ENSURING SAFETY OF PERSONS, AND SHOULD NOT BE RELIED UPON AS A SAFETY COMPONENT OR PROTECTIVE DEVICE FOR SUCH PURPOSES. Please refer to separate catalogs for OMRON's safety rated products.

OMRON shall not be responsible for conformity with any standards, codes, or regulations that apply to the combination of products in the customer's application or use of the product.

At the customer's request, OMRON will provide applicable third party certification documents identifying ratings and limitations of use that apply to the products. This information by itself is not sufficient for a complete determination of the suitability of the products in combination with the end product, machine, system, or other application or use.

The following are some examples of applications for which particular attention must be given.

This is not intended to be an exhaustive list of all possible uses of the products, nor is it intended to imply that the uses listed may be suitable for the products:

- Outdoor use, uses involving potential chemical contamination or electrical interference, or conditions or uses not described in this document.
- Nuclear energy control systems, combustion systems, railroad systems, aviation systems, medical equipment, amusement machines, vehicles, safety equipment, and installations subject to separate industry or government regulations.
- Systems, machines, and equipment that could present a risk to life or property.

Please know and observe all prohibitions of use applicable to the products.

NEVER USE THE PRODUCTS FOR AN APPLICATION INVOLVING SERIOUS RISK TO LIFE OR PROPERTY WITHOUT ENSURING THAT THE SYSTEM AS A WHOLE HAS BEEN DESIGNED TO ADDRESS THE RISKS, AND THAT THE OMRON PRODUCT IS PROPERLY RATED AND INSTALLED FOR THE INTENDED USE WITHIN THE OVERALL EQUIPMENT OR SYSTEM.

Disclaimers

Disclaimers
<p>CHANGE IN SPECIFICATIONS</p> <p>Product specifications and accessories may be changed at any time based on improvements and other reasons.</p> <p>It is our practice to change model numbers when published ratings or features are changed, or when significant construction changes are made. However, some specifications of the products may be changed without any notice. When in doubt, special model numbers may be assigned to fix or establish key specifications for your application on your request. Please consult with your OMRON representative at any time to confirm actual specifications of purchased products.</p>
<p>DIMENSIONS AND WEIGHTS</p> <p>Dimensions and weights are nominal and are not to be used for manufacturing purposes, even when tolerances are shown.</p>
<p>PERFORMANCE DATA</p> <p>Performance data given in this manual is provided as a guide for the user in determining suitability and does not constitute a warranty. It may represent the result of OMRON's test conditions, and the users must correlate it to actual application requirements. Actual performance is subject to the OMRON Warranty and Limitations of Liability.</p>
<p>ERRORS AND OMISSIONS</p> <p>The information in this document has been carefully checked and is believed to be accurate; however, no responsibility is assumed for clerical, typographical, or proofreading errors, or omissions.</p>

Copyright and Copy Permission

Copyright and Copy Permission
<p>COPYRIGHT AND COPY PERMISSION</p> <p>This document shall not be copied for sales or promotions without permission.</p> <p>This document is protected by copyright and is intended solely for use in conjunction with the product. Please notify us before copying or reproducing this document in any manner, for any other purpose. If copying or transmitting this document to another, please copy or transmit it in its entirety.</p>

Precautions

This section provides precautions for using the ZEN Programmable Relays.

This information contained in this section is important for the safe and reliable application of the ZEN. You must read this section and understand the information before attempting to set up for a ZEN.

Safety Precautions	viii
Precautions for Safe Use	x
Precautions for Correct Use	xii

Safety Precautions

Definition of Precautionary Information

The following notation is used in this manual to provide precautions required to ensure safe usage of the product.

The safety precautions that are provided are extremely important to safety. Always read and heed the information provided in all safety precautions.

The following notation is used.



WARNING

Indicates a potentially hazardous situation which, if not avoided, will result in minor or moderate injury, or may result in serious injury or death. Additionally, there may be significant property damage.





CAUTION





Indicates a potentially hazardous situation which, if not avoided, may result in minor or moderate injury or in property damage.

Symbols

Symbol		Meaning
Caution		General Caution Indicates non-specific general cautions, warnings, and dangers.
		Electrical Shock Caution Indicates possibility of electric shock under specific conditions.
		Explosion Caution Indicates possibility of explosion under specific conditions.
Prohibition		Disassembly Prohibition Indicates prohibitions when there is a possibility of injury, such as from electric shock, as the result of disassembly.
Mandatory Caution		General Caution Indicates non-specific general cautions, warnings, and dangers.

Precautions

 WARNING	
<p>Serious human hazard may occasionally occur due to ignition or rupture of the lithium battery used in the Battery Unit. Do not short the battery terminals or charge, disassemble, deform under pressure, or incinerate the battery.</p> <p>Never use any battery that has been dropped on the floor or otherwise subjected to excessive shock.</p>	

 CAUTION	
<p>Electric shock, fire, or malfunction may occur. Do not disassemble, modify, or repair the ZEN or touch any of the internal parts.</p>	
<p>Electrical shock may occur. Never touch the I/O terminals, computer connector, Expansion Unit connector, or Battery Unit connector while power is being supplied.</p>	
<p>Electrical shock may occur. Do not remove the Expansion Unit connector cover unless an Expansion I/O Unit will be permanently installed.</p>	
<p>Fires may occasionally occur. Tighten the terminal block screws to the specified torque (0.5 to 0.6 N·m) so that they do not become loose.</p>	

Precautions for Safe Use

Please observe the following precautions for safe use of this products.

Circuit Design

1. All interface connectors and battery connector are live parts, they may not be directly connected to Softy Extra Low Voltage (SELV) circuit or to accessible conductive parts.
For the programming units and Personal Computers use only the ZEN-CIF01 Connecting Cable (optional accessory) manufactured by OMRON.
ZEN-CIF01 provides safe (reinforced) insulation between Personal Computers and ZEN.
2. Provide emergency stop circuits, external interlock circuits, limit circuits, and other safety circuits in addition to any provided within the ZEN control circuits to ensure safety of the overall system in the event of ZEN failure or external factors.
3. If the ZEN discovers an error during self-diagnosis, operation will be stopped and all outputs will be turned OFF. As a countermeasure for such problems, external safety measures must be provided to ensure safety in the overall system.
4. Outputs from the ZEN may remain ON or OFF due to faults in internal circuits such as output relay fusing or burning, or output transistor destruction. As a countermeasure for such problems, external safety measures must be provided to ensure safety in the overall system.
5. Fail-safe measures must be taken by the user to ensure overall system safety in the event of broken signal lines or momentary power interruptions.
6. The durability of the output relays is largely affected by the switching conditions. Confirm the operation of the system under actual operating conditions and set the switching frequency to ensure that adequate performance will be provided. Insulation faults and burning in the ZEN may result if relays are used after their performance has deteriorated.

Connecting Expansion I/O Units

1. Supply power to both the CPU Unit and Expansion I/O Units from the same power supply and turn them ON and OFF at the same time.
2. When connecting Expansion I/O Units with DC inputs to a CPU Unit with an AC power supply, the burst noise immunity will be 1 kV (IEC 61000-4-4).
3. Expansion I/O Units with AC inputs (ZEN-8E1AR) cannot be connected to a CPU Unit with a DC power supply.

System Startup and Program Changes

1. Check the user program for proper execution before actually running it on the Unit.
2. Disconnect the output lines from the system before testing operation in any system in which incorrect operation can result in injury or equipment damage.
3. Confirm safety before attempting any of the following operations.
 - Changing the operating mode (RUN/STOP).
 - Using the button switches.
 - Changing bit status or parameter settings.
4. Double-check all wiring before turning ON the power supply.
5. Refer to *Cycle Time Calculation Method* on page 130 in the *ZEN Programmable Relay Operation Manual* (Cat. No. Z211) and confirm that the increase in the cycle time will not affect operation. If the cycle time is too long, it may become impossible to read input signals accurately. The increase in the cycle time will be particularly noticeable when set values are written in RUN mode for a CPU Unit with communications (ZEN-10C4□R-□-V2).

Installation and Wiring

1. Do not allow the ZEN to fall during installation.
2. Be sure that the DIN Track mounting levers, Expansion I/O Units, Memory Cassettes, Battery Units, cable connectors, and other items with locking devices are properly locked into place. Improper locking may result in malfunction.
3. When mounting the ZEN to the surface of the control panel, tighten mounting screws to the following torques.
CPU Units: 1.03 N·m max.
Expansion I/O Units: 0.46 N·m max.
4. Use wires with cross-sectional areas of 0.2 to 2.5 mm² (equivalent to AWG24 to AWG14) for wiring and strip them for 6.5 mm. If using stranded wires, always connect straight crimp terminals (0.25 to 2.5 mm²).

Handling

1. The environment of use of ZEN is "Pollution degree 2" and "Overvoltage category II" specified in IEC60664-1.

2. Always use the ZEN within the rated ambient operating temperature and humidity. The rated ambient operating temperature is 0 to 55°C for LCD-type CPU Units and –25 to 55°C for LED-type CPU Units. If the ZEN is used near sources of heat, such as a power supply, the internal temperature of the ZEN may increase, lowering the durability of the ZEN.
3. Discharge static electricity from your body, e.g., by touching a grounded metal plate, before touching any Unit.
4. The exterior of the Units will be damaged if it comes into contact with organic solvents (e.g., benzene or paint thinner), strong alkalis, or strong acids. Never allow such substances to come into contact with the Units.
5. Do not apply voltages exceeding the rated voltages. Internal elements may be destroyed.
6. Short failures or open failures may result from the destruction of output elements. Do not use loads that exceed the rated output current.

Maintenance

When replacing a CPU Unit, transfer to the new Unit and confirm all settings for clock data, internal holding bits, holding timers, and counters before starting operation again.

Transportation and Storage

1. Use special packaging boxes when transporting the ZEN and do not subject it to excessive shock or vibration or drop it during shipment.
2. Store the ZEN at an ambient temperature of –40 to 75°C for LED-type CPU Units and –20 to 75°C for all other types of CPU Units. If the ZEN has been stored at –10°C or lower, allow it to stand at room temperature for 3 hours or longer before turning ON the power supply.

Precautions for Correct Use

Installation Environment

1. Do not install the ZEN in the following locations.
 - Locations subject to radical changes in temperature
 - Location with high humidity subject to condensation
 - Locations subject to excessive dust or dirt
 - Locations subject to corrosive gas
 - Locations subject to direct sunlight
2. Do not install the ZEN in locations subject to shock or vibration. Extended use in such location may cause damage from stress.
3. In environments subject to static electricity (e.g., close to pipes conveying forming materials, powders, or fluid materials), separate the ZEN as far as possible from the source of static electricity.
4. The ZEN is neither waterproof nor oil-proof. Do not use it in locations subject to water or oil.
5. Use the ZEN within the allowable power supply voltage range. Be particularly careful in locations with bad power supply conditions, e.g., large fluctuations in the power supply voltage.
6. Do not install the ZEN in locations subject to excessive noise, which may cause the ZEN to fail.
7. Take appropriate and sufficient countermeasures when installing systems in the following locations:
 - Locations subject to strong electromagnetic fields
 - Locations subject to possible exposure to radioactivity

Power Supply

1. Always turn OFF the power supply to the ZEN (CPU Unit and Expansion I/O Units) before attempting any of the following.
 - Assembling the ZEN
 - Attaching or removing Expansion I/O Units
 - Connecting or disconnecting any cables or wiring
 - Attaching or removing the Memory Cassette
 - Attaching or removing the Battery Unit
2. If the power supply is interrupted for 2 days or more (at 25°C), the internal capacitor will discharge and internal bit status and the contents of PV areas will be lost or corrupted and dates and times will be reset. When restarting operation after the power supply has been interrupted for an extended period of time, check the system in advance to confirm that no errors will occur.

Handling

1. Connect connectors only after confirming that the direction or polarity is correct.
2. Failures could result if dust or dirt enters the ZEN. Always connect the connector cover to the computer connector whenever it is not being used.
3. Do not remove the label from the left side of the CPU Unit if a Battery Unit is not mounted.

EEPROM Write Life

The EEPROM has a limited write life. The write life may be exceeded if communications are used frequently to write settings. Consider this in the system design.

Other

1. The execution of the ladder program in the ZEN is different from that for other PLCs. Refer to *Appendix B Ladder Program Execution* in the *ZEN Programmable Relay Operation Manual* (Cat. No. Z211) when writing the ladder program.
2. Abide by all local ordinances and regulations when disposing of the ZEN.
3. The Battery Unit (ZEN-BAT01, sold separately) contains a lithium battery. Observe all applicable legal requirements for your area when disposing of the lithium battery.

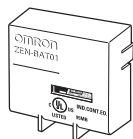

Conventions Used in This Manual

This user's manual describes the communications functions of CPU Units with communications. For information on using other functions, refer to the *ZEN Programmable Relay Operation Manual*.

■ Manual Contents

Item	Description
SECTION 1 Communications Methods	This section briefly describes the supported communications methods and how to wire equipment. Refer to this section before setting up equipment.
SECTION 2 CompoWay/F Communications Protocol	This section describes the protocol for communications using the CompoWay/F format.
SECTION 3 Communications Data	This section lists the details of the communications data in the CompoWay/F communications protocol.
Appendix	ASCII list

■ Related Manuals

ZEN Programmable Relay Operation Manual (Z211)

ZEN Support Software Operation Manual (Z184)

Revision History

■ Manual Revision Code

A manual revision code appears as a suffix to the catalog number on the front and back cover of the manual.

Man. No.	Z212-E1-01
----------	------------

■ Revision History

The following table outlines the changes made to the manual during each revision. Page numbers refer to the previous version.

Revision code	Date	Revised content
01	January 2006	Original production

Table of Contents

	Preface	ii
	Warranty and Application Considerations	iii
Precautions		vii
SECTION 1		
Communications Methods		
1.1	Overview of Communications Methods	2
	Introduction	2
	Communications Specifications	2
	Transmission Procedure	3
	Interface	3
	Wiring	3
	Communications Parameters	4
	Setting Communications Parameters	5
SECTION 2		
CompoWay/F Communications Protocol		
2.1	Data Format	10
	Command Frame	10
	Response Frame	11
	Communications Data	12
2.2	Structure of Command Text	14
	PDU Structure	14
	Addresses	14
	Number of Elements	14
	List of Services	15
2.3	Detailed Description of the Services	16
	Read Variable Area	16
	Variable Type and Read Start Address	16
	Bit Position	16
	Number of Elements	16
	Response Code	16
	Reading Timers, Counters, and Comparators	17
	Reading Work Bits and HR Bits	20
	Write Variable Area	21
	Writing Timer and Counter Set Values	22
	Writing Work Bits and HR Bits	26
	Read Controller Attributes	26
	Read Controller Status	27
	Read Time Data	28
	Write Time Data	29
	Echoback Test	31
	Operation Command	32
2.4	Response Code List	34
SECTION 3		
Communications Data		
3.1	Variable Area (Data Range) List	36
Appendix		41
	ASCII List	42

SECTION 1

Communications Methods

This section briefly describes the supported communications methods and how to wire equipment. Refer to this section when setting up equipment.

1.1	Overview of Communications Methods	2
	Introduction.....	2
	Communications Specifications.....	2
	Transmission Procedure.....	3
	Interface.....	3
	Wiring	3
	Communications Parameters	4
	Setting Communications Parameters	5

1.1 Overview of Communications Methods

Introduction

A host computer (see note 1) can communicate with the ZEN using the CompoWay/F communications protocol. The host computer is programmed to monitor and set ZEN settings. This manual is thus written from the viewpoint of the host computer. Up to 32 nodes including host computers can be connected via CompoWay/F. CompoWay/F is an integrated protocol for OMRON general-purpose serial communications. Consistent frame formats and commands that are compliant with FINS (see note 2), which is widely used with OMRON Programmable Controllers (PLCs), enable easy communications between a host computer and components.

Note 1: Host computers include personal computers.

Note 2: FINS (Factory Interface Network Service) is a message service used between controllers on OMRON FA networks.

The ZEN supports the following communications functions.

- Reading/writing of parameters
- Operation instructions

Note: RS-485 communications are not possible when a computer running ZEN Support Software is online with the CPU Unit.

Communications Specifications

Item	Details	Default settings
Transmission line connection	Multi-drop	None
Communications method	RS-485 (2-wire, half-duplex)	None
Synchronization method	Start-stop synchronization	None
Communications baud rate	4800, 9600, or 19200 bps	9600 bps
Communications code	ASCII	None
Communications data bits	7 or 8 bits	7 bits
Communications stop bits	1 or 2 bits	2 bits
Error detection	Vertical parity (none, even, or odd)	Even
	BCC (Block Check Character)	None
Flow control	None	---
Interface	RS-485	---
Retry function	None	---
Communications buffer	36 bytes	---
Communications protocol	CompoWay/F	None
Number of nodes	1:1 connection: 1 node 1:N connections: 32 nodes max. including host computer	None

■ Transmission Procedure

When the host computer transmits a command frame, the ZEN transmits a response frame that corresponds to the command frame. A single response frame is returned for each command frame. The following diagram shows the operation of the command and response frames.

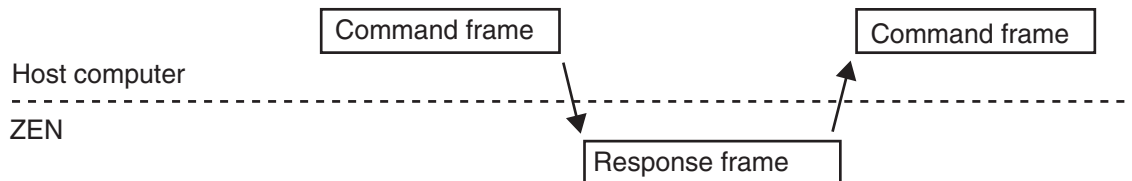

Note: Allow a wait time of at least 2 ms before the next command is sent after the host computer receives a response from the ZEN.

■ Interface

Use of the following Converter for RS-232C and RS-485 interface conversion is recommended.

Name	Model	Details
Interface Converter (OMRON)	K3SC	Communications between the host computer and the ZEN conform to the RS-485 interface.

■ Wiring

This section explains how to perform the ZEN's communications wiring. For details on the host computer, refer to the user documentation provided with the host computer.

- Match the communications specifications of the ZEN and the host computer.
- The connection format can be either one-to-one or one-to-N.
- Up to 32 units including the host computer can be connected in a one-to-N system.
- The total cable length is 500 m max.
- Use a shielded twisted-pair cable with wires of a thickness of AWG28 to AWG14 for communications signal wiring.

Note: When using a 1:N connection, set the same communications specifications in all of the Units, and set a unique node number for each Unit.

● Wiring Diagram

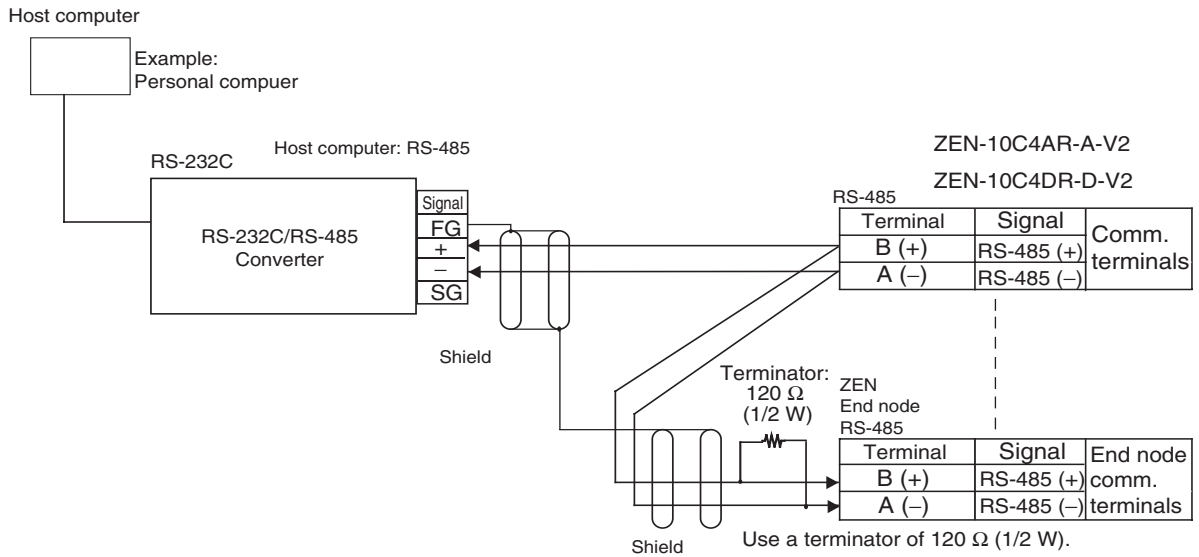

Note: Refer to the operation manual for the RS-232C/RS-485 Converter for wiring between the Converter and host computer.

■ Communications Parameters

Communications are performed with an external host computer. The communications parameters that can be set are listed in the following table.

Note: Refer to the *ZEN Programmable Relay Version 2 Operation Manual* (Cat. No. Z211) for other parameters.

Item	Display	Set values	Default settings	Unit
Node number	NODE NO	00 or 01 to 99	1	---
Communications baud rate	COM SPEED	4800, 9600, or 19200	9600	bps
Communications data length	DATA BIT	7 or 8	7	bit
Stop bits	STOP BIT	1 or 2	2	bit
Parity	PARITY	None, even, or odd	Even	---

- **Node Number**

For communications with a host computer, set a node number for each ZEN so that it can be recognized by the host computer. The node numbers can be set from 00 to 99.

Note: The same node number cannot be set for more than one ZEN. If duplicate node numbers are set, correct operation will not be possible.

- **Communications Baud Rate**

This parameter sets the baud rate for communications with the host computer. The baud rate can be set to any of the following: 4,800 bps, 9,600 bps, or 19,200 bps.

- **Communications Data Length**

This parameter sets the number of communications data bits. Set either 7 bits or 8 bits.

- **Stop Bits**

This parameter sets the number of communications stop bits. Set either 1 or 2.

- **Parity**

This parameter sets the communications parity. Set the parity to none, even, or odd.

■ Setting Communications Parameters

Set the communications parameters for the ZEN from the ZEN Support Software or from the RS-485 communications submenu of the CPU Unit.

- Settings cannot be changed in RUN mode. Switch to STOP mode first using the following procedure and then set the communications parameters.
- Any communications parameters that are set are valid from the next time a communication is received.

● Changing from RUN Mode to STOP Mode

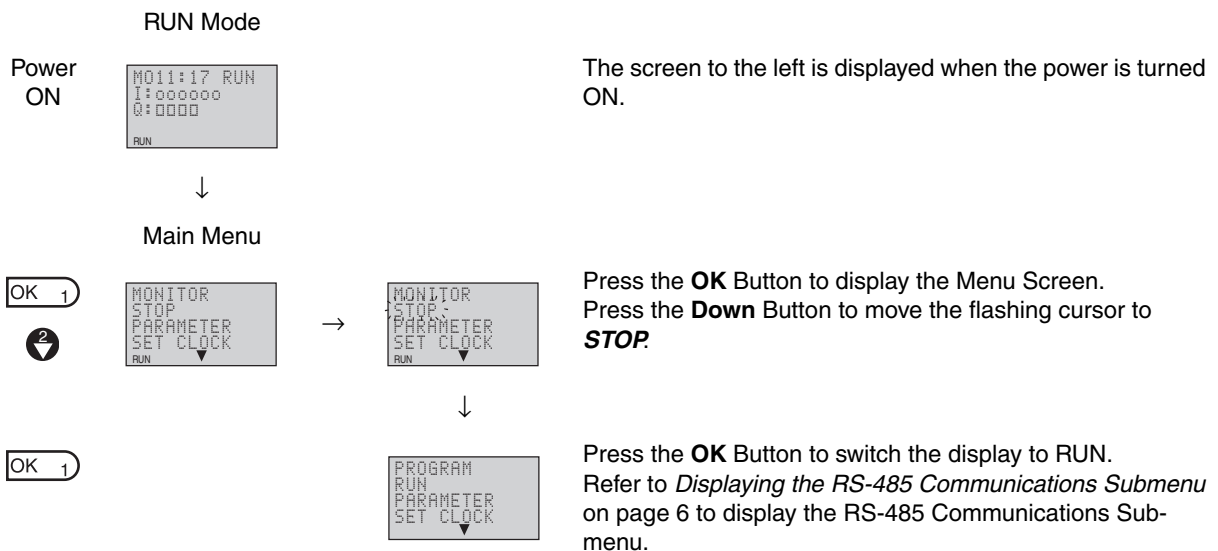

Displaying the RS-485 Communications Submenu

STOP Mode

OK 1

(See note.)

```

M013:15 STOP
I:000000
Q:0000
  
```

The screen at the left will be displayed when the ZEN is in STOP mode.

Press the **OK** Button to display the Menu Screen.

Note: This step is not required after switching from RUN Mode to STOP mode.

Main Menu

2

```

PROGRAM
RUN
PARAMETER
SET CLOCK
  
```

Press the **Down** Button to move the flashing cursor to **RS485**.

Submenu

OK 1

```

SET CLOCK
LANGUAGE
RS485
OTHER
  
```

→

```

NODE NO
COM SPEED
DATA BIT
STOP BIT
  
```

Press the **OK** Button to display the RS-485 Communications Submenu.

↓

Power ON

5 2

```

COM SPEED
DATA BIT
STOP BIT
PARITY
  
```

Press the **Up** and **Down** Buttons to move the flashing cursor to the items on the submenu.

● RS-485 Communications Submenu Setting Examples

RS-485 Communications Submenu

Power ON

5 2

```

NODE NO
COM SPEED
DATA BIT
STOP BIT
  
```

The RS-485 Communications Submenu Screen will be displayed when the power is turned ON. Use the **Up** and **Down** Buttons to move the flashing cursor to **NODE NO**.

↓

OK 1

```

RS485
NODE NO
  
```

Press the **OK** Button to display the currently set value. The highlighted cursor will flash.

↓

OK 1

```

RS485
NODE NO
  
```

Again press the **OK** Button. The highlighted cursor will be changed to a flashing cursor, and the set value will be ready to be changed.

Use the **Right** and **Left** Buttons to move the flashing cursor to the digit that is to be changed.

Use the **Up** and **Down** Buttons to change the number.

↓

OK 1

(See note.)

```

RS485
SET?
OK/ESC
  
```

Press the **OK** Button. A message will be displayed to confirm whether the changed setting is to be saved.

Note: The setting will not be saved if the **ESC** Button is pressed.

↓

OK 1

```

NODE NO
COM SPEED
DATA BIT
STOP BIT
  
```

Press the **OK** Button to save any changes and return to the RS-485 Communications Submenu Screen.



Main Menu

ESC 0

```
SET CLOCK  
LANGUAGE  
RS485  
OTHER ▲
```

Press the **ESC** Button to return to the Menu Screen.

SECTION 2

CompoWay/F Communications Protocol

This section describes the protocol for communications using the CompoWay/F format.

2.1	Data Format.....	10
	Command Frame.....	10
	Response Frame	11
	Communications Data	12
2.2	Structure of Command Text	14
	PDU Structure	14
	Addresses.....	14
	Number of Elements.....	14
	List of Services	15
2.3	Detailed Description of the Services.....	16
	Read Variable Area	16
	Variable Type and Read Start Address	16
	Bit Position.....	16
	Number of Elements.....	16
	Response Code.....	16
	Reading Timers, Counters, and Comparators.....	17
	Reading Work Bits and HR Bits.....	20
	Write Variable Area	21
	Writing Timer and Counter Set Values	22
	Writing Work Bits and HR Bits.....	26
	Read Controller Attributes	26
	Read Controller Status	27
	Read Time Data	28
	Write Time Data.....	29
	Echoback Test.....	31
	Operation Command	32
2.4	Response Code List	34

2.1 Data Format

For CompoWay/F, numeric values for commands are converted to ASCII and expressed as hexadecimal values.

- Numbers prefixed with H' are hexadecimal, e.g., H'02 is 02 hexadecimal.
- The numbers below the various parts of a frame specify the number of bytes.
- Unless specified, all other numbers are ASCII characters. (Refer to the *Appendix* for a table of ASCII characters.)

■ Command Frame

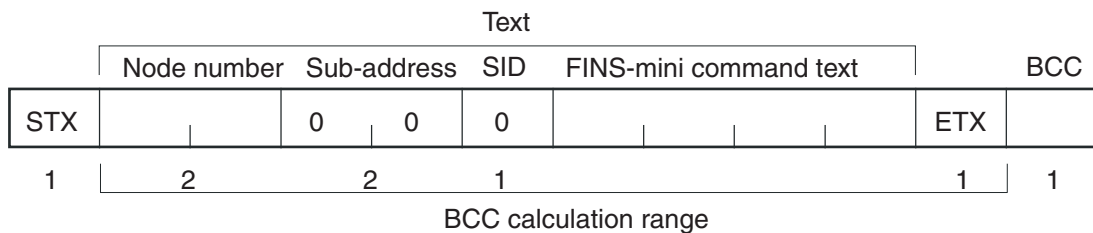

STX	This code (H'02) indicates the beginning of the communications frame (text). Always set STX in the first byte. When STX is received again during reception, reception is carried out again from the point where STX was received.
Node number	<ul style="list-style-type: none"> • This number specifies the transmission destination. • Specify the ZEN's node number. • A BCD value between 00 and 99 or an ASCII value of XX can be set. • Specify "XX" for a broadcast transmission. No responses will be returned for broadcast transmissions. • No responses will be returned from node numbers other than the ones in the above range. • The default setting is 01.
Sub-address	The sub-address is not used in the ZEN. It must be fixed at "00."
SID	<ul style="list-style-type: none"> • Service ID. The service ID is not used in the ZEN. • Be sure to set it to "00."
Command text	This is the command text area. For details, see <i>2.2 Structure of Command Text</i> .
ETX	This code (H'03) indicates the end of the text.
BCC	<ul style="list-style-type: none"> • This is the Block Check Character. • The BCC result is found by calculating the exclusive OR of the bytes from the node number up to ETX.

● BCC Calculation Example

The BCC (Block Check Character) is determined by calculating the exclusive OR of the bytes from the node number up to ETX. The 8-bit result is written to the BCC byte at the end of the frame.

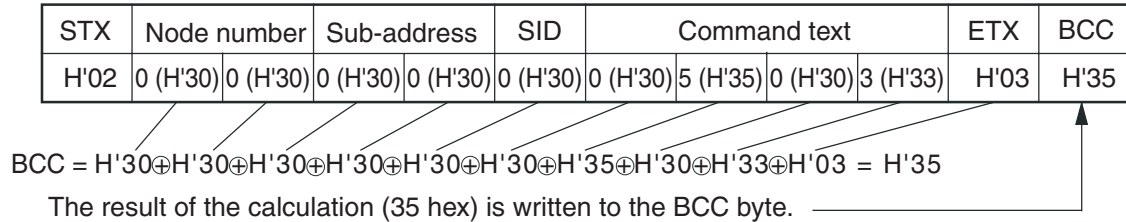

The ⊕ symbols indicate XOR (exclusive OR) operations.

■ Response Frame

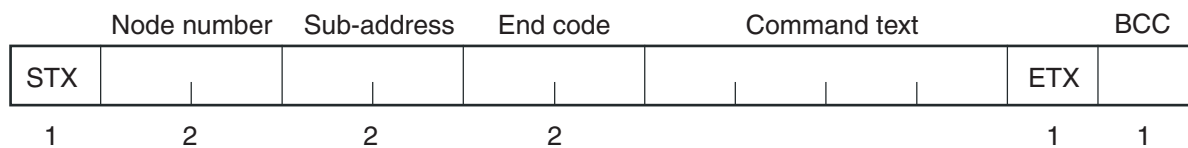

● End Codes

Normal Completion

End code	Name	Description	Error detection priority
00	Normal completion	The command ended normally without error.	None

Error Occurred

End code	Name	Description	Error detection priority
0F	FINS command error	The specified FINS command could not be executed. The FINS response code should indicate why the command could not be executed.	8
10	Parity error	The sum total of bits whose received data is 1 does not match the set value of the "communications parity" bit.	2
11	Framing error	Stop bit is 0.	1
12	Overrun error	New data was transferred when the reception data buffer was already full.	3
13	BCC error	The calculated BCC value is different from the received BCC value.	5
14	Format error	<ul style="list-style-type: none"> The command text contains characters other than 0 to 9, and A to F. Note: This error does not apply to Echoback Tests. Refer to <i>Echoback Test</i> on page 31 for details. <ul style="list-style-type: none"> There was no SID and command text. There was no command text. "MRC/SRC" not included in command text. 	7
16	Sub-address error	<ul style="list-style-type: none"> Illegal (unsupported) sub-address There was no sub-address, SID, and command text. Sub-address was less than two characters, and there was no SID and command text. 	6

18	Frame length error	The received frame exceeds the specified (supported) number of bytes.	4
----	--------------------	---	---

- An end code is returned for each command frame received that was addressed to the local node.
- No response will be returned unless the frame contained all elements up to the ETX and BCC.
- The *Error detection priority* is the priority when two or more errors occur simultaneously.

■ Communications Data

Communications protocol	Set (monitor) values	Negative values	Decimal point
CompoWay/F	8-digit hexadecimal	2's complement	Decimal point is removed and the result is converted to hexadecimal. Example conversion: 105.0 → 1050 → H'0000041A

Note: Refer to *Read Time Data* on page 28 and *Write Time Data* on page 29 for information on time data.

● End Code Examples

The following examples describe end codes when an error is detected in the command.

Example 1

Illegal Sub-address, No SID, and No Command Text

Command

Node number Sub-address BCC

STX		0	A	ETX	
-----	--	---	---	-----	--

Response

Node number Sub-address End code BCC

STX		0	A	16	ETX	
-----	--	---	---	----	-----	--

The end code returned in the response is 16 (sub-address error). The end code 16 is returned in the response when the sub-address error has a higher error detection priority than the format error.

Example 2

No Command Text

Command

Node number Sub-address SID BCC

STX		0	0	0	ETX	
-----	--	---	---	---	-----	--

Response

Node number Sub-address End code BCC

STX		0	0	14	ETX	
-----	--	---	---	----	-----	--

End code 14 (format error) is returned in the response when there is no command text.

Example 3 No Node Number Provided
Command

		BCC	
STX		ETX	

The node number is missing one character.

Response

No response is made.

Example 4 No Sub-address and Illegal BCC

Command

		Node number	BCC	
STX			ETX	Err

Response

		Node number	Sub-address	End code	BCC	
STX		0	0	1	3	ETX

The sub-address is taken as 00 and end code 13 (BCC error) is returned in the response.

2.2 Structure of Command Text

■ PDU Structure

- An MRC (Main Request Code) and SRC (Sub-Request Code) followed by the various required data are transferred in the command text.

Service Request PDU



- The MRES (Main Response Code), SRES (Sub-Response Code), followed by the data are transferred following the above MRC/SRC in the response frame.

Service Response PDU (Normal Response)



- If the specified command text could not be executed, the service response PDU will contain only the MRC/SRC and MRES/SRES.

Note: MRES/SRES provides the response code. MRES/SRES is not output when processing ends in a normal completion.

Service Response PDU (Command Text Not Executed)

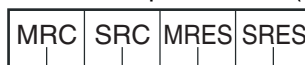

■ Addresses

An address is appended to each of the variable types. Express addresses in 2-byte hexadecimal and append them for the specified access size.

■ Number of Elements

Specify the number of elements as "0001" (fixed). The number of elements is expressed in 2-byte hexadecimal.

■ List of Services

MRC	SRC	Name of service	Processing
01	01	Read Variable Area	This service reads from variable areas.
01	02	Write Variable Area	This service writes to variable areas.
05	03	Read Controller Attributes	This service reads the model number and communications buffer size.
06	01	Read Controller Status	This service reads the operating status.
07	01	Read Time Data	This service reads ZEN time data.
07	02	Write Time Data	This service sets ZEN time data.
08	01	Echoback Test	This service performs an echoback test.
30	05	Operation Command	This service switches between RUN and STOP.

Note: No commands will be accepted and no responses will be returned when a memory error has occurred or the Controller is initializing (until normal operation begins after the power is turned ON).

2.3 Detailed Description of the Services

■ Read Variable Area

This service reads data from a variable area.

Service Request PDU

MRC	SRC	Variable type	Read start address	Bit position	Number of elements
0 1	0 1				
2	2	2	4	2	4

Service Request PDU

MRC	SRC	Response code	Read data (for number of elements)
0 1	0 1		
2	2	4	8 or 12 (See note.)

Note: The read data 12 indicates the weekly timer.

■ Variable Type and Read Start Address

For details on variable types and read start addresses, refer to *3.1 Variable Area (Data Range) List*.

Variables of type C0 are read-only.

■ Bit Position

Bits positions are always 00 except for work bits and HR bits. With the ZEN, bit access supported only for work bits and HR bits.

For details on bits and applications methods, refer to *1-4 Memory Areas* in the *ZEN Programmable Relay Operation Manual (Cat. No. Z211)*.

Note: Refer to *Reading Work Bits and HR Bits* on page 20 for details on reading work bits and HR bits.

■ Number of Elements

Always 0001.

■ Response Code

Normal Completion

Response code	Name	Description
0000	Normal completion	No errors were found.

Error Occurred

Response code	Error name	Cause
1001	Command too long	The command is too long.
1002	Command too short	The command is too short.

Response code	Error name	Cause
1101	Area type error	The variable type is wrong.
110B	Response too long	The number of elements is greater than 0001.
1100	Parameter error	<ul style="list-style-type: none"> • Bit position is not 00. • The bit address is out of range.
2203	Operation error	Unit error (memory error occurred, or unused command was sent.)

■ Reading Timers, Counters, and Comparators

● Reading Timer Types and Time Units

Timer types and time units can be read. For timers other than twin timers (normal timer operation), the data is set in the rightmost four bytes. For twin timers, the data is set in the rightmost and leftmost two bytes.

Example 1: Twin Timer

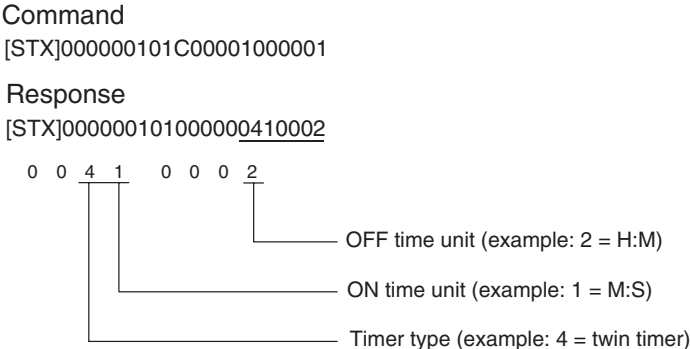

Example 2: Other Timers

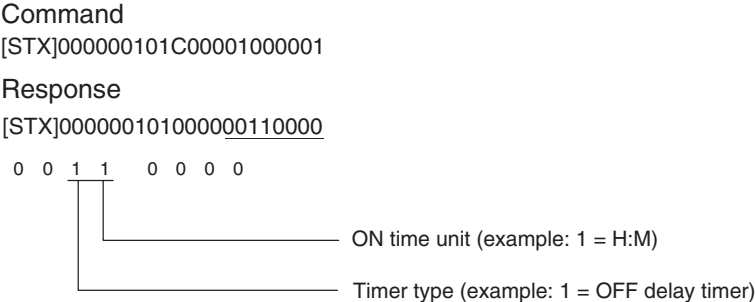

- Timer and Counter Number Specifications

There is more than one timer and more than one counter, and so the leftmost two digits of the address are used to specify the applicable timer or counter. The timer and counter numbers and corresponding addresses are given in the following table.

Contents	Type/number	Variable type	Addresses
Timer PV	T0 to Tf (16 timers)	C0	0000 to 0F00
Timer type and time unit		C0	0001 to 0F01
Timer SV		C1	0000 to 0F00
Holding timer PV	#0 to #7 (8 timers)	C0	0003 to 0703
Holding timer type and time unit		C0	0004 to 0704
Holding timer SV		C2	0000 to 0700
Weekly timer operation mode	@0 to @f (16 timers)	C0	000B to 0F0B
Weekly timer SV		C5	0000 to 0F00
Calendar timer SV	*0 to *f (16 timers)	C6	0000 to 0F00
Counter PV	C0 to Cf (16 counters)	C0	0006 to 0F06
Counter SV		C3	0000 to 0F00

● Reading Comparators

RS-485 communications can be used to read the variable area and perform comparisons with the following three types of comparators.

1. Analog Comparators: Compare an analog input with a constant or two analog inputs.
2. Comparators: Compare the present value of a timer, holding timer, or counter with a constant or the present values of timers, holding timers, or counters.
3. Eight-digit comparators: Compare the present value of an 8-digit comparator with a constant.

Note: Refer to ntlp: 3-10 Analog Inputs (Analog Comparators (A)), 3-11 Comparing Timer/Counter Present Values Using Comparators (P), and 3-12 Comparing the 8-Digit Counter (F) Present Value Using 8-Digit Comparators (G) in the ZEN Programmable Relay Operation Manual for details on comparators.

- Comparator Number Specifications

There is more one of some types of comparators and more than one analog input, and so the leftmost two digits of the address are used to specify the applicable timer or counter. The comparator and analog input numbers and corresponding addresses are given in the following table.

Contents	Type/number	Variable type	Addresses
Analog input PV	I4 and I5	C0	I4: 000D I5: 010D

Analog comparator constant	A0 to A3	C7	0000 to 0300
Analog comparator operator		C0	000E to 030E
Comparator operator	P0 to Pf	C0	000E to 0F0E
Comparator PV		C8	0000 to 0F00
8-digit comparator operator	G0 to G3	C0	0012 to 0312
8-digit comparator constant		C9	0000 to 0300

Note: There is only one 8-digit counter (F). Use address 0008 for the PV and address 0009 for the counting speed.

• Comparator Data Formats

1. Comparison Operators for Analog Comparators

The comparison pattern and operator in the variable area can be specified when reading.

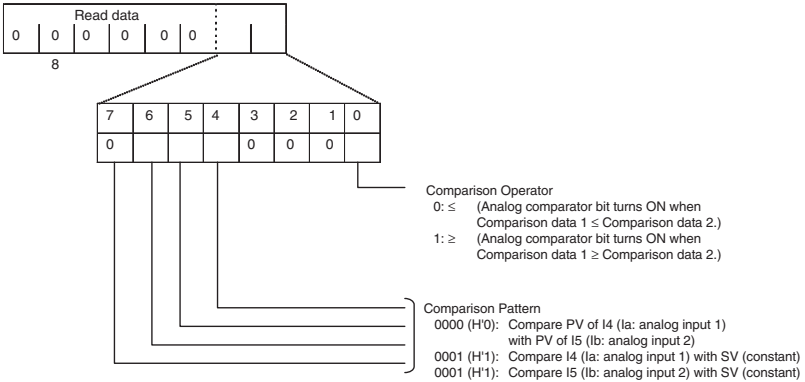

2. Comparison Operators for Comparators

The comparison data and operation in the variable area can be specified when reading.

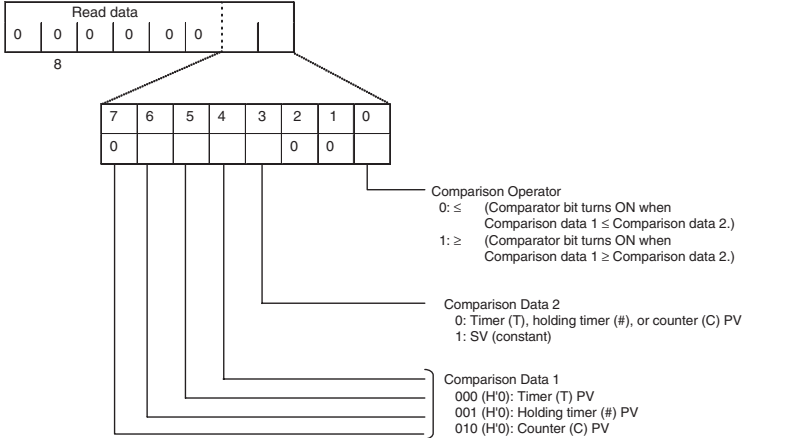

3. Comparison Operators for 8-Digit Comparator

The comparison data and operation in the variable area can be specified when reading.

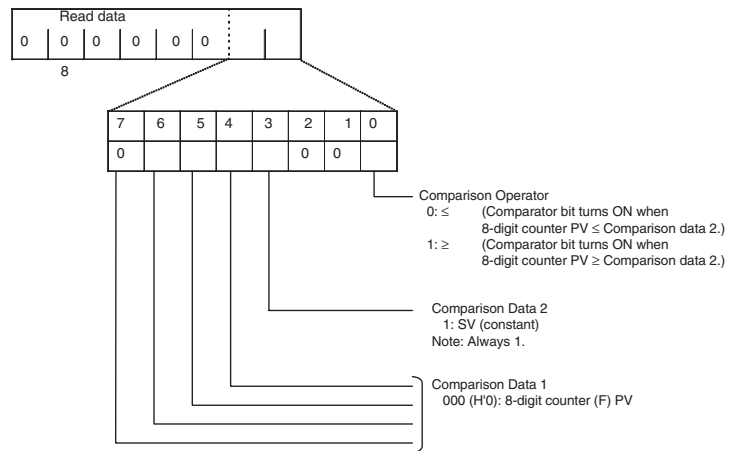

■ Reading Work Bits and HR Bits

Bit positions are specified when reading Work Bits or HR Bits (0 or 1).

Example

Command

[STX]000000101CA000002001

The bit position is specified when reading. In this example, the bit 02 is specified when reading the status of Work Bit M2.

Response

[STX]000000101000000000001

The response says that the specified Work Bit is ON (1).

■ Write Variable Area

This service writes data to a variable area.

Service Request PDU

MRC	SRC	Variable type	Start write address	Bit position	Number of elements	Write Data (for number of elements)
0 1	0 2				0 0 0 1	
2	2	2	4	2	4	8 or 12 (See note.)

Note: The write data 12 indicates the weekly timer.

Service Response PDU

MRC	SRC	Response code
0 1	0 2	
2	2	4

● Variable Type and Write Start Address

For details on variable types and write start addresses, see *3.1 Variable Area (Data Range) List*.

Variable type C0 is read-only.

● Bit Position

Bits positions are always 00 except for work bits and HR bits. With the ZEN, bit access supported only for work bits and HR bits.

For details on bits and applications methods, refer to *1-4 Memory Areas* in the *ZEN Programmable Relay Operation Manual*.

Note: Refer to *Reading Work Bits and HR Bits* on page 20 for details on reading work bits and HR bits.

● Number of Elements

Always to 0001.

● Response Code

Normal Completion

Response code	Name	Description
0000	Normal completion	No errors were found.

Error Occurred

Response code	Error name	Cause
1002	Command too short	The command is too short.
1101	Area type error	The variable type is wrong.
1003	Number of elements/ data mismatch	The number of data does not match the number of elements.
1100	Parameter error	<ul style="list-style-type: none"> • Bit position is not 00. • The write data is out of the setting range. • The bit number is out of range.
3003	Read-only error	Variable type "C0" was written to.
2203	Operation error	Unit error (Memory error occurred, or unused command was sent.)

Note: With the Write Variable Area service, "command too long" errors do not occur. If there is sufficient data for the number of elements in the service request PDU, the error is processed as a "number of elements/data mismatch" error.

■ Writing Timer and Counter Set Values

● Reading and Writing Timer Set Values

Timer set values (SVs) can be read and written. The rightmost and leftmost four bytes contain the ON time and OFF time for twin timers and the rightmost four bytes contain the ON time for other timers.

Example 1: Writing the SV of Timers Other Than Twin Timers

Command

```
[STX]000000102C100000000010000270F
```

ON time: 9999 (H'270F)

Example 2: Reading the SV of Timers Other Than Twin Timers

Command

```
[STX]000000101C10000000001
```

Response

```
[STX]00000010100000000270F
```

ON time: 9999 (H'270F)

Example 3: Writing the SV of Twin Timers

Command

```
[STX]000000102C100000000010064 270F
```

OFF time: 9999 (H'270F)

ON time: 100 (H'64)

Example 4: Writing the SV of Twin Timers

Command

```
[STX]000000101C10000000001
```

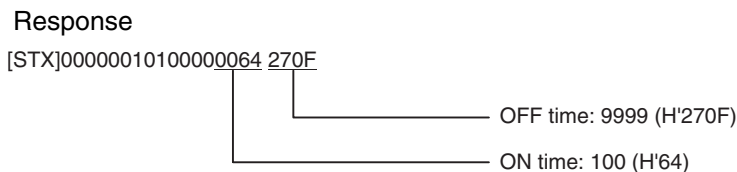

● **Timer, Counter, and Comparator Number Specifications**

There is more than one timer and more than one counter, and so the leftmost two digits of the address are used to specify the applicable timer or counter. Refer to tables in *Timer and Counter Number Specifications* on page 18 and *Comparator Number Specifications* on page 18 for the timer, counter, and comparator numbers and corresponding addresses.

● **Weekly Timers**

Weekly timers are built into the ZEN. The following three operations are possible for weekly timers by combining the day of the week, time, and output time. These can be written using RS-485 communications.

1. Normal Operation: The bit is turned ON and OFF at the set day and times.
2. Multiple-day Operation: The bit is turned ON and OFF at the set days and times (operation across multiple days).
3. Pulse Operation: The bit is turn ON for the set output time at the set start time and day.

Note: refer to *3-8 Using Weekly Timers (@)* in the *ZEN Programmable Relay Operation Manual* (Cat. No. Z211) for details on Weekly Timers.

• Weekly Timer Data Format

The weekly timer data format consists of the following 12 bytes.

1. Normal Operation
2. Multiple-day Operation

Always 00.	+	Start day	+	End day	+	Start time, hour	+	Start time, minutes	+	End time, hour	+	End time, minutes
2		1		1		2		2		2		2

The time data is as follows (BCD):

Time data	BCD
Sunday	0
Monday	1
Tuesday	2
Wednesday	3
Thursday	4
Friday	5
Saturday	6
No day designated	7
Hour	00 to 23

Minutes	00 to 59
---------	----------

Example

[STX]010000102C5000000001005623592359

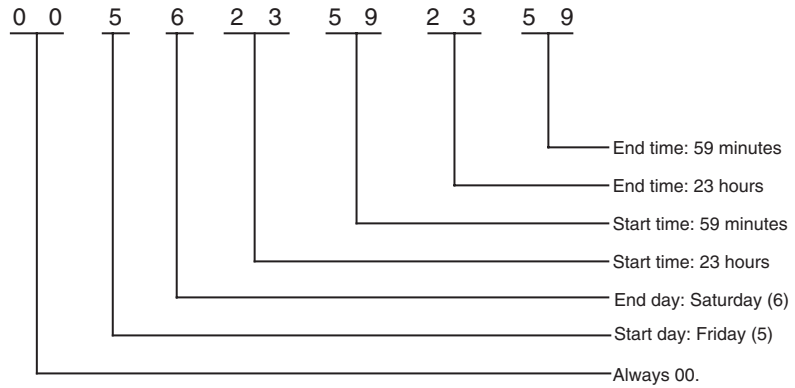

3. Pulse Operation

Always 00.	+	Start day	+	End day	+	Start time, hour	+	Start time, minutes	+	Output time, minutes	+	Output time, seconds
2		1		1		2		2		2		2

The time data is as follows (BCD):

Time data	BCD
Sunday	0
Monday	1
Tuesday	2
Wednesday	3
Thursday	4
Friday	5
Saturday	6
No day designated	7
Start time, hour	00 to 23
Start time, minutes	00 to 59
Output time, minutes	00 to 99
Output time, seconds	00 to 59

Example

[STX]010000102C50000000001005623591520

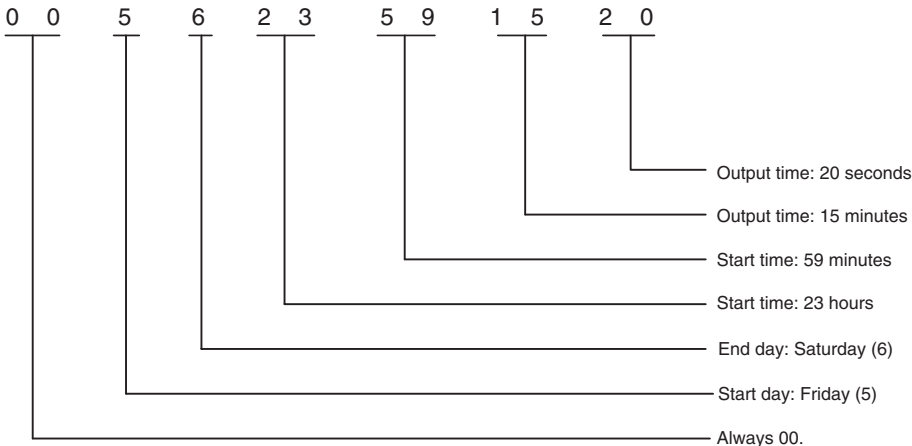

● Calendar Timers

Calendar timers are built into the ZEN. The calendar timers turn ON between the specified start and end days of the specified months. These can be written using RS-485 communications.

Note: refer to 3-9 Using Calendar Timers (*) in the ZEN Programmable Relay Operation Manual (Cat. No. Z211) for details on Calendar Timers.

• Calendar Timer Data Format

The calendar timer data format consists of the following 8 bytes.

Start month	+	Start day	+	End month	+	End day
2		2		2		2

The time data is as follows (BCD):

Time data	BCD
Month	01 to 12
Day	01 to 31

Example

[STX]010000102C5000000000112121230

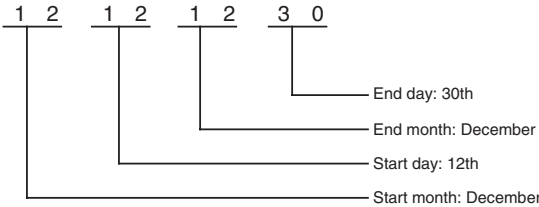

■ Writing Work Bits and HR Bits

Bit positions are specified when writing Work Bits or HR Bits.

Example

Command

[STX]000000102CA0000003000100000001 The bit position is specified when writing. In this example, the bit 03 in HR Bit H2 is turned ON (1).

Response

[STX]0000001020000 Normal response

■ Read Controller Attributes

This service reads the model number and communications buffer size.

Service Request PDU

MRC	SRC
0 5	0 3
2	2

Service Response PDU

MRC	SRC	Response code	Model No.	Buffer size
0 5	0 3			0 0 2 4
2	2	4	10	4

● Model Number

The model number is expressed in 10-byte ASCII. When 10 bytes are not required, pad the remaining bytes with spaces.

Model number	Code
ZEN10C4AR-A-V2	ZEN10C4A
ZEN10C4DR-D-V2	ZEN10C4D

● Buffer Size

The communications buffer size is expressed in 2-byte hexadecimal, and read after being converted to 4-byte ASCII.

Buffer size: 36 bytes (= H'0024)

● Response Code

Normal Completion

Response code	Name	Description
0000	Normal completion	No errors were found.

Error Occurred

Response code	Name	Description
1001	Command too long	The command is too long.
2203	Operation error	Unit error (Memory error occurred, or unused command was sent.)

■ Read Controller Status

This service reads the operating status and error status.

Service Request PDU

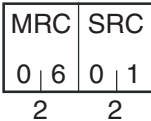

Service Response PDU



● Operating Status

Operating status	Description
00	RUN
01	STOP

● Related Information

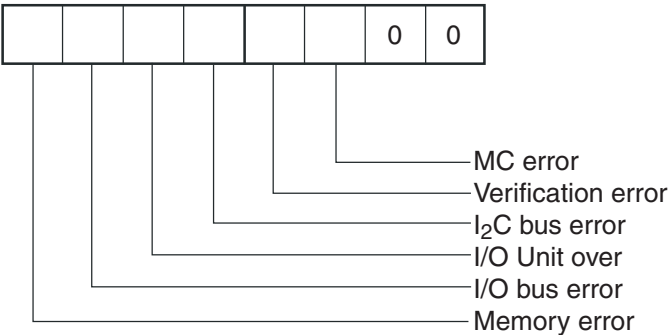

● Response Code

Normal Completion

Response code	Name	Description
0000	Normal completion	No errors were found.

Error Occurred

Response code	Name	Description
1001	Command too long	The command is too long.

■ Read Time Data

This service reads ZEN time data.

Service Request PDU

MRC	SRC
0 7	0 1
2	2

Service Response PDU

MRC	SRC	Year	Month	Day	Hour	Min	Sec	Day
0 7	0 1							
2	2	2	2	2	2	2	2	2

Note: Each element of the time data (year, month, day of month, hour, minutes, seconds, and day of week) is expressed as 2-digit BCD data and converted to ASCII characters.

Time element	BCD	Time element	BCD
Year	00 to 99	Sunday	00
Month	01 to 12	Monday	01
Day of month	01 to 31	Tuesday	02
Hour	00 to 23	Wednesday	03
Minutes	00 to 59	Thursday	04
Seconds	00 to 59	Friday	05
		Saturday	06

Example
 Command
 [STX]000000701
 Response
 [STX]00000070105112823302006

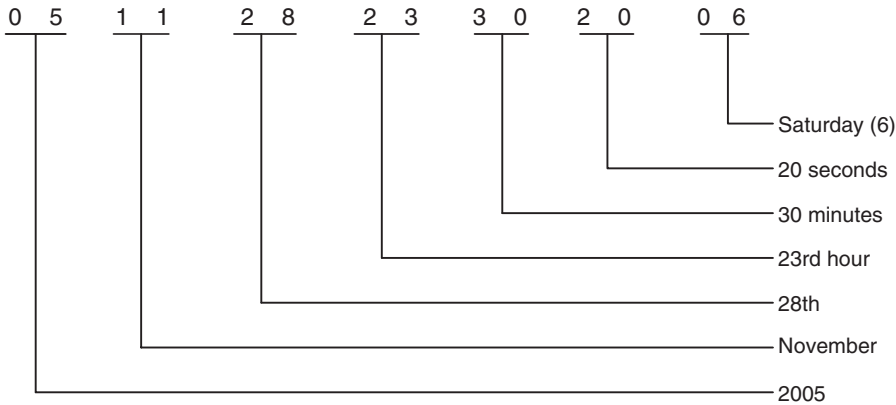

● Year to Seconds

The time data expressed in two digits of BCD data is converted to two ASCII characters.

● Response Code

Normal Completion

Response code	Name	Description
0000	Normal completion	No errors were found.

Error Occurred

Response code	Name	Description
1001	Command too long	The command is too long.
2203	Operation error	Unit error (Memory error occurred, or unused command was sent.)

■ Write Time Data

This service reads ZEN time data.
 Note: Refer to ntlp:3-2 *Setting the Date and Time* in the *ZEN Programmable Relay Operation Manual* (Cat. No. Z211) for information on setting the date and time.

Service Request PDU

MRC	SRC	Year	Month	Day	Hour	Min	Sec	(See note 2.)
0 7	0 2							0 0
2	2	2	2	2	2	2	2	2

Note 1: Each element of the time data (year, month, day of month, hour, minutes, seconds, and day of week) is expressed as 2-digit BCD data and converted to ASCII characters.

Note 2: Always 00.

Service Response PDU

MRC	SRC	Response code
0 7	0 2	
2	2	4

The time data (BCD) is as follows:

Time data	BCD
Year	00 to 99
Month	01 to 12
Day of month	01 to 31
Time, hour	00 to 23
Time, minutes	00 to 59
Time, seconds	00 to 59

Example

Command

[STX]00000070205123123595900

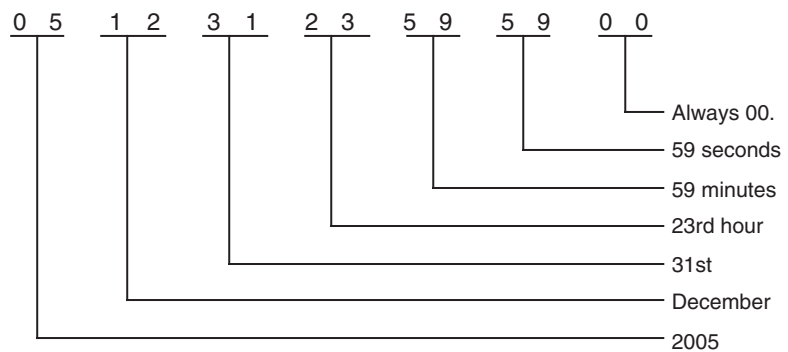

Response

[STX]0000007020000 Normal response

● Year to Seconds

The time data expressed in two digits of BCD data is converted to two ASCII characters.

● **Response Code**

Normal Completion

Response code	Name	Description
0000	Normal completion	No errors were found.

Error Occurred

Response code	Name	Description
1001	Command too long	The command is too long.
1002	Command too short	The command is too short.
1100	Parameter error	The write data is out of the setting range.
2203	Operation error	Unit error (Memory error occurred, or unused command was sent.)

■ **Echoback Test**

This service performs an echoback test.

Service Request PDU

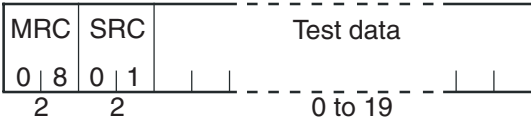

Service Response PDU

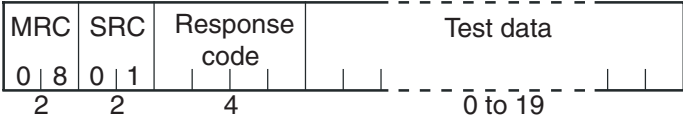

● **Test Data**

Set between 0 and 19 bytes of user-defined test data.
 Set a value for the test data within the ranges shown below according to the communications data length.

Communications data length	Test Data
8 bits	ASCII data: H'20 to H'7E or H'A1 to H'FE
7 bits	ASCII data: H'20 to H'7E

Do not set the value H'40. No response will be returned.

● Response Code

Normal Completion

Response code	Name	Description
0000	Normal completion	No errors were found.

Error Occurred

Response code	Name	Description
1001	Command too long	The command is too long.
2203	Operation error	Unit error (Memory error occurred, or unused command was sent.)

■ Operation Command

This service switches between RUN and STOP.

Service Request PDU

MRC	SRC	Com- mand code	Related informa- tion
3 0	0 5	0 0	
2	2	2	2

Service Response PDU

MRC	SRC	Response code
3 0	0 5	
2	2	4

● Command Code and Related Information

Command code	Command content	Related information
00	RUN/STOP	00: Switch to RUN 01: Switch to STOP

● Response Code

Normal Completion

Response code	Name	Description
0000	Normal completion	No errors were found.

● Operation Commands and Precautions

Response code	Error name	Cause
1001	Command too long	The command is too long.
1002	Command too short	The command is too short.

1100	Parameter error	Command code and related information are wrong.
2203	Operation error	I ₂ C bus error or memory error

2.4 Response Code List

Normal Completion

Response code	Name	Description	Error detection priority
0000	Normal completion	No errors were found.	None

Error Occurred

Response code	Name	Description	Error detection priority
0401	Unsupported command	The service function for the relevant command is not supported.	1
1001	Command too long	The command is too long.	2
1002	Command too short	The command is too short.	3
1101	Area type error	Wrong variable type	4
1003	Number of elements/data mismatch	The amount of data does not match the number of elements.	5
110B	Response too long	The response exceeds the communications buffer size (when the number of elements is larger than 0002).	6
1100	Parameter error	<ul style="list-style-type: none"> • Bit position is not 00. • The write data is out of the setting range. • The command code or related information in the operation command is wrong. • The bit address is out of range. 	7
3003	Read-only error	Variable type "C0" was written to.	8
2203	Operation error	Unit error (Memory error occurred, or unused command was sent.)	9

SECTION 3

Communications Data

This section lists the portions of the variable area that can be set with CompoWay/F communications.

3.1	Variable Area (Data Range) List.....	36
-----	--------------------------------------	----

3.1 Variable Area (Data Range) List

The following tables list data ranges by variable type. When there is a section reference for a setting item, refer to that reference for details.

◆ Variable TypeC0 (Read-only)

Address	Data name	Data range (unit)	Remarks	Page
0000	Timer PV	H'00000000 to H'0000270F (S) H'00000000 to H'000026E7 (M:S) H'00000000 to H'000026E7 (H:M)	Timer number specified by left-most 2 digits of address. 00.00 to 99.99 s 00 min 00 s to 99 min 59 s 00 h 00 min to 99 h 59 min Note: For twin timers, the PV of the currently operating timer is read.	P.18
0001	Timer type, time unit, and monitor	H'00000000 to H'00420002 (-)	Timer number specified by left-most 2 digits of address. 3rd Digit from Left: Timer Type 0: ON delay 1: OFF delay 2: One-shot pulse 3: Flashing pulse 4: Twin timer 4th Digit from Left: Time Unit 0: 0.01 s 1: M:S 2: H:M 8th Digit from Left: OFF Time Unit (See note.) 0: 0.01s 1: M:S 2: H:M Note: Twin timers only.	P.18
0002	Timer bit status	H'00000000 to H'0000FFFF (-)	Bit 0: T0 Bit 8: T8 Bit 1: T1 Bit 9: T9 Bit 2: T2 Bit 10: Ta Bit 3: T3 Bit 11: Tb Bit 4: T4 Bit 12: Tc Bit 5: T5 Bit 13: Td Bit 6: T6 Bit 14: Te Bit 7: T7 Bit 15: Tf	---
0003	Holding timer PV	H'00000000 to H'0000270F (S) H'00000000 to H'000026E7 (M:S) H'00000000 to H'000026E7 (H:M)	Timer number specified by left-most 2 digits of address. 00.00 to 99.99 s 00 min 00 s to 99 min 59 s 00 h 00 min to 99 h 59 min	P.18
0004	Holding timer time unit	H'00000000 to H'00000002 (-)	Timer number specified by left-most 2 digits of address. 0: 0.01 s 1: M:S 2: H:M	P.18

Address	Data name	Data range (unit)	Remarks	Page
0005	Holding timer bit status	H'00000000 to H'000000FF (-)	Bit 0: #0 Bit 1: #1 Bit 2: #2 Bit 3: #3 Bit 4: #4 Bit 5: #5 Bit 6: #6 Bit 7: #7	---
0006	Counter PV	H'00000000 to H'0000270F (-)	Counter number specified by leftmost 2 digits of address.	P.18
0007	Counter bit status	H'00000000 to H'0000FFFF (-)	Bit 0: C0 Bit 8: C8 Bit 1: C1 Bit 9: C9 Bit 2: C2 Bit 10: Ca Bit 3: C3 Bit 11: Cb Bit 4: C4 Bit 12: Cc Bit 5: C5 Bit 13: Cd Bit 6: C6 Bit 14: Ce Bit 7: C7 Bit 15: Cf	---
0008	8-digit counter PV	H'00000000 to H'05F5E0FF (-)	99999999 max.	P.19
0009	8-digit counter counting speed	H'00000000 to H'00000001 (-)	0: Low speed 1: High speed	---
000A	8-digit counter bit status	H'00000000 to H'00000001 (-)	Bit 0: F0	---
000B	Weekly timer operating mode	H'00000000 to H'00000002 (-)	Timer number specified by leftmost 2 digits of address. 0: Normal 1: Multiple-day 2: Pulse	P.23
000C	Weekly timer bit status	H'00000000 to H'0000FFFF (-)	Bit 0: @0 Bit 8: @8 Bit 1: @1 Bit 9: @9 Bit 2: @2 Bit 10: @a Bit 3: @3 Bit 11: @b Bit 4: @4 Bit 12: @c Bit 5: @5 Bit 13: @d Bit 6: @6 Bit 14: @e Bit 7: @7 Bit 15: @f	---
000D	Analog input value	H'00000000 to H'00000069 (V)	Analog number specified by leftmost 2 digits of address. 00: I4 (analog input 1) 01: I5 (analog input 2) 00.0 to 10.5 V	P.18
000E	Analog comparator operator	H'00000000 to H'00000021 (-)	Comparator number specified by leftmost 2 digits of address.	P.19
000F	Analog comparator bit status	H'00000000 to H'0000000F (-)	Bit 0: A0 Bit 1: A1 Bit 2: A2 Bit 3: A3	---
0010	Comparator operator	H'00000000 to H'00000029 (-)	Comparator number specified by leftmost 2 digits of address.	P.19

Address	Data name	Data range (unit)	Remarks	Page
0011	Comparator bit status	H'00000000 to H'0000FFFF (-)	Bit 0: P0 Bit 8: P8 Bit 1: P1 Bit 9: P9 Bit 2: P2 Bit 10: Pa Bit 3: P3 Bit 11: Pb Bit 4: P4 Bit 12: Pc Bit 5: P5 Bit 13: Pd Bit 6: P6 Bit 14: Pe Bit 7: P7 Bit 15: Pf	---
0012	8-digit comparator operator	H'00000008 to H'00000009 (-)	Comparator number specified by leftmost 2 digits of address.	P.19
0013	CPU Unit output bit status	H'00000000 to H'0000000F (-)	Bit 0: Q0 Bit 1: Q1 Bit 2: Q2 Bit 3: Q3 (use as work bit)	---
0014	CPU Unit input bit status	H'00000000 to H'0000003F (-)	Bit 0: I0 Bit 1: I1 Bit 2: I2 Bit 3: I3 Bit 4: I4 Bit 5: I5	---
0015	Expansion I/O output bit status	H'00000000 to H'00000FFF (-)	Bits 0 to 3: Expansion 0, Y0 to Y3 Bits 4 to 7: Expansion 1, Y4 to Y7 Bits 8 to 11: Expansion 2, Y8 to YB	---
0016	Expansion I/O input bit status	H'00000000 to H'00000FFF (-)	Bits 0 to 3: Expansion 0, X0 to X3 Bits 4 to 7: Expansion 1, X4 to X7 Bits 8 to 11: Expansion 2, X8 to XB	---
0017	8-digit comparator bit status	H'00000000 to H'0000000F	Comparator number specified by leftmost 2 digits of address. Bit 0: G0 Bit 1: G1 Bit 2: G2 Bit 3: G3	---

◆ Variable Type C1

Address	Data name	Data range (unit)	Remarks	Page
0000	Timer SV	<ul style="list-style-type: none"> Timers Other Than Twin Timers H'00000001 to H'0000270F (S) H'00000001 to H'000026E7 (M:S) H'00000001 to H'000026E7 (H:M) Twin Timers (See note.) H'00010001 to H'270F270F (-) 	Timer number specified by leftmost 2 digits of address. 00.01 to 99.99 s 00 min 01 s to 99 min 59 s 00 h 01 min to 99 h 59 min	P.18 P.22

Note: The upper limit for twin timers depends on the time unit for the ON time and OFF time settings. For min:s (M:S) or h:min (H:M), the upper limit is 26E7.

◆ Variable Type C2

Address	Data name	Data range (unit)	Remarks	Page
0000	Holding time SV	H'00000001 to H'0000270F (S) H'00000001 to H'000026E7 (M:S) H'00000001 to H'000026E7 (H:M)	Timer number specified by leftmost 2 digits of address. 00.01 to 99.99 s 00 min 01 s to 99 min 59 s 00 h 01 min to 99 h 59 min	P.18

◆ Variable Type C3

Address	Data name	Data range (unit)	Remarks	Page
0000	Counter SV	H'00000001 to H'0000270F (-)	Counter number specified by leftmost 2 digits of address 9999 max.	P.18 P.22

◆ Variable Type C4

Address	Data name	Data range (unit)	Remarks	Page
0000	8-digit counter SV	H'00000001 to H'05F5E0FF (-)	99999999 max.	P.18 P.22

◆ Variable Type C5

Address	Data name	Data range	Remarks	Page
0000	Weekly timer SV	Normal or Multiple-day Operation H'000000000000 to H'006723592359 Pulse Operation H'000000000000 to H'006723599959	Timer number specified by leftmost 2 digits of address. Left 12 bytes are used in the command. Leftmost 4 Bytes: Start/End Day 0: Sunday, 1: Monday, 2: Tuesday, 3: Wednesday, 4: Thursday, 5: Friday, 6: Saturday, 7: No designation Middle 4 Bytes: Start Time 00 h 00 min to 23 h 59 min Rightmost 4 Bytes: End Time 00 h 00 min to 23 h 59 min Rightmost 4 Bytes: Output Time 00 min 00 s to 99 min 59 s 00 h 01 min to 99 h 59 min	P.18 P.23

◆ Variable Type C6

Address	Data name	Data range	Remarks	Page
0000	Calendar timer SV	H'01010101 to H'12311231 (-)	Calendar timer number specified by leftmost 2 digits of address. Leftmost 4 Bytes: Start Month/Day January 01 to December 31 Rightmost 4 Bytes: End Month/Day January 01 to December 31	P.18 P.25

◆ Variable Type C7

Address	Data name	Data range	Remarks	Page
0000	Analog comparator constant	H'00000000 to H'00000069 (V)	Analog comparator number specified by leftmost 2 digits of address. 00.0 to 10.5 V	P.19

◆ Variable Type C8

Address	Data name	Data range	Remarks	Page
0000	Comparator constant	H'00000000 to H'0000270F (-)	Comparator number specified by leftmost 2 digits of address. T/#: 00.00 to 99.99 C: 0000 to 9999	P.19

◆ Variable Type C9

Address	Data name	Data range	Remarks	Page
0000	8-digit comparator constant	H'00000000 to H'05F5E0FF (-)	Comparator number specified by leftmost 2 digits of address. (8-digit comparator) 99999999 max.	P.19

◆ Variable Type CA

Address	Data name	Data range	Remarks	Page
0000	Work bit status	H'00000000 to H'00000001 (-)	Specify the bit position when reading or writing bit status.	P.20 P.26

◆ Variable Type CB

Address	Data name	Data range	Remarks	Page
0000	HR bit status	H'00000000 to H'00000001 (-)	Specify the bit position when reading or writing bit status.	P.20 P.26

Appendix

ASCII List.....	42
-----------------	----

ASCII List

	b8								
	b7	0	0	0	0	1	1	1	1
	b6	0	0	1	1	0	0	1	1
	b5	0	1	0	1	0	1	0	1

	b8	b7	b6	b5	b4	b3	b2	b1
Even parity ↑	0	0	0	0	0	0	0	0
	0	0	0	0	1	0	0	0
	0	0	1	0	0	0	1	0
	0	0	1	1	0	0	1	1
	0	1	0	0	0	1	0	0
	0	1	0	1	0	1	0	1
	0	1	1	1	0	1	1	0
	0	1	1	1	1	0	0	0
	1	0	0	0	0	0	0	0
	1	0	0	0	1	0	0	1
	1	0	1	0	0	1	0	0
	1	0	1	1	0	1	1	1
	1	1	0	0	0	0	0	0
	1	1	0	1	0	1	0	1
	1	1	1	1	0	0	0	0
	1	1	1	1	1	0	1	1

R \ C	0	1	2	3	4	5	6	7
0	NUL	DLE	SPACE	0	@	P	`	p
1	SOH	DC1	!	1	A	Q	a	q
2	STX	DC2	"	2	B	R	b	r
3	ETX	DC3	#	3	C	S	c	s
4	EOT	DC4	\$	4	D	T	d	t
5	ENQ	NAK	%	5	E	U	e	u
6	ACK	SYN	&	6	F	V	f	v
7	BEL	ETB	'	7	G	W	g	w
8	BS	CAN	(8	H	X	h	x
9	HT	EM)	9	I	Y	i	y
A	LF	SUB	*	:	J	Z	j	z
B	VT	ESC	+	;	K	[k	{
C	FF	FS	,	<	L	\	l	
D	CR	GS	-	=	M]	m	}
E	SO	RS	.	>	N	^	n	~
F	SI	US	/	?	O	_	o	DEL

INDEX

A	
addresses	14
analog comparator	18
ASCII list	42
B	
BCC	10
BCC calculation example	11
bit position	16, 21
C	
calendar timer	25
changing from RUN Mode to STOP Mode	5
command frame	10
command text	10
communications baud rate	4
communications data	12, 35
communications data length	5
communications methods	2
communications parameters	4
communications specifications	2
comparator	19
CompoWay/F	9
D	
data format	10
E	
echoback test	31
eight-digit comparator	18
end code	11
end code example	12
ETX	10
I	
interface	3
K	
K3SC	3
L	
list of services	15
M	
MRC (Main Request Code)	14
MRES (Main Response Code)	14
multi-day operation	23
N	
node number	4, 10
normal operation	23
number of elements	14
O	
operation command	32
P	
parity	5
PDU structure	14
pulse operation	23
R	
read controller attributes	26
read controller status	27
read time data	28
read variable area	16
reading comparators	18
reading timers, counters, and comparators	17
reading work bits and HR bits	20
response code list	34
response frame	11
RS-232C	3
RS-485 communications submenu setting example	6
S	
Service Request PDU	14
Service Response PDU	14
setting communications parameters	5
SID	10
SRC (Sub-Request Code)	14
SRES (Sub-Response Code)	14
stop bits	5
structure of command text	14
STX	10
sub-address	10
T	
timer and counter number specifications	18
timer set values	22
timer SV	18
timer, counter, and comparator number specifications	23
transmission procedure	3
twin timer	17, 22
V	
variable area (data range) list	36
W	
weekly timer	23
wiring	3
wiring diagram	4
write time data	29
write variable area	21
writing work bits and HR bits	26