

**SCARA Robots  
YRCX Series**

**YC-Link/E**

**USER'S MANUAL**

**OMRON**



<b>1. Overview of YC-Link/E</b>	<b>1</b>
1.1 Overview	1
1.2 Part names of YC-Link/E compatible units	2
<b>2. Installation and settings</b>	<b>3</b>
2.1 Connecting the LAN cables	3
2.2 LAN cable type	4
2.2.1 Noise prevention	4
2.3 YC-Link/E board settings	5
2.3.1 Master board settings	5
2.3.2 Slave board settings	5
2.4 About communication connector of YC-Link/E slave controller	5
2.5 CE compliance	6
2.6 Circuit examples	6
2.6.1 Category 3	7
2.6.2 Overview of circuit operation	9
<b>3. Basic specifications</b>	<b>10</b>
3.1 Basic specifications	10
3.2 YC-Link/E master	10
3.3 YC-Link/E slave	10
<b>4. Operation</b>	<b>11</b>
4.1 About power-on timing	11
4.2 Checking the communication establishment between the master and slave	12
4.2.1 LED lighting pattern of the YC-Link/E board (both slave and master)	12
4.2.2 7-segment LED display on the controller	12
4.2.3 Judgment by the dedicated output signal (MP READY)	12

---

<b>5. Troubleshooting</b>	<b>13</b>
<b>5.1 Check items at YC-Link/E start-up</b>	<b>13</b>
<hr/>	
<b>5.2 Meanings of LEDs on the YC-Link/E board</b>	<b>14</b>
5.2.1 Master board	14
5.2.2 Slave board	15
<hr/>	
<b>5.3 YC-Link/E related alarms</b>	<b>16</b>

# 1. Overview of YC-Link/E

## 1.1 Overview

### ■ About YC-Link/E

This YC-Link/E system is designed to control multiple YRCX controllers.

Robot controllers that are connected using the YC-Link/E can be controlled in the same manner as the normal YRCX series robot axes. The user can add robots or axes to the YRCX controller without notifying the number of controllers or differences.

Use of the YC-Link/E makes it possible to expand the robot system with maximum four axes (both physical axes/logical axes) using single YRCX series controller into maximum six axes (logical and physical axes, 12 axes in total) per robot and the overall system into maximum four robots and 16 axes (physical axes).

### ■ Control method

The YC-Link/E adopts an EtherCAT <sup>Note</sup> base communication method for the communication among the controllers.

Therefore, there are one master and one or more slaves, and the master controls the slaves.

The slave is identified from the master using the station number that is set with the rotary switches on the YC-Link/E slave board.

The master sends various data or commands to the slaves. A station number is written to this send data as send destination. The slave processes the received data and sends the response. When the master receives the response from the slave, to which the data was sent, the command process is completed. The master uses the synchronous control that uses the distributed clock to periodically execute this send/receive process to each slave.

### ■ YC-Link/E compatible units

The YRCX series controller with the YC-Link/E master board installed becomes the master of the YC-Link/E and the YC-Link/E slave board is installed in the YRCX series controller that becomes the slave of the YC-Link/E. The units with these interfaces are connected using the LAN cables through the multi-drop (daisy chain) to construct a network.

### ■ Features

In the YC-Link/E system, all operations to the slave YRCX series controllers are performed from the master. Therefore, the program, point data, and parameter of the robot connected to each slave are changed by accessing the master. PC applications or handy terminals cannot be connected to the slave controllers.

### ■ Compatible robots

Robots that can be controlled using the YC-Link/E system are OMRON's robots applicable to the YRCX series.

Note. EtherCAT® is registered trademark and patent technology, licensed by Beckhoff Automation GmbH, Germany.

## 1.2 Part names of YC-Link/E compatible units

### ■ YC-Link/E master board

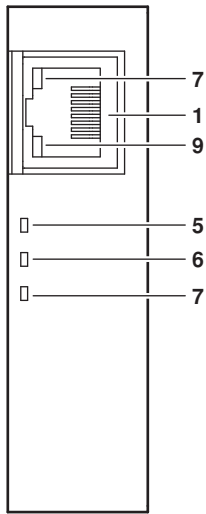

### ■ YC-Link/E slave board

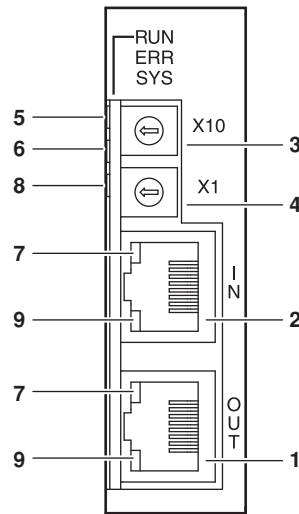

#### 1. OUT connector

A RJ-45 modular connector necessary to connect the next slave.

#### 2. IN connector

A RJ-45 modular connector necessary to connect the previous slave.

#### 3. Station number setting switch (tens digit)

A rotary switch to set the station number of the YC-Link/E slave.

#### 4. Station number setting switch (ones digit)

A rotary switch to set the station number of the YC-Link/E slave.

#### 5. RUN LED

A LED to indicate the RUN status.

#### 6. ERR LED

A LED to indicate the ERROR status.

#### 7. LINK LED

A LED to indicate the LINK status.

#### 8. SYS LED

A LED to indicate the SYSTEM status.

#### 9. Not used.

## 2. Installation and settings

This section describes how to install the YC-Link/E system. For other items, see the controller manuals.

### 2.1 Connecting the LAN cables

Connect the YC-Link/E master board and slave board with the LAN cable that satisfies the conditions specified in section "2.2 LAN cable type". Insert the modular jack of the LAN cable into the modular connector of the controller until a click sounds.

In the YC-Link/E, when connecting the master and slave or the slaves, the controller order becomes important. When purchasing the robot, the controller order is indicated on the label adhered to the YRCX.

"C1" is indicated on the YC-Link/E master controller while "C2" to "C4" are indicated on the slave controllers.

From the place more close to the master (C1), connect the slaves "C2", "C3", and "C4" in order.

Two RJ-45 modular connectors are provided on the YC-Link/E slave board. When connecting the cables, connect the cable coming from the master board to the upper IN connector and the cable coming from the subsequent slave to the lower OUT connector.



#### WARNING

PERFORM THE CABLE CONNECTION WORK AFTER THE POWER TO THE ROBOT CONTROLLER HAS BEEN SHUT DOWN COMPLETELY.



#### CAUTION

- The YC-Link/E cannot use an Ethernet hub.
- Do not connect the cable of the YC-Link/E to the Ethernet port of the controller main body.

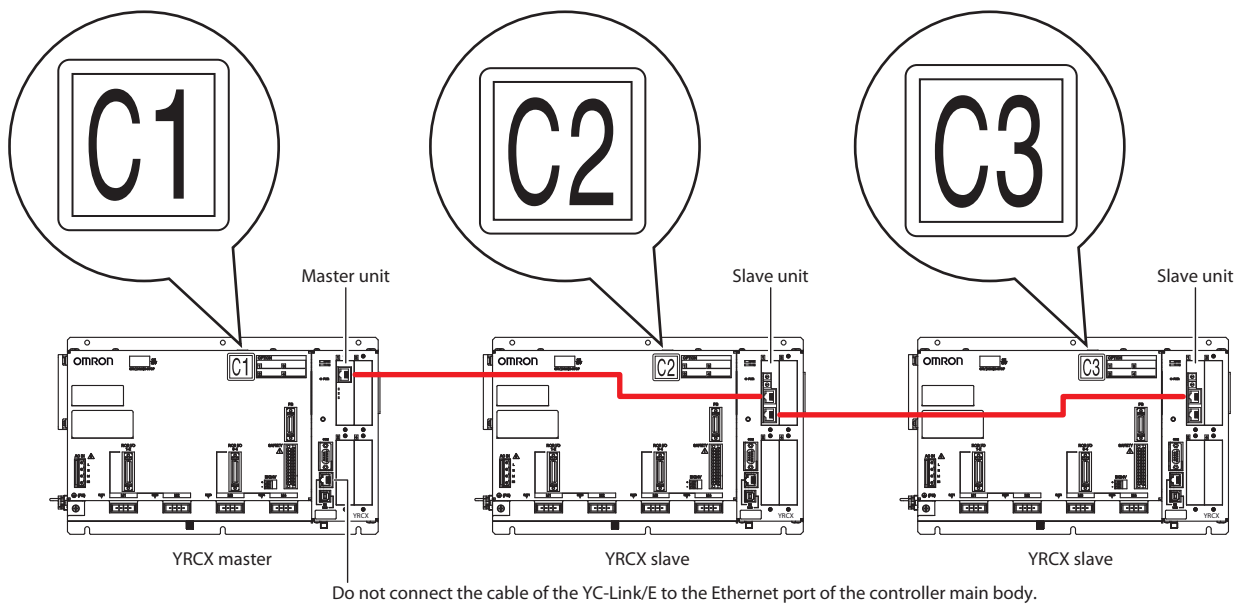

## 2.2 LAN cable type

Use a LAN cable that prevents the noise from entering the inside of the cable.

**Conditions:** CAT5E or higher

Twist pair

Dual-shield (Shielded type RJ45 modular plug)

Recommended cable: NWSMC5E-SON-S2SB-SB-\*\*\* (Straight cable) (Manufacturer: MISUMI)  
(\* shows the cable length. The cable length can be specified in 0.1m-steps.)

Recommended cable: CABLE, NETWORK (Model: KCX-M6479-10) (Manufacturer: OMRON)  
Length: 1m

### 2.2.1 Noise prevention

For the YC-Link/E system, use the shielded LAN cable with a length of 3m or less to prevent adverse effects caused by noise.

Additionally, when using the YC-Link/E system in a severe noise environment, attach a ferrite core to the shielded LAN cable.



**WARNING**

**PERFORM THE CABLE CONNECTION WORK AFTER THE POWER SUPPLY TO THE INPUT POWER CABLE HAS BEEN SHUT DOWN COMPLETELY.**



## 2.3 YC-Link/E board settings

### 2.3.1 Master board settings

When using the YRCX series controller with the YC-Link/E master board installed as YC-Link/E master, select the YRCX series controller parameter [Option]-[Option board enable] to set the YC-Link/E master board (option board) enabled.

After setting, this setting is reflected when the control power to the YRCX series controller is turned on again.

When the YRCX series controller parameter [Option board enable] is set disabled, the YRCX series controller can be operated as a single controller not as YC-Link/E master.

However, to operate the robot as a single controller, it is necessary to make the robot setting again.

The robot cannot be operated with the setting that has been used to operate the robot as a YC-Link/E system.

### 2.3.2 Slave board settings

When using the YRCX series controller with the YC-Link/E slave board installed as YC-Link/E slave, it is necessary to set the rotary switches on the YC-Link/E slave board.

Each slave of the YC-Link/E has a unique node ID and this number is used to perform the communication. Set the slave station number with the rotary switches on the YC-Link/E slave board. To set the station number, turn the arrow mark at the center of the rotary switch with a slotted screwdriver.

The upper switch indicates tens digit and the lower switch indicates ones digit. A station number ranging from 1 to 99 is set.

After changing the rotary switches, this setting is reflected when the control power to the YRCX series controller is turned on again.

When "0" is set, the YRCX series controller can be operated as a single controller not as YC-Link/E slave.

However, to operate the robot as a single controller, it is necessary to make the robot setting again.

The robot setting that has been used to operate the robot as a YC-Link/E slave is not inherited.

## 2.4 About communication connector of YC-Link/E slave controller

The YC-Link/E slave controller cannot be connected to a communication unit.

Do not connect any communication unit to the COM port, Ethernet port, or USB port of the controller.

Additionally, the programming box cannot also be used for the YC-Link/E slave unit. So, connect the dummy connector supplied with the YRCX series controller to the PB connector.

However, when the rotary switch on the YC-Link/E slave board is set at "0" and the YC-Link/E slave controller is used as a single controller, each port is capable of communication.

## 2.5 CE compliance

When controlling multiple robots using the YC-Link/E function, relevant items stated in "Control of multiple robots" of the EN ISO 10218-1 standard shall be satisfied. Additionally, the requirements shown below shall also be satisfied in the same manner as one robot.

In the customer's final system, the performance level (PLr) required of the safety circuit should be determined by means of risk assessment, and then the safety circuit with the corresponding performance level (PL) should be configured.

The following shows an example for conformance.

### 1. Single pendant control

- To control all robots with the single programming box (pendant), the programming box is connected only to the master controller so as to perform the operation. The programming box cannot be operated with the slave controller.
- To operate the robots individually or at the same time, select a relevant robot using the robot selection menu on the programming box.

### 2. Safety requirements

- To put all robots in the same operation mode, an operation mode selector switch is installed and the operation mode is input only to the master controller. The master controller sets all slave controllers in the same operation mode.
- To put all robots in the power shutdown enable status, an operation robot selector switch is installed and a power shutdown circuit that interlocks with the operation robot selector switch is installed in all robots.
- To clearly indicate the selected robot, an indicator is installed at legible location of the selected robot.

## 2.6 Circuit examples

Safety circuit examples are shown when controlling multiple robots with the YC-Link/E function.

To safely operate the robots, take safety measures suitable for the customer's equipment while referring to safety circuit configuration examples.

Examples with the following input and output signals are shown.

<b>Input</b>	Operation mode switch, door switch, external emergency stop, PBEX enable, MP RDY
<b>Output</b>	Contactors, E-STOP RDY, AUTO



#### CAUTION

The controller status output signals of the parallel I/O and serial I/O, such as alarm signal should be monitored by the host device or safety controller.

## 2.6.1 Category 3

Category 3 safety circuit examples are shown below.

### ■ Overview diagram of system (Multiple robots are used)

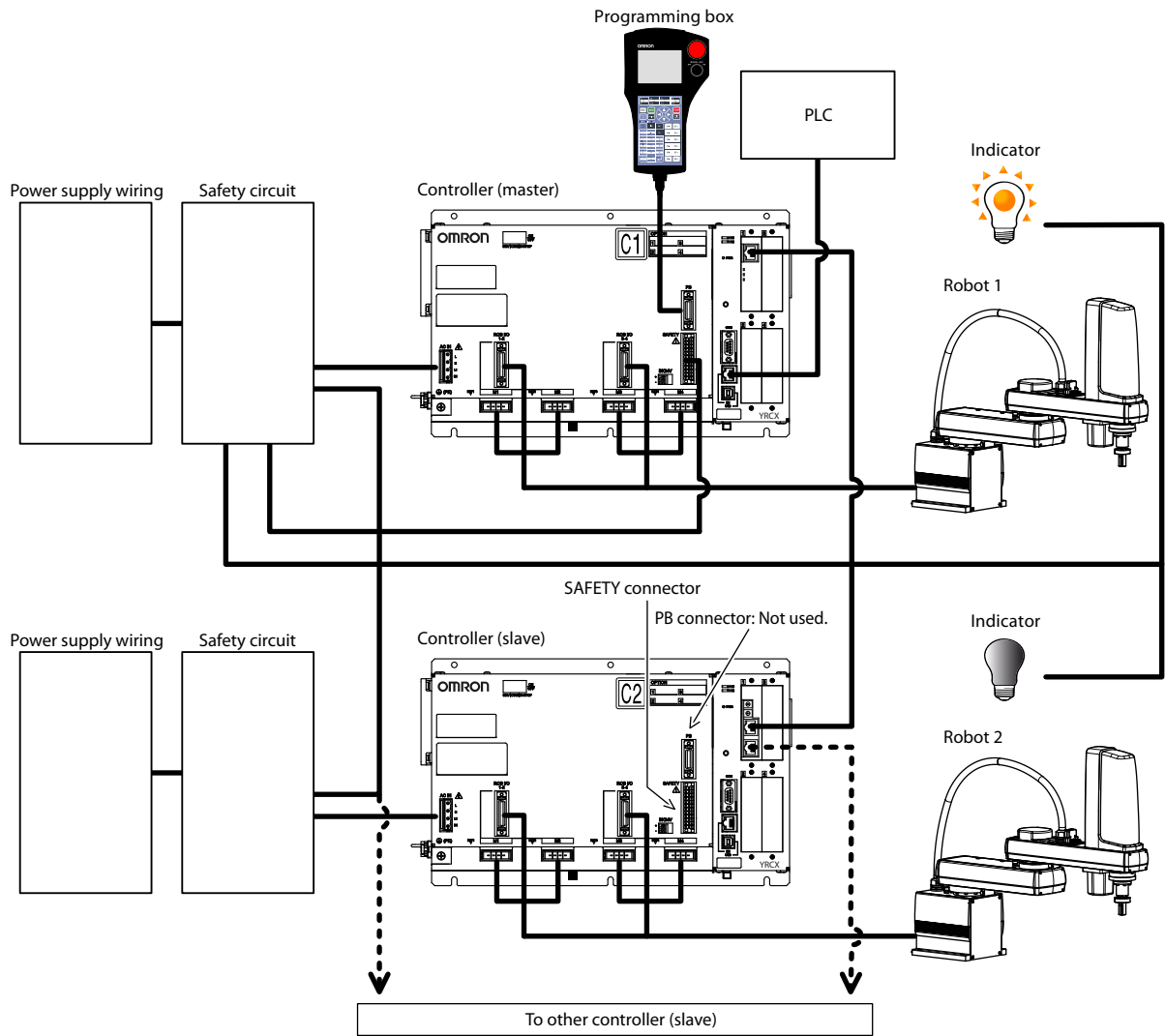

## ■ Category 3 safety circuit example (Multiple robots are used.)

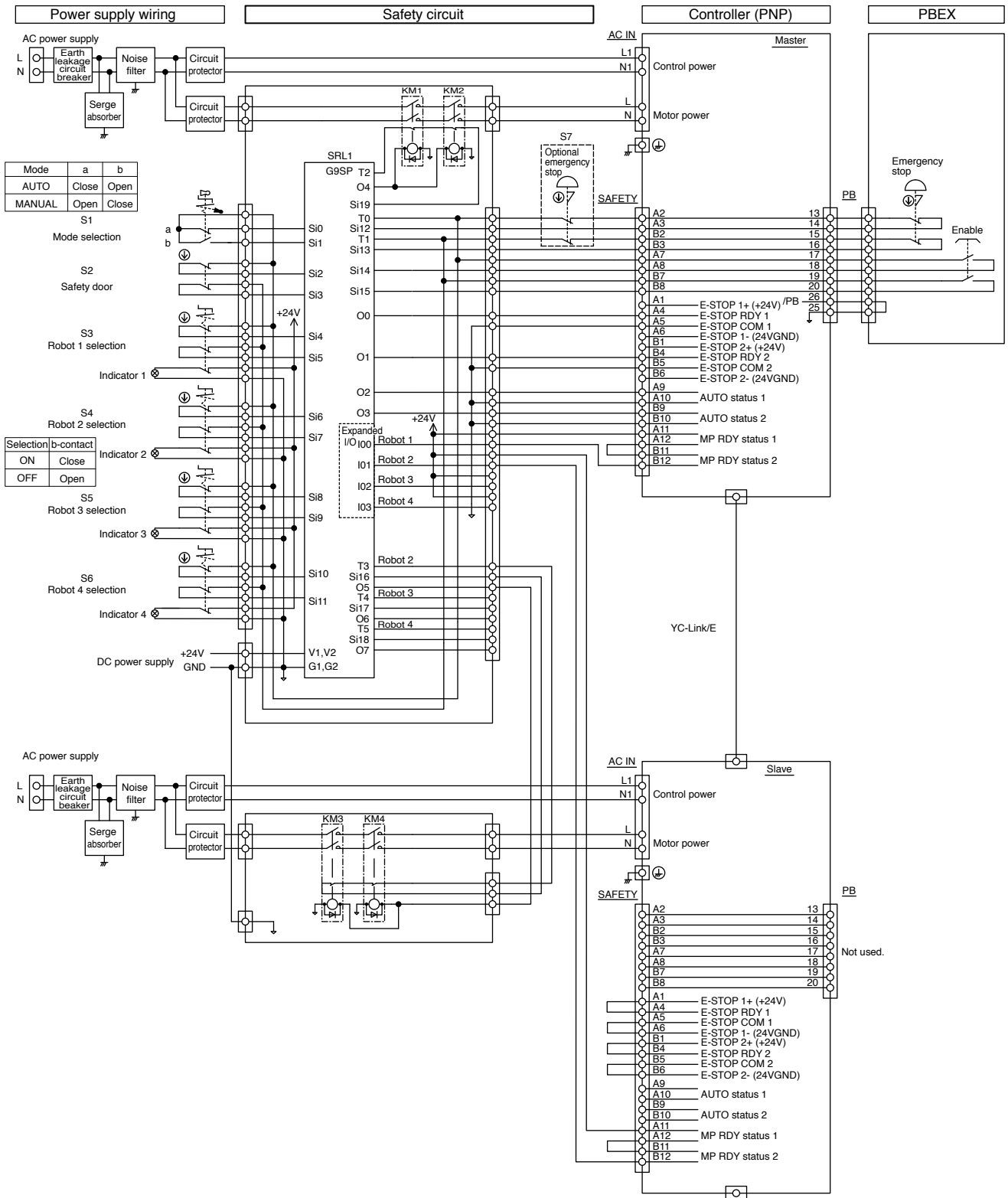

### Parts list

Circuit number	Part name	Model name	Manufacturer
S1	Key selector switch	A22TK series	OMRON
S2	Safety door switch	D4series	OMRON
S3-6	Selector switch	XB5 series	SCHNEIDER ELECTRIC
S7	Emergency stop button	A22Eseries	OMRON
KM1-4	Contactors (mirror contact)	3RTseries	SIEMENS
SRL1	Safety controller	G9SPseries	OMRON

## 2.6.2 Overview of circuit operation

The following describes the overview of the circuit operation of each safety circuit configuration example shown in the previous section.

Programs are made so that the safety controller operates as shown in the table below.

Additionally, programs are also made so that the standard requirements other than operations are also satisfied.

Operation mode		AUTO mode outside safety enclosure						MANUAL mode inside safety enclosure									
Input	Mode selector switch	Input a: Close / Input b: Open						Input a: Open / Input b: Close									
	Emergency stop button	Open	Close						Open	Close							
	Safety door	-	Open	Close						-	Close	Open					
	Enable switch	-	-	-	-	-	-	-	-	Open	Close						
	Robot 1 SEL	-	-	Close	-	-	-	-	-	-	Close	-	-	-			
	Robot 2 SEL	-	-	-	Close	-	-	-	-	-	-	Close	-	-			
	Robot 3 SEL	-	-	-	-	Close	-	-	-	-	-	-	Close	-			
	Robot 4 SEL	-	-	-	-	-	Close	-	-	-	-	-	-	Close			
	MP RDY	Robot 1	-	-	ON	-	-	-	-	-	-	ON	-	-	-		
Robot 2		-	-	-	ON	-	-	-	-	-	-	ON	-	-			
Robot 3		-	-	-	-	ON	-	-	-	-	-	-	ON	-			
Robot 4		-	-	-	-	-	ON	-	-	-	-	-	-	ON			
Output	AUTO mode	ON						OFF									
	E-STOP RDY	OFF	OFF	ON				OFF	OFF	OFF	ON						
	Contactor	Robot 1	OFF	OFF	ON	-	-	-	OFF	OFF	OFF	ON	-	-	-		
		Robot 2	OFF	OFF	-	ON	-	-	OFF	OFF	OFF	-	ON	-	-		
		Robot 3	OFF	OFF	-	-	ON	-	OFF	OFF	OFF	-	-	ON	-		
Robot 4		OFF	OFF	-	-	-	ON	OFF	OFF	OFF	-	-	-	ON			

### 1. Emergency stop operation

When the emergency stop button is pressed, the main power (motor drive power) to the controller is shut down.

Regardless of other switch settings, when pressing the emergency stop button, the emergency stop with category 0 is activated immediately.

### 2. Each mode operation by setting the mode selector switch

#### 2.1 AUTO mode (The mode selector switch is "Input a: Close, Input b: Open".)

The enable switch on the PBEX is disabled, and the contactor turns on and the main power (motor drive power) is supplied to the controller only when all conditions shown below are satisfied.

##### Conditions

- The emergency stop switch is closed.
- The safety door is closed.
- The robot selector switch is ON (close) and the MP RDY is ON (output from the controller when the controller main power is ready to turn on).



##### CAUTION

Connect the PBX terminator or PBEX to the PB connector on the front of the master controller. When the PB connector of the master controller is open, the operation enters the emergency stop status.

#### 2.2 MANUAL mode (The mode selector switch is "Input a: Open, Input b: Close".)

The enable switch on the PBEX is enabled, and the contactor turns on and the main power (motor drive power) is supplied to the controller only when all conditions shown below are satisfied.

##### Conditions

- The emergency stop switch is closed.
- The safety door is open.
- The robot selector switch is ON (close) and the MP RDY is ON (output from the controller when the controller main power is ready to turn on).
- The enable switch on the PBEX is closed (intermediate position).



##### CAUTION

Be sure to disconnect the PBX terminator from the PB connector on the front of the master controller, and connect the PBEX.

## 3. Basic specifications

### 3.1 Basic specifications

Communication cycle	1ms
Control cycle	Min. 1ms/Max. 8ms These values may depend on the robot configuration and controller configuration.
Max. number of robots	4 robots
Max. number of controllable axes	16 axes in total (including 4 axes of the master controller) Max. 12 axes only when using the slave
Option boards that can be used for the YC-Link/E and their operating conditions	Max. 3 PIO boards (This board cannot be installed in the slave controller.) Max. 1 SIO board (This board cannot be installed in the slave controller.) Max. 3 gripper boards (This board cannot be installed in the slave controller.)

### 3.2 YC-Link/E master

Only the YRCX series controller with the YC-Link/E master board option installed becomes the YC-Link/E master.

Topology	Line (daisy chain) only
Data flow	Line: Flows from the master to the first slave and turns up after reached the last slave.
Communication media	Twist pair cable with braided using CAT5e or higher and double-shielded using the aluminum tape
Communication rate	Full duplex, 100Mbit/s
Cycle time	Fixed at 1ms.
Synchronization	DC synchronization 1 using the Distributed Clock in the EtherCAT communication is supported.

### 3.3 YC-Link/E slave

The YRCX series controller with the YC-Link/E slave option installed becomes the YC-Link/E slave.

## 4. Operation

The YC-Link/E system is controlled with the master YRCX series controller. In the YC-Link/E system, when the master and slaves are turned on, the communication establishment process is performed automatically. After the communication has been established, the robot can be operated.

For details about basic operating procedures, see the YRCX series controller manual.

The following describes the YC-Link/E system specific operating procedures and cautions.

### 4.1 About power-on timing

The master controller checks the slave connection at start-up. Therefore, turn on the slave power at the latest until the control power to the master controller turns on. When the master and slave turn on at the same time, it takes a long time to establish the communication, but this is not a problem. (For details, see section "4.2.1 LED lighting pattern of the YC-Link/E board (both slave and master)".)

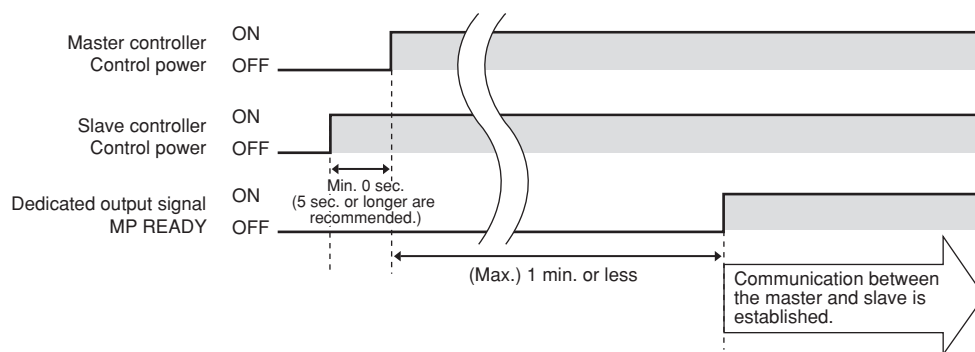

## 4.2 Checking the communication establishment between the master and slave

Use the procedures below to check the communication status among the controllers in the YC-Link/E system.

1. LED lighting pattern of the YC-Link/E boards (both the slave and master boards)
2. 7-segment LED display on the controller
3. Judgment by the dedicated output signal (MP READY)

The following describes how to make the judgment by each procedure.

### 4.2.1 LED lighting pattern of the YC-Link/E board (both slave and master)

#### ■ Master board

The RUN\_LED and ERR\_LED on the master board are lit at the same time immediately after the power has been turned on. When the internal process has been completed, the RUN\_LED starts flashing.

After that, when the slave presence is checked and the communication establishment preparation process is started, the ERR\_LED is off and the RUN\_LED flashes repeatedly at a high speed at intervals of 50ms. The communication is not established while the RUN\_LED is flashing at intervals of 50ms.

Additionally, the LINK\_LED is lit when the master and slave are connected with the cable.

When the communication is established, the RUN\_LED is lit, the ERR\_LED is off, and the LINK\_LED flashes. In this case, the master communicates with at least one slave correctly.

#### ■ Slave board

The SYS\_LED on the slave board is lit approximately 5 sec. after the power has been turned on.

If the SYS\_LED is not lit, the controller may malfunction.

The ERR\_LED starts flashing at about the same timing (uneven intervals). In this status, the communication with the master can be started correctly.

When the communication starts correctly, the RUN\_LED starts flashing at a high speed <sup>Note 1</sup>. After that, the RUN\_LED flashes at a low speed, and then it is lit when the connection is completed.

#### TIP

When both the master and slave controllers are turned on and the connection with the LAN cable is completed before the ERR\_LED on the slave flashes, the master board starts sending the communication packet. However, the slave disposes of the packet that is sent in this status. The master that confirms this disposal performs the re-connection process.

Therefore, when both the slave and master are turned on at the same time, it takes approximately 25 sec. to complete the connection.

Note 1 This high-speed flashing may not be recognized depending on the communication connection status, but this is not a problem.

### 4.2.2 7-segment LED display on the controller

The 7-segment LED on the master controller displays the emergency stop status, servo off, and return-to-origin incomplete status until the communication with the slave is established. After the communication has been established, the slave status is checked and the status of the overall system including the robot to be moved by the slave is displayed.

The number "S.\*\*" ("\*\*" shows the set numeric value) that is set using the rotary switches on the slave board is displayed and flashes on the 7-segment LED on the slave controller.

When the communication with the master is established, the flashing status changes to the lit status.

#### TIP

When the connection to the slave is failed, the master executes the connection retry process only once. (E19) and (400) are alternately displayed on the 7-segment LED on the slave controller during retry process. When the communication status has no problem, this means that the communication with the master is established.

### 4.2.3 Judgment by the dedicated output signal (MP READY)

MP READY signal is provided at number SO04 of the SIO input/output used for the safety connector of the master controller and the option board of the field network. When using the YC-Link/E, this signal is output as the communication between the master and slave is established and the operation enters the servo on enable status.

The host unit uses this signal to judge that the communication between the master and slave of the YC-Link/E is established.



# 5. Troubleshooting

## 5.1 Check items at YC-Link/E start-up

If the communication is not established or the robot cannot be controlled even after the YC-Link/E has been started up while referring to the operating procedures stated in this manual, check the following items in addition to the YRCX series controller status.

1. How are the LEDs on the YC-Link/E board lighting?
2. Does any alarm occur?
3. Does the master communicate with all slaves?

The following shows each check item in detail.

### 1. How are the LEDs on the YC-Link/E board lighting?

Check the status and take corrective actions while referring to sections "4.2.1 LED lighting pattern of the YC-Link/E board (both slave and master)" and "5.2 Meanings of LEDs on the YC-Link/E board".

### 2. Does any alarm occur?

An alarm may occur in the controller or an alarm unique to the YC-Link/E may occur.

Remove the cause of the trouble while referring to the YRCX series controller manual and section "5.3 YC-Link/E related alarms" in this manual.

### 3. Does the master communicate with all slaves?

Even when the number of slaves set in the master is different from the number of communication established slaves, the YC-Link/E enters the communication establishment status. Therefore, even when the communication is established, the master may not exchange the information with all slaves.

Use the programming box, PC application, or host unit and perform either procedure shown below to check that the communications with all connected slaves are established.

1. The current position information of the robots connected to all slave controllers is updated.
2. The version information of all slave controllers is read-out.

## 5.2 Meanings of LEDs on the YC-Link/E board

The following describes the LEDs on the YC-Link/E compatible unit.

These LEDs are used to check the communication status or take troubleshooting actions in case of an error.

### 5.2.1 Master board

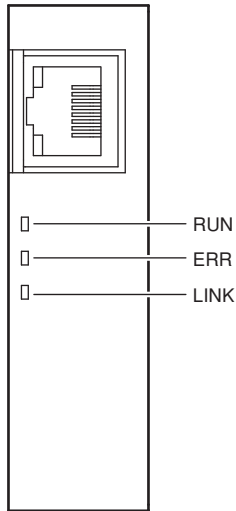

LED type	Color	Lighting	Meaning and corrective action
RUN	Green	Lit.	Meaning: Communicating with the slave. Corrective action: Operate as it is.
		Flashing (50ms intervals)	Meaning: Preparing the communication establishment Corrective action: 1. Please wait. 2. If the ERR LED is lit, check the alarm and take corrective actions according to the displayed alarm. 3. Turn off both the master and slave, and turn them on again.
		Flashing (200ms intervals)	Meaning: The power is turned on, but the communication is not established. Corrective action: 1. If the ERR LED is lit, check the alarm and take corrective actions according to the displayed alarm. 2. Turn off both the master and slave, and turn them on again.
ERR	Red	Lit.	Meaning: Communication stops. Corrective action: 1. Check that the slave is turned on. 2. Check that the cables are connected correctly. 3. After checking 1. and 2. shown above, turn off the controller, and turn it on again.
		Off	Meaning: 1. No error occurs. 2. The power is not turned on. Corrective action: 1. Operate as it is. 2. Turn on the power.
LINK	Green	Lit.	Meaning: The LAN cable is connected to the ports on the master and slave. Corrective action: Operate as it is.
		Off	Meaning: The LAN cable is not connected between the master and slave or the cable is broken. Corrective action: 1. Connect the cable. 2. Replace the LAN cable.

## 5.2.2 Slave board

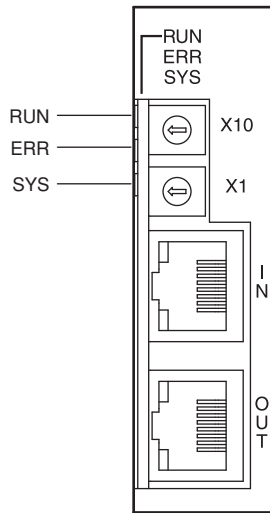

LED type	Color	Lighting	Meaning and corrective action
SYS	Green	Always lit.	Meaning: Normal status Corrective action: Operate as it is.
	Green and red	Lit alternately.	Meaning: Failed to start up correctly. Corrective action: 1. Turn off both the master and slave controllers, and turn them on again. 2. The controller may malfunction.
	Red	Always lit	Meaning: Failed to start up correctly. Corrective action: 1. Turn off both the master and slave controllers, and turn them on again. 2. The controller may malfunction.
	Green and red	Off	Meaning: The slave board is not turned on. Corrective action: 1. Check that both the master and slave controllers are turned on. 2. The controller may malfunction.
RUN	Green	Off	Meaning: INIT status. The communication of the YC-Link/E is not established. Corrective action: If the status does not change after a while, check the cable connections. After that, turn off the master and turn it on again or make the connections again.
		Flashing (ON/OFF at even intervals)	Meaning: PRE-OPERATIONAL status. The communication of the YC-Link/E is not established. Corrective action: If the status does not change after a while, check the cable connections. After that, turn off the master and turn it on again or make the connections again.
		Flash once (Lit instantaneously. Off time is long.)	Meaning: SAFE-OPERATIONAL status. The communication of the YC-Link/E is not established. Corrective action: If the status does not change after a while, check the cable connections. After that, turn off the master and turn it on again or make the connections again.
		Always lit.	Meaning: OPERATIONAL status. The communication of the YC-Link/E is establishing or has been established once. Corrective action: If the communication is not established, check the ERR LED status.
ERR	Red	Off	Meaning: No error occurs.
		Flashing (ON/OFF at even intervals)	Meaning: Failed to start the communication with the master. Corrective action: 1. Check the master power and communication states. 2. Please wait for a while until the communication starts. 3. If the communication does not start even after 1 min. or longer has elapsed, turn off both the master and slave controllers, and turn them on again.
		Flash once. (Lit instantaneously. Off time is long.)	Meaning: Failed to establish the communication. Corrective action: 1. Turn off both the master and slave controllers, and turn them on again. 2. The controller may malfunction.
		Flash twice. (Lit instantaneously. Off time is long.)	Meaning: Watch dog error occurs. Corrective action: 1. Check the cable for faulty wiring. 2. Check that the master is turned on.

## 5.3 YC-Link/E related alarms

This section describes the error messages related to the YC-Link/E system.

### 0.0 : OK

Code: &H0000 &H0000

<b>Meaning/Cause</b>	Correct status. No alarm occurs.
<b>Corrective action</b>	—

### 19.400 : YC/E SLAVE CONNECTING RETRY

Code: &H0013 &H0190

<b>Meaning/Cause</b>	The YC-Link/E slave is retrying the connection establishment with the master.
<b>Corrective action</b>	Retrying the connection. Please wait.

### 19.500 : YC/E MASTER PORT OPEN FAIL

Code: &H0013 &H01F4

<b>Meaning/Cause</b>	The communication port of the YC-Link/E master board does not open within a certain period of time (about 20sec.).
<b>Corrective action</b>	Check that the master and slave are connected with the cables. Check that the slave is turned on.

### 19.501 : YC/E SLAVE INITIALIZE FAIL

Code: &H0013 &H01F5

<b>Meaning/Cause</b>	The communication failed in the initialization process of the YC-Link/E connection.
<b>Corrective action</b>	Restart the controller. Take noise preventive measures. Replace the slave option board.

### 19.502 : YC/E SLAVE PORT WRONG

Code: &H0013 &H01F6

<b>Meaning/Cause</b>	The IN port and OUT port of the YC-Link/E slave are used incorrectly.
<b>Corrective action</b>	Check the connection. Connect the cables to the correct ports.

### 19.800 : YC/E SEND DATA CHECKSUM ERROR

Code: &H0013 &H0320

<b>Meaning/Cause</b>	The checksum error occurred in the data sent from the YC-Link/E master.
<b>Corrective action</b>	After taking noise preventive measures, reset the alarm. Replace the controller.

### 19.801 : YC/E RECEIVE DATA CHECKSUM ERROR

Code: &H0013 &H0321

<b>Meaning/Cause</b>	The checksum error occurred in the data received by the YC-Link/E master. (Host check)
<b>Corrective action</b>	After taking noise preventive measures, reset the alarm. Replace the controller.

**19.802 : YC/E WORKING COUNTER ERROR**

Code: &amp;H0013 &amp;H0322

<b>Meaning/Cause</b>	The YC-Link/E master could not send the data correctly. Or, the slave could not receive the data correctly.
<b>Corrective action</b>	Replace the master board or slave board.

**19.805 : YC/E MASTER RECEIVE CHECKSUM ERROR**

Code: &amp;H0013 &amp;H0325

<b>Meaning/Cause</b>	The checksum error occurred in the data received by the YC-Link/E master. (Master check)
<b>Corrective action</b>	After taking noise preventive measures, reset the alarm. Replace the controller.

**19.900 : YC/E MASTER BOARD WATCHDOG ERROR**

Code: &amp;H0013 &amp;H0384

<b>Meaning/Cause</b>	The data was not sent from the master board of the YC-Link/E for a certain period of time.
<b>Corrective action</b>	Check the LAN cable for disconnection. Take noise preventive measures. Replace the master board.

**19.901 : YC/E MASTER INTERRUPT FAIL**

Code: &amp;H0013 &amp;H0385

<b>Meaning/Cause</b>	The master board of the YC-Link/E could not receive the data from the HOST CPU for a certain period of time.
<b>Corrective action</b>	Check the LAN cable for disconnection. Take noise prevention measures. Replace the master board.

**19.902 : YC/E MASTER DATA SEND FAIL**

Code: &amp;H0013 &amp;H0386

<b>Meaning/Cause</b>	The master board of the YC-Link/E could not send the data for a certain period of time.
<b>Corrective action</b>	Check the LAN cable for disconnection. Take noise preventive measures. Replace the master board.

**19.903 : YC/E MASTER DATA RECEIVE FAIL**

Code: &amp;H0013 &amp;H0387

<b>Meaning/Cause</b>	The return of the data packet sent from the master board of the YC-Link/E could not received for a certain period of time.
<b>Corrective action</b>	Check the LAN cable for disconnection. Take noise preventive measures. Replace the master board.

**19.904 : YC/E MASTER SEND DATA DESTROY**

Code: &amp;H0013 &amp;H0388

<b>Meaning/Cause</b>	The return of the data packet sent from the master board of the YC-Link/E was different from its sent status.
<b>Corrective action</b>	Take noise preventive measures. Replace the master board.

---

**19.905 : YC/E MASTER RECEIVE DATA DESTROY**

Code: &amp;H0013 &amp;H0389

<b>Meaning/Cause</b>	The format of the data received by the master board of the YC-Link/E was faulty.
<b>Corrective action</b>	Take noise preventive measures. Replace the master board.

---

**19.906 : YC/E INVALID SLAVE EXIST**

Code: &amp;H0013 &amp;H038A

<b>Meaning/Cause</b>	Slave that cannot be used exists in the slaves of the YC-Link/E.
<b>Corrective action</b>	Remove the inapplicable slave.

---

**19.907 : YC/E SLAVE UNCONFORMITY**

Code: &amp;H0013 &amp;H038B

<b>Meaning/Cause</b>	The controller mode setting on the master controller of the YC-Link/E is different from that on the slave controller.
<b>Corrective action</b>	Replace the controller.

---

**19.908 : YC/E SLAVE CONFIG MISMATCH**

Code: &amp;H0013 &amp;H038C

<b>Meaning/Cause</b>	The number of controllers set in the master of the YC-Link/E is different from the number of actually connected controllers.
<b>Corrective action</b>	Change the parameter setting or turn off the power, and turn it on again after matching the number of slaves to the setting.

---

**19.909 : YC/E SLAVE POWER LOW**

Code: &amp;H0013 &amp;H038D

<b>Meaning/Cause</b>	The control power voltage of the YC-Link/E slave dropped.
<b>Corrective action</b>	Check the power supply of the slave, and turn off both the master and slave, and turn them on again.

---

**19.910 : YC/E SYSTEM POWER TURN ON AGAIN**

Code: &amp;H0013 &amp;H038E

<b>Meaning/Cause</b>	The slave of the YC-Link/E does not communicate. Only the master might be turned off, and then it might be turned on again.
<b>Corrective action</b>	Turn off both the master and slave, and turn them on again.

---

**19.920 : YC/E MASTER SLAVE LOOSE CONNECTION**

Code: &amp;H0013 &amp;H0398

<b>Meaning/Cause</b>	The connection between the master and slave of the YC-Link/E was faulty.
<b>Corrective action</b>	Turn off both the master and slave, and turn them on again.

---

**19.993 : YC/E MASTER UNKNOWN ERROR**

Code: &amp;H0013 &amp;H03E1

<b>Meaning/Cause</b>	An unknown error occurred in the YC-Link/E.
<b>Corrective action</b>	Inform your distributor of the situation.

---







## Revision history

A manual revision code appears as a suffix to the catalog number on the front cover manual.

Cat. No. I248E-EN-01A

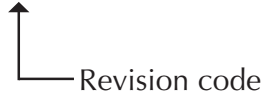

The following table outlines the changes made to the manual during each revision.

Revision code	Date	Description
01	July 2016	Original production
01A	February 2018	Small corrections





# OMRON

**Authorized Distributor:**