

**SCARA Robots
YRCX Series**

Tracking System

USER'S MANUAL

OMRON

Introduction	1
Safety cautions and marks	2
1. Warranty	3
1. Overview	5
1.1 Features and functions	5
1.2 System configuration	6
1.2.1 Tracking System configuration	6
1.2.2 Robot configuration when using the Tracking System	7
1.3 Component names and functions	7
1.4 Required items	8
2. Preparations for Tracking System use	9
3. Connections	10
3.1 Wiring	10
3.1.1 Wiring the AB phase input connector	10
3.1.2 Wiring the optional AB phase input cable (Type: KX0-M66AF-00)	11
3.2 Connecting and removing the AB phase input cable connector	11
3.2.1 Connecting the AB phase input cable connector	11
3.2.2 Disconnecting the AB phase input cable connector	12
3.3 Verifying the robot controller settings	12
4. Parameter	13
4.1 Parameter list	13
4.2 Parameter settings	13
4.3 Parameter details	14
5. Conveyor calibration	16
5.1 Interactive conveyor calibration setting method	18
5.2 Editing conveyor calibration data	24
6. Tracking Monitor	25
7. Robot language commands	26
7.1 Robot language command list	26
7.2 Position monitoring queue and queue element	27
7.2.1 Adding queue elements	28
7.2.2 Deleting robot position data from queue elements	29
7.2.3 Deleting queue elements	29

CONTENTS

7.3 Robot language command details	29
7.3.1 CADDIST	29
7.3.2 CADDQUE	30
7.3.3 CADDQUEV (Reserved)	32
7.3.4 CADDRSLT	33
7.3.5 CCHKQUE	34
7.3.6 CCLRRBT	35
7.3.7 CCOND	35
7.3.8 CGETPULS	36
7.3.9 CGETQUE	36
7.3.10 CGETRATE	37
7.3.11 CGETTAG	37
7.3.12 CGETVELX	37
7.3.13 CGETVELY	38
7.3.14 CQUECNT	39
7.3.15 CRMVQUE	39
7.3.16 CRSTPULS	40
7.3.17 CSETTAG	40
7.3.18 CTDRIVE	40
7.3.19 CTMOVE	42
7.3.20 CTRKEMGN	44
7.3.21 CTRKPADJ	45
7.3.22 CTRKSMGN	46
7.3.23 CTSTOP	46
7.3.24 CTVISION (Reserved)	47
7.3.25 CVELCOEF	47
7.4 Sample programs	48
7.4.1 One robot picks and places the workpiece	48
<hr/>	
8. Troubleshooting	52
8.1 Alarm messages	52
8.2 When trouble occurs	56
8.3 Troubleshooting	57
<hr/>	
9. Specifications list	57
<hr/>	

Introduction

Thank you for purchasing the Tracking System OMRON Robot Controller. Please read this manual carefully before using the Tracking System in order to ensure correct and safe operation. Store this manual where it can be easily accessed for reference, and make sure that it is delivered to the end user.



Before using this product, read this manual and related manuals and take safety Precautions to ensure correct handling.







Although care has been taken to ensure the accuracy of this manual content, please contact your distributor if content errors are found.

Refer to the relevant user's manuals for information regarding the robot, and regarding subjects other than the installation, operations, and adjustments inherent to the Tracking System. Refer to the OMRON Robot Controller YRCX Programming Manual for robot language information beyond basic items such as the robot language command statement format, variables, and constants, and for information outside the scope of the Tracking System's inherent robot language.

Safety cautions and marks

This manual uses the symbol marks shown below to indicate safety instructions which must be heeded, and to specify handling cautions, prohibitions, instructions, and important procedural points, etc. Please familiarize yourself with the meanings of these symbols before reading the manual.

	DANGER	This indicates an immediately hazardous situation which, if not avoided, will result in death or serious injury.
	WARNING	This indicates a potentially hazardous situation which, if not avoided, could result in death or serious injury.
	CAUTION	This indicates a potentially hazardous situation which, if not avoided, could result in minor or moderate injury, or damage to the equipment.

Examples	Meaning
  Fire hazard Electric shock hazard	<p>These warning symbols indicate a caution or warning you must heed.</p> <p>The specific caution or warning is often indicated by a pictorial sign. Always follow these instructions to ensure correct and safe product use.</p>
  No disassembly No wet hands	<p>These symbols indicate a prohibited action.</p> <p>The specific prohibited action is often indicated by a pictorial sign. Never attempt the prohibited action.</p>
  Mandatory action Cut off power	<p>This symbol indicates a mandatory action.</p> <p>The specific instruction is often indicated by a pictorial sign. Read the instructions carefully and always use the specified procedure.</p>

This manual also uses the following marks to indicate key points and tips for operation.

	NOTE	Explains the key point in the operation in a simple and clear manner.
	TIP	Gives supplementary information related to robot controller operation.

1. Warranty

The OMRON robot and/or related product you have purchased are warranted against the defects or malfunctions as described below.

■ Warranty description

If a failure or breakdown occurs due to defects in materials or workmanship in the genuine parts constituting this OMRON robot and/or related product within the warranty period, then OMRON shall supply free of charge the necessary replacement/ repair parts.

■ Warranty period

The warranty period ends 24 months after the date of manufacturing as shown on the products.

■ Exceptions to the warranty

This warranty will not apply in the following cases:

1. Fatigue arising due to the passage of time, natural wear and tear occurring during operation (natural fading of painted or plated surfaces, deterioration of parts subject to wear, etc.)
2. Minor natural phenomena that do not affect the capabilities of the robot and/or related product (noise from computers, motors, etc.)
3. Programs, point data and other internal data were changed or created by the user.

Failures resulting from the following causes are not covered by warranty.

1. Damage due to earthquakes, storms, floods, thunderbolt, fire or any other natural or man-made disaster.
2. Troubles caused by procedures prohibited in this manual.
3. Modifications to the robot and/or related product not approved by OMRON or OMRON sales representative.
4. Use of any other than genuine parts and specified grease and lubricant.
5. Incorrect or inadequate maintenance and inspection.
6. Repairs by other than authorized dealers.

WARRANTY

OMRON's exclusive warranty is that the products are free from defects in materials and workmanship for a period of one year (or other period if specified) from date of sale by OMRON.

OMRON MAKES NO WARRANTY OR REPRESENTATION, EXPRESS OR IMPLIED, REGARDING NONINFRINGEMENT, MERCHANTABILITY, OR FITNESS FOR PARTICULAR PURPOSE OF THE PRODUCTS. ANY BUYER OR USER ACKNOWLEDGES THAT THE BUYER OR USER ALONE HAS DETERMINED THAT THE PRODUCTS WILL SUITABLY MEET THE REQUIREMENTS OF THEIR INTENDED USE. OMRON DISCLAIMS ALL OTHER WARRANTIES, EXPRESS OR IMPLIED.

LIMITATIONS OF LIABILITY OMRON SHALL NOT BE RESPONSIBLE FOR SPECIAL, INDIRECT OR CONSEQUENTIAL DAMAGES, LOSS OF PROFITS OR COMERCIAL LOSS IN ANY WAY CONNECTED WITH THE PRODUCTS, WETHER SUCH CLAIM IS BASED ON CONTRACT, WARRANTY, NEGLIGENCE OR STRICT LIABILITY.

In no event shall the responsibility of OMRON for any act exceed the individual price of the product on which liability is asserted. IN NO EVENT SHALL OMRON BE RESPONSIBLE FOR WARRANTY, REPAIR OR OTHER CLAIMS REGARDING THE PRODUCTS UNLESS OMRON'S ANALYSIS CONFIRMS THAT THE PRODUCTS WERE PROPERLY HANDLED, STORED, INSTALLED AND MAINTAINED AND NOT SUBJECT TO CONTAMINATION, ABUSE, MISUSE OR INAPPROPRIATE MODIFICATION OR REPAIR.

1. Overview

1.1 Features and functions

The OMRON robot controller "Tracking System" is a dedicated board that is installed in the YRCX robot controller to track the conveyor based on counter information obtained from the conveyor's encoder. By using this system, the preliminary man-hours required for the robot to handle a workpiece can be greatly reduced.

■ Easy conveyor calibration

"Conveyor calibration" refers to the process in which the conveyor coordinates are aligned with the robot coordinates. With this Tracking System, the conveyor calibration can be completed easily in a short time using interactive operations with the programming box.

■ Various operations controlled in the robot language

The conveyor tracking can be controlled using a robot language dedicated to the Tracking System.

1.2 System configuration

1.2.1 Tracking System configuration

The Tracking System enables a system configuration like that shown below.

System configuration illustration (Example)

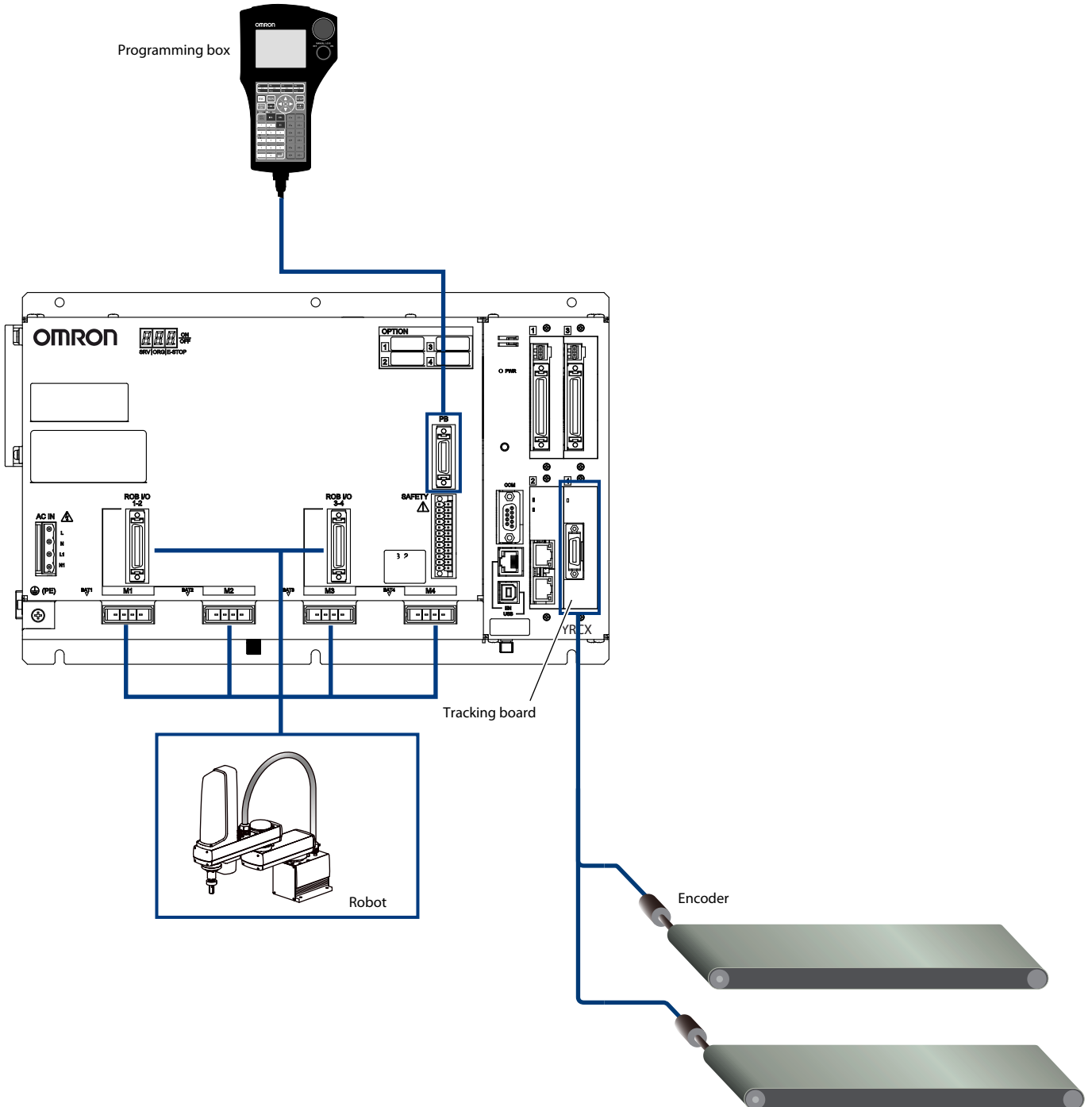

* Connections to the STD.DIO, ACIN, and SAFETY connectors are not shown in the above illustration.

1.2.2 Robot configuration when using the Tracking System

■ Robot configuration when using the Tracking System

The axis configuration of the robot using the Tracking System is limited.

Although a robot purchased for use with a Tracking System can be used without modification, the robot axis configuration must be confirmed if adding a Tracking System to an existing robot.

Contact your distributor for more information when adding a Tracking System to an existing robot.

■ Robot axis configuration when using a Vision System

As shown in the figure below, the standard coordinates of SCARA robots must be set such that the Y-axis plus direction is set at 90 degrees counterclockwise with respect to the X-axis plus direction. Also, the R-axis plus direction must be set counterclockwise.

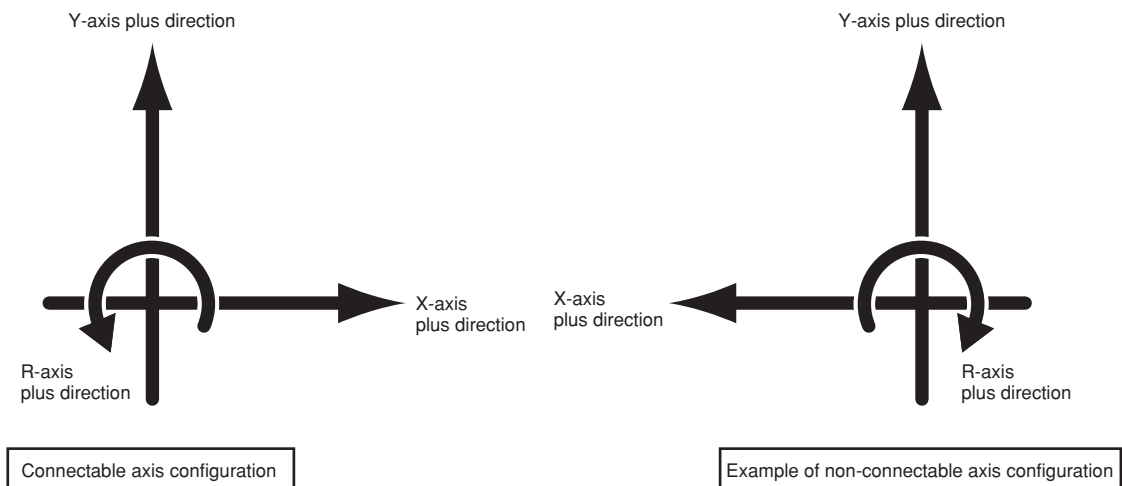

1.3 Component names and functions

This section explains the names and functions for each component of the tracking board.

Names and functions of tracking board components

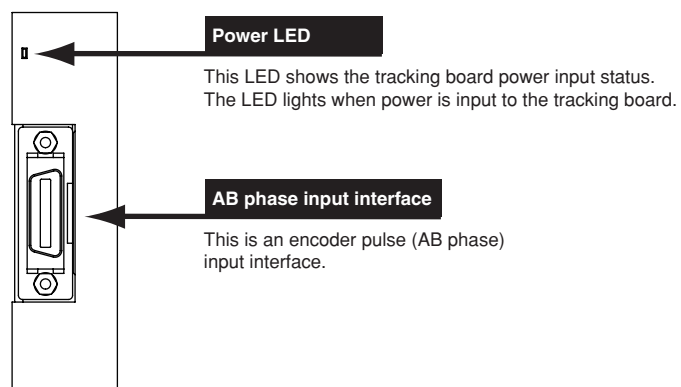

1.4 Required items

The following items are required for conveyor tracking.

1. YRCX tracking board

The tracking board is used to add the conveyor tracking function to the YRCX robot controller.

[Tracking board accessories]

AB phase input cable connector

Type: KX0-M657L-20 1 piece

AB phase input cable connector case

Type: KX0-M657M-20 1 piece

} Set type: KX0-M657K-20

2. Encoder

In this manual, the encoder used for tracking is called a counter.

The encoder connected to the tracking board ch1 is Counter 1, and the encoder connected to ch2 is Counter 2.

Use an encoder that satisfies the following conditions.

Power supply	: 5V DC
Current consumption	: A total of less than 500mA for two counters
Output phase	: A, \bar{A} , B, \bar{B} , Z, \bar{Z}
Output format	: Line driver output (RS422 compliant: with built-in 26LS31 or 26C31 or equivalent)
Max. response frequency	: 2MHz or less

3. Encoder input cable

[Recommended cable]

Shielded twisted pair multi cable: 0.3SQ SPMCU-08 (KANEKO CORD CO., LTD.)

Except for the encoder connection, the cable should be connected directly (no relay).

For the AB phase input cable, a cable already wired to the AB phase input cable connector is available as an optional part.

[Optional AB phase input cable]

Type: KX0-M66AF-00, dedicated cable for connecting Counter 1 (10m)

Refer to section "3.1 Wiring" for details on wiring.

2. Preparations for Tracking System use

This section explains the basic preparation procedures from the point when the Tracking System is purchased, until it is operated. The preparation items are as shown in the illustration below. Refer to the relevant user's manuals for information regarding robot operation and regarding subjects other than the installation, operation, and adjustment procedures inherent to the Tracking System.

	Basic procedures	Refer to:
Installation, connection, wiring	<div style="border: 1px solid black; padding: 5px;">Install the controller.</div> <div style="border: 1px solid black; padding: 5px;"> <ul style="list-style-type: none"> Connect the cables and connectors. Ground the controller. Create an emergency stop circuit. </div> <div style="border: 1px solid black; padding: 5px; margin-left: 200px;">Connect the cables and connectors.</div>	3.1 Wiring
	<div style="border: 1px solid black; padding: 5px;">Specify station number and baud rate settings, etc., which are required when equipped with a serial I/O board. (Settings vary according to the serial I/O board type used.)</div>	
Power ON	<div style="border: 1px solid black; padding: 5px;">Verify that the wiring and power supply voltage are correct, then turn the power on.</div> <div style="border: 1px solid black; padding: 5px;">Verify no alarms have been activated after the power was turned on (operation check).</div>	
	<div style="border: 1px solid black; padding: 5px;">Verify the robot type</div> <div style="border: 1px solid black; padding: 5px;">Verify that the robot type specified at the robot controller matches the type of robot actually being used.</div> <div style="border: 1px solid black; padding: 5px;"> <div style="display: flex; justify-content: space-between;"> <div style="width: 20%;">Parameter settings</div> <div style="width: 60%;"> Specify the following settings to optimize robot operation. <ul style="list-style-type: none"> Tip weight <ul style="list-style-type: none"> * For Multi robots and axes specified as additional, set the "Axis tip weight". Soft limits <ul style="list-style-type: none"> * A return-to-origin must first be performed if the soft limit positions are to be specified by jog movement. </div> <div style="width: 20%; background-color: #4a7ebb; color: white; padding: 5px;">Robot controller connection settings</div> </div> </div> <div style="border: 1px solid black; padding: 5px; margin-top: 5px;"> * These parameters must always be specified when using the robot for the first time. Afterward, set the parameters as necessary. </div> <div style="border: 1px solid black; padding: 5px;">Return-to-origin</div> <div style="border: 1px solid black; padding: 5px;">Perform return-to-origin, and teach the origin position.</div> <div style="border: 1px solid black; padding: 5px; margin-top: 5px;"> This must be performed at first use. Subsequently, perform it in the following cases. <ul style="list-style-type: none"> For incremental axis: Before turning on the power and starting robot operation, or if the origin point becomes indeterminate (origin incomplete). For absolute axis: When the origin point becomes indeterminate (origin incomplete). </div> <div style="border: 1px solid black; padding: 5px; margin-top: 5px;">Specify the standard coordinates (XY coordinate system with the X-axis rotation center set as the origin).</div>	3.3 Verifying the robot controller settings
Data setting	<div style="border: 1px solid black; padding: 5px;">Parameter setting</div> <div style="border: 1px solid black; padding: 5px;">Set the parameters according to the operation conditions.</div> <div style="border: 1px solid black; padding: 5px; margin-left: 200px;">Various parameter settings</div>	4.2 Parameter settings 5. Conveyor calibration * Perform for all the robots to be used in conveyor tracking. 7. Robot language commands
	<div style="border: 1px solid black; padding: 5px;">Point data editing</div> <div style="border: 1px solid black; padding: 5px;">Create or edit the point data according to the robot operation.</div> <div style="border: 1px solid black; padding: 5px; margin-left: 200px;">Conveyor calibration</div>	
	<div style="border: 1px solid black; padding: 5px;">Programming</div> <div style="border: 1px solid black; padding: 5px;">Create programs according to the robot operation.</div> <div style="border: 1px solid black; padding: 5px; margin-left: 200px;">Create programs using dedicated commands.</div>	
Trial operation	<div style="border: 1px solid black; padding: 5px;">Verify that safety devices such as the emergency stop circuit, etc., are functioning properly.</div> <div style="border: 1px solid black; padding: 5px;">Perform a trial run by step operation, etc., and make any necessary adjustments.</div> <div style="border: 1px solid black; padding: 5px; margin-left: 200px;">Use the monitor function.</div>	
	<div style="border: 1px solid black; padding: 5px;">Start operation.</div> <div style="border: 1px solid black; padding: 5px; margin-left: 200px;">Use the monitor function.</div>	

- Dedicated procedures required when using the Tracking System.
- Standard procedures when using the YRCX controller. (These procedures are required even when using the Tracking System.)

3. Connections

3.1 Wiring



DANGER

Always turn the power for the entire system off before starting wiring work. Failing to do so could result in electrical shocks.

3.1.1 Wiring the AB phase input connector

Wire the AB phase input cable connector as shown in the following signal table.



NOTE

This step is not required when using the optional AB phase input cable.

■ AB phase input interface signal table

Terminal No.	Signal Name	Signal Description
1	+5V	Counter power +5V
2	NC	Use is prohibited
3	PA1+	Counter 1 + A phase
4	PA1-	Counter 1 - A phase
5	PB1+	Counter 1 + B phase
6	PB1-	Counter 1 - B phase
7	PZ1+	Counter 1 + Z phase
8	PZ1-	Counter 1 - Z phase
9	0V	Counter power 0V
10	NC	Use is prohibited
11	+5V	Counter power +5V
12	NC	Use is prohibited
13	PA2+	Counter 2 + A phase
14	PA2-	Counter 2 - A phase
15	PB2+	Counter 2 + B phase
16	PB2-	Counter 2 - B phase
17	PZ2+	Counter 2 + Z phase
18	PZ2-	Counter 2 - Z phase
19	0V	Counter power 0V
20	NC	Use is prohibited

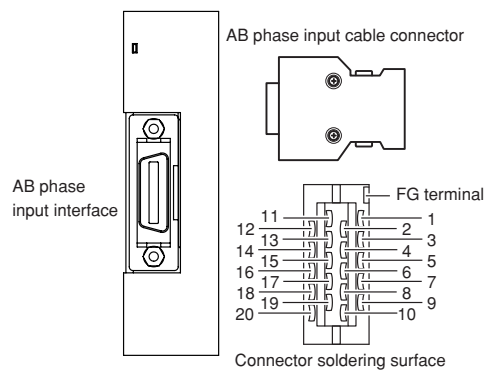

Solder the FG wire to the shield mesh to connect to the FG terminal of the AB phase input cable connector.

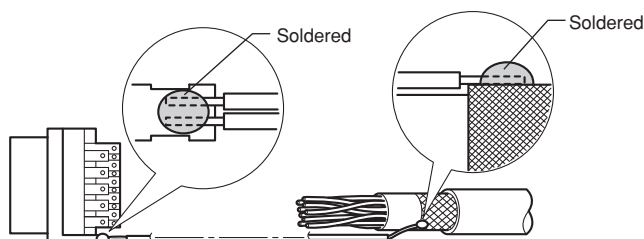

3.1.2 Wiring the optional AB phase input cable (Type: KX0-M66AF-00)

As shown in the illustration below, there is no connector at the end which connects to the encoder. This connector must be prepared by the user.

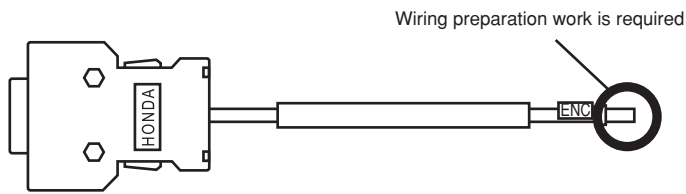

The cable core wires and their corresponding signals are shown in the table below.

Core Wire Color	Signal Name	Signal Description
Blue	PA1+	Counter 1 +A-phase
Orange	PA1-	Counter 1 - A-phase
Green	PB1+	Counter 1 +B-phase
Brown	PB1-	Counter 1 - B-phase
Gray	PZ1+	Counter 1 +Z-phase
Red	PZ1-	Counter 1 - Z-phase
Black	0V	Counter power supply 0V
Yellow	+5V	Counter power supply +5V
Gray (thick)	FG	Frame ground for shielded wire

3.2 Connecting and removing the AB phase input cable connector

3.2.1 Connecting the AB phase input cable connector

Connect the AB phase input cable connector to the AB phase input interface.

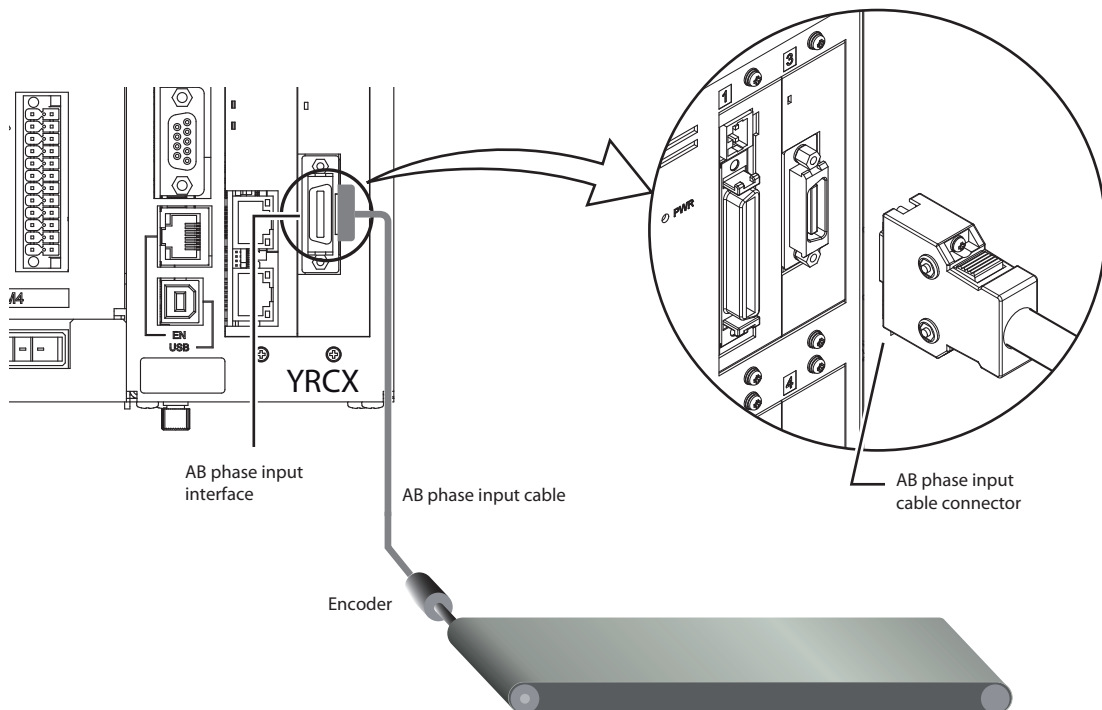

3.2.2 Disconnecting the AB phase input cable connector

To disconnect the AB phase input cable connector, press the cable connector's snap-on lock areas (see illustration below), then pull the connector straight out of the connector port.

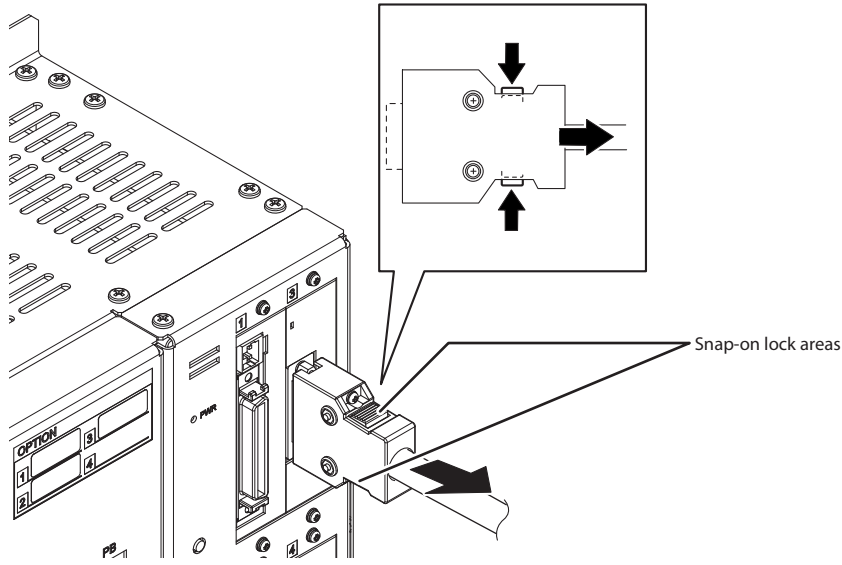

3.3 Verifying the robot controller settings

Mounting of the tracking board in the robot controller can be confirmed from the programming box.

Use the following steps to verify the robot controller settings.

From the initial screen, select "System" - "Properties" to access the properties screen.

Press the F2 key (OPTION); the type and version of the option boards connected to the option slots of the controller are displayed.

If "Tracking" is shown as a Board Name, the tracking board is installed.

■ "OPTION" screen

No.	BoardName	Version
C101	DIO NS	V1.01
C103	Tracking	V1.000
C10V	iVY2_L	V1.00

S:-- RBY:1 MRD
H:-- SPD:28

ROBOT OPTION CLOCK VERSION

4. Parameter

4.1 Parameter list

The following parameters are set for the tracking board.

Name	Identifier	Setting range	Default setting	Units	Restart
Conveyor velocity coef. (conveyor 1 / conveyor 2)	CVELCOE1 / CVELCOE2	0 to 10000	100	%	Not required
Tracking Start Margin (conveyor 1 / conveyor 2)	TRKSMGN1 / TRKSMGN2	0 to 10000	0	ms	Not required
Tracking End Margin (conveyor 1 / conveyor 2)	TRKEMGN1 / TRKEMGN2	0 to 10000	0	ms	Not required
Tracking Position Adjust (conveyor 1 / conveyor 2)	TRKPADJ1 / TRKPADJ2	-9999999 to 9999999	0	0.001 mm	Not required

This is an option parameter below. For details about how to set it, refer to "Option board related parameters" in the YRCX Operator's Manual.

Name	Identifier	Setting range	Default setting	Units	Restart
Tracking CADDQUE Distance (conveyor 1 / conveyor 2)	CADDST1 / CADDST2	0 to 9999999	0	0.001 mm	Not required

4.2 Parameter settings

The methods for setting the parameters are explained below.

Step 1 Open the "Tracking" screen.

Select "Edit" - "Parameter" from the main screen.
Press the F10 key (TRACKING) on the "Parameter" screen.

Step 2 Select the parameter to edit.

Use the cursor keys to select the parameter to edit. Press the F1 key (EDIT).



NOTE
Changing "Tracking Velocity Limit 1" parameter may influence to robot control even though it is selectable. Contact your distributor for changing this parameter.

TIP
When the F2 key (JUMP) is pressed, a popup screen will appear. Select the parameter to edit by inputting the parameter number.

▶ Step 2 Selecting the parameter

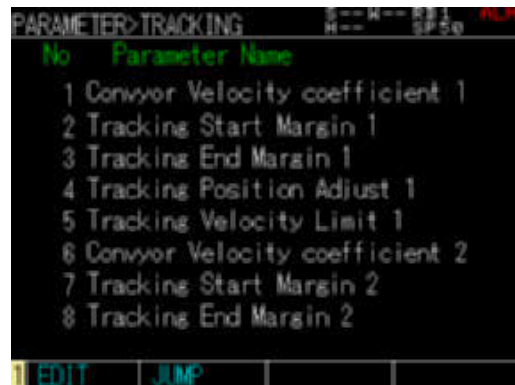

Step 3 Input a value in the parameter.

Input a value using 0 to 9 and ".", and press the ENTER key.
After inputting the value, press the ESC key to finish editing the parameters.

▶ Step 3 Inputting the parameter



4.3 Parameter details

■ Conveyor velocity coefficient (conveyor 1 / conveyor 2) <CVELCOE1 / CVELCOE2>

If the robot's follow-up of a workpiece on the conveyor is delayed, this parameter is used to compensate that delay. Set the coefficient for compensating the robot follow-up position in % units.

The follow-up position compensation amount (distance) is as follows.

Conveyor velocity [mm/sec] x Conveyor velocity coefficient [%] ÷ 10000 (unit: mm)

The setting range is 0 to 10000. This parameter is set to 0 when initialized.

This parameter can be set by robot for each conveyor.

* The robot movement will change if this parameter is changed while following-up operation or following-up state. Take care to change this parameter1.



NOTE

- If the conveyor velocity coefficient is set too high, the robot could vibrate or abnormal noise may be generated.
- Unlike the tracking position adjustment, changing conveyor flow speed changes the compensation amount (distance) of follow-up position by specified ratio.
- The compensation amount of follow-up position by this parameter is not considered in "CCHKQUE" function. Therefore, the target position of follow-up may be outside the working area depending on the "conveyor velocity coef." value. For details on working area, refer to "5. Conveyor calibration".

[Setting example]

To compensate the follow-up position when conveyor speed is 100 [mm/sec], and follow-up delay to workpiece position is 5 [mm]:

	Before setting	After setting
Conveyor velocity coefficient	0 [%]	500 [%]
Follow-up position compensation	0 [mm]	5 [mm] in the conveyor flow direction
Motion		

■ Tracking start margin (conveyor 1 / conveyor 2) <TRKSMGN1 / TRKSMGN2>

This parameter is used when starting the robot follow-up operation before the workpiece on the conveyor enters the working area.

Specify the amount of time needed in milliseconds [ms] to advance the workpiece for robot follow-up operations.

The workpiece will be judged as follow-able if it is in the position of <Conveyor velocity [mm/sec] x Tracking start margin [ms] ÷ 1000 (unit: mm)> before the upstream position of the working area.

The setting range is 0 to 10000. This parameter is set to 0 when initialized.

This parameter can be set by robot for each conveyor.



NOTE

- Set the parameter so that the complete position of the follow-up operation does not exceed the robot movement range.
- The return value when the CCHKQUE function is executed is the value including the tracking start margin. Refer to section "7.3.4 CCHKQUE" for details on the CCHKQUE function.
- If this parameter is changed, the follow-up operation could end before the working area. The robot will shift to follow-up state in this case.

[Setting example]

To start follow-up operation 50 mm before entering the working area at conveyor speed of 100 [mm/sec] (0.1 [mm/ms]):

	Before setting	After setting
Tracking start margin	0 [ms]	500 [ms]
Position judged as follow-able	Upstream position	50 [mm] before upstream position
Motion		

Tracking end margin (conveyor 1 / conveyor 2) <TRKEMGN1 / TRKEMGN2>

This parameter is used to set the work time for a workpiece on the conveyor.

The robot follow-up operation will start only if the work can be completed before the workpiece reaches the downstream position of the working area.



NOTE

In this manual, the time required for the work (picking with an end tool, etc.) carried out while the robot is following the workpiece is called the work time.

Specify the workpiece work time in milliseconds [ms].

The workpiece will be judged as follow-able if it is in the position of $\langle \text{Conveyor velocity [mm/sec]} \times \text{Tracking end margin [ms]} \div 1000 \text{ (unit: mm)} \rangle$ before the downstream position of the working area.

The setting range is 0 to 10000. This parameter is set to 0 when initialized.

This parameter can be set by robot for each conveyor.



NOTE

- If the workpiece being followed by the robot reaches the downstream position of the working area, the corresponded alarms will occur.
- This parameter is taken into consideration when judging whether the CTMOVE command can be executed. If the follow-up target workpiece will exit the working area after (the movement time instructed by CTMOVE + the tracking end margin) time has elapsed, it is judged that CTMOVE command cannot be executed, and an alarm will occur.
- To continue the process after an alarm has occurred, use the "ON ERROR GOTO" statement to recover the state.

[Setting example]

When work time for a workpiece is 1 sec (1000 [ms]) at conveyor speed of 100 [mm/sec] (0.1 [mm/ms]):

	Before setting	After setting
Tracking end margin	0 [ms]	1000 [ms]
Position judged as passing the working area	Downstream position	100 [mm] before downstream position
Motion		

Tracking position adjust (conveyor 1 / conveyor 2) <TRKPADJ1 / TRKPADJ2>

This parameter compensates delay of robot follow-up for the workpiece flowing on the conveyor. The compensation distance is specified in 0.001 mm units.

The compensation amount is adjustment of tracking position in the conveyor flowing direction.

Setting range is between -9999999 and 9999999. When this parameter is initialized, "0" is set.

This parameter can be set by robot for each conveyor.



NOTE

- Unlike the "Conveyor velocity coef. 1/2", this parameter always compensates interval in the conveyor flowing direction even though the conveyor velocity changes.
- The compensation amount of follow-up position by this parameter is not considered in "CCHKQUE" function. Therefore, the target position of follow-up may be outside the working area depending on the "conveyor velocity coef." value. For details on working area, refer to "5. Conveyor calibration".

[Setting example]

To compensate the follow-up position at interval conveyor speed and 10 [mm] follow-up delay.

	Before setting	After setting
Tracking position adjust	0 [0.001 mm]	10000 [0.001 mm]
Follow-up position compensation	0 [mm]	10 [mm] in conveyor flow direction
Motion		

Tracking CADDQUE Distance (conveyor 1 / conveyor 2) <CADDST1 / CADDST2>

This parameter sets the radius (judgment area distance) for judging double-registration when adding a queue element to position monitoring queue "CADDQUE/CADDQUEV" command (units: 0.001 mm). If there already is a queue element that has been added as a position monitoring queue within the radius of the queue element that is about to be added to the position monitoring queue, it is judged as double-registration. The queue that is judged as double-registration will not be added to the position monitoring queue. No alarm occurs in this case.

The setting range is between 0 and 9999999.

When "0" is specified, judging double-registration is invalid. This parameter is set by conveyor.

The judgment area distance specified by "CADDQUE" or "CADDQUEV" command is prior to this parameter.

5. Conveyor calibration

Conveyor calibration refers to the process of aligning the conveyor position with the robot coordinates. By calibrating the conveyor, it can be seen where the positions of the queue elements added to the conveyor position monitoring queue are in relation to the robot coordinates, and conveyor tracking becomes possible. Conveyor calibration must be carried out for all the robots to use the conveyor tracking function. Carry out conveyor calibration after the conveyor, camera, and robot have been installed. If the position of the conveyor, camera, or robot changes, the conveyor must be calibrated again.

TIP

Refer to section "7.2 Position monitoring queue" for details on the position monitoring queue and the queue elements.

With conveyor calibration, the tip of the robot is moved to the fiducial marks arranged on the conveyor. Fiducial marks should be prepared so that the position in relation to the robot tip can be confirmed easily. For the robot tip, use items that can be easily recognized (robot tool tip or jig with distinct tip, etc.) when confirming the position in relation to the fiducial marks.

■ Working area

With conveyor calibration, the robot tracking area is set as the working area on the conveyor.

The working area is set by specifying the upstream and downstream position depending on the fiducial mark position on the conveyor.

Since the robot tip is used to specify the upstream and downstream position, make sure that the working area is within the robot tracking area.

Robot working envelope

Upstream position and downstream position

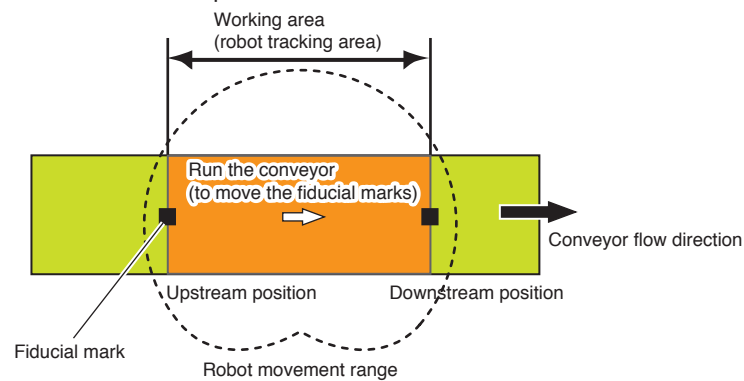

5.1 Interactive conveyor calibration setting method

Step 1 Open the "Calibration" screen.
Select "Edit" - "Calibration" from the main screen.

▶ **Step 1** "Calibration" screen



Step 2 Press the F3 key (CNWIZ).

▶ **Step 3** Selecting NONE (no camera)

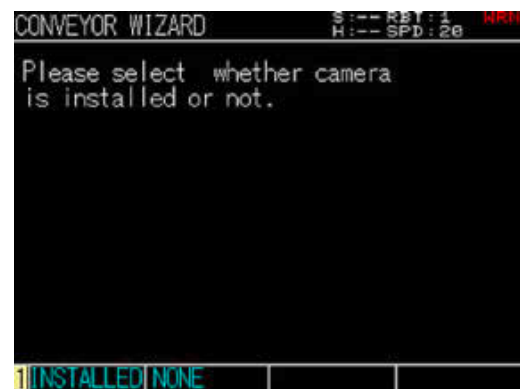

Step 4 Input the number of the robot to be calibrated, and press the F4 key (NEXT).

Step 4 Inputting the robot number



Step 5 Input the number of the conveyor to calibrate, and press the F4 key (NEXT).

Step 5 Inputting the conveyor number



NOTE
Conveyor 1 is calibrated using Counter 1, and Conveyor 2 is calibrated using Counter 2.

TIP
To return to the previous step, press the ESC key. In subsequent operations, returning to the previous step can be conducted by pressing the ESC key.

Step 6 Check the details set up to this point.

A list of set details is displayed.
If the settings are all correct, press the F1 key (START).
To correct the settings from the input of the robot to be calibrated, press the F2 key (RESET).

Step 6 Confirming the settings



Step 7 Run the conveyor and move the fiducial mark to the upstream position of the working area. Then, press the F4 key (NEXT).

▶ Step 7 Moving the fiducial marks

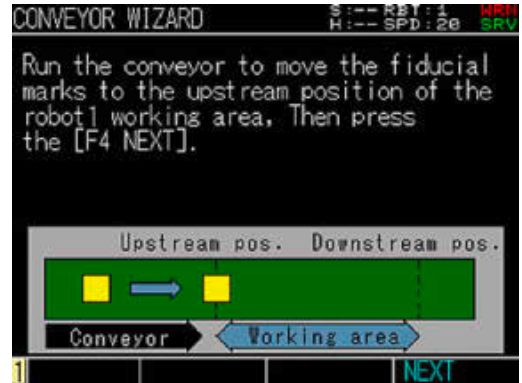
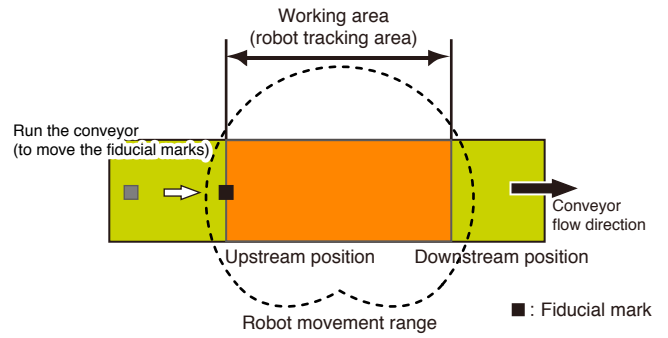

Step 8 Move the tip of the robot to be calibrated to the fiducial mark position and press the F4 key (NEXT).

▶ Step 8 Moving the robot to fiducial mark position



WARNING

- The robot will move when the jog keys are pressed. It is dangerous so do not enter the robot working envelope.
- Always press the emergency stop button on the programming box when moving the robot by hand.

To move the tip of the applicable robot, use the jog keys or press the emergency stop button on the programming box to turn the servo OFF and move the robot by hand.



NOTE

To change the manual movement speed when moving the robot with the jog keys, press the F1 key (SPEED). Change the robot operated with the jog keys as needed. Refer to the YRCX Operator's Manual for details on these operations.

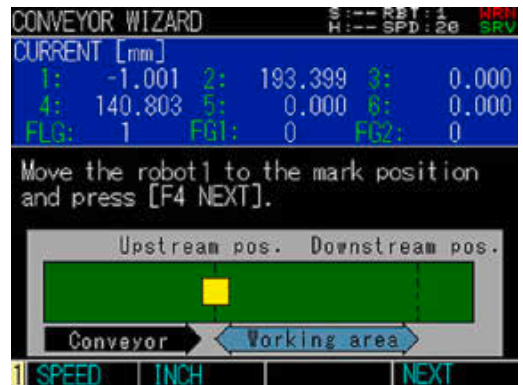

Step 9 Run the conveyor and move the fiducial mark to the downstream position of the working area. Then, press the F4 key (NEXT).

▶ **Step 9** Moving the fiducial marks

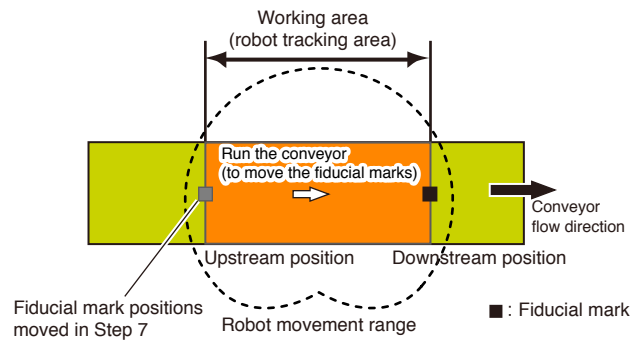

Step 10 Move the tip of the robot to be calibrated to the fiducial mark position and press the F4 key (NEXT).

▶ **Step 10** Moving the robot to fiducial mark position



WARNING

- The robot will move when the jog keys are pressed. It is dangerous so do not enter the robot working envelope.
- Always press the emergency stop button on the programming box when moving the robot by hand.

To move the tip of the applicable robot, use the jog keys or press the emergency stop button on the programming box to turn the servo OFF and move the robot by hand.



Step 11 Execute calibration.

Press the F1 key (CALCULATE) to execute calibration for the robot that is set currently and proceed to Step 18.
 A key (CONTINUE) and proceed to Step 12.

▶ **Step 11** Executing calibration



Step 12 *Input the number of the robot to be calibrated, and press the F4 key (NEXT).*

► **Step 12** Inputting the robot number



Step 13 *Run the conveyor and move the fiducial mark to the upstream position of the working area. Then, press the F4 key (NEXT).*

► **Step 13** Moving the fiducial marks



TIP

The screen for Step 6 will appear when the ESC key is pressed.

Step 14 *Move the tip of the robot to be calibrated to the fiducial mark position and press the F4 key (NEXT).*

► **Step 14** Moving the robot to fiducial mark position



WARNING

- The robot will move when the jog keys are pressed. It is dangerous so do not enter the robot working envelope.
- Always press the emergency stop button on the programming box when moving the robot by hand.

To move the tip of the applicable robot, use the jog keys or press the emergency stop button on the programming box to turn the servo OFF and move the robot by hand.



NOTE

To change the manual movement speed when moving the robot with the jog keys, press the F1 key (SPEED). Change the robot operated with the jog keys as needed. Refer to the YRCX Operator's Manual for details on these operations.

Step 15 *Run the conveyor and move the fiducial mark to the downstream position of the working area, and then press the F4 key (NEXT).*

► **Step 15** Moving the fiducial marks



Step 16 Move the tip of the robot to be calibrated to the fiducial mark position and press the F4 key (NEXT).



WARNING

- The robot will move when the jog keys are pressed. It is dangerous so do not enter the robot working envelope.
- Always press the emergency stop button on the programming box when moving the robot by hand.

To move the tip of the applicable robot, use the jog keys or press the emergency stop button on the programming box to turn the servo OFF and move the robot by hand.

Step 16 Moving the robot to fiducial mark position



Step 17 Execute calibration.

Press the F1 key (CALCULATE) to execute calibration for the robot that is set currently and proceed to Step 18.

To calibrate with another robot, press the F4 key (CONTINUE), repeat Step 12 through 16, press the F1 key (CALCULATE), and proceed to Step 18.

Step 17 Executing calibration

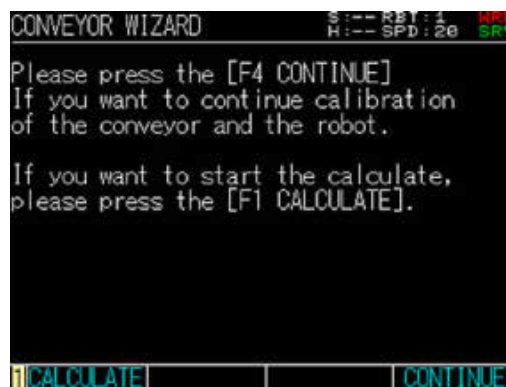

Step 18 Register the calibration results.

Check the calibration results.

TIP

The robot can be switched by pressing the F1 key (ROBOT1) to the F4 key (ROBOT4).

If there are no problems with the calibration results, select (SET) with the cursor keys and press the ENTER key. The conveyor calibration results will be set.



NOTE

If the conveyor wizard is quit without pressing (SET), the calibration results will not be saved.

Step 18 Conveyor calibration results



5.2 Editing conveyor calibration data

The conveyor calibration data editing method is given below.



NOTE

The conveyor calibrated with Counter 1 is called "Conveyor 1", and the conveyor calibrated with Counter 2 is called "Conveyor 2".

Step 1 Open the "Calibration" screen.

Select "Edit" - "Calibration" from the main screen.

▶ Step 1 "Calibration" screen



Step 2 Press the F4 key (CNVEDT).

Step 3 Select the conveyor channel (number) for which the calibration data is to be edited.

Press the F1 key (CV1) to edit the calibration data for Conveyor 1.
Press the F2 key (CV2) to edit the calibration data for Conveyor 2.

▶ Step 3 Selecting the conveyor channel (number)



Step 4 Input a value in the parameter.

Input a value using 0 to 9 and ".", and press the ENTER key to set the parameter. The meaning of each item is explained below.

- **RATIO** (mm/100pls)
Set the workpiece movement strokes for when the counter pulse increases by 100 pulses.
- **SHIFT** (mm), (deg)
Set the shift rate for converting the position on the robot coordinates to the position on the conveyor coordinates.
- **AREA** (mm)
Set the upstream position and downstream position of the working area to the X coordinate on the conveyor coordinates. This sets the working area between the upstream position and downstream position.

After inputting all the values, press the ESC key to finish editing the parameters.

▶ Step 4 Inputting the conveyor calibration data

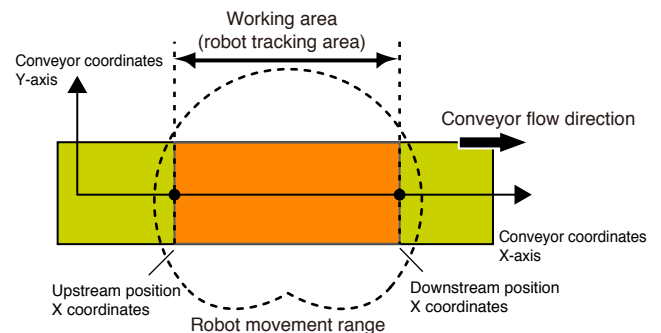

6. Tracking Monitor

The status of the conveyor tracking function can be confirmed.
Select [Tracking Monitor] and press the Enter key in the monitor level to open the "Tracking Monitor" screen.

■ "Tracking Monitor" screen

Item	Counter1	Counter2
Status	Valid	Invalid
Pulse	64483	0
Number Of Workpiece	0	0
First Workpiece	X 0 [mm]	0 [mm]
	Y 0 [mm]	0 [mm]

1. Robot number

Displays the currently selected robot number.

2. Coordinate system

Indicates the selected coordinate system. "Robot coordinate" appears for the robot coordinate system, and "Conveyor coordinate" appears for the conveyor coordinate system.

3. Status

Displays the status of the tracking board counter.

4. Pulse

Displays the counter pulse value in the range of 0 to 65535.
The pulse value indicates the pulses that are output from the encoder.

5. Number of registered workpieces

Displays the number of queue elements registered in the position monitoring queue.

TIP

Refer to section "7.2 Position monitoring queue" for details on the position monitoring queue.

6. Position of first workpiece

The position of the queue elements registered at the head of the position monitoring queue are displayed using the selected robot as the reference.

When the robot coordinate system is selected, the robot coordinate reference position is displayed.

When the conveyor coordinate system is selected, the conveyor coordinate reference position is displayed.

The keys valid on the "Tracking Monitor" screen and the details of the sub-menus are as follows.

Valid keys	Menu	Function
F1	Coordinate selection	Switches the coordinate system between [Robot coordinate] and [Conveyor coordinate].
F2	Robot selection	Switches the selected robot.
ESC		Returns to the previous screen.

7. Robot language commands

This section explains the Tracking System's dedicated robot language commands. Always refer to the YRCX Programming Manual when performing programming operations.



NOTE

- The operand in the (shaded section) of the robot language explanation indicates that it can be omitted.
- *Italic items* should be written in the specific format.
- Items surrounded by | | are selectable.

7.1 Robot language command list



NOTE

- The symbols in the Online column have the following meanings.
- "O" indicates that the command can be used as an online command.
 - "—" indicates that the command cannot be used as an online command.

Language command	Type	Description	Online
		Format	
CADDIST	Command	Changes the judgment area distance. CADDIST(<i>counter number</i>) = <i>setting value</i>	-
	Function	Obtains the judgment area distance. CADDIST(<i>counter number</i>)	O
CADDQUE	Command	Adds a queue element to the end of the position monitoring queue. CADDQUE[<i>robot number</i>] <i>counter number</i> , <i>coordinate data</i> , D = <i>Judgment area distance</i> , TG = <i>Tag</i> , RFG = [<i>target robot number</i> ,...]	-
CADDQUEV (Reserved)	Command	Adds a queue element of the iVY2 search results to the end of the position monitoring queue. CADDQUEV[<i>robot number</i>](<i>task number</i>) <i>counter number</i> , <i>coordinate data</i> , D = <i>Judgment area distance</i> , TG = <i>Tag</i> , RFG = [<i>target robot number</i> ,...]	-
CADDRSLT	Function	Confirms the results of the CADDQUE command/ CADDQUEV command. CADDRSLT(<i>counter number</i>)	O
CCHKQUE	Function	Confirms where a queue element in the position monitoring queue is located in relation to the working area. CCHKQUE[<i>robot number</i>](<i>counter number</i> , <i>queue element number</i>)	O
CCLRRBT	Command	Clears the robot position data from the position monitoring queue elements. CCLRRBT[<i>robot number</i>](<i>counter number</i> , <i>queue element number</i>)	-
CCOND	Command	Switches the valid/invalid state of the counter. CCOND ION/OFFI(<i>counter number</i>)	O
	Function	Obtains the valid/invalid state of the counter. CCOND(<i>counter number</i>)	
CGETPULS	Function	Obtains the counter pulse value. CGETPULS(<i>counter number</i>)	O
CGETQUE	Function	Obtains the position data for a queue element in the position monitoring queue. CGETQUE[<i>robot number</i>](<i>counter number</i> , <i>queue element number</i>)	O
CGETRATE	Function	Obtains the counter speed. CGETRATE(<i>counter number</i>)	O
CGETTAG	Function	Obtains the tag for a queue element in the position monitoring queue. CGETTAG[<i>robot number</i>](<i>counter number</i> , <i>queue element number</i>)	O
CGETVELX	Function	Obtains the speed of X-direction by resolving the conveyor speed to X and Y-direction on the robot Cartesian coordinates. CGETVELX[<i>robot number</i>](<i>counter number</i>)	O
CGETVELY	Function	Obtains the speed of Y-direction by resolving the conveyor speed to X and Y-direction on the robot Cartesian coordinates. CGETVELY[<i>robot number</i>](<i>counter number</i>)	O
CQUECNT	Function	Obtains the quantity of queue elements in the position monitoring queue.	O
		CQUECNT(<i>counter number</i>)	

Language command	Type	Description	Online
		Format	
CRMVQUE	Command	Deletes a queue element from the position monitoring queue.	-
		CRMVQUE [robot number](counter number, queue element number)	
CRSTPULS	Command	Resets the counter pulse value.	○
		CRSTPULS counter number	
CSETTAG	Command	Changes the queue element tag of the position monitoring queue.	-
		CSETTAG [robot number](counter number, queue element number) = Tag	
CTDRIVE	Command	Switches the follow-up height during conveyor follow-up operation.	-
		CTDRIVE [robot number](follow-up height (mm)), option, option...	
CTMOVE	Command	Starts the conveyor follow-up operation.	-
		CTMOVE [robot number](counter number, queue element number), option, option,...	
CTRKEMGN	Command	Changes the tracking end margin.	-
		CTRKEMGN [robot number](counter number) = setting value	
	Function	Obtains the tracking end margin.	○
CTRKPADJ	Command	Changes the tracking position adjustment.	-
		CTRKPADJ [robot number](counter number) = setting value	
	Function	Obtains the tracking position adjustment.	○
CTRKSMGN	Command	Changes the tracking start margin.	-
		CTRKSMGN [robot number](counter number) = setting value	
	Function	Obtains the tracking start margin.	○
CTSTOP	Command	Ends conveyor follow-up.	-
		CTSTOP [robot number]	
CTVISION (Reserved)	Command	Switches whether or not to use iVY2 with conveyor tracking.	○
		CTVISION ION/OFFI [task number](counter number)	
	Function	Obtains the information of whether or not to use the iVY2 with conveyor tracking.	
CVELCOEF	Command	Changes the conveyor velocity coefficient.	-
		CVELCOEF [robot number](counter number) = setting value	
	Function	Obtains the conveyor velocity coefficient.	○
		CVELCOEF [robot number](counter number)	

7.2 Position monitoring queue and queue element

The position monitoring queue can be explained as a container in which queue elements are stored. The workpiece coordinates (position data) on the conveyor and a tag (value between -128 and 127) randomly assigned by the user, etc., are stored in one queue element.



NOTE

When multiple robots are installed on one conveyor, the workpiece coordinates on the conveyor (position data) of each robot are saved into queue elements. Tag is one for one queue element regardless of the robot number.

Position monitoring queue and queue element

- One robot (robot 1)

Queue element

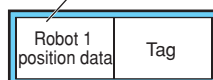

- All the multiple robots (robot 1 to 4) position data is stored.

Queue element

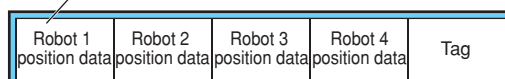

The position data saved in the queue element is constantly monitored. It is updated according to the changes in the conveyor's counter value. There is one position monitoring queue each for Conveyor 1 and Conveyor 2. Up to 80 queue elements can be stored in each position monitoring queue.

7.2.1 Adding queue elements

The queue elements are added to the position monitoring queue with the "CADDQUE" or the "CADDQUEV" command.

The queue elements are counted from #0 in the order that they are added to the position monitoring queue.

Position monitoring queue and queue element

When one robot (robot 1) is installed.

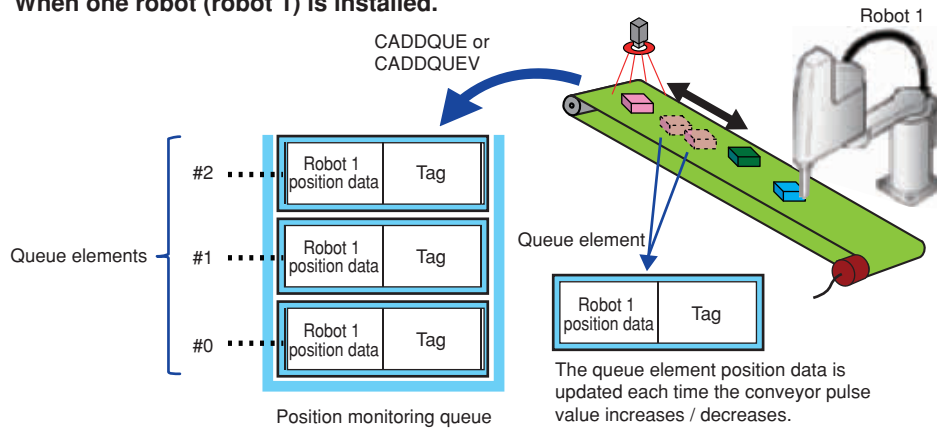

When multiple robots perform conveyor tracking on one conveyor, specifying the robot to work is enabled by queue element. Specify the robot by the RFG option of "CADDQUE" or "CADDQUEV" command. Multiple robots are also specified to the RFG option.

Specified robot position data will be saved in the queue element and that of non-specified robot is not saved.

Position monitoring queue and queue element

When RFG option is specified for "CADDQUE" or "CADDQUEV" commands.

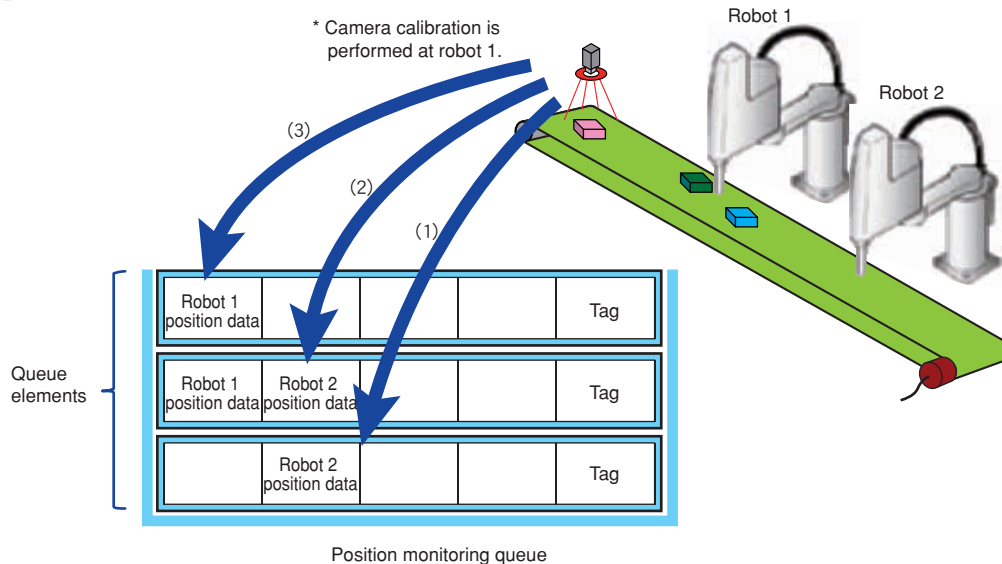

- (1) CADDQUE (omitted), RFG = (2) Add robot 2 position data to the position monitoring queue.
- (2) CADDQUE (omitted), RFG = (1, 2) Add robot 1 and 2 position data to the position monitoring queue.
- (3) CADDQUE (omitted), RFG = (1) Add robot 1 position data to the position monitoring queue.

All the queue elements with the robot position data are called the target queue elements in the condition where some robot sees the queue element in the position monitoring queue.

The queue elements are counted from #0 in the order that the target queue elements of the specified robot are added to the position monitoring queue.

Target queue element

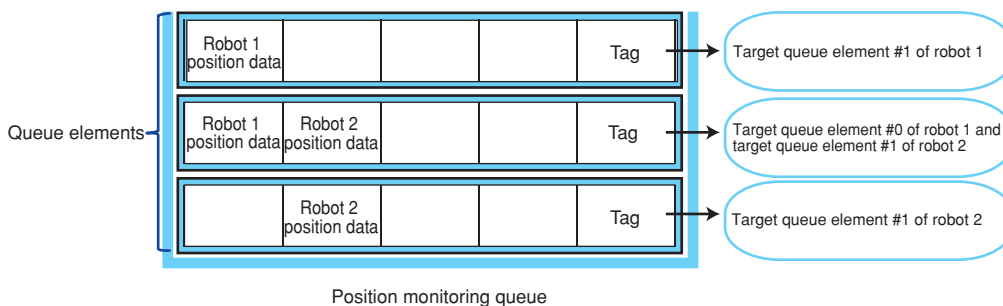

7.2.2 Deleting robot position data from queue elements

The robot position data is deleted from queue element by "CCLRRBT" command. The queue element to be deleted is specified by robot number and queue element number. The numbers of the queue elements after the queue element whose position data was deleted are carried up. "CRMVQUE" command also deletes whole queue elements. For details, refer to section "7.2.3 Deleting queue elements".

Deleting the position data from queue element

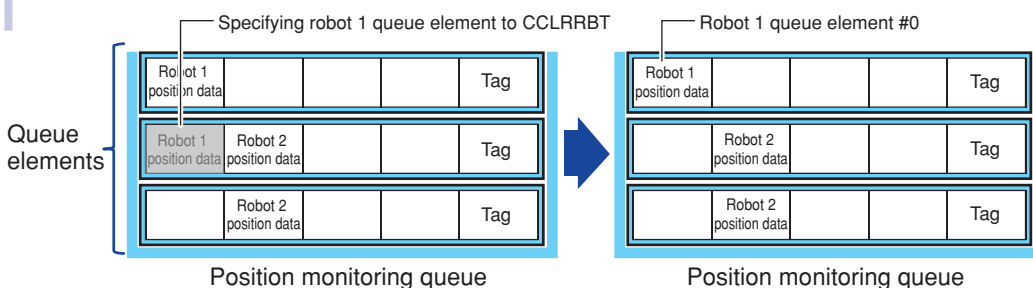

7.2.3 Deleting queue elements

The queue element of the position monitoring queue is deleted by "CRMVQUE" command. The queue element is deleted and the queue after that is carried up. If there is position data of multiple robots in queue elements, all the robot data will be deleted. "CCLRRBT" command also deletes only the robot position data. For details, refer to section "7.2.2 Deleting robot position data from queue element".

Deleting queue elements

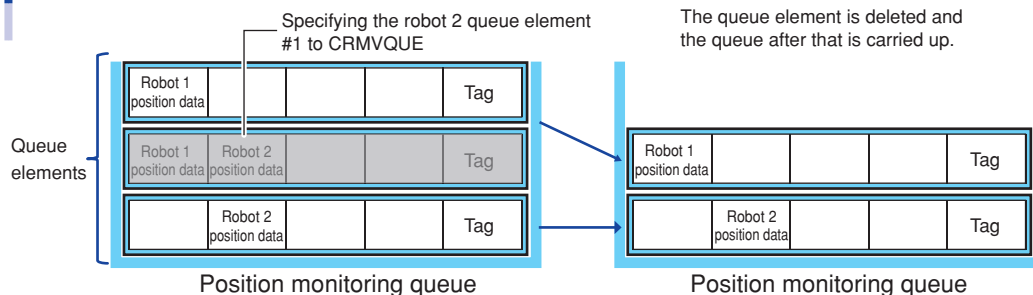

7.3 Robot language command details

7.3.1 CADDIST

● Command

CADDIST	CADDIST(counter number) = setting value
	Changes the judgment area distance.

Description

This command changes the judgment area distance (unit: 0.001 mm) that is specified by the counter number. If this command is executed, the option parameter "Tracking CADDQUE Distance" value will be changed.

Explanation

<Counter number>

Specifies the counter number of the conveyor for which the judgment area distance is to be changed. Either 1 or 2 can be specified. This can also be specified by a variable.

<Setting value>

Specifies the judgment distance (unit: 0.001 mm) of double-registration of queue element to the position monitoring queue. When "0" is specified, the judgment area distance is invalid and double-registration will not be judged.

● Function

CADDIST	CADDIST(<i>counter number</i>)
	Obtains the judgment area distance.

Description

This function obtains the judgment area distance (unit: 0.001 mm). The option parameter "Tracking CADDQUE Distance" that is specified by the counter number is obtained.

Explanation

<Counter number>

Specifies the counter number of the conveyor for which the judgment area distance is to be changed. Either 1 or 2 can be specified. This can also be specified by a variable.

7.3.2 CADDQUE

● Command

CADDQUE	CADDQUE[<i>robot number</i>] <i>counter number, coordinate data, D = Judgment area distance, TG = Tag, RFG = [target robot number,...]</i>
	Adds a queue element to the end of the position monitoring queue.

Description

This command adds a queue element to the end of the position monitoring queue. The queue element is added to the end of the conveyor position monitoring queue that is specified with the counter number. The specified coordinate data is saved as the position data on the Cartesian coordinates of the specified robot number. The currently selected shift coordinates are not applied at this time. Note that if the maximum number of queue elements has been added to the position monitoring queue, further queue elements cannot be added.

TIP

Refer to section "7.2 Position monitoring queue" for details on the position monitoring queue.

Tags and robots that works for queue element (target robot number) can be specified and added to the queue element.



NOTE

- The tag specified here can be obtained with the CGETTAG function. The process can be divided, etc., depending on the specified tag.
- The iVY2 search results are held for each task. If a search result that is held by a task that is not specified by CTVISION ON is added as a queue element to the position monitoring queue with this command, an alarm will occur. Tasks for which the search results are held must be specified with CTVISION ON before searches are executed. Refer to "7.3.15 CTVISION" for details on CTVISION.

Double-registration of queue elements can be prevented by specifying the judgment area distance. The range having the specified coordinate data position as the center and the judgment area distance as the radius is used as the double-registration judgment area. If a queue element that has already been added is found in the judgment area, it is judged as a double-registration and is not registered. An alarm does not occur at this time.

**NOTE**

Use the "CADDQUEV" command to add an iVY2 search result as a queue element.

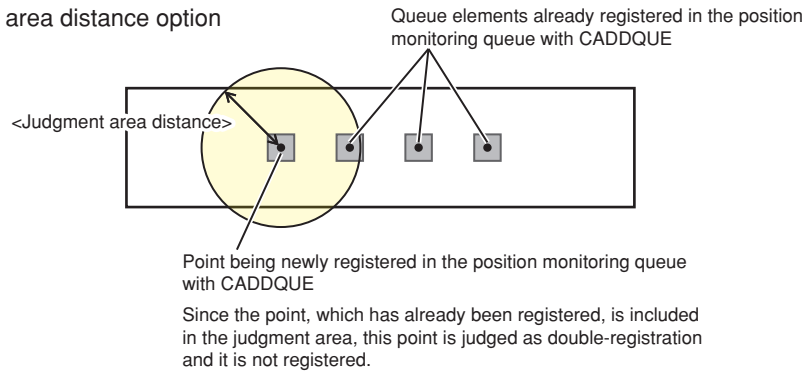
CADDQUE**Judgment area distance option****Explanation****<Robot number>**

The robot number is used to specify the robot Cartesian coordinates that the specified coordinate data belongs to. This can also be specified by a variable. If omitted, Robot 1 is specified.

For example, the point data coordinates of tracking with iVY2 (camera) is the robot Cartesian coordinates that has performed camera calibration. Therefore, specify the number of the robot on which camera calibration has been performed.

TIP

Refer to section "5.1 Interactive conveyor calibration setting method (With iVY2 system)" for details on camera calibration.

<Counter number>

Specifies the conveyor position monitor queue by using the counter number. Either 1 or 2 can be specified. This can also be specified by a variable.

<Coordinate data>

Specifies the position data to save in the queue element by using the coordinate data.

Either a point number or a function using the point data as a return value (ex. VGETPOS) must be specified for the coordinate data. The data must use a [mm] unit.

<Judgment area distance>

Specifies the distance for judging double-registration of the queue elements in the position monitoring queue using a real number (unit: mm). This distance can also be specified by a variable.

The option parameter "Tracking CADDQUE Distance" value is adopted if this setting is omitted.

If a value of 0 or less is specified, both this value and the option parameter "Tracking CADDQUE Distance" value are invalidated and the judgment of double-registration will not be carried out.

<Tag>

Specifies the tag for a queue element added to the position monitoring queue.

A value between -128 and 127 can be specified. If omitted or if a value not between -128 and 127 is set, 0 will be specified.

**NOTE**

The tag specified here can be obtained with the CGETTAG function. The process can be divided, etc., depending on the specified tag.

<Target robot number>

This number specifies the robot that works for the queue elements to be added to the position monitoring queue.

The specified robot position data will be stored in the queue elements. Maximum 4 robots can be specified as the target robot number.

If omitted, all the existed robot will be the target. If the specified robot has not performed calibration, the robot position data will not be stored. When no position data is stored for the queue elements, an alarm occurs.

**NOTE**

Commands such as "CCHKQUE" is executed by specifying robot number. The command target are the only queue elements that has specified robot position data and is called "target queue element" among the position monitoring queue elements.

7.3.3 CADDQUEV (Reserved)

● Command

CADDQUEV	CADDQUEV[robot number](task number) counter number, coordinate data, D = Judgment area distance, TG = Tag RFG = [target robot number,...]
	Adds a queue element of the iVY2 search results to the end of the position monitoring queue.

Description

This command adds the iVY2 search results as a queue element to the position monitoring queue. The queue element is added to the end of the conveyor position monitoring queue that is specified with the counter number. The specified coordinate data is saved as the position data on the Cartesian coordinates of the specified robot number. The currently selected shift coordinates are not applied at this time. For the position data added with this command, the counter pulse variation amount is compensated from the iVY2 capture point to when the queue element is added. Note that if the maximum number of queue elements has been added to the position monitoring queue, further queue elements cannot be added.

TIP

Refer to section "7.2 Position monitoring queue" for details on the position monitoring queue.

Tags and robots that work for queue element (target robot number) can be specified and added to the queue element.



NOTE

- The tag specified here can be obtained with the CGETTAG function. The process can be divided, etc., depending on the specified tag.
- The iVY2 search results are held for each task. If a search result that is held by a task that is not specified by CTVISION ON is added as a queue element to the position monitoring queue with this command, an alarm will occur. Tasks for which the search results are held must be specified with CTVISION ON before searches are executed. Refer to "7.3.24 CTVISION" for details on CTVISION.

Double-registration of queue elements can be prevented by specifying the judgment area distance. The range having the specified coordinate data position as the center and the judgment area distance as the radius is used as the double-registration judgment area. If a queue element that has already been added is found in the judgment area, it is judged as a double-registration and is not registered. No alarm occurs at this time.

CADDQUEV

Judgment area distance option

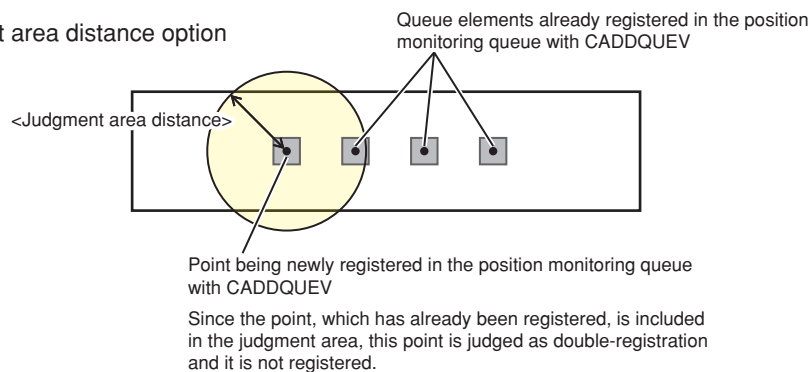

Explanation

<Robot number>

The robot number is used to specify the robot Cartesian coordinates that the specified coordinate data belongs to. This can also be specified by a variable. If omitted, Robot 1 is specified.

<Task number>

Specifies the task number for holding the iVY2 search results. One value between 1 and 16 can be specified. If omitted, the task number executing this command is specified.

<Counter number>

Specifies the conveyor position monitor queue by using the counter number. Either 1 or 2 can be specified. This can also be specified by a variable.

<Coordinate data>

Specifies the position data saved in the queue element by using the coordinate data. Either a point number or a function using the point data as a return value (ex. VGETPOS) must be specified for the coordinate data. The data must be use a [mm] unit.

<Judgment area distance>

Specifies the distance for judging double-registration of the queue elements in the position monitoring queue using a real number (unit: mm).

This distance can also be specified by a variable.

The option parameter "Tracking CADDQUE Distance" value is adopted if this setting is omitted.

If a value of 0 or less is specified, both this value and the option parameter "Tracking CADDQUE Distance" value are invalidated and the judgment of double-registration will not be carried out.

<Tag>

Specifies the tag for a queue element added to the position monitoring queue.

A value between -128 and 127 can be specified. If omitted or if a value not between -128 and 127 is set, 0 will be specified.



NOTE

The tag specified here can be obtained with the CGETTAG function. The process can be divided, etc., depending on the specified tag.

<Target robot number>

This number specifies the robot that works for the queue elements to be added to the position monitoring queue.

The specified robot position data will be stored in the queue elements. Maximum 4 robots can be specified as the target robot number.

If omitted, all the existed robot will be the target. If the specified robot has not performed calibration, the robot position data will not be stored. When no position data is stored for the queue elements, an alarm occurs.



NOTE

Commands such as "CCHKQUE" is executed by specifying robot number. The command target are the only queue elements that has specified robot position data and is called "target queue element" among the position monitoring queue elements.

7.3.4 CADDRSLT

● Function

CADDRSLT	CADDRSLT(<i>counter number</i>)
	Confirms the results of the CADDQUE command/CADDQUEV command.

Description

This function confirms the results of the CADDQAUE command or the CADDQUEV command.

The results of the CADDQUE command or CADDQUEV command executed last for the conveyor position monitoring queue specified with the counter number are confirmed.

This function's return values are as follows:

0 A queue element was added

1 Since the maximum number of queue elements in the position monitoring queue was exceeded, the queue element was not added.

2 Since a double-registration was identified, the queue element was not added.

Explanation

<Counter number>

Specifies the conveyor position monitor queue by using the counter number.

Either 1 or 2 can be specified. This can also be specified by a variable.

7.3.5 CCHKQUE

● Function

CCHKQUE	CCHKQUE[robot number](counter number, queue element number)
	Confirms where a queue element in the position monitoring queue is located in relation to the working area.

Description

This function checks the status of a queue element in the position monitoring queue.

A queue element in the position monitoring queue is specified using the robot number, counter number, and queue element number, and the position of the queue element relative to the working area is confirmed.

This function's return values are as follows:

- 0 Before the working area
- 1 Within the working area
- 1 Beyond the working area
- 2 Tracking in progress
- 2 Specified robot number target queue element was not found.

CCHKQUE

Confirming the status of the queue element

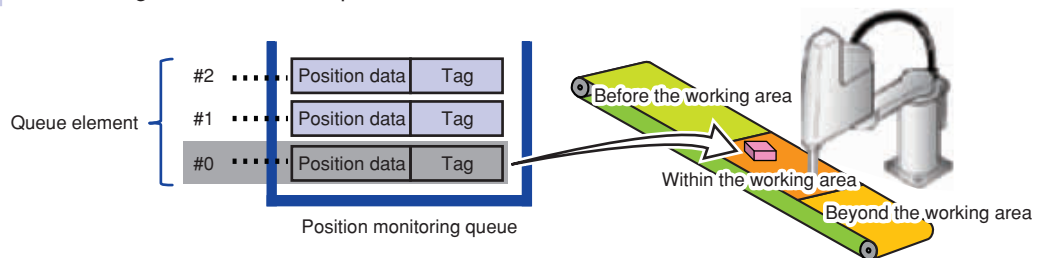

In the above cases, the first queue element of the position monitoring queue () is within the working area.



NOTE

- The working area is set at the time the conveyor is calibrated.
- If the value of the tracking start margin (ms) in the tracking parameter has been changed, the position that should be in the working area will be moved before that position by <the distance of the conveyor velocity x tracking start margin>.
- The compensation amount of follow-up position by this parameter is not considered in "CCHKQUE" function. Therefore, robot tip may operate outside the working area because the target position of follow-up is set outside the working area depending on the "conveyor velocity coef." value. For details on working area, refer to "5. Conveyor calibration".

Explanation

<Robot number>

Specifies the number of the robot to confirm.

Only the queue elements including robot position data specified by the robot number among the position monitoring queue elements are the target status to be confirmed.

The robot number can also be specified by a variable. If omitted, Robot 1 is specified.

<Counter number>

Specifies the conveyor position monitor queue by using the counter number.

Either 1 or 2 can be specified. This can also be specified by a variable.

<Queue element number>

Specifies the queue element number for the position monitoring queue.

One value between 0 and (CQUECNT-1) can be specified. This can also be specified by a variable.

The queue element numbers are counted from #0 in the order that they were added to the position monitoring queue.

However, only the target queue elements (the queue elements including robot position data specified by the robot number among the position monitoring queue elements) are counted.

If omitted, the first target queue elements is specified as the target.

7.3.6 CCLRBT

● Command

CCLRBT	CCLRBT [<i>robot number</i>](<i>counter number</i> , <i>queue element number</i>)
	Clears the robot position data from the position monitoring queue elements.

Description

This command clears the robot position data from the position monitoring queue elements.

The specified robot position data from the position monitoring queue elements specified by the robot number, counter number, or queue number is deleted.

When the robot position data saved in queue element is all deleted by this command, the queue element itself is also deleted. The numbers of the queue elements after the deleted queue element are carried up.



NOTE

- Executing this command while either robot is following-up or for a queue element in follow-up state, the robot position data will not be deleted and an alarm occurs.
- * After finishing the follow-up movement by "CTMOVE", the queue element changes to "following-up state".
- "CRMVQUE" command also deletes whole queue elements. For details, refer to section "7.3.15 CRMVQUE".

Explanation

<Robot number>

Only the queue elements including robot position data specified by the robot number among the position monitoring queue elements are the target position data to be cleared.

The robot number can also be specified by a variable. If omitted, Robot 1 is specified.

<Counter number>

Specifies the conveyor position monitor queue by using the counter number.

Either 1 or 2 can be specified. This can also be specified by a variable.

<Queue element number>

Specifies the queue element number for the position monitoring queue.

One value between 0 and (CQUECNT-1) can be specified. This can also be specified by a variable.

The queue element numbers are counted from #0 in the order that they were added to the position monitoring queue.

However, only the target queue elements (the queue elements including robot position data specified by the robot number among the position monitoring queue elements) are counted.

If omitted, the first target queue elements is specified as the target.

7.3.7 CCOND

● Command

CCOND	CCOND ION/OFFI [<i>counter number</i>]
	Switches the valid/invalid state of the counter.

Description

This command switches the tracking board counter status to Valid or Invalid.

The position data for the queue element added to the position monitoring queue for the conveyor with a valid counter status is updated when there are changes in the counter's pulse value. When the counter status is validated, all the queue elements added to the position monitoring queue up to that point are cleared.

Explanation

<Counter number>

Specifies the counter number of the conveyor for which the counter status is to be changed.

Either 1 or 2 can be specified. This can also be specified by a variable. If omitted, both Counter 1 and Counter 2 are specified.

● Function

CCOND	CCOND(<i>counter number</i>)
	Obtains the valid/invalid state of the counter.

Description

This function obtains the valid/invalid status of the tracking board counter.
The counter status is obtained as 0: Invalid or 1: Valid.

Explanation

<Counter number>

Specifies the counter number of the conveyor for which the counter status is to be obtained.
Either 1 or 2 can be specified. This can also be specified by a variable.

7.3.8 CGETPULS

● Function

CGETPULS	CGETPULS(<i>counter number</i>)
	Obtains the counter pulse value.

Description

This function obtains the counter's pulse value.
The pulse value of the specified counter is obtained within the range of 0 to 65535 (unit: pulses).

Explanation

<Counter number>

Specifies the counter number for which the pulse value is to be obtained.
Either 1 or 2 can be specified. This can also be specified by a variable.

7.3.9 CGETQUE

● Function

CGETQUE	CGETQUE[<i>robot number</i>](<i>counter number</i> , <i>queue element number</i>)
	Obtains the position data for a queue element in the position monitoring queue.

Description

This function obtains the position data of a queue element in the position monitoring queue.
A queue element in the position monitoring queue is specified using the robot number, counter number, and queue element number, and the position data of the queue element is obtained in point data format.
The position data is obtained as the Cartesian coordinate data of the specified robot number.

Explanation

<Robot number>

Specifies which robot's Cartesian coordinate data the position data is to be obtained from.
Only the queue elements including robot position data specified by the robot number among the position monitoring queue elements are the target position data to be confirmed.
The robot number can also be specified by a variable. If omitted, Robot 1 is specified.

<Counter number>

Specifies the conveyor position monitor queue by using the counter number.
Either 1 or 2 can be specified. This can also be specified by a variable.

<Queue element number>

Specifies the queue element number for the position monitoring queue.
One value between 0 and (CQUECNT-1) can be specified. This can also be specified by a variable.
The queue element numbers are counted from #0 in the order that they were added to the position monitoring queue.
However, only the target queue elements (the queue elements including robot position data specified by the robot number among the position monitoring queue elements) are counted.
If omitted, the first target queue elements is specified as the target.

7.3.10 CGETRATE

● Function

CGETRATE	CGETRATE(<i>counter number</i>)
	Obtains the counter speed.

Description

This function obtains the specified counter speed (unit: pulse/10 ms).

Explanation

<Counter number>

Specifies the counter number for the conveyor to obtain the speed.

Either 1 or 2 can be specified. This can also be specified by a variable.

7.3.11 CGETTAG

● Function

CGETTAG	CGETTAG[<i>robot number</i>](<i>counter number</i> , <i>queue element number</i>)
	Obtains the tag for a queue element.

Description

This function obtains the tag of a queue element in the position monitoring queue.

A queue element in the position monitoring queue is specified using the robot number, counter number and queue element number, and the tag for that element is obtained.

Explanation

<Robot number>

Only the queue elements including robot position data specified by the robot number among the position monitoring queue elements are the target for tag to be obtained.

The robot number can also be specified by a variable. If omitted, Robot 1 is specified.

<Counter number>

Specifies the conveyor position monitor queue by using the counter number.

Either 1 or 2 can be specified. This can also be specified by a variable.

<Queue element number>

Specifies the queue element number for the position monitoring queue.

One value between 0 and (CQUECNT-1) can be specified. This can also be specified by a variable.

The queue element numbers are counted in the order that they were added to the position monitoring queue. However, only the target queue elements (the queue elements including robot position data specified by the robot number among the position monitoring queue elements) are counted. If omitted, the status of the #0 queue element is confirmed.

7.3.12 CGETVELX

● Function

CGETVELX	CGETVELX[<i>robot number</i>](<i>counter number</i>)
	Obtains the velocity of X-direction by resolving the conveyor velocity to X and Y-direction on the robot Cartesian coordinates.

Description

This function obtains the X-direction velocity (unit: mm/10 ms) by resolving the conveyor velocity to X and Y-direction on the robot Cartesian coordinates.

The specified robot number conveyor velocity is obtained by X-direction velocity on the specified robot Cartesian coordinates.

Resolving the conveyor speed in X and Y-direction on the robot Cartesian coordinates

CGETVELX (Obtains the speed in X-direction)

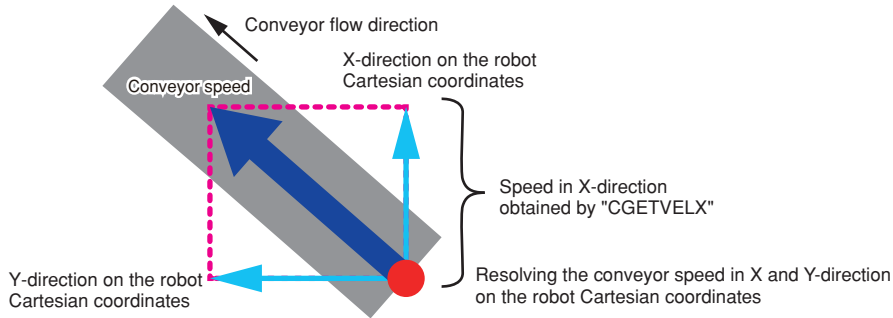

Explanation

<Robot number>

Resolves the velocity in the X-direction on the robot Cartesian coordinates specified by the robot number. The robot number can also be specified by a variable. If omitted, Robot 1 is specified.

<Counter number>

Specifies the counter number of the conveyor for which the velocity is to be obtained. Either 1 or 2 can be specified. This can also be specified by a variable.

7.3.13 CGETVELY

CGETVELY	CGETVELY[robot number](counter number)
	Obtains the velocity of Y-direction by resolving the conveyor velocity to X and Y-direction on the robot Cartesian coordinates.

Description

This function obtains the Y-direction velocity (unit: mm/10 ms) by resolving the conveyor velocity to X and Y-direction on the robot Cartesian coordinates.

The specified robot number conveyor velocity is obtained by Y-direction velocity on the specified robot Cartesian coordinates.

Resolving the conveyor velocity in X and Y-direction on the robot Cartesian coordinates

CGETVELY (Obtains the velocity in Y-direction)

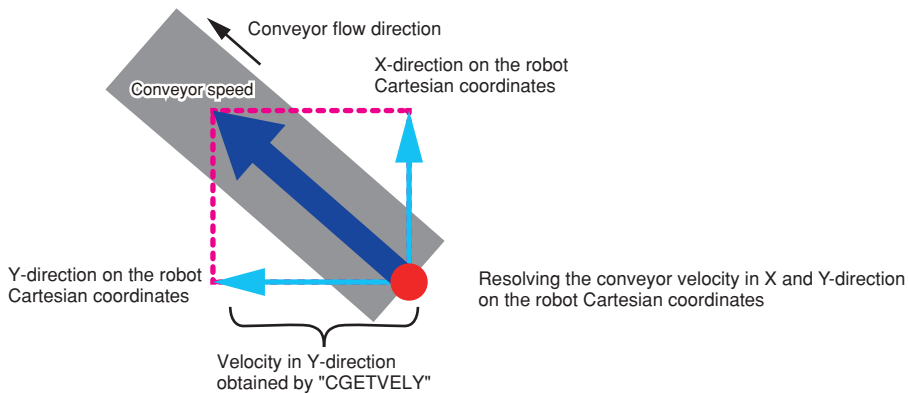

Explanation

<Robot number>

Resolves the velocity in the Y-direction on the robot Cartesian coordinates specified by the robot number. The robot number can also be specified by a variable. If omitted, Robot 1 is specified.

<Counter number>

Specifies the counter number of the conveyor for which the velocity is to be obtained. Either 1 or 2 can be specified. This can also be specified by a variable.

7.3.14 CQUECNT

● **Function**

CQUECNT	CQUECNT(<i>counter number</i>)
	Obtains the quantity of queue elements in the position monitoring queue.

Description

This function obtains the number of queue elements added to the position monitoring queue.
 The number of queue elements added to the position monitoring queue specified with the counter number is obtained.

Explanation

<Counter number>

Specifies the conveyor position monitor queue by using the counter number.
 Either 1 or 2 can be specified. This can also be specified by a variable.

7.3.15 CRMVQUE

● **Command**

CRMVQUE	CRMVQUE[<i>robot number</i>](<i>counter number</i> , <i>queue element number</i>)
	Deletes a queue element from the position monitoring queue.

Description

This command deletes queue elements added to the position monitoring queue.
 A queue element in the position monitoring queue is specified using the robot number, counter number and queue element number, and that queue element is deleted.
 The numbers of the queue elements after the deleted queue element are carried up.



- NOTE
- If this command is executed during follow-up operation or for a queue element in the follow-up state, the queue element will not be deleted and an alarm will occur.
 * After finishing the follow-up movement by "CTMOVE", the queue element changes to "following-up state".
 - If there is position data of multiple robots in queue elements, all the robot data will be deleted.
 - "CCLRRBT" command also deletes whole queue elements. For details, refer to section "7.3.6 CCLRRBT".

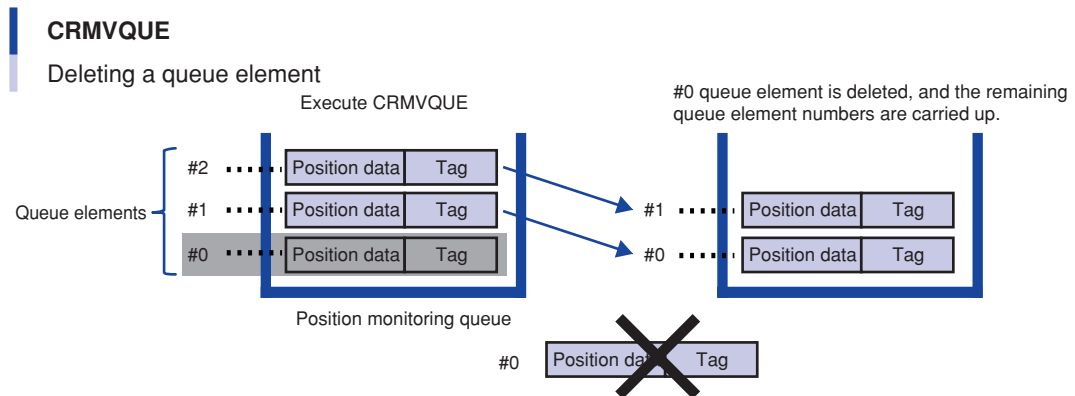

Explanation

<Robot number>

Only the queue elements including robot position data specified by the robot number among the position monitoring queue elements are the target to be deleted.
 The robot number can also be specified by a variable. If omitted, Robot 1 is specified.

<Counter number>

Specifies the conveyor position monitor queue by using the counter number.
 Either 1 or 2 can be specified. This can also be specified by a variable.

<Queue element number>

Specifies the queue element number for the position monitoring queue.

One value between 0 and (CQUECNT-1) can be specified. This can also be specified by a variable.

The queue element numbers are counted in the order that they were added to the position monitoring queue. However, only the target queue elements (the queue elements including robot position data specified by the robot number among the position monitoring queue elements) are counted.

If omitted, the status of the #0 queue element is confirmed.

7.3.16 CRSTPULS

CRSTPULS	CRSTPULS <i>counter number</i>
	Resets the counter pulse value.

Description

This command resets the counter's pulse value.

The pulse value for the specified counter number is set to 0.

Explanation

<Counter number>

Specify the number of the counter for which the pulse value is to be reset.

Either 1 or 2 can be specified. This can also be specified by a variable.

7.3.17 CSETTAG

● Command

CSETTAG	CSETTAG [<i>robot number</i>](<i>counter number</i> , <i>queue element number</i>) = <i>Tag</i>
	Changes the queue element tag of the position monitoring queue.

Description

This command changes the queue element tag of the position monitoring queue.

The position monitoring queue tag specified by robot number, counter number, queue number is changed.

Explanation

<Robot number>

Only the queue elements including robot position data specified by this robot number among the position monitoring queue elements can be the target tag to be changed.

This can also be specified by a variable. If omitted, Robot 1 is specified.

<Counter number>

Specify the conveyor position monitoring queue with this number.

Either 1 or 2 can be specified. This can also be specified by a variable.

<Queue element number>

Specifies the queue element number for the position monitoring queue.

One value between 0 and (CQUECNT-1) can be specified. This can also be specified by a variable.

The queue element numbers are counted from #0 in the order that they were added to the position monitoring queue.

However, only the target queue elements (the queue elements including robot position data specified by the robot number among the position monitoring queue elements) are counted.

If omitted, the first target queue elements is specified as the target.

7.3.18 CTDRIVE

● Command

CTDRIVE	CTDRIVE [<i>robot number</i>](<i>follow-up height (mm)</i>), <i>option</i> , <i>option...</i>
	Switches the follow-up height during conveyor follow-up operation.

Description

This command changes the follow-up height of a robot in the conveyor follow-up state. The operation to change the position of the specified robot's Z-axis to the follow-up height is executed. This command can be executed in a robot that is in the conveyor follow-up state with the CTMOVE command. Note that it cannot be executed for a robot that does not have a Z-axis. Refer to section "7.3.13 CTMOVE" for details on CTMOVE.

CTDRIVE

Example movement

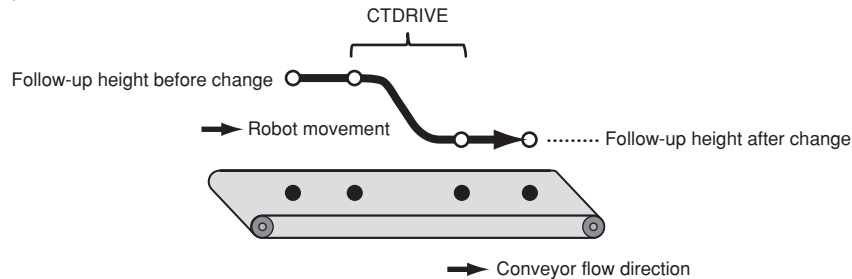

Specifiable options are the speed setting (SPEED), CONT setting, and STOPON condition setting. Options can be omitted.



NOTE

If this command is executed for a robot that is not in the follow-up state, an alarm will occur. To continue the process after an alarm occurring, reset with the "ON ERROR GOTO" statement.

Explanation

<Robot number>

Specifies the number of the robot for which the follow-up height is to be changed. The robot number can also be specified by a variable. If omitted, Robot 1 is specified.

<Follow-up height (mm)>

Specifies the position for moving the Z-axis. A real number (unit: mm) should be used to specify. The follow-up height can also be specified by a variable.



NOTE

The selecting shift and hand information about Z-axis direction (Z-axis offset amount, and so on) are not reflected in the follow-up height.

The followings are options.

<Speed setting (SPEED)>

Format 1: SPEED=<expression>

Format 2: S=<expression>

<expression>...1 to 100 (units: %)

Specifies the program speed in an <expression>.

The actual speed will be as follows:

- Z-axis maximum velocity x automatic movement velocity (%) x program movement speed (%)

<CONT setting>

Format: CONT

When CONT-specified movement is executed, the CTDRIVE can be started without waiting for this command's movement to end.

<STOPON condition setting>

Format: STOPON <conditional expression>

If the conditional expression is established during movement, the robot will start decelerating to a stop.

If the conditional expression is established when starting movement, this command will end without moving.

Note that if a STOPON condition is specified, the CONT setting will be invalidated.

7.3.19 CTMOVE

● Command

CTMOVE	CTMOVE[robot number](counter number, queue element number, option, option,...)
	Starts the conveyor follow-up operation.

Description

This command executes the robot conveyor follow-up operation.

A queue element in the position monitoring queue is specified using the robot number, counter number, and queue element number, and the robot follow-up operation will take place to the position of that queue element.

The conveyor follow-up operation is configured with the following three operations.

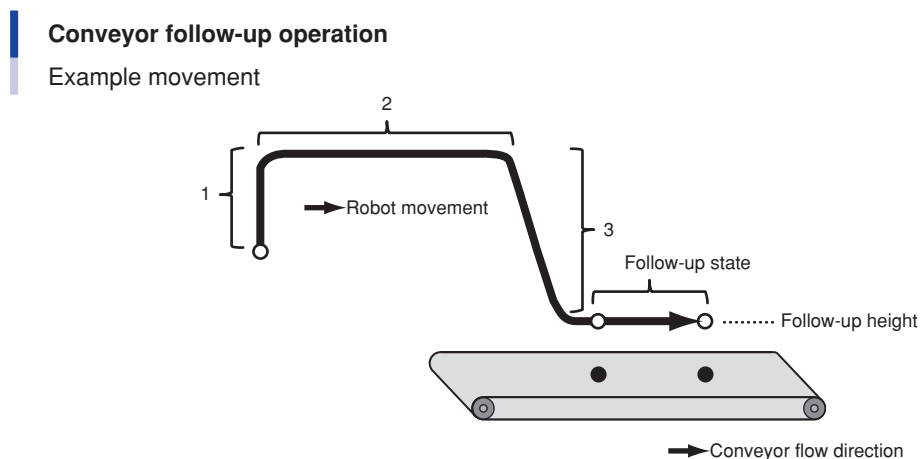

1. Z-axis raising motion

2. Horizontal movement of the X, Y, and R-axis to the position of the queue element in the position monitoring queue

3. Z-axis lowering motion

The raising motion of the Z-axis is executed when the arch motion setting (option) is specified. The lowering motion of the Z-axis is executed when the arch motion setting (option) or follow-up height setting (option) is specified.



NOTE

The raising motion and lowering motion can be executed only with robots that have a Z-axis.

When the follow-up operation is completed, the robot enters the follow-up state and continues to follow the position of the specified queue element. The follow-up state ends not with the "CTDRIVE" or "CTMOVE" command but when another movement command is issued.

Specifiable options are the arch motion setting, STOPON condition setting, CONT setting, and port output setting (remaining time).



NOTE

- Options can be omitted.
- If a follow-up operation cannot be executed, such as when the specified queue element has already passed through the working area or another robot is following-up the specified queue element, an alarm will occur. To continue the process after an alarm, reset with the "ON ERROR GOTO" statement.

Robot hand setting can be switched during follow-up operation.

Although the follow-up operation is not affected by switching hand setting, the next command will be executed with switched setting. The selected hand definition cannot be changed during follow-up operation.

Explanation

<Robot number>

Only the queue elements including robot position data specified by the robot number among the position monitoring can be the target of the follow-up operation.

The robot number can also be specified by a variable. If omitted, Robot 1 is specified.

<Counter number>

Specifies the conveyor position monitor queue by using the counter number.

Either 1 or 2 can be specified. This can also be specified by a variable.

<Queue element number>

Specifies the queue element number for the position monitoring queue.

One value between 0 and (CQUECNT-1) can be specified. This can also be specified by a variable.

Specifies the queue element number for the position monitoring queue.

One value between 0 and (CQUECNT-1) can be specified. This can also be specified by a variable.

The queue element numbers are counted from #0 in the order that they were added to the position monitoring queue.

However, only the target queue elements (the queue elements including robot position data specified by the robot number among the position monitoring queue elements) are counted.

If omitted, the first target queue elements is specified as the target.

<Follow-up height setting>

Format: CTZ=<expression>{<expression 1>}

<expression>...Pulse unit for integer value, and mm unit for real number (with decimal point)

<expression 1>...Pulse unit for integer value, and mm unit for real number (with decimal point)

**NOTE**

- If <expression> or <expression 1> is a real number, all expressions will be handled as real numbers.
- <expression 1> specifies the arch distance 2.
- If <expression 1> is omitted, the axis parameter of arch pulse 2 will be set.
* Refer to <Arch motion setting> for details on arch distance 2 and arch pulse 2.
- The selected information of shift or hand about Z-axis direction (Z-axis offset amount, and so on) is not reflected to specifying the follow-up height.

When the follow-up height is set, the arch lowering motion is executed.

1. XYR axes start horizontal movement.
2. When the XYR axes finish the horizontal movement, the Z-axis starts moving to the follow-up height so that the remaining movement distance of the Z-axis is the arch distance 2.
3. The command is finished when the Z-axis reaches the follow-up height.

**NOTE**

If arch distance 2 is specified for both the follow-up height and arch motion, the value specified last will be used.

<Arch motion setting>

Format: Z=<expression>{<expression 1>,<expression 2>}

<expression>...Pulse unit for integer value, and mm unit for real number (with decimal point)

<expression 1>, <expression 2>...Pulse unit for integer value, and mm unit for real number (with decimal point)

**NOTE**

- If <expression>, <expression 1>, or <expression 2> is a real number, all expressions will be handled as real numbers.
- <expression 1> and <expression 2> specify the arch distance 1 and arch distance 2 respectively.
- If <expression 1> and <expression 2> are omitted, the axis parameters of arch pulse 1 and arch pulse 2 will be set.
- The selected information of shift or hand about Z-axis direction (Z-axis offset amount, and so on) is not reflected to specifying the arch motion.

When the arch motion is specified, the arch raising motion and arch lowering motion are executed.

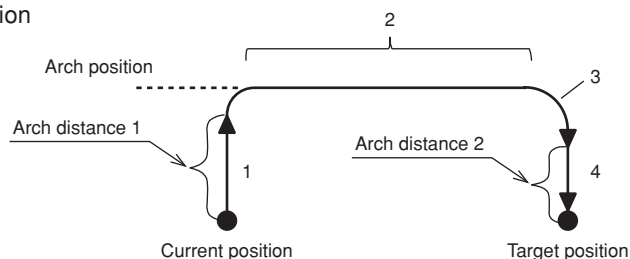
Arch motion**Example operation**

1. Z-axis starts moving to the position specified with the <expression>.
2. When the Z-axis moves to the distance of arch distance 1 or more, the XYR axes start horizontal movement.
3. When the X, Y, and R-axis finish the horizontal movement, the Z-axis starts moving to the position where CTMOVE was started so that the remaining lowering distance is arch distance 2.
4. The command is finished when the Z-axis reaches the position where CTMOVE was started.



NOTE

- The follow-up height and arch motion setting can be specified simultaneously.
- If only the arch motion is set, the Z-axis will move to the same position as where CTMOVE was started in step 4 above.
- If the follow-up height and arch motion setting are specified simultaneously, the Z-axis will move to the follow-up height specified in step 4 above.
- If arch distance 2 is specified for both the follow-up height and arch motion, the value specified last will be used.

<CONT setting>

Format: CONT

If the movement set with CONT is executed, the CTDRIVE can be started without waiting for the follow-up operation to end.

<STOPON condition setting>

Format :STOPON <conditional expression>

If the conditional expression is established during movement, the deceleration to stop will start.



CAUTION

Even if the conditional expression is established before movement starts, movement will not stop until the arch raising motion finishes when using this command's STOPON condition setting with the arch motion setting.



NOTE

If the STOPON condition is set, the CONT setting will be invalid.

<Port output setting (remaining time)>

Format 1: |DO/MO/SO|m(b,...,b)=<expression 1>#<expression 2>

Format 2: |DO/MO/SO|(mb,...,mb)=<expression 1>#<expression 2>

m: port number...2 to 7, 10 to 17, 20 to 27

b: bit definition...0 to 7

<expression 1>...Value which is output to the specified port (only integers are valid).

<expression 2>...Remaining movement time for power output, in [ms] unit (only integers are valid).

The <expression 1> value is output to the specified output port at the timing that the remaining horizontal movement time (unit: ms) is <expression 2> or less. If b, ..., b is omitted in Format 1, all eight bits will be the target.



NOTE

Even if the actual movement time is shorter than the specified remaining movement time, the data is not output to the port until the arch raising motion finishes when using this command's port output setting with the arch motion setting.

7.3.20 CTRKEMGN

● Command

CTRKEMGN	CTRKEMGN[robot number](counter number) = setting value
	Changes the tracking end margin.

Description

This command changes the tracking end margin (unit: ms) specified by the robot number and counter number. When this command is executed, tracking end margin of the tracking parameter is changed.

Explanation

<Robot number>

Specifies the robot number for which the tracking end margin is changed. This can also be specified by a variable. If omitted, Robot 1 is specified.

<Counter number>

Specifies the counter number for which the tracking end margin is changed. Either 1 or 2 can be specified. This can also be specified by a variable.

<Setting value>

Specifies the tracking end margin (unit: ms). This can also be specified by a variable.

● Function

CTRKEMGN	CTRKEMGN <i>[robot number]</i> (<i>counter number</i>)
	Obtains the tracking end margin.

Description

This function obtains the tracking end margin (unit: ms) specified by the robot number and counter number.

Explanation

<Robot number>

Specifies the robot number for which the tracking end margin is obtained.
This can also be specified by a variable. If omitted, Robot 1 is specified.

<Counter number>

Specifies the counter number for which the tracking end margin is changed.
Either 1 or 2 can be specified. This can also be specified by a variable.

7.3.21 CTRKPADJ

● Command

CTRKPADJ	CTRKPADJ <i>[robot number]</i> (<i>counter number</i>) = <i>setting value</i>
	Changes the tracking position adjustment.

Description

This command changes the tracking position adjustment (unit: 0.001 mm) specified by the robot number and counter number.

When this command is executed, tracking position adjustment value of the tracking parameter is changed.

Explanation

<Robot number>

Specifies the robot number for which the tracking position adjustment is changed.
This can also be specified by a variable. If omitted, Robot 1 is specified.

<Counter number>

Specifies the counter number for which the tracking position adjustment is changed.
Either 1 or 2 can be specified. This can also be specified by a variable.

<Setting value>

Specifies the tracking position adjustment (unit: 0.001 mm). This can also be specified by a variable.

● Function

CTRKPADJ	CTRKPADJ <i>[robot number]</i> (<i>counter number</i>)
	Obtains the tracking position adjustment.

Description

This function obtains the tracking position adjustment (unit: 0.001 mm) specified by the robot number and counter number.

Explanation

<Robot number>

Specifies the robot number for which the tracking position adjustment is obtained.
This can also be specified by a variable. If omitted, Robot 1 is specified.

<Counter number>

Specifies the counter number for which the tracking end margin is changed.
Either 1 or 2 can be specified. This can also be specified by a variable.

7.3.22 CTRKSMGN

● Command

CTRKSMGN	CTRKSMGN[robot number](counter number) = setting value
	Changes the tracking start margin.

Description

This command changes the tracking start margin (unit: ms) specified by the robot number and counter number. When this command is executed, tracking start margin of the tracking parameter is changed.

Explanation

<Robot number>

Specifies the robot number for which the tracking start margin is changed. This can also be specified by a variable. If omitted, Robot 1 is specified.

<Counter number>

Specifies the counter number for which the tracking start margin is changed. Either 1 or 2 can be specified. This can also be specified by a variable.

<Setting value>

Specifies the tracking start margin (unit: ms). This can also be specified by a variable.

● Function

CTRKSMGN	CTRKSMGN[robot number](counter number)
	Obtains the tracking start margin.

Description

This function obtains the tracking start margin (unit: ms) specified by the robot number and counter number.

Explanation

<Robot number>

Specifies the robot number for which the tracking start margin is changed. This can also be specified by a variable. If omitted, Robot 1 is specified.

<Counter number>

Specifies the counter number for which the tracking start margin is changed. Either 1 or 2 can be specified. This can also be specified by a variable.

7.3.23 CTSTOP

CTSTOP	CTSTOP[robot number]
	Ends conveyor follow-up.

Description

This command ends and stops the follow-up operation in robots in the conveyor follow-up state. The specified robot stops follow-up of the conveyor, and then decelerates to a stop. If this command is executed for a robot moving with the CTMOVE command or CTDRIVE command, the robot will decelerate to a stop after the movement is completed. If this command is issued to a robot that is not following a conveyor, the command will end immediately.

Explanation

<Robot number>

Specifies the number of the robot that will stop following the conveyor. The robot number can also be specified by a variable. If omitted, Robot 1 is specified.

7.3.24 CTVISION (Reserved)

● Command

CTVISION	CTVISION ION/OFFI[<i>task number</i>](<i>counter number</i>)
	Switches whether or not to use iVY2 with conveyor tracking.

Description

This command switches whether or not to use iVY2 with conveyor tracking.

When this command is executed, the queue element position data becomes data where the counter pulse variation amount is compensated from the iVY2 capture point to when the queue element is added.

Explanation

<Task number>

Specifies the task number for holding the iVY2 search results.

One value between 1 and 16 can be specified. If omitted, the number of the task executing this command will be specified. (With the online command, the task number cannot be omitted.)

This can also be specified by a variable. If omitted, Robot 1 is specified.

<Counter number>

Specifies the conveyor counter number executing the conveyor tracking.

Either 1 or 2 can be specified. This can also be specified by a variable.

If omitted, Counter 1 and Counter 2 are specified.

● Function

CTVISION	CTVISION[<i>task number</i>](<i>counter number</i>)
	Obtains the information of whether or not to use the iVY2 with conveyor tracking.

Description

This function obtains the information of whether or not to use the iVY2 with conveyor tracking.

Obtains either 0: Do not use or 1: Use.

Explanation

<Task number>

Specifies the task number.

One value between 1 and 16 can be specified. If omitted, the number of the task executing this command will be specified. (With the online command, the task number cannot be omitted.)

<Counter number>

Specifies the conveyor counter number.

Either 1 or 2 can be specified. This can also be specified by a variable.

7.3.25 CVELCOEF

● Command

CVELCOEF	CVELCOEF[<i>robot number</i>](<i>counter number</i>) = <i>setting value</i>
	Changes the conveyor velocity coefficient.

Description

This command changes the conveyor velocity coefficient (unit: %) specified by the robot number and counter number.

When this command is executed, the conveyor velocity coefficient of the tracking parameter is changed.

Explanation

<Robot number>

Specifies the robot number for which the conveyor velocity coefficient is changed.

This can also be specified by a variable. If omitted, Robot 1 is specified.

<Counter number>

Specifies the counter number for which the conveyor velocity coefficient is changed.

Either 1 or 2 can be specified. This can also be specified by a variable.

<Setting value>

Specifies the conveyor velocity coefficient (unit: %). This can also be specified by a variable.

● Function

CVELCOEF	CVELCOEF[robot number](counter number)
	Obtains the conveyor velocity coefficient.

Description

This function obtains the conveyor velocity coefficient (unit: %). specified by the robot number and counter number.

Explanation

<Robot number>

Specifies the robot number for which the conveyor velocity coefficient is obtained. This can also be specified by a variable. If omitted, Robot 1 is specified.

<Counter number>

Specifies the counter number for which the conveyor velocity coefficient is changed. Either 1 or 2 can be specified. This can also be specified by a variable.

7.4 Sample programs

7.4.1 One robot picks and places the workpiece

■ Overview

Robot 1 performs tracking workpieces that are detected by a tool such as photoelectric sensor on the conveyor 1.

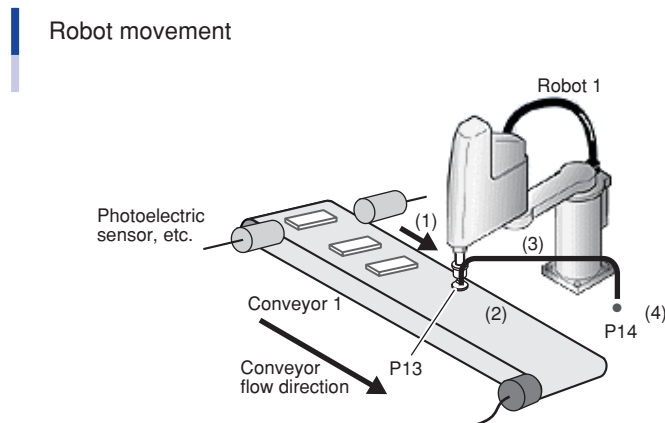

- (1) When the workpiece that is detected by photoelectric sensor and so on, comes to the work are, the robot 1 moves with following-up the conveyor.
- (2) The robot 1 picks up the workpiece.
- (3) The robot 1 moves to the workpiece place point (P14).
- (4) The robot 1 releases the workpiece.

● Points to be used

P0 ... Workpiece position when detected

P13 . Robot 1 waiting position (When the program starts or failed to pick the workpiece up, the robot 1 moves to this point.)

P14 . Workpiece place point for robot

● I/O signals used

Output signal description		Output signal status	
		1	0
DO(20)	Detecting workpieces by photoelectric sensor, etc.	Detected	Not detected
DO(20)	Workpiece pick-and-place command for robot 1	Pick	Release

- **Others**

- One robot (robot 1) is used.
- The conveyor counter number is 1.
- The workpieces are lined, have interval and flown in the same direction.
- The main program and search task for tracking are written in separate program and operated by separate task.
- Program "TRK_MAIN" works on task 1. Any programs are not registered for task 2.
- Judgment area distance is set by the "Tracking CADDQUE Distance" parameter.

■ Sample program

Tracking operation main program

Program name: TRK_MAIN

```

ON ERROR GOTO *ERROR_CHECK1
CCOND ON(1) ..... Validate Counter 1
MOVE P, P13, Z=0.0 ..... Perform arch motion movement to waiting position
START <WORK_INSERT>,T2 ..... Start the workpiece detection task
*CONVEYOR: ..... Label definition
WHILE CCHKQUE(1) = -1 ..... Repeat until there is no workpiece that has passed the
    working area (the first queue element failed to be picked up)
    CRMVQUE(1)..... Delete the first workpiece (first queue element) that passed
    the working area during follow-up from the position
    monitoring queue

WEND
IF CCHKQUE(1) = 1 THEN..... Start work when first workpiece enters the working area
    CTMOVE(1),Z=0.0{10.0,20.0}, CTZ=50.0,CONT ..... Start follow-up movement by arch motion and follow-up
    height setting for the first workpiece

    CTDRIVE(120.0) , S=50 ..... Move to the workpiece height with decelerating from
    CTMOVE operation

    DELAY 200 ..... Wait 200 ms
    DO(20) = 1 ..... Pick up workpiece
    MOVE P , P14 , Z=0.0 ..... Perform arch motion movement to the place point
    CRMVQUE(1)..... Delete the first workpiece (first queue element) that moved
    from the position monitoring queue

    DO(20) = 0 ..... Release the workpiece

ENDIF
GOTO *CONVEYOR ..... Jump to label *CONVEYOR (go to tracking of next workpiece)
*ERROR_CHECK: ..... Label definition (error avoidance)
    (Process continues in the following errors)

IF ERR = &H0002015B THEN *NEXT1 ..... If the alarm (code 2.347: Not tracking status) occurs
IF ERR = &H000C00CE THEN *NEXT1 ..... If the alarm (code 12.206: Tracking queue element doesn't
    exist) occurs

IF ERR = &H0002015C THEN *NEXT2 ..... If the alarm (code 2.348: Over tracking area) occurs
IF ERR = &H000C00CF THEN *NEXT3 ..... If the alarm (code 12.207: Tracking queue element being
    used) occurs

ON ERROR GOTO 0 ..... Display error and stop execution except for alarms above
*NEXT1: ..... Label definition (error avoidance)
RESUME NEXT ..... Jump to the line next to the line where error occurred, and
    continue execution

*NEXT2: ..... Label definition (process for picking failure)
CRMVQUE(1) ..... Delete the first workpiece (first queue element) that passed
    the working area during follow-up from the position
    monitoring queue

MOVE P, P13, Z=0.0 ..... Perform arch motion movement to waiting position
RESUME *CONVEYOR ..... Jump to label *CONVEYOR and continue execution
*NEXT3: ..... Label definition (error avoidance 3)
CTSTOP..... Stop the follow-up status
CRMVQUE(1) ..... Delete the data that the follow-up status ends
RESUME NEXT ..... Jump to the line next to the line where error occurred, and
    continue execution

```

(Continued on next page)

Workpiece detection task

Program: WORK_INSERT

```

*INSERT:..... Label definition (workpiece detection)
WAIT DI(20) = 0 ..... Wait for the workpiece has passed (no workpiece is detected)
WAIT DI(20) = 1 ..... Perform workpiece detection
                        If workpiece is detected
CADDQUE 1,P0..... Set the "Tracking CADDQUE Distance" parameter value to
                        the judgment area distance and add to the position
                        monitoring queue
GOTO *INSERT..... Jump to label *INSERT (repeat workpiece detection)

```

8. Troubleshooting

8.1 Alarm messages

This section explains the Tracking System alarm messages. For details concerning other alarms, refer to the user's manual for the robot controller being used.

If an alarm occurs, relevant alarm message appears on the screen of the programming box. For details about contents of each alarm message, see the list.

The alarm code consists of 2 elements, "group" and "classification". Each code is classified as follows.

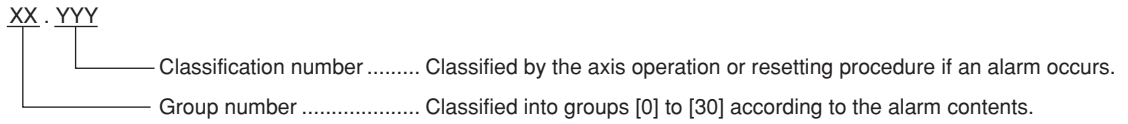

■ Error message display format

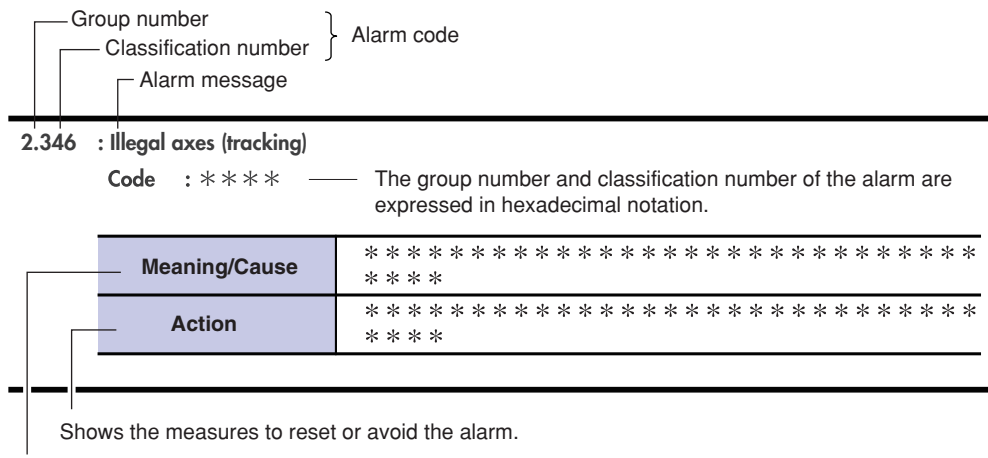

Shows the alarm meaning and the cause of the alarm occurrence.



NOTE

If the alarm cannot be solved even after taking the corrective action, contact your distributor.

* The alarm occurrence status and alarm history can be checked from the programming box. For details on how to check the conditions that caused the alarm and the alarm history, refer to the YRCX Operator's Manual. Information on the alarm occurrence location (axis or option board, etc.) may be added next to the alarm code.

■ Checking the alarm occurrence status

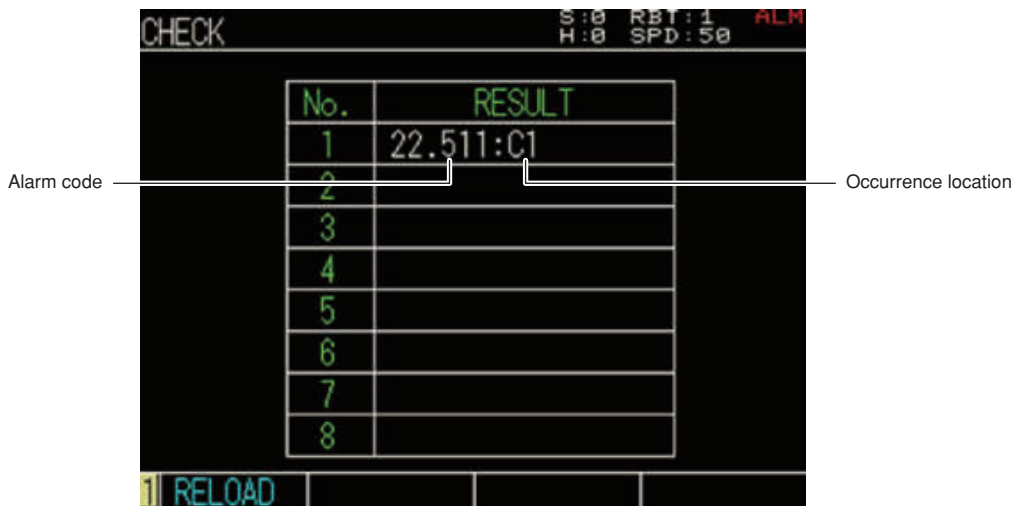

■ Alarm occurrence location list

T*	Task *... Task number
SYS	Startup, memory check, generation
ONL	Online command
RMT	Remote command
SEQ	Sequence program
SIN	Standard input
C*	Controller *... Controller number
C*O*	Option board *... Controller number, option slot number
R*/R*A*	Robot, axis *... Robot number, axis number
M*/C*M*	Physical motor *... Motor number, controller number

For example, when "17.403: M1" is displayed, this shows that the position reset position error occurs in motor 1. In the same manner, when "14.400:T02" is displayed, this shows that the communication shutdown error occurs in task 2.

[2] Alarm related to the robot operation

2.346 : Illegal axes (tracking)

Code : &H0002 &H015A

Meaning/Cause	a. Tracking cannot be executed with this axis configuration. b. "CTDRIVE" or "CTMOVE" command with specifying the Z-axis operation command was executed for the robot without Z-axis.
Action	a. Check the robot axis configuration. b. Change the program so that "CTDRIVE" or "CTMOVE" command with specifying the Z-axis operation command cannot be executed for the robot without Z-axis.

2.347 : Not tracking status

Code : &H0002 &H015B

Meaning/Cause	"CTDRIVE" command was executed for the robot without following the conveyor.
Action	Change the program so that "CTDRIVE" command is executed after following the conveyor by "CTMOVE" command.

2.348 : Over tracking area

Code : &H0002 &H015C

Meaning/Cause	<ul style="list-style-type: none"> • The robot cannot be operated since the elements of position monitoring queue specified by "CTMOVE" command was out of the work area. • The elements of position monitoring queue in following moved out of the work area.
Action	<ul style="list-style-type: none"> • Review the robot program so that the elements of position monitoring queue specified by "CTMOVE" command is in the work area. • Reduce the setting value of the tracking end margin of the tracking parameter. • Change the program so that the next command or "CTSTOP" command execute before moving out of the work area.

2.349 : Can't execute CTMOVE

Code : &H0002 &H015D

Meaning/Cause	"CTMOVE" command was not executed since it was in deceleration control.
Action	"CTMOVE" command cannot be executed in MANUAL mode.

2.708 : System error (Tracking)

Code : &H0002&H02C4

Meaning/Cause	Error occurred in software.
Action	Contact your distributor.

[9] Alarm related to the memory**9.714 : Conveyor data destroyed**

Code : &H0009 &H02CA

Meaning/Cause	Error occurred in the conveyor calibration data.
Action	Initialize the conveyor calibration data.

9.732 : Counter status data destroyed

Code : &H0009 &H02DC

Meaning/Cause	Error occurred in the tracking counter status data. Status specified on "CCOND" and "CTVISION" commands will be initialized.
Action	Re-execute "CCOND" and "CTVISION" commands.

[12] Alarm related to the option board**12.200 : Tracking disabled**

Code : &H000C &H00C8

Meaning/Cause	a. No tracking board is connected to the option slot. b. The tracking board is set to "INVALID".
Action	a. Check that the tracking board is connected. b. Set the tracking board to "VALID".

12.201 : Tracking counter not enabled

Code : &H000C &H00C9

Meaning/Cause	a. The tracking counter status is set "INVALID". b. The value of counter pulse did not change during calibration.
Action	a. Check the counter status and set "VALID". b. Check if the counter value can be read.

12.202 : Tracking vision not enabled

Code : &H000C &H00CA

Meaning/Cause	a. Tasks or counters which did not execute the "CTVISION" command were specified when executing the "CADDQUEV" command. b. The iVY2 system is set "INVALID".
Action	a. Execute the "CTVISION" command on the tasks or counters beforehand. b. Set the iVY2 system "VALID".

12.203 : Tracking calibration incomplete

Code : &H000C &H00CB

Meaning/Cause	Tracking function was executed with the robot or counter on which calibration was not executed.
Action	• Execute calibration. • Write the calibration data. • Set the different calibration data at upstream and downstream positions.

12.204 : Tracking counter number error
Code : &H000C &H00CC

Meaning/Cause	The specified counter number was neither 1 nor 2.
Action	Specify the correct value.

12.205 : Tracking queue element number error
Code : &H000C &H00CD

Meaning/Cause	The position monitor queue element number that is out of specifiable range was specified. Between 0 and 79 can be specified.
Action	Specify the value within the range.

12.206 : Tracking queue element doesn't exist
Code : &H000C &H00CE

Meaning/Cause	The queue element specified by the position monitoring queue does not exist.
Action	<ul style="list-style-type: none"> • Add the queue element to the position monitoring queue. • Check the specified queue element.

12.207 : Tracking queue element being used
Code : &H000C &H00CF

Meaning/Cause	The "CRMVQUE" command was executed during tracking operation.
Action	Execute the command after tracking operation has completed.

12.581 : Counter1 wire breakage
Code : &H000C &H0245

Meaning/Cause	The encoder cable connected to the counter 1 is broken. The break detection is available when the counter 1 is set to "VALID".
Action	<ul style="list-style-type: none"> • Set the counter status to "INVALID" if the encoder is not connected to the counter 1. • Check the encoder cable of the counter 1. • Check if the encoder works normally.

12.582 : Counter2 wire breakage
Code : &H000C &H0246

Meaning/Cause	The encoder cable connected to the counter 2 is broken. The break detection is available when the counter 2 is set to "VALID".
Action	<ul style="list-style-type: none"> • Set the counter status to "INVALID" if the encoder is not connected to the counter 2. • Check the encoder cable of the counter 2. • Check if the encoder works normally.

12.583 : Tracking watchdog error
Code : &H000C &H0247

Meaning/Cause	There is no response from the tracking board for a certain time.
Action	<ul style="list-style-type: none"> • Check the tracking board connection status. • Check if the tracking board is recognized on the programming box. • Turn the power off and on again.

8.2 When trouble occurs

Please contact your distributor with details of the problem that occurs. Report the following items in as much detail as possible.

Item	Description
What happened	<ul style="list-style-type: none"> • Controller model name and serial number example: YRCX • Robot model name and serial number example: R6YXG500 • Controller version number example: V1.05 R0018 • Tracking board version number example: V1.000
When	<ul style="list-style-type: none"> • Date of purchase example: June 2014 • How long used example: Since delivery, about 1 year
Under what conditions	<ul style="list-style-type: none"> • Usage conditions example: when power is turned on when creating program during manual movement when robot is moved to particular location during program operation. during conveyor calibration
Current status is	<ul style="list-style-type: none"> • Status on programming box screen example: Nothing is displayed on screen Error message appears on screen • Robot servo status example: Servo won't turn on Abnormal sound when robot is moved Sets to origin incomplete. • Programming box operating status example: Keys won't function Response after pressing key is slow Only the emergency stop button functions etc.
How often it happens	<ul style="list-style-type: none"> • How often above problem occurs example: Always occurs when power is turned on. Occurs at particular line during program operation. Only occurs once, then does not occur again.

8.3 Troubleshooting

If trouble occurs with the tracking board, check the following items and take appropriate actions.

Symptom	The encoder does not count.
Cause	<ul style="list-style-type: none"> • The AB phase input cable is not connected correctly. • The tracking board counter status is not set to ON. • The encoder is not functioning correctly.
Actions	<ul style="list-style-type: none"> • Refer to section "3.1 Wiring" and correctly connect the AB phase input cable. • Set the counter status to ON by the "CCOND" command. • Replace the encoder with one that is functioning correctly.

Symptom	The encoder does not count correctly.
Cause	<ul style="list-style-type: none"> • The encoder pulse exceeds 2 Mbps. • The AB phase input cable is incorrectly wired.
Actions	<ul style="list-style-type: none"> • Use so that the encoder pulse is 2Mbps or less. • Refer to section "3.1 Wiring" and correctly connect the AB phase input cable.

Symptom	The controller does not start correctly.
Cause	The AB phase input cable is incorrectly wired.
Actions	Refer to section "3.1 Wiring" and correctly connect the AB phase input cable.

9. Specifications list

Specification Item		Tracking board
Basic specifications	Supported controllers	YRCX
	Number of connected encoders	Up to 2 units.
	Encoder power supply	5 VDC (Total of less than 500mA for both channels) (Supplied from controller)
	Applicable encoder	26LS31/26C31 or equivalent line driver (RS422 compliance)
	Input phase	A, \bar{A} , B, \bar{B} , Z, \bar{Z}
	Maximum response frequency	2 MHz
	Counter	0 to 65535
	Multiplier	4-fold
	Other	With disconnection detection function

Revision history

A manual revision code appears as a suffix to the catalog number on the front cover manual.

Cat. No. I249E-EN-01



The following table outlines the changes made to the manual during each revision.

Manual version	Issue date	Description
01	August 2016	Original production

OMRON

Authorized Distributor: