

Industrial PC Platform

NY-series

**IPC Machine Controller**

**Industrial Panel PC / Industrial Box PC**

**Setup**

**User's Manual**

NY512-1□00

NY532-1□00

NY532-5400

Industrial Panel PC

Industrial Box PC



## NOTE

All rights reserved. No part of this publication may be reproduced, stored in a retrieval system, or transmitted, in any form, or by any means, mechanical, electronic, photocopying, recording, or otherwise, without the prior written permission of OMRON.

No patent liability is assumed with respect to the use of the information contained herein. Moreover, because OMRON is constantly striving to improve its high-quality products, the information contained in this manual is subject to change without notice. Every precaution has been taken in the preparation of this manual. Nevertheless, OMRON assumes no responsibility for errors or omissions. Neither is any liability assumed for damages resulting from the use of the information contained in this publication.

## Trademarks

- Sysmac and SYSMAC are trademarks or registered trademarks of OMRON Corporation in Japan and other countries for OMRON factory automation products.
- Windows, Visual Basic and Visual Studio are either registered trademarks or trademarks of Microsoft Corporation in the USA and other countries.
- EtherCAT® is registered trademark and patented technology, licensed by Beckhoff Automation GmbH, Germany.
- ODVA, CIP, CompoNet, DeviceNet, and EtherNet/IP are trademarks of ODVA.
- The SD and SDHC logos are trademarks of SD-3C, LLC. 
- CFAST is a registered trademark of CompactFlash Association.
- Intel, the Intel Logo, Celeron and Intel Core are trademarks or registered trademarks of Intel Corporation or its subsidiaries in the USA and other countries.

Other company names and product names in this document are the trademarks or registered trademarks of their respective companies.

## Copyrights

Microsoft product screen shots reprinted with permission from Microsoft Corporation.

# Introduction

Thank you for purchasing the IPC Machine Controller.

This manual contains information that is necessary to use the IPC Machine Controller (hereafter also named IPC). Please read this manual and make sure you understand the functionality and performance of the IPC before attempting to use it.

Keep this manual in a safe place where it will be available for reference during operation.

## Intended Audience

This manual is intended for the following personnel, who must also have knowledge of software programming (a software engineer or the equivalent).

- Personnel in charge of introducing Factory Automation systems.
- Personnel in charge of designing Factory Automation systems.
- Personnel in charge of software design for Factory Automation systems.
- Personnel in charge of installing and maintaining and programming Factory Automation systems.
- Personnel in charge of managing Factory Automation systems and facilities.

For programming, this manual is intended for personnel who understand the programming language specifications in international standard IEC 61131-3 or Japanese standard JIS B 3503.

## Applicable Products

This manual covers the following products:

Product	Model-ID
Industrial Box PC Machine Controller	<ul style="list-style-type: none"> <li>• NY512-1500</li> <li>• NY512-1400</li> <li>• NY512-1300</li> </ul>
Industrial Panel PC Machine Controller	<ul style="list-style-type: none"> <li>• NY532-1500</li> <li>• NY532-1400</li> <li>• NY532-1300</li> <li>• NY532-5400</li> </ul>



### Additional Information

Refer to *1-3 Product Configuration* on page 1-6 for configuration details.

# Relevant Manuals

The following table provides the relevant manuals for the NY-series Controller. Read all of the manuals that are relevant to your system configuration and application before you use the NY-series Controller. Most operations are performed from the Sysmac Studio Automation Software. Refer to the *Sysmac Studio Version 1 Operation Manual (Cat. No. W504)* for information on the Sysmac Studio.

Purpose of use	Manual										
	Basic information					NY-series Motion Control Instructions Reference Manual	NY-series IPC Machine Controller Industrial Panel PC / Industrial Box PC Motion Control User's Manual	NY-series IPC Machine Controller Industrial Panel PC / Industrial Box PC Built-in EtherCAT Port User's Manual	NY-series IPC Machine Controller Industrial Panel PC / Industrial Box PC Built-in EtherNet/IP Port User's Manual	NY-series NC Integrated Controller User's Manual	NY-series Troubleshooting Manual
	NY-series IPC Machine Controller Industrial Panel PC Hardware User's Manual	NY-series IPC Machine Controller Industrial Box PC Hardware User's Manual	NY-series IPC Machine Controller Industrial Panel PC / Industrial Box PC Setup User's Manual	NY-series IPC Machine Controller Industrial Panel PC / Industrial Box PC Software User's Manual	NY-series Instructions Reference Manual						
Introduction to NY-series Panel PCs	○										
Introduction to NY-series Box PCs		○									
Setting devices and hardware											
Using motion control	○	○				○					
Using EtherCAT							○				
Using EtherNet/IP								○			
Making setup*1											
Making initial settings			○								
Preparing to use Controllers											
Software settings											
Using motion control						○					
Using EtherCAT					○		○				
Using EtherNet/IP								○			
Using numerical control									○		
Writing the user program											
Using motion control							○	○			
Using EtherCAT					○	○		○			
Using EtherNet/IP									○		
Using numerical control										○	
Programming error processing											
Testing operation and debugging											
Using motion control							○				
Using EtherCAT					○			○			
Using EtherNet/IP									○		
Using numerical control										○	
Learning about error management and corrections*2										○	

Purpose of use	Manual									
	Basic information				NY-series Motion Control Instructions Reference Manual	NY-series IPC Machine Controller Industrial Panel PC / Industrial Box PC Motion Control User's Manual	NY-series IPC Machine Controller Industrial Panel PC / Industrial Box PC Built-in EtherCAT Port User's Manual	NY-series IPC Machine Controller Industrial Panel PC / Industrial Box PC Built-in EtherNet/IP Port User's Manual	NJ/Y-series NC Integrated Controller User's Manual	NY-series Troubleshooting Manual
	NY-series IPC Machine Controller Industrial Panel PC Hardware User's Manual	NY-series IPC Machine Controller Industrial Box PC Hardware User's Manual	NY-series IPC Machine Controller Industrial Panel PC / Industrial Box PC Setup User's Manual	NY-series Instructions Reference Manual						
Maintenance										
Using motion control										
Using EtherCAT	○	○			○		○			
Using EtherNet/IP								○		

\*1. Refer to the NY-series Industrial Panel PC / Industrial Box PC Setup User's Manual (Cat. No. W568) for how to set up and how to use the utilities on Windows.

\*2. Refer to the NY-series Troubleshooting Manual (Cat. No. W564) for the error management concepts and the error items.

# Manual Information

This section provides information about this manual.

## Page Structure

The following page structure is used in this manual.

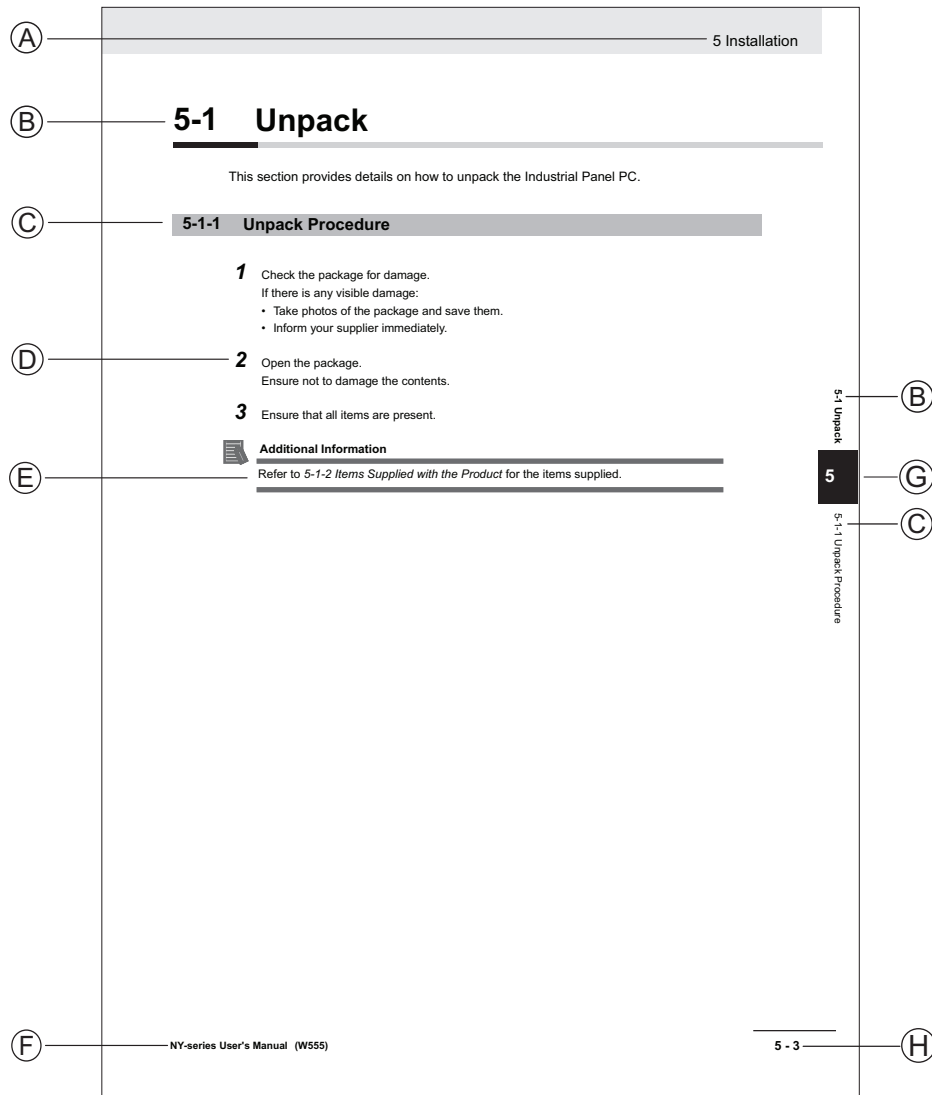

Note: This illustration is provided as a sample. It will not literally appear in this manual.

Item	Explanation	Item	Explanation
A	Level 1 heading	E	Special Information
B	Level 2 heading	F	Manual name
C	Level 3 heading	G	Page tab with the number of the main section
D	Step in a procedure	H	Page number

## Special Information

Special information in this manual is classified as follows:



### Precautions for Safe Use

Precautions on what to do and what not to do to ensure safe usage of the product.



### Precautions for Correct Use

Precautions on what to do and what not to do to ensure proper operation and performance.



### Additional Information

Additional information to read as required.  
This information is provided to increase understanding or make operation easier.



### Version Information

Information on differences in specifications and functionality between different versions.

## Precautions on Terminology

Additional information for some terms used in this manual.

### Download and Upload

In this manual, “download” refers to transferring data from the Sysmac Studio to the physical Controller and “upload” refers to transferring data from the physical Controller to the Sysmac Studio. For the Sysmac Studio, synchronization is used to both upload and download data. Here, “synchronize” means to automatically compare the data for the Sysmac Studio on the computer with the data in the physical Controller and transfer the data in the direction that is specified by the user.

### CPU Unit

Some of the descriptions of functions in this manual are common to NJ/NX-series.

Therefore, note the following conditions.

- The same function names are used for the common functions of the NJ/NX/NY-series. If the term “CPU Unit” is included in the function names, such as the CPU Unit names, CPU Unit write protection, and other functions, it indicates the “Controller” in the NY-series.
- The “CPU Unit” that is described in a list of function specifications in this manual also indicates the “Controller” in the NY-series.





# Sections in this Manual

---

<b>1</b>	Introduction to Industrial PC	<b>I</b>	Index	<b>1</b>	<b>I</b>
<b>2</b>	Initial Settings and Software Utilities			<b>2</b>	
<b>3</b>	Controller Preparation			<b>3</b>	
<b>4</b>	Industrial PC Support Utility			<b>4</b>	
<b>5</b>	NYCompolet			<b>5</b>	
<b>6</b>	Software for Developers			<b>6</b>	
<b>7</b>	Backup and Recovery			<b>7</b>	
<b>8</b>	Troubleshooting during Setup			<b>8</b>	
<b>A</b>	Appendices			<b>A</b>	

# CONTENTS

---

<b>Introduction .....</b>	<b>1</b>
Intended Audience .....	1
Applicable Products .....	1
<b>Relevant Manuals .....</b>	<b>2</b>
<b>Manual Information .....</b>	<b>4</b>
Page Structure .....	4
Special Information .....	5
Precautions on Terminology .....	5
<b>Sections in this Manual .....</b>	<b>7</b>
<b>Terms and Conditions Agreement.....</b>	<b>12</b>
Warranty, Limitations of Liability .....	12
Application Considerations .....	13
Disclaimers .....	14
<b>Safety Precautions .....</b>	<b>15</b>
<b>Precautions for Safe Use .....</b>	<b>16</b>
<b>Precautions for Correct Use .....</b>	<b>17</b>
<b>Regulations and Standards .....</b>	<b>18</b>
Conformance to EU Directives .....	18
Software Licenses and Copyrights .....	18
<b>Versions .....</b>	<b>19</b>
Checking Versions .....	19
<b>Related Manuals .....</b>	<b>21</b>
<b>Revision History.....</b>	<b>25</b>

## Section 1 Introduction to the Industrial PC

---

<b>1-1 Features .....</b>	<b>1-2</b>
<b>1-2 Operation of the Operating System .....</b>	<b>1-3</b>
1-2-1 Overview of Operating System Operation.....	1-3
1-2-2 Data Exchange between Operating Systems .....	1-3
1-2-3 External Interface for Each Operating System.....	1-5
<b>1-3 Product Configuration .....</b>	<b>1-6</b>
<b>1-4 ID Information Label .....</b>	<b>1-8</b>
<b>1-5 Application Procedures.....</b>	<b>1-9</b>
1-5-1 Overall Setup Procedure .....	1-9
<b>1-6 Monitoring Function .....</b>	<b>1-11</b>
1-6-1 Monitoring System Information .....	1-11
1-6-2 Monitoring Controller Status.....	1-12

## Section 2 Initial Settings and Software Utilities

<b>2-1</b>	<b>Initial Settings for Windows</b> .....	<b>2-2</b>
2-1-1	Set up Windows .....	2-2
2-1-2	Install Software.....	2-4
2-1-3	User Account Settings.....	2-5
2-1-4	Customize Windows.....	2-6
2-1-5	Create a Backup .....	2-6
<b>2-2</b>	<b>Starting and Exiting</b> .....	<b>2-7</b>
2-2-1	Starting .....	2-7
2-2-2	Exiting .....	2-8
2-2-3	Restarting.....	2-9
<b>2-3</b>	<b>UPS Settings</b> .....	<b>2-10</b>
<b>2-4</b>	<b>Software Utilities</b> .....	<b>2-11</b>
2-4-1	Installed Software and Utilities .....	2-11
2-4-2	Industrial Monitor Utility .....	2-12
2-4-3	Industrial Monitor Brightness Utility .....	2-19
2-4-4	Industrial PC Tray Utility .....	2-22

## Section 3 Controller Preparation

<b>3-1</b>	<b>Internal Port Settings</b> .....	<b>3-2</b>
<b>3-2</b>	<b>Shared Folder Settings</b> .....	<b>3-3</b>
3-2-1	Windows Settings.....	3-3
3-2-2	Controller Setup .....	3-13

## Section 4 Industrial PC Support Utility

<b>4-1</b>	<b>Industrial PC Support Utility Overview</b> .....	<b>4-2</b>
<b>4-2</b>	<b>Product Information Tab</b> .....	<b>4-3</b>
<b>4-3</b>	<b>System Status Tab</b> .....	<b>4-4</b>
<b>4-4</b>	<b>Controller Status Tab</b> .....	<b>4-6</b>
<b>4-5</b>	<b>Controller Status Tab - Report Logs</b> .....	<b>4-8</b>
<b>4-6</b>	<b>Controller Operation Tab</b> .....	<b>4-10</b>
4-6-1	Mode Change.....	4-11
4-6-2	Resetting the Controller .....	4-12
4-6-3	Controller Backup.....	4-13
<b>4-7</b>	<b>Network Settings for Controller Tab</b> .....	<b>4-18</b>
<b>4-8</b>	<b>Virtual SD Memory Card Settings Tab</b> .....	<b>4-21</b>
<b>4-9</b>	<b>Industrial PC Support Utility Details</b> .....	<b>4-23</b>
4-9-1	Data Update Details .....	4-23
4-9-2	Compatibility.....	4-23
4-9-3	Installation .....	4-23
4-9-4	Startup.....	4-23
4-9-5	Messages.....	4-24
4-9-6	Logging .....	4-24
4-9-7	Operation Authority Verification.....	4-25

## Section 5 NYCompolet

<b>5-1</b>	<b>Outline of NYCompolet</b> .....	<b>5-2</b>
------------	------------------------------------	------------

<b>5-2</b>	<b>How to Use the NYCompolet .....</b>	<b>5-3</b>
<b>5-3</b>	<b>Communications Setup.....</b>	<b>5-4</b>
5-3-1	Communications Setup Procedure .....	5-4
5-3-2	Additional Functions to Communications Setup.....	5-5
<b>5-4</b>	<b>NYCompolet Interface .....</b>	<b>5-6</b>
5-4-1	Interface Members .....	5-6
5-4-2	Usage Method.....	5-7

## Section 6 Software for Developers

---

<b>6-1</b>	<b>Overview of IPC Developer Software for Windows .....</b>	<b>6-2</b>
6-1-1	Development Environment.....	6-2
6-1-2	How to Use the Industrial PC API .....	6-3
<b>6-2</b>	<b>Industrial PC System API .....</b>	<b>6-4</b>
<b>6-3</b>	<b>Industrial Monitor API .....</b>	<b>6-5</b>
<b>6-4</b>	<b>Industrial PC Controller API .....</b>	<b>6-6</b>

## Section 7 Backup and Recovery

---

<b>7-1</b>	<b>Create a Backup.....</b>	<b>7-2</b>
7-1-1	Backing Up, Restoring, and Comparing Controller Data.....	7-2
<b>7-2</b>	<b>Rescue Disk Creator and Utility .....</b>	<b>7-3</b>
7-2-1	Overview .....	7-3
7-2-2	Compatibility.....	7-4
7-2-3	Installation .....	7-5
7-2-4	Startup.....	7-6
7-2-5	Messages.....	7-6
<b>7-3</b>	<b>Create a System Backup with the Rescue Disk .....</b>	<b>7-10</b>
7-3-1	Create a New Rescue Disk with the Rescue Disk Creator .....	7-12
<b>7-4</b>	<b>Check the System Backup Information on the Rescue Disk .....</b>	<b>7-14</b>
<b>7-5</b>	<b>Restore a System Backup with the Rescue Disk.....</b>	<b>7-15</b>

## Section 8 Troubleshooting during Setup

---

<b>8-1</b>	<b>Starting in Safe Mode .....</b>	<b>8-2</b>
------------	------------------------------------	------------

## Appendices

---

<b>A-1</b>	<b>Updating .....</b>	<b>A-2</b>
A-1-1	Updating Windows Software .....	A-2
<b>A-2</b>	<b>Changing the Internal Port Settings.....</b>	<b>A-3</b>
<b>A-3</b>	<b>Changing Windows File Sharing Setting.....</b>	<b>A-4</b>
A-3-1	Procedure to Change .....	A-4
A-3-2	Cautions When Using Virtual SD Memory Card.....	A-4
<b>A-4</b>	<b>Windows Event Viewer .....</b>	<b>A-5</b>
<b>A-5</b>	<b>Software Specifications .....</b>	<b>A-7</b>
A-5-1	Available Windows Operating Systems.....	A-7
A-5-2	Supported Languages.....	A-7
<b>A-6</b>	<b>Customize Windows .....</b>	<b>A-8</b>
A-6-1	Enhanced Write Filter.....	A-8

A-6-2	File-Based Write Filter.....	A-9
A-6-3	Unified Write Filter.....	A-11

## Index

---

# Terms and Conditions Agreement

## Warranty, Limitations of Liability

### Warranties

#### ● Exclusive Warranty

Omron's exclusive warranty is that the Products will be free from defects in materials and workmanship for a period of twelve months from the date of sale by Omron (or such other period expressed in writing by Omron). Omron disclaims all other warranties, express or implied.

#### ● Limitations

OMRON MAKES NO WARRANTY OR REPRESENTATION, EXPRESS OR IMPLIED, ABOUT NON-INFRINGEMENT, MERCHANTABILITY OR FITNESS FOR A PARTICULAR PURPOSE OF THE PRODUCTS. BUYER ACKNOWLEDGES THAT IT ALONE HAS DETERMINED THAT THE PRODUCTS WILL SUITABLY MEET THE REQUIREMENTS OF THEIR INTENDED USE.

Omron further disclaims all warranties and responsibility of any type for claims or expenses based on infringement by the Products or otherwise of any intellectual property right.

#### ● Buyer Remedy

Omron's sole obligation hereunder shall be, at Omron's election, to (i) replace (in the form originally shipped with Buyer responsible for labor charges for removal or replacement thereof) the non-complying Product, (ii) repair the non-complying Product, or (iii) repay or credit Buyer an amount equal to the purchase price of the non-complying Product; provided that in no event shall Omron be responsible for warranty, repair, indemnity or any other claims or expenses regarding the Products unless Omron's analysis confirms that the Products were properly handled, stored, installed and maintained and not subject to contamination, abuse, misuse or inappropriate modification. Return of any Products by Buyer must be approved in writing by Omron before shipment. Omron Companies shall not be liable for the suitability or unsuitability or the results from the use of Products in combination with any electrical or electronic components, circuits, system assemblies or any other materials or substances or environments. Any advice, recommendations or information given orally or in writing, are not to be construed as an amendment or addition to the above warranty.

See <http://www.omron.com/global/> or contact your Omron representative for published information.

## Limitation on Liability; Etc

---

OMRON COMPANIES SHALL NOT BE LIABLE FOR SPECIAL, INDIRECT, INCIDENTAL, OR CONSEQUENTIAL DAMAGES, LOSS OF PROFITS OR PRODUCTION OR COMMERCIAL LOSS IN ANY WAY CONNECTED WITH THE PRODUCTS, WHETHER SUCH CLAIM IS BASED IN CONTRACT, WARRANTY, NEGLIGENCE OR STRICT LIABILITY.

Further, in no event shall liability of Omron Companies exceed the individual price of the Product on which liability is asserted.

## Application Considerations

### Suitability of Use

---

Omron Companies shall not be responsible for conformity with any standards, codes or regulations which apply to the combination of the Product in the Buyer's application or use of the Product. At Buyer's request, Omron will provide applicable third party certification documents identifying ratings and limitations of use which apply to the Product. This information by itself is not sufficient for a complete determination of the suitability of the Product in combination with the end product, machine, system, or other application or use. Buyer shall be solely responsible for determining appropriateness of the particular Product with respect to Buyer's application, product or system. Buyer shall take application responsibility in all cases.

NEVER USE THE PRODUCT FOR AN APPLICATION INVOLVING SERIOUS RISK TO LIFE OR PROPERTY OR IN LARGE QUANTITIES WITHOUT ENSURING THAT THE SYSTEM AS A WHOLE HAS BEEN DESIGNED TO ADDRESS THE RISKS, AND THAT THE OMRON PRODUCT(S) IS PROPERLY RATED AND INSTALLED FOR THE INTENDED USE WITHIN THE OVERALL EQUIPMENT OR SYSTEM.

### Programmable Products

---

Omron Companies shall not be responsible for the user's programming of a programmable Product, or any consequence thereof.

## Disclaimers

### Performance Data

---

Data presented in Omron Company websites, catalogs and other materials is provided as a guide for the user in determining suitability and does not constitute a warranty. It may represent the result of Omron's test conditions, and the user must correlate it to actual application requirements. Actual performance is subject to the Omron's Warranty and Limitations of Liability.

### Change in Specifications

---

Product specifications and accessories may be changed at any time based on improvements and other reasons. It is our practice to change part numbers when published ratings or features are changed, or when significant construction changes are made. However, some specifications of the Product may be changed without any notice. When in doubt, special part numbers may be assigned to fix or establish key specifications for your application. Please consult with your Omron's representative at any time to confirm actual specifications of purchased Product.

### Errors and Omissions

---

Information presented by Omron Companies has been checked and is believed to be accurate; however, no responsibility is assumed for clerical, typographical or proofreading errors or omissions.



# Safety Precautions

---

Information is available in related manuals.

- For NY512-1□□□ refer to the following manuals:
  - *NY-series IPC Machine Controller Industrial Box PC Hardware User's Manual (Cat. No. W556)*
  - *NY-series IPC Machine Controller Industrial Panel PC / Industrial Box PC Software User's Manual (Cat. No. W558)*
- For NY532-1□□□ and NY532-5400 refer to the following manuals:
  - *NY-series IPC Machine Controller Industrial Panel PC Hardware User's Manual (Cat. No. W557)*
  - *NY-series IPC Machine Controller Industrial Panel PC / Industrial Box PC Software User's Manual (Cat. No. W558)*

# Precautions for Safe Use

---

Information is available in related manuals.

- For NY512-1□□□ refer to the following manuals:
  - *NY-series IPC Machine Controller Industrial Box PC Hardware User's Manual (Cat. No. W556)*
  - *NY-series IPC Machine Controller Industrial Panel PC / Industrial Box PC Software User's Manual (Cat. No. W558)*
- For NY532-1□□□ and NY532-5400 refer to the following manuals:
  - *NY-series IPC Machine Controller Industrial Panel PC Hardware User's Manual (Cat. No. W557)*
  - *NY-series IPC Machine Controller Industrial Panel PC / Industrial Box PC Software User's Manual (Cat. No. W558)*

# Precautions for Correct Use

---

Information is available in related manuals.

- For NY512-1□□□ refer to the following manuals:
  - *NY-series IPC Machine Controller Industrial Box PC Hardware User's Manual (Cat. No. W556)*
  - *NY-series IPC Machine Controller Industrial Panel PC / Industrial Box PC Software User's Manual (Cat. No. W558)*
- For NY532-1□□□ and NY532-5400 refer to the following manuals:
  - *NY-series IPC Machine Controller Industrial Panel PC Hardware User's Manual (Cat. No. W557)*
  - *NY-series IPC Machine Controller Industrial Panel PC / Industrial Box PC Software User's Manual (Cat. No. W558)*

# Regulations and Standards

## Conformance to EU Directives

### Applicable Directives

- EMC Directive

### Concepts

#### ● EMC Directive

OMRON devices that comply with EU Directives also conform to the related EMC standards so that they can be more easily built into other devices or the overall machine. The actual products have been checked for conformity to EMC standards.\*

Whether the products conform to the standards in the system used by the customer, however, must be checked by the customer. EMC-related performance of the OMRON devices that comply with EU Directives will vary depending on the configuration, wiring, and other conditions of the equipment or control panel on which the OMRON devices are installed. The customer must, therefore, perform the final check to confirm that devices and the overall machine conform to EMC standards.

\*1. Applicable EMC (Electromagnetic Compatibility) standards are as follows:

EMS (Electromagnetic Susceptibility): EN 61131-2

EMI (Electromagnetic Interference): EN 61131-2

(Radiated emission: 10-m regulations)

#### ● Conformance to EU Directives

The NY-series Controllers comply with EU Directives. To ensure that the machine or device in which the NY-series Controller is used complies with EU Directives, the Controller must be installed as follows:

- The NY-series Controller must be installed within a control panel.
- You must use the power supply in SELV specifications for the DC power supplies connected to DC Power Supply Units and I/O Units.
- NY-series Controllers that comply with EU Directives also conform to the Common Emission Standard (EN 61000-6-4). Radiated emission characteristics (10-m regulations) may vary depending on the configuration of the control panel used, other devices connected to the control panel, wiring, and other conditions.

You must therefore confirm that the overall machine or equipment complies with EC Directives.

## Software Licenses and Copyrights

This product incorporates certain third party software. The license and copyright information associated with this software is available at [http://www.fa.omron.co.jp/nj\\_info\\_e/](http://www.fa.omron.co.jp/nj_info_e/).

# Versions

Hardware revisions and unit versions are used to manage the hardware and software in NY-series Controllers and EtherCAT slaves. The hardware revision or unit version is updated each time there is a change in hardware or software specifications.

Even when two Units or EtherCAT slaves have the same model number, they will have functional or performance differences if they have different hardware revisions or unit versions.

## Checking Versions

You can check versions on the ID information label or with the Sysmac Studio.

### Checking Unit Versions on the ID Information Label

The unit version is given on the ID information label on the back side of the product. The ID information label on an NY-series NY5□2-□□□□ Controller is shown below.

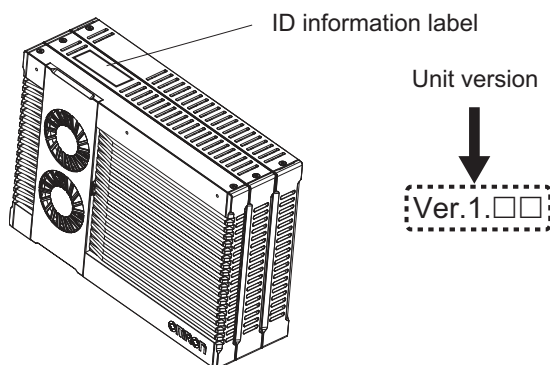

### Checking Unit Versions with the Sysmac Studio

You can use the Sysmac Studio to check unit versions. The procedure is different for Units and for EtherCAT slaves.

#### ● Checking the Unit Version of an NY-series Controller

You can use the Production Information while the Sysmac Studio is online to check the unit version of a Unit. You can only do this for the Controller.

- 1 Right-click **CPU Rack** under **Configurations and Setup - CPU/Expansion Racks** in the Multi-view Explorer and select **Production Information**.  
The Production Information Dialog Box is displayed.

● **Changing Information Displayed in Production Information Dialog Box**

- 1 Click the **Show Detail** or **Show Outline** Button at the lower right of the Production Information Dialog Box.  
The view will change between the production information details and outline.

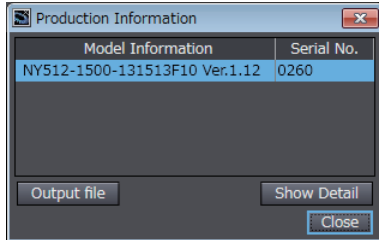

Outline View

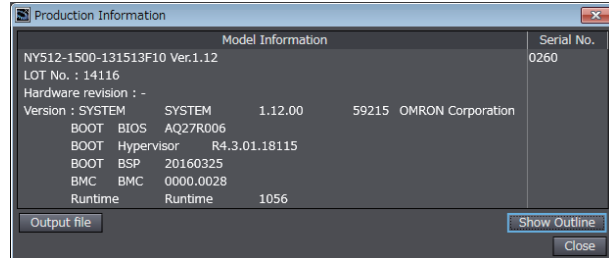

Detail View

The information that is displayed is different for the Outline View and Detail View. The Detail View displays the unit version, hardware revision, and other versions. The Outline View displays only the unit version.

● **Checking the Unit Version of an EtherCAT Slave**

You can use the Production Information while the Sysmac Studio is online to check the unit version of an EtherCAT slave.  
Use the following procedure to check the unit version.

- 1 Double-click **EtherCAT** under **Configurations and Setup** in the Multiview Explorer. Or, right-click **EtherCAT** under **Configurations and Setup** and select **Edit** from the menu.  
The EtherCAT Tab Page is displayed.
- 2 Right-click the master on the EtherCAT Tab Page and select **Display Production Information**.  
The Production Information Dialog Box is displayed.  
The unit version is displayed after “Rev.”

● **Changing Information Displayed in Production Information Dialog Box**

- 1 Click the **Show Detail** or **Show Outline** Button at the lower right of the Production Information Dialog Box.  
The view will change between the production information details and outline.

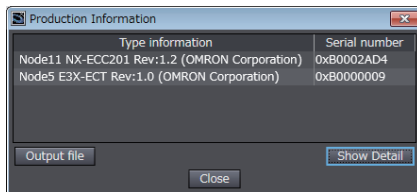

Outline View

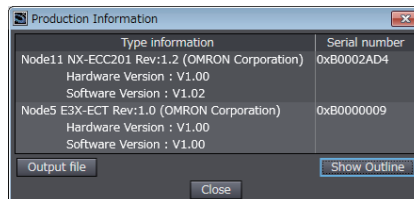

Detail View

# Related Manuals

The following are the manuals related to this manual. Use these manuals for reference.

Manual name	Cat. No.	Model numbers	Application	Description
NY-series IPC Machine Controller Industrial Panel PC Hardware User's Manual	W557	NY532-□□□□	Learning the basic specifications of the NY-series Industrial Panel PCs, including introductory information, designing, installation, and maintenance. Mainly hardware information is provided.	An introduction to the entire NY-series system is provided along with the following information on the Industrial Panel PC. <ul style="list-style-type: none"> <li>• Features and system configuration</li> <li>• Introduction</li> <li>• Part names and functions</li> <li>• General specifications</li> <li>• Installation and wiring</li> <li>• Maintenance and inspection</li> </ul>
NY-series IPC Machine Controller Industrial Box PC Hardware User's Manual	W556	NY512-□□□□	Learning the basic specifications of the NY-series Industrial Box PCs, including introductory information, designing, installation, and maintenance. Mainly hardware information is provided.	An introduction to the entire NY-series system is provided along with the following information on the Industrial Box PC. <ul style="list-style-type: none"> <li>• Features and system configuration</li> <li>• Introduction</li> <li>• Part names and functions</li> <li>• General specifications</li> <li>• Installation and wiring</li> <li>• Maintenance and inspection</li> </ul>
NY-series IPC Machine Controller Industrial Panel PC / Industrial Box PC Setup User's Manual	W568	NY532-□□□□ NY512-□□□□	Learning the initial settings of the NY-series Industrial PCs and preparations to use Controllers.	The following information is provided on an introduction to the entire NY-series system. <ul style="list-style-type: none"> <li>• Two OS systems</li> <li>• Initial settings</li> <li>• Industrial PC Support Utility</li> <li>• NYCompolet</li> <li>• Industrial PC API</li> <li>• Backup and recovery</li> </ul>
NY-series IPC Machine Controller Industrial Panel PC / Industrial Box PC Software User's Manual	W558	NY532-□□□□ NY512-□□□□	Learning how to program and set up the Controller functions of an NY-series Industrial PC.	The following information is provided on the Controller function of an NY-series Controller. <ul style="list-style-type: none"> <li>• Controller operation</li> <li>• Controller features</li> <li>• Controller settings</li> <li>• Programming based on IEC 61131-3 language specifications</li> </ul>

Manual name	Cat. No.	Model numbers	Application	Description
NY-series Instructions Reference Manual	W560	NY532-□□□□ NY512-□□□□	Learning de- tailed specifica- tions on the ba- sic instructions of an NY-series Industrial PC.	The instructions in the instruction set (IEC 61131-3 specifications) are described.
NY-series IPC Machine Controller Industrial Panel PC / Indus- trial Box PC Motion Control User's Manual	W559	NY532-□□□□ NY512-□□□□	Learning about motion control settings and pro- gramming con- cepts of an NY- series Industrial PC.	The settings and operation of the Controller and programming con- cepts for motion control are de- scribed.
NY-series Motion Control Instructions Reference Manual	W561	NY532-□□□□ NY512-□□□□	Learning about the specifica- tions of the mo- tion control in- structions of an NY-series Indus- trial PC.	The motion control instructions are described.
NY-series IPC Machine Controller Industrial Panel PC / Indus- trial Box PC Built-in EtherCAT® Port User's Manual	W562	NY532-□□□□ NY512-□□□□	Using the built-in EtherCAT port in an NY-series In- dustrial PC.	Information on the built-in Ether- CAT port is provided. This manual provides an introduc- tion and provides information on the configuration, features, and setup.
NY-series IPC Machine Controller Industrial Panel PC / Indus- trial Box PC Built-in EtherNet/IP™ Port User's Manual	W563	NY532-□□□□ NY512-□□□□	Using the built-in EtherNet/IP port in an NY-series Industrial PC.	Information on the built-in Ether- Net/IP port is provided. Information is provided on the ba- sic setup, tag data links, and oth- er features.
NJ/NY-series NC Integrated Controller User's Manual	O030	NJ501-53□□ NY532-54□□	Performing nu- merical control with NJ/NY-ser- ies Controllers.	Describes the functionality to per- form the numerical control. Use this manual together with the NJ/NY-series G code Instructions Reference Manual (Cat. No. O031) when programming.
NJ/NY-series G code Instructions Refer- ence Manual	O031	NJ501-53□□ NY532-54□□	Learning about the specifica- tions of the G code/M code in- structions.	The G code/M code instructions are described. Use this manual together with the NJ/NY-series NC Integrated Controller User's Manual (Cat. No. O030) when programming.
NY-series Troubleshooting Manual	W564	NY532-□□□□ NY512-□□□□	Learning about the errors that may be detected in an NY-series Industrial PC.	Concepts on managing errors that may be detected in an NY-series Controller and information on indi- vidual errors are described.



Manual name	Cat. No.	Model numbers	Application	Description
Sysmac Studio Version 1 Operation Manual	W504	SYSMAC-SE2 □□□	Learning about the operating procedures and functions of the Sysmac Studio.	Describes the operating procedures of the Sysmac Studio.
CNC Operator Operation Manual	O032	SYSMAC-RTNC0□ □□D	Learning an introduction of the CNC Operator and how to use it.	An introduction of the CNC Operator, installation procedures, basic operations, connection operations, and operating procedures for main functions are described.
NX-series EtherCAT® Coupler Unit User's Manual	W519	NX-ECC□□□□	Learning how to use an NX-series EtherCAT Coupler Unit and EtherCAT Slave Terminals.	The following items are described: the overall system and configuration methods of an EtherCAT Slave Terminal (which consists of an NX-series EtherCAT Coupler Unit and NX Units), and information on hardware, setup, and functions to set up, control, and monitor NX Units through EtherCAT.
NX-series Safety Control Unit User's Manual	Z930	NX-SL□□□□ NX-SI□□□□ NX-SO□□□□	Learning how to use NX-series Safety Control Units	Describes the hardware, setup methods, and functions of the NX-series Safety Control Units.
Vision System FH/FZ5 series User's Manual	Z340	FH-1□□□ FH-3□□□ FZ5-L35□ FZ5-6□□ FZ5-11□□	Learning how to use the FH/FZ5-series Vision Systems.	Describes the software functions, setup and operating methods required for using the FH/FZ5-series system.
Vision Sensor FQ-M series Specialized Vision Sensors for Positioning User's Manual	Z314	FQ-MS12□	Learning how to use the Specialized Vision Sensors for Positioning.	Describes the hardware, setup methods and functions of the Specialized Vision Sensors for Positioning.
Vision Sensor FZ3 Series User's Manual	Z290	FZ3-□□□□	Learning how to use the FZ3-series Vision Sensors.	Describes the software functions, setup and operating methods of the FZ3-series Vision Sensors.
Displacement Sensor ZW series Confocal Fiber Type Dis- placement Sensor User's Manual	Z332	ZW-CE1 □	Learning how to use the ZW-series Displacement Sensors.	Describes the hardware, setup methods and functions of the ZW-series Displacement Sensors.
NA-series Programmable Terminal Software User's Manual	V118	NA5-□W□□□□	Learning about NA-series PT pages and object functions.	Describes the pages and object functions of the NA-series Programmable Terminals.
NS-series Programmable Terminals Programming Manual	V073	NS15-□□□□□ NS12-□□□□□ NS10-□□□□□ NS8-□□□□□ NS5-□□□□□	Learning how to use the NS-series Programmable Terminals.	Describes the setup methods, functions, etc. of the NS-series Programmable Terminals.

Manual name	Cat. No.	Model numbers	Application	Description
CX-Designer User's Manual	V099	---	Learning to create screen data for NS-series Programmable Terminals.	Describes operating procedures for the CX-Designer.

# Revision History

A manual revision code appears as a suffix to the catalog number on the front and back covers of the manual.

**Cat. No. W568-E2-05**

↑  
Revision code

Revision code	Date	Revised content
05	March 2021	<ul style="list-style-type: none"> <li>• Added CPU Intel® Core™ i5-7440EQ</li> <li>• Added Windows 10</li> <li>• Updated Industrial PC Support Utility</li> <li>• Modified structure and content to be more similar to the related Hardware Manuals</li> <li>• Minor modifications</li> </ul>
04	April 2019	<ul style="list-style-type: none"> <li>• Made changes in specifications of Rescue Disk Utility.</li> <li>• Added information on Industrial PC API.</li> </ul>
03	October 2017	Added information on the functions supported by unit version 1.16 of the Controllers.
02	April 2017	<ul style="list-style-type: none"> <li>• Made changes in specifications of Rescue Disk Utility.</li> <li>• Corrected mistakes.</li> </ul>
01	September 2016	Original production



# 1

## Introduction to the Industrial PC

This section describes the features, basic system, product models, and operating procedure of an Industrial PC Platform NY-series IPC Machine Controller Industrial Panel PC / Industrial Box PC.

---

<b>1-1</b>	<b>Features .....</b>	<b>1-2</b>
<b>1-2</b>	<b>Operation of the Operating System.....</b>	<b>1-3</b>
1-2-1	Overview of Operating System Operation.....	1-3
1-2-2	Data Exchange between Operating Systems.....	1-3
1-2-3	External Interface for Each Operating System.....	1-5
<b>1-3</b>	<b>Product Configuration .....</b>	<b>1-6</b>
<b>1-4</b>	<b>ID Information Label.....</b>	<b>1-8</b>
<b>1-5</b>	<b>Application Procedures .....</b>	<b>1-9</b>
1-5-1	Overall Setup Procedure .....	1-9
<b>1-6</b>	<b>Monitoring Function.....</b>	<b>1-11</b>
1-6-1	Monitoring System Information.....	1-11
1-6-2	Monitoring Controller Status.....	1-12

# 1-1 Features

Industrial PC Platform NY-series IPC Machine Controller Industrial Panel PC / Industrial Box PC (hereafter Industrial PC) is an industrial PC of the next generation. It accomplishes both high speed and high precision Controller function that is necessary for machine control, and safety, reliability, and maintainability as an industrial PC.

The Industrial PC provides the following features.

## ● Concurrent Operation of Windows and Real-Time OS

The Industrial PC is provided with two operating systems: Windows and Real-Time OS. It can concurrently perform both machine controls by using the Controller function on the Real-Time OS and the application processing on Windows. With one Industrial PC, you can control the equipment with the Controller, get the equipment data from the Windows application, and send it to the host PC.

## ● Ensuring Operating System Independency

Each of Windows and the Real-Time OS runs independently. The Controller on the Real-Time OS is not affected by the Windows operation. The Controller continues controlling even if Windows makes an unexpected stop.

## ● Data Exchange between Windows and Controller

Windows and the Controller on the Real-Time OS can exchange data while each makes an independent operation.

Through the shared folder on Windows, you can get data from and write data into the Controller. Also, you can shut down or restart Windows from the Controller.

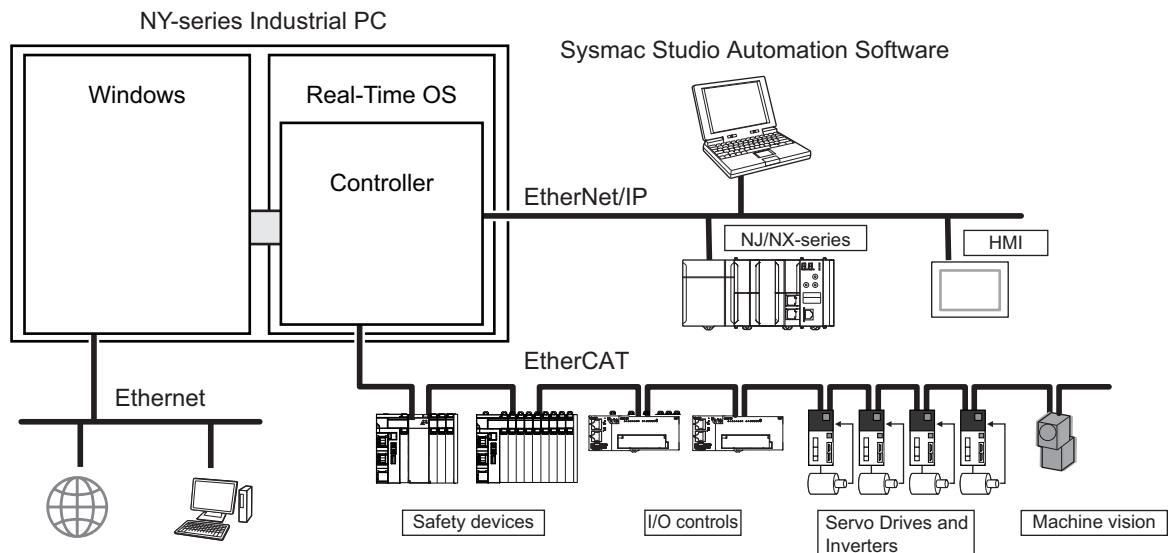

## 1-2 Operation of the Operating System

This section describes how the operating systems of the Industrial PC operate and how the two operating systems relate to.

### 1-2-1 Overview of Operating System Operation

An Industrial PC has two operating systems: Windows and Real-Time OS. Separate processor cores are allocated to each OS.

The Controller function is operated over Real-Time OS. Refer to the *NY-series Industrial Panel PC / Industrial Box PC Software User's Manual (Cat. No. W558)* for details on the Controller function and usage.

The Real-Time OS does not need any maintenance and settings.

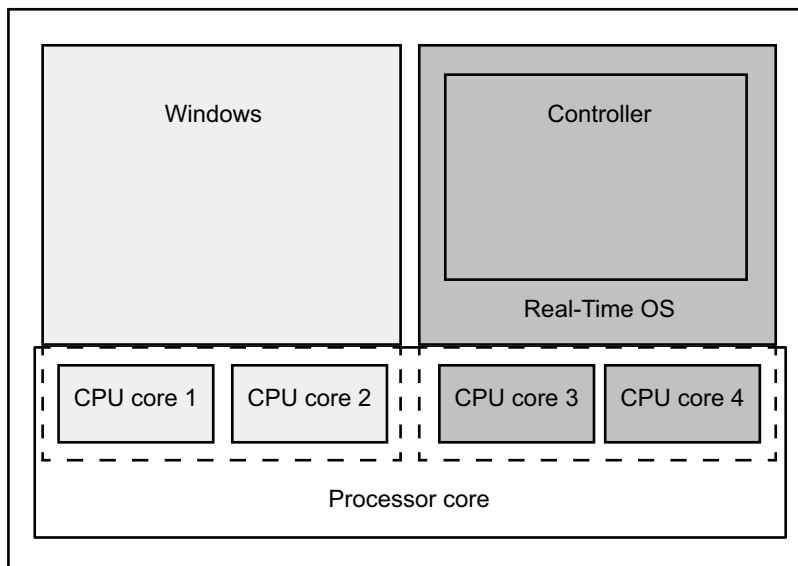

### 1-2-2 Data Exchange between Operating Systems

This section describes data exchange between Windows and the Real-Time OS.

There is a virtual network adapter for Windows. Each of Windows and the Real-Time OS (Controller function) has an internal port. The two OSs exchange data through the internal port and the internal network.

### Accessing Windows from the Controller

You can use Windows shared folder as a Virtual SD Memory Card from the Controller, and backup and restore the Controller data.

You can access the shared folder, as usual, from Windows.

Also, you can shut down or restart Windows by using instructions in the Controller programs.

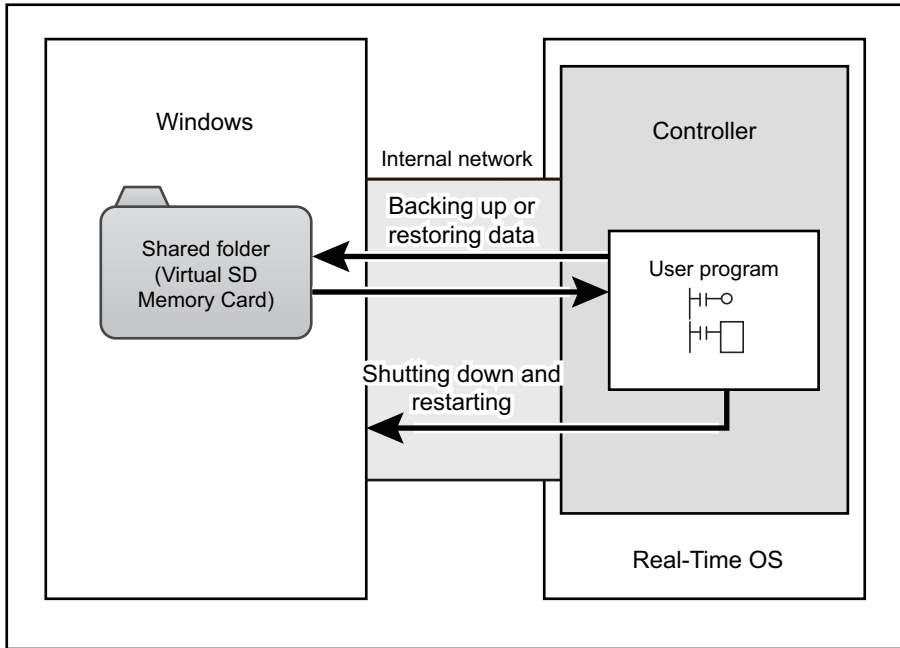

## Accessing the Controller from Windows

You can get the Controller data with the support software or application that runs on Windows.

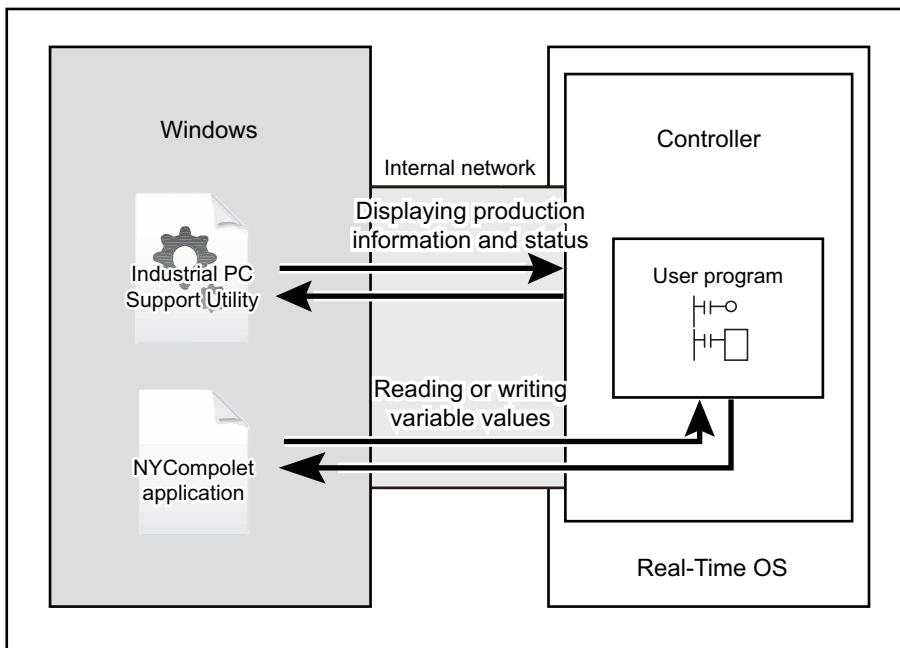

Item	Description
Industrial PC Support Utility	Displays the production information of the Industrial PC, and the status. Also, you can change the operating mode of the Controller, and back up the data. Refer to <i>Section 4 Industrial PC Support Utility</i> on page 4-1 for details.
Applications with the NYCompolet	The NYCompolet is a software component that provides the Windows application the functions to get and refresh the Controller data. You can get the Controller data by creating and using applications with the NYCompolet. Refer to <i>Section 5 NYCompolet</i> on page 5-1 for details on the NYCompolet.



### 1-2-3 External Interface for Each Operating System

External interfaces for Industrial PCs that are supported by Windows and Real-Time OS (Controller function) are given below.

You cannot access an interface which is supported by the other Operating System.

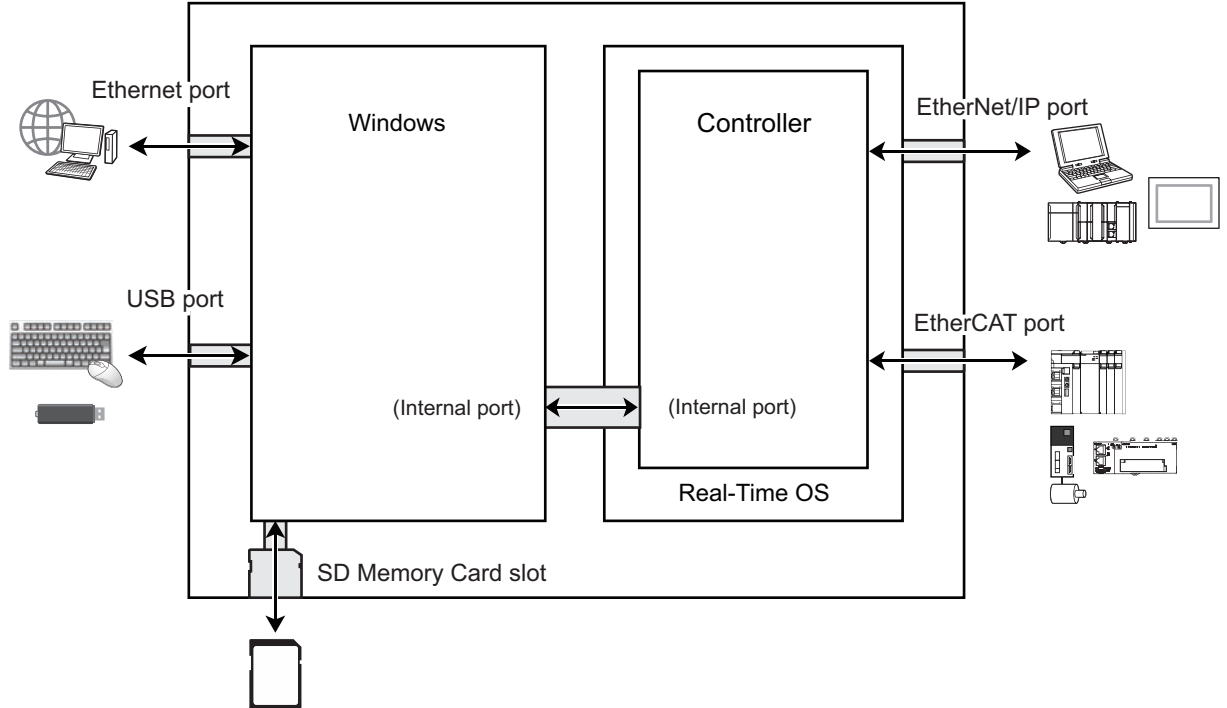

# 1-3 Product Configuration

This section provides an overview of the product configurations available for the IPC Machine Controller.

The product configuration is visible in the model-ID that is mentioned on the ID information label of the product.

The structure of the model-ID is: NY□□□-□□□□-□□□□□□□□□□.

Each item in the model-ID has a specific meaning.

N Y □ □ □ - □ □ □ □ - □ □ □ □ □ □ □ □ □ □  
 1 2 3 4 5 6 7 8 9 10 11 12 13 14 15 16 17

Item	Description	Option / Description
1	Series name	NY: NY-series
2	Controller specifications	5: "5" series: Large scale, high speed and high precision control application for up to 64 axes.
3	Model type	1: Industrial Box PC 3: Industrial Panel PC
4	Sequential number	2 or more
5	Function module	1: Standard 5: NC Integrated Controller
6	Number of axes for motion control	3: 16 axes 4: 32 axes 5: 64 axes
7	Additional Function Software Module	0: ---
8	Reserved	0: ---
9	Expansion slots	0: None 1: 1 PCIe slot
10	Frame type	1: Aluminum frame, black, Projected Capacitive Touch type 2: Aluminum frame, Nickel plated, Projected Capacitive Touch type X: No display (Industrial Box PC)
11	Display size	1: 12.1 inch model 2: 15.4 inch model 3: 18.5 inch model X: No display (Industrial Box PC)
12	Operating system	1: Windows Embedded Standard 7 - 32 bit 2: Windows Embedded Standard 7 - 64 bit 4: Windows 10 IoT Enterprise 2019 LTSC - 64 bit
13	Processor	1: Intel® Core™ i7-4700EQ Processor 4 <sup>th</sup> generation CPU with active cooling 4: Intel® Core™ i5-7440EQ Processor 7 <sup>th</sup> generation CPU with active cooling
14	Main memory	3: 8 GB Non-ECC 5: 32 GB Non-ECC

Item	Description	Option / Description
15	Storage	6: 128 GB CFast MLC 7: 256 GB CFast MLC 8: 32 GB, SSD SLC 9: 64 GB, SSD SLC C: 320 GB, HDD K: 128 GB, SSD MLC P: 1 TB, SSD 3D TLC
16	Optional interface	0: None 1: RS-232C 2: DVI-D 6: NY Monitor Link
17	Logo	0: OMRON 2: Customization X: No display (Industrial Box PC)

## 1-4 ID Information Label

---

The ID information label contains the product configuration and other details on the specific configuration of your Industrial PC.

Information is available in related manuals.

- For NY512-1□□□ refer to *NY-series IPC Machine Controller Industrial Box PC Hardware User's Manual (Cat. No. W556)*
- For NY532-1□□□ and NY532-5400 refer to *NY-series IPC Machine Controller Industrial Panel PC Hardware User's Manual (Cat. No. W557)*

# 1-5 Application Procedures

This section gives the operating procedure of the Industrial PCs. This manual gives the detailed descriptions in the same order as the following operating procedure.

## 1-5-1 Overall Setup Procedure

### 1 Preparations

Perform procedures that are required to use the Industrial PC such as assembling, installation, and connection with peripheral devices including a UPS.

Refer to the *NY-series Industrial Box PC Hardware User's Manual (Cat. No. W556)* or the *NY-series Industrial Panel PC Hardware User's Manual (Cat. No. W557)* for details on assembling, installation, and wiring for the Industrial PC, and on the parts of the Industrial PC.

### 2 Initial Settings

Make the initial settings for Windows and settings for the Industrial Monitor.

Step	Description	Reference
Initial settings for the Windows	Make the settings including the Windows setup when Windows is started up for the first time. Also, back up the status immediately after the Windows setup is completed.	2-1 <i>Initial Settings for Windows</i> on page 2-2
Turing ON or OFF the power supply	Turn ON the power or shut down.	2-2 <i>Starting and Exiting</i> on page 2-7
UPS settings	Make the required UPS settings.	2-3 <i>UPS Settings</i> on page 2-10
Industrial Monitor settings*1	Adjust the brightness and contrast of the Industrial Monitor.	2-4 <i>Software Utilities</i> on page 2-11

\*1. The settings are required when you use the Industrial Panel PC or Industrial Monitor.

### 3 Preparing for the Controller

Make the settings required for the Controller to use Windows shared folder as a Virtual SD Memory Card.

Step	Description	Reference
Internal port settings	Make the settings required for the Controller and Windows to communicate.	3-1 <i>Internal Port Settings</i> on page 3-2
Shared folder settings	Set a shared folder used by the Controller as a Virtual SD Memory Card.	3-2 <i>Shared Folder Settings</i> on page 3-3

### 4 Controller Setup and Programming

Set up the Controller and create control programs. Refer to the *NY-series Industrial Panel PC / Industrial Box PC Software User's Manual (Cat. No. W558)* for details on the setting and programming methods.

### 5 Creating Applications that Run on Windows

Create required applications that run on Windows.

Step	Description	Reference
Creating applications with the NYCompolet	Use the API that operates the Controller, and create an application to obtain variable data of the Controller. Also, use the created application, and make the required communications settings to operate the Controller.	<i>Section 5 NYCompolet</i> on page 5-1
Creating applications with the Industrial PC API	Use the API prepared for the Industrial PC, and create an application that gets the system status information of the Industrial PC as well as the status information of the Controller.	<i>Section 6 Software for Developers</i> on page 6-1

## 6 Backup and Recovery

Back up and recover the Windows data and the Controller data.

Step	Description	Reference
Backing up and recovering the entire Industrial PC system	Back up the data on the hard disk drive of the Industrial PC, and restore it in the USB storage.	<ul style="list-style-type: none"> <li>• <i>7-3 Create a System Backup with the Rescue Disk</i> on page 7-10</li> <li>• <i>7-5 Restore a System Backup with the Rescue Disk</i> on page 7-15</li> </ul>
Backing up and restoring the Controller	Use the backup and restore function of the Controller, and back up and restore the Controller setup, user programs, and variable data.	<i>7-1-1 Backing Up, Restoring, and Comparing Controller Data</i> on page 7-2

# 1-6 Monitoring Function

This section describes the monitoring function of the Industrial PC.

The function is used to monitor the system status and Controller status of the Industrial PC.

The Industrial PC Support Utility is used to obtain and display the system information of the Industrial PC and the status information of the Controller function.

Refer to *Section 4 Industrial PC Support Utility* on page 4-1 for details on the displaying procedures of and the displayed items by the Industrial PC Support Utility.



## Precautions for Correct Use

The Industrial PC Support Utility obtains and displays the system information of the Industrial PC as well as the status information of the Controller function. But it does not support continuous monitoring. To obtain information continuously, use the Industrial PC API and separately create an application that obtains required information. Also, to obtain more information than the Industrial PC Support Utility can obtain and display, you have to create an application as well.

## 1-6-1 Monitoring System Information

To display the system status of the Industrial PC, start up the Industrial PC Support Utility and click the **System Status** tab.

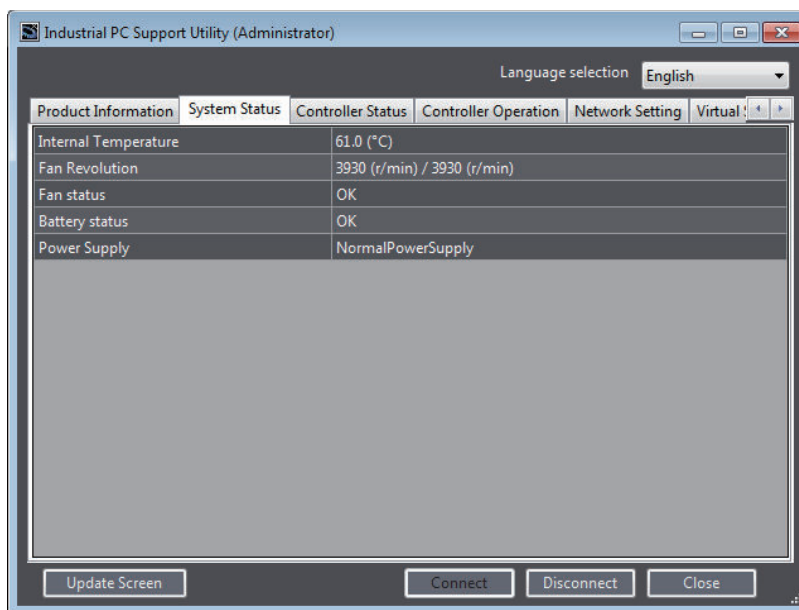

Item	Description
Internal Temperature	Displays the present internal temperature of the Industrial PC.
Fan Revolution	Displays the present revolution of the Fan Unit.
Fan status	Indicates the fan status. Displays “Low revolution speed” when the fan is disconnected or the fan revolution is decreased.
Battery status	Indicates the battery voltage status. Indicates “Low” when the battery is disconnected or the battery voltage is dropped.
Power Supply	Indicates the type of the power supply.

Refer to *4-3 System Status Tab* on page 4-4 for details on each item.

## 1-6-2 Monitoring Controller Status

To display the Controller status, start up the Industrial PC Support Utility and click the **Controller Status** tab.

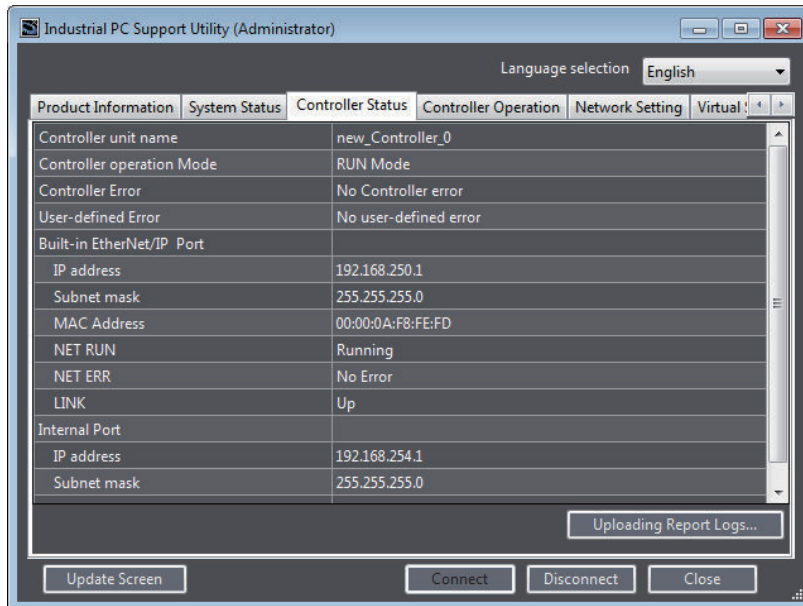

Item	Description
Unit name of the Controller	Displays the unit name that is set for the Controller.
Controller operation Mode	Displays the present operating mode of the Controller.
Controller Error	Displays current Controller errors.
User-defined Error	Displays current user-defined errors.
Built-in EtherNet/IP port	Displays the settings of the built-in EtherNet/IP port through which the Controller communicates with an external device of the Industrial PC.
IP address	Displays the present IP address, subnet mask, and MAC address.
Subnet mask	
MAC address	
NET RUN	Displays the CIP connection status of the EtherNet/IP network.
NET ERR	Displays the communications error status of the EtherNet/IP network.
LINK	Displays the link establishment status of the EtherNet/IP network.
Internal Port	Displays the settings of the internal port through which the Controller communicates with Windows on the Industrial PC.
IP address	Displays the present IP address, subnet mask, and MAC address.
Subnet mask	
Default Gateway	Displays the present default gateway.

Refer to 4-4 *Controller Status Tab* on page 4-6 for details on each item.



### Additional Information

You can use the Controller Status function of the Sysmac Studio to monitor more detailed status of the Controller. Refer to the *Sysmac Studio Version 1 Operation Manual (Cat. No. W504)* for details on the Controller status of the Sysmac Studio.



# 2

## Initial Settings and Software Utilities

This section describes the basic operation and initial settings of the Industrial PC. It also describes starting and exiting the Industrial PC, the initial settings for Windows after turning ON the power for the first time and the UPS settings. This section also gives an overview of the available Software Utilities.

---

<b>2-1</b>	<b>Initial Settings for Windows .....</b>	<b>2-2</b>
2-1-1	Set up Windows .....	2-2
2-1-2	Install Software .....	2-4
2-1-3	User Account Settings .....	2-5
2-1-4	Customize Windows .....	2-6
2-1-5	Create a Backup .....	2-6
<b>2-2</b>	<b>Starting and Exiting .....</b>	<b>2-7</b>
2-2-1	Starting .....	2-7
2-2-2	Exiting .....	2-8
2-2-3	Restarting .....	2-9
<b>2-3</b>	<b>UPS Settings .....</b>	<b>2-10</b>
<b>2-4</b>	<b>Software Utilities .....</b>	<b>2-11</b>
2-4-1	Installed Software and Utilities .....	2-11
2-4-2	Industrial Monitor Utility .....	2-12
2-4-3	Industrial Monitor Brightness Utility .....	2-19
2-4-4	Industrial PC Tray Utility .....	2-22

## 2-1 Initial Settings for Windows

This section describes the setting items and procedures for Windows when the Industrial PC is started up for the first time.

A keyboard and mouse are required to make settings. Before turning on the power supply to the Industrial PC, connect a keyboard and mouse to the USB ports. Also, connect the Industrial Monitor when you use an Industrial Box PC.

Refer to *A-5 Software Specifications* on page A-7 for the specifications of Windows for Industrial PCs.

### 2-1-1 Set up Windows

Perform the Windows setup when the Industrial PC is started up for the first time.

You can set the Windows language, region, and computer name in the following procedure.

It takes about 20 to 30 minutes to complete this procedure.



#### Precautions for Safe Use

- Choose an OS password that is not obvious to prevent unauthorized access.
- Remember the OS user name and password. The product is inaccessible without it.



#### Additional Information

- Do not connect additional storage devices before the installation of the operating system completed. Adding storage devices like a USB flash drive, an SD memory card or a PCIe card might influence the default drive letter sequence.

- 1 Press and release the power button on the Industrial PC within 1 second.  
The Industrial PC is started up and the **Set Up Windows** dialog box is displayed.
- 2 Follow the windows installation procedure.



#### Precautions for Correct Use

- During the Windows setup several times a black screen will appear and an automatic restart will occur, but do not turn off the power until the Windows setup is fully completed.
- Once you click the **Next** button on the language selection page, you cannot return to the page. Be careful not to select a wrong language.

Pay special attention to the following steps:

- Language  
Select the preferred language in the Language Selection Window  
Select the language carefully, the selected system language can not be changed.
- Legal stuff like license agreements
  - Windows 10: Select **Accept** to accept the combined Windows and OMRON license agreements.
  - Windows 7: Select **Accept** separately for Windows and for the OMRON utilities.
- Settings

- Windows 10: Select **Customize** instead of **Use Express settings**.  
Set the settings according to your application environment.
- Windows 7: Select **Use recommended settings**.
- Create a user account and password and enter the **password hint**

## **WARNING**

Security setting adjustments should only be performed by the engineer in charge that possesses a thorough understanding of the security settings. Selecting non-recommended security settings can put your system at risk.



### **Precautions for Safe Use**

---

- Choose an OS password that is not obvious to prevent unauthorized access.
  - Remember the OS user name and password. The product is inaccessible without it.
- 

The IPC will automatically restart.

A black screen will be visible for a few seconds and then the IPC will boot to the Windows start screen.

### **3** Finish the Setup procedure.

For Windows 7: The Setup procedure is finished.

For Windows 10: Login and set the time and the time zone. The Setup procedure is finished.



### **Additional Information**

---

If necessary, use the Rescue Disk Utility to back up the state immediately after completion of the Windows setup.

---

### 2-1-2 Install Software

This section describes how to install the software for the IPC Machine Controller.

#### Internet Browser

---

Depending on the operating system an Internet Browser is preinstalled.

- For Windows 10 the standard Internet Explorer Browser is installed.
- For Windows 7 an executable file for browser installation is provided in the user data partition of the drive. For Windows 7 use the procedure below to perform the browser installation.



#### Additional Information

---

- Check the IT policy of your company for available software and for details on the software environment the IPC Machine Controller will operate in.
  - Install all updates and ensure the browser stays up-to-date.
- 

To install the available Internet Browser in a Windows 7 operating system:

- 1** Use Windows Explorer to examine the contents of the user data partition mapped as drive letter D:.
- 2** Open the Installer folder (D:\OMRON-NY\Installers) and locate the Internet Explorer installer files.
- 3** Select the installer suitable for your system (32/64 bits) and language (English/Japanese).
- 4** Ensure there is a connection to the Internet.
- 5** Launch the installer to begin the installation process.
- 6** Follow the installer steps to complete the browser installation.
- 7** Download and install the latest updates via Windows Update.

The Internet Browser is installed in Windows 7.

## Firewall

---

An industrial network should be separated from an office network.

Depending on the operating system a Firewall is preinstalled.

- For Windows 10 the standard firewall software is installed and enabled.
- For Windows 7 the Firewall software is not installed.



### Precautions for Safe Use

---

- Separate the machine network segment from the office network to avoid communication failures.
  - Install all updates and ensure the firewall stays up-to-date.
- 



### Additional Information

---

Check the IT policy of your company for available software and for details on the software environment the IPC Machine Controller will operate in.

---

## Anti-virus Software

---

The Windows operating system is vulnerable for viruses. Anti-virus software should be installed on the Windows operating system.

Depending on the operating system Anti-virus software is preinstalled.

- For Windows 10 the standard Anti-virus software is installed and enabled.
- For Windows 7 Anti-virus software is not installed.



### Additional Information

---

Check the IT policy of your company for available software and for details on the software environment the IPC Machine Controller will operate in.

---



### Precautions for Safe Use

---

- Make sure that your operating system environment is protected against malicious software and viruses.
  - Install all updates and ensure virus definitions stay up-to-date.
- 

## 2-1-3 User Account Settings

The Controller function uses the Windows shared folder as a Virtual SD Memory Card.

To use this function, you must log onto Windows with the user account of the administrator, and access the shared folder.

When you create and use a user account other than one you set in **Windows Settings**, be sure to add the administrator's access right to it.

### 2-1-4 Customize Windows

Windows provides customization tools. Using these tools is only allowed for experienced software engineers.

Refer to *A-6 Customize Windows* on page A-8 for details on the tools.

### 2-1-5 Create a Backup

Create a backup when all software is installed.

With a backup the system can be restored when needed.

Refer to *7-1 Create a Backup* on page 7-2 for an overview of backup possibilities.

Refer to *7-3 Create a System Backup with the Rescue Disk* on page 7-10 for details.

## 2-2 Starting and Exiting

This section gives the basic starting up and exiting operations of the Industrial PC, and the operation sequences.

### 2-2-1 Starting

During starting up, the Monitor displays the startup status. The following description assumes that you are using an Industrial Panel PC, or an Industrial Box PC to which a Monitor is connected.

#### Startup Operating Modes

The Industrial PC has the following startup operating modes.

Type	Description
Normal mode	The mode is used for normal startup. The Controller is started up in RUN mode.
Safe mode	The Controller is started up in PROGRAM mode. This mode is used to start up the Controller in PROGRAM mode even if the operating mode at power ON is set to <i>RUN mode</i> .

The Normal mode operation procedure is given below.

Refer to *8-1 Starting in Safe Mode* on page 8-2 for information on the Safe mode.

#### Normal Mode

- 1** Press and release the power button on the Industrial PC within 1 second.  
The PWR LED lights, and the BIOS startup view is displayed on the Monitor.
- 2** Wait for the RUN LED to light.  
The RUN LED flashes, and the Real-Time OS (Controller function) starts up in RUN mode.  
When the Controller function is completely started up, the RUN LED lights, and then Windows starts up.



#### Additional Information

- The startup state of the Real-Time OS (Controller function) is not shown on the Monitor. The startup process of the Real-Time OS is completed at the time when the Windows startup view is displayed.
- Refer to *Section 8 Troubleshooting during Setup* on page 8-1 for details on errors that occur during startup.
- Other than pressing the power button, you can use an external input signal to start up the Industrial PC in Normal mode. After the external input signal is turned ON, the same operations as after the power button is pressed follow. Refer to the *NY-series Industrial Box PC Hardware User's Manual (Cat. No. W556)* or the *NY-series Industrial Panel PC Hardware User's Manual (Cat. No. W557)* for details on the startup procedure with an external input signal.

## 2-2-2 Exiting

This section gives procedures to shut down Windows and Real-Time OS (Controller function), and turn OFF the power supply to the Industrial PC.



### Precautions for Safe Use

Before turning OFF the power supply to the Industrial PC, you must ensure that there is no program running on Windows, and that it is safe to shut down the system while the current program is running.

How to turn OFF the power supply to the Industrial PC depends on the trigger types as follows.

Trigger type	Description
Power button	Shutting down by pressing the power button on the Industrial PC. *1
Input signal from UPS	Shutting down with a signal input from UPS to the Industrial PC. The signal input is caused by an interruption of power supply which is connected to the UPS. *1
Shutdown instruction from the Controller	Shutting down in a desired timing when the shutdown instruction is executed in the Controller program. *2

\*1. You can set the shutdown processing time on the Controller Setup. Refer to the *NY-series Industrial Panel PC / Industrial Box PC Software User's Manual (Cat. No. W558)* for details on the settings and shutdown processing.

\*2. Refer to the *NY-series Instructions Reference Manual (Cat. No. W560)* for details on using the shutdown instruction.

The exiting procedure when the trigger is pressing the power button is given below.

- 1 Press and release the power button on the Industrial PC within 1 second.  
The program running on the Controller is stopped, and the Real-Time OS (Controller function) is shut down. Then Windows is shut down, and the power supply to the Industrial PC is turned OFF.



### Precautions for Correct Use

When you press the power button for five seconds or longer, the power is forcedly turned OFF without going through the normal shutting down process. Be careful to use this procedure. It may cause a loss of a program running on the Controller or data in a Windows application.



### Additional Information

- You cannot shut down from the Windows start menu.
- Refer to the *NY-series Industrial Box PC Hardware User's Manual (Cat. No. W556)* or the *NY-series Industrial Panel PC Hardware User's Manual (Cat. No. W557)* for details on abnormal shutdowns by an interruption of power supply when a UPS is not used, or by overheating.



## 2-2-3 Restarting

The procedures to restart the Industrial PC are given below. The types of restarting depend on what is restarted as follows. Each is for a different target to restart.

Type	Description
Restarting Windows	Restarts only Windows. The Controller is not affected by the Windows restart.
Restarting the Controller	Restarts or resets only the Controller. Windows is not affected by the Controller restart.

### Restarting Windows

To restart Windows, use the Restart OS instruction on the Controller. Refer to the *NY-series Instructions Reference Manual (Cat. No. W560)* for details on using the Restart OS instruction.

### Restarting the Controller

Use the Sysmac Studio or Industrial PC Support Utility to restart the Controller.

- **Restarting the Controller with Sysmac Studio**

For how to restart (reset) the Controller with the Sysmac Studio, refer to the *Sysmac Studio Version 1 Operation Manual (Cat. No. W504)*.

- **Restarting the Controller with Industrial PC Support Utility**

When you restart (reset) the Controller from the Industrial PC Support Utility, use the **Reset** button in the **Controller Operation** tab page. Refer to *4-6-2 Resetting the Controller* on page 4-12 for details on the procedure.

## 2-3 UPS Settings

---

If necessary, set the UPS operating mode, Industrial PC's exiting processing during a power interruption, and I/O signal processing.

Refer to the manual for the UPS you use for details on the UPS settings.

Information is available in related manuals.

- For NY512-1□□□ refer to *NY-series IPC Machine Controller Industrial Box PC Hardware User's Manual (Cat. No. W556)*
- For NY532-1□□□ and NY532-5400 refer to *NY-series IPC Machine Controller Industrial Panel PC Hardware User's Manual (Cat. No. W557)*

## 2-4 Software Utilities

This section describes the software utilities available to set up and monitor the Industrial PC including a connected Omron Industrial Monitor when available.

### 2-4-1 Installed Software and Utilities

The software and utilities that are installed in an NY-series Industrial PC are given below.

Name	Description
Industrial PC Support Utility	This is the utility to display the system status and to change settings of an Industrial PC. Refer to <i>Section 4 Industrial PC Support Utility</i> on page 4-1 for details.
Industrial Monitor Utility	This is the utility to set the screen of an Industrial Panel PC and an Industrial Monitor. Refer to <i>2-4-2 Industrial Monitor Utility</i> on page 2-12 for details.
Industrial Monitor Brightness Utility	This is the utility to adjust the brightness of an Industrial Panel PC and an Industrial Monitor. Refer to <i>2-4-3 Industrial Monitor Brightness Utility</i> on page 2-19 for details.
Industrial PC Tray Utility	This is the utility to be resident in the task tray and display the status of the Industrial PC. Refer to <i>2-4-4 Industrial PC Tray Utility</i> on page 2-22 for details.
Industrial Rescue Disk Creator	This is the utility to create the Rescue Disk Utility. Refer to <i>7-2 Rescue Disk Creator and Utility</i> on page 7-3 for details.
Industrial PC System API	This is the API to get and set the system information of the Industrial PC. Refer to <i>6-2 Industrial PC System API</i> on page 6-4 for details.
Industrial Monitor API	This is the API to get and set information of the Industrial Monitor. Refer to <i>6-3 Industrial Monitor API</i> on page 6-5 for details.
Industrial PC Controller API	This is the API to get and set the Controller information of the Industrial PC. Refer to <i>6-4 Industrial PC Controller API</i> on page 6-6 for details.
NYCompolet	This is the software component to change values of the Controller variables for the Industrial PC. Refer to <i>Section 5 NYCompolet</i> on page 5-1 for details.
SYSMAC Gateway	This is the software used for communications of the NYCompolet. Refer to <i>5-3 Communications Setup</i> on page 5-4 for details.
congatec CGOS API	This is the API to operate the Industrial PC System API.
Microsoft .NET Framework 4.6	This is the software to operate the Industrial PC Tray Utility.

## 2-4-2 Industrial Monitor Utility

This section provides an overview of the Industrial Monitor Utility.

### Industrial Monitor Utility Overview

The Industrial Monitor Utility provides a user interface to control settings and display details of connected Industrial Monitors.

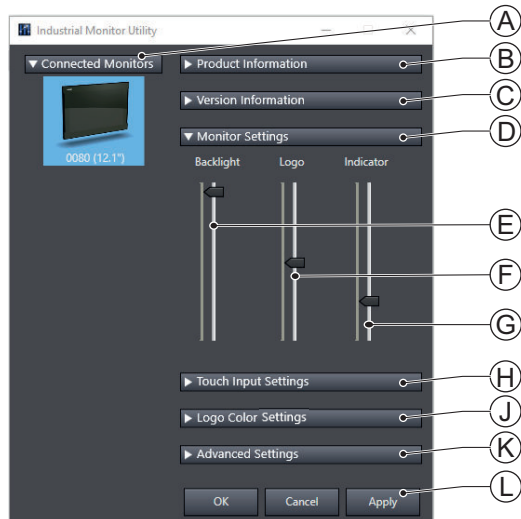

Item	Description	Details
A	Connected Monitors	Shows a list of the connected Industrial Monitors.* <sup>1</sup> Select one Industrial Monitor in the list to display the Monitor Details. When selected the LED Indicators of the selected monitor will flash during 3 seconds.
B	Product Information	Provides details of the selected Industrial Monitor. Refer to <i>Product Information</i> on page 2-13 for details.
C	Version Information	Provides version details of Industrial Monitor Utility software and firmware details of the connected monitor. Refer to <i>Version Information</i> on page 2-13 for details.
D	Monitor Settings	Provides several setting adjustments to control the operation of the selected Industrial Monitor.
E	Backlight Brightness Adjustment * <sup>2</sup>	Use the slider to control the brightness of the selected Industrial Monitor.
F	Logo Brightness Adjustment	Use the slider to control the brightness of the Logo LED.
G	Status Brightness Adjustment	Use the slider to control the brightness of the Status LED Indicator on the monitor.
H	Touch Input Settings	Provides details about the touch settings. Refer to <i>Touch Input Settings</i> on page 2-14 for details.
J	Logo Color Settings	Provides details about the logo color. Refer to <i>Logo Color Settings</i> on page 2-15 for details.
K	Advanced Settings	Provides access to defaults and relevant Windows settings. Refer to <i>Advanced Settings</i> on page 2-16 for details.

Item	Description	Details
L	Standard windows buttons	<ul style="list-style-type: none"> <li>• OK button. Applies changes and closes the window</li> <li>• Cancel button. Exits the utility</li> <li>• Apply button. Applies the changes,</li> </ul>

- \*1. The Industrial Monitor Utility scans the connected USB devices and shows a list of connected monitors. If an Industrial Monitor is not connected with the USB cable, it will not be found.
- \*2. With a very low backlight brightness setting (15%-0%) the displayed information might not be visible in an environment with high ambient light conditions. This prevents brightness adjustments with the Industrial Monitor Utility.



### Additional Information

To adjust the backlight brightness when the brightness setting is set too low:

- Bring the IPC in a low ambient light environment
- Lighten the display with a bright flashlight

## ● Product Information

The Product Information part supplies details of the selected connected monitor.

▼ Product Information	
Serial Number :	22
Screen Size :	18.5"
Model Name :	NYM19W-C1062
Factory Identifier :	OMN
Unit Lot Number :	04817R
Logo Type :	Custom
Video Status :	Ok
Touch Input :	Ok

## ● Version Information

The Version Information part supplies version details of the software and of the selected monitor.

Software details:

- The version of the Industrial Monitor Utility
- The version of the Industrial Monitor API

Monitor details:

- The Hardware version of the monitor
- The version of the Firmware Software installed on the monitor
- The version of the Touch Firmware installed on the monitor

▼ Version Information	
Industrial Monitor Utility :	1.2.9.0
Industrial Monitor API :	1.3.7.0
Hardware Version :	/A
Software Version :	0.15
Touch Firmware :	PM1410.D04.1.0.2 Boot : 5.9 PM1410S.D04.1.0.2 Boot : 5.9

## ● Touch Input Settings

The Touch Input Settings display the actual settings.

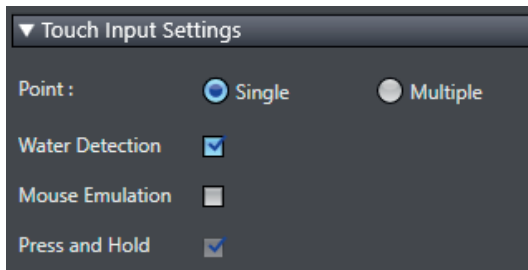

- Point  
Set to Single the monitor accepts only one touch point.  
Set to Multiple allows more touch points simultaneously.
- Water Detection  
When enabled then a message will appear to inform the user when water is detected.  
When disabled then no message will appear when water is detected.
- Mouse Emulation  
When mouse emulation is enabled the Point setting is disabled and Press and Hold is enabled.  
When mouse emulation is disabled the Point setting is enabled and the Press and Hold is disabled.



### Additional Information

---

Do not activate mouse emulation when using multiple industrial monitors in combination with extended mode.

---

- Press and Hold  
When enabled then a right-click mouse action occurs when holding a touch.  
When disabled then holding the touch does not trigger the right-click mouse action.

## ● Logo Color Settings

The logo color settings allows you to control the color of the customized logos of the selected Industrial Monitor.

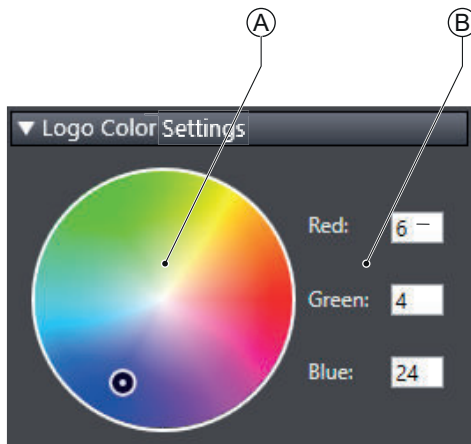

Item	Description	Details
A	Color circle selection	The color overview displaying the selected color. The RGB selection will be updated accordingly
B	RGB selection	Displays the RGB values of the selected color The color circle will be updated accordingly

Move the indicator in the color circle or change the RGB values to change the logo color of the selected monitor.

Activate the Powershell Script to change the logo color of all connected monitors.

Refer to *Powershell Script for Connected Monitors* on page 2-15 for details.



### Additional Information

The color of the standard OMRON logo can not be changed.  
Used with the standard OMRON logo the brightness of the logo will be influenced.

## ■ Powershell Script for Connected Monitors

The powershell script **SetLogoColor.ps1** is a script to make it convenient to change the logo color of all connected monitors.

Any change of the logo color in the Industrial Monitor Utility will update the powershell script with the newly selected color. This script is available at C:\Omron\PSScript\SetLogoColor.ps1.

Run the powerscript to change the logo color of all connected monitors.

● **Advanced Settings**

Advanced settings gives access to the factory settings and shortcuts to relevant Windows settings.

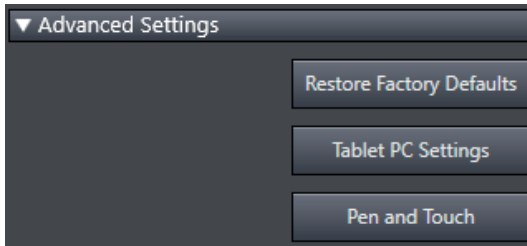

- Restore Factory Defaults button  
Resets all settings of the Industrial Monitor to the factory defaults.
- Tablet PC Settings  
Opens the 'Tablet PC Settings'-dialog of Windows.
- Pen and Touch  
Opens the 'Pen and Touch'-dialog of Windows.

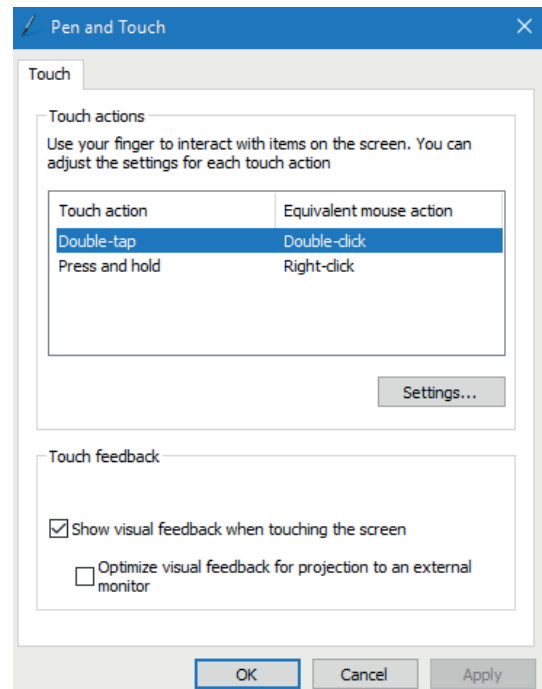
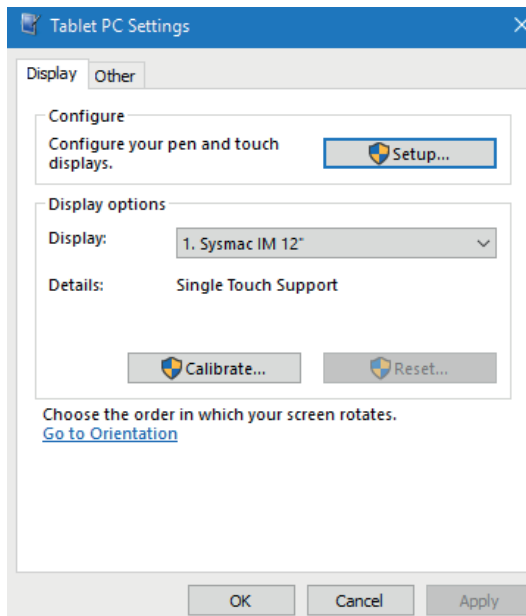



## Compatibility

This monitor utility can be used on any PC that is connected to an OMRON Industrial Monitor.

### Compatibility with Operating Systems

This software utility can be used on an IPC with Windows 7 or higher.

### Compatibility with related software utilities

The Industrial PC Tray Utility, the Industrial PC Support Utility and the Industrial Monitor Utility are related. When during startup the error **Could not load plugin: \*\\OMRON\\\*\\Utility\\\*.dll** appears software utilities are not compatible. Download and install the latest version of these software utilities.



### Additional Information

The Industrial Monitor Utility does not support 3rd party monitors.

## Installation

The Industrial Monitor Utility is pre-installed on the Industrial PC if it comes with a Windows operating system installed.

Download the Industrial Monitor Utility from [the OMRON website](#) for reinstallation or for installation on another Industrial PC.

The Industrial Monitor Utility is installed onto Windows, and can be accessed via the Windows start menu and the Industrial PC Tray Utility. Installing the Industrial Monitor Utility will also install the Industrial PC Tray Utility.



### Precautions for Correct Use

When you use the Industrial Monitor Utility or Industrial Monitor Brightness Utility to adjust the Industrial Monitors, connect them to the Industrial PC with a USB cable in advance.



### Additional Information

Refer to *2-4-4 Industrial PC Tray Utility* on page 2-22 for Industrial PC Tray Utility details.

## Startup

The Industrial Monitor Utility can be started from:

- Windows Start Menu.  
Select **Omron** and then **Industrial Monitor Utility**.
- Industrial PC Tray Utility

## Configuration

The Industrial Monitor Utility can be configured with following options:

Configuration item	Description
Language	Follows the Windows language configuration when that language is supported for the Industrial Monitor Utility. The default language English (EN-US) will be used if the language configured in Windows is not supported.
Monitor identification	If enabled, the Status LED indicator on the selected Industrial Monitor will flash for 3 seconds. To enable: <ol style="list-style-type: none"> <li>1. Open the Windows registry key HKEY_LOCAL_MACHINE\SOFTWARE\Wow6432Node\Omron\IPC\MonitorConfiguration</li> <li>2. Set the registry value Indicate to value True.</li> </ol>

## Messages

The Industrial Monitor Utility can use the Industrial PC Tray Utility to display following messages:

Message type	Message	Description
Info	Connected	A new monitor connected <ul style="list-style-type: none"> <li>• USB cable connected</li> <li>• Monitor powered ON</li> </ul>
Warning	Not Connected	Monitor disconnected <ul style="list-style-type: none"> <li>• USB cable disconnected</li> <li>• Monitor powered OFF</li> </ul>
Warning	Video Disconnected	DVI cable disconnected or NY Monitor Link cable disconnected
Warning	Serial number: <input type="checkbox"/> Water detected on a monitor Touch may be rejected Check all attached monitors for water	Water is detected on monitor <input type="checkbox"/>
Warning	No Signal	DVI cable connected but no signal detected

## Logging

There is logging in the Windows event log of the following utilities:

- Industrial Monitor Utility  
In the Windows Event Viewer filter for event source *IndMonService*.
- Industrial Monitor Brightness Utility  
In the Windows Event Viewer filter for event source *IndMonService*.
- Industrial PC Support Utility  
In the Windows Event Viewer filter for event source *IPCServiceHost* or *OMRON Industrial PC Support Utility*.



### Additional Information

Refer to *A-4 Windows Event Viewer* on page A-5 for the logged messages.

### 2-4-3 Industrial Monitor Brightness Utility

This section provides an overview of the Industrial Monitor Brightness Utility.

#### Industrial Monitor Brightness Utility Overview

The Industrial Monitor Brightness Utility is a software utility that allows you to control the brightness of the screen backlight of all connected Industrial Monitors.

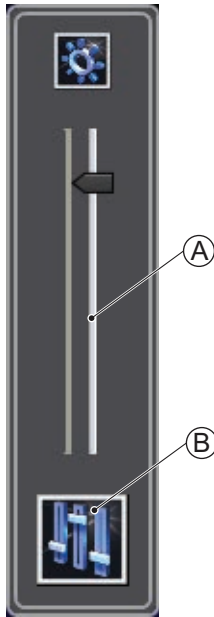

Item	Description	Details
A	Backlight brightness slider	Use the slider to control the display brightness of all connected Industrial Monitors.
B	Industrial Monitor Utility	Button to start the Industrial Monitor Utility.

With a very low backlight brightness setting (15%-0%) the displayed information might not be visible in an environment with high ambient light conditions. This prevents brightness adjustments with the Industrial Monitor Brightness Utility.



#### Additional Information

To adjust the backlight brightness when the brightness setting is set too low:

- Bring the IPC in a low ambient light environment
- Lighten the display with a bright flashlight

## Compatibility

This monitor utility can be used on any PC that is connected to an OMRON Industrial Monitor.

### Compatibility with **Operating Systems**

This software utility can be used on an IPC with Windows 7 or higher.

### Compatibility with **related software utilities**

The Industrial PC Tray Utility, the Industrial PC Support Utility and the Industrial Monitor Utility are related. When during startup the error **Could not load plugin: \*\\OMRON\\Utility\*.dll** appears software utilities are not compatible. Download and install the latest version of these software utilities.



### Additional Information

The Industrial Monitor Utility does not support 3rd party monitors.

## Installation

The Industrial Monitor Brightness Utility is pre-installed on the Industrial PC if it comes with a Windows operating system installed.

Installation of the Industrial Monitor Brightness Utility is part of the installation of the Industrial Monitor Utility.

Download the Industrial Monitor Utility from [the OMRON website](#) for reinstallation or for installation on another PC with a compatible operating system.

The Industrial Monitor Brightness Utility is installed onto Windows, and can be accessed via the Windows start menu and the Industrial PC Tray Utility. Installing the Industrial Monitor Utility will also install the Industrial PC Tray Utility.



### Precautions for Correct Use

When you use the Industrial Monitor Utility or Industrial Monitor Brightness Utility to adjust the Industrial Monitors, connect them to the Industrial PC with a USB cable in advance.



### Additional Information

Refer to *2-4-4 Industrial PC Tray Utility* on page 2-22 for Industrial PC Tray Utility details.

## Startup

Start the Industrial Monitor Brightness Utility from the Industrial PC Tray Utility or from the Windows Start Menu (select **Omron** and then **Industrial Monitor Brightness Utility** ).



### Additional Information

Refer to *2-4-4 Industrial PC Tray Utility* on page 2-22 for Industrial PC Tray Utility details.

## Configuration

---

Configuration is not required.

This utility will detect and support all connected NY-series Industrial Monitors.

## Logging

---

There is logging in the Windows event log of the following utilities:

- Industrial Monitor Utility  
In the Windows Event Viewer filter for event source *IndMonService*.
- Industrial Monitor Brightness Utility  
In the Windows Event Viewer filter for event source *IndMonService*.
- Industrial PC Support Utility  
In the Windows Event Viewer filter for event source *IPCServiceHost* or *OMRON Industrial PC Support Utility*.



### Additional Information

---

Refer to *A-4 Windows Event Viewer* on page A-5 for the logged messages.

---

## 2-4-4 Industrial PC Tray Utility

This section provides an overview of the Industrial PC Tray Utility.

### Industrial PC Tray Utility Overview

The Industrial PC Tray Utility is a software utility that provides information about the current state of the Industrial PC, its related devices, and associated software.

When running, the Industrial PC Tray Utility is always present as a status icon **(A)** in the system tray area **(B)** of Windows.

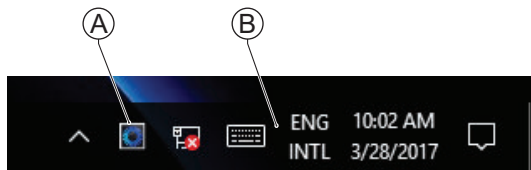

Windows 10

### Features

The Industrial PC Tray Utility provides the following features:

- Display the overall state of all installed OMRON software utilities in the icon in the system tray area.
- Display a menu that can start all installed software utilities and show the state of each installed software utility.
- Display notification messages in popup windows that inform the user about the state of applications or hardware. The Industrial PC Tray Utility displays the messages provided by installed software utilities. Refer to the details of a specific software utility for the messages that can be displayed.

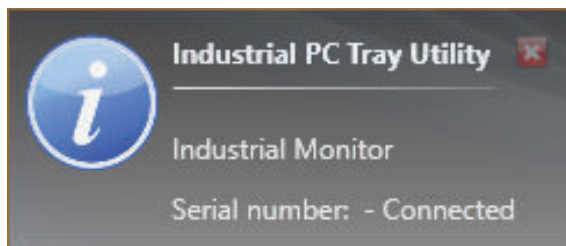

## Menu

Select the Industrial PC Tray Utility icon (F) to display the menu.

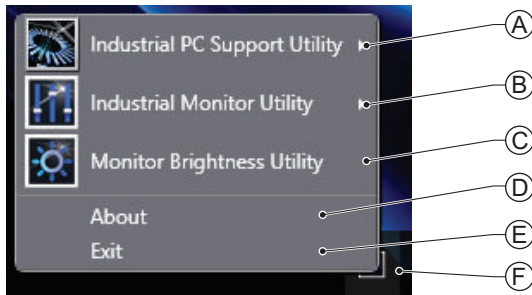

- The application displays the available utilities.
  - Select an entry to launch the associated utility, if applicable.
  - The icons of menu items in the Industrial PC Tray Utility menu will have a warning or error symbol when applicable.
  - The Industrial PC Support Utility (A) is available in the menu when installed.
  - The Industrial Monitor Utility (B) is available in the menu when installed.
  - The Industrial Monitor Brightness Utility (C) is available in the menu when installed.
  - The application area can be configured to show and launch both OMRON and third party utilities.
- The **About** entry (D) shows details of the Industrial PC Tray Utility.  
Refer to *About the Industrial PC Tray Utility* on page 2-23 for details.
- The **Exit** entry (E) closes the utility.

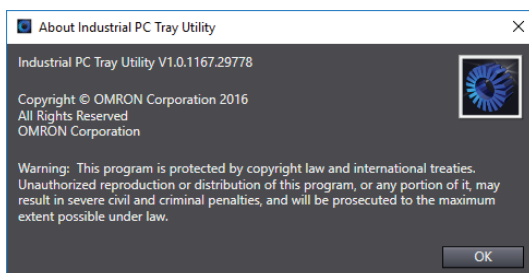

## About the Industrial PC Tray Utility

The About window shows the version of the Industrial PC Tray Utility and copyright information.



## Status Indicators on Icons

The following table provides the indicator details of the Industrial PC Tray Utility.

Overlay type	Icon	Description
None		No OMRON software utility has issued warning or error notifications.
Warning sign		At least one software utility has issued a warning notification.
Error sign		At least one software utility has issued an error notification.

## Compatibility

This software utility can be used on an IPC with Windows 7 or higher.

## Installation

The Industrial PC Tray Utility is pre-installed on the Industrial PC if it comes with a Windows operating system installed.

The Industrial PC Tray Utility is included in the installers of the Industrial PC Support Utility and Industrial Monitor Utility. Install the Industrial PC Support Utility or Industrial Monitor Utility to install the Industrial PC Tray Utility.



## Startup

---

By default the Industrial PC Tray Utility is configured to start automatically at Windows startup.

To manually start the Industrial PC Tray Utility:

- 1** Locate the Industrial PC Tray Utility using the Windows **Start** menu or the Windows search box.
- 2** Use the option **Run as administrator** to activate the Industrial PC Tray Utility.



### Additional Information

---

The procedure to use **Run as administrator** is:

- For Windows 10 using the **Start** menu:  
Right-click the Industrial PC Tray Utility, select **More** and then **Run as administrator**.
  - For Windows 10 using **Search**:  
Right-click the Industrial PC Tray Utility in the search results and select **Run as administrator**.
  - For Windows 7 using the **Start** menu or **Search**:  
Right-click the Industrial PC Tray Utility and select **Run as administrator**.
- 

The Industrial PC Tray Utility started.



# 3

## Controller Preparation

This section describes the settings and procedures for Windows and Controller that are required for using the Controller.

---

<b>3-1</b>	<b>Internal Port Settings .....</b>	<b>3-2</b>
<b>3-2</b>	<b>Shared Folder Settings .....</b>	<b>3-3</b>
3-2-1	Windows Settings .....	3-3
3-2-2	Controller Setup .....	3-13

## 3-1 Internal Port Settings

This section describes the settings of the internal port through which the Controller communicates with Windows.

Refer to *1-2-2 Data Exchange between Operating Systems* on page 1-3.

### Windows Settings

An internal port is set on Windows by default as a virtual network adapter port. The factory setting for the internal port is given below.

Item	Value
Network adapter name	Real-Time Hypervisor PCI Network Adapter
IP address	192.168.254.2
Subnet mask	255.255.255.0
Public range of Windows file shared service	Internal network only

### Controller Setup

The factory setting for the internal port on the Controller is given below.

Item	Value
IP address	192.168.254.1
Subnet mask	255.255.255.0

## 3-2 Shared Folder Settings

This section describes the settings required for the Controller to use the Windows shared folder as a Virtual SD Memory Card.

Refer to the *NY-series Industrial Panel PC / Industrial Box PC Software User's Manual (Cat. No. W558)* for details on the function of a Virtual SD Memory Card.

### 3-2-1 Windows Settings

Prepare a Windows user account with which you access the shared folder directly or through the Controller.

Create a user account first.

#### Create a User Account in Windows 7

Create a new user account with which you access the shared folder through the Controller. First log onto Windows with a user account of administrator level that was created at the Windows settings, and then perform the following procedures.

- 1 Select **Control Panel** from the Windows start menu.

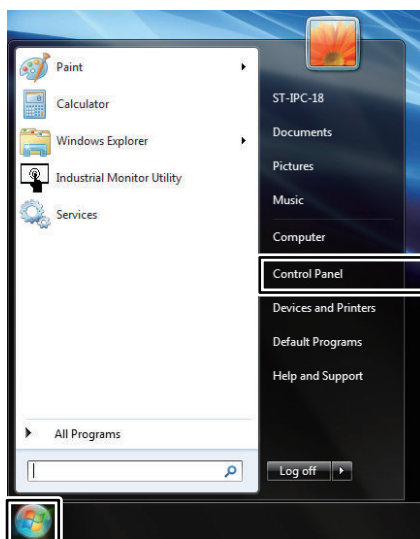

The Controller Panel is displayed.

**2** Select **Add or remove user accounts** on the Control Panel.

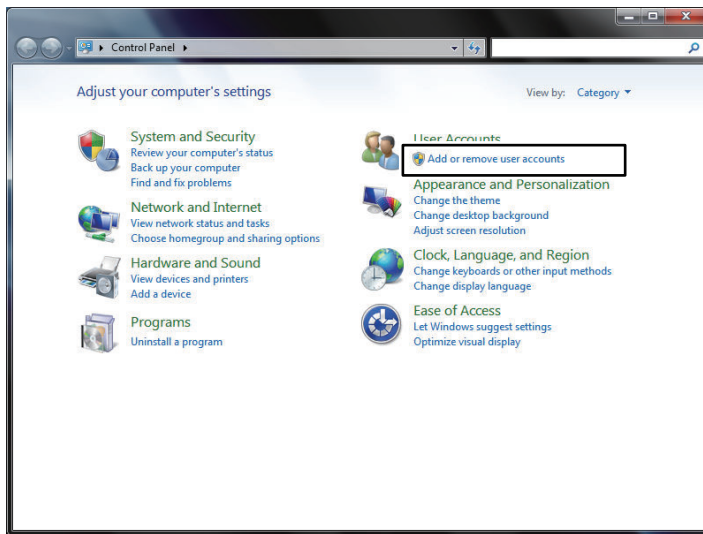

The **Manage accounts** view is displayed.

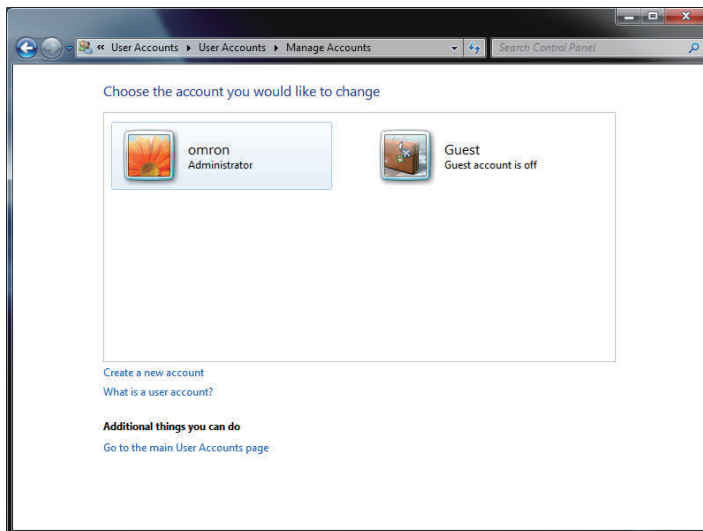

**3** Select **Create a new account**.

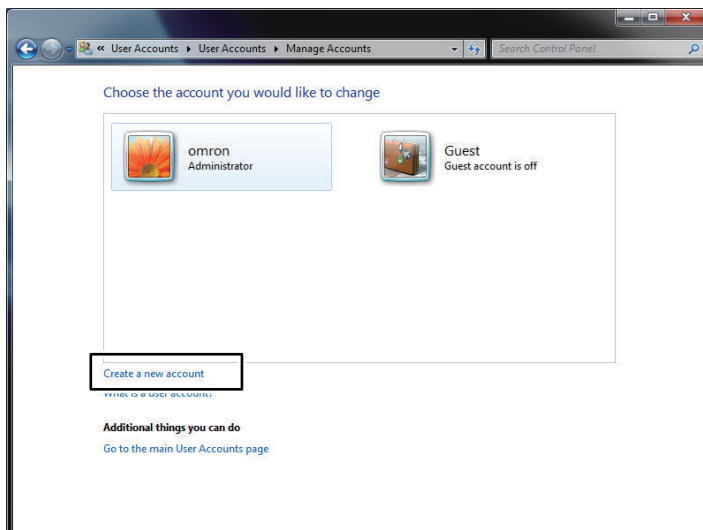

The **Create a new account** view is displayed.

- 4** Enter an account, select **Administrator**, and click the **Create Account** button.  
In the following example, enter *MachineController* as an account.

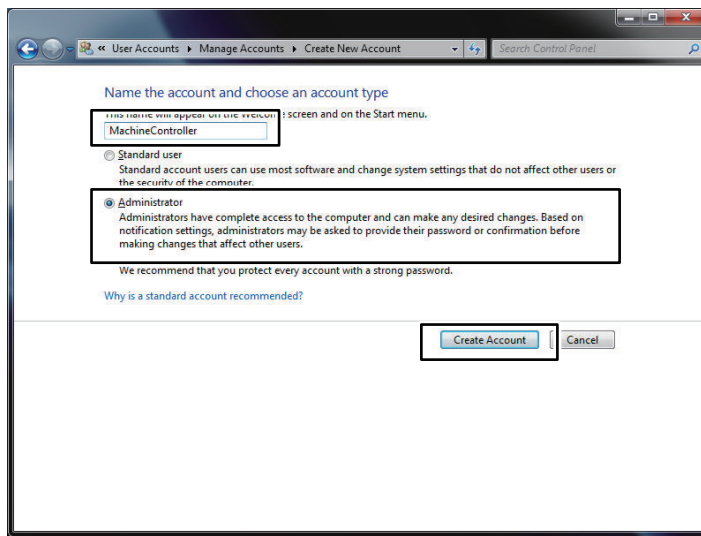

The new account is created.

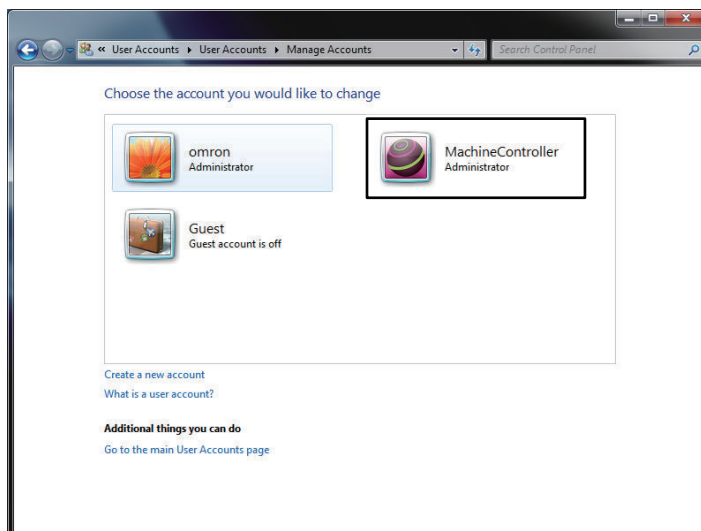

- 5** Click the account that you created on the **Manage accounts** view. Select **Created a password** on the displayed **Change account** view.

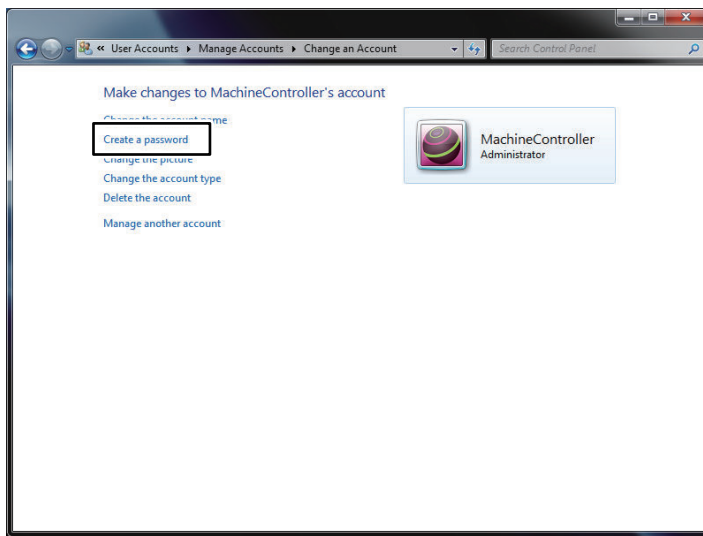

The **Create a password** view is displayed.



- 6 Enter a password, and then click the **Create a password** button. Enter a hint to the password, if necessary.

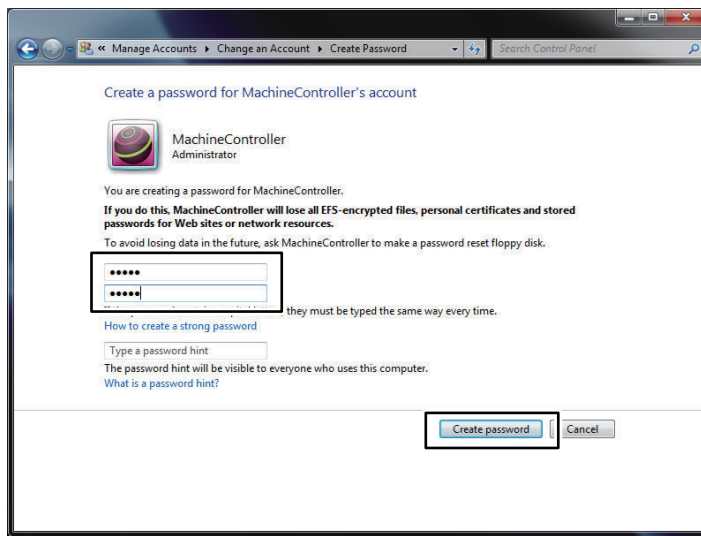

This completes an account creation.

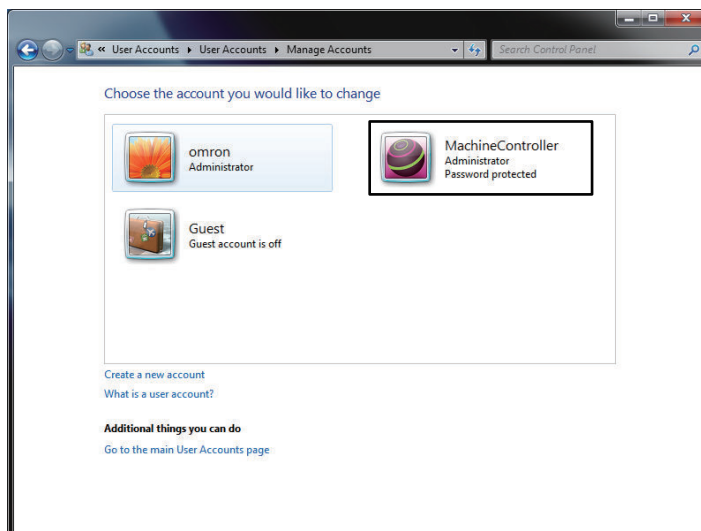

### Precautions for Correct Use

- Characters that you can use for an account name range from 0 to 9, A to Z, a to z, and single-byte symbols (`, !, #, \$, ^, &, (, ), \_ , -, {, }, \, and '). The number of characters for an account is 1 to 274 (without Null). Case insensitive.
- Characters that you can use for a password range from 0 to 9, A to Z, a to z, and single-byte symbols (`, !, @, #, \$, %, ^, &, \*, (, ), \_ , -, +, =, {, }, [, ], \, |, ;, : ; ", ' , < , > , . , ? , and /). The number of characters for a password is 8 to 32 (without Null). Case sensitive.

## Create a User Account in Windows 10

Create a new user account with which you access the shared folder through the Controller. First log onto Windows with a user account of administrator level that was created at the Windows settings, and then perform the following procedures.

- 1 Search in Windows for **add account** .  
Select the search result to display the **Family & other users** setting page.

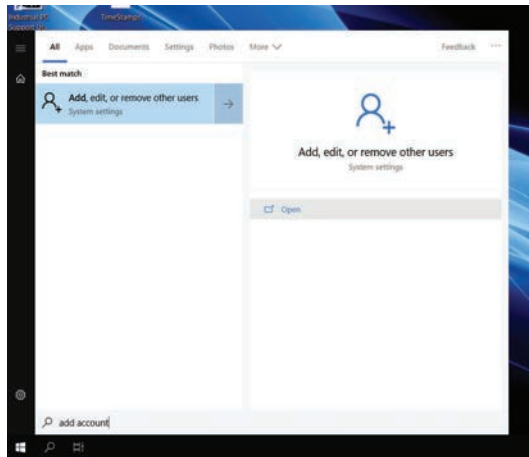

- 2 Select **Add someone else to this PC** to display the account window.

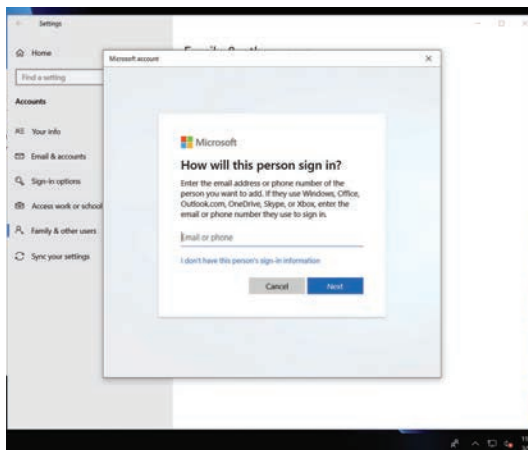

- 3** If the IPC is connected to the internet then this window appears. Select **I don't have this person's sign-in information** to display the **Create an account on this PC** window.

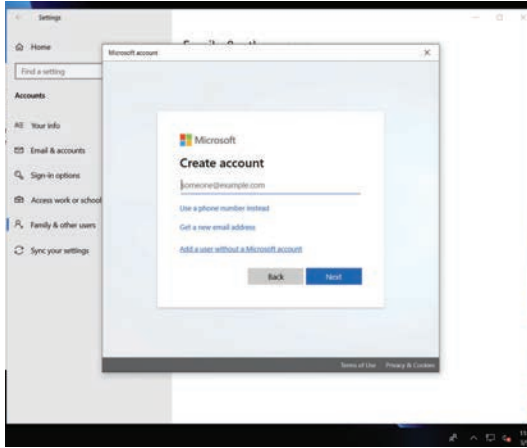

- 4** Select **Add a user without a Microsoft account** to display the **Create an account for this PC** window.

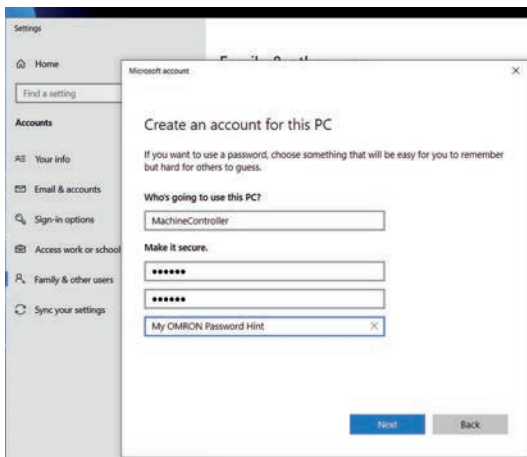

- 5** Enter the account name, your password and a Password Hint. In this example the account name is *MachineController*. Then select **Next** . The new account is created.



- 6** Select the MachineController account and then select **Change account type** . The **Change account type** window appears.

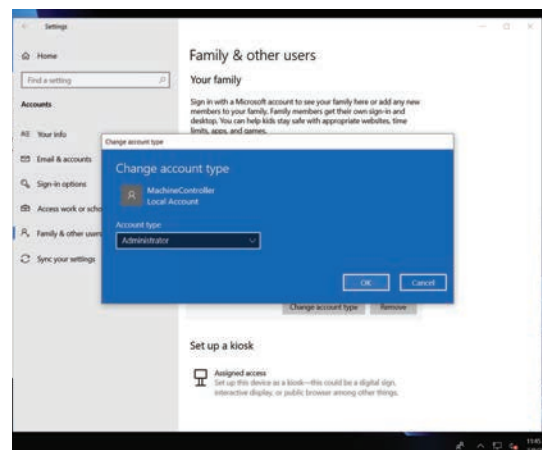
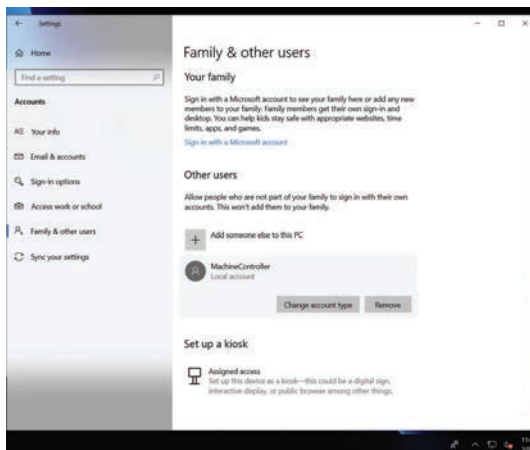

- 7 Select **Administrator** and the select **OK** .  
The created account is now an administrator account.

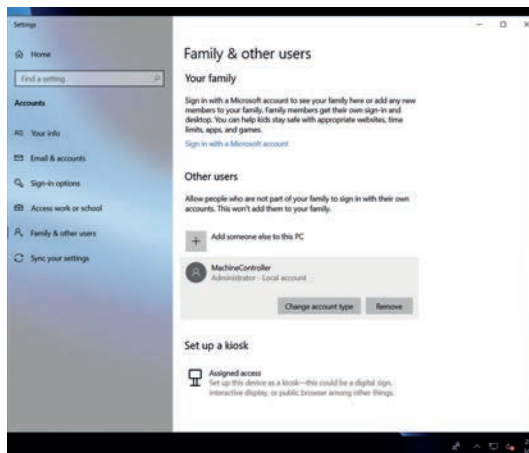

This completes the user account creation.



### Precautions for Correct Use

- Characters that you can use for an account name range from 0 to 9, A to Z, a to z, and single-byte symbols ( ` , ! , # , \$ , ^ , & , ( , ) , \_ , - , { , } , \ , and ' ). The number of characters for an account is 1 to 274 (without Null). Case insensitive.
- Characters that you can use for a password range from 0 to 9, A to Z, a to z, and single-byte symbols ( ` , ! , @ , # , \$ , % , ^ , & , \* , ( , ) , \_ , - , + , = , { , } , [ , ] , \ , | , ; , : , " , ' , < , > , . , ? , and / ). The number of characters for a password is 8 to 32 (without Null). Case sensitive.

## Shared Folder Settings

---

A shared folder that is used as a Virtual SD Memory Card is created by default. You can access the folder from a new account that you create.

The factory setting for the shared folder is given below.

Item	Value
The path for the shared folder	D:\OMRON-NY\VirtualSDCard
Shared folder name	VirtualSDCard
Shared with	Everyone
Permission level	Read/Write



### Precautions for Correct Use

---

When you enable file sharing on external networks, change the accounts that are given access to the shared folder from **Everyone** to properly authorized accounts in order to protect the shared folder against information leaks or data modification.

Refer to *A-3 Changing Windows File Sharing Setting* on page A-4 for file sharing on external networks.

---

## 3-2-2 Controller Setup

With **Controller Setup** on the Sysmac Studio, you can set a shared folder that is used by the Controller as a Virtual SD Memory Card.

The setting items are given below.

Item	Description	Set value	Initial value
Virtual SD Memory Card	Specify whether to use the Windows shared folder as a Virtual SD Memory Card.	Do not use. Use.	Do not use.
Computer name	Specify the Windows computer name.	Text string* <sup>1</sup>	Blank
IP address	Specify the IP address of the Windows internal port.	IPv4* <sup>2</sup>	192.168.254.2
Shared folder name	Specify a shared folder name used as a Virtual SD Memory Card.	Text string* <sup>3</sup>	VirtualSDCard
User name	Specify a shared name of the user who uses the shared folder as a Virtual SD Memory Card. Enter the account name that you set at "Account Settings" of "Windows Settings". * <sup>4</sup>	Text string* <sup>5</sup>	Blank
Password	Specify a password for the account you set for "User name".	Text string* <sup>6</sup>	Blank

\*1. Characters that you can use range from 0 to 9, A to Z, a to z, and a single-byte symbol (-). The number of characters is 1 to 15 (without Null). Case insensitive.  
Search in Windows for **PC name**. In System Settings **About** the Computer Name is available with the label **Device name**.

\*2. You cannot specify the following IP addresses.  
IP addresses that start with 127 (decimal)  
Class-D IP addresses (224.0.0.0 to 239.255.255.255)  
Class-E IP addresses (240.0.0.0 to 255.255.255.255)

\*3. Characters that you can use range from 0 to 9, A to Z, a to z, and a single-byte symbol (-). The number of characters is 1 to 32 (without NULL). Case insensitive.

\*4. Enter <.domain name>\< user name> to specify a domain. You can omit specifying a domain name when users with the same name do not exist as a domain user and local user.

- \*5. Characters that you can use range from 0 to 9, A to Z, a to z, and single-byte symbols ( ` , ! , # , \$ , ^ , & , ( , ) , \_ , - , { , } , \ , and ' ). The number of characters is 1 to 274 (without Null). Case insensitive.
- \*6. Characters that you can use range from 0 to 9, A to Z, a to z, and single-byte symbols ( ` , ! , @ , # , \$ , % , ^ , & , \* , ( , ) , \_ , - , + , = , { , } , [ , ] , \ , | , ; , : , " , ' , < , > , , , ? , and / ). The number of characters is 8 to 32 (without NULL). Case sensitive.

The setting procedure is given below.

- 1 Start the Sysmac Studio, and create a project for the target NY-series Controller.
- 2 Double-click or right-click **Operation Settings** under **Configurations and Setup - Controller Setup** in the Multiview Explorer, and select **Edit** from the menu.  
The **Operation Settings** view is displayed.

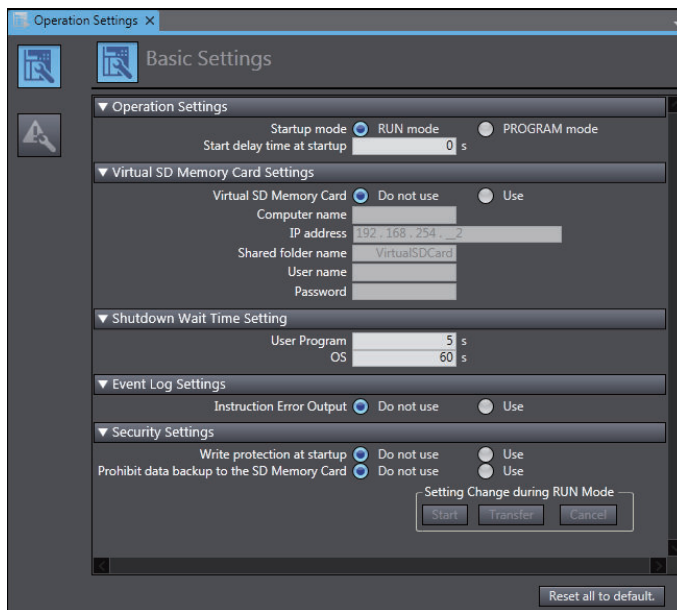

- 3 On the **Virtual SD Memory Card Settings** field of the **Basic Settings** view, select **Use** for **Virtual SD Memory Card** option, and enter required fields.
- 4 Go online with the target Controller from the Sysmac Studio, and transfer the Controller setup to the Controller by using the Synchronization function.

Refer to the *Sysmac Studio Version 1 Operation Manual (Cat. No. W504)* for details on how to create projects, to go online, and to synchronize on the Sysmac Studio.



#### Additional Information

You can perform Virtual SD Memory Card settings for the Controller with the Industrial PC Support Utility. Refer to 4-8 *Virtual SD Memory Card Settings Tab* on page 4-21 for details on the setting procedure with the Industrial PC Support Utility.



# 4

## Industrial PC Support Utility

This section describes the functions and usage of the Industrial PC Support Utility.

4

---

<b>4-1</b>	<b>Industrial PC Support Utility Overview .....</b>	<b>4-2</b>
<b>4-2</b>	<b>Product Information Tab.....</b>	<b>4-3</b>
<b>4-3</b>	<b>System Status Tab .....</b>	<b>4-4</b>
<b>4-4</b>	<b>Controller Status Tab.....</b>	<b>4-6</b>
<b>4-5</b>	<b>Controller Status Tab - Report Logs.....</b>	<b>4-8</b>
<b>4-6</b>	<b>Controller Operation Tab .....</b>	<b>4-10</b>
4-6-1	Mode Change.....	4-11
4-6-2	Resetting the Controller.....	4-12
4-6-3	Controller Backup.....	4-13
<b>4-7</b>	<b>Network Settings for Controller Tab.....</b>	<b>4-18</b>
<b>4-8</b>	<b>Virtual SD Memory Card Settings Tab.....</b>	<b>4-21</b>
<b>4-9</b>	<b>Industrial PC Support Utility Details.....</b>	<b>4-23</b>
4-9-1	Data Update Details .....	4-23
4-9-2	Compatibility .....	4-23
4-9-3	Installation .....	4-23
4-9-4	Startup.....	4-23
4-9-5	Messages .....	4-24
4-9-6	Logging.....	4-24
4-9-7	Operation Authority Verification.....	4-25

## 4-1 Industrial PC Support Utility Overview

The Industrial PC Support Utility is a software utility to assist in diagnosing and resolving problems of the IPC Machine Controller.

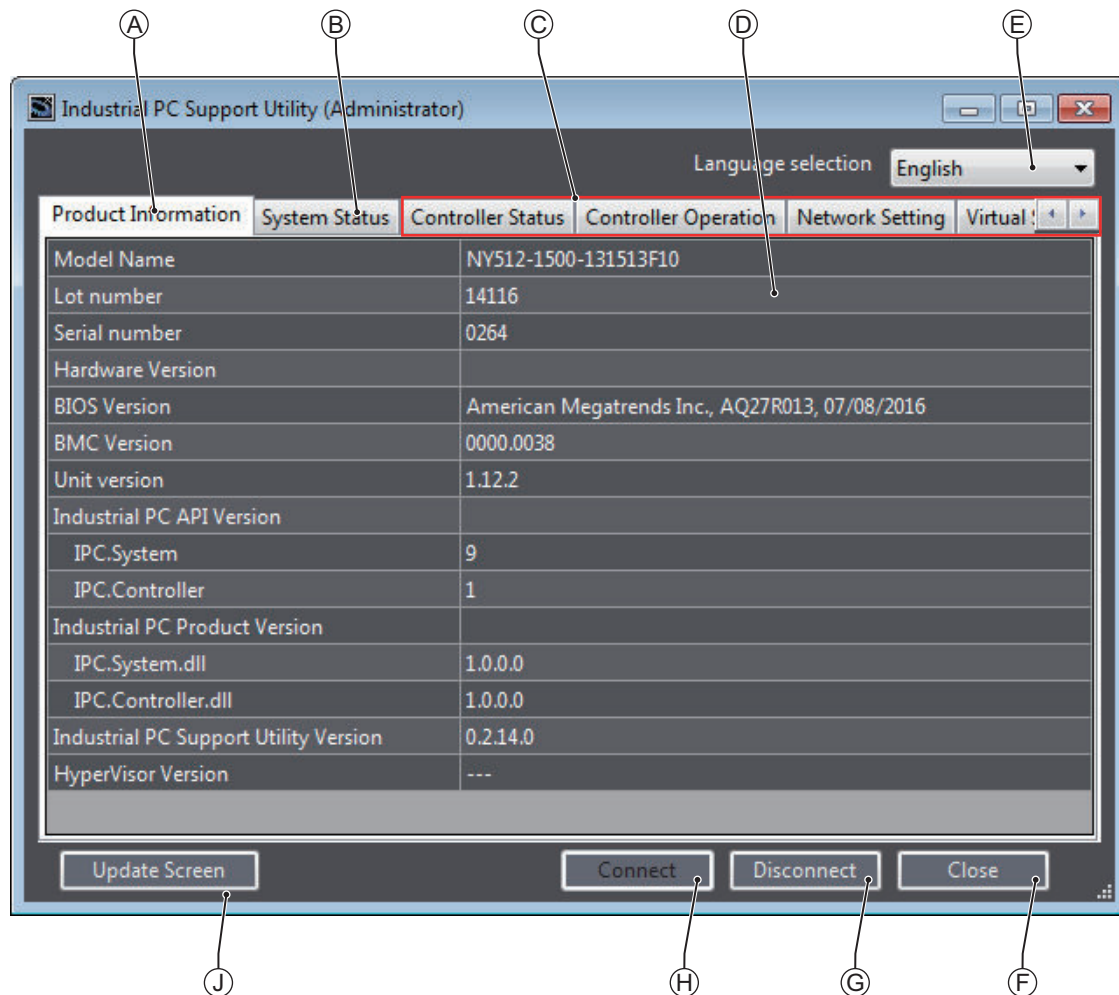

Item	Description	Details
A	Production Data Tab	Select to display Production Data details in the Tab details area (D). Refer to 4-2 <i>Product Information Tab</i> on page 4-3 for details.
B	System Status Tab	Select to display System Status details in the Tab details area (D). Refer to 4-3 <i>System Status Tab</i> on page 4-4 for details.
C	Machine Controller Tabs	A series of tabs with all information about the Controller.
D	Tab details	Details of the selected Tab page.
E	Language Selector	Select to display and choose the UI language of the Industrial PC Support Utility.
F	Close Button	Close the Industrial PC Support Utility.
G	Disconnect Button	Disconnect from the Controller.
H	Connect Button	Connect to the Controller.
J	Update Screen Button	Use this button to retrieve updated values from the IPC Machine Controller.

## 4-2 Product Information Tab

The Production Data tab displays generic IPC Machine Controller information. These are e.g. Model name, Lot number, Serial number, Hardware version, BIOS version, BMC version, and software versions (Industrial PC Support Utility and Industrial PC System API).

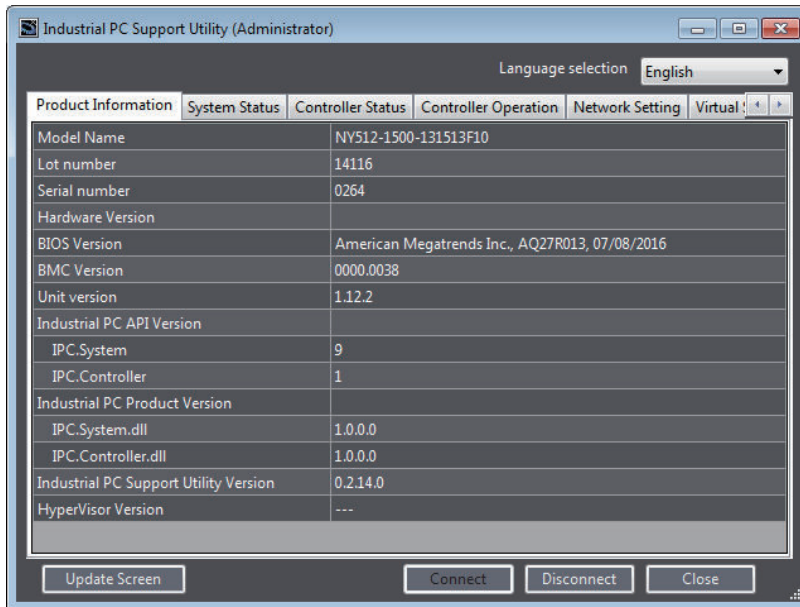

Item	Displayed information
Model Name	The model number of the Industrial PC
Lot number	The lot number of the Industrial PC
Serial number	The serial number of the Industrial PC
Hardware Version	The hardware version of the Industrial PC
BIOS Version	The BIOS version of the Industrial PC
BMC Version	The BMC version of the Industrial PC
Unit Version	The software version of the Controller
Industrial PC API Version	The version of API installed in Windows
IPC.System	The API for the Industrial PC system
IPC.Controller	The API for the Controller
Industrial PC Product Version	The product version of the library installed in Windows
IPC.System.dll	The library for the Industrial PC system
IPC.Controller.dll	The library for the Controller
Industrial PC Support Utility Version	The version of the Industrial PC Support Utility
HyperVisor Version	The version of the software that exchanges data between Windows and the Controller.

Values are not updated automatically. Select the **Update Screen** Button to display the latest values.

## 4-3 System Status Tab

The System Status tab displays actual states and diagnostic information like internal temperature, fan revolution, battery and power supply status.

A status that requires attention is indicated with a red bar.

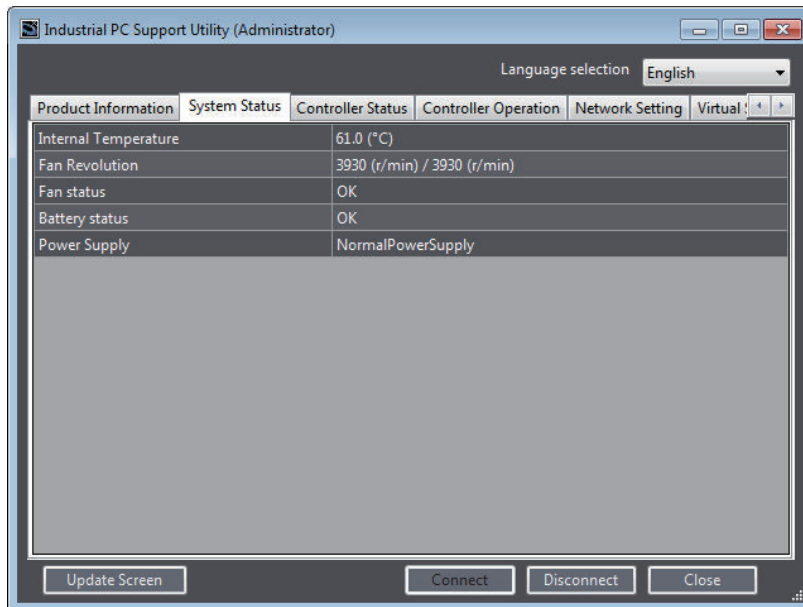

Item	Description
Internal Temperature	The average CPU temperature.
Fan Revolution *1	The actual rotation speed for each fan in revolutions per minute (r/min). <ul style="list-style-type: none"> <li>• First number = rotation speed of fan located closest to Power button.</li> <li>• Second number = rotation speed of fan located closest to battery.</li> </ul>
Fan Status *2	The target speed for the fans is dynamically set based on the CPU temperature. The target speed is compared with the actual fan speed. <ul style="list-style-type: none"> <li>• <b>OK</b> indicates both fans are running on the target speed.</li> <li>• <b>Low revolution speed</b> indicates one or both fans do not reach the target speed. Clean the fans and replace the Fan Unit if the problem persists.</li> </ul>
Battery Status	The battery status. <ul style="list-style-type: none"> <li>• <b>OK</b> indicates the battery is full.</li> <li>• <b>Low</b> indicates the battery voltage is low. Replace the battery.</li> </ul>
Power Supply	The power supply status is determined by the UPS and reported to the IPC via the I/O connector. <ul style="list-style-type: none"> <li>• <b>NormalPowerSupply</b> indicates the IPC is powered by the 24V power supply.</li> <li>• <b>UPS Power Supply</b> indicates that there is no power from the 24V power supply and the IPC runs on battery power from the UPS.</li> </ul>

\*1. The Fan Revolution will always show 0 (r/min) / 0 (r/min) for fanless models  
Refer to *1-3 Product Configuration* on page 1-6 for fan details.

\*2. The Fan Status will always show OK for fanless models

Values are not updated automatically. Select the **Update Screen** Button to display the latest values.

## Display in Industrial PC Tray Utility

For the following items displayed on the **System Status** tab page, you can check the status by the icon in the Industrial PC Tray Utility.

Item	Status	Icon
Fan status	OK	Normal
	Low revolution speed	Warning
Battery status	OK	Normal
	Low	Warning
Power Supply	NormalPowerSupply	Normal
	UpsPowerSupply	Warning

Refer to *2-4-4 Industrial PC Tray Utility* on page 2-22 for details on the Industrial PC Tray Utility.

## 4-4 Controller Status Tab

To display the Controller status, start up the Industrial PC Support Utility and click the **Controller Status** tab.

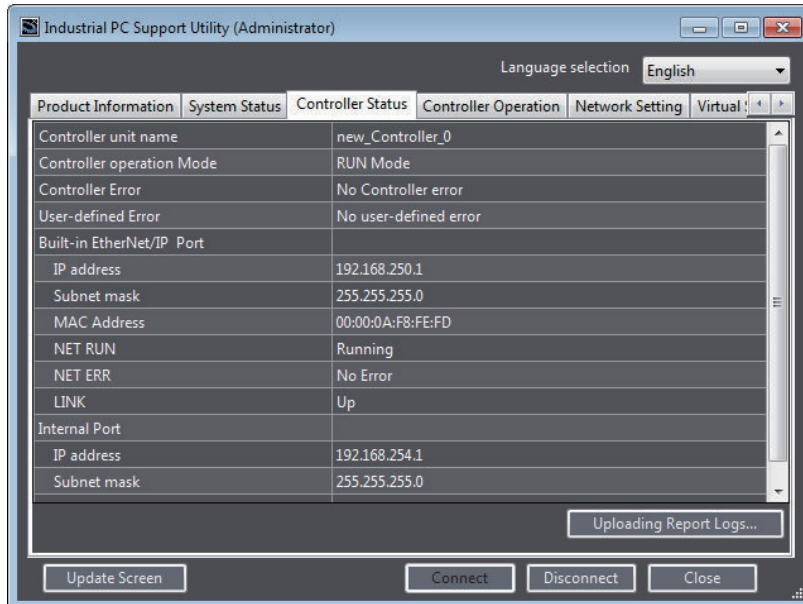

Item	Description
Controller unit name	Displays the unit name that is set for the Controller.
Controller operation Mode	Displays the present operating mode of the Controller.
Controller Error	Displays current Controller errors.
User-defined Error	Displays current user-defined errors.
Built-in EtherNet/IP port	Displays the settings of the built-in EtherNet/IP port through which the Controller communicates with an external device of the Industrial PC.
IP address	Displays the present IP address, subnet mask, and MAC address.
Subnet mask	
MAC address	
NET RUN	Displays the CIP connection status of the EtherNet/IP network.
NET ERR	Displays the communications error status of the EtherNet/IP network.
LINK	Displays the link establishment status of the EtherNet/IP network.
Internal Port	Displays the settings of the internal port through which the Controller communicates with Windows on the Industrial PC.
IP address	Displays the present IP address, subnet mask, and MAC address.
Subnet mask	
Default Gateway	Displays the present default gateway.



### Additional Information

You can use the Controller Status function of the Sysmac Studio to monitor more detailed status of the Controller. Refer to the *Sysmac Studio Version 1 Operation Manual (Cat. No. W504)* for details on the Controller status of the Sysmac Studio.

## Display in Industrial PC Tray Utility

For the following items displayed on the **Controller Status** tab page, you can check the status by the icon in the Industrial PC Tray Utility.

Item	Status	Icon
Controller operation Mode	RUN Mode	Normal
	PROGRAM Mode	Warning
Controller Error	No Controller error	Normal
	Partial or minor fault level Controller error occurs	Warning
	Major fault level Controller error occurs	Error
User-defined Error	No user-defined error	Normal
	User-defined error occurs	Error
NET ERR	No Error	Normal
	Error	Warning
	Critical Error	Error

Refer to *2-4-4 Industrial PC Tray Utility* on page 2-22 for details on the Industrial PC Tray Utility.

## 4-5 Controller Status Tab - Report Logs

If a problem occurs in the Controller, you can use the Report Log function to save information in a file to help solve the problem. Please provide the files that are saved to the OMRON support center when you request support.

### Types of Available Logs

The types of log information that you can get are given below. Each of the following information is saved in a log file with an extension .zip.

Item	Description
Controller Event Log	This is the Controller event log. The user-defined events are not included.
Controller Analysis Log	This is the log to analyze the Controller errors.
Industrial PC Support Utility Operation Log	This is the log that records the operation of the Industrial PC Support Utility. It is recorded in the Windows event log.
Communication Middleware Operation Log	This is the log that records the communications of the communication middleware. It is recorded in the Windows event log.

A log file always save the following information.

- Information on the **Production Information** tab
- Information on the **System Status** tab
- Information on the **Controller Status** tab
- Information on the **Virtual SD Memory Card Setting** tab

### Operation Procedure

The procedure to get a report log is given below.

- 1 Click the **Uploading Report Logs** button on the **Controller Status** tab page.

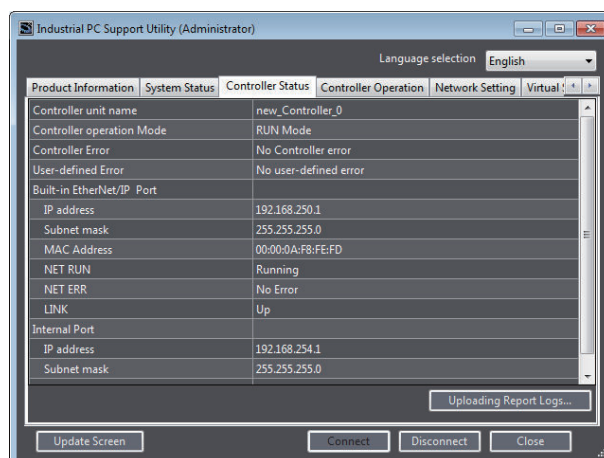

The **Report Log** dialog box is displayed.



- 2 Select the check box for the log to get, and click the **Save** button. Select the checkbox for the files to get according to the instructions provided by the OMRON support center.

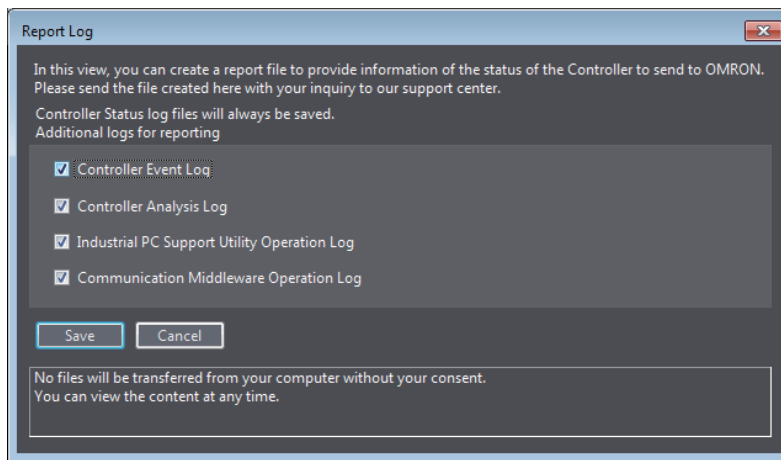

The **Save As** dialog box is displayed.

- 3 Select the folder in which to save the log files and click the **Save** button.

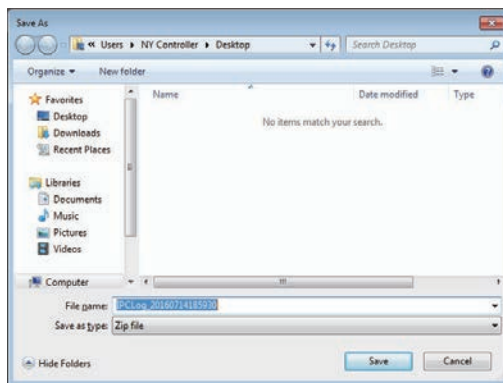

The log files are saved, and the contents saved in the folder are displayed. Send the log files to the support center.



### Additional Information

- The obtained log files do not contain any information that can be used to identify you or any project files of yours (e.g., settings, configurations, and programs).
- The obtained log files will never be sent from your computer to any external party without getting your approval.

## 4-6 Controller Operation Tab

You can perform operations such as operating mode change, backup and restore for the Controller. To display the operation screen, click the **Controller Operation** tab.

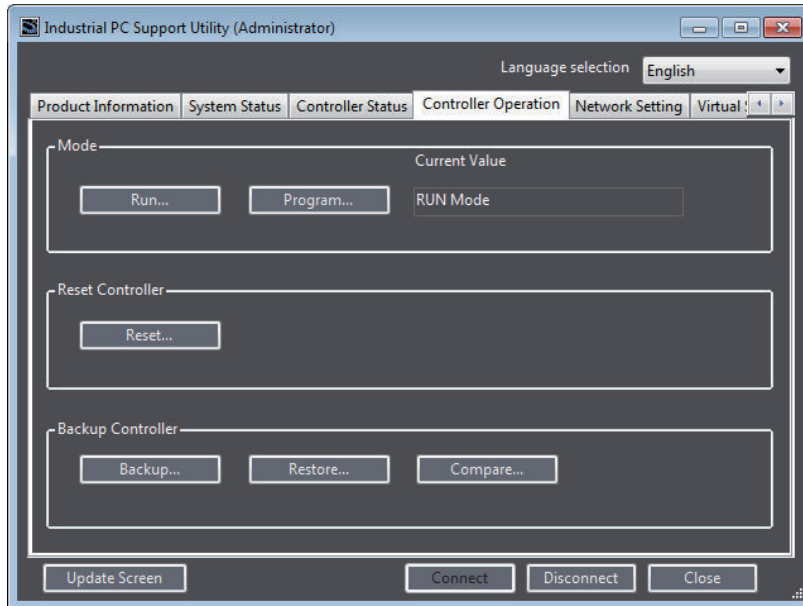

Item	Description	Displayed information
Mode	You can change the operating mode of the Controller. The present operating mode on the right.	RUN Mode, or PROGRAM Mode
Reset Controller	You can reset the Controller.	---
Backup Controller	You can back up and restore the Controller data, and compare the backed up data.	---

Refer to the *NY-series Industrial Panel PC / Industrial Box PC Software User's Manual (Cat. No. W558)* for details on the Controller operations.

## 4-6-1 Mode Change

You can change the Controller operating mode from RUN to PROGRAM mode or from PROGRAM to RUN mode. The procedure to change the operating mode is given below.

- 1 To change the operating mode from RUN to PROGRAM mode, click the **Program** button. A message box appears to confirm the change of the operating mode.

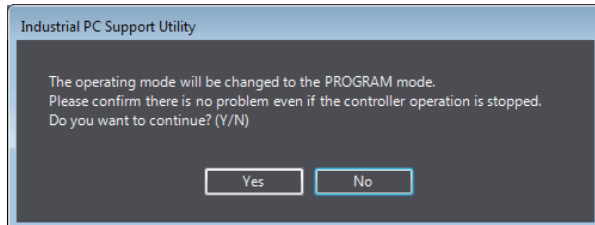

- 2 Confirm that no problem will occur even if you change the operating mode, and then click the **Yes** button. The Controller is changed to PROGRAM mode, and the **PROGRAM Mode** is displayed for the operating mode.

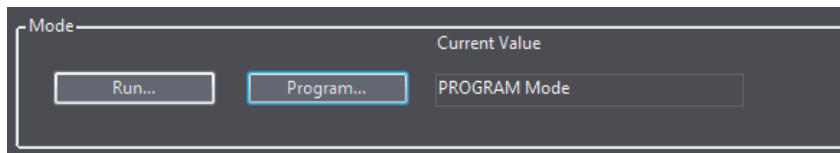

To change PROGRAM mode to RUN mode, click the **Run** button.

## 4-6-2 Resetting the Controller

When the Controller stops due to a major fault level Controller error, you can reset the Controller to restore from the error.

Always confirm the safety of the system before you reset the Controller.

The procedure to reset the Controller is given below.

### 1 Click the **Reset** button under **Reset Controller**.

The following dialog box is displayed if the Controller is in RUN mode.

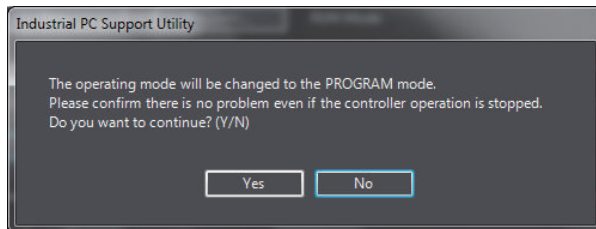

### 2 Confirm that no problem will occur even if you change the operating mode, and then click the **Yes** button.

A message box appears to confirm resetting the Controller.

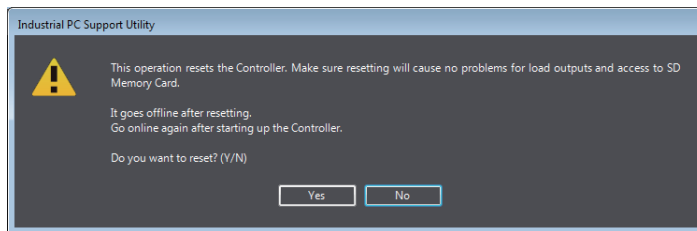

### 3 Confirm that no problem will occur even if you reset the Controller, and then click the **Yes** button. A message box appears again to confirm the resetting. Click the **Yes** button. When the Controller reset is completed, a completion message box is displayed.

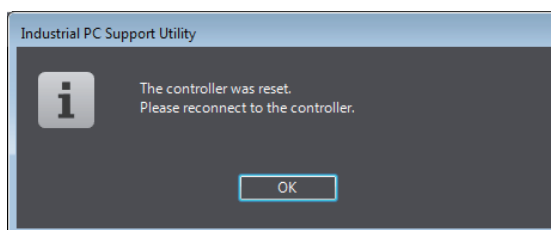

When you click the **OK** button, the **Network Connection** dialog box is displayed.

### 4 Enter the IP address again, and then click the **Connect** button.



#### Additional Information

When the Controller reset is executed, the Controller is restarted, and the connection between the Industrial PC Support Utility and the Controller is disconnected.

### 4-6-3 Controller Backup

You can back up the data from the Controller to a file, and compare or restore the contents of the backup file.

Refer to the *NY-series Industrial Panel PC / Industrial Box PC Software User's Manual (Cat. No. W558)* for details on the backup function and target data.



#### Additional Information

You can also back up the Controller from the Sysmac Studio. Refer to the *Sysmac Studio Version 1 Operation Manual (Cat. No. W504)* for details.

## Backup

The procedure is given below.

- 1 Click the **Backup** button under the **Backup Controller**.  
The **Browse For Folder** dialog box is displayed.

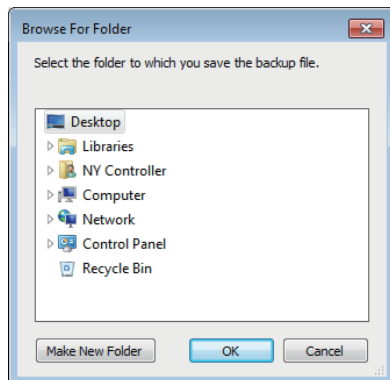

- 2** Select the folder in which to save the backup file and click the **OK** button.  
The **Backup** dialog box is displayed.

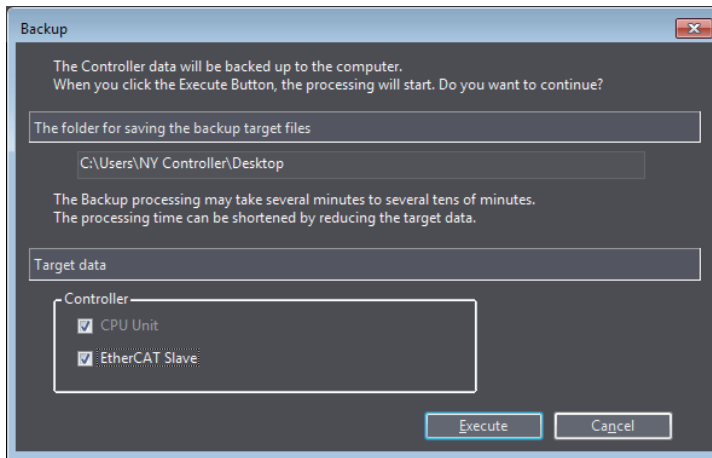

If there is already a backup file in the selected folder, a dialog box is displayed to confirm overwriting the backup file. Click the **Yes** button to overwrite. If you do not want to overwrite, click the **No** button to select another folder.

- 3** Select the check box for the target data to back up, and then click the **Execute** button.  
The backup is started. When the backup is completed, a message box is displayed.

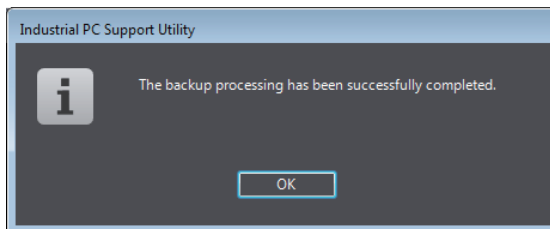

### Additional Information

The name of the backup file is always "NYBackup.dat". You cannot change the file name.

## Restoring

You can perform the restore operation only when the Controller is in PROGRAM mode.  
The procedure is given below.

- 1** Click the **Restore** button under the **Backup Controller**.  
The **Browse For Folder** dialog box is displayed.

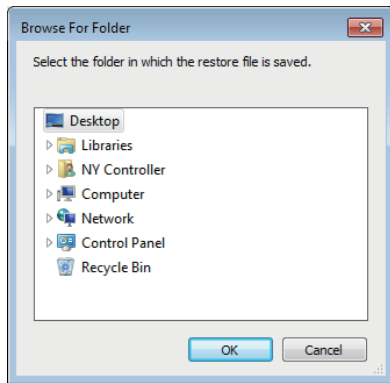

- 2** Select the folder that contains the backup file and click the **OK** button. The **Restore** dialog box is displayed.

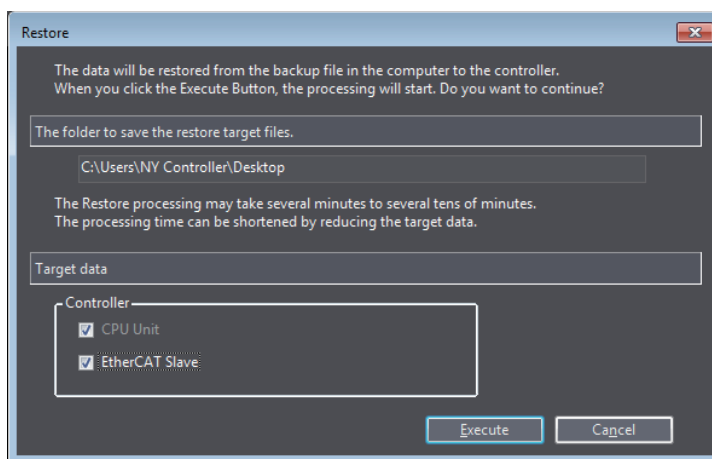

If there is no backup file in the selected folder, the following dialog box is displayed. Click the **OK** button to close the message box, and then select another folder.

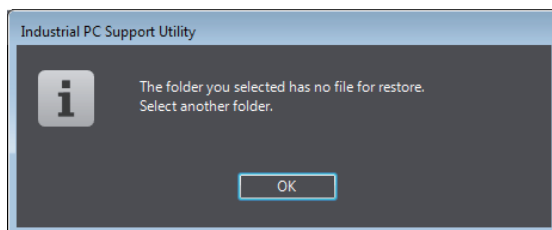

- 3** Select the check box for the target data to restore, and then click the **Execute** button. The following dialog box is displayed if the Controller is in RUN mode.

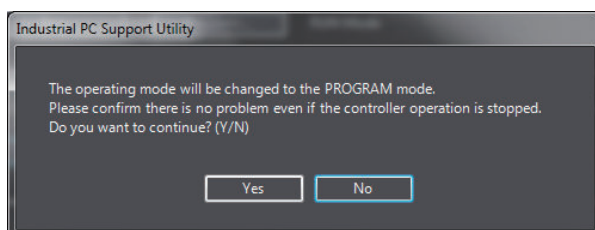

- 4** Confirm that no problem will occur even if you change the operating mode, and then click the **Yes** button. A message box appears to indicate the absolute encoder home offset that will be applied.

- 5** To start restoring the data, click the **Yes** button.  
The restore operation is started. When the restore operation is completed, a message box is displayed.

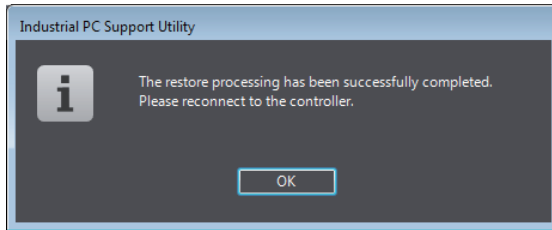

When you click the **OK** button, the **Network Connection** dialog box is displayed.

- 6** Enter the IP address again, and then click the **Connect** button.



### Additional Information

---

- If restoring the data results in changing the IP address of the EtherNet/IP port or internal port, communications may be disconnected. Confirm that the system will not be adversely affected even if the IP address is changed, before you restore the data.
  - You cannot cancel the operation once you started to restore the data.
-



## Comparing

The procedure is given below.

- 1 Click the **Compare** button under the **Backup Controller**.  
The **Browse For Folder** dialog box is displayed.

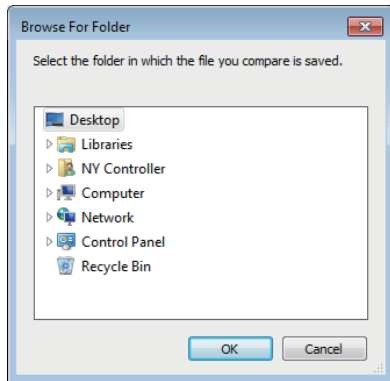

- 2 Select the folder that contains the backup file to compare and click the **OK** button.  
The **Compare** dialog box is displayed.

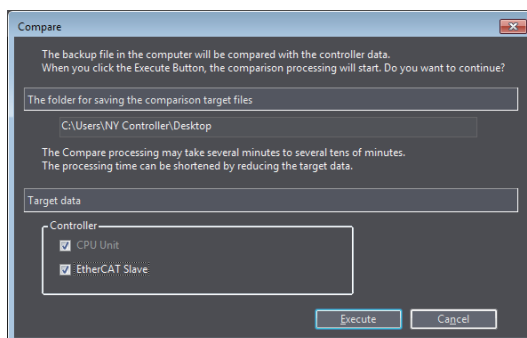

If there is no backup file in the selected folder, the following dialog box is displayed. Click the **OK** button to close the message box, and then select another folder.

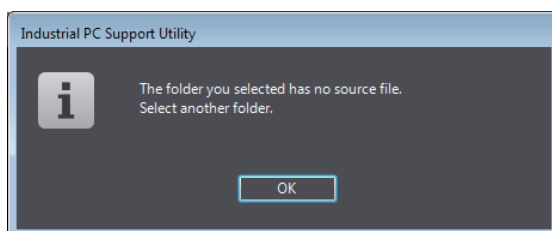

- 3 Select the check box for the target data to compare, and then click the **Execute** button.  
The comparison is started. When the comparison is completed, the comparison result is displayed in the dialog box.

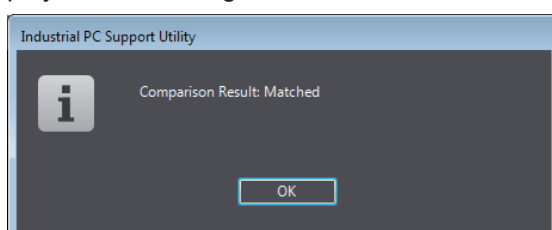

## 4-7 Network Settings for Controller Tab

You can change the network settings for the Controller, such as EtherNet/IP port settings and internal port settings, that were set on the Sysmac Studio. This function is convenient to change the network settings alone without using the Sysmac Studio after you transferred programs or the network settings from the Sysmac Studio to the Controller.

You can make the change only when the Controller is in PROGRAM mode.

To display the screen, click the **Network Settings** tab.

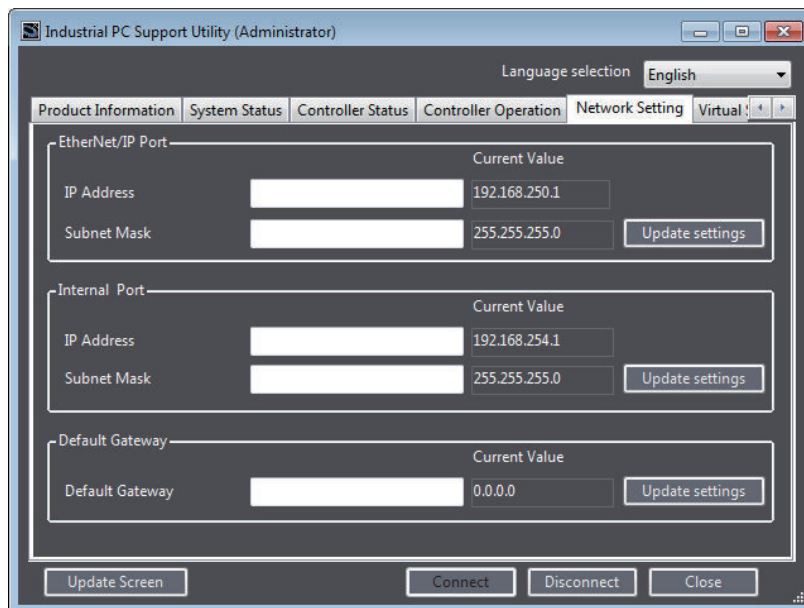

Item	Description	Set value	Initial value
EtherNet/IP port	Change the settings of the built-in EtherNet/IP port through which the Controller communicates with an external device of the Industrial PC.	---	---
IP Address* <sup>1</sup>	Enter the IP address to change to. The current IP address is displayed on the right of the entry box. If the IP address setting method is not the fixed setting, <b>Not fixed setting</b> is displayed and you cannot change this item.	Value as the address* <sup>2*3</sup>	Blank
Subnet Mask* <sup>1</sup>	Enter the subnet mask to change to. The current subnet mask is displayed on the right of the entry box. If the IP address setting method is not the fixed setting, <b>Not fixed setting</b> is displayed and you cannot change this item.	Subnet mask	Blank
Internal Port	Change the settings of the internal port through which the Controller communicates with Windows on the Industrial PC.	---	---
IP Address	Enter the IP address to change to. The current IP address is displayed on the right of the entry box.	Value as the address* <sup>2*3</sup>	Blank
Subnet Mask	Enter the subnet mask to change to. The current subnet mask is displayed on the right of the entry box.	Subnet mask	Blank

Item	Description	Set value	Initial value
Default Gateway	Enter the IP address of the default gateway to change to. This setting is not required when the default gateway is not used. The IP address of the current default gateway is displayed on the right of the entry box.	Value as the address <sup>*2*3</sup>	Blank
<b>Update settings</b> button	The values entered for the built-in EtherNet/IP port, internal port, and default gateway are reflected on the Controller.	---	---

- \*1. It can be entered only when the IP address setting method is "Fixed setting". You can change the IP address setting method on the Sysmac Studio.
- \*2. If the IP address is duplicated or not set correctly, communications are not possible via the built-in EtherNet/IP port or internal port.
- \*3. The IP address range shown below is used by the system and cannot be specified.  
 169.254.0.0 to 169.254.255.255  
 192.168.255.0 to 192.168.255.255  
 Due to Ethernet restrictions, you also cannot specify the IP addresses that are described below.  
 An IP address that is all 0s or all 1s  
 IP addresses that start with 127, 0, or 255 (decimal)  
 Class-D IP addresses (224.0.0.0 to 239.255.255.255)  
 Class-E IP addresses (240.0.0.0 to 255.255.255.255)

Refer to the *NY-series Industrial Panel PC / Industrial Box PC Built-in EtherNet/IP Port User's Manual (Cat. No. W563)* for details on each item.



#### Precautions for Correct Use

- Normally, you don't have to change the default internal port settings for the Controller. If you change the default settings, communication with the internal port for Windows may be disturbed or you may not be able to use the Virtual SD Memory Card. In this case, you must perform the internal port settings for Windows and the Virtual SD Memory Card settings again. Refer to *A-2 Changing the Internal Port Settings* on page A-3 for details on the precautions and methods for changing the internal port settings for the Controller.
- Set IP addresses in such a way that the built-in EtherNet/IP port and the internal port belong to different networks.

## Procedure to Change IP Addresses

---

The procedure to change an IP address is given below.

Before you change the address for the EtherNet/IP port, you must change the operating mode of the Controller to PROGRAM mode.

- 1 Enter the IP address and subnet mask for the target port to change, or the IP address of the default gateway, and click the **Update settings** button.

The IP address and subnet mask for the target port, or the IP address of the default gateway is reflected to the Controller. If there is an error for the entered IP address or subnet mask, the change is not reflected to the Controller, and an error message is displayed instead.

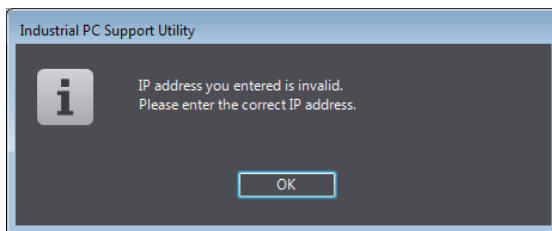

## 4-8 Virtual SD Memory Card Settings Tab

You can change the Virtual SD Memory Card settings for the Controller. The function is convenient to change the Virtual SD Memory Card settings alone without using the Sysmac Studio.

You can make the change only when the Controller is in PROGRAM mode.

To display the screen, click the **Virtual SD Memory Card Setting** tab.

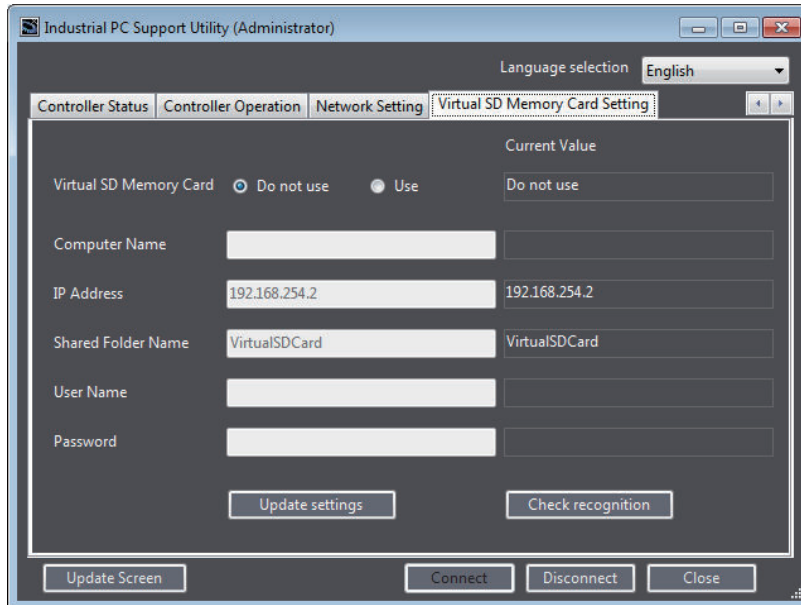

Item	Description	Set value	Initial value
Virtual SD Memory Card	Specify whether to use the Virtual SD Memory Card function or not. If you select <b>Do not use</b> , the Windows shared folder is not recognized as a Virtual SD Memory Card.	Use. Do not use.	Do not use.
Computer Name	Specify the Windows computer name.	Text string* <sup>1</sup>	Blank
IP Address	Specify the IP address of the Windows internal port.	IPv4* <sup>2</sup>	192.168.254.2
Shared Folder Name	Specify the Windows shared folder name used as a Virtual SD Memory Card.	Text string* <sup>3</sup>	VirtualSDCard
User Name	Specify a shared name of the user who uses the shared folder as a Virtual SD Memory Card. * <sup>4</sup>	Text string* <sup>5</sup>	Blank
Password	Set a password for the shared user who uses the shared folder.	Text string* <sup>6</sup>	Blank
<b>Update settings</b> button	The values that are input are reflected in the Controller.	---	---
<b>Check recognition</b> button	Check whether the Virtual SD Memory Card is recognized by the Controller.	---	---

\*1. Search in Windows for **PC name**. In System Settings **About** the Computer Name is available with the label **Device name**.

\*2. You cannot specify the following IP addresses.  
IP addresses that start with 127 (decimal)  
Class-D IP addresses (224.0.0.0 to 239.255.255.255)  
Class-E IP addresses (240.0.0.0 to 255.255.255.255)

\*3. Characters that you can use range from 0 to 9, A to Z, a to z, and a single-byte symbol (-). The number of characters is 1 to 32 (without NULL). Case insensitive.

- \*4. Enter <.domain name>\< user name> to specify a domain. You can omit specifying a domain name when users with the same name do not exist as a domain user and local user.
- \*5. Characters that you can use range from 0 to 9, A to Z, a to z, and single-byte symbols (`, !, #, \$, ^, &, (, ), \_, -, {, }, \, and '). The number of characters is 1 to 274 (without NULL). Case insensitive.
- \*6. Characters that you can use range from 0 to 9, A to Z, a to z, and single-byte symbols (`, !, @, #, \$, %, ^, &, \*, (, ), \_, -, +, =, {, }, [, ], \, |, ;, ; ", ' , <, >, ., ?, and /). The number of characters is 8 to 32 (without NULL). Case sensitive.

The current value set for the Controller is displayed on the right of each entry box.

### Procedure to Change Settings

---

The procedure to change the settings is given below.

- 1** Enter a set value to change to in each of the applicable entry boxes, and click the **Update settings** button.

The Virtual SD Memory Card settings for the Controller are updated.

## 4-9 Industrial PC Support Utility Details

This section describes relevant information that is not directly related to one of the Tabs.

### 4-9-1 Data Update Details

The function is used to monitor the system status and Controller status of the Industrial PC. It displays the system information of the Industrial PC and the status information of the Controller function.



#### Precautions for Correct Use

The Industrial PC Support Utility obtains and displays the system information of the Industrial PC as well as the status information of the Controller function. But it does not support continuous monitoring. To obtain information continuously, use the Industrial PC API and separately create an application that obtains required information. Also, to obtain more information than the Industrial PC Support Utility can obtain and display, you have to create an application as well.

### 4-9-2 Compatibility

This software utility can be used on an IPC with Windows 7 or higher.

### 4-9-3 Installation

The Industrial PC Support Utility is pre-installed on the Industrial PC if it comes with a Windows operating system installed.

Download the Industrial PC Support Utility from [the OMRON website](#) if reinstallation is required.



#### Additional Information

A new installation on a Windows 10 PC will require the installation of the .net Framework. The .net Framework software can be downloaded from a Microsoft website.

### 4-9-4 Startup

The Industrial PC Support Utility can be started from:

- Windows Start Menu  
Select **OMRON** and then **Industrial PC Support Utility**.
- Industrial PC Tray Utility
- Windows desktop shortcut



To connect the Controller the Network Connection dialog box appears.

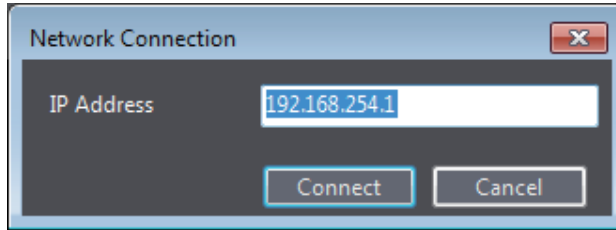

Enter the IP address of the internal port on the Controller, and click the **Connect** button. Refer to *A-2 Changing the Internal Port Settings* on page A-3 for details on the IP address of the internal port on the Controller.



#### Additional Information

If the operation authority verification is set for the Controller, from the Sysmac Studio, you must enter the operation authority level and password to start up. Refer to *4-9-7 Operation Authority Verification* on page 4-25 for details.

## 4-9-5 Messages

The Industrial PC Support Utility can use the Industrial PC Tray Utility to display following messages:

Message type	Message	Description
Warning	A normal shutdown was not performed. (Powerloss)	Power loss
Warning	A normal shutdown was not performed. (Watchdog)	Watchdog was active
Warning	A normal shutdown was not performed. (Forced)	A shutdown was forced
Warning	A normal shutdown was not performed. (CatastrophicTemperature)	Over temperature

## 4-9-6 Logging

There is logging in the Windows event log of the following utilities:

- Industrial Monitor Utility  
In the Windows Event Viewer filter for event source *IndMonService*.
- Industrial Monitor Brightness Utility  
In the Windows Event Viewer filter for event source *IndMonService*.
- Industrial PC Support Utility  
In the Windows Event Viewer filter for event source *IPCServiceHost* or *OMRON Industrial PC Support Utility*.



#### Additional Information

Refer to *A-4 Windows Event Viewer* on page A-5 for the logged messages.



## 4-9-7 Operation Authority Verification

The operation authority verification is the function to restrict the operations of the Industrial PC Support Utility according to the operation authority, and then to protect the user programs and data on the Controller.

The operation authority verification can be set for the Controller from the Sysmac Studio. Refer to the *Sysmac Studio Version 1 Operation Manual (Cat. No. W504)* for details on the function and setting method of the operation authority verification on the Sysmac Studio.

### ● Operation Authority Types and Operable Functions

Operable functions depend on the types of operation authorities.

Operable functions for each type of operation authorities are given below.

○: Allowed, ×: Not allowed

Function	Adminis- trator	Designer	Maintainer	Operator	Observer
Displaying the production information tab page	○	○	○	○	○
Displaying the system status tab page	○	○	○	○	○
Displaying the Controller status tab page	○	○	○	○	○
Getting a report log	○	○	○	×	×
Displaying the Controller Operation tab page	○	○	○	○	○
Changing the operating mode	○	○	○	×	×
Resetting the Controller	○	○	○	○	○
Backup, restore, and compare operations	○	○	○	×	×
Changing the network settings	○	○	○	×	×
Changing the Virtual SD Memory Card settings	○	○	○	×	×

## ● Operation Authority Verification at Startup

If the operation authority verification is set for the Controller from the Sysmac Studio, a dialog box is displayed to verify the operation authority when the Industrial PC Support Utility is started up. To continue the operation, you must select an operation authority and enter a password.

The procedure is given below.

- 1 Connect the Industrial PC Support Utility to the Controller.  
The **Verification** dialog box is displayed.

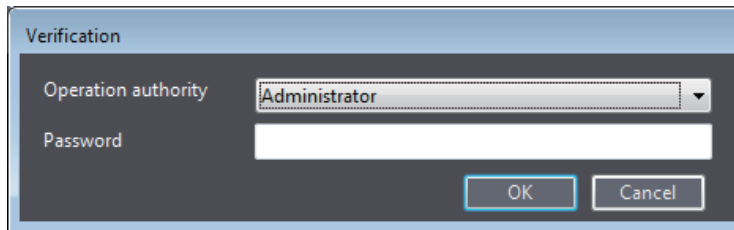

- 2 Select an applicable operation authority from the **Operation authority**, enter a correct password, and click the **OK** button.

When you pass the verification, the Industrial PC Support Utility dialog box is displayed. If the password is incorrect, the following error message is displayed. After that, you can operate only in the range allowed for "Observer".

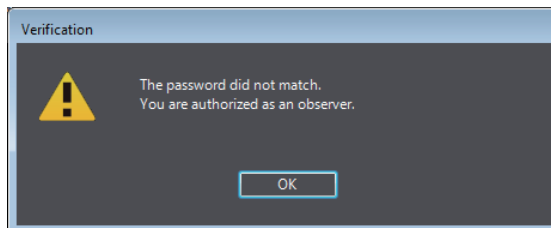

When you click the **Cancel** button on the **Verification** dialog box, the Industrial PC Support Utility starts up with the operation authority set for the "Operation authority when a password entry is omitted" on the Sysmac Studio.



### Additional Information

To change to another operation authority, click the **Disconnect** button to disconnect from the Controller once. When you reconnect, the **Verification** dialog box is displayed.

## ● Operation Lock

If you don't operate the Industrial PC Support Utility for a certain period, you can keep it locked to disable its operations. This function prevents users of different operation authorities from mistakenly performing operations.

When the Industrial PC Support Utility is in the locked state, the **Verification** dialog box is displayed. Enter the password to unlock.

You can enable operation locking and set the time to start locking from the Sysmac Studio. Refer to the *Sysmac Studio Version 1 Operation Manual (Cat. No. W504)* for details.

# 5

## NYCompolet

This section describes the NYCompolet which is a software component used to create applications for operating the Controller.

---

<b>5-1</b>	<b>Outline of NYCompolet .....</b>	<b>5-2</b>
<b>5-2</b>	<b>How to Use the NYCompolet.....</b>	<b>5-3</b>
<b>5-3</b>	<b>Communications Setup .....</b>	<b>5-4</b>
5-3-1	Communications Setup Procedure.....	5-4
5-3-2	Additional Functions to Communications Setup.....	5-5
<b>5-4</b>	<b>NYCompolet Interface.....</b>	<b>5-6</b>
5-4-1	Interface Members .....	5-6
5-4-2	Usage Method .....	5-7

## 5-1 Outline of NYCompolet

The NYCompolet is a software component with which you can create applications to read variables from the Controller and write them to the Controller.

With the NYCompolet, you can create an application to get data such as the OK product ratio that is collected by the Controller and another application to overwrite the recipe data, in the Controller, for the production line. As the communications protocol between Windows and Controller are already provided, there is no need to build a communications command.

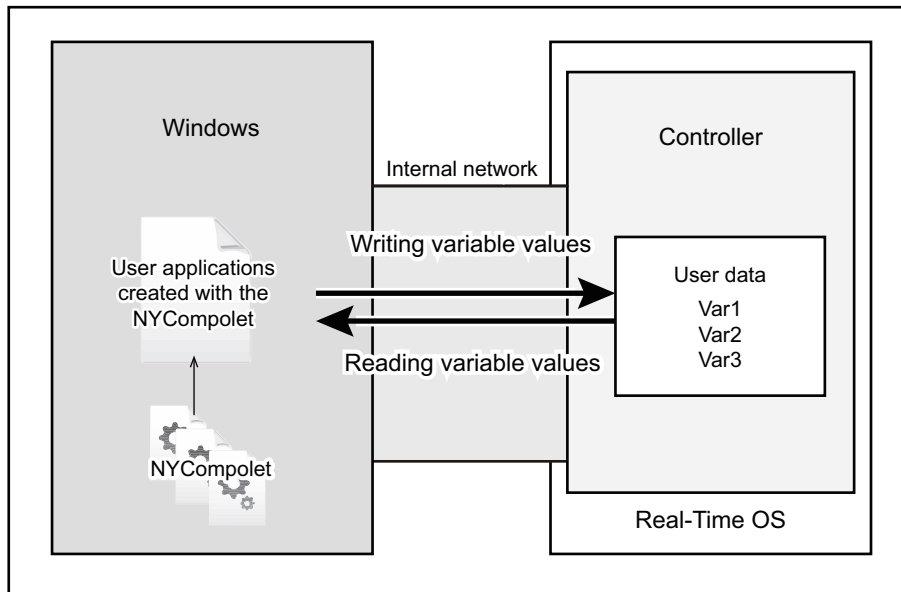

The NYCompolet is pre-installed in Windows of the Industrial PC. You can use it in development environment where Visual Basic or Visual C# is supported.

### Development Environment

The following development environment is required to create applications with the NYCompolet.

- **Integrated Development Environment**

Microsoft Visual Studio 2010, 2012, 2013, or 2015

- **Programming Languages**

- Visual Basic
- Visual C#

Created applications can operate in an environment where Microsoft NET Framework 4.0 or higher is installed.

## 5-2 How to Use the NYCompolet

---

This section gives the operating procedure of the NYCompolet.

- 1** Preparation  
Install the Microsoft Visual Studio to Windows of the Industrial PC.
- 2** Creating an Application  
On the Microsoft Visual Studio, create an application program in Visual Basic or Visual C#. Use a method or property of the NYCompolet in the program, when necessary for the purpose. Refer to *5-4 NYCompolet Interface* on page 5-6 for the method and property types.
- 3** Communications Setup  
Use the additional console function to make the required settings for the created application to communicate with the Controller. Refer to *5-3 Communications Setup* on page 5-4 for details.

## 5-3 Communications Setup

This section describes how to set up the communications between the Controller and the application that you created with the NYCompolet, as well as additional functions.

The SYSMAC Gateway Console is used to make the communications setup.

To start the SYSMAC Gateway Console, select **OMRON - SYSMAC Gateway - SYSMAC Gateway Console** from the Windows start menu.

### 5-3-1 Communications Setup Procedure

The communications setup procedures are given below.

- 1 Click the **Communication Network** tab on the left on the **SYSMAC Gateway Console** dialog box.

The **Communication Network** tab page is displayed.

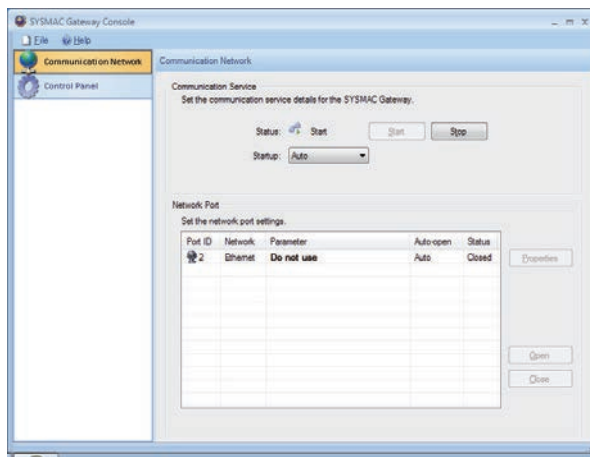

- 2 Click the **Start** button for the **Communications service**.  
The communications service starts to allow communications between the Controller and the application that you created with the NYCompolet. To start the communications service automatically at Windows startup, select **Automatic** from the **Startup** drop-down list.
- 3 Select the Port ID: 2 Network Port from the **Network Port** list, and click the **Open** button.  
The internal port on the Controller becomes open, and the communications between the application and the Controller start.

## 5-3-2 Additional Functions to Communications Setup

The **SYSMAC Gateway Console** is accompanied with the following additional functions.

Item	Description
Communication Test	You can confirm whether communications with the port selected on the <b>Communication Network</b> tag page is possible or not.
Tag Monitor	You can monitor or change variable values for the Controller.
Display Data Monitor	You can display the communications message log.

To display these items, click the **Control Panel** tab on the left on the **SYSMAC Gateway Console** dialog box.

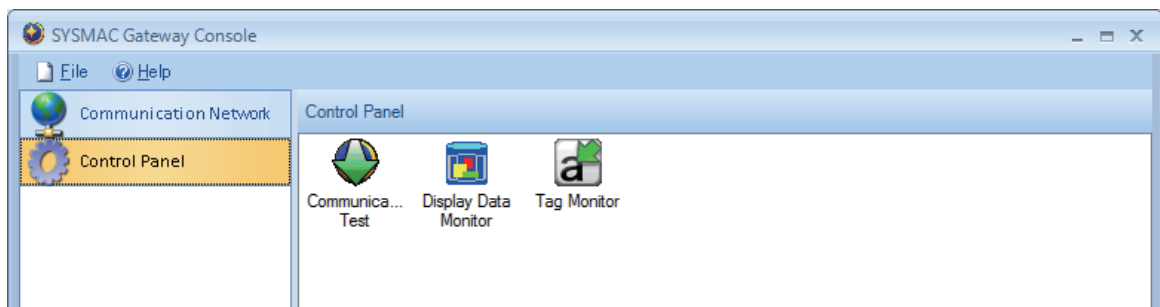

Refer to the help for the SYSMAC Gateway Console for details on each function. To display the help, select **OMRON - Industrial PC - SYSMAC Gateway Console - SYSMAC Gateway Console help** from the Windows start menu.

## 5-4 NYCompolet Interface

This section describes the NYCompolet interface members and the procedures to use them.

### 5-4-1 Interface Members

The NYCompolet interface is provided as the NYCompolet class that operates on the Microsoft NET Framework.

The NYCompolet class members are given below.

Refer to the NYCompolet help for details on each member.

To display the help, select **OMRON - Industrial PC - SYSMAC Gateway Console - NYCompolet help** from the Windows start menu.

### Properties

Name	Meaning
Active	The value that indicates whether it is currently active or not.
ReceiveTimeLimit	Time until connection timeout
PeerAddress	IP address for the Controller
LocalPort	Port ID of the network port for the Controller
IsConnected	Indicates whether it is connected to the Controller or not.
DontFragment	Indicates whether fragments are prohibited in Read or Write.
TypeName	Controller model
Clock	Clock time of the Controller
UnitName	Unit name of the Controller
RunMode	Controller operation Mode
RunStatus	Operating status of the Controller
VariableNames	List of user-defined variable names for the Controller
SystemVariableNames	List of system-defined variable names for the Controller
PLCEncoding	Text string encoding for the Controller variables

### Methods

Name	Meaning
ReadVariable	Reads the value of a variable.
ReadVariableMultiple	Read the values of multiple variables.
WriteVariable	Writes a value to a variable.
ReadRawData	Reads the binary data of a variable.
ReadRawDataMultiple	Reads the binary data of multiple variables.
WriteRawData	Writes a binary data to a variable.
GetVariableInfo	Reads the data type of a variable.



## 5-4-2 Usage Method

To use the NYCompolet members, you must declare the NYCompolet class in Visual Basic or Visual C#.

Refer to the manual or help for the Microsoft Visual Studio for the procedure to declare the class in Visual Basic or Visual C#.

Refer to the NYCompolet help for details on how to use each member of the NYCompolet.



# 6

## Software for Developers

This section provides information on the software that is available for developers.

---

<b>6-1</b>	<b>Overview of IPC Developer Software for Windows</b> .....	<b>6-2</b>
6-1-1	Development Environment.....	6-2
6-1-2	How to Use the Industrial PC API .....	6-3
<b>6-2</b>	<b>Industrial PC System API</b> .....	<b>6-4</b>
<b>6-3</b>	<b>Industrial Monitor API</b> .....	<b>6-5</b>
<b>6-4</b>	<b>Industrial PC Controller API</b> .....	<b>6-6</b>

# 6-1 Overview of IPC Developer Software for Windows

This section gives an overview of the software available for developers for all Industrial PC Platform products with a Windows operating system.

Availability of the developer software:

Product	Developer software
Industrial Monitor	Industrial Monitor SDK Industrial Monitor API
Industrial Box PC	Industrial PC System SDK Industrial PC System API Industrial PC Controller API
Industrial Panel PC	Industrial Monitor SDK Industrial Monitor API Industrial PC System SDK Industrial PC System API Industrial PC Controller API

Select and download the SDK software from [the OMRON website](#).

A short description of the developer software:

Type of API	Description	Reference
Industrial PC System API	Gets information on the Industrial PC, such as production information, temperature, and battery status.	<i>6-2 Industrial PC System API</i> on page 6-4
Industrial Monitor API	Controls the hardware features and gets information from connected Industrial Monitors.	<i>6-3 Industrial Monitor API</i> on page 6-5
Industrial PC Controller API	Gets the operating status of the Controller, and resets the Controller.	<i>6-4 Industrial PC Controller API</i> on page 6-6

## 6-1-1 Development Environment

The following development environment is required to create applications with the Industrial PC API.

### Integrated Development Environment

Microsoft Visual Studio 2010, 2012, or 2013

### Programming Languages

Visual C#

## 6-1-2 How to Use the Industrial PC API

This section gives the operating procedure of the Industrial PC API.

### 1 Preparation

Install the Microsoft Visual Studio to Windows of the Industrial PC.

### 2 Creating an Application

On the Microsoft Visual Studio, create an application program in Visual C#. Call a method or property of the Industrial PC API in the program, when necessary for the purpose.

Refer to the help information in the API for method and property details.

## 6-2 Industrial PC System API

---

This section describes some of the Industrial PC System API functions.

The Industrial PC System API allows programmers to create programs that can retrieve information or set an indicator status of the product.

The API makes use of the included OMRON IPC System Service to manage the hardware.

### Features

---

The Industrial PC System API can:

- Retrieve product information from the Industrial PC
- Retrieve system flags
- Retrieve maintenance information

### Installation

---

The Industrial PC System API is part of the Industrial PC System SDK download.

The Industrial PC System API is pre-installed on the Industrial Panel PC and the Industrial Box PC.

Install the Industrial PC System SDK to use the Industrial PC System API on development PCs.

To use the Industrial PC System API the API needs to be referenced in your development project.

Use the Merge Module to include the Industrial PC System API in the installer for custom applications.

## 6-3 Industrial Monitor API

---

This section describes some of the Industrial Monitor API functions.

The Industrial Monitor API allows programmers to create applications that can control the hardware features and retrieve information from connected Industrial Monitors.

The main function of the Industrial Monitor API is to enable the brightness of the backlight and the LEDs of the monitor to be increased or decreased according to the working environment.

The API makes use of the included OMRON Industrial Monitor Service to manage the hardware.

### Features

---

For all connected Industrial Monitors, the Industrial Monitor API can:

- Retrieve product information from the Industrial Monitor or Industrial Panel PC display
- Retrieve product status information
- Set the brightness of the Status LED indicator
- Set the brightness of the backlight
- Set the brightness of the Logo LED
- Set the touch points of the monitor
- Store settings
- Restore to factory defaults

The API makes use of the included OMRON Industrial Monitor Service to manage all Industrial Monitors connected via USB.

### Installation

---

The Industrial Monitor API is part of the Industrial Monitor SDK download.

The Industrial Monitor API is pre-installed on the Industrial Panel PC and Industrial Box PC.

Install the Industrial Monitor SDK to use the Industrial Monitor API on development PCs.

To use the Industrial Monitor API the API needs to be referenced in your development project.

Use the Merge Module to include the Industrial Monitor API in the installer for custom applications.

## 6-4 Industrial PC Controller API

---

This section describes some of the Industrial PC Controller API functions.

The Industrial PC Controller API allows programmers to create programs that can reset the Controller and retrieve the default gateway.

### Features

---

The Industrial PC Controller API can:

- Reset the Controller
- Retrieve and set the default gateway
- Retrieve and set an IP address and subnet mask of the specified port

### Installation

---

The Industrial PC Controller API is part of the SDK download.

The Industrial PC Controller API is pre-installed on the NY5□□-1□□□ Industrial Panel PC and the NY53□-5□□□ Industrial Box PC.

Install the Industrial PC Controller SDK to use the Industrial PC Controller API on development PCs. The Industrial PC Controller API (Omron.lpc.Controller.dll) is included in the installer for custom applications.

The API needs to be referenced in your development project to use the Industrial PC Controller API.



# 7

## Backup and Recovery

This section describes backup and recovery procedures for the Industrial PC system, and backup, restoration, and comparison procedures for the Controller.

You can use the Rescue Disk Utility for backing up and recovery.

---

<b>7-1</b>	<b>Create a Backup .....</b>	<b>7-2</b>
7-1-1	Backing Up, Restoring, and Comparing Controller Data .....	7-2
<b>7-2</b>	<b>Rescue Disk Creator and Utility .....</b>	<b>7-3</b>
7-2-1	Overview .....	7-3
7-2-2	Compatibility .....	7-4
7-2-3	Installation .....	7-5
7-2-4	Startup .....	7-6
7-2-5	Messages .....	7-6
<b>7-3</b>	<b>Create a System Backup with the Rescue Disk .....</b>	<b>7-10</b>
7-3-1	Create a New Rescue Disk with the Rescue Disk Creator .....	7-12
<b>7-4</b>	<b>Check the System Backup Information on the Rescue Disk .....</b>	<b>7-14</b>
<b>7-5</b>	<b>Restore a System Backup with the Rescue Disk .....</b>	<b>7-15</b>

## 7-1 Create a Backup

Create a backup of the Industrial PC in the state immediately after the Windows setup is completed. With that backup you can restore the Industrial PC to the state immediately after the Windows setup is completed. Use this backup when Windows or the Real-Time Operating System (Controller function) have irrecoverable problems.

Use the Rescue Disk Utility to backup both Windows and the Machine Controller.

Refer to *7-3 Create a System Backup with the Rescue Disk* on page 7-10 for details.

### 7-1-1 Backing Up, Restoring, and Comparing Controller Data

You can use the Controller function to back up all of the data on the settings and user programs in the Controller to a Virtual SD Memory Card or a computer, and restore or compare the backed up data.

Refer to the *NY-series Industrial Panel PC / Industrial Box PC Software User's Manual (Cat. No. W558)* for details on the Controller backup function.

You can back up, restore, and compare data in the Controller with the following procedures.

Type of function	Description	Reference
Industrial PC Support Utility backup function	Backs up the Controller data to Windows of the Industrial PC.	<i>4-6-3 Controller Backup</i> on page 4-13
Controller to SD Memory Card backup function	Backs up the Controller data to a Virtual SD Memory Card.	<i>NY-series Industrial Panel PC / Industrial Box PC Software User's Manual (Cat. No. W558)</i>
Sysmac Studio backup function	Backs up the Controller data to a computer on which the Sysmac Studio operates.	<i>Sysmac Studio Version 1 Operation Manual (Cat. No. W504)</i>

## 7-2 Rescue Disk Creator and Utility

This section provides an overview of the Rescue Disk software.

The **Rescue Disk Creator** is software that creates the Rescue Disk Utility on a USB storage device.

The **Rescue Disk Utility** is a tool used to back up and recover data of Windows and Real-Time OS (Controller function) of an Industrial PC. The Rescue Disk Utility creates image files of the storage device of an Industrial PC, and backs them up in a USB connected storage device.

When Windows or the Real-Time OS malfunctions you can recover the Industrial PC with the previously created image files of the back up.

### 7-2-1 Overview

The Rescue Disk Creator (RDC) creates a Rescue Disk.

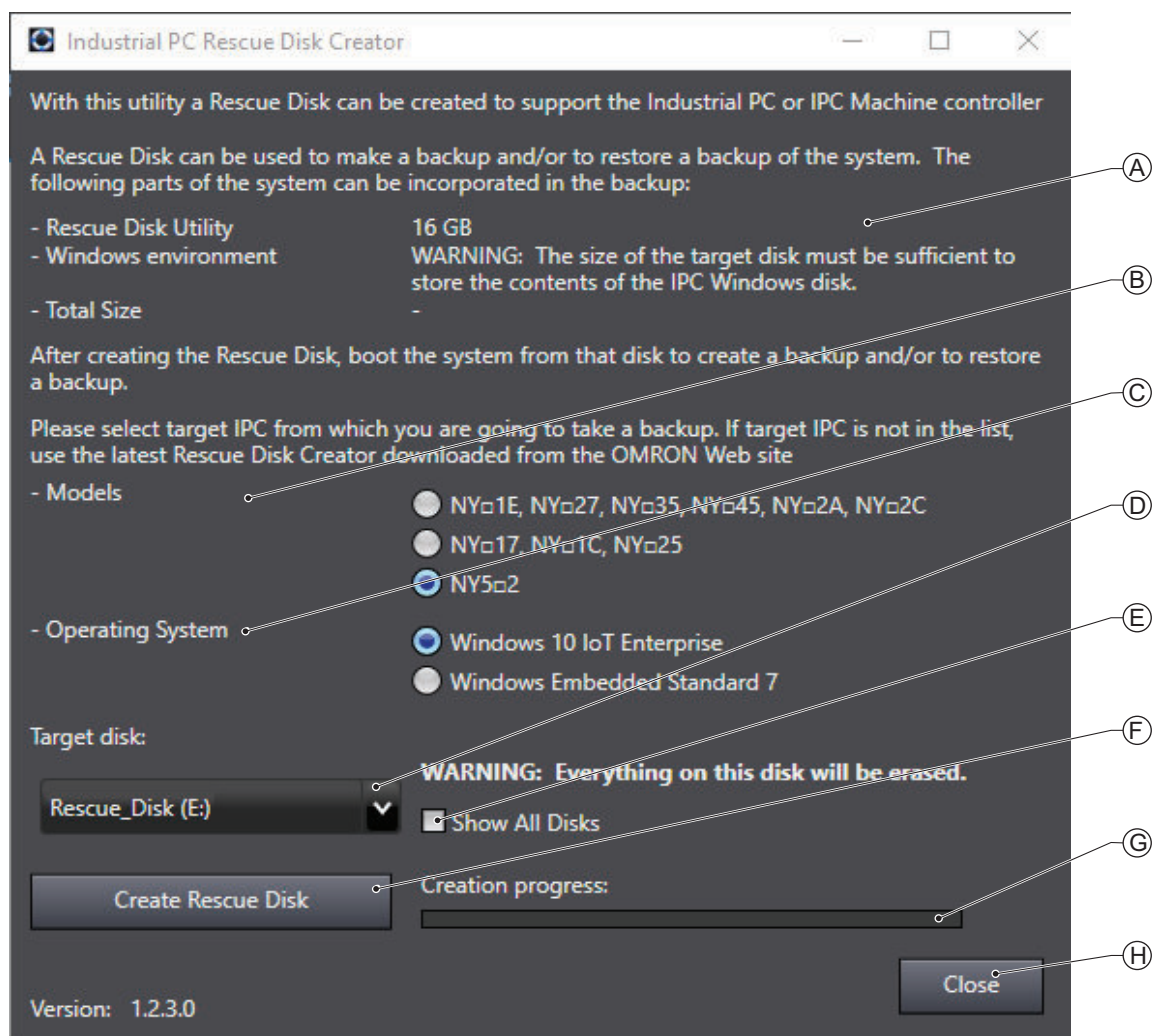

A Rescue Disk is a disk with the Rescue Disk Utility; this is the software that performs the system backup and system restore procedures.





### Version Information

Specifications and functionality can change between different versions of the Rescue Disk Creator Utility. This can result in changes in the content of the Utility window.

Major change in version (1.2.3.0) is the addition of Model selection  and Operating System selection .

Item	Description	Details
A	Explanation area	Information about the utility and the backup. In the right bottom corner messages are displayed when applicable.
B	Model selection	The RDC on an OMRON IPC displays the found model name without radio buttons. The RDC on other PCs displays the radio buttons for a selection by the user.
C	Operating System selection	The RDC on an OMRON IPC displays the found operating system without radio buttons. The RDC on other PCs displays the radio buttons for a selection by the user.
D	Target disk selection	Selection of the disk that will become the Rescue Disk.
E	Show All Disks	Check the box to display not only the removable storage devices but also the non-removable (internal) storage devices and USB Flash Drives and other USB storage devices.
F	Create Rescue Disk Button	Start the Rescue Disk creation.
G	Creation progress bar	Display the progress of the Rescue Disk creation.
H	Close Button	Close the Rescue Disk Creator.



### Additional Information

- Refer to 7-3 *Create a System Backup with the Rescue Disk* on page 7-10 for system backup details.
- Refer to 7-5 *Restore a System Backup with the Rescue Disk* on page 7-15 for system restore details.

## 7-2-2 Compatibility

### Compatibility with Operating Systems

This Rescue Disk software can be used on the IPC but also on any other PC with one of the following operating systems:

- Windows 10
- Windows 7

### Compatibility between controller versions

Use the created backup only for an IPC with the same unit version of the controller.

To find the software version of the controller refer to:

- *Checking Versions* on page 19  
or
- 4-2 *Product Information Tab* on page 4-3



### Precautions for Correct Use

The unit version of Industrial PCs that create the backup data with the Rescue Disk Utility and the unit version of Industrial PCs to be recovered must match. If the unit version does not match, the relevant Industrial PCs may not start after the recovery.

If you updated the unit version of Industrial PCs, always create the new backup data for Industrial PCs with the Rescue Disk Utility. Do not use the backup data that was created before updating to recover Industrial PCs for which the unit version was updated.

Compatibility related to **versions** of Rescue Disk software

Refer to **Control Panel - Programs and Features** for the version of Rescue Disk Creator.



### Precautions for Correct Use

Rescue Disk Creator version **1.0.830**

The data that was backed up with the Rescue Disk Utility installed with Rescue Disk Creator version 1.0.830 can be used only to recover the Industrial PC from which you backed up the data. You cannot use the data to recover other Industrial PCs.

Rescue Disk Creator version **1.1.1257 or higher**

The data that was backed up with the Rescue Disk Utility installed with Rescue Disk Creator version 1.1.1257 or higher can be recovered for an Industrial PC with the same unit version and an identical model-ID. Refer to *1-3 Product Configuration* on page 1-6 for details.



### Version Information

Rescue Disk Creator version **1.1.2004 or lower**

Supports Windows 7.

Rescue Disk Creator version **1.2.3.0178 or higher**

Supports Windows 7 and Windows 10.

## 7-2-3 Installation

The Rescue Disk Creator is preinstalled on the Industrial PC if it comes with a Windows operating system installed.

Use the following procedure to reinstall the Rescue Disk Creator:

- 1** Use Windows Explorer to open the Rescue Disk folder (C:\Program Files (x86)\OMRON\Industrial PC\Rescue Disk).
- 2** Activate the installer file **setup.exe**.  
A progress bar will visualize the extraction process and then a language selection window opens.
- 3** Select your language and then select **OK**.  
The installer window opens.
- 4** Follow the installer steps to complete the Rescue Disk Creator installation.

The Rescue Disk Creator is installed and available in the OMRON folder in the Windows Start Menu.

## 7-2-4 Startup

To manually start the Rescue Disk Creator:

- 1** Locate the Rescue Disk Creator using the Windows **Start** menu or the Windows search box.
- 2** Use the option **Run as administrator** to start the Rescue Disk Creator.



### Additional Information

The procedure to use **Run as administrator** is:

- For Windows 10 using the **Start** menu:  
Right-click the **Rescue Disk Creator**, select **More** and then **Run as administrator**.
- For Windows 10 using **Search**:  
Right-click the **Rescue Disk Creator** in the search results and select **Run as administrator**.
- For Windows 7 using the **Start** menu or **Search**:  
Right-click the **Rescue Disk Creator** and select **Run as administrator**.

- 3** Follow the on-screen instructions to complete the rescue disk.  
Use a USB storage device with a capacity of at least the Windows partition size + 16 GB. The recommended minimum read/write speed is 190 MB/s.



### Additional Information

Depending on the situation additional actions might be required:

- When the RDC is active on an IPC then the applicable **Models** and **Operating System**'are automatically displayed.  
When this information can not be retrieved the message **The IPC model is unknown, please use the latest Rescue Disk Creator downloaded from the OMRON Website**. appears. In that situation download and install the latest RDC from the OMRON website and restart this procedure.
- When the RDC is active on a PC then manually select the type of **Models** and **Operating System**'applicable to your system.

A Rescue Disk is created by the Rescue Disk Creator.

## 7-2-5 Messages

The Rescue Disk Creator creates a rescue disk in two steps:

1. Format the target disk
2. Copy the rescue disk image to the target disk

Messages can inform the user of an error when applicable.

Refer to *Error Messages Creating the Rescue Disk* on page 7-7 for details.

Use the rescue disk to create a backup or restore your disk.

Messages can inform the user of a backup or restore error when applicable.

Refer to *Messages Using the Rescue Disk* on page 7-8 for details.

## Error Messages Creating the Rescue Disk

The Rescue Disk Creator can display the following error messages:

Message	Description
<p>Creation progress: Failed to format the disk. Reason:</p> <ul style="list-style-type: none"> <li>• Access denied</li> <li>• Call canceled</li> <li>• Call cancellation request too late</li> <li>• Cluster size is beyond 32 bits</li> <li>• Cluster size is too large</li> <li>• Cluster size is too small</li> <li>• Incompatible media in drive</li> <li>• Invalid volume label</li> <li>• Input/Output (I/O) error</li> <li>• No media in drive</li> <li>• Unable to quick format</li> <li>• Unknown error</li> <li>• Unsupported file system</li> <li>• Volume lock failed</li> <li>• Volume is not mounted</li> <li>• Volume is too large</li> <li>• Volume is too small</li> <li>• Volume write protected</li> </ul>	<p>The mentioned reason prevented formatting of the connected storage device.</p> <p>Ensure the connected storage device:</p> <ul style="list-style-type: none"> <li>• Is not write protected or read-only</li> <li>• Has a cluster size too small or more than the maximum 32 bits</li> <li>• Has a valid volume label</li> <li>• Has sufficient storage capacity to store the rescue disk utility and a full system backup</li> </ul>
<p>Creation progress: Failed to copy image to rescue disk.</p> <p>Reason:</p> <ul style="list-style-type: none"> <li>• Unable to revoke access to the disk</li> <li>• Unable to revoke access to the drive</li> <li>• Disk write failed</li> <li>• Unable to dismount the drive</li> <li>• Invalid drive</li> <li>• Unable to obtain exclusive access to the drive</li> <li>• The disk could not be accessed</li> <li>• The drive could not be accessed</li> <li>• Unable to revoke exclusive access to the drive</li> </ul>	<p>The mentioned reason prevented copying the image to the connected storage device.</p> <p>Ensure the connected storage device:</p> <ul style="list-style-type: none"> <li>• Is not used by other programs</li> <li>• Is not write protected or read-only</li> </ul>

To solve an error:

1. Check that the correct target disk was selected.
2. Check that the target disk has sufficient storage capacity to store the rescue disk utility and a full system backup
3. If the storage device is removable, check that it is inserted properly and is of the correct type.
4. Check whether the storage device is write protected. SD Memory Cards often have a small mechanical write protection switch on them.
5. Check that the user has the necessary access rights for the target disk.
6. Check that the Rescue Disk Creator is running "As Administrator".
7. Check that no other applications are using the target disk.
8. Retry the operation with the same target disk.
9. Retry the operation with a different target disk.



10. Restart the IPC and then retry the operation.
11. If the issue persists, contact your OMRON representative.

## Messages Using the Rescue Disk

Using the Rescue Disk the rescue disk utility can display the following messages:

Error ID	Message
10	Backup creation of *1partition failed. Please try again or contact an Omron service representative if the problem persists
11	Restore action of *1partition failed. Please try again or contact an Omron service representative if the problem persists
12	Cannot allocate the partition for storing backup data. There may be a problem with the target USB device. Create the Rescue Disk utility on another USB device and try again
13	Cannot create a partition for storing backup data. There may be a problem with the target USB device. Create the Rescue Disk utility on another USB device and try again
14	The partition for storing backup data cannot be identified. There may be a problem with the target USB device. Create the Rescue Disk utility on another USB device and try again
15	The partition for storing backup data cannot be prepared for use. There may be a problem with the target USB device. Create the Rescue Disk utility on another USB device and try again
16	Unable to identify an Omron Industrial PC. Power cycle the system using the power connector, then try again
17	Unable to identify an Omron Industrial PC. Power cycle the system using the power connector, then try again
18	Backup creation of *1partition failed. Please try again or contact an Omron service representative if the problem persists
19	Restore action of *1partition failed. Please try again or contact an Omron service representative if the problem persists
20	Cannot mount the partition for storing backup data. There may be a problem with the target USB device. Create the Rescue Disk utility on another USB device and try again
21	Failed creating *1partition verification files. Please try again or contact an Omron service representative if the problem persists
22	Failed to verify *1partition backup files. Please try again or contact an Omron service representative if the problem persists
23	Cannot create a backup. An Omron NY-series Industrial PC has not been detected. Please contact an Omron service representative
24	Cannot restore the backup. An Omron NY-series Industrial PC has not been detected. Please contact an Omron service representative
25	Cannot find a destination device. Please ensure that there is an SSD or HDD inserted in the IPC
26	Cannot find the Rescue Disk medium. Please ensure the Rescue Disk USB device is connected to the Industrial PC, then restart the system and try again
27	Cannot mount Windows partition. Please ensure that you have a functional Windows system before creating a backup
28	Cannot restore. The backup of the system partition is corrupted
29	Cannot deploy OSB due to an invalid system partition. Please perform a restore operation of the complete MBR and system partition and try again
30	OSB deployment was unsuccessful. Please restart the Rescue Disk utility and try again
31	Multiple Rescue Disk media detected. Ensure there is only a single Rescue Disk USB device connected to the Industrial PC, then reboot the system and try again



Error ID	Message
32	Cannot create backup records data due to missing OSB data
33	Cannot create backup records due to missing NX data
34	Cannot create backup records due to a missing system partition
35	Cannot find a source device. Please ensure that there is an SSD or HDD inserted in the IPC
36	Multiple disks detected with the same partition layout. Please ensure there is only one SSD or HDD inserted in the IPC to restore the backup
37	Multiple source devices detected. To backup the correct disk, please ensure that there is only one SSD or HDD inserted in the IPC
42	Unable to identify any Windows disk. Please ensure that a Windows disk is inserted in the IPC
43	Multiple Windows disks detected. Please ensure that there is only one Windows disk inserted in the IPC
44	Can not find the Master Boot Record.
45	Self diagnostics tool could not be found.
46	Self diagnostics tool could not detect any disks.
47	This Rescue Disk Utility version is not compatible with this Industrial PC. Please make a new Rescue Disk Utility using the Rescue Disk Creator on your IPC. Refer to 7-2-2 <i>Compatibility</i> on page 7-4 for details.
48	This Rescue Disk Utility version is not compatible with this Industrial PC. Please make a new Rescue Disk Utility using the Rescue Disk Creator on your IPC. Refer to 7-2-2 <i>Compatibility</i> on page 7-4 for details.

\*1. The partition name will be indicated. Examples are 'System partition' or 'Master Boot Record'.

## 7-3 Create a System Backup with the Rescue Disk

A Rescue Disk is a disk with the Rescue Disk Utility; this is the software that performs the system backup and system restore procedures of the IPC.

A system backup contains the Windows partition, the system partition and the MBR.

A system backup can not include the User Data partition.



### Precautions for Correct Use

The backup data of the Rescue Disk can be used to recover the data of the IPC that created that backup. It can also restore data to another IPC if the product configuration is identical to the IPC that created the backup.



### Additional Information

To create a system backup a Rescue Disk should be available.

- Refer to *7-3-1 Create a New Rescue Disk with the Rescue Disk Creator* on page 7-12 for Rescue Disk creation.
- Refer to *Messages Using the Rescue Disk* on page 7-8 for Rescue Disk error messages.

To create a system backup:

- 1** Ensure the IPC is powered OFF.
- 2** Ensure a keyboard is connected to the IPC.
- 3** Connect the Rescue Disk to a USB connector of the IPC.
- 4** Power ON the IPC while pressing the **F11** key twice per second.  
The option to select your boot device will appear.

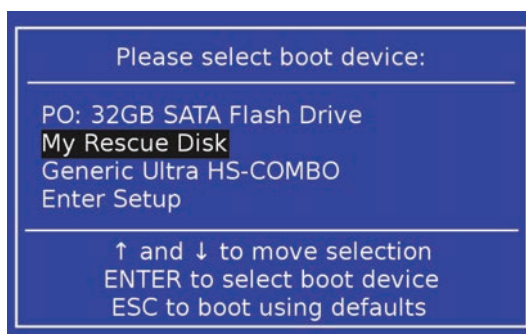

Your Rescue Disk will be displayed in this boot menu with the manufacturer data of your USB device.

If your boot device is not visible in this list:

- 1) Disconnect the USB connector of the Rescue Disk.
- 2) Re-insert the USB connector of the Rescue Disk.
- 3) Select **Ctrl, Alt** and **Delete** to reboot the IPC.

- 4) Press the **F11** key twice per second.  
The option to select your boot device will appear with your boot device in the list.

**5** Use the arrow keys to select the Rescue Disk and then select **Enter**.

The menu window opens.

The mentioned number can be different from the number displayed on your screen.

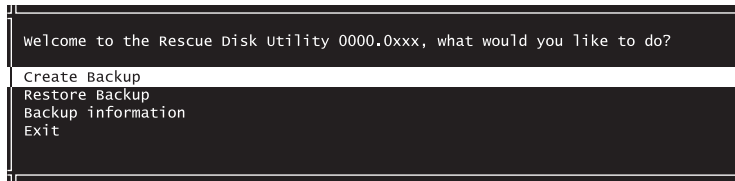

**6** Select **Create Backup**.

The backup confirmation window opens.

For:

- NY5□2-□□00-□□□1
- NY5□2-□□00-□□□2

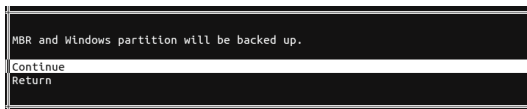

Windows 7

or For NY5□2-□□00-□□□4

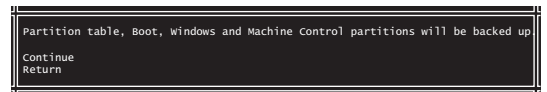

Windows 10

**7** Select **Continue** to start the system backup process.

Wait until the message **Backup finished** appears.

**8** The message **Would you like to enter an optional comment for the created backup?** gives the option to add an extra remark to the created backup.

Select **No** to exit without an optional comment.

Select **Yes** to add the optional comment. Add the comment and press [Enter] to finalize the backup creation.

**9** Select **OK** to return to the main menu.

**10** Select **Exit** to close the Rescue Disk Utility.

The IPC will power OFF.

**11** Remove the Rescue Disk and store it in a safe place.

A system backup is created on the Rescue Disk.



### Precautions for Correct Use

Create backups to prevent data loss and system integrity issues.



### Additional Information

Refer to *7-5 Restore a System Backup with the Rescue Disk* on page 7-15 for system restore details.

## 7-3-1 Create a New Rescue Disk with the Rescue Disk Creator

A Rescue Disk is a disk with the Rescue Disk Utility that enables users to create a system backup and to do a system restore.

A system backup contains the Windows partition, the system partition and the MBR.

Prepare:

- The Rescue Disk Creator

Refer to 7-2-3 *Installation* on page 7-5 for installation details.

Refer to *Error Messages Creating the Rescue Disk* on page 7-7 for message details.

- A USB storage device that has sufficient capacity to backup the content of the IPC. The capacity should be at least the Windows partition size + 16 GB. The recommended minimum read/write speed is 190 MB/s.

Note that all content on this USB storage device will be erased during the Rescue Disk creation.

Use the following procedure to create a new Rescue Disk:

- 1 Connect a USB storage device that has sufficient capacity to backup the content of the IPC.
- 2 Select the Windows **Start** Button.
- 3 In the search field, input *Rescue*.
- 4 Right-click **Rescue Disk Creator** and then select **Run as administrator**.  
The Rescue Disk Creator Utility window opens.

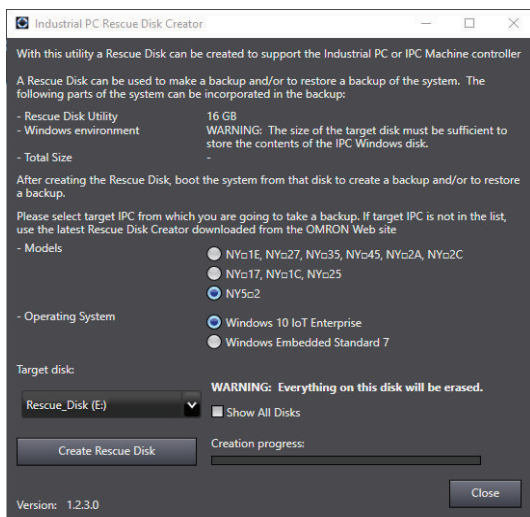

### Version Information

Specifications and functionality can change between different versions of the Rescue Disk Creator Utility. This can result in changes in the content of the Utility window.

- 5 Select the connected USB storage device at **Target disk**:  
Refer to 7-2-5 *Messages* on page 7-6 for message details if required.  
The button **Create Rescue Disk** will be enabled as soon as a USB storage device is detected and accepted.

- 6 Select the **Create Rescue Disk** button to start the creation process. Wait until the progress bar shows the Rescue Disk creation finished. Refer to *7-2-5 Messages* on page 7-6 for message details if required.

- 7 Select **Close** to close the Rescue Disk Creator.

The Rescue Disk is **available but it is still empty**, there is no system backup on the Rescue Disk. Next step is to create a system backup with this Rescue Disk.



#### Additional Information

---

- Refer to *7-3 Create a System Backup with the Rescue Disk* on page 7-10 for system backup details.
  - Refer to *7-5 Restore a System Backup with the Rescue Disk* on page 7-15 for system restore details.
-

## 7-4 Check the System Backup Information on the Rescue Disk

Use the following procedure to check the rescue disk for the system backup.

- 1 Use the rescue disk to boot the IPC.  
Refer to *7-5 Restore a System Backup with the Rescue Disk* on page 7-15 for details.  
Follow the first few steps of the procedure until following screen appears:

```
Welcome to the Rescue Disk Utility 0000.0xxx, what would you like to do?
Create Backup
Restore Backup
Backup information
Exit
```

- 2 Select **Backup information** and then **Enter**.  
Following screen will appear:

```
Backup created on Fri Dec 1 12:34:56
Model name      : NY512-1300
Serial number   : 0123
Lot number      : 01234N
Content         : MBR, Boot, windows and Machine Control partitions
Unit version    : V1.16.00
OSB version     : 0000.0016
Comment by user : demo for manual - your content will be different

Current System:
Model name      : NY
Serial number   : 0123
Lot number      : 01234N
Unit version    : V1.16.00
OSB version     : 0000.0016

OK
```

- 3 Check the content. If there is no content then there is no usable backup on this Rescue Disk.
- 4 Select **Exit**.

The rescue disk information is checked.

## 7-5 Restore a System Backup with the Rescue Disk

A Rescue Disk is a disk with the Rescue Disk Utility; this is the software that performs the backup and restore procedures.

Use the Rescue Disk to restore the system backup. This will restore the Windows partition, the system partition and the MBR to the moment the Rescue Disk backup was created.



### Precautions for Correct Use

The backup data of the Rescue Disk can be used to recover the data of the IPC that created that backup. It can also restore data to another IPC if the product configuration is identical to the IPC that created the backup.



### Additional Information

To restore a system backup, a Rescue Disk with a system backup should be available.

- Refer to *7-3-1 Create a New Rescue Disk with the Rescue Disk Creator* on page 7-12 for Rescue Disk creation details.
- Refer to *7-3 Create a System Backup with the Rescue Disk* on page 7-10 for system backup details.
- Refer to *Messages Using the Rescue Disk* on page 7-8 for Rescue Disk error messages.

To restore a system backup:

- 1 Ensure the IPC is powered OFF.
- 2 Ensure a keyboard is connected to the IPC.
- 3 Connect the Rescue Disk to a USB connector of the IPC.
- 4 Power ON the IPC while pressing the **F11** key twice per second. The option to select your boot device will appear.

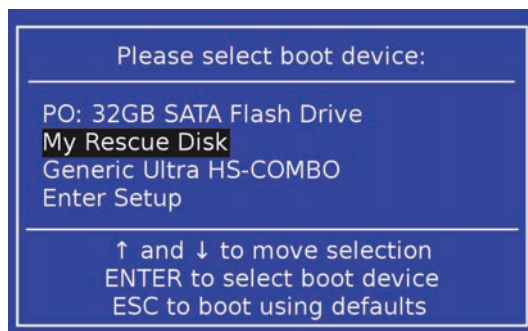

Your Rescue Disk will be displayed in this boot menu with the manufacturer data of your USB device.

If your boot device is not visible in this list:

- 1) Disconnect the USB connector of the Rescue Disk.
- 2) Re-insert the USB connector of the Rescue Disk.

- 3) Select **Ctrl**, **Alt** and **Delete** to reboot the IPC.
- 4) Press the **F11** key twice per second.  
The option to select your boot device will appear with your boot device in the list.

- 5** Use the arrow keys to select the Rescue Disk and then select **Enter**.  
The menu window opens.

```
welcome to the Rescue Disk utility 0000.0xxx, what would you like to do?
Create Backup
Restore Backup
Backup Information
Exit
```

The mentioned number in the first line can be different from the number displayed on your screen.

- 6** Select **Restore Backup**.  
The restore selection window opens.

For:

- NY5□2-□□00-□□□1
- NY5□2-□□00-□□□2

```
Select the restore option:
MBR
MBR and Boot Partition
MBR and Windows Partition
MBR, Boot and Machine Control Partitions
MBR, Boot, Windows and Machine Control Partitions
Return
```

Windows 7

or

For NY5□2-□□00-□□□4

```
Select the restore option:
Partition table and Boot partition
Partition table, Boot and windows partitions
Partition table, Boot and Machine Control partitions
Partition table, Boot, windows and Machine Control partitions
Return
```

Windows 10

- 7** Make your selection to restore the system.  
The overwrite confirmation window opens.

```
The target device will be overwritten. Would you like to continue?
Yes
No
```

- 8** Select **Yes** to start the system restore process.  
Wait until the message **Restore finished** appears.

- 9** Select **OK** to return to the main menu.

- 10** Select **Exit** to close the Rescue Disk Utility.  
The IPC will power OFF.

- 11** Remove the Rescue Disk and store it in a safe place.  
The system backup of the IPC is restored.



#### Additional Information

- Refer to 7-3-1 *Create a New Rescue Disk with the Rescue Disk Creator* on page 7-12 for Rescue Disk creation details.
- Refer to 7-3 *Create a System Backup with the Rescue Disk* on page 7-10 for system backup details.





# Troubleshooting during Setup

---

This section describes the typical errors that may occur during setup and the procedure for troubleshooting.

---

<b>8-1</b>	<b>Starting in Safe Mode.....</b>	<b>8-2</b>
------------	-----------------------------------	------------

## 8-1 Starting in Safe Mode

---

In Safe mode, the Controller is started up in PROGRAM mode. The mode is used when the Sysmac Studio or the Industrial PC Support Utility cannot connect to the Controller and the Controller operating mode cannot be changed.

Use the following procedure for starting in Safe mode.

- 1** Pull out the power connector from the Industrial PC.
- 2** Press and hold the power button and connect the power connector.
- 3** Continue to hold down the power button for 10 seconds.  
The PWR LED lights, and the BIOS startup view is displayed on the Monitor. Then, start the Controller and Windows in the same order as Normal mode. In this case, the Controller is started in PROGRAM mode.



# Appendices

This section describes methods for updating the Industrial PC and for changing the internal port settings, and other supplemental information for the body of this manual.

---

<b>A-1</b>	<b>Updating</b> .....	<b>A-2</b>
A-1-1	Updating Windows Software .....	A-2
<b>A-2</b>	<b>Changing the Internal Port Settings</b> .....	<b>A-3</b>
<b>A-3</b>	<b>Changing Windows File Sharing Setting</b> .....	<b>A-4</b>
A-3-1	Procedure to Change .....	A-4
A-3-2	Cautions When Using Virtual SD Memory Card.....	A-4
<b>A-4</b>	<b>Windows Event Viewer</b> .....	<b>A-5</b>
<b>A-5</b>	<b>Software Specifications</b> .....	<b>A-7</b>
A-5-1	Available Windows Operating Systems.....	A-7
A-5-2	Supported Languages .....	A-7
<b>A-6</b>	<b>Customize Windows</b> .....	<b>A-8</b>
A-6-1	Enhanced Write Filter .....	A-8
A-6-2	File-Based Write Filter .....	A-9
A-6-3	Unified Write Filter .....	A-11

# A-1 Updating

---

This section describes the Industrial PC software update.

## A-1-1 Updating Windows Software

Always keep software installed on Windows at the latest released version to ensure stable operation. Especially, make sure that the following software stays up-to-date.

- Anti-virus software
- Firewall software
- Internet browser
- Windows security patches
- OMRON software



### **Precautions for Correct Use**

---

After an OS update or a peripheral device driver update for the Industrial PC is executed, the PC behavior might be different. Confirm that operation is correct before you start actual operation.

---

## A-2 Changing the Internal Port Settings

Communications between the Controller and Windows are enabled in the default setting for the internal ports on the Controller and Windows.

Normally, you do not have to change the internal port setting. However, you may need to change the initial IP address (192.168.254.\*/24) in the following case.

- An IP address on an external network connected to the Industrial PC is the same as a network address in the internal network.

This section explains the method and precautions for changing the internal port settings for the Controller and Windows.

When you change the internal port setting for the Controller, you must also change the internal port setting for Windows to ensure communications between the Controller and Windows.

The procedure to change the settings is given below.

### 1 Changing Internal Port Setting for Controller

Change the IP address of the internal port for the Controller so that it does not overlap with a network address used on an external network.

Use the Industrial PC Support Utility or Sysmac Studio to change the internal port setting for the Controller.

Refer to *4-7 Network Settings for Controller Tab* on page 4-18 or the *Sysmac Studio Version 1 Operation Manual (Cat. No. W504)* for details on the changing method.

### 2 Changing Internal Port Setting for Windows

Change the IP address of the internal port for Windows so that it is the same as the new network address of the internal port for the Controller.

To change the internal port setting for Windows, change the setting of a virtual network adapter. Refer to *3-1 Internal Port Settings* on page 3-2 for details on virtual network adapters.

### 3 Changing Virtual SD Memory Card Settings

When a Virtual SD Memory Card is used, the IP address setting for the Virtual SD Memory Card is updated with the new IP address of the internal port for Windows. Use the Industrial PC Support Utility or Sysmac Studio to change the Virtual SD Memory Card settings.

Refer to *4-8 Virtual SD Memory Card Settings Tab* on page 4-21 or the *Sysmac Studio Version 1 Operation Manual (Cat. No. W504)* for details on the changing method.



#### Additional Information

When the IP address of the internal port for the Controller is changed, the connection with the Industrial PC Support Utility is disconnected. In the Network Connection dialog box of the Industrial PC Support Utility, enter the new IP address of the internal port to establish the connection again.

## A-3 Changing Windows File Sharing Setting

In the factory setting, Windows file sharing is enabled only between Windows and Controllers. To share files on external networks to the Industrial PC, change the setting of the network adapter to use.

### A-3-1 Procedure to Change

In the properties dialog box of the external network to use, select the network adapter, and select the *File and Printer Sharing for Microsoft Networks* check box.

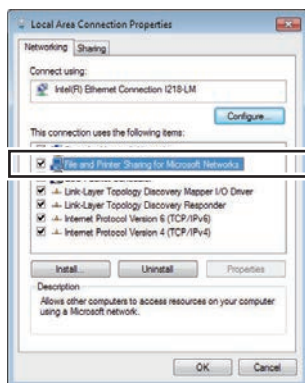

### A-3-2 Cautions When Using Virtual SD Memory Card

When file sharing on an external network is enabled, the shared folder which is used by the Controller as a Virtual SD Memory Card is also published on the external network. The shared folder used as a Virtual SD Memory Card is set to be shared with **Everyone** by default. **Everyone** means there is no limit on access from external networks. To prevent unauthorized access to the Virtual SD Memory Card from terminals on external networks, perform proper management of the settings and accounts for terminals that are given access to the file.

For example, you can delete **Everyone** from the sharing settings for the shared folder used as a Virtual SD Memory Card, and register only accounts created with *Create a User Account in Windows 7* on page 3-3 for Controllers.

# A-4 Windows Event Viewer

The Windows Event Viewer displays logged events. These logged events can support you in corrective maintenance.

- 1 Select the Windows **Start** Button.
- 2 In the search field, input *Event*.
- 3 Select **View event logs**.  
The Event Viewer opens.

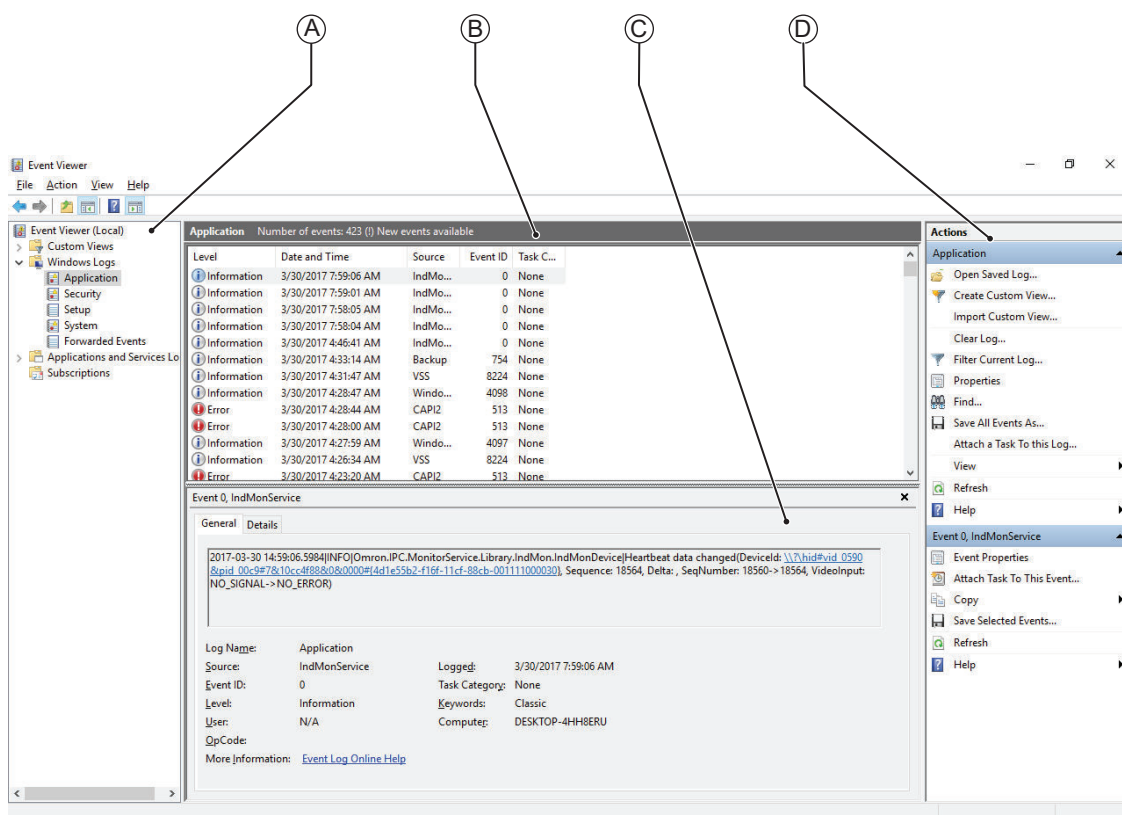

A-4 Windows Event Viewer

A

Item	
A	Selection tree
B	Event list
C	Event details
D	Action list

- 4 In the Selection tree expand **Windows Logs** and select **Application**.  
The Event list will display the Events.
- 5 Select the heading **Source** to sort the event messages per application.
- 6 Scroll to the event you want to investigate.  
Refer to the section 'Logging' of a specific utility for more details.

- 7** Select the event to display details in the Event details window or to take action in the Action overview window.



## A-5 Software Specifications

This section provides software specifications.

### A-5-1 Available Windows Operating Systems

The CPU type determines what Windows Operating Systems are available.

The CPU type is part of the model-ID.

Refer to *1-3 Product Configuration* on page 1-6 for model-ID details.

Model-ID	Windows Operating System	Windows Edition	Remark
<ul style="list-style-type: none"> <li>NY512 -1□□□</li> <li>NY532 -1□00</li> </ul>	Windows 10	Windows 10 IoT Enterprise 2019 LTSC - 64 bit	The Long-term Servicing Channel of Windows is primarily for specialized devices. The LTSC of Windows excludes most of the bundled applications, including Microsoft Edge. Note: In the software the name LTSC might still be displayed.
<ul style="list-style-type: none"> <li>NY512 -1□□□</li> <li>NY532 -1□00</li> <li>NY532 -5400</li> </ul>	Windows 7	<ul style="list-style-type: none"> <li>Windows Embedded Standard 7 SP1 - 32 bit</li> <li>Windows Embedded Standard 7 SP1 - 64 bit</li> </ul>	The Long-term Service Branch of Windows is primarily for specialized devices. The LTSB of Windows excludes most of the bundled applications, including Microsoft Edge.

### A-5-2 Supported Languages

Languages default supported by the operating system are:

Operating System	Languages							
	EN	CN*1	DE	ES	FR	IT	JA	KO
Windows 10	✓	✓	✓	✓	✓	✓	✓	✓
Windows 7	✓	✓	✓	✓	✓	✓	✓	

\*1. CN Simplified (ZH-CN) and CN Traditional (ZH-TW)



#### Additional Information

Refer to the Microsoft support information for details on available language packs.

## A-6 Customize Windows

This section provides an overview of the tools to customize Windows.

### A-6-1 Enhanced Write Filter

The Enhanced Write Filter (EWF) is applicable to IPCs with a Windows 7 operating system. The Enhanced Write Filter (EWF) intercepts disk changes and stores them into a memory overlay in RAM memory instead of applying them to the original volume.



#### Additional Information

- File-Based Write Filter (FBWF) provides a similar function, but operates at the file level, while EWF operates at the sector level.
- Refer to [the Microsoft Developer Network \(MSDN\)](#) for detailed information.

### Advantages

EWF and FBWF and UWF provide the following benefits:

- Write-protect one or more partitions on a system.
- Make it possible to revert changes and revert to the original disk content.
- Enable booting from read-only media.

By redirecting all write requests to RAM the run-time maintains the appearance of a writable run-time image.

- Improve the file system performance when using relatively slow storage.
- Minimize write actions to the disk.

For example, minimize write access to flash memory. Write cycles on flash memory are limited for technical reasons.

### Usage

EWF is included in the Windows Embedded Standard 7 image and disabled by default. The configuration of this component can be defined with the command line tool `EWFMGR.EXE`.

To run to EWF Manager, open the Command Prompt with Administrator rights.

Command	Function	Remarks
<code>ewfmgr</code>	Shows an overview with current status.	---
<code>ewfmgr c: -enable</code>	Enables the write filter for the drive C:.	The protection is not effective until the system is restarted.
<code>ewfmgr c: -commit</code>	Writes all the changes in the memory overlay to the physical disk during the next restart.	Committing the overlay can affect the speed of the boot process.
<code>ewfmgr c: -commitanddisable</code>	Writes all the changes in the memory overlay to the physical disk during the next restart, and disables the disk protection.	Committing the overlay can affect the speed of the boot process. The protection is not disabled until the system is restarted.

Command	Function	Remarks
<code>ewfmgr c: -commitanddisable -live</code>	Writes all the changes in the memory overlay to the physical disk immediately, and disables the disk protection.	Protection is also disabled immediately. No restart is required.
<code>ewfmgr c: -disable</code>	Disables the disk protection.	The protection is not disabled until the system is restarted.
<code>ewfmgr /h</code>	Displays a helpscreen that explains all commands and options available.	A complete reference can also be found at <a href="#">the Microsoft Developer Network (MSDN)</a> .

## Considerations

Using the EWF the following issues need careful consideration:

- EWF and FBWF cannot be used simultaneously.
- To prevent data loss in the event of a power failure, the use of a UPS is recommended.
- When the EWF function is enabled and a large amount of data is written, the system memory space will be reduced and operation may become unstable. To prevent this problem, it is recommended that a large amount of data be written to a different location.
- Automatic Adjustment of daylight saving time (DST) is incompatible with the Enhanced Write Filter (EWF).



### Additional Information

Refer to [the Microsoft Developer Network \(MSDN\)](#) for DST details.

## A-6-2 File-Based Write Filter

The File-Based Write Filter (FBWF) is applicable to IPCs with a Windows 7 operating system.

The File-Based Write Filter (FBWF) intercepts file changes and stores them into a memory overlay in RAM memory instead of applying them to the original volume.

When FBWF is enabled, all files and folders of a partition are protected unless they are included in an exception list.



### Additional Information

- Enhanced Write Filter (EWF) provides a similar function, but operates at the sector level, while FBWF operates at the file level. FBWF is more flexible in its configuration than EWF and allows immediate writing without rebooting.
- Refer to [the Microsoft Developer Network \(MSDN\)](#) for detailed information.

## Advantages

EWF and FBWF and UWF provide the following benefits:

- Write-protect one or more partitions on a system.
- Make it possible to revert changes and revert to the original disk content.
- Enable booting from read-only media.

By redirecting all write requests to RAM the run-time maintains the appearance of a writable run-time image.

- Improve the file system performance when using relatively slow storage.
- Minimize write actions to the disk.  
For example, minimize write access to flash memory. Write cycles on flash memory are limited for technical reasons.

## Usage

FBWF is included in the Windows Embedded Standard 7 image and disabled by default. The configuration of this component can be defined with the command line tool `FBWFMGR.EXE`.

To run to FBWF Manager, open the Command Prompt with Administrator rights.

Command	Function	Remarks
<code>fbwfmgr</code>	Shows an overview with current status.	---
<code>fbwfmgr /displayconfig</code>	Shows current configuration.	---
<code>fbwfmgr /enable</code>	Enables the write filter.	The protection is not effective until the system is restarted.
<code>fbwfmgr /addvolume c:</code>	Adds a volume to the protected volume list.	That volume will be protected after the next restart.
<code>fbwfmgr /commit c: \Test.txt</code>	Writes the changes to the protected file/folder.	---
<code>fbwfmgr /addexclusion C: \Test.txt</code>	Adds a write-through path to the exclusion list (file/folder).	The exclusion is active after the next restart.
<code>fbwfmgr /removeexclusion C: \Test.txt</code>	Removes the write-through path from the exclusion list (file/folder).	The exclusion is removed after the next restart.
<code>fbwfmgr /h</code>	Displays a helpscreen that explains all commands and options available.	A complete reference can also be found at <a href="#">the Microsoft Developer Network (MSDN)</a> .



### Additional Information

When specifying a file name, notice the space between drive name (c:) and file path (\Test.txt).

## Considerations

Using the FBWF the following issues need careful consideration:

- EWF and FBWF cannot be used simultaneously.
- FBWF can only protect formatted volumes. Do not move files between protected and unprotected volumes.
- When the FBWF function is enabled and a large amount of data is written, the system memory space will be reduced and operation may become unstable. To prevent this problem, it is recommended that a large amount of data be written to a different location.
- FBWF supports only NTFS and FAT32 file systems.
- Automatic Adjustment of daylight saving time (DST) is incompatible with the File-Based Write Filter (FBWF).



### Additional Information

Refer to [the Microsoft Developer Network \(MSDN\)](#) for DST details.

## A-6-3 Unified Write Filter

The Unified Write Filter (UWF) is applicable to IPCs with a Windows 10 operating system. The UWF intercepts disk changes and stores them into a memory overlay in RAM memory instead of applying them to the original volume.



### Additional Information

- Refer to *Advantages* on page A-8 for details.
- Refer to *Considerations* on page A-11 for details.
- Refer to [the Microsoft Developer Network \(MSDN\)](#) for details.

## Advantages

EWf and FBWF and UWF provide the following benefits:

- Write-protect one or more partitions on a system.
- Make it possible to revert changes and revert to the original disk content.
- Enable booting from read-only media.

By redirecting all write requests to RAM the run-time maintains the appearance of a writable run-time image.

- Improve the file system performance when using relatively slow storage.
- Minimize write actions to the disk.

For example, minimize write access to flash memory. Write cycles on flash memory are limited for technical reasons.

## Considerations

When using the Unified Write Filter (UWF) all disk changes are stored into a memory overlay in RAM memory instead of applying them to the original volume. This also applies to the installation of software or changing parameters. For software changes, like Windows updates or system parameter changes, it is required to disable the UWF, install the software and then enable the UWF again.

Using the UWF the following issues need careful consideration:

- To prevent data loss in the event of a power failure, the use of a UPS is recommended.
- When the UWF function is enabled and a large amount of data is written, the system memory space will be reduced and operation may become unstable. To prevent this problem, it is recommended that a large amount of data be written to a different location.
- Automatic Adjustment of daylight saving time (DST) is incompatible with the UWF enabled.

## Configuration

The Unified Write Filter (UWF) is included in the Windows 10 image.

The UWF is default disabled for an Industrial PC.

The configuration of this component can be defined with the command line tool `uwfmgr .EXE`.

To run the UWF Manager, open the Command Prompt with Administrator rights.

Command	Function	Remarks
<code>uwfmgr.exe get-config</code>	Shows an overview with current status	Use this command to check the status after another command is executed
<code>uwfmgr.exe filter</code>	Configures basic UWF settings	- - -
<code>uwfmgr.exe enable</code>	Enables the unified write filter	This change is not effective until the system is restarted
<code>uwfmgr.exe disable</code>	Disables the unified write filter	This change is not effective until the system is restarted
<code>uwfmgr.exe volume protect C:</code>	Enables the unified write filter for the C: drive	- - -
<code>uwfmgr.exe file commit C:\temp\test1.txt</code>	Issues a commit for a new file with the name C:\temp\test1.txt	Committing the overlay can affect the speed of the boot process
<code>uwfmgr.exe help</code>	Displays a helpscreen that explains all commands and options available	A complete reference can also be found at <a href="#">the Microsoft Developer Network (MSDN)</a>



# Index



# Index

- A**
- Account settings..... 2-5
  - Anti-virus software ..... 2-5
- B**
- Backup..... 4-13, 7-2, 7-3
  - Browser ..... 2-4
- C**
- Configuration ..... 1-6
  - Controller operation..... 4-10
  - Controller Status..... 4-6
- E**
- Enhanced Write Filter (EWF) ..... A-8
  - Event viewer..... A-5
  - Exiting..... 2-7, 2-8
- F**
- File-Based Write Filter (FBWF) ..... A-9
  - Firewall ..... 2-5
- I**
- Industrial Monitor Brightness Utility ..... 2-19
  - Industrial Monitor Utility ..... 2-12
  - Industrial PC..... 1-2
  - Industrial PC API..... 1-10, 1-11
  - Industrial PC Controller API..... 6-6
  - Industrial PC Support Utility ..... 4-2
    - Controller operation ..... 4-10
    - Controller status ..... 4-6
    - Network settings ..... 4-18
    - Product information ..... 4-3
    - System status ..... 4-4
    - Virtual SD memory card settings ..... 4-21
  - Industrial PC Tray Utility ..... 2-22
  - Internal network..... 1-3
  - Internal port..... 1-3, 1-9, 3-2, A-3
- L**
- Languages ..... A-7
  - Logging
    - Event viewer ..... A-5
    - Messages ..... 2-18, 2-21, 4-24
- M**
- Model-ID ..... 1-6
- N**
- Network settings..... 4-18
  - Normal mode..... 2-7
  - NYCompolet..... 1-10, 5-2
- O**
- Operating modes..... 2-7
  - Operating system ..... A-7
  - Operation authority verification..... 4-25
  - Operation lock..... 4-26
- P**
- Product ..... 1-6
  - Production information..... 19
- R**
- Real-Time OS..... 1-2, 1-3
  - Rescue Disk Creator
    - Installation ..... 7-5
  - Rescue Disk Utility ..... 7-3
  - Rescue Disk ..... 7-12
    - Backup ..... 7-10
    - Restore ..... 7-15
  - Reset Controller..... 4-12
  - Restore..... 4-14, 7-3
- S**
- Safe mode..... 8-2
  - Shared folder..... 1-3, 1-9, 3-3, 3-12
  - Shutdown..... 2-8
  - Starting..... 2-7
  - SYSMAC Gateway Console..... 5-4
  - System API ..... 6-4
- U**
- Unified Write Filter (UWF) ..... A-11
  - Update..... A-2
  - UPS..... 1-9, 2-10
- V**
- Versions..... 19
  - Virtual SD Memory Card..... 3-3, 3-13
  - Virtual SD Memory Card settings..... 4-21
- W**
- Windows setup..... 2-2
  - Windows
    - Customize ..... A-8





**OMRON Corporation** Industrial Automation Company  
Kyoto, JAPAN

Contact: [www.ia.omron.com](http://www.ia.omron.com)

**Regional Headquarters**

**OMRON EUROPE B.V.**

Wegalaan 67-69, 2132 JD Hoofddorp  
The Netherlands  
Tel: (31)2356-81-300/Fax: (31)2356-81-388

**OMRON ELECTRONICS LLC**

2895 Greenspoint Parkway, Suite 200  
Hoffman Estates, IL 60169 U.S.A.  
Tel: (1) 847-843-7900/Fax: (1) 847-843-7787

**OMRON ASIA PACIFIC PTE. LTD.**

No. 438A Alexandra Road # 05-05/08 (Lobby 2),  
Alexandra Technopark,  
Singapore 119967  
Tel: (65) 6835-3011/Fax: (65) 6835-2711

**OMRON (CHINA) CO., LTD.**

Room 2211, Bank of China Tower,  
200 Yin Cheng Zhong Road,  
PuDong New Area, Shanghai, 200120, China  
Tel: (86) 21-5037-2222/Fax: (86) 21-5037-2200

Authorized Distributor:

© OMRON Corporation 2016-2021 All Rights Reserved.  
In the interest of product improvement,  
specifications are subject to change without notice.

Cat. No. W568-E2-05

0321