

Industrial PC Platform

NY-series

Troubleshooting Manual

NY532-1500

NY532-1400

NY532-1300

NY532-5400

NY512-1500

NY512-1400

NY512-1300

NOTE

1. All rights reserved. No part of this publication may be reproduced, stored in a retrieval system, or transmitted, in any form, or by any means, mechanical, electronic, photocopying, recording, or otherwise, without the prior written permission of OMRON.
2. No patent liability is assumed with respect to the use of the information contained herein. Moreover, because OMRON is constantly striving to improve its high-quality products, the information contained in this manual is subject to change without notice.
3. Every precaution has been taken in the preparation of this manual. Nevertheless, OMRON assumes no responsibility for errors or omissions. Neither is any liability assumed for damages resulting from the use of the information contained in this publication.

Trademarks

- Sysmac and SYSMAC are trademarks or registered trademarks of OMRON Corporation in Japan and other countries for OMRON factory automation products.
- Microsoft, Windows, Excel, and Visual Basic are either registered trademarks or trademarks of Microsoft Corporation in the United States and other countries.
- EtherCAT® is registered trademark and patented technology, licensed by Beckhoff Automation GmbH, Germany.
- ODVA, CIP, CompoNet, DeviceNet, and EtherNet/IP are trademarks of ODVA.
- The SD and SDHC logos are trademarks of SD-3C, LLC. 
- Intel and Intel Core are trademarks of Intel Corporation in the U.S. and / or other countries.

Other company names and product names in this document are the trademarks or registered trademarks of their respective companies.

Copyrights

- Microsoft product screen shots used with permission from Microsoft.
- This product incorporates certain third party software. The license and copyright information associated with this software is available at http://www.fa.omron.co.jp/nj_info_e/.

Introduction

Thank you for purchasing an NY-series IPC Machine Controller Industrial Panel PC / Industrial Box PC.

This manual provides a collective term of Industrial Panel PC and Industrial Box PC which are applicable products as the NY-series Industrial PC. This manual also provides the range of devices that are directly controlled by the Controller functions embedded the Real-Time OS in the NY-series Industrial PC as the Controller.

This manual contains information that is necessary to use the NY-series Controller. Please read this manual and make sure you understand the functionality and performance of the NY-series Controller before you attempt to use it in a control system.

Keep this manual in a safe place where it will be available for reference during operation.

Intended Audience

This manual is intended for the following personnel, who must also have knowledge of electrical systems (an electrical engineer or the equivalent).

- Personnel in charge of introducing FA systems.
- Personnel in charge of designing FA systems.
- Personnel in charge of installing and maintaining FA systems.
- Personnel in charge of managing FA systems and facilities.

For programming, this manual is intended for personnel who understand the programming language specifications in international standard IEC 61131-3 or Japanese standard JIS B 3503.

Applicable Products

This manual covers the following products.

- NY-series IPC Machine Controller Industrial Panel PC
 - NY532-15□□
 - NY532-14□□
 - NY532-13□□
 - NY532-5400
- NY-series IPC Machine Controller Industrial Box PC
 - NY512-15□□
 - NY512-14□□
 - NY512-13□□

Part of the specifications and restrictions for the Industrial PC are given in other manuals. Refer to *Relevant Manuals* on page 2 and *Related Manuals* on page 22.

Relevant Manuals

The following table provides the relevant manuals for the NY-series Controller. Read all of the manuals that are relevant to your system configuration and application before you use the NY-series Controller. Most operations are performed from the Sysmac Studio Automation Software. Refer to the *Sysmac Studio Version 1 Operation Manual (Cat. No. W504)* for information on the Sysmac Studio.

Purpose of use	Manual									
	Basic information				NY-series Instructions Reference Manual	NY-series IPC Machine Controller Industrial Panel PC / Industrial Box PC Motion Control User's Manual	NY-series Motion Control Instructions Reference Manual	NY-series IPC Machine Controller Industrial Panel PC / Industrial Box PC Built-in EtherNet/IP Port User's Manual	NY-series IPC Machine Controller Industrial Panel PC / Industrial Box PC Built-in EtherCAT Port User's Manual	NJ/NY-series NC Integrated Controller User's Manual
	NY-series IPC Machine Controller Industrial Panel PC Hardware User's Manual	NY-series IPC Machine Controller Industrial Box PC Hardware User's Manual	NY-series IPC Machine Controller Industrial Panel PC / Industrial Box PC Setup User's Manual	NY-series IPC Machine Controller Industrial Panel PC / Industrial Box PC Software User's Manual						
Introduction to NY-series Panel PCs	○									
Introduction to NY-series Box PCs		○								
Setting devices and hardware	○	○								
Using motion control						○				
Using EtherCAT								○		
Using EtherNet/IP								○		
Making setup*1										
Making the initial settings			○							
Preparing to use Controllers										
Software settings										
Using motion control							○			
Using EtherCAT								○		
Using EtherNet/IP				○					○	
Using numerical control										○
Writing the user program										
Using motion control							○	○		
Using EtherCAT								○		
Using EtherNet/IP				○					○	
Using numerical control					○					○
Programming error processing										○

Purpose of use	Manual									
	Basic information				NY-series Industrial Panel PC / Industrial Box PC Software User's Manual	NY-series IPC Machine Controller Industrial Panel PC / Industrial Box PC Motion Control User's Manual	NY-series Motion Control Instructions Reference Manual	NY-series IPC Machine Controller Industrial Panel PC / Industrial Box PC Built-in EtherCAT Port User's Manual	NY-series NC Integrated Controller User's Manual	NY-series Troubleshooting Manual
	NY-series IPC Machine Controller Industrial Panel PC Hardware User's Manual	NY-series IPC Machine Controller Industrial Box PC Hardware User's Manual	NY-series IPC Machine Controller Industrial Panel PC / Industrial Box PC Setup User's Manual	NY-series IPC Machine Controller Industrial Panel PC / Industrial Box PC Software User's Manual						
Testing operation and debugging				○				○		
Using motion control					○					
Using EtherCAT							○			
Using EtherNet/IP								○		
Using numerical control									○	
Learning about error management and corrections*2									△	○
Maintenance										
Using motion control	○	○					○			
Using EtherCAT								○		
Using EtherNet/IP									○	

*1. Refer to the *NY-series Industrial Panel PC / Industrial Box PC Setup User's Manual (Cat. No. W568)* for how to set up and how to use the utilities on Windows.

*2. Refer to the *NY-series Troubleshooting Manual (Cat. No. W564)* for the error management concepts and the error items. However, refer to the manuals that are indicated with triangles for details on errors corresponding to the products with the manuals that are indicated with triangles.

Manual Structure

Page Structure

The following page structure is used in this manual.

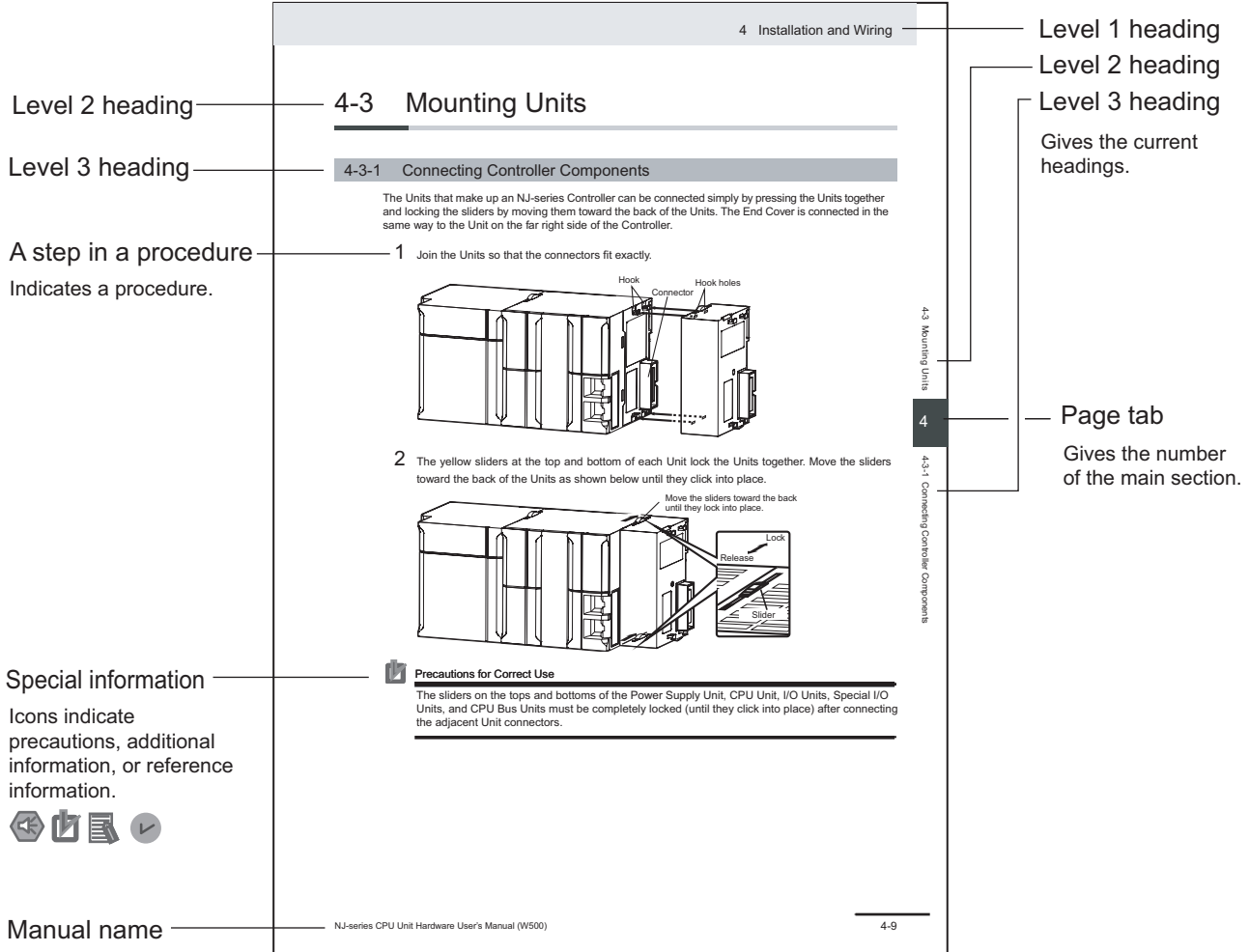

This illustration is provided only as a sample. It may not literally appear in this manual.

Special Information

Special information in this manual is classified as follows:



Precautions for Safe Use

Precautions on what to do and what not to do to ensure safe usage of the product.



Precautions for Correct Use

Precautions on what to do and what not to do to ensure proper operation and performance.



Additional Information

Additional information to read as required.

This information is provided to increase understanding or make operation easier.



Version Information

Information on differences in specifications and functionality for Controller with different unit versions and for different versions of the Sysmac Studio is given.

Precaution on Terminology

In this manual, "download" refers to transferring data from the Sysmac Studio to the physical Controller and "upload" refers to transferring data from the physical Controller to the Sysmac Studio. For the Sysmac Studio, "synchronization" is used to both "upload" and "download" data. Here, "synchronize" means to automatically compare the data for the Sysmac Studio on the computer with the data in the physical Controller and transfer the data in the direction that is specified by the user.

Sections in this Manual

1	Overview of Errors	1
2	Error Troubleshooting Methods	2
3	Error Descriptions and Corrections	3
A	Appendix	A
I	Index	I

CONTENTS

Introduction	1
Intended Audience	1
Applicable Products	1
Relevant Manuals	2
Manual Structure	4
Page Structure	4
Special Information	5
Precaution on Terminology	5
Sections in this Manual	7
Terms and Conditions Agreement	11
Warranty, Limitations of Liability	11
Application Considerations	12
Disclaimers	12
Safety Precautions	14
Precautions for Safe Use	15
Precautions for Correct Use	16
Regulations and Standards	17
Versions	18
Checking Versions	18
Unit Versions of Controllers and Sysmac Studio Versions	21
Related Manuals	22
Revision History	26

Section 1 Overview of Errors

1-1 Overview of NY-series Errors	1-2
1-1-1 Types of Errors	1-4
1-1-2 NY-series Industrial PC Status	1-5
1-2 Fatal Errors	1-7
1-2-1 Types of Fatal Errors	1-7
1-2-2 Checking for Fatal Errors	1-7
1-3 Non-fatal Errors	1-8
1-3-1 Types of Non-fatal Errors	1-8
1-3-2 Checking for Non-fatal Errors	1-19
1-3-3 Resetting Non-fatal Errors	1-23
1-3-4 Errors Related to the Motion Control Function Module	1-25
1-3-5 Errors Related to the EtherNet/IP Function Module	1-29
1-3-6 Errors Related to the EtherCAT Master Function Module	1-31

Section 2 Error Troubleshooting Methods

2-1	Troubleshooting Flowcharts	2-2
2-1-1	Flowchart to Check Operation of NY-series Controller.....	2-2
2-1-2	Flowchart to Check Error Status on EtherNet/IP Function Module.....	2-3
2-2	Troubleshooting Fatal Errors	2-4
2-3	Troubleshooting Non-fatal Errors	2-6
2-3-1	Identifying and Resetting Errors with the Sysmac Studio	2-6
2-3-2	Identifying and Resetting Errors with an HMI	2-11
2-3-3	Identifying and Resetting Errors from the User Program	2-14
2-3-4	Checking for Errors with System-defined Variables	2-15
2-4	Troubleshooting When You Cannot Go Online from the Sysmac Studio	2-17
2-4-1	Causes and Correction When You Cannot Go Online from the Sysmac Studio.....	2-17
2-4-2	Troubleshooting for Each Cause.....	2-17

Section 3 Error Descriptions and Corrections

3-1	Interpreting Tables	3-2
3-1-1	Interpreting Error Table	3-3
3-1-2	Interpreting Error Descriptions	3-4
3-2	Errors in the PLC Function Module	3-5
3-2-1	Error Tables.....	3-5
3-2-2	Error Descriptions	3-59
3-2-3	Other Troubles and Corrections	3-271
3-3	Errors in the Motion Control Function Module	3-273
3-3-1	Error Tables.....	3-273
3-3-2	Error Descriptions	3-311
3-3-3	Other Troubles and Corrections	3-446
3-4	Errors in the EtherNet/IP Function Module	3-451
3-4-1	Error Tables.....	3-451
3-4-2	Error Descriptions	3-456
3-4-3	Other Troubles and Corrections	3-483
3-5	Errors in the EtherCAT Master Function Module	3-484
3-5-1	Error Tables.....	3-484
3-5-2	Error Descriptions	3-491

Appendix

A-1	Other Errors (Events) That Can Occur in the CPU Units	A-2
A-1-1	Errors in the CNC Function	A-2
A-2	Errors (Events) That Can Occur in Connected Devices	A-23
A-2-1	Errors in Slave Terminals	A-23
A-2-2	Errors in EtherCAT Slaves	A-79
A-3	Events in Order of Event Codes	A-127
A-3-1	Interpreting Error Descriptions	A-127
A-3-2	Events in Order of Event Codes.....	A-128
A-4	Applicable Range of the HMI Troubleshooter	A-174
A-4-1	HMIs on which Troubleshooter Can Be Used	A-174
A-4-2	System Configuration Elements Supported by the Troubleshooter	A-175
A-5	Checking Errors with Windows	A-176
A-5-1	Industrial PC Support Utility	A-176
A-5-2	Windows Issues and Troubleshooting.....	A-176

Index

Terms and Conditions Agreement

Warranty, Limitations of Liability

Warranties

- **Exclusive Warranty**

Omron's exclusive warranty is that the Products will be free from defects in materials and workmanship for a period of twelve months from the date of sale by Omron (or such other period expressed in writing by Omron). Omron disclaims all other warranties, express or implied.

- **Limitations**

OMRON MAKES NO WARRANTY OR REPRESENTATION, EXPRESS OR IMPLIED, ABOUT NON-INFRINGEMENT, MERCHANTABILITY OR FITNESS FOR A PARTICULAR PURPOSE OF THE PRODUCTS. BUYER ACKNOWLEDGES THAT IT ALONE HAS DETERMINED THAT THE PRODUCTS WILL SUITABLY MEET THE REQUIREMENTS OF THEIR INTENDED USE.

Omron further disclaims all warranties and responsibility of any type for claims or expenses based on infringement by the Products or otherwise of any intellectual property right.

- **Buyer Remedy**

Omron's sole obligation hereunder shall be, at Omron's election, to (i) replace (in the form originally shipped with Buyer responsible for labor charges for removal or replacement thereof) the non-complying Product, (ii) repair the non-complying Product, or (iii) repay or credit Buyer an amount equal to the purchase price of the non-complying Product; provided that in no event shall Omron be responsible for warranty, repair, indemnity or any other claims or expenses regarding the Products unless Omron's analysis confirms that the Products were properly handled, stored, installed and maintained and not subject to contamination, abuse, misuse or inappropriate modification. Return of any Products by Buyer must be approved in writing by Omron before shipment. Omron Companies shall not be liable for the suitability or unsuitability or the results from the use of Products in combination with any electrical or electronic components, circuits, system assemblies or any other materials or substances or environments. Any advice, recommendations or information given orally or in writing, are not to be construed as an amendment or addition to the above warranty.

See <http://www.omron.com/global/> or contact your Omron representative for published information.

Limitation on Liability; Etc

OMRON COMPANIES SHALL NOT BE LIABLE FOR SPECIAL, INDIRECT, INCIDENTAL, OR CONSEQUENTIAL DAMAGES, LOSS OF PROFITS OR PRODUCTION OR COMMERCIAL LOSS IN ANY

WAY CONNECTED WITH THE PRODUCTS, WHETHER SUCH CLAIM IS BASED IN CONTRACT, WARRANTY, NEGLIGENCE OR STRICT LIABILITY.

Further, in no event shall liability of Omron Companies exceed the individual price of the Product on which liability is asserted.

Application Considerations

Suitability of Use

Omron Companies shall not be responsible for conformity with any standards, codes or regulations which apply to the combination of the Product in the Buyer's application or use of the Product. At Buyer's request, Omron will provide applicable third party certification documents identifying ratings and limitations of use which apply to the Product. This information by itself is not sufficient for a complete determination of the suitability of the Product in combination with the end product, machine, system, or other application or use. Buyer shall be solely responsible for determining appropriateness of the particular Product with respect to Buyer's application, product or system. Buyer shall take application responsibility in all cases.

NEVER USE THE PRODUCT FOR AN APPLICATION INVOLVING SERIOUS RISK TO LIFE OR PROPERTY OR IN LARGE QUANTITIES WITHOUT ENSURING THAT THE SYSTEM AS A WHOLE HAS BEEN DESIGNED TO ADDRESS THE RISKS, AND THAT THE OMRON PRODUCT(S) IS PROPERLY RATED AND INSTALLED FOR THE INTENDED USE WITHIN THE OVERALL EQUIPMENT OR SYSTEM.

Programmable Products

Omron Companies shall not be responsible for the user's programming of a programmable Product, or any consequence thereof.

Disclaimers

Performance Data

Data presented in Omron Company websites, catalogs and other materials is provided as a guide for the user in determining suitability and does not constitute a warranty. It may represent the result of Omron's test conditions, and the user must correlate it to actual application requirements. Actual performance is subject to the Omron's Warranty and Limitations of Liability.

Change in Specifications

Product specifications and accessories may be changed at any time based on improvements and other reasons. It is our practice to change part numbers when published ratings or features are changed, or when significant construction changes are made. However, some specifications of the Product may

be changed without any notice. When in doubt, special part numbers may be assigned to fix or establish key specifications for your application. Please consult with your Omron's representative at any time to confirm actual specifications of purchased Product.

Errors and Omissions

Information presented by Omron Companies has been checked and is believed to be accurate; however, no responsibility is assumed for clerical, typographical or proofreading errors or omissions.

Safety Precautions

Refer to the following manuals for safety precautions.

- *NY-series Industrial Box PC Hardware User's Manual (Cat. No. W556)*
- *NY-series Industrial Panel PC Hardware User's Manual (Cat. No. W557)*
- *NY-series Industrial Panel PC / Industrial Box PC Software User's Manual (Cat. No. W558)*

Precautions for Safe Use

Refer to the following manuals for precautions for safe use.

- *NY-series Industrial Box PC Hardware User's Manual (Cat. No. W556)*
- *NY-series Industrial Panel PC Hardware User's Manual (Cat. No. W557)*
- *NY-series Industrial Panel PC / Industrial Box PC Software User's Manual (Cat. No. W558)*

Precautions for Correct Use

Refer to the following manuals for precautions for correct use.

- *NY-series Industrial Box PC Hardware User's Manual (Cat. No. W556)*
- *NY-series Industrial Panel PC Hardware User's Manual (Cat. No. W557)*
- *NY-series Industrial Panel PC / Industrial Box PC Software User's Manual (Cat. No. W558)*

Regulations and Standards

Refer to the following manuals for Regulations and Standards.

- *NY-series Industrial Box PC Hardware User's Manual (Cat. No. W556)*
- *NY-series Industrial Panel PC Hardware User's Manual (Cat. No. W557)*

Versions

Hardware revisions and unit versions are used to manage the hardware and software in NY-series Controllers and EtherCAT slaves. The hardware revision or unit version is updated each time there is a change in hardware or software specifications. Even when two Units or EtherCAT slaves have the same model number, they will have functional or performance differences if they have different hardware revisions or unit versions.

Checking Versions

You can check versions on the ID information indications or with the Sysmac Studio.

Checking Unit Versions on ID Information Indications

The unit version is given on the ID information indication on the side of the product. The ID information on an NY-series NY5□2-□□□□ Controller is shown below.

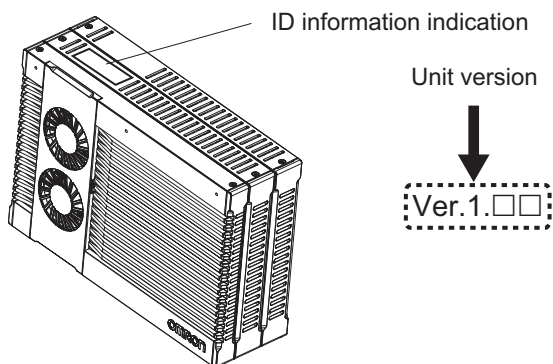

Checking Unit Versions with the Sysmac Studio

You can use the Sysmac Studio to check unit versions. The procedure is different for Units and for EtherCAT slaves.

● Checking the Unit Version of an NY-series Controller

You can use the Production Information while the Sysmac Studio is online to check the unit version of a Unit. You can do this only for the Controller.

- 1 Right-click **CPU Rack** under **Configurations and Setup - CPU/Expansion Racks** in the Multi-view Explorer, and select **Production Information**.
The Production Information Dialog Box is displayed.

● Changing Information Displayed in Production Information Dialog Box

- 1 Click the **Show Outline** or **Show Detail** Button at the lower right of the Production Information Dialog Box.
The view will change between the production information details and outline.

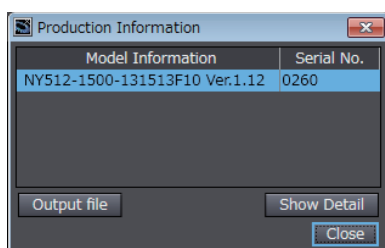

Outline View

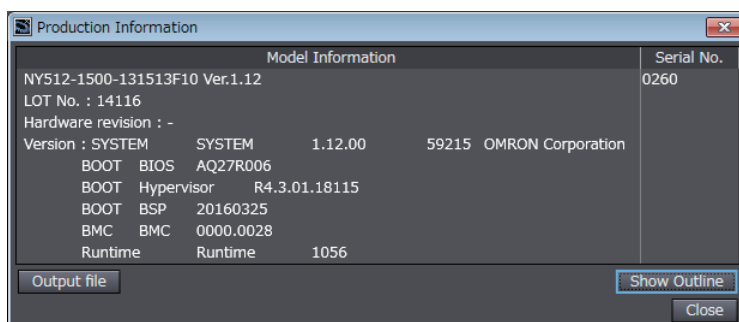

Detail View

The information that is displayed is different for the Outline View and Detail View. The Detail View displays the unit version, hardware revision, and other versions. The Outline View displays only the unit version.

● Checking the Unit Version of an EtherCAT Slave

You can use the Production Information while the Sysmac Studio is online to check the unit version of an EtherCAT slave.

Use the following procedure to check the unit version.

- 1 Double-click **EtherCAT** under **Configurations and Setup** in the Multiview Explorer. Or, right-click **EtherCAT** under **Configurations and Setup** and select **Edit** from the menu.
The EtherCAT Tab Page is displayed.
- 2 Right-click the master on the EtherCAT Tab Page and select **Display Production Information**.
The Production Information Dialog Box is displayed.
The unit version is displayed after “Rev.”

● **Changing Information Displayed in Production Information Dialog Box**

- 1** Click the **Show Detail** or **Show Outline** Button at the lower right of the Production Information Dialog Box.

The view will change between the production information details and outline.

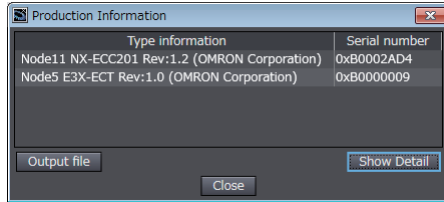

Outline View

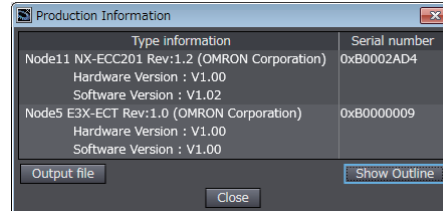

Detail View

Unit Versions of Controllers and Sysmac Studio Versions

The events that can occur depend on the unit versions of the NY-series Controller, the EtherCAT slaves, and the NX Units. You must use the corresponding version of Sysmac Studio to display events that were added for version upgrades when troubleshooting from the Sysmac Studio or from the Troubleshooter on an HMI.

Refer to the product manuals for information on the unit versions of the Controller, EtherCAT slaves, and NX Units, and for the relationship with the version of the Sysmac Studio.

Related Manuals

The followings are the manuals related to this manual. Use these manuals for reference.

Manual name	Cat. No.	Model numbers	Application	Description
NY-series IPC Machine Controller Industrial Panel PC Hardware User's Manual	W557	NY532-□□□□	Learning the basic specifications of the NY-series Industrial Panel PCs, including introductory information, designing, installation, and maintenance. Mainly hardware information is provided.	An introduction to the entire NY-series system is provided along with the following information on the Industrial Panel PC. <ul style="list-style-type: none"> • Features and system configuration • Introduction • Part names and functions • General specifications • Installation and wiring • Maintenance and inspection
NY-series IPC Machine Controller Industrial Box PC Hardware User's Manual	W556	NY512-□□□□	Learning the basic specifications of the NY-series Industrial Box PCs, including introductory information, designing, installation, and maintenance. Mainly hardware information is provided.	An introduction to the entire NY-series system is provided along with the following information on the Industrial Box PC. <ul style="list-style-type: none"> • Features and system configuration • Introduction • Part names and functions • General specifications • Installation and wiring • Maintenance and inspection
NY-series IPC Machine Controller Industrial Panel PC / Industrial Box PC Setup User's Manual	W568	NY532-□□□□ NY512-□□□□	Learning about initial setting of the NY-series Industrial PCs and preparations to use Controllers.	The following information is provided on an introduction to the entire NY-series system. <ul style="list-style-type: none"> • Two OS systems • Initial settings • Industrial PC Support Utility • NYCompolet • Industrial PC API • Backup and recovery
NY-series IPC Machine Controller Industrial Panel PC / Industrial Box PC Software User's Manual	W558	NY532-□□□□ NY512-□□□□	Learning how to program and set up the Controller functions of an NY-series Industrial PC.	The following information is provided on the NY-series Controller functions. <ul style="list-style-type: none"> • Controller operation • Controller features • Controller settings • Programming based on IEC 61131-3 language specifications
NY-series Instructions Reference Manual	W560	NY532-□□□□ NY512-□□□□	Learning detailed specifications on the basic instructions of an NY-series Industrial PC.	The instructions in the instruction set (IEC 61131-3 specifications) are described.
NY-series IPC Machine Controller Industrial Panel PC / Industrial Box PC Motion Control User's Manual	W559	NY532-□□□□ NY512-□□□□	Learning about motion control settings and programming concepts of an NY-series Industrial PC.	The settings and operation of the Controller and programming concepts for motion control are described.
NY-series Motion Control Instructions Reference Manual	W561	NY532-□□□□ NY512-□□□□	Learning about the specifications of the motion control instructions of an NY-series Industrial PC.	The motion control instructions are described.

Manual name	Cat. No.	Model numbers	Application	Description
NY-series IPC Machine Controller Industrial Panel PC / Industrial Box PC Built-in EtherCAT® Port User's Manual	W562	NY532-□□□□ NY512-□□□□	Using the built-in EtherCAT port in an NY-series Industrial PC.	Information on the built-in EtherCAT port is provided. This manual provides an introduction and provides information on the configuration, features, and setup.
NY-series IPC Machine Controller Industrial Panel PC / Industrial Box PC Built-in EtherNet/IP™ Port User's Manual	W563	NY532-□□□□ NY512-□□□□	Using the built-in EtherNet/IP port in an NY-series Industrial PC.	Information on the built-in EtherNet/IP port is provided. Information is provided on the basic setup, tag data links, and other features.
NJ/NY-series NC Integrated Controller User's Manual	O030	NJ501-5300 NY532-5400	Performing numerical control with NJ/NY-series Controllers.	Describes the functionality to perform the numerical control.
NJ/NY-series G code Instructions Reference Manual	O031	NJ501-5300 NY532-5400	Learning about the specifications of the G code/M code instructions.	The G code/M code instructions are described.
NY-series Troubleshooting Manual	W564	NY532-□□□□ NY512-□□□□	Learning about the errors that may be detected in an NY-series Industrial PC.	Concepts on managing errors that may be detected in an NY-series Controller and information on individual errors are described.
Sysmac Studio Version 1 Operation Manual	W504	SYSMAC -SE2□□□	Learning about the operating procedures and functions of the Sysmac Studio.	Describes the operating procedures of the Sysmac Studio.
CNC Operator Operation Manual	O032	SYSMAC-RTNC0□ □□D	Learning an introduction of the CNC Operator and how to use it.	An introduction of the CNC Operator, installation procedures, basic operations, connection operations, and operating procedures for main functions are described.
NX-series EtherCAT® Coupler Unit User's Manual	W519	NX-ECC□□□	Learning how to use the NX-series Ether- CAT Coupler Unit and EtherCAT Slave Terminals.	The following items are described: the overall system and configuration methods of an EtherCAT Slave Terminal (which consists of an NX-series EtherCAT Coupler Unit and NX Units), and information on hardware, setup, and functions to set up, control, and monitor NX Units through EtherCAT.
NX-series NX Units User's Manual	W521	NX-ID□□□□ NX-IA□□□□ NX-OC□□□□ NX-OD□□□□ NX-MD□□□□	Learning how to use NX Units.	Describes the hardware, setup methods, and functions of the NX Units. Manuals are available for the following Units. Digital I/O Units, Analog I/O Units, System Units, Position Interface Units, Communications Interface Units, Load Cell Input Unit, and IO-Link Master Units.
	W522	NX-AD□□□□ NX-DA□□□□		
	W592	NX-HAD□□□		
	W566	NX-TS□□□□ NX-HB□□□□		
	W523	NX-PD1□□□ NX-PF0□□□ NX-PC0□□□ NX-TBX01		
	W524	NX-EC0□□□ NX-ECS□□□ NX-PG0□□□		
	W540	NX-CIF□□□		
	W565	NX-RS□□□□		
W567	NX-ILM□□□			

Manual name	Cat. No.	Model numbers	Application	Description
NX-series Data Reference Manual	W525	NX-□□□□□□	Referencing lists of the data that is required to configure systems with NX-series Units.	Lists of the power consumptions, weights, and other NX Unit data that is required to configure systems with NX-series Units are provided.
NX-series Safety Control Unit User's Manual	Z930	NX-SL□□□□ NX-SI□□□□ NX-SO□□□□	Learning how to use NX-series Safety Control Units.	Describes the hardware, setup methods, and functions of the NX-series Safety Control Units.
NX-series Safety Control Unit Instructions Reference Manual	Z931	NX-SL□□□□	Learning about the specifications of instructions for the Safety CPU Unit.	Describes the instructions for the Safety CPU Unit.
IO-Link System User's Manual	W570	NX-ILM□□□ GX-ILM□□□	Learning everything from an introduction to details about IO-Link Systems, including mainly software information common to all IO-Link masters, Support Software operating methods, and troubleshooting.	Provides an overview of IO-Link Systems and explains the system configuration, communications specifications, communications methods, I/O data, parameters, models, Support Software, and troubleshooting.
GX-series EtherCAT Slave Units User's Manual	W488	GX-ID□□□□ GX-OD□□□□ GX-OC□□□□ GX-MD□□□□ GX-AD□□□□ GX-DA□□□□ GX-EC□□□□ XWT-ID□□ XWT-OD□□	Learning how to use the EtherCAT remote I/O terminals.	Describes the hardware, setup methods and functions of the EtherCAT remote I/O terminals.
MX2/RX Series Inverter EtherCAT Communications Unit User's Manual	I574	3G3AX-MX2-ECT 3G3AX-RX-ECT	Learning how to connect a 3G3AX-MX2-ECT or 3G3AX-RX-ECT EtherCAT Communications Unit for MX2/RX-series Inverters.	Describes the following information for the 3G3AX-MX2-ECT and 3G3AX-RX-ECT EtherCAT Communications Unit for MX2/RX-series Inverters: installation, parameter settings required for operation, troubleshooting, and inspection methods.
AC Servomotors/Servo Drives 1S-series with Built-in EtherCAT® Communi- cations User's Manual	I586	R88M-1□ R88D-1SN□-ECT	Learning how to use the Servomotors/ Servo Drives with built-in EtherCAT Communications.	Describes the hardware, setup methods and functions of the Servomotors/Servo Drives with built-in EtherCAT Communications.
	I621	R88M-1AL□/-1AM □ R88D-1SAN□-ECT		
AC Servomotors/Servo Drives G5 Series with Built-in EtherCAT® Communi- cations User's Manual	I576	R88M-K□ R88D-KN□-ECT	Learning how to use the AC Servomotors/ Servo Drives with built-in EtherCAT Communications.	Describes the hardware, setup methods and functions of the AC Servomotors/Servo Drives with built-in EtherCAT Communications. The Linear Motor Type models and dedicated models for position control are available in G5-series.
	I577	R88L-EC-□ R88D-KN□-ECT-L		
EtherCAT Digital-type Sensor Communication Unit Operation Manual	E413	E3X-ECT	Learning how to connect E3X-series EtherCAT Slave Units.	Provides the specifications of and describes application methods for E3X-series EtherCAT Slave Units.
E3NW-ECT EtherCAT Digital Sensor Communications Unit Operation Manual	E429	E3NW-ECT	Learning how to connect E3NW EtherCAT Slave Units.	Provides the specifications of and describes application methods for E3NW EtherCAT Slave Units.

Manual name	Cat. No.	Model numbers	Application	Description
FQ-M-series Specialized Vision Sensor for Positioning User's Manual	Z314	FQ-MS12□	Learning how to connect FQ-M-series Specialized Vision Sensor for Positioning.	Describes the following information for the FQ-Mseries Specialized Vision Sensor for Positioning: installation, wiring methods, parameter settings required for operation, troubleshooting, and inspection methods.
Vision System FH/FZ5 Series User's Manual for Communications Settings	Z342	FH-□□□□ FH-□□□□-□□ FZ5-□□□□ FZ5-□□□□-□□ FZ5-□□□□ FZ5-□□□□-□□	Learning how to connect FH/FZ5-series Vision Systems	The functions, settings, and communications methods to communicate with FH/FZ5 -series Vision Systems from a PLC or other external device are described.
Displacement Sensor ZW-series Confocal Fiber Type Displacement Sensors User's Manual	Z332	ZW-CE1□	Learning how to use the ZW-series Displacement Sensors.	Describes the hardware, setup methods and functions of the ZW-series Displacement Sensors.
NA-series Programmable Terminal User's Manual User's Manual	V117	NA5-□W□□□□	Learning the specifications and settings required to install an NA-series Programmable Terminals and connect peripheral devices.	Information is provided on NA-series Programmable Terminal specifications, part names, installation procedures, and procedures to connect an NA Unit to peripheral devices. Information is also provided on maintenance after operation and troubleshooting.
NA-series Programmable Terminal Software User's Manual	V118	NA5-□W□□□□	Learning about NA-series PT pages and object functions.	Describes the pages and object functions of the NA-series Programmable Terminals.
NS-series Programmable Terminals Programming Manual	V073	NS15-□□□□□□ NS12-□□□□□□ NS10-□□□□□□ NS8-□□□□□□ NS5-□□□□□□	Learning how to use the NS-series Programmable Terminals.	Describes the setup methods, functions, etc. of the NS-series Programmable Terminals.

*1. Temperature Input Units are introduced in Cat. No. W522 before Cat. No. W566 is released.

Revision History

A manual revision code appears as a suffix to the catalog number on the front and back covers of the manual.

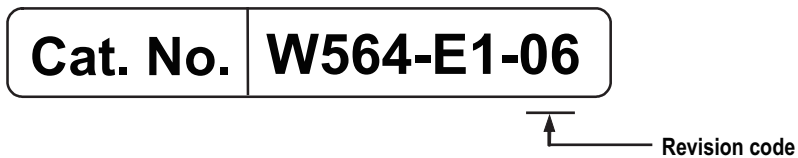

Revision code	Date	Revised content
01	September 2016	Original production
02	April 2017	<ul style="list-style-type: none"> • Made changes accompanying release of unit version 1.14 of the CPU Unit. • Corrected mistakes.
03	October 2017	<ul style="list-style-type: none"> • Made changes accompanying release of unit version 1.16 of the CPU Unit. • Corrected mistakes.
04	January 2019	<ul style="list-style-type: none"> • Made changes to events related to the CPU units. • Corrected mistakes.
05	July 2019	<ul style="list-style-type: none"> • Made changes accompanying release of unit version 1.21 of the CPU Unit.
06	March 2021	<ul style="list-style-type: none"> • Made changes accompanying release of unit version 1.24 of the CPU Unit. • Corrected mistakes.

1

Overview of Errors

This section provides information that is required to troubleshoot errors. It introduces the types of errors that can occur on an NY-series, the operation that occurs in response to errors, and the methods you can use to check for errors. Refer to *Section 2 Error Troubleshooting Methods* on page 2-1 for information on troubleshooting errors.

1-1	Overview of NY-series Errors	1-2
1-1-1	Types of Errors	1-4
1-1-2	NY-series Industrial PC Status	1-5
1-2	Fatal Errors	1-7
1-2-1	Types of Fatal Errors	1-7
1-2-2	Checking for Fatal Errors	1-7
1-3	Non-fatal Errors	1-8
1-3-1	Types of Non-fatal Errors	1-8
1-3-2	Checking for Non-fatal Errors	1-19
1-3-3	Resetting Non-fatal Errors	1-23
1-3-4	Errors Related to the Motion Control Function Module	1-25
1-3-5	Errors Related to the EtherNet/IP Function Module	1-29
1-3-6	Errors Related to the EtherCAT Master Function Module	1-31

1-1 Overview of NY-series Errors

You manage all of the errors that occur on the NY-series Controller as events. The same methods are used for all events. This allows you to see what errors have occurred and find corrections for them with the same methods for the entire range of errors that is managed (i.e., NY-series Controller, NX-series Slave Terminals, and EtherCAT slaves*¹).

*1. Only Sysmac devices are supported. For information on EtherCAT slaves that are Sysmac devices, refer to the *NY-series Industrial Panel PC / Industrial Box PC Built-in EtherCAT Port User's Manual (Cat. No. W562)*.

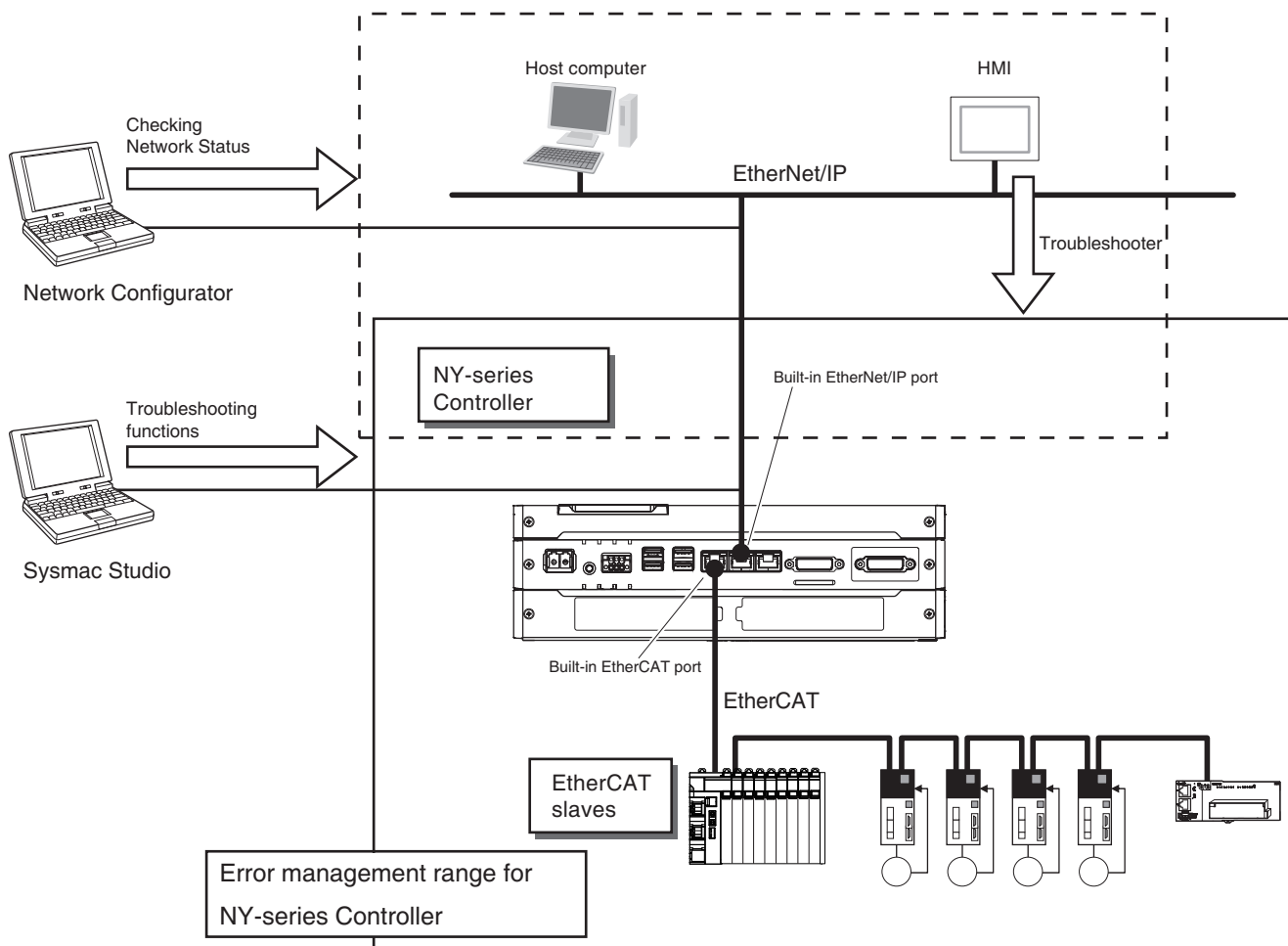

You can use the troubleshooting functions of the Sysmac Studio or the Troubleshooter on an HMI to quickly check for errors that have occurred and find corrections for them.

To perform troubleshooting from an HMI, connect the HMI to the built-in EtherNet/IP port on the Controller.

You can also use the Network Configurator to check the network status of EtherNet/IP. For the procedure to check network status, refer to the methods of communications status check and troubleshooting for the EtherNet/IP network described in the *NY-series Industrial Panel PC / Industrial Box PC Built-in EtherNet/IP Port User's Manual (Cat. No. W563)*.



Precautions for Correct Use

Refer to *A-4 Applicable Range of the HMI Troubleshooter* on page A-174 for the applicable range of the HMI Troubleshooter.

1-1-1 Types of Errors

There are two main types of errors (events) depending on whether the NY-series can manage them or not.

● Fatal Errors

These errors are not detected by the event management function of the NY-series because the Controller stops operation.

You cannot identify or reset these errors with the Sysmac Studio or an HMI.

Refer to *1-2 Fatal Errors* on page 1-7 for error types and confirmation methods of fatal errors in the Controller.

● Non-fatal errors

These errors are detected and managed with the event management function of the NY-series. You can confirm these errors with the Sysmac Studio or an HMI.

Refer to *1-3 Non-fatal Errors* on page 1-8 for error types and confirmation methods of non-fatal errors in the Controller.

1-1-2 NY-series Industrial PC Status

You can check the operating status of the NY-series Industrial PC with the PWR, RUN, and ERR indicators on the NY-series Industrial PC.

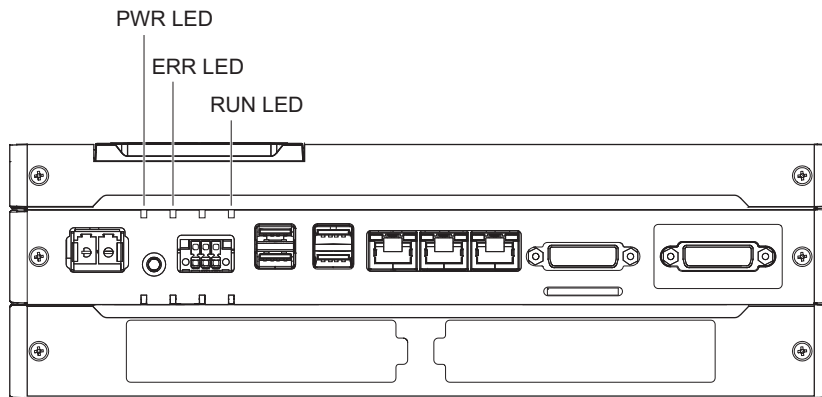

The following table shows the status of indicators, the status of user program execution, and the ability to connect communications to the Sysmac Studio or an HMI during startup, during normal operation, and when errors occur.

(○: Lit/●: Not lit/◐: Flashing)

NY-series Controller operating status		PWR (green)	ERR (red)	RUN (green)	User program execution status	Communications with Sysmac Studio or HMI
Startup	Industrial PC System Boot ^{*1}	○	●	● followed by ◐	Stopped.	Not possible.
	Controller Starting Up	○	●	◐ (2-s intervals followed by 0.5-s intervals)	Stopped.	Not possible.
Normal operation	RUN mode	○	●	○	Continues.	Possible.
	PROGRAM mode	○	●	●	Stopped.	
Fatal error in NY-series Controller	Error during Industrial PC System Boot ^{*1*2}	○	● or ○	●	Stopped.	Not possible.
	Power Supply Failure ^{*2}	●	●	●	Stopped.	
	CPU Unit Reset ^{*2}	○	●	●	Stopped.	
	CPU Unit Error ^{*2}	○	○	● or ◐ (2-s intervals or 0.5-s intervals)	Stopped.	
	System Initialization Error ^{*2}	○	●	◐ (2-s intervals) for 30 s or longer	Stopped.	

NY-series Controller operating status		PWR (green)	ERR (red)	RUN (green)	User program execution status	Communications with Sysmac Studio or HMI
Non-fatal error in NY-series Controller	Major fault ^{*3}	○	○	●	Stopped.	Possible. (Communications can be connected from an HMI if EtherNet/IP is operating normally.)
	Partial fault ^{*3}	○	◐ (1-s intervals)	○	Continues. ^{*4}	
	Minor fault ^{*3}	○	◐ (1-s intervals)	○	Continues.	
	Observation ^{*3}	○	●	○	Continues.	

*1. You can check the messages given during Industrial PC System Boot on the monitor screen. Refer to *Error during Industrial PC System Boot* on page 2-4 for what is displayed on the monitor screen when an error occurs.

*2. Refer to *1-2 Fatal Errors* on page 1-7 for information on individual errors.

*3. Refer to *1-3 Non-fatal Errors* on page 1-8 for information on individual errors.

*4. The function module where the error occurred stops.

1-2 Fatal Errors

1-2-1 Types of Fatal Errors

This section describes the errors that cause the operation of the NY-series Controller to stop. Software connections to the Sysmac Studio or an HMI cannot be made if there is a fatal error in the NY-series Controller.

Error	Description
Error during Industrial PC System Boot	The NY-series Industrial PC cannot start up correctly due to an error that occurred before the Controller starts up (e.g. during BIOS startup or before OS startup).
Power Supply Error	Power is not supplied, or the voltage is outside of the allowed range.
CPU Unit Reset	The NY-series Controller stops operation because of a hardware error.
CPU Unit Error	This error can occur for an NY-series Industrial PC. It indicates that there is a hardware failure or that the CPU is running out of control due to temporary data corruption.
System Initialization Error	This error can occur for an NY-series Industrial PC. It indicates a hardware failure. The RUN indicator flashes at 2-second intervals while the NY-series Industrial PC is starting, but if it flashes for 30 seconds or longer, then this error occurs.

1-2-2 Checking for Fatal Errors

You can identify fatal errors in the NY-series Controller based on the status of the PWR, RUN and ERR indicators, the monitor display, as well as by the possibility to go online from the Sysmac Studio. Refer to *Section 2 Error Troubleshooting Methods* on page 2-1 for information on identifying errors and corrections.

(○: Lit/●: Not lit/⊙: Flashing)

Indicators			Monitor display	Communications with Sysmac Studio	NY-series Industrial PC operating status
PWR (green)	ERR (red)	RUN (green)			
○	● or ○	●	Error message	Not possible. *1	Error during Industrial PC System Boot
●	●	●	---		Power Supply Error
○	●	●	---		CPU Unit Reset
○	○	● or ⊙(2-s intervals or 0.5-s intervals)	---		CPU Unit Error
○	●	⊙(2-s intervals) for 30 s or longer	---		System Initialization Error

*1. An online connection to the Sysmac Studio is necessary to differentiate between CPU Unit Resets, CPU Unit Errors, and non-fatal errors in the NY-series Controller. Power Supply Errors and System Initialization Errors can be differentiated with the indicators. There is no need to see if you can go online with the NY-series Controller from the Sysmac Studio.

1-3 Non-fatal Errors

Non-fatal errors can occur on the NY-series Controller and on the Windows. This section gives the errors that can occur on the NY-series Controller. Refer to the Windows descriptions for the errors on the Windows.

1-3-1 Types of Non-fatal Errors

Non-fatal errors that occur in the NY-series Controller are managed as events. You can check the event to find out what type of error occurred.

● Controller Events

The Controller automatically detects these events. Controller events include events for the function modules in the NY-series Controller, NX-series Slave Terminal, and EtherCAT slaves.

● User-defined Events

These are events that occur in applications that the user developed.

This manual does not describe user-defined events. Refer to the *NY-series Industrial Panel PC / Industrial Box PC Software User's Manual (Cat. No. W558)* for information on user-defined events.

Overview of Controller Events (Errors and Information)

You use the same methods to manage all of the events that occur on the NY-series Controller. The events that occur are saved in the NY-series Industrial PC and NX-series Slave Terminals.

You can use the Sysmac Studio or an HMI to confirm current Controller events and the log of events that occurred before. This log is called an event log.

To use an HMI to check events, connect the HMI to the built-in EtherNet/IP port on the Controller.

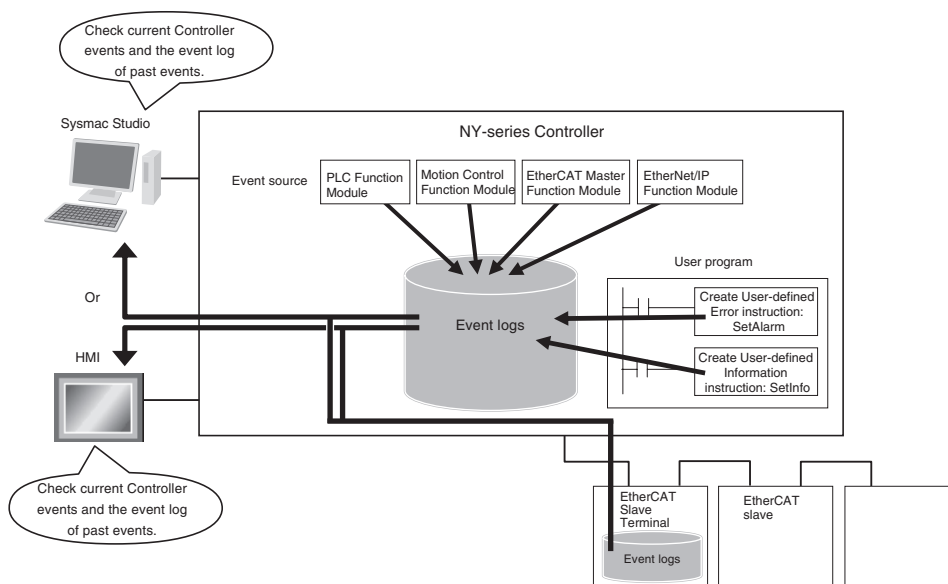



Additional Information

- Refer to the manual for the Communications Coupler Unit for details on the event log in a Slave Terminal.
 - When there is an emergency message that notifies an error from an EtherCAT slave to the Controller, it is recorded in the event log of the EtherCAT Master Function Module as the Emergency Message Detected (64200000 hex) event.
 - You cannot confirm the event log for an EtherCAT slave that has no event log. To record an error history as an event, you have to change the setting of the EtherCAT slave to notify emergency messages, then the Emergency Message Detected (64200000 hex) event is recorded. However, errors which cannot be notified by emergency messages from EtherCAT slaves are not recorded in the event log.
Meanwhile, there is a way to display error history of some EtherCAT slaves that do not have the event log, on the Sysmac Studio version 1.15 or higher as the event log. Refer to relevant manuals for EtherCAT slaves for the possibility to display error history as the event log.
 - Refer to relevant manuals for the slaves for the procedures to read error history of EtherCAT slaves.
-

Details on Controller Events (Errors and Information)

● Controller Event Times

The time of occurrence is recorded when an event occurs.

The times when errors occurred are kept based on the Windows clock data in the NY-series Industrial PC.

For events that occur in EtherCAT Slave Terminals, the times of occurrence are recorded based on the Windows clock data that the EtherCAT Slave Terminal receives from the NY-series Industrial PC.

If the EtherCAT Slave Terminal cannot obtain the clock data from the NY-series Industrial PC, the time of occurrence on the Sysmac Studio is displayed as ----/--/-- --:--:----:--:--. For an event occurred before the EtherCAT Slave Terminal obtains the clock data from the NY-series Industrial PC, the time of occurrence is also displayed as ----/--/-- --:--:--.

The time of occurrence for an event is displayed on the Sysmac Studio or HMI.



Version Information

If the EtherCAT Slave Terminal cannot obtain the clock data from the NY-series Industrial PC or an event occurred before the EtherCAT Slave Terminal obtains the clock data from the NY-series Industrial PC, the time of occurrence is displayed as 1970/1/1 0:00:00 with Sysmac Studio version 1.14 or lower.

● Sources of Controller Events

The Event source information indicates the location where an event occurred.

The event source identifies the particular function module in the Controller in which the event occurred.

For some function modules, there is more detailed information about the event source. This information is called the Source details.

The following information is provided as the event source details.

Event source	Source details
PLC Function Module	Instructions or Windows
Motion Control Function Module	Common, axis, or axes group
EtherCAT Master Function Module	Communications port, EtherCAT master, EtherCAT Coupler Unit, NX Unit, or EtherCAT slave
EtherNet/IP Function Module	Communications port, communications port 1, internal port 1, CIP, FTP, NTP, or SNMP

Note An NC Integrated Controller has the CNC Function Module. For how to check and correct errors in the CNC Function Module, refer to *NJ/NY-series NC Integrated Controller User's Manual (Cat. No. 0030)*.

The event source is displayed on the Sysmac Studio or HMI.

● Levels of Controller Events (Errors and Information)

The following table classifies the levels of Controller events according to the effect that the errors have on control. All events in impact levels as errors are collectively called Controller errors. All other events that are not classified into errors but mean information are called Controller information.

No.	Level	Level name	Classification
1	High	Major fault level	Controller errors
2		Partial fault level	
3		Minor fault level	
4		Observation	
5	Low	Information	Controller information

Errors with a higher level have a greater impact on the functions that the NY-series Controller provides, and are more difficult to recover from.

When an event occurs, the Sysmac Studio or HMI will display the level name.

Each event level is described below.

Level	Description
Major fault level	<p>These errors prevent control operations for the entire Controller.</p> <p>When the CPU Unit detects a major fault, it immediately stops the execution of the user program and turns OFF the loads of all slave, including remote I/O.</p> <p>With EtherCAT slaves, and some NX Units, you can set the slave settings to select whether outputs will go OFF or retain their previous status.</p> <p>You cannot reset major fault level errors from the user program, the Sysmac Studio or an HMI. You cannot reset major fault level errors from the user program, the Sysmac Studio or an HMI. To recover from a major fault level error, remove the cause of the error, and either cycle the power supply to the Controller, or reset the Controller from the Sysmac Studio.</p>
Partial fault level	<p>These errors prevent control operations in a certain function module in the Controller.</p> <p>The NY-series Controller continues to execute the user program even after a partial fault level error occurs. You can include error processing in the user program in order to stop equipment safely.</p> <p>After you remove the cause of the error, execute one of the following to return to normal status.</p> <ul style="list-style-type: none"> • Reset the error from the user program, the Sysmac Studio, or an HMI. • Cycle the power supply. • Reset the Controller from the Sysmac Studio.
Minor fault level	<p>These errors prevent part of the control operations in a certain function module in the Controller.</p> <p>The troubleshooting for minor fault level errors is the same as the processing for partial fault level errors.</p>
Observations	<p>These errors do not affect the control operations of the Controller.</p> <p>The observation notifies you of potential problems before they develop into a minor fault level error or worse.</p>
Information	<p>Events that are classified as information provide information that do not indicate errors.</p>

You can change the event level for some events. Refer to the *NY-series Industrial Panel PC / Industrial Box PC Software User's Manual (Cat. No. W558)* for details on changing event levels. Refer to *Section 3 Error Descriptions and Corrections* on page 3-1 and *A-2 Errors (Events) That Can Occur in Connected Devices* on page A-23 to see the events for which you can change the event level.

● **Operation for Each Level**

The way that the Controller operates when an event occurs depends on the level of the Controller event.

Item	Level of current event					
	Controller errors				Controller information	
	Major fault level	Partial fault level	Minor fault level	Observation	Information	
Definition	These errors are serious errors that prevent control operations for the entire Controller.	These errors prevent all of the control in a function module other than PLC Function Module.	These errors prevent part of the control operations in a certain function module.	These errors do not affect system control operations.	These are not errors, but appear in the event log to notify the user of specific information.	
Event examples	<ul style="list-style-type: none"> Non-volatile Memory Data Corrupted (PLC Function) 	<ul style="list-style-type: none"> Motion Control Period Exceeded (Motion Control Function Module) Communications Controller Failure (EtherCAT Master Function Module) 	<ul style="list-style-type: none"> Positive Limit Input Detected (Motion Control Function Module) Low Battery Voltage (PLC Function Module) 	<ul style="list-style-type: none"> Packet Discarded Due to Full Reception Buffer (EtherNet/IP Function Module) 	<ul style="list-style-type: none"> Power Turned ON Power Interrupted Memory All Cleared 	
Indicators*1	PWR (green)	Lit	Lit	Lit	Lit	Lit
	RUN (green)	Not lit	Lit	Lit	Lit	Lit
	ERROR (red)	Lit	Flashes at 1-s intervals.	Flashes at 1-s intervals.	Not lit	Not lit
NY-series Controller operation	User program execution status	Stops.	Continues.*2	Continues.	Continues.	Continues.
	Outputs turned OFF	Yes	No	No	No	No
	Error reset	Not possible.	Depends on the nature of the error.	Depends on the nature of the error.	---	---
	Event logs	Recorded. (Some errors are not recorded.)	Recorded.	Recorded.	Recorded.	Recorded.

Item	Level of current event				
	Controller errors				Controller information
	Major fault level	Partial fault level	Minor fault level	Observation	Information
Outputs from EtherCAT slaves and Basic Output Units	Refer to <i>I/O Operation for Major Fault Level Controller Errors</i> on page 1-16	<ul style="list-style-type: none"> Errors in EtherCAT Master Function Module: Depends on settings in the slave. Errors in other function modules: According to user program. 	According to user program.	According to user program.	According to user program.
Sysmac Studio display (when online)	Error messages are automatically displayed in the Controller Status Pane. The user can display detailed information in the Troubleshooting Dialog Box.			These items are not displayed in the error display in the Controller Status Pane.	

- *1. If multiple Controller errors have occurred, the indicators show the error with the highest event level.
- *2. Operation stops in the function module (Motion Control Function Module, EtherCAT Master Function Module, or EtherNet/IP Function Module) in which the error occurred.

● Operation in the Function Module Where an Error Event Occurred

Function module	Level of current event			
	Major fault level	Partial fault level	Minor fault level	Observation
PLC Function Module	User program execution stops.	---	Operation continues.	
Motion Control Function Module	---	All axes stop. (The stop method depends on the error.)	<ul style="list-style-type: none"> The affected axis/axes group stops. (The stop method depends on the settings.) The motion control instruction is not executed (for instructions related to axis operation.) 	<ul style="list-style-type: none"> Axis operation continues. The motion control instruction is not executed (for instructions not related to axis operation).
EtherCAT Master Function Module	---	EtherCAT communications stop. (The slaves operate according to the settings in the slaves.)	I/O refreshing for EtherCAT communications stops or continues according to the Fail-soft Operation Setting in the master. (If I/O refreshing stops, the slaves operate according to the settings in the slaves.)(If I/O refreshing stops, the slaves operate according to the settings in the slaves.)	I/O refreshing for EtherCAT communications continues.
EtherNet/IP Function Module	---	EtherNet/IP communications stop. (Online connections to the Sysmac Studio and communications connections with an HMI is not possible.)	Part of the EtherNet/IP communications stop. (Online connections to the Sysmac Studio and communications connections with an HMI is possible if the online connections or communications connection is not the cause of the error.)	EtherNet/IP communications continue.

Note Major fault level errors occur only in the PLC Function Module.

● I/O Operation for Major Fault Level Controller Errors

The following table gives the operation of the Controller and the I/O devices.

Unit	Controller operation	Unit or slave operation
NX-series Slave Terminal	The NX-series Slave Terminal moves to Safe-Operational state.	Depends on the NX Unit settings.
EtherCAT Slave ^{*1}	The slave is placed in the Safe-Operational state.	Depends on the slave settings. ^{*2}
Servo Drive or NX Unit assigned to an axis	Updating the command values is stopped.	All axes stop immediately.
Devices connected with EtherNet/IP	<ul style="list-style-type: none"> For the originators of tag data links, the variables and I/O memory addresses for input (consume) tags are not refreshed. For the targets of tag data links, operation depends on the settings of the tags sets for the output (produce) tags. ^{*3} 	Depends on the specifications of the connected devices.

*1. Excluding Servo Drives assigned to an axis.

*2. Settings and setting methods depend on the slave. Refer to the manual for the slave. For a Servo Drive, operation depends on the setting of object 605E hex (Fault Reaction Option Code).

*3. You can set whether to clear output or maintain the data from before the error occurred. Refer to *NY-series Industrial Panel PC / Industrial Box PC Built-inEtherNet/IP Port User's Manual (Cat. No. W563)* for details.

● Event Code

Events that occur in a Controller have an event code.

When an event occurs, the Sysmac Studio or HMI will display the event code.

You can use the instructions that get error status to read the error codes of current errors from the user program.

The event codes are 8-digit hexadecimal values.

The first digit of a Controller event represents its category. These categories are listed in the table below.

First digit of the code (hex)	Classification	Meaning
0	Hardware errors	An error caused by a hardware problem such as an internal part malfunction, contact failure, temperature error, undervoltage, overvoltage, or overcurrent.
1	Data errors	An error caused by incorrectly saved data or data corruption in the Controller.
2	Hardware setting errors	An error caused by incorrect handling of hardware settings (e.g., hardware switches) or restrictions (e.g., Unit assignment locations).
3	Configuration errors	An error caused by incorrect parameter values, parameters and hardware configurations that do not match, or configurations set by the user.
4	Software errors	An error caused by Controller software.
5	User software errors	An error that is caused by the user program. (For example, an input value to an instruction that is out of range.)
6	Observation errors	An error that was detected in monitoring operation that occurs due to user settings in the Controller. (For example, if the task period is exceeded or if a position outside of the motion range is detected.)
7	Control errors	An error caused by a control process. (For example, if the operating status does not meet the required conditions or if the timing is incorrect.)
8	Communications errors	An error caused by communications with an external device or host system.
9	Information	Events that are classified as information and provide information that do not indicate errors.

● Relationship between Event Codes and Error Codes

In addition to the event codes that indicate errors, the function modules and Units have their own error codes.

If there are corresponding event and error codes, you can tell what the other code is if you know either one of them. This allows you to know when the same error is being given when you check errors with more than one method.

The following table shows the relationship between the error codes and event codes.

Error code (4-digit hexadecimal)		Corresponding event code (8-digit hexadecimal)		Example: Event code for an error code of A123 hex
Classification	Used in	Upper 4 digits	Lower 4 digits	
Error codes for basic instructions	<i>ErrorID</i> output variable for each instruction	5401 hex	Error code	5401A123 hex
Error codes in the Motion Control Function Module	<ul style="list-style-type: none"> • <i>ErrorID</i> output variable for motion control instructions • System-defined variables for motion control*1 	Error code	0000 hex	A1230000 hex

*1. The following are system-defined variables for motion control:

Variable	Name
<code>_MC_COM.PFaultLvl.Code</code>	MC Common Partial Fault Code
<code>_MC_COM.MFaultLvl.Code</code>	MC Common Minor Fault Code
<code>_MC_COM.Obsr.Code</code>	MC Common Observation Code
<code>_MC_AX[].MFaultLvl.Code</code>	Axis Minor Fault Code
<code>_MC_AX[].Obsr.Code</code>	Axis Observation Code
<code>_MC_GRP[].MFaultLvl.Code</code>	Axes Group Minor Fault Code
<code>_MC_GRP[].Obsr.Code</code>	Axes Group Observation Code

● Exporting the Event Log

You can use the Sysmac Studio or an HMI to export the displayed event log to a CSV file.

Refer to the *NY-series Industrial Panel PC / Industrial Box PC Software User's Manual (Cat. No. W558)* for information on exporting event logs.

1-3-2 Checking for Non-fatal Errors

Checking Methods

Use the following methods to check for non-fatal errors in the Controller.

Checking method	What you can check
Checking the indicators	Operating status of the Controller
Checking with the Industrial PC Support Utility	Operating status of the Controller and error status of the EtherNet/IP port
Checking with the troubleshooting function of the Sysmac Studio	You can check for current Controller errors, a log of past Controller errors, error sources, error causes, and corrections.
Checking with the Troubleshooter of an HMI*1	You can check for current Controller errors, a log of past Controller errors, error sources, error causes, and corrections.
Instructions that read error status	You can check the highest-level status and highest-level event code in the current Controller errors.
Checking with system-defined variables	You can check the current Controller error status for each function module.
Checking communications status with the Network Configurator	You can check the communications status (e.g., tag data link connection status) for each device on the EtherNet/IP network.
Checking with the EtherCAT diagnostic and statistical information on the Sysmac Studio	You can check the statistical information such as the number of communications frames on the EtherCAT network as well as the number of frames for which errors were detected.

*1. To perform troubleshooting from an HMI, connect the HMI to the built-in EtherNet/IP port on the Controller. Refer to *A-4 Applicable Range of the HMI Troubleshooter* on page A-174 for the applicable range of the HMI Troubleshooter.

Checking the Indicators

● Checking the Level of a Controller Error

You can use the PWR, RUN, and ERR indicators to determine the level of an error.

The following table shows the relationship between the Controller's indicators and the event level.

(○:Lit/●:Not lit/◐:Flashing)

Indicators			Event level
PWR (green)	RUN (green)	ERR (red)	
○	●	○	Major fault level
○	○	◐ (1-s intervals).	Partial fault level
○	○	●	Minor fault level
○	○	●	Observation

Checking with the Industrial PC Support Utility

You can check error status of the NY-series Controller with the Industrial PC Support Utility.



Additional Information

For details on the Industrial PC Support Utility, refer to the *NY-series Industrial Panel PC / Industrial Box PC Setup User's Manual (Cat. No. W568)*.

● Checking the Level of a Controller Error

You can check whether an error has occurred in the **Controller Error** area in the **Controller Status** tab page on the Industrial PC Support Utility. You can also check the level of the error if it exists.

● Checking the Status of an EtherNet/IP Port Error

In the **NET ERR Status** area under **Built-in EtherNet/IP Port** in the **Controller Status** tab page on the Industrial PC Support Utility, you can check whether an error in the minor fault level or a higher level has occurred in the EtherNet/IP port.

The following table shows the status that you can check.

NET ERR LED status	Indicated status
Critical Error	An error for which normal status cannot be recovered through user actions (i.e., errors for which you must replace the NY-series Industrial PC or contact your OMRON representative) has occurred.
Error	An error for which normal status can be recovered through user actions has occurred.
No Error	There is no minor fault level or higher-level error.

Checking with the Troubleshooting Function of Sysmac Studio

When an error occurs, you can connect the Sysmac Studio online to the Controller to check current Controller errors and the log of past Controller errors.

● Current Errors

Open the Sysmac Studio's **Controller Error** Tab Page to check the current error's level, source, source details, event name, event code, details, attached information 1 to 4, actions, and corrections.

Errors are not displayed for observations.

● Log of Past Errors

Open the Sysmac Studio's **Controller Event Log** Tab Page to check the times, levels, sources, source details, event names, event codes, details, attached information 1 to 4, actions, and corrections for previous errors.

Refer to the *Sysmac Studio Version 1 Operation Manual (Cat. No. W504)* for details on troubleshooting with the Sysmac Studio.

Checking with the Troubleshooter of an HMI

When an error occurs, if you can connect communications between an HMI and the Controller, you can check current Controller errors and the log of past Controller errors.

To perform troubleshooting from an HMI, connect the HMI to the built-in EtherNet/IP port on the Controller.



Precautions for Correct Use

Refer to *A-4 Applicable Range of the HMI Troubleshooter* on page A-174 for the applicable range of the HMI Troubleshooter.

● Current Errors

You can check the current error's event name, event code, level, source, source details, time, details, and attached information 1 to 4.

Also, observations are not displayed as errors.

● Log of Past Errors

You can check the time, level, source, source details, event name, event code, details, attached information 1 to 4 for past errors.

Refer to the relevant HMI manual for information on the HMI Troubleshooter.

Checking with Instructions That Read Error Status

You can determine the error status with the instructions that get error status provided for each function module from the user program.

These instructions get the status and the event code of the error with the highest level.

Applicable function module	Instruction name	Instruction
PLC Function Module	Get PLC Controller Error Status	GetPLCError
Motion Control Function Module	Get Motion Control Error Status	GetMCError
EtherCAT Master Function Module	Get EtherCAT Error Status	GetECError
EtherNet/IP Function Module	Get EtherNet/IP Error Status	GetEIPError

Note An NC Integrated Controller has the CNC Function Module. For how to check and correct errors in the CNC Function Module, refer to *NJ/NY-series NC Integrated Controller User's Manual (Cat. No. O030)*.

For details on the instructions that get error status, refer to the *NY-series Instructions Reference Manual (Cat. No. W560)*.

Checking with System-Defined Variables

You can check the error status variables in the system-defined variables to determine the status of errors in a Controller.

You can read the Error Status variable from an external device by using communications.

You can monitor the MC Common Variable, Axis Variables, and Axes Group Variables of the system defined variables for motion control to see if errors have occurred in the Motion Control Function Module.

Refer to the *NY-series Industrial Panel PC / Industrial Box PC Software User's Manual (Cat. No. W558)* for information on system-defined variables.

Checking Communications Status with the Network Configurator

You can use the Network Configurator to check the communications status (e.g., tag data link connection status) for each device on the EtherNet/IP network. For details, refer to the methods of communications status check and troubleshooting for the EtherNet/IP network described in the *NY-series Industrial Panel PC / Industrial Box PC Built-in EtherNet/IP Port User's Manual (Cat. No. W563)*.

Checking with the EtherCAT Diagnostic and Statistical Information on the Sysmac Studio

With the Sysmac Studio, you can check the statistical information such as the number of communications frames on the EtherCAT network as well as the number of frames for which errors were detected. For details, refer to the diagnosis and statistics information for EtherCAT described in the *NY-series Industrial Panel PC / Industrial Box PC Built-in EtherCAT Port User's Manual (Cat. No. W562)*.

1-3-3 Resetting Non-fatal Errors

Unless you reset an error, the Controller will retain the error status until you turn OFF the power supply to the Controller or reset the Controller.

To reset a Controller error, it is necessary to eliminate the cause of the error. The same error will occur again if you reset the error, but do not eliminate the cause of the error.



Precautions for Safe Use

Always confirm safety at the connected equipment before you reset Controller errors with an event level of partial fault or higher for the EtherCAT Master Function Module. When the error is reset, all slaves that were in any state other than Operational state (in which outputs are disabled) due to the Controller error with an event level of partial fault or higher will go to Operational state and the outputs will be enabled.

Before you reset all errors, confirm that no Controller errors with an event level of partial fault have occurred for the EtherCAT Master Function Module.



Precautions for Correct Use

Resetting an error is not the same as eliminating the cause of the error.

Always eliminate the cause of an error before you perform the procedure to reset the error.

Error Resetting Methods

Method	Operation	Errors that are re-set	Description
Commands from Sysmac Studio	Resetting Controller errors	Resetting all errors in the entire Controller	Reset the Controller errors from the Sysmac Studio's Troubleshooting Dialog Box.
		Resetting all Slave Terminal errors	Refer to the manual for the Communications Coupler Unit for details on resetting errors in a Slave Terminal.
		Resetting errors for individually specified NX Units	
	Downloading	Resetting all errors for a specific function module	After the causes of the Controller errors are removed, all Controller errors in the relevant function module are reset as a result. Errors are not reset when you download the Controller Configurations and Setup.
	Clear All Memory	Resetting all errors for all function modules	After the causes of the Controller errors are removed, all Controller errors in all function modules are reset as a result. Errors for Slave Terminals are not reset.* ¹
	Controller reset		After the causes of the Controller errors are removed, all Controller errors in all function modules are reset as a result. Errors for Slave Terminals are not reset.* ¹
Clear All Memory operation for Slave Terminal	Resetting all Slave Terminal errors	If the causes for the Controller errors are removed, all Controller errors in the Slave Terminals are reset.	
Restarting the Slave Terminal			

Method	Operation	Errors that are reset	Description
Commands from an HMI*2	Resetting Controller errors	Resetting all errors in the entire Controller	Reset Controller errors from the Troubleshooter of an HMI. You can reset errors from an HMI that is not directly compatible with the NY-series Controller or another company's HMI if you use the HMI in combination with the reset error instruction for the function module in the user program.
Commands from the user program	Resetting Controller errors	Resetting errors for individual function modules	Execute the reset error instruction for the function module in the user program. <ul style="list-style-type: none"> For the Motion Control Function Module, you can reset all errors, errors for a particular axis, or errors for a particular axes group.
Commands from a host computer	Resetting Controller errors with CIP messages	Resetting all errors for all function modules	Use a CIP message from a host computer to reset errors.
Cycling the Controller's power supply	---	Resets all errors.	After the causes of the Controller errors are removed, all Controller errors in all function modules are reset as a result.
Cycling the power supply to the Slave Terminal	---	Resetting all Slave Terminal errors	If the causes for the Controller errors are removed, all Controller errors in the Slave Terminals are reset.

*1. Some errors are reset when the EtherCAT communications link is established rather than when the reset operation is performed.

*2. To reset errors from an HMI, connect the HMI to the built-in EtherNet/IP port on the Controller.

Refer to the *Sysmac Studio Version 1 Operation Manual (Cat. No. W504)* for details on clearing errors from the Sysmac Studio.

1-3-4 Errors Related to the Motion Control Function Module

This section describes errors related to the Motion Control Function Module (sometimes abbreviated to “MC Function Module”).

Sources of Errors Related to the Motion Control Function Module

Errors can occur internally in the Motion Control Function Module, or they can occur in EtherCAT communications, which are used to connect to the Servo Drives and other slaves.

- Inside MC Function Module
- EtherCAT Master Function Module
- Built-in EtherCAT communications port hardware
- EtherCAT slaves

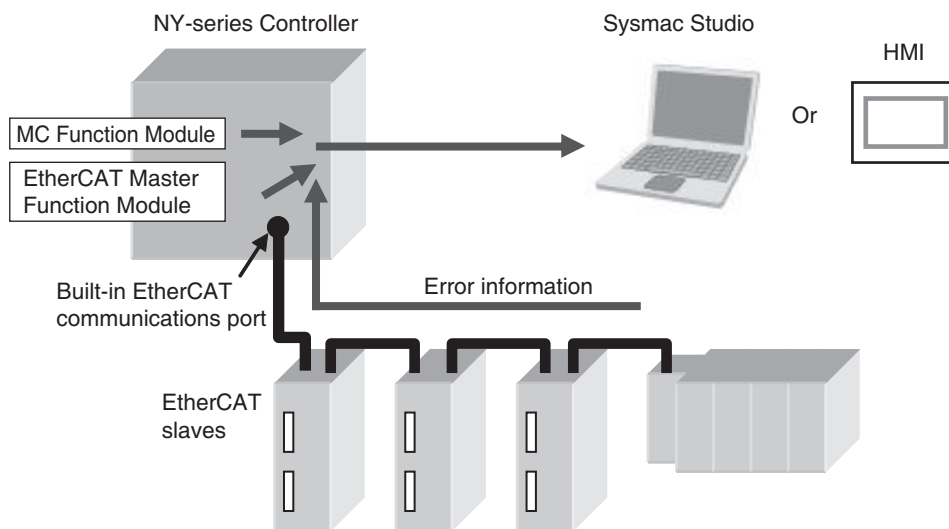

Classifications

There are the following three sources of errors in the Motion Control Function Module.

Classification	Description
MC Common Errors	If an error is detected in the common portion of the Motion Control Function Module, the corresponding bit in the MC Common Error Status variable shows the error.
Axis Error	If an error is detected for an axis, the corresponding bit in the Axis Error Status variable shows the error.*1
Axes Group Errors	If an error is detected for an axes group, the corresponding bit in the Axes Group Error Status variable shows the error.

*1. If an axis error with a minor fault level or higher level occurs, operation is also not possible for an axes group that contains the axis as a composition axis.

Note Refer to *NY-series Industrial Panel PC / Industrial Box PC Software User's Manual (Cat. No. W558)* for details on status variables.

Event Source and Level

The following tables list the errors in each event level that can occur for each source.

● MC Common Errors

Level	Error name
Major fault	None
Partial fault	<ul style="list-style-type: none"> • Motion Control Parameter Setting Error • Cam Data Read Error • Required Process Data Object Not Set • Axis Slave Disabled • Network Configuration Information Missing for Axis Slave • Motion Control Initialization Error • Motion Control Period Exceeded Error • Absolute Encoder Home Offset Read Error
Minor Fault	<ul style="list-style-type: none"> • Cam Table Save Error • Other execution errors for motion control instructions
Observation	<ul style="list-style-type: none"> • Cannot Execute Save Cam Table Instruction
Information	Error Clear from MC Test Run Tab Page

● Axis Errors

Level	Error name
Major fault	None
Partial fault	None
Minor fault	<ul style="list-style-type: none"> • Cam Table Data Error during Cam Motion • Immediate Stop Instruction Executed • Positive Software Limit Exceeded • Negative Software Limit Exceeded • In-position Check Time Exceeded • Following Error Limit Exceeded • Immediate Stop Input • Positive Limit Input Detected • Negative Limit Input Detected • Illegal Following Error • Servo OFF Error • Absolute Encoder Current Position Calculation Failed • Servo Main Circuit Power OFF • Interrupt Feeding Interrupt Signal Missing • Homing Opposite Direction Limit Input Detected • Homing Direction Limit Input Detected • Homing Limit Inputs Detected in Both Directions • Home Proximity/Homing Opposite Direction Limit Input Detected • Home Proximity/Homing Direction Limit Input Detected • Home Input/Homing Opposite Direction Limit Input Detected • Home Input/Homing Direction Limit Input Detected • Invalid Home Input Mask Distance • No Home Input • No Home Proximity Input • Slave Error Detected • MC Common Error Occurrence • Latch Position Overflow • Latch Position Underflow • Master Sync Direction Error • Slave Disconnection during Servo ON • Feed Distance Overflow • Error in Changing Servo Drive Control Mode • Master Axis Position Read Error • Auxiliary Axis Position Read Error • EtherCAT Slave Communications Error • Other execution errors for motion control instructions

Level	Error name
Observation	<ul style="list-style-type: none"> • Following Error Warning • Velocity Warning • Acceleration Warning • Deceleration Warning • Positive Torque Warning • Negative Torque Warning • Command Position Overflow • Command Position Underflow • Actual Position Overflow • Actual Position Underflow • Slave Observation Detected • Notice of Insufficient Travel Distance to Achieve Blending Transit Velocity • Other execution errors for motion control instructions
Information	Slave Error Code Report

● Axes Group Errors

Level	Error name
Major fault	None
Partial fault	None
Minor fault	<ul style="list-style-type: none"> • Axes Group Immediate Stop Instruction Executed • Home Undefined during Coordinated Motion • Axes Group Composition Axis Error • Other execution errors for motion control instructions
Observation	<ul style="list-style-type: none"> • Velocity Warning • Acceleration Warning • Deceleration Warning • Notice of Insufficient Travel Distance to Achieve Blending Transit Velocity
Information	None

Errors Related to EtherCAT Communications, EtherCAT Slaves, and NX Units

The following Motion Control Function Module error can occur due to errors in EtherCAT communications, EtherCAT slaves, or NX Units.

Error name	Event code	Cause	Operation for error
EtherCAT Slave Communications Error	8440 0000 hex	A communications error occurred for the EtherCAT slave or NX Unit that is allocated to an axis in the Motion Control Function Module. *1	The Servo is turned OFF for the axis with an error and operations other than error resets are not acknowledged. *2
Slave Error Detected	742F 0000 hex	An error was detected for the EtherCAT slave or NX Unit that is allocated to an axis in the Motion Control Function Module.	The Servo is turned OFF for the axis with an error and operations other than error resets are not acknowledged.

*1. When an error occurs in communications with an EtherCAT slave, an error also occurs in the EtherCAT Master Function Module. If you assign more than one device to the same axis, a communications error occurs for the axis if a communications error occurs for even one of the devices.

*2. When an error occurs in slave communications, home becomes undefined for the axis.

Servo Drive Errors

This section describes the notification that is provided for errors that occur in OMRON 1S-series Servo Drives and G5-series Servo Drives.

There is a difference between the timing of when the Motion Control Function Module detects the error in the Servo Drive and when the error code is obtained from the Servo Drive.

The Motion Control Function Module therefore reports different events for the error in the Servo Drive and the error code.

● Error Notification

When the Motion Control Function Module detects an error, a Slave Error Detected minor fault level error (742F0000 hex) occurs.

At this point, the Motion Control Function Module performs the error operation (i.e., it turns OFF the Servo).

● Error Code Notification

When the Servo Drive reports the error code, the Motion Control Function Module generates a Slave Error Code Report information event (94220000 hex).

The error code (the main part of the error display number) from the Servo Drive is included in the lower two digits of the attached information of the Slave Error Code Report event.

For example, if the attached information is displayed as FF13, the error with display number 13 (Main Circuit Power Supply Undervoltage) occurred in the Servo Drive.



Precautions for Correct Use

You must change the settings to receive notification of the Slave Error Code Report event. Map object 603F hex (Error Code) in the PDO Edit Pane.

Errors Related to NX Units

Error and error code notifications are provided for errors that occur for OMRON NX-series Position Interface Units in the same way as they are for OMRON 1S-series Servo Drives and G5-series Servo Drives.

However, NX-series Position Interface Units do not have an object that corresponds to object 603F hex (Error Code), so 0000 hex is given for the Slave Error Code Report (94220000 hex) in the attached information.

Refer to the *NX-series Position Interface Units User's Manual (W524)* or the *NX-series EtherCAT Coupler Unit User's Manual (Cat. No. W519)* for details on errors that occur in NX-series Position Interface Units.

1-3-5 Errors Related to the EtherNet/IP Function Module

This section describes the errors that are related to the EtherNet/IP Function Module.

Classifications

There are the following sources of errors in the EtherNet/IP Master Function Module.

Classification	Description
Communications port 1 errors	If an error is detected for EtherNet/IP communications port 1, the corresponding bit in the Communications Port 1 Error status variable shows the error.
Internal port 1 errors	If an error is detected for EtherNet/IP internal port 1, the corresponding bit in the Internal Port 1 Error status variable shows the error.
CIP communications errors	If an error that is related to the tag data links or CIP message communications is detected for EtherNet/IP communications port 1, the corresponding bit in the CIP Error Communications Error status variable shows the error.*1
TCP application errors	If an error that is related to the FTP server, NTP, or SNMP client is detected, the corresponding bit in the TCP Application Communications Error status variable shows the error.

*1. Other Ethernet communications are not affected.

Note Refer to the *NY-series Industrial Panel PC / Industrial Box PC Software User's Manual (Cat. No. W558)* for details on status variables.

Event Source and Level

The following table gives sources and levels of the events that can occur in the EtherNet/IP Function Module.

Level	Source		
	Communications port	CIP communications	TCP application
Major fault	None	None	None
Partial fault	EtherNet/IP Processing Error	None	None
Minor fault	<ul style="list-style-type: none"> • Communications Controller Failure • MAC Address Error • IP Route Table Setting Error • Basic Ethernet Setting Error • IP Address Setting Error • DNS Setting Error • DNS Server Connection Error • IP Address Duplication Error • BOOTP Server Connection Error 	<ul style="list-style-type: none"> • Identity Error • Tag Data Link Setting Error • Tag Name Resolution Error • Controller Insufficient Memory Warning • Tag Data Link Connection Failed • Tag Data Link Timeout • Tag Data Link Connection Timeout • Allowed Communications Bandwidth per Unit Exceeded 	<ul style="list-style-type: none"> • FTP Server Setting Error • NTP Client Setting Error • SNMP Setting Error • NTP Server Connection Error

Level	Source		
	Communications port	CIP communications	TCP application
Observation	<ul style="list-style-type: none"> • Access Detected Outside Range of Variable • Packet Discarded Due to Full Receive Buffer • Link OFF Detected 	None	None
Information	<ul style="list-style-type: none"> • Link Detected • Restarting Ethernet Port • IP Address Fixed • BOOTP Client Started 	<ul style="list-style-type: none"> • Tag Data Link Download Started • Tag Data Link Download Finished • Tag Data Link Stopped • Tag Data Link Started • Tag Data Link All Run 	<ul style="list-style-type: none"> • FTP Server Started • NTP Client Started • SNMP Started

1-3-6 Errors Related to the EtherCAT Master Function Module

This section describes the errors that are related to the EtherCAT Master Function Module.

Locations of Errors in the EtherCAT Master Function Module

Errors can occur internally in the EtherCAT Master Function Module, or they can occur in the built-in EtherCAT port or in EtherCAT slaves.

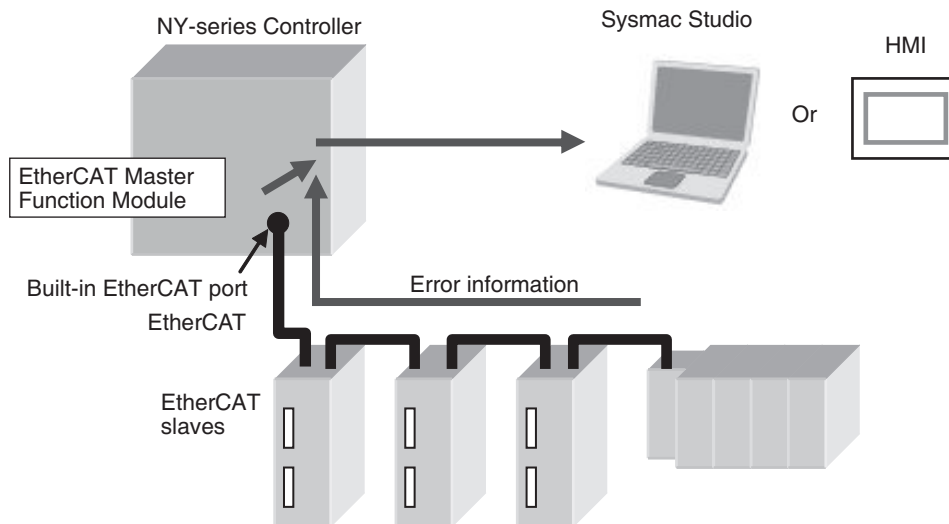

Additional Information

If any one of the following errors occurs at the same time for more than one slave, only the error for the slave that is closest to the master is recorded in the event log. The same error is not recorded in the event log for slaves that are connected further from the master.

- Network Configuration Verification Error
- Process Data Communications Error (when caused by a disconnected cable)
- Slave Node Address Duplicated
- Slave Initialization Error

Classifications

There are the following sources of errors in the EtherCAT Master Function Module.

Classification	Description
Communications port errors	If an error is detected in overall EtherCAT communications, the corresponding bit in the Communications Port Error status variable shows the <i>error</i> .
EtherCAT master errors	If the EtherCAT master detects an error in its own settings or processing, the corresponding bit in the Master Error status variable shows the <i>error</i> . If the EtherCAT master detects an error in a slave, the corresponding bit in the Master Error status variable shows the <i>error</i> .
EtherCAT slave errors	If the EtherCAT master detects an error in a slave, the error status for the slave will show that the <i>master detected an error</i> . *1*2*3

*1. The EtherCAT master periodically reads error status information from the slaves. It updates the system-defined variables at the same time as the I/O data.

- *2. The EtherCAT master will set the bits for EtherCAT slaves that do not report error status to FALSE in the Slave Error Table.
- *3. If the error in the slave is corrected after it occurs, you do not need to reset it. It is reset automatically.

Note Refer to the *NY-series Industrial Panel PC / Industrial Box PC Software User's Manual (Cat. No. W558)* for details on status variables.



Additional Information

Refer to the *NX-series EtherCAT Coupler Unit User's Manual (Cat. No. W519)* for the events that can occur for an EtherCAT Slave Terminal.

Event Source and Level

The following table gives sources and levels of the events that can occur in the EtherCAT Master Function Module.

Level	Source		
	Communications port	EtherCAT master	EtherCAT slaves *1
Major fault	None	None	None
Partial fault	<ul style="list-style-type: none"> • Communications Controller Failure • MAC Address Error • Link OFF Error 	<ul style="list-style-type: none"> • EtherCAT Processing Error • EtherCAT Frame Not Received 	<ul style="list-style-type: none"> • EtherCAT Frame Not Received
Minor fault	None	<ul style="list-style-type: none"> • Slave Node Address Duplicated • Network Configuration Information Error • EtherCAT Communications Cycle Exceeded • Network Configuration Error • Network Configuration Verification Error • Slave Initialization Error • Process Data Transmission Error • Process Data Reception Timeout Error • Input Process Data Invalid Error 	<ul style="list-style-type: none"> • Network Configuration Verification Error • Slave Application Error • Process Data Communications Error • Slave Node Address Duplicated • Slave Initialization Error
Observation	None	<ul style="list-style-type: none"> • EtherCAT Slave Backup Failed • EtherCAT Slave Restore Operation Failed • EtherCAT Message Error 	<ul style="list-style-type: none"> • Emergency Message Detected

Level	Source		
	Communications port	EtherCAT master	EtherCAT slaves *1
Information	None	<ul style="list-style-type: none"> • Error Reset • EtherCAT Diagnosis/ Statistics Log Started • EtherCAT Diagnosis/ Statistics Log Ended 	<ul style="list-style-type: none"> • Slave Disconnected • Slave Connected • Slave Disabled • Slave Enabled

*1. Slave errors that are detected by the master are listed. There will also be a master error if any of these errors occurs. For slave errors that are not detected by the master, the errors and levels are defined by the individual slaves. Refer to the manual for the slave.

Refer to the *NX-series EtherCAT Coupler Unit User's Manual (Cat. No. W519)* for the events that can occur for an EtherCAT Slave Terminal.

Error Reset of EtherCAT Master Function Module

There are three methods to reset errors of the EtherCAT Master Function Module.

- Sysmac Studio
- HMI
- Execution of the Reset EtherCAT Error (ResetECError) instruction

Refer to *2-3 Troubleshooting Non-fatal Errors* on page 2-6 for the resetting procedures from the Sysmac Studio or an HMI.

Refer to the *NY-series Instructions Reference Manual (Cat. No. W560)* for details on the Reset EtherCAT Error (ResetECError) instruction.

● Resetting Errors in the EtherCAT Master Function Module

Before you reset the following errors, always make sure that the slave with the error is participating in the network.

- Resetting a Network Configuration Verification Error or Process Data Communications Error while the power supply to the slave is ON or while the cable is connected
- Resetting a Link OFF Error while the power supply is ON to the first slave where the cable was disconnected or while the cable is connected

Use the following procedure.

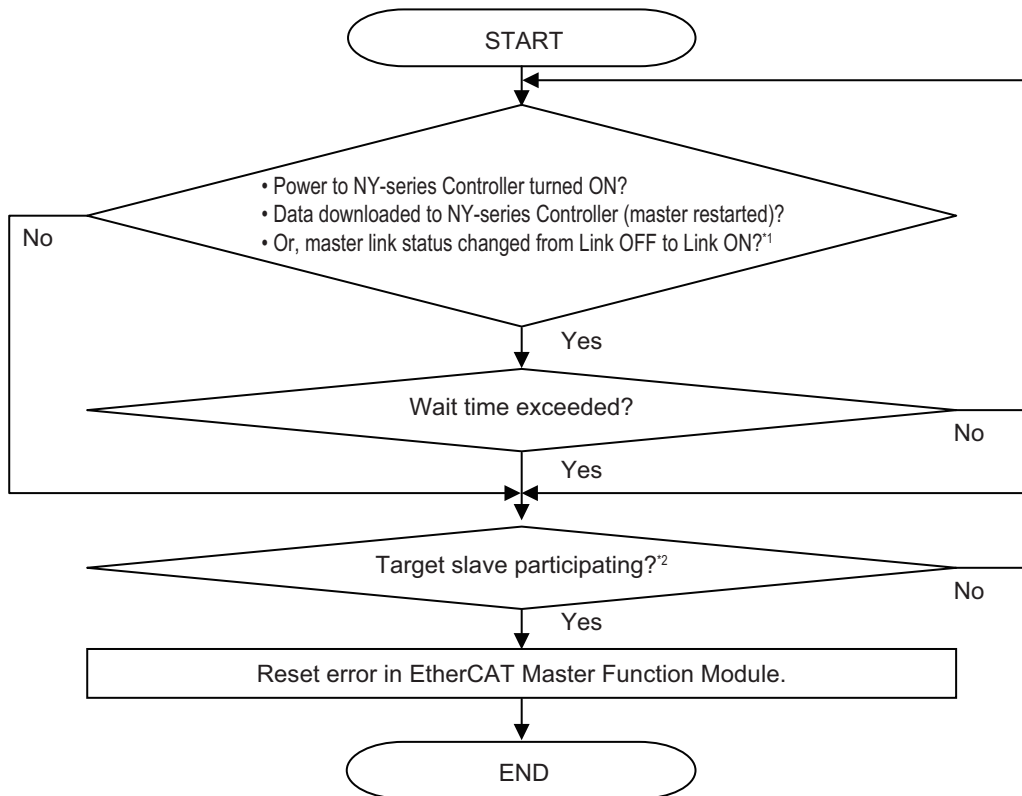

*1. Check the `_EC_LinkStatus` (Link Status) system-defined variable.

*2. Check the `_EC_EntrySlavTbl[]` (Network Connected Slave Table) system-defined variable.

Also, set the wait time for slave startup in the EtherCAT master settings (EtherCAT master parameter settings) long enough to allow for the power supply startup time of all of the slaves.

If you reset the error in the EtherCAT Master Function Module without using the above procedure, the EtherCAT master may access a slave with a different node address than the specified node address, or other unexpected operations may occur. Also, the error may not be reset correctly.

● Resetting Slave Errors

You can reset errors in the EtherCAT Master Function Module to reset slave errors. However, process data communications between the EtherCAT master and EtherCAT slave must be active to reset a slave error.

If process data communications with the slave are not active, check the slave after you reset errors in the EtherCAT Master Function Module to see if process data communications are active. Then, to reset the error in the slave, reset errors in the EtherCAT Master Function Module again.

Precautions When Connecting or Disconnecting Slaves during Communications

This section describes the procedure and precautions for replacing a slave that is currently performing communications.

● Procedure for Disconnecting Slaves during Communications

Always use the following procedure to turn OFF the slave power supply or disconnect cables during EtherCAT master communications.*

* This includes the safe-operational and operational states.

Step 1: Use the Sysmac Studio or an instruction to send a command to disconnect the slave.

Step 2: Confirm that the slave was disconnected normally.

Step 3: Turn OFF the power supply to the slave or disconnect the cable.

If you turn OFF the power supply or disconnect the cable without performing steps 1 and 2, the slaves that are operating may be adversely affected.

● Prohibition to Physically Disconnecting a Slave and Resetting an Error or Connecting a Slave at the Same Time

If you perform the following operation (a) or (b) at the same time as operation (c), an error will occur.

a. Turn OFF the power supply to the slave or disconnect the cable.

b. Turn ON the power supply to the slave or connect the cable.

c. Reset an error in the EtherCAT Master Function Module or connect the slave.*

* This can happen when the Reset EtherCAT Error (ResetECError) instruction or Connect EtherCAT Slave (EC_ConnectSlave) instruction is cyclically executed in the user program.

If you perform these operations at the same time, the EtherCAT master may access a slave with a different node address than the specified node address, or other unexpected operations may occur. Therefore, never turn OFF the power supply to the slave or disconnect the cable at the same time as you reset an error or connect a slave.

2

Error Troubleshooting Methods

This section describes troubleshooting methods for specific errors.

2-1	Troubleshooting Flowcharts	2-2
2-1-1	Flowchart to Check Operation of NY-series Controller.....	2-2
2-1-2	Flowchart to Check Error Status on EtherNet/IP Function Module	2-3
2-2	Troubleshooting Fatal Errors	2-4
2-3	Troubleshooting Non-fatal Errors	2-6
2-3-1	Identifying and Resetting Errors with the Sysmac Studio.....	2-6
2-3-2	Identifying and Resetting Errors with an HMI	2-11
2-3-3	Identifying and Resetting Errors from the User Program	2-14
2-3-4	Checking for Errors with System-defined Variables	2-15
2-4	Troubleshooting When You Cannot Go Online from the Sysmac Studio	2-17
2-4-1	Causes and Correction When You Cannot Go Online from the Sysmac Studio	2-17
2-4-2	Troubleshooting for Each Cause	2-17

2-1 Troubleshooting Flowcharts

This section provides basic error identification and troubleshooting flowcharts. Use them when an error occurs in the NY-series Controller.

2-1-1 Flowchart to Check Operation of NY-series Controller

When an error occurs in the NY-series Controller, use the following flowchart to determine whether the error is a fatal error or a non-fatal error.

For a non-fatal error, use the Sysmac Studio or an HMI to troubleshoot the error.

If you cannot go online from the Sysmac Studio, perform *2-4 Troubleshooting When You Cannot Go Online from the Sysmac Studio* on page 2-17 before you assume that the error is a fatal error.

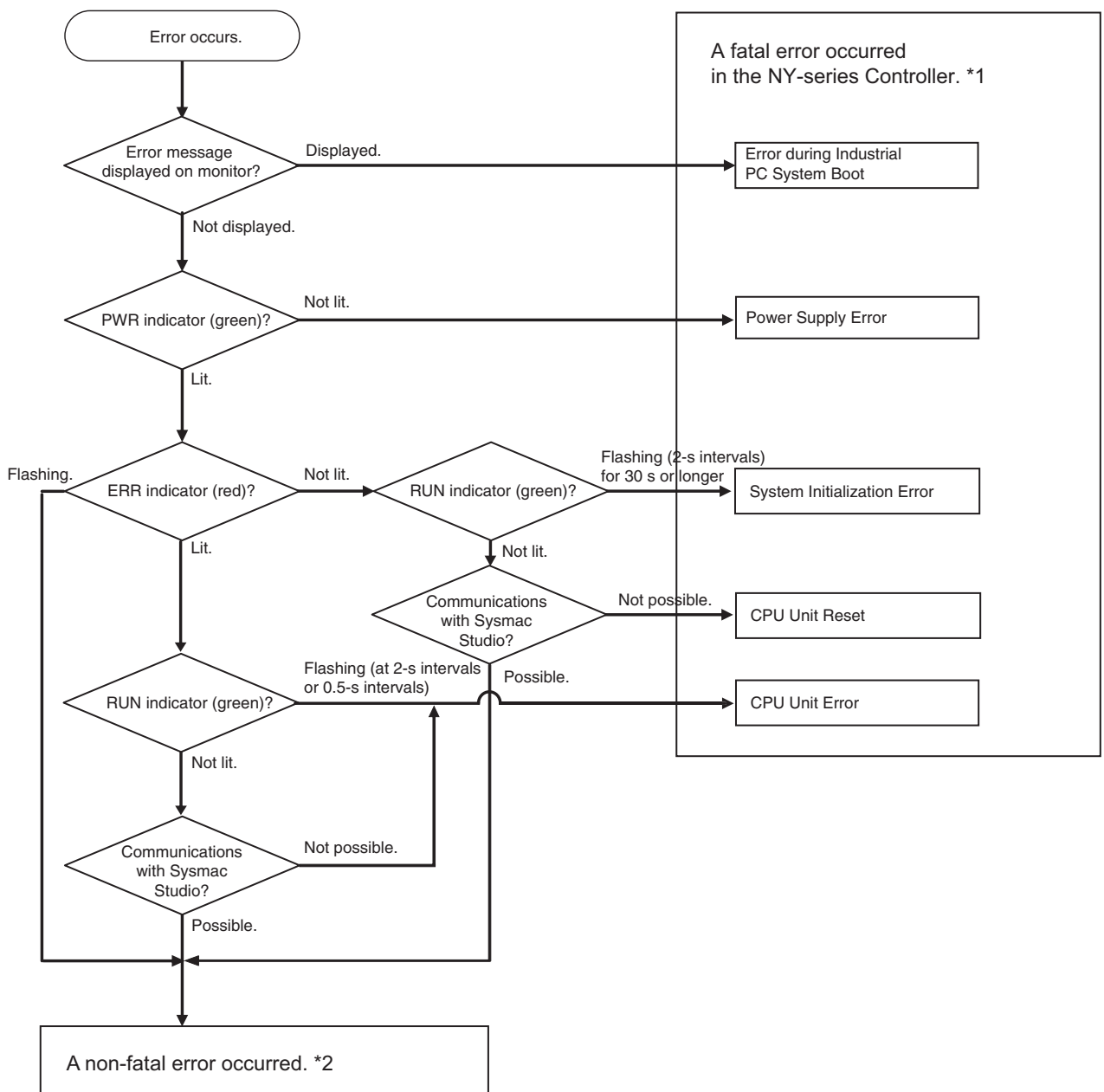

*1. Refer to *2-2 Troubleshooting Fatal Errors* on page 2-4.

*2. Refer to 2-3 Troubleshooting Non-fatal Errors on page 2-6.

Note When the error is determined to be non-fatal for the NY-series Controller, you can check the level of the error with the ERR indicator.

Lit: Major fault level

Flashing: Partial fault level or minor fault level

Not lit: Observation

2-1-2 Flowchart to Check Error Status on EtherNet/IP Function Module

When an error occurs in the EtherNet/IP Function Module, use the following flowchart to check the error and take necessary measures.

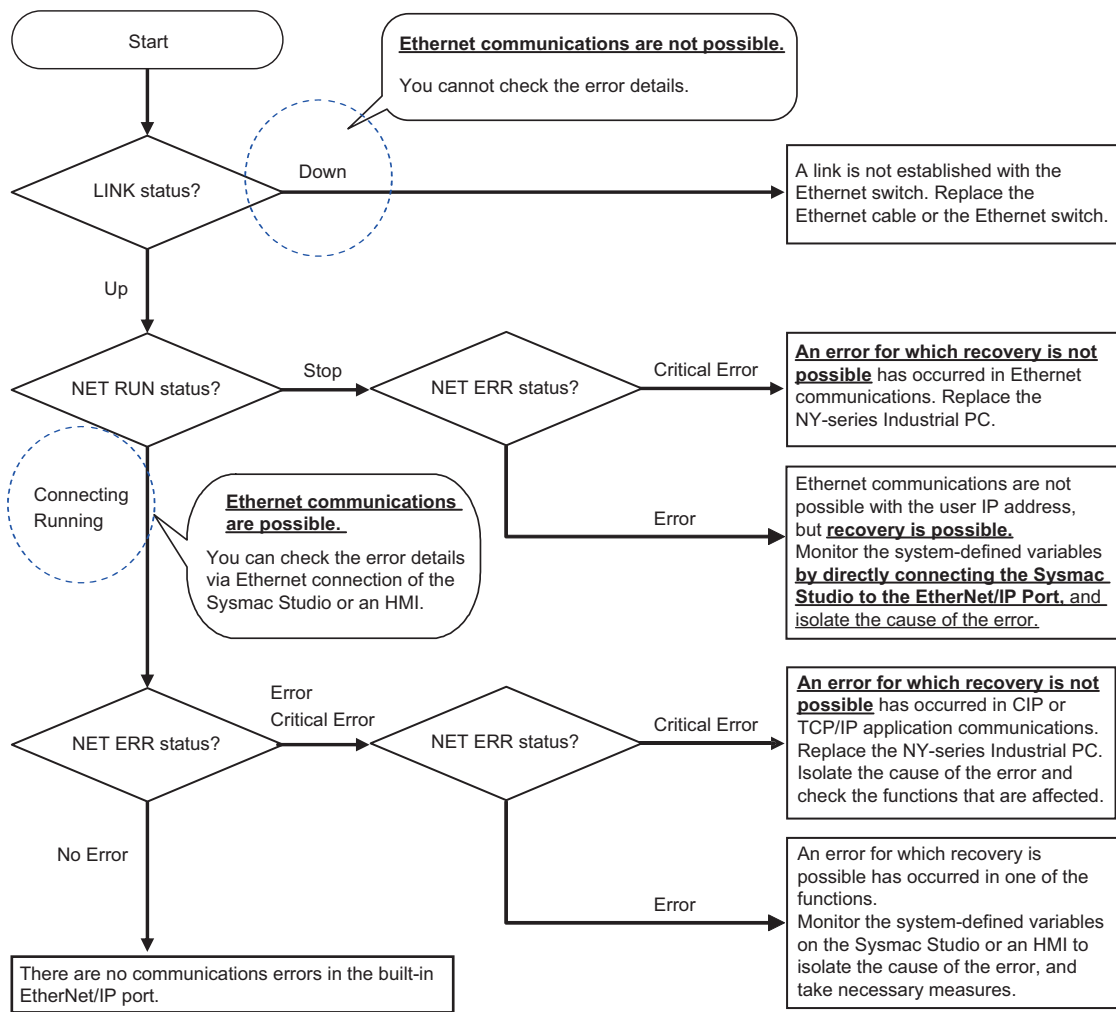

Note The NET RUN status, LINK status, and NET ERR status in the flowchart correspond to **NET RUN Status**, **LINK Status**, and **NET ERR Status** under **Built-in EtherNet/IP Port** in the **Controller Status** tab page on the Industrial PC Support Utility, respectively.

2-2 Troubleshooting Fatal Errors

The section describes the procedure to troubleshoot fatal errors in the Controller.

● Error during Industrial PC System Boot

For errors that occur before Controller startup, check the monitor display and perform corrections.

Cause	Monitor display	Correction
BIOS power on self test	BIOS error message (POST failure)	Follow instructions on screen
BIOS configuration unsupported	BIOS machine control enable message	Change BIOS setting and restart
MBR/GPT overwritten/erased	BIOS error message (no bootable device)	Use Rescue disk to restore system software
Reboot after user install of Windows (MBR/GPT overwritten)* ¹	Windows determines screen output	Use Rescue disk to restore MBR/GPT
Reboot after user install of other OS (MBR/GPT overwritten)* ¹	Other OS determines screen output	Use Rescue disk to restore system software
Detection of missing file or changed file during Secure Boot	Secure Boot error message	Use Rescue disk to restore system software

*1. Do not use mediums other than the Rescue disk to perform user install of Windows and other OS.

● Power Supply Failure

Cause	Correction
Power is not supplied.	Turn ON the power.
The voltage is outside of the allowable range for the power supply.	Check the Controller's power supply system, and correct it so that the voltage is within the allowable range.
Power supply failure	If the error persists even after you make the above corrections, replace the NY-series Industrial PC.

● CPU Unit Reset

Cause	Correction
A conductive object has gotten inside.	If there is conductive material nearby, blow out the NY-series Industrial PC with air.
Noise	If the error did not result from the above causes, cycle the power to the Controller and see if that resets the error. If the error occurs frequently, check the FG and power supply lines to see if noise is entering on them. Implement noise countermeasures as required.
NY-series Industrial PC failure	If the error persists even after you make the above corrections, replace the NY-series Industrial PC.

● CPU Unit Error

Cause	Correction
A conductive object has gotten inside.	If there is conductive material nearby, blow out the NY-series Industrial PC with air.

Cause	Correction
Noise	If the error did not result from the above causes, cycle the power to the Controller and see if that resets the error. If the error occurs frequently, check the FG and power supply lines to see if noise is entering on them. Implement noise countermeasures as required.
NY-series Industrial PC failure	If the error persists even after you make the above corrections, replace the NY-series Industrial PC.

● System Initialization Error

Cause	Correction
A conductive object has gotten inside.	If there is conductive material nearby, blow out the NY-series Industrial PC with air.
Noise	If the error did not result from the above causes, cycle the power to the Controller and see if that resets the error. If the error occurs frequently, check the FG and power supply lines to see if noise is entering on them. Implement noise countermeasures as required.
NY-series Industrial PC failure	If the error persists even after you make the above corrections, replace the NY-series Industrial PC.

2-3 Troubleshooting Non-fatal Errors

2-3-1 Identifying and Resetting Errors with the Sysmac Studio

Troubleshooting functions are provided by the Sysmac Studio.

You can use the troubleshooting functions to identify errors that occur in a Controller, and reset the errors.



Precautions for Correct Use

On the Sysmac Studio, the descriptions of events that are common to NY-series and NJ/NXseries Controllers are displayed as the descriptions of NJ/NX-series Controller. Therefore, it is necessary to interpret the displayed contents when your use an NY-series Controller. Refer to *Interpreting Description of Events When Using NY-series Controllers* on page 3-2 for how to interpret the contents.

Displaying Errors on the Sysmac Studio

If an error occurs while the Sysmac Studio is online with the Controller, the Sysmac Studio notifies the user of the error in the Controller Status Pane. From there, you can open the Troubleshooting and Event Logs Window to read detailed error information and troubleshooting methods.

Click the **Troubleshooting** Button in the toolbar, or select **Troubleshooting** from the **Tools** Menu.

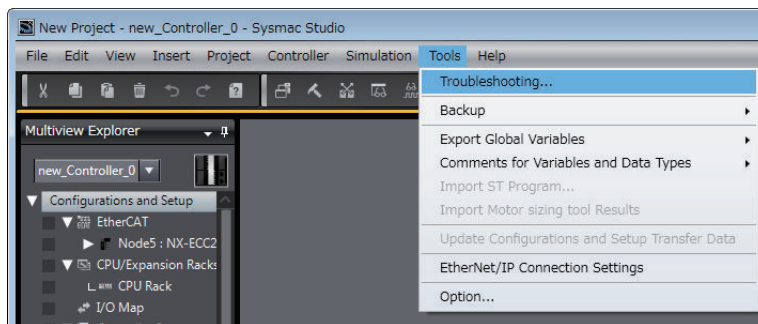

The Sysmac Studio automatically collects the Controller's error information, and opens the **Troubleshooting** Dialog Box.

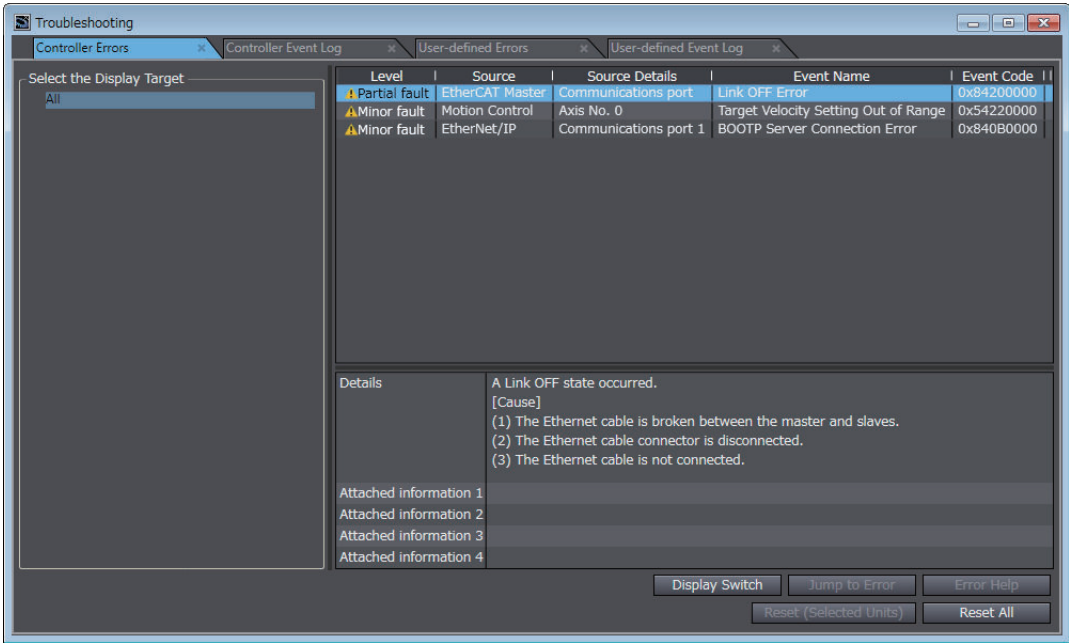

Checking Current Errors and the Event Logs with the Sysmac Studio

● Checking Current Errors with the Sysmac Studio

You can click the **Controller Errors** Tab in the **Troubleshooting** Dialog Box to read information on current errors in the Controller.

The **Controller Errors** Tab Page lists the current errors in order of their levels.

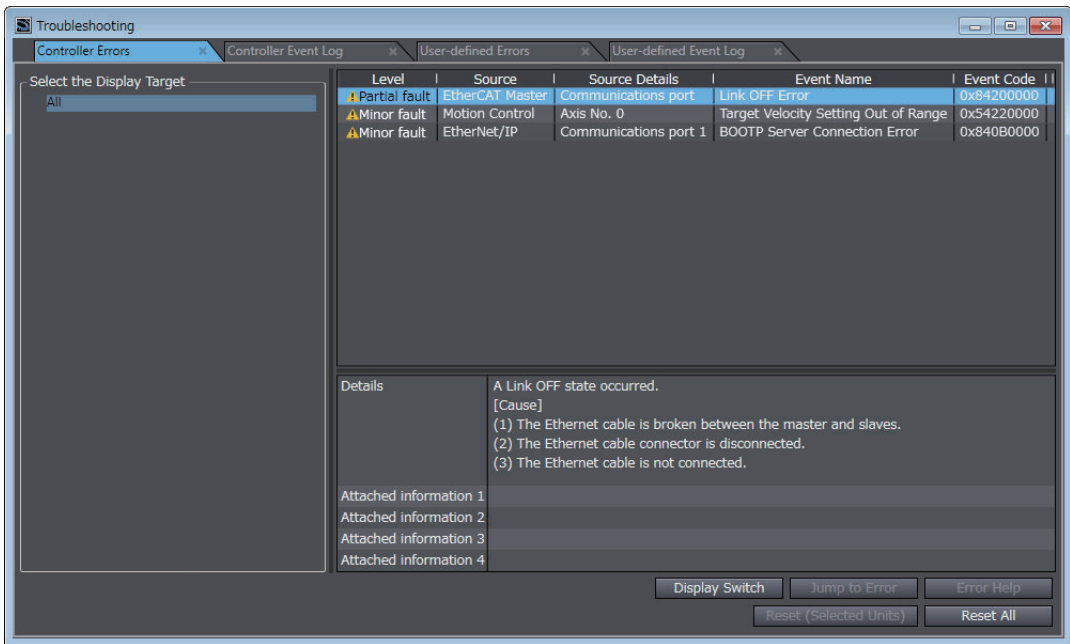

Displayed Item	Description
Level	This is the event level of the error.
Source and Source Details	This is the physical location and functional location of the error.

Displayed Item	Description
Event Name	Error name
Event Code	This is the code of the error.

You can click the column headings in the Controller error list, such as the **Level** or **Source**, to reorder the table rows according to that heading.

For example, the following change occurs when you click the **Source** heading.

Before **Source** heading is clicked.

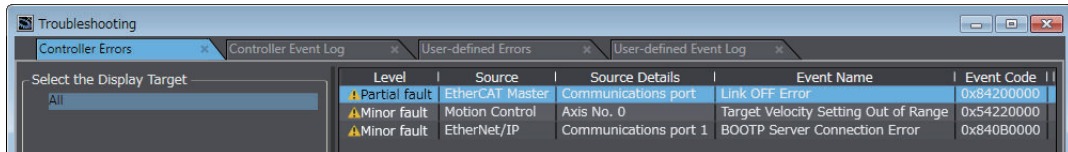

After **Source** heading is clicked.

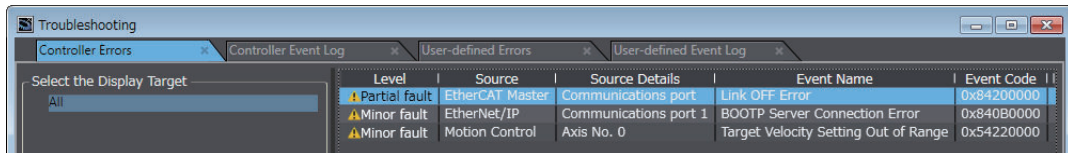

● Displaying Event Logs with the Sysmac Studio

With Sysmac Studio, you can check a log of the Controller events that previously occurred on the **Controller Event Log** Tab Page.

You can select the event logs and levels to display in the Display Settings Area.

Information on the event that you specified are displayed in the Details Pane.

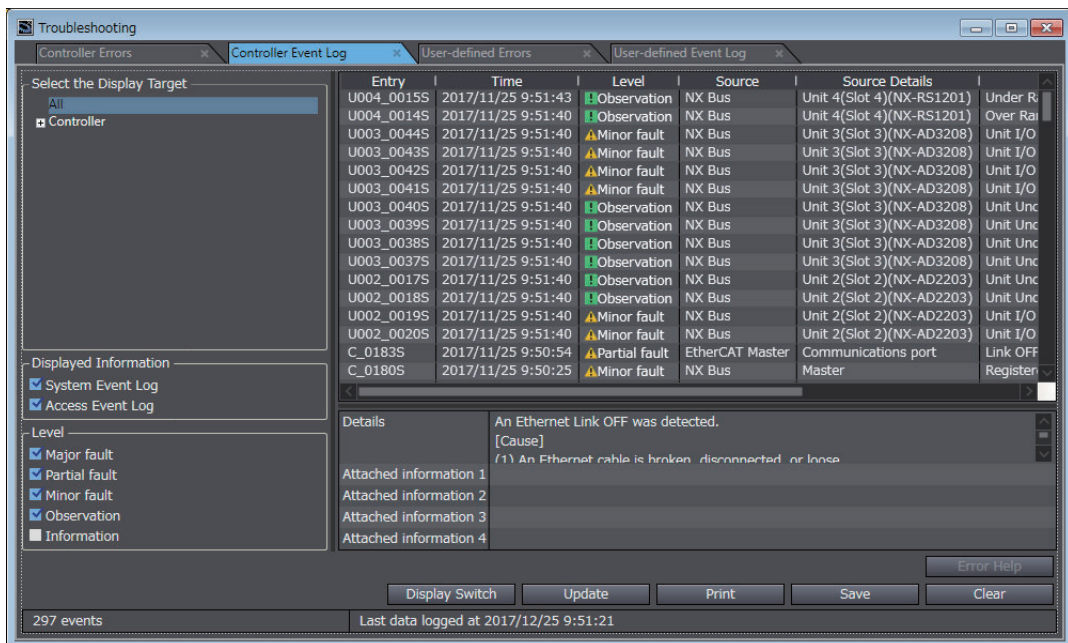

Resetting Errors with the Sysmac Studio

You can use the Sysmac Studio to reset errors that occur in a Controller.

Before you attempt to reset a Controller error, isolate and remove the cause of the error.

The Troubleshooting Dialog Box displays the cause, source, and corrections for the error. You can select any of the items from the error list to display the following information about that error.

Click the **Display Switch** Button to switch between displaying details and attached information and displaying actions and corrections.

Displayed item	Description
Details	Detailed information on the error is displayed, such as the probable causes.
Attached information 1 through 4	Detailed information about the source of the error is displayed.
Action and Correction	Methods to correct the probable causes of the error are displayed.

After confirming the cause of the displayed error and the conditions in which it occurred, perform the displayed error corrections to eliminate the cause of the error.

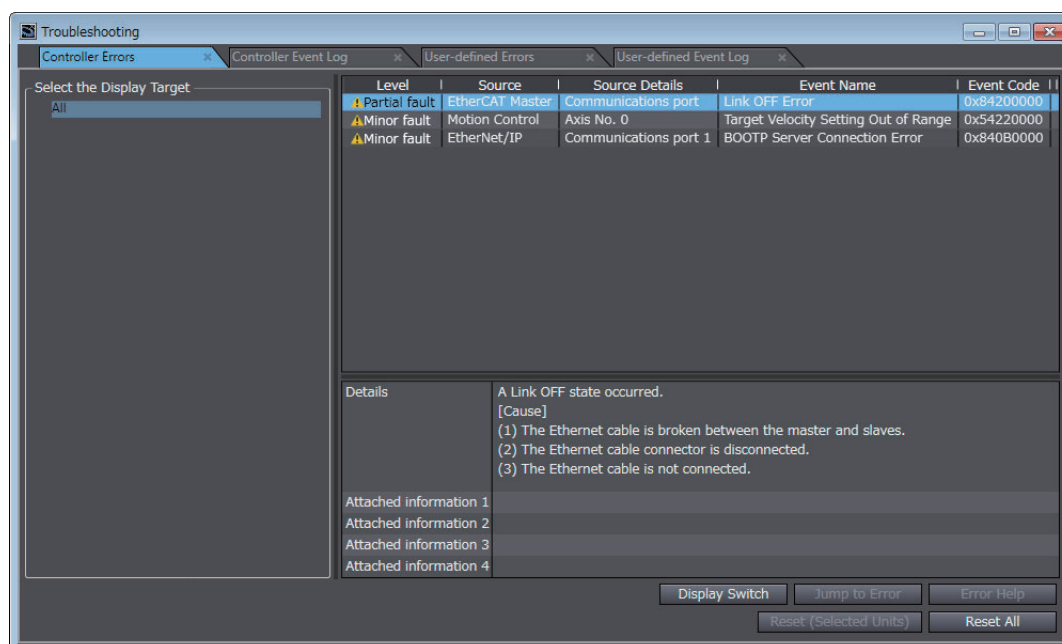

To eliminate the cause of the error, first select the item to perform from the Action and Correction list. When you select the appropriate step in the Action and Correction list, either the **Jump to Error** or **Error Help** Button is enabled, depending on the contents. In some cases, neither button will operate. Click the enabled button, and proceed with the displayed troubleshooting steps.

After you complete all of the troubleshooting steps for the current errors, click the **Reset (Selected Units)** or **Reset All** Button to reset all of the current errors.

If the cause of the error is not removed, or if the power supply is not cycled or the Controller is not reset as required after resetting the error, the error will occur again.

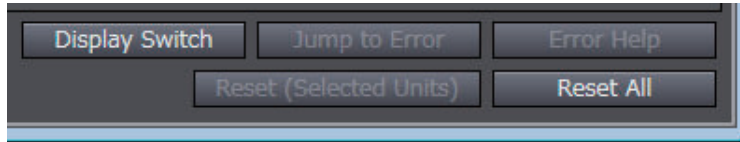

Button	Description
Jump to Error	This button is enabled when the error correction involves a change in the Sysmac Studio settings. When you click the button, the Sysmac Studio will automatically switch to the Editing Pane.
Error Help	The correction methods or the attached information is displayed if it is not possible to jump to the settings display.
Reset (Selected Units)	This button resets the current errors in the selected Unit.
Reset All	This button resets all of the current errors, and reads errors again.

It is necessary to synchronize the data between the Sysmac Studio and the connected Controller before you use the **Jump to Error** Button.

For details on synchronization, refer to the *Sysmac Studio Version 1 Operation Manual (Cat. No. W504)*.

If you have enabled the verification of operation authority, it is necessary to confirm your authority before you can reset Controller errors.

The Operator, Maintainer, Designer, and Administrator have the authority to reset errors. For an Operator, however, verification is required each time.

Refer to the *NY-series Industrial Panel PC / Industrial Box PC Software User's Manual (Cat. No. W558)* for information on operation authority.

The Controller errors in all function modules are reset when you reset the Controller from the Sysmac Studio.

If the cause of the error is not removed, the error will occur again.

2-3-2 Identifying and Resetting Errors with an HMI

You can connect an OMRON HMI to an NY-series Controller through an EtherNet/IP network, and use it to read and reset errors that occurred in the Controller. (The Troubleshooter of the HMI is used.) To perform troubleshooting from an HMI, connect the HMI to the built-in EtherNet/IP port on the Controller.



Precautions for Correct Use

- Refer to *A-4 Applicable Range of the HMI Troubleshooter* on page A-174 for the applicable range of the HMI Troubleshooter.
- On the HMI, the descriptions of events that are common to NY-series and NJ/NX-series Controllers are displayed as the descriptions of NJ/NX-series Controller. Therefore, it is necessary to interpret the displayed contents when your use an NY-series Controller. Refer to *Interpreting Description of Events When Using NY-series Controllers* on page 3-2 for how to interpret the contents.

Checking for Current Errors with an HMI

You can check for errors in the Controller using the Troubleshooter of an HMI. You can also use the Troubleshooter to read detailed error information and corrections for current errors. Refer to the relevant HMI manual for details on the HMI Troubleshooter.

The following example demonstrates the procedure used to check for errors with an NA-series HMI.

You can check the names and status of all connected Controllers in the Controller Status Screen of the NJ/NX Troubleshooter of the NA-series HMI. If there is an error, *Error* is displayed as the status of the Controller.

Controllers	Controller Event Status	User Event Status
new_Controller_0	Error	Normal
new_Controller_1	Normal	Normal

Select the Controller with an error and click the **Show Controller Events** Button to display the Controller Event List Screen. In the Controller Event List Screen, you can check the list of Controller errors that currently exist in the selected Controller.

NJ/NX Troubleshooter 5/13/2016 5:10:56 PM Exit

Active Events

Controller Events | User Events | Back

Event Source: All Change

Event Level	Event Source	Event Code	Event Name
Partial fault	EtherCAT - Communications port	0x84200000	Link OFF Error
Partial fault	EtherNet/IP - Communications port	0x84010000	IP Address Duplication Error
Minor fault	PLC	0x000B0000	Low Battery Voltage
Minor fault	EtherNet/IP - Communications port	0x84030000	DNS Server Connection Error

Screen Shot | Error Reset | Show Detail

RUN | new_Controller_0 (192.168.250.1)

Resetting Errors with an HMI

You can use the Troubleshooter in an HMI to reset errors that occur in the Controller. Before you attempt to reset a Controller error, identify and remove the cause of the error.

The following example demonstrates the procedure used to check for errors with an NA-series HMI.

Select an event in the Controller Event List Screen and click the **Show Detail** Button to display error causes and corrections. In the Details Screen, information such as the error causes and corrections are displayed.

After you confirm the cause of the displayed error, perform the steps in the displayed correction.

NJ/NX Troubleshooter 5/13/2016 5:11:46 PM

Event Name: IP Address Duplication Error Back

Event Code: 0x84010000 Date/Time: 5/13/2016 4:28:15 PM

Event Source: EtherNet/IP - Communications port

Event Level: Partial fault

Detailed Information

The same IP address is used more than once.
 [Cause]
 The IP address of the built-in EtherNet/IP port is also used as the IP address of another node.
 [Attached information 1]
 Duplicated IP address (example: 0xC0A8FA01 = address 192.168.250.1)

Attached Info 1: 0xC0A8FA01
 Attached Info 2:
 Attached Info 3:
 Attached Info 4:
 Screen Shot

RUN | new_Controller_0 (192.168.250.1)

After you complete all of the correction steps for the current errors, click the **Error Reset** Button in the Controller Event List Screen to reset all of the current errors.

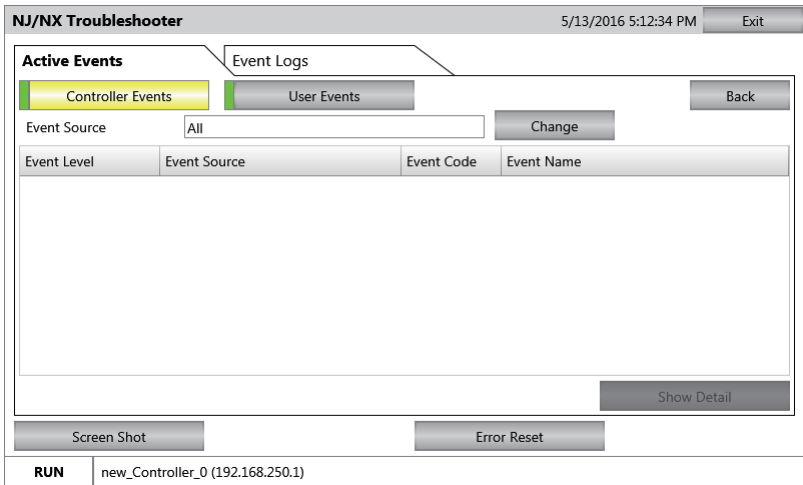

Return to the Controller Status Screen and check the Controller status. The status of the Controller whose errors were completely reset is displayed as “Normal”.

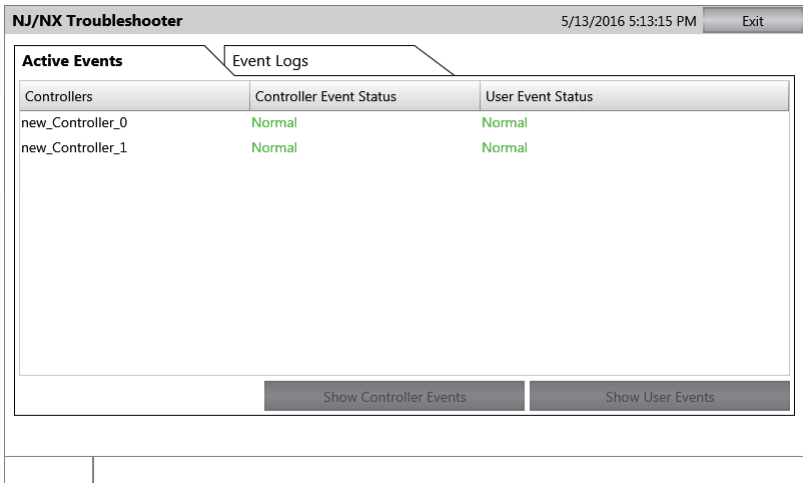

If the cause of the error is not removed, or if the power supply is not cycled or the Controller is not reset as required after resetting the error, the error will occur again.

Refer to the relevant HMI manual for details on the HMI Troubleshooter.

2-3-3 Identifying and Resetting Errors from the User Program

In a controller, you can check for errors that have occurred from the user program. This feature allows you to program operations in the user program according to the error status. Special instructions are provided for this purpose.

These include instructions to get Controller error information and instructions to reset Controller errors.

Instructions That Get Controller Error Information

Determine the error status with the instruction to get error information that is provided for each function module.

The following table lists the instruction that are used to get error information for each function module.

Instruction name	Instruction	Function
Get PLC Controller Error Status	GetPLCError	Gets the status and the event code of the error with the highest level of the Controller errors in the PLC Function Module.
Get Motion Control Error Status	GetMCErr	Gets the status and the event code of the error with the highest level of the Controller errors in the Motion Control Function Module.
Get EtherNet/IP Error Status	GetEIPError	Gets the status and the event code of the error with the highest level of the Controller errors in the EtherNet/IP Function Module.
Get EtherCAT Error Status	GetECErr	Gets the status and the event code of the error with the highest level of the communications port errors and master errors detected by the EtherCAT Master Function Module.

Refer to *NY-series Instructions Reference Manual (Cat. No. W560)* for details on these instructions.

Example of Error Detection for the EtherCAT Master Function Module

Name	Data type	Initial value	Comment
Trigger	BOOL	FALSE	Get Condition
EC_Error	BOOL	FALSE	EtherCAT Master Error Flag

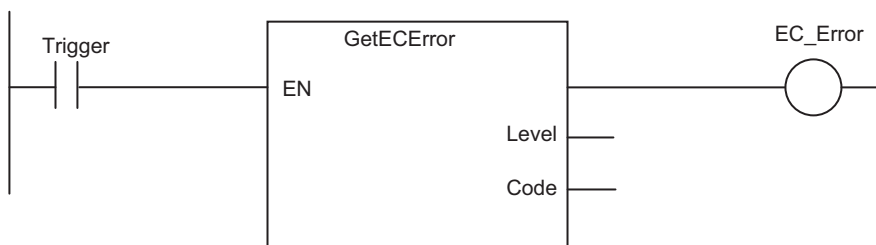

Resetting Controller Errors with Instructions

You can use the instructions that are provided to reset errors in the user program to reset errors that occur in the Controller.

Before you attempt to reset a Controller error, isolate and remove the cause of the error.

Reset the errors with the instruction provided to reset errors for each function module.

Instruction name	Instruction	Function
Reset PLC Controller Error	ResetPLCError	Resets current Controller errors from the PLC Function Module.
Reset Motion Control Error	ResetMCErr	Resets current Controller errors from the Motion Control Function Module.
Reset EtherCAT Error	ResetECErr	Resets current Controller errors from the EtherCAT Master Function Module.

Refer to the *NY-series Instructions Reference Manual (Cat. No. W560)* for details on these instructions.

2-3-4 Checking for Errors with System-defined Variables

The system-defined variables include an Error Status variable, which shows the error status in a hierarchical structure. The system determines the error status of each level by logically ORing the error status information of the next lower level.

You can read the Error Status variable from an external device through communications.

Refer to the *NY-series Industrial Panel PC / Industrial Box PC Software User's Manual (Cat. No. W558)* for information on system-defined variables.

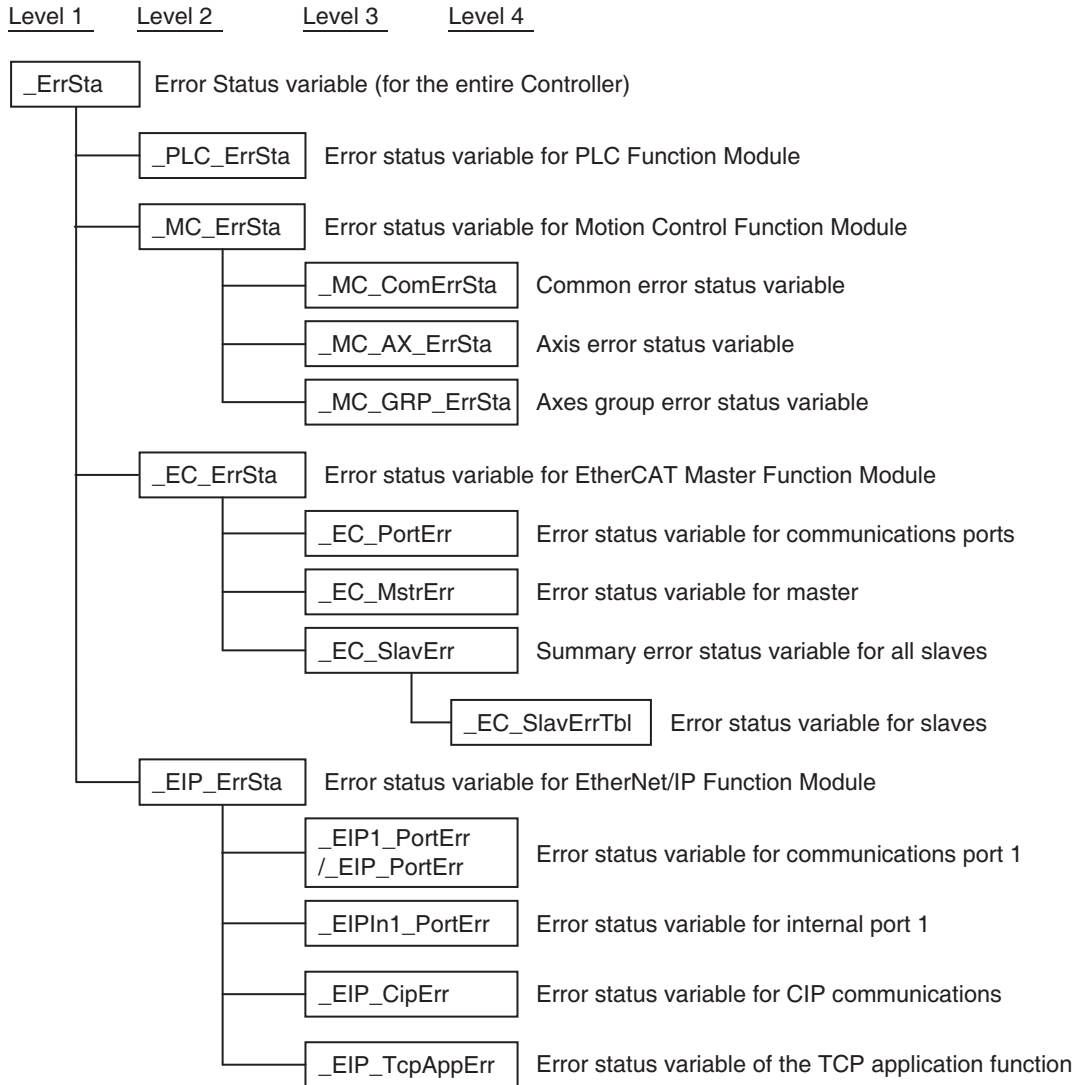

2-4 Troubleshooting When You Cannot Go Online from the Sysmac Studio

The section describes the procedure to troubleshoot when you cannot go online with the Controller from the Sysmac Studio.

2-4-1 Causes and Correction When You Cannot Go Online from the Sysmac Studio

The following table lists the possible causes when you cannot go online with the Controller from the Sysmac Studio.

Cause	Description	Correction
Incorrect settings or faulty communications path	There is a mistake in the settings that the Sysmac Studio uses to go online with the Controller. Or, the communications path is faulty.	Refer to <i>Troubleshooting Incorrect Settings and Faulty Communications Path</i> on page 2-18 in 2-4-2 <i>Troubleshooting for Each Cause</i> on page 2-17
Fatal error in the Controller	A fatal error occurred in the Controller.	Refer to 2-1-1 <i>Flowchart to Check Operation of NY-series Controller</i> on page 2-2.
Errors in the EtherNet/IP Function Module	An error occurred in the EtherNet/IP Function Module.	Refer to 2-1-2 <i>Flowchart to Check Error Status on EtherNet/IP Function Module</i> on page 2-3.

You can use the status of the RUN indicator on the Controller to isolate the cause. Implement the troubleshooting for the applicable cause.

○ : Cause

RUN RED	Causes	
	Incorrect settings or faulty communications path	Fatal error in the NY-series Controller
● No lit.	○	○
⊙ Flashing at 2-s intervals or 0.5-s intervals.	---	○*1
○ Lit.	○	---

*1. If the ERR indicator is lit at the same time or if the RUN indicator flashes at a 2-second interval for more than 30 seconds, a fatal NY-series Controller error has occurred.

2-4-2 Troubleshooting for Each Cause

This section provides troubleshooting methods for incorrect settings and fault communications paths.

Troubleshooting Incorrect Settings and Faulty Communications Path

- **Direct Connection with EtherNet/IP Port**

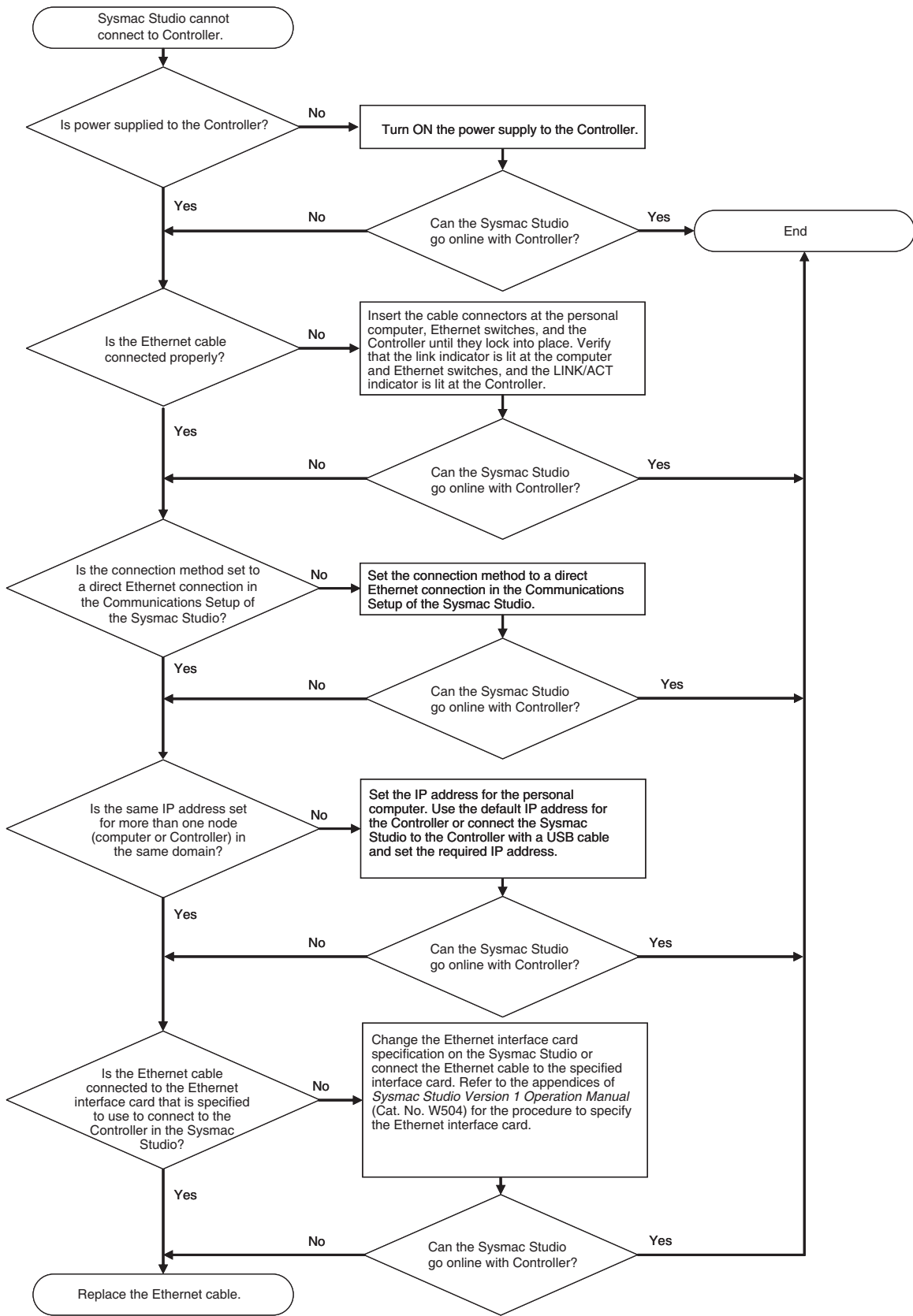

● Ethernet Hub Connection

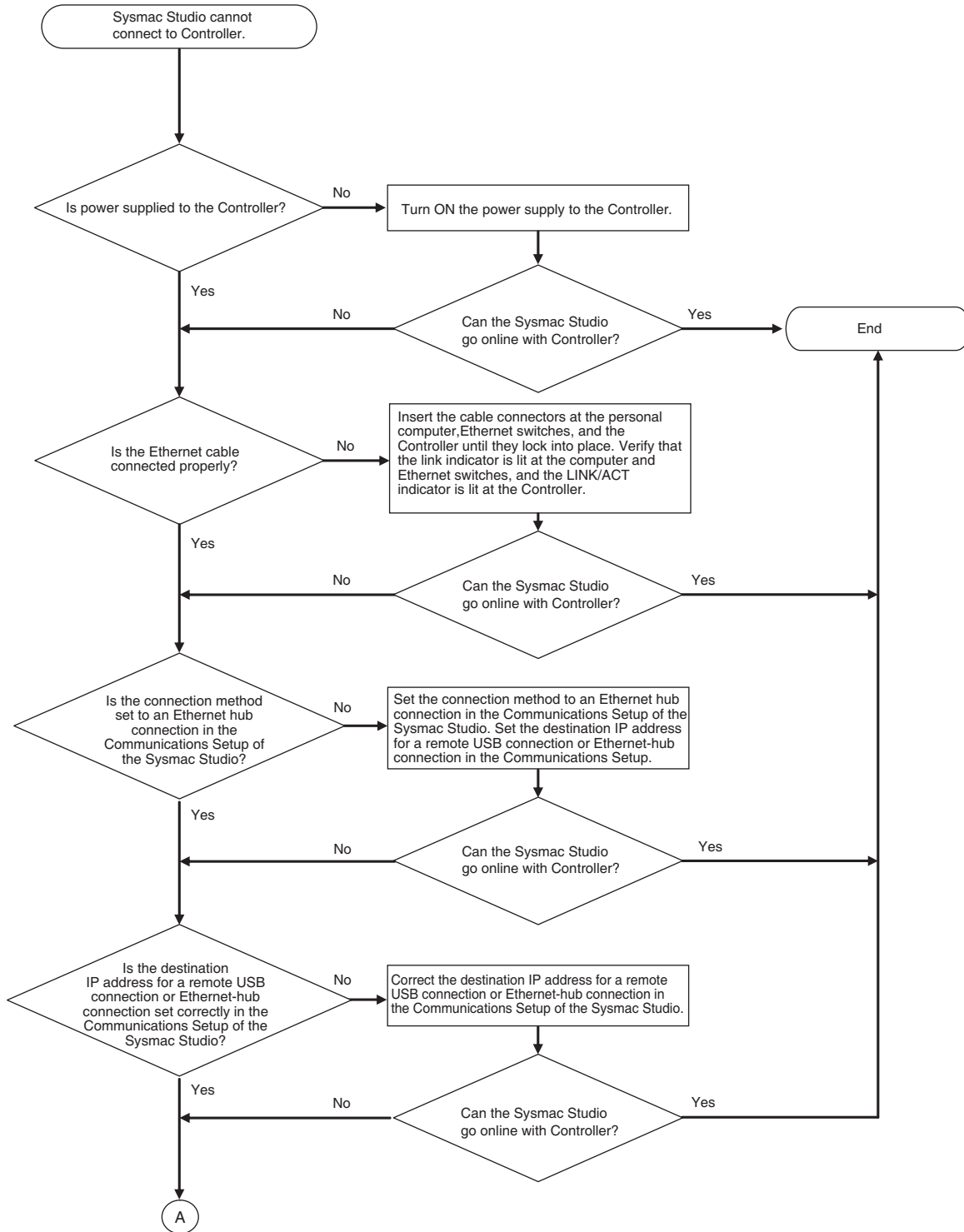

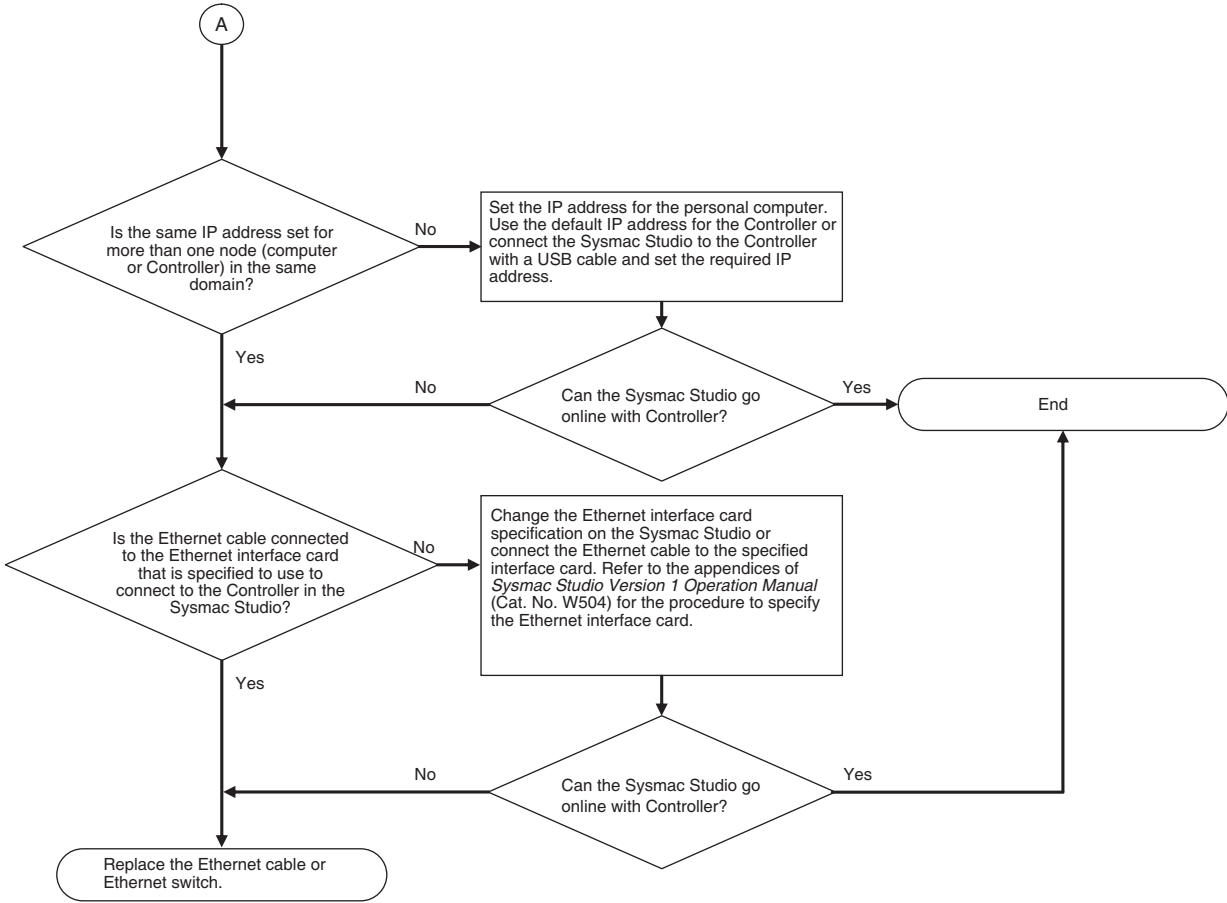

3

Error Descriptions and Corrections

This section describes all of the errors (events) that can occur on NY-series Controllers and corrections for these errors.

For errors (events) that can occur in models other than the standard Controllers and the errors (events) that can occur in connected devices, only tables of errors are provided in *Appendix* on page A-1. Refer to the manual for the specific product for details on errors.

3-1	Interpreting Tables	3-2
3-1-1	Interpreting Error Table.....	3-3
3-1-2	Interpreting Error Descriptions	3-4
3-2	Errors in the PLC Function Module	3-5
3-2-1	Error Tables	3-5
3-2-2	Error Descriptions.....	3-59
3-2-3	Other Troubles and Corrections	3-271
3-3	Errors in the Motion Control Function Module.....	3-273
3-3-1	Error Tables	3-273
3-3-2	Error Descriptions.....	3-311
3-3-3	Other Troubles and Corrections	3-446
3-4	Errors in the EtherNet/IP Function Module.....	3-451
3-4-1	Error Tables	3-451
3-4-2	Error Descriptions.....	3-456
3-4-3	Other Troubles and Corrections	3-483
3-5	Errors in the EtherCAT Master Function Module	3-484
3-5-1	Error Tables	3-484
3-5-2	Error Descriptions.....	3-491

3-1 Interpreting Tables

Within each source, errors (events) are given by functional classifications. Also, events that are not errors are given.



Additional Information

For descriptions of the error codes for the motion control instructions and other instructions, refer to the descriptions of the corresponding event codes. Events that occur for motion control instructions are given in *3-2 Errors in the PLC Function Module* on page 3-5. Events that occur for other instructions are given in *3-3 Errors in the Motion Control Function Module* on page 3-273. Refer to *Relationship between Event Codes and Error Codes* on page 1-18 for the relationship between event codes and error codes.

● Interpreting Description of Events When Using NY-series Controllers

On the Sysmac Studio, the descriptions of events that are common to NY-series Controllers and NJ/NX-series Controllers are displayed as the descriptions of NJ/NX-series Controllers. Therefore, it is necessary to interpret the displayed contents when you use an NY-series Controller. Note the following conditions.

- You cannot connect a CJ-series Unit with NY-series Controllers. In the instructions, skip items related to CJ-series Units.
- In explanation of the errors, replace the term “CPU Unit” with “NY-series Controller” or “NY-series Industrial PC.”
- NY-series Controllers have no SD Memory Card slots. Instead, they provide the Virtual SD Memory Card function that uses the Windows shared folder. Therefore, replace the term “SD Memory Card” with “Virtual SD Memory Card.” Refer to the *NY-series Industrial Panel PC / Industrial Box PC Setup User’s Manual (Cat. No. W568)* for details on the Virtual SD Memory Card function.
- NY-series Controllers do not have the SD PWR and SD BUSY indicators. In the instructions, skip items related to the SD PWR and SD BUSY indicators.
- NY-series Controllers do not have the RUN, ERR, and LINK/ACT indicators for EtherCAT. In the instructions, skip items related to the RUN, ERR and LINK/ACT indicators for EtherCAT.
- Replace the NJ/NX-series manuals with the NY-series manuals in the Reference column.
- The unit version of the NY-series Controller is 1.12 or later. If the description of an event contains information for the relevant unit versions, read the part that is related to the relevant unit versions.

3-1-1 Interpreting Error Table

The contents of the error tables are described below.

Item	Description
Event code	The event code of the error in the NY-series Controller is given. The codes are given in eight hexadecimal digits.
Event name	The name of the error is given
Meaning	A short description of the error is given.
Assumed cause	The assumed cause of the error is given
Level	<p>The level of influence on control is given.</p> <p>The abbreviations have the following meanings.</p> <p>Maj: Major fault level Prt: Partial fault level Min: Minor fault level Obs: Observation Info: Information</p> <p>The symbols have the following meanings.</p> <p>○: Event levels that are defined by the system. ⊙: Event levels that can be changed by the user. *1</p>
Reference	The catalog number of the manual that provides details on the event is given. The manual name that corresponds to the manual number is given before each error table.

*1. This symbol appears only for events for which the user can change the event level.

3-1-2 Interpreting Error Descriptions

The items that are used to describe individual errors (events) are described in the following copy of an error table.

Event name	Gives the name of the error.		Event code	Gives the code of the error.		
Meaning	Gives a short description of the error.					
Source	Gives the source of the error.		Source details	Gives details on the source of the error.	Detection timing	Tells when the error is detected.
Error attributes	Level	Tells the level of influence on control. *1	Recovery	Gives the recovery method. *2	Log category	Tells which log the error is saved in. *3
Effects	User program	Tells what will happen to execution of the user program. *4	Operation	Provides special information on the operation that results from the error.		
Indicators/ Status	Gives the status you can check with the built-in EtherCAT port indicators or the Industrial PC Support Utility for the built-in EtherNet/IP port. Indicator status is given only for errors in the EtherCAT Master Function Module and the EtherNet/IP Function Module.					
System-defined variables	Variable	Data type		Name		
	Lists the variable names, data types, and meanings for system-defined variables that provide direct error notification, that are directly affected by the error, or that contain settings that cause the error.					
Cause and correction	Assumed cause	Correction		Prevention		
	Lists the possible causes, corrections, and preventive measures for the error.					
Attached information	This is the attached information that is displayed by the Sysmac Studio or an HMI. *5					
Precautions/ Remarks	Provides precautions, restrictions, and supplemental information. If the user can set the event level, the event levels that can be set, the recovery method, operational information, and other information is also provided.					

*1. One of the following:

Major fault: Major fault level

Partial fault: Partial fault level

Minor fault: Minor fault level

Observation

Information

*2. After the correction is performed, one of the following methods is used to reset the Controller error state:

Automatic recovery: Normal status is restored automatically when the cause of the error is removed.

Error reset: Normal status is restored when the error is reset after the cause of the error is removed.

Cycle the power supply: Normal status is restored when the power supply to the Controller is turned OFF and then back ON after the cause of the error is removed.

Controller reset: Normal status is restored when the Controller is reset after the cause of the error is removed.

Depends on cause: The recovery method depends on the cause of the error.

*3. One of the following:

System: System event log

Access: Access event log

*4. One of the following:

Continues: Execution of the user program will continue.

Stops: Execution of the user program stops.

Starts: Execution of the user program starts.

*5. Refer to *A-4 Applicable Range of the HMI Troubleshooter* on page A-174 for the applicable range of the HMI Troubleshooter.

3-2 Errors in the PLC Function Module

The section provides tables of the errors (events) that can occur in the PLC Function Module. They are divided into the following functional classifications.

- Self-diagnosis
- Tasks
- Controller operation
- Instructions



Additional Information

- To create instruction events, you must select **Use** for **Event Log Settings - Instruction Error Output** on the Controller Setup. With the default setting, instructions events are not output.

3-2-1 Error Tables

Errors for Self Diagnosis

Event code	Event name	Meaning	Assumed cause	Level					Reference
				M a j	P r t	M i n	O b s	I n f o	
000D0000 hex	Internal Bus Check Error	A fatal error was detected on the internal bus.	<ul style="list-style-type: none"> • A conductive material has gotten inside. • Noise • The CPU Unit has failed. 	○					page 3-59
000E0000 hex	Non-volatile Memory Life Exceeded	The specified number of deletions for non-volatile memory was exceeded. Or, the number of bad blocks in memory exceeded the specified value.	<ul style="list-style-type: none"> • Non-volatile memory life expired. 	○					page 3-60
00110000 hex	CPU Unit Overheat (Operation Stopped)	Operation was stopped because the temperature inside the CPU Unit was too high.	<ul style="list-style-type: none"> • The ambient operating temperature is too high. 	○					page 3-60
10010000 hex	Non-volatile Memory Restored or Formatted	An error was detected in the non-volatile memory check and file system recovery or formatting was executed. Previous files may have been deleted.	<ul style="list-style-type: none"> • The Controller power supply was turned OFF while the BUSY indicator was lit. • The power supply to the Controller was interrupted momentarily while the BUSY indicator was lit. 	○					page 3-61

Event code	Event name	Meaning	Assumed cause	Level					Reference
				M a j	P r t	M i n	O b s	I n f o	
10020000 hex	Non-volatile Memory Data Corrupted	A file that must be in non-volatile memory is missing or corrupted.	<ul style="list-style-type: none"> The Controller power supply was turned OFF while the BUSY indicator was lit. The power supply to the Controller was interrupted momentarily while the BUSY indicator was lit. The CPU Unit has failed. 	○					page 3-62
10080000 hex	Main Memory Check Error	An error was detected in the memory check of the main memory in the CPU Unit.	<ul style="list-style-type: none"> A conductive material has gotten inside. Noise There is a software error. The CPU Unit has failed. 	○					page 3-63
100B0000 hex	Non-volatile Memory Data Corrupted	A file that must be in non-volatile memory is missing or corrupted.	<ul style="list-style-type: none"> The Controller power supply was turned OFF while the BUSY indicator was lit. The power supply to the Controller was interrupted momentarily while the BUSY indicator was lit. The CPU Unit has failed. 	○					page 3-64
100C0000 hex	Event Level Setting Error	The settings in the event level setting file are not correct.	<ul style="list-style-type: none"> The event level settings are not correct because the power supply to the Controller was interrupted or communications with the Sysmac Studio were disconnected during a download of the event level settings. The event level settings are not correct because the power supply to the Controller was interrupted during a Clear All Memory operation. Non-volatile memory failed. 	○					page 3-65
100F0000 hex	Present Values of Retained Variables Restoration Error	An error occurred in the software and the present values of retained variables could not be restored at startup.	An error occurred in the software.	○					page 3-66
10100000 hex	Present Values of Retained Variables Not Saved	A forced shutdown is performed or an error occurred in the software and the present values of retained variables could not be saved during power-OFF processing.	<ul style="list-style-type: none"> A forced shutdown is performed. (NY-series Controllers) An error occurred in the software. 	○					page 3-67

Event code	Event name	Meaning	Assumed cause	Level					Reference
				M a j	P r t	M i n	O b s	I n f o	
10120000 hex	Firmware Configuration Mismatch	An inconsistency was detected in the software which configures the firmware.	<ul style="list-style-type: none"> The firmware upgrade is not completed. The firmware was partially restored using the Rescue disk. The storage device was replaced. 	○					page 3-68
40030000 hex	PLC System Processing Error	A fatal error was detected in the PLC Function Module.	<ul style="list-style-type: none"> An error occurred in the software. 	○					page 3-68
40040000 hex	PLC System Processing Error	A fatal error was detected in the PLC Function Module.	<ul style="list-style-type: none"> An error occurred in the software. 	○					page 3-69
000B0000 hex	Low Battery Voltage	The voltage of the Battery has dropped.	<ul style="list-style-type: none"> The battery voltage is low. The battery connector has come loose. The Battery is missing. 			○	○		page 3-69
000C0000 hex	CPU Unit Overheat	The temperature inside the CPU Unit exceeded the specified value.	<ul style="list-style-type: none"> The ambient operating temperature is too high. 			○			page 3-70
00120000 hex	Slow Fan	The speed of the fan dropped to a specified level or lower.	<ul style="list-style-type: none"> Something is interfering with fan operation, such as dust, wire scraps, or cuttings. The fan has reached the end of its service life. The fan is faulty. 			○	○		page 3-70
100E0000 hex	Shared Folder Access Power OFF Error	The power supply to the Controller was interrupted during access to the shared folder was in progress.	<ul style="list-style-type: none"> The Controller power supply was turned OFF while access to the file was in progress. The power supply to the Controller was interrupted momentarily while access to the file was in progress. 				○		page 3-71
90220000 hex	UPS Battery Operation Started	The USP battery operation was started.	The power was interrupted while a UPS is connected.					○	page 3-71

Errors Related to Tasks

Event code	Event name	Meaning	Assumed cause	Level					Reference
				M a j	P r t	M i n	O b s	I n f o	
60020000 hex	Task Execution Timeout	Task execution exceeded the timeout detection time.	<ul style="list-style-type: none"> The timeout detection time setting is too short. The task period setting is too short. A user program is too large. The number of times that processing is repeated is larger than expected. Task Priority Error Frequent Event Task Execution 	○					page 3-72
60030000 hex	I/O Refreshing Timeout Error	Consecutive I/O refresh failures occurred during the primary periodic task or periodic task period.	<ul style="list-style-type: none"> The task period setting is too short. Task Priority Error for Periodic Tasks and Event Tasks There are too many Units and slaves that perform I/O refresh in the task period. Frequent Event Task Execution 	○					page 3-73
60010000 hex	Task Period Exceeded	Task execution was not completed during the set task period for the primary periodic task or a periodic task.	<ul style="list-style-type: none"> The task period setting is too short. A user program is too large. The number of times that processing is repeated is larger than expected. Task Priority Error for Periodic Tasks and Event Tasks Frequent Event Task Execution 			○			page 3-74
60050000 hex	Task Period Exceeded	Task execution was not completed during the set task period for the primary periodic task or fixed periodic task.	<ul style="list-style-type: none"> The task period setting is too short. A user program is too large. The number of times that processing is repeated is larger than expected. Task Priority Error for Periodic Tasks and Event Tasks Frequent Event Task Execution 				○		page 3-75

Errors Related to Controller Operation

Event code	Event name	Meaning	Assumed cause	Level					Reference
				M a j	P r t	M i n	O b s	I n f o	
10200000 hex	User Program/ Controller Configurations and Setup Transfer Error	The user program or Controller Configurations and Setup were not transferred correctly.	<ul style="list-style-type: none"> The user program or Controller Configurations and Setup are not correct because the power supply to the Controller was interrupted during a download of the user program or the Controller Configurations and Setup. The user program or Controller Configurations and Setup are not correct because the power supply to the Controller was interrupted during online editing. The user program or Controller Configurations and Setup are not correct because the power supply to the Controller was interrupted during a Clear All Memory operation. The user program or Controller Configurations and Setup are not correct because the power supply to the Controller was interrupted during a restore operation. Non-volatile memory failed. 	○					page 3-76
10210000 hex	Illegal User Program Execution ID	The user program execution IDs set in the user program and in the CPU Unit do not match.	<ul style="list-style-type: none"> The user program execution IDs set in the user program and in the CPU Unit do not match. A user program execution ID is set in the CPU Unit but not in the user program. 	○					page 3-77
10240000 hex	Illegal User Program	The user program is not correct.	<ul style="list-style-type: none"> There are more than 8 nesting levels for functions or function blocks. 	○					page 3-77
10250000 hex	Illegal User Program/ Controller Configurations and Setup	The upper limit of the usable memory was exceeded or the user program or Controller Configurations and Setup is corrupted.	<ul style="list-style-type: none"> The upper limit of the data size was exceeded. The main memory capacity was exceeded. Non-volatile memory is deteriorating or has failed. 	○					page 3-78
40110000 hex	PLC Function Processing Error	A fatal error was detected in the PLC Function Module.	<ul style="list-style-type: none"> An error occurred in the software. 	○					page 3-79
44420000 hex	PLC Function Processing Error	A fatal error was detected in the PLC Function Module.	<ul style="list-style-type: none"> An error occurred in the software. 	○					page 3-79

Event code	Event name	Meaning	Assumed cause	Level					Reference
				M a j	P r t	M i n	O b s	I n f o	
40120000 hex	PLC Function Processing Error	A fatal error was detected in the PLC Function Module.	<ul style="list-style-type: none"> An error occurred in the software. 		○				page 3-80
40130000 hex	PLC Function Processing Error	A fatal error was detected in part of the PLC Function Module.	<ul style="list-style-type: none"> An error occurred in the software. 			○			page 3-80
10230000 hex	Event Log Save Error	Saving the event log failed.	<ul style="list-style-type: none"> A low battery voltage prevented retention of memory during a power interruption. (NJ/NX-series) A forced shutdown is performed. (NY-series Controllers) Data in the event log area are invalid. (NY-series) Data in the event log area are invalid. 				○		page 3-81
10260000 hex	Trace Setting Transfer Failure	The power supply was interrupted while transferring the trace settings.	<ul style="list-style-type: none"> The power supply was interrupted while transferring the trace settings. 				○		page 3-81
10350000 hex	Backup Failed to Start	An error was detected in preexecution checks for a backup operation.	<ul style="list-style-type: none"> The shared folder is not recognized. The Prohibiting backing up data to the SD Memory Card parameter is set to <i>prohibit</i> backing up data to an SD Memory Card. Another backup operation is in progress. Synchronization, online editing, or the Clear All Memory operation is in progress. The backup was canceled by the user. The online connection with the Sysmac Studio was disconnected. It was not possible to recognize the shared folder because of the following reasons: Windows storage failure, erroneous operation or fault of Windows. 				○		page 3-82

Event code	Event name	Meaning	Assumed cause	Level					Reference
				M a j	P r t	M i n	O b s	I n f o	
10360000 hex	Backup Failed	The backup operation ended in an error.	<ul style="list-style-type: none"> It was not possible to access the shared folder due to the following causes. <ul style="list-style-type: none"> There is no authority for writing to the shared folder in an account for the Controller. The shared folder recognition was canceled during a backup operation. For the assumed causes of canceling the recognition, refer to the following event: Shared Folder Recognition Cancel Completed (103B0000 hex). The partition in which the shared folder is stored lacks sufficient capacity. The number of files or directories in the shared folder exceeded the maximum number. Execution of the Save Cam Table instruction or changing the CPU Unit name is in progress. A file already exists with the same name as the specified directory. It was not possible to save the backup data because the shared folder recognition was canceled during the backup operation. A slave backup operation failed. The backup was canceled by the user. The online connection with the Sysmac Studio was disconnected. It was not possible to save the data that was specified for backup to the computer. 					○	page 3-84

Event code	Event name	Meaning	Assumed cause	Level					Reference
				M a j	P r t	M i n	O b s	I n f o	
10370000 hex	Restore Operation Failed to Start	An error was detected in preexecution checks for a restore operation.	<ul style="list-style-type: none"> Either the backup files in the shared folder are corrupted or required data is not in the backup files in the shared folder. The unit version of the CPU Unit to which to restore the files is older than the unit version of the backup files in the shared folder. The model of the CPU Unit to which to restore the files is not the same as the model of the CPU Unit of the backup files in the shared folder. The CPU Unit is write-protected. Another backup operation is in progress. Synchronization, online editing, or the Clear All Memory operation is in progress. The online connection with the Sysmac Studio was disconnected. 				○		page 3-87
10380000 hex	Restore Operation Failed	The restore operation ended in an error.	<ul style="list-style-type: none"> The backup files are corrupted. Failed to restore a slave. 				○		page 3-88
10390000 hex	Shared Folder Recognition Failed	It was not possible to recognize the shared folder.	<ul style="list-style-type: none"> The Controller cannot access the shared folder due to the reasons of Windows. The Controller cannot access the shared folder because the network segment of the IP address for the internal port of Windows differs from that for the internal port on the Controller. The Controller cannot access the shared folder because the items specified by the Virtual SD Memory Card settings on the Controller differ from the settings for Windows. The Controller failed to be authorized to log on to the shared folder because the user name or password specified by the Virtual SD Memory Card settings on the Controller differs from the settings for Windows. 				○		page 3-89

Event code	Event name	Meaning	Assumed cause	Level					Reference
				M a j	P r t	M i n	O b s	I n f o	
103A0000 hex	Shared Folder Recognition Cancel Failed	It was not possible to cancel the shared folder recognition.	<ul style="list-style-type: none"> The Virtual SD Memory Card settings were changed while access to the shared folder is in progress. 				○		page 3-90
103B0000 hex	Shared Folder Recognition Cancel Completed	The shared folder recognition was canceled.	<ul style="list-style-type: none"> The Virtual SD Memory Card settings were updated. Therefore, the shared folder recognition which was based on the previous Virtual SD Memory Card settings was canceled. File sharing was canceled. 				○		page 3-91
40140000 hex	PLC System Information	This event provides internal information from the PLC Function Module.	<ul style="list-style-type: none"> This event provides internal information from the PLC Function Module. It is recorded to provide additional information for another event. 				○		page 3-92
40170000 hex	Safe Mode	The Controller started in Safe Mode.	<ul style="list-style-type: none"> The Controller started in Safe Mode. 				○		page 3-92
44600000 hex	OS Processing Error	An error was detected on Windows.	<ul style="list-style-type: none"> A software error occurred on Windows to stop operations. 				○		page 3-93
80230000 hex	NX Message Communications Error	An error has occurred in message communications.	<ul style="list-style-type: none"> The communications cable is broken. The communications cable connector is disconnected. The NX message communications load is high. 				○		page 3-93
40150000 hex	PLC System Information	This event provides internal information from the PLC Function Module.	<ul style="list-style-type: none"> This event provides internal information from the PLC Function Module. It is recorded to provide additional information for another event. 				○		page 3-94
44430000 hex	PLC System Information	This event provides internal information from the PLC Function Module.	<ul style="list-style-type: none"> This event provides internal information from the PLC Function Module. It is recorded to provide additional information for another event. 				○		page 3-94
90050000 hex	User Program/Controller Configurations and Setup Downloaded	The user program and the Controller configurations and setup were downloaded.	<ul style="list-style-type: none"> The user program and the Controller configurations and setup were downloaded. 				○		page 3-95
90070000 hex	Online Edits Transferred	The user program was edited online.	<ul style="list-style-type: none"> The user program was edited online and the edits were transferred to the Controller. 				○		page 3-95
90080000 hex	Variable Changed to TRUE with Forced Refreshing	Changing a variable to TRUE with forced refreshing was specified.	<ul style="list-style-type: none"> Changing a variable to TRUE with forced refreshing was specified by the user. 				○		page 3-96

Event code	Event name	Meaning	Assumed cause	Level					Reference
				M a j	P r t	M i n	O b s	I n f o	
90090000 hex	Variable Changed to FALSE with Forced Refreshing	Changing a variable to FALSE with forced refreshing was specified.	• Changing a variable to FALSE with forced refreshing was specified by the user.					○	page 3-96
900A0000 hex	All Forced Refreshing Cleared	Clearing all forced refreshing values was specified.	• Clearing all forced refreshing values was specified by the user.					○	page 3-97
900B0000 hex	Memory All Cleared	All memory was cleared.	• A user with Administrator rights cleared all of the memory.					○	page 3-97
900C0000 hex	Event Log Cleared	The event log was cleared.	• The event log was cleared by the user.					○	page 3-97
90110000 hex	Power Turned ON	The power supply was turned ON.	• The power supply was turned ON.					○	page 3-98
90120000 hex	Power Interrupted	The power supply was interrupted.	• The power supply was interrupted.					○	page 3-98
90130000 hex	Operation Started	Operation was started.	• A command to start operation was received.					○	page 3-98
90140000 hex	Operation Stopped	Operation was stopped.	• A command to stop operation was received.					○	page 3-99
90150000 hex	Reset Executed	A reset was executed.	• A reset command was received.					○	page 3-99
90160000 hex	User Program Execution ID Write	The user program execution ID was set or changed in the CPU Unit.	• A user with Administrator rights changed the user program execution ID that is set in the CPU Unit.					○	page 3-99
90180000 hex	All Controller Errors Cleared	All current errors were cleared.	• The user cleared all current errors.					○	page 3-100
90190000 hex	Forced Refreshing Cleared	Clearing a forced refreshing value was specified.	• Clearing a forced refreshing value was specified by the user.					○	page 3-100
90230000 hex	Forced Shutdown	A forced shutdown was used by the user to finish the system.	• A forced shutdown was used by the user to finish the system.					○	page 3-100
90240000 hex	Backup Started	A backup operation was started.	• A backup operation was started.					○	page 3-101
90250000 hex	Backup Completed	The backup operation ended normally.	• The backup operation ended normally.					○	page 3-101
90260000 hex	Restore Operation Started	A restore operation started.	• A restore operation started.					○	page 3-102
90270000 hex	Restore Operation Completed	The restore operation ended normally.	• The restore operation ended normally.					○	page 3-102
90280000 hex	Shared Folder Recognition Completed	The shared folder was recognized.	• The shared folder was recognized.					○	page 3-103

Event code	Event name	Meaning	Assumed cause	Level					Reference
				M a j	P r t	M i n	O b s	I n f o	
95700000 hex	OS Started	Windows is started up.	<ul style="list-style-type: none"> An Industrial PC was started. Windows was restarted by an instruction. Windows was restarted by Windows operation. 					○	page 3-104
95710000 hex	OS Shut Down	Windows was shut down.	<ul style="list-style-type: none"> An Industrial PC was shut down. Windows was restarted by an instruction. Windows was restarted by Windows operation. 					○	page 3-104

Instructions

This section provides a table of errors (events) that occur for instructions. The lower four digits of the event code represent the error code (ErrorID) for the instruction. For descriptions of an error code, refer to the description of the corresponding event code. For example, if the error code of the instruction is 16#0400, refer to the description of event code 54010400 hex.

Event code	Event name	Meaning	Assumed cause	Level					Reference
				M a j	P r t	M i n	O b s	I n f o	
54010400 hex	Input Value Out of Range	An input parameter for an instruction exceeded the valid range for an input variable. Or, division by an integer of 0 occurred in division or remainder calculations.	<ul style="list-style-type: none"> An input parameter for an instruction exceeded the valid range for an input variable. Or, division by an integer of 0 occurred in division or remainder calculations. 				○		page 3-105
54010401 hex	Input Mismatch	The relationship for the instruction input parameters did not meet required conditions. Or, a numeric value during or after instruction execution did not meet conditions.	<ul style="list-style-type: none"> The relationship for an input parameter did not meet required conditions. A value when processing an instruction or in the result does not meet the conditions. 				○		page 3-106
54010402 hex	Floating-point Error	Non-numeric data was input for a floating-point number input parameter to an instruction.	<ul style="list-style-type: none"> Non-numeric data was input for a floating-point number input parameter to an instruction. 				○		page 3-106
54010403 hex	BCD Error	A value that was not BCD was input for a BCD input parameter to an instruction.	<ul style="list-style-type: none"> A hexadecimal digit of A, B, C, D, E, or F was input for a BCD input parameter to an instruction. 				○		page 3-107

Event code	Event name	Meaning	Assumed cause	Level					Reference
				M a j	P r t	M i n	O b s	I n f o	
54010404 hex	Signed BCD Error	An illegal value was input for the most significant digit for a signed BCD input parameter to an instruction.	<ul style="list-style-type: none"> An illegal value was input for the most significant digit for a signed BCD input parameter to an instruction. The most-significant digit was 2 to F when <code>_BCD0</code> was specified as the BCD format. The most-significant digit was A, B, C, D, or E when <code>_BCD2</code> was specified as the BCD format. The most-significant digit was B, C, D, or E when <code>_BCD3</code> was specified as the BCD format. 				○		page 3-108
54010405 hex	Illegal Bit Position Specified	The bit position specified for an instruction was illegal.	<ul style="list-style-type: none"> The bit position specified for an instruction exceeds the data range. 				○		page 3-109
54010406 hex	Illegal Data Position Specified	A memory address or data size that was specified for the instruction is not suitable.	<ul style="list-style-type: none"> A memory address that was specified for an instruction was outside the valid range. The data size that was specified for an instruction exceeded the valid range. For example, the data type of a variable and the data size may not agree. 				○		page 3-109
54010407 hex	Data Range Exceeded	The results of instruction processing exceeded the data area range of the output parameter.	<ul style="list-style-type: none"> The results of instruction processing, such as the number of array elements, exceeded the data area range of the output parameter. 				○		page 3-110
54010409 hex	No Errors to Clear	An instruction to clear a Controller error was executed when there was no error in the Controller.	<ul style="list-style-type: none"> An instruction to clear a Controller error was executed when there was no error in the Controller. 				○		page 3-110
5401040B hex	No User Errors to Clear	An instruction to clear user-defined errors was executed when there was no user-defined error.	<ul style="list-style-type: none"> An instruction to clear user-defined errors was executed when there was no user-defined error. 				○		page 3-111
5401040C hex	Limit Exceeded for User-defined Errors	An attempt was made to use the Create User-defined Error instruction to create more than the maximum number of user-defined errors.	<ul style="list-style-type: none"> An attempt was made to use the Create User-defined Error instruction to create more than the maximum number of user-defined errors. 				○		page 3-111

Event code	Event name	Meaning	Assumed cause	Level					Reference
				M a j	P r t	M i n	O b s	I n f o	
54010410 hex	Text String Format Error	The text string input to an instruction is not correct.	<ul style="list-style-type: none"> The text string that is input to the instruction for conversion to a number does not represent a number or it does not represent a positive number. The input text string does not end in NULL. 				○		page 3-112
54010411 hex	Illegal Program Specified	The program specified for an instruction does not exist.	<ul style="list-style-type: none"> The program specified by the function does not exist (e.g., it was deleted). 				○		page 3-113
54010414 hex	Stack Underflow	There is no data in a stack.	<ul style="list-style-type: none"> An attempt was made to read data from a stack that contains no data. 				○		page 3-113
54010416 hex	Illegal Number of Array Elements or Dimensions	The valid range was exceeded for the number of array elements or dimensions in an array I/O parameter for an instruction.	<ul style="list-style-type: none"> The valid range was exceeded for the number of array elements or dimensions in an array I/O parameter for an instruction. 				○		page 3-114
54010417 hex	Specified Task Does Not Exist	The task specified for the instruction does not exist.	<ul style="list-style-type: none"> The specified task does not exist. 				○		page 3-114
54010418 hex	Unallowed Task Specification	An unallowed task was specified for an instruction.	<ul style="list-style-type: none"> The local task, the primary periodic task, or a periodic task was specified. 				○		page 3-115
54010419 hex	Incorrect Data Type	A data type that cannot be used for an instruction is specified for an input or in-out variable.	<ul style="list-style-type: none"> A data type that cannot be used for an instruction is specified for an input or in-out variable. 				○		page 3-115
5401041A hex	Multi-execution of Instructions	Multi-execution was specified for an instruction that does not support it.	<ul style="list-style-type: none"> Execution of an instruction that does not support multi-execution of instructions was specified more than once. 				○		page 3-116
5401041B hex	Data Capacity Exceeded	Processing was not possible because the data that was passed to the instruction was too large.	<ul style="list-style-type: none"> Data that exceeded the size that can be processed was passed to an instruction. 				○		page 3-116
5401041C hex	Different Data Sizes	The size of the data specified for instruction input or in-out data is different from the size of the target parameter.	<ul style="list-style-type: none"> Data of a size that is different from the size of the target parameter was specified for the input or in-out data of an instruction. 				○		page 3-117

Event code	Event name	Meaning	Assumed cause	Level					Reference
				M a j	P r t	M i n	O b s	I n f o	
5401041D hex	Exceeded Simultaneous Instruction Executed Resources	The maximum resources that you can use for the relevant instruction group at the same time was exceeded.	<ul style="list-style-type: none"> More than the maximum number of relevant instructions were executed at the same time. 				○		page 3-117
54010C03 hex	Full Reception Buffer	The reception buffer is full.	<ul style="list-style-type: none"> The reception buffer is full. 				○		page 3-118
54010C04 hex	Multi-execution of Ports	The serial communications instructions that cannot be executed simultaneously were executed.	<ul style="list-style-type: none"> An instruction was executed while another instruction that cannot be executed at the same time with the former instruction was executed. 				○		page 3-119
54010C05 hex	Parity Error	A parity error occurred in the data received.	<ul style="list-style-type: none"> The communications settings or baud rate settings are not compatible with the remote device. Noise 				○		page 3-119
54010C06 hex	Framing Error	A framing error occurred in the data received.	<ul style="list-style-type: none"> The communications settings or baud rate settings are not compatible with the remote device. Noise 				○		page 3-120
54010C07 hex	Overrun Error	An overrun error occurred in the data received.	<ul style="list-style-type: none"> The next data was received during processing of received data because the baud rate is too high. 				○		page 3-120
54010C08 hex	CRC Mismatch	The receive data had different CRC.	<ul style="list-style-type: none"> A wrong message was received. Noise 				○		page 3-121
54010C0B hex	Serial Communications Timeout	A timeout occurred in serial communications.	<ul style="list-style-type: none"> Wiring to the remote device is not connected. Power to the remote device is OFF. The communications settings or baud rate settings are not compatible with the remote device. Noise 				○		page 3-122
54010C0C hex	Instruction Executed to Inapplicable Port	An instruction was executed to an inapplicable port.	<ul style="list-style-type: none"> An instruction was executed to an inapplicable port. 				○		page 3-123
54010C0D hex (Ver. 1.14 or later)	CIF Unit Initialized	A CIF Unit was initialized, so the communications data buffered in the CIF Unit was lost.	A CIF Unit was initialized.				○		page 3-123
54010C10 hex	Exceptional Modbus Response	An exceptional code was returned from the Modbus slave.	<ul style="list-style-type: none"> An error was detected on the Modbus slave. 				○		page 3-124

Event code	Event name	Meaning	Assumed cause	Level					Reference
				M a j	P r t	M i n	O b s	I n f o	
54010C11 hex	Invalid Modbus Response	An unexpected response was returned from the Modbus slave.	<ul style="list-style-type: none"> The function code or data size of the response received from the Modbus slave was incorrect. 				○		page 3-124
54011403 hex	File Does Not Exist	The file specified for an instruction does not exist. Or, the specified file is corrupted.	<ul style="list-style-type: none"> The specified file does not exist. The specified file is corrupted. The SD Memory Card cannot be normally accessed due to a contact failure or other causes. 				○		page 3-125
54011405 hex	File Already in Use	A file specified for an instruction cannot be accessed because it is already being used.	<ul style="list-style-type: none"> An instruction attempted to read or write a file already being accessed by another instruction. 				○		page 3-126
54011406 hex	Open Mode Mismatch	A file operation for an instruction was inconsistent with the open mode of the file.	<ul style="list-style-type: none"> The file open mode specified by the Open File instruction does not match the file operation attempted by a subsequent SD Memory Card instruction. 				○		page 3-126
54011407 hex	Offset Out of Range	Access to the address is not possible for the offset specified for an instruction.	<ul style="list-style-type: none"> An attempt was made to access beyond the size of the file. 				○		page 3-127
54011408 hex	Directory Not Empty	A directory was not empty when the Delete Directory instruction was executed or when an attempt was made to change the directory name.	<ul style="list-style-type: none"> A directory was not empty when the Delete Directory instruction was executed. A directory contained another directory when an attempt was made to change the directory name. 				○		page 3-127
54011409 hex	That File Name Already Exists	An instruction could not be executed because the file name specified for the instruction already exists.	<ul style="list-style-type: none"> A file already exists with the same name as the name specified for the instruction to create. 				○		page 3-128
5401140A hex	Write Access Denied	An attempt was made to write to a write-protected file or directory when an instruction was executed.	<ul style="list-style-type: none"> The file or directory specified for the instruction to write is write-protected. 				○		page 3-128
5401140B hex	Too Many Files Open	The maximum number of open files was exceeded when opening a file for an instruction.	<ul style="list-style-type: none"> The maximum number of open files was exceeded when opening a file for an instruction. 				○		page 3-129
5401140C hex	Directory Does Not Exist	The directory specified for an instruction does not exist.	<ul style="list-style-type: none"> The directory specified for an instruction does not exist. 				○		page 3-129

Event code	Event name	Meaning	Assumed cause	Level					Reference
				M a j	P r t	M i n	O b s	I n f o	
5401140F hex	Backup Operation Already in Progress	Another backup operation is already in progress.	<ul style="list-style-type: none"> Another backup operation is already in progress. 				○		page 3-130
54011410 hex	Cannot Execute Backup	Execution of a backup operation was not possible because execution of another operation was in progress.	<ul style="list-style-type: none"> Execution of the instruction was attempted during execution of online editing. Execution of the instruction was attempted during execution of a Save Cam Table instruction. Execution of the instruction was attempted while a CPU Unit name change operation was in progress. 				○		page 3-130
54011800 hex	EtherCAT Communications Error	Accessing the EtherCAT network failed when an instruction was executed.	<ul style="list-style-type: none"> The EtherCAT network is not in a usable status. 				○		page 3-131
54011801 hex	EtherCAT Slave Does Not Respond	Accessing the target slave failed when an instruction was executed.	<ul style="list-style-type: none"> The target slave does not exist. The target slave is not in an operating condition. 				○		page 3-131
54011802 hex	EtherCAT Timeout	A timeout occurred while trying to access an EtherCAT slave when an instruction was executed.	<ul style="list-style-type: none"> Communications with the target slave timed out. 				○		page 3-132
54011803 hex	Reception Buffer Overflow	The receive data from an EtherCAT slave overflowed the receive buffer when an instruction was executed.	<ul style="list-style-type: none"> The receive data from the slave overflowed the receive buffer. 				○		page 3-132
54011804 hex	SDO Abort Error	An SDO abort error was received from an EtherCAT slave when an instruction was executed.	<ul style="list-style-type: none"> Depends on the specifications of the slave. 				○		page 3-133
54011805 hex	Saving Packet Monitor File	An instruction for packet monitoring was executed while saving an EtherCAT packet monitor file.	<ul style="list-style-type: none"> An instruction for packet monitoring was executed while saving an EtherCAT packet monitor file. 				○		page 3-133
54011806 hex	Packet Monitoring Function Not Started	A Stop EtherCAT Packet Monitor instruction was executed when EtherCAT packet monitoring was stopped.	<ul style="list-style-type: none"> A Stop EtherCAT Packet Monitor instruction was executed when EtherCAT packet monitoring was stopped. 				○		page 3-134

Event code	Event name	Meaning	Assumed cause	Level					Reference
				M a j	P r t	M i n	O b s	I n f o	
54011807 hex	Packet Monitoring Function in Operation	A Start EtherCAT Packet Monitor instruction was executed when EtherCAT packet monitoring was already being executed.	<ul style="list-style-type: none"> The Start EtherCAT Packet Monitor instruction was executed again while the EtherCAT packet monitoring function was already in operation. 				○		page 3-134
54011808 hex	Communications Resource Overflow	More than 32 EtherCAT communications instructions were executed at the same time.	<ul style="list-style-type: none"> More than 32 EtherCAT communications instructions were executed at the same time. The EtherCAT communications instructions are listed below. <ul style="list-style-type: none"> EC_CoESDOWrite instruction EC_CoESDORead instruction EC_ConnectSlave instruction EC_DisconnectSlave instruction EC_ChangeEnableSetting Instruction EC_StartMon instruction EC_SaveMon instruction EC_StopMon instruction EC_CopyMon instruction 				○		page 3-135
54011809 hex	Packet Monitoring Function Not Supported	Packets cannot be monitored.	<ul style="list-style-type: none"> An instruction for packet monitoring was executed for a CPU Unit that does not support packet monitoring. 				○		page 3-136
54011C00 hex	Explicit Message Error	An error response code was returned for an explicit message that was sent with a CIP communications instruction.	<ul style="list-style-type: none"> Depends on the nature of the error. 				○		page 3-136
54011C01 hex	Incorrect Route Path	The format of the route path that is specified for a CIP communications instruction is not correct.	<ul style="list-style-type: none"> The format of the route path that is specified for a CIP communications instruction is not correct. Address resolution failed for the host name that was specified in a CIP communications instruction. 				○		page 3-137
54011C02 hex	CIP Handle Out of Range	The handle that is specified for the CIP communications instruction is not correct.	<ul style="list-style-type: none"> The handle that is specified for the CIP communications instruction is not correct. 				○		page 3-137

Event code	Event name	Meaning	Assumed cause	Level					Reference
				M a j	P r t	M i n	O b s	I n f o	
54011C03 hex	CIP Communications Resource Overflow	The maximum resources that you can use for CIP communications instructions at the same time was exceeded.	<ul style="list-style-type: none"> More than 32 CIP communications instructions were executed at the same time. An attempt was made to use more than 32 handles at the same time. 				○		page 3-138
54011C04 hex	CIP Timeout	A CIP timeout occurred during execution of a CIP communications instruction.	<ul style="list-style-type: none"> A device does not exist for the specified IP address. The CIP connection for the specified handle timed out and was closed. Power to the remote device is OFF. Communications are stopped at the remote device. The Ethernet cable connector for EtherNet/IP is disconnected. The Ethernet cable for EtherNet/IP is disconnected. Noise 				○		page 3-139
54011C05 hex	Class-3 Connection Not Established	Establishing a class-3 connection failed for a CIP communications instruction.	<ul style="list-style-type: none"> The CIPOpen instruction was executed for a device that does not support class 3 (Large_Forward_Open). The CIPOpenWithDataSize instruction was executed with a specified data size of 510 bytes or larger for a device that does not support class 3 (Large_Forward_Open). 				○		page 3-140
54011C06 hex	CIP Communications Data Size Exceeded	An attempt was made to send a class-3 explicit message with a data size that is larger than the sendable size with a CIP communications instruction.	<ul style="list-style-type: none"> The data size that was specified for the input variable to the CIPRead, CIPWrite, or CIPSend instruction exceeded the data size that was specified with the CIPOpenWithDataSize instruction. 				○		page 3-141
54012000 hex	Local IP Address Setting Error	An instruction was executed when there was a setting error in the local IP address.	<ul style="list-style-type: none"> An instruction was executed when there was a setting error in the local IP address. 				○		page 3-141
54012001 hex	TCP/UDP Port Already in Use	The UDP or TCP port was already in use when the instruction was executed.	<ul style="list-style-type: none"> The UDP or TCP port is already in use. 				○		page 3-142

Event code	Event name	Meaning	Assumed cause	Level					Reference
				M a j	P r t	M i n	O b s	I n f o	
54012002 hex	Address Resolution Failed	Address resolution failed for a remote node with the host name that was specified in the instruction.	<ul style="list-style-type: none"> The host name specified for the instruction is not correct. The hosts and DNS settings in the Controller are incorrect. The DNS server settings are incorrect. 				○		page 3-142

Event code	Event name	Meaning	Assumed cause	Level					Reference
				M a j	P r t	M i n	O b s	I n f o	
54012003 hex	Socket Status Error	The status was not suitable for execution of the socket service instruction.	<ul style="list-style-type: none"> • SktUDPCreate Instruction The UDP port specified with the <i>SrcUdpPort</i> input variable is in one of the following states. <ul style="list-style-type: none"> • It is already open. • It is being closed. • SktUDPRcv Instruction <ul style="list-style-type: none"> • The specified socket is receiving data. • The specified socket is closed. • SktUDPSend Instruction <ul style="list-style-type: none"> • The specified socket is sending data. • The specified socket is closed. • SktTCPAccept Instruction The specified TCP port is in one of the following states. <ul style="list-style-type: none"> • The port is being opened. • The port is being closed. • A connection is already established for this instruction for the same IP address and TCP port. • SktTCPConnect Instruction <ul style="list-style-type: none"> • The TCP port that is specified with the <i>SrcTcpPort</i> input variable is already open. • The remote node that is specified with <i>DstAdr</i> input variable does not exist. • The remote node that is specified with <i>DstAdr</i> and <i>DstTcpPort</i> input variables is not waiting for a connection. • SktTCPrcv Instruction <ul style="list-style-type: none"> • The specified socket is receiving data. • The specified socket is closed. • SktTCPsend Instruction <ul style="list-style-type: none"> • The specified socket is sending data. • The specified socket is closed. • The send buffer of the specified socket is full (because the power to the remote node is OFF, the line is disconnected, etc.) 					○	page 3-143

Event code	Event name	Meaning	Assumed cause	Level					Reference
				M a j	P r t	M i n	O b s	I n f o	
			<ul style="list-style-type: none"> • SktSetOption instruction • The specified socket already started communications. • The option type not supported by the specified socket was specified. 						
54012004 hex	Local IP Address Not Set	The local IP address was not set when a socket service instruction was executed.	<ul style="list-style-type: none"> • There is a BOOTP server setting error. • The BOOTP server does not exist. • The local IP address is not set because operation just started. 				○		page 3-145
54012006 hex	Socket Timeout	A timeout occurred for a socket service instruction.	<ul style="list-style-type: none"> • SktTCPAccept instruction: There was no request for a connection from the remote node during the user-set timeout time. • SktTCPRcv or SktUDPRcv instruction: Data was not received from the remote node during the user-set timeout time. 				○		page 3-146
54012007 hex	Socket Handle Out of Range	The handle that is specified for the socket service instruction is not correct.	<ul style="list-style-type: none"> • The handle that is specified for the socket service instruction is not correct. 				○		page 3-147
54012008 hex	Socket Communications Resource Overflow	The maximum resources that you can use for socket service instructions at the same time was exceeded.	<ul style="list-style-type: none"> • More than 32 socket service instructions were executed at the same time (64 for NX102). • More than 30 socket handles were used at the same time (60 for NX102, 16 for CPU Units with unit version 1.02 or earlier). 				○		page 3-148

Event code	Event name	Meaning	Assumed cause	Level					Reference
				M a j	P r t	M i n	O b s	I n f o	
54012400 hex	No Execution Right	An instruction to change the settings of an EtherNet/IP port was executed when execution was not possible.	<ul style="list-style-type: none"> An instruction to change the settings of the built-in EtherNet/IP port or a CJ-series EtherNet/IP Unit was executed when restart processing was in progress for the built-in EtherNet/IP port. An instruction to change the settings of a CJ-series EtherNet/IP Unit was executed when restart processing was in progress for the Unit. An instruction to change the settings of the built-in EtherNet/IP port or a CJ-series EtherNet/IP Unit was executed when changing settings was in progress for an instruction or CIP message for the built-in EtherNet/IP port. An instruction to change the settings of a CJ-series EtherNet/IP Unit was executed when changing settings was in progress for an instruction or CIP message for the Unit. The unit number that was specified for the instruction is not for a built-in EtherNet/IP port or a CJ-series EtherNet/IP Unit. 				○		page 3-149
54012401 hex	Settings Update Failed	It was not possible to update the settings of the CJ-series EtherNet/IP Unit that were changed.	<ul style="list-style-type: none"> Restart processing for a Unit or built-in EtherNet/IP port was started during execution of an instruction to change the settings of a CJ-series EtherNet/IP Unit. 				○		page 3-150
54012402 hex	Too Many Simultaneous Instruction Executions	Too many instructions to change the communications setup of the Controller were executed at the same time.	<ul style="list-style-type: none"> Two or more instructions to change the communications setup of the Controller were executed at the same time. 				○		page 3-150
54012403 hex	FTP Client Execution Limit Exceeded	Too many FTP client communications instructions were executed at the same time.	<ul style="list-style-type: none"> Four or more FTP client communications instructions were executed at the same time. 				○		page 3-151

Event code	Event name	Meaning	Assumed cause	Level					Reference
				M a j	P r t	M i n	O b s	I n f o	
54012404 hex	File Number Limit Exceeded	The number of files specified with a wildcard for an FTP client communications instruction exceeded 1,000.	<ul style="list-style-type: none"> The number of files specified with a file name that contained a wildcard for an FTP client communications instruction exceeded 1,000. 				○		page 3-151
54012405 hex	Directory Does Not Exist (FTP)	The directory specified for an FTP client communications instruction does not exist in the Controller or an incorrect path was specified.	<ul style="list-style-type: none"> The directory specified for an FTP client communications instruction does not exist in the Controller or an incorrect path was specified. 				○		page 3-152
54012406 hex	FTP Server Connection Error	The destination FTP server that was specified for an FTP client communications instruction does not exist on the network or the specified FTP server is not operating.	<ul style="list-style-type: none"> The destination FTP server that was specified for an FTP client communications instruction does not exist on the network. The destination FTP server that was specified for an FTP client communications instruction is not operating. 				○		page 3-152
54012407 hex	Destination FTP Server Execution Failure	The destination FTP server for an FTP client communications instruction returned an error.	<ul style="list-style-type: none"> The destination FTP server for the FTP client communications instruction failed to execute the requested processing. 				○		page 3-153
54012408 hex	SD Memory Card Access Failed for FTP	SD Memory Card access from the FTP client failed.	<ul style="list-style-type: none"> An SD Memory Card is not inserted. The SD Memory Card was removed during execution of the FTP client communications instruction. The capacity of the SD Memory Card is insufficient. The SD Memory Card is write protected. 				○		page 3-154
54012409 hex	Specified File Does Not Exist	A file specified for an FTP client communications instruction does not exist in the Controller.	<ul style="list-style-type: none"> A file specified for an FTP client communications instruction does not exist in the Controller. 				○		page 3-154
5401240A hex	Specified File Is Write Protected	The data was not transferred because the FTP client communications instruction was set to not overwrite files with the same name.	<ul style="list-style-type: none"> The data was not transferred because the FTP client communications instruction was set to not overwrite files with the same name and a file with the specified file name already existed at the destination. 				○		page 3-155

Event code	Event name	Meaning	Assumed cause	Level					Reference
				M a j	P r t	M i n	O b s	I n f o	
5401240B hex	Failed To Delete Specified File	A file was not deleted after it was transferred with an FTP client communications instruction.	<ul style="list-style-type: none"> The FTP client communications instruction was set to delete files after they are transferred, but it was not possible to delete the specified file because it had a read-only attribute. It was not possible to delete the file specified for the FTP client communications instruction because it was in use by another application. 				○		page 3-156
5401240C hex	Specified File Access Failed	An FTP transfer for an FTP client communications instruction failed because file access failed.	<ul style="list-style-type: none"> The file specified for the FTP client communications instruction was in use by another application. The file or directory specified for the FTP client communications instruction to write is write protected. 				○		page 3-157
5401240D hex	IP Address Setting Invalid	Instruction execution was not possible because there is an error between the IP address setting of the port specified in the instruction and the other port settings.	<ul style="list-style-type: none"> The network address of the port specified in the instruction is the same as the network address of another port. Both the port specified in the instruction and all other ports are set as unused ports. 				○		page 3-158
54012C00 hex	NX Message Error	An error response code was returned for an NX message.	<ul style="list-style-type: none"> Depends on the nature of the error. 				○		page 3-159
54012C01 hex	NX Message Resource Overflow	The maximum resources that you can use for NX message instructions at the same time was exceeded.	<ul style="list-style-type: none"> More than 32 NX message instructions were executed at the same time. 				○		page 3-159
54012C02 hex	NX Message Timeout	A timeout occurred during execution of an NX message.	<ul style="list-style-type: none"> The specified NX Unit does not exist. The NX message was closed because it timed out. Power to the remote Unit is OFF. Communications are stopped at the remote Unit. The communications cable connector is disconnected. The communications cable is broken. Noise 				○		page 3-160

Event code	Event name	Meaning	Assumed cause	Level					Reference
				M a j	P r t	M i n	O b s	I n f o	
54012C03 hex	Incorrect NX Message Length	The length of the NX message is not correct.	<ul style="list-style-type: none"> The size that is specified for WriteDat or Path is too long. 				○		page 3-161
54012C05 hex	NX Message EtherCAT Network Error	An error occurred in EtherCAT communications on the NX message path.	<ul style="list-style-type: none"> An error occurred in EtherCAT communications on the NX message path. 				○		page 3-161
54012C06 hex	External Restart Already Executed for Specified NX Units	A restart was already in execution from the Sysmac Studio when the instruction was executed.	<ul style="list-style-type: none"> A restart was already in execution from the Sysmac Studio when the instruction was executed. 				○		page 3-162
54012C07 hex	Unapplicable Unit Specified for Instruction	A slave that cannot be specified for the instruction was connected at the slave node address of the specified Unit.	<ul style="list-style-type: none"> A slave that cannot be specified for the instruction was connected to the slave node address of the specified Unit. 				○		page 3-162
54012C08 hex	Invalid Total Power ON Time Record	The total power ON time could not be read.	<ul style="list-style-type: none"> Non-volatile memory failure 				○		page 3-163
54013461 hex	Process Data Object Setting Missing	The PDO mapping is not correct.	<ul style="list-style-type: none"> The PDOs that are required for the motion control instruction are not mapped. The relevant instruction was executed for a device that does not have an object that supports the instruction. A motion control instruction that specifies phase Z (_mcEncoderMark) as the trigger conditions was executed for an axis that is mapped to an OMRON GXEC02 EtherCAT Encoder slave. 				○		page 3-164
54014000 hex	OS Timeout	Restarting Windows was not completed within the specified time.	<ul style="list-style-type: none"> The value specified for the TimeOut input variable was too short for Windows to restart. 				○		page 3-165
54014001 hex	OS Shutdown Execution Error	The instruction to shut down OS was executed while Windows was not running.	<ul style="list-style-type: none"> The instruction to shut down OS was executed while Windows was not running. 				○		page 3-165
54014002 hex	OS Reboot Execution Error	The instruction to reboot OS was executed without a forced reboot while there was an error on Windows.	<ul style="list-style-type: none"> The relevant instruction was executed without using a forced reboot while there was an error on Windows. 				○		page 3-166

Event code	Event name	Meaning	Assumed cause	Level					Reference
				M a j	P r t	M i n	O b s	I n f o	
54014400 hex	Shared Folder Access Failure	Accessing the shared folder failed when an instruction was executed.	• The shared folder is not recognized.				○		page 3-166
54014402 hex	Shared Folder Insufficient Capacity	The capacity of the shared folder was insufficient when writing to the shared folder for an instruction.	• The shared folder has run out of free space.				○		page 3-167
54014404 hex	Too Many Files/Directories	The maximum number of files/directories was exceeded when creating a file/directory for an instruction.	• The number of files or directories exceeded the maximum number.				○		page 3-167
5401440D hex	File or Directory Name Is Too Long	The file name or directory name that was specified for an instruction is too long.	• The file name or directory name that was specified for the instruction to create is too long.				○		page 3-168
5401440E hex	Shared Folder Access Failed	The access to the shared folder failed.	• The shared folder is corrupted.				○		page 3-168
54014411 hex	Slave Backup Failed	A slave backup operation failed.	• A slave backup operation failed.				○		page 3-169
54014800 hex	Device Error Received	An error response from the device was received.	• An error response from the device was received.				○		page 3-169
54014801 hex	Specified Unit Does Not Exist	The specified Unit does not exist.	• The IO-Link master is not connected to or mounted on the specified position.				○		page 3-170
54014802 hex	Message Processing Limit Exceeded	An instruction cannot be executed because the IO-Link master is processing the message from another application.	• An instruction cannot be executed because the IO-Link master is processing the message from another application (an instruction execution or a tool connection).				○		page 3-170
54014803 hex	Specified Unit Status Error	The specified Unit is not in a condition to receive messages.	• The specified Unit is not in a condition to receive messages.				○		page 3-171
54014804 hex	Too Many Simultaneous Instruction Executions	The number of instructions that can be simultaneously executed was exceeded.	• More than 32 NX message instructions and EtherCAT communications instructions were executed at the same time.				○		page 3-171
54014805 hex	Communications Timeout	A timeout occurred in communications.	<ul style="list-style-type: none"> • The communications timeout time is shorter than the message response time. • The cable for EtherCAT or for IO-Link is broken. • Noise • Device failure 				○		page 3-172

Event code	Event name	Meaning	Assumed cause	Level					Reference
				M a j	P r t	M i n	O b s	I n f o	
54014806 hex	Invalid Mode	The specified IO-Link master port is not the IO-Link mode.	<ul style="list-style-type: none"> The specified IO-Link master port is not the IO-Link mode. 				○		page 3-172
54014807 hex	I/O Power OFF Status	The I/O power is not supplied to the specified IOLink master port.	<ul style="list-style-type: none"> The I/O power is not supplied to the specified IOLink master port. 				○		page 3-173
54014808 hex	Verification Error	The specified IO-Link master port had a verification error or a communications error.	<ul style="list-style-type: none"> The specified IO-Link master port had a verification error or a communications error. 				○		page 3-173
54015420 hex	Electronic Gear Ratio Numerator Setting Out of Range	The parameter specified for the <i>RatioNumerator</i> input variable to a motion control instruction is out of range.	<ul style="list-style-type: none"> Instruction input parameter exceeded the valid range of the input variable. 				○		page 3-174
54015421 hex	Electronic Gear Ratio Denominator Setting Out of Range	The parameter specified for the <i>RatioDenominator</i> input variable to a motion control instruction is out of range.	<ul style="list-style-type: none"> Instruction input parameter exceeded the valid range of the input variable. 				○		page 3-174
54015422 hex	Target Velocity Setting Out of Range	The parameter specified for the <i>Velocity</i> input variable to a motion control instruction is out of range.	<ul style="list-style-type: none"> Instruction input parameter exceeded the valid range of the input variable. 				○		page 3-175
54015423 hex	Acceleration Setting Out of Range	The parameter specified for the <i>Acceleration</i> input variable to a motion control instruction is out of range.	<ul style="list-style-type: none"> Instruction input parameter exceeded the valid range of the input variable. 				○		page 3-175
54015424 hex	Deceleration Setting Out of Range	The parameter specified for the <i>Deceleration</i> input variable to a motion control instruction is out of range.	<ul style="list-style-type: none"> Instruction input parameter exceeded the valid range of the input variable. 				○		page 3-176
54015425 hex	Jerk Setting Out of Range	The parameter specified for the <i>Jerk</i> input variable to a motion control instruction is out of range.	<ul style="list-style-type: none"> Instruction input parameter exceeded the valid range of the input variable. 				○		page 3-176

Event code	Event name	Meaning	Assumed cause	Level					Reference
				M a j	P r t	M i n	O b s	I n f o	
54015427 hex	Torque Ramp Setting Out of Range	The parameter specified for the <i>TorqueRamp</i> input variable to a motion control instruction is out of range.	<ul style="list-style-type: none"> Instruction input parameter exceeded the valid range of the input variable. 				○		page 3-177
54015428 hex	Master Coefficient Scaling Out of Range	The parameter specified for the <i>MasterScaling</i> input variable to a motion control instruction is out of range.	<ul style="list-style-type: none"> Instruction input parameter exceeded the valid range of the input variable. 				○		page 3-177
54015429 hex	Slave Coefficient Scaling Out of Range	The parameter specified for the <i>SlaveScaling</i> input variable to a motion control instruction is out of range.	<ul style="list-style-type: none"> Instruction input parameter exceeded the valid range of the input variable. 				○		page 3-178
5401542A hex	Feeding Velocity Setting Out of Range	The parameter specified for the <i>FeedVelocity</i> input variable to a motion control instruction is out of range.	<ul style="list-style-type: none"> The Feed Velocity (input variable <i>FeedVelocity</i>) is still at the default (0). 				○		page 3-178
5401542B hex	Buffer Mode Selection Out of Range	The parameter specified for the <i>BufferMode</i> input variable to a motion control instruction is out of range.	<ul style="list-style-type: none"> Instruction input parameter exceeded the valid range of the input variable. 				○		page 3-179
5401542C hex	Coordinate System Selection Out of Range	The parameter specified for the <i>CoordSystem</i> input variable to a motion control instruction is out of range.	<ul style="list-style-type: none"> Instruction input parameter exceeded the valid range of the input variable. 				○		page 3-179
5401542D hex	Circular Interpolation Mode Selection Out of Range	The parameter specified for the <i>CircMode</i> input variable to a motion control instruction is out of range.	<ul style="list-style-type: none"> Instruction input parameter exceeded the valid range of the input variable. 				○		page 3-180
5401542E hex	Direction Selection Out of Range	The parameter specified for the <i>Direction</i> input variable to a motion control instruction is out of range.	<ul style="list-style-type: none"> Instruction input parameter exceeded the valid range of the input variable. 				○		page 3-180

Event code	Event name	Meaning	Assumed cause	Level					Reference
				M a j	P r t	M i n	O b s	I n f o	
5401542F hex	Path Selection Out of Range	The parameter specified for the <i>PathChoice</i> input variable to a motion control instruction is out of range.	<ul style="list-style-type: none"> Instruction input parameter exceeded the valid range of the input variable. 				○		page 3-181
54015430 hex	Position Type Selection Out of Range	The parameter specified for the <i>ReferenceType</i> input variable to a motion control instruction is out of range.	<ul style="list-style-type: none"> Instruction input parameter exceeded the valid range of the input variable. 				○		page 3-181
54015431 hex	Travel Mode Selection Out of Range	The parameter specified for the <i>MoveMode</i> input variable to a motion control instruction is out of range.	<ul style="list-style-type: none"> Instruction input parameter exceeded the valid range of the input variable. 				○		page 3-182
54015432 hex	Transition Mode Selection Out of Range	The parameter specified for the <i>TransitionMode</i> input variable to a motion control instruction is out of range.	<ul style="list-style-type: none"> Instruction input parameter exceeded the valid range of the input variable. <i>_mcAborting</i> or <i>_mcBuffered</i> was specified for <i>BufferMode</i> and <i>_mcTMCornerSuperimposed</i> was specified for <i>TransitionMode</i>. 				○		page 3-182
54015433 hex	Continue Method Selection Out of Range	The value of the reserved input variable <i>Continuous</i> to a motion control instruction changed.	<ul style="list-style-type: none"> The value of the reserved input variable <i>Continuous</i> changed. 				○		page 3-183
54015434 hex	Combine Mode Selection Out of Range	The parameter specified for the <i>CombineMode</i> input variable to a motion control instruction is out of range.	<ul style="list-style-type: none"> Instruction input parameter exceeded the valid range of the input variable. 				○		page 3-183
54015435 hex	Synchronization Start Condition Selection Out of Range	The parameter specified for the <i>LinkOption</i> input variable to a motion control instruction is out of range.	<ul style="list-style-type: none"> Instruction input parameter exceeded the valid range of the input variable. 				○		page 3-184
54015436 hex	Master and Slave Defined as Same Axis	The same axis is specified for the <i>Master</i> and <i>Slave</i> input variables to a motion control instruction.	<ul style="list-style-type: none"> The parameter is the same for the <i>Master</i> and <i>Slave</i> input variables to the instruction. 				○		page 3-184

Event code	Event name	Meaning	Assumed cause	Level					Reference
				M a j	P r t	M i n	O b s	I n f o	
54015437 hex	Master and Auxiliary Defined as Same Axis	The same axis is specified for the <i>Master</i> and <i>Auxiliary</i> input variables to a motion control instruction.	<ul style="list-style-type: none"> The parameter is the same for the <i>Master</i> and <i>Auxiliary</i> input variables to the instruction. 				○		page 3-185
54015438 hex	Master/ Slave Axis Numbers Not in Ascending Order	The axis numbers specified for the <i>Master</i> and <i>Slave</i> input variables to a motion control instruction are not in ascending order.	<ul style="list-style-type: none"> The parameters for the <i>Master</i> and <i>Slave</i> input variables to the instruction were not in ascending order when <i>_mclatestCommand</i> was specified for the <i>ReferenceType</i> input variable to the instruction. 				○		page 3-185
54015439 hex	Incorrect Cam Table Specification	The parameter specified for the <i>CamTable</i> input variable to a motion control instruction is out of range.	<ul style="list-style-type: none"> Something other than a cam data variable was specified for the <i>CamTable</i> input variable to the instruction. 				○		page 3-186
5401543A hex	Synchronization Stopped	A synchronized control motion control instruction was executed, but conditions required for execution were not met.	<ul style="list-style-type: none"> The MC_CamOut (End Cam Operation) instruction was executed even though the MC_CamIn (Start Cam Operation) instruction is not being executed. The MC_GearOut (End Gear Operation) instruction was executed even though the MC_GearIn (Start Gear Operation) or the MC_GearInPos (Positioning Gear Operation) instruction is not being executed. The MC_Phasing (Shift Master Axis Phase) instruction was executed even though the MC_CamIn (Start Cam Operation), MC_GearIn (Start Gear Operation), MC_GearInPos (Start Gear Operation), or MC_MoveLink (Synchronous Positioning) instruction is not being executed. 				○		page 3-187
5401543B hex	Motion Control Instruction Re-execution Disabled	An attempt was made to re-execute a motion control instruction that cannot be re-executed.	<ul style="list-style-type: none"> A motion control instruction that cannot be re-executed was re-executed. 				○		page 3-188

Event code	Event name	Meaning	Assumed cause	Level					Reference
				M a j	P r t	M i n	O b s	I n f o	
5401543C hex	Motion Control Instruction Multi-execution Disabled	Multiple functions that cannot be executed simultaneously were executed for the same target (MC common, axis, or axes group).	<ul style="list-style-type: none"> Multiple functions that cannot be executed simultaneously were executed for the same target (MC common or axis). 				○		page 3-189
5401543D hex	Instruction Not Allowed for Encoder Axis Type	An operation instruction was executed for an encoder axis.	<ul style="list-style-type: none"> An operation instruction was executed for an encoder axis. 				○		page 3-189
5401543E hex	Instruction Cannot Be Executed during Multi-axes Coordinated Control	<ul style="list-style-type: none"> An operation instruction was executed for an axis or an axes group that was in a coordinated multi-axes motion. A robot instruction that you cannot use for an axes group in a Group-Enable state was executed. 	<ul style="list-style-type: none"> An operation instruction was executed for an axis or an axes group that was in a coordinated multi-axes motion. The MC_SetKinTransform instruction was executed for an axes group in a GroupEnable state. 				○		page 3-190
5401543F hex	Multi-axes Coordinated Control Instruction Executed for Disabled Axes Group	A multi-axes coordinated control instruction was executed for an axes group that was in a GroupDisable state.	<ul style="list-style-type: none"> A multi-axes coordinated control instruction was executed for an axes group that was in a GroupDisable state. One of the following instructions was executed for an axes group that was in a GroupDisable state. MC_MoveTimeAbsolute MC_SyncLinearConveyor MC_SyncOut MC_RobotJog 				○		page 3-191
54015440 hex	Axes Group Cannot Be Enabled	Execution of the MC_GroupEnable (Enable Axes Group) instruction failed.	<ul style="list-style-type: none"> When the MC_GroupEnable (Enable Axes Group) instruction was executed, there was a composition axis that was not stopped. When the MC_GroupEnable (Enable Axes Group) instruction was executed, there was a composition axis for which the MC_TouchProbe (Enable External Latch) instruction was being executed. 				○		page 3-192

Event code	Event name	Meaning	Assumed cause	Level					Reference
				M a j	P r t	M i n	O b s	I n f o	
54015441 hex	Impossible Axis Operation Specified when the Servo is OFF	An operation instruction was executed for an axis for which the Servo is OFF.	<ul style="list-style-type: none"> An operation instruction was executed for an axis for which the Servo is OFF. Home was preset with the MC_Home or MC_HomeWithParameter instruction for an axis for which EtherCAT process data communications are not established. 				○		page 3-193
54015442 hex	Composition Axis Stopped Error	A motion instruction was executed for an axes group while the MC_Stop instruction was being executed for a composition axis.	<ul style="list-style-type: none"> A motion instruction was executed for an axes group while the MC_Stop instruction was being executed for a composition axis. 				○		page 3-194
54015443 hex	Motion Control Instruction Multi-execution Buffer Limit Exceeded	The number of motion control instructions that is buffered for Buffered or Blending Buffer Modes exceeded the buffer limit.	<ul style="list-style-type: none"> An axis instruction was executed when there was already a current instruction and a buffered instruction for the same axis. An axes group instruction was executed when there was already eight current instructions and buffered instructions for the same axis. 				○		page 3-194
54015444 hex	Insufficient Travel Distance	The specified motion cannot be executed for the deceleration rate or acceleration rate that was specified for multi-execution or re-execution of a positioning instruction.	<ul style="list-style-type: none"> Stopping at the target position was not possible for the specified acceleration/deceleration rate for multi-execution or re-execution of a positioning instruction when the Acceleration/Deceleration Over parameter was set to generate a minor fault and stop. 				○		page 3-195
54015445 hex	Insufficient Travel Distance to Achieve Blending Transit Velocity	There is not sufficient travel distance to accelerate or decelerate to the transit velocity.	<ul style="list-style-type: none"> There was not sufficient travel distance to accelerate the current command to the transit velocity when the Acceleration/Deceleration Over parameter was set to generate a minor fault and stop. 				○		page 3-196
54015446 hex	Move Link Constant Velocity Insufficient Travel Distance	The constant-velocity travel distance of the master axis is less than zero.	<ul style="list-style-type: none"> The constant velocity travel distance of the master axis is below 0 for the MC_MoveLink (Synchronous Positioning) instruction. 				○		page 3-196

Event code	Event name	Meaning	Assumed cause	Level					Reference
				M a j	P r t	M i n	O b s	I n f o	
54015447 hex	Positioning Gear Operation Insufficient Target Velocity	For the MC_GearInPos (Positioning Gear Operation) instruction, the <i>target velocity</i> of the slave axis is too small to achieve the required velocity.	<ul style="list-style-type: none"> For the MC_GearInPos (Positioning Gear Operation) instruction, the value of the <i>Velocity (Target Velocity)</i> input variable is smaller than the master axis velocity multiplied by the gear ratio when the instruction was executed. 				○		page 3-197
54015448 hex	Same Start Point and End Point for Circular Interpolation	The start point and end point were the same when the radius method was specified for the MC_MoveCircular2D (Circular 2D Interpolation) instruction. Or, the start point, end point, and border point were the same when the border point method was specified.	<ul style="list-style-type: none"> The start point and end point were the same when the radius method was specified for the MC_MoveCircular2D (Circular 2D Interpolation) instruction. The start point, end point, and border point were the same when the border point method was specified for the MC_MoveCircular2D (Circular 2D Interpolation) instruction. 				○		page 3-198
54015449 hex	Circular Interpolation Center Specification Position Out of Range	The position specified for the center point exceeded the allowed range when the center method was specified for the MC_MoveCircular2D (Circular 2D Interpolation) instruction.	<ul style="list-style-type: none"> The difference between the distance from the start point to the center point and the distance between the end point to the center point exceeded the permitted value specified for the correction allowance ratio in the axes group settings when the center designation method was specified for the MC_MoveCircular2D (Circular 2D Interpolation) instruction. 				○		page 3-199
5401544A hex	Instruction Execution Error Caused by Count Mode Setting	An instruction that cannot be used when the Count Mode is set to Rotary Mode was executed for an axis that was set to Rotary Mode.	<ul style="list-style-type: none"> An instruction that cannot be used when the Count Mode is set to Rotary Mode was executed for an axis that was set to Rotary Mode. 				○		page 3-199
5401544C hex	Parameter Selection Out of Range	The parameter specified for the <i>ParameterNumber</i> input variable to a motion control instruction is out of range.	<ul style="list-style-type: none"> Instruction input parameter exceeded the valid range of the input variable. 				○		page 3-200

Event code	Event name	Meaning	Assumed cause	Level					Reference
				M a j	P r t	M i n	O b s	I n f o	
5401544D hex	Stop Method Selection Out of Range	The parameter specified for the <i>StopMode</i> input variable to a motion control instruction is out of range.	<ul style="list-style-type: none"> Instruction input parameter exceeded the valid range of the input variable. 				○		page 3-200
5401544E hex	Latch ID Selection Out of Range for Trigger Input Condition	The parameter specified for the <i>TriggerInput::LatchID</i> input variable to a motion control instruction is out of range.	<ul style="list-style-type: none"> Instruction input parameter exceeded the valid range of the input variable. 				○		page 3-201
5401544F hex	Setting Out of Range for Writing MC Setting	The parameter specified for the <i>SettingValue</i> input variable to a motion control instruction is out of range.	<ul style="list-style-type: none"> Instruction input parameter exceeded the valid range of the input variable. The parameter specification and the data type of the setting value do not agree. 				○		page 3-201
54015450 hex	Trigger Input Condition Mode Selection Out of Range	The parameter specified for the <i>TriggerInput::Mode</i> input variable to a motion control instruction is out of range.	<ul style="list-style-type: none"> Instruction input parameter exceeded the valid range of the input variable. 				○		page 3-202
54015451 hex	Drive Trigger Signal Selection Out of Range for Trigger Input Condition	The parameter specified for the <i>TriggerInput::InputDrive</i> input variable to a motion control instruction is out of range.	<ul style="list-style-type: none"> Instruction input parameter exceeded the valid range of the input variable. 				○		page 3-202
54015453 hex	Motion Control Instruction Re-execution Disabled (Axis Specification)	An attempt was made to change the parameter for the <i>Axis</i> input variable when re-executing a motion control instruction. (This input variable cannot be changed when re-executing an instruction.)	<ul style="list-style-type: none"> A parameter for an input variable that cannot be changed for re-execution was changed. 				○		page 3-203

Event code	Event name	Meaning	Assumed cause	Level					Reference
				M a j	P r t	M i n	O b s	I n f o	
54015454 hex	Motion Control Instruction Re-execution Disabled (Buffer Mode Selection)	An attempt was made to change the parameter for the <i>BufferMode</i> input variable when re-executing a motion control instruction. (This input variable cannot be changed when re-executing an instruction.)	<ul style="list-style-type: none"> A parameter for an input variable that cannot be changed for re-execution was changed. 				○		page 3-204
54015455 hex	Motion Control Instruction Re-execution Disabled (Direction Selection)	An attempt was made to change the parameter for the <i>Direction</i> input variable when re-executing a motion control instruction. (This input variable cannot be changed when re-executing an instruction.)	<ul style="list-style-type: none"> An input variable that cannot be changed for re-execution was changed. 				○		page 3-205
54015456 hex	Motion Control Instruction Re-execution Disabled (Execution Mode)	An attempt was made to change the parameter for the <i>Periodic</i> input variable when re-executing a motion control instruction. (This input variable cannot be changed when re-executing an instruction.)	<ul style="list-style-type: none"> A parameter for an input variable that cannot be changed for re-execution was changed. 				○		page 3-205
54015457 hex	Motion Control Instruction Re-execution Disabled (Axes Group Specification)	An attempt was made to change the parameter for the <i>AxesGroup</i> input variable when re-executing a motion control instruction. (This input variable cannot be changed when re-executing an instruction.)	<ul style="list-style-type: none"> A parameter for an input variable that cannot be changed for re-execution was changed. 				○		page 3-206
54015458 hex	Motion Control Instruction Re-execution Disabled (Jerk Setting)	An attempt was made to change the parameter for the <i>Jerk</i> input variable when re-executing a motion control instruction. (This input variable cannot be changed when re-executing an instruction.)	<ul style="list-style-type: none"> A parameter for an input variable that cannot be changed for re-execution was changed. 				○		page 3-207

Event code	Event name	Meaning	Assumed cause	Level					Reference
				M a j	P r t	M i n	O b s	I n f o	
54015459 hex	Motion Control Instruction Re-execution Disabled (Master Axis)	An attempt was made to change the parameter for the <i>Master</i> input variable when re-executing a motion control instruction. (This input variable cannot be changed when re-executing an instruction.)	<ul style="list-style-type: none"> A parameter for an input variable that cannot be changed for re-execution was changed. 				○		page 3-208
5401545A hex	Motion Control Instruction Re-execution Disabled (MasterOffset)	An attempt was made to change the parameter for the <i>MasterOffset</i> input variable when re-executing a motion control instruction. (This input variable cannot be changed when re-executing an instruction.)	<ul style="list-style-type: none"> A parameter for an input variable that cannot be changed for re-execution was changed. 				○		page 3-208
5401545B hex	Motion Control Instruction Re-execution Disabled (MasterScaling)	An attempt was made to change the parameter for the <i>MasterScaling</i> input variable when re-executing a motion control instruction. (This input variable cannot be changed when re-executing an instruction.)	<ul style="list-style-type: none"> A parameter for an input variable that cannot be changed for re-execution was changed. 				○		page 3-209
5401545C hex	Motion Control Instruction Re-execution Disabled (MasterStartDistance)	An attempt was made to change the parameter for the <i>MasterStartDistance</i> input variable when re-executing a motion control instruction. (This input variable cannot be changed when re-executing an instruction.)	<ul style="list-style-type: none"> A parameter for an input variable that cannot be changed for re-execution was changed. 				○		page 3-209

Event code	Event name	Meaning	Assumed cause	Level					Reference
				M a j	P r t	M i n	O b s	I n f o	
5401545D hex	Motion Control Instruction Re-execution Disabled (Continuous)	An attempt was made to change the parameter for the <i>Continuous</i> input variable when re-executing a motion control instruction. (This input variable cannot be changed when re-executing an instruction.)	<ul style="list-style-type: none"> A parameter for an input variable that cannot be changed for re-execution was changed. 				○		page 3-210
5401545E hex	Motion Control Instruction Re-execution Disabled (MoveMode)	An attempt was made to change the parameter for the <i>MoveMode</i> input variable when re-executing a motion control instruction. (This input variable cannot be changed when re-executing an instruction.)	<ul style="list-style-type: none"> A parameter for an input variable that cannot be changed for re-execution was changed. 				○		page 3-210
5401545F hex	Illegal Auxiliary Axis Specification	The axis specified for the <i>Auxiliary</i> input variable to a motion control instruction does not exist.	<ul style="list-style-type: none"> An axis does not exist for the variable specified for the <i>Auxiliary</i> input variable to the instruction. 				○		page 3-211
54015460 hex	Illegal Axis Specification	The axis specified for the <i>Axis</i> input variable to a motion control instruction does not exist.	<ul style="list-style-type: none"> An axis does not exist for the variable specified for the <i>Axis</i> input variable to the instruction. 				○		page 3-211
54015461 hex	Illegal Axes Group Specification	The axes group specified for the <i>AxesGroup</i> input variable to a motion control instruction does not exist or is not a used group.	<ul style="list-style-type: none"> An axes group does not exist for the variable specified for the <i>AxesGroup</i> input variable to the instruction. The axes group specified for the <i>AxesGroup</i> input variable to the instruction is not specified as a used group. 				○		page 3-212
54015462 hex	Illegal Master Axis Specification	The axis that is specified for the <i>Master</i> input variable to a motion control instruction is not correct.	<ul style="list-style-type: none"> An axis does not exist for the variable specified for the <i>Master</i> input variable to the instruction. The axis that was specified for the <i>Master</i> input variable to the MC_Phasing (Shift Master Axis Phase) instruction is not the master axis for syncing. The master axis and a slave axis are not assigned to the same task. 				○		page 3-213

Event code	Event name	Meaning	Assumed cause	Level					Reference
				M a j	P r t	M i n	O b s	I n f o	
54015463 hex	Motion Control Instruction Re-execution Disabled (Slave-Offset)	An attempt was made to change the <i>SlaveOffset</i> input variable when re-executing a motion control instruction. (This input variable cannot be changed when re-executing an instruction.)	<ul style="list-style-type: none"> A parameter for an input variable that cannot be changed for re-execution was changed. 				○		page 3-214
54015464 hex	Motion Control Instruction Re-execution Disabled (Slave-Scaling)	An attempt was made to change the <i>SlaveScaling</i> input variable when re-executing a motion control instruction. (This input variable cannot be changed when re-executing an instruction.)	<ul style="list-style-type: none"> A parameter for an input variable that cannot be changed for re-execution was changed. 				○		page 3-214
54015465 hex	Motion Control Instruction Re-execution Disabled (Start-Position)	An attempt was made to change the <i>StartPosition</i> input variable when re-executing a motion control instruction. (This input variable cannot be changed when re-executing an instruction.)	<ul style="list-style-type: none"> A parameter for an input variable that cannot be changed for re-execution was changed. 				○		page 3-215
54015466 hex	Instruction Execution Error with Undefined Home	High-speed homing or an interpolation instruction was executed when home was undefined.	<ul style="list-style-type: none"> High-speed homing was executed when home was undefined. An interpolation instruction was executed for an axes group that includes an axis with no defined home. One of the following robot instructions was executed for an axes group that includes a logical axis with no defined home. MC_SetKinTransform MC_MoveTimeAbsolute MC_SyncLinearConveyor MC_SyncOut MC_GroupMon MC_RobotJog 				○		page 3-216

Event code	Event name	Meaning	Assumed cause	Level					Reference
				M a j	P r t	M i n	O b s	I n f o	
54015467 hex	Motion Control Instruction Re-execution Disabled (Position Type)	An attempt was made to change the <i>ReferenceType</i> input variable when re-executing a motion control instruction. (This input variable cannot be changed when re-executing an instruction.)	<ul style="list-style-type: none"> A parameter for an input variable that cannot be changed for re-execution was changed. 				○		page 3-217
54015468 hex	Unused Axis Specification for Master Axis	The master axis specified for a motion control instruction is an unused axis.	<ul style="list-style-type: none"> The master axis specified for a motion control instruction is an unused axis. 				○		page 3-217
54015469 hex	First Position Setting Out of Range	The parameter specified for the <i>FirstPosition</i> input variable to a motion control instruction is out of range.	<ul style="list-style-type: none"> Instruction input parameter exceeded the valid range of the input variable. 				○		page 3-218
5401546A hex	Last Position Setting Out of Range	The parameter specified for the <i>LastPosition</i> input variable to a motion control instruction is out of range.	<ul style="list-style-type: none"> Instruction input parameter exceeded the valid range of the input variable. 				○		page 3-218
5401546B hex	Illegal First/Last Position Size Relationship (Linear Mode)	The parameter specified for the <i>LastPosition</i> input variable to a motion control instruction is smaller than the parameter specified for the <i>FirstPosition</i> input variable.	<ul style="list-style-type: none"> The value of the <i>LastPosition</i> input parameter is less than the value of the <i>FirstPosition</i> input variable for the instruction when the Count Mode is set to Linear Mode. 				○		page 3-219
5401546C hex	Master Sync Start Position Setting Out of Range	The parameter specified for the <i>MasterSyncPosition</i> input variable to a motion control instruction is out of range.	<ul style="list-style-type: none"> Instruction input parameter exceeded the valid range of the input variable. 				○		page 3-219
5401546D hex	Slave Sync Start Position Setting Out of Range	The parameter specified for the <i>SlaveSyncPosition</i> input variable to a motion control instruction is out of range.	<ul style="list-style-type: none"> Instruction input parameter exceeded the valid range of the input variable. 				○		page 3-220

Event code	Event name	Meaning	Assumed cause	Level					Reference
				M a j	P r t	M i n	O b s	I n f o	
5401546E hex	Duplicate Latch ID for Trigger Input Condition	The same latch ID was specified for more than one motion control instruction.	<ul style="list-style-type: none"> The same latch ID is used simultaneously for more than one of the following instructions: MC_TouchProbe (Enable External Latch) instruction, MC_MoveLink (Synchronous Positioning) instruction, and MC_MoveFeed (Interrupt Feeding) instruction. The MC_AbortTrigger (Disable External Latch) instruction was executed to cancel a latch that was used by an instruction other than the MC_TouchProbe (Enable External Latch) instruction. 				○		page 3-220
5401546F hex	Jerk Override Factor Out of Range	The parameter specified for the <i>JerkFactor</i> input variable to a motion control instruction is out of range.	<ul style="list-style-type: none"> Instruction input parameter exceeded the valid range of the input variable. 				○		page 3-221
54015470 hex	Acceleration/Deceleration Override Factor Out of Range	The parameter specified for the <i>AccFactor</i> input variable to a motion control instruction is out of range.	<ul style="list-style-type: none"> Instruction input parameter exceeded the valid range of the input variable. 				○		page 3-221
54015471 hex	First Position Method Specification Out of Range	The parameter specified for the <i>StartMode</i> input variable to a motion control instruction is out of range.	<ul style="list-style-type: none"> Instruction input parameter exceeded the valid range of the input variable. 				○		page 3-222
54015472 hex	Motion Control Instruction Re-execution Disabled (First Position Method)	An attempt was made to change the <i>StartMode</i> input variable when re-executing a motion control instruction. (This input variable cannot be changed when re-executing an instruction.)	<ul style="list-style-type: none"> A parameter for an input variable that cannot be changed for re-execution was changed. 				○		page 3-222
54015474 hex	Unused Axis Specification for Auxiliary Axis	The axis specified for the <i>Auxiliary</i> input variable to a motion control instruction is an unused axis.	<ul style="list-style-type: none"> The axis specified for the <i>Auxiliary</i> input variable to the instruction is an unused axis. 				○		page 3-223

Event code	Event name	Meaning	Assumed cause	Level					Reference
				M a j	P r t	M i n	O b s	I n f o	
54015475 hex	Position Gear Value Error	Synchronized motion is not possible for the velocity, acceleration rate, and deceleration rate that were input to a motion control instruction.	<ul style="list-style-type: none"> The specified synchronized motion cannot be performed at the velocity, acceleration rate, or deceleration rate that is input to the instruction. 				○		page 3-223
54015476 hex	Position Gear Master Axis Zero Velocity	The velocity of the master axis was zero when a motion control instruction was started.	<ul style="list-style-type: none"> The velocity of the master axis was 0 when the instruction was started. 				○		page 3-224
54015478 hex	Target Position Setting Out of Range	The parameter specified for the <i>Position</i> input variable to a motion control instruction is out of range.	<ul style="list-style-type: none"> Instruction input parameter exceeded the valid range of the input variable. The target position of a Rotary Mode axis is not within the ring setting range. 				○		page 3-224
54015479 hex	Travel Distance Out of Range	The parameter that was specified for the <i>Distance</i> input variable to a motion control instruction is out of range or the target position with the value of <i>Distance</i> added is out of range.	<ul style="list-style-type: none"> The absolute value of the instruction input parameter exceeded the range of 40-bit data when it is converted to pulses. For a Linear Mode axis, the target position with the travel distance added exceeded signed 40-bit data when the absolute value is converted to pulses. 				○		page 3-225
5401547A hex	Cam Table Start Point Setting Out of Range	The parameter specified for the <i>StartPosition</i> input variable to a motion control instruction is out of range.	<ul style="list-style-type: none"> Instruction input parameter exceeded the valid range of the input variable. 				○		page 3-225
5401547B hex	Cam Master Axis Following First Position Setting Out of Range	The parameter specified for the <i>MasterStartDistance</i> input variable to a motion control instruction is out of range.	<ul style="list-style-type: none"> Instruction input parameter exceeded the valid range of the input variable. 				○		page 3-226
5401547C hex	Circular Interpolation Radius Setting Error	It was not possible to create a circular path for the specified radius when the radius method was specified for the MC_MoveCircular2D (Circular 2D Interpolation) instruction.	<ul style="list-style-type: none"> For the MC_MoveCircular2D (Circular 2D Interpolation) instruction, it was not possible to create a circular path for the specified radius when the radius method was specified for circular interpolation. 				○		page 3-226

Event code	Event name	Meaning	Assumed cause	Level					Reference
				M a j	P r t	M i n	O b s	I n f o	
5401547D hex	Circular Interpolation Radius Overflow	For the MC_MoveCircular2D (Circular 2D Interpolation) instruction, the radius of the circle exceeded the maximum value for the border point or center specification method.	<ul style="list-style-type: none"> For the MC_MoveCircular2D (Circular 2D Interpolation) instruction, the radius of the circle exceeded 40-bit data when converted to pulses for the border point or center specification method. 				○		page 3-227
5401547E hex	Circular Interpolation Setting Out of Range	The parameter specified for the <i>CircAxes</i> input variable to a motion control instruction is out of range.	<ul style="list-style-type: none"> Instruction input parameter exceeded the valid range of the input variable. The axes that were specified in <i>CircAxes</i> are not included in the composition axes in the Axes Group Settings. The same axis was specified for both axes of <i>CircAxes</i>. 				○		page 3-228
5401547F hex	Auxiliary/ Slave Axis Numbers Not in Ascending Order	The values of the parameters for the <i>Auxiliary</i> and <i>Slave</i> input variables to a motion control instruction are not in ascending order.	<ul style="list-style-type: none"> The parameters for the <i>Auxiliary</i> and <i>Slave</i> input variables to the instruction are not in ascending order. 				○		page 3-228
54015480 hex	Cam Table Property Ascending Data Error at Update	A phase that was not in ascending order was found during calculating the number of valid data. Or, after calculations, the number of valid data is 0.	<ul style="list-style-type: none"> A phase that was not in ascending order was found when calculating the number of valid data. After calculations, the number of valid data is 0. 				○		page 3-229
54015481 hex	MC_Write Target Out of Range	The parameter specified for the <i>Target</i> input variable to a motion control instruction is out of range.	<ul style="list-style-type: none"> Instruction input parameter exceeded the valid range of the input variable. 				○		page 3-229
54015482 hex	Master Travel Distance Specification Out of Range	The parameter specified for the <i>MasterDistance</i> input variable to a motion control instruction is out of range.	<ul style="list-style-type: none"> Instruction input parameter exceeded the valid range of the input variable. 				○		page 3-230
54015483 hex	Master Distance in Acceleration Specification Out of Range	The parameter specified for the <i>MasterDistanceACC</i> input variable to a motion control instruction is out of range.	<ul style="list-style-type: none"> Instruction input parameter exceeded the valid range of the input variable. 				○		page 3-230

Event code	Event name	Meaning	Assumed cause	Level					Reference
				M a j	P r t	M i n	O b s	I n f o	
54015484 hex	Master Distance in Deceleration Specification Out of Range	The parameter specified for the <i>MasterDistanceDEC</i> input variable to a motion control instruction is out of range.	<ul style="list-style-type: none"> Instruction input parameter exceeded the valid range of the input variable. 				○		page 3-231
54015487 hex	Execution Mode Selection Out of Range	The parameter specified for the <i>ExecutionMode</i> input variable to a motion control instruction is out of range.	<ul style="list-style-type: none"> Instruction input parameter exceeded the valid range of the input variable. 				○		page 3-231
54015488 hex	Permitted Following Error Out of Range	The parameter specified for the <i>PermittedDeviation</i> input variable to a motion control instruction is out of range.	<ul style="list-style-type: none"> Instruction input parameter exceeded the valid range of the input variable. 				○		page 3-232
54015489 hex	Border Point/Center Position/Radius Specification Out of Range	The parameter specified for the <i>AuxPoint</i> input variable to a motion control instruction is out of range.	<ul style="list-style-type: none"> The value of <i>AuxPoint</i> exceeded signed 40-bit data when converted to pulses for the border point or center specification method. For a radius specifications, the absolute value of <i>AuxPoint[0]</i> exceeded 40-bit data when converted to pulses. 				○		page 3-232
5401548A hex	End Point Specification Out of Range	The parameter specified for the <i>EndPoint</i> input variable to a motion control instruction is out of range.	<ul style="list-style-type: none"> The instruction input parameter exceeded the range of signed 40-bit data when it was converted to pulses. 				○		page 3-233
5401548B hex	Slave Travel Distance Specification Out of Range	The parameter specified for the <i>SlaveDistance</i> input variable to a motion control instruction is out of range.	<ul style="list-style-type: none"> The instruction input parameter exceeded the range of 40-bit data when it is converted to pulses. 				○		page 3-233
5401548C hex	Phase Shift Amount Out of Range	The parameter specified for the <i>PhaseShift</i> input variable to a motion control instruction is out of range.	<ul style="list-style-type: none"> The absolute value of the instruction input parameter exceeded the range of 40-bit data when it is converted to pulses. 				○		page 3-234

Event code	Event name	Meaning	Assumed cause	Level					Reference
				M a j	P r t	M i n	O b s	I n f o	
5401548D hex	Feeding Distance Out of Range	The parameter specified for the <i>FeedDistance</i> input variable to a motion control instruction is out of range.	<ul style="list-style-type: none"> The absolute value of the instruction input parameter exceeded the range of 40-bit data when it is converted to pulses. 				○		page 3-234
5401548E hex	Auxiliary and Slave Defined as Same Axis	The same axis was specified for the <i>Auxiliary</i> and <i>Slave</i> input variables to a motion control instruction.	<ul style="list-style-type: none"> The parameter is the same for the <i>Auxiliary</i> and <i>Slave</i> input variables to the instruction. 				○		page 3-235
5401548F hex	Relative Position Selection Out of Range	The parameter specified for the <i>Relative</i> input variable to a motion control instruction is out of range.	<ul style="list-style-type: none"> Instruction input parameter exceeded the valid range of the input variable. 				○		page 3-235
54015490 hex	Cam Transition Specification Out of Range	The parameter specified for the <i>CamTransition</i> input variable to a motion control instruction is out of range.	<ul style="list-style-type: none"> Instruction input parameter exceeded the valid range of the input variable. 				○		page 3-236
54015491 hex	Synchronized Control End Mode Selection Out of Range	The parameter specified for the <i>OutMode</i> input variable to a motion control instruction is out of range.	<ul style="list-style-type: none"> Instruction input parameter exceeded the valid range of the input variable. 				○		page 3-236
54015492 hex	Enable External Latch Instruction Execution Disabled	<i>_mclImmediateStop</i> was specified for the <i>StopMode</i> input variable when the <i>MC_TouchProbe</i> (Enable External Latch) instruction was executed in Drive Mode for an encoder axis.	<ul style="list-style-type: none"> <i>_mclImmediateStop</i> was specified for the <i>StopMode</i> input variable when the <i>MC_TouchProbe</i> (Enable External Latch) instruction was executed in Drive Mode for an encoder axis. 				○		page 3-237
54015493 hex	Master Axis Offset Out of Range	The parameter specified for the <i>MasterOffset</i> input variable to a motion control instruction is out of range.	<ul style="list-style-type: none"> The instruction input parameter exceeded the range of signed 40-bit data when it was converted to pulses. 				○		page 3-237
54015494 hex	Slave Axis Offset Out of Range	The parameter specified for the <i>SlaveOffset</i> input variable to a motion control instruction is out of range.	<ul style="list-style-type: none"> The instruction input parameter exceeded the range of signed 40-bit data when it was converted to pulses. 				○		page 3-238

Event code	Event name	Meaning	Assumed cause	Level					Reference
				M a j	P r t	M i n	O b s	I n f o	
54015495 hex	Command Current Position Count Selection Out of Range	The parameter specified for the <i>CmdPosMode</i> input variable to a motion control instruction is out of range.	<ul style="list-style-type: none"> Instruction input parameter exceeded the valid range of the input variable. 				○		page 3-238
54015496 hex	Master Axis Gear Ratio Numerator Out of Range	The parameter specified for the <i>RatioNumeratorMaster</i> input variable to a motion control instruction is out of range.	<ul style="list-style-type: none"> Instruction input parameter exceeded the valid range of the input variable. 				○		page 3-239
54015497 hex	Master Axis Gear Ratio Denominator Out of Range	The parameter specified for the <i>RatioDenominatorMaster</i> input variable to a motion control instruction is out of range.	<ul style="list-style-type: none"> Instruction input parameter exceeded the valid range of the input variable. 				○		page 3-239
54015498 hex	Auxiliary Axis Gear Ratio Numerator Out of Range	The parameter specified for the <i>RatioNumeratorAuxiliary</i> input variable to a motion control instruction is out of range.	<ul style="list-style-type: none"> Instruction input parameter exceeded the valid range of the input variable. 				○		page 3-240
54015499 hex	Auxiliary Axis Gear Ratio Denominator Out of Range	The parameter specified for the <i>RatioDenominatorAuxiliary</i> input variable to a motion control instruction is out of range.	<ul style="list-style-type: none"> Instruction input parameter exceeded the valid range of the input variable. 				○		page 3-240
5401549A hex	Master Axis Position Type Selection Out of Range	The parameter specified for the <i>ReferenceTypeMaster</i> input variable to a motion control instruction is out of range.	<ul style="list-style-type: none"> Instruction input parameter exceeded the valid range of the input variable. 				○		page 3-241
5401549B hex	Auxiliary Axis Position Type Selection Out of Range	The parameter specified for the <i>ReferenceTypeAuxiliary</i> input variable to a motion control instruction is out of range.	<ul style="list-style-type: none"> Instruction input parameter exceeded the valid range of the input variable. 				○		page 3-241

Event code	Event name	Meaning	Assumed cause	Level					Reference
				M a j	P r t	M i n	O b s	I n f o	
5401549C hex	Target Position Ring Counter Out of Range	Operation is not possible because the target position is out of range for the ring counter of the executed instruction.	<ul style="list-style-type: none"> High-speed homing was executed when 0 was not included in the ring counter. 				○		page 3-242
5401549D hex	Axes Group Composition Axis Setting Out of Range	The parameter specified for the <i>Axes</i> input variable to a motion control instruction is out of range.	<ul style="list-style-type: none"> Instruction input parameter exceeded the valid range of the input variable. The composition axes in the axes group are not assigned to the same task. 				○		page 3-242
5401549E hex	Axis Use Setting Out of Range	The parameter specified for the <i>AxisUse</i> input variable to a motion control instruction is out of range.	<ul style="list-style-type: none"> Instruction input parameter exceeded the valid range of the input variable. 				○		page 3-243
54015700 hex	Homing Parameter Setting Out of Range	The parameter specified for the <i>HomingParameter</i> input variable to a motion control instruction is out of range.	<ul style="list-style-type: none"> Instruction input parameter exceeded the valid range of the input variable. 				○		page 3-243
54015702 hex	Axis Use Change Error	The MC_ChangeAxisUse (Change Axis Use) instruction was executed when the axis was not stopped or when the command velocity of the axis was saturated.	<ul style="list-style-type: none"> The MC_ChangeAxisUse (Change Axis Use) instruction was executed when the axis was not stopped or when the command velocity of the axis was saturated. 				○		page 3-244
54015703 hex	Cannot Change Axis Use	The MC_ChangeAxisUse (Change Axis Use) instruction was executed in a way that would cause the maximum number of used real axes or the maximum number of used motion control servo axes to be exceeded.	<ul style="list-style-type: none"> The MC_ChangeAxisUse (Change Axis Use) instruction was executed in a way that would cause the maximum number of used real axes to be exceeded. The MC_ChangeAxisUse (Change Axis Use) instruction was executed in a way that would cause the maximum number of used motion control servo axes to be exceeded. 				○		page 3-245

Event code	Event name	Meaning	Assumed cause	Level					Reference
				M a j	P r t	M i n	O b s	I n f o	
54015720 hex	Motion Control Parameter Setting Error When Changing Axis Use	The motion control parameter settings for the axis that was changed to a used axis are incorrect.	<ul style="list-style-type: none"> The MC_ChangeAxisUse (Change Axis Use) instruction was used to change an unused axis to a used axis, but the motion control parameter settings of the axis are not correct. The power supply was interrupted while a download of the motion control parameter settings was in progress. The non-volatile memory is faulty or the life of the non-volatile memory has been exceeded. 				○		page 3-246
54015721 hex	Required Process Data Object Not Set When Changing Axis Use	The objects that are required for the axis type of the axis that was changed to a used axis are not set.	<ul style="list-style-type: none"> The objects that are required for the axis type of the axis that was changed to a used axis are not set in the PDO map settings. The power supply was interrupted while a download of the motion control parameter settings was in progress. The non-volatile memory is faulty or the life of the non-volatile memory has been exceeded. The MC_ChangeAxisUse (Change Axis Use) instruction was executed for an axis that is set to Unused axis (unchangeable to used axis). 				○		page 3-247
54015722 hex	Actual Position Overflow/Underflow	An instruction was executed that is not supported during an actual position overflow/underflow.	<ul style="list-style-type: none"> An instruction was executed that is not supported during an actual position overflow or underflow. 				○		page 3-248
54015723 hex	Switch Structure Track Number Setting Out of Range	The value of <i>TrackNumber</i> that is specified in the <i>Switches</i> in-out variable to a motion control instruction is out of range.	<ul style="list-style-type: none"> The value of the member of the structure variable that was specified for the in-out variable of the instruction is out of range. 				○		page 3-248
54015724 hex	Switch Structure First ON Position Setting Out of Range	The value of <i>FirstOnPosition</i> that is specified in the <i>Switches</i> in-out variable to a motion control instruction is out of range.	<ul style="list-style-type: none"> The value of the member of the structure variable that was specified for the in-out variable of the instruction is out of range. 				○		page 3-249

Event code	Event name	Meaning	Assumed cause	Level					Reference
				M a j	P r t	M i n	O b s	I n f o	
54015725 hex	Switch Structure Last ON Position Setting Out of Range	The value of <i>LastOnPosition</i> that is specified in the <i>Switches</i> in-out variable to a motion control instruction is out of range.	<ul style="list-style-type: none"> The value of the member of the structure variable that was specified for the in-out variable of the instruction is out of range. 				○		page 3-249
54015726 hex	Switch Structure Axis Direction Out of Range	The value of <i>AxisDirection</i> that is specified in the <i>Switches</i> in-out variable to a motion control instruction is out of range.	<ul style="list-style-type: none"> The value of the member of the structure variable that was specified for the in-out variable of the instruction is out of range. 				○		page 3-250
54015727 hex	Switch Structure Cam Switch Mode Out of Range	The value of <i>CamSwitchMode</i> that is specified in the <i>Switches</i> in-out variable to a motion control instruction is out of range.	<ul style="list-style-type: none"> The value of the member of the structure variable that was specified for the in-out variable of the instruction is out of range. 				○		page 3-250
54015728 hex	Switch Structure Duration Setting Out of Range	The value of <i>Duration</i> that is specified in the <i>Switches</i> in-out variable to a motion control instruction is out of range.	<ul style="list-style-type: none"> The value of the member of the structure variable that was specified for the in-out variable of the instruction is out of range. 				○		page 3-251
54015729 hex	Track Option Structure ON Compensation Setting Out of Range	The value of <i>OnCompensation</i> that is specified in the <i>TrackOptions</i> in-out variable to a motion control instruction is out of range.	<ul style="list-style-type: none"> The value of the member of the structure variable that was specified for the in-out variable of the instruction is out of range. 				○		page 3-251
5401572A hex	Track Option Structure OFF Compensation Setting Out of Range	The value of <i>OffCompensation</i> that is specified in the <i>TrackOptions</i> in-out variable to a motion control instruction is out of range.	<ul style="list-style-type: none"> The value of the member of the structure variable that was specified for the in-out variable of the instruction is out of range. 				○		page 3-252
5401572B hex	Number of Array Elements in Switch Structure Variable Out of Range	The number of elements in an array in the structure variable that is specified in the <i>Switches</i> in-out variable to a motion control instruction is out of range.	<ul style="list-style-type: none"> The number of elements in an array of the structure variable that was specified for the in-out variable of the instruction is out of range. 				○		page 3-252

Event code	Event name	Meaning	Assumed cause	Level					Reference
				M a j	P r t	M i n	O b s	I n f o	
5401572C hex	Number of Array Elements in Output Signal Structure Variable Out of Range	The number of elements in an array in the structure variable that is specified in the <i>Outputs</i> in-out variable to a motion control instruction is out of range.	<ul style="list-style-type: none"> The number of elements in an array of the structure variable that was specified for the in-out variable of the instruction is out of range. 				○		page 3-253
5401572D hex	Number of Array Elements in Track Option Structure Variable Out of Range	The number of elements in an array in the structure variable that is specified in the <i>TrackOptions</i> in-out variable to a motion control instruction is out of range.	<ul style="list-style-type: none"> The number of elements in an array of the structure variable that was specified for the in-out variable of the instruction is out of range. 				○		page 3-253
5401572E hex	Numbers of Elements in Output Signals and Track Option Arrays Not Matched	The arrays in the structure variables that are specified for the <i>Outputs</i> and <i>Track-Options</i> in-out variables to a motion control instruction do not have the same number of elements.	<ul style="list-style-type: none"> The arrays in the output signal structure variable and track option structure variable that are specified for the in-out variables to the instruction do not have the same number of elements. 				○		page 3-254
5401572F hex	Motion Control Instruction Multi-execution Disabled (Master Axis)	A <i>Master</i> in-out variable that cannot be changed during multi-execution of instructions was changed.	<ul style="list-style-type: none"> A <i>Master</i> in-out variable that cannot be changed during multi-execution of instructions was changed. 				○		page 3-254
54015730 hex	Motion Control Instruction Multi-execution Disabled (Position Type Selection)	A <i>ReferenceType</i> in-out variable that cannot be changed during multi-execution of instructions was changed.	<ul style="list-style-type: none"> A <i>ReferenceType</i> in-out variable that cannot be changed during multi-execution of instructions was changed. 				○		page 3-255
54015731 hex	Same Track Number Setting in Switch Structure Out of Range	The same track number was specified more than the allowable number of times for the <i>TrackNumber</i> in the <i>Switches</i> in-out variable to a motion control instruction.	<ul style="list-style-type: none"> The same track number was specified more than the allowable number of times for the <i>TrackNumber</i> in the <i>Switches</i> in-out variable to a motion control instruction. 				○		page 3-255
5401573A hex	Cannot Write Axis Parameters	The instruction was executed for an axis that is not an unused axis.	<ul style="list-style-type: none"> The instruction was executed for a used axis or an undefined axis. 				○		page 3-256

Event code	Event name	Meaning	Assumed cause	Level					Reference
				M a j	P r t	M i n	O b s	I n f o	
5401573B hex	Axis Parameter Setting Out of Range	The parameter specified for the <i>AxisParameter</i> input variable to a motion control instruction is outside of the valid range.	<ul style="list-style-type: none"> The parameter specified for the <i>AxisParameter</i> input variable to the instruction is out of range for the input variable. 				○		page 3-256
5401573C hex	Cam Property Setting Out of Range	The parameter specified for the <i>CamProperty</i> input variable to a motion control instruction is outside of the valid range.	<ul style="list-style-type: none"> The parameter specified for the <i>CamProperty</i> input variable to the instruction is out of range for the input variable. 				○		page 3-257
5401573D hex	Cam Node Setting Out of Range	The parameter specified for the <i>CamNodes</i> input variable to a motion control instruction is outside of the valid range.	<ul style="list-style-type: none"> The parameter specified for the <i>CamNodes</i> input variable to the instruction is out of range for the input variable. 				○		page 3-257
5401573E hex	Incorrect Cam Node Type Specification	The parameter specified for the <i>CamNodes</i> input variable to a motion control instruction is not an <code>_sMC_CAM_NODE</code> array variable.	<ul style="list-style-type: none"> The parameter specified for the <i>CamNodes</i> input variable to the instruction is not an <code>_sMC_CAM_NODE</code> array variable. 				○		page 3-258
5401573F hex	Insufficient Nodes in Cam Table	The array variable of the parameter specified for the <i>CamNodes</i> input variable to a motion control instruction has a Phase value of 0 for element number 0.	<ul style="list-style-type: none"> The array variable of the parameter specified for the <i>CamNodes</i> input variable to the instruction has a Phase (master axis phase) value of 0 for element number 0. 				○		page 3-258
54015740 hex	Cam Node Master Axis Phase Not in Ascending Order	The values of Phase in the array variable of the parameter specified for the <i>CamNodes</i> input variable to a motion control instruction are not in ascending order according to the element numbers.	<ul style="list-style-type: none"> The values of Phase (master axis phase) in the array variable of the parameter specified for the <i>CamNodes</i> input variable to the instruction are not in ascending order according to the element numbers. Or, truncating the digits that are not effective more than seven digits caused the phases not to be in ascending order. 				○		page 3-259

Event code	Event name	Meaning	Assumed cause	Level					Reference
				M a j	P r t	M i n	O b s	I n f o	
54015741 hex	Too Many Data Points in Cam Table	The number of generated cam data points exceeded the number of elements in the array in the cam data variable that is specified for the <i>CamTable</i> input variable to a motion control instruction.	<ul style="list-style-type: none"> The number of cam data points in the generated cam table exceeded the number of elements in the array in the cam data variable that is specified for the <i>CamTable</i> input variable to the instruction. 				○		page 3-260
54015742 hex	Cam Table Displacement Overflow	Distance in the generated cam table exceeded the range of REAL data.	<ul style="list-style-type: none"> Distance in the generated cam table exceeded the range of REAL data. 				○		page 3-261
54015743 hex	Aborted Cam Table Used	A cam data variable that was aborted during generation was specified for the <i>CamTable</i> input variable to an instruction.	<ul style="list-style-type: none"> A cam data variable that was aborted during generation due to an error in the MC_GenerateCamTable (Generate Cam Table) instruction was specified for the <i>CamTable</i> input variable to the instruction. 				○		page 3-262
54015749 hex	Execution ID Setting Out of Range	The parameter specified for the <i>ExecID</i> input variable to a motion control instruction is out of range.	<ul style="list-style-type: none"> The parameter specified for the <i>ExecID</i> input variable to the instruction is out of range for the input variable. 				○		page 3-262
5401574A hex	Position Offset Out of Range	The parameter specified for the <i>OffsetPosition</i> input variable to a motion control instruction is out of range.	<ul style="list-style-type: none"> The position offset exceeded the range of signed 40-bit data when it was converted to pulses. 				○		page 3-263
5401574B hex	PDS State Transition Command Selection Out of Range	The parameter specified for the <i>TransitionCmd</i> input variable to a motion control instruction is out of range.	<ul style="list-style-type: none"> Instruction input parameter exceeded the valid range of the input variable. 				○		page 3-263
54015751 hex (Ver. 1.21 or later)	Cam Monitor Mode Selection Out of Range	The cam monitor mode selection specified for the <i>CamMonitorMode</i> input variable to a motion control instruction is out of range.	<ul style="list-style-type: none"> The cam monitor mode selection is out of the valid range. 				○		page 3-264

Event code	Event name	Meaning	Assumed cause	Level					Reference
				M a j	P r t	M i n	O b s	I n f o	
54015752 hex (Ver. 1.21 or later)	Data Type of Cam Monitor Values Mismatch	The data type of the cam monitor values specified for the <i>CamMonitorValue</i> input variable to a motion control instruction does not match the cam monitor mode selection.	<ul style="list-style-type: none"> The data type of the variable specified for the cam monitor values does not match the cam monitor mode selection. 				○		page 3-264
54016440 hex	Target Position Positive Software Limit Exceeded	The specified position exceeds the positive software limit.	<ul style="list-style-type: none"> The parameter specified for the <i>Position</i> input variable to the instruction is beyond the positive software limit. The first position is beyond the positive software limit and an instruction that specifies motion in the opposite direction of the software limit was executed. The parameter that was specified for the <i>AuxPoint</i> input variable to a border point MC_MoveCircular2D (Circular 2D Interpolation) instruction is beyond the positive software limit. 				○		page 3-265
54016441 hex	Target Position Negative Software Limit Exceeded	The specified position exceeds the negative software limit.	<ul style="list-style-type: none"> The parameter specified for the <i>Position</i> input variable to the instruction is beyond the negative software limit. The first position is beyond the negative software limit and an instruction that specifies motion in the opposite direction of the software limit was executed. The parameter that was specified for the <i>AuxPoint</i> input variable to a border point MC_MoveCircular2D (Circular 2D Interpolation) instruction is beyond the negative software limit. 				○		page 3-266

Event code	Event name	Meaning	Assumed cause	Level					Reference
				M a j	P r t	M i n	O b s	I n f o	
54016442 hex	Command Position Overflow/ Underflow	Positioning, an instruction in the underflow/overflow direction, or an instruction for which the direction is not specified was executed when there was an underflow/ overflow in the command position.	<ul style="list-style-type: none"> One of the following was executed when there was a command position overflow/underflow. A positioning instruction A continuous control instruction in the underflow/overflow direction An instruction for which the direction is not specified (syncing or torque control) 				○		page 3-267
54016443 hex	Positive Limit Input	An instruction was executed for a motion in the positive direction when the positive limit input was ON.	<ul style="list-style-type: none"> An instruction for a motion in the positive direction was executed when the positive limit input was ON, or an instruction for a motion with no direction specification was executed when the positive limit input was ON. An axes group motion control instruction was executed when the positive limit input was ON. 				○		page 3-268
54016444 hex	Negative Limit Input	An instruction for a motion in the negative direction was executed when the negative limit input was ON.	<ul style="list-style-type: none"> An instruction for a motion in the negative direction was executed when the negative limit input was ON, or an instruction for a motion with no direction specification was executed when the negative limit input was ON. An axes group motion control instruction was executed when the negative limit input was ON. 				○		page 3-269
54017422 hex	Servo Main Circuits OFF	An attempt was made to turn ON the Servo when the main circuit power supply to the Servo Drive was OFF.	<ul style="list-style-type: none"> An attempt was made to turn ON the Servo when the main circuit power supply to the Servo Drive was OFF. 				○		page 3-270

3-2-2 Error Descriptions

Errors for Self Diagnosis

Event name	Internal Bus Check Error		Event code	000D0000 hex	
Meaning	A fatal error was detected on the internal bus.				
Source	PLC Function Module		Source details	None	Detection timing Continuously
Error attributes	Level	Major fault	Recovery	Cycle the power supply.	Log category System
Effects	User program	Stops.	Operation	Stops. *1 A connection to the Sysmac Studio may not be possible.	
System-defined variables	Variable	Data type		Name	
	None	---		---	
Cause and correction	Assumed cause		Correction		Prevention
	A conductive material has gotten inside.		If there is conductive material nearby, blow out the CPU Unit with air.		Do not do any metal working in the vicinity of the control panel. Also, make sure that the operating environment is free of dirt and dust. Close the control panel.
	Noise <ul style="list-style-type: none"> • There is data corruption in bus signals. • There is malfunctioning in bus interface circuits. 		If the error occurs even after making the above correction, check the FG, and power supply lines, and other noise entry paths, and implement noise countermeasures as required.		Implement noise countermeasures.
	The CPU Unit has failed. <ul style="list-style-type: none"> • The internal bus is disconnected. 		If this error persists even after you make the above two corrections, replace the CPU Unit.		None
Attached information	Attached information 1: System information				
Precautions/Remarks	When this error occurs, the CPU Unit stops and the error is recorded in the event log. If cycling the power to the Controller clears the error, you will be able to see whether this error occurred by checking the event log. However, a restart is sometimes not possible depending on the error location.				

*1. For details, refer to *I/O Operation for Major Fault Level Controller Errors* on page 1-16.

Event name	Non-volatile Memory Life Exceeded		Event code	000E0000 hex	
Meaning	The specified number of deletions for non-volatile memory was exceeded. Or, the number of bad blocks in memory exceeded the specified value.				
Source	PLC Function Module		Source details	None	Detection timing Continuously
Error attributes	Level	Major fault	Recovery	Cycle the power supply.	Log category System
Effects	User program	Stops.	Operation	Stops.*1	
System-defined variables	Variable	Data type		Name	
	None	---		---	
Cause and correction	Assumed cause		Correction		Prevention
	Non-volatile memory life expired.		Replace the CPU Unit.		---
Attached information	None				
Precautions/Remarks	None				

*1. For details, refer to *I/O Operation for Major Fault Level Controller Errors* on page 1-16.

Event name	CPU Unit Overheat (Operation Stopped)		Event code	00110000 hex	
Meaning	Operation was stopped because the temperature inside the CPU Unit was too high.				
Source	PLC Function Module		Source details	None	Detection timing Continuously
Error attributes	Level	Major fault	Recovery	Cycle the power supply or reset the Controller.	Log category System
Effects	User program	Stops.	Operation	Stops.*1 A connection to the Sysmac Studio is not possible.	
System-defined variables	Variable	Data type		Name	
	None	---		---	
Cause and correction	Assumed cause		Correction		Prevention
	The ambient operating temperature is too high.		<p>Make sure that the ambient operating temperature stays between 0 and 55°C.</p> <ul style="list-style-type: none"> • Provide enough space for good air flow. • Do not install the Controller directly above equipment that generates a large amount of heat, such as heaters, transformers, or high-capacity resistors. • If the ambient temperature exceeds 55 °C, install a cooling fan or air conditioner. 		Make sure that the ambient temperature stays between 0 and 55°C.
Attached information	None				
Precautions/Remarks	None				

*1. For details, refer to *I/O Operation for Major Fault Level Controller Errors* on page 1-16.

Event name	Non-volatile Memory Restored or Formatted		Event code	10010000 hex	
Meaning	An error was detected in the non-volatile memory check and file system recovery or formatting was executed. Previous files may have been deleted.				
Source	PLC Function Module		Source details	None	Detection timing At power ON or Controller reset
Error attributes	Level	Major fault	Recovery	Cycle the power supply or reset the Controller.	Log category System
Effects	User program	Stops.	Operation	Stops.*1	
System-defined variables	Variable	Data type		Name	
	None	---		---	
Cause and correction	Assumed cause		Correction		Prevention
	The Controller power supply was turned OFF while the BUSY indicator was lit.		Compare the project with the project on the Sysmac Studio. If they match, cycle the power supply to the Controller or reset the Controller to see if that clears the error. If the error is cleared, check that the device operates correctly. If the comparison shows a mismatch, if the error is not cleared, or if the device does not operate correctly, clear all of memory and then download the project from the Sysmac Studio again. If cycling the power supply to the Controller or resetting the Controller does not clear the error, the memory is corrupted. Replace the CPU Unit. Unexpected operation may occur and can be very dangerous if the power to the Controller is cycled or the Controller is reset before you download the project again.		Do not turn OFF the power supply while the BUSY indicator is lit.
	The power supply to the Controller was interrupted momentarily while the BUSY indicator was lit.				Take appropriate measures to ensure that the specified power with the rated voltage and frequency is supplied in places where the power supply is unstable.
Attached information	Attached information 1: Recovered content <ul style="list-style-type: none"> • (00000000 hex: File system recovery successful, • 00000001 hex: Formatted) 				
Precautions/Remarks	Make sure that the projects match and that the device operates correctly, or transfer the project again. If you cycle the power to the Controller or reset the Controller before you do this, unexpected operation may occur and can be very dangerous.				

*1. For details, refer to *I/O Operation for Major Fault Level Controller Errors* on page 1-16.

Event name	Non-volatile Memory Data Corrupted		Event code	10020000 hex	
Meaning	A file that must be in non-volatile memory is missing or corrupted.				
Source	PLC Function Module		Source details	None	Detection timing At power ON or Controller reset
Error attributes	Level	Major fault	Recovery	Cycle the power supply or reset the Controller.	Log category System
Effects	User program	Stops.	Operation	Stops.*1	
System-defined variables	Variable	Data type		Name	
	None	---		---	
Cause and correction	Assumed cause		Correction		Prevention
	The Controller power supply was turned OFF while the BUSY indicator was lit.		Clear all of memory and then download the project from the Sysmac Studio.		Do not turn OFF the power supply while the BUSY indicator is lit.
	The power supply to the Controller was interrupted momentarily while the BUSY indicator was lit.				Take appropriate measures to ensure that the specified power with the rated voltage and frequency is supplied in places where the power supply is unstable.
The CPU Unit has failed.		If this error remains even after making the above corrections, replace the CPU Unit.		None	
Attached information	None				
Precautions/Remarks	None				

*1. For details, refer to *I/O Operation for Major Fault Level Controller Errors* on page 1-16.

Event name	Main Memory Check Error		Event code	10080000 hex	
Meaning	An error was detected in the memory check of the main memory in the CPU Unit.				
Source	PLC Function Module		Source details	None	Detection timing Continuously
Error attributes	Level	Major fault	Recovery	Cycle the power supply.	Log category System
Effects	User program	Stops.	Operation	Stops.*1	
System-defined variables	Variable	Data type		Name	
	None	---		---	
Cause and correction	Assumed cause		Correction		Prevention
	A conductive material has gotten inside.		If there is conductive material nearby, blow out the CPU Unit with air.		Do not do any metal working in the vicinity of the control panel. Use the control panel only when it is closed.
	Noise <ul style="list-style-type: none"> • Data corruption in memory • Microcomputer malfunctioning • Memory write circuit malfunctioning 		If the error did not result from the above causes, cycle the power to the Controller and see if that clears the error. If the error occurs frequently, check the FG, power supply lines, and other noise entry paths, and implement noise countermeasures as required.		Implement noise countermeasures.
	There is a software error. <ul style="list-style-type: none"> • Data corruption was caused by cosmic rays or radiation. 		If the error did not result from the above causes, and cycling the power to the Controller or resetting the Controller does not clear the error, replace the CPU Unit.		None
The CPU Unit has failed. <ul style="list-style-type: none"> • Memory element failure • Memory peripheral circuit failure 		Perform regular inspections.			
Attached information	Attached information 1: System information				
Precautions/Remarks	None				

*1. For details, refer to *I/O Operation for Major Fault Level Controller Errors* on page 1-16.

Event name	Non-volatile Memory Data Corrupted		Event code	100B0000 hex	
Meaning	A file that must be in non-volatile memory is missing or corrupted.				
Source	PLC Function Module		Source details	None	Detection timing At power ON or Controller reset
Error attributes	Level	Major fault	Recovery	Cycle the power supply or reset the Controller.	Log category System
Effects	User program	Stops.	Operation	Stops.*1	
System-defined variables	Variable	Data type		Name	
	None	---		---	
Cause and correction	Assumed cause		Correction		Prevention
	The Controller power supply was turned OFF while the BUSY indicator was lit.		Clear all of memory and then download the project from the Sysmac Studio.		Do not turn OFF the power supply while the BUSY indicator is lit.
	The power supply to the Controller was interrupted momentarily while the BUSY indicator was lit.				Take appropriate measures to ensure that the specified power with the rated voltage and frequency is supplied in places where the power supply is unstable.
The CPU Unit has failed.		If this error remains even after making the above corrections, replace the CPU Unit.		None	
Attached information	None				
Precautions/Remarks	None				

*1. For details, refer to *I/O Operation for Major Fault Level Controller Errors* on page 1-16.

Event name	Event Level Setting Error		Event code	100C0000 hex	
Meaning	The settings in the event level setting file are not correct.				
Source	PLC Function Module		Source details	None	Detection timing At power ON or Controller reset
Error attributes	Level	Major fault	Recovery	Cycle the power supply or reset the Controller.	Log category System
Effects	User program	Stops.	Operation	Stops.* ¹	
System-defined variables	Variable	Data type		Name	
	None	---		---	
Cause and correction	Assumed cause		Correction		Prevention
	The event level settings are not correct because the power supply to the Controller was interrupted or communications with the Sysmac Studio were disconnected during a download of the event level settings.		Perform a Memory All Clear operation and then transfer the event level setting file again.		Do not interrupt the power supply to the Controller or disconnect communications with the Sysmac Studio during a download of the event level settings.
	The event level settings are not correct because the power supply to the Controller was interrupted during a Clear All Memory operation.				Do not interrupt the power supply to the Controller during a Clear All Memory operation.
	Non-volatile memory failed.		If the error persists even after you make the above correction, replace the CPU Unit.		None
Attached information	None				
Precautions/Remarks	None				

*1. For details, refer to *I/O Operation for Major Fault Level Controller Errors* on page 1-16.

Event name	Present Values of Retained Variables Restoration Error		Event code	100F0000 hex	
Meaning	An error occurred in the software and the present values of retained variables could not be restored at startup. The values were initialized.				
Source	PLC Function Module		Source details	None	Detection timing At power ON or Controller reset
Error attributes	Level	Major fault	Recovery	Cycle the power supply or reset the Controller.	Log category System
Effects	User program	Stops.	Operation	Stops.*1 The variables with a Retain attribute and memory for CJseries Units in the DM, EM, and Holding Areas were corrupted. Normal user program execution or normal Unit operation may not be possible. (NX1P2 CPU Unit) The variables with a Retain attribute were corrupted. Normal user program execution or normal Unit operation may not be possible. (NY-series Controllers)	
System-defined variables	Variable	Data type		Name	
	_RetainFail	BOOL		Retention Failure Flag	
Cause and correction	Assumed cause		Correction		Prevention
	An error occurred in the software.		Perform the following: <ul style="list-style-type: none"> • Check the values of the retained variables and the retained areas in the memory used for CJ-series Units and change them to the correct values. (NX1P2 CPU Unit) • Check the values of the retained variables and change them to the correct values. (NY-series Controllers) • If the system uses a Servomotor with an absolute encoder, turn ON the power supply, and then turn ON the Servo and check the actual current position of the axis. 		None
Attached information	None				
Precautions/Remarks	The following values are initialized. <ul style="list-style-type: none"> • Retained variables (variables with a Retain attribute or variables in retained areas with AT specifications) (NX1P2 CPU Unit) • Retained variables (variables with a Retain attribute) (NY-series Controllers) • Retained areas in the memory used for CJ-series Units (NX1P2 CPU Unit) • Absolute encoder home offset data 				

*1. For details, refer to *I/O Operation for Major Fault Level Controller Errors* on page 1-16.

Event name	Present Values of Retained Variables Not Saved		Event code	10100000 hex	
Meaning	A forced shutdown is performed or an error occurred in the software and the present values of retained variables could not be saved during power-OFF processing.				
Source	PLC Function Module		Source details	None	Detection timing At power ON or Controller reset
Error attributes	Level	Major fault	Recovery	Cycle the power supply.	Log category System
Effects	User program	Stops.	Operation	Stops.*1 The values of the variables with a Retain attribute and memory for CJ-series Units in the DM, EM, and Holding Areas were not same as the values just before the power interruption. Normal user program execution or normal Unit operation may not be possible. (NX102 CPU Unit and NX1P2 CPU Unit) The values of the variables with a Retain attribute were not same as the values just before the power interruption. Normal user program execution or normal Unit operation may not be possible. (NY-series Controllers)	
System-defined variables	Variable	Data type		Name	
	None	---		---	
Cause and correction	Assumed cause		Correction		Prevention
	A forced shutdown is performed. (NY-series Controllers)		Perform the following: <ul style="list-style-type: none"> • Check the values of the retained variables and the retained areas in the memory used for CJ-series Units and change them to the correct values. (NX102 CPU Unit and NX1P2 CPU Unit) • Check the values of the retained variables and change them to the correct values. (NY-series Controllers) • If the system uses a Servomotor with an absolute encoder, turn ON the power supply, and then turn ON the Servo and check the actual current position of the axis. 		Perform a shutdown with other method than the forced shutdown.
	An error occurred in the software.				None
Attached information	None				
Precautions/Remarks	The following values are initialized. <ul style="list-style-type: none"> • Retained variables (variables with a Retain attribute or variables in retained areas with AT specifications) (NX1P2 CPU Unit) • Retained variables (variables with a Retain attribute) (NY-series Controllers) • Retained areas in the memory used for CJ-series Units (NX1P2 CPU Unit) • Absolute encoder home offset data 				

*1. For details, refer to *I/O Operation for Major Fault Level Controller Errors* on page 1-16.

Event name	Firmware Configuration Mismatch			Event code	10120000 hex
Meaning	An inconsistency was detected in the software which configures the firmware.				
Source	PLC Function Module		Source details	None	Detection timing At power ON or Controller reset
Error attributes	Level	Major fault	Recovery	Cycle the power supply.	Log category System
Effects	User program	Stops.	Operation	Stops.*1	
System-defined variables	Variable		Data type		Name
	None		---		---
Cause and correction	Assumed cause		Correction		Prevention
	The firmware upgrade is not completed.		Upgrade the firmware again.		None
	The firmware was partially restored using the Rescue disk.		Restore the whole system using the Rescue disk.		None
	The storage device was replaced.				
Attached information	Attached information 1: The name and version of the software in which an inconsistency occurred.				
Precautions/Remarks	None				

*1. Refer to *I/O Operation for Major Fault Level Controller Errors* on page 1-16 for details.

Event name	PLC System Processing Error			Event code	40030000 hex
Meaning	A fatal error was detected in the PLC Function Module.				
Source	PLC Function Module		Source details	None	Detection timing Continuously
Error attributes	Level	Major fault	Recovery	Cycle the power supply.	Log category System
Effects	User program	Stops.	Operation	Stops.*1	
System-defined variables	Variable		Data type		Name
	None		---		---
Cause and correction	Assumed cause		Correction		Prevention
	An error occurred in the software.		Contact your OMRON representative.		None
Attached information	Attached information 1: System information				
Precautions/Remarks	None				

*1. For details, refer to *I/O Operation for Major Fault Level Controller Errors* on page 1-16.

Event name	PLC System Processing Error			Event code	40040000 hex	
Meaning	A fatal error was detected in the PLC Function Module.					
Source	PLC Function Module		Source details	None	Detection timing	Continuously
Error attributes	Level	Major fault	Recovery	Cycle the power supply.	Log category	System
Effects	User program	Stops.	Operation	Stops.*1 A connection to the Sysmac Studio is not possible.		
System-defined variables	Variable	Data type		Name		
	None	---		---		
Cause and correction	Assumed cause		Correction		Prevention	
	An error occurred in the software.		Contact your OMRON representative.		None	
Attached information	None					
Precautions/Remarks	None					

*1. For details, refer to *I/O Operation for Major Fault Level Controller Errors* on page 1-16.

Event name	Low Battery Voltage			Event code	000B0000 hex	
Meaning	The voltage of the Battery has dropped.					
Source	PLC Function Module		Source details	None	Detection timing	Continuously
Error attributes	Level	Minor fault	Recovery	Error reset	Log category	System
Effects	User program	Continues.	Operation	No affected.		
System-defined variables	Variable	Data type		Name		
	_SelfTest_LowBattery	BOOL		Low Battery Flag		
Cause and correction	Assumed cause		Correction		Prevention	
	The battery voltage is low.		Replace the Battery.		Regularly replace the Battery.	
	The battery connector has come loose.		Reconnect the connector and make sure it is mated correctly.		Check for vibration and shock.	
	The Battery is missing.		Install a Battery.		Install a Battery.	
Attached information	None					
Precautions/Remarks	You may lose the clock data the next time that the power supply is interrupted. You can change the event level to the observation level. If you change the level to the observation level, recovery procedures are not required.					

Event name	CPU Unit Overheat			Event code	000C0000 hex	
Meaning	The temperature inside the CPU Unit exceeded the specified value.					
Source	PLC Function Module		Source details	None	Detection timing	Continuously
Error attributes	Level	Minor fault	Recovery	Cycle the power supply or reset the Controller.	Log category	System
Effects	User program	Continues.	Operation	Not affected.		
System-defined variables	Variable		Data type		Name	
	_SelfTest_HighTemperature		BOOL		CPU Unit High Temperature Flag	
Cause and correction	Assumed cause		Correction		Prevention	
	The ambient operating temperature is too high.		<p>Make sure that the ambient operating temperature stays between 0 and 55°C.</p> <ul style="list-style-type: none"> • Provide enough space for good air flow. • Do not install the Controller above equipment that generates a large amount of heat, such as heaters, transformers, or high-capacity resistors. • If the ambient temperature exceeds 55 °C, install a cooling fan or air conditioner. 		Make sure that the ambient temperature stays between 0 and 55°C.	
Attached information	None					
Precautions/Remarks	This event may occur due to the load on Windows. If that occurs, reduce the load on Windows.					

Event name	Slow Fan			Event code	00120000 hex	
Meaning	The speed of the fan dropped to a specified level or lower.					
Source	PLC Function Module		Source details	None	Detection timing	Continuously
Error attributes	Level	Minor fault	Recovery	Error reset	Log category	System
Effects	User program	Continues.	Operation	Not affected.		
System-defined variables	Variable		Data type		Name	
	_SelfTest_LowFanRevolution		BOOL		Low FAN Revolution Flag	
Cause and correction	Assumed cause		Correction		Prevention	
	Something is interfering with fan operation, such as dust, wire scraps, or cuttings.		Remove the material that is interfering with fan operation.		Make sure that nothing is interfering with the fan during operation.	
	The fan has reached the end of its service life.		Replace the Fan Unit.*1		Regularly replace the Fan Unit.*1	
	The fan is faulty.					
Attached information	None					
Precautions/Remarks	You can change the event level to the observation level. If you change the level to the observation level, recovery procedures are not required.					

*1. Refer to the *NY-series Industrial Box PC Hardware User's Manual (Cat. No. W556)* or *NY-series Industrial Panel PC Hardware User's Manual (Cat. No. W557)* for the Fan Unit replacement procedure and life.

Event name	Shared Folder Access Power OFF Error			Event code	100E0000 hex
Meaning	The power supply to the Controller was interrupted during access to the shared folder was in progress.				
Source	PLC Function Module		Source details	None	Detection timing At power ON or Controller reset
Error attributes	Level	Observation	Recovery	---	Log category System
Effects	User program	Continues.	Operation	Operation is controlled by the user program when the file is corrupted.	
System-defined variables	Variable		Data type		Name
	_Card1PowerFail		BOOL		SD Memory Card Power Interruption Flag
Cause and correction	Assumed cause		Correction		Prevention
	The Controller power supply was turned OFF while access to the file was in progress.		Check that the correct file is in the shared folder, or that the system operates correctly.		Do not turn OFF the power supply while access to the file is in progress.
	The power supply to the Controller was interrupted momentarily while access to the file was in progress.		If the correct file is missing or the system does not operate properly, download the correct file to the shared folder again. Cycle the power supply to the Controller or reset the Controller and confirm that the system operates correctly. When you have finished the corrections, change _Card1PowerFail (SD Memory Card Power Interruption Flag) to FALSE.		Be sure to use a UPS. Also, take appropriate measures to ensure that the specified power with the rated voltage and frequency is supplied in places where the power supply is unstable.
Attached information	None				
Precautions/Remarks	When the measure is completed, change the SD Memory Card Power Interruption Flag to FALSE.				

Event name	UPS Battery Operation Started			Event code	90220000 hex
Meaning	The USP battery operation was started.				
Source	PLC Function Module		Source details	None	Detection timing At power interruption during UPS connection
Error attributes	Level	Information	Recovery	---	Log category System
Effects	User program	Continues.	Operation	Operation will be stopped within the specified time.	
System-defined variables	Variable		Data type		Name
	_SelfTest_UPSSignal		BOOL		UPS Signal Detection Flag
Cause and correction	Assumed cause		Correction		Prevention
	The power was interrupted while a UPS is connected.		---		---
Attached information	None				
Precautions/Remarks	None				

Errors Related to Tasks

Event name	Task Execution Timeout		Event code	60020000 hex			
Meaning	Task execution exceeded the timeout detection time.						
Source	PLC Function Module		Source details	None	Detection timing	Continuously	
Error attributes	Level	Major fault	Recovery	Cycle the power supply or reset the Controller.	Log category	System	
Effects	User program	Stops.	Operation	Stops.*1			
System-defined variables	Variable		Data type		Name		
	_<Task_name>_Exceeded		BOOL		Task Period Exceeded Flag		
	_<Task_name>_ExceedCount		UDINT		Task Period Exceeded Count		
	_<Task_name>_LastExecTime		TIME		Last Task Execution Time		
		_<Task_name>_MaxExecTime		TIME		Maximum Task Execution Time	
Cause and correction	Assumed cause		Correction		Prevention		
	The timeout detection time setting is too short.		Increase the timeout detection time.		Design the tasks considering the corrections that are given on the left.		
	The task period setting is too short.		Increase the task period.				
	A user program is too large.		Separate the processes into different tasks, for example move processes that do not need a short execution period to a periodic task with a lower priority.				
	The number of times that processing is repeated is larger than expected.		If there is a program with an extremely high number of repetitions, correct the program to achieve the correct number of repetitions. Set a trap in the user program that monitors the number of times a process is executed to check the number of repetitions.				
	Task Priority Error		Increase the priority of the periodic task. Or, decrease the priorities of the other tasks.				
Frequent Event Task Execution		Lower the frequency of event task execution. Or, decrease the priorities of the event tasks.					
Attached information	Attached Information 1: Name of task where error occurred						
Precautions/Remarks	None						

*1. For details, refer to *I/O Operation for Major Fault Level Controller Errors* on page 1-16.

Event name	I/O Refreshing Timeout Error		Event code	60030000 hex	
Meaning	Consecutive I/O refresh failures occurred during the primary periodic task or periodic task period.				
Source	PLC Function Module		Source details	None	Detection timing Continuously
Error attributes	Level	Major fault	Recovery	Cycle the power supply or reset the Controller.	Log category System
Effects	User program	Stops.	Operation	Stops.*1	
System-defined variables	Variable		Data type		Name
	_<Task_name>_Exceeded		BOOL		Task Period Exceeded Flag
	_<Task_name>_ExceedCount		UDINT		Task Period Exceeded Count
	_<Task_name>_LastExecTime		TIME		Last Task Execution Time
Cause and correction	Assumed cause		Correction		Prevention
	The task period setting is too short.		Check the task execution time and change the task period to an appropriate value.		Design the tasks considering the corrections that are given on the left.
	Task Priority Error for Periodic Tasks and Event Tasks		Increase the priorities of the periodic tasks. Or, decrease the priorities of the event tasks so that they are lower than the priorities of the periodic tasks.		
	There are too many Units and slaves that perform I/O refresh in the task period.		Move the I/O refresh processes to other tasks, for example move I/O refresh processes within the task to other tasks.		
Frequent Event Task Execution		Lower the frequency of event task execution. Or, decrease the priorities of the event tasks.			
Attached information	Attached Information 1: Name of task where error occurred				
Precautions/Remarks	None				

*1. For details, refer to *I/O Operation for Major Fault Level Controller Errors* on page 1-16.

Event name	Task Period Exceeded		Event code	60010000 hex	
Meaning	Task execution was not completed during the set task period for the primary periodic task or a periodic task.				
Source	PLC Function Module		Source details	None	Detection timing Continuously
Error attributes	Level	Minor fault	Recovery	Error reset	Log category System
Effects	User program	Continues.	Operation	<p>If the task execution does not finish within the set task period, the I/O refresh operation will be as follows:</p> <ul style="list-style-type: none"> • CJ-series Units: No I/O refresh is executed. When task execution is completed, I/O refreshing for the next period is executed. • EtherCAT slaves: The same values are output as for the previous output refresh. <p>If the task execution does not finish within the set task period, overall control of the equipment may become impossible.</p>	
System-defined variables	Variable	Data type		Name	
	_ Task_name _Exceeded	BOOL		Task Period Exceeded Flag	
	_ Task_name _ExceedCount	UDINT		Task Period Exceeded Count	
	_ Task_name _LastExecTime	TIME		Last Task Execution Time	
	_ Task_name _MaxExecTime	TIME		Maximum Task Execution Time	
Cause and correction	Assumed cause	Correction		Prevention	
	The task period setting is too short.	Check the task execution time and change the task period to an appropriate value.		Design the tasks considering the corrections that are given on the left.	
	A user program is too large.	Separate the processes into different tasks, for example move processes that need a short execution period to a periodic task with a lower priority.			
	The number of times that processing is repeated is larger than expected.	If there is a program with an extremely high number of repetitions, correct the program to achieve the correct number of repetitions. Set a trap in the user program that monitors the number of times a process is executed to check the number of repetitions.			
	Task Priority Error for Periodic Tasks and Event Tasks	Increase the priorities of the periodic tasks. Or, decrease the priorities of the event tasks so that they are lower than the priorities of the periodic tasks.			
Frequent Event Task Execution	Lower the frequency of event task execution. Or, decrease the priorities of the event tasks.				
Attached information	Attached Information 1: Name of task where error occurred				
Precautions/Remarks	You can change the level of the error to an observation in the task settings.				

Event name	Task Period Exceeded		Event code	60050000 hex	
Meaning	Task execution was not completed during the set task period for the primary periodic task or fixed periodic task.				
Source	PLC Function Module		Source details	None	Detection timing Continuously
Error attributes	Level	Observation	Recovery	---	Log category System
Effects	User program	Continues.	Operation	<p>If the task execution does not finish within the set task period, the I/O refresh operation will be as follows:</p> <ul style="list-style-type: none"> • CJ-series Units: No I/O refresh is executed. When task execution is completed, I/O refreshing for the next period is executed. • EtherCAT slaves: The same values are output as for the previous output refresh. <p>If the task execution does not finish within the set task period, overall control of the equipment may become impossible.</p>	
System-defined variables	Variable	Data type		Name	
	_ <Task_name> _Exceeded	BOOL		Task Period Exceeded Flag	
	_ <Task_name> _ExceedCount	UDINT		Task Period Exceeded Count	
	_ <Task_name> _LastExecTime	TIME		Last Task Execution Time	
	_ <Task_name> _MaxExecTime	TIME		Maximum Task Execution Time	
Cause and correction	Assumed cause		Correction		Prevention
	The task period setting is too short.		Check the task execution time and change the task period to an appropriate value.		
	A user program is too large.		Separate the processes into different tasks, for example move processes that need a short execution period to a periodic task with a lower priority.		
	The number of times that processing is repeated is larger than expected.		If there is a program with an extremely high number of repetitions, correct the program to achieve the correct number of repetitions. Set a trap in the user program that monitors the number of times a process is executed to check the number of repetitions.		
	Task Priority Error for Periodic Tasks and Event Tasks		Increase the priorities of the periodic tasks. Or, decrease the priorities of the event tasks so that they are lower than the priorities of the periodic tasks.		
Frequent Event Task Execution		Lower the frequency of event task execution. Or, decrease the priorities of the event tasks.			
Attached information	Attached Information 1: Name of task where error occurred				
Precautions/Remarks	This error can occur if you change the level of the error to an observation in the task settings.				

Errors Related to Controller Operation

Event name	User Program/Controller Configurations and Setup Transfer Error		Event code	10200000 hex	
Meaning	The user program or Controller Configurations and Setup were not transferred correctly.				
Source	PLC Function Module		Source details	None or I/O bus master	Detection timing At power ON or Controller reset
Error attributes	Level	Major fault	Recovery	Cycle the power supply or reset the Controller.	Log category System
Effects	User program	Stops.	Operation	Stops.*1	
System-defined variables	Variable	Data type		Name	
	None	---		---	
Cause and correction	Assumed cause	Correction		Prevention	
	The user program or Controller Configurations and Setup are not correct because the power supply to the Controller was interrupted during a download of the user program or the Controller Configurations and Setup.	Clear all of memory and then download the project from the Sysmac Studio. If attached information is registered, cycle the power supply to the Controller and then implement the above correction.		Do not turn OFF the power supply to the Controller during a download of the user program or the Controller Configurations and Setup.	
	The user program or Controller Configurations and Setup are not correct because the power supply to the Controller was interrupted during online editing.	If you cannot perform a Clear All Memory operation from the Sysmac Studio, transfer the project to the Controller with a restore operation from an SD Memory Card.		Do not interrupt the power supply to the Controller during online editing.	
	The user program or Controller Configurations and Setup are not correct because the power supply to the Controller was interrupted during a Clear All Memory operation.			Do not interrupt the power supply to the Controller during a Clear All Memory operation.	
	The user program or Controller Configurations and Setup are not correct because the power supply to the Controller was interrupted during a restore operation.			Do not interrupt the power supply to the Controller during a restore operation.	
	Non-volatile memory failed.	If the error persists even after you make the above correction, replace the CPU Unit.		None	
Attached information	Attached Information 1: Cause Details <ul style="list-style-type: none"> • None: Power was interrupted during a download, during online editing, or during restoration. • Downloading/Predownloading: For other causes, the timing of error occurrence (during download or during download preparations) is given. 				
Precautions/Remarks	None				

*1. For details, refer to *I/O Operation for Major Fault Level Controller Errors* on page 1-16.

Event name	Illegal User Program Execution ID		Event code	10210000 hex	
Meaning	The user program execution IDs set in the user program and in the CPU Unit do not match.				
Source	PLC Function Module		Source details	None	Detection timing At user program download, power ON, or Controller reset
Error attributes	Level	Major fault	Recovery	Cycle the power supply or reset the Controller.	Log category System
Effects	User program	Stops.	Operation	Stops.*1	
System-defined variables	Variable	Data type		Name	
	None	---		---	
Cause and correction	Assumed cause		Correction		Prevention
	The user program execution IDs set in the user program and in the CPU Unit do not match.		Set the same user program execution ID in the user program and CPU Unit.		Set the same user program execution ID in the user program and CPU Unit.
	A user program execution ID is set in the CPU Unit but not in the user program.		If user program execution ID is not set in the user program, clear the user program execution ID set in the CPU Unit by clearing all memory in the CPU Unit.		Keep a record of the user program execution IDs set in the user program and in the CPU Unit. They are not displayed.
Attached information	None				
Precautions/Remarks	None				

*1. For details, refer to *I/O Operation for Major Fault Level Controller Errors* on page 1-16.

Event name	Illegal User Program		Event code	10240000 hex	
Meaning	The user program is not correct.				
Source	PLC Function Module		Source details	None	Detection timing At download, At power ON, or Controller reset
Error attributes	Level	Major fault	Recovery	Cycle the power supply or reset the Controller.	Log category System
Effects	User program	Stops.	Operation	Stops.*1	
System-defined variables	Variable	Data type		Name	
	None	---		---	
Cause and correction	Assumed cause		Correction		Prevention
	There are more than 8 nesting levels for functions or function blocks.		Find the location in the user program with more than 8 nesting levels for functions or function blocks and reduce the number of nesting levels to 8 or fewer. Then, download the user program again.		Write the user program so that there is never more than 8 nesting levels for functions or function blocks. Use the program check on the Sysmac Studio to confirm that there are not more than 8 nesting levels.
Attached information	None				
Precautions/Remarks	None				

*1. For details, refer to *I/O Operation for Major Fault Level Controller Errors* on page 1-16.

Event name	Illegal User Program/Controller Configurations and Setup		Event code	10250000 hex	
Meaning	The upper limit of the usable memory was exceeded or the user program or Controller Configurations and Setup is corrupted.				
Source	PLC Function Module		Source details	None	Detection timing At download, power ON, or Controller reset
Error attributes	Level	Major fault	Recovery	Cycle the power supply or reset the Controller.	Log category System
Effects	User program	Stops.	Operation	Stops.* ¹	
System-defined variables	Variable		Data type		Name
	None		---		---
Cause and correction	Assumed cause		Correction		Prevention
	The upper limit of the data size was exceeded.		If an event on restrictions on the number of items used occurred at the same time as this event, correct the user program and settings so that the number of items used is not exceeded and then download the data again.		None
	The main memory capacity was exceeded.		If an event on restrictions on the number of items used did not occur at the same time as this event, perform the Clear All Memory operation, cycle the power supply, and then confirm that this event was cleared. If it was cleared, reduce the size of the project, e.g., by sharing programming, and then download the project again.		
Non-volatile memory is deteriorating or has failed.		If this error persists even after you implement the above two corrections, replace the CPU Unit.			
Attached information	None				
Precautions/Remarks	None				

*1. For details, refer to *I/O Operation for Major Fault Level Controller Errors* on page 1-16.

Event name	PLC Function Processing Error			Event code	40110000 hex	
Meaning	A fatal error was detected in the PLC Function Module.					
Source	PLC Function Module		Source details	None	Detection timing	Continuously
Error attributes	Level	Major fault	Recovery	Cycle the power supply.	Log category	System
Effects	User program	Stops.	Operation	Stops.*1		
System-defined variables	Variable		Data type		Name	
	None		---		---	
Cause and correction	Assumed cause		Correction		Prevention	
	An error occurred in the software.		Contact your OMRON representative.		None	
Attached information	Attached information 1: System information Attached information 2: System information Attached information 3: System information Attached information 4: System information					
Precautions/Remarks	None					

*1. For details, refer to *I/O Operation for Major Fault Level Controller Errors* on page 1-16.

Event name	PLC Function Processing Error			Event code	44420000 hex	
Meaning	A fatal error was detected in the PLC Function Module.					
Source	PLC Function Module		Source details	None	Detection timing	Continuously
Error attributes	Level	Major fault	Recovery	Cycle the power supply or reset the Controller.	Log category	System
Effects	User program	Stops.	Operation	Stops.*1		
System-defined variables	Variable		Data type		Name	
	None		---		---	
Cause and correction	Assumed cause		Correction		Prevention	
	An error occurred in the software.		Contact your OMRON representative.		None	
Attached information	Attached information 1: System information Attached information 2: System information Attached information 3: System information Attached information 4: System information					
Precautions/Remarks	None					

*1. For details, refer to *I/O Operation for Major Fault Level Controller Errors* on page 1-16.

3 Error Descriptions and Corrections

Event name	PLC Function Processing Error			Event code	40120000 hex
Meaning	A fatal error was detected in the PLC Function Module.				
Source	PLC Function Module		Source details	None	Detection timing Continuously
Error attributes	Level	Partial fault	Recovery	Cycle the power supply.	Log category System
Effects	User program	Stops.	Operation	Stops.*1	
System-defined variables	Variable		Data type		Name
	None		---		---
Cause and correction	Assumed cause		Correction		Prevention
	An error occurred in the software.		Contact your OMRON representative.		None
Attached information	Attached information 1: System information Attached information 2: System information Attached information 3: System information Attached information 4: System information				
Precautions/Remarks	None				

*1. Operation is the same as for a major fault level error. For details, refer to *I/O Operation for Major Fault Level Controller Errors* on page 1-16.

Event name	PLC Function Processing Error			Event code	40130000 hex
Meaning	A fatal error was detected in part of the PLC Function Module.				
Source	PLC Function Module		Source details	None	Detection timing Continuously
Error attributes	Level	Minor fault	Recovery	Cycle the power supply or reset the Controller.	Log category System
Effects	User program	Continues.	Operation	Not affected.	
System-defined variables	Variable		Data type		Name
	None		---		---
Cause and correction	Assumed cause		Correction		Prevention
	An error occurred in the software.		Contact your OMRON representative.		None
Attached information	Attached information 1: System information Attached information 2: System information Attached information 3: System information Attached information 4: System information				
Precautions/Remarks	None				

Event name	Event Log Save Error			Event code	10230000 hex	
Meaning	Saving the event log failed.					
Source	PLC Function Module		Source details	None	Detection timing	At power ON, or Controller reset
Error attributes	Level	Observation	Recovery	---	Log category	System
Effects	User program	Starts.	Operation	Not affected. However, part or all of the past event log cannot be read.		
System-defined variables	Variable	Data type		Name		
	None	---		---		
Cause and correction	Assumed cause		Correction		Prevention	
	A low battery voltage prevented retention of memory during a power interruption. (NJ/NX-series)		Replace the Battery.		Replace the battery periodically.	
	A forced shutdown was performed. (NY-series)		None		Perform a shutdown with other method than the forced shutdown.	
	Data in the event log area are invalid. (NY-series)		If the error persists even after you cycle the power to the Industrial PC, a hardware failure may occur in the event log area. Replace the Industrial PC if you use the event logs in the Industrial PC.		None	
Data in the event log area are invalid.		If this error persists even after you cycle the power supply to the CPU Unit, a hardware failure may occur in the event log area. Replace the CPU Unit if you use the event logs in the CPU Unit.		None		
Attached information	Attached Information 1: Error Details <ul style="list-style-type: none"> • 0: Failure to save all categories of logs, • 1: Failure to save system event log, • 2: Failure to save access event log, • 100: Failure to save user-defined event log 					
Precautions/Remarks	None					

Event name	Trace Setting Transfer Failure			Event code	10260000 hex	
Meaning	The power supply was interrupted while transferring the trace settings.					
Source	PLC Function Module		Source details	None	Detection timing	At power ON, or Controller reset
Error attributes	Level	Observation	Recovery	Cycle the power supply or reset the Controller.	Log category	System
Effects	User program	Continues.	Operation	Not affected.		
System-defined variables	Variable	Data type		Name		
	None	---		---		
Cause and correction	Assumed cause		Correction		Prevention	
	The power supply was interrupted while transferring the trace settings.		Transfer the trace settings again.		Do not interrupt the power supply while transferring the trace settings.	
Attached information	None					
Precautions/Remarks	All trace settings are initialized when this error occurs.					

Event name	Backup Failed to Start			Event code	10350000 hex
Meaning	An error was detected in pre-execution checks for a backup operation.				
Source	PLC Function Module		Source details	None	Detection timing When backup is specified by the user
Error attributes	Level	Observation	Recovery	---	Log category System
Effects	User program	Continues.	Operation	Not affected.	
System-defined variables	Variable		Data type		Name
	None		---		---
Cause and correction	Assumed cause		Correction		Prevention
	The shared folder is not recognized.		Transfer the Virtual SD Memory Card settings so that the shared folder can be recognized. If the shared folder cannot be recognized yet, refer to the corrections for the following event: Shared Folder Recognition Failed (10390000 hex).		Transfer the Virtual SD Memory Card settings so that the shared folder can be recognized.
	The Prohibiting backing up data to the SD Memory Card parameter is set to prohibit backing up data to an SD Memory Card.		Change the setting of the Prohibiting backing up data to the SD Memory Card parameter to enable backing up data to an SD Memory Card.		Set the Prohibiting backing up data to the SD Memory Card parameter to enable backing up data to an SD Memory Card.
	Another backup operation is in progress.		Wait for the other backup operation to end and then perform the backup operation again.		Do not attempt to perform other backup operation during a backup operation.
	Synchronization, online editing, or the Clear All Memory operation is in progress.		Wait for the synchronization, online editing, or the Clear All Memory operation to end and then perform the backup operation again.		Do not attempt to perform a backup operation during a synchronization, online editing, or the Clear All Memory operation.
	The backup was canceled by the user.		None		None
	The online connection with the Sysmac Studio was disconnected.		Check the cable connections. Go offline and then go back online and execute the backup again.		Check the cable to see if it is disconnected or broken. Make sure the cable is connected properly
It was not possible to recognize the shared folder because of the following reasons: Windows storage failure, erroneous operation or fault of Windows.		Refer to the corrections for the following event: Shared Folder Recognition Cancel Completed (103B0000 hex).		Refer to the preventive information for the following event: Shared Folder Recognition Cancel Completed (103B0000 hex).	
Attached information	<p>Attached information 1: Operation type</p> <ul style="list-style-type: none"> • 0102 hex: Controller to shared folder for system-defined variable operation • 0103 hex: Controller to shared folder for Sysmac Studio operation • 0104 hex: Controller to shared folder for instruction operation • 0201 hex: Controller to computer for Sysmac Studio operation or Industrial PC Support Utility operation <p>Attached information 2: Error details</p> <ul style="list-style-type: none"> • 0001 hex: A shared folder is not recognized. • 0204 hex: SD Memory Card backup is prohibited.. • 0205 hex: Another backup operation is in progress. • 0206 hex: Synchronization, online editing, or the Clear All Memory operation is in progress. • 0207 hex: A prohibited character is used in the directory name that is specified in the system-defined variable. • 0401 hex: The backup was canceled by the user. • 0501 hex: The online connection with the Sysmac Studio was disconnected. 				

Precautions/ Remarks	None
---------------------------------	------

Event name	Backup Failed		Event code	10360000 hex		
Meaning	The backup operation ended in an error.					
Source	PLC Function Module		Source details	None	Detection timing	During backup operation
Error attributes	Level	Observation	Recovery	---	Log category	System
Effects	User program	Continues.	Operation	Not affected.		
System-defined variables	Variable	Data type		Name		
	None	---		---		

Cause and correction	Assumed cause	Correction	Prevention
	<p>It was not possible to access the shared folder due to the following causes.</p> <ul style="list-style-type: none"> • There is no authority for writing to the shared folder in an account for the Controller. • The shared folder recognition was canceled during a backup operation. <p>For the assumed causes of canceling the recognition, refer to the following event: Shared Folder Recognition Cancel Completed (103B0000 hex).</p>	<ul style="list-style-type: none"> • Set the authority to permit writing to the shared folder in an account for the Controller and execute the backup operation again. • Re-recognize the shared folder and execute the backup operation again. For the re-recognition methods, refer to the corrections for the following event: Shared Folder Recognition Cancel Completed (103B0000 hex). 	<ul style="list-style-type: none"> • Set the authority to permit reading from and writing to the shared folder in an account for the Controller. • Do not perform any operations to cancel the shared folder recognition during a backup operation. For details, refer to the assumed causes for the following event: Shared Folder Recognition Cancel Completed (103B0000 hex).
	The partition in which the shared folder is stored lacks sufficient capacity.	Confirm available capacity in the partition in which the shared folder is stored.	Confirm available capacity in the partition in which the shared folder is stored.
	The number of files or directories in the shared folder exceeded the maximum number.	Reduce the number of files and directories in the shared folder and then execute the backup operation again.	Delete unnecessary files and directories in the shared folder or move the files and directories to the other place.
	Execution of the Save Cam Table instruction or changing the CPU Unit name is in progress.	Perform the operation after execution of the Save Cam Table instruction or changing the CPU Unit name is completed.	Do not perform a backup during execution of the Save Cam Table instruction or while changing the CPU Unit name.
	A file already exists with the same name as the specified directory.	Specify the directory that the same filename does not exist and execute the backup operation again.	Do not create a file with the same name as the specified directory to backup.
	<p>It was not possible to save the backup data because the shared folder recognition was canceled during the backup operation.</p> <p>For the assumed causes of canceling the recognition, refer to the following event: Shared Folder Recognition Cancel Completed (103B0000 hex).</p>	<p>Re-recognize the shared folder and execute the backup operation again. For the re-recognition methods, refer to the corrections for the following event: Shared Folder Recognition Cancel Completed (103B0000 hex)</p>	<p>Do not perform any operations to cancel the shared folder recognition during a backup operation. For details, refer to the assumed causes for the following event: Shared Folder Recognition Cancel Completed (103B0000 hex).</p>
	A slave backup operation failed.	Refer to the corrections for the following event: EtherCAT Slave Backup Failed (102F0000 hex).	Refer to the preventive information for the following event: EtherCAT Slave Backup Failed (102F0000 hex).
	The backup was canceled by the user.	None	None
	The online connection with the Sysmac Studio was disconnected.	Check the cable connections. Go offline and then go back online and execute the backup again.	Check the cable to see if it is disconnected or broken. Make sure the cable is connected properly.
	It was not possible to save the data that was specified for backup to the computer.	Increase the available space on the hard disk on the computer.	Make sure there is sufficient space available on the hard disk before you perform a backup.

Attached information	<p>Attached information 1: Operation type</p> <ul style="list-style-type: none"> • 0102 hex: Controller to shared folder for system-defined variable operation • 0103 hex: Controller to shared folder for Sysmac Studio operation • 0104 hex: Controller to shared folder for instruction operation • 0201 hex: Controller to computer for Sysmac Studio operation or Industrial PC Support Utility operation <p>Attached information 2: Error details</p> <ul style="list-style-type: none"> • 7F01 hex : It was not possible to access the shared folder. • 0005 hex: The partition in which the shared folder is stored lacks sufficient capacity. • 0006 hex: Too many files or directories. • 0206 hex: Execution of the Save Cam Table instruction or changing the CPU Unit name is in progress. • 0210 hex: Specified directory and file with same name already exist. • 0302 hex: Saving the backup data failed. • 0304 hex: A slave backup operation failed. • 0401 hex: The backup was canceled by the user. • 0501 hex: The online connection with the Sysmac Studio was disconnected. • 0502 hex: It was not possible to save the data that was specified for backup to the computer.
Precautions/Remarks	<p>None</p>

Event name	Restore Operation Failed to Start		Event code	10370000 hex	
Meaning	An error was detected in pre-execution checks for a restore operation.				
Source	PLC Function Module		Source details	None	Detection timing When restoring data is specified by the user
Error attributes	Level	Observation	Recovery	---	Log category System
Effects	User program	---	Operation	Not affected.	
System-defined variables	Variable	Data type		Name	
	None	---		---	
Cause and correction	Assumed cause		Correction		Prevention
	Either the backup files in the shared folder are corrupted or required data is not in the backup files in the shared folder.		Create the backup files again.		Do not edit the backup files on the computer.
	The unit version of the CPU Unit to which to restore the files is older than the unit version of the backup files in the shared folder.		Replace the CPU Unit with a CPU Unit that has a unit version that is the same as or newer than the unit version of the CPU that was used to create the backup files. Or, specify backup files with the correct unit version for the CPU Unit.		Make sure that the unit version of the CPU Unit and the unit version of the backup files are compatible.
	The model of the CPU Unit to which to restore the files is not the same as the model of the CPU Unit of the backup files in the shared folder.		Replace the CPU Unit with a CPU Unit that has the same model as the CPU Unit that was used to create the backup files. Or, specify backup files with the correct model for the CPU Unit.		Make sure that the model of the CPU Unit is the same as the model of the CPU Unit that was used to create the backup files.
	The CPU Unit is write-protected.		If you use the restore function, select the <i>Do not use</i> Option for the Write protection at startup setting of the CPU Unit.		If you use the restore function, select the Do not use Option for the Write protection at startup setting of the CPU Unit.
	Another backup operation is in progress.		Wait for the backup operation to end and then perform the restore operation again.		Do not attempt to perform a restore operation during a backup operation.
	Synchronization, online editing, or the Clear All Memory operation is in progress.		Wait for the synchronization, online editing, or the Clear All Memory operation to end and then perform the restore operation again.		Do not attempt to perform a restore operation during a synchronization, online editing, or the Clear All Memory operation.
	The online connection with the Sysmac Studio was disconnected.		Check the cable connections. Go offline and then go back online and execute the backup again.		Check the cable to see if it is disconnected or broken. Make sure the cable is connected properly.
Attached information	<p>Attached information 1: Operation type</p> <ul style="list-style-type: none"> • 0201 hex: Controller to computer for Sysmac Studio operation or Industrial PC Support Utility operation <p>Attached information 2: Error details</p> <ul style="list-style-type: none"> • 0103 hex: The backup files are corrupted. • 0105 hex: The required transfer data is not in the backup file. • 0201 hex: The unit version of the CPU Unit is old. • 0202 hex: The model numbers of the CPU Unit are not the same. • 0203 hex: The CPU Unit is write-protected. • 0205 hex: Another backup operation is in progress. • 0206 hex: Synchronization, online editing, or the Clear All Memory operation is in progress. • 0501 hex: The online connection with the Sysmac Studio was disconnected. 				
Precautions/Remarks	None				

Event name	Restore Operation Failed		Event code	10380000 hex	
Meaning	The restore operation ended in an error.				
Source	PLC Function Module		Source details	None	Detection timing During restore operation
Error attributes	Level	Observation	Recovery	---	Log category System
Effects	User program	---	Operation	Not affected.	
System-defined variables	Variable	Data type		Name	
	None	---		---	
Cause and correction	Assumed cause		Correction		Prevention
	The backup files are corrupted.		Create the backup files again.		Do not edit the backup files on the computer.
	Failed to restore a slave.		Refer to the corrections for the following event: EtherCAT Slave Restore Operation Failed (10300000 hex).		Refer to the preventive information for the following event: EtherCAT Slave Restore Operation Failed (10300000 hex).
Attached information	Attached information 1: Operation type • 0201 hex: Controller to computer for Sysmac Studio operation or Industrial PC Support Utility operation Attached information 2: Error details • 0103 hex: The backup files are corrupted. • 00303 hex: Failed to restore a slave.				
Precautions/Remarks	None				

Event name	Shared Folder Recognition Failed		Event code	10390000 hex		
Meaning	It was not possible to recognize the shared folder.					
Source	PLC Function Module	Source details	None	Detection timing	At Controller startup, download, restore operation, when changing the Virtual SD Memory Card settings, or when confirming the shared folder recognition	
Error attributes	Level	Observation	Recovery	---	Log category	System
Effects	User program	Continues.	Operation	Not affected.		
System-defined variables	Variable	Data type		Name		
	_Card1Ready	BOOL		SD Memory Card Ready Flag		
Cause and correction	Assumed cause	Correction		Prevention		
	The Controller cannot access the shared folder due to the following reasons of Windows. <ul style="list-style-type: none"> Windows is stopped. The file sharing service (Server service) of Windows is stopped or disabled. 	Start up Windows, and enable the file sharing service (Server service) of Windows.		Start up Windows, and enable the file sharing service (Server service) of Windows.		
	The Controller cannot access the shared folder because the network segment of the IP address for the internal port of Windows differs from that for the internal port on the Controller.	Make the network segment of the IP address same for both internal ports for Windows and on the Controller.		Make the network segment of the IP address same for both internal ports for Windows and on the Controller.		
	The Controller cannot access the shared folder because the following items specified by the Virtual SD Memory Card settings on the Controller differ from the settings for Windows. <ul style="list-style-type: none"> Computer name on Windows IP address of the internal port for Windows Shared folder name 	Make the Virtual SD Memory Card settings same for both on the Controller and for Windows.		Make the Virtual SD Memory Card settings same for both on the Controller and for Windows.		
	The Controller failed to be authorized to log on to the shared folder because the user name or password specified by the Virtual SD Memory Card settings on the Controller differs from the settings for Windows.					
Attached information	Attached information 1: Error details <ul style="list-style-type: none"> 1: Failed to access. 2: Fail in logon authorization 					
Precautions/Remarks	None					

Event name	Shared Folder Recognition Cancel Failed		Event code	103A0000 hex		
Meaning	It was not possible to cancel the shared folder recognition.					
Source	PLC Function Module		Source details	None	Detection timing	At download, restore operation, or when changing the Virtual SD Memory Card settings
Error attributes	Level	Observation	Recovery	---	Log category	System
Effects	User program	---	Operation	Not affected.		
System-defined variables	Variable	Data type		Name		
	_Card1Ready	BOOL		SD Memory Card Ready Flag		
Cause and correction	Assumed cause	Correction		Prevention		
	The Virtual SD Memory Card settings were changed while access to the shared folder is in progress.	After access to the shared folder is completed, take one of the following actions to read the Virtual SD Memory Card settings to the Controller again and cancel the shared folder recognition. <ul style="list-style-type: none"> • Restart the Controller. • Download again. • Restore again. • Change the Virtual SD Memory Card settings with the Industrial PC Support Utility. 		While access to the shared folder is in progress, do not change the Virtual SD Memory Card settings on the Controller by downloading, restore operation, or changing the Virtual SD Memory Card settings with the Industrial PC Support Utility.		
Attached information	None					
Precautions/Remarks	None					

Event name	Shared Folder Recognition Cancel Completed		Event code	103B0000 hex	
Meaning	The shared folder recognition was canceled.				
Source	PLC Function Module		Source details	None	Detection timing At download, restore operation, when changing the Virtual SD Memory Card settings, at an error on Windows, or at an erroneous operation on Windows or Controller
Error attributes	Level	Observation	Recovery	---	Log category System
Effects	User program	Continues.	Operation	Not affected.	
System-defined variables	Variable	Data type		Name	
	_Card1Ready	BOOL		SD Memory Card Ready Flag	
Cause and correction	Assumed cause		Correction		Prevention
	The Virtual SD Memory Card settings were updated. Therefore, the shared folder recognition which was based on the previous Virtual SD Memory Card settings was canceled.		None		None
	File sharing was canceled due to one of the following reasons. Error or erroneous operation on Windows <ul style="list-style-type: none"> Windows was shut down or restarted. File sharing service of Windows was stopped or disabled. The computer name on Windows was changed. The IP address of the internal port for Windows was changed. Sharing the shared folder was canceled. The shared folder was deleted. The access right of the shared user which was used from the Controller to recognize the folder was completely deleted from the folder sharing settings. Erroneous operation on Controller <ul style="list-style-type: none"> The IP address of the internal port on the Controller was changed to be different from the network segment of the IP address of the internal port for Windows. 		Remove the cause of the error to recognize the shared folder. The shared folder is automatically re-recognized. However, if the cause is sharing the shared folder was canceled or the shared folder was deleted, follow the procedure given below. <ol style="list-style-type: none"> Re-share the shared folder. Close the file that is opened with an instruction in the SD Memory Card instructions. Perform the recognition check from the Industrial PC Support Utility to re-recognize the shared folder soon. If you do not perform the recognition check, when the idle session time (15 minutes for the default) for Windows is elapsed after sharing the shared folder was canceled, the shared folder is re-recognized. 		Do not perform any operations listed in the assumed causes while the system runs.
Attached information	Attached information 1: Execution trigger for recognition cancel <ul style="list-style-type: none"> 1: Update of the Virtual SD Memory Card settings 2: Others 				

Precautions/Remarks	None				
Event name	PLC System Information			Event code	40140000 hex
Meaning	This event provides internal information from the PLC Function Module.				
Source	PLC Function Module		Source details	None	Detection timing Continuously
Error attributes	Level	Observation	Recovery	---	Log category System
Effects	User program	Continues.	Operation	Not affected.	
System-defined variables	Variable		Data type		Name
	None		---		---
Cause and correction	Assumed cause		Correction		Prevention
	This event provides internal information from the PLC Function Module. It is recorded to provide additional information for another event.		---		---
Attached information	Attached information 1: System information Attached information 2: System information Attached information 3: System information Attached information 4: System information				
Precautions/Remarks	None				

Event name	Safe Mode			Event code	40170000 hex
Meaning	The Controller started in Safe Mode.				
Source	PLC Function Module		Source details	None	Detection timing At power ON or Controller reset
Error attributes	Level	Observation	Recovery	---	Log category System
Effects	User program	Stops.	Operation	---	
System-defined variables	Variable		Data type		Name
	None		---		---
Cause and correction	Assumed cause		Correction		Prevention
	The Controller started in Safe Mode.		---		---
Attached information	None				
Precautions/Remarks	If the Controller is started when the CPU Unit is in Safe Mode, the CPU Unit will start in PROGRAM mode even if the startup mode is set to RUN mode.				

Event name	OS Processing Error			Event code	44600000 hex	
Meaning	An error was detected on Windows.					
Source	PLC Function Module		Source details	Windows	Detection timing	Continuously
Error attributes	Level	Observation	Recovery	---	Log category	System
Effects	User program	---	Operation	Not affected.		
System-defined variables	Variable		Data type		Name	
	_OSRunning		BOOL		OS Running Flag	
	_OSHalted		BOOL		OS Halted Flag	
	_OSErrorState		BOOL		OS Error State Flag	
Cause and correction	Assumed cause		Correction		Prevention	
	A software error occurred on Windows to stop operations.		Restart Windows.		---	
Attached information	None					
Precautions/Remarks	None					

Event name	NX Message Communications Error			Event code	80230000 hex	
Meaning	An error has occurred in message communications.					
Source	PLC Function Module, EtherCAT Master Function Module, EtherNet/IP Function Module, or NX Bus Function Module		Source details	None	Detection timing	During NX message communications
Error attributes	Level	Observation	Recovery	---	Log category	System
Effects	User program	Continues.	Operation	---		
System-defined variables	Variable		Data type		Name	
	None		---		---	
Cause and correction	Assumed cause		Correction		Prevention	
	The communications cable is broken.		Check the communications cable and replace it if it is broken.		Check the communications cable to see if it is operating properly.	
	The communications cable connector is disconnected.		Reconnect the connector and make sure it is mated correctly.		Make sure the communications cable is connected properly.	
	The NX message communications load is high.		Reduce the number of times that instructions are used to send NX messages. Or, increase the value of the <i>TimeOut</i> input variable to the instruction. If more than one copy of the Sysmac Studio is connected, reduce the frequency of simultaneous operations.		Reduce the number of times that instructions are used to send NX messages. Or, increase the value of the <i>TimeOut</i> input variable to the instruction. If more than one copy of the Sysmac Studio is connected, reduce the frequency of simultaneous operations.	
Attached information	Attached information 1: System information Attached information 2: Type of communications <ul style="list-style-type: none"> • 0: NX bus • 1: EtherCAT • 65,535: Unit internal communications (routing) 					
Precautions/Remarks	None					

Event name	PLC System Information			Event code	40150000 hex
Meaning	This event provides internal information from the PLC Function Module.				
Source	PLC Function Module		Source details	None	Detection timing Continuously
Error attributes	Level	Information	Recovery	---	Log category System
Effects	User program	Continues.	Operation	Not affected.	
System-defined variables	Variable		Data type		Name
	None		---		---
Cause and correction	Assumed cause		Correction		Prevention
	This event provides internal information from the PLC Function Module. It is recorded to provide additional information for another event.		---		---
Attached information	Attached information 1: System information Attached information 2: System information Attached information 3: System information Attached information 4: System information				
Precautions/Remarks	None				

Event name	PLC System Information			Event code	44430000 hex
Meaning	This event provides internal information from the PLC Function Module.				
Source	PLC Function Module		Source details	None	Detection timing Continuously
Error attributes	Level	Information	Recovery	---	Log category System
Effects	User program	Continues.	Operation	Not affected.	
System-defined variables	Variable		Data type		Name
	None		---		---
Cause and correction	Assumed cause		Correction		Prevention
	This event provides internal information from the PLC Function Module. It is recorded to provide additional information for another event.		---		---
Attached information	Attached information 1: System information Attached information 2: System information Attached information 3: System information Attached information 4: System information				
Precautions/Remarks	None				

Event name	User Program/Controller Configurations and Setup Downloaded		Event code	90050000 hex		
Meaning	The user program and the Controller configurations and setup were downloaded.					
Source	PLC Function Module		Source details	None	Detection timing	During user program/Controller configurations and setup download
Error attributes	Level	Information	Recovery	---	Log category	Access
Effects	User program	Continues.	Operation	Operation starts according to the user program and the Controller setup data that were downloaded.		
System-defined variables	Variable	Data type		Name		
	None	---		---		
Cause and correction	Assumed cause		Correction		Prevention	
	The user program and the Controller configurations and setup were downloaded.		---		---	
Attached information	<p>Attached Information 1: Connection method</p> <ul style="list-style-type: none"> • 1: Direct USB connection • 2: Direct Ethernet connection • 3: Remote USB connection or Ethernet hub connection <p>Attached Information 2: Connecting IP address, Connection through proxy: Proxy IP address (When attached information 1 is 2 or 3)</p> <p>Attached information 3: Device Output Hold Status</p> <ul style="list-style-type: none"> • 1: Retained. • 2: Not retained. 					
Precautions/Remarks	None					

Event name	Online Edits Transferred		Event code	90070000 hex		
Meaning	The user program was edited online.					
Source	PLC Function Module		Source details	None	Detection timing	When transferring online edits is started
Error attributes	Level	Information	Recovery	---	Log category	Access
Effects	User program	Continues.	Operation	Operation is performed according to the changed user program.		
System-defined variables	Variable	Data type		Name		
	None	---		---		
Cause and correction	Assumed cause		Correction		Prevention	
	The user program was edited online and the edits were transferred to the Controller.		---		---	
Attached information	<p>Attached Information 1: Connection method</p> <ul style="list-style-type: none"> • 1: Direct USB connection • 2: Direct Ethernet connection • 3: Remote USB connection or Ethernet hub connection <p>Attached Information 2: Connecting IP address, Connection through proxy: Proxy IP address (When attached information 1 is 2 or 3)</p>					
Precautions/Remarks	None					

3 Error Descriptions and Corrections

Event name	Variable Changed to TRUE with Forced Refreshing		Event code	90080000 hex	
Meaning	Changing a variable to TRUE with forced refreshing was specified.				
Source	PLC Function Module		Source details	None	Detection timing Commands from user
Error attributes	Level	Information	Recovery	---	Log category Access
Effects	User program	Continues.	Operation	Operation is performed according to the forced refreshing values.	
System-defined variables	Variable		Data type		Name
	None		---		---
Cause and correction	Assumed cause		Correction		Prevention
	Changing a variable to TRUE with forced refreshing was specified by the user.		---		---
Attached information	None				
Precautions/Remarks	None				

Event name	Variable Changed to FALSE with Forced Refreshing		Event code	90090000 hex	
Meaning	Changing a variable to FALSE with forced refreshing was specified.				
Source	PLC Function Module		Source details	None	Detection timing Commands from user
Error attributes	Level	Information	Recovery	---	Log category Access
Effects	User program	Continues.	Operation	Operation is performed according to the forced refreshing values.	
System-defined variables	Variable		Data type		Name
	None		---		---
Cause and correction	Assumed cause		Correction		Prevention
	Changing a variable to FALSE with forced refreshing was specified by the user.		---		---
Attached information	None				
Precautions/Remarks	None				

Event name	All Forced Refreshing Cleared			Event code	900A0000 hex	
Meaning	Clearing all forced refreshing values was specified.					
Source	PLC Function Module		Source details	None	Detection timing	Commands from user
Error attributes	Level	Information	Recovery	---	Log category	Access
Effects	User program	Continues.	Operation	Forced refreshing values are all cleared and operation is performed according to the user program.		
System-defined variables	Variable		Data type		Name	
	None		---		---	
Cause and correction	Assumed cause		Correction		Prevention	
	Clearing all forced refreshing values was specified by the user.		---		---	
Attached information	None					
Precautions/Remarks	None					

Event name	Memory All Cleared			Event code	900B0000 hex	
Meaning	All of memory was cleared.					
Source	PLC Function Module		Source details	None	Detection timing	Commands from user
Error attributes	Level	Information	Recovery	---	Log category	Access
Effects	User program	---	Operation	Operation returns to the factory state.		
System-defined variables	Variable		Data type		Name	
	None		---		---	
Cause and correction	Assumed cause		Correction		Prevention	
	A user with Administrator rights cleared all of the memory.		---		---	
Attached information	None					
Precautions/Remarks	None					

Event name	Event Log Cleared			Event code	900C0000 hex	
Meaning	The event log was cleared.					
Source	PLC Function Module		Source details	None	Detection timing	Commands from user
Error attributes	Level	Information	Recovery	---	Log category	Access
Effects	User program	Continues.	Operation	Not affected.		
System-defined variables	Variable		Data type		Name	
	None		---		---	
Cause and correction	Assumed cause		Correction		Prevention	
	The event log was cleared by the user.		---		---	
Attached information	Attached information 1: Cleared events <ul style="list-style-type: none"> • 0: All log categories were cleared • 1: The system event log was cleared. • 2: The access event log was cleared. • 100: The user-defined event log was cleared. 					
Precautions/Remarks	None					

Event name	Power Turned ON			Event code	90110000 hex	
Meaning	The power supply was turned ON.					
Source	PLC Function Module		Source details	None	Detection timing	At power ON
Error attributes	Level	Information	Recovery	---	Log category	System
Effects	User program	---	Operation	Operation starts.		
System-defined variables	Variable		Data type		Name	
	None		---		---	
Cause and correction	Assumed cause		Correction		Prevention	
	The power supply was turned ON.		---		---	
Attached information	None					
Precautions/Remarks	None					

Event name	Power Interrupted			Event code	90120000 hex	
Meaning	The power supply was interrupted.					
Source	PLC Function Module		Source details	None	Detection timing	At power interruption
Error attributes	Level	Information	Recovery	---	Log category	System
Effects	User program	Stops.	Operation	All operations stop.		
System-defined variables	Variable		Data type		Name	
	None		---		---	
Cause and correction	Assumed cause		Correction		Prevention	
	The power supply was interrupted.		---		---	
Attached information	None					
Precautions/Remarks	None					

Event name	Operation Started			Event code	90130000 hex	
Meaning	Operation was started.					
Source	PLC Function Module		Source details	None	Detection timing	When changing to RUN mode
Error attributes	Level	Information	Recovery	---	Log category	System
Effects	User program	Starts.	Operation	User program execution starts.		
System-defined variables	Variable		Data type		Name	
	None		---		---	
Cause and correction	Assumed cause		Correction		Prevention	
	A command to start operation was received.		---		---	
Attached information	Attached information 1: Device Output Hold Status <ul style="list-style-type: none"> • 1: Retained. • 2: Not retained. 					
Precautions/Remarks	None					

Event name	Operation Stopped			Event code	90140000 hex	
Meaning	Operation was stopped.					
Source	PLC Function Module		Source details	None	Detection timing	When changing to PROGRAM mode
Error attributes	Level	Information	Recovery	---	Log category	System
Effects	User program	Stops.	Operation	User program execution stops.		
System-defined variables	Variable	Data type		Name		
	None	---		---		
Cause and correction	Assumed cause		Correction		Prevention	
	A command to stop operation was received.		---		---	
Attached information	Attached information 1: Device Output Hold Status <ul style="list-style-type: none"> • 1: Retained. • 2: Not retained. 					
Precautions/Remarks	None					

Event name	Reset Executed			Event code	90150000 hex	
Meaning	A reset was executed.					
Source	PLC Function Module		Source details	None	Detection timing	Commands from user
Error attributes	Level	Information	Recovery	---	Log category	Access
Effects	User program	---	Operation	Operation is started after a reset is executed.		
System-defined variables	Variable	Data type		Name		
	None	---		---		
Cause and correction	Assumed cause		Correction		Prevention	
	A reset command was received.		---		---	
Attached information	None					
Precautions/Remarks	None					

Event name	User Program Execution ID Write			Event code	90160000 hex	
Meaning	The user program execution ID was set or changed in the CPU Unit.					
Source	PLC Function Module		Source details	None	Detection timing	When downloading
Error attributes	Level	Information	Recovery	---	Log category	Access
Effects	User program	Continues.	Operation	Not affected.		
System-defined variables	Variable	Data type		Name		
	None	---		---		
Cause and correction	Assumed cause		Correction		Prevention	
	A user with Administrator rights changed the user program execution ID that is set in the CPU Unit.		---		---	
Attached information	None					
Precautions/Remarks	None					

Event name	All Controller Errors Cleared			Event code	90180000 hex	
Meaning	All current errors were cleared.					
Source	PLC Function Module		Source details	None	Detection timing	Commands from user
Error attributes	Level	Information	Recovery	---	Log category	Access
Effects	User program	Continues.	Operation	Clearing all errors for which the causes have been removed.		
System-defined variables	Variable		Data type		Name	
	None		---		---	
Cause and correction	Assumed cause		Correction		Prevention	
	The user cleared all current errors.		---		---	
Attached information	None					
Precautions/Remarks	None					

Event name	Forced Refreshing Cleared			Event code	90190000 hex	
Meaning	Clearing a forced refreshing value was specified.					
Source	PLC Function Module		Source details	None	Detection timing	Commands from user
Error attributes	Level	Information	Recovery	---	Log category	Access
Effects	User program	Continues.	Operation	Forced refreshing values are cleared and operation is performed according to the user program.		
System-defined variables	Variable		Data type		Name	
	None		---		---	
Cause and correction	Assumed cause		Correction		Prevention	
	Clearing a forced refreshing value was specified by the user.		---		---	
Attached information	None					
Precautions/Remarks	None					

Event name	Forced Shutdown			Event code	90230000 hex	
Meaning	A forced shutdown was used by the user to finish the system.					
Source	PLC Function Module		Source details	None	Detection timing	At power ON
Error attributes	Level	Information	Recovery	---	Log category	System
Effects	User program	Continues.	Operation	Not affected.		
System-defined variables	Variable		Data type		Name	
	None		---		---	
Cause and correction	Assumed cause		Correction		Prevention	
	A forced shutdown was used by the user to finish the system.		---		---	
Attached information	None					
Precautions/Remarks	None					

Event name	Backup Started			Event code	90240000 hex	
Meaning	A backup operation was started.					
Source	PLC Function Module		Source details	None	Detection timing	At start of backup operation
Error attributes	Level	Information	Recovery	---	Log category	System
Effects	User program	Continues.	Operation	Not affected.		
System-defined variables	Variable	Data type		Name		
	None	---		---		
Cause and correction	Assumed cause		Correction		Prevention	
	A backup operation was started.		---		---	
Attached information	Attached information 1: Operation type <ul style="list-style-type: none"> • 0102 hex: Controller to shared folder for system-defined variable operation • 0103 hex: Controller to shared folder for Sysmac Studio operation • 0104 hex: Controller to shared folder for instruction operation • 0201 hex: Controller to computer for Sysmac Studio operation or Industrial PC Support Utility operation 					
Precautions/Remarks	None					

Event name	Backup Completed			Event code	90250000 hex	
Meaning	The backup operation ended normally.					
Source	PLC Function Module		Source details	None	Detection timing	At end of normal backup operation
Error attributes	Level	Information	Recovery	---	Log category	System
Effects	User program	Continues.	Operation	Not affected.		
System-defined variables	Variable	Data type		Name		
	None	---		---		
Cause and correction	Assumed cause		Correction		Prevention	
	The backup operation ended normally.		---		---	
Attached information	Attached information 1: Operation type <ul style="list-style-type: none"> • 0102 hex: Controller to shared folder for system-defined variable operation • 0103 hex: Controller to shared folder for Sysmac Studio operation • 0104 hex: Controller to shared folder for instruction operation • 0201 hex: Controller to computer for Sysmac Studio operation or Industrial PC Support Utility operation 					
Precautions/Remarks	None					

Event name	Restore Operation Started			Event code	90260000 hex
Meaning	A restore operation started.				
Source	PLC Function Module		Source details	None	Detection timing At start of restore operation
Error attributes	Level	Information	Recovery	---	Log category System
Effects	User program	---	Operation	Not affected.	
System-defined variables	Variable		Data type		Name
	None		---		---
Cause and correction	Assumed cause		Correction		Prevention
	A restore operation started.		---		---
Attached information	Attached information 1: Operation type <ul style="list-style-type: none"> • 0201 hex: Controller to computer for Sysmac Studio operation or Industrial PC Support Utility operation 				
Precautions/Remarks	None				

Event name	Restore Operation Completed			Event code	90270000 hex
Meaning	The restore operation ended normally.				
Source	PLC Function Module		Source details	None	Detection timing At end of normal restore operation
Error attributes	Level	Information	Recovery	---	Log category System
Effects	User program	---	Operation	Operation cannot be started after the completion of a restore operation. Operation starts according to the restored user program and settings, when the power supply to the Controller is turned OFF once, and then turned ON again after all pins on the DIP switch on the CPU Unit are turned OFF.	
System-defined variables	Variable		Data type		Name
	None		---		---
Cause and correction	Assumed cause		Correction		Prevention
	The restore operation ended normally.		---		---
Attached information	Attached information 1: Operation type <ul style="list-style-type: none"> • 0201 hex: Controller to computer for Sysmac Studio operation or Industrial PC Support Utility operation 				
Precautions/Remarks	None				

Event name	Shared Folder Recognition Completed		Event code	90280000 hex		
Meaning	The shared folder was recognized.					
Source	PLC Function Module	Source details	None	Detection timing	At Controller startup, download, restore operation, when changing the Virtual SD Memory Card settings, or when confirming the shared folder recognition	
Error attributes	Level	Information	Recovery	---	Log category	System
Effects	User program	Continues.	Operation	Not affected.		
System-defined variables	Variable	Data type		Name		
	_Card1Ready	BOOL		SD Memory Card Ready Flag		
Cause and correction	Assumed cause	Correction		Prevention		
	The shared folder was recognized.	---		---		
Attached information	<p>Attached information 1: Execution trigger for recognition</p> <ul style="list-style-type: none"> 1: Reading the Virtual SD Memory Card settings The shared folder was recognized by reading the Virtual SD Memory Card settings during the following operations. At Controller startup At download At a restore operation When the Virtual SD Memory Card settings were changed with the Industrial PC Support Utility When the shared folder recognition was confirmed with the Industrial PC Support Utility 2: Others When the shared folder recognition was confirmed with the Industrial PC Support UtilityThe shared folder recognition was canceled due to an error of Windows or an erroneous operation of Windows or Controller. But this state was changed by removing the causes of canceling the shared folder recognition. Then the Controller automatically recognized the shared folder again. For the causes, refer to assumed causes and corrections for the following event: Shared Folder Recognition Cancel Completed (103B0000 hex). 					
Precautions/Remarks	None					

Event name	OS Started			Event code	95700000 hex	
Meaning	Windows is started up.					
Source	PLC Function Module		Source details	Windows	Detection timing	Continuously
Error attributes	Level	Information	Recovery	---	Log category	System
Effects	User program	---	Operation	Not affected.		
System-defined variables	Variable		Data type		Name	
	_OSRunning		BOOL		OS Running Flag	
	_OSHalted		BOOL		OS Halted Flag	
	_OSErrorState		BOOL		OS Error State Flag	
Cause and correction	Assumed cause		Correction		Prevention	
	An Industrial PC was started.		---		---	
	Windows was restarted by an instruction.		---		---	
	Windows was restarted by Windows operation.		---		---	
Attached information	None					
Precautions/Remarks	None					

Event name	OS Shut Down			Event code	95710000 hex	
Meaning	Windows was shut down.					
Source	PLC Function Module		Source details	Windows	Detection timing	Continuously
Error attributes	Level	Information	Recovery	---	Log category	System
Effects	User program	---	Operation	Not affected.		
System-defined variables	Variable		Data type		Name	
	_OSRunning		BOOL		OS Running Flag	
	_OSHalted		BOOL		OS Halted Flag	
	_OSErrorState		BOOL		OS Error State Flag	
Cause and correction	Assumed cause		Correction		Prevention	
	An Industrial PC was shut down.		---		---	
	Windows was restarted by an instruction.		---		---	
	Windows was restarted by Windows operation.Windows was restarted by an instruction.		---		---	
Attached information	Attached information 1: Cause of the shutdown <ul style="list-style-type: none"> • 1: An Industrial PC was shut down. • 2: Windows was restarted by an instruction. • 3: 3: Windows was restarted by Windows operation. 					
Precautions/Remarks	None					

Instructions

This section provides detailed information on errors (events) that occur for instructions. The lower four digits of the event code represents the error code (ErrorID) for the instruction. For descriptions of an error code, refer to the description of the corresponding event code. For example, when the error code of the instruction is 16#0400, refer to the description of event code, 54010400 hex.

Event name	Input Value Out of Range		Event code	54010400 hex	
Meaning	An input parameter for an instruction exceeded the valid range for an input variable. Or, division by an integer of 0 occurred in division or remainder calculations.				
Source	PLC Function Module		Source details	Instruction	Detection timing At instruction execution
Error attributes	Level	Observation	Recovery	---	Log category System
Effects	User program	Continues.	Operation	The relevant instruction will end according to specifications.	
System-defined variables	Variable	Data type		Name	
	None	---		---	
Cause and correction	Assumed cause		Correction		Prevention
	An input parameter for an instruction exceeded the valid range for an input variable. Or, division by an integer of 0 occurred in division or remainder calculations.		Check the valid range for the input variables of the instruction. Make sure the input parameters are within the valid range and that no division by 0 or remainder calculation for 0 is performed.		Set the value of the input parameter to the instruction so that the input range is not exceeded.
Attached information	Attached Information 1: Error Location Attached Information 2: Error Location Details (Rung Number). For a program section, the rung number from the start of the section is given. For ST, the line number is given. Attached Information 3: Names of the Instruction and Instruction Instance Where the Error Occurred. If there is more than one possible instruction, information is given on all of them. Nothing is given if the instruction cannot be identified. Attached Information 4: Expansion Error Code (<i>ErrorIDEx</i>)				
Precautions/Remarks	If a program is changed after an error occurs, the attached information that is displayed may not be correct.				

Event name	Input Mismatch		Event code	54010401 hex		
Meaning	The relationship for the instruction input parameters did not meet required conditions. Or, a numeric value during or after instruction execution did not meet conditions.					
Source	PLC Function Module		Source details	Instruction	Detection timing	At instruction execution
Error attributes	Level	Observation	Recovery	---	Log category	System
Effects	User program	Continues.	Operation	The relevant instruction will end according to specifications.		
System-defined variables	Variable		Data type		Name	
	None		---		---	
Cause and correction	Assumed cause		Correction		Prevention	
	The relationship for an input parameter did not meet required conditions.		Check the meaning and the relationship of the input variables of the instruction. Correct them so that the relationships for the input parameters meet the required conditions.		Set the input parameter to the instruction so that the value meets the conditions of the relationship for the input variables.	
	A value when processing an instruction or in the result does not meet the conditions.		Check the execution process of the instruction. Set the value of the input parameter so that it does not cause inappropriate processing results.		Check the execution process of the instruction. Set the input parameter so that it does not cause this error during processing.	
Attached information	Attached Information 1: Error Location Attached Information 2: Error Location Details (Rung Number). For a program section, the rung number from the start of the section is given. For ST, the line number is given. Attached Information 3: Names of the Instruction and Instruction Instance Where the Error Occurred. If there is more than one possible instruction, information is given on all of them. Nothing is given if the instruction cannot be identified. Attached Information 4: Expansion Error Code (<i>ErrorIDEx</i>)					
Precautions/Remarks	If a program is changed after an error occurs, the attached information that is displayed may not be correct.					

Event name	Floating-point Error		Event code	54010402 hex		
Meaning	Non-numeric data was input for a floating-point number input parameter to an instruction.					
Source	PLC Function Module		Source details	Instruction	Detection timing	At instruction execution
Error attributes	Level	Observation	Recovery	---	Log category	System
Effects	User program	Continues.	Operation	The relevant instruction will end according to specifications.		
System-defined variables	Variable		Data type		Name	
	None		---		---	
Cause and correction	Assumed cause		Correction		Prevention	
	Non-numeric data was input for a floating-point number input parameter to an instruction.		Correct the instruction so that a numeric value is input for the floating-point number input parameter.		Use numeric values for the floating-point number input parameters.	
Attached information	Attached Information 1: Error Location Attached Information 2: Error Location Details (Rung Number). For a program section, the rung number from the start of the section is given. For ST, the line number is given. Attached Information 3: Names of the Instruction and Instruction Instance Where the Error Occurred. If there is more than one possible instruction, information is given on all of them. Nothing is given if the instruction cannot be identified. Attached Information 4: Expansion Error Code (<i>ErrorIDEx</i>)					
Precautions/Remarks	If a program is changed after an error occurs, the attached information that is displayed may not be correct.					

Event name	BCD Error		Event code	54010403 hex	
Meaning	A value that was not BCD was input for a BCD input parameter to an instruction.				
Source	PLC Function Module		Source details	Instruction	Detection timing At instruction execution
Error attributes	Level	Observation	Recovery	---	Log category System
Effects	User program	Continues.	Operation	The relevant instruction will end according to specifications.	
System-defined variables	Variable	Data type		Name	
	None	---		---	
Cause and correction	Assumed cause		Correction		Prevention
	A hexadecimal digit of A, B, C, D, E, or F was input for a BCD input parameter to an instruction.		Correct the instruction so that BCD data is input for the BCD input parameter.		Change the BCD input parameter for the instruction to BCD data.
Attached information	<p>Attached Information 1: Error Location</p> <p>Attached Information 2: Error Location Details (Rung Number). For a program section, the rung number from the start of the section is given. For ST, the line number is given.</p> <p>Attached Information 3: Names of the Instruction and Instruction Instance Where the Error Occurred. If there is more than one possible instruction, information is given on all of them. Nothing is given if the instruction cannot be identified.</p> <p>Attached Information 4: Expansion Error Code (<i>ErrorIDEx</i>)</p>				
Precautions/Remarks	If a program is changed after an error occurs, the attached information that is displayed may not be correct.				

Event name	Signed BCD Error		Event code	54010404 hex	
Meaning	An illegal value was input for the most significant digit for a signed BCD input parameter to an instruction.				
Source	PLC Function Module		Source details	Instruction	Detection timing At instruction execution
Error attributes	Level	Observation	Recovery	---	Log category System
Effects	User program	Continues.	Operation	The relevant instruction will end according to specifications.	
System-defined variables	Variable	Data type		Name	
	None	---		---	
Cause and correction	Assumed cause	Correction		Prevention	
	<p>An illegal value was input for the most significant digit for a signed BCD input parameter to an instruction.</p> <ul style="list-style-type: none"> The most-significant digit was 2 to F when <code>_BCD0</code> was specified as the BCD format. The most-significant digit was A, B, C, D, or E when <code>_BCD2</code> was specified as the BCD format. The most-significant digit was B, C, D, or E when <code>_BCD3</code> was specified as the BCD format. 	Correct the instruction so that proper signed BCD data is input for the BCD input parameter.		Set the most-significant digit of the signed BCD data input parameter for the instruction to the correct value.	
Attached information	<p>Attached Information 1: Error Location</p> <p>Attached Information 2: Error Location Details (Rung Number). For a program section, the rung number from the start of the section is given. For ST, the line number is given.</p> <p>Attached Information 3: Names of the Instruction and Instruction Instance Where the Error Occurred. If there is more than one possible instruction, information is given on all of them. Nothing is given if the instruction cannot be identified.</p> <p>Attached Information 4: Expansion Error Code (<i>ErrorIDEx</i>)</p>				
Precautions/Remarks	If a program is changed after an error occurs, the attached information that is displayed may not be correct.				

Event name	Illegal Bit Position Specified			Event code	54010405 hex	
Meaning	The bit position specified for an instruction was illegal.					
Source	PLC Function Module		Source details	Instruction	Detection timing	At instruction execution
Error attributes	Level	Observation	Recovery	---	Log category	System
Effects	User program	Continues.	Operation	The relevant instruction will end according to specifications.		
System-defined variables	Variable	Data type		Name		
	None	---		---		
Cause and correction	Assumed cause		Correction		Prevention	
	The bit position specified for an instruction exceeds the data range.		Correct the instruction so that the bit position specified for an instruction does not exceed the data range.		Use the instruction so that the bit position specified for an instruction does not exceed the data range.	
Attached information	<p>Attached Information 1: Error Location</p> <p>Attached Information 2: Error Location Details (Rung Number). For a program section, the rung number from the start of the section is given. For ST, the line number is given.</p> <p>Attached Information 3: Names of the Instruction and Instruction Instance Where the Error Occurred. If there is more than one possible instruction, information is given on all of them. Nothing is given if the instruction cannot be identified.</p> <p>Attached Information 4: Expansion Error Code (<i>ErrorIDEx</i>)</p>					
Precautions/Remarks	If a program is changed after an error occurs, the attached information that is displayed may not be correct.					

Event name	Illegal Data Position Specified			Event code	54010406 hex	
Meaning	A memory address or data size that was specified for the instruction is not suitable.					
Source	PLC Function Module		Source details	Instruction	Detection timing	At instruction execution
Error attributes	Level	Observation	Recovery	---	Log category	System
Effects	User program	Continues.	Operation	The relevant instruction will end according to specifications.		
System-defined variables	Variable	Data type		Name		
	None	---		---		
Cause and correction	Assumed cause		Correction		Prevention	
	A memory address that was specified for an instruction was outside the valid range. The data size that was specified for an instruction exceeded the valid range. For example, the data type of a variable and the data size may not agree.		Correct the instruction so that the data position or data size specified for an instruction does not exceed the range of the data area.		Use the instruction so that the data position or data size specified for an instruction does not exceed the data range.	
Attached information	<p>Attached Information 1: Error Location</p> <p>Attached Information 2: Error Location Details (Rung Number). For a program section, the rung number from the start of the section is given. For ST, the line number is given.</p> <p>Attached Information 3: Names of the Instruction and Instruction Instance Where the Error Occurred. If there is more than one possible instruction, information is given on all of them. Nothing is given if the instruction cannot be identified.</p> <p>Attached Information 4: Expansion Error Code (<i>ErrorIDEx</i>)</p>					
Precautions/Remarks	If a program is changed after an error occurs, the attached information that is displayed may not be correct.					

Event name	Data Range Exceeded			Event code	54010407 hex	
Meaning	The results of instruction processing exceeded the data area range of the output parameter.					
Source	PLC Function Module		Source details	Instruction	Detection timing	At instruction execution
Error attributes	Level	Observation	Recovery	---	Log category	System
Effects	User program	Continues.	Operation	The relevant instruction will end according to specifications.		
System-defined variables	Variable		Data type		Name	
	None		---		---	
Cause and correction	Assumed cause		Correction		Prevention	
	The results of instruction processing, such as the number of array elements, exceeded the data area range of the output parameter.		Correct the input parameters so that the processing result of the instruction does not exceed the range of the data area of the output parameter.		Set the input parameter so that the processing result of the instruction does not exceed the range of the data area of the output parameter.	
Attached information	<p>Attached Information 1: Error Location</p> <p>Attached Information 2: Error Location Details (Rung Number). For a program section, the rung number from the start of the section is given. For ST, the line number is given.</p> <p>Attached Information 3: Names of the Instruction and Instruction Instance Where the Error Occurred. If there is more than one possible instruction, information is given on all of them. Nothing is given if the instruction cannot be identified.</p> <p>Attached Information 4: Expansion Error Code (<i>ErrorIDEx</i>)</p>					
Precautions/Remarks	If a program is changed after an error occurs, the attached information that is displayed may not be correct.					

Event name	No Errors to Clear			Event code	54010409 hex	
Meaning	An instruction to clear a Controller error was executed when there was no error in the Controller.					
Source	PLC Function Module		Source details	Instruction	Detection timing	At instruction execution
Error attributes	Level	Observation	Recovery	---	Log category	System
Effects	User program	Continues.	Operation	The relevant instruction will end according to specifications. The output or Unit operation is not affected.		
System-defined variables	Variable		Data type		Name	
	None		---		---	
Cause and correction	Assumed cause		Correction		Prevention	
	An instruction to clear a Controller error was executed when there was no error in the Controller.		Correct the program so that the instruction is executed when there is a Controller error.		Write the program so that the instruction is executed when there is a Controller error.	
Attached information	<p>Attached Information 1: Error Location</p> <p>Attached Information 2: Error Location Details (Rung Number). For a program section, the rung number from the start of the section is given. For ST, the line number is given.</p> <p>Attached Information 3: Names of the Instruction and Instruction Instance Where the Error Occurred. If there is more than one possible instruction, information is given on all of them. Nothing is given if the instruction cannot be identified.</p> <p>Attached Information 4: Expansion Error Code (<i>ErrorIDEx</i>)</p>					
Precautions/Remarks	If a program is changed after an error occurs, the attached information that is displayed may not be correct.					

Event name	No User Errors to Clear		Event code	5401040B hex	
Meaning	An instruction to clear user-defined errors was executed when there was no user-defined error.				
Source	PLC Function Module		Source details	Instruction	Detection timing At instruction execution
Error attributes	Level	Observation	Recovery	---	Log category System
Effects	User program	Continues.	Operation	The relevant instruction will end according to specifications. The output or Unit operation is not affected.	
System-defined variables	Variable	Data type		Name	
	None	---		---	
Cause and correction	Assumed cause		Correction		Prevention
	An instruction to clear user-defined errors was executed when there was no user-defined error.		Correct the program so that the instruction is executed when there is a user-defined error.		Write the program so that the instruction is executed when there is a user-defined error.
Attached information	<p>Attached Information 1: Error Location</p> <p>Attached Information 2: Error Location Details (Rung Number). For a program section, the rung number from the start of the section is given. For ST, the line number is given.</p> <p>Attached Information 3: Names of the Instruction and Instruction Instance Where the Error Occurred. If there is more than one possible instruction, information is given on all of them. Nothing is given if the instruction cannot be identified.</p> <p>Attached Information 4: Expansion Error Code (<i>ErrorIDEx</i>)</p>				
Precautions/Remarks	If a program is changed after an error occurs, the attached information that is displayed may not be correct.				

Event name	Limit Exceeded for User-defined Errors		Event code	5401040C hex	
Meaning	An attempt was made to use the Create User-defined Error instruction to create more than the maximum number of user-defined errors.				
Source	PLC Function Module		Source details	Instruction	Detection timing At instruction execution
Error attributes	Level	Observation	Recovery	---	Log category System
Effects	User program	Continues.	Operation	The relevant instruction will end according to specifications. The output or Unit operation is not affected.	
System-defined variables	Variable	Data type		Name	
	None	---		---	
Cause and correction	Assumed cause		Correction		Prevention
	An attempt was made to use the Create User-defined Error instruction to create more than the maximum number of user-defined errors.		Execute the Reset User-defined Error instruction. Monitor the number of user-defined errors in the system-defined variable to check the number of user-defined errors.		Write the program so that it checks the number of user-defined errors as a condition to execute the user-defined error instruction.
Attached information	<p>Attached Information 1: Error Location</p> <p>Attached Information 2: Error Location Details (Rung Number). For a program section, the rung number from the start of the section is given. For ST, the line number is given.</p> <p>Attached Information 3: Names of the Instruction and Instruction Instance Where the Error Occurred. If there is more than one possible instruction, information is given on all of them. Nothing is given if the instruction cannot be identified.</p> <p>Attached Information 4: Expansion Error Code (<i>ErrorIDEx</i>)</p>				
Precautions/Remarks	If a program is changed after an error occurs, the attached information that is displayed may not be correct.				

Event name	Text String Format Error		Event code	54010410 hex	
Meaning	The text string input to an instruction is not correct.				
Source	PLC Function Module		Source details	Instruction	Detection timing At instruction execution
Error attributes	Level	Observation	Recovery	---	Log category System
Effects	User program	Continues.	Operation	The relevant instruction will end according to specifications.	
System-defined variables	Variable	Data type		Name	
	None	---		---	
Cause and correction	Assumed cause		Correction		Prevention
	The text string that is input to the instruction for conversion to a number does not represent a number or it does not represent a positive number.		Correct the text string so that it is properly formatted for the instruction.		When converting a text string to a number, make sure that the text string that is input to the instruction represents a number. If the number must be positive, make sure the text string represents a positive number.
	The input text string does not end in NULL.		Correct the text string that is input to the instruction so that it ends in NULL.		When converting a text string to a number, make sure that the text string that is input to the instruction ends in NULL.
Attached information	<p>Attached Information 1: Error Location</p> <p>Attached Information 2: Error Location Details (Rung Number). For a program section, the rung number from the start of the section is given. For ST, the line number is given.</p> <p>Attached Information 3: Names of the Instruction and Instruction Instance Where the Error Occurred. If there is more than one possible instruction, information is given on all of them. Nothing is given if the instruction cannot be identified.</p> <p>Attached Information 4: Expansion Error Code (<i>ErrorIDEx</i>)</p>				
Precautions/Remarks	If a program is changed after an error occurs, the attached information that is displayed may not be correct.				

Event name	Illegal Program Specified		Event code	54010411 hex	
Meaning	The program specified for an instruction does not exist.				
Source	PLC Function Module		Source details	Instruction	Detection timing At instruction execution
Error attributes	Level	Observation	Recovery	---	Log category System
Effects	User program	Continues.	Operation	The relevant instruction will end according to specifications.	
System-defined variables	Variable	Data type		Name	
	None	---		---	
Cause and correction	Assumed cause		Correction		Prevention
	The program specified by the function does not exist (e.g., it was deleted).		Make sure that the program that is specified by the instruction exists. Or, add the program that is specified for the instruction.		Make sure that the programs that are specified by instructions exist. Be careful not to delete any programs that are used by instructions.
Attached information	Attached Information 1: Error Location Attached Information 2: Error Location Details (Rung Number). For a program section, the rung number from the start of the section is given. For ST, the line number is given. Attached Information 3: Names of the Instruction and Instruction Instance Where the Error Occurred. If there is more than one possible instruction, information is given on all of them. Nothing is given if the instruction cannot be identified. Attached Information 4: Expansion Error Code (<i>ErrorIDEx</i>)				
Precautions/Remarks	If a program is changed after an error occurs, the attached information that is displayed may not be correct.				

Event name	Stack Underflow		Event code	54010414 hex	
Meaning	There is no data in a stack.				
Source	PLC Function Module		Source details	Instruction	Detection timing At instruction execution
Error attributes	Level	Observation	Recovery	---	Log category System
Effects	User program	Continues.	Operation	The relevant instruction will end according to specifications.	
System-defined variables	Variable	Data type		Name	
	None	---		---	
Cause and correction	Assumed cause		Correction		Prevention
	An attempt was made to read data from a stack that contains no data.		Correct the program so that the data is read only after it is stored in the stack.		Correct the program so that the data is read only after it is stored in the stack.
Attached information	Attached Information 1: Error Location Attached Information 2: Error Location Details (Rung Number). For a program section, the rung number from the start of the section is given. For ST, the line number is given. Attached Information 3: Names of the Instruction and Instruction Instance Where the Error Occurred. If there is more than one possible instruction, information is given on all of them. Nothing is given if the instruction cannot be identified. Attached Information 4: Expansion Error Code (<i>ErrorIDEx</i>)				
Precautions/Remarks	If a program is changed after an error occurs, the attached information that is displayed may not be correct.				

Event name	Illegal Number of Array Elements or Dimensions		Event code	54010416 hex		
Meaning	The valid range was exceeded for the number of array elements or dimensions in an array I/O parameter for an instruction.					
Source	PLC Function Module		Source details	Instruction	Detection timing	At instruction execution
Error attributes	Level	Observation	Recovery	---	Log category	System
Effects	User program	Continues.	Operation	The relevant instruction will end according to specifications.		
System-defined variables	Variable	Data type		Name		
	None	---		---		
Cause and correction	Assumed cause	Correction		Prevention		
	The valid range was exceeded for the number of array elements or dimensions in an array I/O parameter for an instruction.	Correct the instruction so that the valid range for the number of array elements or dimensions in an array I/O parameter is not exceeded.		Correct the instruction so that the valid range for the number of array elements or dimensions in an array I/O parameter is not exceeded.		
Attached information	<p>Attached Information 1: Error Location</p> <p>Attached Information 2: Error Location Details (Rung Number). For a program section, the rung number from the start of the section is given. For ST, the line number is given.</p> <p>Attached Information 3: Names of the Instruction and Instruction Instance Where the Error Occurred. If there is more than one possible instruction, information is given on all of them. Nothing is given if the instruction cannot be identified.</p> <p>Attached Information 4: Expansion Error Code (<i>ErrorIDEx</i>)</p>					
Precautions/Remarks	If a program is changed after an error occurs, the attached information that is displayed may not be correct.					

Event name	Specified Task Does Not Exist		Event code	54010417 hex		
Meaning	The task specified for the instruction does not exist.					
Source	PLC Function Module		Source details	Instruction	Detection timing	At instruction execution
Error attributes	Level	Observation	Recovery	---	Log category	System
Effects	User program	Continues.	Operation	The relevant instruction will end according to specifications.		
System-defined variables	Variable	Data type		Name		
	None	---		---		
Cause and correction	Assumed cause	Correction		Prevention		
	The specified task does not exist.	Correct the user program so that it specifies an existing task.		Write the user program so that it specifies only existing tasks.		
Attached information	<p>Attached Information 1: Error Location</p> <p>Attached Information 2: Error Location Details (Rung Number). For a program section, the rung number from the start of the section is given. For ST, the line number is given.</p> <p>Attached Information 3: Names of the Instruction and Instruction Instance Where the Error Occurred. If there is more than one possible instruction, information is given on all of them. Nothing is given if the instruction cannot be identified.</p> <p>Attached Information 4: Expansion Error Code (<i>ErrorIDEx</i>)</p>					
Precautions/Remarks	If a program is changed after an error occurs, the attached information that is displayed may not be correct.					

Event name	Unallowed Task Specification			Event code	54010418 hex	
Meaning	An unallowed task was specified for an instruction.					
Source	PLC Function Module		Source details	Instruction	Detection timing	At instruction execution
Error attributes	Level	Observation	Recovery	---	Log category	System
Effects	User program	Continues.	Operation	The relevant instruction will end according to specifications.		
System-defined variables	Variable	Data type		Name		
	None	---		---		
Cause and correction	Assumed cause		Correction		Prevention	
	The local task, the primary periodic task, or a periodic task was specified.		Correct the user program so that it specifies an event task that is not the local task.		Write the user program so that it specifies event tasks that are not the local task.	
Attached information	<p>Attached Information 1: Error Location</p> <p>Attached Information 2: Error Location Details (Rung Number). For a program section, the rung number from the start of the section is given. For ST, the line number is given.</p> <p>Attached Information 3: Names of the Instruction and Instruction Instance Where the Error Occurred. If there is more than one possible instruction, information is given on all of them. Nothing is given if the instruction cannot be identified.</p> <p>Attached Information 4: Expansion Error Code (<i>ErrorIDEx</i>)</p>					
Precautions/Remarks	If a program is changed after an error occurs, the attached information that is displayed may not be correct.					

Event name	Incorrect Data Type			Event code	54010419 hex	
Meaning	A data type that cannot be used for an instruction is specified for an input or in-out variable.					
Source	PLC Function Module		Source details	Instruction	Detection timing	At instruction execution
Error attributes	Level	Observation	Recovery	---	Log category	System
Effects	User program	Continues.	Operation	The relevant instruction will end according to specifications.		
System-defined variables	Variable	Data type		Name		
	None	---		---		
Cause and correction	Assumed cause		Correction		Prevention	
	A data type that cannot be used for an instruction is specified for an input or in-out variable.		Check the data types of the input and in-out variables of the instruction and correct them to correct data types.		Check the allowed data types for input and in-out variables for the instruction and use correct data types.	
Attached information	<p>Attached Information 1: Error Location</p> <p>Attached Information 2: Error Location Details (Rung Number). For a program section, the rung number from the start of the section is given. For ST, the line number is given.</p> <p>Attached Information 3: Names of the Instruction and Instruction Instance Where the Error Occurred. If there is more than one possible instruction, information is given on all of them. Nothing is given if the instruction cannot be identified.</p> <p>Attached Information 4: Expansion Error Code (<i>ErrorIDEx</i>)</p>					
Precautions/Remarks	If a program is changed after an error occurs, the attached information that is displayed may not be correct.					

Event name	Multi-execution of Instructions		Event code	5401041A hex	
Meaning	Multi-execution was specified for an instruction that does not support it.				
Source	PLC Function Module		Source details	Instruction	Detection timing At instruction execution
Error attributes	Level	Observation	Recovery	---	Log category System
Effects	User program	Continues.	Operation	The relevant instruction will end according to specifications.	
System-defined variables	Variable	Data type		Name	
	None	---		---	
Cause and correction	Assumed cause	Correction		Prevention	
	Execution of an instruction that does not support multi-execution of instructions was specified more than once.	Correct the program so that any instance of an instruction that does not support multi-execution is completed before another instance is executed.		Write the user program so that any instance of an instruction that does not support multi-execution is completed before another instance is executed.	
Attached information	<p>Attached Information 1: Error Location</p> <p>Attached Information 2: Error Location Details (Rung Number). For a program section, the rung number from the start of the section is given. For ST, the line number is given.</p> <p>Attached Information 3: Names of the Instruction and Instruction Instance Where the Error Occurred. If there is more than one possible instruction, information is given on all of them. Nothing is given if the instruction cannot be identified.</p> <p>Attached Information 4: Expansion Error Code (<i>ErrorIDEx</i>)</p>				
Precautions/Remarks	If a program is changed after an error occurs, the attached information that is displayed may not be correct.				

Event name	Data Capacity Exceeded		Event code	5401041B hex	
Meaning	The data that was passed to the instruction was too large to process.				
Source	PLC Function Module		Source details	Instruction	Detection timing At instruction execution
Error attributes	Level	Observation	Recovery	---	Log category System
Effects	User program	Continues.	Operation	The relevant instruction will end according to specifications.	
System-defined variables	Variable	Data type		Name	
	None	---		---	
Cause and correction	Assumed cause	Correction		Prevention	
	Data that was larger than the capacity that can be processed was passed to the instruction.	Correct the program so that the size of the data that is passed to the instruction does not exceed the processing capacity.		Make sure that the data that is passed to the instruction is not larger than the processing capacity.	
Attached information	<p>Attached Information 1: Error Location</p> <p>Attached Information 2: Error Location Details (Rung Number). For a program section, the rung number from the start of the section is given. For ST, the line number is given.</p> <p>Attached Information 3: Names of the Instruction and Instruction Instance Where the Error Occurred. If there is more than one possible instruction, information is given on all of them. Nothing is given if the instruction cannot be identified.</p> <p>Attached Information 4: Expansion Error Code (<i>ErrorIDEx</i>)</p>				
Precautions/Remarks	If a program is changed after an error occurs, the attached information that is displayed may not be correct.				

Event name	Different Data Sizes		Event code	5401041C hex	
Meaning	The size of the data specified for instruction input or in-out data is different from the size of the target parameter.				
Source	PLC Function Module		Source details	Instruction	Detection timing At instruction execution
Error attributes	Level	Observation	Recovery	---	Log category System
Effects	User program	Continues.	Operation	The relevant instruction will end according to specifications.	
System-defined variables	Variable	Data type		Name	
	None	---		---	
Cause and correction	Assumed cause		Correction		Prevention
	Data of a size that is different from the size of the target parameter was specified for the input or in-out data of an instruction.		Check the size of the target parameter and correct the program so that the size of the input data is the same.		Check the size of the target parameter and correct the program so that the size of the input data is the same.
Attached information	Attached Information 1: Error Location Attached Information 2: Error Location Details (Rung Number). For a program section, the rung number from the start of the section is given. For ST, the line number is given. Attached Information 3: Names of the Instruction and Instruction Instance Where the Error Occurred. If there is more than one possible instruction, information is given on all of them. Nothing is given if the instruction cannot be identified. Attached Information 4: Expansion Error Code (<i>ErrorIDEx</i>)				
Precautions/Remarks	If a program is changed after an error occurs, the attached information that is displayed may not be correct.				

Event name	Exceeded Simultaneous Instruction Executed Resources		Event code	5401041D hex	
Meaning	The maximum resources that you can use for the relevant instruction group at the same time was exceeded.				
Source	PLC Function Module		Source details	Instruction	Detection timing At instruction execution
Error attributes	Level	Observation	Recovery	---	Log category System
Effects	User program	Continues.	Operation	The relevant instruction will end according to specifications.	
System-defined variables	Variable	Data type		Name	
	None	---		---	
Cause and correction	Assumed cause		Correction		Prevention
	More than the maximum number of relevant instructions were executed at the same time.		Correct the program so that no more than the maximum number of the relevant instructions are executed at the same time.		Write the program so that no more than the maximum number of the relevant instructions are executed at the same time.
Attached information	Attached Information 1: Error Location Attached Information 2: Error Location Details (Rung Number). For a program section, the rung number from the start of the section is given. For ST, the line number is given. Attached Information 3: Names of the Instruction and Instruction Instance Where the Error Occurred. If there is more than one possible instruction, information is given on all of them. Nothing is given if the instruction cannot be identified. Attached Information 4: Expansion Error Code (<i>ErrorIDEx</i>)				
Precautions/Remarks	If a program is changed after an error occurs, the attached information that is displayed may not be correct.				

Event name	Full Reception Buffer		Event code	54010C03 hex		
Meaning	The reception buffer is full.					
Source	PLC Function Module		Source details	Instruction	Detection timing	At instruction execution
Error attributes	Level	Observation	Recovery	---	Log category	System
Effects	User program	Continues.	Operation	The relevant instruction will end according to specifications. Even if the instruction was ended by this error, the received data is saved partially for the amount the receive data storage can store.		
System-defined variables	Variable	Data type		Name		
	None	---		---		
Cause and correction	Assumed cause	Correction		Prevention		
	<p>The reception buffer is full due to the following causes.</p> <ul style="list-style-type: none"> • The transmission frequency of the remote device is high. • The baud rate is too high. • The reception processing frequency from the buffer is low. 	<p>Take either or all of the following correction measures and ensure that the reception buffer will not be full.</p> <ul style="list-style-type: none"> • Lower the transmission frequency of the remote device. • Decrease the baud rate. • Increase the reception processing frequency from the buffer. 		<p>Consider the following four factors and ensure that the reception buffer will not be full.</p> <ul style="list-style-type: none"> • Transmission frequency of the remote device • Baud rate • Reception processing frequency from the buffer • Using flow control 		
Attached information	<p>Attached Information 1: Error Location</p> <p>Attached Information 2: Error Location Details (Rung Number). For a program section, the rung number from the start of the section is given. For ST, the line number is given.</p> <p>Attached Information 3: Names of the Instruction and Instruction Instance Where the Error Occurred. If there is more than one possible instruction, information is given on all of them. Nothing is given if the instruction cannot be identified.</p> <p>Attached Information 4: Expansion Error Code (<i>ErrorIDEx</i>)</p>					
Precautions/Remarks	If a program is changed after an error occurs, the attached information that is displayed may not be correct.					

Event name	Multi-execution of Ports			Event code	54010C04 hex	
Meaning	The serial communications instructions that cannot be executed simultaneously were executed.					
Source	PLC Function Module		Source details	Instruction	Detection timing	At instruction execution
Error attributes	Level	Observation	Recovery	---	Log category	System
Effects	User program	Continues.	Operation	The relevant instruction will end according to specifications. The communications output will follow the specifications of the instruction.		
System-defined variables	Variable	Data type		Name		
	None	---		---		
Cause and correction	Assumed cause		Correction		Prevention	
	An instruction was executed while another instruction that cannot be executed at the same time with the former instruction was executed.		Correct the program so that instructions that cannot be executed at the same time are mutually excluded.		Create a program so that instructions that cannot be executed at the same time are mutually excluded.	
Attached information	<p>Attached Information 1: Error Location</p> <p>Attached Information 2: Error Location Details (Rung Number). For a program section, the rung number from the start of the section is given. For ST, the line number is given.</p> <p>Attached Information 3: Names of the Instruction and Instruction Instance Where the Error Occurred. If there is more than one possible instruction, information is given on all of them. Nothing is given if the instruction cannot be identified.</p> <p>Attached Information 4: Expansion Error Code (<i>ErrorIDEx</i>)</p>					
Precautions/Remarks	<ul style="list-style-type: none"> • If a program is changed after an error occurs, the attached information that is displayed may not be correct. • Refer to individual instruction descriptions for the serial communications instructions that cannot be executed at the same time. 					

Event name	Parity Error			Event code	54010C05 hex	
Meaning	A parity error occurred in the data received.					
Source	PLC Function Module		Source details	Instruction	Detection timing	At instruction execution
Error attributes	Level	Observation	Recovery	---	Log category	System
Effects	User program	Continues.	Operation	The relevant instruction will end according to specifications. The communications output will follow the specifications of the instruction.		
System-defined variables	Variable	Data type		Name		
	None	---		---		
Cause and correction	Assumed cause		Correction		Prevention	
	The communications settings or baud rate settings are not compatible with the remote device.		Make the communications settings and baud rate settings compatible with the remote device.		Make the communications settings and baud rate settings compatible with the remote device.	
	Noise		Implement noise countermeasures.		Implement noise countermeasures.	
Attached information	<p>Attached Information 1: Error Location</p> <p>Attached Information 2: Error Location Details (Rung Number). For a program section, the rung number from the start of the section is given. For ST, the line number is given.</p> <p>Attached Information 3: Names of the Instruction and Instruction Instance Where the Error Occurred. If there is more than one possible instruction, information is given on all of them. Nothing is given if the instruction cannot be identified.</p> <p>Attached Information 4: Expansion Error Code (<i>ErrorIDEx</i>)</p>					
Precautions/Remarks	If a program is changed after an error occurs, the attached information that is displayed may not be correct.					

Event name	Framing Error			Event code	54010C06 hex	
Meaning	A framing error occurred in the data received.					
Source	PLC Function Module		Source details	Instruction	Detection timing	At instruction execution
Error attributes	Level	Observation	Recovery	---	Log category	System
Effects	User program	Continues.	Operation	The relevant instruction will end according to specifications. The communications output will follow the specifications of the instruction.		
System-defined variables	Variable	Data type		Name		
	None	---		---		
Cause and correction	Assumed cause		Correction		Prevention	
	The communications settings or baud rate settings are not compatible with the remote device.		Make the communications settings and baud rate settings compatible with the remote device.		Make the communications settings and baud rate settings compatible with the remote device.	
	Noise		Implement noise countermeasures.		Implement noise countermeasures.	
Attached information	<p>Attached Information 1: Error Location</p> <p>Attached Information 2: Error Location Details (Rung Number). For a program section, the rung number from the start of the section is given. For ST, the line number is given.</p> <p>Attached Information 3: Names of the Instruction and Instruction Instance Where the Error Occurred. If there is more than one possible instruction, information is given on all of them. Nothing is given if the instruction cannot be identified.</p> <p>Attached Information 4: Expansion Error Code (<i>ErrorIDEx</i>)</p>					
Precautions/Remarks	If a program is changed after an error occurs, the attached information that is displayed may not be correct.					

Event name	Overrun Error			Event code	54010C07 hex	
Meaning	An overrun error occurred in the data received.					
Source	PLC Function Module		Source details	Instruction	Detection timing	At instruction execution
Error attributes	Level	Observation	Recovery	---	Log category	System
Effects	User program	Continues.	Operation	The relevant instruction will end according to specifications. The communications output will follow the specifications of the instruction.		
System-defined variables	Variable	Data type		Name		
	None	---		---		
Cause and correction	Assumed cause		Correction		Prevention	
	The next data was received during processing of received data because the baud rate is too high.		Reduce the baud rate.		Reduce the baud rate.	
Attached information	<p>Attached Information 1: Error Location</p> <p>Attached Information 2: Error Location Details (Rung Number). For a program section, the rung number from the start of the section is given. For ST, the line number is given.</p> <p>Attached Information 3: Names of the Instruction and Instruction Instance Where the Error Occurred. If there is more than one possible instruction, information is given on all of them. Nothing is given if the instruction cannot be identified.</p> <p>Attached Information 4: Expansion Error Code (<i>ErrorIDEx</i>)</p>					
Precautions/Remarks	If a program is changed after an error occurs, the attached information that is displayed may not be correct.					

Event name	CRC Mismatch		Event code	54010C08 hex	
Meaning	The receive data had different CRC.				
Source	PLC Function Module		Source details	Instruction	Detection timing At instruction execution
Error attributes	Level	Observation	Recovery	---	Log category System
Effects	User program	Continues.	Operation	The relevant instruction will end according to specifications. The communications output will follow the specifications of the instruction.	
System-defined variables	Variable	Data type		Name	
	None	---		---	
Cause and correction	Assumed cause		Correction		Prevention
	A wrong message was received.		Correct the CRC generation method for the remote device to be the one as intended.		Confirm the CRC generation method for the remote device to be the one as intended.
	Noise		Receive the data again. Or, implement noise countermeasures.		Implement noise countermeasures.
Attached information	<p>Attached Information 1: Error Location</p> <p>Attached Information 2: Error Location Details (Rung Number). For a program section, the rung number from the start of the section is given. For ST, the line number is given.</p> <p>Attached Information 3: Names of the Instruction and Instruction Instance Where the Error Occurred. If there is more than one possible instruction, information is given on all of them. Nothing is given if the instruction cannot be identified.</p> <p>Attached Information 4: Expansion Error Code (<i>ErrorIDEx</i>)</p>				
Precautions/Remarks	If a program is changed after an error occurs, the attached information that is displayed may not be correct.				

Event name	Serial Communications Timeout		Event code	54010C0B hex	
Meaning	A timeout occurred in serial communications.				
Source	PLC Function Module		Source details	Instruction	Detection timing At instruction execution
Error attributes	Level	Observation	Recovery	---	Log category System
Effects	User program	Continues.	Operation	The relevant instruction will end according to specifications. The communications output will follow the specifications of the instruction.	
System-defined variables	Variable	Data type		Name	
	None	---		---	
Cause and correction	Assumed cause	Correction		Prevention	
	Wiring to the remote device is not connected.	Check the wiring to the remote device and correct the wiring if there are any problems.		Confirm that wiring to the remote device is connected.	
	Power to the remote device is OFF.	Turn ON the power to the remote device.		Confirm that the power to the remote device is turned ON.	
	The communications settings or baud rate settings are not compatible with the remote device.	Make the communications settings and baud rate settings compatible with the remote device.		Make the communications settings and baud rate settings compatible with the remote device.	
	Noise	Implement noise countermeasures.		Implement noise countermeasures.	
Attached information	<p>Attached Information 1: Error Location</p> <p>Attached Information 2: Error Location Details (Rung Number). For a program section, the rung number from the start of the section is given. For ST, the line number is given.</p> <p>Attached Information 3: Names of the Instruction and Instruction Instance Where the Error Occurred. If there is more than one possible instruction, information is given on all of them. Nothing is given if the instruction cannot be identified.</p> <p>Attached Information 4: Expansion Error Code (<i>ErrorIDEx</i>)</p>				
Precautions/Remarks	If a program is changed after an error occurs, the attached information that is displayed may not be correct.				

Event name	Instruction Executed to Inapplicable Port			Event code	54010C0C hex	
Meaning	An instruction was executed to an inapplicable port.					
Source	PLC Function Module		Source details	Instruction	Detection timing	At instruction execution
Error attributes	Level	Observation	Recovery	---	Log category	System
Effects	User program	Continues.	Operation	The relevant instruction will end according to specifications. The communications output will follow the specifications of the instruction.		
System-defined variables	Variable	Data type		Name		
	None	---		---		
Cause and correction	Assumed cause		Correction		Prevention	
	An instruction was executed to an inapplicable port.		Specify a port that is applicable for the instruction, from the device port structure, and execute the instruction.		Specify a port that is applicable for the instruction, from the device port structure, and execute the instruction.	
Attached information	Attached Information 1: Error Location Attached Information 2: Error Location Details (Rung Number). For a program section, the rung number from the start of the section is given. For ST, the line number is given. Attached Information 3: Names of the Instruction and Instruction Instance Where the Error Occurred. If there is more than one possible instruction, information is given on all of them. Nothing is given if the instruction cannot be identified. Attached Information 4: Expansion Error Code (<i>ErrorIDEx</i>)					
Precautions/Remarks	If a program is changed after an error occurs, the attached information that is displayed may not be correct.					

Event name	CIF Unit Initialized			Event code	54010C0D hex ^{*1}	
Meaning	A CIF Unit was initialized, so the communications data buffered in the CIF Unit was lost.					
Source	PLC Function Module		Source details	Instruction	Detection timing	At instruction execution
Error attributes	Level	Observation	Recovery	---	Log category	System
Effects	User program	Continues.	Operation	The relevant instruction will end according to specifications. The communications output will follow the specifications of the instruction.		
System-defined variables	Variable	Data type		Name		
	None	---		---		
Cause and correction	Assumed cause		Correction		Prevention	
	A CIF Unit was initialized.		Send or receive the data again, as required.		When a program that buffers communications data in a CIF Unit is executed, do not restart the CIF Unit.	
Attached information	Attached Information 1: Error Location Attached Information 2: Error Location Details (Rung Number). For a program section, the rung number from the start of the section is given. For ST, the line number is given. Attached Information 3: Names of the Instruction and Instruction Instance Where the Error Occurred. If there is more than one possible instruction, information is given on all of them. Nothing is given if the instruction cannot be identified. Attached Information 4: Expansion Error Code (<i>ErrorIDEx</i>)					
Precautions/Remarks	If a program is changed after an error occurs, the attached information that is displayed may not be correct.					

*1. Error code 16#0C0D occurs for unit version 1.14 or later of the CPU Unit.

Event name	Exceptional Modbus Response		Event code	54010C10 hex		
Meaning	An exceptional code was returned from the Modbus slave.					
Source	PLC Function Module		Source details	Instruction	Detection timing	At instruction execution
Error attributes	Level	Observation	Recovery	---	Log category	System
Effects	User program	Continues.	Operation	The relevant instruction will end according to specifications. The communications output will follow the specifications of the instruction.		
System-defined variables	Variable	Data type		Name		
	None	---		---		
Cause and correction	Assumed cause		Correction		Prevention	
	An error was detected on the Modbus slave.		Check the value xx in 16#0000_00xx of ErrorIDEx, identify error causes in the Modbus Protocol, and take required measures. Refer to the description for the relevant instruction for the reference to the Modbus Protocol.		Write the user program, including ones for remote devices, according to the Modbus Protocol.	
Attached information	<p>Attached Information 1: Error Location</p> <p>Attached Information 2: Error Location Details (Rung Number). For a program section, the rung number from the start of the section is given. For ST, the line number is given.</p> <p>Attached Information 3: Names of the Instruction and Instruction Instance Where the Error Occurred. If there is more than one possible instruction, information is given on all of them. Nothing is given if the instruction cannot be identified.</p> <p>Attached Information 4: Expansion Error Code (<i>ErrorIDEx</i>)</p>					
Precautions/Remarks	If a program is changed after an error occurs, the attached information that is displayed may not be correct.					

Event name	Invalid Modbus Response		Event code	54010C11 hex		
Meaning	An unexpected response was returned from the Modbus slave.					
Source	PLC Function Module		Source details	Instruction	Detection timing	At instruction execution
Error attributes	Level	Observation	Recovery	---	Log category	System
Effects	User program	Continues.	Operation	The relevant instruction will end according to specifications. The communications output will follow the specifications of the instruction.		
System-defined variables	Variable	Data type		Name		
	None	---		---		
Cause and correction	Assumed cause		Correction		Prevention	
	The function code or data size of the response received from the Modbus slave was incorrect.		Review the transmission sequence with the remote devices, such as the send delay, reception monitoring time, and other options.		Write the user program so that the next command is not sent before a response is returned.	
Attached information	<p>Attached Information 1: Error Location</p> <p>Attached Information 2: Error Location Details (Rung Number). For a program section, the rung number from the start of the section is given. For ST, the line number is given.</p> <p>Attached Information 3: Names of the Instruction and Instruction Instance Where the Error Occurred. If there is more than one possible instruction, information is given on all of them. Nothing is given if the instruction cannot be identified.</p> <p>Attached Information 4: Expansion Error Code (<i>ErrorIDEx</i>)</p>					
Precautions/Remarks	If a program is changed after an error occurs, the attached information that is displayed may not be correct.					

Event name	File Does Not Exist		Event code	54011403 hex	
Meaning	The file specified for an instruction does not exist. Or, the specified file is corrupted.				
Source	PLC Function Module		Source details	Instruction	Detection timing At instruction execution
Error attributes	Level	Observation	Recovery	---	Log category System
Effects	User program	Continues.	Operation	The relevant instruction will end according to specifications. The operation of the Unit is not affected.	
System-defined variables	Variable	Data type		Name	
	None	---		---	
Cause and correction	Assumed cause		Correction		Prevention
	The specified file does not exist.		Make sure that the filename that is specified for the instruction exists. Or, modify the filename so that it matches the filename specified for the instruction.		Make sure that the filename that is specified for the instruction exists.
	The specified file is corrupted.		Specify the other filename.		None
	The SD Memory Card cannot be normally accessed due to a contact failure or other causes.		Insert the SD Memory Card again or replace it.		None
Attached information	<p>Attached Information 1: Error Location</p> <p>Attached Information 2: Error Location Details (Rung Number). For a program section, the rung number from the start of the section is given. For ST, the line number is given.</p> <p>Attached Information 3: Names of the Instruction and Instruction Instance Where the Error Occurred. If there is more than one possible instruction, information is given on all of them. Nothing is given if the instruction cannot be identified.</p> <p>Attached Information 4: Expansion Error Code (<i>ErrorIDEx</i>)</p>				
Precautions/Remarks	If a program is changed after an error occurs, the attached information that is displayed may not be correct.				

Event name	File Already in Use		Event code	54011405 hex		
Meaning	A file specified for an instruction cannot be accessed because it is already being used.					
Source	PLC Function Module		Source details	Instruction	Detection timing	At instruction execution
Error attributes	Level	Observation	Recovery	---	Log category	System
Effects	User program	Continues.	Operation	The relevant instruction will end according to specifications. The operation of the Unit is not affected.		
System-defined variables	Variable	Data type		Name		
	None	---		---		
Cause and correction	Assumed cause		Correction		Prevention	
	An instruction attempted to read or write a file already being accessed by another instruction.		Correct the program so that the relevant instruction is only executed when the <i>Busy</i> output variable for all other instructions for the same file are FALSE.		When you execute multiple instructions that access the same file, write the program so that the instructions are not executed simultaneously. Make sure that the <i>Busy</i> output variable for all other instructions for the same file is FALSE.	
Attached information	Attached Information 1: Error Location Attached Information 2: Error Location Details (Rung Number). For a program section, the rung number from the start of the section is given. For ST, the line number is given. Attached Information 3: Names of the Instruction and Instruction Instance Where the Error Occurred. If there is more than one possible instruction, information is given on all of them. Nothing is given if the instruction cannot be identified. Attached Information 4: Expansion Error Code (<i>ErrorIDEx</i>)					
Precautions/Remarks	If a program is changed after an error occurs, the attached information that is displayed may not be correct.					

Event name	Open Mode Mismatch		Event code	54011406 hex		
Meaning	A file operation for an instruction was inconsistent with the open mode of the file.					
Source	PLC Function Module		Source details	Instruction	Detection timing	At instruction execution
Error attributes	Level	Observation	Recovery	---	Log category	System
Effects	User program	Continues.	Operation	The relevant instruction will end according to specifications. The operation of the Unit is not affected.		
System-defined variables	Variable	Data type		Name		
	None	---		---		
Cause and correction	Assumed cause		Correction		Prevention	
	The file open mode specified by the Open File instruction does not match the file operation attempted by a subsequent SD Memory Card instruction.		Correct the Open File instruction to open the file in an open mode that is suitable for the file operation.		Change the Open File instruction to open the file in an open mode that is suitable for the file operation.	
Attached information	Attached Information 1: Error Location Attached Information 2: Error Location Details (Rung Number). For a program section, the rung number from the start of the section is given. For ST, the line number is given. Attached Information 3: Names of the Instruction and Instruction Instance Where the Error Occurred. If there is more than one possible instruction, information is given on all of them. Nothing is given if the instruction cannot be identified. Attached Information 4: Expansion Error Code (<i>ErrorIDEx</i>)					
Precautions/Remarks	If a program is changed after an error occurs, the attached information that is displayed may not be correct.					

Event name	Offset Out of Range			Event code	54011407 hex	
Meaning	Access to the address is not possible for the offset specified for an instruction.					
Source	PLC Function Module		Source details	Instruction	Detection timing	At instruction execution
Error attributes	Level	Observation	Recovery	---	Log category	System
Effects	User program	Continues.	Operation	The relevant instruction will end according to specifications. The operation of the Unit is not affected.		
System-defined variables	Variable	Data type		Name		
	None	---		---		
Cause and correction	Assumed cause		Correction		Prevention	
	An attempt was made to access beyond the size of the file.		Decrease the offset specified for the instruction.		Include information in the file so that the file format can be identified, and modify the program to check that information in order to perform appropriate file seeking.	
Attached information	Attached Information 1: Error Location Attached Information 2: Error Location Details (Rung Number). For a program section, the rung number from the start of the section is given. For ST, the line number is given. Attached Information 3: Names of the Instruction and Instruction Instance Where the Error Occurred. If there is more than one possible instruction, information is given on all of them. Nothing is given if the instruction cannot be identified. Attached Information 4: Expansion Error Code (<i>ErrorIDEx</i>)					
Precautions/Remarks	If a program is changed after an error occurs, the attached information that is displayed may not be correct.					

Event name	Directory Not Empty			Event code	54011408 hex	
Meaning	A directory was not empty when the Delete Directory instruction was executed or when an attempt was made to change the directory name.					
Source	PLC Function Module		Source details	Instruction	Detection timing	At instruction execution
Error attributes	Level	Observation	Recovery	---	Log category	System
Effects	User program	Continues.	Operation	The relevant instruction will end according to specifications. The operation of the Unit is not affected.		
System-defined variables	Variable	Data type		Name		
	None	---		---		
Cause and correction	Assumed cause		Correction		Prevention	
	A directory was not empty when the Delete Directory instruction was executed.		Delete all files in the relevant directory.		Check the contents of a directory before you delete the directory using the Delete Directory instruction or before you change the directory name.	
A directory contained another directory when an attempt was made to change the directory name.		Delete all directories from the relevant directory.				
Attached information	Attached Information 1: Error Location Attached Information 2: Error Location Details (Rung Number). For a program section, the rung number from the start of the section is given. For ST, the line number is given. Attached Information 3: Names of the Instruction and Instruction Instance Where the Error Occurred. If there is more than one possible instruction, information is given on all of them. Nothing is given if the instruction cannot be identified. Attached Information 4: Expansion Error Code (<i>ErrorIDEx</i>)					
Precautions/Remarks	If a program is changed after an error occurs, the attached information that is displayed may not be correct.					

3 Error Descriptions and Corrections

Event name	That File Name Already Exists			Event code	54011409 hex	
Meaning	An instruction could not be executed because the file name specified for the instruction already exists.					
Source	PLC Function Module		Source details	Instruction	Detection timing	At instruction execution
Error attributes	Level	Observation	Recovery	---	Log category	System
Effects	User program	Continues.	Operation	The relevant instruction will end according to specifications. The operation of the Unit is not affected.		
System-defined variables	Variable	None		Data type	---	
Cause and correction	Assumed cause		Correction		Prevention	
	A file already exists with the same name as the name specified for the instruction to create.		Correct the program so that the filename specified for the instruction does not already exist. Or, delete the existing file.		Make sure that the file specified does not already exist when you create a file with an instruction.	
Attached information	<p>Attached Information 1: Error Location</p> <p>Attached Information 2: Error Location Details (Rung Number). For a program section, the rung number from the start of the section is given. For ST, the line number is given.</p> <p>Attached Information 3: Names of the Instruction and Instruction Instance Where the Error Occurred. If there is more than one possible instruction, information is given on all of them. Nothing is given if the instruction cannot be identified.</p> <p>Attached Information 4: Expansion Error Code (<i>ErrorIDEx</i>)</p>					
Precautions/Remarks	<ul style="list-style-type: none"> If a program is changed after an error occurs, the attached information that is displayed may not be correct. When you delete an existing file, check to make sure that you no longer need the file. 					

Event name	Write Access Denied			Event code	5401140A hex	
Meaning	An attempt was made to write to a write-protected file or directory when an instruction was executed.					
Source	PLC Function Module		Source details	Instruction	Detection timing	At instruction execution
Error attributes	Level	Observation	Recovery	---	Log category	System
Effects	User program	Continues.	Operation	The relevant instruction will end according to specifications. The operation of the Unit is not affected.		
System-defined variables	Variable	None		Data type	---	
Cause and correction	Assumed cause		Correction		Prevention	
	The file or directory specified for the instruction to write is write-protected.		Remove write protection from the file or directory specified for the instruction. Or, change the filename of the file to write.		Do not write-protect any files that need to be written to.	
Attached information	<p>Attached Information 1: Error Location</p> <p>Attached Information 2: Error Location Details (Rung Number). For a program section, the rung number from the start of the section is given. For ST, the line number is given.</p> <p>Attached Information 3: Names of the Instruction and Instruction Instance Where the Error Occurred. If there is more than one possible instruction, information is given on all of them. Nothing is given if the instruction cannot be identified.</p> <p>Attached Information 4: Expansion Error Code (<i>ErrorIDEx</i>)</p>					
Precautions/Remarks	<ul style="list-style-type: none"> If a program is changed after an error occurs, the attached information that is displayed may not be correct. Before you remove write protection from a file, be sure it is OK to overwrite the file. 					

Event name	Too Many Files Open			Event code	5401140B hex	
Meaning	The maximum number of open files was exceeded when opening a file for an instruction.					
Source	PLC Function Module		Source details	Instruction	Detection timing	At instruction execution
Error attributes	Level	Observation	Recovery	---	Log category	System
Effects	User program	Continues.	Operation	The relevant instruction will end according to specifications. The operation of the Unit is not affected.		
System-defined variables	Variable	Data type		Name		
	None	---		---		
Cause and correction	Assumed cause		Correction		Prevention	
	The maximum number of open files was exceeded when opening a file for an instruction.		Correct the program to decrease the number of open files.		Decrease the number of files. Or, write the program so that files that no longer need to be open are closed in order to prevent too many files from being open at once.	
Attached information	Attached Information 1: Error Location Attached Information 2: Error Location Details (Rung Number). For a program section, the rung number from the start of the section is given. For ST, the line number is given. Attached Information 3: Names of the Instruction and Instruction Instance Where the Error Occurred. If there is more than one possible instruction, information is given on all of them. Nothing is given if the instruction cannot be identified. Attached Information 4: Expansion Error Code (<i>ErrorIDEx</i>)					
Precautions/Remarks	If a program is changed after an error occurs, the attached information that is displayed may not be correct.					

Event name	Directory Does Not Exist			Event code	5401140C hex	
Meaning	The directory specified for an instruction does not exist.					
Source	PLC Function Module		Source details	Instruction	Detection timing	At instruction execution
Error attributes	Level	Observation	Recovery	---	Log category	System
Effects	User program	Continues.	Operation	The relevant instruction will end according to specifications. The operation of the Unit is not affected.		
System-defined variables	Variable	Data type		Name		
	None	---		---		
Cause and correction	Assumed cause		Correction		Prevention	
	The directory specified for an instruction does not exist.		Correct the program so that the directory specified for the instruction exists. Or, create the relevant directory in advance.		Make sure that the directory specified for the instruction directory actually exists when using an instruction that accesses a directory.	
Attached information	Attached Information 1: Error Location Attached Information 2: Error Location Details (Rung Number). For a program section, the rung number from the start of the section is given. For ST, the line number is given. Attached Information 3: Names of the Instruction and Instruction Instance Where the Error Occurred. If there is more than one possible instruction, information is given on all of them. Nothing is given if the instruction cannot be identified. Attached Information 4: Expansion Error Code (<i>ErrorIDEx</i>)					
Precautions/Remarks	If a program is changed after an error occurs, the attached information that is displayed may not be correct.					

Event name	Backup Operation Already in Progress		Event code	5401140F hex ^{*1}	
Meaning	Another backup operation is already in progress.				
Source	PLC Function Module		Source details	Instruction	Detection timing At instruction execution
Error attributes	Level	Observation	Recovery	---	Log category System
Effects	User program	Continues.	Operation	The relevant instruction will end according to specifications. The operation of the Unit is not affected.	
System-defined variables	Variable	Data type		Name	
	None	---		---	
Cause and correction	Assumed cause		Correction		Prevention
	Another backup operation is already in progress.		Wait for the backup operation to end and then execute the instruction again.		Do not attempt to execute other backup operation during a backup operation.
Attached information	<p>Attached Information 1: Error Location</p> <p>Attached Information 2: Error Location Details (Rung Number). For a program section, the rung number from the start of the section is given. For ST, the line number is given.</p> <p>Attached Information 3: Names of the Instruction and Instruction Instance Where the Error Occurred. If there is more than one possible instruction, information is given on all of them. Nothing is given if the instruction cannot be identified.</p> <p>Attached Information 4: Expansion Error Code (<i>ErrorIDEx</i>)</p>				
Precautions/Remarks	If a program is changed after an error occurs, the attached information that is displayed may not be correct.				

*1. Error code 16#140F occurs for unit version 1.08 or later of the CPU Unit.

Event name	Cannot Execute Backup		Event code	54011410 hex	
Meaning	Execution of a backup operation was not possible because execution of another operation was in progress.				
Source	PLC Function Module		Source details	Instruction	Detection timing At instruction execution
Error attributes	Level	Observation	Recovery	---	Log category System
Effects	User program	Continues.	Operation	The relevant instruction will end according to specifications. The operation of the Unit is not affected.	
System-defined variables	Variable	Data type		Name	
	None	---		---	
Cause and correction	Assumed cause		Correction		Prevention
	Execution of the instruction was attempted during execution of online editing.		Complete online editing and then execute the instruction again.		Do not attempt to execute a backup operation during execution of online editing.
	Execution of the instruction was attempted during execution of a Save Cam Table instruction.		Complete the Save Cam Table instruction and then execute the instruction again.		Do not attempt to execute a backup operation during execution of a Save Cam Table instruction.
	Execution of the instruction was attempted while a CPU Unit name change operation was in progress.		Complete the CPU Unit name change and then execute the instruction again.		Do not attempt to execute a backup operation during execution of a CPU Unit name change.
Attached information	<p>Attached Information 1: Error Location</p> <p>Attached Information 2: Error Location Details (Rung Number). For a program section, the rung number from the start of the section is given. For ST, the line number is given.</p> <p>Attached Information 3: Names of the Instruction and Instruction Instance Where the Error Occurred. If there is more than one possible instruction, information is given on all of them. Nothing is given if the instruction cannot be identified.</p> <p>Attached Information 4: Expansion Error Code (<i>ErrorIDEx</i>)</p>				
Precautions/Remarks	If a program is changed after an error occurs, the attached information that is displayed may not be correct.				

Event name	EtherCAT Communications Error			Event code	54011800 hex	
Meaning	Accessing the EtherCAT network failed when an instruction was executed.					
Source	PLC Function Module		Source details	Instruction	Detection timing	At instruction execution
Error attributes	Level	Observation	Recovery	---	Log category	System
Effects	User program	Continues.	Operation	The relevant instruction will end according to specifications.		
System-defined variables	Variable	Data type		Name		
	None	---		---		
Cause and correction	Assumed cause		Correction		Prevention	
	The EtherCAT network is not in a usable status.		Check the operation status of the EtherCAT network by checking the status of the EtherCAT master. Use this information to correct the cause of the problem.		Depends on the nature of the error.	
Attached information	Attached Information 1: Error Location Attached Information 2: Error Location Details (Rung Number). For a program section, the rung number from the start of the section is given. For ST, the line number is given. Attached Information 3: Names of the Instruction and Instruction Instance Where the Error Occurred. If there is more than one possible instruction, information is given on all of them. Nothing is given if the instruction cannot be identified. Attached Information 4: Expansion Error Code (<i>ErrorIDEx</i>)					
Precautions/Remarks	If a program is changed after an error occurs, the attached information that is displayed may not be correct.					

Event name	EtherCAT Slave Does Not Respond			Event code	54011801 hex	
Meaning	Accessing the target slave failed when an instruction was executed.					
Source	PLC Function Module		Source details	Instruction	Detection timing	At instruction execution
Error attributes	Level	Observation	Recovery	---	Log category	System
Effects	User program	Continues.	Operation	The relevant instruction will end according to specifications.		
System-defined variables	Variable	Data type		Name		
	None	---		---		
Cause and correction	Assumed cause		Correction		Prevention	
	The target slave does not exist.		Specify an existing node address.		Specify an existing node address for the target slave.	
	The target slave is not in an operating condition.		Check the status of the target EtherCAT slave. Make sure that the target slave is in a usable status.		Make sure that the target slave is in a usable status.	
Attached information	Attached Information 1: Error Location Attached Information 2: Error Location Details (Rung Number). For a program section, the rung number from the start of the section is given. For ST, the line number is given. Attached Information 3: Names of the Instruction and Instruction Instance Where the Error Occurred. If there is more than one possible instruction, information is given on all of them. Nothing is given if the instruction cannot be identified. Attached Information 4: Expansion Error Code (<i>ErrorIDEx</i>)					
Precautions/Remarks	If a program is changed after an error occurs, the attached information that is displayed may not be correct.					

Event name	EtherCAT Timeout		Event code	54011802 hex	
Meaning	A timeout occurred while trying to access an EtherCAT slave when an instruction was executed.				
Source	PLC Function Module		Source details	Instruction	Detection timing At instruction execution
Error attributes	Level	Observation	Recovery	---	Log category System
Effects	User program	Continues.	Operation	The relevant instruction will end according to specifications.	
System-defined variables	Variable	Data type		Name	
	None	---		---	
Cause and correction	Assumed cause		Correction		Prevention
	Communications with the target slave timed out.		Check the operating status of the target slave and correct the cause of the problem.		Depends on the nature of the error.
Attached information	<p>Attached Information 1: Error Location</p> <p>Attached Information 2: Error Location Details (Rung Number). For a program section, the rung number from the start of the section is given. For ST, the line number is given.</p> <p>Attached Information 3: Names of the Instruction and Instruction Instance Where the Error Occurred. If there is more than one possible instruction, information is given on all of them. Nothing is given if the instruction cannot be identified.</p> <p>Attached Information 4: Expansion Error Code (<i>ErrorIDEx</i>)</p>				
Precautions/Remarks	If a program is changed after an error occurs, the attached information that is displayed may not be correct.				

Event name	Reception Buffer Overflow		Event code	54011803 hex	
Meaning	The receive data from an EtherCAT slave overflowed the receive buffer when an instruction was executed.				
Source	PLC Function Module		Source details	Instruction	Detection timing At instruction execution
Error attributes	Level	Observation	Recovery	---	Log category System
Effects	User program	Continues.	Operation	The relevant instruction will end according to specifications. It will not be possible to receive data from the slave.	
System-defined variables	Variable	Data type		Name	
	None	---		---	
Cause and correction	Assumed cause		Correction		Prevention
	The receive data from the slave overflowed the receive buffer.		Set the size of the reception buffer to a value larger than the size of the receive data from the slave.		Set the size of the receive buffer to a value larger than the size of the receive data from the slave.
Attached information	<p>Attached Information 1: Error Location</p> <p>Attached Information 2: Error Location Details (Rung Number). For a program section, the rung number from the start of the section is given. For ST, the line number is given.</p> <p>Attached Information 3: Names of the Instruction and Instruction Instance Where the Error Occurred. If there is more than one possible instruction, information is given on all of them. Nothing is given if the instruction cannot be identified.</p> <p>Attached Information 4: Expansion Error Code (<i>ErrorIDEx</i>)</p>				
Precautions/Remarks	If a program is changed after an error occurs, the attached information that is displayed may not be correct.				

Event name	SDO Abort Error			Event code	54011804 hex	
Meaning	An SDO abort error was received from an EtherCAT slave when an instruction was executed.					
Source	PLC Function Module		Source details	Instruction	Detection timing	At instruction execution
Error attributes	Level	Observation	Recovery	---	Log category	System
Effects	User program	Continues.	Operation	The relevant instruction will end according to specifications.		
System-defined variables	Variable	Data type		Name		
	None	---		---		
Cause and correction	Assumed cause		Correction		Prevention	
	Depends on the specifications of the slave.		Refer to the manual for the slave and correct the problem.		Refer to the manual for the slave and take the necessary steps to prevent the problem.	
Attached information	<p>Attached Information 1: Error Location</p> <p>Attached Information 2: Error Location Details (Rung Number). For a program section, the rung number from the start of the section is given. For ST, the line number is given.</p> <p>Attached Information 3: Names of the Instruction and Instruction Instance Where the Error Occurred. If there is more than one possible instruction, information is given on all of them. Nothing is given if the instruction cannot be identified.</p> <p>Attached Information 4: Expansion Error Code (<i>ErrorIDEx</i>)</p>					
Precautions/Remarks	If a program is changed after an error occurs, the attached information that is displayed may not be correct.					

Event name	Saving Packet Monitor File			Event code	54011805 hex	
Meaning	An instruction for packet monitoring was executed while saving an EtherCAT packet monitor file.					
Source	PLC Function Module		Source details	Instruction	Detection timing	At instruction execution
Error attributes	Level	Observation	Recovery	---	Log category	System
Effects	User program	Continues.	Operation	The relevant instruction will end according to specifications.		
System-defined variables	Variable	Data type		Name		
	None	---		---		
Cause and correction	Assumed cause		Correction		Prevention	
	An instruction for packet monitoring was executed while saving an EtherCAT packet monitor file.		Execute the instruction for packet monitoring after saving the EtherCAT packet monitor file is completed. You can check packet monitor file save status to see if saving a packet monitor file is completed.		Execute packet monitoring instructions only after the packet monitor file is saved. You can check packet monitor file save status to see if saving a packet monitor file is completed.	
Attached information	<p>Attached Information 1: Error Location</p> <p>Attached Information 2: Error Location Details (Rung Number). For a program section, the rung number from the start of the section is given. For ST, the line number is given.</p> <p>Attached Information 3: Names of the Instruction and Instruction Instance Where the Error Occurred. If there is more than one possible instruction, information is given on all of them. Nothing is given if the instruction cannot be identified.</p> <p>Attached Information 4: Expansion Error Code (<i>ErrorIDEx</i>)</p>					
Precautions/Remarks	If a program is changed after an error occurs, the attached information that is displayed may not be correct.					

Event name	Packet Monitoring Function Not Started		Event code	54011806 hex	
Meaning	A Stop EtherCAT Packet Monitor instruction was executed when EtherCAT packet monitoring was stopped.				
Source	PLC Function Module		Source details	Instruction	Detection timing At instruction execution
Error attributes	Level	Observation	Recovery	---	Log category System
Effects	User program	Continues.	Operation	The relevant instruction will end according to specifications.	
System-defined variables	Variable	Data type		Name	
	None	---		---	
Cause and correction	Assumed cause	Correction		Prevention	
	A Stop EtherCAT Packet Monitor instruction was executed when EtherCAT packet monitoring was stopped.	Execute the Stop EtherCAT Packet Monitor instruction after starting the packet monitoring function. You can check packet monitoring function operation status to see if the packet monitoring function is currently in operation.		Execute the Stop EtherCAT Packet Monitor instruction after starting the packet monitoring function. You can check packet monitoring function operation status to see if the packet monitoring function is currently in operation.	
Attached information	<p>Attached Information 1: Error Location</p> <p>Attached Information 2: Error Location Details (Rung Number). For a program section, the rung number from the start of the section is given. For ST, the line number is given.</p> <p>Attached Information 3: Names of the Instruction and Instruction Instance Where the Error Occurred. If there is more than one possible instruction, information is given on all of them. Nothing is given if the instruction cannot be identified.</p> <p>Attached Information 4: Expansion Error Code (<i>ErrorIDEx</i>)</p>				
Precautions/Remarks	If a program is changed after an error occurs, the attached information that is displayed may not be correct.				

Event name	Packet Monitoring Function in Operation		Event code	54011807 hex	
Meaning	A Start EtherCAT Packet Monitor instruction was executed when EtherCAT packet monitoring was already being executed.				
Source	PLC Function Module		Source details	Instruction	Detection timing At instruction execution
Error attributes	Level	Observation	Recovery	---	Log category System
Effects	User program	Continues.	Operation	The relevant instruction will end according to specifications.	
System-defined variables	Variable	Data type		Name	
	None	---		---	
Cause and correction	Assumed cause	Correction		Prevention	
	The Start EtherCAT Packet Monitor instruction was executed again while the EtherCAT packet monitoring function was already in operation.	Execute the Start EtherCAT Packet Monitor instruction after the packet monitoring function was stopped. You can check packet monitoring function operation status to see if the packet monitoring function is stopped.		Execute the Start EtherCAT Packet Monitor instruction after the packet monitoring function is stopped. You can check packet monitoring function operation status to see if the packet monitoring function is stopped.	
Attached information	<p>Attached Information 1: Error Location</p> <p>Attached Information 2: Error Location Details (Rung Number). For a program section, the rung number from the start of the section is given. For ST, the line number is given.</p> <p>Attached Information 3: Names of the Instruction and Instruction Instance Where the Error Occurred. If there is more than one possible instruction, information is given on all of them. Nothing is given if the instruction cannot be identified.</p> <p>Attached Information 4: Expansion Error Code (<i>ErrorIDEx</i>)</p>				
Precautions/Remarks	If a program is changed after an error occurs, the attached information that is displayed may not be correct.				

Event name	Communications Resource Overflow		Event code	54011808 hex	
Meaning	More than 32 EtherCAT communications instructions were executed at the same time.				
Source	PLC Function Module		Source details	Instruction	Detection timing At instruction execution
Error attributes	Level	Observation	Recovery	---	Log category System
Effects	User program	Continues.	Operation	The relevant instruction will end according to specifications.	
System-defined variables	Variable	Data type		Name	
	None	---		---	
Cause and correction	Assumed cause		Correction		Prevention
	<p>More than 32 EtherCAT communications instructions were executed at the same time. The EtherCAT communications instructions are listed below.</p> <ul style="list-style-type: none"> • EC_CoESDOWrite instruction • EC_CoESDORRead instruction • EC_ConnectSlave instruction • EC_DisconnectSlave instruction • EC_ChangeEnableSetting Instruction • EC_StartMon instruction • EC_SaveMon instruction • EC_StopMon instruction • EC_CopyMon instruction 		Correct the user program so that no more than 32 EtherCAT communications instructions are executed at the same time.		Write the user program so that no more than 32 EtherCAT communications instructions are executed at the same time.
Attached information	<p>Attached Information 1: Error Location</p> <p>Attached Information 2: Error Location Details (Rung Number). For a program section, the rung number from the start of the section is given. For ST, the line number is given.</p> <p>Attached Information 3: Names of the Instruction and Instruction Instance Where the Error Occurred. If there is more than one possible instruction, information is given on all of them. Nothing is given if the instruction cannot be identified.</p> <p>Attached Information 4: Expansion Error Code (<i>ErrorIDEx</i>)</p>				
Precautions/Remarks	If a program is changed after an error occurs, the attached information that is displayed may not be correct.				

Event name	Packet Monitoring Function Not Supported			Event code	54011809 hex	
Meaning	Packets cannot be monitored.					
Source	PLC Function Module		Source details	Instruction	Detection timing	At instruction execution
Error attributes	Level	Observation	Recovery	---	Log category	System
Effects	User program	Continues.	Operation	The relevant instruction will end according to specifications.		
System-defined variables	Variable	Data type		Name		
	None	---		---		
Cause and correction	Assumed cause	Correction		Prevention		
	An instruction for packet monitoring was executed for a CPU Unit that does not support packet monitoring.	Do not execute the EC_StartMon, EC_SaveMon, EC_StopMon, or EC_CopyMon instruction. If packet monitoring is required, use a CPU Unit that supports packet monitoring.		Do not execute instructions for packet monitoring for a CPU Unit that does not support packet monitoring.		
Attached information	<p>Attached Information 1: Error Location</p> <p>Attached Information 2: Error Location Details (Rung Number). For a program section, the rung number from the start of the section is given. For ST, the line number is given.</p> <p>Attached Information 3: Names of the Instruction and Instruction Instance Where the Error Occurred. If there is more than one possible instruction, information is given on all of them. Nothing is given if the instruction cannot be identified.</p> <p>Attached Information 4: Expansion Error Code (<i>ErrorIDEx</i>)</p>					
Precautions/Remarks	If a program is changed after an error occurs, the attached information that is displayed may not be correct.					

Event name	Explicit Message Error			Event code	54011C00 hex	
Meaning	An error response code was returned for an explicit message that was sent with a CIP communications instruction.					
Source	PLC Function Module		Source details	Instruction	Detection timing	At instruction execution
Error attributes	Level	Observation	Recovery	---	Log category	System
Effects	User program	Continues.	Operation	The relevant instruction will end according to specifications.		
System-defined variables	Variable	Data type		Name		
	None	---		---		
Cause and correction	Assumed cause	Correction		Prevention		
	Depends on the nature of the error.	Check the value of the <i>ErrorIDEx</i> output variable from the instruction and refer to the description in this manual of the CIP message error code.		Depends on the nature of the error. Refer to the description in this manual of the CIP message error code.		
Attached information	<p>Attached Information 1: Error Location</p> <p>Attached Information 2: Error Location Details (Rung Number). For a program section, the rung number from the start of the section is given. For ST, the line number is given.</p> <p>Attached Information 3: Names of the Instruction and Instruction Instance Where the Error Occurred. If there is more than one possible instruction, information is given on all of them. Nothing is given if the instruction cannot be identified.</p> <p>Attached Information 4: Expansion Error Code (<i>ErrorIDEx</i>)</p>					
Precautions/Remarks	If a program is changed after an error occurs, the attached information that is displayed may not be correct.					

Event name	Incorrect Route Path			Event code	54011C01 hex	
Meaning	The format of the route path that is specified for a CIP communications instruction is not correct.					
Source	PLC Function Module		Source details	Instruction	Detection timing	At instruction execution
Error attributes	Level	Observation	Recovery	---	Log category	System
Effects	User program	Continues.	Operation	The relevant instruction will end according to specifications.		
System-defined variables	Variable	Data type		Name		
	None	---		---		
Cause and correction	Assumed cause		Correction		Prevention	
	The format of the route path that is specified for a CIP communications instruction is not correct.		Correct the route path that is specified by the instruction.		Make sure that the instructions specify correct route paths.	
	Address resolution failed for the host name that was specified in a CIP communications instruction.		Refer to the corrections for the following event: Address Resolution Failed (54012002 hex).		Refer to the preventive information for the following event: Address Resolution Failed (54012002 hex).	
Attached information	<p>Attached Information 1: Error Location</p> <p>Attached Information 2: Error Location Details (Rung Number). For a program section, the rung number from the start of the section is given. For ST, the line number is given.</p> <p>Attached Information 3: Names of the Instruction and Instruction Instance Where the Error Occurred. If there is more than one possible instruction, information is given on all of them. Nothing is given if the instruction cannot be identified.</p> <p>Attached Information 4: Expansion Error Code (<i>ErrorIDEx</i>)</p>					
Precautions/Remarks	If a program is changed after an error occurs, the attached information that is displayed may not be correct.					

Event name	CIP Handle Out of Range			Event code	54011C02 hex	
Meaning	The handle that is specified for the CIP communications instruction is not correct.					
Source	PLC Function Module		Source details	Instruction	Detection timing	At instruction execution
Error attributes	Level	Observation	Recovery	---	Log category	System
Effects	User program	Continues.	Operation	The relevant instruction will end according to specifications.		
System-defined variables	Variable	Data type		Name		
	None	---		---		
Cause and correction	Assumed cause		Correction		Prevention	
	The handle that is specified for the CIP communications instruction is not correct.		Correct the handle for the instruction to the handle that was obtained with the CIPOpen instruction.		Specify handles that were obtained with the CIPOpen instruction.	
Attached information	<p>Attached Information 1: Error Location</p> <p>Attached Information 2: Error Location Details (Rung Number). For a program section, the rung number from the start of the section is given. For ST, the line number is given.</p> <p>Attached Information 3: Names of the Instruction and Instruction Instance Where the Error Occurred. If there is more than one possible instruction, information is given on all of them. Nothing is given if the instruction cannot be identified.</p> <p>Attached Information 4: Expansion Error Code (<i>ErrorIDEx</i>)</p>					
Precautions/Remarks	If a program is changed after an error occurs, the attached information that is displayed may not be correct.					

Event name	CIP Communications Resource Overflow		Event code	54011C03 hex	
Meaning	The maximum resources that you can use for CIP communications instructions at the same time was exceeded.				
Source	PLC Function Module		Source details	Instruction	Detection timing At instruction execution
Error attributes	Level	Observation	Recovery	---	Log category System
Effects	User program	Continues.	Operation	The relevant instruction will end according to specifications.	
System-defined variables	Variable	Data type		Name	
	None	---		---	
Cause and correction	Assumed cause	Correction		Prevention	
	More than 32 CIP communications instructions were executed at the same time.	Correct the user program so that no more than 32 CIP communications instructions are executed at the same time.		Write the user program so that no more than 32 CIP communications instructions are executed at the same time.	
	An attempt was made to use more than 32 handles at the same time.	Correct the user program so that no more than 32 handles are used at the same time.		Write the user program so that no more than 32 handles are used at the same time.	
Attached information	<p>Attached Information 1: Error Location</p> <p>Attached Information 2: Error Location Details (Rung Number). For a program section, the rung number from the start of the section is given. For ST, the line number is given.</p> <p>Attached Information 3: Names of the Instruction and Instruction Instance Where the Error Occurred. If there is more than one possible instruction, information is given on all of them. Nothing is given if the instruction cannot be identified.</p> <p>Attached Information 4: Expansion Error Code (<i>ErrorIDEx</i>)</p>				
Precautions/Remarks	If a program is changed after an error occurs, the attached information that is displayed may not be correct.				

Event name	CIP Timeout		Event code	54011C04 hex	
Meaning	A CIP timeout occurred during execution of a CIP communications instruction.				
Source	PLC Function Module		Source details	Instruction	Detection timing At instruction execution
Error attributes	Level	Observation	Recovery	---	Log category System
Effects	User program	Continues.	Operation	The relevant instruction will end according to specifications.	
System-defined variables	Variable	Data type		Name	
	None	---		---	
Cause and correction	Assumed cause		Correction		Prevention
	A device does not exist for the specified IP address.		Correct the specified IP address to the IP address of the remote device.		Specify the correct IP address of the remote device.
	The CIP connection for the specified handle timed out and was closed.		Execute the instruction before the connection times out. Or, increase the timeout time of the connection.		Execute the instruction before the connection times out.
	Power to the remote device is OFF.		Check the status of the remote device and start it normally.		Check the status of the remote device and start it normally.
	Communications are stopped at the remote device.				
	The Ethernet cable connector for EtherNet/IP is disconnected.		Reconnect the connector and make sure it is mated correctly.		Connect the connector securely.
	The Ethernet cable for EtherNet/IP is disconnected.		Replace the Ethernet cable.		None
	Noise		Implement noise countermeasures if there is excessive noise.		Implement noise countermeasures if there is excessive noise.
Attached information	<p>Attached Information 1: Error Location</p> <p>Attached Information 2: Error Location Details (Rung Number). For a program section, the rung number from the start of the section is given. For ST, the line number is given.</p> <p>Attached Information 3: Names of the Instruction and Instruction Instance Where the Error Occurred. If there is more than one possible instruction, information is given on all of them. Nothing is given if the instruction cannot be identified.</p> <p>Attached Information 4: Expansion Error Code (<i>ErrorIDEx</i>)</p>				
Precautions/Remarks	If a program is changed after an error occurs, the attached information that is displayed may not be correct.				

Event name	Class-3 Connection Not Established		Event code	54011C05 hex	
Meaning	Establishing a class-3 connection failed for a CIP communications instruction.				
Source	PLC Function Module		Source details	Instruction	Detection timing At instruction execution
Error attributes	Level	Observation	Recovery	---	Log category System
Effects	User program	Continues.	Operation	The relevant instruction will end according to specifications.	
System-defined variables	Variable	Data type		Name	
	None	---		---	
Cause and correction	Assumed cause	Correction		Prevention	
	The CIPOpen instruction was executed for a device that does not support class 3 (Large_Forward_Open).	Correct the program to use the CIPOpenWithDataSize instruction for the device that does not support class 3 (Large_Forward_Open) and set the data size to less than 510 bytes.		Write the program to use the CIPOpenWithDataSize instruction for any device that does not support class 3 (Large_Forward_Open) and set the data size to less than 510 bytes.	
	The CIPOpenWithDataSize instruction was executed with a specified data size of 510 bytes or larger for a device that does not support class 3 (Large_Forward_Open).	Correct the program to set the data size to less than 510 bytes in the CIPOpenWithDataSize instruction for the device that does not support class 3 (Large_Forward_Open).		Write the program to set the data size to less than 510 bytes in the CIPOpenWithDataSize instruction for any device that does not support class 3 (Large_Forward_Open).	
Attached information	<p>Attached Information 1: Error Location</p> <p>Attached Information 2: Error Location Details (Rung Number). For a program section, the rung number from the start of the section is given. For ST, the line number is given.</p> <p>Attached Information 3: Names of the Instruction and Instruction Instance Where the Error Occurred. If there is more than one possible instruction, information is given on all of them. Nothing is given if the instruction cannot be identified.</p> <p>Attached Information 4: Expansion Error Code (<i>ErrorIDEx</i>)</p>				
Precautions/Remarks	If a program is changed after an error occurs, the attached information that is displayed may not be correct.				

Event name	CIP Communications Data Size Exceeded		Event code	54011C06 hex	
Meaning	An attempt was made to send a class-3 explicit message with a data size that is larger than the sendable size with a CIP communications instruction.				
Source	PLC Function Module		Source details	Instruction	Detection timing At instruction execution
Error attributes	Level	Observation	Recovery	---	Log category System
Effects	User program	Continues.	Operation	The relevant instruction will end according to specifications.	
System-defined variables	Variable	Data type		Name	
	None	---		---	
Cause and correction	Assumed cause		Correction		Prevention
	The data size that was specified for the input variable to the CIP-Read, CIPWrite, or CIPSend instruction exceeded the data size that was specified with the CIPOpenWithDataSize instruction.		Correct the program so that the data size of the relevant instruction does not exceed the data size that was set with the CIPOpenWithDataSize instruction. Or, set the data size of the CIPOpenWithDataSize instruction to the data size of the relevant instruction or larger to establish a connection.		Write the program so that the data size of the relevant instruction does not exceed the data size that was set with the CIPOpenWithDataSize instruction. Or, set the data size of the CIPOpenWithDataSize instruction to the data size of the relevant instruction or larger to establish a connection.
Attached information	Attached Information 1: Error Location Attached Information 2: Error Location Details (Rung Number). For a program section, the rung number from the start of the section is given. For ST, the line number is given. Attached Information 3: Names of the Instruction and Instruction Instance Where the Error Occurred. If there is more than one possible instruction, information is given on all of them. Nothing is given if the instruction cannot be identified. Attached Information 4: Expansion Error Code (<i>ErrorIDEx</i>)				
Precautions/Remarks	If a program is changed after an error occurs, the attached information that is displayed may not be correct.				

Event name	Local IP Address Setting Error		Event code	54012000 hex	
Meaning	An instruction was executed when there was a setting error in the local IP address.				
Source	PLC Function Module		Source details	Instruction	Detection timing At instruction execution
Error attributes	Level	Observation	Recovery	---	Log category System
Effects	User program	Continues.	Operation	The relevant instruction will end according to specifications.	
System-defined variables	Variable	Data type		Name	
	None	---		---	
Cause and correction	Assumed cause		Correction		Prevention
	An instruction was executed when there was a setting error in the local IP address.		There was a TCP/IP Basic Setting Error (IP Address Setting Error) when the instruction was executed. Remove the cause of the TCP/IP Basic Setting Error.		Set the IP addresses correctly so that a TCP/IP Basic Setting Error does not occur.
Attached information	Attached Information 1: Error Location Attached Information 2: Error Location Details (Rung Number). For a program section, the rung number from the start of the section is given. For ST, the line number is given. Attached Information 3: Names of the Instruction and Instruction Instance Where the Error Occurred. If there is more than one possible instruction, information is given on all of them. Nothing is given if the instruction cannot be identified. Attached Information 4: Expansion Error Code (<i>ErrorIDEx</i>)				
Precautions/Remarks	If a program is changed after an error occurs, the attached information that is displayed may not be correct.				

Event name	TCP/UDP Port Already in Use		Event code	54012001 hex		
Meaning	The UDP or TCP port was already in use when the instruction was executed.					
Source	PLC Function Module		Source details	Instruction	Detection timing	At instruction execution
Error attributes	Level	Observation	Recovery	---	Log category	System
Effects	User program	Continues.	Operation	The relevant instruction will end according to specifications.		
System-defined variables	Variable	Data type		Name		
	None	---		---		
Cause and correction	Assumed cause		Correction		Prevention	
	The UDP or TCP port is already in use.		Correct the user program so that an unused port is specified for the instruction.		Write the user program so that used ports are not specified for instructions.	
Attached information	<p>Attached Information 1: Error Location</p> <p>Attached Information 2: Error Location Details (Rung Number). For a program section, the rung number from the start of the section is given. For ST, the line number is given.</p> <p>Attached Information 3: Names of the Instruction and Instruction Instance Where the Error Occurred. If there is more than one possible instruction, information is given on all of them. Nothing is given if the instruction cannot be identified.</p> <p>Attached Information 4: Expansion Error Code (<i>ErrorIDEx</i>)</p>					
Precautions/Remarks	If a program is changed after an error occurs, the attached information that is displayed may not be correct.					

Event name	Address Resolution Failed		Event code	54012002 hex		
Meaning	Address resolution failed for a remote node with the host name that was specified in the instruction.					
Source	PLC Function Module		Source details	Instruction	Detection timing	At instruction execution
Error attributes	Level	Observation	Recovery	---	Log category	System
Effects	User program	Continues.	Operation	The relevant instruction will end according to specifications.		
System-defined variables	Variable	Data type		Name		
	None	---		---		
Cause and correction	Assumed cause		Correction		Prevention	
	The host name specified for the instruction is not correct.		Correct the domain name that is specified in the instruction.		Specify correct domain names in instructions.	
	The hosts and DNS settings in the Controller are incorrect.		Correct the hosts and DNS settings in the Controller.		Check the hosts and DNS settings in the Controller and make sure they are correct.	
	The DNS server settings are incorrect.		Correct the DNS server settings.		Check that there are no mistakes in the DNS server settings.	
Attached information	<p>Attached Information 1: Error Location</p> <p>Attached Information 2: Error Location Details (Rung Number). For a program section, the rung number from the start of the section is given. For ST, the line number is given.</p> <p>Attached Information 3: Names of the Instruction and Instruction Instance Where the Error Occurred. If there is more than one possible instruction, information is given on all of them. Nothing is given if the instruction cannot be identified.</p> <p>Attached Information 4: Expansion Error Code (<i>ErrorIDEx</i>)</p>					
Precautions/Remarks	If a program is changed after an error occurs, the attached information that is displayed may not be correct.					

Event name	Socket Status Error		Event code	54012003 hex	
Meaning	The status was not suitable for execution of the socket service instruction.				
Source	PLC Function Module		Source details	Instruction	Detection timing At instruction execution
Error attributes	Level	Observation	Recovery	---	Log category System
Effects	User program	Continues.	Operation	The relevant instruction will end according to specifications.	
System-defined variables	Variable	Data type		Name	
	None	---		---	

Cause and correction	Assumed cause	Correction	Prevention
	<ul style="list-style-type: none"> • SktUDPCreate Instruction The UDP port specified with the <i>SrcUdpPort</i> input variable is in one of the following states. • It is already open. • It is being closed. • SktUDPRcv Instruction • The specified socket is receiving data. • The specified socket is closed. • SktUDPSend Instruction • The specified socket is sending data. • The specified socket is closed. • SktTCPAccept Instruction The specified TCP port is in one of the following states. • The port is being opened. • The port is being closed. • A connection is already established for this instruction for the same IP address and TCP port. • SktTCPConnect Instruction • The TCP port that is specified with the <i>SrcTcpPort</i> input variable is already open. • The remote node that is specified with <i>DstAdr</i> input variable does not exist. • The remote node that is specified with <i>DstAdr</i> and <i>DstTcpPort</i> input variables is not waiting for a connection. • SktTCPRcv Instruction • The specified socket is receiving data. • The specified socket is closed. • SktTCPSend Instruction • The specified socket is sending data. • The specified socket is closed. • The send buffer of the specified socket is full (because the power to the remote node is OFF, the line is disconnected, etc.) • SktSetOption Instruction • The specified socket already started transmission. • An option type which is not supported by the specified socket was selected. 	<p>Remove the cause of the error for the instruction.</p>	<p>Do not execute the instruction when it will cause an error.</p>

Attached information	Attached Information 1: Error Location Attached Information 2: Error Location Details (Rung Number). For a program section, the rung number from the start of the section is given. For ST, the line number is given. Attached Information 3: Names of the Instruction and Instruction Instance Where the Error Occurred. If there is more than one possible instruction, information is given on all of them. Nothing is given if the instruction cannot be identified. Attached Information 4: Expansion Error Code (<i>ErrorIDEx</i>)
Precautions/Remarks	If a program is changed after an error occurs, the attached information that is displayed may not be correct.

Event name	Local IP Address Not Set		Event code	54012004 hex	
Meaning	The local IP address was not set when a socket service instruction was executed.				
Source	PLC Function Module		Source details	Instruction	Detection timing At instruction execution
Error attributes	Level	Observation	Recovery	---	Log category System
Effects	User program	Continues.	Operation	The relevant instruction will end according to specifications.	
System-defined variables	Variable	Data type		Name	
	None	---		---	
Cause and correction	Assumed cause		Correction		Prevention
	There is a BOOTP server setting error.		Correct any errors in the BOOTP server settings.		Check that there are no mistakes in the BOOTP server settings.
	The BOOTP server does not exist.		Make sure that the BOOTP server has started normally and is normally connected to the network.		Make sure that the BOOTP server has started normally and is normally connected to the network.
	The local IP address is not set because operation just started.		Wait until the local IP address is set before executing socket service instructions.		Wait until the local IP address is set before executing socket service instructions.
Attached information	Attached Information 1: Error Location Attached Information 2: Error Location Details (Rung Number). For a program section, the rung number from the start of the section is given. For ST, the line number is given. Attached Information 3: Names of the Instruction and Instruction Instance Where the Error Occurred. If there is more than one possible instruction, information is given on all of them. Nothing is given if the instruction cannot be identified. Attached Information 4: Expansion Error Code (<i>ErrorIDEx</i>)				
Precautions/Remarks	If a program is changed after an error occurs, the attached information that is displayed may not be correct.				

Event name	Socket Timeout		Event code	54012006 hex	
Meaning	A timeout occurred for a socket service instruction.				
Source	PLC Function Module		Source details	Instruction	Detection timing At instruction execution
Error attributes	Level	Observation	Recovery	---	Log category System
Effects	User program	Continues.	Operation	The relevant instruction will end according to specifications.	
System-defined variables	Variable	Data type		Name	
	None	---		---	
Cause and correction	Assumed cause		Correction		Prevention
	SktTCPAccept instruction: There was no request for a connection from the remote node during the user-set timeout time.		Correct the system and user program so that there is a connection request from the remote node within the timeout time after the instruction is executed. Or, increase the timeout time.		Set up the system and user program so that there is a connection request from the remote node within the timeout time after the instruction is executed.
	SktTCPRecv or SktUDPRcv instruction: Data was not received from the remote node during the user-set timeout time.		Correct the system and user program so that data is received from the remote node within the timeout time after the instruction is executed. Or, increase the timeout time.		Set up the system and user program so that data is received from the remote node within the timeout time after the instruction is executed.
Attached information	<p>Attached Information 1: Error Location</p> <p>Attached Information 2: Error Location Details (Rung Number). For a program section, the rung number from the start of the section is given. For ST, the line number is given.</p> <p>Attached Information 3: Names of the Instruction and Instruction Instance Where the Error Occurred. If there is more than one possible instruction, information is given on all of them. Nothing is given if the instruction cannot be identified.</p> <p>Attached Information 4: Expansion Error Code (<i>ErrorIDEx</i>)</p>				
Precautions/Remarks	If a program is changed after an error occurs, the attached information that is displayed may not be correct.				

Event name	Socket Handle Out of Range		Event code	54012007 hex	
Meaning	The handle that is specified for the socket service instruction is not correct.				
Source	PLC Function Module		Source details	Instruction	Detection timing At instruction execution
Error attributes	Level	Observation	Recovery	---	Log category System
Effects	User program	Continues.	Operation	The relevant instruction will end according to specifications.	
System-defined variables	Variable	Data type		Name	
	None	---		---	
Cause and correction	Assumed cause		Correction		Prevention
	The handle that is specified for the socket service instruction is not correct.		Correct the socket handle for the instruction to the handle that was obtained with one of the following instructions. <ul style="list-style-type: none"> • SktUDPCreate instruction • SktTCPConnect instruction • SktTCPAccept instruction 		Specify handles that are obtained with the following instructions. <ul style="list-style-type: none"> • SktUDPCreate instruction • SktTCPConnect instruction • SktTCPAccept instruction
Attached information	Attached Information 1: Error Location Attached Information 2: Error Location Details (Rung Number). For a program section, the rung number from the start of the section is given. For ST, the line number is given. Attached Information 3: Names of the Instruction and Instruction Instance Where the Error Occurred. If there is more than one possible instruction, information is given on all of them. Nothing is given if the instruction cannot be identified. Attached Information 4: Expansion Error Code (<i>ErrorIDEx</i>)				
Precautions/Remarks	If a program is changed after an error occurs, the attached information that is displayed may not be correct.				

Event name	Socket Communications Resource Overflow		Event code	54012008 hex	
Meaning	The maximum resources that you can use for socket service instructions at the same time was exceeded.				
Source	PLC Function Module		Source details	Instruction	Detection timing At instruction execution
Error attributes	Level	Observation	Recovery	---	Log category System
Effects	User program	Continues.	Operation	The relevant instruction will end according to specifications.	
System-defined variables	Variable	Data type		Name	
	None	---		---	
Cause and correction	Assumed cause		Correction		Prevention
	More than 32 socket service instructions were executed at the same time (64 for NX102).		Correct the user program so that no more than 32 socket service instructions are executed at the same time (64 for NX102).		Create a user program so that no more than 32 socket service instructions are executed at the same time (64 for NX102).
	More than 30 socket handles were used at the same time (60 for NX102, 16 for CPU Units with unit version 1.02 or earlier).		Correct the user program so that no more than 30 socket handles are used at the same time (60 for NX102, 16 for CPU Units with unit version 1.02 or earlier).		Create a user program so that no more than 30 socket handles are used at the same time (60 for NX102, 16 for CPU Units with unit version 1.02 or earlier).
Attached information	<p>Attached Information 1: Error Location</p> <p>Attached Information 2: Error Location Details (Rung Number). For a program section, the rung number from the start of the section is given. For ST, the line number is given.</p> <p>Attached Information 3: Names of the Instruction and Instruction Instance Where the Error Occurred. If there is more than one possible instruction, information is given on all of them. Nothing is given if the instruction cannot be identified.</p> <p>Attached Information 4: Expansion Error Code (<i>ErrorIDEx</i>)</p>				
Precautions/Remarks	If a program is changed after an error occurs, the attached information that is displayed may not be correct.				

Event name	No Execution Right		Event code	54012400 hex	
Meaning	An instruction was executed to change the settings of the EtherNet/IP port when execution was not possible.				
Source	PLC Function Module		Source details	Instruction	Detection timing At instruction execution
Error attributes	Level	Observation	Recovery	---	Log category System
Effects	User program	Continues.	Operation	Not affected.	
System-defined variables	Variable	Data type		Name	
	None	---		---	
Cause and correction	Assumed cause		Correction		Prevention
	An instruction to change the settings of the built-in EtherNet/IP port or a CJ-series EtherNet/IP Unit was executed when restart processing was in progress for the built-in EtherNet/IP port.		Execute the instruction to change the settings after restart processing or setting changes for the built-in EtherNet/IP port or CJ-series EtherNet/IP Unit are completed.		Execute the instruction to change the settings when restart processing or setting changes are not in progress for the built-in EtherNet/IP port or CJ-series EtherNet/IP Unit.
	An instruction to change the settings of a CJ-series EtherNet/IP Unit was executed when restart processing was in progress for the Unit.				
	An instruction to change the settings of the built-in EtherNet/IP port or a CJ-series EtherNet/IP Unit was executed when changing settings was in progress for an instruction or CIP message for the built-in EtherNet/IP port.				
	An instruction to change the settings of a CJ-series EtherNet/IP Unit was executed when changing settings was in progress for an instruction or CIP message for the Unit.				
	The unit number that was specified for the instruction is not for a built-in EtherNet/IP port or a CJ-series EtherNet/IP Unit.		Specify the unit number of a built-in EtherNet/IP port or CJ-series EtherNet/IP Unit for the instruction. If the Unit configuration is not correct, correct the Unit configuration.		Specify the unit number of a built-in EtherNet/IP port or CJ-series EtherNet/IP Unit for the instruction.
Attached information	<p>Attached Information 1: Error Location</p> <p>Attached Information 2: Error Location Details (Rung Number). For a program section, the rung number from the start of the section is given. For ST, the line number is given.</p> <p>Attached Information 3: Names of the Instruction and Instruction Instance Where the Error Occurred. If there is more than one possible instruction, information is given on all of them. Nothing is given if the instruction cannot be identified.</p> <p>Attached Information 4: Expansion Error Code (<i>ErrorIDEx</i>)</p>				
Precautions/Remarks	If a program is changed after an error occurs, the attached information that is displayed may not be correct.				

Event name	Settings Update Failed		Event code	54012401 hex	
Meaning	It was not possible to update the settings of the CJ-series EtherNet/IP Unit that were changed.				
Source	PLC Function Module		Source details	Instruction	Detection timing At instruction execution
Error attributes	Level	Observation	Recovery	---	Log category System
Effects	User program	Continues.	Operation	Not affected.	
System-defined variables	Variable	Data type		Name	
	None	---		---	
Cause and correction	Assumed cause	Correction		Prevention	
	Restart processing for a Unit or built-in EtherNet/IP port was started during execution of an instruction to change the settings of a CJ-series EtherNet/IP Unit.	Execute the instruction again to change the settings after restart processing for the built-in EtherNet/IP port or CJ-series EtherNet/IP Unit is completed.		Do not start restart processing for a Unit or built-in EtherNet/IP port during execution of an instruction to change the settings of a CJ-series EtherNet/IP Unit.	
Attached information	<p>Attached Information 1: Error Location</p> <p>Attached Information 2: Error Location Details (Rung Number). For a program section, the rung number from the start of the section is given. For ST, the line number is given.</p> <p>Attached Information 3: Names of the Instruction and Instruction Instance Where the Error Occurred. If there is more than one possible instruction, information is given on all of them. Nothing is given if the instruction cannot be identified.</p> <p>Attached Information 4: Expansion Error Code (<i>ErrorIDEx</i>)</p>				
Precautions/Remarks	If a program is changed after an error occurs, the attached information that is displayed may not be correct.				

Event name	Too Many Simultaneous Instruction Executions		Event code	54012402 hex	
Meaning	Too many instructions to change the communications setup of the Controller were executed at the same time.				
Source	PLC Function Module		Source details	Instruction	Detection timing At instruction execution
Error attributes	Level	Observation	Recovery	---	Log category System
Effects	User program	Continues.	Operation	Not affected.	
System-defined variables	Variable	Data type		Name	
	None	---		---	
Cause and correction	Assumed cause	Correction		Prevention	
	Two or more instructions to change the communications setup of the Controller were executed at the same time.	Correct the user program so that only one instruction to change the communications setup of the Controller is executed at the same time.		Write the user program so that only one instruction to change the communications setup of the Controller is executed at the same time.	
Attached information	<p>Attached Information 1: Error Location</p> <p>Attached Information 2: Error Location Details (Rung Number). For a program section, the rung number from the start of the section is given. For ST, the line number is given.</p> <p>Attached Information 3: Names of the Instruction and Instruction Instance Where the Error Occurred. If there is more than one possible instruction, information is given on all of them. Nothing is given if the instruction cannot be identified.</p> <p>Attached Information 4: Expansion Error Code (<i>ErrorIDEx</i>)</p>				
Precautions/Remarks	If a program is changed after an error occurs, the attached information that is displayed may not be correct.				

Event name	FTP Client Execution Limit Exceeded		Event code	54012403 hex	
Meaning	Too many FTP client communications instructions were executed at the same time.				
Source	PLC Function Module		Source details	Instruction	Detection timing At instruction execution
Error attributes	Level	Observation	Recovery	---	Log category System
Effects	User program	Continues.	Operation	Not affected.	
System-defined variables	Variable	Data type		Name	
	None	---		---	
Cause and correction	Assumed cause		Correction		Prevention
	Four or more FTP client communications instructions were executed at the same time.		Correct the user program so that no more than three FTP client communications instructions are executed at the same time.		Write the user program so that no more than three FTP client communications instructions are executed at the same time.
Attached information	<p>Attached Information 1: Error Location</p> <p>Attached Information 2: Error Location Details (Rung Number). For a program section, the rung number from the start of the section is given. For ST, the line number is given.</p> <p>Attached Information 3: Names of the Instruction and Instruction Instance Where the Error Occurred. If there is more than one possible instruction, information is given on all of them. Nothing is given if the instruction cannot be identified.</p> <p>Attached Information 4: Expansion Error Code (<i>ErrorIDEx</i>)</p>				
Precautions/Remarks	If a program is changed after an error occurs, the attached information that is displayed may not be correct.				

Event name	File Number Limit Exceeded		Event code	54012404 hex	
Meaning	The number of files specified with a wildcard for an FTP client communications instruction exceeded 1,000.				
Source	PLC Function Module		Source details	Instruction	Detection timing At instruction execution
Error attributes	Level	Observation	Recovery	---	Log category System
Effects	User program	Continues.	Operation	Not affected.	
System-defined variables	Variable	Data type		Name	
	None	---		---	
Cause and correction	Assumed cause		Correction		Prevention
	The number of files specified with a file name that contained a wildcard for an FTP client communications instruction exceeded 1,000.		Correct the program so that the number of files specified with a wildcard for an FTP client communications instruction does not exceed 1,000.		Write the program so that the number of files specified with a wildcard for an FTP client communications instruction does not exceed 1,000.
Attached information	<p>Attached Information 1: Error Location</p> <p>Attached Information 2: Error Location Details (Rung Number). For a program section, the rung number from the start of the section is given. For ST, the line number is given.</p> <p>Attached Information 3: Names of the Instruction and Instruction Instance Where the Error Occurred. If there is more than one possible instruction, information is given on all of them. Nothing is given if the instruction cannot be identified.</p> <p>Attached Information 4: Expansion Error Code (<i>ErrorIDEx</i>)</p>				
Precautions/Remarks	If a program is changed after an error occurs, the attached information that is displayed may not be correct.				

3 Error Descriptions and Corrections

Event name	Directory Does Not Exist (FTP)		Event code	54012405 hex	
Meaning	The directory specified for an FTP client communications instruction does not exist in the Controller or an incorrect path was specified.				
Source	PLC Function Module		Source details	Instruction	Detection timing At instruction execution
Error attributes	Level	Observation	Recovery	---	Log category System
Effects	User program	Continues.	Operation	Not affected.	
System-defined variables	Variable	Data type		Name	
	None	---		---	
Cause and correction	Assumed cause		Correction		Prevention
	The directory specified for an FTP client communications instruction does not exist in the Controller or an incorrect path was specified.		Correct the program so that the directory specified for the FTP client communications instruction exists in the SD Memory Card.		Write the program so that the directory specified for the FTP client communications instruction exists in the SD Memory Card.
Attached information	Attached Information 1: Error Location Attached Information 2: Error Location Details (Rung Number). For a program section, the rung number from the start of the section is given. For ST, the line number is given. Attached Information 3: Names of the Instruction and Instruction Instance Where the Error Occurred. If there is more than one possible instruction, information is given on all of them. Nothing is given if the instruction cannot be identified. Attached Information 4: Expansion Error Code (<i>ErrorIDEx</i>)				
Precautions/Remarks	If a program is changed after an error occurs, the attached information that is displayed may not be correct.				

Event name	FTP Server Connection Error		Event code	54012406 hex	
Meaning	The destination FTP server that was specified for an FTP client communications instruction does not exist on the network or the specified FTP server is not operating.				
Source	PLC Function Module		Source details	Instruction	Detection timing At instruction execution
Error attributes	Level	Observation	Recovery	---	Log category System
Effects	User program	Continues.	Operation	Not affected.	
System-defined variables	Variable	Data type		Name	
	None	---		---	
Cause and correction	Assumed cause		Correction		Prevention
	The destination FTP server that was specified for an FTP client communications instruction does not exist on the network.		Correct the program so that the FTP server specified for the FTP client communications instruction exists on the network.		Write the program so that the FTP server specified for the FTP client communications instruction exists on the network.
	The destination FTP server that was specified for an FTP client communications instruction is not operating.		Start the FTP server that was specified as the destination FTP server and then execute the instruction again.		Confirm that the FTP server that is specified as the destination FTP server is operating before you execute the instruction.
Attached information	Attached Information 1: Error Location Attached Information 2: Error Location Details (Rung Number). For a program section, the rung number from the start of the section is given. For ST, the line number is given. Attached Information 3: Names of the Instruction and Instruction Instance Where the Error Occurred. If there is more than one possible instruction, information is given on all of them. Nothing is given if the instruction cannot be identified. Attached Information 4: Expansion Error Code (<i>ErrorIDEx</i>)				
Precautions/Remarks	If a program is changed after an error occurs, the attached information that is displayed may not be correct.				

Event name	Destination FTP Server Execution Failure		Event code	54012407 hex	
Meaning	The destination FTP server for an FTP client communications instruction returned an error.				
Source	PLC Function Module		Source details	Instruction	Detection timing At instruction execution
Error attributes	Level	Observation	Recovery	---	Log category System
Effects	User program	Continues.	Operation	Not affected.	
System-defined variables	Variable		Data type		Name
	None		---		---
Cause and correction	Assumed cause		Correction		Prevention
	The destination FTP server for the FTP client communications instruction failed to execute the requested processing.		Check the response code from the destination FTP server in the value of the <i>ErrorIDEx</i> output variable from the instruction and refer to the description in this manual for the expansion error code (<i>ErrorIDEx</i>) with the same value for the instruction.		Read the description of <i>ErrorIDEx</i> in advance for the instruction and program correctly.
Attached information	Attached Information 1: Error Location Attached Information 2: Error Location Details (Rung Number). For a program section, the rung number from the start of the section is given. For ST, the line number is given. Attached Information 3: Names of the Instruction and Instruction Instance Where the Error Occurred. If there is more than one possible instruction, information is given on all of them. Nothing is given if the instruction cannot be identified. Attached Information 4: Expansion Error Code (<i>ErrorIDEx</i>)				
Precautions/Remarks	If a program is changed after an error occurs, the attached information that is displayed may not be correct.				

Event name	SD Memory Card Access Failed for FTP		Event code	54012408 hex	
Meaning	SD Memory Card access from the FTP client failed.				
Source	PLC Function Module		Source details	Instruction	Detection timing At instruction execution
Error attributes	Level	Observation	Recovery	---	Log category System
Effects	User program	Continues.	Operation	Not affected.	
System-defined variables	Variable	Data type		Name	
	None	---		---	
Cause and correction	Assumed cause		Correction		Prevention
	An SD Memory Card is not inserted.		Insert an SD Memory Card and then execute the instruction again.		Insert an SD Memory Card.
	The SD Memory Card was removed during execution of the FTP client communications instruction.		Insert an SD Memory Card and then execute the instruction again.		Do not remove the SD Memory Card during execution of the FTP client communications instruction.
	The capacity of the SD Memory Card is insufficient.		Replace the SD Memory Card for one with sufficient available capacity.		Use an SD Memory Card with sufficient available capacity.
	The SD Memory Card is write protected.		Remove write protection from the SD Memory Card.		Make sure that the SD Memory Card is not write protected.
Attached information	<p>Attached Information 1: Error Location</p> <p>Attached Information 2: Error Location Details (Rung Number). For a program section, the rung number from the start of the section is given. For ST, the line number is given.</p> <p>Attached Information 3: Names of the Instruction and Instruction Instance Where the Error Occurred. If there is more than one possible instruction, information is given on all of them. Nothing is given if the instruction cannot be identified.</p> <p>Attached Information 4: Expansion Error Code (<i>ErrorIDEx</i>)</p>				
Precautions/Remarks	If a program is changed after an error occurs, the attached information that is displayed may not be correct.				

Event name	Specified File Does Not Exist		Event code	54012409 hex	
Meaning	A file specified for an FTP client communications instruction does not exist.				
Source	PLC Function Module		Source details	Instruction	Detection timing At instruction execution
Error attributes	Level	Observation	Recovery	---	Log category System
Effects	User program	Continues.	Operation	Not affected.	
System-defined variables	Variable	Data type		Name	
	None	---		---	
Cause and correction	Assumed cause		Correction		Prevention
	A file specified for an FTP client communications instruction does not exist.		Correct the program so that the file specified for the FTP client communications instruction exists.		Write the program so that the file specified for the FTP client communications instruction exists.
Attached information	<p>Attached Information 1: Error Location</p> <p>Attached Information 2: Error Location Details (Rung Number). For a program section, the rung number from the start of the section is given. For ST, the line number is given.</p> <p>Attached Information 3: Names of the Instruction and Instruction Instance Where the Error Occurred. If there is more than one possible instruction, information is given on all of them. Nothing is given if the instruction cannot be identified.</p> <p>Attached Information 4: Expansion Error Code (<i>ErrorIDEx</i>)</p>				
Precautions/Remarks	If a program is changed after an error occurs, the attached information that is displayed may not be correct.				

Event name	Specified File Is Write Protected		Event code	5401240A hex	
Meaning	The data was not transferred because the FTP client communications instruction was set to not overwrite files with the same name.				
Source	PLC Function Module		Source details	Instruction	Detection timing At instruction execution
Error attributes	Level	Observation	Recovery	---	Log category System
Effects	User program	Continues.	Operation	Not affected.	
System-defined variables	Variable	Data type		Name	
	None	---		---	
Cause and correction	Assumed cause		Correction		Prevention
	The data was not transferred because the FTP client communications instruction was set to not overwrite files with the same name and a file with the specified file name already existed at the destination.		Set the FTP client communications instruction to overwrite files with the same name and then execute the instruction again. Or, change the file name at the source or destination and then execute the instruction again.		Set the FTP client communications instruction to overwrite files with the same name. Or, make sure different file names are used at the source and destination.
Attached information	Attached Information 1: Error Location Attached Information 2: Error Location Details (Rung Number). For a program section, the rung number from the start of the section is given. For ST, the line number is given. Attached Information 3: Names of the Instruction and Instruction Instance Where the Error Occurred. If there is more than one possible instruction, information is given on all of them. Nothing is given if the instruction cannot be identified. Attached Information 4: Expansion Error Code (<i>ErrorIDEx</i>)				
Precautions/Remarks	If a program is changed after an error occurs, the attached information that is displayed may not be correct.				

Event name	Failed To Delete Specified File		Event code	5401240B hex	
Meaning	A file was not deleted after it was transferred with an FTP client communications instruction.				
Source	PLC Function Module		Source details	Instruction	Detection timing At instruction execution
Error attributes	Level	Observation	Recovery	---	Log category System
Effects	User program	Continues.	Operation	Not affected.	
System-defined variables	Variable	Data type		Name	
	None	---		---	
Cause and correction	Assumed cause	Correction		Prevention	
	The FTP client communications instruction was set to delete files after they are transferred, but it was not possible to delete the specified file because it had a read-only attribute.	Set the FTP client communications instruction to not delete files after they are transferred and then execute the instruction again. Or, change the attribute of the source file to enable writing it and then execute the instruction again.		Set the FTP client communications instruction to not delete files after they are transferred. Or do not set the attribute of source files to read-only.	
	It was not possible to delete the file specified for the FTP client communications instruction because it was in use by another application.	Execute the FTP client communications instruction when the specified file is not in use by another application.		Do not use the file specified for the FTP client communications instruction in another application.	
Attached information	<p>Attached Information 1: Error Location</p> <p>Attached Information 2: Error Location Details (Rung Number). For a program section, the rung number from the start of the section is given. For ST, the line number is given.</p> <p>Attached Information 3: Names of the Instruction and Instruction Instance Where the Error Occurred. If there is more than one possible instruction, information is given on all of them. Nothing is given if the instruction cannot be identified.</p> <p>Attached Information 4: Expansion Error Code (<i>ErrorIDEx</i>)</p>				
Precautions/Remarks	If a program is changed after an error occurs, the attached information that is displayed may not be correct.				

Event name	Specified File Access Failed		Event code	5401240C hex	
Meaning	An FTP transfer for an FTP client communications instruction failed because file access failed.				
Source	PLC Function Module		Source details	Instruction	Detection timing At instruction execution
Error attributes	Level	Observation	Recovery	---	Log category System
Effects	User program	Continues.	Operation	Not affected.	
System-defined variables	Variable	Data type		Name	
	None	---		---	
Cause and correction	Assumed cause		Correction		Prevention
	The file specified for the FTP client communications instruction was in use by another application.		Execute the FTP client communications instruction when the specified file is not in use by another application.		Do not use the file specified for the FTP client communications instruction in another application.
	The file or directory specified for the FTP client communications instruction to write is write protected.		Remove write protection from the file specified for the FTP client communications instruction to write. Or, change the filename of the file to write.		Do not write-protect the file specified for an FTP client communications instruction to write.
Attached information	<p>Attached Information 1: Error Location</p> <p>Attached Information 2: Error Location Details (Rung Number). For a program section, the rung number from the start of the section is given. For ST, the line number is given.</p> <p>Attached Information 3: Names of the Instruction and Instruction Instance Where the Error Occurred. If there is more than one possible instruction, information is given on all of them. Nothing is given if the instruction cannot be identified.</p> <p>Attached Information 4: Expansion Error Code (<i>ErrorIDEx</i>)</p>				
Precautions/Remarks	If a program is changed after an error occurs, the attached information that is displayed may not be correct.				

Event name	IP Address Setting Invalid		Event code	5401240D hex	
Meaning	Instruction execution was not possible because there is an error between the IP address setting of the port specified in the instruction and the other port settings.				
Source	PLC Function Module		Source details	Instruction	Detection timing At instruction execution
Error attributes	Level	Observation	Recovery	---	Log category System
Effects	User program	Continues.	Operation	Not affected.	
System-defined variables	Variable	Data type		Name	
	None	---		---	
Cause and correction	Assumed cause		Correction		Prevention
	The network address of the port specified in the instruction is the same as the network address of another port.		Correct the instruction so that it specifies a network address that is not the same as the network address of another port. Or, change the network address of the other port in advance.		When using instructions to change IP addresses, specify network addresses that are not the same as the network addresses of other ports.
Both the port specified in the instruction and all other ports are set as unused ports.		Correct the setting of the port specified in the instruction to anything but an unused port. Or, change the unused port setting of another port in advance.		When you use an instruction to change the IP address, make sure that the port specified in the instruction and the other ports are not all set to unused ports.	
Attached information	<p>Attached Information 1: Error Location</p> <p>Attached Information 2: Error Location Details (Rung Number). For a program section, the rung number from the start of the section is given. For ST, the line number is given.</p> <p>Attached Information 3: Names of the Instruction and Instruction Instance Where the Error Occurred. If there is more than one possible instruction, information is given on all of them. Nothing is given if the instruction cannot be identified.</p> <p>Attached Information 4: Expansion Error Code (<i>ErrorIDEx</i>)</p>				
Precautions/Remarks	If a program is changed after an error occurs, the attached information that is displayed may not be correct.				

Event name	NX Message Error		Event code	54012C00 hex	
Meaning	An error response code was returned for an NX message.				
Source	PLC Function Module		Source details	Instruction	Detection timing At instruction execution
Error attributes	Level	Observation	Recovery	---	Log category System
Effects	User program	Continues.	Operation	The relevant instruction will end according to specifications.	
System-defined variables	Variable	Data type		Name	
	None	---		---	
Cause and correction	Assumed cause		Correction		Prevention
	Depends on the nature of the error.		Check the value of the <i>ErrorIDEx</i> output variable from the instruction and refer to the description in this manual of the NX message error code.		Depends on the nature of the error. Refer to the description in this manual of the NX message error code.
Attached information	<p>Attached Information 1: Error Location</p> <p>Attached Information 2: Error Location Details (Rung Number). For a program section, the rung number from the start of the section is given. For ST, the line number is given.</p> <p>Attached Information 3: Names of the Instruction and Instruction Instance Where the Error Occurred. If there is more than one possible instruction, information is given on all of them. Nothing is given if the instruction cannot be identified.</p> <p>Attached Information 4: Expansion Error Code (<i>ErrorIDEx</i>)</p>				
Precautions/Remarks	If a program is changed after an error occurs, the attached information that is displayed may not be correct.				

Event name	NX Message Resource Overflow		Event code	54012C01 hex	
Meaning	The maximum resources that you can use for NX message instructions at the same time was exceeded.				
Source	PLC Function Module		Source details	Instruction	Detection timing At instruction execution
Error attributes	Level	Observation	Recovery	---	Log category System
Effects	User program	Continues.	Operation	The relevant instruction will end according to specifications.	
System-defined variables	Variable	Data type		Name	
	None	---		---	
Cause and correction	Assumed cause		Correction		Prevention
	More than 32 NX message instructions were executed at the same time.		Correct the user program so that no more than 32 NX message instructions are executed at the same time.		Write the user program so that no more than 32 NX message instructions are executed at the same time.
Attached information	<p>Attached Information 1: Error Location</p> <p>Attached Information 2: Error Location Details (Rung Number). For a program section, the rung number from the start of the section is given. For ST, the line number is given.</p> <p>Attached Information 3: Names of the Instruction and Instruction Instance Where the Error Occurred. If there is more than one possible instruction, information is given on all of them. Nothing is given if the instruction cannot be identified.</p> <p>Attached Information 4: Expansion Error Code (<i>ErrorIDEx</i>)</p>				
Precautions/Remarks	If a program is changed after an error occurs, the attached information that is displayed may not be correct.				

Event name	NX Message Timeout		Event code	54012C02 hex	
Meaning	A timeout occurred during execution of an NX message.				
Source	PLC Function Module		Source details	Instruction	Detection timing At instruction execution
Error attributes	Level	Observation	Recovery	---	Log category System
Effects	User program	Continues.	Operation	The relevant instruction will end according to specifications.	
System-defined variables	Variable	Data type		Name	
	None	---		---	
Cause and correction	Assumed cause	Correction		Prevention	
	The specified NX Unit does not exist.	Make corrections so that the Unit specification and the remote Unit configuration agree.		Make sure that Unit specifications and the remote Unit configuration agree.	
	The NX message was closed because it timed out.	Increase the response timeout time that is specified for the <i>TimeOut</i> input variable in the instruction.		Execute instructions after setting suitable response timeout times for the <i>TimeOut</i> input variable.	
	Power to the remote Unit is OFF.	Check the status of the remote Unit and start it normally.		Check the status of the remote Unit and start it normally.	
	Communications are stopped at the remote Unit.				
	The communications cable connector is disconnected.	Reconnect the connector and make sure it is mated correctly.		Connect the connector securely.	
	The communications cable is broken.	Replace the communications cable.		None	
	Noise	Implement noise countermeasures if there is excessive noise.		Implement noise countermeasures if there is excessive noise.	
Attached information	<p>Attached Information 1: Error Location</p> <p>Attached Information 2: Error Location Details (Rung Number). For a program section, the rung number from the start of the section is given. For ST, the line number is given.</p> <p>Attached Information 3: Names of the Instruction and Instruction Instance Where the Error Occurred. If there is more than one possible instruction, information is given on all of them. Nothing is given if the instruction cannot be identified.</p> <p>Attached Information 4: Expansion Error Code (<i>ErrorIDEx</i>)</p>				
Precautions/Remarks	If a program is changed after an error occurs, the attached information that is displayed may not be correct.				

Event name	Incorrect NX Message Length			Event code	54012C03 hex	
Meaning	The length of the NX message is not correct.					
Source	PLC Function Module		Source details	Instruction	Detection timing	At instruction execution
Error attributes	Level	Observation	Recovery	---	Log category	System
Effects	User program	Continues.	Operation	The relevant instruction will end according to specifications.		
System-defined variables	Variable	Data type		Name		
	None	---		---		
Cause and correction	Assumed cause		Correction		Prevention	
	The size that is specified for WriteDat or Path is too long.		Correct the program so that the size that is specified for WriteDat or Path is within the restriction.		Write the program so that the size that is specified for WriteDat or Path is within the restriction.	
Attached information	<p>Attached Information 1: Error Location</p> <p>Attached Information 2: Error Location Details (Rung Number). For a program section, the rung number from the start of the section is given. For ST, the line number is given.</p> <p>Attached Information 3: Names of the Instruction and Instruction Instance Where the Error Occurred. If there is more than one possible instruction, information is given on all of them. Nothing is given if the instruction cannot be identified.</p> <p>Attached Information 4: Expansion Error Code (<i>ErrorIDEx</i>)</p>					
Precautions/Remarks	If a program is changed after an error occurs, the attached information that is displayed may not be correct.					

Event name	NX Message EtherCAT Network Error			Event code	54012C05 hex	
Meaning	An error occurred in EtherCAT communications on the NX message path.					
Source	PLC Function Module		Source details	Instruction	Detection timing	At instruction execution
Error attributes	Level	Observation	Recovery	---	Log category	System
Effects	User program	Continues.	Operation	The relevant instruction will end according to specifications.		
System-defined variables	Variable	Data type		Name		
	None	---		---		
Cause and correction	Assumed cause		Correction		Prevention	
	An error occurred in EtherCAT communications on the NX message path.		Check for errors in EtherCAT communications and execute the instruction after clearing any errors.		Depends on the nature of the error.	
Attached information	<p>Attached Information 1: Error Location</p> <p>Attached Information 2: Error Location Details (Rung Number). For a program section, the rung number from the start of the section is given. For ST, the line number is given.</p> <p>Attached Information 3: Names of the Instruction and Instruction Instance Where the Error Occurred. If there is more than one possible instruction, information is given on all of them. Nothing is given if the instruction cannot be identified.</p> <p>Attached Information 4: Expansion Error Code (<i>ErrorIDEx</i>)</p>					
Precautions/Remarks	If a program is changed after an error occurs, the attached information that is displayed may not be correct.					

Event name	External Restart Already Executed for Specified NX Units		Event code	54012C06 hex		
Meaning	A restart was already in execution from the Sysmac Studio when the instruction was executed.					
Source	PLC Function Module		Source details	Instruction	Detection timing	At instruction execution
Error attributes	Level	Observation	Recovery	---	Log category	System
Effects	User program	Continues.	Operation	The relevant instruction will end according to specifications.		
System-defined variables	Variable		Data type		Name	
	None		---		---	
Cause and correction	Assumed cause		Correction		Prevention	
	A restart was already in execution from the Sysmac Studio when the instruction was executed.		Restarting with an instruction is not necessary if a restart was already executed from the Sysmac Studio.		Do not execute restarts from the Sysmac Studio during operation.	
Attached information	<p>Attached Information 1: Error Location</p> <p>Attached Information 2: Error Location Details (Rung Number). For a program section, the rung number from the start of the section is given. For ST, the line number is given.</p> <p>Attached Information 3: Names of the Instruction and Instruction Instance Where the Error Occurred. If there is more than one possible instruction, information is given on all of them. Nothing is given if the instruction cannot be identified.</p> <p>Attached Information 4: Expansion Error Code (<i>ErrorIDEx</i>)</p>					
Precautions/Remarks	If a program is changed after an error occurs, the attached information that is displayed may not be correct.					

Event name	Unapplicable Unit Specified for Instruction		Event code	54012C07 hex		
Meaning	A slave that cannot be specified for the instruction was connected at the slave node address of the specified Unit.					
Source	PLC Function Module		Source details	Instruction	Detection timing	At instruction execution
Error attributes	Level	Observation	Recovery	---	Log category	System
Effects	User program	Continues.	Operation	The relevant instruction will end according to specifications.		
System-defined variables	Variable		Data type		Name	
	None		---		---	
Cause and correction	Assumed cause		Correction		Prevention	
	A slave that cannot be specified for the instruction was connected to the slave node address of the specified Unit.		Connect the applicable Unit for the instruction that is specified in the network configuration information.		Do not connect a slave that cannot be specified for the instruction to the slave node address of the specified Unit.	
Attached information	<p>Attached Information 1: Error Location</p> <p>Attached Information 2: Error Location Details (Rung Number). For a program section, the rung number from the start of the section is given. For ST, the line number is given.</p> <p>Attached Information 3: Names of the Instruction and Instruction Instance Where the Error Occurred. If there is more than one possible instruction, information is given on all of them. Nothing is given if the instruction cannot be identified.</p> <p>Attached Information 4: Expansion Error Code (<i>ErrorIDEx</i>)</p>					
Precautions/Remarks	If a program is changed after an error occurs, the attached information that is displayed may not be correct.					

Event name	Invalid Total Power ON Time Record		Event code	54012C08 hex	
Meaning	The total power ON time could not be read.				
Source	PLC Function Module		Source details	Instruction	Detection timing At instruction execution
Error attributes	Level	Observation	Recovery	---	Log category System
Effects	User program	Continues.	Operation	The relevant instruction will end according to specifications.	
System-defined variables	Variable	Data type		Name	
	None	---		---	
Cause and correction	Assumed cause		Correction		Prevention
	Non-volatile memory failure		Replace the Unit for which the total power ON time could not be read.		None
Attached information	<p>Attached Information 1: Error Location</p> <p>Attached Information 2: Error Location Details (Rung Number). For a program section, the rung number from the start of the section is given. For ST, the line number is given.</p> <p>Attached Information 3: Names of the Instruction and Instruction Instance Where the Error Occurred. If there is more than one possible instruction, information is given on all of them. Nothing is given if the instruction cannot be identified.</p> <p>Attached Information 4: Expansion Error Code (<i>ErrorIDEx</i>)</p>				
Precautions/Remarks	If a program is changed after an error occurs, the attached information that is displayed may not be correct.				

Event name	Process Data Object Setting Missing		Event code	54013461 hex	
Meaning	The PDO mapping is not correct.				
Source	PLC Function Module		Source details	Instruction	Detection timing At instruction execution
Error attributes	Level	Observation	Recovery	---	Log category System
Effects	User program	Continues.	Operation	The relevant instruction will end according to specifications.	
System-defined variables	Variable	Data type		Name	
	_MC_AX[*].MFAultLvl.Active		BOOL		Axis Minor Fault Occurrence
Cause and correction	Assumed cause	Correction		Prevention	
	The PDOs that are required for the motion control instruction are not mapped.	Map the PDOs that are required for the instruction. Refer to the Function section of the relevant instruction for the required PDOs.		Map the PDOs that are required for the instructions that are used. Refer to the <i>NJ/NX-series CPU Unit Motion Control User's Manual (Cat. No. W507)</i> for the PDOs (Servo Drive settings) that you must map for each instruction.	
	The relevant instruction was executed for a device that does not have an object that supports the instruction.	Some devices do not support the relevant instruction. Refer to the manual for the target device, check to see if the relevant instruction is supported, and correct the program so that unsupported instructions are not executed.		Refer to the manual for the target device and write the program so that unsupported instructions are not executed.	
	A motion control instruction that specifies phase Z (_mcEncoderMark) as the trigger conditions was executed for an axis that is mapped to an OMRON GX-EC02□□ EtherCAT Encoder slave.	Use an external input (_mcEXT) as the trigger conditions for an axis that is mapped to an OMRON GX-EC02□□ EtherCAT Encoder slave.		Use an external input (_mcEXT) as the trigger conditions for an axis that is mapped to an OMRON GX-EC02□□ EtherCAT Encoder slave.	
Attached information	Attached Information 1: Error Location Attached Information 3: Names of the Instruction and Instruction Instance Where the Error Occurred. If there is more than one possible instruction, information is given on all of them. Nothing is given if the instruction cannot be identified.				
Precautions/Remarks	If a program is changed after an error occurs, the attached information that is displayed may not be correct.				

Event name	OS Timeout		Event code	54014000 hex	
Meaning	Restarting Windows was not completed within the specified time.				
Source	PLC Function Module		Source details	Instruction	Detection timing At instruction execution
Error attributes	Level	Observation	Recovery	---	Log category System
Effects	User program	Continues.	Operation	Not affected.	
System-defined variables	Variable	Data type		Name	
	None	---		---	
Cause and correction	Assumed cause		Correction		Prevention
	The value specified for the Time-Out input variable was too short for Windows to restart.		Wait until restarting Windows is completed.		Increase the value that is specified for the TimeOut input variable to the instruction.
	An error occurred while Windows restart was in progress, and Windows could not be restarted.		Shut down the Controller and restart it.		None
Attached information	<p>Attached Information 1: Error Location</p> <p>Attached Information 2: Error Location Details (Rung Number). For a program section, the rung number from the start of the section is given. For ST, the line number is given.</p> <p>Attached Information 3: Names of the Instruction and Instruction Instance Where the Error Occurred. If there is more than one possible instruction, information is given on all of them. Nothing is given if the instruction cannot be identified.</p> <p>Attached Information 4: Expansion Error Code (<i>ErrorIDEx</i>)</p>				
Precautions/Remarks	If a program is changed after an error occurs, the attached information that is displayed may not be correct.				

Event name	OS Shutdown Execution Error		Event code	54014001 hex	
Meaning	The instruction to shut down OS was executed while Windows was not running.				
Source	PLC Function Module		Source details	Instruction	Detection timing At instruction execution
Error attributes	Level	Observation	Recovery	---	Log category System
Effects	User program	Continues.	Operation	Not affected.	
System-defined variables	Variable	Data type		Name	
	None	---		---	
Cause and correction	Assumed cause		Correction		Prevention
	The instruction to shut down OS was executed while Windows was not running.		Confirm that Windows is already shut down.		Write the program so that the relevant instruction is executed after the Windows status is confirmed.
Attached information	<p>Attached Information 1: Error Location</p> <p>Attached Information 2: Error Location Details (Rung Number). For a program section, the rung number from the start of the section is given. For ST, the line number is given.</p> <p>Attached Information 3: Names of the Instruction and Instruction Instance Where the Error Occurred. If there is more than one possible instruction, information is given on all of them. Nothing is given if the instruction cannot be identified.</p> <p>Attached Information 4: Expansion Error Code (<i>ErrorIDEx</i>)</p>				
Precautions/Remarks	If a program is changed after an error occurs, the attached information that is displayed may not be correct.				

Event name	OS Reboot Execution Error			Event code	54014002 hex
Meaning	The instruction to reboot OS was executed without a forced reboot while there was an error on Windows.				
Source	PLC Function Module		Source details	Instruction	Detection timing At instruction execution
Error attributes	Level	Observation	Recovery	---	Log category System
Effects	User program	Continues.	Operation	Not affected.	
System-defined variables	Variable	Data type		Name	
	None	---		---	
Cause and correction	Assumed cause		Correction		Prevention
	The relevant instruction was executed without using a forced reboot while there was an error on Windows.		Execute the relevant instruction by a forced reboot.		To reboot OS even there is an error on Windows, write the program so that the relevant instruction is executed by a forced reboot.
Attached information	<p>Attached Information 1: Error Location</p> <p>Attached Information 2: Error Location Details (Rung Number). For a program section, the rung number from the start of the section is given. For ST, the line number is given.</p> <p>Attached Information 3: Names of the Instruction and Instruction Instance Where the Error Occurred. If there is more than one possible instruction, information is given on all of them. Nothing is given if the instruction cannot be identified.</p> <p>Attached Information 4: Expansion Error Code (<i>ErrorIDEx</i>)</p>				
Precautions/Remarks	If a program is changed after an error occurs, the attached information that is displayed may not be correct.				

Event name	Shared Folder Access Failure			Event code	54014400 hex
Meaning	Accessing the shared folder failed when an instruction was executed.				
Source	PLC Function Module		Source details	Instruction	Detection timing At instruction execution
Error attributes	Level	Observation	Recovery	---	Log category System
Effects	User program	Continues.	Operation	The relevant instruction will end according to specifications. The operation of the Unit is not affected.	
System-defined variables	Variable	Data type		Name	
	None	---		---	
Cause and correction	Assumed cause		Correction		Prevention
	The shared folder is not recognized.		Transfer the Virtual SD Memory Card settings so that the shared folder can be recognized. If the shared folder cannot be recognized yet, refer to the corrections for the following event: Shared Folder Recognition Failed (10390000 hex).		Transfer the Virtual SD Memory Card settings so that the shared folder can be recognized.
Attached information	<p>Attached Information 1: Error Location</p> <p>Attached Information 2: Error Location Details (Rung Number). For a program section, the rung number from the start of the section is given. For ST, the line number is given.</p> <p>Attached Information 3: Names of the Instruction and Instruction Instance Where the Error Occurred. If there is more than one possible instruction, information is given on all of them. Nothing is given if the instruction cannot be identified.</p> <p>Attached Information 4: Expansion Error Code (<i>ErrorIDEx</i>)</p>				
Precautions/Remarks	If a program is changed after an error occurs, the attached information that is displayed may not be correct.				

Event name	Shared Folder Insufficient Capacity		Event code	54014402 hex	
Meaning	The capacity of the shared folder was insufficient when writing to the shared folder for an instruction.				
Source	PLC Function Module		Source details	Instruction	Detection timing At instruction execution
Error attributes	Level	Observation	Recovery	---	Log category System
Effects	User program	Continues.	Operation	The relevant instruction will end according to specifications. The operation of the Unit is not affected.	
System-defined variables	Variable	Data type		Name	
	None	---		---	
Cause and correction	Assumed cause		Correction		Prevention
	The shared folder has run out of free space.		Mount a shared folder with sufficient available capacity.		Use a shared folder with sufficient available space when you additionally write to the shared folder.
Attached information	<p>Attached Information 1: Error Location</p> <p>Attached Information 2: Error Location Details (Rung Number). For a program section, the rung number from the start of the section is given. For ST, the line number is given.</p> <p>Attached Information 3: Names of the Instruction and Instruction Instance Where the Error Occurred. If there is more than one possible instruction, information is given on all of them. Nothing is given if the instruction cannot be identified.</p> <p>Attached Information 4: Expansion Error Code (<i>ErrorIDEx</i>)</p>				
Precautions/Remarks	<ul style="list-style-type: none"> • If a program is changed after an error occurs, the attached information that is displayed may not be correct. • Do not unmount the shared folder during access to the folder is in progress. That may damage the shared folder or corrupt the data in it. 				

Event name	Too Many Files/Directories		Event code	54014404 hex	
Meaning	The maximum number of files/directories was exceeded when creating a file/directory for an instruction.				
Source	PLC Function Module		Source details	Instruction	Detection timing At instruction execution
Error attributes	Level	Observation	Recovery	---	Log category System
Effects	User program	Continues.	Operation	The relevant instruction will end according to specifications. The operation of the Unit is not affected.	
System-defined variables	Variable	Data type		Name	
	None	---		---	
Cause and correction	Assumed cause		Correction		Prevention
	The number of files or directories exceeded the maximum number.		Delete any unnecessary files and/or directories. Or, replace the shared folder with one that has fewer files and directories compared to the maximum number of files and directories for NTFS.		<p>Delete unnecessary files and directories so that there are not too many files and directories in the shared folder.</p> <p>Regularly replace the shared folder when the number of files grows constantly.</p>
Attached information	<p>Attached Information 1: Error Location</p> <p>Attached Information 2: Error Location Details (Rung Number). For a program section, the rung number from the start of the section is given. For ST, the line number is given.</p> <p>Attached Information 3: Names of the Instruction and Instruction Instance Where the Error Occurred. If there is more than one possible instruction, information is given on all of them. Nothing is given if the instruction cannot be identified.</p> <p>Attached Information 4: Expansion Error Code (<i>ErrorIDEx</i>)</p>				
Precautions/Remarks	If a program is changed after an error occurs, the attached information that is displayed may not be correct.				

3 Error Descriptions and Corrections

Event name	File or Directory Name Is Too Long		Event code	5401440D hex		
Meaning	The file name or directory name that was specified for an instruction is too long.					
Source	PLC Function Module		Source details	Instruction	Detection timing	At instruction execution
Error attributes	Level	Observation	Recovery	---	Log category	System
Effects	User program	Continues.	Operation	The relevant instruction will end according to specifications. The operation of the Unit is not affected.		
System-defined variables	Variable	Data type		Name		
	None	---		---		
Cause and correction	Assumed cause		Correction		Prevention	
	The file name or directory name that was specified for the instruction to create is too long.		Correct the program so that the file name or directory name specified for the instruction is within NTFS restrictions.		Write the program so that the specified file names and directory names are within NTFS restrictions.	
Attached information	<p>Attached Information 1: Error Location</p> <p>Attached Information 2: Error Location Details (Rung Number). For a program section, the rung number from the start of the section is given. For ST, the line number is given.</p> <p>Attached Information 3: Names of the Instruction and Instruction Instance Where the Error Occurred. If there is more than one possible instruction, information is given on all of them. Nothing is given if the instruction cannot be identified.</p> <p>Attached Information 4: Expansion Error Code (<i>ErrorIDEx</i>)</p>					
Precautions/Remarks	If a program is changed after an error occurs, the attached information that is displayed may not be correct.					

Event name	Shared Folder Access Failed		Event code	5401440E hex		
Meaning	The access to the shared folder failed.					
Source	PLC Function Module		Source details	Instruction	Detection timing	At instruction execution
Error attributes	Level	Observation	Recovery	---	Log category	System
Effects	User program	Continues.	Operation	The relevant instruction will end according to specifications. The operation of the Unit is not affected.		
System-defined variables	Variable	Data type		Name		
	None	---		---		
Cause and correction	Assumed cause		Correction		Prevention	
	The shared folder is corrupted.		Create the shared folder again.		None	
Attached information	<p>Attached Information 1: Error Location</p> <p>Attached Information 2: Error Location Details (Rung Number). For a program section, the rung number from the start of the section is given. For ST, the line number is given.</p> <p>Attached Information 3: Names of the Instruction and Instruction Instance Where the Error Occurred. If there is more than one possible instruction, information is given on all of them. Nothing is given if the instruction cannot be identified.</p> <p>Attached Information 4: Expansion Error Code (<i>ErrorIDEx</i>)</p>					
Precautions/Remarks	If a program is changed after an error occurs, the attached information that is displayed may not be correct.					

Event name	Slave Backup Failed			Event code	54014411 hex	
Meaning	A slave backup operation failed.					
Source	PLC Function Module		Source details	Instruction	Detection timing	At instruction execution
Error attributes	Level	Observation	Recovery	---	Log category	System
Effects	User program	Continues.	Operation	The relevant instruction will end according to specifications. The operation of the Unit is not affected.		
System-defined variables	Variable	Data type		Name		
	None	---		---		
Cause and correction	Assumed cause		Correction		Prevention	
	A slave backup operation failed.		Refer to the corrections for the following event: EtherCAT Slave Backup Failed (102F0000 hex).		Refer to the preventive information for the following event: EtherCAT Slave Backup Failed (102F0000 hex).	
Attached information	Attached Information 1: Error Location Attached Information 2: Error Location Details (Rung Number). For a program section, the rung number from the start of the section is given. For ST, the line number is given. Attached Information 3: Names of the Instruction and Instruction Instance Where the Error Occurred. If there is more than one possible instruction, information is given on all of them. Nothing is given if the instruction cannot be identified. Attached Information 4: Expansion Error Code (<i>ErrorIDEx</i>)					
Precautions/Remarks	If a program is changed after an error occurs, the attached information that is displayed may not be correct.					

Event name	Device Error Received			Event code	54014800 hex	
Meaning	An error response from the device was received.					
Source	PLC Function Module		Source details	Instruction	Detection timing	At instruction execution
Error attributes	Level	Observation	Recovery	---	Log category	System
Effects	User program	Continues.	Operation	The relevant instruction will end according to specifications.		
System-defined variables	Variable	Data type		Name		
	None	---		---		
Cause and correction	Assumed cause		Correction		Prevention	
	An error response from the device was received.		The error code that is returned by the device is output to the Error-Type output variable of the instruction. Check the error information in the manual for the target device and correct the problem.		Check the error cause in the manual for the device before you write the user program and execute the instruction.	
Attached information	Attached Information 1: Error Location Attached Information 2: Error Location Details (Rung Number). For a program section, the rung number from the start of the section is given. For ST, the line number is given. Attached Information 3: Names of the Instruction and Instruction Instance Where the Error Occurred. If there is more than one possible instruction, information is given on all of them. Nothing is given if the instruction cannot be identified. Attached Information 4: Expansion Error Code (<i>ErrorType</i>)					
Precautions/Remarks	If a program is changed after an error occurs, the attached information that is displayed may not be correct.					

Event name	Specified Unit Does Not Exist		Event code	54014801 hex		
Meaning	The specified Unit does not exist.					
Source	PLC Function Module		Source details	Instruction	Detection timing	At instruction execution
Error attributes	Level	Observation	Recovery	---	Log category	System
Effects	User program	Continues.	Operation	The relevant instruction will end according to specifications.		
System-defined variables	Variable	Data type		Name		
	None	---		---		
Cause and correction	Assumed cause		Correction		Prevention	
	The IO-Link master is not connected to or mounted on the specified position.		Connect or mount the IO-Link master to or on the specified position. Or, specify the position where the IO-Link master is connected or mounted.		Connect or mount the IO-Link master to or on the specified position. Or, specify the position where the IO-Link master is connected or mounted.	
Attached information	<p>Attached Information 1: Error Location</p> <p>Attached Information 2: Error Location Details (Rung Number). For a program section, the rung number from the start of the section is given. For ST, the line number is given.</p> <p>Attached Information 3: Names of the Instruction and Instruction Instance Where the Error Occurred. If there is more than one possible instruction, information is given on all of them. Nothing is given if the instruction cannot be identified.</p> <p>Attached Information 4: Expansion Error Code (ErrorType)</p>					
Precautions/Remarks	If a program is changed after an error occurs, the attached information that is displayed may not be correct.					

Event name	Message Processing Limit Exceeded		Event code	54014802 hex		
Meaning	An instruction cannot be executed because the IO-Link master is processing the message from another application.					
Source	PLC Function Module		Source details	Instruction	Detection timing	At instruction execution
Error attributes	Level	Observation	Recovery	---	Log category	System
Effects	User program	Continues.	Operation	The relevant instruction will end according to specifications.		
System-defined variables	Variable	Data type		Name		
	None	---		---		
Cause and correction	Assumed cause		Correction		Prevention	
	An instruction cannot be executed because the IO-Link master is processing the message from another application (an instruction execution or a tool connection).		Execute the instruction again.		Perform processing for exclusive control of messages in applications (an instruction execution or a tool connection). Or, increase the number of retries.	
Attached information	<p>Attached Information 1: Error Location</p> <p>Attached Information 2: Error Location Details (Rung Number). For a program section, the rung number from the start of the section is given. For ST, the line number is given.</p> <p>Attached Information 3: Names of the Instruction and Instruction Instance Where the Error Occurred. If there is more than one possible instruction, information is given on all of them. Nothing is given if the instruction cannot be identified.</p> <p>Attached Information 4: Expansion Error Code (ErrorType)</p>					
Precautions/Remarks	If a program is changed after an error occurs, the attached information that is displayed may not be correct.					

Event name	Specified Unit Status Error		Event code	54014803 hex	
Meaning	The specified Unit is not in a condition to receive messages.				
Source	PLC Function Module		Source details	Instruction	Detection timing At instruction execution
Error attributes	Level	Observation	Recovery	---	Log category System
Effects	User program	Continues.	Operation	The relevant instruction will end according to specifications.	
System-defined variables	Variable	Data type		Name	
	None	---		---	
Cause and correction	Assumed cause		Correction		Prevention
	The specified Unit is not in a condition to receive messages.		Execute the instruction again.		When this error occurs, execute the instruction again.
Attached information	<p>Attached Information 1: Error Location</p> <p>Attached Information 2: Error Location Details (Rung Number). For a program section, the rung number from the start of the section is given. For ST, the line number is given.</p> <p>Attached Information 3: Names of the Instruction and Instruction Instance Where the Error Occurred. If there is more than one possible instruction, information is given on all of them. Nothing is given if the instruction cannot be identified.</p> <p>Attached Information 4: Expansion Error Code (ErrorType)</p>				
Precautions/Remarks	If a program is changed after an error occurs, the attached information that is displayed may not be correct.				

Event name	Too Many Simultaneous Instruction Executions		Event code	54014804 hex	
Meaning	The number of instructions that can be simultaneously executed was exceeded.				
Source	PLC Function Module		Source details	Instruction	Detection timing At instruction execution
Error attributes	Level	Observation	Recovery	---	Log category System
Effects	User program	Continues.	Operation	The relevant instruction will end according to specifications.	
System-defined variables	Variable	Data type		Name	
	None	---		---	
Cause and correction	Assumed cause		Correction		Prevention
	More than 32 NX message instructions and EtherCAT communications instructions were executed at the same time.		Correct the user program so that no more than 32 NX message instructions and EtherCAT communications instructions are executed at the same time.		Write the user program so that no more than 32 NX message instructions and EtherCAT communications instructions are executed at the same time.
Attached information	<p>Attached Information 1: Error Location</p> <p>Attached Information 2: Error Location Details (Rung Number). For a program section, the rung number from the start of the section is given. For ST, the line number is given.</p> <p>Attached Information 3: Names of the Instruction and Instruction Instance Where the Error Occurred. If there is more than one possible instruction, information is given on all of them. Nothing is given if the instruction cannot be identified.</p> <p>Attached Information 4: Expansion Error Code (ErrorType)</p>				
Precautions/Remarks	If a program is changed after an error occurs, the attached information that is displayed may not be correct.				

Event name	Communications Timeout		Event code	54014805 hex		
Meaning	A timeout occurred in communications.					
Source	PLC Function Module		Source details	Instruction	Detection timing	At instruction execution
Error attributes	Level	Observation	Recovery	---	Log category	System
Effects	User program	Continues.	Operation	The relevant instruction will end according to specifications.		
System-defined variables	Variable		Data type		Name	
	None		---		---	
Cause and correction	Assumed cause		Correction		Prevention	
	The communications timeout time is shorter than the message response time.		Calculate the message response time, and make a setting so that the communications timeout time is longer than the message response time.		Calculate the message response time, and make a setting so that the communications timeout time is longer than the message response time.	
	The cable for EtherCAT or for IO-Link is broken.		Replace the cable.		None	
	Noise		Implement noise countermeasures.		Implement noise countermeasures.	
	Device failure		Replace the relevant device.		None	
Attached information	<p>Attached Information 1: Error Location</p> <p>Attached Information 2: Error Location Details (Rung Number). For a program section, the rung number from the start of the section is given. For ST, the line number is given.</p> <p>Attached Information 3: Names of the Instruction and Instruction Instance Where the Error Occurred. If there is more than one possible instruction, information is given on all of them. Nothing is given if the instruction cannot be identified.</p> <p>Attached Information 4: Expansion Error Code (ErrorType)</p>					
Precautions/Remarks	If a program is changed after an error occurs, the attached information that is displayed may not be correct.					

Event name	Invalid Mode		Event code	54014806 hex		
Meaning	The specified IO-Link master port is not the IO-Link mode.					
Source	PLC Function Module		Source details	Instruction	Detection timing	At instruction execution
Error attributes	Level	Observation	Recovery	---	Log category	System
Effects	User program	Continues.	Operation	The relevant instruction will end according to specifications.		
System-defined variables	Variable		Data type		Name	
	None		---		---	
Cause and correction	Assumed cause		Correction		Prevention	
	The specified IO-Link master port is not the IO-Link mode.		Set the specified IO-Link master port to the IO-Link mode, and execute the instruction again.		Set the IO-Link master port to specify to the IO-Link mode, and execute the instruction.	
Attached information	<p>Attached Information 1: Error Location</p> <p>Attached Information 2: Error Location Details (Rung Number). For a program section, the rung number from the start of the section is given. For ST, the line number is given.</p> <p>Attached Information 3: Names of the Instruction and Instruction Instance Where the Error Occurred. If there is more than one possible instruction, information is given on all of them. Nothing is given if the instruction cannot be identified.</p> <p>Attached Information 4: Expansion Error Code (ErrorType)</p>					
Precautions/Remarks	If a program is changed after an error occurs, the attached information that is displayed may not be correct.					

Event name	I/O Power OFF Status		Event code	54014807 hex	
Meaning	The I/O power is not supplied to the specified IO-Link master port.				
Source	PLC Function Module		Source details	Instruction	Detection timing At instruction execution
Error attributes	Level	Observation	Recovery	---	Log category System
Effects	User program	Continues.	Operation	The relevant instruction will end according to specifications.	
System-defined variables	Variable	Data type		Name	
	None	---		---	
Cause and correction	Assumed cause		Correction		Prevention
	The I/O power is not supplied to the specified IO-Link master port.		Supply the I/O power to the specified IO-Link master port, and then execute the instruction.		Make sure that an I/O power is supplied to the specified IO-Link master port before you execute the instruction.
Attached information	<p>Attached Information 1: Error Location</p> <p>Attached Information 2: Error Location Details (Rung Number). For a program section, the rung number from the start of the section is given. For ST, the line number is given.</p> <p>Attached Information 3: Names of the Instruction and Instruction Instance Where the Error Occurred. If there is more than one possible instruction, information is given on all of them. Nothing is given if the instruction cannot be identified.</p> <p>Attached Information 4: Expansion Error Code (ErrorType)</p>				
Precautions/Remarks	If a program is changed after an error occurs, the attached information that is displayed may not be correct.				

Event name	Verification Error		Event code	54014808 hex	
Meaning	The specified IO-Link master port had a verification error or a communications error.				
Source	PLC Function Module		Source details	Instruction	Detection timing At instruction execution
Error attributes	Level	Observation	Recovery	---	Log category System
Effects	User program	Continues.	Operation	The relevant instruction will end according to specifications.	
System-defined variables	Variable	Data type		Name	
	None	---		---	
Cause and correction	Assumed cause		Correction		Prevention
	The specified IO-Link master port had a verification error or a communications error.		Clear the error, and then execute the instruction again.		Execute the instruction while there is no error.
Attached information	<p>Attached Information 1: Error Location</p> <p>Attached Information 2: Error Location Details (Rung Number). For a program section, the rung number from the start of the section is given. For ST, the line number is given.</p> <p>Attached Information 3: Names of the Instruction and Instruction Instance Where the Error Occurred. If there is more than one possible instruction, information is given on all of them. Nothing is given if the instruction cannot be identified.</p> <p>Attached Information 4: Expansion Error Code (ErrorType)</p>				
Precautions/Remarks	If a program is changed after an error occurs, the attached information that is displayed may not be correct.				

3 Error Descriptions and Corrections

Event name	Electronic Gear Ratio Numerator Setting Out of Range		Event code	54015420 hex		
Meaning	The parameter specified for the <i>RatioNumerator</i> input variable to a motion control instruction is out of range.					
Source	PLC Function Module		Source details	Instruction	Detection timing	At instruction execution
Error attributes	Level	Observation	Recovery	---	Log category	System
Effects	User program	Continues.	Operation	The relevant instruction will end according to specifications.		
System-defined variables	Variable		Data type		Name	
	_MC_AX[*].MFaultLvl.Active		BOOL		Axis Minor Fault Occurrence	
Cause and correction	Assumed cause		Correction		Prevention	
	Instruction input parameter exceeded the valid range of the input variable.		Correct the parameter so that the valid range of the input variable is not exceeded for the relevant instruction.		Set the input parameter to the instruction so that the valid range of the input variable is not exceeded.	
Attached information	Attached Information 1: Error Location Attached Information 3: Names of the Instruction and Instruction Instance Where the Error Occurred. If there is more than one possible instruction, information is given on all of them. Nothing is given if the instruction cannot be identified.					
Precautions/Remarks	If a program is changed after an error occurs, the attached information that is displayed may not be correct.					

Event name	Electronic Gear Ratio Denominator Setting Out of Range		Event code	54015421 hex		
Meaning	The parameter specified for the <i>RatioDenominator</i> input variable to a motion control instruction is out of range.					
Source	PLC Function Module		Source details	Instruction	Detection timing	At instruction execution
Error attributes	Level	Observation	Recovery	---	Log category	System
Effects	User program	Continues.	Operation	The relevant instruction will end according to specifications.		
System-defined variables	Variable		Data type		Name	
	_MC_AX[*].MFaultLvl.Active		BOOL		Axis Minor Fault Occurrence	
Cause and correction	Assumed cause		Correction		Prevention	
	Instruction input parameter exceeded the valid range of the input variable.		Correct the parameter so that the valid range of the input variable is not exceeded for the relevant instruction.		Set the input parameter to the instruction so that the valid range of the input variable is not exceeded.	
Attached information	Attached Information 1: Error Location Attached Information 3: Names of the Instruction and Instruction Instance Where the Error Occurred. If there is more than one possible instruction, information is given on all of them. Nothing is given if the instruction cannot be identified.					
Precautions/Remarks	If a program is changed after an error occurs, the attached information that is displayed may not be correct.					

Event name	Target Velocity Setting Out of Range		Event code	54015422 hex	
Meaning	The parameter specified for the <i>Velocity</i> input variable to a motion control instruction is out of range.				
Source	PLC Function Module		Source details	Instruction	Detection timing At instruction execution
Error attributes	Level	Observation	Recovery	---	Log category System
Effects	User program	Continues.	Operation	The relevant instruction will end according to specifications.	
System-defined variables	Variable		Data type		Name
	_MC_AX[*].MFAultLvl.Active		BOOL		Axis Minor Fault Occurrence
		_MC_GRP[*].MFAultLvl.Active		BOOL	Axes Group Minor Fault Occurrence
Cause and correction	Assumed cause		Correction		Prevention
	Instruction input parameter exceeded the valid range of the input variable.		Correct the parameter so that the valid range of the input variable is not exceeded for the relevant instruction.		Set the input parameter to the instruction so that the valid range of the input variable is not exceeded.
Attached information	Attached Information 1: Error Location Attached Information 3: Names of the Instruction and Instruction Instance Where the Error Occurred. If there is more than one possible instruction, information is given on all of them. Nothing is given if the instruction cannot be identified.				
Precautions/Remarks	If a program is changed after an error occurs, the attached information that is displayed may not be correct.				

Event name	Acceleration Setting Out of Range		Event code	54015423 hex	
Meaning	The parameter specified for the <i>Acceleration</i> input variable to a motion control instruction is out of range.				
Source	PLC Function Module		Source details	Instruction	Detection timing At instruction execution
Error attributes	Level	Observation	Recovery	---	Log category System
Effects	User program	Continues.	Operation	The relevant instruction will end according to specifications.	
System-defined variables	Variable		Data type		Name
	_MC_AX[*].MFAultLvl.Active		BOOL		Axis Minor Fault Occurrence
		_MC_GRP[*].MFAultLvl.Active		BOOL	Axes Group Minor Fault Occurrence
Cause and correction	Assumed cause		Correction		Prevention
	Instruction input parameter exceeded the valid range of the input variable.		Correct the parameter so that the valid range of the input variable is not exceeded for the relevant instruction.		Set the input parameter to the instruction so that the valid range of the input variable is not exceeded.
Attached information	Attached Information 1: Error Location Attached Information 3: Names of the Instruction and Instruction Instance Where the Error Occurred. If there is more than one possible instruction, information is given on all of them. Nothing is given if the instruction cannot be identified.				
Precautions/Remarks	If a program is changed after an error occurs, the attached information that is displayed may not be correct.				

3 Error Descriptions and Corrections

Event name	Deceleration Setting Out of Range		Event code	54015424 hex	
Meaning	The parameter specified for the <i>Deceleration</i> input variable to a motion control instruction is out of range.				
Source	PLC Function Module		Source details	Instruction	Detection timing At instruction execution
Error attributes	Level	Observation	Recovery	---	Log category System
Effects	User program	Continues.	Operation	The relevant instruction will end according to specifications.	
System-defined variables	Variable		Data type		Name
	_MC_AX[*].MFAultLvl.Active		BOOL		Axis Minor Fault Occurrence
	_MC_GRP[*].MFAultLvl.Active		BOOL		Axes Group Minor Fault Occurrence
Cause and correction	Assumed cause		Correction		Prevention
	Instruction input parameter exceeded the valid range of the input variable.		Correct the parameter so that the valid range of the input variable is not exceeded for the relevant instruction.		Set the input parameter to the instruction so that the valid range of the input variable is not exceeded.
Attached information	Attached Information 1: Error Location Attached Information 3: Names of the Instruction and Instruction Instance Where the Error Occurred. If there is more than one possible instruction, information is given on all of them. Nothing is given if the instruction cannot be identified.				
Precautions/Remarks	If a program is changed after an error occurs, the attached information that is displayed may not be correct.				

Event name	Jerk Setting Out of Range		Event code	54015425 hex	
Meaning	The parameter specified for the <i>Jerk</i> input variable to a motion control instruction is out of range.				
Source	PLC Function Module		Source details	Instruction	Detection timing At instruction execution
Error attributes	Level	Observation	Recovery	---	Log category System
Effects	User program	Continues.	Operation	The relevant instruction will end according to specifications.	
System-defined variables	Variable		Data type		Name
	_MC_AX[*].MFAultLvl.Active		BOOL		Axis Minor Fault Occurrence
	_MC_GRP[*].MFAultLvl.Active		BOOL		Axes Group Minor Fault Occurrence
Cause and correction	Assumed cause		Correction		Prevention
	Instruction input parameter exceeded the valid range of the input variable.		Correct the parameter so that the valid range of the input variable is not exceeded for the relevant instruction.		Set the input parameter to the instruction so that the valid range of the input variable is not exceeded.
Attached information	Attached Information 1: Error Location Attached Information 3: Names of the Instruction and Instruction Instance Where the Error Occurred. If there is more than one possible instruction, information is given on all of them. Nothing is given if the instruction cannot be identified.				
Precautions/Remarks	If a program is changed after an error occurs, the attached information that is displayed may not be correct.				

Event name	Torque Ramp Setting Out of Range		Event code	54015427 hex	
Meaning	The parameter specified for the <i>TorqueRamp</i> input variable to a motion control instruction is out of range.				
Source	PLC Function Module		Source details	Instruction	Detection timing At instruction execution
Error attributes	Level	Observation	Recovery	---	Log category System
Effects	User program	Continues.	Operation	The relevant instruction will end according to specifications.	
System-defined variables	Variable		Data type		Name
	_MC_AX[*].MFAultLvl.Active		BOOL		Axis Minor Fault Occurrence
Cause and correction	Assumed cause		Correction		Prevention
	Instruction input parameter exceeded the valid range of the input variable.		Correct the parameter so that the valid range of the input variable is not exceeded for the relevant instruction.		Set the input parameter to the instruction so that the valid range of the input variable is not exceeded.
Attached information	Attached Information 1: Error Location Attached Information 3: Names of the Instruction and Instruction Instance Where the Error Occurred. If there is more than one possible instruction, information is given on all of them. Nothing is given if the instruction cannot be identified.				
Precautions/Remarks	If a program is changed after an error occurs, the attached information that is displayed may not be correct.				

Event name	Master Coefficient Scaling Out of Range		Event code	54015428 hex	
Meaning	The parameter specified for the <i>MasterScaling</i> input variable to a motion control instruction is out of range.				
Source	PLC Function Module		Source details	Instruction	Detection timing At instruction execution
Error attributes	Level	Observation	Recovery	---	Log category System
Effects	User program	Continues.	Operation	The relevant instruction will end according to specifications.	
System-defined variables	Variable		Data type		Name
	_MC_AX[*].MFAultLvl.Active		BOOL		Axis Minor Fault Occurrence
Cause and correction	Assumed cause		Correction		Prevention
	Instruction input parameter exceeded the valid range of the input variable.		Correct the parameter so that the valid range of the input variable is not exceeded for the relevant instruction.		Set the input parameter to the instruction so that the valid range of the input variable is not exceeded.
Attached information	Attached Information 1: Error Location Attached Information 3: Names of the Instruction and Instruction Instance Where the Error Occurred. If there is more than one possible instruction, information is given on all of them. Nothing is given if the instruction cannot be identified.				
Precautions/Remarks	If a program is changed after an error occurs, the attached information that is displayed may not be correct.				

3 Error Descriptions and Corrections

Event name	Slave Coefficient Scaling Out of Range		Event code	54015429 hex		
Meaning	The parameter specified for the <i>SlaveScaling</i> input variable to a motion control instruction is out of range.					
Source	PLC Function Module		Source details	Instruction	Detection timing	At instruction execution
Error attributes	Level	Observation	Recovery	---	Log category	System
Effects	User program	Continues.	Operation	The relevant instruction will end according to specifications.		
System-defined variables	Variable	Data type		Name		
	_MC_AX[*].MFaultLvl.Active	BOOL		Axis Minor Fault Occurrence		
Cause and correction	Assumed cause		Correction		Prevention	
	Instruction input parameter exceeded the valid range of the input variable.		Correct the parameter so that the valid range of the input variable is not exceeded for the relevant instruction.		Set the input parameter to the instruction so that the valid range of the input variable is not exceeded.	
Attached information	Attached Information 1: Error Location Attached Information 3: Names of the Instruction and Instruction Instance Where the Error Occurred. If there is more than one possible instruction, information is given on all of them. Nothing is given if the instruction cannot be identified.					
Precautions/Remarks	If a program is changed after an error occurs, the attached information that is displayed may not be correct.					

Event name	Feeding Velocity Setting Out of Range		Event code	5401542A hex		
Meaning	The parameter specified for the <i>FeedVelocity</i> input variable to a motion control instruction is out of range.					
Source	PLC Function Module		Source details	Instruction	Detection timing	At instruction execution
Error attributes	Level	Observation	Recovery	---	Log category	System
Effects	User program	Continues.	Operation	The relevant instruction will end according to specifications.		
System-defined variables	Variable	Data type		Name		
	_MC_AX[*].MFaultLvl.Active	BOOL		Axis Minor Fault Occurrence		
Cause and correction	Assumed cause		Correction		Prevention	
	The Feed Velocity (input variable <i>FeedVelocity</i>) is still at the default (0).		Specify a positive value for the Feed Velocity (input variable <i>FeedVelocity</i>).		Set the input parameter to the instruction so that the valid range of the input variable is not exceeded.	
Attached information	Attached Information 1: Error Location Attached Information 3: Names of the Instruction and Instruction Instance Where the Error Occurred. If there is more than one possible instruction, information is given on all of them. Nothing is given if the instruction cannot be identified.					
Precautions/Remarks	If a program is changed after an error occurs, the attached information that is displayed may not be correct.					

Event name	Buffer Mode Selection Out of Range		Event code	5401542B hex	
Meaning). <i>BufferMode</i> input variable to a motion control instruction is out of range.				
Source	PLC Function Module		Source details	Instruction	Detection timing At instruction execution
Error attributes	Level	Observation	Recovery	---	Log category System
Effects	User program	Continues.	Operation	The relevant instruction will end according to specifications.	
System-defined variables	Variable		Data type	Name	
	_MC_AX[*].MFAultLvl.Active		BOOL	Axis Minor Fault Occurrence	
	_MC_GRP[*].MFAultLvl.Active		BOOL	Axes Group Minor Fault Occurrence	
Cause and correction	Assumed cause		Correction		Prevention
	Instruction input parameter exceeded the valid range of the input variable.		Correct the parameter so that the valid range of the input variable is not exceeded for the relevant instruction.		Set the input parameter to the instruction so that the valid range of the input variable is not exceeded.
Attached information	Attached Information 1: Error Location Attached Information 3: Names of the Instruction and Instruction Instance Where the Error Occurred. If there is more than one possible instruction, information is given on all of them. Nothing is given if the instruction cannot be identified.				
Precautions/Remarks	If a program is changed after an error occurs, the attached information that is displayed may not be correct.				

Event name	Coordinate System Selection Out of Range		Event code	5401542C hex	
Meaning	The parameter specified for the <i>CoordSystem</i> input variable to a motion control instruction is out of range.				
Source	PLC Function Module		Source details	Instruction	Detection timing At instruction execution
Error attributes	Level	Observation	Recovery	---	Log category System
Effects	User program	Continues.	Operation	The relevant instruction will end according to specifications.	
System-defined variables	Variable		Data type	Name	
	_MC_GRP[*].MFAultLvl.Active		BOOL	Axes Group Minor Fault Occurrence	
Cause and correction	Assumed cause		Correction		Prevention
	Instruction input parameter exceeded the valid range of the input variable.		Correct the parameter so that the valid range of the input variable is not exceeded for the relevant instruction.		Set the input parameter to the instruction so that the valid range of the input variable is not exceeded.
Attached information	Attached Information 1: Error Location Attached Information 3: Names of the Instruction and Instruction Instance Where the Error Occurred. If there is more than one possible instruction, information is given on all of them. Nothing is given if the instruction cannot be identified.				
Precautions/Remarks	If a program is changed after an error occurs, the attached information that is displayed may not be correct.				

Event name	Circular Interpolation Mode Selection Out of Range		Event code	5401542D hex		
Meaning	The parameter specified for the <i>CircMode</i> input variable to a motion control instruction is out of range.					
Source	PLC Function Module		Source details	Instruction	Detection timing	At instruction execution
Error attributes	Level	Observation	Recovery	---	Log category	System
Effects	User program	Continues.	Operation	The relevant instruction will end according to specifications.		
System-defined variables	Variable		Data type		Name	
	_MC_GRP[*].MFaultLvl.Active		BOOL		Axes Group Minor Fault Occurrence	
Cause and correction	Assumed cause		Correction		Prevention	
	Instruction input parameter exceeded the valid range of the input variable.		Correct the parameter so that the valid range of the input variable is not exceeded for the relevant instruction.		Set the input parameter to the instruction so that the valid range of the input variable is not exceeded.	
Attached information	Attached Information 1: Error Location Attached Information 3: Names of the Instruction and Instruction Instance Where the Error Occurred. If there is more than one possible instruction, information is given on all of them. Nothing is given if the instruction cannot be identified.					
Precautions/Remarks	If a program is changed after an error occurs, the attached information that is displayed may not be correct.					

Event name	Direction Selection Out of Range		Event code	5401542E hex		
Meaning	The parameter specified for the <i>Direction</i> input variable to a motion control instruction is out of range.					
Source	PLC Function Module		Source details	Instruction	Detection timing	At instruction execution
Error attributes	Level	Observation	Recovery	---	Log category	System
Effects	User program	Continues.	Operation	The relevant instruction will end according to specifications.		
System-defined variables	Variable		Data type		Name	
	_MC_AX[*].MFaultLvl.Active		BOOL		Axis Minor Fault Occurrence	
Cause and correction	Assumed cause		Correction		Prevention	
	Instruction input parameter exceeded the valid range of the input variable.		Correct the parameter so that the valid range of the input variable is not exceeded for the relevant instruction.		Set the input parameter to the instruction so that the valid range of the input variable is not exceeded.	
Attached information	Attached Information 1: Error Location Attached Information 3: Names of the Instruction and Instruction Instance Where the Error Occurred. If there is more than one possible instruction, information is given on all of them. Nothing is given if the instruction cannot be identified.					
Precautions/Remarks	If a program is changed after an error occurs, the attached information that is displayed may not be correct.					

Event name	Path Selection Out of Range		Event code	5401542F hex	
Meaning	The parameter specified for the <i>PathChoice</i> input variable to a motion control instruction is out of range.				
Source	PLC Function Module		Source details	Instruction	Detection timing At instruction execution
Error attributes	Level	Observation	Recovery	---	Log category System
Effects	User program	Continues.	Operation	The relevant instruction will end according to specifications.	
System-defined variables	Variable		Data type		Name
	_MC_GRP[*].MFaultLvl.Active		BOOL		Axes Group Minor Fault Occurrence
Cause and correction	Assumed cause		Correction		Prevention
	Instruction input parameter exceeded the valid range of the input variable.		Correct the parameter so that the valid range of the input variable is not exceeded for the relevant instruction.		Set the input parameter to the instruction so that the valid range of the input variable is not exceeded.
Attached information	Attached Information 1: Error Location Attached Information 3: Names of the Instruction and Instruction Instance Where the Error Occurred. If there is more than one possible instruction, information is given on all of them. Nothing is given if the instruction cannot be identified.				
Precautions/Remarks	If a program is changed after an error occurs, the attached information that is displayed may not be correct.				

Event name	Position Type Selection Out of Range		Event code	54015430 hex	
Meaning	The parameter specified for the <i>ReferenceType</i> input variable to a motion control instruction is out of range.				
Source	PLC Function Module		Source details	Instruction	Detection timing At instruction execution
Error attributes	Level	Observation	Recovery	---	Log category System
Effects	User program	Continues.	Operation	The relevant instruction will end according to specifications.	
System-defined variables	Variable		Data type		Name
	_MC_COM.MFaultLvl.Active		BOOL		MC Common Minor Fault Occurrence
	_MC_AX[*].MFaultLvl.Active		BOOL		Axis Minor Fault Occurrence
Cause and correction	Assumed cause		Correction		Prevention
	Instruction input parameter exceeded the valid range of the input variable.		Correct the parameter so that the valid range of the input variable is not exceeded for the relevant instruction.		Set the input parameter to the instruction so that the valid range of the input variable is not exceeded.
Attached information	Attached Information 1: Error Location Attached Information 3: Names of the Instruction and Instruction Instance Where the Error Occurred. If there is more than one possible instruction, information is given on all of them. Nothing is given if the instruction cannot be identified.				
Precautions/Remarks	If a program is changed after an error occurs, the attached information that is displayed may not be correct.				

3 Error Descriptions and Corrections

Event name	Travel Mode Selection Out of Range		Event code	54015431 hex	
Meaning	The parameter specified for the <i>MoveMode</i> input variable to a motion control instruction is out of range.				
Source	PLC Function Module		Source details	Instruction	Detection timing At instruction execution
Error attributes	Level	Observation	Recovery	---	Log category System
Effects	User program	Continues.	Operation	The relevant instruction will end according to specifications.	
System-defined variables	Variable		Data type		Name
	_MC_AX[*].MFAultLvl.Active		BOOL		Axis Minor Fault Occurrence
	_MC_GRP[*].MFAultLvl.Active		BOOL		Axes Group Minor Fault Occurrence
Cause and correction	Assumed cause		Correction		Prevention
	Instruction input parameter exceeded the valid range of the input variable.		Correct the parameter so that the valid range of the input variable is not exceeded for the relevant instruction.		Set the input parameter to the instruction so that the valid range of the input variable is not exceeded.
Attached information	Attached Information 1: Error Location Attached Information 3: Names of the Instruction and Instruction Instance Where the Error Occurred. If there is more than one possible instruction, information is given on all of them. Nothing is given if the instruction cannot be identified.				
Precautions/Remarks	If a program is changed after an error occurs, the attached information that is displayed may not be correct.				

Event name	Transition Mode Selection Out of Range		Event code	54015432 hex	
Meaning	The parameter specified for the <i>TransitionMode</i> input variable to a motion control instruction is out of range.				
Source	PLC Function Module		Source details	Instruction	Detection timing At instruction execution
Error attributes	Level	Observation	Recovery	---	Log category System
Effects	User program	Continues.	Operation	The relevant instruction will end according to specifications.	
System-defined variables	Variable		Data type		Name
	_MC_GRP[*].MFAultLvl.Active		BOOL		Axes Group Minor Fault Occurrence
Cause and correction	Assumed cause		Correction		Prevention
	Instruction input parameter exceeded the valid range of the input variable.		Correct the parameter so that the valid range of the input variable is not exceeded for the relevant instruction.		Set the input parameter to the instruction so that the valid range of the input variable is not exceeded.
	_mcAborting or _mcBuffered was specified for BufferMode and _mcTMCornerSuperimposed was specified for TransitionMode .		If you specify _mcAborting or _mcBuffered for BufferMode , specify _mcTMNone for TransitionMode . If you specify _mcTMCornerSuperimposed for TransitionMode , specify _mcBlendingLow, _mcBlendingPrevious, _mcBlendingNext, or _mcBlendingHigh for BufferMode .		If you specify _mcAborting or _mcBuffered for BufferMode , specify _mcTMNone for TransitionMode . If you specify _mcTMCornerSuperimposed for TransitionMode , specify _mcBlendingLow, _mcBlendingPrevious, _mcBlendingNext, or _mcBlendingHigh for BufferMode .
Attached information	Attached Information 1: Error Location Attached Information 3: Names of the Instruction and Instruction Instance Where the Error Occurred. If there is more than one possible instruction, information is given on all of them. Nothing is given if the instruction cannot be identified.				
Precautions/Remarks	If a program is changed after an error occurs, the attached information that is displayed may not be correct.				

Event name	Continue Method Selection Out of Range		Event code	54015433 hex	
Meaning	The value of the reserved input variable <i>Continuous</i> to a motion control instruction changed.				
Source	PLC Function Module		Source details	Instruction	Detection timing At instruction execution
Error attributes	Level	Observation	Recovery	---	Log category System
Effects	User program	Continues.	Operation	The relevant instruction will end according to specifications.	
System-defined variables	Variable	Data type		Name	
	_MC_AX[*].MFaultLvl.Active	BOOL		Axis Minor Fault Occurrence	
Cause and correction	Assumed cause		Correction		Prevention
	The value of the reserved input variable <i>Continuous</i> changed.		Correct the program so that the value of the reserved input variable <i>Continuous</i> does not change.		Write the user program so that the value of the reserved input variable <i>Continuous</i> does not change.
Attached information	Attached Information 1: Error Location Attached Information 3: Names of the Instruction and Instruction Instance Where the Error Occurred. If there is more than one possible instruction, information is given on all of them. Nothing is given if the instruction cannot be identified.				
Precautions/Remarks	If a program is changed after an error occurs, the attached information that is displayed may not be correct.				

Event name	Combine Mode Selection Out of Range		Event code	54015434 hex	
Meaning	The parameter specified for the <i>CombineMode</i> input variable to a motion control instruction is out of range.				
Source	PLC Function Module		Source details	Instruction	Detection timing At instruction execution
Error attributes	Level	Observation	Recovery	---	Log category System
Effects	User program	Continues.	Operation	The relevant instruction will end according to specifications.	
System-defined variables	Variable	Data type		Name	
	_MC_AX[*].MFaultLvl.Active	BOOL		Axis Minor Fault Occurrence	
Cause and correction	Assumed cause		Correction		Prevention
	Instruction input parameter exceeded the valid range of the input variable.		Correct the parameter so that the valid range of the input variable is not exceeded for the relevant instruction.		Set the input parameter to the instruction so that the valid range of the input variable is not exceeded.
Attached information	Attached Information 1: Error Location Attached Information 3: Names of the Instruction and Instruction Instance Where the Error Occurred. If there is more than one possible instruction, information is given on all of them. Nothing is given if the instruction cannot be identified.				
Precautions/Remarks	If a program is changed after an error occurs, the attached information that is displayed may not be correct.				

Event name	Synchronization Start Condition Selection Out of Range		Event code	54015435 hex		
Meaning	The parameter specified for the <i>LinkOption</i> input variable to a motion control instruction is out of range.					
Source	PLC Function Module		Source details	Instruction	Detection timing	At instruction execution
Error attributes	Level	Observation	Recovery	---	Log category	System
Effects	User program	Continues.	Operation	The relevant instruction will end according to specifications.		
System-defined variables	Variable		Data type		Name	
	_MC_AX[*].MFAultLvl.Active		BOOL		Axis Minor Fault Occurrence	
Cause and correction	Assumed cause		Correction		Prevention	
	Instruction input parameter exceeded the valid range of the input variable.		Correct the parameter so that the valid range of the input variable is not exceeded for the relevant instruction.		Set the input parameter to the instruction so that the valid range of the input variable is not exceeded.	
Attached information	Attached Information 1: Error Location Attached Information 3: Names of the Instruction and Instruction Instance Where the Error Occurred. If there is more than one possible instruction, information is given on all of them. Nothing is given if the instruction cannot be identified.					
Precautions/Remarks	If a program is changed after an error occurs, the attached information that is displayed may not be correct.					

Event name	Master and Slave Defined as Same Axis		Event code	54015436 hex		
Meaning	The same axis is specified for the <i>Master</i> and <i>Slave</i> input variables to a motion control instruction.					
Source	PLC Function Module		Source details	Instruction	Detection timing	At instruction execution
Error attributes	Level	Observation	Recovery	---	Log category	System
Effects	User program	Continues.	Operation	The relevant instruction will end according to specifications.		
System-defined variables	Variable		Data type		Name	
	_MC_COM.MFAultLvl.Active		BOOL		MC Common Minor Fault Occurrence	
	_MC_AX[*].MFAultLvl.Active		BOOL		Axis Minor Fault Occurrence	
Cause and correction	Assumed cause		Correction		Prevention	
	The parameter is the same for the <i>Master</i> and <i>Slave</i> input variables to the instruction.		Correct the parameters so that different axes are specified for the <i>Master</i> and <i>Slave</i> input variables to the instruction.		Specify different axes for the <i>Master</i> and <i>Slave</i> input variables to the instruction.	
Attached information	Attached Information 1: Error Location Attached Information 3: Names of the Instruction and Instruction Instance Where the Error Occurred. If there is more than one possible instruction, information is given on all of them. Nothing is given if the instruction cannot be identified.					
Precautions/Remarks	If a program is changed after an error occurs, the attached information that is displayed may not be correct.					

Event name	Master and Auxiliary Defined as Same Axis		Event code	54015437 hex	
Meaning	The same axis is specified for the <i>Master</i> and <i>Auxiliary</i> input variables to a motion control instruction.				
Source	PLC Function Module		Source details	Instruction	Detection timing At instruction execution
Error attributes	Level	Observation	Recovery	---	Log category System
Effects	User program	Continues.	Operation	The relevant instruction will end according to specifications.	
System-defined variables	Variable	Data type		Name	
	_MC_AX[*].MFAultLvl.Active	BOOL		Axis Minor Fault Occurrence	
Cause and correction	Assumed cause	Correction		Prevention	
	The parameter is the same for the <i>Master</i> and <i>Auxiliary</i> input variables to the instruction.	Correct the parameters so that different axes are specified for the <i>Master</i> and <i>Auxiliary</i> input variables to the instruction.		Specify different axes for the <i>Master</i> and <i>Auxiliary</i> input variables to the instruction.	
Attached information	Attached Information 1: Error Location Attached Information 3: Names of the Instruction and Instruction Instance Where the Error Occurred. If there is more than one possible instruction, information is given on all of them. Nothing is given if the instruction cannot be identified.				
Precautions/Remarks	If a program is changed after an error occurs, the attached information that is displayed may not be correct.				

Event name	Master/Slave Axis Numbers Not in Ascending Order		Event code	54015438 hex	
Meaning	The axis numbers specified for the <i>Master</i> and <i>Slave</i> input variables to a motion control instruction are not in ascending order.				
Source	PLC Function Module		Source details	Instruction	Detection timing At instruction execution
Error attributes	Level	Observation	Recovery	---	Log category System
Effects	User program	Continues.	Operation	The relevant instruction will end according to specifications.	
System-defined variables	Variable	Data type		Name	
	_MC_AX[*].MFAultLvl.Active	BOOL		Axis Minor Fault Occurrence	
Cause and correction	Assumed cause	Correction		Prevention	
	The parameters for the <i>Master</i> and <i>Slave</i> input variables to the instruction were not in ascending order when <i>_mcLatestCommand</i> was specified for the <i>ReferenceType</i> input variable to the instruction.	When specifying <i>_mcLatestCommand</i> for the <i>ReferenceType</i> input variable to the instruction, correct the parameters so that the axis numbers specified for the <i>Master</i> and <i>Slave</i> input variables to the instruction are in ascending order. Or, specify <i>_mcCommand</i> for the Master Axis Position Type Selection.		When specifying <i>_mcLatestCommand</i> for the <i>ReferenceType</i> input variable, make sure to specify the master axis and slave axis input variables so that they are in ascending order.	
Attached information	Attached Information 1: Error Location Attached Information 3: Names of the Instruction and Instruction Instance Where the Error Occurred. If there is more than one possible instruction, information is given on all of them. Nothing is given if the instruction cannot be identified.				
Precautions/Remarks	If a program is changed after an error occurs, the attached information that is displayed may not be correct.				

Event name	Incorrect Cam Table Specification		Event code	54015439 hex	
Meaning	The parameter specified for the <i>CamTable</i> input variable to a motion control instruction is out of range.				
Source	PLC Function Module		Source details	Instruction	Detection timing At instruction execution
Error attributes	Level	Observation	Recovery	---	Log category System
Effects	User program	Continues.	Operation	The relevant instruction will end according to specifications.	
System-defined variables	Variable	Data type		Name	
	_MC_COM.MFaultLvl.Active	BOOL		MC Common Minor Fault Occurrence	
	_MC_AX[*].MFaultLvl.Active	BOOL		Axis Minor Fault Occurrence	
Cause and correction	Assumed cause		Correction		Prevention
	Something other than a cam data variable was specified for the <i>CamTable</i> input variable to the instruction.		Correct the parameter specified for the <i>CamTable</i> input variable to the instruction so that it is a cam data variable.		Specify a cam data variable for the <i>CamTable</i> input variable to the instruction.
Attached information	Attached Information 1: Error Location Attached Information 3: Names of the Instruction and Instruction Instance Where the Error Occurred. If there is more than one possible instruction, information is given on all of them. Nothing is given if the instruction cannot be identified.				
Precautions/Remarks	If a program is changed after an error occurs, the attached information that is displayed may not be correct.				

Event name	Synchronization Stopped		Event code	5401543A hex	
Meaning	A synchronized control motion control instruction was executed, but conditions required for execution were not met.				
Source	PLC Function Module		Source details	Instruction	Detection timing At instruction execution
Error attributes	Level	Observation	Recovery	---	Log category System
Effects	User program	Continues.	Operation	The relevant instruction will end according to specifications.	
System-defined variables	Variable	Data type		Name	
	_MC_AX[*].MFAultLvl.Active	BOOL		Axis Minor Fault Occurrence	
Cause and correction	Assumed cause	Correction		Prevention	
	<ul style="list-style-type: none"> The MC_CamOut (End Cam Operation) instruction was executed even though the MC_CamIn (Start Cam Operation) instruction is not being executed. The MC_GearOut (End Gear Operation) instruction was executed even though the MC_GearIn (Start Gear Operation) or the MC_GearInPos (Positioning Gear Operation) instruction is not being executed. The MC_Phasing (Shift Master Axis Phase) instruction was executed even though the MC_CamIn (Start Cam Operation), MC_GearIn (Start Gear Operation), MC_GearInPos (Start Gear Operation), or MC_MoveLink (Synchronous Positioning) instruction is not being executed. 	Correct the program so that required conditions are met when the instruction is executed.		Make sure that required conditions for execution are met when you execute synchronized control instructions.	
Attached information	Attached Information 1: Error Location Attached Information 3: Names of the Instruction and Instruction Instance Where the Error Occurred. If there is more than one possible instruction, information is given on all of them. Nothing is given if the instruction cannot be identified.				
Precautions/Remarks	If a program is changed after an error occurs, the attached information that is displayed may not be correct.				

Event name	Motion Control Instruction Re-execution Disabled		Event code	5401543B hex	
Meaning	An attempt was made to re-execute a motion control instruction that cannot be re-executed.				
Source	PLC Function Module		Source details	Instruction	Detection timing At instruction execution
Error attributes	Level	Observation	Recovery	---	Log category System
Effects	User program	Continues.	Operation	The relevant instruction will end according to specifications.	
System-defined variables	Variable		Data type		Name
	_MC_COM.MFaultLvl.Active		BOOL		MC Common Minor Fault Occurrence
	_MC_AX[*].MFaultLvl.Active		BOOL		Axis Minor Fault Occurrence
		_MC_GRP[*].MFaultLvl.Active		Axes Group Minor Fault Occurrence	
Cause and correction	Assumed cause		Correction		Prevention
	A motion control instruction that cannot be re-executed was re-executed.		Correct the program so that the <i>Execute</i> input variable does not change to TRUE until the <i>Busy</i> output variable from the instruction changes to FALSE.		When using instructions that cannot be re-executed, include a condition for the <i>Execute</i> input variable so that it does not change to TRUE unless the <i>Busy</i> output variable for the previous instruction is FALSE. Or, stop the instruction before executing it again.
Attached information	Attached Information 1: Error Location Attached Information 3: Names of the Instruction and Instruction Instance Where the Error Occurred. If there is more than one possible instruction, information is given on all of them. Nothing is given if the instruction cannot be identified.				
Precautions/Remarks	If a program is changed after an error occurs, the attached information that is displayed may not be correct.				

Event name	Motion Control Instruction Multi-execution Disabled		Event code	5401543C hex		
Meaning	Multiple functions that cannot be executed simultaneously were executed for the same target (MC common, axis, or axes group).					
Source	PLC Function Module		Source details	Instruction	Detection timing	At multi-execution of instructions
Error attributes	Level	Observation	Recovery	---	Log category	System
Effects	User program	Continues.	Operation	The relevant instruction will end according to specifications.		
System-defined variables	Variable	Data type		Name		
	_MC_COM.MFaultLvl.Active	BOOL		MC Common Minor Fault Occurrence		
	_MC_AX[*].MFaultLvl.Active	BOOL		Axis Minor Fault Occurrence		
System-defined variables	_MC_GRP[*].MFaultLvl.Active	BOOL		Axes Group Minor Fault Occurrence		
	Assumed cause	Correction		Prevention		
	Multiple functions that cannot be executed simultaneously were executed for the same target (MC common or axis).	Check the specifications of multi-execution of instructions for this instruction and correct the program so that instructions that cannot be executed at the same time are not executed simultaneously.		Check the specifications for multi-execution of instructions for the instruction and do not execute instructions that cannot be executed at the same time.		
Attached information	Attached Information 1: Error Location Attached Information 3: Names of the Instruction and Instruction Instance Where the Error Occurred. If there is more than one possible instruction, information is given on all of them. Nothing is given if the instruction cannot be identified.					
Precautions/Remarks	If a program is changed after an error occurs, the attached information that is displayed may not be correct.					

Event name	Instruction Not Allowed for Encoder Axis Type		Event code	5401543D hex		
Meaning	An operation instruction was executed for an encoder axis.					
Source	PLC Function Module		Source details	Instruction	Detection timing	At instruction execution
Error attributes	Level	Observation	Recovery	---	Log category	System
Effects	User program	Continues.	Operation	The relevant instruction will end according to specifications.		
System-defined variables	Variable	Data type		Name		
	_MC_AX[*].MFaultLvl.Active	BOOL		Axis Minor Fault Occurrence		
	Assumed cause	Correction		Prevention		
System-defined variables	An operation instruction was executed for an encoder axis.	Specify either a Servo axis or virtual Servo axis as the axis type for the instruction, or correct the program so that the instruction is not executed for an encoder axis.		Only execute motion instructions for Servo axes or virtual Servo axes.		
Attached information	Attached Information 1: Error Location Attached Information 3: Names of the Instruction and Instruction Instance Where the Error Occurred. If there is more than one possible instruction, information is given on all of them. Nothing is given if the instruction cannot be identified.					
Precautions/Remarks	If a program is changed after an error occurs, the attached information that is displayed may not be correct.					

Event name	Instruction Cannot Be Executed during Multi-axes Coordinated Control		Event code	5401543E hex		
Meaning	<ul style="list-style-type: none"> An operation instruction was executed for an axis or an axes group that was in a coordinated multi-axes motion. A robot instruction that you cannot use for an axes group in a GroupEnable state was executed. 					
Source	PLC Function Module		Source details	Instruction	Detection timing	At multi-execution of instructions
Error attributes	Level	Observation	Recovery	---	Log category	System
Effects	User program	Continues.	Operation	The relevant instruction will end according to specifications.		
System-defined variables	Variable	Data type		Name		
	_MC_AX[*].MFAultLvl.Active	BOOL		Axis Minor Fault Occurrence		
	_MC_GRP[*].MFAultLvl.Active	BOOL		Axes Group Minor Fault Occurrence		
Cause and correction	Assumed cause	Correction		Prevention		
	An operation instruction was executed for an axis or an axes group that was in a coordinated multi-axes motion.	Correct the program so that axis operation instructions are executed only for axes or axes groups that are not in coordinated multi-axes motion.		Execute axis operation instructions only for axes or axes groups that are not in coordinated multi-axes motion.		
	The MC_SetKinTransform (Set Kinematics Transformation) instruction was executed for an axes group in a GroupEnable state.	Correct the program so that the instruction is executed only when the axes group is in a GroupDisable state.		Execute the instruction only when the axes group is in a GroupDisable state.		
Attached information	Attached Information 1: Error Location Attached Information 3: Names of the Instruction and Instruction Instance Where the Error Occurred. If there is more than one possible instruction, information is given on all of them. Nothing is given if the instruction cannot be identified.					
Precautions/Remarks	If a program is changed after an error occurs, the attached information that is displayed may not be correct.					

Event name	Multi-axes Coordinated Control Instruction Executed for Disabled Axes Group		Event code	5401543F hex	
Meaning	A multi-axes coordinated control instruction was executed for an axes group that was in a GroupDisable state.				
Source	PLC Function Module		Source details	Instruction	Detection timing At instruction execution
Error attributes	Level	Observation	Recovery	---	Log category System
Effects	User program	Continues.	Operation	The relevant instruction will end according to specifications.	
System-defined variables	Variable	Data type		Name	
	_MC_GRP[*].MFAultLvl.Active	BOOL		Axes Group Minor Fault Occurrence	
Cause and correction	Assumed cause	Correction		Prevention	
	A multi-axes coordinated control instruction was executed for an axes group that was in a GroupDisable state.	Correct the program so that the instruction is executed only after changing the axes group to the Axes Group Enabled state. Execute the MC_GroupEnable (Enable Axes Group) instruction to change an axes group to the Axes Group Enabled state.		Execute multi-axes coordinated operation instructions only after enabling the axes group. Execute the MC_GroupEnable (Enable Axes Group) instruction to change an axes group to the Axes Group Enabled state.	
	One of the following instructions was executed for an axes group that was in a GroupDisable state. <ul style="list-style-type: none"> Execute the instruction only when the axes group is in a GroupDisable state. MC_SyncLinearConveyor (Start Conveyor Synchronization) instruction MC_SyncOut (End Synchronization) instruction MC_RobotJog (Axes Group Jog) instruction 				
Attached information	Attached Information 1: Error Location Attached Information 3: Names of the Instruction and Instruction Instance Where the Error Occurred. If there is more than one possible instruction, information is given on all of them. Nothing is given if the instruction cannot be identified.				
Precautions/Remarks	If a program is changed after an error occurs, the attached information that is displayed may not be correct.				

Event name	Axes Group Cannot Be Enabled		Event code	54015440 hex	
Meaning	Execution of the MC_GroupEnable (Enable Axes Group) instruction failed.				
Source	PLC Function Module		Source details	Instruction	Detection timing At instruction execution
Error attributes	Level	Observation	Recovery	---	Log category System
Effects	User program	Continues.	Operation	The relevant instruction will end according to specifications.	
System-defined variables	Variable	Data type		Name	
	_MC_GRP[*].MFAultLvl.Active	BOOL		Axes Group Minor Fault Occurrence	
Cause and correction	Assumed cause	Correction		Prevention	
	When the MC_GroupEnable (Enable Axes Group) instruction was executed, there was a composition axis that was not stopped.	Correct the program so that the MC_GroupEnable (Enable Axes Group) instruction is executed only when all composition axes are stopped. An axis is stopped if <i>Status.Disabled</i> or <i>Status.Standstill</i> is TRUE in the Axis Variable.		Write the programs so that the MC_GroupEnable (Enable Axes Group) instruction is executed only when all composition axes are stopped. An axis is stopped if <i>Status.Disabled</i> or <i>Status.Standstill</i> is TRUE in the Axis Variable.	
	When the MC_GroupEnable (Enable Axes Group) instruction was executed, there was a composition axis for which the MC_TouchProbe (Enable External Latch) instruction was being executed.	Correct the program so that the MC_GroupEnable (Enable Axes Group) instruction is executed only when the MC_TouchProbe (Enable External Latch) instruction is not being executed for any of the composition axes.		Write the program so that the MC_GroupEnable (Enable Axes Group) instruction is executed only when the MC_TouchProbe (Enable External Latch) instruction is not being executed for any of the composition axes.	
Attached information	Attached Information 1: Error Location Attached Information 3: Names of the Instruction and Instruction Instance Where the Error Occurred. If there is more than one possible instruction, information is given on all of them. Nothing is given if the instruction cannot be identified.				
Precautions/Remarks	If a program is changed after an error occurs, the attached information that is displayed may not be correct.				

Event name	Impossible Axis Operation Specified when the Servo is OFF		Event code	54015441 hex	
Meaning	An operation instruction was executed for an axis for which the Servo is OFF.				
Source	PLC Function Module		Source details	Instruction	Detection timing At instruction execution
Error attributes	Level	Observation	Recovery	---	Log category System
Effects	User program	Continues.	Operation	The relevant instruction will end according to specifications.	
System-defined variables	Variable		Data type		Name
	_MC_AX[*].MFaultLvl.Active		BOOL		Axis Minor Fault Occurrence
	_MC_GRP[*].MFaultLvl.Active		BOOL		Axes Group Minor Fault Occurrence
Cause and correction	Assumed cause		Correction		Prevention
	An operation instruction was executed for an axis for which the Servo is OFF.		Correct the program so that the instruction is executed after the Servo is turned ON.		Make sure to execute the axis operation instruction after the Servo is turned ON.
Home was preset with the MC_Home or MC_HomeWithParameter instruction for an axis for which EtherCAT process data communications are not established.		If the <code>_EC_PDSlavTbl</code> (Process Data Communicating Slave Table) systemdefined variable for the EtherCAT master of the master axis is FALSE, remove the cause and execute the MC_Home or MC_HomeWithParameter instruction to preset home after <code>_EC_PDSlavTbl</code> changes to TRUE.		If you execute the MC_Home or MC_HomeWithParameter instruction to preset home immediately after you turn ON the power supply to the Controller, download data, reset a slave communications error, disconnect the slave, reconnect the slave, enable the slave, or disable the slave, write the program to make sure that the <code>_EC_PDSlavTbl</code> (Process Data Communicating Slave Table) systemdefined variable for the EtherCAT master is TRUE before you execute MC_Home or MC_HomeWithParameter.	
Attached information	Attached Information 1: Error Location Attached Information 3: Names of the Instruction and Instruction Instance Where the Error Occurred. If there is more than one possible instruction, information is given on all of them. Nothing is given if the instruction cannot be identified.				
Precautions/Remarks	If a program is changed after an error occurs, the attached information that is displayed may not be correct.				

Event name	Composition Axis Stopped Error		Event code	54015442 hex		
Meaning	A motion instruction was executed for an axes group while the MC_Stop instruction was being executed for a composition axis.					
Source	PLC Function Module		Source details	Instruction	Detection timing	At instruction execution
Error attributes	Level	Observation	Recovery	---	Log category	System
Effects	User program	Continues.	Operation	The relevant instruction will end according to specifications.		
System-defined variables	Variable		Data type		Name	
	_MC_GRP[*].MFaultLvl.Active		BOOL		Axes Group Minor Fault Occurrence	
Cause and correction	Assumed cause		Correction		Prevention	
	A motion instruction was executed for an axes group while the MC_Stop instruction was being executed for a composition axis.		Change the <i>Execute</i> input variable to the MC_Stop instruction for the composition axis to FALSE, reset the error, and then execute the motion control instruction.		Change the <i>Execute</i> input variables to the MC_Stop instructions for all of the composition axes to FALSE before you execute motion control instruction.	
Attached information	Attached Information 1: Error Location Attached Information 3: Names of the Instruction and Instruction Instance Where the Error Occurred. If there is more than one possible instruction, information is given on all of them. Nothing is given if the instruction cannot be identified.					
Precautions/Remarks	If a program is changed after an error occurs, the attached information that is displayed may not be correct.					

Event name	Motion Control Instruction Multi-execution Buffer Limit Exceeded		Event code	54015443 hex		
Meaning	The number of motion control instructions that is buffered for Buffered or Blending Buffer Modes exceeded the buffer limit.					
Source	PLC Function Module		Source details	Instruction	Detection timing	At multi-execution of instructions
Error attributes	Level	Observation	Recovery	---	Log category	System
Effects	User program	Continues.	Operation	The relevant instruction will end according to specifications.		
System-defined variables	Variable		Data type		Name	
	_MC_AX[*].MFaultLvl.Active		BOOL		Axis Minor Fault Occurrence	
	_MC_GRP[*].MFaultLvl.Active		BOOL		Axes Group Minor Fault Occurrence	
Cause and correction	Assumed cause		Correction		Prevention	
	An axis instruction was executed when there was already a current instruction and a buffered instruction for the same axis.		Correct the program so that the number of executed instructions does not exceed the buffer limit.		Do not execute an axis instruction when there is already a current instruction and a buffered instruction for the same axis.	
An axes group instruction was executed when there was already eight current instructions and buffered instructions for the same axis.		Do not execute an axes group instruction when there are already eight current and buffered instructions for the same axis.				
Attached information	Attached Information 1: Error Location Attached Information 3: Names of the Instruction and Instruction Instance Where the Error Occurred. If there is more than one possible instruction, information is given on all of them. Nothing is given if the instruction cannot be identified.					
Precautions/Remarks	If a program is changed after an error occurs, the attached information that is displayed may not be correct.					

Event name	Insufficient Travel Distance		Event code	54015444 hex	
Meaning	The specified motion cannot be executed for the deceleration rate or acceleration rate that was specified for multi-execution or re-execution of a positioning instruction.				
Source	PLC Function Module		Source details	Instruction	Detection timing At instruction execution
Error attributes	Level	Observation	Recovery	---	Log category System
Effects	User program	Continues.	Operation	The relevant instruction will end according to specifications.	
System-defined variables	Variable	Data type		Name	
	_MC_AX[*].MFaultLvl.Active	BOOL		Axis Minor Fault Occurrence	
	_MC_GRP[*].MFaultLvl.Active	BOOL		Axes Group Minor Fault Occurrence	
Cause and correction	Assumed cause		Correction		Prevention
	Stopping at the target position was not possible for the specified acceleration/deceleration rate for multi-execution or re-execution of a positioning instruction when the Acceleration/Deceleration Over parameter was set to generate a minor fault and stop.		Correct the program based on the operating specifications for the instruction so that the target position is not exceeded at the deceleration rate or acceleration rate specified for multi-execution or re-execution of the positioning instruction. Or, change the Acceleration/Deceleration Over parameter to a setting other than to generate a minor fault and stop.		Check the operating specifications for the relevant instruction and write the program so that this error does not occur. Or, change the Acceleration/Deceleration Over parameter to a setting other than to generate a minor fault and stop.
Attached information	Attached Information 1: Error Location Attached Information 3: Names of the Instruction and Instruction Instance Where the Error Occurred. If there is more than one possible instruction, information is given on all of them. Nothing is given if the instruction cannot be identified.				
Precautions/Remarks	If a program is changed after an error occurs, the attached information that is displayed may not be correct.				

Event name	Insufficient Travel Distance to Achieve Blending Transit Velocity		Event code	54015445 hex		
Meaning	There is not sufficient travel distance to accelerate or decelerate to the transit velocity.					
Source	PLC Function Module		Source details	Instruction	Detection timing	At multi-execution of instructions
Error attributes	Level	Observation	Recovery	---	Log category	System
Effects	User program	Continues.	Operation	The relevant instruction will end according to specifications.		
System-defined variables	Variable		Data type		Name	
	_MC_AX[*].MFAultLvl.Active		BOOL		Axis Minor Fault Occurrence	
	_MC_GRP[*].MFAultLvl.Active		BOOL		Axes Group Minor Fault Occurrence	
Cause and correction	Assumed cause		Correction		Prevention	
	There was not sufficient travel distance to accelerate the current command to the transit velocity when the Acceleration/Deceleration Over parameter was set to generate a minor fault and stop.		Correct the program to allow a sufficient travel distance according to the operating specifications of the instruction. Or, change the Acceleration/Deceleration Over parameter to a setting other than to generate a minor fault and stop.		Check the operating specifications for the relevant instruction and write the program so that this error does not occur. Or, change the Acceleration/Deceleration Over parameter to a setting other than to generate a minor fault and stop.	
Attached information	Attached Information 1: Error Location Attached Information 3: Names of the Instruction and Instruction Instance Where the Error Occurred. If there is more than one possible instruction, information is given on all of them. Nothing is given if the instruction cannot be identified.					
Precautions/Remarks	If a program is changed after an error occurs, the attached information that is displayed may not be correct.					

Event name	Move Link Constant Velocity Insufficient Travel Distance		Event code	54015446 hex		
Meaning	The constant-velocity travel distance of the master axis is less than zero.					
Source	PLC Function Module		Source details	Instruction	Detection timing	At instruction execution
Error attributes	Level	Observation	Recovery	---	Log category	System
Effects	User program	Continues.	Operation	The relevant instruction will end according to specifications.		
System-defined variables	Variable		Data type		Name	
	_MC_AX[*].MFAultLvl.Active		BOOL		Axis Minor Fault Occurrence	
Cause and correction	Assumed cause		Correction		Prevention	
	The constant velocity travel distance of the master axis is below 0 for the MC_MoveLink (Synchronous Positioning) instruction.		Correct the program so that the master distance is greater than or equal to the master distance in acceleration plus the master distance in deceleration.		Check the operating specifications for the relevant instruction and write the program so that this error does not occur.	
Attached information	Attached Information 1: Error Location Attached Information 3: Names of the Instruction and Instruction Instance Where the Error Occurred. If there is more than one possible instruction, information is given on all of them. Nothing is given if the instruction cannot be identified.					
Precautions/Remarks	If a program is changed after an error occurs, the attached information that is displayed may not be correct.					

Event name	Positioning Gear Operation Insufficient Target Velocity		Event code	54015447 hex	
Meaning	For the MC_GearInPos (Positioning Gear Operation) instruction, the target velocity of the slave axis is too small to achieve the required velocity.				
Source	PLC Function Module		Source details	Instruction	Detection timing At instruction execution
Error attributes	Level	Observation	Recovery	---	Log category System
Effects	User program	Continues.	Operation	The relevant instruction will end according to specifications.	
System-defined variables	Variable	Data type		Name	
	_MC_AX[*].MFAultLvl.Active	BOOL		Axis Minor Fault Occurrence	
Cause and correction	Assumed cause		Correction		Prevention
	For the MC_GearInPos (Positioning Gear Operation) instruction, the value of the <i>Velocity (Target Velocity)</i> input variable is smaller than the master axis velocity multiplied by the gear ratio when the instruction was executed.		Set the value of the <i>Velocity (Target Velocity)</i> input variable to a value that is greater than the master axis velocity multiplied by the gear ratio when the instruction is executed based on the operating specifications of the instruction.		Check the operating specifications for the relevant instruction and write the program so that this error does not occur.
Attached information	Attached Information 1: Error Location Attached Information 3: Names of the Instruction and Instruction Instance Where the Error Occurred. If there is more than one possible instruction, information is given on all of them. Nothing is given if the instruction cannot be identified.				
Precautions/Remarks	If a program is changed after an error occurs, the attached information that is displayed may not be correct.				

Event name	Same Start Point and End Point for Circular Interpolation		Event code	54015448 hex		
Meaning	The start point and end point were the same when the radius method was specified for the MC_MoveCircular2D (Circular 2D Interpolation) instruction. Or, the start point, end point, and border point were the same when the border point method was specified.					
Source	PLC Function Module		Source details	Instruction	Detection timing	At instruction execution
Error attributes	Level	Observation	Recovery	---	Log category	System
Effects	User program	Continues.	Operation	The relevant instruction will end according to specifications.		
System-defined variables	Variable	Data type		Name		
	_MC_GRP[*].MFAultLvl.Active	BOOL		Axes Group Minor Fault Occurrence		
Cause and correction	Assumed cause	Correction		Prevention		
	The start point and end point were the same when the radius method was specified for the MC_MoveCircular2D (Circular 2D Interpolation) instruction.	Correct the program so that the radius specification is not used when the start point and end point for the instruction are the same.		Do not use the same start point and end point when you execute circular interpolation with a radius specification.		
	The start point, end point, and border point were the same when the border point method was specified for the MC_MoveCircular2D (Circular 2D Interpolation) instruction.	Correct the program so that border point specification is not used when the start point, end point, and border point for the instruction are the same.		Do not use the same start point, end point, and border point when you execute circular interpolation with a border point specification.		
Attached information	Attached Information 1: Error Location Attached Information 3: Names of the Instruction and Instruction Instance Where the Error Occurred. If there is more than one possible instruction, information is given on all of them. Nothing is given if the instruction cannot be identified.					
Precautions/Remarks	If a program is changed after an error occurs, the attached information that is displayed may not be correct.					

Event name	Circular Interpolation Center Specification Position Out of Range		Event code	54015449 hex		
Meaning	The position specified for the center point exceeded the allowed range when the center method was specified for the MC_MoveCircular2D (Circular 2D Interpolation) instruction.					
Source	PLC Function Module		Source details	Instruction	Detection timing	At instruction execution
Error attributes	Level	Observation	Recovery	---	Log category	System
Effects	User program	Continues.	Operation	The relevant instruction will end according to specifications.		
System-defined variables	Variable	Data type		Name		
	_MC_GRP[*].MFaultLvl.Active	BOOL		Axes Group Minor Fault Occurrence		
Cause and correction	Assumed cause		Correction		Prevention	
	The difference between the distance from the start point to the center point and the distance between the end point to the center point exceeded the permitted value specified for the correction allowance ratio in the axes group settings when the center designation method was specified for the MC_MoveCircular2D (Circular 2D Interpolation) instruction.		Correct the center point so that the difference between the distance from the start point to the center point input variables and the distance between the end point to the center point input variables is less than the permitted value specified for the correction allowance ratio in the axes group settings.		Correct the difference between the distance from the start point to the center point and the distance between the end point to the center point so that it does not exceed the correction allowance ratio in the axes group settings.	
Attached information	Attached Information 1: Error Location Attached Information 3: Names of the Instruction and Instruction Instance Where the Error Occurred. If there is more than one possible instruction, information is given on all of them. Nothing is given if the instruction cannot be identified.					
Precautions/Remarks	If a program is changed after an error occurs, the attached information that is displayed may not be correct.					

Event name	Instruction Execution Error Caused by Count Mode Setting		Event code	5401544A hex		
Meaning	An instruction that cannot be used when the Count Mode is set to Rotary Mode was executed for an axis that was set to Rotary Mode.					
Source	PLC Function Module		Source details	Instruction	Detection timing	At instruction execution
Error attributes	Level	Observation	Recovery	---	Log category	System
Effects	User program	Continues.	Operation	The relevant instruction will end according to specifications.		
System-defined variables	Variable	Data type		Name		
	_MC_GRP[*].MFaultLvl.Active	BOOL		Axes Group Minor Fault Occurrence		
Cause and correction	Assumed cause		Correction		Prevention	
	An instruction that cannot be used when the Count Mode is set to Rotary Mode was executed for an axis that was set to Rotary Mode.		Change the Count Mode of the relevant axis to Linear Mode.		Confirm the Count Mode in which you can execute the instruction and set the correct Count Mode for the axis.	
Attached information	Attached Information 1: Error Location Attached Information 3: Names of the Instruction and Instruction Instance Where the Error Occurred. If there is more than one possible instruction, information is given on all of them. Nothing is given if the instruction cannot be identified.					
Precautions/Remarks	If a program is changed after an error occurs, the attached information that is displayed may not be correct.					

Event name	Parameter Selection Out of Range		Event code	5401544C hex		
Meaning	The parameter specified for the <i>ParameterNumber</i> input variable to a motion control instruction is out of range.					
Source	PLC Function Module		Source details	Instruction	Detection timing	At instruction execution
Error attributes	Level	Observation	Recovery	---	Log category	System
Effects	User program	Continues.	Operation	The relevant instruction will end according to specifications.		
System-defined variables	Variable	Data type		Name		
	_MC_COM.MFaultLvl.Active	BOOL		MC Common Minor Fault Occurrence		
Cause and correction	Assumed cause		Correction		Prevention	
	Instruction input parameter exceeded the valid range of the input variable.		Correct the parameter so that the valid range of the input variable is not exceeded for the relevant instruction.		Set the input parameter to the instruction so that the valid range of the input variable is not exceeded.	
Attached information	Attached Information 1: Error Location Attached Information 3: Names of the Instruction and Instruction Instance Where the Error Occurred. If there is more than one possible instruction, information is given on all of them. Nothing is given if the instruction cannot be identified.					
Precautions/Remarks	If a program is changed after an error occurs, the attached information that is displayed may not be correct.					

Event name	Stop Method Selection Out of Range		Event code	5401544D hex		
Meaning	The parameter specified for the <i>StopMode</i> input variable to a motion control instruction is out of range.					
Source	PLC Function Module		Source details	Instruction	Detection timing	At instruction execution
Error attributes	Level	Observation	Recovery	---	Log category	System
Effects	User program	Continues.	Operation	The relevant instruction will end according to specifications.		
System-defined variables	Variable	Data type		Name		
	_MC_AX[*].MFaultLvl.Active	BOOL		Axis Minor Fault Occurrence		
Cause and correction	Assumed cause		Correction		Prevention	
	Instruction input parameter exceeded the valid range of the input variable.		Correct the parameter so that the valid range of the input variable is not exceeded for the relevant instruction.		Set the input parameter to the instruction so that the valid range of the input variable is not exceeded.	
Attached information	Attached Information 1: Error Location Attached Information 3: Names of the Instruction and Instruction Instance Where the Error Occurred. If there is more than one possible instruction, information is given on all of them. Nothing is given if the instruction cannot be identified.					
Precautions/Remarks	If a program is changed after an error occurs, the attached information that is displayed may not be correct.					

Event name	Latch ID Selection Out of Range for Trigger Input Condition		Event code	5401544E hex		
Meaning	The parameter specified for the <i>TriggerInput::LatchID</i> input variable to a motion control instruction is out of range.					
Source	PLC Function Module		Source details	Instruction	Detection timing	At instruction execution
Error attributes	Level	Observation	Recovery	---	Log category	System
Effects	User program	Continues.	Operation	The relevant instruction will end according to specifications.		
System-defined variables	Variable	Data type		Name		
	_MC_AX[*].MFAultLvl.Active	BOOL		Axis Minor Fault Occurrence		
Cause and correction	Assumed cause		Correction		Prevention	
	Instruction input parameter exceeded the valid range of the input variable.		Correct the parameter so that the valid range of the input variable is not exceeded for the relevant instruction.		Set the input parameter to the instruction so that the valid range of the input variable is not exceeded.	
Attached information	Attached Information 1: Error Location Attached Information 3: Names of the Instruction and Instruction Instance Where the Error Occurred. If there is more than one possible instruction, information is given on all of them. Nothing is given if the instruction cannot be identified.					
Precautions/Remarks	If a program is changed after an error occurs, the attached information that is displayed may not be correct.					

Event name	Setting Out of Range for Writing MC Setting		Event code	5401544F hex		
Meaning	The parameter specified for the <i>SettingValue</i> input variable to a motion control instruction is out of range.					
Source	PLC Function Module		Source details	Instruction	Detection timing	At instruction execution
Error attributes	Level	Observation	Recovery	---	Log category	System
Effects	User program	Continues.	Operation	The relevant instruction will end according to specifications.		
System-defined variables	Variable	Data type		Name		
	_MC_COM.MFAultLvl.Active	BOOL		MC Common Minor Fault Occurrence		
Cause and correction	Assumed cause		Correction		Prevention	
	Instruction input parameter exceeded the valid range of the input variable.		Correct the parameter so that the valid range of the input variable is not exceeded for the relevant instruction.		Set the input parameter to the instruction so that the valid range of the input variable is not exceeded.	
	The parameter specification and the data type of the setting value do not agree.		Make corrections so that the parameter settings and the data types of the settings agree.		Make sure the parameter settings and the data type of the setting values agree.	
Attached information	Attached Information 1: Error Location Attached Information 3: Names of the Instruction and Instruction Instance Where the Error Occurred. If there is more than one possible instruction, information is given on all of them. Nothing is given if the instruction cannot be identified.					
Precautions/Remarks	If a program is changed after an error occurs, the attached information that is displayed may not be correct.					

3 Error Descriptions and Corrections

Event name	Trigger Input Condition Mode Selection Out of Range		Event code	54015450 hex		
Meaning	The parameter specified for the <i>TriggerInput::Mode</i> input variable to a motion control instruction is out of range.					
Source	PLC Function Module		Source details	Instruction	Detection timing	At instruction execution
Error attributes	Level	Observation	Recovery	---	Log category	System
Effects	User program	Continues.	Operation	The relevant instruction will end according to specifications.		
System-defined variables	Variable		Data type		Name	
	_MC_AX[*].MFaultLvl.Active		BOOL		Axis Minor Fault Occurrence	
Cause and correction	Assumed cause		Correction		Prevention	
	Instruction input parameter exceeded the valid range of the input variable.		Correct the parameter so that the valid range of the input variable is not exceeded for the relevant instruction.		Set the input parameter to the instruction so that the valid range of the input variable is not exceeded.	
Attached information	Attached Information 1: Error Location Attached Information 3: Names of the Instruction and Instruction Instance Where the Error Occurred. If there is more than one possible instruction, information is given on all of them. Nothing is given if the instruction cannot be identified.					
Precautions/Remarks	If a program is changed after an error occurs, the attached information that is displayed may not be correct.					

Event name	Drive Trigger Signal Selection Out of Range for Trigger Input Condition		Event code	54015451 hex		
Meaning	The parameter specified for the <i>TriggerInput::InputDrive</i> input variable to a motion control instruction is out of range.					
Source	PLC Function Module		Source details	Instruction	Detection timing	At instruction execution
Error attributes	Level	Observation	Recovery	---	Log category	System
Effects	User program	Continues.	Operation	The relevant instruction will end according to specifications.		
System-defined variables	Variable		Data type		Name	
	_MC_AX[*].MFaultLvl.Active		BOOL		Axis Minor Fault Occurrence	
Cause and correction	Assumed cause		Correction		Prevention	
	Instruction input parameter exceeded the valid range of the input variable.		Correct the parameter so that the valid range of the input variable is not exceeded for the relevant instruction.		Set the input parameter to the instruction so that the valid range of the input variable is not exceeded.	
Attached information	Attached Information 1: Error Location Attached Information 3: Names of the Instruction and Instruction Instance Where the Error Occurred. If there is more than one possible instruction, information is given on all of them. Nothing is given if the instruction cannot be identified.					
Precautions/Remarks	If a program is changed after an error occurs, the attached information that is displayed may not be correct.					

Event name	Motion Control Instruction Re-execution Disabled (Axis Specification)		Event code	54015453 hex		
Meaning	An attempt was made to change the parameter for the Axis input variable when re-executing a motion control instruction. (This input variable cannot be changed when re-executing an instruction.)					
Source	PLC Function Module		Source details	Instruction	Detection timing	At instruction re-execution
Error attributes	Level	Observation	Recovery	---	Log category	System
Effects	User program	Continues.	Operation	The relevant instruction will end according to specifications.		
System-defined variables	Variable	Data type		Name		
	_MC_AX[*].MFaultLvl.Active	BOOL		Axis Minor Fault Occurrence		
Cause and correction	Assumed cause		Correction		Prevention	
	A parameter for an input variable that cannot be changed for re-execution was changed.		Correct the program so that the parameter for the relevant input variable does not change when the relevant instruction is re-executed.		Check the manual to see if the input variables to the relevant motion control instruction can be changed by re-execution. Write the program so that the input parameters for any input variable that cannot be changed do not change upon re-execution.	
Attached information	Attached Information 1: Error Location Attached Information 3: Names of the Instruction and Instruction Instance Where the Error Occurred. If there is more than one possible instruction, information is given on all of them. Nothing is given if the instruction cannot be identified.					
Precautions/Remarks	If a program is changed after an error occurs, the attached information that is displayed may not be correct.					

Event name	Motion Control Instruction Re-execution Disabled (Buffer Mode Selection)		Event code	54015454 hex		
Meaning	An attempt was made to change the parameter for the <i>BufferMode</i> input variable when re-executing a motion control instruction. (This input variable cannot be changed when re-executing an instruction.)					
Source	PLC Function Module		Source details	Instruction	Detection timing	At instruction re-execution
Error attributes	Level	Observation	Recovery	---	Log category	System
Effects	User program	Continues.	Operation	The relevant instruction will end according to specifications.		
System-defined variables	Variable		Data type		Name	
	_MC_AX[*].MFaultLvl.Active		BOOL		Axis Minor Fault Occurrence	
	_MC_GRP[*].MFaultLvl.Active		BOOL		Axes Group Minor Fault Occurrence	
Cause and correction	Assumed cause		Correction		Prevention	
	A parameter for an input variable that cannot be changed for re-execution was changed.		Correct the program so that the parameter for the relevant input variable does not change when the relevant instruction is re-executed.		Check the manual to see if the input variables to the relevant motion control instruction can be changed by re-execution. Write the program so that the input parameters for any input variable that cannot be changed do not change upon re-execution.	
Attached information	Attached Information 1: Error Location Attached Information 3: Names of the Instruction and Instruction Instance Where the Error Occurred. If there is more than one possible instruction, information is given on all of them. Nothing is given if the instruction cannot be identified.					
Precautions/Remarks	If a program is changed after an error occurs, the attached information that is displayed may not be correct.					

Event name	Motion Control Instruction Re-execution Disabled (Direction Selection)		Event code	54015455 hex		
Meaning	An attempt was made to change the parameter for the <i>Direction</i> input variable when re-executing a motion control instruction. (This input variable cannot be changed when re-executing an instruction.)					
Source	PLC Function Module		Source details	Instruction	Detection timing	At instruction re-execution
Error attributes	Level	Observation	Recovery	---	Log category	System
Effects	User program	Continues.	Operation	The relevant instruction will end according to specifications.		
System-defined variables	Variable	Data type		Name		
	_MC_AX[*].MFAultLvl.Active	BOOL		Axis Minor Fault Occurrence		
Cause and correction	Assumed cause		Correction		Prevention	
	An input variable that cannot be changed for re-execution was changed.		Correct the program so that the parameter for the relevant input variable does not change when the relevant instruction is re-executed.		Check the manual to see if the input variables to the relevant motion control instruction can be changed by re-execution. Write the program so that the input parameters for any input variable that cannot be changed do not change upon re-execution.	
Attached information	Attached Information 1: Error Location Attached Information 3: Names of the Instruction and Instruction Instance Where the Error Occurred. If there is more than one possible instruction, information is given on all of them. Nothing is given if the instruction cannot be identified.					
Precautions/Remarks	If a program is changed after an error occurs, the attached information that is displayed may not be correct.					

Event name	Motion Control Instruction Re-execution Disabled (Execution Mode)		Event code	54015456 hex		
Meaning	An attempt was made to change the parameter for the <i>Periodic</i> input variable when re-executing a motion control instruction. (This input variable cannot be changed when re-executing an instruction.)					
Source	PLC Function Module		Source details	Instruction	Detection timing	At instruction re-execution
Error attributes	Level	Observation	Recovery	---	Log category	System
Effects	User program	Continues.	Operation	The relevant instruction will end according to specifications.		
System-defined variables	Variable	Data type		Name		
	_MC_AX[*].MFAultLvl.Active	BOOL		Axis Minor Fault Occurrence		
Cause and correction	Assumed cause		Correction		Prevention	
	A parameter for an input variable that cannot be changed for re-execution was changed.		Correct the program so that the parameter for the relevant input variable does not change when the relevant instruction is re-executed.		Check the manual to see if the input variables to the relevant motion control instruction can be changed by re-execution. Write the program so that the input parameters for any input variable that cannot be changed do not change upon re-execution.	
Attached information	Attached Information 1: Error Location Attached Information 3: Names of the Instruction and Instruction Instance Where the Error Occurred. If there is more than one possible instruction, information is given on all of them. Nothing is given if the instruction cannot be identified.					
Precautions/Remarks	If a program is changed after an error occurs, the attached information that is displayed may not be correct.					

Event name	Motion Control Instruction Re-execution Disabled (Axes Group Specification)		Event code	54015457 hex		
Meaning	An attempt was made to change the parameter for the <i>AxesGroup</i> input variable when re-executing a motion control instruction. (This input variable cannot be changed when re-executing an instruction.)					
Source	PLC Function Module		Source details	Instruction	Detection timing	At instruction re-execution
Error attributes	Level	Observation	Recovery	---	Log category	System
Effects	User program	Continues.	Operation	The relevant instruction will end according to specifications.		
System-defined variables	Variable		Data type		Name	
	_MC_GRP[*].MFAultLvl.Active		BOOL		Axes Group Minor Fault Occurrence	
Cause and correction	Assumed cause		Correction		Prevention	
	A parameter for an input variable that cannot be changed for re-execution was changed.		Correct the program so that the parameter for the relevant input variable does not change when the relevant instruction is re-executed.		Check the manual to see if the input variables to the relevant motion control instruction can be changed by re-execution. Write the program so that the input parameters for any input variable that cannot be changed do not change upon re-execution.	
Attached information	Attached Information 1: Error Location Attached Information 3: Names of the Instruction and Instruction Instance Where the Error Occurred. If there is more than one possible instruction, information is given on all of them. Nothing is given if the instruction cannot be identified.					
Precautions/Remarks	If a program is changed after an error occurs, the attached information that is displayed may not be correct.					

Event name	Motion Control Instruction Re-execution Disabled (Jerk Setting)		Event code	54015458 hex		
Meaning	An attempt was made to change the parameter for the <i>Jerk</i> input variable when re-executing a motion control instruction. (This input variable cannot be changed when re-executing an instruction.)					
Source	PLC Function Module		Source details	Instruction	Detection timing	At instruction re-execution
Error attributes	Level	Observation	Recovery	---	Log category	System
Effects	User program	Continues.	Operation	The relevant instruction will end according to specifications.		
System-defined variables	Variable		Data type		Name	
	_MC_AX[*].MFaultLvl.Active		BOOL		Axis Minor Fault Occurrence	
	_MC_GRP[*].MFaultLvl.Active		BOOL		Axes Group Minor Fault Occurrence	
Cause and correction	Assumed cause		Correction		Prevention	
	A parameter for an input variable that cannot be changed for re-execution was changed.		Correct the program so that the parameter for the relevant input variable does not change when the relevant instruction is re-executed.		Check the manual to see if the input variables to the relevant motion control instruction can be changed by re-execution. Write the program so that the input parameters for any input variable that cannot be changed do not change upon re-execution.	
Attached information	Attached Information 1: Error Location Attached Information 3: Names of the Instruction and Instruction Instance Where the Error Occurred. If there is more than one possible instruction, information is given on all of them. Nothing is given if the instruction cannot be identified.					
Precautions/Remarks	If a program is changed after an error occurs, the attached information that is displayed may not be correct.					

Event name	Motion Control Instruction Re-execution Disabled (Master Axis)		Event code	54015459 hex		
Meaning	An attempt was made to change the parameter for the <i>Master</i> input variable when re-executing a motion control instruction. (This input variable cannot be changed when re-executing an instruction.)					
Source	PLC Function Module		Source details	Instruction	Detection timing	At instruction re-execution
Error attributes	Level	Observation	Recovery	---	Log category	System
Effects	User program	Continues.	Operation	The relevant instruction will end according to specifications.		
System-defined variables	Variable	Data type		Name		
	_MC_AX[*].MFAultLvl.Active	BOOL		Axis Minor Fault Occurrence		
Cause and correction	Assumed cause		Correction		Prevention	
	A parameter for an input variable that cannot be changed for re-execution was changed.		Correct the program so that the parameter for the relevant input variable does not change when the relevant instruction is re-executed.		Check the manual to see if the input variables to the relevant motion control instruction can be changed by re-execution. Write the program so that the input parameters for any input variable that cannot be changed do not change upon re-execution.	
Attached information	Attached Information 1: Error Location Attached Information 3: Names of the Instruction and Instruction Instance Where the Error Occurred. If there is more than one possible instruction, information is given on all of them. Nothing is given if the instruction cannot be identified.					
Precautions/Remarks	If a program is changed after an error occurs, the attached information that is displayed may not be correct.					

Event name	Motion Control Instruction Re-execution Disabled (MasterOffset)		Event code	5401545A hex		
Meaning	An attempt was made to change the parameter for the <i>MasterOffset</i> input variable when re-executing a motion control instruction. (This input variable cannot be changed when re-executing an instruction.)					
Source	PLC Function Module		Source details	Instruction	Detection timing	At instruction re-execution
Error attributes	Level	Observation	Recovery	---	Log category	System
Effects	User program	Continues.	Operation	The relevant instruction will end according to specifications.		
System-defined variables	Variable	Data type		Name		
	_MC_AX[*].MFAultLvl.Active	BOOL		Axis Minor Fault Occurrence		
Cause and correction	Assumed cause		Correction		Prevention	
	A parameter for an input variable that cannot be changed for re-execution was changed.		Correct the program so that the parameter for the relevant input variable does not change when the relevant instruction is re-executed.		Check the manual to see if the input variables to the relevant motion control instruction can be changed by re-execution. Write the program so that the input parameters for any input variable that cannot be changed do not change upon re-execution.	
Attached information	Attached Information 1: Error Location Attached Information 3: Names of the Instruction and Instruction Instance Where the Error Occurred. If there is more than one possible instruction, information is given on all of them. Nothing is given if the instruction cannot be identified.					
Precautions/Remarks	If a program is changed after an error occurs, the attached information that is displayed may not be correct.					

Event name	Motion Control Instruction Re-execution Disabled (MasterScaling)		Event code	5401545B hex		
Meaning	An attempt was made to change the parameter for the <i>MasterScaling</i> input variable when re-executing a motion control instruction. (This input variable cannot be changed when re-executing an instruction.)					
Source	PLC Function Module		Source details	Instruction	Detection timing	At instruction re-execution
Error attributes	Level	Observation	Recovery	---	Log category	System
Effects	User program	Continues.	Operation	The relevant instruction will end according to specifications.		
System-defined variables	Variable	Data type		Name		
	_MC_AX[*].MFAultLvl.Active	BOOL		Axis Minor Fault Occurrence		
Cause and correction	Assumed cause		Correction		Prevention	
	A parameter for an input variable that cannot be changed for re-execution was changed.		Correct the program so that the parameter for the relevant input variable does not change when the relevant instruction is re-executed.		Check the manual to see if the input variables to the relevant motion control instruction can be changed by re-execution. Write the program so that the input parameters for any input variable that cannot be changed do not change upon re-execution.	
Attached information	Attached Information 1: Error Location Attached Information 3: Names of the Instruction and Instruction Instance Where the Error Occurred. If there is more than one possible instruction, information is given on all of them. Nothing is given if the instruction cannot be identified.					
Precautions/Remarks	If a program is changed after an error occurs, the attached information that is displayed may not be correct.					

Event name	Motion Control Instruction Re-execution Disabled (MasterStartDistance)		Event code	5401545C hex		
Meaning	An attempt was made to change the parameter for the <i>MasterStartDistance</i> input variable when re-executing a motion control instruction. (This input variable cannot be changed when re-executing an instruction.)					
Source	PLC Function Module		Source details	Instruction	Detection timing	At instruction re-execution
Error attributes	Level	Observation	Recovery	---	Log category	System
Effects	User program	Continues.	Operation	The relevant instruction will end according to specifications.		
System-defined variables	Variable	Data type		Name		
	_MC_AX[*].MFAultLvl.Active	BOOL		Axis Minor Fault Occurrence		
Cause and correction	Assumed cause		Correction		Prevention	
	A parameter for an input variable that cannot be changed for re-execution was changed.		Correct the program so that the parameter for the relevant input variable does not change when the relevant instruction is re-executed.		Check the manual to see if the input variables to the relevant motion control instruction can be changed by re-execution. Write the program so that the input parameters for any input variable that cannot be changed do not change upon re-execution.	
Attached information	Attached Information 1: Error Location Attached Information 3: Names of the Instruction and Instruction Instance Where the Error Occurred. If there is more than one possible instruction, information is given on all of them. Nothing is given if the instruction cannot be identified.					
Precautions/Remarks	If a program is changed after an error occurs, the attached information that is displayed may not be correct.					

3 Error Descriptions and Corrections

Event name	Motion Control Instruction Re-execution Disabled (Continuous)		Event code	5401545D hex		
Meaning	An attempt was made to change the parameter for the <i>Continuous</i> input variable when re-executing a motion control instruction. (This input variable cannot be changed when re-executing an instruction.)					
Source	PLC Function Module		Source details	Instruction	Detection timing	At instruction re-execution
Error attributes	Level	Observation	Recovery	---	Log category	System
Effects	User program	Continues.	Operation	The relevant instruction will end according to specifications.		
System-defined variables	Variable		Data type		Name	
	_MC_AX[*].MFAultLvl.Active		BOOL		Axis Minor Fault Occurrence	
Cause and correction	Assumed cause		Correction		Prevention	
	A parameter for an input variable that cannot be changed for re-execution was changed.		Correct the program so that the parameter for the relevant input variable does not change when the relevant instruction is re-executed.		Check the manual to see if the input variables to the relevant motion control instruction can be changed by re-execution. Write the program so that the input parameters for any input variable that cannot be changed do not change upon re-execution.	
Attached information	Attached Information 1: Error Location Attached Information 3: Names of the Instruction and Instruction Instance Where the Error Occurred. If there is more than one possible instruction, information is given on all of them. Nothing is given if the instruction cannot be identified.					
Precautions/Remarks	If a program is changed after an error occurs, the attached information that is displayed may not be correct.					

Event name	Motion Control Instruction Re-execution Disabled (MoveMode)		Event code	5401545E hex		
Meaning	An attempt was made to change the parameter for the <i>MoveMode</i> input variable when re-executing a motion control instruction. (This input variable cannot be changed when re-executing an instruction.)					
Source	PLC Function Module		Source details	Instruction	Detection timing	At instruction re-execution
Error attributes	Level	Observation	Recovery	---	Log category	System
Effects	User program	Continues.	Operation	The relevant instruction will end according to specifications.		
System-defined variables	Variable		Data type		Name	
	_MC_AX[*].MFAultLvl.Active		BOOL		Axis Minor Fault Occurrence	
Cause and correction	Assumed cause		Correction		Prevention	
	A parameter for an input variable that cannot be changed for re-execution was changed.		Correct the program so that the parameter for the relevant input variable does not change when the relevant instruction is re-executed.		Check the manual to see if the input variables to the relevant motion control instruction can be changed by re-execution. Write the program so that the input parameters for any input variable that cannot be changed do not change upon re-execution.	
Attached information	Attached Information 1: Error Location Attached Information 3: Names of the Instruction and Instruction Instance Where the Error Occurred. If there is more than one possible instruction, information is given on all of them. Nothing is given if the instruction cannot be identified.					
Precautions/Remarks	If a program is changed after an error occurs, the attached information that is displayed may not be correct.					

Event name	Illegal Auxiliary Axis Specification			Event code	5401545F hex	
Meaning	The axis specified for the <i>Auxiliary</i> input variable to a motion control instruction does not exist.					
Source	PLC Function Module		Source details	Instruction	Detection timing	At instruction execution
Error attributes	Level	Observation	Recovery	---	Log category	System
Effects	User program	Continues.	Operation	The relevant instruction will end according to specifications.		
System-defined variables	Variable		Data type		Name	
	_MC_AX[*].MFAultLvl.Active		BOOL		Axis Minor Fault Occurrence	
Cause and correction	Assumed cause		Correction		Prevention	
	An axis does not exist for the variable specified for the <i>Auxiliary</i> input variable to the instruction.		Correct the instruction so that the variable exists for the axis that was specified for the instruction.		Make sure to specify variables that exist when specifying variables for the input parameters to an instruction.	
Attached information	Attached Information 1: Error Location Attached Information 3: Names of the Instruction and Instruction Instance Where the Error Occurred. If there is more than one possible instruction, information is given on all of them. Nothing is given if the instruction cannot be identified.					
Precautions/Remarks	If a program is changed after an error occurs, the attached information that is displayed may not be correct.					

Event name	Illegal Axis Specification			Event code	54015460 hex	
Meaning	The axis specified for the <i>Axis</i> input variable to a motion control instruction does not exist.					
Source	PLC Function Module		Source details	Instruction	Detection timing	At instruction execution
Error attributes	Level	Observation	Recovery	---	Log category	System
Effects	User program	Continues.	Operation	The relevant instruction will end according to specifications.		
System-defined variables	Variable		Data type		Name	
	_MC_COM.MFAultLvl.Active		BOOL		MC Common Minor Fault Occurrence	
Cause and correction	Assumed cause		Correction		Prevention	
	An axis does not exist for the variable specified for the <i>Axis</i> input variable to the instruction.		Correct the instruction so that the variable exists for the axis that was specified for the instruction.		Make sure to specify variables that exist when specifying variables for the input parameters to an instruction.	
Attached information	Attached Information 1: Error Location Attached Information 3: Names of the Instruction and Instruction Instance Where the Error Occurred. If there is more than one possible instruction, information is given on all of them. Nothing is given if the instruction cannot be identified.					
Precautions/Remarks	If a program is changed after an error occurs, the attached information that is displayed may not be correct.					

Event name	Illegal Axes Group Specification		Event code	54015461 hex	
Meaning	The axes group specified for the <i>AxesGroup</i> input variable to a motion control instruction does not exist or is not a used group.				
Source	PLC Function Module		Source details	Instruction	Detection timing At instruction execution
Error attributes	Level	Observation	Recovery	---	Log category System
Effects	User program	Continues.	Operation	The relevant instruction will end according to specifications.	
System-defined variables	Variable	Data type		Name	
	_MC_COM.MFaultLvl.Active	BOOL		MC Common Minor Fault Occurrence	
Cause and correction	Assumed cause	Correction		Prevention	
	An axes group does not exist for the variable specified for the <i>AxesGroup</i> input variable to the instruction..	Correct the specification for the instruction so that the specified axes group exists.		Specify a variable that exists when specifying a variable for an input parameter to an instruction.	
	The axes group specified for the <i>AxesGroup</i> input variable to the instruction is not specified as a used group.	Correct the axes group specified by the instruction to a used group.		Set a used axes group for the <i>AxesGroup</i> input variable to the instruction.	
Attached information	Attached Information 1: Error Location Attached Information 3: Names of the Instruction and Instruction Instance Where the Error Occurred. If there is more than one possible instruction, information is given on all of them. Nothing is given if the instruction cannot be identified.				
Precautions/Remarks	If a program is changed after an error occurs, the attached information that is displayed may not be correct.				

Event name	Illegal Master Axis Specification		Event code	54015462 hex	
Meaning	The axis that is specified for the <i>Master</i> input variable to a motion control instruction is not correct.				
Source	PLC Function Module		Source details	Instruction	Detection timing At instruction execution
Error attributes	Level	Observation	Recovery	---	Log category System
Effects	User program	Continues.	Operation	The relevant instruction will end according to specifications.	
System-defined variables	Variable	Data type		Name	
	_MC_COM.MFaultLvl.Active	BOOL		MC Common Minor Fault Occurrence	
	_MC_AX[*].MFaultLvl.Active	BOOL		Axis Minor Fault Occurrence	
Cause and correction	Assumed cause		Correction		Prevention
	An axis does not exist for the variable specified for the <i>Master</i> input variable to the instruction.		Correct the instruction so that the variable exists for the axis that was specified for the instruction.		Specify a variable that exists when specifying a variable for an input parameter to an instruction.
	The axis that was specified for the <i>Master</i> input variable to the MC_Phasing (Shift Master Axis Phase) instruction is not the master axis for syncing.		Correct the variable that is input to the <i>Master</i> input variable of the MC_Phasing (Shift Master Axis Phase) instruction to the axis variable that is specified as the master axis of the synchronized control instruction.		Correct the variable that is input to the <i>Master</i> input variable of the MC_Phasing (Shift Master Axis Phase) instruction to the axis variable that is specified as the master axis of the synchronized control instruction.
	The master axis and a slave axis are not assigned to the same task.		Assign the axes that are input to the <i>Master</i> and <i>Slave</i> input variables to the instruction to the same task.		Specify axes that are assigned to the same tasks for the master and slave axes.
Attached information	Attached Information 1: Error Location Attached Information 3: Names of the Instruction and Instruction Instance Where the Error Occurred. If there is more than one possible instruction, information is given on all of them. Nothing is given if the instruction cannot be identified.				
Precautions/Remarks	If a program is changed after an error occurs, the attached information that is displayed may not be correct.				

3 Error Descriptions and Corrections

Event name	Motion Control Instruction Re-execution Disabled (SlaveOffset)		Event code	54015463 hex		
Meaning	An attempt was made to change the <i>SlaveOffset</i> input variable when re-executing a motion control instruction. (This input variable cannot be changed when re-executing an instruction.)					
Source	PLC Function Module		Source details	Instruction	Detection timing	At instruction re-execution
Error attributes	Level	Observation	Recovery	---	Log category	System
Effects	User program	Continues.	Operation	The relevant instruction will end according to specifications.		
System-defined variables	Variable		Data type		Name	
	_MC_AX[*].MFAultLvl.Active		BOOL		Axis Minor Fault Occurrence	
Cause and correction	Assumed cause		Correction		Prevention	
	A parameter for an input variable that cannot be changed for re-execution was changed.		Correct the program so that the parameter for the relevant input variable does not change when the relevant instruction is re-executed.		Check the manual to see if the input variables to the relevant motion control instruction can be changed by re-execution. Write the program so that the input parameters for any input variable that cannot be changed do not change upon re-execution.	
Attached information	Attached Information 1: Error Location Attached Information 3: Names of the Instruction and Instruction Instance Where the Error Occurred. If there is more than one possible instruction, information is given on all of them. Nothing is given if the instruction cannot be identified.					
Precautions/Remarks	If a program is changed after an error occurs, the attached information that is displayed may not be correct.					

Event name	Motion Control Instruction Re-execution Disabled (SlaveScaling)		Event code	54015464 hex		
Meaning	An attempt was made to change the <i>SlaveScaling</i> input variable when re-executing a motion control instruction. (This input variable cannot be changed when re-executing an instruction.)					
Source	PLC Function Module		Source details	Instruction	Detection timing	At instruction re-execution
Error attributes	Level	Observation	Recovery	---	Log category	System
Effects	User program	Continues.	Operation	The relevant instruction will end according to specifications.		
System-defined variables	Variable		Data type		Name	
	_MC_AX[*].MFAultLvl.Active		BOOL		Axis Minor Fault Occurrence	
Cause and correction	Assumed cause		Correction		Prevention	
	A parameter for an input variable that cannot be changed for re-execution was changed.		Correct the program so that the parameter for the relevant input variable does not change when the relevant instruction is re-executed.		Check the manual to see if the input variables to the relevant motion control instruction can be changed by re-execution. Write the program so that the input parameters for any input variable that cannot be changed do not change upon re-execution.	
Attached information	Attached Information 1: Error Location Attached Information 3: Names of the Instruction and Instruction Instance Where the Error Occurred. If there is more than one possible instruction, information is given on all of them. Nothing is given if the instruction cannot be identified.					
Precautions/Remarks	If a program is changed after an error occurs, the attached information that is displayed may not be correct.					

Event name	Motion Control Instruction Re-execution Disabled (StartPosition)		Event code	54015465 hex		
Meaning	An attempt was made to change the <i>StartPosition</i> input variable when re-executing a motion control instruction. (This input variable cannot be changed when re-executing an instruction.)					
Source	PLC Function Module		Source details	Instruction	Detection timing	At instruction re-execution
Error attributes	Level	Observation	Recovery	---	Log category	System
Effects	User program	Continues.	Operation	The relevant instruction will end according to specifications.		
System-defined variables	Variable	Data type		Name		
	_MC_AX[*].MFAultLvl.Active	BOOL		Axis Minor Fault Occurrence		
Cause and correction	Assumed cause		Correction		Prevention	
	A parameter for an input variable that cannot be changed for re-execution was changed.		Correct the program so that the parameter for the relevant input variable does not change when the relevant instruction is re-executed.		Check the manual to see if the input variables to the relevant motion control instruction can be changed by reexecution. Write the program so that the input parameters for any input variable that cannot be changed do not change upon re-execution.	
Attached information	Attached Information 1: Error Location Attached Information 3: Names of the Instruction and Instruction Instance Where the Error Occurred. If there is more than one possible instruction, information is given on all of them. Nothing is given if the instruction cannot be identified.					
Precautions/Remarks	If a program is changed after an error occurs, the attached information that is displayed may not be correct.					

Event name	Instruction Execution Error with Undefined Home		Event code	54015466 hex	
Meaning	High-speed homing or an interpolation instruction was executed when home was undefined.				
Source	PLC Function Module		Source details	Instruction	Detection timing At instruction execution
Error attributes	Level	Observation	Recovery	---	Log category System
Effects	User program	Continues.	Operation	The relevant instruction will end according to specifications.	
System-defined variables	Variable		Data type		Name
	_MC_AX[*].MFaultLvl.Active		BOOL		Axis Minor Fault Occurrence
	_MC_GRP[*].MFaultLvl.Active		BOOL		Axes Group Minor Fault Occurrence
Cause and correction	Assumed cause		Correction		Prevention
	High-speed homing was executed when home was undefined.		Execute the high-speed homing operation only after homing to define home.		Execute the high-speed homing instruction only after home is defined by homing.
	An interpolation instruction was executed for an axes group that includes an axis with no defined home.		Perform homing to define home for all axes in the axes group before executing the interpolation instruction.		Perform homing to define home for all axes in the axes group before executing the interpolation instruction.
	One of the following robot instructions was executed for an axes group that includes a logical axis with no defined home. <ul style="list-style-type: none"> • MC_SetKinTransform • MC_MoveTimeAbsolute • MC_SyncLinearConveyor • MC_SyncOut • MC_GroupMon • MC_RobotJog 				
Attached information	Attached Information 1: Error Location Attached Information 3: Names of the Instruction and Instruction Instance Where the Error Occurred. If there is more than one possible instruction, information is given on all of them. Nothing is given if the instruction cannot be identified.				
Precautions/Remarks	<ul style="list-style-type: none"> • If a program is changed after an error occurs, the attached information that is displayed may not be correct. • If you execute the Set Position instruction after performing homing, home will again be undefined. You must perform homing again to define home in this case. 				

Event name	Motion Control Instruction Re-execution Disabled (Position Type)		Event code	54015467 hex	
Meaning	An attempt was made to change the <i>ReferenceType</i> input variable when re-executing a motion control instruction. (This input variable cannot be changed when re-executing an instruction.)				
Source	PLC Function Module		Source details	Instruction	Detection timing At instruction re-execution
Error attributes	Level	Observation	Recovery	---	Log category System
Effects	User program	Continues.	Operation	The relevant instruction will end according to specifications.	
System-defined variables	Variable	Data type		Name	
	_MC_AX[*].MFAultLvl.Active	BOOL		Axis Minor Fault Occurrence	
Cause and correction	Assumed cause		Correction		Prevention
	A parameter for an input variable that cannot be changed for re-execution was changed.		Correct the program so that the parameter for the relevant input variable does not change when the relevant instruction is re-executed.		Check the manual to see if the input variables to the relevant motion control instruction can be changed by reexecution. Write the program so that the input parameters for any input variable that cannot be changed do not change upon re-execution.
Attached information	Attached Information 1: Error Location Attached Information 3: Names of the Instruction and Instruction Instance Where the Error Occurred. If there is more than one possible instruction, information is given on all of them. Nothing is given if the instruction cannot be identified.				
Precautions/Remarks	If a program is changed after an error occurs, the attached information that is displayed may not be correct.				

Event name	Unused Axis Specification for Master Axis		Event code	54015468 hex	
Meaning	The master axis specified for a motion control instruction is an unused axis.				
Source	PLC Function Module		Source details	Instruction	Detection timing At instruction execution
Error attributes	Level	Observation	Recovery	---	Log category System
Effects	User program	Continues.	Operation	The relevant instruction will end according to specifications.	
System-defined variables	Variable	Data type		Name	
	_MC_AX[*].MFAultLvl.Active	BOOL		Axis Minor Fault Occurrence	
Cause and correction	Assumed cause		Correction		Prevention
	The master axis specified for a motion control instruction is an unused axis.		Set a used axis for the master axis that is specified for the instruction.		Make sure the master axis specified for the motion control instruction is a used axis.
Attached information	Attached Information 1: Error Location Attached Information 3: Names of the Instruction and Instruction Instance Where the Error Occurred. If there is more than one possible instruction, information is given on all of them. Nothing is given if the instruction cannot be identified.				
Precautions/Remarks	If a program is changed after an error occurs, the attached information that is displayed may not be correct.				

3 Error Descriptions and Corrections

Event name	First Position Setting Out of Range		Event code	54015469 hex		
Meaning	The parameter specified for the <i>FirstPosition</i> input variable to a motion control instruction is out of range.					
Source	PLC Function Module		Source details	Instruction	Detection timing	At instruction execution
Error attributes	Level	Observation	Recovery	---	Log category	System
Effects	User program	Continues.	Operation	The relevant instruction will end according to specifications.		
System-defined variables	Variable		Data type		Name	
	_MC_AX[*].MFaultLvl.Active		BOOL		Axis Minor Fault Occurrence	
Cause and correction	Assumed cause		Correction		Prevention	
	Instruction input parameter exceeded the valid range of the input variable.		Correct the parameter so that the valid range of the input variable is not exceeded for the relevant instruction.		Set the input parameter to the instruction so that the valid range of the input variable is not exceeded.	
Attached information	Attached Information 1: Error Location Attached Information 3: Names of the Instruction and Instruction Instance Where the Error Occurred. If there is more than one possible instruction, information is given on all of them. Nothing is given if the instruction cannot be identified.					
Precautions/Remarks	If a program is changed after an error occurs, the attached information that is displayed may not be correct.					

Event name	Last Position Setting Out of Range		Event code	5401546A hex		
Meaning	The parameter specified for the <i>LastPosition</i> input variable to a motion control instruction is out of range.					
Source	PLC Function Module		Source details	Instruction	Detection timing	At instruction execution
Error attributes	Level	Observation	Recovery	---	Log category	System
Effects	User program	Continues.	Operation	The relevant instruction will end according to specifications.		
System-defined variables	Variable		Data type		Name	
	_MC_AX[*].MFaultLvl.Active		BOOL		Axis Minor Fault Occurrence	
Cause and correction	Assumed cause		Correction		Prevention	
	Instruction input parameter exceeded the valid range of the input variable.		Correct the parameter so that the valid range of the input variable is not exceeded for the relevant instruction.		Set the input parameter to the instruction so that the valid range of the input variable is not exceeded.	
Attached information	Attached Information 1: Error Location Attached Information 3: Names of the Instruction and Instruction Instance Where the Error Occurred. If there is more than one possible instruction, information is given on all of them. Nothing is given if the instruction cannot be identified.					
Precautions/Remarks	If a program is changed after an error occurs, the attached information that is displayed may not be correct.					

Event name	Illegal First/Last Position Size Relationship (Linear Mode)		Event code	5401546B hex		
Meaning	The parameter specified for the <i>LastPosition</i> input variable to a motion control instruction is smaller than the parameter specified for the <i>FirstPosition</i> input variable.					
Source	PLC Function Module		Source details	Instruction	Detection timing	At instruction execution
Error attributes	Level	Observation	Recovery	---	Log category	System
Effects	User program	Continues.	Operation	The relevant instruction will end according to specifications.		
System-defined variables	Variable	Data type		Name		
	_MC_AX[*].MFAultLvl.Active	BOOL		Axis Minor Fault Occurrence		
Cause and correction	Assumed cause		Correction		Prevention	
	The value of the LastPosition input parameter is less than the value of the <i>FirstPosition</i> input variable for the instruction when the Count Mode is set to Linear Mode.		Correct the program so that the value of the LastPosition specified for the instruction is larger than the value of the <i>FirstPosition</i> . Or, change the value of the Count Mode to Rotary Mode.		Write the program so that the value of the LastPosition specified for the instruction is larger than the value of the <i>FirstPosition</i> . Or, check to make sure that the Count Mode of the relevant axis is set to Rotary Mode.	
Attached information	Attached Information 1: Error Location Attached Information 3: Names of the Instruction and Instruction Instance Where the Error Occurred. If there is more than one possible instruction, information is given on all of them. Nothing is given if the instruction cannot be identified.					
Precautions/Remarks	If a program is changed after an error occurs, the attached information that is displayed may not be correct.					

Event name	Master Sync Start Position Setting Out of Range		Event code	5401546C hex		
Meaning	The parameter specified for the <i>MasterSyncPosition</i> input variable to a motion control instruction is out of range.					
Source	PLC Function Module		Source details	Instruction	Detection timing	At instruction execution
Error attributes	Level	Observation	Recovery	---	Log category	System
Effects	User program	Continues.	Operation	The relevant instruction will end according to specifications.		
System-defined variables	Variable	Data type		Name		
	_MC_AX[*].MFAultLvl.Active	BOOL		Axis Minor Fault Occurrence		
Cause and correction	Assumed cause		Correction		Prevention	
	Instruction input parameter exceeded the valid range of the input variable.		Correct the parameter so that the valid range of the input variable is not exceeded for the relevant instruction.		Set the input parameter to the instruction so that the valid range of the input variable is not exceeded.	
Attached information	Attached Information 1: Error Location Attached Information 3: Names of the Instruction and Instruction Instance Where the Error Occurred. If there is more than one possible instruction, information is given on all of them. Nothing is given if the instruction cannot be identified.					
Precautions/Remarks	If a program is changed after an error occurs, the attached information that is displayed may not be correct.					

Event name	Slave Sync Start Position Setting Out of Range		Event code	5401546D hex	
Meaning	The parameter specified for the <i>SlaveSyncPosition</i> input variable to a motion control instruction is out of range.				
Source	PLC Function Module		Source details	Instruction	Detection timing At instruction execution
Error attributes	Level	Observation	Recovery	---	Log category System
Effects	User program	Continues.	Operation	The relevant instruction will end according to specifications.	
System-defined variables	Variable		Data type		Name
	_MC_AX[*].MFaultLvl.Active		BOOL		Axis Minor Fault Occurrence
Cause and correction	Assumed cause		Correction		Prevention
	Instruction input parameter exceeded the valid range of the input variable.		Correct the parameter so that the valid range of the input variable is not exceeded for the relevant instruction.		Set the input parameter to the instruction so that the valid range of the input variable is not exceeded.
Attached information	Attached Information 1: Error Location Attached Information 3: Names of the Instruction and Instruction Instance Where the Error Occurred. If there is more than one possible instruction, information is given on all of them. Nothing is given if the instruction cannot be identified.				
Precautions/Remarks	If a program is changed after an error occurs, the attached information that is displayed may not be correct.				

Event name	Duplicate Latch ID for Trigger Input Condition		Event code	5401546E hex	
Meaning	The same latch ID was specified for more than one motion control instruction.				
Source	PLC Function Module		Source details	Instruction	Detection timing At instruction execution
Error attributes	Level	Observation	Recovery	---	Log category System
Effects	User program	Continues.	Operation	The relevant instruction will end according to specifications.	
System-defined variables	Variable		Data type		Name
	_MC_AX[*].MFaultLvl.Active		BOOL		Axis Minor Fault Occurrence
Cause and correction	Assumed cause		Correction		Prevention
	The same latch ID is used simultaneously for more than one of the following instructions: MC_TouchProbe (Enable External Latch) instruction, MC_MoveLink (Synchronous Positioning) instruction, and MC_MoveFeed (Interrupt Feeding) instruction.		Correct the program so that the same latch ID is not used by another instruction at the same time as this instruction. Either use a different latch ID or do not execute any instructions that use the same latch ID at the same time. Both latch 1 and latch 2 are treated as being in use during execution of the MC_Home or MC_HomeWithParameter instruction.		Do not use the same latch ID simultaneously for more than one of the following instructions: MC_TouchProbe (Enable External Latch) instruction, MC_MoveLink (Synchronous Positioning) instruction, and MC_MoveFeed (Interrupt Feeding) instruction.
Cause and correction	The MC_AbortTrigger (Disable External Latch) instruction was executed to cancel a latch that was used by an instruction other than the MC_TouchProbe (Enable External Latch) instruction.		Do not use the Disable External Latch instruction to cancel a latch that is used by an instruction other than the Enable External Latch instruction.		Do not execute the Disable External Latch instruction for a latch that is used by an instruction other than the Enable External Latch instruction.
Attached information	Attached Information 1: Error Location Attached Information 3: Names of the Instruction and Instruction Instance Where the Error Occurred. If there is more than one possible instruction, information is given on all of them. Nothing is given if the instruction cannot be identified.				
Precautions/Remarks	<ul style="list-style-type: none"> If a program is changed after an error occurs, the attached information that is displayed may not be correct. If you decide to change the latch ID, make sure that same latch ID is not used by any other instructions. 				

Event name	Jerk Override Factor Out of Range		Event code	5401546F hex	
Meaning	The parameter specified for the <i>JerkFactor</i> input variable to a motion control instruction is out of range.				
Source	PLC Function Module		Source details	Instruction	Detection timing At instruction execution
Error attributes	Level	Observation	Recovery	---	Log category System
Effects	User program	Continues.	Operation	The relevant instruction will end according to specifications.	
System-defined variables	Variable	Data type		Name	
	_MC_AX[*].MFaultLvl.Active	BOOL		Axis Minor Fault Occurrence	
Cause and correction	Assumed cause		Correction		Prevention
	Instruction input parameter exceeded the valid range of the input variable.		Correct the parameter so that the valid range of the input variable is not exceeded for the relevant instruction.		Set the input parameter to the instruction so that the valid range of the input variable is not exceeded.
Attached information	Attached Information 1: Error Location Attached Information 3: Names of the Instruction and Instruction Instance Where the Error Occurred. If there is more than one possible instruction, information is given on all of them. Nothing is given if the instruction cannot be identified.				
Precautions/Remarks	If a program is changed after an error occurs, the attached information that is displayed may not be correct.				

Event name	Acceleration/Deceleration Override Factor Out of Range		Event code	54015470 hex	
Meaning	The parameter specified for the <i>AccFactor</i> input variable to a motion control instruction is out of range.				
Source	PLC Function Module		Source details	Instruction	Detection timing At instruction execution
Error attributes	Level	Observation	Recovery	---	Log category System
Effects	User program	Continues.	Operation	The relevant instruction will end according to specifications.	
System-defined variables	Variable	Data type		Name	
	_MC_AX[*].MFaultLvl.Active	BOOL		Axis Minor Fault Occurrence	
Cause and correction	Assumed cause		Correction		Prevention
	Instruction input parameter exceeded the valid range of the input variable.		Correct the parameter so that the valid range of the input variable is not exceeded for the relevant instruction.		Set the input parameter to the instruction so that the valid range of the input variable is not exceeded.
Attached information	Attached Information 1: Error Location Attached Information 3: Names of the Instruction and Instruction Instance Where the Error Occurred. If there is more than one possible instruction, information is given on all of them. Nothing is given if the instruction cannot be identified.				
Precautions/Remarks	If a program is changed after an error occurs, the attached information that is displayed may not be correct.				

3 Error Descriptions and Corrections

Event name	First Position Method Specification Out of Range		Event code	54015471 hex		
Meaning	The parameter specified for the <i>StartMode</i> input variable to a motion control instruction is out of range.					
Source	PLC Function Module		Source details	Instruction	Detection timing	At instruction execution
Error attributes	Level	Observation	Recovery	---	Log category	System
Effects	User program	Continues.	Operation	The relevant instruction will end according to specifications.		
System-defined variables	Variable		Data type		Name	
	_MC_AX[*].MFaultLvl.Active		BOOL		Axis Minor Fault Occurrence	
Cause and correction	Assumed cause		Correction		Prevention	
	Instruction input parameter exceeded the valid range of the input variable.		Correct the parameter so that the valid range of the input variable is not exceeded for the relevant instruction.		Set the input parameter to the instruction so that the valid range of the input variable is not exceeded.	
Attached information	Attached Information 1: Error Location Attached Information 3: Names of the Instruction and Instruction Instance Where the Error Occurred. If there is more than one possible instruction, information is given on all of them. Nothing is given if the instruction cannot be identified.					
Precautions/Remarks	If a program is changed after an error occurs, the attached information that is displayed may not be correct.					

Event name	Motion Control Instruction Re-execution Disabled (First Position Method)		Event code	54015472 hex		
Meaning	An attempt was made to change the <i>StartMode</i> input variable when re-executing a motion control instruction. (This input variable cannot be changed when re-executing an instruction.)					
Source	PLC Function Module		Source details	Instruction	Detection timing	At instruction re-execution
Error attributes	Level	Observation	Recovery	---	Log category	System
Effects	User program	Continues.	Operation	The relevant instruction will end according to specifications.		
System-defined variables	Variable		Data type		Name	
	_MC_AX[*].MFaultLvl.Active		BOOL		Axis Minor Fault Occurrence	
Cause and correction	Assumed cause		Correction		Prevention	
	A parameter for an input variable that cannot be changed for re-execution was changed.		Correct the program so that the parameter for the relevant input variable does not change when the relevant instruction is re-executed.		Check the manual to see if the input variables to the relevant motion control instruction can be changed by re-execution. Write the program so that the input parameters for any input variable that cannot be changed do not change upon re-execution.	
Attached information	Attached Information 1: Error Location Attached Information 3: Names of the Instruction and Instruction Instance Where the Error Occurred. If there is more than one possible instruction, information is given on all of them. Nothing is given if the instruction cannot be identified.					
Precautions/Remarks	If a program is changed after an error occurs, the attached information that is displayed may not be correct.					

Event name	Unused Axis Specification for Auxiliary Axis		Event code	54015474 hex	
Meaning	The axis specified for the <i>Auxiliary</i> input variable to a motion control instruction is an unused axis.				
Source	PLC Function Module		Source details	Instruction	Detection timing At instruction execution
Error attributes	Level	Observation	Recovery	---	Log category System
Effects	User program	Continues.	Operation	The relevant instruction will end according to specifications.	
System-defined variables	Variable		Data type		Name
	_MC_AX[*].MFAultLvl.Active		BOOL		Axis Minor Fault Occurrence
Cause and correction	Assumed cause		Correction		Prevention
	The axis specified for the <i>Auxiliary</i> input variable to the instruction is an unused axis.		Set a used axis for the axis that is specified for the instruction. Or, correct the parameter so that it specifies a used axis.		Make sure that the axis specified for the instruction is a used axis.
Attached information	Attached Information 1: Error Location Attached Information 3: Names of the Instruction and Instruction Instance Where the Error Occurred. If there is more than one possible instruction, information is given on all of them. Nothing is given if the instruction cannot be identified.				
Precautions/Remarks	If a program is changed after an error occurs, the attached information that is displayed may not be correct.				

Event name	Position Gear Value Error		Event code	54015475 hex	
Meaning	Synchronized motion is not possible for the velocity, acceleration rate, and deceleration rate that were input to a motion control instruction.				
Source	PLC Function Module		Source details	Instruction	Detection timing At instruction execution
Error attributes	Level	Observation	Recovery	---	Log category System
Effects	User program	Continues.	Operation	The relevant instruction will end according to specifications.	
System-defined variables	Variable		Data type		Name
	_MC_AX[*].MFAultLvl.Active		BOOL		Axis Minor Fault Occurrence
Cause and correction	Assumed cause		Correction		Prevention
	The specified synchronized motion cannot be performed at the velocity, acceleration rate, or deceleration rate that is input to the instruction.		Correct the program to enable synchronized motion according to the operating specifications of the MC_GearInPos (Positioning Gear Operation) instruction.		Check the processing of the relevant instruction and set a value that allows for synchronized motion.
Attached information	Attached Information 1: Error Location Attached Information 3: Names of the Instruction and Instruction Instance Where the Error Occurred. If there is more than one possible instruction, information is given on all of them. Nothing is given if the instruction cannot be identified.				
Precautions/Remarks	If a program is changed after an error occurs, the attached information that is displayed may not be correct.				

3 Error Descriptions and Corrections

Event name	Position Gear Master Axis Zero Velocity		Event code	54015476 hex		
Meaning	The velocity of the master axis was zero when a motion control instruction was started.					
Source	PLC Function Module		Source details	Instruction	Detection timing	At instruction execution
Error attributes	Level	Observation	Recovery	---	Log category	System
Effects	User program	Continues.	Operation	The relevant instruction will end according to specifications.		
System-defined variables	Variable		Data type		Name	
	_MC_AX[*].MFaultLvl.Active		BOOL		Axis Minor Fault Occurrence	
Cause and correction	Assumed cause		Correction		Prevention	
	The velocity of the master axis was 0 when the instruction was started.		Correct the program so that the velocity of the master axis is not 0 when the instruction is started.		Write the program so that the velocity of the master axis is not 0 when the instruction is started.	
Attached information	Attached Information 1: Error Location Attached Information 3: Names of the Instruction and Instruction Instance Where the Error Occurred. If there is more than one possible instruction, information is given on all of them. Nothing is given if the instruction cannot be identified.					
Precautions/Remarks	If a program is changed after an error occurs, the attached information that is displayed may not be correct.					

Event name	Target Position Setting Out of Range		Event code	54015478 hex		
Meaning	The parameter specified for the <i>Position</i> input variable to a motion control instruction is out of range.					
Source	PLC Function Module		Source details	Instruction	Detection timing	At instruction execution
Error attributes	Level	Observation	Recovery	---	Log category	System
Effects	User program	Continues.	Operation	The relevant instruction will end according to specifications.		
System-defined variables	Variable		Data type		Name	
	_MC_AX[*].MFaultLvl.Active		BOOL		Axis Minor Fault Occurrence	
	_MC_GRP[*].MFaultLvl.Active		BOOL		Axes Group Minor Fault Occurrence	
Cause and correction	Assumed cause		Correction		Prevention	
	Instruction input parameter exceeded the valid range of the input variable.		Correct the parameter so that the valid range of the input variable is not exceeded for the relevant instruction.		Set the input parameter to the instruction so that the valid range of the input variable is not exceeded.	
	The target position of a Rotary Mode axis is not within the ring setting range.		Correct the target position of the Rotary Mode axis to within the ring setting range.		Set the target position of the Rotary Mode axis to within the ring setting range.	
Attached information	Attached Information 1: Error Location Attached Information 3: Names of the Instruction and Instruction Instance Where the Error Occurred. If there is more than one possible instruction, information is given on all of them. Nothing is given if the instruction cannot be identified.					
Precautions/Remarks	If a program is changed after an error occurs, the attached information that is displayed may not be correct.					

Event name	Travel Distance Out of Range		Event code	54015479 hex	
Meaning	The parameter that was specified for the <i>Distance</i> input variable to a motion control instruction is out of range or the target position with the value of <i>Distance</i> added is out of range.				
Source	PLC Function Module		Source details	Instruction	Detection timing At instruction execution
Error attributes	Level	Observation	Recovery	---	Log category System
Effects	User program	Continues.	Operation	The relevant instruction will end according to specifications.	
System-defined variables	Variable		Data type	Name	
	_MC_AX[*].MFAultLvl.Active		BOOL	Axis Minor Fault Occurrence	
		_MC_GRP[*].MFAultLvl.Active		BOOL	Axes Group Minor Fault Occurrence
Cause and correction	Assumed cause		Correction		Prevention
	The absolute value of the instruction input parameter exceeded the range of 40-bit data when it is converted to pulses. For a Linear Mode axis, the target position with the travel distance added exceeded signed 40-bit data when the absolute value is converted to pulses.		Correct the input parameter specified for the <i>Distance</i> input variable of the instruction so that the travel distance and the target position are not out of range.		Write the program so that the travel distance and the target position for the instruction are not out of range.
Attached information	Attached Information 1: Error Location Attached Information 3: Names of the Instruction and Instruction Instance Where the Error Occurred. If there is more than one possible instruction, information is given on all of them. Nothing is given if the instruction cannot be identified.				
Precautions/Remarks	If a program is changed after an error occurs, the attached information that is displayed may not be correct.				

Event name	Cam Table Start Point Setting Out of Range		Event code	5401547A hex	
Meaning	The parameter specified for the <i>StartPosition</i> input variable to a motion control instruction is out of range.				
Source	PLC Function Module		Source details	Instruction	Detection timing At instruction execution
Error attributes	Level	Observation	Recovery	---	Log category System
Effects	User program	Continues.	Operation	The relevant instruction will end according to specifications.	
System-defined variables	Variable		Data type	Name	
	_MC_AX[*].MFAultLvl.Active		BOOL	Axis Minor Fault Occurrence	
Cause and correction	Assumed cause		Correction		Prevention
	Instruction input parameter exceeded the valid range of the input variable.		Correct the parameter so that the valid range of the input variable is not exceeded for the relevant instruction.		Set the input parameter to the instruction so that the valid range of the input variable is not exceeded.
Attached information	Attached Information 1: Error Location Attached Information 3: Names of the Instruction and Instruction Instance Where the Error Occurred. If there is more than one possible instruction, information is given on all of them. Nothing is given if the instruction cannot be identified.				
Precautions/Remarks	If a program is changed after an error occurs, the attached information that is displayed may not be correct.				

3 Error Descriptions and Corrections

Event name	Cam Master Axis Following First Position Setting Out of Range		Event code	5401547B hex		
Meaning	The parameter specified for the <i>MasterStartDistance</i> input variable to a motion control instruction is out of range.					
Source	PLC Function Module		Source details	Instruction	Detection timing	At instruction execution
Error attributes	Level	Observation	Recovery	---	Log category	System
Effects	User program	Continues.	Operation	The relevant instruction will end according to specifications.		
System-defined variables	Variable		Data type		Name	
	_MC_AX[*].MFAultLvl.Active		BOOL		Axis Minor Fault Occurrence	
Cause and correction	Assumed cause		Correction		Prevention	
	Instruction input parameter exceeded the valid range of the input variable.		Correct the parameter so that the valid range of the input variable is not exceeded for the relevant instruction.		Set the input parameter to the instruction so that the valid range of the input variable is not exceeded.	
Attached information	Attached Information 1: Error Location Attached Information 3: Names of the Instruction and Instruction Instance Where the Error Occurred. If there is more than one possible instruction, information is given on all of them. Nothing is given if the instruction cannot be identified.					
Precautions/Remarks	If a program is changed after an error occurs, the attached information that is displayed may not be correct.					

Event name	Circular Interpolation Radius Setting Error		Event code	5401547C hex		
Meaning	It was not possible to create a circular path for the specified radius when the radius method was specified for the MC_MoveCircular2D (Circular 2D Interpolation) instruction.					
Source	PLC Function Module		Source details	Instruction	Detection timing	At instruction execution
Error attributes	Level	Observation	Recovery	---	Log category	System
Effects	User program	Continues.	Operation	The relevant instruction will end according to specifications.		
System-defined variables	Variable		Data type		Name	
	_MC_GRP[*].MFAultLvl.Active		BOOL		Axes Group Minor Fault Occurrence	
Cause and correction	Assumed cause		Correction		Prevention	
	For the MC_MoveCircular2D (Circular 2D Interpolation) instruction, it was not possible to create a circular path for the specified radius when the radius method was specified for circular interpolation.		Correct the radius so that the circular path can be created.		Check the processing of the relevant instruction and set a radius that allows the creation of a circular path.	
Attached information	Attached Information 1: Error Location Attached Information 3: Names of the Instruction and Instruction Instance Where the Error Occurred. If there is more than one possible instruction, information is given on all of them. Nothing is given if the instruction cannot be identified.					
Precautions/Remarks	If a program is changed after an error occurs, the attached information that is displayed may not be correct.					

Event name	Circular Interpolation Radius Overflow		Event code	5401547D hex	
Meaning	For the MC_MoveCircular2D (Circular 2D Interpolation) instruction, the radius of the circle exceeded the maximum value for the border point or center specification method.				
Source	PLC Function Module		Source details	Instruction	Detection timing At instruction execution
Error attributes	Level	Observation	Recovery	---	Log category System
Effects	User program	Continues.	Operation	The relevant instruction will end according to specifications.	
System-defined variables	Variable	Data type		Name	
	_MC_GRP[*].MFaultLvl.Active	BOOL		Axes Group Minor Fault Occurrence	
Cause and correction	Assumed cause	Correction		Prevention	
	For the MC_MoveCircular2D (Circular 2D Interpolation) instruction, the radius of the circle exceeded 40-bit data when it is converted to pulses for the border point or center specification method.	Correct the input parameter so that the circle radius does not exceed 40-bit data when it is converted to pulses based on the operating specifications of the instruction. Border point specification: Start point, border point, and end point Center point specification: Start point, end point, and center point		Check the processing of the instruction and correct the input parameters so that the circle radius does not exceed 40-bit data it is when converted to pulses.	
Attached information	Attached Information 1: Error Location Attached Information 3: Names of the Instruction and Instruction Instance Where the Error Occurred. If there is more than one possible instruction, information is given on all of them. Nothing is given if the instruction cannot be identified.				
Precautions/Remarks	<ul style="list-style-type: none"> • If a program is changed after an error occurs, the attached information that is displayed may not be correct. • If the maximum radius is exceeded when the radius specification method is used, a Border Point/Center Position/Radius Specification Out of Range error occurs. 				

3 Error Descriptions and Corrections

Event name	Circular Interpolation Setting Out of Range		Event code	5401547E hex	
Meaning	The parameter specified for the <i>CircAxes</i> input variable to a motion control instruction is out of range.				
Source	PLC Function Module		Source details	Instruction	Detection timing At instruction execution
Error attributes	Level	Observation	Recovery	---	Log category System
Effects	User program	Continues.	Operation	The relevant instruction will end according to specifications.	
System-defined variables	Variable		Data type		Name
	_MC_GRP[*].MFaultLvl.Active		BOOL		Axes Group Minor Fault Occurrence
Cause and correction	Assumed cause		Correction		Prevention
	Instruction input parameter exceeded the valid range of the input variable.		Correct the parameter so that the valid range of the input variable is not exceeded for the relevant instruction.		Set the input parameters to the instruction so that the valid range of the input variables is not exceeded.
	The axes that were specified in <i>CircAxes</i> are not included in the composition axes in the Axes Group Settings.		Set the axes that are specified for <i>CircAxes</i> so that they are in an axes group configuration.		Make sure that the axes that are specified for <i>CircAxes</i> are in an axes group configuration.
	The same axis was specified for both axes of <i>CircAxes</i> .		Correct the settings so that the two axes specified for <i>CircAxes</i> are different axes.		Write the program so that the two axes specified for <i>CircAxes</i> are different axes.
Attached information	Attached Information 1: Error Location Attached Information 3: Names of the Instruction and Instruction Instance Where the Error Occurred. If there is more than one possible instruction, information is given on all of them. Nothing is given if the instruction cannot be identified.				
Precautions/Remarks	If a program is changed after an error occurs, the attached information that is displayed may not be correct.				

Event name	Auxiliary/Slave Axis Numbers Not in Ascending Order		Event code	5401547F hex	
Meaning	The values of the parameters for the <i>Auxiliary</i> and <i>Slave</i> input variables to a motion control instruction are not in ascending order.				
Source	PLC Function Module		Source details	Instruction	Detection timing At instruction execution
Error attributes	Level	Observation	Recovery	---	Log category System
Effects	User program	Continues.	Operation	The relevant instruction will end according to specifications.	
System-defined variables	Variable		Data type		Name
	_MC_AX[*].MFaultLvl.Active		BOOL		Axis Minor Fault Occurrence
Cause and correction	Assumed cause		Correction		Prevention
	The parameters for the <i>Auxiliary</i> and <i>Slave</i> input variables to the instruction are not in ascending order.		Correct the axis numbers specified for the <i>Auxiliary</i> and <i>Slave</i> input parameters to the instruction so that they are in ascending order.		Write the program so that the axis numbers specified for <i>Auxiliary</i> and <i>Slave</i> are in ascending order.
Attached information	Attached Information 1: Error Location Attached Information 3: Names of the Instruction and Instruction Instance Where the Error Occurred. If there is more than one possible instruction, information is given on all of them. Nothing is given if the instruction cannot be identified.				
Precautions/Remarks	If a program is changed after an error occurs, the attached information that is displayed may not be correct.				

Event name	Cam Table Property Ascending Data Error at Update		Event code	54015480 hex	
Meaning	A phase that was not in ascending order was found during calculating the number of valid data. Or, after calculations, the number of valid data is 0.				
Source	PLC Function Module		Source details	Instruction	Detection timing During instruction execution
Error attributes	Level	Observation	Recovery	---	Log category System
Effects	User program	Continues.	Operation	The relevant instruction will end according to specifications.	
System-defined variables	Variable	Data type		Name	
	_MC_COM.MFaultLvl.Active	BOOL		MC Common Minor Fault Occurrence	
Cause and correction	Assumed cause		Correction		Prevention
	A phase that was not in ascending order was found when calculating the number of valid data.		Place the phase data into ascending order in the cam table data.		Place the phase data into ascending order in the cam table data.
	After calculations, the number of valid data is 0.		Correct the cam table data so that it includes phases that are not 0.		Create the cam table data so that it includes phases that are not 0.
Attached information	Attached Information 1: Error Location Attached Information 3: Names of the Instruction and Instruction Instance Where the Error Occurred. If there is more than one possible instruction, information is given on all of them. Nothing is given if the instruction cannot be identified.				
Precautions/Remarks	If a program is changed after an error occurs, the attached information that is displayed may not be correct.				

Event name	MC_Write Target Out of Range		Event code	54015481 hex	
Meaning	The parameter specified for the <i>Target</i> input variable to a motion control instruction is out of range.				
Source	PLC Function Module		Source details	Instruction	Detection timing At instruction execution
Error attributes	Level	Observation	Recovery	---	Log category System
Effects	User program	Continues.	Operation	The relevant instruction will end according to specifications.	
System-defined variables	Variable	Data type		Name	
	_MC_COM.MFaultLvl.Active	BOOL		MC Common Minor Fault Occurrence	
Cause and correction	Assumed cause		Correction		Prevention
	Instruction input parameter exceeded the valid range of the input variable.		Correct the parameter so that the valid range of the input variable is not exceeded for the relevant instruction.		Set the input parameter to the instruction so that the valid range of the input variable is not exceeded.
Attached information	Attached Information 1: Error Location Attached Information 3: Names of the Instruction and Instruction Instance Where the Error Occurred. If there is more than one possible instruction, information is given on all of them. Nothing is given if the instruction cannot be identified.				
Precautions/Remarks	If a program is changed after an error occurs, the attached information that is displayed may not be correct.				

3 Error Descriptions and Corrections

Event name	Master Travel Distance Specification Out of Range		Event code	54015482 hex		
Meaning	The parameter specified for the <i>MasterDistance</i> input variable to a motion control instruction is out of range.					
Source	PLC Function Module		Source details	Instruction	Detection timing	At instruction execution
Error attributes	Level	Observation	Recovery	---	Log category	System
Effects	User program	Continues.	Operation	The relevant instruction will end according to specifications.		
System-defined variables	Variable		Data type		Name	
	_MC_AX[*].MFAultLvl.Active		BOOL		Axis Minor Fault Occurrence	
Cause and correction	Assumed cause		Correction		Prevention	
	Instruction input parameter exceeded the valid range of the input variable.		Correct the parameter so that the valid range of the input variable is not exceeded for the relevant instruction.		Set the input parameter to the instruction so that the valid range of the input variable is not exceeded.	
Attached information	Attached Information 1: Error Location Attached Information 3: Names of the Instruction and Instruction Instance Where the Error Occurred. If there is more than one possible instruction, information is given on all of them. Nothing is given if the instruction cannot be identified.					
Precautions/Remarks	If a program is changed after an error occurs, the attached information that is displayed may not be correct.					

Event name	Master Distance in Acceleration Specification Out of Range		Event code	54015483 hex		
Meaning	The parameter specified for the <i>MasterDistanceInACC</i> input variable to a motion control instruction is out of range.					
Source	PLC Function Module		Source details	Instruction	Detection timing	At instruction execution
Error attributes	Level	Observation	Recovery	---	Log category	System
Effects	User program	Continues.	Operation	The relevant instruction will end according to specifications.		
System-defined variables	Variable		Data type		Name	
	_MC_AX[*].MFAultLvl.Active		BOOL		Axis Minor Fault Occurrence	
Cause and correction	Assumed cause		Correction		Prevention	
	Instruction input parameter exceeded the valid range of the input variable.		Correct the parameter so that the valid range of the input variable is not exceeded for the relevant instruction.		Set the input parameter to the instruction so that the valid range of the input variable is not exceeded.	
Attached information	Attached Information 1: Error Location Attached Information 3: Names of the Instruction and Instruction Instance Where the Error Occurred. If there is more than one possible instruction, information is given on all of them. Nothing is given if the instruction cannot be identified.					
Precautions/Remarks	If a program is changed after an error occurs, the attached information that is displayed may not be correct.					

Event name	Master Distance in Deceleration Specification Out of Range		Event code	54015484 hex		
Meaning	The parameter specified for the <i>MasterDistanceInDEC</i> input variable to a motion control instruction is out of range.					
Source	PLC Function Module		Source details	Instruction	Detection timing	At instruction execution
Error attributes	Level	Observation	Recovery	---	Log category	System
Effects	User program	Continues.	Operation	The relevant instruction will end according to specifications.		
System-defined variables	Variable	Data type		Name		
	_MC_AX[*].MFAultLvl.Active	BOOL		Axis Minor Fault Occurrence		
Cause and correction	Assumed cause		Correction		Prevention	
	Instruction input parameter exceeded the valid range of the input variable.		Correct the parameter so that the valid range of the input variable is not exceeded for the relevant instruction.		Set the input parameter to the instruction so that the valid range of the input variable is not exceeded.	
Attached information	Attached Information 1: Error Location Attached Information 3: Names of the Instruction and Instruction Instance Where the Error Occurred. If there is more than one possible instruction, information is given on all of them. Nothing is given if the instruction cannot be identified.					
Precautions/Remarks	If a program is changed after an error occurs, the attached information that is displayed may not be correct.					

Event name	Execution Mode Selection Out of Range		Event code	54015487 hex		
Meaning	The parameter specified for the <i>ExecutionMode</i> input variable to a motion control instruction is out of range.					
Source	PLC Function Module		Source details	Instruction	Detection timing	At instruction execution
Error attributes	Level	Observation	Recovery	---	Log category	System
Effects	User program	Continues.	Operation	The relevant instruction will end according to specifications.		
System-defined variables	Variable	Data type		Name		
	_MC_AX[*].MFAultLvl.Active	BOOL		Axis Minor Fault Occurrence		
Cause and correction	Assumed cause		Correction		Prevention	
	Instruction input parameter exceeded the valid range of the input variable.		Correct the parameter so that the valid range of the input variable is not exceeded for the relevant instruction.		Set the input parameter to the instruction so that the valid range of the input variable is not exceeded.	
Attached information	Attached Information 1: Error Location Attached Information 3: Names of the Instruction and Instruction Instance Where the Error Occurred. If there is more than one possible instruction, information is given on all of them. Nothing is given if the instruction cannot be identified.					
Precautions/Remarks	If a program is changed after an error occurs, the attached information that is displayed may not be correct.					

Event name	Permitted Following Error Out of Range		Event code	54015488 hex		
Meaning	The parameter specified for the <i>PermittedDeviation</i> input variable to a motion control instruction is out of range.					
Source	PLC Function Module		Source details	Instruction	Detection timing	At instruction execution
Error attributes	Level	Observation	Recovery	---	Log category	System
Effects	User program	Continues.	Operation	The relevant instruction will end according to specifications.		
System-defined variables	Variable		Data type		Name	
	_MC_COM.MFaultLvl.Active		BOOL		MC Common Minor Fault Occurrence	
Cause and correction	Assumed cause		Correction		Prevention	
	Instruction input parameter exceeded the valid range of the input variable.		Correct the parameter so that the valid range of the input variable is not exceeded for the relevant instruction.		Set the input parameter to the instruction so that the valid range of the input variable is not exceeded.	
Attached information	Attached Information 1: Error Location Attached Information 3: Names of the Instruction and Instruction Instance Where the Error Occurred. If there is more than one possible instruction, information is given on all of them. Nothing is given if the instruction cannot be identified.					
Precautions/Remarks	If a program is changed after an error occurs, the attached information that is displayed may not be correct.					

Event name	Border Point/Center Position/Radius Specification Out of Range		Event code	54015489 hex		
Meaning	The parameter specified for the <i>AuxPoint</i> input variable to a motion control instruction is out of range.					
Source	PLC Function Module		Source details	Instruction	Detection timing	At instruction execution
Error attributes	Level	Observation	Recovery	---	Log category	System
Effects	User program	Continues.	Operation	The relevant instruction will end according to specifications.		
System-defined variables	Variable		Data type		Name	
	_MC_GRP[*].MFaultLvl.Active		BOOL		Axes Group Minor Fault Occurrence	
Cause and correction	Assumed cause		Correction		Prevention	
	The value of <i>AuxPoint</i> exceeded signed 40-bit data when converted to pulses for the border point or center specification method. For a radius specifications, the absolute value of <i>AuxPoint[0]</i> exceeded 40-bit data when it is converted to pulses.		Correct the parameter so that the valid range of the input variable is not exceeded for the relevant instruction.		Set the input parameter to the instruction so that the valid range of the input variable is not exceeded.	
Attached information	Attached Information 1: Error Location Attached Information 3: Names of the Instruction and Instruction Instance Where the Error Occurred. If there is more than one possible instruction, information is given on all of them. Nothing is given if the instruction cannot be identified.					
Precautions/Remarks	If a program is changed after an error occurs, the attached information that is displayed may not be correct.					

Event name	End Point Specification Out of Range		Event code	5401548A hex	
Meaning	The parameter specified for the <i>EndPoint</i> input variable to a motion control instruction is out of range.				
Source	PLC Function Module		Source details	Instruction	Detection timing At instruction execution
Error attributes	Level	Observation	Recovery	---	Log category System
Effects	User program	Continues.	Operation	The relevant instruction will end according to specifications.	
System-defined variables	Variable	Data type		Name	
	_MC_GRP[*].MFaultLvl.Active	BOOL		Axes Group Minor Fault Occurrence	
Cause and correction	Assumed cause		Correction		Prevention
	The instruction input parameter exceeded the range of signed 40-bit data when it was converted to pulses.		Correct the parameter so that the valid range of the input variable is not exceeded for the relevant instruction.		Set the input parameter to the instruction so that the valid range of the input variable is not exceeded.
Attached information	Attached Information 1: Error Location Attached Information 3: Names of the Instruction and Instruction Instance Where the Error Occurred. If there is more than one possible instruction, information is given on all of them. Nothing is given if the instruction cannot be identified.				
Precautions/Remarks	If a program is changed after an error occurs, the attached information that is displayed may not be correct.				

Event name	Slave Travel Distance Specification Out of Range		Event code	5401548B hex	
Meaning	The parameter specified for the <i>SlaveDistance</i> input variable to a motion control instruction is out of range.				
Source	PLC Function Module		Source details	Instruction	Detection timing At instruction execution
Error attributes	Level	Observation	Recovery	---	Log category System
Effects	User program	Continues.	Operation	The relevant instruction will end according to specifications.	
System-defined variables	Variable	Data type		Name	
	_MC_AX[*].MFaultLvl.Active	BOOL		Axis Minor Fault Occurrence	
Cause and correction	Assumed cause		Correction		Prevention
	The instruction input parameter exceeded the range of 40-bit data when it is converted to pulses.		Correct the parameter so that the valid range of the input variable is not exceeded for the relevant instruction.		Set the input parameter to the instruction so that the valid range of the input variable is not exceeded.
Attached information	Attached Information 1: Error Location Attached Information 3: Names of the Instruction and Instruction Instance Where the Error Occurred. If there is more than one possible instruction, information is given on all of them. Nothing is given if the instruction cannot be identified.				
Precautions/Remarks	If a program is changed after an error occurs, the attached information that is displayed may not be correct.				

Event name	Phase Shift Amount Out of Range		Event code	5401548C hex	
Meaning	The parameter specified for the <i>PhaseShift</i> input variable to a motion control instruction is out of range.				
Source	PLC Function Module		Source details	Instruction	Detection timing At instruction execution
Error attributes	Level	Observation	Recovery	---	Log category System
Effects	User program	Continues.	Operation	The relevant instruction will end according to specifications.	
System-defined variables	Variable		Data type		Name
	_MC_AX[*].MFAultLvl.Active		BOOL		Axis Minor Fault Occurrence
Cause and correction	Assumed cause		Correction		Prevention
	The absolute value of the instruction input parameter exceeded the range of 40-bit data when it is converted to pulses.		Correct the parameter so that the valid range of the input variable is not exceeded for the relevant instruction.		Set the input parameter to the instruction so that the valid range of the input variable is not exceeded.
Attached information	Attached Information 1: Error Location Attached Information 3: Names of the Instruction and Instruction Instance Where the Error Occurred. If there is more than one possible instruction, information is given on all of them. Nothing is given if the instruction cannot be identified.				
Precautions/Remarks	If a program is changed after an error occurs, the attached information that is displayed may not be correct.				

Event name	Feeding Distance Out of Range		Event code	5401548D hex	
Meaning	The parameter specified for the <i>FeedDistance</i> input variable to a motion control instruction is out of range.				
Source	PLC Function Module		Source details	Instruction	Detection timing At instruction execution
Error attributes	Level	Observation	Recovery	---	Log category System
Effects	User program	Continues.	Operation	The relevant instruction will end according to specifications.	
System-defined variables	Variable		Data type		Name
	_MC_AX[*].MFAultLvl.Active		BOOL		Axis Minor Fault Occurrence
Cause and correction	Assumed cause		Correction		Prevention
	The absolute value of the instruction input parameter exceeded the range of 40-bit data when it is converted to pulses.		Correct the parameter so that the valid range of the input variable is not exceeded for the relevant instruction.		Set the input parameter to the instruction so that the valid range of the input variable is not exceeded.
Attached information	Attached Information 1: Error Location Attached Information 3: Names of the Instruction and Instruction Instance Where the Error Occurred. If there is more than one possible instruction, information is given on all of them. Nothing is given if the instruction cannot be identified.				
Precautions/Remarks	If a program is changed after an error occurs, the attached information that is displayed may not be correct.				

Event name	Auxiliary and Slave Defined as Same Axis		Event code	5401548E hex	
Meaning	The same axis was specified for the <i>Auxiliary</i> and <i>Slave</i> input variables to a motion control instruction.				
Source	PLC Function Module		Source details	Instruction	Detection timing At instruction execution
Error attributes	Level	Observation	Recovery	---	Log category System
Effects	User program	Continues.	Operation	The relevant instruction will end according to specifications.	
System-defined variables	Variable	Data type		Name	
	_MC_AX[*].MFAultLvl.Active	BOOL		Axis Minor Fault Occurrence	
Cause and correction	Assumed cause		Correction		Prevention
	The parameter was the same for the <i>Auxiliary</i> and <i>Slave</i> input variables to the instruction.		Correct the parameters so that different axes are specified for the <i>Auxiliary</i> and <i>Slave</i> input variables to the instruction.		Specify different axes for the auxiliary axis and slave axis for a motion control instruction.
Attached information	Attached Information 1: Error Location Attached Information 3: Names of the Instruction and Instruction Instance Where the Error Occurred. If there is more than one possible instruction, information is given on all of them. Nothing is given if the instruction cannot be identified.				
Precautions/Remarks	If a program is changed after an error occurs, the attached information that is displayed may not be correct.				

Event name	Relative Position Selection Out of Range		Event code	5401548F hex	
Meaning	The parameter specified for the <i>Relative</i> input variable to a motion control instruction is out of range.				
Source	PLC Function Module		Source details	Instruction	Detection timing At instruction execution
Error attributes	Level	Observation	Recovery	---	Log category System
Effects	User program	Continues.	Operation	The relevant instruction will end according to specifications.	
System-defined variables	Variable	Data type		Name	
	_MC_AX[*].MFAultLvl.Active	BOOL		Axis Minor Fault Occurrence	
Cause and correction	Assumed cause		Correction		Prevention
	Instruction input parameter exceeded the valid range of the input variable.		Correct the parameter so that the valid range of the input variable is not exceeded for the relevant instruction.		Set the input parameter to the instruction so that the valid range of the input variable is not exceeded.
Attached information	Attached Information 1: Error Location Attached Information 3: Names of the Instruction and Instruction Instance Where the Error Occurred. If there is more than one possible instruction, information is given on all of them. Nothing is given if the instruction cannot be identified.				
Precautions/Remarks	If a program is changed after an error occurs, the attached information that is displayed may not be correct.				

3 Error Descriptions and Corrections

Event name	Cam Transition Specification Out of Range		Event code	54015490 hex		
Meaning	The parameter specified for the <i>CamTransition</i> input variable to a motion control instruction is out of range.					
Source	PLC Function Module		Source details	Instruction	Detection timing	At instruction execution
Error attributes	Level	Observation	Recovery	---	Log category	System
Effects	User program	Continues.	Operation	The relevant instruction will end according to specifications.		
System-defined variables	Variable		Data type		Name	
	_MC_AX[*].MFAultLvl.Active		BOOL		Axis Minor Fault Occurrence	
Cause and correction	Assumed cause		Correction		Prevention	
	Instruction input parameter exceeded the valid range of the input variable.		Correct the parameter so that the valid range of the input variable is not exceeded for the relevant instruction.		Set the input parameter to the instruction so that the valid range of the input variable is not exceeded.	
Attached information	Attached Information 1: Error Location Attached Information 3: Names of the Instruction and Instruction Instance Where the Error Occurred. If there is more than one possible instruction, information is given on all of them. Nothing is given if the instruction cannot be identified.					
Precautions/Remarks	If a program is changed after an error occurs, the attached information that is displayed may not be correct.					

Event name	Synchronized Control End Mode Selection Out of Range		Event code	54015491 hex		
Meaning	The parameter specified for the <i>OutMode</i> input variable to a motion control instruction is out of range.					
Source	PLC Function Module		Source details	Instruction	Detection timing	At instruction execution
Error attributes	Level	Observation	Recovery	---	Log category	System
Effects	User program	Continues.	Operation	The relevant instruction will end according to specifications.		
System-defined variables	Variable		Data type		Name	
	_MC_AX[*].MFAultLvl.Active		BOOL		Axis Minor Fault Occurrence	
Cause and correction	Assumed cause		Correction		Prevention	
	Instruction input parameter exceeded the valid range of the input variable.		Correct the parameter so that the valid range of the input variable is not exceeded for the relevant instruction.		Set the input parameter to the instruction so that the valid range of the input variable is not exceeded.	
Attached information	Attached Information 1: Error Location Attached Information 3: Names of the Instruction and Instruction Instance Where the Error Occurred. If there is more than one possible instruction, information is given on all of them. Nothing is given if the instruction cannot be identified.					
Precautions/Remarks	If a program is changed after an error occurs, the attached information that is displayed may not be correct.					

Event name	Enable External Latch Instruction Execution Disabled		Event code	54015492 hex	
Meaning	_mclmediateStop was specified for the StopMode input variable when the MC_TouchProbe (Enable External Latch) instruction was executed in Drive Mode for an encoder axis.				
Source	PLC Function Module		Source details	Instruction	Detection timing At instruction execution
Error attributes	Level	Observation	Recovery	---	Log category System
Effects	User program	Continues.	Operation	The relevant instruction will end according to specifications.	
System-defined variables	Variable	Data type		Name	
	_MC_AX[*].MFAultLvl.Active	BOOL		Axis Minor Fault Occurrence	
Cause and correction	Assumed cause	Correction		Prevention	
	_mclmediateStop was specified for the StopMode input variable when the MC_TouchProbe (Enable External Latch) instruction was executed in Drive Mode for an encoder axis.	Correct the program so that _mclmediateStop is not specified for StopMode for the encoder axis.		If you specify _mclmediateStop and use Drive Mode, execute the MC_TouchProbe (Enable External Latch) instruction only for a servo axis.	
Attached information	Attached Information 1: Error Location Attached Information 3: Names of the Instruction and Instruction Instance Where the Error Occurred. If there is more than one possible instruction, information is given on all of them. Nothing is given if the instruction cannot be identified.				
Precautions/Remarks	If a program is changed after an error occurs, the attached information that is displayed may not be correct.				

Event name	Master Axis Offset Out of Range		Event code	54015493 hex	
Meaning	The parameter specified for the MasterOffset input variable to a motion control instruction is out of range.				
Source	PLC Function Module		Source details	Instruction	Detection timing At instruction execution
Error attributes	Level	Observation	Recovery	---	Log category System
Effects	User program	Continues.	Operation	The relevant instruction will end according to specifications.	
System-defined variables	Variable	Data type		Name	
	_MC_AX[*].MFAultLvl.Active	BOOL		Axis Minor Fault Occurrence	
Cause and correction	Assumed cause	Correction		Prevention	
	The instruction input parameter exceeded the range of signed 40-bit data when it was converted to pulses.	Correct the parameter so that the valid range of the input variable is not exceeded for the relevant instruction.		Set the input parameter to the instruction so that the valid range of the input variable is not exceeded.	
Attached information	Attached Information 1: Error Location Attached Information 3: Names of the Instruction and Instruction Instance Where the Error Occurred. If there is more than one possible instruction, information is given on all of them. Nothing is given if the instruction cannot be identified.				
Precautions/Remarks	If a program is changed after an error occurs, the attached information that is displayed may not be correct.				

Event name	Slave Axis Offset Out of Range		Event code	54015494 hex		
Meaning	The parameter specified for the <i>SlaveOffset</i> input variable to a motion control instruction is out of range.					
Source	PLC Function Module		Source details	Instruction	Detection timing	At instruction execution
Error attributes	Level	Observation	Recovery	---	Log category	System
Effects	User program	Continues.	Operation	The relevant instruction will end according to specifications.		
System-defined variables	Variable		Data type		Name	
	_MC_AX[*].MFAultLvl.Active		BOOL		Axis Minor Fault Occurrence	
Cause and correction	Assumed cause		Correction		Prevention	
	The instruction input parameter exceeded the range of signed 40-bit data when it was converted to pulses.		Correct the parameter so that the valid range of the input variable is not exceeded for the relevant instruction.		Set the input parameter to the instruction so that the valid range of the input variable is not exceeded.	
Attached information	Attached Information 1: Error Location Attached Information 3: Names of the Instruction and Instruction Instance Where the Error Occurred. If there is more than one possible instruction, information is given on all of them. Nothing is given if the instruction cannot be identified.					
Precautions/Remarks	If a program is changed after an error occurs, the attached information that is displayed may not be correct.					

Event name	Command Current Position Count Selection Out of Range		Event code	54015495 hex		
Meaning	The parameter specified for the <i>CmdPosMode</i> input variable to a motion control instruction is out of range.					
Source	PLC Function Module		Source details	Instruction	Detection timing	At instruction execution
Error attributes	Level	Observation	Recovery	---	Log category	System
Effects	User program	Continues.	Operation	The relevant instruction will end according to specifications.		
System-defined variables	Variable		Data type		Name	
	_MC_AX[*].MFAultLvl.Active		BOOL		Axis Minor Fault Occurrence	
Cause and correction	Assumed cause		Correction		Prevention	
	Instruction input parameter exceeded the valid range of the input variable.		Correct the parameter so that the valid range of the input variable is not exceeded for the relevant instruction.		Set the input parameter to the instruction so that the valid range of the input variable is not exceeded.	
Attached information	Attached Information 1: Error Location Attached Information 3: Names of the Instruction and Instruction Instance Where the Error Occurred. If there is more than one possible instruction, information is given on all of them. Nothing is given if the instruction cannot be identified.					
Precautions/Remarks	If a program is changed after an error occurs, the attached information that is displayed may not be correct.					

Event name	Master Axis Gear Ratio Numerator Out of Range		Event code	54015496 hex	
Meaning	The parameter specified for the <i>RatioNumeratorMaster</i> input variable to a motion control instruction is out of range.				
Source	PLC Function Module		Source details	Instruction	Detection timing At instruction execution
Error attributes	Level	Observation	Recovery	---	Log category System
Effects	User program	Continues.	Operation	The relevant instruction will end according to specifications.	
System-defined variables	Variable	Data type		Name	
	_MC_AX[*].MFAultLvl.Active	BOOL		Axis Minor Fault Occurrence	
Cause and correction	Assumed cause		Correction		Prevention
	Instruction input parameter exceeded the valid range of the input variable.		Correct the parameter so that the valid range of the input variable is not exceeded for the relevant instruction.		Set the input parameter to the instruction so that the valid range of the input variable is not exceeded.
Attached information	Attached Information 1: Error Location Attached Information 3: Names of the Instruction and Instruction Instance Where the Error Occurred. If there is more than one possible instruction, information is given on all of them. Nothing is given if the instruction cannot be identified.				
Precautions/Remarks	If a program is changed after an error occurs, the attached information that is displayed may not be correct.				

Event name	Master Axis Gear Ratio Denominator Out of Range		Event code	54015497 hex	
Meaning	The parameter specified for the <i>RatioDenominatorMaster</i> input variable to a motion control instruction is out of range.				
Source	PLC Function Module		Source details	Instruction	Detection timing At instruction execution
Error attributes	Level	Observation	Recovery	---	Log category System
Effects	User program	Continues.	Operation	The relevant instruction will end according to specifications.	
System-defined variables	Variable	Data type		Name	
	_MC_AX[*].MFAultLvl.Active	BOOL		Axis Minor Fault Occurrence	
Cause and correction	Assumed cause		Correction		Prevention
	Instruction input parameter exceeded the valid range of the input variable.		Correct the parameter so that the valid range of the input variable is not exceeded for the relevant instruction.		Set the input parameter to the instruction so that the valid range of the input variable is not exceeded.
Attached information	Attached Information 1: Error Location Attached Information 3: Names of the Instruction and Instruction Instance Where the Error Occurred. If there is more than one possible instruction, information is given on all of them. Nothing is given if the instruction cannot be identified.				
Precautions/Remarks	If a program is changed after an error occurs, the attached information that is displayed may not be correct.				

3 Error Descriptions and Corrections

Event name	Auxiliary Axis Gear Ratio Numerator Out of Range		Event code	54015498 hex		
Meaning	The parameter specified for the <i>RatioNumeratorAuxiliary</i> input variable to a motion control instruction is out of range.					
Source	PLC Function Module		Source details	Instruction	Detection timing	At instruction execution
Error attributes	Level	Observation	Recovery	---	Log category	System
Effects	User program	Continues.	Operation	The relevant instruction will end according to specifications.		
System-defined variables	Variable		Data type		Name	
	_MC_AX[*].MFaultLvl.Active		BOOL		Axis Minor Fault Occurrence	
Cause and correction	Assumed cause		Correction		Prevention	
	Instruction input parameter exceeded the valid range of the input variable.		Correct the parameter so that the valid range of the input variable is not exceeded for the relevant instruction.		Set the input parameter to the instruction so that the valid range of the input variable is not exceeded.	
Attached information	Attached Information 1: Error Location Attached Information 3: Names of the Instruction and Instruction Instance Where the Error Occurred. If there is more than one possible instruction, information is given on all of them. Nothing is given if the instruction cannot be identified.					
Precautions/Remarks	If a program is changed after an error occurs, the attached information that is displayed may not be correct.					

Event name	Auxiliary Axis Gear Ratio Denominator Out of Range		Event code	54015499 hex		
Meaning	The parameter specified for the <i>RatioDenominatorAuxiliary</i> input variable to a motion control instruction is out of range.					
Source	PLC Function Module		Source details	Instruction	Detection timing	At instruction execution
Error attributes	Level	Observation	Recovery	---	Log category	System
Effects	User program	Continues.	Operation	The relevant instruction will end according to specifications.		
System-defined variables	Variable		Data type		Name	
	_MC_AX[*].MFaultLvl.Active		BOOL		Axis Minor Fault Occurrence	
Cause and correction	Assumed cause		Correction		Prevention	
	Instruction input parameter exceeded the valid range of the input variable.		Correct the parameter so that the valid range of the input variable is not exceeded for the relevant instruction.		Set the input parameter to the instruction so that the valid range of the input variable is not exceeded.	
Attached information	Attached Information 1: Error Location Attached Information 3: Names of the Instruction and Instruction Instance Where the Error Occurred. If there is more than one possible instruction, information is given on all of them. Nothing is given if the instruction cannot be identified.					
Precautions/Remarks	If a program is changed after an error occurs, the attached information that is displayed may not be correct.					

Event name	Master Axis Position Type Selection Out of Range		Event code	5401549A hex	
Meaning	The parameter specified for the <i>ReferenceTypeMaster</i> input variable to a motion control instruction is out of range.				
Source	PLC Function Module		Source details	Instruction	Detection timing At instruction execution
Error attributes	Level	Observation	Recovery	---	Log category System
Effects	User program	Continues.	Operation	The relevant instruction will end according to specifications.	
System-defined variables	Variable	Data type		Name	
	_MC_AX[*].MFAultLvl.Active	BOOL		Axis Minor Fault Occurrence	
Cause and correction	Assumed cause		Correction		Prevention
	Instruction input parameter exceeded the valid range of the input variable.		Correct the parameter so that the valid range of the input variable is not exceeded for the relevant instruction.		Set the input parameter to the instruction so that the valid range of the input variable is not exceeded.
Attached information	Attached Information 1: Error Location Attached Information 3: Names of the Instruction and Instruction Instance Where the Error Occurred. If there is more than one possible instruction, information is given on all of them. Nothing is given if the instruction cannot be identified.				
Precautions/Remarks	If a program is changed after an error occurs, the attached information that is displayed may not be correct.				

Event name	Auxiliary Axis Position Type Selection Out of Range		Event code	5401549B hex	
Meaning	The parameter specified for the <i>ReferenceTypeAuxiliary</i> input variable to a motion control instruction is out of range.				
Source	PLC Function Module		Source details	Instruction	Detection timing At instruction execution
Error attributes	Level	Observation	Recovery	---	Log category System
Effects	User program	Continues.	Operation	The relevant instruction will end according to specifications.	
System-defined variables	Variable	Data type		Name	
	_MC_AX[*].MFAultLvl.Active	BOOL		Axis Minor Fault Occurrence	
Cause and correction	Assumed cause		Correction		Prevention
	Instruction input parameter exceeded the valid range of the input variable.		Correct the parameter so that the valid range of the input variable is not exceeded for the relevant instruction.		Set the input parameter to the instruction so that the valid range of the input variable is not exceeded.
Attached information	Attached Information 1: Error Location Attached Information 3: Names of the Instruction and Instruction Instance Where the Error Occurred. If there is more than one possible instruction, information is given on all of them. Nothing is given if the instruction cannot be identified.				
Precautions/Remarks	If a program is changed after an error occurs, the attached information that is displayed may not be correct.				

Event name	Target Position Ring Counter Out of Range		Event code	5401549C hex		
Meaning	Operation is not possible because the target position is out of range for the ring counter of the executed instruction.					
Source	PLC Function Module		Source details	Instruction	Detection timing	At instruction execution
Error attributes	Level	Observation	Recovery	---	Log category	System
Effects	User program	Continues.	Operation	The relevant instruction will end according to specifications.		
System-defined variables	Variable		Data type		Name	
	_MC_AX[*].MFAultLvl.Active		BOOL		Axis Minor Fault Occurrence	
Cause and correction	Assumed cause		Correction		Prevention	
	High-speed homing was executed when 0 was not included in the ring counter.		High-speed homing cannot be executed when the ring counter range does not include 0. Correct the program so that high-speed homing is not performed. Or change the settings so that the ring counter range includes 0.		High-speed homing cannot be executed when the ring counter range does not include 0. Write the program so that high-speed homing is not performed. Or make the settings so that the ring counter range includes 0.	
Attached information	Attached Information 1: Error Location Attached Information 3: Names of the Instruction and Instruction Instance Where the Error Occurred. If there is more than one possible instruction, information is given on all of them. Nothing is given if the instruction cannot be identified.					
Precautions/Remarks	If a program is changed after an error occurs, the attached information that is displayed may not be correct.					

Event name	Axes Group Composition Axis Setting Out of Range		Event code	5401549D hex		
Meaning	The parameter specified for the Axes input variable to a motion control instruction is out of range.					
Source	PLC Function Module		Source details	Instruction	Detection timing	At instruction execution
Error attributes	Level	Observation	Recovery	---	Log category	System
Effects	User program	Continues.	Operation	The relevant instruction will end according to specifications.		
System-defined variables	Variable		Data type		Name	
	_MC_GRP[*].MFAultLvl.Active		BOOL		Axes Group Minor Fault Occurrence	
Cause and correction	Assumed cause		Correction		Prevention	
	Instruction input parameter exceeded the valid range of the input variable.		Correct the parameter so that the valid range of the input variable is not exceeded for the relevant instruction.		Set the input parameter to the instruction so that the valid range of the input variable is not exceeded.	
	The composition axes in the axes group are not assigned to the same task.		Assign all of the axes that are specified for the Axes input variable to the instruction to the same task.		Specify axes that are assigned to the same task for all of the composition axes in an axes group.	
Attached information	Attached Information 1: Error Location Attached Information 3: Names of the Instruction and Instruction Instance Where the Error Occurred. If there is more than one possible instruction, information is given on all of them. Nothing is given if the instruction cannot be identified.					
Precautions/Remarks	If a program is changed after an error occurs, the attached information that is displayed may not be correct.					

Event name	Axis Use Setting Out of Range		Event code	5401549E hex	
Meaning	The parameter specified for the <i>AxisUse</i> input variable to a motion control instruction is out of range.				
Source	PLC Function Module		Source details	Instruction	Detection timing At instruction execution
Error attributes	Level	Observation	Recovery	---	Log category System
Effects	User program	Continues.	Operation	The relevant instruction will end according to specifications.	
System-defined variables	Variable	Data type		Name	
	_MC_COM.MFaultLvl.Active	BOOL		MC Common Minor Fault Occurrence	
Cause and correction	Assumed cause	Correction		Prevention	
	Instruction input parameter exceeded the valid range of the input variable.	Correct the parameter so that the valid range of the input variable is not exceeded for the relevant instruction.		Set the input parameter to the instruction so that the valid range of the input variable is not exceeded.	
Attached information	Attached Information 1: Error Location Attached Information 3: Names of the Instruction and Instruction Instance Where the Error Occurred. If there is more than one possible instruction, information is given on all of them. Nothing is given if the instruction cannot be identified.				
Precautions/Remarks	If a program is changed after an error occurs, the attached information that is displayed may not be correct.				

Event name	Homing Parameter Setting Out of Range		Event code	54015700 hex	
Meaning	The parameter specified for the <i>HomingParameter</i> input variable to a motion control instruction is out of range.				
Source	PLC Function Module		Source details	Instruction	Detection timing At instruction execution
Error attributes	Level	Observation	Recovery	---	Log category System
Effects	User program	Continues.	Operation	The relevant instruction will end according to specifications.	
System-defined variables	Variable	Data type		Name	
	_MC_COM.MFaultLvl.Active	BOOL		MC Common Minor Fault Occurrence	
Cause and correction	Assumed cause	Correction		Prevention	
	Instruction input parameter exceeded the valid range of the input variable.	Correct the parameter so that the valid range of the input variable is not exceeded for the relevant instruction.		Set the input parameter to the instruction so that the valid range of the input variable is not exceeded.	
Attached information	Attached Information 1: Error Location Attached Information 3: Names of the Instruction and Instruction Instance Where the Error Occurred. If there is more than one possible instruction, information is given on all of them. Nothing is given if the instruction cannot be identified.				
Precautions/Remarks	If a program is changed after an error occurs, the attached information that is displayed may not be correct.				

Event name	Axis Use Change Error		Event code	54015702 hex	
Meaning	The MC_ChangeAxisUse (Change Axis Use) instruction was executed when the axis was not stopped or when the command velocity of the axis was saturated.				
Source	PLC Function Module		Source details	Instruction	Detection timing At instruction execution
Error attributes	Level	Observation	Recovery	---	Log category System
Effects	User program	Continues.	Operation	The relevant instruction will end according to specifications.	
System-defined variables	Variable	Data type		Name	
	_MC_AX[*].MFAultLvl.Active	BOOL		Axis Minor Fault Occurrence	
Cause and correction	Assumed cause	Correction		Prevention	
	The MC_ChangeAxisUse (Change Axis Use) instruction was executed when the axis was not stopped or when the command velocity of the axis was saturated.	Reset the error and execute the MC_ChangeAxisUse (Change Axis Use) instruction when the axis is stopped or when the command velocity of the axis is not saturated. An axis is stopped if <i>Status.Disabled</i> or <i>Status.Standstill</i> is TRUE in the Axis Variable. The command velocity for an axis is saturated if <i>Details.VelLimit</i> is TRUE in the Axis Variable.		Execute the MC_ChangeAxisUse (Change Axis Use) instruction when the axis is stopped and the command velocity is not saturated.	
Attached information	Attached Information 1: Error Location Attached Information 3: Names of the Instruction and Instruction Instance Where the Error Occurred. If there is more than one possible instruction, information is given on all of them. Nothing is given if the instruction cannot be identified.				
Precautions/Remarks	If a program is changed after an error occurs, the attached information that is displayed may not be correct.				

Event name	Cannot Change Axis Use		Event code	54015703 hex	
Meaning	The MC_ChangeAxisUse (Change Axis Use) instruction was executed in a way that would cause the maximum number of used real axes or the maximum number of used motion control servo axes to be exceeded.				
Source	PLC Function Module		Source details	Instruction	Detection timing At instruction execution
Error attributes	Level	Observation	Recovery	---	Log category System
Effects	User program	Continues.	Operation	The relevant instruction will end according to specifications.	
System-defined variables	Variable	Data type		Name	
	_MC_COM.MFaultLvl.Active	BOOL		MC Common Minor Fault Occurrence	
Cause and correction	Assumed cause	Correction		Prevention	
	The MC_ChangeAxisUse (Change Axis Use) instruction was executed in a way that would cause the maximum number of actually usable axes to be exceeded.	Correct the program so that the maximum number of axes that can actually be used by the CPU Unit is not exceeded.		Write the program so that the maximum number of axes that can actually be used by the CPU Unit is not exceeded.	
	The MC_ChangeAxisUse (Change Axis Use) instruction was executed in a way that would cause the maximum number of used motion control servo axes to be exceeded.	Correct the program so that the maximum number of used motion control servo axes that can be used by the CPU Unit is not exceeded.		Write the program so that the maximum number of used motion control servo axes that can be used by the CPU Unit is not exceeded.	
Attached information	Attached Information 1: Error Location Attached Information 3: Names of the Instruction and Instruction Instance Where the Error Occurred. If there is more than one possible instruction, information is given on all of them. Nothing is given if the instruction cannot be identified.				
Precautions/Remarks	If a program is changed after an error occurs, the attached information that is displayed may not be correct.				

Event name	Motion Control Parameter Setting Error When Changing Axis Use		Event code	54015720 hex	
Meaning	The motion control parameter settings for the axis that was changed to a used axis are incorrect.				
Source	PLC Function Module		Source details	Instruction	Detection timing At instruction execution
Error attributes	Level	Observation	Recovery	---	Log category System
Effects	User program	Continues.	Operation	The relevant instruction will end according to specifications.	
System-defined variables	Variable	Data type		Name	
	_MC_COM.MFaultLvl.Active	BOOL		MC Common Minor Fault Occurrence	
Cause and correction	Assumed cause	Correction		Prevention	
	The MC_ChangeAxisUse (Change Axis Use) instruction was used to change an unused axis to a used axis, but the motion control parameter settings of the axis are not correct.	Use the Sysmac Studio to change the Axis Use of the axis where the error occurred to a Used Axis , and then check and correct the error location. If an error does not occur, change the setting to an Unused Axis and then download the settings again.		Make sure that operation is correct when the axis is set to a Used Axis and then download the settings with it set to an Unused Axis .	
	The power supply was interrupted while a download of the motion control parameter settings was in progress.	Download the MC parameters from the Sysmac Studio.		Do not interrupt the power supply while saving the parameter settings.	
	The non-volatile memory is faulty or the life of the non-volatile memory has been exceeded.	If this error remains even after making the above corrections, replace the CPU Unit.		None	
Attached information	Attached Information 1: Error Location Attached Information 3: Names of the Instruction and Instruction Instance Where the Error Occurred. If there is more than one possible instruction, information is given on all of them. Nothing is given if the instruction cannot be identified.				
Precautions/Remarks	If a program is changed after an error occurs, the attached information that is displayed may not be correct.				

Event name	Required Process Data Object Not Set When Changing Axis Use		Event code	54015721 hex	
Meaning	The objects that are required for the axis type of the axis that was changed to a used axis are not set.				
Source	PLC Function Module		Source details	Instruction	Detection timing At instruction execution
Error attributes	Level	Observation	Recovery	---	Log category System
Effects	User program	Continues.	Operation	The relevant instruction will end according to specifications.	
System-defined variables	Variable	Data type		Name	
	_MC_COM.MFaultLvl.Active	BOOL		MC Common Minor Fault Occurrence	
Cause and correction	Assumed cause	Correction		Prevention	
	The objects that are required for the axis type of the axis that was changed to a used axis are not set in the PDO map settings.	Edit the PDO map settings on the Sysmac Studio and set the objects that are required for the axis where the error occurred. For details on the required objects, refer to the <i>NJ/NX-series Motion Control Instructions Reference Manual (Cat. No. W508)</i> .		Make sure that operation is correct when the axis is set to a Used Axis and then download the settings with it set to an Unused Axis .	
	The power supply was interrupted while a download of the motion control parameter settings was in progress.	Download the MC parameters from the Sysmac Studio.		Do not interrupt the power supply while saving the parameter settings.	
	The non-volatile memory is faulty or the life of the non-volatile memory has been exceeded.	If this error remains even after making the above corrections, replace the CPU Unit.		None	
	The MC_ChangeAxisUse (Change Axis Use) instruction was executed for an axis that Axis Use is set to Unused axis (unchangeable to used axis) .	Correct the program so that the MC_ChangeAxisUse (Change Axis Use) instruction is not executed for an axis that Axis Use is set to Unused axis (unchangeable to used axis) .		Write the program so that the MC_ChangeAxisUse (Change Axis Use) instruction is not executed for an axis that Axis Use is set to Unused axis (unchangeable to used axis) .	
Attached information	Attached Information 1: Error Location Attached Information 3: Names of the Instruction and Instruction Instance Where the Error Occurred. If there is more than one possible instruction, information is given on all of them. Nothing is given if the instruction cannot be identified.				
Precautions/Remarks	If a program is changed after an error occurs, the attached information that is displayed may not be correct.				

3 Error Descriptions and Corrections

Event name	Actual Position Overflow/Underflow		Event code	54015722 hex	
Meaning	An instruction was executed that is not supported during an actual position overflow/underflow.				
Source	PLC Function Module		Source details	Instruction	Detection timing At instruction execution
Error attributes	Level	Observation	Recovery	---	Log category System
Effects	User program	Continues.	Operation	The relevant instruction will end according to specifications.	
System-defined variables	Variable		Data type		Name
	_MC_AX[*].Obsr.Active		BOOL		Axis Observation Occurrence
Cause and correction	Assumed cause		Correction		Prevention
	An instruction was executed that is not supported during an actual position overflow or underflow.		Execute an error reset and then clear the overflow or underflow state by changing the current position or homing.		Write the program so that overflows and underflows do not occur.
Attached information	Attached Information 1: Error Location Attached Information 3: Names of the Instruction and Instruction Instance Where the Error Occurred. If there is more than one possible instruction, information is given on all of them. Nothing is given if the instruction cannot be identified.				
Precautions/Remarks	If a program is changed after an error occurs, the attached information that is displayed may not be correct.				

Event name	Switch Structure Track Number Setting Out of Range		Event code	54015723 hex	
Meaning	The value of <i>TrackNumber</i> that is specified in the <i>Switches</i> in-out variable to a motion control instruction is out of range.				
Source	PLC Function Module		Source details	Instruction	Detection timing At instruction execution
Error attributes	Level	Observation	Recovery	---	Log category System
Effects	User program	Continues.	Operation	The relevant instruction will end according to specifications.	
System-defined variables	Variable		Data type		Name
	_MC_AX[*].Obsr.Active		BOOL		Axis Observation Occurrence
Cause and correction	Assumed cause		Correction		Prevention
	The value of the member of the structure variable that was specified for the in-out variable of the instruction is out of range.		Correct the value of the member of the structure variable that is specified for the in-out variable of the relevant instruction so that it is in the valid range.		Make sure that the value of the member of the structure variable that is specified for the in-out variable of the relevant instruction is in the valid range.
Attached information	Attached Information 1: Error Location Attached Information 3: Names of the Instruction and Instruction Instance Where the Error Occurred. If there is more than one possible instruction, information is given on all of them. Nothing is given if the instruction cannot be identified.				
Precautions/Remarks	If a program is changed after an error occurs, the attached information that is displayed may not be correct.				

Event name	Switch Structure First ON Position Setting Out of Range		Event code	54015724 hex		
Meaning	The value of <i>FirstOnPosition</i> that is specified in the <i>Switches</i> in-out variable to a motion control instruction is out of range.					
Source	PLC Function Module		Source details	Instruction	Detection timing	At instruction execution
Error attributes	Level	Observation	Recovery	---	Log category	System
Effects	User program	Continues.	Operation	The relevant instruction will end according to specifications.		
System-defined variables	Variable	Data type		Name		
	_MC_AX[*].Obsr.Active	BOOL		Axis Observation Occurrence		
Cause and correction	Assumed cause		Correction		Prevention	
	The value of the member of the structure variable that was specified for the in-out variable of the instruction is out of range.		Correct the value of the member of the structure variable that is specified for the in-out variable of the relevant instruction so that it is in the valid range.		Make sure that the value of the member of the structure variable that is specified for the in-out variable of the relevant instruction is in the valid range.	
Attached information	Attached Information 1: Error Location Attached Information 3: Names of the Instruction and Instruction Instance Where the Error Occurred. If there is more than one possible instruction, information is given on all of them. Nothing is given if the instruction cannot be identified.					
Precautions/Remarks	If a program is changed after an error occurs, the attached information that is displayed may not be correct.					

Event name	Switch Structure Last ON Position Setting Out of Range		Event code	54015725 hex		
Meaning	The value of <i>LastOnPosition</i> that is specified in the <i>Switches</i> in-out variable to a motion control instruction is out of range.					
Source	PLC Function Module		Source details	Instruction	Detection timing	At instruction execution
Error attributes	Level	Observation	Recovery	---	Log category	System
Effects	User program	Continues.	Operation	The relevant instruction will end according to specifications.		
System-defined variables	Variable	Data type		Name		
	_MC_AX[*].Obsr.Active	BOOL		Axis Observation Occurrence		
Cause and correction	Assumed cause		Correction		Prevention	
	The value of the member of the structure variable that was specified for the in-out variable of the instruction is out of range.		Correct the value of the member of the structure variable that is specified for the in-out variable of the relevant instruction so that it is in the valid range.		Make sure that the value of the member of the structure variable that is specified for the in-out variable of the relevant instruction is in the valid range.	
Attached information	Attached Information 1: Error Location Attached Information 3: Names of the Instruction and Instruction Instance Where the Error Occurred. If there is more than one possible instruction, information is given on all of them. Nothing is given if the instruction cannot be identified.					
Precautions/Remarks	If a program is changed after an error occurs, the attached information that is displayed may not be correct.					

3 Error Descriptions and Corrections

Event name	Switch Structure Axis Direction Out of Range		Event code	54015726 hex		
Meaning	The value of <i>AxisDirection</i> that is specified in the <i>Switches</i> in-out variable to a motion control instruction is out of range.					
Source	PLC Function Module		Source details	Instruction	Detection timing	At instruction execution
Error attributes	Level	Observation	Recovery	---	Log category	System
Effects	User program	Continues.	Operation	The relevant instruction will end according to specifications.		
System-defined variables	Variable	Data type		Name		
	_MC_AX[*].Obsr.Active	BOOL		Axis Observation Occurrence		
Cause and correction	Assumed cause	Correction		Prevention		
	The value of the member of the structure variable that was specified for the in-out variable of the instruction is out of range.	Correct the value of the member of the structure variable that is specified for the in-out variable of the relevant instruction so that it is in the valid range.		Make sure that the value of the member of the structure variable that is specified for the in-out variable of the relevant instruction is in the valid range.		
Attached information	Attached Information 1: Error Location Attached Information 3: Names of the Instruction and Instruction Instance Where the Error Occurred. If there is more than one possible instruction, information is given on all of them. Nothing is given if the instruction cannot be identified.					
Precautions/Remarks	If a program is changed after an error occurs, the attached information that is displayed may not be correct.					

Event name	Switch Structure Cam Switch Mode Out of Range		Event code	54015727 hex		
Meaning	The value of <i>CamSwitchMode</i> that is specified in the <i>Switches</i> in-out variable to a motion control instruction is out of range.					
Source	PLC Function Module		Source details	Instruction	Detection timing	At instruction execution
Error attributes	Level	Observation	Recovery	---	Log category	System
Effects	User program	Continues.	Operation	The relevant instruction will end according to specifications.		
System-defined variables	Variable	Data type		Name		
	_MC_AX[*].Obsr.Active	BOOL		Axis Observation Occurrence		
Cause and correction	Assumed cause	Correction		Prevention		
	The value of the member of the structure variable that was specified for the in-out variable of the instruction is out of range.	Correct the value of the member of the structure variable that is specified for the in-out variable of the relevant instruction so that it is in the valid range.		Make sure that the value of the member of the structure variable that is specified for the in-out variable of the relevant instruction is in the valid range.		
Attached information	Attached Information 1: Error Location Attached Information 3: Names of the Instruction and Instruction Instance Where the Error Occurred. If there is more than one possible instruction, information is given on all of them. Nothing is given if the instruction cannot be identified.					
Precautions/Remarks	If a program is changed after an error occurs, the attached information that is displayed may not be correct.					

Event name	Switch Structure Duration Setting Out of Range		Event code	54015728 hex	
Meaning	The value of <i>Duration</i> that is specified in the <i>Switches</i> in-out variable to a motion control instruction is out of range.				
Source	PLC Function Module		Source details	Instruction	Detection timing At instruction execution
Error attributes	Level	Observation	Recovery	---	Log category System
Effects	User program	Continues.	Operation	The relevant instruction will end according to specifications.	
System-defined variables	Variable	Data type		Name	
	_MC_AX[*].Obsr.Active	BOOL		Axis Observation Occurrence	
Cause and correction	Assumed cause	Correction		Prevention	
	The value of the member of the structure variable that was specified for the in-out variable of the instruction is out of range.	Correct the value of the member of the structure variable that is specified for the in-out variable of the relevant instruction so that it is in the valid range.		Make sure that the value of the member of the structure variable that is specified for the in-out variable of the relevant instruction is in the valid range.	
Attached information	Attached Information 1: Error Location Attached Information 3: Names of the Instruction and Instruction Instance Where the Error Occurred. If there is more than one possible instruction, information is given on all of them. Nothing is given if the instruction cannot be identified.				
Precautions/Remarks	If a program is changed after an error occurs, the attached information that is displayed may not be correct.				

Event name	Track Option Structure ON Compensation Setting Out of Range		Event code	54015729 hex	
Meaning	The value of <i>OnCompensation</i> that is specified in the <i>TrackOptions</i> in-out variable to a motion control instruction is out of range.				
Source	PLC Function Module		Source details	Instruction	Detection timing At instruction execution
Error attributes	Level	Observation	Recovery	---	Log category System
Effects	User program	Continues.	Operation	The relevant instruction will end according to specifications.	
System-defined variables	Variable	Data type		Name	
	_MC_AX[*].Obsr.Active	BOOL		Axis Observation Occurrence	
Cause and correction	Assumed cause	Correction		Prevention	
	The value of the member of the structure variable that was specified for the in-out variable of the instruction is out of range.	Correct the value of the member of the structure variable that is specified for the in-out variable of the relevant instruction so that it is in the valid range.		Make sure that the value of the member of the structure variable that is specified for the in-out variable of the relevant instruction is in the valid range.	
Attached information	Attached Information 1: Error Location Attached Information 3: Names of the Instruction and Instruction Instance Where the Error Occurred. If there is more than one possible instruction, information is given on all of them. Nothing is given if the instruction cannot be identified.				
Precautions/Remarks	If a program is changed after an error occurs, the attached information that is displayed may not be correct.				

Event name	Track Option Structure OFF Compensation Setting Out of Range		Event code	5401572A hex		
Meaning	The value of <i>TrackOptions</i> that is specified in the <i>OffCompensation</i> in-out variable to a motion control instruction is out of range.					
Source	PLC Function Module		Source details	Instruction	Detection timing	At instruction execution
Error attributes	Level	Observation	Recovery	---	Log category	System
Effects	User program	Continues.	Operation	The relevant instruction will end according to specifications.		
System-defined variables	Variable		Data type		Name	
	_MC_AX[*].Obsr.Active		BOOL		Axis Observation Occurrence	
Cause and correction	Assumed cause		Correction		Prevention	
	The value of the member of the structure variable that was specified for the in-out variable of the instruction is out of range.		Correct the value of the member of the structure variable that is specified for the in-out variable of the relevant instruction so that it is in the valid range.		Make sure that the value of the member of the structure variable that is specified for the in-out variable of the relevant instruction is in the valid range.	
Attached information	Attached Information 1: Error Location Attached Information 3: Names of the Instruction and Instruction Instance Where the Error Occurred. If there is more than one possible instruction, information is given on all of them. Nothing is given if the instruction cannot be identified.					
Precautions/Remarks	If a program is changed after an error occurs, the attached information that is displayed may not be correct.					

Event name	Number of Array Elements in Switch Structure Variable Out of Range		Event code	5401572B hex		
Meaning	The number of elements in an array in the structure variable that is specified in the <i>Switches</i> in-out variable to a motion control instruction is out of range.					
Source	PLC Function Module		Source details	Instruction	Detection timing	At instruction execution
Error attributes	Level	Observation	Recovery	---	Log category	System
Effects	User program	Continues.	Operation	The relevant instruction will end according to specifications.		
System-defined variables	Variable		Data type		Name	
	_MC_AX[*].Obsr.Active		BOOL		Axis Observation Occurrence	
Cause and correction	Assumed cause		Correction		Prevention	
	The number of elements in an array of the structure variable that was specified for the in-out variable of the instruction is out of range.		Correct the number of elements in the array in the structure variable that is specified for the in-out variable of the relevant instruction so that it is in the valid range.		Make sure that the number of elements in the array in the structure variable that is specified for the in-out variable of the relevant instruction is in the valid range.	
Attached information	Attached Information 1: Error Location Attached Information 3: Names of the Instruction and Instruction Instance Where the Error Occurred. If there is more than one possible instruction, information is given on all of them. Nothing is given if the instruction cannot be identified.					
Precautions/Remarks	If a program is changed after an error occurs, the attached information that is displayed may not be correct.					

Event name	Number of Array Elements in Output Signal Structure Variable Out of Range		Event code	5401572C hex		
Meaning	The number of elements in an array in the structure variable that is specified in the <i>Outputs</i> in-out variable to a motion control instruction is out of range.					
Source	PLC Function Module		Source details	Instruction	Detection timing	At instruction execution
Error attributes	Level	Observation	Recovery	---	Log category	System
Effects	User program	Continues.	Operation	The relevant instruction will end according to specifications.		
System-defined variables	Variable	Data type		Name		
	_MC_AX[*].Obsr.Active	BOOL		Axis Observation Occurrence		
Cause and correction	Assumed cause	Correction		Prevention		
	The number of elements in an array of the structure variable that was specified for the in-out variable of the instruction is out of range.	Correct the number of elements in the array in the structure variable that is specified for the in-out variable of the relevant instruction so that it is in the valid range.		Make sure that the number of elements in the array in the structure variable that is specified for the in-out variable of the relevant instruction is in the valid range.		
Attached information	Attached Information 1: Error Location Attached Information 3: Names of the Instruction and Instruction Instance Where the Error Occurred. If there is more than one possible instruction, information is given on all of them. Nothing is given if the instruction cannot be identified.					
Precautions/Remarks	If a program is changed after an error occurs, the attached information that is displayed may not be correct.					

Event name	Number of Array Elements in Track Option Structure Variable Out of Range		Event code	5401572D hex		
Meaning	The number of elements in an array in the structure variable that is specified in the <i>TrackOptions</i> in-out variable to a motion control instruction is out of range.					
Source	PLC Function Module		Source details	Instruction	Detection timing	At instruction execution
Error attributes	Level	Observation	Recovery	---	Log category	System
Effects	User program	Continues.	Operation	The relevant instruction will end according to specifications.		
System-defined variables	Variable	Data type		Name		
	_MC_AX[*].Obsr.Active	BOOL		Axis Observation Occurrence		
Cause and correction	Assumed cause	Correction		Prevention		
	The number of elements in an array of the structure variable that was specified for the in-out variable of the instruction is out of range.	Correct the number of elements in the array in the structure variable that is specified for the in-out variable of the relevant instruction so that it is in the valid range.		Make sure that the number of elements in the array in the structure variable that is specified for the in-out variable of the relevant instruction is in the valid range.		
Attached information	Attached Information 1: Error Location Attached Information 3: Names of the Instruction and Instruction Instance Where the Error Occurred. If there is more than one possible instruction, information is given on all of them. Nothing is given if the instruction cannot be identified.					
Precautions/Remarks	If a program is changed after an error occurs, the attached information that is displayed may not be correct.					

Event name	Numbers of Elements in Output Signals and Track Option Arrays Not Matched		Event code	5401572E hex		
Meaning	The arrays in the structure variables that are specified for the <i>Outputs</i> and <i>TrackOptions</i> in-out variables to a motion control instruction do not have the same number of elements.					
Source	PLC Function Module		Source details	Instruction	Detection timing	At instruction execution
Error attributes	Level	Observation	Recovery	---	Log category	System
Effects	User program	Continues.	Operation	The relevant instruction will end according to specifications.		
System-defined variables	Variable		Data type		Name	
	_MC_AX[*].Obsr.Active		BOOL		Axis Observation Occurrence	
Cause and correction	Assumed cause		Correction		Prevention	
	The arrays in the output signal structure variable and track option structure variable that are specified for the in-out variables to the instruction do not have the same number of elements.		Correct the output signal structure variable and track option structure variable that are specified for the in-out variables to the relevant instruction so that the arrays in them have the same number of elements.		Make sure that the arrays in the output signal structure variable and track option structure variable that are specified for the in-out variables to the relevant instruction have the same number of elements.	
Attached information	Attached Information 1: Error Location Attached Information 3: Names of the Instruction and Instruction Instance Where the Error Occurred. If there is more than one possible instruction, information is given on all of them. Nothing is given if the instruction cannot be identified.					
Precautions/Remarks	If a program is changed after an error occurs, the attached information that is displayed may not be correct.					

Event name	Motion Control Instruction Multi-execution Disabled (Master Axis)		Event code	5401572F hex		
Meaning	A <i>Master</i> in-out variable that cannot be changed during multi-execution of instructions was changed.					
Source	PLC Function Module		Source details	Instruction	Detection timing	At instruction execution
Error attributes	Level	Observation	Recovery	---	Log category	System
Effects	User program	Continues.	Operation	The relevant instruction will end according to specifications.		
System-defined variables	Variable		Data type		Name	
	_MC_AX[*].MFaultLvl.Active		BOOL		Axis Minor Fault Occurrence	
Cause and correction	Assumed cause		Correction		Prevention	
	A <i>Master</i> in-out variable that cannot be changed during multi-execution of instructions was changed.		Correct the program so that the value of the <i>Master</i> in-out variable is not changed during multi-execution of the relevant instructions.		Write the program so that the value of the <i>Master</i> in-out variable is not changed during multi-execution of the relevant instructions.	
Attached information	Attached Information 1: Error Location Attached Information 3: Names of the Instruction and Instruction Instance Where the Error Occurred. If there is more than one possible instruction, information is given on all of them. Nothing is given if the instruction cannot be identified.					
Precautions/Remarks	If a program is changed after an error occurs, the attached information that is displayed may not be correct.					

Event name	Motion Control Instruction Multi-execution Disabled (Position Type Selection)		Event code	54015730 hex	
Meaning	A <i>ReferenceType</i> in-out variable that cannot be changed during multi-execution of instructions was changed.				
Source	PLC Function Module		Source details	Instruction	Detection timing At instruction execution
Error attributes	Level	Observation	Recovery	---	Log category System
Effects	User program	Continues.	Operation	The relevant instruction will end according to specifications.	
System-defined variables	Variable	Data type		Name	
	_MC_AX[*].MFAultLvl.Active	BOOL		Axis Minor Fault Occurrence	
Cause and correction	Assumed cause	Correction		Prevention	
	A <i>ReferenceType</i> in-out variable that cannot be changed during multi-execution of instructions was changed.	Correct the program so that the value of the <i>ReferenceType</i> in-out variable is not changed during multi-execution of the relevant instructions.		Write the program so that the value of the <i>ReferenceType</i> in-out variable is not changed during multi-execution of the relevant instructions.	
Attached information	Attached Information 1: Error Location Attached Information 3: Names of the Instruction and Instruction Instance Where the Error Occurred. If there is more than one possible instruction, information is given on all of them. Nothing is given if the instruction cannot be identified.				
Precautions/Remarks	If a program is changed after an error occurs, the attached information that is displayed may not be correct.				

Event name	Same Track Number Setting in Switch Structure Out of Range		Event code	54015731 hex	
Meaning	The same track number was specified more than the allowable number of times for the <i>TrackNumber</i> in the <i>Switches</i> in-out variable to a motion control instruction.				
Source	PLC Function Module		Source details	Instruction	Detection timing At instruction execution
Error attributes	Level	Observation	Recovery	---	Log category System
Effects	User program	Continues.	Operation	The relevant instruction will end according to specifications.	
System-defined variables	Variable	Data type		Name	
	_MC_AX[*].Obsr.Active	BOOL		Axis Observation Occurrence	
Cause and correction	Assumed cause	Correction		Prevention	
	The same track number was specified more than the allowable number of times for the <i>TrackNumber</i> in the <i>Switches</i> in-out variable to a motion control instruction.	Correct the values in the <i>TrackNumber</i> so that the same track number is not specified more than the maximum number of times.		Set the values in the <i>TrackNumber</i> so that the same track number is not specified more than the maximum number of times.	
Attached information	Attached Information 1: Error Location Attached Information 3: Names of the Instruction and Instruction Instance Where the Error Occurred. If there is more than one possible instruction, information is given on all of them. Nothing is given if the instruction cannot be identified.				
Precautions/Remarks	If a program is changed after an error occurs, the attached information that is displayed may not be correct.				

Event name	Cannot Write Axis Parameters			Event code	5401573A hex	
Meaning	The instruction was executed for an axis that is not an unused axis.					
Source	PLC Function Module		Source details	Instruction	Detection timing	At instruction execution
Error attributes	Level	Observation	Recovery	---	Log category	System
Effects	User program	Continues.	Operation	The relevant instruction will end according to specifications.		
System-defined variables	Variable		Data type		Name	
	_MC_COM.MFaultLvl.Active		BOOL		MC Common Minor Fault Occurrence	
Cause and correction	Assumed cause		Correction		Prevention	
	The instruction was executed for a used axis or an undefined axis.		Correct the program so that the MC_ChangeAxisUse (Change Axis Use) instruction is executed after the specified axis is changed to an unused axis.		Write the program so that the specified axis is an unused axis when the instruction is executed.	
Attached information	Attached Information 1: Error Location Attached Information 3: Names of the Instruction and Instruction Instance Where the Error Occurred. If there is more than one possible instruction, information is given on all of them. Nothing is given if the instruction cannot be identified.					
Precautions/Remarks	If a program is changed after an error occurs, the attached information that is displayed may not be correct.					

Event name	Axis Parameter Setting Out of Range			Event code	5401573B hex	
Meaning	The parameter specified for the <i>AxisParameter</i> input variable to a motion control instruction is outside of the valid range.					
Source	PLC Function Module		Source details	Instruction	Detection timing	At instruction execution
Error attributes	Level	Observation	Recovery	---	Log category	System
Effects	User program	Continues.	Operation	The relevant instruction will end according to specifications.		
System-defined variables	Variable		Data type		Name	
	_MC_COM.MFaultLvl.Active		BOOL		MC Common Minor Fault Occurrence	
Cause and correction	Assumed cause		Correction		Prevention	
	The parameter specified for the <i>AxisParameter</i> input variable to the instruction is out of range for the input variable.		Correct the parameter so that the valid range of the input variable is not exceeded for the instruction. Confirm which parameter exceeded the range or what parameters are inconsistent in the attached information.		Set the input parameter to the instruction so that the valid range of the input variable is not exceeded. Refer to information on the MC_WriteAxisParameter (Write Axis Parameters) instruction for the valid ranges of the input variables.	
Attached information	Attached Information 1: Error Location Attached Information 3: Names of the Instruction and Instruction Instance Where the Error Occurred. If there is more than one possible instruction, information is given on all of them. Nothing is given if the instruction cannot be identified.					
Precautions/Remarks	If a program is changed after an error occurs, the attached information that is displayed may not be correct.					

Event name	Cam Property Setting Out of Range		Event code	5401573C hex	
Meaning	The parameter specified for the <i>CamProperty</i> input variable to a motion control instruction is outside of the valid range.				
Source	PLC Function Module		Source details	Instruction	Detection timing At instruction execution
Error attributes	Level	Observation	Recovery	---	Log category System
Effects	User program	Continues.	Operation	The relevant instruction will end according to specifications.	
System-defined variables	Variable	Data type		Name	
	_MC_COM.MFaultLvl.Active	BOOL		MC Common Minor Fault Occurrence	
Cause and correction	Assumed cause	Correction		Prevention	
	The parameter specified for the <i>CamProperty</i> input variable to the instruction is out of range for the input variable.	Correct the parameter so that the valid range of the input variable is not exceeded for the instruction. Confirm which parameter exceeded the range in the attached information.		Set the input parameter to the instruction so that the valid range of the input variable is not exceeded.	
Attached information	Attached Information 1: Error Location Attached Information 3: Names of the Instruction and Instruction Instance Where the Error Occurred. If there is more than one possible instruction, information is given on all of them. Nothing is given if the instruction cannot be identified.				
Precautions/Remarks	If a program is changed after an error occurs, the attached information that is displayed may not be correct.				

Event name	Cam Node Setting Out of Range		Event code	5401573D hex	
Meaning	The parameter specified for the <i>CamNodes</i> input variable to a motion control instruction is outside of the valid range.				
Source	PLC Function Module		Source details	Instruction	Detection timing At instruction execution
Error attributes	Level	Observation	Recovery	---	Log category System
Effects	User program	Continues.	Operation	The relevant instruction will end according to specifications.	
System-defined variables	Variable	Data type		Name	
	_MC_COM.MFaultLvl.Active	BOOL		MC Common Minor Fault Occurrence	
Cause and correction	Assumed cause	Correction		Prevention	
	The parameter specified for the <i>CamNodes</i> input variable to the instruction is out of range for the input variable.	Correct the parameter so that the valid range of the input variable is not exceeded for the instruction. Confirm which parameter exceeded the range in the attached information.		Set the input parameter to the instruction so that the valid range of the input variable is not exceeded.	
Attached information	Attached Information 1: Error Location Attached Information 3: Names of the Instruction and Instruction Instance Where the Error Occurred. If there is more than one possible instruction, information is given on all of them. Nothing is given if the instruction cannot be identified.				
Precautions/Remarks	If a program is changed after an error occurs, the attached information that is displayed may not be correct.				

Event name	Incorrect Cam Node Type Specification		Event code	5401573E hex		
Meaning	The parameter specified for the <i>CamNodes</i> input variable to a motion control instruction is not an <i>_sMC_CAM_NODE</i> array variable.					
Source	PLC Function Module		Source details	Instruction	Detection timing	At instruction execution
Error attributes	Level	Observation	Recovery	---	Log category	System
Effects	User program	Continues.	Operation	The relevant instruction will end according to specifications.		
System-defined variables	Variable		Data type		Name	
	_MC_COM.MFaultLvl.Active		BOOL		MC Common Minor Fault Occurrence	
Cause and correction	Assumed cause		Correction		Prevention	
	The parameter specified for the <i>CamNodes</i> input variable to the instruction is not an <i>_sMC_CAM_NODE</i> array variable.		Correct the program to specify an <i>sMC_CAM_NODE</i> array variable for the input variable to the instruction.		Write the program to specify an <i>sMC_CAM_NODE</i> array variable for the input variable to the instruction.	
Attached information	Attached Information 1: Error Location Attached Information 3: Names of the Instruction and Instruction Instance Where the Error Occurred. If there is more than one possible instruction, information is given on all of them. Nothing is given if the instruction cannot be identified.					
Precautions/Remarks	If a program is changed after an error occurs, the attached information that is displayed may not be correct.					

Event name	Insufficient Nodes in Cam Table		Event code	5401573F hex		
Meaning	The array variable of the parameter specified for the <i>CamNodes</i> input variable to a motion control instruction has a Phase value of 0 for element number 0.					
Source	PLC Function Module		Source details	Instruction	Detection timing	At instruction execution
Error attributes	Level	Observation	Recovery	---	Log category	System
Effects	User program	Continues.	Operation	The relevant instruction will end according to specifications.		
System-defined variables	Variable		Data type		Name	
	_MC_COM.MFaultLvl.Active		BOOL		MC Common Minor Fault Occurrence	
Cause and correction	Assumed cause		Correction		Prevention	
	The array variable of the parameter specified for the <i>CamNodes</i> input variable to the instruction has a Phase (master axis phase) value of 0 for element number 0.		Correct the program so that the value of Phase (master axis phase) for element number 0 in the array variable for the parameter specified for the <i>CamNodes</i> input variable is not 0.		Write the program so that the value of Phase (master axis phase) for element number 0 in the array variable for the parameter specified for the <i>CamNodes</i> input variable is not 0.	
Attached information	Attached Information 1: Error Location Attached Information 3: Names of the Instruction and Instruction Instance Where the Error Occurred. If there is more than one possible instruction, information is given on all of them. Nothing is given if the instruction cannot be identified.					
Precautions/Remarks	If a program is changed after an error occurs, the attached information that is displayed may not be correct.					

Event name	Cam Node Master Axis Phase Not in Ascending Order		Event code	54015740 hex		
Meaning	The values of Phase in the array variable of the parameter specified for the <i>CamNodes</i> input variable to a motion control instruction are not in ascending order according to the element numbers.					
Source	PLC Function Module		Source details	Instruction	Detection timing	At instruction execution
Error attributes	Level	Observation	Recovery	---	Log category	System
Effects	User program	Continues.	Operation	The relevant instruction will end according to specifications.		
System-defined variables	Variable	Data type		Name		
	_MC_COM.MFaultLvl.Active	BOOL		MC Common Minor Fault Occurrence		
Cause and correction	Assumed cause		Correction		Prevention	
	The values of Phase (master axis phase) in the array variable of the parameter specified for the <i>CamNodes</i> input variable to the instruction are not in ascending order according to the element numbers. Or, truncating the digits that are not effective more than seven digits caused the phases not to be in ascending order.		Correct the program so that the values of Phase (master axis phase) in the array variable for the parameter specified for the <i>CamNodes</i> input variable are in ascending order according to the element numbers.		Write the program so that the values of Phase (master axis phase) in the array variable for the parameter specified for the <i>CamNodes</i> input variable are in ascending order according to the element numbers.	
Attached information	Attached Information 1: Error Location Attached Information 3: Names of the Instruction and Instruction Instance Where the Error Occurred. If there is more than one possible instruction, information is given on all of them. Nothing is given if the instruction cannot be identified.					
Precautions/Remarks	If a program is changed after an error occurs, the attached information that is displayed may not be correct.					

Event name	Too Many Data Points in Cam Table		Event code	54015741 hex		
Meaning	The number of generated cam data points exceeded the number of elements in the array in the cam data variable that is specified for the <i>CamTable</i> input variable to a motion control instruction.					
Source	PLC Function Module		Source details	Instruction	Detection timing	At instruction execution
Error attributes	Level	Observation	Recovery	---	Log category	System
Effects	User program	Continues.	Operation	The relevant instruction will end according to specifications.		
System-defined variables	Variable	Data type		Name		
	_MC_COM.MFaultLvl.Active	BOOL		MC Common Minor Fault Occurrence		
Cause and correction	Assumed cause	Correction		Prevention		
	The number of cam data points in the generated cam table exceeded the number of elements in the array in the cam data variable that is specified for the <i>CamTable</i> input variable to the instruction.	Correct the program so that the number of cam data points in the generated cam table does not exceed the number of elements in the array in the cam data variable that is specified for the <i>CamTable</i> input variable to the instruction. Refer to information on the MC_GenerateCamTable (Generate Cam Table) instruction for the number of cam data points in generated cam tables.		Write the program so that the number of cam data points in the generated cam table does not exceed the number of elements in the array in the cam data variable that is specified for the <i>CamTable</i> input variable to the instruction. Refer to information on the MC_GenerateCamTable (Generate Cam Table) instruction for the number of cam data points in generated cam tables.		
Attached information	Attached Information 1: Error Location Attached Information 3: Names of the Instruction and Instruction Instance Where the Error Occurred. If there is more than one possible instruction, information is given on all of them. Nothing is given if the instruction cannot be identified.					
Precautions/Remarks	If a program is changed after an error occurs, the attached information that is displayed may not be correct.					

Event name	Cam Table Displacement Overflow		Event code	54015742 hex	
Meaning	Distance in the generated cam table exceeded the range of REAL data.				
Source	PLC Function Module		Source details	Instruction	Detection timing At instruction execution or during instruction execution
Error attributes	Level	Observation	Recovery	---	Log category System
Effects	User program	Continues.	Operation	The relevant instruction will end according to specifications.	
System-defined variables	Variable	Data type		Name	
	_MC_COM.MFaultLvl.Active	BOOL		MC Common Minor Fault Occurrence	
Cause and correction	Assumed cause	Correction		Prevention	
	Distance in the generated cam table exceeded the range of REAL data.	Correct the values of InitVel (initial velocity), ConnectingVel (connecting velocity), and ConnectingAcc (connecting acceleration) so that Distance does not overflow when a polynomial 3 curve or polynomial 5 curve is specified for Curve (curve shape) in the <i>CamNodes</i> input variable. Refer to information on the MC_GenerateCamTable (Generate Cam Table) instruction for the method to calculate Distance.		Specify the values of InitVel (initial velocity), ConnectingVel (connecting velocity), and ConnectingAcc (connecting acceleration) so that Distance does not overflow when a polynomial 3 curve or polynomial 5 curve is specified for Curve (curve shape) in the <i>CamNodes</i> input variable. Refer to information on the MC_GenerateCamTable (Generate Cam Table) instruction for the method to calculate Distance.	
Attached information	Attached Information 1: Error Location Attached Information 3: Names of the Instruction and Instruction Instance Where the Error Occurred. If there is more than one possible instruction, information is given on all of them. Nothing is given if the instruction cannot be identified.				
Precautions/Remarks	If a program is changed after an error occurs, the attached information that is displayed may not be correct.				

Event name	Aborted Cam Table Used		Event code	54015743 hex		
Meaning	A cam data variable that was aborted during generation was specified for the <i>CamTableA</i> cam data variable that was aborted during generation was specified for the					
Source	PLC Function Module		Source details	Instruction	Detection timing	At instruction execution
Error attributes	Level	Observation	Recovery	---	Log category	System
Effects	User program	Continues.	Operation	The relevant instruction will end according to specifications.		
System-defined variables	Variable	Data type		Name		
	_MC_COM.MFaultLvl.Active	BOOL		MC Common Minor Fault Occurrence		
	_MC_AX[*].MFaultLvl.Active	BOOL		Axis Minor Fault Occurrence		
Cause and correction	Assumed cause		Correction		Prevention	
	A cam data variable that was aborted during generation due to an error in the MC_GenerateCamTable (Generate Cam Table) instruction was specified for the <i>CamTable</i> input variable to the instruction.		Check the ErrorID (end code), ErrorParameterCode (parameter detail code), and ErrorNodePointIndex (node point element number) output variables from the MC_GenerateCamTable (Generate Cam Table) instruction and correct the program so that correct cam table variables are created.		Write the program so that the MC_GenerateCamTable (Generate Cam Table) instruction creates correct cam data variables. Or, write the program so that the relevant instruction is executed only when the MC_GenerateCamTable (Generate Cam Table) instruction ends normally.	
Attached information	Attached Information 1: Error Location Attached Information 3: Names of the Instruction and Instruction Instance Where the Error Occurred. If there is more than one possible instruction, information is given on all of them. Nothing is given if the instruction cannot be identified.					
Precautions/Remarks	If a program is changed after an error occurs, the attached information that is displayed may not be correct.					

Event name	Execution ID Setting Out of Range		Event code	54015749 hex		
Meaning	The parameter specified for the <i>ExecID</i> input variable to a motion control instruction is out of range.					
Source	PLC Function Module		Source details	Instruction	Detection timing	At instruction execution
Error attributes	Level	Observation	Recovery	---	Log category	System
Effects	User program	Continues.	Operation	The relevant instruction will end according to specifications.		
System-defined variables	Variable	Data type		Name		
	_MC_AX[*].MFaultLvl.Active	BOOL		Axis Minor Fault Occurrence		
Cause and correction	Assumed cause		Correction		Prevention	
	The parameter specified for the <i>ExecID</i> input variable to the instruction is out of range for the input variable.		Correct the program so that the input parameter specified for the <i>ExecID</i> input variable to the instruction is within the setting range.		Create the program so that the input parameter specified for the <i>ExecID</i> input variable to the instruction is within the setting range.	
Attached information	Attached Information 1: Error Location Attached Information 3: Names of the Instruction and Instruction Instance Where the Error Occurred. If there is more than one possible instruction, information is given on all of them. Nothing is given if the instruction cannot be identified.					
Precautions/Remarks	If a program is changed after an error occurs, the attached information that is displayed may not be correct.					

Event name	Position Offset Out of Range			Event code	5401574A hex	
Meaning	The parameter specified for the <i>OffsetPosition</i> input variable to a motion control instruction is out of range.					
Source	PLC Function Module		Source details	Instruction	Detection timing	At instruction execution
Error attributes	Level	Observation	Recovery	---	Log category	System
Effects	User program	Continues.	Operation	The relevant instruction will end according to specifications.		
System-defined variables	Variable		Data type		Name	
	_MC_AX[*].MFAultLvl.Active		BOOL		Axis Minor Fault Occurrence	
Cause and correction	Assumed cause		Correction		Prevention	
	The instruction input parameter exceeded the range of signed 40-bit data when it was converted to pulses.		Correct the parameter so that the valid range of the input variable is not exceeded for the relevant instruction.		Set the input parameter to the instruction so that the valid range of the input variable is not exceeded.	
Attached information	Attached Information 1: Error Location Attached Information 3: Names of the Instruction and Instruction Instance Where the Error Occurred. If there is more than one possible instruction, information is given on all of them. Nothing is given if the instruction cannot be identified.					
Precautions/Remarks	If a program is changed after an error occurs, the attached information that is displayed may not be correct.					

Event name	PDS State Transition Command Selection Out of Range			Event code	5401574B hex	
Meaning	The parameter specified for the <i>TransitionCmd</i> input variable to a motion control instruction is out of range.					
Source	PLC Function Module		Source details	Instruction	Detection timing	At instruction execution
Error attributes	Level	Observation	Recovery	---	Log category	System
Effects	User program	Continues.	Operation	The relevant instruction will end according to specifications.		
System-defined variables	Variable		Data type		Name	
	_MC_AX[*].MFAultLvl.Active		BOOL		Axis Minor Fault Occurrence	
Cause and correction	Assumed cause		Correction		Prevention	
	Instruction input parameter exceeded the valid range of the input variable.		Correct the parameter so that the valid range of the input variable is not exceeded for the relevant instruction.		Set the input parameter to the instruction so that the valid range of the input variable is not exceeded.	
Attached information	Attached Information 1: Error Location Attached Information 3: Names of the Instruction and Instruction Instance Where the Error Occurred. If there is more than one possible instruction, information is given on all of them. Nothing is given if the instruction cannot be identified.					
Precautions/Remarks	If a program is changed after an error occurs, the attached information that is displayed may not be correct.					

Event name	Cam Monitor Mode Selection Out of Range		Event code	54015751 hex *1		
Meaning	The cam monitor mode selection specified for the <i>CamMonitorMode</i> input variable to a motion control instruction is out of range.					
Source	PLC Function Module		Source details	Instruction	Detection timing	At instruction execution
Error attributes	Level	Observation	Recovery	---	Log category	System
Effects	User program	Continues.	Operation	The relevant instruction will end according to specifications.		
System-defined variables	Variable		Data type		Name	
	_MC_AX[*].MFAultLvl.Active		BOOL		Axis Minor Fault Occurrence	
Cause and correction	Assumed cause		Correction		Prevention	
	The cam monitor mode selection is out of the valid range.		Make a correction so that the cam monitor mode selection is within the valid range.		Make a setting so that the cam monitor mode selection is within the valid range.	
Attached information	Attached information 1: Error Location Attached information 3: Names of the Instruction and Instruction Instance Where the Error Occurred. If there is more than one possible instruction, information is given on all of them. Nothing is given if the instruction cannot be identified.					
Precautions/Remarks	If a program is changed after an error occurs, the attached information that is displayed may not be correct.					

*1. Error code 16#5751 occurs for unit version 1.21 or later of the CPU Unit.

Event name	Data Type of Cam Monitor Values Mismatch		Event code	54015752 hex *1		
Meaning	The data type of the cam monitor values specified for the <i>CamMonitorValue</i> in-out variable to a motion control instruction does not match the cam monitor mode selection.					
Source	PLC Function Module		Source details	Instruction	Detection timing	At instruction execution
Error attributes	Level	Observation	Recovery	---	Log category	System
Effects	User program	Continues.	Operation	The relevant instruction will end according to specifications.		
System-defined variables	Variable		Data type		Name	
	_MC_AX[*].MFAultLvl.Active		BOOL		Axis Minor Fault Occurrence	
Cause and correction	Assumed cause		Correction		Prevention	
	The data type of the variable specified for the cam monitor values does not match the cam monitor mode selection.		Make a correction of the data type of the variable specified for the cam monitor values.		Set the data type of the variable specified for the cam monitor values correctly.	
Attached information	Attached information 1: Error Location Attached information 3: Names of the Instruction and Instruction Instance Where the Error Occurred. If there is more than one possible instruction, information is given on all of them. Nothing is given if the instruction cannot be identified.					
Precautions/Remarks	If a program is changed after an error occurs, the attached information that is displayed may not be correct.					

*1. Error code 16#5752 occurs for unit version 1.21 or later of the CPU Unit.

Event name	Target Position Positive Software Limit Exceeded		Event code	54016440 hex	
Meaning	The specified position exceeds the positive software limit.				
Source	PLC Function Module		Source details	Instruction	Detection timing At instruction execution
Error attributes	Level	Observation	Recovery	---	Log category System
Effects	User program	Continues.	Operation	The relevant instruction will end according to specifications.	
System-defined variables	Variable		Data type		Name
	_MC_AX[*].MFAultLvl.Active		BOOL		Axis Minor Fault Occurrence
	_MC_GRP[*].MFAultLvl.Active		BOOL		Axes Group Minor Fault Occurrence
Cause and correction	Assumed cause		Correction		Prevention
	The parameter specified for the <i>Position</i> input variable to the instruction is beyond the positive software limit.		Correct the parameter specified for the <i>Position</i> input variable to the instruction so that it is within the positive software limit.		Set the parameter specified for the <i>Position</i> input variable to the instruction so that it is within the positive software limit.
	The starting position is beyond the positive software limit and an instruction that specifies motion in the opposite direction of the software limit was executed.		Correct the program so that the travel direction for the instruction is towards the positive software limit.		If the starting position is beyond the positive software limit, write the program so that the travel direction is in the direction of the positive software limit.
	The parameter that was specified for the <i>AuxPoint</i> input variable to a border point MC_MoveCircular2D (Circular 2D Interpolation) instruction is beyond the positive software limit.		Correct the parameter specified for the <i>AuxPoint</i> input variable to the instruction so that it is within the positive software limit.		Set the parameter specified for the <i>AuxPoint</i> input variable to the border point MC_MoveCircular2D (Circular 2D Interpolation) instruction so that it is within the negative software limit.
Attached information	Attached Information 1: Error Location Attached Information 3: Names of the Instruction and Instruction Instance Where the Error Occurred. If there is more than one possible instruction, information is given on all of them. Nothing is given if the instruction cannot be identified.				
Precautions/Remarks	If a program is changed after an error occurs, the attached information that is displayed may not be correct.				

Event name	Target Position Negative Software Limit Exceeded		Event code	54016441 hex	
Meaning	The specified position exceeds the negative software limit.				
Source	PLC Function Module		Source details	Instruction	Detection timing At instruction execution
Error attributes	Level	Observation	Recovery	---	Log category System
Effects	User program	Continues.	Operation	The relevant instruction will end according to specifications.	
System-defined variables	Variable		Data type		Name
	_MC_AX[*].MFaultLvl.Active		BOOL		Axis Minor Fault Occurrence
	_MC_GRP[*].MFaultLvl.Active		BOOL		Axes Group Minor Fault Occurrence
Cause and correction	Assumed cause		Correction		Prevention
	The parameter specified for the <i>Position</i> input variable to the instruction is beyond the negative software limit.		Correct the parameter specified for the <i>Position</i> input variable to the instruction so that it is within the negative software limit.		Correct the input parameter specified for the <i>Position</i> input variable to the instruction so that it is within the negative software limit.
	The starting position is beyond the negative software limit and an instruction that specifies motion in the opposite direction of the software limit was executed.		Correct the program so that the travel direction for the instruction is towards the negative software limit.		If the starting position is beyond the negative software limit, write the program so that the travel direction is in the direction of the negative software limit.
	The parameter that was specified for the <i>AuxPoint</i> input variable to a border point MC_MoveCircular2D (Circular 2D Interpolation) instruction is beyond the negative software limit.		Correct the parameter specified for the <i>AuxPoint</i> input variable to the instruction so that it is within the negative software limit.		Set the parameter specified for the <i>AuxPoint</i> input variable to the border point MC_MoveCircular2D (Circular 2D Interpolation) instruction so that it is within the negative software limit.
Attached information	Attached Information 1: Error Location Attached Information 3: Names of the Instruction and Instruction Instance Where the Error Occurred. If there is more than one possible instruction, information is given on all of them. Nothing is given if the instruction cannot be identified.				
Precautions/Remarks	If a program is changed after an error occurs, the attached information that is displayed may not be correct.				

Event name	Command Position Overflow/Underflow		Event code	54016442 hex	
Meaning	Positioning, an instruction in the underflow/overflow direction, or an instruction for which the direction is not specified was executed when there was an underflow/overflow in the command position.				
Source	PLC Function Module		Source details	Instruction	Detection timing At instruction execution
Error attributes	Level	Observation	Recovery	---	Log category System
Effects	User program	Continues.	Operation	The relevant instruction will end according to specifications.	
System-defined variables	Variable	Data type		Name	
	_MC_AX[*].MFAultLvl.Active	BOOL		Axis Minor Fault Occurrence	
Cause and correction	Assumed cause	Correction		Prevention	
	One of the following was executed when there was a command position overflow/underflow. <ul style="list-style-type: none"> • A positioning instruction • A continuous control instruction in the underflow/overflow direction • An instruction for which the direction is not specified (syncing or torque control) 	Execute an error reset and then clear the overflow/underflow state by executing homing or presetting the actual position.		Make sure that overflow or underflow does not occur.	
Attached information	Attached Information 1: Error Location Attached Information 3: Names of the Instruction and Instruction Instance Where the Error Occurred. If there is more than one possible instruction, information is given on all of them. Nothing is given if the instruction cannot be identified.				
Precautions/Remarks	If a program is changed after an error occurs, the attached information that is displayed may not be correct.				

Event name	Positive Limit Input		Event code	54016443 hex	
Meaning	An instruction was executed for a motion in the positive direction when the positive limit input was ON.				
Source	PLC Function Module		Source details	Instruction	Detection timing At instruction execution
Error attributes	Level	Observation	Recovery	---	Log category System
Effects	User program	Continues.	Operation	The relevant instruction will end according to specifications.	
System-defined variables	Variable		Data type		Name
	_MC_AX[*].MFaultLvl.Active		BOOL		Axis Minor Fault Occurrence
	_MC_GRP[*].MFaultLvl.Active		BOOL		Axes Group Minor Fault Occurrence
Cause and correction	Assumed cause		Correction		Prevention
	An instruction for a motion in the positive direction was executed when the positive limit input was ON, or an instruction for a motion with no direction specification was executed when the positive limit input was ON. An axes group motion control instruction was executed when the positive limit input was ON.		Execute an error reset and then perform a recovery operation in the negative direction. If the error occurred during an axes group motion control instruction, disable the axes group and then perform the above operation. If this error occurs again, check the connection of the positive limit signal, the logic setting for the positive limit input, and the execution conditions for the start command, and correct any mistakes. Check the logic settings both in the axis parameters and in the slave settings.		Check to make sure there are no problems with the positive limit signal connection, the logic setting for the positive limit input, and the execute conditions for the instruction. Check the logic settings both in the axis parameters and in the slave settings.
Attached information	Attached Information 1: Error Location Attached Information 3: Names of the Instruction and Instruction Instance Where the Error Occurred. If there is more than one possible instruction, information is given on all of them. Nothing is given if the instruction cannot be identified.				
Precautions/Remarks	If a program is changed after an error occurs, the attached information that is displayed may not be correct.				

Event name	Negative Limit Input		Event code	54016444 hex	
Meaning	An instruction for a motion in the negative direction was executed when the negative limit input was ON.				
Source	PLC Function Module		Source details	Instruction	Detection timing At instruction execution
Error attributes	Level	Observation	Recovery	---	Log category System
Effects	User program	Continues.	Operation	The relevant instruction will end according to specifications.	
System-defined variables	Variable		Data type		Name
	_MC_AX[*].MFAultLvl.Active		BOOL		Axis Minor Fault Occurrence
	_MC_GRP[*].MFAultLvl.Active		BOOL		Axes Group Minor Fault Occurrence
Cause and correction	Assumed cause		Correction		Prevention
	An instruction for a motion in the negative direction was executed when the negative limit input was ON, or an instruction for a motion with no direction specification was executed when the negative limit input was ON. An axes group motion control instruction was executed when the negative limit input was ON.		Execute an error reset and then perform a recovery operation in the positive direction. If the error occurred during an axes group motion control instruction, disable the axes group and then perform the above operation. If this error occurs again, check the connection of the negative limit signal, the logic setting for the negative limit input, and the execution conditions for the start command, and correct any mistakes. Check the logic settings both in the axis parameters and in the slave settings.		Check to make sure there are no problems with the negative limit signal connection, the logic setting for the negative limit input, and the execute conditions for the instruction. Check the logic settings both in the axis parameters and in the slave settings.
Attached information	Attached Information 1: Error Location Attached Information 3: Names of the Instruction and Instruction Instance Where the Error Occurred. If there is more than one possible instruction, information is given on all of them. Nothing is given if the instruction cannot be identified.				
Precautions/Remarks	If a program is changed after an error occurs, the attached information that is displayed may not be correct.				

Event name	Servo Main Circuits OFF		Event code	54017422 hex	
Meaning	An attempt was made to turn ON the Servo when the main circuit power supply to the Servo Drive was OFF.				
Source	PLC Function Module		Source details	Instruction	Detection timing At instruction execution
Error attributes	Level	Observation	Recovery	---	Log category System
Effects	User program	Continues.	Operation	The relevant instruction will end according to specifications.	
System-defined variables	Variable	Data type		Name	
	_MC_AX[*].MFaultLvl.Active	BOOL		Axis Minor Fault Occurrence	
Cause and correction	Assumed cause	Correction		Prevention	
	An attempt was made to turn ON the Servo when the main circuit power supply to the Servo Drive was OFF.	Turn ON the Servo after turning ON the main circuit power of the Servo Drive for the axis where the error occurred.		Turn ON the Servo after turning ON the main circuit power supply to the Servo Drive.	
Attached information	Attached Information 1: Error Location Attached Information 3: Names of the Instruction and Instruction Instance Where the Error Occurred. If there is more than one possible instruction, information is given on all of them. Nothing is given if the instruction cannot be identified.				
Precautions/Remarks	If a program is changed after an error occurs, the attached information that is displayed may not be correct.				

3-2-3 Other Troubles and Corrections

Security Errors

No.	Problem	Correction
1	Forgot the Administrator password.	You cannot access the Administrator's password. Always record the Administrator password so that you do not forget it.
2	Cannot release the operation lock with the Sysmac Studio.	Log in with verification authority that is equal to or higher than the verification rights when you connected online.
3	Operation was locked when verifying operation authority on the Sysmac Studio.	If the password for verification of operation authority is entered incorrectly five times in row, operation is locked for 10 minutes. Wait until the operation lock is released.
4	An online connection was made with the operation authority that is required for operation, but operation authority verification was requested for a specific operation.	Verification of operation authority is required every time for the following functions to prevent hazards to equipment and people. <ul style="list-style-type: none"> • I/O monitoring (writing) by an Operator • Operating mode change by a Maintainer • Online editing by a Maintainer
5	Cannot release the operation lock with the Sysmac Studio after the operator left the Sysmac Studio unattended.	You can release the operation lock with an operation authority that is equal to or higher than the operator. The required operation authority will be that of an operator (the operation authority that was verified when going online with the Sysmac Studio).
6	Some of the user program data cannot be read for certain operations. <ul style="list-style-type: none"> • Monitoring Variables • Operation Commands SET/RESET, forced refreshing, online editing, data tracing, MC Test Run, and setting the user program execution ID in the Controller • Synchronizing, Uploading, Verification, and Backup POU algorithms	The source data was not downloaded along with the user program. You will be able to read the data if you download the user program normally.
7	Writing to the Controller is not possible for some operations. <ul style="list-style-type: none"> • Names Controller name • Operation Commands Online editing, Clear All Memory, event log clearing, and setting the user program execution ID in the Controller • Synchronizing and Downloading User program, Controller Configuration and Setup, EtherCAT Settings, Controller Setup, Axis Settings, Cam Table Settings, Data Trace Settings, User-defined Event Setup, restoring 	The Controller is write protected. Release the write protection.

No.	Problem	Correction
8	I do not know how to change the user program execution ID.	The user program execution ID cannot be changed or deleted after it is set.
9	I forgot the user program execution ID assigned to user program.	This is no way to access the user program execution ID that is set. Always record the user program execution ID so that you do not forget it.
10	I forgot the user program execution ID that is registered in the Controller.	This is no way to access the user program execution ID that is set. Set the user program execution ID again. You can also clear the user program execution ID in the Controller if you execute the Clear All Memory operation.

3-3 Errors in the Motion Control Function Module

The section provides tables of the errors (events) that can occur in the Motion Control Function Module.

They are divided into the following functional classifications.

- General motion control
- Motion control instructions

Motion control instruction errors occur when a motion control instruction is executed. Notification of these errors is provided as events, but also the upper four digits of the event code is output to the *ErrorID* output variable of the motion control instruction and to the **.Lvl.Code* system-defined variable for motion control. When you troubleshoot from the event code, make suitable corrections that are described in the corresponding event code.

3-3-1 Error Tables

General Motion Control

Event code	Event name	Meaning	Assumed cause	Level					Reference
				M a j	P r t	M i n	O b s	I n f o	
44210000 hex	Motion Control Function Processing Error	A fatal error was detected in the Motion Control Function Module.	<ul style="list-style-type: none"> • An error occurred in the software. 	○					page 3-311
14600000 hex	Absolute Encoder Home Offset Read Error	The absolute encoder current position that is retained during power interruptions was lost.	<ul style="list-style-type: none"> • When the retained variables are backed up with a battery, this event indicates that the life of the battery in the CPU Unit has expired. • An error occurred in the software. • Backup memory failure 		○				page 3-312
14610000 hex	Motion Control Parameter Setting Error	The MC parameters that were saved in non-volatile memory are missing.	<ul style="list-style-type: none"> • The power supply to the Controller was interrupted or communications with the Sysmac Studio were disconnected while downloading the motion control parameter settings or clearing memory. • Non-volatile memory failure 		○				page 3-313
14620000 hex	Cam Data Read Error	The cam data that was saved in non-volatile memory is missing.	<ul style="list-style-type: none"> • Power was interrupted during save processing for cam data • Non-volatile memory failure 		○				page 3-314

Event code	Event name	Meaning	Assumed cause	Level					Reference
				M a j	P r t	M i n	O b s	I n f o	
34600000 hex	Required Process Data Object Not Set	The object that is required for the axis type is not allocated to PDO.	<ul style="list-style-type: none"> The required PDOs are not mapped when the axis type is set to a servo axis or encoder axis. Non-volatile memory failure 		○				page 3-315
34630000 hex	Axis Slave Disabled	The slave to which the axis is assigned is disabled.	<ul style="list-style-type: none"> The slave to which the axis is assigned is disabled. 		○				page 3-316
34640000 hex	Network Configuration Information Missing for Axis Slave	The network configuration information is not registered for the slave to which the axis is assigned.	<ul style="list-style-type: none"> The EtherCAT network configuration information is not registered for the slave to which the axis is assigned. 		○				page 3-316
44200000 hex	Motion Control Initialization Error	A fatal error occurred in the system and prevented initialization of the Motion Control Function Module.	<ul style="list-style-type: none"> Hardware has failed. 		○				page 3-317
74200000 hex	Motion Control Period Exceeded	Processing for the primary periodic task was not finished within two control periods.	<ul style="list-style-type: none"> The processing load in the primary periodic task is too heavy. 		○				page 3-317
14630000 hex	Cam Table Save Error	Saving a cam table to a file failed.	<ul style="list-style-type: none"> Saving a cam table to a file failed. 			○			page 3-318
54770000 hex	Cam Table Data Error during Cam Motion	The phases are not in ascending order in the cam table.	<ul style="list-style-type: none"> Data containing cam table phases that are not in ascending order was detected during cam motion. The phase and displacement of the start point in the cam table were not 0 during cam operation. The phase of the end point in the cam table when it is converted to pulses was not 1 pulse or greater during cam operation. 			○			page 3-318
54850000 hex	Immediate Stop Instruction Executed	An Immediate Stop (MC_ImmediateStop) instruction was executed.	<ul style="list-style-type: none"> An Immediate Stop instruction was executed. 			○			page 3-319
54860000 hex	Axes Group Immediate Stop Instruction Executed	An Axes Group Immediate Stop (MC_GroupImmediateStop) instruction was executed.	<ul style="list-style-type: none"> A Group Immediate Stop instruction was executed. 			○			page 3-319

Event code	Event name	Meaning	Assumed cause	Level					Reference
				M a j	P r t	M i n	O b s	I n f o	
64450000 hex	Positive Software Limit Exceeded	The position exceeded the positive software limit while the axis is in motion.	<ul style="list-style-type: none"> The position exceeded the positive software limit. 			○			page 3-320
64460000 hex	Negative Software Limit Exceeded	The position exceeded the negative software limit while the axis is in motion.	<ul style="list-style-type: none"> The position exceeded the negative software limit. 			○			page 3-320
64470000 hex	In-position Check Time Exceeded	The in-position check was not completed within the monitoring time.	<ul style="list-style-type: none"> Time is required to complete positioning. 			○			page 3-321
64480000 hex	Following Error Limit Exceeded	The error between the command current position and actual current value exceeded the Following Error Over Value.	<ul style="list-style-type: none"> The positioning operation has poor following performance and the actual motion is slower than the command. 			○			page 3-321
64490000 hex	Immediate Stop Input	The immediate stop input turned ON.	<ul style="list-style-type: none"> An immediate stop input signal was detected. The immediate stop input signal is not connected correctly or the logic setting for the immediate stop input is wrong. 			○			page 3-322
644A0000 hex	Positive Limit Input Detected	The positive limit input turned ON.	<ul style="list-style-type: none"> A positive limit input signal was detected. The positive limit input signal is not connected correctly or the logic setting for the positive limit input is wrong. 			○			page 3-323
644B0000 hex	Negative Limit Input Detected	The negative limit input turned ON.	<ul style="list-style-type: none"> A negative limit input signal was detected. The negative limit input signal is not connected correctly or the logic setting for the negative limit input is wrong. 			○			page 3-324
64560000 hex	Illegal Following Error	The difference between the command position and the actual current position exceeds the range of 30-bit data when converted to pulses.	<ul style="list-style-type: none"> The command current position was restricted so that the axis velocity would not exceed the axis maximum velocity for the specified travel distance. Performance of positioning operation is poor and the actual motion is slower than the command. 			○			page 3-325
64570000 hex	Servo OFF Error	The Servo was turned OFF for an axis due to an axes group error.	<ul style="list-style-type: none"> The Servo was turned OFF for an axis due to an axes group error. 			○			page 3-325

Event code	Event name	Meaning	Assumed cause	Level					Reference
				M a j	P r t	M i n	O b s	I n f o	
64580000 hex	Absolute Encoder Current Position Calculation Failed	It was not possible to correctly restore the current position from the absolute encoder information that was saved when power was interrupted.	<ul style="list-style-type: none"> The unit conversion settings, the ring counter setting in the Controller, or the ring counter setting in the Servo Drive settings was changed. The position to restore when converted to pulses exceeded the range of signed 40-bit data. 			○			page 3-326
64590000 hex	Home Undefined during Coordinated Motion	Home of the logical axis became undefined during axes group motion or while decelerating to a stop.	<ul style="list-style-type: none"> The command position or actual position overflowed or underflowed for a logical axis in an axes group motion or a logical axis that was decelerating to a stop and the home definition was lost. A slave communications error occurred for a logical axis and home became undefined during axes group motion or while decelerating to a stop. A slave for a logical axis left the network or was disabled and home became undefined during axes group motion or while decelerating to a stop. 			○			page 3-327
74210000 hex	Servo Main Circuit Power OFF	The main circuit power of the Servo Drive turned OFF while the Servo was ON.	<ul style="list-style-type: none"> The main circuit power of the Servo Drive was interrupted while the Servo was ON. 			○			page 3-327
74230000 hex	Interrupt Feeding Interrupt Signal Missing	An interrupt input was not received during execution of an MC_MoveFeed (Interrupt Feeding) instruction.	<ul style="list-style-type: none"> The latch enabled range specification is invalid. There is a problem with the wiring of the interrupt signal. The sensor that outputs the interrupt signal has failed. 			○			page 3-328
74240000 hex	Homing Opposite Direction Limit Input Detected	The limit signal in the direction opposite to the homing direction was detected during a homing operation.	<ul style="list-style-type: none"> The Operation Selection at Negative Limit Input or Operation Selection at Positive Limit Input parameter is set to No reverse turn. The location of the homing input signal sensors, homing settings, and homing start position cause a limit input to be reached. The input signal sensor wiring is incorrect or the sensor is faulty. 			○			page 3-328

Event code	Event name	Meaning	Assumed cause	Level					Reference
				M a j	P r t	M i n	O b s	I n f o	
74250000 hex	Homing Direction Limit Input Detected	The limit signal in the homing direction was detected during a homing operation.	<ul style="list-style-type: none"> The Operation Selection at Negative Limit Input or Operation Selection at Positive Limit Input parameter is set to No reverse turn. The location of the homing input signal sensors, homing settings, and homing start position cause a limit input to be reached. The input signal sensor wiring is incorrect or the sensor is faulty. 			○			page 3-329
74260000 hex	Homing Limit Inputs Detected in Both Directions	The limit signals in both directions were detected during a homing operation.	<ul style="list-style-type: none"> The wiring of the limit signal is incorrect. The limit sensor is installed in the wrong location. The contact logic of the limit signal is not correct. The limit sensor failed. 			○			page 3-329
74270000 hex	Home Proximity/Homing Opposite Direction Limit Input Detected	The home proximity input and the limit signal in the direction opposite to the homing direction were detected during a homing operation.	<ul style="list-style-type: none"> The wiring of the home proximity signal or limit signal is incorrect. The home proximity sensor or limit sensor is installed in the wrong location. The contact logic of the home proximity signal or limit signal is not correct. The home proximity sensor or limit sensor failed. 			○			page 3-330
74280000 hex	Home Proximity/Homing Direction Limit Input Detected	The home proximity input and the limit signal in the homing direction were detected at the same time during a homing operation.	<ul style="list-style-type: none"> The wiring of the home proximity signal or limit signal is incorrect. The home proximity sensor or limit sensor is installed in the wrong location. The contact logic of the home proximity signal or limit signal is not correct. The home proximity sensor or limit sensor failed. 			○			page 3-331

Event code	Event name	Meaning	Assumed cause	Level					Reference
				M a j	P r t	M i n	O b s	I n f o	
74290000 hex	Home Input/ Homing Opposite Direction Limit Input Detected	The home input and the limit signal in the direction opposite to the homing direction were detected at the same time during a homing operation.	<ul style="list-style-type: none"> The wiring of the home input signal or limit signal is incorrect. The home input sensor or limit sensor is installed in the wrong location. The contact logic of the home input signal or limit signal is not correct. The home input signal output device or limit sensor failed. 			○			page 3-332
742A0000 hex	Home Input/ Homing Direction Limit Input Detected	The home input and the limit signal in the homing direction were detected at the same time during a homing operation.	<ul style="list-style-type: none"> The wiring of the home input signal or limit signal is incorrect. The home input sensor or limit sensor is installed in the wrong location. The contact logic of the home input signal or limit signal is not correct. The home input signal output device or limit sensor failed. 			○			page 3-333
742B0000 hex	Invalid Home Input Mask Distance	The setting of the home input mask distance is not suitable for the MC_Home or MC_HomeWithParameter instruction.	<ul style="list-style-type: none"> The set value of the home input mask distance when the operating mode of the MC_Home instruction is set to Proximity Reverse Turn/Home Input Mask Distance is insufficient to decelerate from the homing velocity to the homing approach velocity. 			○			page 3-333
742C0000 hex	No Home Input	There was no home signal input during the homing operation. Or, a limit signal was detected before there was a home input.	<ul style="list-style-type: none"> There was no home signal input during the homing operation. A limit signal was detected before there was a home input. 			○			page 3-334
742D0000 hex	No Home Proximity Input	There was no home proximity signal input during the homing operation.	<ul style="list-style-type: none"> There was no home proximity signal input during the homing operation when a home proximity input signal was specified. 			○			page 3-334
742F 0000 hex	Slave Error Detected	An error was detected for the EtherCAT slave or NX Unit that is allocated to an axis.	<ul style="list-style-type: none"> An error was detected for the EtherCAT slave or NX Unit that is allocated to an axis. 			○			page 3-335
74300000 hex	Axes Group Composition Axis Error	An error occurred for an axis in an axes group.	<ul style="list-style-type: none"> An error occurred for an axis in an axes group that was in motion. 			○			page 3-335

Event code	Event name	Meaning	Assumed cause	Level					Reference
				M a j	P r t	M i n	O b s	I n f o	
74330000 hex	MC Common Error Occurrence	An MC common error occurred.	<ul style="list-style-type: none"> Partial fault level MC common error occurred. 			○			page 3-336
74340000 hex	Latch Position Overflow	An overflow occurred for the latched position for the MC_TouchProbe (Enable External Latch) instruction.	<ul style="list-style-type: none"> An overflow occurred for the latched position for the MC_TouchProbe (Enable External Latch) instruction. 			○			page 3-336
74350000 hex	Latch Position Underflow	An underflow occurred for the latched position for the MC_TouchProbe (Enable External Latch) instruction.	<ul style="list-style-type: none"> An underflow occurred for the latched position for the MC_TouchProbe (Enable External Latch) instruction. 			○			page 3-337
74360000 hex	Master Sync Direction Error	The master axis continued to move in the direction opposite to the sync direction.	<ul style="list-style-type: none"> The master axis continued to move in the direction opposite to the sync direction of the master and slave axes, resulting in an overflow. 			○			page 3-337
74370000 hex	Slave Disconnection during Servo ON	One of the following occurred while the Servo was ON for the EtherCAT slave or NX Unit that is allocated to an axis. <ul style="list-style-type: none"> Disconnection or replacement Disablement Restart of the NX bus on the NXseries CPU Unit 	<ul style="list-style-type: none"> One of the following occurred while the Servo was ON for the EtherCAT slave or NX Unit that is allocated to an axis. <ul style="list-style-type: none"> Disconnection or replacement Disablement Restart of the NX bus on the NX-series CPU Unit 			○			page 3-338
74380000 hex	Feed Distance Overflow	The target position after the interrupt input was received for the MC_MoveFeed (Interrupt Feeding) instruction overflowed or underflowed.	<ul style="list-style-type: none"> The target position after the interrupt input was received for the MC_MoveFeed (Interrupt Feeding) instruction exceeded the range of signed 40-bit data when it is converted to pulses. 			○			page 3-338

Event code	Event name	Meaning	Assumed cause	Level					Reference
				M a j	P r t	M i n	O b s	I n f o	
74390000 hex	Error in Changing Servo Drive Control Mode	Changing the Control Mode was not completed within the specified time.	<ul style="list-style-type: none"> When the MC_SyncMoveVelocity instruction was stopped, the actual current velocity was not reduced to 10% or less of the maximum velocity within 10 seconds for three consecutive periods after a command velocity of 0 was output. For an OMRON 1S-series Servo Drive or G5-series Servo Drive, the actual current velocity was not reduced to 10% or less of the maximum velocity within 10 seconds for three consecutive periods when the MC_TorqueControl instruction was stopped. Changing the Control Mode of the Servo Drive between CSP, CSV, and CST was not completed within one second after the command was executed. 			○			page 3-339
743A0000 hex	Master Axis Position Read Error	The synchronized control instruction was not executed because an error occurred in the position of the master axis of the synchronized control instruction.	<ul style="list-style-type: none"> EtherCAT process data communications are not established for the master axis of the synchronized control instruction or the I/O data of the NX Unit cannot be used for control. The slave of the master axis for the synchronized control instruction was disconnected or disabled. An Absolute Encoder Current Position Calculation Failed error (64580000 hex) was detected for the master axis of the synchronized control instruction. The master axis for the synchronized control instruction is an unused axis. 			○			page 3-340

Event code	Event name	Meaning	Assumed cause	Level					Reference
				M a j	P r t	M i n	O b s	I n f o	
743B0000 hex	Auxiliary Axis Position Read Error	The synchronized control instruction was not executed because an error occurred in the position of the auxiliary axis of the synchronized control instruction.	<ul style="list-style-type: none"> EtherCAT process data communications are not established for the auxiliary axis of the synchronized control instruction or the I/O data of the NX Unit cannot be used for control. The slave of the auxiliary axis for the synchronized control instruction was disconnected or disabled. An Absolute Encoder Current Position Calculation Failed error (64580000 hex) was detected for the auxiliary axis of the synchronized control instruction. The auxiliary axis for the synchronized control instruction is an unused axis. 			○			page 3-341
84400000 hex	EtherCAT Slave Communications Error	A communications error occurred for the EtherCAT slave or NX Unit that is allocated to an axis.	<ul style="list-style-type: none"> A communications error occurred for the EtherCAT slave or NX Unit that is allocated to an axis. 			○			page 3-342
644C0000 hex	Following Error Warning	The following error exceeded the Following Error Warning Value.	<ul style="list-style-type: none"> Performance of positioning operation is poor and the actual motion is slower than the command. 				○		page 3-342
644D0000 hex	Velocity Warning	The command velocity exceeded the velocity warning value.	<ul style="list-style-type: none"> The command velocity exceeded the velocity warning value. 			⊙	○		page 3-343
644E0000 hex	Acceleration Warning	The command acceleration exceeded the acceleration warning value.	<ul style="list-style-type: none"> The command acceleration rate exceeded the acceleration warning value. 			⊙	○		page 3-343
644F0000 hex	Deceleration Warning	The command deceleration exceeded the deceleration warning value.	<ul style="list-style-type: none"> The command deceleration rate exceeded the deceleration warning value. 			⊙	○		page 3-344
64500000 hex	Positive Torque Warning	The torque command value exceeded the positive torque warning value.	<ul style="list-style-type: none"> The torque command value exceeded the positive torque warning value. 			⊙	○		page 3-344
64510000 hex	Negative Torque Warning	The torque command value exceeded the negative torque warning value.	<ul style="list-style-type: none"> The torque command value exceeded the negative torque warning value. 			⊙	○		page 3-345

Event code	Event name	Meaning	Assumed cause	Level					Reference
				M a j	P r t	M i n	O b s	I n f o	
64520000 hex	Command Position Overflow	The number of pulses for the command position overflowed.	<ul style="list-style-type: none"> In Linear Mode, the command position when converted to pulses exceeded the upper limit of signed 40-bit data. 			○	○		page 3-345
64530000 hex	Command Position Underflow	The number of pulses for the command position exceeded the valid range. (It underflowed.)	<ul style="list-style-type: none"> In Linear Mode, the command position when converted to pulses exceeded the lower limit of signed 40-bit data. 			○	○		page 3-346
64540000 hex	Actual Position Overflow	The number of pulses for the actual position overflowed.	<ul style="list-style-type: none"> The actual position when converted to pulses exceeded the upper limit of signed 40-bit data. 			○	○		page 3-346
64550000 hex	Actual Position Underflow	The number of pulses for the actual position underflowed.	<ul style="list-style-type: none"> The actual position when converted to pulses exceeded the lower limit of signed 40-bit data. 			○	○		page 3-347
74320000 hex	Slave Observation Detected	A warning was detected for an EtherCAT slave or NX Unit.	<ul style="list-style-type: none"> A warning was detected for the EtherCAT slave or NX Unit that is allocated to an axis. 			○	○		page 3-347
743C0000 hex	Cannot Execute Save Cam Table Instruction	You cannot save a cam table to a file when non-volatile memory is being accessed by another operation.	<ul style="list-style-type: none"> An attempt was made to execute the MC_SaveCamTable instruction when another operation was accessing the non-volatile memory (e.g., transfer or data trace operation from the Sysmac Studio). 				○		page 3-348
94200000 hex	Notice of Insufficient Travel Distance to Achieve Blending Transit Velocity	There is not sufficient travel distance to accelerate or decelerate to the transit velocity during blending operation.	<ul style="list-style-type: none"> When the Acceleration/Deceleration Over parameter was set to Use rapid acceleration/deceleration (Blending is changed to Buffered), the results of profile creation caused the acceleration/deceleration rate to be exceeded when blending was specified, so buffered was used. Blending was specified, but the target position was already reached, so it was changed to Buffered because the profile could not be created. 			○	○		page 3-348
94210000 hex	Error Clear from MC Test Run Tab Page	An error was cleared from the MC Test Run Pane of the Sysmac Studio.	<ul style="list-style-type: none"> An error was cleared from the MC Test Run Pane of the Sysmac Studio. 				○		page 3-349
94220000 hex	Slave Error Code Report	The error code was reported by the slave when a Slave Error Detected error occurred.	<ul style="list-style-type: none"> The error code was reported by the slave when a Slave Error Detected error (742F0000 hex) occurred. 				○		page 3-349

Motion Control Instructions

This section provides a table of errors (events) that occur for motion control instructions. The upper four digits of the event code give the error code (ErrorID) for the motion control instruction. For descriptions of an error code, refer to the description of the corresponding event code. For example, if the error code for the motion control instruction is 16#3461, refer to the description for event code 34610000 hex.

Event code	Event name	Meaning	Assumed cause	Level					Reference
				M a j	P r t	M i n	O b s	I n f o	
34610000 hex	Process Data Object Setting Missing	The PDO mapping is not correct.	<ul style="list-style-type: none"> The PDOs that are required for the motion control instruction are not mapped. The relevant instruction was executed for a device that does not have an object that supports the instruction. A motion control instruction that specifies phase Z (<code>_mcEncoderMark</code>) as the trigger conditions was executed for an axis that is mapped to an OMRON GXEC02 EtherCAT Encoder slave. 			○			page 3-350
54200000 hex	Electronic Gear Ratio Numerator Setting Out of Range	The parameter specified for the <i>RatioNumerator</i> input variable to a motion control instruction is out of range.	<ul style="list-style-type: none"> Instruction input parameter exceeded the valid range of the input variable. 			○			page 3-351
54210000 hex	Electronic Gear Ratio Denominator Setting Out of Range	The parameter specified for the <i>RatioDenominator</i> input variable to a motion control instruction is out of range.	<ul style="list-style-type: none"> Instruction input parameter exceeded the valid range of the input variable. 			○			page 3-351
54220000 hex	Target Velocity Setting Out of Range	The parameter specified for the <i>Velocity</i> input variable to a motion control instruction is out of range.	<ul style="list-style-type: none"> Instruction input parameter exceeded the valid range of the input variable. 			○			page 3-352
54230000 hex	Acceleration Setting Out of Range	The parameter specified for the <i>Acceleration</i> input variable to a motion control instruction is out of range.	<ul style="list-style-type: none"> Instruction input parameter exceeded the valid range of the input variable. 			○			page 3-352

Event code	Event name	Meaning	Assumed cause	Level					Reference
				M a j	P r t	M i n	O b s	I n f o	
54240000 hex	Deceleration Setting Out of Range	The parameter specified for the <i>Deceleration</i> input variable to a motion control instruction is out of range.	<ul style="list-style-type: none"> Instruction input parameter exceeded the valid range of the input variable. 			○			page 3-353
54250000 hex	Jerk Setting Out of Range	The parameter specified for the <i>Jerk</i> input variable to a motion control instruction is out of range.	<ul style="list-style-type: none"> Instruction input parameter exceeded the valid range of the input variable. 			○			page 3-353
54270000 hex	Torque Ramp Setting Out of Range	The parameter specified for the <i>TorqueRamp</i> input variable to a motion control instruction is out of range.	<ul style="list-style-type: none"> Instruction input parameter exceeded the valid range of the input variable. 			○			page 3-354
54280000 hex	Master Coefficient Scaling Out of Range	The parameter specified for the <i>MasterScaling</i> input variable to a motion control instruction is out of range.	<ul style="list-style-type: none"> Instruction input parameter exceeded the valid range of the input variable. 			○			page 3-354
54290000 hex	Slave Coefficient Scaling Out of Range	The parameter specified for the <i>SlaveScaling</i> input variable to a motion control instruction is out of range.	<ul style="list-style-type: none"> Instruction input parameter exceeded the valid range of the input variable. 			○			page 3-355
542A0000 hex	Feeding Velocity Setting Out of Range	The parameter specified for the <i>FeedVelocity</i> input variable to a motion control instruction is out of range.	<ul style="list-style-type: none"> The Feed Velocity (input variable <i>FeedVelocity</i>) is still at the default (0). 			○			page 3-355
542B0000 hex	Buffer Mode Selection Out of Range	The parameter specified for the <i>BufferMode</i> input variable to a motion control instruction is out of range.	<ul style="list-style-type: none"> Instruction input parameter exceeded the valid range of the input variable. 			○			page 3-356
542C0000 hex	Coordinate System Selection Out of Range	The parameter specified for the <i>CoordSystem</i> input variable to a motion control instruction is out of range.	<ul style="list-style-type: none"> Instruction input parameter exceeded the valid range of the input variable. 			○			page 3-356

Event code	Event name	Meaning	Assumed cause	Level					Reference
				M a j	P r t	M i n	O b s	I n f o	
542D0000 hex	Circular Interpolation Mode Selection Out of Range	The parameter specified for the <i>CircMode</i> input variable to a motion control instruction is out of range.	<ul style="list-style-type: none"> Instruction input parameter exceeded the valid range of the input variable. 			○			page 3-357
542E0000 hex	Direction Selection Out of Range	The parameter specified for the <i>Direction</i> input variable to a motion control instruction is out of range.	<ul style="list-style-type: none"> Instruction input parameter exceeded the valid range of the input variable. 			○			page 3-357
542F0000 hex	Path Selection Out of Range	The parameter specified for the <i>PathChoice</i> input variable to a motion control instruction is out of range.	<ul style="list-style-type: none"> Instruction input parameter exceeded the valid range of the input variable. 			○			page 3-358
54300000 hex	Position Type Selection Out of Range	The parameter specified for the <i>ReferenceType</i> input variable to a motion control instruction is out of range.	<ul style="list-style-type: none"> Instruction input parameter exceeded the valid range of the input variable. 			○			page 3-358
54310000 hex	Travel Mode Selection Out of Range	The parameter specified for the <i>MoveMode</i> input variable to a motion control instruction is out of range.	<ul style="list-style-type: none"> Instruction input parameter exceeded the valid range of the input variable. 			○			page 3-359
54320000 hex	Transition Mode Selection Out of Range	The parameter specified for the <i>TransitionMode</i> input variable to a motion control instruction is out of range.	<ul style="list-style-type: none"> Instruction input parameter exceeded the valid range of the input variable. <i>_mcAborting</i> or <i>_mcBuffered</i> was specified for <i>BufferMode</i> and <i>_mcTMCornerSuperimposed</i> was specified for <i>TransitionMode</i>. 			○			page 3-360
54330000 hex	Continue Method Selection Out of Range	The value of the reserved input variable <i>Continuous</i> to a motion control instruction changed.	<ul style="list-style-type: none"> The value of the reserved input variable <i>Continuous</i> changed. 			○			page 3-360
54340000 hex	Combine Mode Selection Out of Range	The parameter specified for the <i>CombineMode</i> input variable to a motion control instruction is out of range.	<ul style="list-style-type: none"> Instruction input parameter exceeded the valid range of the input variable. 			○			page 3-361

Event code	Event name	Meaning	Assumed cause	Level					Reference
				M a j	P r t	M i n	O b s	I n f o	
54350000 hex	Synchroni- zation Start Condition Selection Out of Range	The parameter speci- fied for the <i>LinkOption</i> input vari- able to a motion control instruction is out of range.	<ul style="list-style-type: none"> Instruction input parameter ex- ceeded the valid range of the input variable. 			○			page 3-361
54360000 hex	Master and Slave De- fined as Same Axis	The same axis is specified for the <i>Master</i> and <i>Slave</i> in- put variables to a mo- tion control instruc- tion.	<ul style="list-style-type: none"> The parameter is the same for the <i>Master</i> and <i>Slave</i> input variables to the instruction. 			○			page 3-362
54370000 hex	Master and Auxiliary De- fined as Same Axis	The same axis is specified for the <i>Master</i> and <i>Auxiliary</i> input variables to a motion control in- struction.	<ul style="list-style-type: none"> The parameter is the same for the <i>Master</i> and <i>Auxiliary</i> input variables to the instruction. 			○			page 3-362
54380000 hex	Master/ Slave Axis Numbers Not in As- cending Or- der	The axis numbers specified for the <i>Master</i> and <i>Slave</i> in- put variables to a mo- tion control instruction are not in ascending order.	<ul style="list-style-type: none"> The parameters for the <i>Master</i> and <i>Slave</i> input variables to the instruction were not in as- cending order when <i>_mcLatestCommand</i> was specified for the <i>ReferenceType</i> input variable to the instruction. 			○			page 3-363
54390000 hex	Incorrect Cam Table Specification	The parameter speci- fied for the <i>CamTable</i> input variable to a motion control in- struction is out of range.	<ul style="list-style-type: none"> Something other than a cam data variable was specified for the <i>CamTable</i> input variable to the instruction. 			○			page 3-363

Event code	Event name	Meaning	Assumed cause	Level					Reference
				M a j	P r t	M i n	O b s	I n f o	
543A0000 hex	Synchroni- zation Stop- ped	A synchronized control motion control instruction was executed, but conditions required for execution were not met.	<ul style="list-style-type: none"> The MC_CamOut (End Cam Operation) instruction was executed even though the MC_CamIn (Start Cam Operation) instruction is not being executed. The MC_GearOut (End Gear Operation) instruction was executed even though the MC_GearIn (Start Gear Operation) or the MC_GearInPos (Positioning Gear Operation) instruction is not being executed. The MC_Phasing (Shift Master Axis Phase) instruction was executed even though the MC_CamIn (Start Cam Operation), MC_GearIn (Start Gear Operation), MC_GearInPos (Start Gear Operation), or MC_MoveLink (Synchronous Positioning) instruction is not being executed. 						page 3-364
543B0000 hex	Motion Control Instruction Re-execution Disabled	An attempt was made to re-execute a motion control instruction that cannot be re-executed.	<ul style="list-style-type: none"> A motion control instruction that cannot be re-executed was re-executed. 						page 3-365
543C0000 hex	Motion Control Instruction Multi-execution Disabled	Multiple functions that cannot be executed simultaneously were executed for the same target (MC common, axis, or axes group).	<ul style="list-style-type: none"> Multiple functions that cannot be executed simultaneously were executed for the same target (MC common, axis, or axes group). 						page 3-366
543D0000 hex	Instruction Not Allowed for Encoder Axis Type	An operation instruction was executed for an encoder axis.	<ul style="list-style-type: none"> An operation instruction was executed for an encoder axis. 						page 3-366

Event code	Event name	Meaning	Assumed cause	Level					Reference
				M a j	P r t	M i n	O b s	I n f o	
543E0000 hex	Instruction Cannot Be Executed during Multi-axes Coordinated Control	<ul style="list-style-type: none"> An operation instruction was executed for an axis or an axes group that was in a coordinated multi-axes motion. A robot instruction that you cannot use for an axes group in a Group-Enable state was executed. 	<ul style="list-style-type: none"> An operation instruction was executed for an axis or an axes group that was in a coordinated multi-axes motion. The MC_SetKinTransform instruction was executed for an axes group in a GroupEnable state. 				○		page 3-367
543F0000 hex	Multi-axes Coordinated Control Instruction Executed for Disabled Axes Group	A multi-axes coordinated control instruction was executed for an axes group that was in a GroupDisable state.	<ul style="list-style-type: none"> A multi-axes coordinated control instruction was executed for an axes group that was in a GroupDisable state. One of the following instructions was executed for an axes group that was in a GroupDisable state. <ul style="list-style-type: none"> MC_MoveTimeAbsolute MC_SyncLinearConveyor MC_SyncOut MC_RobotJog 				○		page 3-368
54400000 hex	Axes Group Cannot Be Enabled	Execution of the MC_GroupEnable (Enable Axes Group) instruction failed.	<ul style="list-style-type: none"> When the MC_GroupEnable (Enable Axes Group) instruction was executed, there was a composition axis that was not stopped. When the MC_GroupEnable (Enable Axes Group) instruction was executed, there was a composition axis for which the MC_TouchProbe (Enable External Latch) instruction was being executed. 				○		page 3-369
54410000 hex	Impossible Axis Operation Specified when the Servo is OFF	An operation instruction was executed for an axis for which the Servo is OFF.	<ul style="list-style-type: none"> An operation instruction was executed for an axis for which the Servo is OFF. Home was preset with the MC_Home or MC_HomeWith-Parameter instruction for an axis for which EtherCAT process data communications are not established. 				○		page 3-370

Event code	Event name	Meaning	Assumed cause	Level					Reference
				M a j	P r t	M i n	O b s	I n f o	
54420000 hex	Composition Axis Stopped Error	A motion instruction was executed for an axes group while the MC_Stop instruction was being executed for a composition axis.	<ul style="list-style-type: none"> A motion instruction was executed for an axes group while the MC_Stop instruction was being executed for a composition axis. 			○			page 3-371
54430000 hex	Motion Control Instruction Multi-execution Buffer Limit Exceeded	The number of motion control instructions that is buffered for Buffered or Blending Buffer Modes exceeded the buffer limit.	<ul style="list-style-type: none"> An axis instruction was executed when there was already a current instruction and a buffered instruction for the same axis. An axes group instruction was executed when there was already eight current instructions and buffered instructions for the same axis. 			○			page 3-371
54440000 hex	Insufficient Travel Distance	The specified motion cannot be executed for the deceleration rate or acceleration rate that was specified for multi-execution or re-execution of a positioning instruction.	<ul style="list-style-type: none"> Stopping at the target position was not possible for the specified acceleration/deceleration rate for multi-execution or re-execution of a positioning instruction when the Acceleration/Deceleration Over parameter was set to generate a minor fault and stop. 			○			page 3-372
54450000 hex	Insufficient Travel Distance to Achieve Blending Transit Velocity	There is not sufficient travel distance to accelerate or decelerate to the transit velocity.	<ul style="list-style-type: none"> There was not sufficient travel distance to accelerate the current command to the transit velocity when the Acceleration/Deceleration Over parameter was set to generate a minor fault and stop. 			○			page 3-373
54460000 hex	Move Link Constant Velocity Insufficient Travel Distance	The constant-velocity travel distance of the master axis is less than zero.	<ul style="list-style-type: none"> The constant velocity travel distance of the master axis is below 0 for the MC_MoveLink (Synchronous Positioning) instruction. 			○			page 3-373
54470000 hex	Positioning Gear Operation Insufficient Target Velocity	For the MC_GearInPos (Positioning Gear Operation) instruction, the target velocity of the slave axis is too small to achieve the required velocity.	<ul style="list-style-type: none"> For the MC_GearInPos (Positioning Gear Operation) instruction, the value of the <i>Velocity</i> (Target Velocity) input variable is smaller than the master axis velocity multiplied by the gear ratio when the instruction was executed. 			○			page 3-374

Event code	Event name	Meaning	Assumed cause	Level					Reference
				M a j	P r t	M i n	O b s	I n f o	
54480000 hex	Same Start Point and End Point for Circular Interpolation	The start point and end point were the same when the radius method was specified for the MC_MoveCircular2D (Circular 2D Interpolation) instruction. Or, the start point, end point, and border point were the same when the border point method was specified.	<ul style="list-style-type: none"> The start point and end point were the same when the radius method was specified for the MC_MoveCircular2D (Circular 2D Interpolation) instruction. The start point, end point, and border point were the same when the border point method was specified for the MC_MoveCircular2D (Circular 2D Interpolation) instruction. 			○			page 3-374
54490000 hex	Circular Interpolation Center Specification Position Out of Range	The position specified for the center point exceeded the allowed range when the center method was specified for the MC_MoveCircular2D (Circular 2D Interpolation) instruction.	<ul style="list-style-type: none"> The difference between the distance from the start point to the center point and the distance between the end point to the center point exceeded the permitted value specified for the correction allowance ratio in the axes group settings when the center designation method was specified for the MC_MoveCircular2D (Circular 2D Interpolation) instruction. 			○			page 3-375
544A0000 hex	Instruction Execution Error Caused by Count Mode Setting	An instruction that cannot be used when the Count Mode is set to Rotary Mode was executed for an axis that was set to Rotary Mode.	<ul style="list-style-type: none"> An instruction that cannot be used when the Count Mode is set to Rotary Mode was executed for an axis that was set to Rotary Mode. 			○			page 3-375
544C0000 hex	Parameter Selection Out of Range	The parameter specified for the <i>ParameterNumber</i> input variable to a motion control instruction is out of range.	<ul style="list-style-type: none"> Instruction input parameter exceeded the valid range of the input variable. 			○			page 3-376
544D0000 hex	Stop Method Selection Out of Range	The parameter specified for the <i>StopMode</i> input variable to a motion control instruction is out of range.	<ul style="list-style-type: none"> Instruction input parameter exceeded the valid range of the input variable. 			○			page 3-376
544E0000 hex	Latch ID Selection Out of Range for Trigger Input Condition	The parameter specified for the <i>TriggerInput::LatchID</i> input variable to a motion control instruction is out of range.	<ul style="list-style-type: none"> Instruction input parameter exceeded the valid range of the input variable. 			○			page 3-377

Event code	Event name	Meaning	Assumed cause	Level					Reference
				M a j	P r t	M i n	O b s	I n f o	
544F0000 hex	Setting Out of Range for Writing MC Setting	The parameter specified for the <i>SettingValue</i> input variable to a motion control instruction is out of range.	<ul style="list-style-type: none"> Instruction input parameter exceeded the valid range of the input variable. The parameter specification and the data type of the setting value do not agree. 			○			page 3-377
54500000 hex	Trigger Input Condition Mode Selection Out of Range	The parameter specified for the <i>TriggerInput:: Mode</i> input variable to a motion control instruction is out of range.	<ul style="list-style-type: none"> Instruction input parameter exceeded the valid range of the input variable. 			○			page 3-378
54510000 hex	Drive Trigger Signal Selection Out of Range for Trigger Input Condition	The parameter specified for the <i>TriggerInput::InputDrive</i> input variable to a motion control instruction is out of range.	<ul style="list-style-type: none"> Instruction input parameter exceeded the valid range of the input variable. 			○			page 3-378
54530000 hex	Motion Control Instruction Re-execution Disabled (Axis Specification)	An attempt was made to change the parameter for the <i>Axis</i> input variable when re-executing a motion control instruction. (This input variable cannot be changed when re-executing an instruction.)	<ul style="list-style-type: none"> A parameter for an input variable that cannot be changed for re-execution was changed. 			○			page 3-379
54540000 hex	Motion Control Instruction Re-execution Disabled (Buffer Mode Selection)	An attempt was made to change the parameter for the <i>BufferMode</i> input variable when re-executing a motion control instruction. (This input variable cannot be changed when re-executing an instruction.)	<ul style="list-style-type: none"> A parameter for an input variable that cannot be changed for re-execution was changed. 			○			page 3-380
54550000 hex	Motion Control Instruction Re-execution Disabled (Direction Selection)	An attempt was made to change the parameter for the <i>Direction</i> input variable when re-executing a motion control instruction. (This input variable cannot be changed when re-executing an instruction.)	<ul style="list-style-type: none"> An input variable that cannot be changed for re-execution was changed. 			○			page 3-381

Event code	Event name	Meaning	Assumed cause	Level					Reference
				M a j	P r t	M i n	O b s	I n f o	
54560000 hex	Motion Control Instruction Re-execution Disabled (Execution Mode)	An attempt was made to change the parameter for the <i>Periodic</i> input variable when re-executing a motion control instruction. (This input variable cannot be changed when re-executing an instruction.)	<ul style="list-style-type: none"> A parameter for an input variable that cannot be changed for re-execution was changed. 			○			page 3-381
54570000 hex	Motion Control Instruction Re-execution Disabled (Axes Group Specification)	An attempt was made to change the parameter for the <i>AxesGroup</i> input variable when re-executing a motion control instruction. (This input variable cannot be changed when re-executing an instruction.)	<ul style="list-style-type: none"> A parameter for an input variable that cannot be changed for re-execution was changed. 			○			page 3-382
54580000 hex	Motion Control Instruction Re-execution Disabled (Jerk Setting)	An attempt was made to change the parameter for the <i>Jerk</i> input variable when re-executing a motion control instruction. (This input variable cannot be changed when re-executing an instruction.)	<ul style="list-style-type: none"> A parameter for an input variable that cannot be changed for re-execution was changed. 			○			page 3-383
54590000 hex	Motion Control Instruction Re-execution Disabled (Master Axis)	An attempt was made to change the parameter for the <i>Master</i> input variable when re-executing a motion control instruction. (This input variable cannot be changed when re-executing an instruction.)	<ul style="list-style-type: none"> A parameter for an input variable that cannot be changed for re-execution was changed. 			○			page 3-384
545A0000 hex	Motion Control Instruction Re-execution Disabled (MasterOffset)	An attempt was made to change the parameter for the <i>MasterOffset</i> input variable when re-executing a motion control instruction. (This input variable cannot be changed when re-executing an instruction.)	<ul style="list-style-type: none"> A parameter for an input variable that cannot be changed for re-execution was changed. 			○			page 3-384

Event code	Event name	Meaning	Assumed cause	Level					Reference
				M a j	P r t	M i n	O b s	I n f o	
545B0000 hex	Motion Control Instruction Re-execution Disabled (MasterScaling)	An attempt was made to change the parameter for the <i>MasterScaling</i> input variable when re-executing a motion control instruction. (This input variable cannot be changed when re-executing an instruction.)	<ul style="list-style-type: none"> A parameter for an input variable that cannot be changed for re-execution was changed. 			○			page 3-385
545C0000 hex	Motion Control Instruction Re-execution Disabled (MasterStartDistance)	An attempt was made to change the parameter for the <i>MasterStartDistance</i> input variable when re-executing a motion control instruction. (This input variable cannot be changed when re-executing an instruction.)	<ul style="list-style-type: none"> A parameter for an input variable that cannot be changed for re-execution was changed. 			○			page 3-385
545D0000 hex	Motion Control Instruction Re-execution Disabled (Continuous)	An attempt was made to change the parameter for the <i>Continuous</i> input variable when re-executing a motion control instruction. (This input variable cannot be changed when re-executing an instruction.)	<ul style="list-style-type: none"> A parameter for an input variable that cannot be changed for re-execution was changed. 			○			page 3-386
545E0000 hex	Motion Control Instruction Re-execution Disabled (MoveMode)	An attempt was made to change the parameter for the <i>MoveMode</i> input variable when re-executing a motion control instruction. (This input variable cannot be changed when re-executing an instruction.)	<ul style="list-style-type: none"> A parameter for an input variable that cannot be changed for re-execution was changed. 			○			page 3-386
545F0000 hex	Illegal Auxiliary Axis Specification	The axis specified for the <i>Auxiliary</i> input variable to a motion control instruction does not exist.	<ul style="list-style-type: none"> An axis does not exist for the variable specified for the <i>Auxiliary</i> input variable to the instruction. 			○			page 3-387

Event code	Event name	Meaning	Assumed cause	Level					Reference
				M a j	P r t	M i n	O b s	I n f o	
54600000 hex	Illegal Axis Specification	The axis specified for the <i>Axis</i> input variable to a motion control instruction does not exist.	<ul style="list-style-type: none"> An axis does not exist for the variable specified for the <i>Axis</i> input variable to the instruction. 			○			page 3-387
54610000 hex	Illegal Axes Group Specification	The axes group specified for the <i>AxesGroup</i> input variable to a motion control instruction does not exist or is not a used group.	<ul style="list-style-type: none"> An axes group does not exist for the variable specified for the <i>AxesGroup</i> input variable to the instruction. The axes group specified for the <i>AxesGroup</i> input variable to the instruction is not specified as a used group. 			○			page 3-388
54620000 hex	Illegal Master Axis Specification	The axis that is specified for the <i>Master</i> input variable to a motion control instruction is not correct.	<ul style="list-style-type: none"> An axis does not exist for the variable specified for the <i>Master</i> input variable to the instruction. The axis that was specified for the <i>Master</i> input variable to the MC_Phasing (Shift Master Axis Phase) instruction is not the master axis for syncing. The master axis and a slave axis are not assigned to the same task. 			○			page 3-389
54630000 hex	Motion Control Instruction Re-execution Disabled (Slave-Offset)	An attempt was made to change the <i>SlaveOffset</i> input variable when re-executing a motion control instruction. (This input variable cannot be changed when re-executing an instruction.)	<ul style="list-style-type: none"> A parameter for an input variable that cannot be changed for re-execution was changed. 			○			page 3-390
54640000 hex	Motion Control Instruction Re-execution Disabled (Slave-Scaling)	An attempt was made to change the <i>SlaveScaling</i> input variable when re-executing a motion control instruction. (This input variable cannot be changed when re-executing an instruction.)	<ul style="list-style-type: none"> A parameter for an input variable that cannot be changed for re-execution was changed. 			○			page 3-390

Event code	Event name	Meaning	Assumed cause	Level					Reference
				M a j	P r t	M i n	O b s	I n f o	
54650000 hex	Motion Control Instruction Re-execution Disabled (Start-Position)	An attempt was made to change the <i>StartPosition</i> input variable when re-executing a motion control instruction. (This input variable cannot be changed when re-executing an instruction.)	<ul style="list-style-type: none"> A parameter for an input variable that cannot be changed for re-execution was changed. 			○			page 3-391
54660000 hex	Instruction Execution Error with Undefined Home	High-speed homing or an interpolation instruction was executed when home was undefined.	<ul style="list-style-type: none"> High-speed homing was executed when home was undefined. An interpolation instruction was executed for an axes group that includes an axis with no defined home. One of the following robot instructions was executed for an axes group that includes a logical axis with no defined home. MC_SetKinTransform MC_MoveTimeAbsolute MC_SyncLinearConveyor MC_SyncOut MC_GroupMon MC_RobotJog 			○			page 3-392
54670000 hex	Motion Control Instruction Re-execution Disabled (Position Type)	An attempt was made to change the <i>ReferenceType</i> input variable when re-executing a motion control instruction. (This input variable cannot be changed when re-executing an instruction.)	<ul style="list-style-type: none"> A parameter for an input variable that cannot be changed for re-execution was changed. 			○			page 3-393
54680000 hex	Unused Axis Specification for Master Axis	The master axis specified for a motion control instruction is an unused axis.	<ul style="list-style-type: none"> The master axis specified for a motion control instruction is an unused axis. 			○			page 3-393
54690000 hex	First Position Setting Out of Range	The parameter specified for the <i>FirstPosition</i> input variable to a motion control instruction is out of range.	<ul style="list-style-type: none"> Instruction input parameter exceeded the valid range of the input variable. 			○			page 3-394

Event code	Event name	Meaning	Assumed cause	Level					Reference
				M a j	P r t	M i n	O b s	I n f o	
546A0000 hex	Last Position Setting Out of Range	The parameter specified for the <i>LastPosition</i> input variable to a motion control instruction is out of range.	<ul style="list-style-type: none"> Instruction input parameter exceeded the valid range of the input variable. 			○			page 3-394
546B0000 hex	Illegal First/Last Position Size Relationship (Linear Mode)	The parameter specified for the <i>LastPosition</i> input variable to a motion control instruction is smaller than the parameter specified for the <i>FirstPosition</i> input variable.	<ul style="list-style-type: none"> The value of the <i>LastPosition</i> input parameter is less than the value of the <i>FirstPosition</i> input variable for the instruction when the Count Mode is set to Linear Mode. 			○			page 3-395
546C0000 hex	Master Sync Start Position Setting Out of Range	The parameter specified for the <i>MasterSyncPosition</i> input variable to a motion control instruction is out of range.	<ul style="list-style-type: none"> Instruction input parameter exceeded the valid range of the input variable. 			○			page 3-395
546D0000 hex	Slave Sync Start Position Setting Out of Range	The parameter specified for the <i>SlaveSyncPosition</i> input variable to a motion control instruction is out of range.	<ul style="list-style-type: none"> Instruction input parameter exceeded the valid range of the input variable. 			○			page 3-396
546E0000 hex	Duplicate Latch ID for Trigger Input Condition	The same latch ID was specified for more than one motion control instruction.	<ul style="list-style-type: none"> The same latch ID is used simultaneously for more than one of the following instructions: MC_TouchProbe (Enable External Latch) instruction, MC_MoveLink (Synchronous Positioning) instruction, and MC_MoveFeed (Interrupt Feeding) instruction. The MC_AbortTrigger (Disable External Latch) instruction was executed to cancel a latch that was used by an instruction other than the MC_TouchProbe (Enable External Latch) instruction. 			○			page 3-396
546F0000 hex	Jerk Override Factor Out of Range	The parameter specified for the <i>JerkFactor</i> input variable to a motion control instruction is out of range.	<ul style="list-style-type: none"> Instruction input parameter exceeded the valid range of the input variable. 			○			page 3-397

Event code	Event name	Meaning	Assumed cause	Level					Reference
				M a j	P r t	M i n	O b s	I n f o	
54700000 hex	Acceleration/ Deceleration Override Factor Out of Range	The parameter specified for the <i>AccFactor</i> input variable to a motion control instruction is out of range.	<ul style="list-style-type: none"> Instruction input parameter exceeded the valid range of the input variable. 			○			page 3-397
54710000 hex	First Position Method Specification Out of Range	The parameter specified for the <i>StartMode</i> input variable to a motion control instruction is out of range.	<ul style="list-style-type: none"> Instruction input parameter exceeded the valid range of the input variable. 			○			page 3-398
54720000 hex	Motion Control Instruction Re-execution Disabled (First Position Method)	An attempt was made to change the <i>StartMode</i> input variable when re-executing a motion control instruction. (This input variable cannot be changed when re-executing an instruction.)	<ul style="list-style-type: none"> A parameter for an input variable that cannot be changed for re-execution was changed. 			○			page 3-398
54740000 hex	Unused Axis Specification for Auxiliary Axis	The axis specified for the <i>Auxiliary</i> input variable to a motion control instruction is an unused axis.	<ul style="list-style-type: none"> The axis specified for the <i>Auxiliary</i> input variable to the instruction is an unused axis. 			○			page 3-399
54750000 hex	Position Gear Value Error	Synchronized motion is not possible for the velocity, acceleration rate, and deceleration rate that were input to a motion control instruction.	<ul style="list-style-type: none"> The specified synchronized motion cannot be performed at the velocity, acceleration rate, or deceleration rate that is input to the instruction. 			○			page 3-399
54760000 hex	Position Gear Master Axis Zero Velocity	The velocity of the master axis was zero when a motion control instruction was started.	<ul style="list-style-type: none"> The velocity of the master axis was 0 when the instruction was started. 			○			page 3-400
54780000 hex	Target Position Setting Out of Range	The parameter specified for the <i>Position</i> input variable to a motion control instruction is out of range.	<ul style="list-style-type: none"> Instruction input parameter exceeded the valid range of the input variable. The target position of a Rotary Mode axis is not within the ring setting range. 			○			page 3-400

Event code	Event name	Meaning	Assumed cause	Level					Reference
				M a j	P r t	M i n	O b s	I n f o	
54790000 hex	Travel Distance Out of Range	The parameter that was specified for the <i>Distance</i> input variable to a motion control instruction is out of range or the target position with the value of <i>Distance</i> added is out of range.	<ul style="list-style-type: none"> The absolute value of the instruction input parameter exceeded the range of 40-bit data when it is converted to pulses. For a Linear Mode axis, the target position with the travel distance added exceeded signed 40-bit data when the absolute value is converted to pulses. 			○			page 3-401
547A0000 hex	Cam Table Start Point Setting Out of Range	The parameter specified for the <i>StartPosition</i> input variable to a motion control instruction is out of range.	<ul style="list-style-type: none"> Instruction input parameter exceeded the valid range of the input variable. 			○			page 3-401
547B0000 hex	Cam Master Axis Following First Position Setting Out of Range	The parameter specified for the <i>MasterStartDistance</i> input variable to a motion control instruction is out of range.	<ul style="list-style-type: none"> Instruction input parameter exceeded the valid range of the input variable. 			○			page 3-402
547C0000 hex	Circular Interpolation Radius Setting Error	It was not possible to create a circular path for the specified radius when the radius method was specified for the MC_MoveCircular2D (Circular 2D Interpolation) instruction.	<ul style="list-style-type: none"> For the MC_MoveCircular2D (Circular 2D Interpolation) instruction, it was not possible to create a circular path for the specified radius when the radius method was specified for circular interpolation. 			○			page 3-402
547D0000 hex	Circular Interpolation Radius Overflow	For the MC_MoveCircular2D (Circular 2D Interpolation) instruction, the radius of the circle exceeded the maximum value for the border point or center specification method.	<ul style="list-style-type: none"> For the MC_MoveCircular2D (Circular 2D Interpolation) instruction, the radius of the circle exceeded 40-bit data when converted to pulses for the border point or center specification method. 			○			page 3-403
547E0000 hex	Circular Interpolation Setting Out of Range	The parameter specified for the <i>CircAxes</i> input variable to a motion control instruction is out of range.	<ul style="list-style-type: none"> Instruction input parameter exceeded the valid range of the input variable. The axes that were specified in <i>CircAxes</i> are not included in the composition axes in the Axes Group Settings. The same axis was specified for both axes of <i>CircAxes</i>. 			○			page 3-403

Event code	Event name	Meaning	Assumed cause	Level					Reference
				M a j	P r t	M i n	O b s	I n f o	
547F0000 hex	Auxiliary/ Slave Axis Numbers Not in As- cending Or- der	The values of the pa- rameters for the <i>Auxiliary</i> and <i>Slave</i> input variables to a motion control in- struction are not in ascending order.	<ul style="list-style-type: none"> The parameters for the <i>Auxiliary</i> and <i>Slave</i> input variables to the instruction are not in ascending order. 			○			page 3-404
54800000 hex	Cam Table Property As- cending Da- ta Error at Update	A phase that was not in ascending order was found during cal- culating the number of valid data. Or, after calculations, the num- ber of valid data is 0.	<ul style="list-style-type: none"> A phase that was not in as- cending order was found when calculating the number of valid data. After calculations, the number of valid data is 0. 			○			page 3-404
54810000 hex	MC_Write Target Out of Range	The parameter speci- fied for the <i>Target</i> in- put variable to a mo- tion control instruction is out of range.	<ul style="list-style-type: none"> Instruction input parameter ex- ceeded the valid range of the input variable. 			○			page 3-405
54820000 hex	Master Trav- el Distance Specification Out of Range	The parameter speci- fied for the <i>MasterDistance</i> input variable to a motion control instruction is out of range.	<ul style="list-style-type: none"> Instruction input parameter ex- ceeded the valid range of the input variable. 			○			page 3-405
54830000 hex	Master Dis- tance in Ac- celeration Specification Out of Range	The parameter speci- fied for the <i>MasterDistanceACC</i> input variable to a motion control in- struction is out of range.	<ul style="list-style-type: none"> Instruction input parameter ex- ceeded the valid range of the input variable. 			○			page 3-406
54840000 hex	Master Dis- tance in De- celeration Specification Out of Range	The parameter speci- fied for the <i>MasterDistanceDEC</i> input variable to a motion control in- struction is out of range.	<ul style="list-style-type: none"> Instruction input parameter ex- ceeded the valid range of the input variable. 			○			page 3-406
54870000 hex	Execution Mode Selec- tion Out of Range	The parameter speci- fied for the <i>ExecutionMode</i> input variable to a motion control instruction is out of range.	<ul style="list-style-type: none"> Instruction input parameter ex- ceeded the valid range of the input variable. 			○			page 3-407
54880000 hex	Permitted Following Error Out of Range	The parameter speci- fied for the <i>PermittedDeviation</i> input variable to a motion control in- struction is out of range.	<ul style="list-style-type: none"> Instruction input parameter ex- ceeded the valid range of the input variable. 			○			page 3-407

Event code	Event name	Meaning	Assumed cause	Level					Reference
				M a j	P r t	M i n	O b s	I n f o	
54890000 hex	Border Point/Center Position/ Radius Specification Out of Range	The parameter specified for the <i>AuxPoint</i> input variable to a motion control instruction is out of range.	<ul style="list-style-type: none"> The value of <i>AuxPoint</i> exceeded signed 40-bit data when converted to pulses for the border point or center specification method. For a radius specifications, the absolute value of <i>AuxPoint[0]</i> exceeded 40-bit data when it is converted to pulses. 			○			page 3-408
548A0000 hex	End Point Specification Out of Range	The parameter specified for the <i>EndPoint</i> input variable to a motion control instruction is out of range.	<ul style="list-style-type: none"> The instruction input parameter exceeded the range of signed 40-bit data when it was converted to pulses. 			○			page 3-408
548B0000 hex	Slave Travel Distance Specification Out of Range	The parameter specified for the <i>SlaveDistance</i> input variable to a motion control instruction is out of range.	<ul style="list-style-type: none"> The instruction input parameter exceeded the range of 40-bit data when it is converted to pulses. 			○			page 3-409
548C0000 hex	Phase Shift Amount Out of Range	The parameter specified for the <i>PhaseShift</i> input variable to a motion control instruction is out of range.	<ul style="list-style-type: none"> The absolute value of the instruction input parameter exceeded the range of 40-bit data when it is converted to pulses. 			○			page 3-409
548D0000 hex	Feeding Distance Out of Range	The parameter specified for the <i>FeedDistance</i> input variable to a motion control instruction is out of range.	<ul style="list-style-type: none"> The absolute value of the instruction input parameter exceeded the range of 40-bit data when it is converted to pulses. 			○			page 3-410
548E0000 hex	Auxiliary and Slave Defined as Same Axis	The same axis was specified for the <i>Auxiliary</i> and <i>Slave</i> input variables to a motion control instruction.	<ul style="list-style-type: none"> The parameter was the same for the <i>Auxiliary</i> and <i>Slave</i> input variables to the instruction. 			○			page 3-410
548F0000 hex	Relative Position Selection Out of Range	The parameter specified for the <i>Relative</i> input variable to a motion control instruction is out of range.	<ul style="list-style-type: none"> Instruction input parameter exceeded the valid range of the input variable. 			○			page 3-411
54900000 hex	Cam Transition Specification Out of Range	The parameter specified for the <i>CamTransition</i> input variable to a motion control instruction is out of range.	<ul style="list-style-type: none"> Instruction input parameter exceeded the valid range of the input variable. 			○			page 3-411

Event code	Event name	Meaning	Assumed cause	Level					Reference
				M a j	P r t	M i n	O b s	I n f o	
54910000 hex	Synchron- ized Control End Mode Selection Out of Range	The parameter speci- fied for the <i>OutMode</i> input variable to a motion control in- struction is out of range.	<ul style="list-style-type: none"> Instruction input parameter ex- ceeded the valid range of the input variable. 			○			page 3-412
54920000 hex	Enable Ex- ternal Latch Instruction Execution Disabled	<i>_mclImmediateStop</i> (<i>Immediate Stop</i>) was specified for the <i>StopMode</i> input vari- able when the MC_TouchProbe (En- able External Latch) instruction was exe- cuted in Drive Mode for an encoder axis.	<ul style="list-style-type: none"> <i>_mclImmediateStop</i> (<i>Immediate Stop</i>) was speci- fied for the <i>StopMode</i> input variable when the MC_TouchProbe (Enable Ex- ternal Latch) instruction was executed in Drive Mode for an encoder axis. 			○			page 3-412
54930000 hex	Master Axis Offset Out of Range	The parameter speci- fied for the <i>MasterOffset</i> input variable to a motion control instruction is out of range.	<ul style="list-style-type: none"> The instruction input paramete- r exceeded the range of signed 40-bit data when it was converted to pulses. 			○			page 3-413
54940000 hex	Slave Axis Offset Out of Range	The parameter speci- fied for the <i>SlaveOffset</i> input vari- able to a motion con- trol instruction is out of range.	<ul style="list-style-type: none"> The instruction input paramete- r exceeded the range of signed 40-bit data when it was converted to pulses. 			○			page 3-413
54950000 hex	Command Current Po- sition Count Selection Out of Range	The parameter speci- fied for the <i>CmdPosMode</i> input variable to a motion control instruction is out of range.	<ul style="list-style-type: none"> Instruction input parameter ex- ceeded the valid range of the input variable. 			○			page 3-414
54960000 hex	Master Axis Gear Ratio Numerator Out of Range	The parameter speci- fied for the <i>RatioNumeratorMast</i> <i>er</i> input variable to a motion control in- struction is out of range.	<ul style="list-style-type: none"> Instruction input parameter ex- ceeded the valid range of the input variable. 			○			page 3-414
54970000 hex	Master Axis Gear Ratio Denominator Out of Range	The parameter speci- fied for the <i>RatioDenominatorMa</i> <i>ster</i> input variable to a motion control in- struction is out of range.	<ul style="list-style-type: none"> Instruction input parameter ex- ceeded the valid range of the input variable. 			○			page 3-415

Event code	Event name	Meaning	Assumed cause	Level					Reference
				M a j	P r t	M i n	O b s	I n f o	
54980000 hex	Auxiliary Axis Gear Ratio Numerator Out of Range	The parameter specified for the <i>RatioNumeratorAuxiliary</i> input variable to a motion control instruction is out of range.	<ul style="list-style-type: none"> Instruction input parameter exceeded the valid range of the input variable. 			○			page 3-415
54990000 hex	Auxiliary Axis Gear Ratio Denominator Out of Range	The parameter specified for the <i>RatioDenominatorAuxiliary</i> input variable to a motion control instruction is out of range.	<ul style="list-style-type: none"> Instruction input parameter exceeded the valid range of the input variable. 			○			page 3-416
549A0000 hex	Master Axis Position Type Selection Out of Range	The parameter specified for the <i>ReferenceTypeMaster</i> input variable to a motion control instruction is out of range.	<ul style="list-style-type: none"> Instruction input parameter exceeded the valid range of the input variable. 			○			page 3-416
549B0000 hex	Auxiliary Axis Position Type Selection Out of Range	The parameter specified for the <i>ReferenceTypeAuxiliary</i> input variable to a motion control instruction is out of range.	<ul style="list-style-type: none"> Instruction input parameter exceeded the valid range of the input variable. 			○			page 3-417
549C0000 hex	Target Position Ring Counter Out of Range	Operation is not possible because the target position is out of range for the ring counter of the executed instruction.	<ul style="list-style-type: none"> High-speed homing was executed when 0 was not included in the ring counter. 			○			page 3-417
549D0000 hex	Axes Group Composition Axis Setting Out of Range	The parameter specified for the <i>Axes</i> input variable to a motion control instruction is out of range.	<ul style="list-style-type: none"> Instruction input parameter exceeded the valid range of the input variable. The composition axes in the axes group are not assigned to the same task. 			○			page 3-418
549E0000 hex	Axis Use Setting Out of Range	The parameter specified for the <i>AxisUse</i> input variable to a motion control instruction is out of range.	<ul style="list-style-type: none"> Instruction input parameter exceeded the valid range of the input variable. 			○			page 3-418
57000000 hex	Homing Parameter Setting Out of Range	The parameter specified for the <i>HomingParameter</i> input variable to a motion control instruction is out of range.	<ul style="list-style-type: none"> Instruction input parameter exceeded the valid range of the input variable. 			○			page 3-419

Event code	Event name	Meaning	Assumed cause	Level					Reference
				M a j	P r t	M i n	O b s	I n f o	
57020000 hex	Axis Use Change Error	The MC_ChangeAxisUse (Change Axis Use) instruction was executed when the axis was not stopped or when the command velocity of the axis was saturated.	<ul style="list-style-type: none"> The MC_ChangeAxisUse (Change Axis Use) instruction was executed when the axis was not stopped or when the command velocity of the axis was saturated. 				○		page 3-420
57030000 hex	Cannot Change Axis Use	The MC_ChangeAxisUse (Change Axis Use) instruction was executed in a way that would cause the maximum number of used real axes or the maximum number of used motion control servo axes to be exceeded.	<ul style="list-style-type: none"> The MC_ChangeAxisUse (Change Axis Use) instruction was executed in a way that would cause the maximum number of used real axes to be exceeded. The MC_ChangeAxisUse (Change Axis Use) instruction was executed in a way that would cause the maximum number of used motion control servo axes to be exceeded. 				○		page 3-420
57200000 hex	Motion Control Parameter Setting Error When Changing Axis Use	The motion control parameter settings for the axis that was changed to a used axis are incorrect.	<ul style="list-style-type: none"> The MC_ChangeAxisUse (Change Axis Use) instruction was used to change an unused axis to a used axis, but the motion control parameter settings of the axis are not correct. The power supply was interrupted while a download of the motion control parameter settings was in progress. The non-volatile memory is faulty or the life of the non-volatile memory has been exceeded. 				○		page 3-421

Event code	Event name	Meaning	Assumed cause	Level					Reference
				M a j	P r t	M i n	O b s	I n f o	
57210000 hex	Required Process Data Object Not Set When Changing Axis Use	The objects that are required for the axis type of the axis that was changed to a used axis are not set.	<ul style="list-style-type: none"> The objects that are required for the axis type of the axis that was changed to a used axis are not set in the PDO map settings. The power supply was interrupted while a download of the motion control parameter settings was in progress. The non-volatile memory is faulty or the life of the non-volatile memory has been exceeded. The MC_ChangeAxisUse (Change Axis Use) instruction was executed for an axis that Axis Use is set to Unused axis (unchangeable to used axis). 			○			page 3-422
572F0000 hex	Motion Control Instruction Multi-execution Disabled (Master Axis)	A <i>Master</i> in-out variable that cannot be changed during multi-execution of instructions was changed.	<ul style="list-style-type: none"> A <i>Master</i> in-out variable that cannot be changed during multi-execution of instructions was changed. 			○			page 3-423
57300000 hex	Motion Control Instruction Multi-execution Disabled (Position Type Selection)	A <i>ReferenceType</i> in-out variable that cannot be changed during multi-execution of instructions was changed.	<ul style="list-style-type: none"> A <i>ReferenceType</i> in-out variable that cannot be changed during multi-execution of instructions was changed. 			○			page 3-423
573A0000 hex	Cannot Write Axis Parameters	The instruction was executed for an axis that is not an unused axis.	<ul style="list-style-type: none"> The instruction was executed for a used axis or an undefined axis. 			○			page 3-424
573B0000 hex	Axis Parameter Setting Out of Range	The parameter specified for the <i>AxisParameter</i> input variable to a motion control instruction is outside of the valid range.	<ul style="list-style-type: none"> The parameter specified for the <i>AxisParameter</i> input variable to the instruction is out of range for the input variable. 			○			page 3-425
573C0000 hex	Cam Property Setting Out of Range	The parameter specified for the <i>CamProperty</i> input variable to a motion control instruction is outside of the valid range.	<ul style="list-style-type: none"> The parameter specified for the <i>CamProperty</i> input variable to the instruction is out of range for the input variable. 			○			page 3-427

Event code	Event name	Meaning	Assumed cause	Level					Reference
				M a j	P r t	M i n	O b s	I n f o	
573D0000 hex	Cam Node Setting Out of Range	The parameter specified for the <i>CamNodes</i> input variable to a motion control instruction is outside of the valid range.	<ul style="list-style-type: none"> The parameter specified for the <i>CamNodes</i> input variable to the instruction is out of range for the input variable. 			○			page 3-427
573E0000 hex	Incorrect Cam Node Type Specification	The parameter specified for the <i>CamNodes</i> input variable to a motion control instruction is not an <i>_sMC_CAM_NODE</i> array variable.	<ul style="list-style-type: none"> The parameter specified for the <i>CamNodes</i> input variable to the instruction is not an <i>_sMC_CAM_NODE</i> array variable. 			○			page 3-428
573F0000 hex	Insufficient Nodes in Cam Table	The array variable of the parameter specified for the <i>CamNodes</i> input variable to a motion control instruction has a <i>Phase</i> value of 0 for element number 0.	<ul style="list-style-type: none"> The array variable of the parameter specified for <i>CamNodes</i> input variable to the instruction has a <i>Phase</i> (master axis phase) value of 0 for element number 0. 			○			page 3-428
57400000 hex	Cam Node Master Axis Phase Not in Ascending Order	The values of <i>Phase</i> in the array variable of the parameter specified for the <i>CamNodes</i> input variable to a motion control instruction are not in ascending order according to the element numbers.	<ul style="list-style-type: none"> The values of <i>Phase</i> (master axis phase) in the array variable of the parameter specified for the <i>CamNodes</i> input variable to the instruction are not in ascending order according to the element numbers. Or, truncating the digits that are not effective more than seven digits caused the phases not to be in ascending order. 			○			page 3-429
57410000 hex	Too Many Data Points in Cam Table	The number of generated cam data points exceeded the number of elements in the array in the cam data variable that is specified for the <i>CamTable</i> input variable to a motion control instruction.	<ul style="list-style-type: none"> The number of cam data points in the generated cam table exceeded the number of elements in the array in the cam data variable that is specified for the <i>CamTable</i> input variable to the instruction. 			○			page 3-429
57420000 hex	Cam Table Displacement Overflow	<i>Distance</i> in the generated cam table exceeded the range of REAL data.	<ul style="list-style-type: none"> <i>Distance</i> in the generated cam table exceeded the range of REAL data. 			○			page 3-430

Event code	Event name	Meaning	Assumed cause	Level					Reference
				M a j	P r t	M i n	O b s	I n f o	
57430000 hex	Aborted Cam Table Used	A cam data variable that was aborted during generation was specified for the <i>CamTable</i> input variable to an instruction.	<ul style="list-style-type: none"> A cam data variable that was aborted during generation due to an error in the MC_GenerateCamTable (Generate Cam Table) instruction was specified for the <i>CamTable</i> input variable to the instruction. 			○			page 3-431
57490000 hex	Execution ID Setting Out of Range	The parameter specified for the <i>ExecID</i> input variable to a motion control instruction is out of range.	<ul style="list-style-type: none"> The parameter specified for the <i>ExecID</i> input variable to the instruction is out of range for the input variable. 			○			page 3-431
574A0000 hex	Position Offset Out of Range	The parameter specified for the <i>OffsetPosition</i> input variable to a motion control instruction is out of range.	<ul style="list-style-type: none"> The position offset exceeded the range of signed 40-bit data when it was converted to pulses. 			○			page 3-432
574B0000 hex	PDS State Transition Command Selection Out of Range	The parameter specified for the <i>TransitionCmd</i> input variable to a motion control instruction is out of range.	<ul style="list-style-type: none"> Instruction input parameter exceeded the valid range of the input variable. 			○			page 3-432
57510000 hex (Ver. 1.21 or later)	Cam Monitor Mode Selection Out of Range	The cam monitor mode selection specified for the <i>CamMonitorMode</i> input variable to a motion control instruction is out of range.	<ul style="list-style-type: none"> The cam monitor mode selection is out of the valid range. 			○			page 3-433
57520000 hex (Ver. 1.21 or later)	Data Type of Cam Monitor Values Mismatch	The data type of the cam monitor values specified for the <i>CamMonitorValue</i> input variable to a motion control instruction does not match the cam monitor mode selection.	<ul style="list-style-type: none"> The data type of the variable specified for the cam monitor values does not match the cam monitor mode selection. 			○			page 3-433

Event code	Event name	Meaning	Assumed cause	Level					Reference
				M a j	P r t	M i n	O b s	I n f o	
64400000 hex	Target Position Positive Software Limit Exceeded	The specified position exceeds the positive software limit.	<ul style="list-style-type: none"> The parameter specified for the <i>Position</i> input variable to the instruction is beyond the positive software limit. The starting position is beyond the positive software limit and an instruction that specifies motion in the opposite direction of the software limit was executed. The parameter that was specified for the <i>AuxPoint</i> input variable to a border point MC_MoveCircular2D (Circular 2D Interpolation) instruction is beyond the positive software limit. 			○			page 3-434
64410000 hex	Target Position Negative Software Limit Exceeded	The specified position exceeds the negative software limit.	<ul style="list-style-type: none"> The parameter specified for the <i>Position</i> input variable to the instruction is beyond the negative software limit. The first position is beyond the negative software limit and an instruction that specifies motion in the opposite direction of the software limit was executed. The parameter that was specified for the <i>AuxPoint</i> input variable to a border point MC_MoveCircular2D (Circular 2D Interpolation) instruction is beyond the negative software limit. 			○			page 3-435
64420000 hex	Command Position Overflow/Underflow	Positioning, an instruction in the underflow/overflow direction, or an instruction for which the direction is not specified was executed when there was an underflow/overflow in the command position.	<ul style="list-style-type: none"> One of the following was executed when there was a command position overflow/underflow. A positioning instruction A continuous control instruction in the underflow/overflow direction An instruction for which the direction is not specified (syncing or torque control) 			○			page 3-436

Event code	Event name	Meaning	Assumed cause	Level					Reference
				M a j	P r t	M i n	O b s	I n f o	
64430000 hex	Positive Limit Input	An instruction was executed for a motion in the positive direction when the positive limit input was ON.	<ul style="list-style-type: none"> An instruction for a motion in the positive direction was executed when the positive limit input was ON, or an instruction for a motion with no direction specification was executed when the positive limit input was ON. An axes group motion control instruction was executed when the positive limit input was ON. 			○			page 3-437
64440000 hex	Negative Limit Input	An instruction for a motion in the negative direction was executed when the negative limit input was ON.	<ul style="list-style-type: none"> An instruction for a motion in the negative direction was executed when the negative limit input was ON, or an instruction for a motion with no direction specification was executed when the negative limit input was ON. An axes group motion control instruction was executed when the negative limit input was ON. 			○			page 3-438
74220000 hex	Servo Main Circuits OFF	An attempt was made to turn ON the Servo when the main circuit power supply to the Servo Drive was OFF.	<ul style="list-style-type: none"> An attempt was made to turn ON the Servo when the main circuit power supply to the Servo Drive was OFF. 			○			page 3-438
57220000 hex	Actual Position Overflow/Underflow	An instruction was executed that is not supported during an actual position overflow/underflow.	<ul style="list-style-type: none"> An instruction was executed that is not supported during an actual position overflow or underflow. 				○		page 3-439
57230000 hex	Switch Structure Track Number Setting Out of Range	The value of <i>TrackNumber</i> that is specified in the <i>Switches</i> in-out variable to a motion control instruction is out of range.	<ul style="list-style-type: none"> The value of the member of the structure variable that was specified for the in-out variable of the instruction is out of range. 				○		page 3-439
57240000 hex	Switch Structure First ON Position Setting Out of Range	The value of <i>FirstOnPosition</i> that is specified in the <i>Switches</i> in-out variable to a motion control instruction is out of range.	<ul style="list-style-type: none"> The value of the member of the structure variable that was specified for the in-out variable of the instruction is out of range. 				○		page 3-440

Event code	Event name	Meaning	Assumed cause	Level					Reference
				M a j	P r t	M i n	O b s	I n f o	
57250000 hex	Switch Structure Last ON Position Setting Out of Range	The value of <i>LastOnPosition</i> that is specified in the <i>Switches</i> in-out variable to a motion control instruction is out of range.	<ul style="list-style-type: none"> The value of the member of the structure variable that was specified for the in-out variable of the instruction is out of range. 				○		page 3-440
57260000 hex	Switch Structure Axis Direction Out of Range	The value of <i>AxisDirection</i> that is specified in the <i>Switches</i> in-out variable to a motion control instruction is out of range.	<ul style="list-style-type: none"> The value of the member of the structure variable that was specified for the in-out variable of the instruction is out of range. 				○		page 3-441
57270000 hex	Switch Structure Cam Switch Mode Out of Range	The value of <i>CamSwitchMode</i> that is specified in the <i>Switches</i> in-out variable to a motion control instruction is out of range.	<ul style="list-style-type: none"> The value of the member of the structure variable that was specified for the in-out variable of the instruction is out of range. 				○		page 3-441
57280000 hex	Switch Structure Duration Setting Out of Range	The value of <i>Duration</i> that is specified in the <i>Switches</i> in-out variable to a motion control instruction is out of range.	<ul style="list-style-type: none"> The value of the member of the structure variable that was specified for the in-out variable of the instruction is out of range. 				○		page 3-442
57290000 hex	Track Option Structure ON Compensation Setting Out of Range	The value of <i>OnCompensation</i> that is specified in the <i>TrackOptions</i> in-out variable to a motion control instruction is out of range.	<ul style="list-style-type: none"> The value of the member of the structure variable that was specified for the in-out variable of the instruction is out of range. 				○		page 3-442
572A0000 hex	Track Option Structure OFF Compensation Setting Out of Range	The value of <i>OffCompensation</i> that is specified in the <i>TrackOptions</i> in-out variable to a motion control instruction is out of range.	<ul style="list-style-type: none"> The value of the member of the structure variable that was specified for the in-out variable of the instruction is out of range. 				○		page 3-443
572B0000 hex	Number of Array Elements in Switch Structure Variable Out of Range	The number of elements in an array in the structure variable that is specified in the <i>Switches</i> in-out variable to a motion control instruction is out of range.	<ul style="list-style-type: none"> The number of elements in an array of the structure variable that was specified for the in-out variable of the instruction is out of range. 				○		page 3-443

Event code	Event name	Meaning	Assumed cause	Level					Reference
				M a j	P r t	M i n	O b s	I n f o	
572C0000 hex	Number of Array Elements in Output Signal Structure Variable Out of Range	The number of elements in an array in the structure variable that is specified in the <i>Outputs</i> in-out variable to a motion control instruction is out of range.	<ul style="list-style-type: none"> The number of elements in an array of the structure variable that was specified for the in-out variable of the instruction is out of range. 				○		page 3-444
572D0000 hex	Number of Array Elements in Track Option Structure Variable Out of Range	The number of elements in an array in the structure variable that is specified in the <i>TrackOptions</i> in-out variable to a motion control instruction is out of range.	<ul style="list-style-type: none"> The number of elements in an array of the structure variable that was specified for the in-out variable of the instruction is out of range. 				○		page 3-444
572E0000 hex	Numbers of Elements in Output Signals and Track Option Arrays Not Matched	The arrays in the structure variables that are specified for the <i>Outputs</i> and <i>TrackOptions</i> in-out variables to a motion control instruction do not have the same number of elements.	<ul style="list-style-type: none"> The arrays in the output signal structure variable and track option structure variable that are specified for the in-out variables to the instruction do not have the same number of elements. 				○		page 3-445
57310000 hex	Same Track Number Setting in Switch Structure Out of Range	The same track number was specified more than the allowable number of times for the <i>TrackNumber</i> in the <i>Switches</i> in-out variable to a motion control instruction.	<ul style="list-style-type: none"> The same track number was specified more than the allowable number of times for the <i>TrackNumber</i> in the <i>Switches</i> in-out variable to a motion control instruction. 				○		page 3-445

3-3-2 Error Descriptions

General Motion Control



Version Information

For an NX-series CPU Unit, a variable name that starts with `_MC_AX[*]` may start with `_MC1_AX[*]` or `_MC2_AX[*]` instead. Similarly, a variable name that starts with `_MC_GRP[*]` may start with `_MC1_GRP[*]` or `_MC2_GRP[*]` instead.

Event name	Motion Control Function Processing Error		Event code	44210000 hex	
Meaning	A fatal error was detected in the Motion Control Function Module.				
Source	PLC Function Module		Source details	MC Common	Detection timing
					Continuously
Error attributes	Level	Major fault	Recovery	Cycle the power supply.	Log category
					System
Effects	User program	Stops.	Operation	It will not be possible to perform axis control. The Controller will stop.	
System-defined variables	Variable		Data type		Name
	None		---		---
Cause and correction	Assumed cause		Correction		Prevention
	An error occurred in the software.		Contact your OMRON representative.		None
Attached information	Attached information 1: System information Attached information 2: System information Attached information 3: System information Attached information 4: System information				
Precautions/Remarks	None				

Event name	Absolute Encoder Home Offset Read Error		Event code	14600000 hex		
Meaning	The absolute encoder current position that is retained during power interruptions was lost.					
Source	Motion Control Function Module		Source details	MC Common	Detection timing	At power ON, at Controller reset, or when downloading
Error attributes	Level	Partial fault	Recovery	Error reset	Log category	System
Effects	User program	Continues.	Operation	It will not be possible to perform axis control.		
System-defined variables	Variable		Data type		Name	
	_MC_COM.PFaultLvl.Active		BOOL		MC Common Partial Fault Occurrence	
Cause and correction	Assumed cause		Correction		Prevention	
	When the retained variables are backed up with a battery, this event indicates that the life of the battery in the CPU Unit has expired.		Replace the Battery in the CPU Unit, reset the error, and perform homing to define home.		When the retained variables are backed up with a battery, periodically replace the battery in the CPU Unit. For the Battery life, refer to the <i>NX-series CPU Unit Hardware User's Manual (Cat. No. W535)</i> or the <i>NJ-series CPU Unit Hardware User's Manual (Cat. No. W500)</i> .	
	An error occurred in the software. Backup memory failure		If this error persists, replace the CPU Unit, reset the error, and perform homing to define home.		None	
Attached information	None					
Precautions/Remarks	None					

Event name	Motion Control Parameter Setting Error		Event code	14610000 hex	
Meaning	The MC parameters that were saved in non-volatile memory are missing.				
Source	Motion Control Function Module		Source details	MC Common	Detection timing At power ON, at Controller reset, or when downloading
Error attributes	Level	Partial fault	Recovery	Cycle the power supply or reset the Controller.	Log category System
Effects	User program	Continues.	Operation	It will not be possible to perform axis control.	
System-defined variables	Variable		Data type		Name
	_MC_COM.PFaultLvl.Active		BOOL		MC Common Partial Fault Occurrence
Cause and correction	Assumed cause		Correction		Prevention
	The power supply to the Controller was interrupted or communications with the Sysmac Studio were disconnected while downloading the motion control parameter settings or clearing memory.		Download the MC parameters from the Sysmac Studio.		Do not turn OFF the power supply during save processing for the parameters.
	Non-volatile memory failure		If the error occurs even after the above correction is performed, non-volatile memory has failed. After you replace the CPU Unit, download all settings including the Axis Settings from the Sysmac Studio.		None
Attached information	None				
Precautions/Remarks	None				

Event name	Cam Data Read Error		Event code	14620000 hex	
Meaning	The cam data that was saved in non-volatile memory is missing.				
Source	Motion Control Function Module		Source details	MC Common	Detection timing At power ON, at Controller reset, or when downloading
Error attributes	Level	Partial fault	Recovery	Cycle the power supply or reset the Controller.	Log category System
Effects	User program	Continues.	Operation	It will not be possible to perform axis control.	
System-defined variables	Variable		Data type		Name
	_MC_COM.PFaultLvl.Active		BOOL		MC Common Partial Fault Occurrence
Cause and correction	Assumed cause		Correction		Prevention
	Power was interrupted during save processing for cam data		Download the cam data from the Sysmac Studio.		Do not turn OFF the power supply during save processing for the cam data.
	Non-volatile memory failure		If the error occurs even after the above correction is performed, non-volatile memory has failed. After you replace the CPU Unit, download all settings including the Axis Settings from the Sysmac Studio.		None
Attached information	None				
Precautions/Remarks	None				

Event name	Required Process Data Object Not Set		Event code	34600000 hex	
Meaning	The object that is required for the axis type is not allocated to PDO.				
Source	Motion Control Function Module		Source details	MC Common	Detection timing At power ON, at Controller reset, or when downloading
Error attributes	Level	Partial fault	Recovery	Cycle the power supply or reset the Controller.	Log category System
Effects	User program	Continues.	Operation	It will not be possible to perform axis control.	
System-defined variables	Variable		Data type		Name
	_MC_COM.PFaultLvl.Active		BOOL		MC Common Partial Fault Occurrence
Cause and correction	Assumed cause		Correction		Prevention
	The required PDOs are not mapped when the axis type is set to a servo axis or encoder axis.		Map the PDOs that are required for the relevant axis type. Refer to the description of the relevant Servo Drive Settings in the appendices of the motion control user's manual.		Map the PDOs that are required for the axis types that are used. Refer to the description of the relevant Servo Drive Settings in the appendices of the motion control user's manual.
	Non-volatile memory failure		If the error occurs even after the above correction is performed, non-volatile memory has failed. After you replace the CPU Unit, download all settings including the Axis Parameter Settings from the Sysmac Studio.		None
Attached information	None				
Precautions/Remarks	None				

Event name	Axis Slave Disabled		Event code	34630000 hex	
Meaning	The slave to which the axis is assigned is disabled.				
Source	Motion Control Function Module		Source details	MC Common	Detection timing At power ON, at Controller reset, or when downloading
Error attributes	Level	Partial fault	Recovery	Cycle the power supply or reset the Controller.	Log category System
Effects	User program	Continues.	Operation	It will not be possible to perform axis control.	
System-defined variables	Variable		Data type		Name
	_MC_COM.PFaultLvl.Active		BOOL		MC Common Partial Fault Occurrence
Cause and correction	Assumed cause		Correction		Prevention
	The slave to which the axis is assigned is disabled.		Enable the slave to which the axis is assigned in the EtherCAT settings. If there is no slave, set the axis type to a virtual axis .		Enable the slaves to which axes are assigned in the EtherCAT settings. If there are no slaves, set the axis type to a virtual axis when using an axis in the program.
Attached information	None				
Precautions/Remarks	None				

Event name	Network Configuration Information Missing for Axis Slave		Event code	34640000 hex	
Meaning	The network configuration information is not registered for the slave to which the axis is assigned.				
Source	Motion Control Function Module		Source details	MC Common	Detection timing At power ON, at Controller reset, when downloading, when starting Servo ON status, or when changing an unused axis to a used axis
Error attributes	Level	Partial fault	Recovery	Cycle the power supply or reset the Controller.	Log category System
Effects	User program	Continues.	Operation	It will not be possible to perform axis control.	
System-defined variables	Variable		Data type		Name
	_MC_COM.PFaultLvl.Active		BOOL		MC Common Partial Fault Occurrence
Cause and correction	Assumed cause		Correction		Prevention
	The EtherCAT network configuration information is not registered for the slave to which the axis is assigned.		Register the EtherCAT network configuration information for the slave to which the axis is assigned. Or, set the axis type to a virtual axis .		Register the network configuration information for the slaves to which axes are assigned.
Attached information	None				
Precautions/Remarks	None				

Event name	Motion Control Initialization Error		Event code	44200000 hex	
Meaning	A fatal error occurred in the system and prevented initialization of the Motion Control Function Module.				
Source	Motion Control Function Module		Source details	MC Common	Detection timing
					At power ON, at Controller reset, or when downloading
Error attributes	Level	Partial fault	Recovery	Cycle the power supply.	Log category
					System
Effects	User program	Continues.	Operation	It will not be possible to perform axis control. It will not be possible to execute motion control instructions.	
System-defined variables	Variable		Data type		Name
	_MC_COM.PFaultLvl.Active		BOOL		MC Common Partial Fault Occurrence
Cause and correction	Assumed cause		Correction		Prevention
	Hardware has failed.		Replace the CPU Unit.		None
Attached information	Attached information 1: System information				
Precautions/Remarks	None				

Event name	Motion Control Period Exceeded		Event code	74200000 hex	
Meaning	Processing for the primary periodic task was not finished within two control periods.				
Source	Motion Control Function Module		Source details	MC Common	Detection timing
					Continuously
Error attributes	Level	Partial fault	Recovery	Error reset	Log category
					System
Effects	User program	Continues.	Operation	Operation is not possible for all axes. Axes in motion stop immediately.	
System-defined variables	Variable		Data type		Name
	_MC_COM.PFaultLvl.Active		BOOL		MC Common Partial Fault Occurrence
Cause and correction	Assumed cause		Correction		Prevention
	The processing load in the primary periodic task is too heavy.		Reduce the amount of processing in the primary periodic task or set the control period to a value that is long enough not to cause operation problems. Check the task period in the Task Period Monitor of the Sysmac Studio.		Write the programs for the primary periodic task so that they perform only the processes required in the specified period. Or, set the period of the primary periodic task to be long enough to complete all required processing.
Attached information	None				
Precautions/Remarks	None				

Event name	Cam Table Save Error		Event code	14630000 hex		
Meaning	Saving a cam table to a file failed.					
Source	Motion Control Function Module		Source details	MC Common	Detection timing	During instruction execution
Error attributes	Level	Minor fault	Recovery	Error reset or cycling power supply	Log category	System
Effects	User program	Continues.	Operation	This error may occur when you read a cam table because the cam data in non-volatile memory may be corrupted.		
System-defined variables	Variable		Data type		Name	
	_MC_COM.MFaultLvl.Active		BOOL		MC Common Minor Fault Occurrence	
Cause and correction	Assumed cause		Correction		Prevention	
	Saving a cam table to a file failed.		Save the file again. If the problem still occurs, non-volatile memory has failed. Replace the CPU Unit.		None	
Attached information	None					
Precautions/Remarks	None					

Event name	Cam Table Data Error during Cam Motion		Event code	54770000 hex		
Meaning	The phases are not in ascending order in the cam table.					
Source	Motion Control Function Module		Source details	Axis	Detection timing	During instruction execution
Error attributes	Level	Minor fault	Recovery	Error reset	Log category	System
Effects	User program	Continues.	Operation	Operation is not possible for relevant axis. Relevant axis decelerates to a stop if it is in motion.		
System-defined variables	Variable		Data type		Name	
	_MC_AX[*].MFaultLvl.Active		BOOL		Axis Minor Fault Occurrence	
Cause and correction	Assumed cause		Correction		Prevention	
	Data containing cam table phases that are not in ascending order was detected during cam motion.		Correct the cam table data so that the phases are in ascending order.		Place the phase data into ascending order in the cam table data.	
	The phase and displacement of the start point in the cam table were not 0 during cam operation.		Correct the cam table data so that the phase and displacement of the start point are 0.		Set the cam table data so that the phase and displacement of the start point are 0.	
	The phase of the end point in the cam table when converted to pulses was not 1 pulse or greater during cam operation.		Correct the cam table data so that the phase of the end point is 1 pulse or greater when it is converted to pulses.		Set the cam table data so that the phase of the end point is 1 pulse or greater when it is converted to pulses.	
Attached information	None					
Precautions/Remarks	None					

Event name	Immediate Stop Instruction Executed		Event code	54850000 hex		
Meaning	An Immediate Stop (MC_ImmediateStop) instruction was executed.					
Source	Motion Control Function Module		Source details	Axis	Detection timing	At instruction execution
Error attributes	Level	Minor fault	Recovery	Error reset	Log category	System
Effects	User program	Continues.	Operation	An immediate stop is performed according to the Stop Mode that is set in the <i>StopMode</i> input variable to the MC_ImmediateStop instruction. If the axis is part of an axes group in motion, all other axes will act according to the Axes Group Stop Mode Selection .		
System-defined variables	Variable		Data type		Name	
	_MC_AX[*].MFAultLvl.Active		BOOL		Axis Minor Fault Occurrence	
Cause and correction	Assumed cause		Correction		Prevention	
	An Immediate Stop instruction was executed.		---		---	
Attached information	None					
Precautions/Remarks	None					

Event name	Axes Group Immediate Stop Instruction Executed		Event code	54860000 hex		
Meaning	An Axes Group Immediate Stop (MC_GroupImmediateStop) instruction was executed.					
Source	Motion Control Function Module		Source details	Axes group	Detection timing	At instruction execution
Error attributes	Level	Minor fault	Recovery	Error reset	Log category	System
Effects	User program	Continues.	Operation	An immediate stop is performed for all axes in the axes group according to the Immediate Stop Input Stop Method axis parameter.		
System-defined variables	Variable		Data type		Name	
	_MC_GRP[*].MFAultLvl.Active		BOOL		Axes Group Minor Fault Occurrence	
Cause and correction	Assumed cause		Correction		Prevention	
	A Group Immediate Stop instruction was executed.		---		---	
Attached information	None					
Precautions/Remarks	None					

Event name	Positive Software Limit Exceeded		Event code	64450000 hex	
Meaning	The position exceeded the positive software limit while the axis is in motion.				
Source	Motion Control Function Module		Source details	Axis	Detection timing During instruction execution
Error attributes	Level	Minor fault	Recovery	Error reset	Log category System
Effects	User program	Continues.	Operation	Follows the setting of the Software Limit Function Selection .	
System-defined variables	Variable		Data type		Name
	_MC_AX[*].MFaultLvl.Active		BOOL		Axis Minor Fault Occurrence
Cause and correction	Assumed cause		Correction		Prevention
	The position exceeded the positive software limit.		Find the reason that the software limit was exceeded and make suitable corrections.		(The goal is to enable detecting the software limits when they are exceeded due to unanticipated causes. Preventative measures are not required.)
Attached information	None				
Precautions/Remarks	Whenever you change the positive software limit setting, make sure that the new setting is safe.				

Event name	Negative Software Limit Exceeded		Event code	64460000 hex	
Meaning	The position exceeded the negative software limit while the axis is in motion.				
Source	Motion Control Function Module		Source details	Axis	Detection timing During instruction execution
Error attributes	Level	Minor fault	Recovery	Error reset	Log category System
Effects	User program	Continues.	Operation	Follows the setting of the Software Limit Function Selection .	
System-defined variables	Variable		Data type		Name
	_MC_AX[*].MFaultLvl.Active		BOOL		Axis Minor Fault Occurrence
Cause and correction	Assumed cause		Correction		Prevention
	The position exceeded the negative software limit.		Find the reason that the software limit was exceeded and make suitable corrections.		(The goal is to enable detecting the software limits when they are exceeded due to unanticipated causes. Preventative measures are not required.)
Attached information	None				
Precautions/Remarks	Whenever you change the negative software limit setting, make sure that the new setting is safe.				

Event name	In-position Check Time Exceeded		Event code	64470000 hex	
Meaning	The in-position check was not completed within the monitoring time.				
Source	Motion Control Function Module		Source details	Axis	Detection timing During instruction execution
Error attributes	Level	Minor fault	Recovery	Error reset	Log category System
Effects	User program	Continues.	Operation	Operation is not possible for relevant axis. Relevant axis decelerates to a stop if it is in motion.	
System-defined variables	Variable		Data type		Name
	_MC_AX[*].MFAultLvl.Active		BOOL		Axis Minor Fault Occurrence
Cause and correction	Assumed cause		Correction		Prevention
	Time is required to complete positioning.		Determine the cause of the slow positioning and remove the cause of the error. Or, adjust the Servo Drive or adjust the In-position Check Time or In-position Range. Increase the loop gain if you adjust the Servo Drive. However, make sure that you keep the loop gain low enough so that the control does not oscillate.		Remove the cause of poor following performance or oscillation/vibration in the positioning operation as much as possible.
Attached information	None				
Precautions/Remarks	None				

Event name	Following Error Limit Exceeded		Event code	64480000 hex	
Meaning	The error between the command current position and actual current value exceeded the Following Error Over Value.				
Source	Motion Control Function Module		Source details	Axis	Detection timing During instruction execution
Error attributes	Level	Minor fault	Recovery	Error reset	Log category System
Effects	User program	Continues.	Operation	Operation is not possible for relevant axis. Relevant axis decelerates to a stop if it is in motion.	
System-defined variables	Variable		Data type		Name
	_MC_AX[*].MFAultLvl.Active		BOOL		Axis Minor Fault Occurrence
Cause and correction	Assumed cause		Correction		Prevention
	The positioning operation has poor following performance and the actual motion is slower than the command.		Remove the cause of poor following performance in the positioning operation. Or increase the Following Error Over Value within the range that will not create problems.		Remove the cause of poor following performance in the positioning operation as best you can.
Attached information	None				
Precautions/Remarks	None				

Event name	Immediate Stop Input		Event code	64490000 hex	
Meaning	The immediate stop input turned ON.				
Source	Motion Control Function Module		Source details	Axis	Detection timing Continuously
Error attributes	Level	Minor fault	Recovery	Error reset	Log category System
Effects	User program	Continues.	Operation	According to the Immediate Stop Input Stop Method .	
System-defined variables	Variable		Data type		Name
	_MC_AX[*].MFAultLvl.Active		BOOL		Axis Minor Fault Occurrence
Cause and correction	Assumed cause		Correction		Prevention
	An immediate stop input signal was detected.		Turn OFF the immediate stop input signal.		(The goal is to detect the immediate stop input. Preventative measures are not required.)
	The immediate stop input signal is not connected correctly or the logic setting for the immediate stop input is wrong.		If the error occurs even when the immediate stop input signal is OFF, correct the immediate stop signal connection and logic setting for the immediate stop input. Check the logic settings both in the axis parameters and in the slave settings.		Make sure that the immediate stop signal connection and logic setting for the immediate stop input are correct. Check the logic settings both in the axis parameters and in the slave settings.
Attached information	None				
Precautions/Remarks	You must turn OFF the immediate stop input signal before you reset the error.				

Event name	Positive Limit Input Detected		Event code	644A0000 hex	
Meaning	The positive limit input turned ON.				
Source	Motion Control Function Module		Source details	Axis	Detection timing Continuously
Error attributes	Level	Minor fault	Recovery	Error reset	Log category System
Effects	User program	Continues.	Operation	According to the Limit Input Stop Method .	
System-defined variables	Variable		Data type		Name
	_MC_AX[*].MFAultLvl.Active		BOOL		Axis Minor Fault Occurrence
Cause and correction	Assumed cause		Correction		Prevention
	A positive limit input signal was detected.		Reset the error and move the axis back in the negative direction before it exceeds the limit in the positive direction. If the error occurred during an axes group motion instruction, disable the axes group and then perform the above operation. Find the reason the limit was exceeded and make suitable corrections.		The goal is to detect the positive limit input. Preventative measures are not required. However, be sure not to exceed the positive limit input when making programs.
	The positive limit input signal is not connected correctly or the logic setting for the positive limit input is wrong.		If a positive limit input signal does not occur, correct the connection of the positive limit signal and the logic setting for the positive limit input. Check the logic settings both in the axis parameters and in the slave settings.		Make sure that the positive limit signal connection and logic setting for the positive limit input are correct. Check the logic settings both in the axis parameters and in the slave settings.
Attached information	None				
Precautions/Remarks	None				

Event name	Negative Limit Input Detected		Event code	644B0000 hex	
Meaning	The negative limit input turned ON.				
Source	Motion Control Function Module		Source details	Axis	Detection timing Continuously
Error attributes	Level	Minor fault	Recovery	Error reset	Log category System
Effects	User program	Continues.	Operation	According to the Limit Input Stop Method .	
System-defined variables	Variable		Data type		Name
	_MC_AX[*].MFaultLvl.Active		BOOL		Axis Minor Fault Occurrence
Cause and correction	Assumed cause		Correction		Prevention
	A negative limit input signal was detected.		Reset the error and move the axis back in the positive direction before it exceeds the limit in the negative direction. If the error occurred during an axes group motion control instruction, disable the axes group and then perform the above operation. Find the reason the limit was exceeded and make suitable corrections.		The goal is to detect the negative limit input. Preventative measures are not required. However, be sure not to exceed the negative limit input when making programs.
	The negative limit input signal is not connected correctly or the logic setting for the negative limit input is wrong.		If a negative limit input signal does not occur, correct the connection of the negative limit signal and the logic setting for the negative limit input. Check the logic settings both in the axis parameters and in the slave settings.		Make sure that the negative limit signal connection and logic setting for the negative limit input are correct. Check the logic settings both in the axis parameters and in the slave settings.
Attached information	None				
Precautions/Remarks	None				

Event name	Illegal Following Error		Event code	64560000 hex	
Meaning	The difference between the command position and the actual current position exceeds the range of 30-bit data when converted to pulses.				
Source	Motion Control Function Module		Source details	Axis	Detection timing Continuously
Error attributes	Level	Minor fault	Recovery	Error reset	Log category System
Effects	User program	Continues.	Operation	The Servo for the axis turns OFF.	
System-defined variables	Variable		Data type		Name
	_MC_AX[*].MFAultLvl.Active		BOOL		Axis Minor Fault Occurrence
Cause and correction	Assumed cause		Correction		Prevention
	The command current position was restricted so that the axis velocity would not exceed the axis maximum velocity for the specified travel distance.		Correct the program or correct the electronic gear ratio so that the axis does not exceed the maximum velocity.		Write the program or set the electronic gear ratio so that the axis does not exceed the maximum velocity.
	Performance of positioning operation is poor and the actual motion is slower than the command.		Remove the cause of poor following performance in the positioning operation.		Remove the cause of poor following performance in the positioning operation as best you can.
Attached information	None				
Precautions/Remarks	None				

Event name	Servo OFF Error		Event code	64570000 hex	
Meaning	The Servo was turned OFF for an axis due to an axes group error.				
Source	Motion Control Function Module		Source details	Axis	Detection timing Continuously
Error attributes	Level	Minor fault	Recovery	Error reset	Log category System
Effects	User program	Continues.	Operation	The Servo for the axis turns OFF.	
System-defined variables	Variable		Data type		Name
	_MC_AX[*].MFAultLvl.Active		BOOL		Axis Minor Fault Occurrence
Cause and correction	Assumed cause		Correction		Prevention
	The Servo was turned OFF for an axis due to an axes group error.		Find the cause of the error and take suitable measures.		None
Attached information	None				
Precautions/Remarks	This error occurs for axes for which the Servos are turned OFF for an axes group error to interlock the axes so that the Servos cannot be turned ON with the MC_Power (Power Servo) instruction. This error occurs only when an immediate stop of the command value and turning OFF Servo at same time (free-run stop) is specified for the Axes Group Stop Method Selection .				

Event name	Absolute Encoder Current Position Calculation Failed		Event code	64580000 hex		
Meaning	It was not possible to correctly restore the current position from the absolute encoder information that was saved when power was interrupted.					
Source	Motion Control Function Module		Source details	Axis	Detection timing	At power ON, at Controller reset, when downloading, when starting Servo ON status, or when changing an unused axis to a used axis
Error attributes	Level	Minor fault	Recovery	Error reset	Log category	System
Effects	User program	Continues.	Operation	Operation is not possible for relevant axis.		
System-defined variables	Variable		Data type		Name	
	_MC_AX[*].MFAultLvl.Active		BOOL		Axis Minor Fault Occurrence	
Cause and correction	Assumed cause		Correction		Prevention	
	<ul style="list-style-type: none"> The unit conversion settings, the ring counter setting in the Controller, or the ring counter setting in the Servo Drive settings was changed. The position to restore when converted to pulses exceeded the range of signed 40-bit data. 		Reset the error and perform homing. Perform homing near the position where the absolute encoder is set up so that the position to restore does not exceed the range of signed 40-bit data.		Perform homing again if you changed any parameters related to position, such as the modulo maximum position setting value. Perform homing near the position where the absolute encoder is set up so that the position to restore does not exceed the range of signed 40-bit data. Also, do not execute the MC_Power (Power Servo) instruction, change an unused axis to a used axis, or cycle the power supply when the encoder position exceeds the range of signed 40-bit data.	
Attached information	None					
Precautions/Remarks	None					

Event name	Home Undefined during Coordinated Motion		Event code	64590000 hex	
Meaning	Home of the logical axis became undefined during axes group motion or while decelerating to a stop.				
Source	Motion Control Function Module		Source details	Axes group	Detection timing During instruction execution
Error attributes	Level	Minor fault	Recovery	Error reset	Log category System
Effects	User program	Continues.	Operation	The axes group decelerates to a stop.	
System-defined variables	Variable		Data type		Name
	_MC_GRP[*].MFaultLvl.Active		BOOL		Axes Group Minor Fault Occurrence
Cause and correction	Assumed cause		Correction		Prevention
	The command position or actual position overflowed or underflowed for a logical axis in an axes group motion or a logical axis that was decelerating to a stop and the home definition was lost.		Correct the program so that the axis operates within ranges that do not cause overflows or underflows in the command position or actual position.		Write the program so that the axis operates within ranges that do not cause overflows or underflows in the command position or actual position.
	A slave communications error occurred for a logical axis and home became undefined during axes group motion or while decelerating to a stop.		Correct the slave communications error and define home.		None
	A slave for a logical axis left the network or was disabled and home became undefined during axes group motion or while decelerating to a stop.		Connect the disconnected or disabled slave to the network again and define home.		Do not disconnect or disable the slave of a logical axis during axes group motion or while decelerating to a stop.
Attached information	None				
Precautions/Remarks	None				

Event name	Servo Main Circuit Power OFF		Event code	74210000 hex	
Meaning	The main circuit power of the Servo Drive turned OFF while the Servo was ON.				
Source	Motion Control Function Module		Source details	Axis	Detection timing Whenever Servo is ON
Error attributes	Level	Minor fault	Recovery	Error reset	Log category System
Effects	User program	Continues.	Operation	The Servo for the axis turns OFF.	
System-defined variables	Variable		Data type		Name
	_MC_AX[*].MFaultLvl.Active		BOOL		Axis Minor Fault Occurrence
Cause and correction	Assumed cause		Correction		Prevention
	The main circuit power of the Servo Drive was interrupted while the Servo was ON.		Turn ON the main circuit power of the Servo Drive for the axis where the error occurred, reset the error, and then turn ON the Servo.		Turn OFF the Servo, then turn OFF the main circuit power of the Servo Drive.
Attached information	None				
Precautions/Remarks	None				

Event name	Interrupt Feeding Interrupt Signal Missing		Event code	74230000 hex	
Meaning	An interrupt input was not received during execution of an MC_MoveFeed (Interrupt Feeding) instruction.				
Source	Motion Control Function Module		Source details	Axis	Detection timing During instruction execution
Error attributes	Level	Minor fault	Recovery	Error reset	Log category System
Effects	User program	Continues.	Operation	The axis decelerates to a stop.	
System-defined variables	Variable		Data type		Name
	_MC_AX[*].MFAultLvl.Active		BOOL		Axis Minor Fault Occurrence
Cause and correction	Assumed cause		Correction		Prevention
	The latch enabled range specification is invalid.		If an invalid latch enabled range is specified to the instruction, correct it.		Specify a correct latch enabled range based on the relationship between the motion and sensor position.
	There is a problem with the wiring of the interrupt signal.		Correct any problems with the wiring for the interrupt signal for the instruction.		Make sure that the wiring of the interrupt signal is correct.
	The sensor that outputs the interrupt signal has failed.		If neither of the two causes listed above are applicable, the sensor that outputs the interrupt signal has failed. Replace the sensor that outputs the interrupt signal for the instruction where this error occurred.		None
Attached information	None				
Precautions/Remarks	None				

Event name	Homing Opposite Direction Limit Input Detected		Event code	74240000 hex	
Meaning	The limit signal in the direction opposite to the homing direction was detected during a homing operation.				
Source	Motion Control Function Module		Source details	Axis	Detection timing During instruction execution
Error attributes	Level	Minor fault	Recovery	Error reset	Log category System
Effects	User program	Continues.	Operation	The axis stops with the stop method for the homing execution status.	
System-defined variables	Variable		Data type		Name
	_MC_AX[*].MFAultLvl.Active		BOOL		Axis Minor Fault Occurrence
Cause and correction	Assumed cause		Correction		Prevention
	The Operation Selection at Negative Limit Input or Operation Selection at Positive Limit Input parameter is set to No reverse turn.		To prevent errors at the limit inputs, set the Operation Selection at Negative Limit Input and Operation Selection at Positive Limit Input parameters to Reverse turn.		Check to see if any of the conditions that are given as causes exist in advance.
	The location of the homing input signal sensors, homing settings, and homing start position cause a limit input to be reached.		Correct the location of the input signal sensors, homing settings, and homing start position so that a limit input is not reached.		
	The input signal sensor wiring is incorrect or the sensor is faulty.		Correct the wiring of the input signal sensor or replace the sensor.		
Attached information	None				
Precautions/Remarks	None				

Event name	Homing Direction Limit Input Detected		Event code	74250000 hex		
Meaning	The limit signal in the homing direction was detected during a homing operation.					
Source	Motion Control Function Module		Source details	Axis	Detection timing	During instruction execution
Error attributes	Level	Minor fault	Recovery	Error reset	Log category	System
Effects	User program	Continues.	Operation	The axis stops with the stop method for the homing execution status.		
System-defined variables	Variable		Data type		Name	
	_MC_AX[*].MFAultLvl.Active		BOOL		Axis Minor Fault Occurrence	
Cause and correction	Assumed cause		Correction		Prevention	
	The Operation Selection at Negative Limit Input or Operation Selection at Positive Limit Input parameter is set to No reverse turn.		To prevent errors at the limit inputs, set the Operation Selection at Negative Limit Input and Operation Selection at Positive Limit Input parameters to Reverse turn.		Check to see if any of the conditions that are given as causes exist in advance.	
	The location of the homing input signal sensors, homing settings, and homing start position cause a limit input to be reached.		Correct the location of the input signal sensors, homing settings, and homing start position so that a limit input is not reached.			
	The input signal sensor wiring is incorrect or the sensor is faulty.		Correct the wiring of the input signal sensor or replace the sensor.			
Attached information	None					
Precautions/Remarks	None					

Event name	Homing Limit Inputs Detected in Both Directions		Event code	74260000 hex		
Meaning	The limit signals in both directions were detected during a homing operation.					
Source	Motion Control Function Module		Source details	Axis	Detection timing	During instruction execution
Error attributes	Level	Minor fault	Recovery	Error reset	Log category	System
Effects	User program	Continues.	Operation	The axis stops with the stop method for the homing execution status.		
System-defined variables	Variable		Data type		Name	
	_MC_AX[*].MFAultLvl.Active		BOOL		Axis Minor Fault Occurrence	
Cause and correction	Assumed cause		Correction		Prevention	
	The wiring of the limit signal is incorrect.		Correct the wiring of the limit signal.		Check to see if any of the conditions that are given as causes exist in advance.	
	The limit sensor is installed in the wrong location.		Correct the installation locations of the limit sensors so that they do not turn ON at the same time.			
	The contact logic of the limit signal is not correct.		Correct the contact logic (N.C./N.O.) of the limit signal.			
The limit sensor failed.		Replace the limit sensor.				
Attached information	None					
Precautions/Remarks	None					

Event name	Home Proximity/Homing Opposite Direction Limit Input Detected		Event code	74270000 hex		
Meaning	The home proximity input and the limit signal in the direction opposite to the homing direction were detected at the same time during a homing operation.					
Source	Motion Control Function Module		Source details	Axis	Detection timing	During instruction execution
Error attributes	Level	Minor fault	Recovery	Error reset	Log category	System
Effects	User program	Continues.	Operation	The axis stops with the stop method for the homing execution status.		
System-defined variables	Variable		Data type		Name	
	_MC_AX[*].MFAultLvl.Active		BOOL		Axis Minor Fault Occurrence	
Cause and correction	Assumed cause		Correction		Prevention Check to see if any of the conditions that are given as causes exist in advance.	
	The wiring of the home proximity signal or limit signal is incorrect.		Correct the wiring of the home proximity signal or limit signal.			
	The home proximity sensor or limit sensor is installed in the wrong location.		Correct the installation location of the home proximity sensor or limit sensor so that they do not turn ON at the same time.			
	The contact logic of the home proximity signal or limit signal is not correct.		Correct the contact logic (N.C./N.O.) of the home proximity sensor or limit sensor.			
	The home proximity sensor or limit sensor failed.		Replace the home proximity sensor or limit sensor.			
Attached information	None					
Precautions/Remarks	None					

Event name	Home Proximity/Homing Direction Limit Input Detected		Event code	74280000 hex		
Meaning	The home proximity input and the limit signal in the homing direction were detected at the same time during a homing operation.					
Source	Motion Control Function Module		Source details	Axis	Detection timing	During instruction execution
Error attributes	Level	Minor fault	Recovery	Error reset	Log category	System
Effects	User program	Continues.	Operation	The axis stops with the stop method for the homing execution status.		
System-defined variables	Variable		Data type		Name	
	_MC_AX[*].MFAultLvl.Active		BOOL		Axis Minor Fault Occurrence	
Cause and correction	Assumed cause		Correction		Prevention Check to see if any of the conditions that are given as causes exist in advance.	
	The wiring of the home proximity signal or limit signal is incorrect.		Correct the wiring of the home proximity signal or limit signal.			
	The home proximity sensor or limit sensor is installed in the wrong location.		Correct the installation location of the home proximity sensor or limit sensor so that they do not turn ON at the same time.			
	The contact logic of the home proximity signal or limit signal is not correct.		Correct the contact logic (N.C./N.O.) of the home proximity sensor or limit sensor.			
	The home proximity sensor or limit sensor failed.		Replace the home proximity sensor or limit sensor.			
Attached information	None					
Precautions/Remarks	None					

Event name	Home Input/Homing Opposite Direction Limit Input Detected		Event code	74290000 hex		
Meaning	The home input and the limit signal in the direction opposite to the homing direction were detected at the same time during a homing operation.					
Source	Motion Control Function Module		Source details	Axis	Detection timing	During instruction execution
Error attributes	Level	Minor fault	Recovery	Error reset	Log category	System
Effects	User program	Continues.	Operation	The axis stops with the stop method for the homing execution status.		
System-defined variables	Variable		Data type		Name	
	_MC_AX[*].MFAultLvl.Active		BOOL		Axis Minor Fault Occurrence	
Cause and correction	Assumed cause		Correction		Prevention Check to see if any of the conditions that are given as causes exist in advance.	
	The wiring of the home input signal or limit signal is incorrect.		Correct the wiring of the home input signal or limit signal.			
	The home input sensor or limit sensor is installed in the wrong location.		Correct the installation location of the home input sensor or limit sensor so that they do not turn ON at the same time.			
	The contact logic of the home input signal or limit signal is not correct.		Correct the contact logic (N.C./N.O.) of the home input signal or limit sensor.			
	The home input signal output device or limit sensor failed.		Replace the home input signal output device or limit sensor.			
Attached information	None					
Precautions/Remarks	None					

Event name	Home Input/Homing Direction Limit Input Detected		Event code	742A0000 hex		
Meaning	The home input and the limit signal in the homing direction were detected at the same time during a homing operation.					
Source	Motion Control Function Module		Source details	Axis	Detection timing	During instruction execution
Error attributes	Level	Minor fault	Recovery	Error reset	Log category	System
Effects	User program	Continues.	Operation	The axis stops with the stop method for the homing execution status.		
System-defined variables	Variable		Data type		Name	
	_MC_AX[*].MFAultLvl.Active		BOOL		Axis Minor Fault Occurrence	
Cause and correction	Assumed cause		Correction		Prevention	
	The wiring of the home input signal or limit signal is incorrect.		Correct the wiring of the home input signal or limit signal.		Check to see if any of the conditions that are given as causes exist in advance.	
	The home input sensor or limit sensor is installed in the wrong location.		Correct the installation location of the home input sensor or limit sensor so that they do not turn ON at the same time.			
	The contact logic of the home input signal or limit signal is not correct.		Correct the contact logic (N.C./N.O.) of the home input signal or limit sensor.			
	The home input signal output device or limit sensor failed.		Replace the home input signal output device or limit sensor.			
None		None				
Attached information	None					
Precautions/Remarks	None					

Event name	Invalid Home Input Mask Distance		Event code	742B0000 hex		
Meaning	The setting of the home input mask distance is not suitable for the MC_Home or MC_HomeWithParameter instruction.					
Source	Motion Control Function Module		Source details	Axis	Detection timing	During instruction execution
Error attributes	Level	Minor fault	Recovery	Error reset	Log category	System
Effects	User program	Continues.	Operation	The axis stops with the stop method for the homing execution status.		
System-defined variables	Variable		Data type		Name	
	_MC_AX[*].MFAultLvl.Active		BOOL		Axis Minor Fault Occurrence	
Cause and correction	Assumed cause		Correction		Prevention	
	The set value of the home input mask distance when the operating mode of the MC_Home instruction is set to Proximity Reverse Turn/Home Input Mask Distance is insufficient to decelerate from the homing velocity to the homing approach velocity.		Check the home input mask distance, homing velocity, and homing approach velocity. Change the settings so that they provide sufficient travel distance to decelerate based on the operating specifications of the MC_Home or MC_HomeWithParameter instruction.		Check the operating specifications for the MC_Home or MC_HomeWithParameter instruction, then set the home input mask distance, homing velocity, and homing approach velocity so that they provide sufficient travel distance to decelerate.	
	None		None		None	
	None		None		None	
	None		None		None	
Attached information	None					
Precautions/Remarks	None					

3 Error Descriptions and Corrections

Event name	No Home Input		Event code	742C0000 hex		
Meaning	There was no home signal input during the homing operation. Or, a limit signal was detected before there was a home input.					
Source	Motion Control Function Module		Source details	Axis	Detection timing	During instruction execution
Error attributes	Level	Minor fault	Recovery	Error reset	Log category	System
Effects	User program	Continues.	Operation	The axis stops with the stop method for the homing execution status.		
System-defined variables	Variable		Data type		Name	
	_MC_AX[*].MFAultLvl.Active		BOOL		Axis Minor Fault Occurrence	
Cause and correction	Assumed cause		Correction		Prevention	
	<ul style="list-style-type: none"> There was no home signal input during the homing operation. A limit signal was detected before there was a home input. 		Check the home input settings and wiring and correct them so that the home signal is input during homing based on the operation specifications of the MC_Home or MC_HomeWithParameter instruction. Also, set the system so that the home signal is detected before the limit signals.		Set the system so that the home signal is input during the homing operation. Make sure that the home signal is detected before a limit signal. Also check to make sure there are no wiring problems with the home input.	
Attached information	None					
Precautions/Remarks	None					

Event name	No Home Proximity Input		Event code	742D0000 hex		
Meaning	There was no home proximity signal input during the homing operation.					
Source	Motion Control Function Module		Source details	Axis	Detection timing	During instruction execution
Error attributes	Level	Minor fault	Recovery	Error reset	Log category	System
Effects	User program	Continues.	Operation	The axis stops with the stop method for the homing execution status.		
System-defined variables	Variable		Data type		Name	
	_MC_AX[*].MFAultLvl.Active		BOOL		Axis Minor Fault Occurrence	
Cause and correction	Assumed cause		Correction		Prevention	
	There was no home proximity signal input during the homing operation when a home proximity input signal was specified.		Check the home proximity input settings and wiring and correct them so that the home proximity signal is input during homing based on the operation specifications of the MC_Home or MC_HomeWithParameter instruction.		Set the system so that the home proximity signal is input during the homing operation. Also check to make sure there are no wiring problems with the home proximity input.	
Attached information	None					
Precautions/Remarks	None					

Event name	Slave Error Detected		Event code	742F 0000 hex		
Meaning	An error was detected for the EtherCAT slave or NX Unit that is allocated to an axis.					
Source	Motion Control Function Module		Source details	Axis	Detection timing	Continuously
Error attributes	Level	Minor fault	Recovery	Error reset	Log category	System
Effects	User program	Continues.	Operation	The Servo for the axis turns OFF.		
System-defined variables	Variable		Data type		Name	
	_MC_AX[*].MFAultLvl.Active		BOOL		Axis Minor Fault Occurrence	
Cause and correction	Assumed cause		Correction		Prevention	
	An error was detected for the EtherCAT slave or NX Unit that is allocated to an axis.		Check the error at the slave and check the slave error code reported in Slave Error Code Report (94220000 hex) and perform the required corrections.		None	
Attached information	None					
Precautions/Remarks	None					

Event name	Axes Group Composition Axis Error		Event code	74300000 hex		
Meaning	An error occurred for an axis in an axes group.					
Source	Motion Control Function Module		Source details	Axes group	Detection timing	Continuously
Error attributes	Level	Minor fault	Recovery	Error reset	Log category	System
Effects	User program	Continues.	Operation	If an immediate stop is performed for one of the composition axes, operation will follow the setting of the Axes Group Stop Method Selection . Otherwise, an interpolated path stop is performed.		
System-defined variables	Variable		Data type		Name	
	_MC_GRP[*].MFAultLvl.Active		BOOL		Axes Group Minor Fault Occurrence	
Cause and correction	Assumed cause		Correction		Prevention	
	An error occurred for an axis in an axes group that was in motion.		Check the error code of the axes in the axes group and remove the cause of the error.		None	
Attached information	None					
Precautions/Remarks	When an axis error occurs, any axes group that contains that axis will not operate.					

Event name	MC Common Error Occurrence		Event code	74330000 hex		
Meaning	An MC common error occurred.					
Source	Motion Control Function Module		Source details	Axis	Detection timing	Continuously
Error attributes	Level	Minor fault	Recovery	Error reset	Log category	System
Effects	User program	Continues.	Operation	Operation is not possible for relevant axis.		
System-defined variables	Variable		Data type		Name	
	_MC_AX[*].MFAultLvl.Active		BOOL		Axis Minor Fault Occurrence	
Cause and correction	Assumed cause		Correction		Prevention	
	Partial fault level MC common error occurred.		Check the MC common error that occurred and remove the cause of the error.		None	
Attached information	None					
Precautions/Remarks	When a partial fault level MC common error occurs, the axis and axis group do not operate.					

Event name	Latch Position Overflow		Event code	74340000 hex		
Meaning	An overflow occurred for the latched position for the MC_TouchProbe (Enable External Latch) instruction.					
Source	Motion Control Function Module		Source details	Axis	Detection timing	During instruction execution
Error attributes	Level	Minor fault	Recovery	Error reset	Log category	System
Effects	User program	Continues.	Operation	The axis decelerates to a stop. The Enable External Latch instruction cannot retrieve the latch position.		
System-defined variables	Variable		Data type		Name	
	_MC_AX[*].MFAultLvl.Active		BOOL		Axis Minor Fault Occurrence	
Cause and correction	Assumed cause		Correction		Prevention	
	An overflow occurred for the latched position for the MC_TouchProbe (Enable External Latch) instruction.		Correct the program so that the axis position does not overflow.		Write the program so that the axis position does not overflow.	
Attached information	None					
Precautions/Remarks	None					

Event name	Latch Position Underflow		Event code	74350000 hex	
Meaning	An underflow occurred for the latched position for the MC_TouchProbe (Enable External Latch) instruction.				
Source	Motion Control Function Module		Source details	Axis	Detection timing During instruction execution
Error attributes	Level	Minor fault	Recovery	Error reset	Log category System
Effects	User program	Continues.	Operation	The axis decelerates to a stop. The Enable External Latch instruction cannot retrieve the latch position.	
System-defined variables	Variable		Data type		Name
	_MC_AX[*].MFAultLvl.Active		BOOL		Axis Minor Fault Occurrence
Cause and correction	Assumed cause		Correction		Prevention
	An underflow occurred for the latched position for the MC_TouchProbe (Enable External Latch) instruction.		Correct the program so that the axis position does not underflow.		Write the program so that the axis position does not underflow.
Attached information	None				
Precautions/Remarks	None				

Event name	Master Sync Direction Error		Event code	74360000 hex	
Meaning	The master axis continued to move in the direction opposite to the sync direction.				
Source	Motion Control Function Module		Source details	Axis	Detection timing During instruction execution
Error attributes	Level	Minor fault	Recovery	Error reset	Log category System
Effects	User program	Continues.	Operation	The axis decelerates to a stop.	
System-defined variables	Variable		Data type		Name
	_MC_AX[*].MFAultLvl.Active		BOOL		Axis Minor Fault Occurrence
Cause and correction	Assumed cause		Correction		Prevention
	The master axis continued to move in the direction opposite to the sync direction of the master and slave axes, resulting in an overflow.		Correct the program so that the movement direction and travel distance of the master axis are in the sync direction after the start of synchronization.		Write the program so that the movement direction and travel distance of the master axis is the sync direction after the start of synchronization.
Attached information	None				
Precautions/Remarks	None				

Event name	Slave Disconnection during Servo ON		Event code	74370000 hex		
Meaning	One of the following occurred while the Servo was ON for the EtherCAT slave or NX Unit that is allocated to an axis. <ul style="list-style-type: none"> • Disconnection or replacement • Disablement • Restart of the NX bus on the NX-series CPU Unit 					
Source	Motion Control Function Module		Source details	Axis	Detection timing	Whenever Servo is ON
Error attributes	Level	Minor fault	Recovery	Error reset	Log category	System
Effects	User program	Continues.	Operation	The Servo for the axis turns OFF.		
System-defined variables	Variable		Data type		Name	
	_MC_AX[*].MFAultLvl.Active		BOOL		Axis Minor Fault Occurrence	
Cause and correction	Assumed cause		Correction		Prevention	
	One of the following occurred while the Servo was ON for the EtherCAT slave or NX Unit that is allocated to an axis. <ul style="list-style-type: none"> • Disconnection or replacement • Disablement • Restart of the NX bus on the NX-series CPU Unit 		Reconnect the EtherCAT slave or NX Unit that is allocated to the axis to the network.		Turn OFF the Servo before you perform any of the following for the EtherCAT slave or NX Unit. <ul style="list-style-type: none"> • Disconnection or replacement • Disablement • Restart of the NX bus on the NX-series CPU Unit 	
Attached information	None					
Precautions/Remarks	None					

Event name	Feed Distance Overflow		Event code	74380000 hex		
Meaning	The target position after the interrupt input was received for the MC_MoveFeed (Interrupt Feeding) instruction overflowed or underflowed.					
Source	Motion Control Function Module		Source details	Axis	Detection timing	During instruction execution
Error attributes	Level	Minor fault	Recovery	Error reset	Log category	System
Effects	User program	Continues.	Operation	The axis decelerates to a stop.		
System-defined variables	Variable		Data type		Name	
	_MC_AX[*].MFAultLvl.Active		BOOL		Axis Minor Fault Occurrence	
Cause and correction	Assumed cause		Correction		Prevention	
	The target position after the interrupt input was received for the MC_MoveFeed (Interrupt Feeding) instruction exceeded the range of signed 40-bit data when converted to pulses.		Correct the input value for the command position in the program. The target value after the interrupt input is received must not exceed the valid range for the number of pulses when it is converted to pulses.		Write the program correctly. The input value for the command position must not cause the target value after the interrupt input is received to exceed the valid range. The valid range is signed 40-bit data for the number of pulses when the target value is converted to pulses.	
Attached information	None					
Precautions/Remarks	None					

Event name	Error in Changing Servo Drive Control Mode		Event code	74390000 hex	
Meaning	Changing the Control Mode was not completed within the specified time.				
Source	Motion Control Function Module		Source details	Axis	Detection timing During instruction execution
Error attributes	Level	Minor fault	Recovery	Error reset	Log category System
Effects	User program	Continues.	Operation	The Servo for the axis turns OFF.	
System-defined variables	Variable		Data type		Name
	_MC_AX[*].MFAultLvl.Active		BOOL		Axis Minor Fault Occurrence
Cause and correction	Assumed cause		Correction		Prevention
	When the MC_SyncMoveVelocity instruction was stopped, the actual current velocity was not reduced to 10% or less of the maximum velocity within 10 seconds for three consecutive periods after a command velocity of 0 was output.		Adjust the commands and load so that an error does not occur.		Adjust the commands and load so that an error does not occur.
	For an OMRON 1S-series Servo Drive or G5-series Servo Drive, the actual current velocity was not reduced to 10% or less of the maximum velocity within 10 seconds for three consecutive periods when the MC_TorqueControl instruction was stopped.				
Changing the Control Mode of the Servo Drive between CSP, CSV, and CST was not completed within one second after the command was executed.		Check to see if there is an error in the Servo Drive and to see if settings are correct. Correct any problems that are found. When changing the control mode to perform control operations, set the PDO map to reference positions for CSP.		Make sure that there are no errors in the Servo Drives and make sure that the settings are correct. When changing the control mode to perform control operations, set the PDO map to reference positions for CSP.	
Attached information	None				
Precautions/Remarks	None				

Event name	Master Axis Position Read Error		Event code	743A0000 hex		
Meaning	The synchronized control instruction was not executed because an error occurred in the position of the master axis of the synchronized control instruction.					
Source	Motion Control Function Module		Source details	Axis	Detection timing	At or during instruction execution
Error attributes	Level	Minor fault	Recovery	Error reset	Log category	System
Effects	User program	Continues.	Operation	Operation is not possible for relevant slave axis. Relevant slave axis decelerates to a stop if it is in motion.		
System-defined variables	Variable		Data type		Name	
	_MC_AX[*].MFaultLvl.Active		BOOL		Axis Minor Fault Occurrence	
Cause and correction	Assumed cause		Correction		Prevention	
	EtherCAT process data communications are not established for the master axis of the synchronized control instruction or the I/O data of the NX Unit cannot be used for control.		If the _EC_PDslavTbl (Process Data Communicating Slave Table) system-defined variable for the EtherCAT master of the master axis is FALSE, investigate the error in the master axis and remove the cause. If the master axis is assigned to an NX Unit, perform the same correction for the process data communicating status of the NX Unit.		If you execute synchronized control instructions after you turn ON the power supply, download data, or reset slave communications error, make sure that the _EC_PDslavTbl (Process Data Communicating Slave Table) system-defined variable for the EtherCAT master is TRUE for the node of the master axis before you execute the synchronized control instruction. If the master axis is assigned to an NX Unit, perform the same correction for the process data communicating status of the NX Unit.	
	The slave of the master axis for the synchronized control instruction was disconnected or disabled.		Check the slave of the master axis and reconnect it if it was disconnected or enable it if it was disabled.		Make sure that the slave of the master axis is not disconnected or disabled during execution of the synchronized control instruction.	
	An Absolute Encoder Current Position Calculation Failed error (64580000 hex) was detected for the master axis of the synchronized control instruction.		See if an Absolute Encoder Current Position Calculation Failed error (64580000 hex) occurred for the master axis and make suitable corrections to restore operation.		Do not use an axis with an Absolute Encoder Current Position Calculation Failed error (64580000 hex) as the master axis in the synchronized control instruction.	
	The master axis for the synchronized control instruction is an unused axis.		Set the master axis to a Used Axis.		Do not change the master axis to an unused axis when executing synchronized control instructions.	
Attached information	None					
Precautions/Remarks	None					

Event name	Auxiliary Axis Position Read Error		Event code	743B0000 hex		
Meaning	The synchronized control instruction was not executed because an error occurred in the position of the auxiliary axis of the synchronized control instruction.					
Source	Motion Control Function Module		Source details	Axis	Detection timing	At or during instruction execution
Error attributes	Level	Minor fault	Recovery	Error reset	Log category	System
Effects	User program	Continues.	Operation	Operation is not possible for relevant slave axis. Relevant slave axis decelerates to a stop if it is in motion.		
System-defined variables	Variable		Data type		Name	
	_MC_AX[*].MFAultLvl.Active		BOOL		Axis Minor Fault Occurrence	
Cause and correction	Assumed cause		Correction		Prevention	
	EtherCAT process data communications are not established for the auxiliary axis of the synchronized control instruction or the I/O data of the NX Unit cannot be used for control.		If the _EC_PDslavTbl (Process Data Communicating Slave Table) system-defined variable for the EtherCAT master of the auxiliary axis is FALSE, investigate the error in the auxiliary axis and remove the cause. If the auxiliary axis is assigned to an NX Unit, perform the same correction for the process data communicating status of the NX Unit.		If you execute synchronized control instructions after you turn ON the power supply, download data, or reset slave communications error, make sure that the _EC_PDslavTbl (Process Data Communicating Slave Table) system-defined variable for the EtherCAT master is TRUE for the node of the auxiliary axis before you execute the synchronized control instruction. If If the auxiliary axis is assigned to an NX Unit, perform the same correction for the process data communicating status of the NX Unit.	
	The slave of the auxiliary axis for the synchronized control instruction was disconnected or disabled.		Check the slave of the auxiliary axis and reconnect if it was disconnected or enable it if it was disabled.		Make sure that the slave of the auxiliary axis is not disconnected or disabled during execution of the synchronized control instruction.	
	An Absolute Encoder Current Position Calculation Failed error (64580000 hex) was detected for the auxiliary axis of the synchronized control instruction.		See if an Absolute Encoder Current Position Calculation Failed error (64580000 hex) occurred for the auxiliary axis and make suitable corrections to restore operation.		Do not use an axis with a Absolute Encoder Current Position Calculation Failed error (64580000 hex) as the auxiliary axis in a synchronized control instruction.	
	The auxiliary axis for the synchronized control instruction is an unused axis.		Set the auxiliary axis to a Used Axis.		Do not change the auxiliary axis to an unused axis when executing synchronized control instructions.	
Attached information	None					
Precautions/Remarks	None					

Event name	EtherCAT Slave Communications Error		Event code	84400000 hex		
Meaning	A communications error occurred for the EtherCAT slave or NX Unit that is allocated to an axis.					
Source	Motion Control Function Module		Source details	Axis	Detection timing	Continuously
Error attributes	Level	Minor fault	Recovery	Error reset	Log category	System
Effects	User program	Continues.	Operation	The Servo for the axis turns OFF.		
System-defined variables	Variable		Data type		Name	
	_MC_AX[*].MFAultLvl.Active		BOOL		Axis Minor Fault Occurrence	
Cause and correction	Assumed cause		Correction		Prevention	
	A communications error occurred for the EtherCAT slave or NX Unit that is allocated to an axis.		Check the event log for the error that occurred in the EtherCAT Master Function Module or NX Bus Function Module. Remove the cause of the error and clear the relevant error.		None	
Attached information	None					
Precautions/Remarks	Even if this error is reset, the error in the EtherCAT Master Function Module or NX Bus Function Module that is connected with the slave or NX Unit allocated to an axis is not reset. This error can be reset without resetting the error in the EtherCAT Master Function Module or NX Bus Function Module, but the axis will still be disabled.					

Event name	Following Error Warning		Event code	644C0000 hex		
Meaning	The following error exceeded the Following Error Warning Value.					
Source	Motion Control Function Module		Source details	Axis	Detection timing	During instruction execution
Error attributes	Level	Observation	Recovery	---	Log category	System
Effects	User program	Continues.	Operation	Not affected.		
System-defined variables	Variable		Data type		Name	
	_MC_AX[*].Obsr.Active		BOOL		Axis Observation Occurrence	
Cause and correction	Assumed cause		Correction		Prevention	
	Performance of positioning operation is poor and the actual motion is slower than the command.		Remove the cause of poor following performance in the positioning operation. Or increase the Following Error Warning Value within the range that will not create problems.		Remove the cause of poor following performance in the positioning operation much as possible.	
Attached information	None					
Precautions/Remarks	None					

Event name	Velocity Warning		Event code	644D0000 hex	
Meaning	The command velocity exceeded the velocity warning value.				
Source	Motion Control Function Module		Source details	Axis/axes group	Detection timing During instruction execution
Error attributes	Level	Observation	Recovery	---	Log category System
Effects	User program	Continues.	Operation	Not affected.	
System-defined variables	Variable		Data type		Name
	_MC_AX[*].Obsr.Active		BOOL		Axis Observation Occurrence
	_MC_GRP[*].Obsr.Active		BOOL		Axes Group Observation Occurrence
Cause and correction	Assumed cause		Correction		Prevention
	The command velocity exceeded the velocity warning value.		Find the reason the velocity warning value was exceeded and make suitable corrections. Or increase the Velocity Warning Value within the range that will not create problems.		(The goal is to enable detecting when the velocity warning value is exceeded. Preventative measures are not required.)
Attached information	None				
Precautions/Remarks	You can change the event level to the minor fault level. If you change the level to the minor fault level, the Recovery column above will be changed to "Error reset" and the Operation column will be "The axis/axes group decelerates to a stop."				

Event name	Acceleration Warning		Event code	644E0000 hex	
Meaning	The command acceleration exceeded the acceleration warning value.				
Source	Motion Control Function Module		Source details	Axis/axes group	Detection timing During instruction execution
Error attributes	Level	Observation	Recovery	---	Log category System
Effects	User program	Continues.	Operation	Not affected.	
System-defined variables	Variable		Data type		Name
	_MC_AX[*].Obsr.Active		BOOL		Axis Observation Occurrence
	_MC_GRP[*].Obsr.Active		BOOL		Axes Group Observation Occurrence
Cause and correction	Assumed cause		Correction		Prevention
	The command acceleration rate exceeded the acceleration warning value.		Find the reason the acceleration warning value was exceeded and make suitable corrections. Or increase the Acceleration Warning Value within the range that will not create problems.		(The goal is to enable detecting when the acceleration warning value is exceeded. Preventative measures are not required.)
Attached information	None				
Precautions/Remarks	You can change the event level to the minor fault level. If you change the level to the minor fault level, the Recovery column above will be changed to "Error reset" and the Operation column will be "The axis/axes group decelerates to a stop."				

Event name	Deceleration Warning		Event code	644F0000 hex	
Meaning	The command deceleration exceeded the deceleration warning value.				
Source	Motion Control Function Module		Source details	Axis/axes group	Detection timing During instruction execution
Error attributes	Level	Observation	Recovery	---	Log category System
Effects	User program	Continues.	Operation	Not affected.	
System-defined variables	Variable		Data type		Name
	_MC_AX[*].Obsr.Active		BOOL		Axis Observation Occurrence
		_MC_GRP[*].Obsr.Active		BOOL	
				Axes Group Observation Occurrence	
Cause and correction	Assumed cause		Correction		Prevention
	The command deceleration rate exceeded the deceleration warning value.		Find the reason the deceleration warning value was exceeded and make suitable corrections. Or increase the Deceleration Warning Value within the range that will not create problems.		(The goal is to enable detecting when the deceleration warning value is exceeded. Preventative measures are not required.)
Attached information	None				
Precautions/Remarks	You can change the event level to the minor fault level. If you change the level to the minor fault level, the Recovery column above will be changed to "Error reset" and the Operation column will be "The axis/axes group decelerates to a stop."				

Event name	Positive Torque Warning		Event code	64500000 hex	
Meaning	The torque command value exceeded the positive torque warning value.				
Source	Motion Control Function Module		Source details	Axis	Detection timing During instruction execution
Error attributes	Level	Observation	Recovery	---	Log category System
Effects	User program	Continues.	Operation	Not affected.	
System-defined variables	Variable		Data type		Name
	_MC_AX[*].Obsr.Active		BOOL		Axis Observation Occurrence
Cause and correction	Assumed cause		Correction		Prevention
	The torque command value exceeded the positive torque warning value.		Find the reason the torque warning value was exceeded and make suitable corrections. Or increase the Positive Torque Warning Value within the range that will not create problems.		(The goal is to enable detecting when the torque warning value is exceeded. Preventative measures are not required.)
Attached information	None				
Precautions/Remarks	You can change the event level to the minor fault level. If you change the level to the minor fault level, the Recovery column above will be changed to "Error reset" and the Operation column will be "The axis/axes group decelerates to a stop."				

Event name	Negative Torque Warning		Event code	64510000 hex		
Meaning	The torque command value exceeded the negative torque warning value.					
Source	Motion Control Function Module		Source details	Axis	Detection timing	During instruction execution
Error attributes	Level	Observation	Recovery	---	Log category	System
Effects	User program	Continues.	Operation	Not affected.		
System-defined variables	Variable		Data type		Name	
	_MC_AX[*].Obsr.Active		BOOL		Axis Observation Occurrence	
Cause and correction	Assumed cause		Correction		Prevention	
	The torque command value exceeded the negative torque warning value.		Find the reason the torque warning value was exceeded and make suitable corrections. Or increase the Negative Torque Warning Value within the range that will not create problems.		(The goal is to enable detecting when the torque warning value is exceeded. Preventative measures are not required.)	
Attached information	None					
Precautions/Remarks	You can change the event level to the minor fault level. If you change the level to the minor fault level, the Recovery column above will be changed to "Error reset" and the Operation column will be "The axis/axes group decelerates to a stop."					

Event name	Command Position Overflow		Event code	64520000 hex		
Meaning	The number of pulses for the command position overflowed.					
Source	Motion Control Function Module		Source details	Axis	Detection timing	Continuously
Error attributes	Level	Observation	Recovery	---	Log category	System
Effects	User program	Continues.	Operation	The position is not updated, but motion continues.		
System-defined variables	Variable		Data type		Name	
	_MC_AX[*].Obsr.Active		BOOL		Axis Observation Occurrence	
Cause and correction	Assumed cause		Correction		Prevention	
	In Linear Mode, the command position when converted to pulses exceeded the upper limit of signed 40-bit data.		Correct the program so that the input value for the command position does not exceed the range for the number of pulses for the instruction. Or, change the electronic gear ratio settings. To recover from the overflow, change the current position or perform the homing operation.		Check the gear ratio setting and the target position setting value, and make sure that the converted number of pulses does not exceed the range of signed 40-bit data.	
Attached information	None					
Precautions/Remarks	You can change the event level to the minor fault level. If you change the level to the minor fault level, the Recovery column above will be changed to "Error reset" and the Operation column will be "The axis/axes group decelerates to a stop."					

Event name	Command Position Underflow			Event code	64530000 hex	
Meaning	The number of pulses for the command position exceeded the valid range. (It underflowed.)					
Source	Motion Control Function Module		Source details	Axis	Detection timing	Continuously
Error attributes	Level	Observation	Recovery	---	Log category	System
Effects	User program	Continues.	Operation	The position is not updated, but motion continues.		
System-defined variables	Variable		Data type		Name	
	_MC_AX[*].Obsr.Active		BOOL		Axis Observation Occurrence	
Cause and correction	Assumed cause		Correction		Prevention	
	In Linear Mode, the command position when converted to pulses exceeded the lower limit of signed 40-bit data.		Correct the program so that the input value for the command position does not exceed the pulse number limit for the instruction. Or, change the electronic gear ratio settings. To recover from the underflow, change the current position or perform the homing operation.		Check the gear ratio setting and the target position setting value, and make sure that the converted number of pulses does not exceed the range of signed 40-bit data.	
Attached information	None					
Precautions/Remarks	You can change the event level to the minor fault level. If you change the level to the minor fault level, the Recovery column above will be changed to "Error reset" and the Operation column will be "The axis/axes group decelerates to a stop."					

Event name	Actual Position Overflow			Event code	64540000 hex	
Meaning	The number of pulses for the actual position overflowed.					
Source	Motion Control Function Module		Source details	Axis	Detection timing	Continuously
Error attributes	Level	Observation	Recovery	---	Log category	System
Effects	User program	Continues.	Operation	The position is not updated, but motion continues.		
System-defined variables	Variable		Data type		Name	
	_MC_AX[*].Obsr.Active		BOOL		Axis Observation Occurrence	
Cause and correction	Assumed cause		Correction		Prevention	
	The actual position when converted to pulses exceeded the upper limit of signed 40-bit data.		Correct the program so that the target position is well within the pulse number limit so that the actual position does not exceed the pulse number limit for the instruction. Or, change the electronic gear ratio settings. To recover from the overflow, change the current position or perform the homing operation.		Check the gear ratio setting and the target position setting value, and make sure that the converted number of pulses does not exceed the range of signed 40-bit data. Allow some leeway.	
Attached information	None					
Precautions/Remarks	You can change the event level to the minor fault level. If you change the level to the minor fault level, the Recovery column above will be changed to "Error reset" and the Operation column will be "The axis/axes group decelerates to a stop."					

Event name	Actual Position Underflow		Event code	64550000 hex	
Meaning	The number of pulses for the actual position underflowed.				
Source	Motion Control Function Module		Source details	Axis	Detection timing Continuously
Error attributes	Level	Observation	Recovery	---	Log category System
Effects	User program	Continues.	Operation	The position is not updated, but motion continues.	
System-defined variables	Variable		Data type		Name
	_MC_AX[*].Obsr.Active		BOOL		Axis Observation Occurrence
Cause and correction	Assumed cause		Correction		Prevention
	The actual position when converted to pulses exceeded the lower limit of signed 40-bit data.		Correct the program so that the target position is well within the pulse number limit so that the actual position does not exceed the pulse number limit for the instruction. Or, change the electronic gear ratio settings. To recover from the underflow, change the current position or perform the homing operation.		Check the gear ratio setting and the target position setting value, and make sure that the converted number of pulses does not exceed the range of signed 40-bit data. Allow some leeway.
Attached information	None				
Precautions/Remarks	You can change the event level to the minor fault level. If you change the level to the minor fault level, the Recovery column above will be changed to "Error reset" and the Operation column will be "The axis/axes group decelerates to a stop."				

Event name	Slave Observation Detected		Event code	74320000 hex	
Meaning	A warning was detected for an EtherCAT slave or NX Unit.				
Source	Motion Control Function Module		Source details	Axis	Detection timing Continuously
Error attributes	Level	Observation	Recovery	---	Log category System
Effects	User program	Continues.	Operation	Not affected.	
System-defined variables	Variable		Data type		Name
	_MC_AX[*].Obsr.Active		BOOL		Axis Observation Occurrence
Cause and correction	Assumed cause		Correction		Prevention
	A warning was detected for the EtherCAT slave or NX Unit that is allocated to an axis.		Check the warning code for the EtherCAT slave and remove the cause of the warning.		None
Attached information	Attached information 1: Drive warning code				
Precautions/Remarks	You can change the event level to the minor fault level. If you change the level to the minor fault level, the Recovery column above will be changed to "Error reset" and the Operation column will be "The axis/axes group decelerates to a stop."				

3 Error Descriptions and Corrections

Event name	Cannot Execute Save Cam Table Instruction		Event code	743C0000 hex		
Meaning	You cannot save a cam table to a file when non-volatile memory is being accessed by another operation.					
Source	Motion Control Function Module		Source details	MC Common	Detection timing	At instruction execution
Error attributes	Level	Observation	Recovery	---	Log category	System
Effects	User program	Continues.	Operation	Not affected.		
System-defined variables	Variable		Data type		Name	
	_MC_COM.Obsr.Active		BOOL		MC Common Observation Active	
Cause and correction	Assumed cause		Correction		Prevention	
	An attempt was made to execute the MC_SaveCamTable instruction when another operation was accessing the non-volatile memory (e.g., transfer or data trace operation from the Sysmac Studio).		Execute the MC_SaveCamTable instruction again.		None	
Attached information	None					
Precautions/Remarks	None					

Event name	Notice of Insufficient Travel Distance to Achieve Blending Transit Velocity		Event code	94200000 hex		
Meaning	There is not sufficient travel distance to accelerate or decelerate to the transit velocity during blending operation.					
Source	Motion Control Function Module		Source details	Axis/axes group	Detection timing	At multi-execution of instructions
Error attributes	Level	Observation	Recovery	---	Log category	System
Effects	User program	Continues.	Operation	Not affected.		
System-defined variables	Variable		Data type		Name	
	_MC_AX[*].Obsr.Active		BOOL		Axis Observation Occurrence	
System-defined variables	_MC_GRP[*].Obsr.Active		BOOL		Axes Group Observation Occurrence	
	Assumed cause		Correction		Prevention	
Cause and correction	When the Acceleration/Deceleration Over parameter was set to Use rapid acceleration/deceleration (Blending is changed to Buffered), the results of profile creation caused the acceleration/deceleration rate to be exceeded when blending was specified, so buffered was used.		Set the Acceleration/Deceleration Over parameter to a value other than Use rapid acceleration/deceleration (Blending is changed to Buffered) if you do not want to change to Buffered operation.		Set the Acceleration/Deceleration Over parameter to a value other than Use rapid acceleration/deceleration (Blending is changed to Buffered) if you do not want to change to Buffered operation.	
	Blending was specified, but the target position was already reached, so it was changed to Buffered because the profile could not be created.		If unanticipated operation occurs from the switch to Buffered operation, correct the program so that the causes given at the left do not occur.		If unanticipated operation occurs from the switch to Buffered operation, write the program so that the causes given at the left do not occur.	
Attached information	None					
Precautions/Remarks	You can change the event level to the minor fault level. If you change the level to the minor fault level, the Recovery column above will be changed to "Error reset" and the Operation column will be "The axis/axes group decelerates to a stop."					

Event name	Error Clear from MC Test Run Tab Page		Event code	94210000 hex		
Meaning	An error was cleared from the MC Test Run Pane of the Sysmac Studio.					
Source	Motion Control Function Module		Source details	MC Common	Detection timing	When MC Test Run error is reset
Error attributes	Level	Information	Recovery	---	Log category	System
Effects	User program	Continues.	Operation	Not affected.		
System-defined variables	Variable		Data type		Name	
	None		---		---	
Cause and correction	Assumed cause		Correction		Prevention	
	An error was cleared from the MC Test Run Pane of the Sysmac Studio.		---		---	
Attached information	Attached information 1: Execution results (0000_0000 hex: All errors reset, 0000_0001 hex: Resetting all errors failed)					
Precautions/Remarks	None					

Event name	Slave Error Code Report		Event code	94220000 hex		
Meaning	The error code was reported by the slave when a Slave Error Detected error occurred.					
Source	Motion Control Function Module		Source details	Axis	Detection timing	After Slave Error Detected error (742F0000 hex)
Error attributes	Level	Information	Recovery	---	Log category	System
Effects	User program	Continues.	Operation	Not affected.		
System-defined variables	Variable		Data type		Name	
	None		---		---	
Cause and correction	Assumed cause		Correction		Prevention	
	The error code was reported by the slave when a Slave Error Detected error (742F0000 hex) occurred.		This error accompanies a Slave Error Detected error (742F0000 hex). Check the slave error code in the attached information and make the required corrections.		None	
Attached information	Attached information 1: Slave error code					
Precautions/Remarks	For an OMRON 1S-series Servo Drive or G5-series Servo Drive, the error code (the main part of the error display number) from the Servo Drive is included in the lower two digits of the attached information. For example, if the attached information is displayed as FF13, the error with display number 13 (Main Circuit Power Supply Undervoltage) occurred in the Servo Drive.					

Motion Control Instructions

This section provides a table of errors (events) that occur for motion control instructions. The upper four digits of the event code give the error code (ErrorID) for the motion control instruction. For descriptions of an error code, refer to the description of the corresponding event code. For example, if the error code for the motion control instruction is 16#3461, refer to the description for event code 34610000 hex.



Precautions for Correct Use

With CPU Unit with unit version 1.10 or later, a variable name that starts with `_MC_AX[*]` may start with `_MC1_AX[*]` or `_MC2_AX[*]` instead. In the same way, a variable name that starts with `_MC_GRP[*]` may start with `_MC1_GRP[*]` or `_MC2_GRP[*]` instead.

Event name	Process Data Object Setting Missing			Event code	34610000 hex	
Meaning	The PDO mapping is not correct.					
Source	Motion Control Function Module		Source details	Axis	Detection timing	At instruction execution
Error attributes	Level	Minor fault	Recovery	Error reset	Log category	System
Effects	User program	Continues.	Operation	Operation is not possible for relevant axis.		
System-defined variables	Variable	Data type		Name		
	<code>_MC_AX[*].MFAultLvl.Active</code>	BOOL		Axis Minor Fault Occurrence		
Cause and correction	Assumed cause	Correction		Prevention		
	The PDOs that are required for the motion control instruction are not mapped.	Map the PDOs that are required for the instruction. Refer to the <i>Function section</i> of the relevant instruction for the required PDOs.		Map the PDOs that are required for the instructions that are used. Refer to the <i>NJ/NX-series CPU Unit Motion Control User's Manual (Cat. No. W507)</i> for the PDOs (Servo Drive settings) that you must map for each instruction.		
	The relevant instruction was executed for a device that does not have an object that supports the instruction.	Some devices do not support the relevant instruction. Refer to the manual for the target device, check to see if the relevant instruction is supported, and correct the program so that unsupported instructions are not executed.		Refer to the manual for the target device and write the program so that unsupported instructions are not executed.		
	A motion control instruction that specifies phase Z (<code>_mcEncoderMark</code>) as the trigger conditions was executed for an axis that is mapped to an OMRON GXEC02□□ EtherCAT Encoder slave.	Use an external input (<code>_mcEXT</code>) as the trigger conditions for an axis that is mapped to an OMRON GX-EC02□□ EtherCAT Encoder slave.		Use an external input (<code>_mcEXT</code>) as the trigger conditions for an axis that is mapped to an OMRON GX-EC02□□ EtherCAT Encoder slave.		
Attached information	None					
Precautions/Remarks	None					

Event name	Electronic Gear Ratio Numerator Setting Out of Range		Event code	54200000 hex		
Meaning	The parameter specified for the <i>RatioNumerator</i> input variable to a motion control instruction is out of range.					
Source	Motion Control Function Module		Source details	Axis	Detection timing	At instruction execution
Error attributes	Level	Minor fault	Recovery	Error reset	Log category	System
Effects	User program	Continues.	Operation	Operation is not possible for the slave axis. Relevant slave axis decelerates to a stop if it is in motion.		
System-defined variables	Variable		Data type		Name	
	_MC_AX[*].MFAultLvl.Active		BOOL		Axis Minor Fault Occurrence	
Cause and correction	Assumed cause		Correction		Prevention	
	Instruction input parameter exceeded the valid range of the input variable.		Correct the parameter so that the valid range of the input variable is not exceeded for the instruction.		Set the input parameter to the instruction so that the valid range of the input variable is not exceeded.	
Attached information	None					
Precautions/Remarks	None					

Event name	Electronic Gear Ratio Denominator Setting Out of Range		Event code	54210000 hex		
Meaning	The parameter specified for the <i>RatioDenominator</i> input variable to a motion control instruction is out of range.					
Source	Motion Control Function Module		Source details	Axis	Detection timing	At instruction execution
Error attributes	Level	Minor fault	Recovery	Error reset	Log category	System
Effects	User program	Continues.	Operation	Operation is not possible for relevant slave axis. Relevant slave axis decelerates to a stop if it is in motion.		
System-defined variables	Variable		Data type		Name	
	_MC_AX[*].MFAultLvl.Active		BOOL		Axis Minor Fault Occurrence	
Cause and correction	Assumed cause		Correction		Prevention	
	Instruction input parameter exceeded the valid range of the input variable.		Correct the parameter so that the valid range of the input variable is not exceeded for the relevant instruction.		Set the input parameter to the instruction so that the valid range of the input variable is not exceeded.	
Attached information	None					
Precautions/Remarks	None					

Event name	Target Velocity Setting Out of Range		Event code	54220000 hex		
Meaning	The parameter specified for the <i>Velocity</i> input variable to a motion control instruction is out of range.					
Source	Motion Control Function Module		Source details	Axis/axes group	Detection timing	At instruction execution
Error attributes	Level	Minor fault	Recovery	Error reset	Log category	System
Effects	User program	Continues.	Operation	<p>If “axis” is given for the source details, operation is not possible for relevant axis. Relevant axis decelerates to a stop if it is in motion.</p> <p>If “axes group” is given for the source details, operation is not possible for relevant axes group. Relevant axes group decelerates to a stop if it is in motion.</p>		
System-defined variables	Variable		Data type		Name	
	_MC_AX[*].MFAultLvl.Active		BOOL		Axis Minor Fault Occurrence	
		_MC_GRP[*].MFAultLvl.Active		BOOL		Axes Group Minor Fault Occurrence
Cause and correction	Assumed cause		Correction		Prevention	
	Instruction input parameter exceeded the valid range of the input variable.		Correct the parameter so that the valid range of the input variable is not exceeded for the relevant instruction.		Set the input parameter to the instruction so that the valid range of the input variable is not exceeded.	
Attached information	None					
Precautions/Remarks	None					

Event name	Acceleration Setting Out of Range		Event code	54230000 hex		
Meaning	The parameter specified for the <i>Acceleration</i> input variable to a motion control instruction is out of range.					
Source	Motion Control Function Module		Source details	Axis/axes group	Detection timing	At instruction execution
Error attributes	Level	Minor fault	Recovery	Error reset	Log category	System
Effects	User program	Continues.	Operation	<p>If “axis” is given for the source details, operation is not possible for relevant axis. Relevant axis decelerates to a stop if it is in motion.</p> <p>If “axes group” is given for the source details, operation is not possible for relevant axes group. Relevant axes group decelerates to a stop if it is in motion.</p>		
System-defined variables	Variable		Data type		Name	
	_MC_AX[*].MFAultLvl.Active		BOOL		Axis Minor Fault Occurrence	
		_MC_GRP[*].MFAultLvl.Active		BOOL		Axes Group Minor Fault Occurrence
Cause and correction	Assumed cause		Correction		Prevention	
	Instruction input parameter exceeded the valid range of the input variable.		Correct the parameter so that the valid range of the input variable is not exceeded for the relevant instruction.		Set the input parameter to the instruction so that the valid range of the input variable is not exceeded.	
Attached information	None					
Precautions/Remarks	None					

Event name	Deceleration Setting Out of Range		Event code	54240000 hex		
Meaning	The parameter specified for the <i>Deceleration</i> input variable to a motion control instruction is out of range.					
Source	Motion Control Function Module		Source details	Axis/axes group	Detection timing	At instruction execution
Error attributes	Level	Minor fault	Recovery	Error reset	Log category	System
Effects	User program	Continues.	Operation	If “axis” is given for the source details, operation is not possible for relevant axis. Relevant axis decelerates to a stop if it is in motion. If “axes group” is given for the source details, operation is not possible for relevant axes group. Relevant axes group decelerates to a stop if it is in motion.		
System-defined variables	Variable	Data type		Name		
	_MC_AX[*].MFAultLvl.Active	BOOL		Axis Minor Fault Occurrence		
	_MC_GRP[*].MFAultLvl.Active	BOOL		Axes Group Minor Fault Occurrence		
Cause and correction	Assumed cause		Correction		Prevention	
	Instruction input parameter exceeded the valid range of the input variable.		Correct the parameter so that the valid range of the input variable is not exceeded for the relevant instruction.		Set the input parameter to the instruction so that the valid range of the input variable is not exceeded.	
Attached information	None					
Precautions/Remarks	None					

Event name	Jerk Setting Out of Range		Event code	54250000 hex		
Meaning	The parameter specified for the <i>Jerk</i> input variable to a motion control instruction is out of range.					
Source	Motion Control Function Module		Source details	Axis/axes group	Detection timing	At instruction execution
Error attributes	Level	Minor fault	Recovery	Error reset	Log category	System
Effects	User program	Continues.	Operation	If “axis” is given for the source details, operation is not possible for relevant axis. Relevant axis decelerates to a stop if it is in motion. If “axes group” is given for the source details, operation is not possible for relevant axes group. Relevant axes group decelerates to a stop if it is in motion.		
System-defined variables	Variable	Data type		Name		
	_MC_AX[*].MFAultLvl.Active	BOOL		Axis Minor Fault Occurrence		
	_MC_GRP[*].MFAultLvl.Active	BOOL		Axes Group Minor Fault Occurrence		
Cause and correction	Assumed cause		Correction		Prevention	
	Instruction input parameter exceeded the valid range of the input variable.		Correct the parameter so that the valid range of the input variable is not exceeded for the relevant instruction.		Set the input parameter to the instruction so that the valid range of the input variable is not exceeded.	
Attached information	None					
Precautions/Remarks	None					

Event name	Torque Ramp Setting Out of Range		Event code	54270000 hex		
Meaning	The parameter specified for the <i>TorqueRamp</i> input variable to a motion control instruction is out of range.					
Source	Motion Control Function Module		Source details	Axis	Detection timing	At instruction execution
Error attributes	Level	Minor fault	Recovery	Error reset	Log category	System
Effects	User program	Continues.	Operation	Operation is not possible for relevant axis. Relevant axis decelerates to a stop if it is in motion.		
System-defined variables	Variable		Data type		Name	
	_MC_AX[*].MFaultLvl.Active		BOOL		Axis Minor Fault Occurrence	
Cause and correction	Assumed cause		Correction		Prevention	
	Instruction input parameter exceeded the valid range of the input variable.		Correct the parameter so that the valid range of the input variable is not exceeded for the relevant instruction.		Set the input parameter to the instruction so that the valid range of the input variable is not exceeded.	
Attached information	None					
Precautions/Remarks	None					

Event name	Master Coefficient Scaling Out of Range		Event code	54280000 hex		
Meaning	The parameter specified for the <i>MasterScaling</i> input variable to a motion control instruction is out of range.					
Source	Motion Control Function Module		Source details	Axis	Detection timing	At instruction execution
Error attributes	Level	Minor fault	Recovery	Error reset	Log category	System
Effects	User program	Continues.	Operation	Operation is not possible for relevant slave axis. Relevant slave axis decelerates to a stop if it is in motion.		
System-defined variables	Variable		Data type		Name	
	_MC_AX[*].MFaultLvl.Active		BOOL		Axis Minor Fault Occurrence	
Cause and correction	Assumed cause		Correction		Prevention	
	Instruction input parameter exceeded the valid range of the input variable.		Correct the parameter so that the valid range of the input variable is not exceeded for the relevant instruction.		Set the input parameter to the instruction so that the valid range of the input variable is not exceeded.	
Attached information	None					
Precautions/Remarks	None					

Event name	Slave Coefficient Scaling Out of Range			Event code	54290000 hex	
Meaning	The parameter specified for the <i>SlaveScaling</i> input variable to a motion control instruction is out of range.					
Source	Motion Control Function Module		Source details	Axis	Detection timing	At instruction execution
Error attributes	Level	Minor fault	Recovery	Error reset	Log category	System
Effects	User program	Continues.	Operation	Operation is not possible for relevant slave axis. Relevant slave axis decelerates to a stop if it is in motion.		
System-defined variables	Variable	Data type		Name		
	_MC_AX[*].MFAultLvl.Active	BOOL		Axis Minor Fault Occurrence		
Cause and correction	Assumed cause		Correction		Prevention	
	Instruction input parameter exceeded the valid range of the input variable.		Correct the parameter so that the valid range of the input variable is not exceeded for the relevant instruction.		Set the input parameter to the instruction so that the valid range of the input variable is not exceeded.	
Attached information	None					
Precautions/Remarks	None					

Event name	Feeding Velocity Setting Out of Range			Event code	542A0000 hex	
Meaning	The parameter specified for the <i>FeedVelocity</i> input variable to a motion control instruction is out of range.					
Source	Motion Control Function Module		Source details	Axis	Detection timing	At instruction execution
Error attributes	Level	Minor fault	Recovery	Error reset	Log category	System
Effects	User program	Continues.	Operation	Operation is not possible for relevant axis. Relevant axis decelerates to a stop if it is in motion.		
System-defined variables	Variable	Data type		Name		
	_MC_AX[*].MFAultLvl.Active	BOOL		Axis Minor Fault Occurrence		
Cause and correction	Assumed cause		Correction		Prevention	
	The Feed Velocity (input variable <i>FeedVelocity</i>) is still at the default (0).		Specify a positive value for the Feed Velocity (input variable <i>FeedVelocity</i>).		Set the input parameter to the instruction so that the valid range of the input variable is not exceeded.	
Attached information	None					
Precautions/Remarks	None					

Event name	Buffer Mode Selection Out of Range		Event code	5420000 hex		
Meaning	The parameter specified for the <i>BufferMode</i> input variable to a motion control instruction is out of range.					
Source	Motion Control Function Module		Source details	Axis/axes group	Detection timing	At instruction execution
Error attributes	Level	Minor fault	Recovery	Error reset	Log category	System
Effects	User program	Continues.	Operation	<p>If “axis” is given for the source details, operation is not possible for relevant axis. Relevant axis decelerates to a stop if it is in motion.</p> <p>If “axes group” is given for the source details, operation is not possible for relevant axes group. Relevant axes group decelerates to a stop if it is in motion.</p>		
System-defined variables	Variable		Data type		Name	
	_MC_AX[*].MFAultLvl.Active		BOOL		Axis Minor Fault Occurrence	
	_MC_GRP[*].MFAultLvl.Active		BOOL		Axes Group Minor Fault Occurrence	
Cause and correction	Assumed cause		Correction		Prevention	
	Instruction input parameter exceeded the valid range of the input variable.		Correct the parameter so that the valid range of the input variable is not exceeded for the relevant instruction.		Set the input parameter to the instruction so that the valid range of the input variable is not exceeded.	
Attached information	None					
Precautions/Remarks	None					

Event name	Coordinate System Selection Out of Range		Event code	542C0000 hex		
Meaning	The parameter specified for the <i>CoordSystem</i> input variable to a motion control instruction is out of range.					
Source	Motion Control Function Module		Source details	Axes group	Detection timing	At instruction execution
Error attributes	Level	Minor fault	Recovery	Error reset	Log category	System
Effects	User program	Continues.	Operation	<p>Operation is not possible for relevant axes group. Relevant axes group decelerates to a stop if it is in motion.</p>		
System-defined variables	Variable		Data type		Name	
	_MC_GRP[*].MFAultLvl.Active		BOOL		Axes Group Minor Fault Occurrence	
Cause and correction	Assumed cause		Correction		Prevention	
	Instruction input parameter exceeded the valid range of the input variable.		Correct the parameter so that the valid range of the input variable is not exceeded for the relevant instruction.		Set the input parameter to the instruction so that the valid range of the input variable is not exceeded.	
Attached information	None					
Precautions/Remarks	None					

Event name	Circular Interpolation Mode Selection Out of Range		Event code	542D0000 hex		
Meaning	The parameter specified for the <i>CircMode</i> input variable to a motion control instruction is out of range.					
Source	Motion Control Function Module		Source details	Axes group	Detection timing	At instruction execution
Error attributes	Level	Minor fault	Recovery	Error reset	Log category	System
Effects	User program	Continues.	Operation	Operation is not possible for relevant axes group. Relevant axes group decelerates to a stop if it is in motion.		
System-defined variables	Variable	Data type		Name		
	_MC_GRP[*].MFAultLvl.Active	BOOL		Axes Group Minor Fault Occurrence		
Cause and correction	Assumed cause		Correction		Prevention	
	Instruction input parameter exceeded the valid range of the input variable.		Correct the parameter so that the valid range of the input variable is not exceeded for the relevant instruction.		Set the input parameter to the instruction so that the valid range of the input variable is not exceeded.	
Attached information	None					
Precautions/Remarks	None					

Event name	Direction Selection Out of Range		Event code	542E0000 hex		
Meaning	The parameter specified for the <i>Direction</i> input variable to a motion control instruction is out of range.					
Source	Motion Control Function Module		Source details	Axis	Detection timing	At instruction execution
Error attributes	Level	Minor fault	Recovery	Error reset	Log category	System
Effects	User program	Continues.	Operation	Operation is not possible for relevant axis. Relevant axis decelerates to a stop if it is in motion.		
System-defined variables	Variable	Data type		Name		
	_MC_AX[*].MFAultLvl.Active	BOOL		Axis Minor Fault Occurrence		
Cause and correction	Assumed cause		Correction		Prevention	
	Instruction input parameter exceeded the valid range of the input variable.		Correct the parameter so that the valid range of the input variable is not exceeded for the relevant instruction.		Set the input parameter to the instruction so that the valid range of the input variable is not exceeded.	
Attached information	None					
Precautions/Remarks	None					

3 Error Descriptions and Corrections

Event name	Path Selection Out of Range			Event code	542F0000 hex	
Meaning	The parameter specified for the <i>PathChoice</i> input variable to a motion control instruction is out of range.					
Source	Motion Control Function Module		Source details	Axes group	Detection timing	At instruction execution
Error attributes	Level	Minor fault	Recovery	Error reset	Log category	System
Effects	User program	Continues.	Operation	Operation is not possible for relevant axes group. Relevant axes group decelerates to a stop if it is in motion.		
System-defined variables	Variable		Data type		Name	
	_MC_GRP[*].MFAultLvl.Active		BOOL		Axes Group Minor Fault Occurrence	
Cause and correction	Assumed cause		Correction		Prevention	
	Instruction input parameter exceeded the valid range of the input variable.		Correct the parameter so that the valid range of the input variable is not exceeded for the relevant instruction.		Set the input parameter to the instruction so that the valid range of the input variable is not exceeded.	
Attached information	None					
Precautions/Remarks	None					

Event name	Position Type Selection Out of Range			Event code	54300000 hex	
Meaning	The parameter specified for the <i>ReferenceType</i> input variable to a motion control instruction is out of range.					
Source	Motion Control Function Module		Source details	MC common or axis	Detection timing	At instruction execution
Error attributes	Level	Minor fault	Recovery	Error reset	Log category	System
Effects	User program	Continues.	Operation	Operation is not possible for relevant axis. Relevant axis decelerates to a stop if it is in motion.		
System-defined variables	Variable		Data type		Name	
	_MC_COM.MFAultLvl.Active		BOOL		MC Common Minor Fault Occurrence	
	_MC_AX[*].MFAultLvl.Active		BOOL		Axis Minor Fault Occurrence	
Cause and correction	Assumed cause		Correction		Prevention	
	Instruction input parameter exceeded the valid range of the input variable.		Correct the parameter so that the valid range of the input variable is not exceeded for the relevant instruction.		Set the input parameter to the instruction so that the valid range of the input variable is not exceeded.	
Attached information	None					
Precautions/Remarks	None					

Event name	Travel Mode Selection Out of Range		Event code	54310000 hex		
Meaning	The parameter specified for the <i>MoveMode</i> input variable to a motion control instruction is out of range.					
Source	Motion Control Function Module		Source details	Axis/axes group	Detection timing	At instruction execution
Error attributes	Level	Minor fault	Recovery	Error reset	Log category	System
Effects	User program	Continues.	Operation	If "axis" is given for the source details, operation is not possible for relevant axis. Relevant axis decelerates to a stop if it is in motion. If "axes group" is given for the source details, operation is not possible for relevant axes group. Relevant axes group decelerates to a stop if it is in motion.		
System-defined variables	Variable		Data type		Name	
	_MC_AX[*].MFAultLvl.Active		BOOL		Axis Minor Fault Occurrence	
	_MC_GRP[*].MFAultLvl.Active		BOOL		Axes Group Minor Fault Occurrence	
Cause and correction	Assumed cause		Correction		Prevention	
	Instruction input parameter exceeded the valid range of the input variable.		Correct the parameter so that the valid range of the input variable is not exceeded for the relevant instruction.		Set the input parameter to the instruction so that the valid range of the input variable is not exceeded.	
Attached information	None					
Precautions/Remarks	None					

3 Error Descriptions and Corrections

Event name	Transition Mode Selection Out of Range			Event code	54320000 hex	
Meaning	The parameter specified for the <i>TransitionMode</i> input variable to a motion control instruction is out of range.					
Source	Motion Control Function Module		Source details	Axes group	Detection timing	At instruction execution
Error attributes	Level	Minor fault	Recovery	Error reset	Log category	System
Effects	User program	Continues.	Operation	Operation is not possible for relevant axes group. Relevant axes group decelerates to a stop if it is in motion.		
System-defined variables	Variable		Data type		Name	
	_MC_GRP[*].MFaultLvl.Active		BOOL		Axes Group Minor Fault Occurrence	
Cause and correction	Assumed cause		Correction		Prevention	
	Instruction input parameter exceeded the valid range of the input variable.		Correct the parameter so that the valid range of the input variable is not exceeded for the relevant instruction.		Set the input parameter to the instruction so that the valid range of the input variable is not exceeded.	
	_mcAborting or _mcBuffered was specified for <i>BufferMode</i> and _mcTMCornerSuperimposed was specified for <i>TransitionMode</i> .		If you specify _mcAborting or _mcBuffered for <i>BufferMode</i> , specify _mcTMNone for <i>TransitionMode</i> . If you specify _mcTMCornerSuperimposed for <i>TransitionMode</i> , specify _mcBlendingLow, _mcBlendingPrevious, _mcBlendingNext, or _mcBlendingHigh for <i>BufferMode</i> .		If you specify _mcAborting or _mcBuffered for <i>BufferMode</i> , specify _mcTMNone for <i>TransitionMode</i> . If you specify _mcTMCornerSuperimposed for <i>TransitionMode</i> , specify _mcBlendingLow, _mcBlendingPrevious, _mcBlendingNext, or _mcBlendingHigh for <i>BufferMode</i> .	
Attached information	None					
Precautions/Remarks	None					

Event name	Continue Method Selection Out of Range			Event code	54330000 hex	
Meaning	The value of the reserved input variable <i>Continuous</i> to a motion control instruction changed.					
Source	Motion Control Function Module		Source details	Axis	Detection timing	At instruction execution
Error attributes	Level	Minor fault	Recovery	Error reset	Log category	System
Effects	User program	Continues.	Operation	Operation is not possible for relevant axis. Relevant axis decelerates to a stop if it is in motion.		
System-defined variables	Variable		Data type		Name	
	_MC_AX[*].MFaultLvl.Active		BOOL		Axis Minor Fault Occurrence	
Cause and correction	Assumed cause		Correction		Prevention	
	The value of the reserved input variable <i>Continuous</i> changed.		Correct the program so that the value of the reserved input variable <i>Continuous</i> does not change.		Write the user program so that the value of the reserved input variable <i>Continuous</i> does not change.	
Attached information	None					
Precautions/Remarks	None					

Event name	Combine Mode Selection Out of Range			Event code	54340000 hex	
Meaning	The parameter specified for the <i>CombineMode</i> input variable to a motion control instruction is out of range.					
Source	Motion Control Function Module		Source details	Axis	Detection timing	At instruction execution
Error attributes	Level	Minor fault	Recovery	Error reset	Log category	System
Effects	User program	Continues.	Operation	Operation is not possible for relevant axis. Relevant axis decelerates to a stop if it is in motion.		
System-defined variables	Variable		Data type		Name	
	_MC_AX[*].MFAultLvl.Active		BOOL		Axis Minor Fault Occurrence	
Cause and correction	Assumed cause		Correction		Prevention	
	Instruction input parameter exceeded the valid range of the input variable.		Correct the parameter so that the valid range of the input variable is not exceeded for the relevant instruction.		Set the input parameter to the instruction so that the valid range of the input variable is not exceeded.	
Attached information	None					
Precautions/Remarks	None					

Event name	Synchronization Start Condition Selection Out of Range			Event code	54350000 hex	
Meaning	The parameter specified for the <i>LinkOption</i> input variable to a motion control instruction is out of range.					
Source	Motion Control Function Module		Source details	Axis	Detection timing	At instruction execution
Error attributes	Level	Minor fault	Recovery	Error reset	Log category	System
Effects	User program	Continues.	Operation	Operation is not possible for relevant axis. Relevant axis decelerates to a stop if it is in motion.		
System-defined variables	Variable		Data type		Name	
	_MC_AX[*].MFAultLvl.Active		BOOL		Axis Minor Fault Occurrence	
Cause and correction	Assumed cause		Correction		Prevention	
	Instruction input parameter exceeded the valid range of the input variable.		Correct the parameter so that the valid range of the input variable is not exceeded for the relevant instruction.		Set the input parameter to the instruction so that the valid range of the input variable is not exceeded.	
Attached information	None					
Precautions/Remarks	None					

Event name	Master and Slave Defined as Same Axis		Event code	54360000 hex		
Meaning	The same axis is specified for the <i>Master</i> and <i>Slave</i> input variables to a motion control instruction.					
Source	Motion Control Function Module		Source details	MC common or axis	Detection timing	At instruction execution
Error attributes	Level	Minor fault	Recovery	Error reset	Log category	System
Effects	User program	Continues.	Operation	Operation is not possible for relevant slave axis. Relevant slave axis decelerates to a stop if it is in motion.		
System-defined variables	Variable	Data type		Name		
	_MC_COM.MFaultLvl.Active	BOOL		MC Common Minor Fault Occurrence		
	_MC_AX[*].MFaultLvl.Active	BOOL		Axis Minor Fault Occurrence		
Cause and correction	Assumed cause		Correction		Prevention	
	The parameter is the same for the <i>Master</i> and <i>Slave</i> input variables to the instruction.		Correct the parameters so that different axes are specified for the <i>Master</i> and <i>Slave</i> input variables to the instruction.		Specify different axes for the <i>Master</i> and <i>Slave</i> input variables to the instruction.	
Attached information	None					
Precautions/Remarks	None					

Event name	Master and Auxiliary Defined as Same Axis		Event code	54370000 hex		
Meaning	The same axis is specified for the <i>Master</i> and <i>Auxiliary</i> input variables to a motion control instruction.					
Source	Motion Control Function Module		Source details	Axis	Detection timing	At instruction execution
Error attributes	Level	Minor fault	Recovery	Error reset	Log category	System
Effects	User program	Continues.	Operation	Operation is not possible for relevant slave axis. Relevant slave axis decelerates to a stop if it is in motion.		
System-defined variables	Variable	Data type		Name		
	_MC_AX[*].MFaultLvl.Active	BOOL		Axis Minor Fault Occurrence		
Cause and correction	Assumed cause		Correction		Prevention	
	The parameter is the same for the <i>Master</i> and <i>Auxiliary</i> input variables to the instruction.		Correct the parameters so that different axes are specified for the <i>Master</i> and <i>Auxiliary</i> input variables to the instruction.		Specify different axes for the <i>Master</i> and <i>Auxiliary</i> input variables to the instruction.	
Attached information	None					
Precautions/Remarks	None					

Event name	Master/Slave Axis Numbers Not in Ascending Order		Event code	54380000 hex		
Meaning	The axis numbers specified for the <i>Master</i> and <i>Slave</i> input variables to a motion control instruction are not in ascending order.					
Source	Motion Control Function Module		Source details	Axis	Detection timing	At instruction execution
Error attributes	Level	Minor fault	Recovery	Error reset	Log category	System
Effects	User program	Continues.	Operation	Operation is not possible for relevant slave axis. Relevant slave axis decelerates to a stop if it is in motion.		
System-defined variables	Variable	Data type		Name		
	_MC_AX[*].MFAultLvl.Active	BOOL		Axis Minor Fault Occurrence		
Cause and correction	Assumed cause		Correction		Prevention	
	The parameters for the <i>Master</i> and <i>Slave</i> input variables to the instruction were not in ascending order when <i>_mcLatestCommand</i> was specified for the <i>ReferenceType</i> input variable to the instruction.		When specifying <i>_mcLatestCommand</i> for the <i>ReferenceType</i> input variable to the instruction, correct the parameters so that the axis numbers specified for the <i>Master</i> and <i>Slave</i> input variables to the instruction are in ascending order. Or, specify <i>_mcCommand</i> for the Master Axis Position Type Selection.		When specifying <i>_mcLatestCommand</i> for the <i>ReferenceType</i> input variable, make sure to specify the master axis and slave axis input variables so that they are in ascending order.	
Attached information	None					
Precautions/Remarks	None					

Event name	Incorrect Cam Table Specification		Event code	54390000 hex		
Meaning	The parameter specified for the <i>CamTable</i> input variable to a motion control instruction is out of range.					
Source	Motion Control Function Module		Source details	MC common or axis	Detection timing	At instruction execution
Error attributes	Level	Minor fault	Recovery	Error reset	Log category	System
Effects	User program	Continues.	Operation	If "MC Common" is given for the source details, Not affected. If "axis" is given for the source details, operation is not possible for relevant slave axis.		
System-defined variables	Variable	Data type		Name		
	_MC_COM.MFAultLvl.Active	BOOL		MC Common Minor Fault Occurrence		
	_MC_AX[*].MFAultLvl.Active	BOOL		Axis Minor Fault Occurrence		
Cause and correction	Assumed cause		Correction		Prevention	
	Something other than a cam data variable was specified for the <i>CamTable</i> input variable to the instruction.		Correct the parameter specified for the <i>CamTable</i> input variable to the instruction so that it is a cam data variable.		Specify a cam data variable for the <i>CamTable</i> input variable to the instruction.	
Attached information	None					
Precautions/Remarks	None					

Event name	Synchronization Stopped		Event code	543A0000 hex		
Meaning	A synchronized control motion control instruction was executed, but conditions required for execution were not met.					
Source	Motion Control Function Module		Source details	Axis	Detection timing	At instruction execution
Error attributes	Level	Minor fault	Recovery	Error reset	Log category	System
Effects	User program	Continues.	Operation	Operation is not possible for relevant slave axis. Relevant slave axis decelerates to a stop if it is in motion.		
System-defined variables	Variable	Data type		Name		
	_MC_AX[*].MFAultLvl.Active	BOOL		Axis Minor Fault Occurrence		
Cause and correction	Assumed cause	Correction		Prevention		
	<ul style="list-style-type: none"> The MC_CamOut (End Cam Operation) instruction was executed even though the MC_CamIn (Start Cam Operation) instruction is not being executed. The MC_GearOut (End Gear Operation) instruction was executed even though the MC_GearIn (Start Gear Operation) or the MC_GearInPos (Positioning Gear Operation) instruction is not being executed. The MC_Phasing (Shift Master Axis Phase) instruction was executed even though the MC_CamIn (Start Cam Operation), MC_GearIn (Start Gear Operation), MC_GearInPos (Start Gear Operation), or MC_MoveLink (Synchronous Positioning) instruction is not being executed. 	Correct the program so that required conditions are met when the instruction is executed.		Make sure that required conditions for execution are met when you execute synchronized control instructions.		
Attached information	None					
Precautions/Remarks	None					

Event name	Motion Control Instruction Re-execution Disabled		Event code	543B0000 hex	
Meaning	An attempt was made to re-execute a motion control instruction that cannot be re-executed.				
Source	Motion Control Function Module	Source details	MC common, axis, or axes group	Detection timing	At instruction execution
Error attributes	Level	Minor fault	Recovery	Error reset	Log category System
Effects	User program	Continues.	Operation	<p>If “MC Common” is given for the source details, Not affected.</p> <p>If “axis” is given for the source details, operation is not possible for relevant axis. Relevant axis decelerates to a stop if it is in motion.</p> <p>If “axes group” is given for the source details, operation is not possible for relevant axes group. Relevant axes group decelerates to a stop if it is in motion.</p>	
System-defined variables	Variable	Data type		Name	
	_MC_COM.MFaultLvl.Active	BOOL		MC Common Minor Fault Occurrence	
	_MC_AX[*].MFaultLvl.Active	BOOL		Axis Minor Fault Occurrence	
	_MC_GRP[*].MFaultLvl.Active	BOOL		Axes Group Minor Fault Occurrence	
Cause and correction	Assumed cause	Correction		Prevention	
	A motion control instruction that cannot be re-executed was re-executed.	Correct the program so that the <i>Execute</i> input variable does not change to TRUE until the <i>Busy</i> output variable from the instruction changes to FALSE.		When using instructions that cannot be re-executed, include a condition for the <i>Execute</i> input variable so that it does not change to TRUE unless the <i>Busy</i> output variable for the previous instruction is FALSE. Or, stop the instruction before executing it again.	
Attached information	None				
Precautions/Remarks	None				

3 Error Descriptions and Corrections

Event name	Motion Control Instruction Multi-execution Disabled		Event code	543C0000 hex			
Meaning	Multiple functions that cannot be executed simultaneously were executed for the same target (MC common, axis, or axes group).						
Source	Motion Control Function Module		Source details	MC common, axis, or axes group	Detection timing	At multi-execution of instructions	
Error attributes	Level	Minor fault	Recovery	Error reset	Log category	System	
Effects	User program	Continues.	Operation	<p>If “MC Common” is given for the source details, Not affected.</p> <p>If “axis” is given for the source details, operation is not possible for relevant axis. Relevant axis decelerates to a stop if it is in motion.</p> <p>If “axes group” is given for the source details, operation is not possible for relevant axes group. Relevant axes group decelerates to a stop if it is in motion.</p>			
System-defined variables	Variable		Data type		Name		
	_MC_COM.MFaultLvl.Active		BOOL		MC Common Minor Fault Occurrence		
	_MC_AX[*].MFaultLvl.Active		BOOL		Axis Minor Fault Occurrence		
		_MC_GRP[*].MFaultLvl.Active		BOOL		Axes Group Minor Fault Occurrence	
Cause and correction	Assumed cause		Correction		Prevention		
	Multiple functions that cannot be executed simultaneously were executed for the same target (MC common, axis, or axes group).		Check the specifications of multi-execution of instructions for this instruction and correct the program so that instructions that cannot be executed at the same time are not executed simultaneously.		Check the specifications for multi-execution of instructions for the instruction and do not execute instructions that cannot be executed at the same time.		
Attached information	None						
Precautions/Remarks	None						

Event name	Instruction Not Allowed for Encoder Axis Type		Event code	543D0000 hex		
Meaning	An operation instruction was executed for an encoder axis.					
Source	Motion Control Function Module		Source details	Axis	Detection timing	At instruction execution
Error attributes	Level	Minor fault	Recovery	Error reset	Log category	System
Effects	User program	Continues.	Operation	Operation is not possible for relevant axis.		
System-defined variables	Variable		Data type		Name	
	_MC_AX[*].MFaultLvl.Active		BOOL		Axis Minor Fault Occurrence	
Cause and correction	Assumed cause		Correction		Prevention	
	An operation instruction was executed for an encoder axis.		Specify either a Servo axis or virtual Servo axis as the axis type for the instruction, or correct the program so that the instruction is not executed for an encoder axis.		Only execute motion instructions for Servo axes or virtual Servo axes.	
Attached information	None					
Precautions/Remarks	None					

Event name	Instruction Cannot Be Executed during Multi-axes Co-ordinated Control		Event code	543E0000 hex		
Meaning	<ul style="list-style-type: none"> An operation instruction was executed for an axis or an axes group that was in a coordinated multi-axes motion. A robot instruction that you cannot use for an axes group in a GroupEnable state was executed. 					
Source	Motion Control Function Module		Source details	Axis or axis group	Detection timing	At multi-execution of instructions
Error attributes	Level	Minor fault	Recovery	Error reset	Log category	System
Effects	User program	Continues.	Operation	The axes group decelerates to a stop.		
System-defined variables	Variable		Data type		Name	
	_MC_AX[*].MFAultLvl.Active		BOOL		Axis Minor Fault Occurrence	
	_MC_GRP[*].MFAultLvl.Active		BOOL		Axes Group Minor Fault Occurrence	
Cause and correction	Assumed cause		Correction		Prevention	
	An operation instruction was executed for an axis or an axes group that was in a coordinated multi-axes motion.		Correct the program so that axis operation instructions are executed only for axes or axes groups that are not in coordinated multi-axes motion.		Execute axis operation instructions only for axes or axes groups that are not in coordinated multi-axes motion.	
	The MC_SetKinTransform (Set Kinematics Transformation) instruction was executed for an axes group in a GroupEnable state.		Correct the program so that the instruction is executed only when the axes group is in a GroupDisable state.		Execute the instruction only when the axes group is in a GroupDisable state.	
Attached information	None					
Precautions/Remarks	None					

Event name	Multi-axes Coordinated Control Instruction Executed for Disabled Axes Group		Event code	543F0000 hex		
Meaning	A multi-axes coordinated control instruction was executed for an axes group that was in the Axes Group Disabled state.					
Source	Motion Control Function Module		Source details	Axes group	Detection timing	At instruction execution
Error attributes	Level	Minor fault	Recovery	Error reset	Log category	System
Effects	User program	Continues.	Operation	Operation is not possible for relevant axes group. Relevant axes group decelerates to a stop if it is in motion.		
System-defined variables	Variable	Data type		Name		
	_MC_GRP[*].MFAultLvl.Active	BOOL		Axes Group Minor Fault Occurrence		
Cause and correction	Assumed cause	Correction		Prevention		
	A multi-axes coordinated control instruction was executed for an axes group that was in the Axes Group Disabled state.	Correct the program so that the instruction is executed only after changing the axes group to the Axes Group Enabled state. Execute the MC_GroupEnable (Enable Axes Group) instruction to change an axes group to the Axes Group Enabled state.		Execute multi-axes coordinated operation instructions only after enabling the axes group. Execute the MC_GroupEnable (Enable Axes Group) instruction to change an axes group to the Axes Group Enabled state.		
	One of the following instructions was executed for an axes group that was in a GroupDisable state. <ul style="list-style-type: none"> • MC_MoveTimeAbsolute (Time-specified Absolute Positioning) instruction • MC_SyncLinearConveyor (Start Conveyor Synchronization) instruction • MC_SyncOut (End Synchronization) instruction • MC_RobotJog (Axes Group Jog) instruction 					
Attached information	None					
Precautions/Remarks	None					

Event name	Axes Group Cannot Be Enabled		Event code	54400000 hex	
Meaning	Execution of the MC_GroupEnable (Enable Axes Group) instruction failed.				
Source	Motion Control Function Module		Source details	Axes group	Detection timing At instruction execution
Error attributes	Level	Minor fault	Recovery	Error reset	Log category System
Effects	User program	Continues.	Operation	Operation is not possible for relevant axes group. The operation of the composition axes will continue.	
System-defined variables	Variable		Data type	Name	
	_MC_GRP[*].MFAultLvl.Active		BOOL	Axes Group Minor Fault Occurrence	
Cause and correction	Assumed cause		Correction	Prevention	
	When the MC_GroupEnable (Enable Axes Group) instruction was executed, there was a composition axis that was not stopped.		Correct the program so that the MC_GroupEnable (Enable Axes Group) instruction is executed only when all composition axes are stopped. An axis is stopped if <i>Status.Disabled</i> or <i>Status.Standstill</i> is TRUE in the Axis Variable.	Write the programs so that the MC_GroupEnable (Enable Axes Group) instruction is executed only when all composition axes are stopped. An axis is stopped if <i>Status.Disabled</i> or <i>Status.Standstill</i> is TRUE in the Axis Variable.	
	When the MC_GroupEnable (Enable Axes Group) instruction was executed, there was a composition axis for which the MC_TouchProbe (Enable External Latch) instruction was being executed.		Correct the program so that the MC_GroupEnable (Enable Axes Group) instruction is executed only when the MC_TouchProbe (Enable External Latch) instruction is not being executed for any of the composition axes.	Write the program so that the MC_GroupEnable (Enable Axes Group) instruction is executed only when the MC_TouchProbe (Enable External Latch) instruction is not being executed for any of the composition axes.	
Attached information	None				
Precautions/Remarks	None				

Event name	Impossible Axis Operation Specified when the Servo is OFF		Event code	54410000 hex		
Meaning	An operation instruction was executed for an axis for which the Servo is OFF.					
Source	Motion Control Function Module		Source details	Axis/axes group	Detection timing	At instruction execution
Error attributes	Level	Minor fault	Recovery	Error reset	Log category	System
Effects	User program	Continues.	Operation	The motion instruction will not start.		
System-defined variables	Variable		Data type		Name	
	_MC_AX[*].MFAultLvl.Active		BOOL		Axis Minor Fault Occurrence	
	_MC_GRP[*].MFAultLvl.Active		BOOL		Axes Group Minor Fault Occurrence	
Cause and correction	Assumed cause		Correction		Prevention	
	An operation instruction was executed for an axis for which the Servo is OFF.		Correct the program so that the instruction is executed after the Servo is turned ON.		Make sure to execute the axis operation instruction after the Servo is turned ON.	
Home was preset with the MC_Home or MC_HomeWithParameter instruction for an axis for which EtherCAT process data communications are not established.		If the <code>_EC_PDSlavTbl</code> (Process Data Communicating Slave Table) system-defined variable for the EtherCAT master of the master axis is FALSE, remove the cause and execute the MC_Home or MC_HomeWithParameter instruction to preset home after <code>_EC_PDSlavTbl</code> changes to TRUE.		If you execute the MC_Home or MC_HomeWithParameter instruction to preset home immediately after you turn ON the power supply to the Controller, download data, reset a slave communications error, disconnect the slave, reconnect the slave, enable the slave, or disable the slave, write the program to make sure that the <code>_EC_PDSlavTbl</code> (Process Data Communicating Slave Table) system-defined variable for the EtherCAT master is TRUE before you execute MC_Home or MC_HomeWithParameter.		
Attached information	Attached Information 1: Depends on the source details <ul style="list-style-type: none"> • Axis: 0 • Axes group: Number of the logical axis where the error occurred 					
Precautions/Remarks	None					

Event name	Composition Axis Stopped Error		Event code	54420000 hex		
Meaning	A motion instruction was executed for an axes group while the MC_Stop instruction was being executed for a composition axis.					
Source	Motion Control Function Module		Source details	Axes group	Detection timing	At instruction execution
Error attributes	Level	Minor fault	Recovery	Error reset	Log category	System
Effects	User program	Continues.	Operation	Operation is not possible for relevant axes group.		
System-defined variables	Variable		Data type		Name	
	_MC_GRP[*].MFAultLvl.Active		BOOL		Axes Group Minor Fault Occurrence	
Cause and correction	Assumed cause		Correction		Prevention	
	A motion instruction was executed for an axes group while the MC_Stop instruction was being executed for a composition axis.		Change the <i>Execute</i> input variable to the MC_Stop instruction for the composition axis to FALSE, reset the error, and then execute the motion control instruction.		Change the <i>Execute</i> input variables to the MC_Stop instructions for all of the composition axes to FALSE before you execute motion control instruction.	
Attached information	Attached information 1: Number of the logical axis that was stopped.					
Precautions/Remarks	None					

Event name	Motion Control Instruction Multi-execution Buffer Limit Exceeded		Event code	54430000 hex		
Meaning	The number of motion control instructions that is buffered for Buffered or Blending Buffer Modes exceeded the buffer limit.					
Source	Motion Control Function Module		Source details	Axis/axes group	Detection timing	At multi-execution of instructions
Error attributes	Level	Minor fault	Recovery	Error reset	Log category	System
Effects	User program	Continues.	Operation	If "axis" is given for the source details, operation is not possible for relevant axis. Relevant axis decelerates to a stop if it is in motion. If "axes group" is given for the source details, operation is not possible for relevant axes group. Relevant axes group decelerates to a stop if it is in motion.		
System-defined variables	Variable		Data type		Name	
	_MC_AX[*].MFAultLvl.Active		BOOL		Axis Minor Fault Occurrence	
	_MC_GRP[*].MFAultLvl.Active		BOOL		Axes Group Minor Fault Occurrence	
Cause and correction	Assumed cause		Correction		Prevention	
	An axis instruction was executed when there was already a current instruction and a buffered instruction for the same axis.		Correct the program so that the number of executed instructions does not exceed the buffer limit.		Do not execute an axis instruction when there is already a current instruction and a buffered instruction for the same axis.	
An axes group instruction was executed when there was already eight current instructions and buffered instructions for the same axis.		Do not execute an axes group instruction when there are already eight current and buffered instructions for the same axis.				
Attached information	None					
Precautions/Remarks	None					

Event name	Insufficient Travel Distance		Event code	54440000 hex		
Meaning	The specified motion cannot be executed for the deceleration rate or acceleration rate that was specified for multi-execution or re-execution of a positioning instruction.					
Source	Motion Control Function Module		Source details	Axis/axes group	Detection timing	At instruction execution
Error attributes	Level	Minor fault	Recovery	Error reset	Log category	System
Effects	User program	Continues.	Operation	If "axis" is given for the source details, operation is not possible for relevant axis. Relevant axis decelerates to a stop if it is in motion. If "axes group" is given for the source details, operation is not possible for relevant axes group. Relevant axes group decelerates to a stop if it is in motion.		
System-defined variables	Variable	Data type		Name		
	_MC_AX[*].MFAultLvl.Active	BOOL		Axis Minor Fault Occurrence		
	_MC_GRP[*].MFAultLvl.Active	BOOL		Axes Group Minor Fault Occurrence		
Cause and correction	Assumed cause		Correction		Prevention	
	Stopping at the target position was not possible for the specified acceleration/deceleration rate for multi-execution or re-execution of a positioning instruction when the Acceleration/Deceleration Over parameter was set to generate a minor fault and stop.		Correct the program based on the operating specifications for the instruction so that the target position is not exceeded at the deceleration rate or acceleration rate specified for multi-execution or re-execution of the positioning instruction. Or, change the Acceleration/Deceleration Over parameter to a setting other than to generate a minor fault and stop.		Check the operating specifications for the relevant instruction and write the program so that this error does not occur. Or, change the Acceleration/Deceleration Over parameter to a setting other than to generate a minor fault and stop.	
Attached information	None					
Precautions/Remarks	None					

Event name	Insufficient Travel Distance to Achieve Blending Transit Velocity		Event code	54450000 hex		
Meaning	There is not sufficient travel distance to accelerate or decelerate to the transit velocity.					
Source	Motion Control Function Module		Source details	Axis/axes group	Detection timing	At multi-execution of instructions
Error attributes	Level	Minor fault	Recovery	Error reset	Log category	System
Effects	User program	Continues.	Operation	If "axis" is given for the source details, operation is not possible for relevant axis. Relevant axis decelerates to a stop if it is in motion. If "axes group" is given for the source details, operation is not possible for relevant axes group. Relevant axes group decelerates to a stop if it is in motion.		
System-defined variables	Variable		Data type		Name	
	_MC_AX[*].MFAultLvl.Active		BOOL		Axis Minor Fault Occurrence	
	_MC_GRP[*].MFAultLvl.Active		BOOL		Axes Group Minor Fault Occurrence	
Cause and correction	Assumed cause		Correction		Prevention	
	There was not sufficient travel distance to accelerate the current command to the transit velocity when the Acceleration/Deceleration Over parameter was set to generate a minor fault and stop.		Correct the program to allow a sufficient travel distance according to the operating specifications of the instruction. Or, change the Acceleration/Deceleration Over parameter to a setting other than to generate a minor fault and stop.		Check the operating specifications for the relevant instruction and write the program so that this error does not occur. Or, change the Acceleration/Deceleration Over parameter to a setting other than to generate a minor fault and stop.	
Attached information	None					
Precautions/Remarks	None					

Event name	Move Link Constant Velocity Insufficient Travel Distance		Event code	54460000 hex		
Meaning	The constant-velocity travel distance of the master axis is less than zero.					
Source	Motion Control Function Module		Source details	Axis	Detection timing	At instruction execution
Error attributes	Level	Minor fault	Recovery	Error reset	Log category	System
Effects	User program	Continues.	Operation	Operation is not possible for relevant axis. Relevant axis decelerates to a stop if it is in motion.		
System-defined variables	Variable		Data type		Name	
	_MC_AX[*].MFAultLvl.Active		BOOL		Axis Minor Fault Occurrence	
Cause and correction	Assumed cause		Correction		Prevention	
	The constant velocity travel distance of the master axis is below 0 for the MC_MoveLink (Synchronous Positioning) instruction.		Correct the program so that the master axis travel distance is greater than or equal to the master distance in acceleration plus the master distance in deceleration.		Check the operating specifications for the relevant instruction and write the program so that this error does not occur.	
Attached information	None					
Precautions/Remarks	None					

3 Error Descriptions and Corrections

Event name	Positioning Gear Operation Insufficient Target Velocity		Event code	54470000 hex		
Meaning	For the MC_GearInPos (Positioning Gear Operation) instruction, the target velocity of the slave axis is too small to achieve the required velocity.					
Source	Motion Control Function Module		Source details	Axis	Detection timing	At instruction execution
Error attributes	Level	Minor fault	Recovery	Error reset	Log category	System
Effects	User program	Continues.	Operation	Operation is not possible for relevant axis. Relevant axis decelerates to a stop if it is in motion.		
System-defined variables	Variable		Data type		Name	
	_MC_AX[*].MFAultLvl.Active		BOOL		Axis Minor Fault Occurrence	
Cause and correction	Assumed cause		Correction		Prevention	
	For the MC_GearInPos (Positioning Gear Operation) instruction, the value of the <i>Velocity</i> (Target Velocity) input variable is smaller than the master axis velocity multiplied by the gear ratio when the instruction was executed.		Set the value of the <i>Velocity</i> (Target Velocity) input variable to a value that is greater than the master axis velocity multiplied by the gear ratio when the instruction is executed based on the operating specifications of the instruction.		Check the operating specifications for the relevant instruction and write the program so that this error does not occur.	
Attached information	None					
Precautions/Remarks	None					

Event name	Same Start Point and End Point for Circular Interpolation		Event code	54480000 hex		
Meaning	The start point and end point were the same when the radius method was specified for the MC_MoveCircular2D (Circular 2D Interpolation) instruction. Or, the start point, end point, and border point were the same when the border point method was specified.					
Source	Motion Control Function Module		Source details	Axes group	Detection timing	At instruction execution
Error attributes	Level	Minor fault	Recovery	Error reset	Log category	System
Effects	User program	Continues.	Operation	Operation is not possible for relevant axes group. Relevant axes group decelerates to a stop if it is in motion.		
System-defined variables	Variable		Data type		Name	
	_MC_GRP[*].MFAultLvl.Active		BOOL		Axes Group Minor Fault Occurrence	
Cause and correction	Assumed cause		Correction		Prevention	
	The start point and end point were the same when the radius method was specified for the MC_MoveCircular2D (Circular 2D Interpolation) instruction.		Correct the program so that the radius specification is not used when the start point and end point for the instruction are the same.		Do not use the same start point and end point when you execute circular interpolation with a radius specification.	
	The start point, end point, and border point were the same when the border point method was specified for the MC_MoveCircular2D (Circular 2D Interpolation) instruction.		Correct the program so that border point specification is not used when the start point, end point, and border point for the instruction are the same.		Do not use the same start point, end point, and border point when you execute circular interpolation with a border point specification.	
Attached information	None					
Precautions/Remarks	None					

Event name	Circular Interpolation Center Specification Position Out of Range		Event code	54490000 hex		
Meaning	The position specified for the center point exceeded the allowed range when the center method was specified for the MC_MoveCircular2D (Circular 2D Interpolation) instruction.					
Source	Motion Control Function Module		Source details	Axes group	Detection timing	At instruction execution
Error attributes	Level	Minor fault	Recovery	Error reset	Log category	System
Effects	User program	Continues.	Operation	Operation is not possible for relevant axes group. Relevant axes group decelerates to a stop if it is in motion.		
System-defined variables	Variable	Data type		Name		
	_MC_GRP[*].MFAultLvl.Active	BOOL		Axes Group Minor Fault Occurrence		
Cause and correction	Assumed cause		Correction		Prevention	
	The difference between the distance from the start point to the center point and the distance between the end point to the center point exceeded the permitted value specified for the correction allowance ratio in the axes group settings when the center designation method was specified for the MC_MoveCircular2D (Circular 2D Interpolation) instruction.		Correct the center point so that the difference between the distance from the start point to the center point input variables and the distance between the end point to the center point input variables is less than the permitted value specified for the correction allowance ratio in the axes group settings.		Correct the difference between the distance from the start point to the center point and the distance between the end point to the center point so that it does not exceed the correction allowance ratio in the axes group settings.	
Attached information	None					
Precautions/Remarks	None					

Event name	Instruction Execution Error Caused by Count Mode Setting		Event code	544A0000 hex		
Meaning	An instruction that cannot be used when the Count Mode is set to Rotary Mode was executed for an axis that was set to Rotary Mode.					
Source	Motion Control Function Module		Source details	Axes group	Detection timing	At instruction execution
Error attributes	Level	Minor fault	Recovery	Error reset	Log category	System
Effects	User program	Continues.	Operation	Operation is not possible for relevant axes group. Relevant axes group decelerates to a stop if it is in motion.		
System-defined variables	Variable	Data type		Name		
	_MC_GRP[*].MFAultLvl.Active	BOOL		Axes Group Minor Fault Occurrence		
Cause and correction	Assumed cause		Correction		Prevention	
	An instruction that cannot be used when the Count Mode is set to Rotary Mode was executed for an axis that was set to Rotary Mode.		Change the Count Mode of the relevant axis to Linear Mode.		Confirm the Count Mode in which you can execute the instruction and set the correct Count Mode for the axis.	
Attached information	None					
Precautions/Remarks	None					

3 Error Descriptions and Corrections

Event name	Parameter Selection Out of Range			Event code	544C0000 hex	
Meaning	The parameter specified for the <i>ParameterNumber</i> input variable to a motion control instruction is out of range.					
Source	Motion Control Function Module		Source details	MC Common	Detection timing	At instruction execution
Error attributes	Level	Minor fault	Recovery	Error reset	Log category	System
Effects	User program	Continues.	Operation	The instruction is not executed.		
System-defined variables	Variable		Data type		Name	
	_MC_COM.MFaultLvl.Active		BOOL		MC Common Minor Fault Occurrence	
Cause and correction	Assumed cause		Correction		Prevention	
	Instruction input parameter exceeded the valid range of the input variable.		Correct the parameter so that the valid range of the input variable is not exceeded for the relevant instruction.		Set the input parameter to the instruction so that the valid range of the input variable is not exceeded.	
Attached information	None					
Precautions/Remarks	None					

Event name	Stop Method Selection Out of Range			Event code	544D0000 hex	
Meaning	The parameter specified for the <i>StopMode</i> input variable to a motion control instruction is out of range.					
Source	Motion Control Function Module		Source details	Axis	Detection timing	At instruction execution
Error attributes	Level	Minor fault	Recovery	Error reset	Log category	System
Effects	User program	Continues.	Operation	Operation is not possible for relevant axis. Relevant axis decelerates to a stop if it is in motion.		
System-defined variables	Variable		Data type		Name	
	_MC_AX[*].MFaultLvl.Active		BOOL		Axis Minor Fault Occurrence	
Cause and correction	Assumed cause		Correction		Prevention	
	Instruction input parameter exceeded the valid range of the input variable.		Correct the parameter so that the valid range of the input variable is not exceeded for the relevant instruction.		Set the input parameter to the instruction so that the valid range of the input variable is not exceeded.	
Attached information	None					
Precautions/Remarks	None					

Event name	Latch ID Selection Out of Range for Trigger Input Condition		Event code	544E0000 hex		
Meaning	The parameter specified for the <i>TriggerInput::LatchID</i> input variable to a motion control instruction is out of range.					
Source	Motion Control Function Module		Source details	Axis	Detection timing	At instruction execution
Error attributes	Level	Minor fault	Recovery	Error reset	Log category	System
Effects	User program	Continues.	Operation	Operation is not possible for relevant axis. Relevant axis decelerates to a stop if it is in motion.		
System-defined variables	Variable		Data type		Name	
	_MC_AX[*].MFAultLvl.Active		BOOL		Axis Minor Fault Occurrence	
Cause and correction	Assumed cause		Correction		Prevention	
	Instruction input parameter exceeded the valid range of the input variable.		Correct the parameter so that the valid range of the input variable is not exceeded for the relevant instruction.		Set the input parameter to the instruction so that the valid range of the input variable is not exceeded.	
Attached information	None					
Precautions/Remarks	None					

Event name	Setting Out of Range for Writing MC Setting		Event code	544F0000 hex		
Meaning	The parameter specified for the <i>SettingValue</i> input variable to a motion control instruction is out of range.					
Source	Motion Control Function Module		Source details	MC Common	Detection timing	At instruction execution
Error attributes	Level	Minor fault	Recovery	Error reset	Log category	System
Effects	User program	Continues.	Operation	The instruction is not executed.		
System-defined variables	Variable		Data type		Name	
	_MC_COM.MFAultLvl.Active		BOOL		MC Common Minor Fault Occurrence	
Cause and correction	Assumed cause		Correction		Prevention	
	Instruction input parameter exceeded the valid range of the input variable.		Correct the parameter so that the valid range of the input variable is not exceeded for the relevant instruction.		Set the input parameter to the instruction so that the valid range of the input variable is not exceeded.	
	The parameter specification and the data type of the setting value do not agree.		Make corrections so that the parameter settings and the data types of the settings agree.		Make sure the parameter settings and the data type of the setting values agree.	
Attached information	None					
Precautions/Remarks	None					

3 Error Descriptions and Corrections

Event name	Trigger Input Condition Mode Selection Out of Range		Event code	54500000 hex		
Meaning	The parameter specified for the <i>TriggerInput::Mode</i> input variable to a motion control instruction is out of range.					
Source	Motion Control Function Module		Source details	Axis	Detection timing	At instruction execution
Error attributes	Level	Minor fault	Recovery	Error reset	Log category	System
Effects	User program	Continues.	Operation	Operation is not possible for relevant axis. Relevant axis decelerates to a stop if it is in motion.		
System-defined variables	Variable		Data type		Name	
	_MC_AX[*].MFAultLvl.Active		BOOL		Axis Minor Fault Occurrence	
Cause and correction	Assumed cause		Correction		Prevention	
	Instruction input parameter exceeded the valid range of the input variable.		Correct the parameter so that the valid range of the input variable is not exceeded for the relevant instruction.		Set the input parameter to the instruction so that the valid range of the input variable is not exceeded.	
Attached information	None					
Precautions/Remarks	None					

Event name	Drive Trigger Signal Selection Out of Range for Trigger Input Condition		Event code	54510000 hex		
Meaning	The parameter specified for the <i>TriggerInput::InputDrive</i> input variable to a motion control instruction is out of range.					
Source	Motion Control Function Module		Source details	Axis	Detection timing	At instruction execution
Error attributes	Level	Minor fault	Recovery	Error reset	Log category	System
Effects	User program	Continues.	Operation	Operation is not possible for relevant axis. Relevant axis decelerates to a stop if it is in motion.		
System-defined variables	Variable		Data type		Name	
	_MC_AX[*].MFAultLvl.Active		BOOL		Axis Minor Fault Occurrence	
Cause and correction	Assumed cause		Correction		Prevention	
	Instruction input parameter exceeded the valid range of the input variable.		Correct the parameter so that the valid range of the input variable is not exceeded for the relevant instruction.		Set the input parameter to the instruction so that the valid range of the input variable is not exceeded.	
Attached information	None					
Precautions/Remarks	None					

Event name	Motion Control Instruction Re-execution Disabled (Axis Specification)		Event code	54530000 hex		
Meaning	An attempt was made to change the parameter for the Axis input variable when re-executing a motion control instruction. (This input variable cannot be changed when re-executing an instruction.)					
Source	Motion Control Function Module		Source details	Axis	Detection timing	At instruction re-execution
Error attributes	Level	Minor fault	Recovery	Error reset	Log category	System
Effects	User program	Continues.	Operation	Operation is not possible for relevant axis. Relevant axis decelerates to a stop if it is in motion.		
System-defined variables	Variable	Data type		Name		
	_MC_AX[*].MFAultLvl.Active	BOOL		Axis Minor Fault Occurrence		
Cause and correction	Assumed cause		Correction		Prevention	
	A parameter for an input variable that cannot be changed for re-execution was changed.		Correct the program so that the parameter for the relevant input variable does not change when the relevant instruction is re-executed.		Check the manual to see if the input variables to the relevant motion control instruction can be changed by re-execution. Write the program so that the input parameters for any input variable that cannot be changed do not change upon re-execution.	
Attached information	None					
Precautions/Remarks	None					

Event name	Motion Control Instruction Re-execution Disabled (Buffer Mode Selection)		Event code	54540000 hex		
Meaning	An attempt was made to change the parameter for the <i>BufferMode</i> input variable when re-executing a motion control instruction. (This input variable cannot be changed when re-executing an instruction.)					
Source	Motion Control Function Module		Source details	Axis/axes group	Detection timing	At instruction re-execution
Error attributes	Level	Minor fault	Recovery	Error reset	Log category	System
Effects	User program	Continues.	Operation	If "axis" is given for the source details, operation is not possible for relevant axis. Relevant axis decelerates to a stop if it is in motion. If "axes group" is given for the source details, operation is not possible for relevant axes group. Relevant axes group decelerates to a stop if it is in motion.		
System-defined variables	Variable	Data type		Name		
	_MC_AX[*].MFAultLvl.Active	BOOL		Axis Minor Fault Occurrence		
	_MC_GRP[*].MFAultLvl.Active	BOOL		Axes Group Minor Fault Occurrence		
Cause and correction	Assumed cause		Correction		Prevention	
	A parameter for an input variable that cannot be changed for re-execution was changed.		Correct the program so that the parameter for the relevant input variable does not change when the relevant instruction is re-executed.		Check the manual to see if the input variables to the relevant motion control instruction can be changed by re-execution. Write the program so that the input parameters for any input variable that cannot be changed do not change upon re-execution.	
Attached information	None					
Precautions/Remarks	None					

Event name	Motion Control Instruction Re-execution Disabled (Direction Selection)		Event code	54550000 hex		
Meaning	An attempt was made to change the parameter for the <i>Direction</i> input variable when re-executing a motion control instruction. (This input variable cannot be changed when re-executing an instruction.)					
Source	Motion Control Function Module		Source details	Axis	Detection timing	At instruction re-execution
Error attributes	Level	Minor fault	Recovery	Error reset	Log category	System
Effects	User program	Continues.	Operation	Operation is not possible for relevant axis. Relevant axis decelerates to a stop if it is in motion.		
System-defined variables	Variable	Data type		Name		
	_MC_AX[*].MFAultLvl.Active	BOOL		Axis Minor Fault Occurrence		
Cause and correction	Assumed cause	Correction		Prevention		
	An input variable that cannot be changed for re-execution was changed.	Correct the program so that the parameter for the relevant input variable does not change when the relevant instruction is re-executed.		Check the manual to see if the input variables to the relevant motion control instruction can be changed by re-execution. Write the program so that the input parameters for any input variable that cannot be changed do not change upon re-execution.		
Attached information	None					
Precautions/Remarks	None					

Event name	Motion Control Instruction Re-execution Disabled (Execution Mode)		Event code	54560000 hex		
Meaning	An attempt was made to change the parameter for the <i>Periodic</i> input variable when re-executing a motion control instruction. (This input variable cannot be changed when re-executing an instruction.)					
Source	Motion Control Function Module		Source details	Axis	Detection timing	At instruction re-execution
Error attributes	Level	Minor fault	Recovery	Error reset	Log category	System
Effects	User program	Continues.	Operation	Operation is not possible for relevant axis. Relevant axis decelerates to a stop if it is in motion.		
System-defined variables	Variable	Data type		Name		
	_MC_AX[*].MFAultLvl.Active	BOOL		Axis Minor Fault Occurrence		
Cause and correction	Assumed cause	Correction		Prevention		
	A parameter for an input variable that cannot be changed for re-execution was changed.	Correct the program so that the parameter for the relevant input variable does not change when the relevant instruction is re-executed.		Check the manual to see if the input variables to the relevant motion control instruction can be changed by re-execution. Write the program so that the input parameters for any input variable that cannot be changed do not change upon re-execution.		
Attached information	None					
Precautions/Remarks	None					

Event name	Motion Control Instruction Re-execution Disabled (Axes Group Specification)		Event code	54570000 hex		
Meaning	An attempt was made to change the parameter for the <i>AxesGroup</i> input variable when re-executing a motion control instruction. (This input variable cannot be changed when re-executing an instruction.)					
Source	Motion Control Function Module		Source details	Axes group	Detection timing	At instruction re-execution
Error attributes	Level	Minor fault	Recovery	Error reset	Log category	System
Effects	User program	Continues.	Operation	Operation is not possible for relevant axes group. Relevant axes group decelerates to a stop if it is in motion.		
System-defined variables	Variable		Data type		Name	
	_MC_GRP[*].MFAultLvl.Active		BOOL		Axes Group Minor Fault Occurrence	
Cause and correction	Assumed cause		Correction		Prevention	
	A parameter for an input variable that cannot be changed for re-execution was changed.		Correct the program so that the parameter for the relevant input variable does not change when the relevant instruction is re-executed.		Check the manual to see if the input variables to the relevant motion control instruction can be changed by re-execution. Write the program so that the input parameters for any input variable that cannot be changed do not change upon re-execution.	
Attached information	None					
Precautions/Remarks	None					

Event name	Motion Control Instruction Re-execution Disabled (Jerk Setting)		Event code	54580000 hex		
Meaning	An attempt was made to change the parameter for the <i>Jerk</i> input variable when re-executing a motion control instruction. (This input variable cannot be changed when re-executing an instruction.)					
Source	Motion Control Function Module		Source details	Axis/axes group	Detection timing	At instruction re-execution
Error attributes	Level	Minor fault	Recovery	Error reset	Log category	System
Effects	User program	Continues.	Operation	If "axis" is given for the source details, operation is not possible for relevant axis. Relevant axis decelerates to a stop if it is in motion. If "axes group" is given for the source details, operation is not possible for relevant axes group. Relevant axes group decelerates to a stop if it is in motion.		
System-defined variables	Variable	Data type		Name		
	_MC_AX[*].MFAultLvl.Active	BOOL		Axis Minor Fault Occurrence		
	_MC_GRP[*].MFAultLvl.Active	BOOL		Axes Group Minor Fault Occurrence		
Cause and correction	Assumed cause		Correction		Prevention	
	A parameter for an input variable that cannot be changed for re-execution was changed.		Correct the program so that the parameter for the relevant input variable does not change when the relevant instruction is re-executed.		Check the manual to see if the input variables to the relevant motion control instruction can be changed by re-execution. Write the program so that the input parameters for any input variable that cannot be changed do not change upon re-execution.	
Attached information	None					
Precautions/Remarks	None					

3 Error Descriptions and Corrections

Event name	Motion Control Instruction Re-execution Disabled (Master Axis)		Event code	54590000 hex		
Meaning	An attempt was made to change the parameter for the <i>Master</i> input variable when re-executing a motion control instruction. (This input variable cannot be changed when re-executing an instruction.)					
Source	Motion Control Function Module		Source details	Axis	Detection timing	At instruction re-execution
Error attributes	Level	Minor fault	Recovery	Error reset	Log category	System
Effects	User program	Continues.	Operation	Operation is not possible for relevant axis. Relevant axis decelerates to a stop if it is in motion.		
System-defined variables	Variable		Data type		Name	
	_MC_AX[*].MFAultLvl.Active		BOOL		Axis Minor Fault Occurrence	
Cause and correction	Assumed cause		Correction		Prevention	
	A parameter for an input variable that cannot be changed for re-execution was changed.		Correct the program so that the parameter for the relevant input variable does not change when the relevant instruction is re-executed.		Check the manual to see if the input variables to the relevant motion control instruction can be changed by re-execution. Write the program so that the input parameters for any input variable that cannot be changed do not change upon re-execution.	
Attached information	None					
Precautions/Remarks	None					

Event name	Motion Control Instruction Re-execution Disabled (MasterOffset)		Event code	545A0000 hex		
Meaning	An attempt was made to change the parameter for the <i>MasterOffset</i> input variable when re-executing a motion control instruction. (This input variable cannot be changed when re-executing an instruction.)					
Source	Motion Control Function Module		Source details	Axis	Detection timing	At instruction re-execution
Error attributes	Level	Minor fault	Recovery	Error reset	Log category	System
Effects	User program	Continues.	Operation	Operation is not possible for relevant axis. Relevant axis decelerates to a stop if it is in motion.		
System-defined variables	Variable		Data type		Name	
	_MC_AX[*].MFAultLvl.Active		BOOL		Axis Minor Fault Occurrence	
Cause and correction	Assumed cause		Correction		Prevention	
	A parameter for an input variable that cannot be changed for re-execution was changed.		Correct the program so that the parameter for the relevant input variable does not change when the relevant instruction is re-executed.		Check the manual to see if the input variables to the relevant motion control instruction can be changed by re-execution. Write the program so that the input parameters for any input variable that cannot be changed do not change upon re-execution.	
Attached information	None					
Precautions/Remarks	None					

Event name	Motion Control Instruction Re-execution Disabled (MasterScaling)		Event code	545B0000 hex		
Meaning	An attempt was made to change the parameter for the <i>MasterScaling</i> input variable when re-executing a motion control instruction. (This input variable cannot be changed when re-executing an instruction.)					
Source	Motion Control Function Module		Source details	Axis	Detection timing	At instruction re-execution
Error attributes	Level	Minor fault	Recovery	Error reset	Log category	System
Effects	User program	Continues.	Operation	Operation is not possible for relevant axis. Relevant axis decelerates to a stop if it is in motion.		
System-defined variables	Variable		Data type		Name	
	_MC_AX[*].MFAultLvl.Active		BOOL		Axis Minor Fault Occurrence	
Cause and correction	Assumed cause		Correction		Prevention	
	A parameter for an input variable that cannot be changed for re-execution was changed.		Correct the program so that the parameter for the relevant input variable does not change when the relevant instruction is re-executed.		Check the manual to see if the input variables to the relevant motion control instruction can be changed by re-execution. Write the program so that the input parameters for any input variable that cannot be changed do not change upon re-execution.	
Attached information	None					
Precautions/Remarks	None					

Event name	Motion Control Instruction Re-execution Disabled (MasterStartDistance)		Event code	545C0000 hex		
Meaning	An attempt was made to change the parameter for the <i>MasterStartDistance</i> input variable when re-executing a motion control instruction. (This input variable cannot be changed when re-executing an instruction.)					
Source	Motion Control Function Module		Source details	Axis	Detection timing	At instruction re-execution
Error attributes	Level	Minor fault	Recovery	Error reset	Log category	System
Effects	User program	Continues.	Operation	Operation is not possible for relevant axis. Relevant axis decelerates to a stop if it is in motion.		
System-defined variables	Variable		Data type		Name	
	_MC_AX[*].MFAultLvl.Active		BOOL		Axis Minor Fault Occurrence	
Cause and correction	Assumed cause		Correction		Prevention	
	A parameter for an input variable that cannot be changed for re-execution was changed.		Correct the program so that the parameter for the relevant input variable does not change when the relevant instruction is re-executed.		Check the manual to see if the input variables to the relevant motion control instruction can be changed by re-execution. Write the program so that the input parameters for any input variable that cannot be changed do not change upon re-execution.	
Attached information	None					
Precautions/Remarks	None					

3 Error Descriptions and Corrections

Event name	Motion Control Instruction Re-execution Disabled (Continuous)		Event code	545D0000 hex		
Meaning	An attempt was made to change the parameter for the <i>Continuous</i> input variable when re-executing a motion control instruction. (This input variable cannot be changed when re-executing an instruction.)					
Source	Motion Control Function Module		Source details	Axis	Detection timing	At instruction re-execution
Error attributes	Level	Minor fault	Recovery	Error reset	Log category	System
Effects	User program	Continues.	Operation	Operation is not possible for relevant axis. Relevant axis decelerates to a stop if it is in motion.		
System-defined variables	Variable		Data type		Name	
	_MC_AX[*].MFAultLvl.Active		BOOL		Axis Minor Fault Occurrence	
Cause and correction	Assumed cause		Correction		Prevention	
	A parameter for an input variable that cannot be changed for re-execution was changed.		Correct the program so that the parameter for the relevant input variable does not change when the relevant instruction is re-executed.		Check the manual to see if the input variables to the relevant motion control instruction can be changed by re-execution. Write the program so that the input parameters for any input variable that cannot be changed do not change upon re-execution.	
Attached information	None					
Precautions/Remarks	None					

Event name	Motion Control Instruction Re-execution Disabled (MoveMode)		Event code	545E0000 hex		
Meaning	An attempt was made to change the parameter for the <i>MoveMode</i> input variable when re-executing a motion control instruction. (This input variable cannot be changed when re-executing an instruction.)					
Source	Motion Control Function Module		Source details	Axis	Detection timing	At instruction re-execution
Error attributes	Level	Minor fault	Recovery	Error reset	Log category	System
Effects	User program	Continues.	Operation	Operation is not possible for relevant axis. Relevant axis decelerates to a stop if it is in motion.		
System-defined variables	Variable		Data type		Name	
	_MC_AX[*].MFAultLvl.Active		BOOL		Axis Minor Fault Occurrence	
Cause and correction	Assumed cause		Correction		Prevention	
	A parameter for an input variable that cannot be changed for re-execution was changed.		Correct the program so that the parameter for the relevant input variable does not change when the relevant instruction is re-executed.		Check the manual to see if the input variables to the relevant motion control instruction can be changed by re-execution. Write the program so that the input parameters for any input variable that cannot be changed do not change upon re-execution.	
Attached information	None					
Precautions/Remarks	None					

Event name	Illegal Auxiliary Axis Specification			Event code	545F0000 hex	
Meaning	The axis specified for the <i>Auxiliary</i> input variable to a motion control instruction does not exist.					
Source	Motion Control Function Module		Source details	Axis	Detection timing	At instruction execution
Error attributes	Level	Minor fault	Recovery	Error reset	Log category	System
Effects	User program	Continues.	Operation	Operation is not possible for relevant slave axis. The slave axis decelerates to a stop if it is in motion.		
System-defined variables	Variable		Data type		Name	
	_MC_AX[*].MFAultLvl.Active		BOOL		Axis Minor Fault Occurrence	
Cause and correction	Assumed cause		Correction		Prevention	
	An axis does not exist for the variable specified for the <i>Auxiliary</i> input variable to the instruction.		Correct the instruction so that the variable exists for the axis that was specified for the instruction.		Make sure to specify variables that exist when specifying variables for the input parameters to an instruction.	
Attached information	None					
Precautions/Remarks	None					

Event name	Illegal Axis Specification			Event code	54600000 hex	
Meaning	The axis specified for the <i>Axis</i> input variable to a motion control instruction does not exist.					
Source	Motion Control Function Module		Source details	MC Common	Detection timing	At instruction execution
Error attributes	Level	Minor fault	Recovery	Error reset	Log category	System
Effects	User program	Continues.	Operation	The instruction is not executed.		
System-defined variables	Variable		Data type		Name	
	_MC_COM.MFAultLvl.Active		BOOL		MC Common Minor Fault Occurrence	
Cause and correction	Assumed cause		Correction		Prevention	
	An axis does not exist for the variable specified for the <i>Axis</i> input variable to the instruction.		Correct the instruction so that the variable exists for the axis that was specified for the instruction.		Make sure to specify a variable that exists when specifying a variable for an input parameter to an instruction.	
Attached information	None					
Precautions/Remarks	None					

Event name	Illegal Axes Group Specification		Event code	54610000 hex		
Meaning	The axes group specified for the <i>AxesGroup</i> input variable to a motion control instruction does not exist or is not a used group.					
Source	Motion Control Function Module		Source details	MC Common	Detection timing	At instruction execution
Error attributes	Level	Minor fault	Recovery	Error reset	Log category	System
Effects	User program	Continues.	Operation	The instruction is not executed.		
System-defined variables	Variable		Data type		Name	
	_MC_COM.MFaultLvl.Active		BOOL		MC Common Minor Fault Occurrence	
Cause and correction	Assumed cause		Correction		Prevention	
	An axes group does not exist for the variable specified for the <i>AxesGroup</i> input variable to the instruction.		Correct the specification for the instruction so that the specified axes group exists.		Specify a variable that exists when specifying a variable for an input parameter to an instruction.	
	The axes group specified for the <i>AxesGroup</i> input variable to the instruction is not specified as a used group.		Correct the axes group specified by the instruction to a used group.		Set a used axes group for the <i>AxesGroup</i> input variable to the instruction.	
Attached information	None					
Precautions/Remarks	None					

Event name	Illegal Master Axis Specification			Event code	54620000 hex	
Meaning	The axis that is specified for the <i>Master</i> input variable to a motion control instruction is not correct.					
Source	Motion Control Function Module		Source details	MC common or axis	Detection timing	At instruction execution
Error attributes	Level	Minor fault	Recovery	Error reset	Log category	System
Effects	User program	Continues.	Operation	Operation is not possible for relevant slave axis. The slave axis decelerates to a stop if it is in motion.		
System-defined variables	Variable	Data type		Name		
	_MC_COM.MFaultLvl.Active	BOOL		MC Common Minor Fault Occurrence		
	_MC_AX[*].MFaultLvl.Active	BOOL		Axis Minor Fault Occurrence		
Cause and correction	Assumed cause	Correction		Prevention		
	An axis does not exist for the variable specified for the <i>Master</i> input variable to the instruction.	Correct the instruction so that the variable exists for the axis that was specified for the instruction.		Specify a variable that exists when specifying a variable for an input parameter to an instruction.		
	The axis that was specified for the <i>Master</i> input variable to the MC_Phasing (Shift Master Axis Phase) instruction is not the master axis for syncing.	Correct the variable that is input to the <i>Master</i> input variable of the MC_Phasing (Shift Master Axis Phase) instruction to the axis variable that is specified as the master axis of the synchronized control instruction.		Set the variable that is input to the <i>Master</i> input variable of the MC_Phasing (Shift Master Axis Phase) instruction to the axis variable that is specified as the master axis of the synchronized control instruction.		
	The master axis and a slave axis are not assigned to the same task.	Assign the axes that are input to the <i>Master</i> and <i>Slave</i> input variables to the instruction to the same task.		Specify axes that are assigned to the same tasks for the master and slave axes.		
Attached information	None					
Precautions/Remarks	None					

3 Error Descriptions and Corrections

Event name	Motion Control Instruction Re-execution Disabled (SlaveOffset)		Event code	54630000 hex		
Meaning	An attempt was made to change the <i>SlaveOffset</i> input variable when re-executing a motion control instruction. (This input variable cannot be changed when re-executing an instruction.)					
Source	Motion Control Function Module		Source details	Axis	Detection timing	At instruction re-execution
Error attributes	Level	Minor fault	Recovery	Error reset	Log category	System
Effects	User program	Continues.	Operation	Operation is not possible for relevant axis. Relevant axis decelerates to a stop if it is in motion.		
System-defined variables	Variable		Data type		Name	
	_MC_AX[*].MFAultLvl.Active		BOOL		Axis Minor Fault Occurrence	
Cause and correction	Assumed cause		Correction		Prevention	
	A parameter for an input variable that cannot be changed for re-execution was changed.		Correct the program so that the parameter for the relevant input variable does not change when the relevant instruction is re-executed.		Check the manual to see if the input variables to the relevant motion control instruction can be changed by re-execution. Write the program so that the input parameters for any input variable that cannot be changed do not change upon re-execution.	
Attached information	None					
Precautions/Remarks	None					

Event name	Motion Control Instruction Re-execution Disabled (SlaveScaling)		Event code	54640000 hex		
Meaning	An attempt was made to change the <i>SlaveScaling</i> input variable when re-executing a motion control instruction. (This input variable cannot be changed when re-executing an instruction.)					
Source	Motion Control Function Module		Source details	Axis	Detection timing	At instruction re-execution
Error attributes	Level	Minor fault	Recovery	Error reset	Log category	System
Effects	User program	Continues.	Operation	Operation is not possible for relevant axis. Relevant axis decelerates to a stop if it is in motion.		
System-defined variables	Variable		Data type		Name	
	_MC_AX[*].MFAultLvl.Active		BOOL		Axis Minor Fault Occurrence	
Cause and correction	Assumed cause		Correction		Prevention	
	A parameter for an input variable that cannot be changed for re-execution was changed.		Correct the program so that the parameter for the relevant input variable does not change when the relevant instruction is re-executed.		Check the manual to see if the input variables to the relevant motion control instruction can be changed by re-execution. Write the program so that the input parameters for any input variable that cannot be changed do not change upon re-execution.	
Attached information	None					
Precautions/Remarks	None					

Event name	Motion Control Instruction Re-execution Disabled (StartPosition)		Event code	54650000 hex		
Meaning	An attempt was made to change the <i>StartPosition</i> input variable when re-executing a motion control instruction. (This input variable cannot be changed when re-executing an instruction.)					
Source	Motion Control Function Module		Source details	Axis	Detection timing	At instruction re-execution
Error attributes	Level	Minor fault	Recovery	Error reset	Log category	System
Effects	User program	Continues.	Operation	Operation is not possible for relevant axis. Relevant axis decelerates to a stop if it is in motion.		
System-defined variables	Variable	Data type		Name		
	_MC_AX[*].MFAultLvl.Active	BOOL		Axis Minor Fault Occurrence		
Cause and correction	Assumed cause		Correction		Prevention	
	A parameter for an input variable that cannot be changed for re-execution was changed.		Correct the program so that the parameter for the relevant input variable does not change when the relevant instruction is re-executed.		Check the manual to see if the input variables to the relevant motion control instruction can be changed by re-execution. Write the program so that the input parameters for any input variable that cannot be changed do not change upon re-execution.	
Attached information	None					
Precautions/Remarks	None					

Event name	Instruction Execution Error with Undefined Home		Event code	54660000 hex		
Meaning	High-speed homing or an interpolation instruction was executed when home was undefined.					
Source	Motion Control Function Module		Source details	Axis/axes group	Detection timing	At instruction execution
Error attributes	Level	Minor fault	Recovery	Error reset	Log category	System
Effects	User program	Continues.	Operation	<p>If “axis” is given for the source details, operation is not possible for relevant axis. Relevant axis decelerates to a stop if it is in motion.</p> <p>If “axes group” is given for the source details, operation is not possible for relevant axes group. Relevant axes group decelerates to a stop if it is in motion.</p>		
System-defined variables	Variable		Data type		Name	
	_MC_AX[*].MFAultLvl.Active		BOOL		Axis Minor Fault Occurrence	
	_MC_GRP[*].MFAultLvl.Active		BOOL		Axes Group Minor Fault Occurrence	
Cause and correction	Assumed cause		Correction		Prevention	
	High-speed homing was executed when home was undefined.		Execute the high-speed homing operation only after homing to define home.		Execute the high-speed homing instruction only after home is defined by homing.	
	<p>An interpolation instruction was executed for an axes group that includes an axis with no defined home.</p> <p>One of the following robot instructions was executed for an axes group that includes a logical axis with no defined home.</p> <ul style="list-style-type: none"> • MC_SetKinTransform (Set Kinematics Transformation) instruction • MC_MoveTimeAbsolute (Time-specified Absolute Positioning) instruction • MC_SyncLinearConveyor (Start Conveyor Synchronization) instruction • MC_SyncOut (End Synchronization) instruction • MC_GroupMon (Group Monitor) instruction • MC_RobotJog (Axes Group Jog) instruction 		Perform homing to define home for all axes in the axes group before executing the interpolation instruction.		Perform homing to define home for all axes in the axes group before executing the interpolation instruction.	
Attached information	<p>Attached Information 1: Depends on the source details</p> <ul style="list-style-type: none"> • Axis: 0 • Axes group: Logical axis number 					
Precautions/Remarks	If you execute the Set Position instruction after performing homing, home will again be undefined. You must perform homing again to define home in this case.					

Event name	Motion Control Instruction Re-execution Disabled (Position Type)		Event code	54670000 hex		
Meaning	An attempt was made to change the <i>ReferenceType</i> input variable when re-executing a motion control instruction. (This input variable cannot be changed when re-executing an instruction.)					
Source	Motion Control Function Module		Source details	Axis	Detection timing	At instruction re-execution
Error attributes	Level	Minor fault	Recovery	Error reset	Log category	System
Effects	User program	Continues.	Operation	Operation is not possible for relevant axis. Relevant axis decelerates to a stop if it is in motion.		
System-defined variables	Variable	Data type		Name		
	_MC_AX[*].MFAultLvl.Active	BOOL		Axis Minor Fault Occurrence		
Cause and correction	Assumed cause	Correction		Prevention		
	A parameter for an input variable that cannot be changed for re-execution was changed.	Correct the program so that the parameter for the relevant input variable does not change when the relevant instruction is re-executed.		Check the manual to see if the input variables to the relevant motion control instruction can be changed by re-execution. Write the program so that the input parameters for any input variable that cannot be changed do not change upon re-execution.		
Attached information	None					
Precautions/Remarks	None					

Event name	Unused Axis Specification for Master Axis		Event code	54680000 hex		
Meaning	The master axis specified for a motion control instruction is an unused axis.					
Source	Motion Control Function Module		Source details	Axis	Detection timing	At instruction execution
Error attributes	Level	Minor fault	Recovery	Error reset	Log category	System
Effects	User program	Continues.	Operation	Operation is not possible for relevant slave axis. Relevant slave axis decelerates to a stop if it is in motion.		
System-defined variables	Variable	Data type		Name		
	_MC_AX[*].MFAultLvl.Active	BOOL		Axis Minor Fault Occurrence		
Cause and correction	Assumed cause	Correction		Prevention		
	The master axis specified for a motion control instruction is an unused axis.	Set a used axis for the master axis that is specified for the instruction.		Make sure the master axis specified for the motion control instruction is a used axis.		
Attached information	None					
Precautions/Remarks	None					

3 Error Descriptions and Corrections

Event name	First Position Setting Out of Range			Event code	54690000 hex	
Meaning	The parameter specified for the <i>FirstPosition</i> input variable to a motion control instruction is out of range.					
Source	Motion Control Function Module		Source details	Axis	Detection timing	At instruction execution
Error attributes	Level	Minor fault	Recovery	Error reset	Log category	System
Effects	User program	Continues.	Operation	Operation is not possible for relevant axis. Relevant axis decelerates to a stop if it is in motion.		
System-defined variables	Variable		Data type		Name	
	_MC_AX[*].MFAultLvl.Active		BOOL		Axis Minor Fault Occurrence	
Cause and correction	Assumed cause		Correction		Prevention	
	Instruction input parameter exceeded the valid range of the input variable.		Correct the parameter so that the valid range of the input variable is not exceeded for the relevant instruction.		Set the input parameter to the instruction so that the valid range of the input variable is not exceeded.	
Attached information	None					
Precautions/Remarks	None					

Event name	Last Position Setting Out of Range			Event code	546A0000 hex	
Meaning	The parameter specified for the <i>LastPosition</i> input variable to a motion control instruction is out of range.					
Source	Motion Control Function Module		Source details	Axis	Detection timing	At instruction execution
Error attributes	Level	Minor fault	Recovery	Error reset	Log category	System
Effects	User program	Continues.	Operation	Operation is not possible for relevant axis. Relevant axis decelerates to a stop if it is in motion.		
System-defined variables	Variable		Data type		Name	
	_MC_AX[*].MFAultLvl.Active		BOOL		Axis Minor Fault Occurrence	
Cause and correction	Assumed cause		Correction		Prevention	
	Instruction input parameter exceeded the valid range of the input variable.		Correct the parameter so that the valid range of the input variable is not exceeded for the relevant instruction.		Set the input parameter to the instruction so that the valid range of the input variable is not exceeded.	
Attached information	None					
Precautions/Remarks	None					

Event name	Illegal First/Last Position Size Relationship (Linear Mode)		Event code	546B0000 hex		
Meaning	The parameter specified for the <i>LastPosition</i> input variable to a motion control instruction is smaller than the parameter specified for the <i>FirstPosition</i> input variable.					
Source	Motion Control Function Module		Source details	Axis	Detection timing	At instruction execution
Error attributes	Level	Minor fault	Recovery	Error reset	Log category	System
Effects	User program	Continues.	Operation	Operation is not possible for relevant axis. Relevant axis decelerates to a stop if it is in motion.		
System-defined variables	Variable	Data type		Name		
	_MC_AX[*].MFAultLvl.Active	BOOL		Axis Minor Fault Occurrence		
Cause and correction	Assumed cause	Correction		Prevention		
	The value of the <i>LastPosition</i> input parameter is less than the value of the <i>FirstPosition</i> input variable for the instruction when the Count Mode is set to Linear Mode.	Correct the program so that the value of the <i>LastPosition</i> specified for the instruction is larger than the value of the <i>FirstPosition</i> . Or, change the value of the Count Mode to Rotary Mode.		Write the program so that the value of the <i>LastPosition</i> specified for the instruction is larger than the value of the <i>FirstPosition</i> . Or, check to make sure that the Count Mode of the relevant axis is set to Rotary Mode.		
Attached information	None					
Precautions/Remarks	None					

Event name	Master Sync Start Position Setting Out of Range		Event code	546C0000 hex		
Meaning	The parameter specified for the <i>MasterSyncPosition</i> input variable to a motion control instruction is out of range.					
Source	Motion Control Function Module		Source details	Axis	Detection timing	At instruction execution
Error attributes	Level	Minor fault	Recovery	Error reset	Log category	System
Effects	User program	Continues.	Operation	Operation is not possible for relevant slave axis. Relevant slave axis decelerates to a stop if it is in motion.		
System-defined variables	Variable	Data type		Name		
	_MC_AX[*].MFAultLvl.Active	BOOL		Axis Minor Fault Occurrence		
Cause and correction	Assumed cause	Correction		Prevention		
	Instruction input parameter exceeded the valid range of the input variable.	Correct the parameter so that the valid range of the input variable is not exceeded for the relevant instruction.		Set the input parameter to the instruction so that the valid range of the input variable is not exceeded.		
Attached information	None					
Precautions/Remarks	None					

3 Error Descriptions and Corrections

Event name	Slave Sync Start Position Setting Out of Range		Event code	546D0000 hex		
Meaning	The parameter specified for the <i>SlaveSyncPosition</i> input variable to a motion control instruction is out of range.					
Source	Motion Control Function Module		Source details	Axis	Detection timing	At instruction execution
Error attributes	Level	Minor fault	Recovery	Error reset	Log category	System
Effects	User program	Continues.	Operation	Operation is not possible for relevant axis. Relevant axis decelerates to a stop if it is in motion.		
System-defined variables	Variable		Data type		Name	
	_MC_AX[*].MFAultLvl.Active		BOOL		Axis Minor Fault Occurrence	
Cause and correction	Assumed cause		Correction		Prevention	
	Instruction input parameter exceeded the valid range of the input variable.		Correct the parameter so that the valid range of the input variable is not exceeded for the relevant instruction.		Set the input parameter to the instruction so that the valid range of the input variable is not exceeded.	
Attached information	None					
Precautions/Remarks	None					

Event name	Duplicate Latch ID for Trigger Input Condition		Event code	546E0000 hex		
Meaning	The same latch ID was specified for more than one motion control instruction.					
Source	Motion Control Function Module		Source details	Axis	Detection timing	At instruction execution
Error attributes	Level	Minor fault	Recovery	Error reset	Log category	System
Effects	User program	Continues.	Operation	Operation is not possible for relevant axis. Relevant axis decelerates to a stop if it is in motion.		
System-defined variables	Variable		Data type		Name	
	_MC_AX[*].MFAultLvl.Active		BOOL		Axis Minor Fault Occurrence	
Cause and correction	Assumed cause		Correction		Prevention	
	The same latch ID is used simultaneously for more than one of the following instructions: MC_TouchProbe (Enable External Latch) instruction, MC_MoveLink (Synchronous Positioning) instruction, and MC_MoveFeed (Interrupt Feeding) instruction.		Correct the program so that the same latch ID is not used by another instruction at the same time as this instruction. Either use a different latch ID or do not execute any instructions that use the same latch ID at the same time. Both latch 1 and latch 2 are treated as being in use during execution of the MC_Home or MC_HomeWithParameter instruction.		Do not use the same latch ID simultaneously for more than one of the following instructions: MC_TouchProbe (Enable External Latch) instruction, MC_MoveLink (Synchronous Positioning) instruction, and MC_MoveFeed (Interrupt Feeding) instruction.	
	The MC_AbortTrigger (Disable External Latch) instruction was executed to cancel a latch that was used by an instruction other than the MC_TouchProbe (Enable External Latch) instruction.		Do not use the Disable External Latch instruction to cancel a latch that is used by an instruction other than the Enable External Latch instruction.		Do not execute the Disable External Latch instruction for a latch that is used by an instruction other than the Enable External Latch instruction.	
Attached information	None					
Precautions/Remarks	If you decide to change the latch ID, make sure that same latch ID is not used by any other instructions.					

Event name	Jerk Override Factor Out of Range		Event code	546F0000 hex		
Meaning	The parameter specified for the <i>JerkFactor</i> input variable to a motion control instruction is out of range.					
Source	Motion Control Function Module		Source details	Axis/axes group	Detection timing	At instruction execution
Error attributes	Level	Minor fault	Recovery	Error reset	Log category	System
Effects	User program	Continues.	Operation	Operation is not possible for relevant axis. Relevant axis decelerates to a stop if it is in motion.		
System-defined variables	Variable		Data type		Name	
	_MC_AX[*].MFAultLvl.Active		BOOL		Axis Minor Fault Occurrence	
Cause and correction	Assumed cause		Correction		Prevention	
	Instruction input parameter exceeded the valid range of the input variable.		Correct the parameter so that the valid range of the input variable is not exceeded for the relevant instruction.		Set the input parameter to the instruction so that the valid range of the input variable is not exceeded.	
Attached information	None					
Precautions/Remarks	None					

Event name	Acceleration/Deceleration Override Factor Out of Range		Event code	54700000 hex		
Meaning	The parameter specified for the <i>AccFactor</i> input variable to a motion control instruction is out of range.					
Source	Motion Control Function Module		Source details	Axis/axes group	Detection timing	At instruction execution
Error attributes	Level	Minor fault	Recovery	Error reset	Log category	System
Effects	User program	Continues.	Operation	Operation is not possible for relevant axis. Relevant axis decelerates to a stop if it is in motion.		
System-defined variables	Variable		Data type		Name	
	_MC_AX[*].MFAultLvl.Active		BOOL		Axis Minor Fault Occurrence	
Cause and correction	Assumed cause		Correction		Prevention	
	Instruction input parameter exceeded the valid range of the input variable.		Correct the parameter so that the valid range of the input variable is not exceeded for the relevant instruction.		Set the input parameter to the instruction so that the valid range of the input variable is not exceeded.	
Attached information	None					
Precautions/Remarks	None					

Event name	First Position Method Specification Out of Range		Event code	54710000 hex		
Meaning	The parameter specified for the <i>StartMode</i> input variable to a motion control instruction is out of range.					
Source	Motion Control Function Module		Source details	Axis	Detection timing	At instruction execution
Error attributes	Level	Minor fault	Recovery	Error reset	Log category	System
Effects	User program	Continues.	Operation	Operation is not possible for relevant axis. Relevant axis decelerates to a stop if it is in motion.		
System-defined variables	Variable		Data type		Name	
	_MC_AX[*].MFAultLvl.Active		BOOL		Axis Minor Fault Occurrence	
Cause and correction	Assumed cause		Correction		Prevention	
	Instruction input parameter exceeded the valid range of the input variable.		Correct the parameter so that the valid range of the input variable is not exceeded for the relevant instruction.		Set the input parameter to the instruction so that the valid range of the input variable is not exceeded.	
Attached information	None					
Precautions/Remarks	None					

Event name	Motion Control Instruction Re-execution Disabled (First Position Method)		Event code	54720000 hex		
Meaning	An attempt was made to change the <i>StartMode</i> input variable when re-executing a motion control instruction. (This input variable cannot be changed when re-executing an instruction.)					
Source	Motion Control Function Module		Source details	Axis	Detection timing	At instruction re-execution
Error attributes	Level	Minor fault	Recovery	Error reset	Log category	System
Effects	User program	Continues.	Operation	Operation is not possible for relevant axis. Relevant axis decelerates to a stop if it is in motion.		
System-defined variables	Variable		Data type		Name	
	_MC_AX[*].MFAultLvl.Active		BOOL		Axis Minor Fault Occurrence	
Cause and correction	Assumed cause		Correction		Prevention	
	A parameter for an input variable that cannot be changed for re-execution was changed.		Correct the program so that the parameter for the relevant input variable does not change when the relevant instruction is re-executed.		Check the manual to see if the input variables to the relevant motion control instruction can be changed by re-execution. Write the program so that the input parameters for any input variable that cannot be changed do not change upon re-execution.	
Attached information	None					
Precautions/Remarks	None					

Event name	Unused Axis Specification for Auxiliary Axis		Event code	54740000 hex		
Meaning	The axis specified for the <i>Auxiliary</i> input variable to a motion control instruction is an unused axis.					
Source	Motion Control Function Module		Source details	Axis	Detection timing	At instruction execution
Error attributes	Level	Minor fault	Recovery	Error reset	Log category	System
Effects	User program	Continues.	Operation	Operation is not possible for relevant slave axis. Relevant slave axis decelerates to a stop if it is in motion.		
System-defined variables	Variable	Data type		Name		
	_MC_AX[*].MFAultLvl.Active	BOOL		Axis Minor Fault Occurrence		
Cause and correction	Assumed cause		Correction		Prevention	
	The axis specified for the <i>Auxiliary</i> input variable to the instruction is an unused axis.		Set a used axis for the axis that is specified for the instruction. Or, correct the parameter so that it specifies a used axis.		Make sure that the axis specified for the instruction is a used axis.	
Attached information	None					
Precautions/Remarks	None					

Event name	Position Gear Value Error		Event code	54750000 hex		
Meaning	Synchronized motion is not possible for the velocity, acceleration rate, and deceleration rate that were input to a motion control instruction.					
Source	Motion Control Function Module		Source details	Axis	Detection timing	At instruction execution
Error attributes	Level	Minor fault	Recovery	Error reset	Log category	System
Effects	User program	Continues.	Operation	Operation is not possible for relevant slave axis. Relevant slave axis decelerates to a stop if it is in motion.		
System-defined variables	Variable	Data type		Name		
	_MC_AX[*].MFAultLvl.Active	BOOL		Axis Minor Fault Occurrence		
Cause and correction	Assumed cause		Correction		Prevention	
	The specified synchronized motion cannot be performed at the velocity, acceleration rate, or deceleration rate that is input to the instruction.		Correct the program to enable synchronized motion according to the operating specifications of the MC_GearInPos (Positioning Gear Operation) instruction.		Check the processing of the relevant instruction and set a value that allows for synchronized motion.	
Attached information	None					
Precautions/Remarks	None					

Event name	Position Gear Master Axis Zero Velocity		Event code	54760000 hex		
Meaning	The velocity of the master axis was zero when a motion control instruction was started.					
Source	Motion Control Function Module		Source details	Axis	Detection timing	At instruction execution
Error attributes	Level	Minor fault	Recovery	Error reset	Log category	System
Effects	User program	Continues.	Operation	Operation is not possible for relevant slave axis. Relevant slave axis decelerates to a stop if it is in motion.		
System-defined variables	Variable	Data type		Name		
	_MC_AX[*].MFAultLvl.Active	BOOL		Axis Minor Fault Occurrence		
Cause and correction	Assumed cause		Correction		Prevention	
	The velocity of the master axis was 0 when the instruction was started.		Correct the program so that the velocity of the master axis is not 0 when the instruction is started.		Write the program so that the velocity of the master axis is not 0 when the instruction is started.	
Attached information	None					
Precautions/Remarks	None					

Event name	Target Position Setting Out of Range		Event code	54780000 hex		
Meaning	The parameter specified for the <i>Position</i> input variable to a motion control instruction is out of range.					
Source	Motion Control Function Module		Source details	Axis/axes group	Detection timing	At instruction execution
Error attributes	Level	Minor fault	Recovery	Error reset	Log category	System
Effects	User program	Continues.	Operation	If "axis" is given for the source details, operation is not possible for relevant axis. Relevant axis decelerates to a stop if it is in motion. If "axes group" is given for the source details, operation is not possible for relevant axes group. Relevant axes group decelerates to a stop if it is in motion.		
System-defined variables	Variable	Data type		Name		
	_MC_AX[*].MFAultLvl.Active	BOOL		Axis Minor Fault Occurrence		
	_MC_GRP[*].MFAultLvl.Active	BOOL		Axes Group Minor Fault Occurrence		
Cause and correction	Assumed cause		Correction		Prevention	
	Instruction input parameter exceeded the valid range of the input variable.		Correct the parameter so that the valid range of the input variable is not exceeded for the relevant instruction.		Set the input parameter to the instruction so that the valid range of the input variable is not exceeded.	
	The target position of a Rotary Mode axis is not within the ring setting range.		Correct the target position of the Rotary Mode axis to within the ring setting range.		Set the target position of the Rotary Mode axis to within the ring setting range.	
Attached information	Attached Information 1: Depends on the source details <ul style="list-style-type: none"> • Axis: 0 • Axes group: Element number that is out of range in the <i>Position</i> input variable to the instruction. 					
Precautions/Remarks	None					

Event name	Travel Distance Out of Range		Event code	54790000 hex		
Meaning	The parameter that was specified for the <i>Distance</i> input variable to a motion control instruction is out of range or the target position with the value of <i>Distance</i> added is out of range.					
Source	Motion Control Function Module		Source details	Axis/axes group	Detection timing	At instruction execution
Error attributes	Level	Minor fault	Recovery	Error reset	Log category	System
Effects	User program	Continues.	Operation	If "axis" is given for the source details, operation is not possible for relevant axis. Relevant axis decelerates to a stop if it is in motion. If "axes group" is given for the source details, operation is not possible for relevant axes group. Relevant axes group decelerates to a stop if it is in motion.		
System-defined variables	Variable	Data type		Name		
	<code>_MC_AX[*].MFAultLvl.Active</code>	BOOL		Axis Minor Fault Occurrence		
	<code>_MC_GRP[*].MFAultLvl.Active</code>	BOOL		Axes Group Minor Fault Occurrence		
Cause and correction	Assumed cause		Correction		Prevention	
	The absolute value of the instruction input parameter exceeded the range of 40-bit data when it is converted to pulses. For a Linear Mode axis, the target position with the travel distance added exceeded signed 40-bit data when the absolute value is converted to pulses.		Correct the input parameter specified for the <i>Distance</i> input variable of the instruction so that the travel distance and the target position are not out of range.		Write the program so that the travel distance and the target position for the instruction are not out of range.	
Attached information	None					
Precautions/Remarks	None					

Event name	Cam Table Start Point Setting Out of Range		Event code	547A0000 hex		
Meaning	The parameter specified for the <i>StartPosition</i> input variable to a motion control instruction is out of range.					
Source	Motion Control Function Module		Source details	Axis	Detection timing	At instruction execution
Error attributes	Level	Minor fault	Recovery	Error reset	Log category	System
Effects	User program	Continues.	Operation	Operation is not possible for relevant axis. Relevant axis decelerates to a stop if it is in motion.		
System-defined variables	Variable	Data type		Name		
	<code>_MC_AX[*].MFAultLvl.Active</code>	BOOL		Axis Minor Fault Occurrence		
Cause and correction	Assumed cause		Correction		Prevention	
	Instruction input parameter exceeded the valid range of the input variable.		Correct the parameter so that the valid range of the input variable is not exceeded for the relevant instruction.		Set the input parameter to the instruction so that the valid range of the input variable is not exceeded.	
Attached information	None					
Precautions/Remarks	None					

3 Error Descriptions and Corrections

Event name	Cam Master Axis Following First Position Setting Out of Range		Event code	547B0000 hex		
Meaning	The parameter specified for the <i>MasterStartDistance</i> input variable to a motion control instruction is out of range.					
Source	Motion Control Function Module		Source details	Axis	Detection timing	At instruction execution
Error attributes	Level	Minor fault	Recovery	Error reset	Log category	System
Effects	User program	Continues.	Operation	Operation is not possible for relevant axis. Relevant axis decelerates to a stop if it is in motion.		
System-defined variables	Variable	Data type		Name		
	_MC_AX[*].MFAultLvl.Active	BOOL		Axis Minor Fault Occurrence		
Cause and correction	Assumed cause		Correction		Prevention	
	Instruction input parameter exceeded the valid range of the input variable.		Correct the parameter so that the valid range of the input variable is not exceeded for the relevant instruction.		Set the input parameter to the instruction so that the valid range of the input variable is not exceeded.	
Attached information	None					
Precautions/Remarks	None					

Event name	Circular Interpolation Radius Setting Error		Event code	547C0000 hex		
Meaning	It was not possible to create a circular path for the specified radius when the radius method was specified for the MC_MoveCircular2D (Circular 2D Interpolation) instruction.					
Source	Motion Control Function Module		Source details	Axes group	Detection timing	At instruction execution
Error attributes	Level	Minor fault	Recovery	Error reset	Log category	System
Effects	User program	Continues.	Operation	Operation is not possible for relevant axes group. Relevant axes group decelerates to a stop if it is in motion.		
System-defined variables	Variable	Data type		Name		
	_MC_GRP[*].MFAultLvl.Active	BOOL		Axes Group Minor Fault Occurrence		
Cause and correction	Assumed cause		Correction		Prevention	
	For the MC_MoveCircular2D (Circular 2D Interpolation) instruction, it was not possible to create a circular path for the specified radius when the radius method was specified for circular interpolation.		Correct the radius so that the circular path can be created.		Check the processing of the relevant instruction and set a radius that allows the creation of a circular path.	
Attached information	None					
Precautions/Remarks	None					

Event name	Circular Interpolation Radius Overflow		Event code	547D0000 hex		
Meaning	For the MC_MoveCircular2D (Circular 2D Interpolation) instruction, the radius of the circle exceeded the maximum value for the border point or center specification method.					
Source	Motion Control Function Module		Source details	Axes group	Detection timing	At instruction execution
Error attributes	Level	Minor fault	Recovery	Error reset	Log category	System
Effects	User program	Continues.	Operation	Operation is not possible for relevant axes group. Relevant axes group decelerates to a stop if it is in motion.		
System-defined variables	Variable	Data type		Name		
	_MC_GRP[*].MFAultLvl.Active	BOOL		Axes Group Minor Fault Occurrence		
Cause and correction	Assumed cause	Correction		Prevention		
	For the MC_MoveCircular2D (Circular 2D Interpolation) instruction, the radius of the circle exceeded 40-bit data when it is converted to pulses for the border point or center specification method.	Correct the input parameter so that the circle radius does not exceed 40-bit data when it is converted to pulses based on the operating specifications of the instruction. Border point specification: Start point, border point, and end point Center point specification: Start point, end point, and center point		Check the processing of the instruction and correct the input parameters so that the circle radius does not exceed 40-bit data it is when converted to pulses.		
Attached information	None					
Precautions/Remarks	If the maximum radius is exceeded when the radius specification method is used, a Border Point/Center Position/Radius Specification Out of Range error occurs.					

Event name	Circular Interpolation Setting Out of Range		Event code	547E0000 hex		
Meaning	The parameter specified for the <i>CircAxes</i> input variable to a motion control instruction is out of range.					
Source	Motion Control Function Module		Source details	Axes group	Detection timing	At instruction execution
Error attributes	Level	Minor fault	Recovery	Error reset	Log category	System
Effects	User program	Continues.	Operation	Operation is not possible for relevant axes group. Relevant axes group decelerates to a stop if it is in motion.		
System-defined variables	Variable	Data type		Name		
	_MC_GRP[*].MFAultLvl.Active	BOOL		Axes Group Minor Fault Occurrence		
Cause and correction	Assumed cause	Correction		Prevention		
	Instruction input parameter exceeded the valid range of the input variable.	Correct the parameter so that the valid range of the input variable is not exceeded for the relevant instruction.		Set the input parameters to the instruction so that the valid range of the input variables is not exceeded.		
	The axes that were specified in <i>CircAxes</i> are not included in the composition axes in the Axes Group Settings.	Set the axes that are specified for <i>CircAxes</i> so that they are in an axes group configuration.		Make sure that the axes that are specified for <i>CircAxes</i> are in an axes group configuration.		
	The same axis was specified for both axes of <i>CircAxes</i> .	Correct the settings so that the two axes specified for <i>CircAxes</i> are different axes.		Write the program so that the two axes specified for <i>CircAxes</i> are different axes.		
Attached information	None					
Precautions/Remarks	None					

Event name	Auxiliary/Slave Axis Numbers Not in Ascending Order		Event code	547F0000 hex		
Meaning	The values of the parameters for the <i>Auxiliary</i> and <i>Slave</i> input variables to a motion control instruction are not in ascending order.					
Source	Motion Control Function Module		Source details	Axis	Detection timing	At instruction execution
Error attributes	Level	Minor fault	Recovery	Error reset	Log category	System
Effects	User program	Continues.	Operation	Operation is not possible for relevant axis. Relevant axis decelerates to a stop if it is in motion.		
System-defined variables	Variable		Data type		Name	
	_MC_AX[*].MFAultLvl.Active		BOOL		Axis Minor Fault Occurrence	
Cause and correction	Assumed cause		Correction		Prevention	
	The parameters for the <i>Auxiliary</i> and <i>Slave</i> input variables to the instruction are not in ascending order.		Correct the axis numbers specified for the <i>Auxiliary</i> and <i>Slave</i> input parameters to the instruction so that they are in ascending order.		Write the program so that the axis numbers specified for <i>Auxiliary</i> and <i>Slave</i> are in ascending order.	
Attached information	None					
Precautions/Remarks	None					

Event name	Cam Table Property Ascending Data Error at Update		Event code	54800000 hex		
Meaning	A phase that was not in ascending order was found during calculating the number of valid data. Or, after calculations, the number of valid data is 0.					
Source	Motion Control Function Module		Source details	MC Common	Detection timing	During instruction execution
Error attributes	Level	Minor fault	Recovery	Error reset	Log category	System
Effects	User program	Continues.	Operation	Not affected.		
System-defined variables	Variable		Data type		Name	
	_MC_COM.MFAultLvl.Active		BOOL		MC Common Minor Fault Occurrence	
Cause and correction	Assumed cause		Correction		Prevention	
	A phase that was not in ascending order was found when calculating the number of valid data.		Place the phase data into ascending order in the cam table data.		Place the phase data into ascending order in the cam table data.	
	After calculations, the number of valid data is 0.		Correct the cam table data so that it includes phases that are not 0.		Create the cam table data so that it includes phases that are not 0.	
Attached information	None					
Precautions/Remarks	None					

Event name	MC_Write Target Out of Range		Event code	54810000 hex		
Meaning	The parameter specified for the <i>Target</i> input variable to a motion control instruction is out of range.					
Source	Motion Control Function Module		Source details	MC Common	Detection timing	At instruction execution
Error attributes	Level	Minor fault	Recovery	Error reset	Log category	System
Effects	User program	Continues.	Operation	Not affected.		
System-defined variables	Variable		Data type		Name	
	_MC_COM.MFaultLvl.Active		BOOL		MC Common Minor Fault Occurrence	
Cause and correction	Assumed cause		Correction		Prevention	
	Instruction input parameter exceeded the valid range of the input variable.		Correct the parameter so that the valid range of the input variable is not exceeded for the relevant instruction.		Set the input parameter to the instruction so that the valid range of the input variable is not exceeded.	
Attached information	None					
Precautions/Remarks	None					

Event name	Master Travel Distance Specification Out of Range		Event code	54820000 hex		
Meaning	The parameter specified for the <i>MasterDistance</i> input variable to a motion control instruction is out of range.					
Source	Motion Control Function Module		Source details	Axis	Detection timing	At instruction execution
Error attributes	Level	Minor fault	Recovery	Error reset	Log category	System
Effects	User program	Continues.	Operation	Operation is not possible for relevant slave axis. Relevant slave axis decelerates to a stop if it is in motion.		
System-defined variables	Variable		Data type		Name	
	_MC_AX[*].MFaultLvl.Active		BOOL		Axis Minor Fault Occurrence	
Cause and correction	Assumed cause		Correction		Prevention	
	Instruction input parameter exceeded the valid range of the input variable.		Correct the parameter so that the valid range of the input variable is not exceeded for the relevant instruction.		Set the input parameter to the instruction so that the valid range of the input variable is not exceeded.	
Attached information	None					
Precautions/Remarks	None					

3 Error Descriptions and Corrections

Event name	Master Distance in Acceleration Specification Out of Range		Event code	54830000 hex		
Meaning	The parameter specified for the <i>MasterDistanceACC</i> input variable to a motion control instruction is out of range.					
Source	Motion Control Function Module		Source details	Axis	Detection timing	At instruction execution
Error attributes	Level	Minor fault	Recovery	Error reset	Log category	System
Effects	User program	Continues.	Operation	Operation is not possible for relevant slave axis. Relevant slave axis decelerates to a stop if it is in motion.		
System-defined variables	Variable		Data type		Name	
	_MC_AX[*].MFAultLvl.Active		BOOL		Axis Minor Fault Occurrence	
Cause and correction	Assumed cause		Correction		Prevention	
	Instruction input parameter exceeded the valid range of the input variable.		Correct the parameter so that the valid range of the input variable is not exceeded for the relevant instruction.		Set the input parameter to the instruction so that the valid range of the input variable is not exceeded.	
Attached information	None					
Precautions/Remarks	None					

Event name	Master Distance in Deceleration Specification Out of Range		Event code	54840000 hex		
Meaning	The parameter specified for the <i>MasterDistanceDEC</i> input variable to a motion control instruction is out of range.					
Source	Motion Control Function Module		Source details	Axis	Detection timing	At instruction execution
Error attributes	Level	Minor fault	Recovery	Error reset	Log category	System
Effects	User program	Continues.	Operation	Operation is not possible for relevant slave axis. Relevant slave axis decelerates to a stop if it is in motion.		
System-defined variables	Variable		Data type		Name	
	_MC_AX[*].MFAultLvl.Active		BOOL		Axis Minor Fault Occurrence	
Cause and correction	Assumed cause		Correction		Prevention	
	Instruction input parameter exceeded the valid range of the input variable.		Correct the parameter so that the valid range of the input variable is not exceeded for the relevant instruction.		Set the input parameter to the instruction so that the valid range of the input variable is not exceeded.	
Attached information	None					
Precautions/Remarks	None					

Event name	Execution Mode Selection Out of Range		Event code	54870000 hex		
Meaning	The parameter specified for the <i>ExecutionMode</i> input variable to a motion control instruction is out of range.					
Source	Motion Control Function Module		Source details	Axis	Detection timing	At instruction execution
Error attributes	Level	Minor fault	Recovery	Error reset	Log category	System
Effects	User program	Continues.	Operation	Operation is not possible for relevant axis. Relevant axis decelerates to a stop if it is in motion.		
System-defined variables	Variable		Data type		Name	
	_MC_AX[*].MFAultLvl.Active		BOOL		Axis Minor Fault Occurrence	
Cause and correction	Assumed cause		Correction		Prevention	
	Instruction input parameter exceeded the valid range of the input variable.		Correct the parameter so that the valid range of the input variable is not exceeded for the relevant instruction.		Set the input parameter to the instruction so that the valid range of the input variable is not exceeded.	
Attached information	None					
Precautions/Remarks	None					

Event name	Permitted Following Error Out of Range		Event code	54880000 hex		
Meaning	The parameter specified for the <i>PermittedDeviation</i> input variable to a motion control instruction is out of range.					
Source	Motion Control Function Module		Source details	MC Common	Detection timing	At instruction execution
Error attributes	Level	Minor fault	Recovery	Error reset	Log category	System
Effects	User program	Continues.	Operation	The instruction is not executed.		
System-defined variables	Variable		Data type		Name	
	_MC_COM.MFAultLvl.Active		BOOL		MC Common Minor Fault Occurrence	
Cause and correction	Assumed cause		Correction		Prevention	
	Instruction input parameter exceeded the valid range of the input variable.		Correct the parameter so that the valid range of the input variable is not exceeded for the relevant instruction.		Set the input parameter to the instruction so that the valid range of the input variable is not exceeded.	
Attached information	None					
Precautions/Remarks	None					

Event name	Border Point/Center Position/Radius Specification Out of Range		Event code	54890000 hex		
Meaning	The parameter specified for the <i>AuxPoint</i> input variable to a motion control instruction is out of range.					
Source	Motion Control Function Module		Source details	Axes group	Detection timing	At instruction execution
Error attributes	Level	Minor fault	Recovery	Error reset	Log category	System
Effects	User program	Continues.	Operation	Operation is not possible for relevant axes group. Relevant axes group decelerates to a stop if it is in motion.		
System-defined variables	Variable		Data type		Name	
	_MC_GRP[*].MFAultLvl.Active		BOOL		Axes Group Minor Fault Occurrence	
Cause and correction	Assumed cause		Correction		Prevention	
	The value of <i>AuxPoint</i> exceeded signed 40-bit data when converted to pulses for the border point or center specification method. For a radius specifications, the absolute value of <i>AuxPoint[0]</i> exceeded 40-bit data when it is converted to pulses.		Correct the parameter so that the valid range of the input variable is not exceeded for the relevant instruction.		Set the input parameter to the instruction so that the valid range of the input variable is not exceeded.	
Attached information	None					
Precautions/Remarks	None					

Event name	End Point Specification Out of Range		Event code	548A0000 hex		
Meaning	The parameter specified for the <i>EndPoint</i> input variable to a motion control instruction is out of range.					
Source	Motion Control Function Module		Source details	Axes group	Detection timing	At instruction execution
Error attributes	Level	Minor fault	Recovery	Error reset	Log category	System
Effects	User program	Continues.	Operation	Operation is not possible for relevant axes group. Relevant axes group decelerates to a stop if it is in motion.		
System-defined variables	Variable		Data type		Name	
	_MC_GRP[*].MFAultLvl.Active		BOOL		Axes Group Minor Fault Occurrence	
Cause and correction	Assumed cause		Correction		Prevention	
	The instruction input parameter exceeded the range of signed 40-bit data when it is converted to pulses.		Correct the parameter so that the valid range of the input variable is not exceeded for the relevant instruction.		Set the input parameter to the instruction so that the valid range of the input variable is not exceeded.	
Attached information	None					
Precautions/Remarks	None					

Event name	Slave Travel Distance Specification Out of Range		Event code	548B0000 hex	
Meaning	The parameter specified for the <i>SlaveDistance</i> input variable to a motion control instruction is out of range.				
Source	Motion Control Function Module		Source details	Axis	Detection timing At instruction execution
Error attributes	Level	Minor fault	Recovery	Error reset	Log category System
Effects	User program	Continues.	Operation	Operation is not possible for relevant slave axis. Relevant slave axis decelerates to a stop if it is in motion.	
System-defined variables	Variable	Data type		Name	
	_MC_AX[*].MFAultLvl.Active	BOOL		Axis Minor Fault Occurrence	
Cause and correction	Assumed cause		Correction		Prevention
	The instruction input parameter exceeded the range of 40-bit data when it is converted to pulses.		Correct the parameter so that the valid range of the input variable is not exceeded for the relevant instruction.		Set the input parameter to the instruction so that the valid range of the input variable is not exceeded.
Attached information	None				
Precautions/Remarks	None				

Event name	Phase Shift Amount Out of Range		Event code	548C0000 hex	
Meaning	The parameter specified for the <i>PhaseShift</i> input variable to a motion control instruction is out of range.				
Source	Motion Control Function Module		Source details	Axis	Detection timing At instruction execution
Error attributes	Level	Minor fault	Recovery	Error reset	Log category System
Effects	User program	Continues.	Operation	Operation is not possible for relevant slave axis. Relevant slave axis decelerates to a stop if it is in motion.	
System-defined variables	Variable	Data type		Name	
	_MC_AX[*].MFAultLvl.Active	BOOL		Axis Minor Fault Occurrence	
Cause and correction	Assumed cause		Correction		Prevention
	The absolute value of the instruction input parameter exceeded the range of 40-bit data when it is converted to pulses.		Correct the parameter so that the valid range of the input variable is not exceeded for the relevant instruction.		Set the input parameter to the instruction so that the valid range of the input variable is not exceeded.
Attached information	None				
Precautions/Remarks	None				

Event name	Feeding Distance Out of Range			Event code	548D0000 hex	
Meaning	The parameter specified for the <i>FeedDistance</i> input variable to a motion control instruction is out of range.					
Source	Motion Control Function Module		Source details	Axis	Detection timing	At instruction execution
Error attributes	Level	Minor fault	Recovery	Error reset	Log category	System
Effects	User program	Continues.	Operation	Operation is not possible for relevant axis. Relevant axis decelerates to a stop if it is in motion.		
System-defined variables	Variable		Data type		Name	
	_MC_AX[*].MFAultLvl.Active		BOOL		Axis Minor Fault Occurrence	
Cause and correction	Assumed cause		Correction		Prevention	
	The absolute value of the instruction input parameter exceeded the range of 40-bit data when it is converted to pulses.		Correct the parameter so that the valid range of the input variable is not exceeded for the relevant instruction.		Set the input parameter to the instruction so that the valid range of the input variable is not exceeded.	
Attached information	None					
Precautions/Remarks	None					

Event name	Auxiliary and Slave Defined as Same Axis			Event code	548E0000 hex	
Meaning	The same axis is specified for the <i>Auxiliary</i> and <i>Slave</i> input variables to a motion control instruction.					
Source	Motion Control Function Module		Source details	Axis	Detection timing	At instruction execution
Error attributes	Level	Minor fault	Recovery	Error reset	Log category	System
Effects	User program	Continues.	Operation	Operation is not possible for relevant slave axis. Relevant slave axis decelerates to a stop if it is in motion.		
System-defined variables	Variable		Data type		Name	
	_MC_AX[*].MFAultLvl.Active		BOOL		Axis Minor Fault Occurrence	
Cause and correction	Assumed cause		Correction		Prevention	
	The parameter was the same for the <i>Auxiliary</i> and <i>Slave</i> input variables to the instruction.		Correct the parameters so that different axes are specified for the <i>Auxiliary</i> and <i>Slave</i> input variables to the instruction.		Specify different axes for the auxiliary axis and slave axis for a motion control instruction.	
Attached information	None					
Precautions/Remarks	None					

Event name	Relative Position Selection Out of Range		Event code	548F0000 hex		
Meaning	The parameter specified for the <i>Relative</i> input variable to a motion control instruction is out of range.					
Source	Motion Control Function Module		Source details	Axis	Detection timing	At instruction execution
Error attributes	Level	Minor fault	Recovery	Error reset	Log category	System
Effects	User program	Continues.	Operation	Operation is not possible for relevant axis. Relevant axis decelerates to a stop if it is in motion.		
System-defined variables	Variable		Data type		Name	
	_MC_AX[*].MFAultLvl.Active		BOOL		Axis Minor Fault Occurrence	
Cause and correction	Assumed cause		Correction		Prevention	
	Instruction input parameter exceeded the valid range of the input variable.		Correct the parameter so that the valid range of the input variable is not exceeded for the relevant instruction.		Set the input parameter to the instruction so that the valid range of the input variable is not exceeded.	
Attached information	None					
Precautions/Remarks	None					

Event name	Cam Transition Specification Out of Range		Event code	54900000 hex		
Meaning	The parameter specified for the <i>CamTransition</i> input variable to a motion control instruction is out of range.					
Source	Motion Control Function Module		Source details	Axis	Detection timing	At instruction execution
Error attributes	Level	Minor fault	Recovery	Error reset	Log category	System
Effects	User program	Continues.	Operation	Operation is not possible for relevant slave axis. Relevant slave axis decelerates to a stop if it is in motion.		
System-defined variables	Variable		Data type		Name	
	_MC_AX[*].MFAultLvl.Active		BOOL		Axis Minor Fault Occurrence	
Cause and correction	Assumed cause		Correction		Prevention	
	Instruction input parameter exceeded the valid range of the input variable.		Correct the parameter so that the valid range of the input variable is not exceeded for the relevant instruction.		Set the input parameter to the instruction so that the valid range of the input variable is not exceeded.	
Attached information	None					
Precautions/Remarks	None					

3 Error Descriptions and Corrections

Event name	Synchronized Control End Mode Selection Out of Range		Event code	54910000 hex		
Meaning	The parameter specified for the <i>OutMode</i> input variable to a motion control instruction is out of range.					
Source	Motion Control Function Module		Source details	Axis	Detection timing	At instruction execution
Error attributes	Level	Minor fault	Recovery	Error reset	Log category	System
Effects	User program	Continues.	Operation	Operation is not possible for relevant slave axis. Relevant slave axis decelerates to a stop if it is in motion.		
System-defined variables	Variable	Data type		Name		
	_MC_AX[*].MFAultLvl.Active	BOOL		Axis Minor Fault Occurrence		
Cause and correction	Assumed cause		Correction		Prevention	
	Instruction input parameter exceeded the valid range of the input variable.		Correct the parameter so that the valid range of the input variable is not exceeded for the relevant instruction.		Set the input parameter to the instruction so that the valid range of the input variable is not exceeded.	
Attached information	None					
Precautions/Remarks	None					

Event name	Enable External Latch Instruction Execution Disabled		Event code	54920000 hex		
Meaning	<i>_mclImmediateStop (Immediate Stop)</i> was specified for the <i>StopMode</i> input variable when the MC_TouchProbe (Enable External Latch) instruction was executed in Drive Mode for an encoder axis.					
Source	Motion Control Function Module		Source details	Axis	Detection timing	At instruction execution
Error attributes	Level	Minor fault	Recovery	Error reset	Log category	System
Effects	User program	Continues.	Operation	Operation is not possible for relevant axis. Relevant axis decelerates to a stop if it is in motion.		
System-defined variables	Variable	Data type		Name		
	_MC_AX[*].MFAultLvl.Active	BOOL		Axis Minor Fault Occurrence		
Cause and correction	Assumed cause		Correction		Prevention	
	<i>_mclImmediateStop (Immediate Stop)</i> was specified for the <i>StopMode</i> input variable when the MC_TouchProbe (Enable External Latch) instruction was executed in Drive Mode for an encoder axis.		Correct the program so that <i>_mclImmediateStop (Immediate Stop)</i> is not specified for <i>StopMode</i> for the encoder axis.		If you specify <i>_mclImmediateStop (Immediate Stop)</i> and use Drive Mode, execute the MC_TouchProbe (Enable External Latch) instruction only for a servo axis.	
Attached information	None					
Precautions/Remarks	None					

Event name	Master Axis Offset Out of Range			Event code	54930000 hex	
Meaning	The parameter specified for the <i>MasterOffset</i> input variable to a motion control instruction is out of range.					
Source	Motion Control Function Module		Source details	Axis	Detection timing	At instruction execution
Error attributes	Level	Minor fault	Recovery	Error reset	Log category	System
Effects	User program	Continues.	Operation	Operation is not possible for relevant slave axis. Relevant slave axis decelerates to a stop if it is in motion.		
System-defined variables	Variable	Data type		Name		
	_MC_AX[*].MFAultLvl.Active	BOOL		Axis Minor Fault Occurrence		
Cause and correction	Assumed cause		Correction		Prevention	
	The instruction input parameter exceeded the range of signed 40-bit data when it is converted to pulses.		Correct the parameter so that the valid range of the input variable is not exceeded for the relevant instruction.		Set the input parameter to the instruction so that the valid range of the input variable is not exceeded.	
Attached information	None					
Precautions/Remarks	None					

Event name	Slave Axis Offset Out of Range			Event code	54940000 hex	
Meaning	The parameter specified for the <i>SlaveOffset</i> input variable to a motion control instruction is out of range.					
Source	Motion Control Function Module		Source details	Axis	Detection timing	At instruction execution
Error attributes	Level	Minor fault	Recovery	Error reset	Log category	System
Effects	User program	Continues.	Operation	Operation is not possible for relevant slave axis. Relevant slave axis decelerates to a stop if it is in motion.		
System-defined variables	Variable	Data type		Name		
	_MC_AX[*].MFAultLvl.Active	BOOL		Axis Minor Fault Occurrence		
Cause and correction	Assumed cause		Correction		Prevention	
	The instruction input parameter exceeded the range of signed 40-bit data when it is converted to pulses.		Correct the parameter so that the valid range of the input variable is not exceeded for the relevant instruction.		Set the input parameter to the instruction so that the valid range of the input variable is not exceeded.	
Attached information	None					
Precautions/Remarks	None					

Event name	Command Current Position Count Selection Out of Range		Event code	54950000 hex		
Meaning	The parameter specified for the <i>CmdPosMode</i> input variable to a motion control instruction is out of range.					
Source	Motion Control Function Module		Source details	Axis	Detection timing	At instruction execution
Error attributes	Level	Minor fault	Recovery	Error reset	Log category	System
Effects	User program	Continues.	Operation	Operation is not possible for relevant axis. Relevant axis decelerates to a stop if it is in motion.		
System-defined variables	Variable		Data type		Name	
	_MC_AX[*].MFaultLvl.Active		BOOL		Axis Minor Fault Occurrence	
Cause and correction	Assumed cause		Correction		Prevention	
	Instruction input parameter exceeded the valid range of the input variable.		Correct the parameter so that the valid range of the input variable is not exceeded for the relevant instruction.		Set the input parameter to the instruction so that the valid range of the input variable is not exceeded.	
Attached information	None					
Precautions/Remarks	None					

Event name	Master Axis Gear Ratio Numerator Out of Range		Event code	54960000 hex		
Meaning	The parameter specified for the <i>RatioNumeratorMaster</i> input variable to a motion control instruction is out of range.					
Source	Motion Control Function Module		Source details	Axis	Detection timing	At instruction execution
Error attributes	Level	Minor fault	Recovery	Error reset	Log category	System
Effects	User program	Continues.	Operation	Operation is not possible for relevant slave axis. Relevant slave axis decelerates to a stop if it is in motion.		
System-defined variables	Variable		Data type		Name	
	_MC_AX[*].MFaultLvl.Active		BOOL		Axis Minor Fault Occurrence	
Cause and correction	Assumed cause		Correction		Prevention	
	Instruction input parameter exceeded the valid range of the input variable.		Correct the parameter so that the valid range of the input variable is not exceeded for the relevant instruction.		Set the input parameter to the instruction so that the valid range of the input variable is not exceeded.	
Attached information	None					
Precautions/Remarks	None					

Event name	Master Axis Gear Ratio Denominator Out of Range		Event code	54970000 hex		
Meaning	The parameter specified for the <i>RatioDenominatorMaster</i> input variable to a motion control instruction is out of range.					
Source	Motion Control Function Module		Source details	Axis	Detection timing	At instruction execution
Error attributes	Level	Minor fault	Recovery	Error reset	Log category	System
Effects	User program	Continues.	Operation	Operation is not possible for relevant slave axis. Relevant slave axis decelerates to a stop if it is in motion.		
System-defined variables	Variable		Data type		Name	
	_MC_AX[*].MFaultLvl.Active		BOOL		Axis Minor Fault Occurrence	
Cause and correction	Assumed cause		Correction		Prevention	
	Instruction input parameter exceeded the valid range of the input variable.		Correct the parameter so that the valid range of the input variable is not exceeded for the relevant instruction.		Set the input parameter to the instruction so that the valid range of the input variable is not exceeded.	
Attached information	None					
Precautions/Remarks	None					

Event name	Auxiliary Axis Gear Ratio Numerator Out of Range		Event code	54980000 hex		
Meaning	The parameter specified for the <i>RatioNumeratorAuxiliary</i> input variable to a motion control instruction is out of range.					
Source	Motion Control Function Module		Source details	Axis	Detection timing	At instruction execution
Error attributes	Level	Minor fault	Recovery	Error reset	Log category	System
Effects	User program	Continues.	Operation	Operation is not possible for relevant slave axis. Relevant slave axis decelerates to a stop if it is in motion.		
System-defined variables	Variable		Data type		Name	
	_MC_AX[*].MFaultLvl.Active		BOOL		Axis Minor Fault Occurrence	
Cause and correction	Assumed cause		Correction		Prevention	
	Instruction input parameter exceeded the valid range of the input variable.		Correct the parameter so that the valid range of the input variable is not exceeded for the relevant instruction.		Set the input parameter to the instruction so that the valid range of the input variable is not exceeded.	
Attached information	None					
Precautions/Remarks	None					

3 Error Descriptions and Corrections

Event name	Auxiliary Axis Gear Ratio Denominator Out of Range		Event code	54990000 hex		
Meaning	The parameter specified for the <i>RatioDenominatorAuxiliary</i> input variable to a motion control instruction is out of range.					
Source	Motion Control Function Module		Source details	Axis	Detection timing	At instruction execution
Error attributes	Level	Minor fault	Recovery	Error reset	Log category	System
Effects	User program	Continues.	Operation	Operation is not possible for relevant slave axis. Relevant slave axis decelerates to a stop if it is in motion.		
System-defined variables	Variable		Data type		Name	
	_MC_AX[*].MFAultLvl.Active		BOOL		Axis Minor Fault Occurrence	
Cause and correction	Assumed cause		Correction		Prevention	
	Instruction input parameter exceeded the valid range of the input variable.		Correct the parameter so that the valid range of the input variable is not exceeded for the relevant instruction.		Set the input parameter to the instruction so that the valid range of the input variable is not exceeded.	
Attached information	None					
Precautions/Remarks	None					

Event name	Master Axis Position Type Selection Out of Range		Event code	549A0000 hex		
Meaning	The parameter specified for the <i>ReferenceTypeMaster</i> input variable to a motion control instruction is out of range.					
Source	Motion Control Function Module		Source details	Axis	Detection timing	At instruction execution
Error attributes	Level	Minor fault	Recovery	Error reset	Log category	System
Effects	User program	Continues.	Operation	Operation is not possible for relevant slave axis. Relevant slave axis decelerates to a stop if it is in motion.		
System-defined variables	Variable		Data type		Name	
	_MC_AX[*].MFAultLvl.Active		BOOL		Axis Minor Fault Occurrence	
Cause and correction	Assumed cause		Correction		Prevention	
	Instruction input parameter exceeded the valid range of the input variable.		Correct the parameter so that the valid range of the input variable is not exceeded for the relevant instruction.		Set the input parameter to the instruction so that the valid range of the input variable is not exceeded.	
Attached information	None					
Precautions/Remarks	None					

Event name	Auxiliary Axis Position Type Selection Out of Range		Event code	549B0000 hex		
Meaning	The parameter specified for the <i>ReferenceTypeAuxiliary</i> input variable to a motion control instruction is out of range.					
Source	Motion Control Function Module		Source details	Axis	Detection timing	At instruction execution
Error attributes	Level	Minor fault	Recovery	Error reset	Log category	System
Effects	User program	Continues.	Operation	Operation is not possible for relevant slave axis. Relevant slave axis decelerates to a stop if it is in motion.		
System-defined variables	Variable	Data type		Name		
	_MC_AX[*].MFAultLvl.Active	BOOL		Axis Minor Fault Occurrence		
Cause and correction	Assumed cause		Correction		Prevention	
	Instruction input parameter exceeded the valid range of the input variable.		Correct the parameter so that the valid range of the input variable is not exceeded for the relevant instruction.		Set the input parameter to the instruction so that the valid range of the input variable is not exceeded.	
Attached information	None					
Precautions/Remarks	None					

Event name	Target Position Ring Counter Out of Range		Event code	549C0000 hex		
Meaning	Operation is not possible because the target position is out of range for the ring counter of the executed instruction.					
Source	Motion Control Function Module		Source details	Axis	Detection timing	At instruction execution
Error attributes	Level	Minor fault	Recovery	Error reset	Log category	System
Effects	User program	Continues.	Operation	Operation is not possible for relevant axis. Relevant axis decelerates to a stop if it is in motion.		
System-defined variables	Variable	Data type		Name		
	_MC_AX[*].MFAultLvl.Active	BOOL		Axis Minor Fault Occurrence		
Cause and correction	Assumed cause		Correction		Prevention	
	High-speed homing was executed when 0 was not included in the ring counter.		High-speed homing cannot be executed when the ring counter range does not include 0. Correct the program so that high-speed homing is not performed. Or change the settings so that the ring counter range includes 0.		High-speed homing cannot be executed when the ring counter range does not include 0. Write the program so that high-speed homing is not performed. Or make the settings so that the ring counter range includes 0.	
Attached information	None					
Precautions/Remarks	None					

3 Error Descriptions and Corrections

Event name	Axes Group Composition Axis Setting Out of Range		Event code	549D0000 hex		
Meaning	The parameter specified for the <i>Axes</i> input variable to a motion control instruction is out of range.					
Source	Motion Control Function Module		Source details	Axes group	Detection timing	At instruction execution
Error attributes	Level	Minor fault	Recovery	Error reset	Log category	System
Effects	User program	Continues.	Operation	Operation is not possible for relevant axes group. Relevant axes group decelerates to a stop if the axes are in motion.		
System-defined variables	Variable		Data type		Name	
	_MC_GRP[*].MFaultLvl.Active		BOOL		Axes Group Minor Fault Occurrence	
Cause and correction	Assumed cause		Correction		Prevention	
	Instruction input parameter exceeded the valid range of the input variable.		Correct the parameter so that the valid range of the input variable is not exceeded for the relevant instruction.		Set the input parameter to the instruction so that the valid range of the input variable is not exceeded.	
	The composition axes in the axes group are not assigned to the same task.		Assign all of the axes that are specified for the <i>Axes</i> input variable to the instruction to the same task.		Specify axes that are assigned to the same task for all of the composition axes in an axes group.	
Attached information	Attached Information 1: Error Details 01 hex: There is a type specification error. 02 hex: The number of elements in the array is lower than the number of composition axes. 03 hex: The same axis number is specified twice, the axis type of the specified axis number is not supported, or the specified axis number is out of range. 04 hex: The axis with the specified axis number cannot be set as the composition axis because it is a single-axis position control axis.					
Precautions/Remarks	None					

Event name	Axis Use Setting Out of Range		Event code	549E0000 hex		
Meaning	The parameter specified for the <i>AxisUse</i> input variable to a motion control instruction is out of range.					
Source	Motion Control Function Module		Source details	MC common or axis	Detection timing	At instruction execution
Error attributes	Level	Minor fault	Recovery	Error reset	Log category	System
Effects	User program	Continues.	Operation	Not affected.		
System-defined variables	Variable		Data type		Name	
	_MC_COM.MFaultLvl.Active		BOOL		MC Common Minor Fault Occurrence	
	_MC_AX[*].MFaultLvl.Active		BOOL		Axis Minor Fault Occurrence	
Cause and correction	Assumed cause		Correction		Prevention	
	Instruction input parameter exceeded the valid range of the input variable.		Correct the parameter so that the valid range of the input variable is not exceeded for the relevant instruction.		Set the input parameter to the instruction so that the valid range of the input variable is not exceeded.	
Attached information	None					
Precautions/Remarks	If an error occurs in executing an instruction for a used axis, an axis error will occur. If an error occurs in executing an instruction for an unused axis, an MC common error will occur.					

Event name	Homing Parameter Setting Out of Range		Event code	57000000 hex		
Meaning	The parameter specified for the <i>HomingParameter</i> input variable to a motion control instruction is out of range.					
Source	Motion Control Function Module	Source details	Axis	Detection timing	At instruction execution	
Error attributes	Level	Minor fault	Recovery	Error reset	Log category	System
Effects	User program	Continues.	Operation	Not affected.		
System-defined variables	Variable	Data type		Name		
	_MC_COM.MFaultLvl.Active	BOOL		MC Common Minor Fault Occurrence		
Cause and correction	Assumed cause	Correction		Prevention		
	Instruction input parameter exceeded the valid range of the input variable.	Correct the parameter so that the valid range of the input variable is not exceeded for the relevant instruction.		Set the input parameter to the instruction so that the valid range of the input variable is not exceeded.		
Attached information	Attached Information 1: Error Details 1: Homing Method out of range, 2: Home Input Signal out of range, 3: Homing Start Direction out of range, 4: Home Input Detection Direction out of range, 5: Operation Selection at Positive Limit Input out of range, 6: Operation Selection at Negative Limit Input out of range, 7: Homing Velocity out of range, 8: Homing Approach Velocity out of range, 9: Homing Acceleration out of range, 10: Homing Deceleration out of range, 11: Homing Jerk out of range, 12: Home Input Mask Distance out of range, 13: Absolute Encoder Home Offset out of range, 14: Homing Holding Time out of range, 15: Homing Compensation Value out of range, 16: Homing Compensation Velocity out of range, 100: Home Input Mask Distance exceeded 40-bit range when converted to pulses, 101: Home Input Mask Distance exceeded modulo length, 102: Homing Compensation Value exceeded 40-bit range when converted to pulses, 103: Homing Compensation Value exceeded modulo length, 104: Home Offset exceeded 40-bit range when converted to pulses, 105: Home Offset exceeded modulo range, 106: Homing Velocity exceeded maximum velocity, 107: Homing Approach Velocity exceeded maximum velocity, 108: Homing Approach Velocity was not less than or equal to Homing Velocity, 109: Homing Compensation Velocity is not less than or equal to Maximum Velocity, 110: Homing Acceleration exceeded maximum acceleration rate, 111: Homing Deceleration exceeded maximum deceleration rate					
Precautions/Remarks	None					

Event name	Axis Use Change Error		Event code	57020000 hex		
Meaning	The MC_ChangeAxisUse (Change Axis Use) instruction was executed when the axis was not stopped or when the command velocity of the axis was saturated.					
Source	Motion Control Function Module		Source details	Axis	Detection timing	At instruction execution
Error attributes	Level	Minor fault	Recovery	Error reset	Log category	System
Effects	User program	Continues.	Operation	Not affected.		
System-defined variables	Variable		Data type		Name	
	_MC_AX[*].MFAultLvl.Active		BOOL		Axis Minor Fault Occurrence	
Cause and correction	Assumed cause		Correction		Prevention	
	The MC_ChangeAxisUse (Change Axis Use) instruction was executed when the axis was not stopped or when the command velocity of the axis was saturated.		Reset the error and execute the MC_ChangeAxisUse (Change Axis Use) instruction when the axis is stopped or when the command velocity of the axis is not saturated. An axis is stopped if <i>Status.Disabled</i> or <i>Status.Standstill</i> is TRUE in the Axis Variable. The command velocity for an axis is saturated if <i>Details.VelLimit</i> is TRUE in the Axis Variable.		Execute the MC_ChangeAxisUse (Change Axis Use) instruction when the axis is stopped and the command velocity is not saturated.	
Attached information	None					
Precautions/Remarks	None					

Event name	Cannot Change Axis Use		Event code	57030000 hex			
Meaning	The MC_ChangeAxisUse (Change Axis Use) instruction was executed in a way that would cause the maximum number of used real axes or the maximum number of used motion control servo axes to be exceeded.						
Source	Motion Control Function Module		Source details	MC Common	Detection timing	At instruction execution	
Error attributes	Level	Minor fault	Recovery	Error reset	Log category	System	
Effects	User program	Continues.	Operation	Not affected.			
System-defined variables	Variable		Data type		Name		
	_MC_COM.MFAultLvl.Active		BOOL		MC Common Minor Fault Occurrence		
Cause and correction	Assumed cause		Correction		Prevention		
	The MC_ChangeAxisUse (Change Axis Use) instruction was executed in a way that would cause the maximum number of used real axes to be exceeded.		Correct the program so that the maximum number of real axes used by the CPU Unit is not exceeded.		Write the program so that the maximum number of real axes used by the CPU Unit is not exceeded.		
		The MC_ChangeAxisUse (Change Axis Use) instruction was executed in a way that would cause the maximum number of used motion control servo axes to be exceeded.		Correct the program so that the maximum number of used motion control servo axes that can be used by the CPU Unit is not exceeded.		Write the program so that the maximum number of used motion control servo axes that can be used by the CPU Unit is not exceeded.	
Attached information	Attached Information 1: Cause of the Error <ul style="list-style-type: none"> • 1: Maximum number of used real axes exceeded • 2: Maximum number of used motion control servo axes exceeded 						
Precautions/Remarks	None						

Event name	Motion Control Parameter Setting Error When Changing Axis Use		Event code	57200000 hex	
Meaning	The motion control parameter settings for the axis that was changed to a used axis are incorrect.				
Source	Motion Control Function Module		Source details	MC Common	Detection timing At instruction execution
Error attributes	Level	Minor fault	Recovery	Error reset	Log category System
Effects	User program	Continues.	Operation	Not affected.	
System-defined variables	Variable		Data type		Name
	_MC_COM.MFaultLvl.Active		BOOL		MC Common Minor Fault Occurrence
Cause and correction	Assumed cause		Correction		Prevention
	The MC_ChangeAxisUse (Change Axis Use) instruction was used to change an unused axis to a used axis, but the motion control parameter settings of the axis are not correct.		Use the Sysmac Studio to change the Axis Use of the axis where the error occurred to a Used Axis , and then check and correct the error location. If an error does not occur, change the setting to an Unused Axis and then download the settings again.		Make sure that operation is correct when the axis is set to a Used Axis and then download the settings with it set to an Unused Axis .
	The power supply was interrupted while a download of the motion control parameter settings was in progress.		Download the MC parameters from the Sysmac Studio.		Do not interrupt the power supply while saving the parameter settings.
	The non-volatile memory is faulty or the life of the non-volatile memory has been exceeded.		If this error remains even after making the above corrections, replace the CPU Unit.		None
Attached information	None				
Precautions/Remarks	None				

Event name	Required Process Data Object Not Set When Changing Axis Use		Event code	57210000 hex	
Meaning	The objects that are required for the axis type of the axis that was changed to a used axis are not set.				
Source	Motion Control Function Module		Source details	MC Common	Detection timing At instruction execution
Error attributes	Level	Minor fault	Recovery	Error reset	Log category System
Effects	User program	Continues.	Operation	Not affected.	
System-defined variables	Variable		Data type		Name
	_MC_COM.MFaultLvl.Active		BOOL		MC Common Minor Fault Occurrence
Cause and correction	Assumed cause		Correction		Prevention
	The objects that are required for the axis type of the axis that was changed to a used axis are not set in the PDO map settings.		Edit the PDO map settings on the Sysmac Studio and set the objects that are required for the axis where the error occurred. Refer to PDO Mapping on page 2-35 for the required objects.		Make sure that operation is correct when the axis is set to a Used Axis and then download the settings with it set to an Unused Axis .
	The power supply was interrupted while a download of the motion control parameter settings was in progress.		Download the MC parameters from the Sysmac Studio.		Do not interrupt the power supply while saving the parameter settings.
	The non-volatile memory is faulty or the life of the non-volatile memory has been exceeded.		If this error remains even after making the above corrections, replace the CPU Unit.		None
	The MC_ChangeAxisUse (Change Axis Use) instruction was executed for an axis that Axis Use is set to Unused axis (unchangeable to used axis) .		Correct the program so that the MC_ChangeAxisUse (Change Axis Use) instruction is not executed for an axis that Axis Use is set to Unused axis (unchangeable to used axis) .		Write the program so that the MC_ChangeAxisUse (Change Axis Use) instruction is not executed for an axis that Axis Use is set to Unused axis (unchangeable to used axis) .
Attached information	None				
Precautions/Remarks	None				

Event name	Motion Control Instruction Multi-execution Disabled (Master Axis)		Event code	572F0000 hex		
Meaning	A <i>Master</i> in-out variable that cannot be changed during multi-execution of instructions was changed.					
Source	Motion Control Function Module		Source details	Axis	Detection timing	At multi-execution of instructions
Error attributes	Level	Minor fault	Recovery	Error reset	Log category	System
Effects	User program	Continues.	Operation	Not affected.		
System-defined variables	Variable	Data type		Name		
	_MC_AX[*].MFAultLvl.Active	BOOL		Axis Minor Fault Occurrence		
Cause and correction	Assumed cause	Correction		Prevention		
	A <i>Master</i> in-out variable that cannot be changed during multi-execution of instructions was changed.	Correct the program so that the value of the <i>Master</i> in-out variable is not changed during multi-execution of the relevant instructions.		Write the program so that the value of the <i>Master</i> in-out variable is not changed during multi-execution of the relevant instructions.		
Attached information	None					
Precautions/Remarks	None					

Event name	Motion Control Instruction Multi-execution Disabled (Position Type Selection)		Event code	57300000 hex		
Meaning	A <i>ReferenceType</i> in-out variable that cannot be changed during multi-execution of instructions was changed.					
Source	Motion Control Function Module		Source details	Axis	Detection timing	At multi-execution of instructions
Error attributes	Level	Minor fault	Recovery	Error reset	Log category	System
Effects	User program	Continues.	Operation	Not affected.		
System-defined variables	Variable	Data type		Name		
	_MC_AX[*].MFAultLvl.Active	BOOL		Axis Minor Fault Occurrence		
Cause and correction	Assumed cause	Correction		Prevention		
	A <i>ReferenceType</i> in-out variable that cannot be changed during multi-execution of instructions was changed.	Correct the program so that the value of the <i>ReferenceType</i> in-out variable is not changed during multi-execution of the relevant instructions.		Write the program so that the value of the <i>ReferenceType</i> in-out variable is not changed during multi-execution of the relevant instructions.		
Attached information	None					
Precautions/Remarks	None					

Event name	Cannot Write Axis Parameters		Event code	573A0000 hex		
Meaning	The instruction was executed for an axis that is not an unused axis.					
Source	Motion Control Function Module		Source details	MC Common	Detection timing	At instruction execution
Error attributes	Level	Minor fault	Recovery	Error reset	Log category	System
Effects	User program	Continues.	Operation	Not affected.		
System-defined variables	Variable		Data type		Name	
	_MC_COM.MFaultLvl.Active		BOOL		MC Common Minor Fault Occurrence	
Cause and correction	Assumed cause		Correction		Prevention	
	The instruction was executed for a used axis or an undefined axis.		Correct the program so that the MC_ChangeAxisUse (Change Axis Use) instruction is executed after the specified axis is changed to an unused axis.		Write the program so that the specified axis is an unused axis when the instruction is executed.	
Attached information	None					
Precautions/Remarks	None					

Event name	Axis Parameter Setting Out of Range		Event code	573B0000 hex	
Meaning	The parameter specified for the <i>AxisParameter</i> input variable to a motion control instruction is outside of the valid range.				
Source	Motion Control Function Module		Source details	MC Common	Detection timing At instruction execution
Error attributes	Level	Minor fault	Recovery	Error reset	Log category System
Effects	User program	Continues.	Operation	Not affected.	
System-defined variables	Variable	Data type		Name	
	_MC_COM.MFaultLvl.Active	BOOL		MC Common Minor Fault Occurrence	
Cause and correction	Assumed cause	Correction		Prevention	
	The parameter specified for the <i>AxisParameter</i> input variable to the instruction is out of range for the input variable.	Correct the parameter so that the valid range of the input variable is not exceeded for the instruction. Confirm which parameter exceeded the range or what parameters are inconsistent in the attached information.		Set the input parameter to the instruction so that the valid range of the input variable is not exceeded. Refer to information on the MC_WriteAxisParameter (Write Axis Parameters) instruction for the valid ranges of the input variables.	

Attached information	<p>Attached Information 1: Error Details</p> <ul style="list-style-type: none"> Range Check Detail Codes <p>0000 hex: Unit of Display out of range, 0001 hex: Command Pulse Count Per Motor Rotation out of range, 0002 hex: Work Travel Distance Per Motor Rotation out of range, 0003 hex: Work Travel Distance Per Rotation out of range, 0004 hex: Work Gear Ratio out of range, 0005 hex: Motor Gear Ratio out of range, 0100 hex: Maximum Velocity out of range, 0101 hex: Start Velocity out of range, 0102 hex: Maximum Jog Velocity out of range, 0103 hex: Maximum Acceleration out of range, 0104 hex: Maximum Deceleration out of range, 0105 hex: Acceleration/Deceleration Over out of range, 0106 hex: Operation Selection at Reversing out of range, 0107 hex: Velocity Warning Value out of range, 0108 hex: Acceleration Warning Value out of range, 0109 hex: Deceleration Warning Value out of range, 010A hex: Positive Torque Warning Value out of range, 010B hex: Negative Torque Warning Value out of range, 010C hex: In-position Range out of range, 010D hex: In-position Check Time out of range, 010E hex: Actual Velocity Filter Time Constant out of range, 010F hex: Zero Position Range out of range, 0200 hex: Immediate Stop Input Stop Method out of range, 0201 hex: Limit Input Stop Method out of range, 0202 hex: Drive Error Reset Monitoring Time out of range, 0203 hex: Maximum Positive Torque Limit out of range, 0204 hex: Maximum Negative Torque Limit out of range, 0300 hex: Software Limits out of range, 0301 hex: Positive Software Limit out of range, 0302 hex: Negative Software Limit out of range, 0303 hex: Following Error Over Limit Value out of range, 0304 hex: Following Error Warning Value out of range, 0400 hex: Count Mode out of range, 0401 hex: Modulo Maximum Position Setting Value out of range, 0402 hex: Modulo Minimum Position Setting Value out of range, 0500 hex: Homing Method out of range, 0501 hex: Home Input Signal out of range, 0502 hex: Homing Start Direction out of range, 0503 hex: Home Input Detection Direction out of range, 0504 hex: Operation Selection at Positive Limit Input out of range, 0505 hex: Operation Selection at Negative Limit Input out of range, 0506 hex: Homing Velocity out of range, 0507 hex: Homing Approach Velocity out of range, 0508 hex: Homing Acceleration out of range, 0509 hex: Homing Deceleration out of range, 050A hex: Homing Jerk out of range, 050B hex: Home Input Mask Distance out of range, 050C hex: Home Offset out of range, 050D hex: Homing Holding Time out of range, 050E hex: Homing Compensation Value out of range, 050F hex: Homing Compensation Velocity out of range</p> <ul style="list-style-type: none"> Consistency Check Detail Codes <p>1000 hex: The value found by the following calculation was out of the range between 0.000000001 and $2^{32}-1$: Work Travel Distance Per Rotation \times Work Gear Ratio/Motor Gear Ratio, 1001 hex: The value found by the following formula exceeded 40-bit range: Command Pulse Count Per Motor Rotation \times Motor Gear Ratio, 1100 hex: Maximum Velocity exceeded the upper limit*¹ when converted to pluses, 1101 hex: Start Velocity exceeded Maximum Velocity, 1102 hex: Maximum Jog Velocity exceeded Maximum Velocity, 1103 hex: In-position Range exceeded 40-bit range when converted to pulses, 1104 hex: Zero Position Range exceeded 40-bit range when converted to pulses, 1300 hex: Positive Software Limit exceeded 40-bit range when converted to pulses, 1301 hex: Negative Software Limit exceeded 40-bit range when converted to pulses, 1302 hex: Positive Software Limit was not greater than Negative Software Limit, 1303 hex: Following Error Over Value exceeded 40-bit range when converted to pulses, 1304 hex: Following Error Over Value was not greater than or equal to Following Error Warning Value, 1400 hex: Modulo Maximum Position Setting Value exceeded 40-bit range when converted to pulses, 1401 hex: Modulo Minimum Position Setting Value exceeded 40-bit range when converted to pulses, 1402 hex: Modulo Maximum Position Setting Value was not greater than Modulo Minimum Position Setting Value, 1403 hex: Absolute value of Modulo Maximum Position Setting Value minus Modulo Minimum Position Setting Value was not 2 or greater after conversion to pulses, 1500 hex: Homing Velocity exceeded Maximum Velocity, 1501 hex: Homing Approach Velocity was not less than or equal to Homing Velocity, 1502 hex: Homing Acceleration exceeded Maximum Acceleration, 1503 hex: Homing Deceleration exceeded Maximum Deceleration, 1504 hex: Home Input Mask Distance exceeded 40-bit range when converted to pulses, 1505 hex: Home Input Mask Distance exceeded modulo length, 1506 hex: Home Offset exceeded 40-bit range when converted to pulses, 1507 hex: Home Offset exceeded modulo length, 1508 hex: Absolute value of Homing Compensation Value exceeded 40-bit range when converted to pulses, 1509 hex: Absolute value of Homing Compensation Value exceeded modulo length, 150A hex: Homing Compensation Velocity was not less than or equal to Maximum Velocity</p> <p>Note Only one error code is given even if more than one error occurs. The range check detail codes are given priority over the consistency check detail codes.</p>
Precautions/Remarks	None

*1. The upper limit of the Maximum Velocity is 2,147,483,647 Hz.

Event name	Cam Property Setting Out of Range		Event code	573C0000 hex	
Meaning	The parameter specified for the <i>CamProperty</i> input variable to a motion control instruction is outside of the valid range.				
Source	Motion Control Function Module		Source details	MC Common	Detection timing At instruction execution
Error attributes	Level	Minor fault	Recovery	Error reset	Log category System
Effects	User program	Continues.	Operation	Not affected.	
System-defined variables	Variable	Data type		Name	
	_MC_COM.MFaultLvl.Active	BOOL		MC Common Minor Fault Occurrence	
Cause and correction	Assumed cause	Correction		Prevention	
	The parameter specified for the <i>CamProperty</i> input variable to the instruction is out of range for the input variable.	Correct the parameter so that the valid range of the input variable is not exceeded for the instruction. Confirm which parameter exceeded the range in the attached information.		Set the input parameter to the instruction so that the valid range of the input variable is not exceeded.	
Attached information	Attached Information 1: Error Details <ul style="list-style-type: none"> • 0000 hex: Initial Velocity out of range • 0001 hex: Initial Acceleration out of range • 0002 hex: Cycle Time out of range 				
Precautions/Remarks	None				

Event name	Cam Node Setting Out of Range		Event code	573D0000 hex	
Meaning	The parameter specified for the <i>CamNodes</i> input variable to a motion control instruction is outside of the valid range.				
Source	Motion Control Function Module		Source details	MC Common	Detection timing At instruction execution
Error attributes	Level	Minor fault	Recovery	Error reset	Log category System
Effects	User program	Continues.	Operation	Not affected.	
System-defined variables	Variable	Data type		Name	
	_MC_COM.MFaultLvl.Active	BOOL		MC Common Minor Fault Occurrence	
Cause and correction	Assumed cause	Correction		Prevention	
	The parameter specified for the <i>CamNodes</i> input variable to the instruction is out of range for the input variable.	Correct the parameter so that the valid range of the input variable is not exceeded for the instruction. Confirm which parameter exceeded the range in the attached information.		Set the input parameter to the instruction so that the valid range of the input variable is not exceeded.	
Attached information	Attached Information 1: Error Details <ul style="list-style-type: none"> • 0000 hex: Master Axis Phase out of range • 0001 hex: Slave Axis Displacement out of range • 0002 hex: Curve Shape out of range • 0003 hex: Connecting Velocity out of range • 0004 hex: Connecting Acceleration out of range • 0005 hex: Phase Pitch out of range Attached Information 2: Element Number of Error Node Point				
Precautions/Remarks	None				

Event name	Incorrect Cam Node Type Specification		Event code	573E0000 hex		
Meaning	The parameter specified for the <i>CamNodes</i> input variable to a motion control instruction is not an <i>_sMC_CAM_NODE</i> array variable.					
Source	Motion Control Function Module		Source details	MC Common	Detection timing	At instruction execution
Error attributes	Level	Minor fault	Recovery	Error reset	Log category	System
Effects	User program	Continues.	Operation	Not affected.		
System-defined variables	Variable		Data type		Name	
	_MC_COM.MFaultLvl.Active		BOOL		MC Common Minor Fault Occurrence	
Cause and correction	Assumed cause		Correction		Prevention	
	The parameter specified for the <i>CamNodes</i> input variable to the instruction is not an <i>_sMC_CAM_NODE</i> array variable.		Correct the program to specify an <i>sMC_CAM_NODE</i> array variable for the input variable to the instruction.		Write the program to specify an <i>sMC_CAM_NODE</i> array variable for the input variable to the instruction.	
Attached information	None					
Precautions/Remarks	None					

Event name	Insufficient Nodes in Cam Table		Event code	573F0000 hex		
Meaning	The array variable of the parameter specified for the <i>CamNodes</i> input variable to a motion control instruction has a <i>Phase</i> value of 0 for element number 0.					
Source	Motion Control Function Module		Source details	MC Common	Detection timing	At instruction execution
Error attributes	Level	Minor fault	Recovery	Error reset	Log category	System
Effects	User program	Continues.	Operation	Not affected.		
System-defined variables	Variable		Data type		Name	
	_MC_COM.MFaultLvl.Active		BOOL		MC Common Minor Fault Occurrence	
Cause and correction	Assumed cause		Correction		Prevention	
	The array variable of the parameter specified for <i>CamNodes</i> input variable to the instruction has a <i>Phase</i> (master axis phase) value of 0 for element number 0.		Correct the program so that the value of <i>Phase</i> (master axis phase) for element number 0 in the array variable for the parameter specified for the <i>CamNodes</i> input variable is not 0.		Write the program so that the value of <i>Phase</i> (master axis phase) for element number 0 in the array variable for the parameter specified for the <i>CamNodes</i> input variable is not 0.	
Attached information	None					
Precautions/Remarks	None					

Event name	Cam Node Master Axis Phase Not in Ascending Order		Event code	57400000 hex		
Meaning	The values of <i>Phase</i> in the array variable of the parameter specified for the <i>CamNodes</i> input variable to a motion control instruction are not in ascending order according to the element numbers.					
Source	Motion Control Function Module		Source details	MC Common	Detection timing	At instruction execution
Error attributes	Level	Minor fault	Recovery	Error reset	Log category	System
Effects	User program	Continues.	Operation	Not affected.		
System-defined variables	Variable		Data type		Name	
	_MC_COM.MFaultLvl.Active		BOOL		MC Common Minor Fault Occurrence	
Cause and correction	Assumed cause		Correction		Prevention	
	The values of <i>Phase</i> (master axis phase) in the array variable of the parameter specified for the instruction are not in ascending order according to the element numbers. Or, truncating the digits that are not effective more than seven digits caused the phases not to be in ascending order.		Correct the program so that the values of <i>Phase</i> (master axis phase) in the array variable for the parameter specified for the <i>CamNodes</i> input variable are in ascending order according to the element numbers.		Write the program so that the values of <i>Phase</i> (master axis phase) in the array variable for the parameter specified for the <i>CamNodes</i> input variable are in ascending order according to the element numbers.	
Attached information	Attached Information 1: Element Number of Error Node Point					
Precautions/Remarks	None					

Event name	Too Many Data Points in Cam Table		Event code	57410000 hex		
Meaning	The number of generated cam data points exceeded the number of elements in the array in the cam data variable that is specified for the <i>CamTable</i> input variable to a motion control instruction.					
Source	Motion Control Function Module		Source details	MC Common	Detection timing	At instruction execution
Error attributes	Level	Minor fault	Recovery	Error reset	Log category	System
Effects	User program	Continues.	Operation	Not affected.		
System-defined variables	Variable		Data type		Name	
	_MC_COM.MFaultLvl.Active		BOOL		MC Common Minor Fault Occurrence	
Cause and correction	Assumed cause		Correction		Prevention	
	The number of cam data points in the generated cam table exceeded the number of elements in the array in the cam data variable that is specified for the <i>CamTable</i> input variable to the instruction.		Correct the program so that the number of cam data points in the generated cam table does not exceed the number of elements in the array in the cam data variable that is specified for the <i>CamTable</i> input variable to the instruction. Refer to information on the MC_GenerateCamTable (Generate Cam Table) instruction for the number of cam data points in generated cam tables.		Write the program so that the number of cam data points in the generated cam table does not exceed the number of elements in the array in the cam data variable that is specified for the <i>CamTable</i> input variable to the instruction. Refer to information on the MC_GenerateCamTable (Generate Cam Table) instruction for the number of cam data points in generated cam tables.	
Attached information	Attached Information 1: Element Number of Error Node Point					
Precautions/Remarks	None					

Event name	Cam Table Displacement Overflow		Event code	57420000 hex		
Meaning	<i>Distance</i> in the generated cam table exceeded the range of REAL data.					
Source	Motion Control Function Module		Source details	MC Common	Detection timing	At or during instruction execution
Error attributes	Level	Minor fault	Recovery	Error reset	Log category	System
Effects	User program	Continues.	Operation	Not affected.		
System-defined variables	Variable	Data type		Name		
	_MC_COM.MFaultLvl.Active	BOOL		MC Common Minor Fault Occurrence		
Cause and correction	Assumed cause	Correction		Prevention		
	<i>Distance</i> in the generated cam table exceeded the range of REAL data.	Correct the values of <i>InitVel</i> (initial velocity), <i>ConnectingVel</i> (connecting velocity), and <i>ConnectingAcc</i> (connecting acceleration) so that <i>Distance</i> does not overflow when a polynomial 3 curve or polynomial 5 curve is specified for <i>Curve</i> (curve shape) in the <i>CamNodes</i> input variable. Refer to information on the MC_GenerateCamTable (Generate Cam Table) instruction for the method to calculate <i>Distance</i> .		Specify the values of <i>InitVel</i> (initial velocity), <i>ConnectingVel</i> (connecting velocity), and <i>ConnectingAcc</i> (connecting acceleration) so that <i>Distance</i> does not overflow when a polynomial 3 curve or polynomial 5 curve is specified for <i>Curve</i> (curve shape) in the <i>CamNodes</i> input variable. Refer to information on the MC_GenerateCamTable (Generate Cam Table) instruction for the method to calculate <i>Distance</i> .		
Attached information	Attached Information 1: Element Number of Error Node Point					
Precautions/Remarks	None					

Event name	Aborted Cam Table Used		Event code	57430000 hex		
Meaning	A cam data variable that was aborted during generation was specified for the <i>CamTable</i> input variable to an instruction.					
Source	Motion Control Function Module		Source details	MC common or axis	Detection timing	At instruction execution
Error attributes	Level	Minor fault	Recovery	Error reset	Log category	System
Effects	User program	Continues.	Operation	Not affected.		
System-defined variables	Variable	Data type		Name		
	_MC_COM.MFaultLvl.Active	BOOL		MC Common Minor Fault Occurrence		
	_MC_AX[*].MFaultLvl.Active	BOOL		Axis Minor Fault Occurrence		
Cause and correction	Assumed cause	Correction		Prevention		
	A cam data variable that was aborted during generation due to an error in the MC_GenerateCamTable (Generate Cam Table) instruction was specified for the <i>CamTable</i> input variable to the instruction.	Check the <i>ErrorID</i> (error code), <i>ErrorParameterCode</i> (parameter detail code), and <i>ErrorNodePointIndex</i> (node point element number) output variables from the MC_GenerateCamTable (Generate Cam Table) instruction and correct the program so that correct cam table variables are created.		Write the program so that the MC_GenerateCamTable (Generate Cam Table) instruction creates correct cam data variables. Or, write the program so that the relevant instruction is executed only when the MC_GenerateCamTable (Generate Cam Table) instruction ends normally.		
Attached information	None					
Precautions/Remarks	None					

Event name	Execution ID Setting Out of Range		Event code	57490000 hex		
Meaning	The parameter specified for the <i>ExecID</i> input variable to a motion control instruction is out of range.					
Source	Motion Control Function Module		Source details	Axis	Detection timing	At instruction execution
Error attributes	Level	Minor fault	Recovery	Error reset	Log category	System
Effects	User program	Continues.	Operation	Relevant axis decelerates to a stop if it is in motion.		
System-defined variables	Variable	Data type		Name		
	_MC_AX[*].MFaultLvl.Active	BOOL		Axis Minor Fault Occurrence		
Cause and correction	Assumed cause	Correction		Prevention		
	The parameter specified for the <i>ExecID</i> input variable to the instruction is out of range for the input variable.	Correct the program so that the input parameter specified for the <i>ExecID</i> input variable to the instruction is within the setting range.		Create the program so that the input parameter specified for the <i>ExecID</i> input variable to the instruction is within the setting range.		
Attached information	None					
Precautions/Remarks	None					

Event name	Position Offset Out of Range		Event code	574A0000 hex		
Meaning	The parameter specified for the <i>OffsetPosition</i> input variable to a motion control instruction is out of range.					
Source	Motion Control Function Module		Source details	Axis	Detection timing	At instruction execution
Error attributes	Level	Minor fault	Recovery	Error reset	Log category	System
Effects	User program	Continues.	Operation	Operation is not possible for relevant axis. Relevant axis decelerates to a stop if it is in motion.		
System-defined variables	Variable		Data type		Name	
	_MC_AX[*].MFAultLvl.Active		BOOL		Axis Minor Fault Occurrence	
Cause and correction	Assumed cause		Correction		Prevention	
	The instruction input parameter exceeded the range of signed 40-bit data when it is converted to pulses.		Correct the parameter so that the valid range of the input variable is not exceeded for the instruction.		Set the input parameter to the instruction so that the valid range of the input variable is not exceeded.	
Attached information	None					
Precautions/Remarks	None					

Event name	PDS State Transition Command Selection Out of Range		Event code	574B0000 hex		
Meaning	The parameter specified for the <i>TransitionCmd</i> input variable to a motion control instruction is out of range.					
Source	Motion Control Function Module		Source details	Axis	Detection timing	At instruction execution
Error attributes	Level	Minor fault	Recovery	Error reset	Log category	System
Effects	User program	Continues.	Operation	Operation is not possible for relevant axis. Relevant axis decelerates to a stop if it is in motion.		
System-defined variables	Variable		Data type		Name	
	_MC_AX[*].MFAultLvl.Active		BOOL		Axis Minor Fault Occurrence	
Cause and correction	Assumed cause		Correction		Prevention	
	Instruction input parameter exceeded the valid range of the input variable.		Correct the parameter so that the valid range of the input variable is not exceeded for the instruction.		Set the input parameter to the instruction so that the valid range of the input variable is not exceeded.	
Attached information	None					
Precautions/Remarks	None					

Event name	Cam Monitor Mode Selection Out of Range		Event code	57510000 hex *1	
Meaning	The cam monitor mode selection specified for the <i>CamMonitorMode</i> input variable to a motion control instruction is out of range.				
Source	Motion Control Function Module		Source details	Axis	Detection timing At instruction execution
Error attributes	Level	Minor fault	Recovery	Error reset	Log category System
Effects	User program	Continues.	Operation	Operation is not possible for relevant axis. Relevant axis decelerates to a stop if it is in motion.	
System-defined variable	Variable	Data type		Name	
	_MC_AX[*].MFAultLvl.Active	BOOL		Axis Minor Fault Occurrence	
Cause and correction	Assumed cause		Correction		Prevention
	The cam monitor mode selection is out of the valid range.		Make a correction so that the cam monitor mode selection is within the valid range.		Make a setting so that the cam monitor mode selection is within the valid range.
Attached information	None				
Precautions/Remarks	None				

*1. This event code occurs for a CPU Unit with unit version 1.21 or later.

Event name	Data Type of Cam Monitor Values Mismatch		Event code	57520000 hex *1	
Meaning	The data type of the cam monitor values specified for the <i>CamMonitorValue</i> in-out variable to a motion control instruction does not match the cam monitor mode selection.				
Source	Motion Control Function Module		Source details	Axis	Detection timing At instruction execution
Error attributes	Level	Minor fault	Recovery	Error reset	Log category System
Effects	User program	Continues.	Operation	Operation is not possible for relevant axis. Relevant axis decelerates to a stop if it is in motion.	
system-defined variable	Variable	Data type		Name	
	_MC_AX[*].MFAultLvl.Active	BOOL		Axis Minor Fault Occurrence	
Cause and correction	Assumed cause		Correction		Prevention
	The data type of the variable specified for the cam monitor values does not match the cam monitor mode selection.		Make a correction of the data type of the variable specified for the cam monitor values.		Set the data type of the variable specified for the cam monitor values correctly.
Attached information	None				
Precautions/Remarks	None				

*1. This event code occurs for a CPU Unit with unit version 1.21 or later.

Event name	Target Position Positive Software Limit Exceeded		Event code	64400000 hex		
Meaning	The specified position exceeds the positive software limit.					
Source	Motion Control Function Module		Source details	Axis/axes group	Detection timing	At instruction execution
Error attributes	Level	Minor fault	Recovery	Error reset	Log category	System
Effects	User program	Continues.	Operation	<p>If “axis” is given for the source details, operation is not possible for relevant axis. Relevant axis decelerates to a stop if it is in motion.</p> <p>If “axes group” is given for the source details, operation is not possible for relevant axes group. Relevant axes group decelerates to a stop if it is in motion.</p>		
System-defined variables	Variable		Data type	Name		
		_MC_AX[*].MFAultLvl.Active	BOOL	Axis Minor Fault Occurrence		
		_MC_GRP[*].MFAultLvl.Active	BOOL	Axes Group Minor Fault Occurrence		
Cause and correction	Assumed cause		Correction	Prevention		
		The parameter specified for the <i>Position</i> input variable to the instruction is beyond the positive software limit.	Correct the parameter specified for the <i>Position</i> input variable to the instruction so that it is within the positive software limit.	Set the parameter specified for the <i>Position</i> input variable to the instruction so that it is within the positive software limit.		
		The starting position is beyond the positive software limit and an instruction that specifies motion in the opposite direction of the software limit was executed.	Correct the program so that the travel direction for the instruction is towards the positive software limit.	If the starting position is beyond the positive software limit, write the program so that the travel direction is in the direction of the positive software limit.		
	The parameter that was specified for the <i>AuxPoint</i> input variable to a border point MC_MoveCircular2D (Circular 2D Interpolation) instruction is beyond the positive software limit.	Correct the parameter specified for the <i>AuxPoint</i> input variable to the instruction so that it is within the positive software limit.	Set the parameter specified for the <i>AuxPoint</i> input variable to the border point MC_MoveCircular2D (Circular 2D Interpolation) instruction so that it is within the negative software limit.			
Attached information	Attached Information 1: Depends on the source details.					
	<ul style="list-style-type: none"> • Axis: 0 • Axes group: Logical axis number 					
Precautions/Remarks	None					

Event name	Target Position Negative Software Limit Exceeded		Event code	64410000 hex		
Meaning	The specified position exceeds the negative software limit.					
Source	Motion Control Function Module		Source details	Axis/axes group	Detection timing	At instruction execution
Error attributes	Level	Minor fault	Recovery	Error reset	Log category	System
Effects	User program	Continues.	Operation	<p>If “axis” is given for the source details, operation is not possible for relevant axis. Relevant axis decelerates to a stop if it is in motion.</p> <p>If “axes group” is given for the source details, operation is not possible for relevant axes group. Relevant axes group decelerates to a stop if it is in motion.</p>		
System-defined variables	Variable		Data type	Name		
		_MC_AX[*].MFAultLvl.Active	BOOL	Axis Minor Fault Occurrence		
		_MC_GRP[*].MFAultLvl.Active	BOOL	Axes Group Minor Fault Occurrence		
Cause and correction	Assumed cause		Correction	Prevention		
		The parameter specified for the <i>Position</i> input variable to the instruction is beyond the negative software limit.	Correct the parameter specified for the <i>Position</i> input variable to the instruction so that it is within the negative software limit.	Correct the input parameter specified for the <i>Position</i> input variable to the instruction so that it is within the negative software limit.		
		The starting position is beyond the negative software limit and an instruction that specifies motion in the opposite direction of the software limit was executed.	Correct the program so that the travel direction for the instruction is towards the negative software limit.	If the starting position is beyond the negative software limit, write the program so that the travel direction is in the direction of the negative software limit.		
	The parameter that was specified for the <i>AuxPoint</i> input variable to a border point MC_MoveCircular2D (Circular 2D Interpolation) instruction is beyond the negative software limit.	Correct the parameter specified for the <i>AuxPoint</i> input variable to the instruction so that it is within the negative software limit.	Set the parameter specified for the <i>AuxPoint</i> input variable to the border point MC_MoveCircular2D (Circular 2D Interpolation) instruction so that it is within the negative software limit.			
Attached information	Attached Information 1: Depends on the source details. <ul style="list-style-type: none"> • Axis: 0 • Axes group: Logical axis number 					
Precautions/Remarks	None					

Event name	Command Position Overflow/Underflow		Event code	64420000 hex	
Meaning	Positioning, an instruction in the underflow/overflow direction, or an instruction for which the direction is not specified was executed when there was an underflow/overflow in the command position.				
Source	Motion Control Function Module		Source details	Axis	Detection timing At instruction execution
Error attributes	Level	Minor fault	Recovery	Error reset	Log category System
Effects	User program	Continues.	Operation	Operation is not possible for relevant axis. Relevant axis decelerates to a stop if it is in motion.	
System-defined variables	Variable	Data type		Name	
	_MC_AX[*].MFAultLvl.Active	BOOL		Axis Minor Fault Occurrence	
Cause and correction	Assumed cause		Correction		Prevention
	<p>One of the following was executed when there was a command position overflow/underflow.</p> <ul style="list-style-type: none"> • A positioning instruction • A continuous control instruction in the underflow/overflow direction • An instruction for which the direction is not specified (syncing or torque control) 		Execute an error reset and then clear the overflow/underflow state by executing homing or presetting the actual position.		Make sure that overflow or underflow does not occur.
Attached information	None				
Precautions/Remarks	None				

Event name	Positive Limit Input		Event code	64430000 hex		
Meaning	An instruction was executed for a motion in the positive direction when the positive limit input was ON.					
Source	Motion Control Function Module		Source details	Axis/axes group	Detection timing	At instruction execution
Error attributes	Level	Minor fault	Recovery	Error reset	Log category	System
Effects	User program	Continues.	Operation	If "axis" is given for the source details, operation is not possible for relevant axis. If "axes group" is given for the source details, operation is not possible for relevant axes group.		
System-defined variables	Variable	Data type		Name		
	_MC_AX[*].MFAultLvl.Active	BOOL		Axis Minor Fault Occurrence		
	_MC_GRP[*].MFAultLvl.Active	BOOL		Axes Group Minor Fault Occurrence		
Cause and correction	Assumed cause	Correction		Prevention		
	An instruction for a motion in the positive direction was executed when the positive limit input was ON, or an instruction for a motion with no direction specification was executed when the positive limit input was ON. An axes group motion control instruction was executed when the positive limit input was ON.	Execute an error reset and then perform a recovery operation in the negative direction. If the error occurred during an axes group motion control instruction, disable the axes group and then perform the above operation. If this error occurs again, check the connection of the positive limit signal, the logic setting for the positive limit input, and the execution conditions for the start command, and correct any mistakes. Check the logic settings both in the axis parameters and in the slave settings.		Check to make sure there are no problems with the positive limit signal connection, the logic setting for the positive limit input, and the execute conditions for the instruction. Check the logic settings both in the axis parameters and in the slave settings.		
Attached information	Attached Information 1: Depends on the source details. <ul style="list-style-type: none"> • Axis: 0 • Axes group: Logical axis number 					
Precautions/Remarks	None					

3 Error Descriptions and Corrections

Event name	Negative Limit Input			Event code	64440000 hex	
Meaning	An instruction for a motion in the negative direction was executed when the negative limit input was ON.					
Source	Motion Control Function Module		Source details	Axis/axes group	Detection timing	At instruction execution
Error attributes	Level	Minor fault	Recovery	Error reset	Log category	System
Effects	User program	Continues.	Operation	<p>If “axis” is given for the source details, operation is not possible for relevant axis.</p> <p>If “axes group” is given for the source details, operation is not possible for relevant axes group.</p>		
System-defined variables	Variable		Data type		Name	
	_MC_AX[*].MFaultLvl.Active		BOOL		Axis Minor Fault Occurrence	
	_MC_GRP[*].MFaultLvl.Active		BOOL		Axes Group Minor Fault Occurrence	
Cause and correction	Assumed cause		Correction		Prevention	
	<p>An instruction for a motion in the negative direction was executed when the negative limit input was ON, or an instruction for a motion with no direction specification was executed when the negative limit input was ON. An axes group motion control instruction was executed when the negative limit input was ON.</p>		<p>Execute an error reset and then perform a recovery operation in the positive direction. If the error occurred during an axes group motion control instruction, disable the axes group and then perform the above operation. If this error occurs again, check the connection of the negative limit signal, the logic setting for the negative limit input, and the execution conditions for the start command, and correct any mistakes.</p> <p>Check the logic settings both in the axis parameters and in the slave settings.</p>		<p>Check to make sure there are no problems with the negative limit signal connection, the logic setting for the negative limit input, and the execute conditions for the instruction.</p> <p>Check the logic settings both in the axis parameters and in the slave settings.</p>	
Attached information	<p>Attached Information 1: Depends on the source details.</p> <ul style="list-style-type: none"> • Axis: 0 • Axes group: Logical axis number 					
Precautions/Remarks	None					

Event name	Servo Main Circuits OFF			Event code	74220000 hex	
Meaning	An attempt was made to turn ON the Servo when the main circuit power supply to the Servo Drive was OFF.					
Source	Motion Control Function Module		Source details	Axis	Detection timing	At instruction execution
Error attributes	Level	Minor fault	Recovery	Error reset	Log category	System
Effects	User program	Continues.	Operation	The Servo for the axis turns OFF.		
System-defined variables	Variable		Data type		Name	
	_MC_AX[*].MFaultLvl.Active		BOOL		Axis Minor Fault Occurrence	
Cause and correction	Assumed cause		Correction		Prevention	
	<p>An attempt was made to turn ON the Servo when the main circuit power supply to the Servo Drive was OFF.</p>		<p>Turn ON the Servo after turning ON the main circuit power of the Servo Drive for the axis where the error occurred.</p>		<p>Turn ON the Servo after turning ON the main circuit power supply to the Servo Drive.</p>	
Attached information	None					
Precautions/Remarks	None					

Event name	Actual Position Overflow/Underflow		Event code	57220000 hex		
Meaning	An instruction was executed that is not supported during an actual position overflow/underflow.					
Source	Motion Control Function Module	Source details	Axis	Detection timing	At instruction execution	
Error attributes	Level	Observation	Recovery	---	Log category	System
Effects	User program	Continues.	Operation	Not affected.		
System-defined variables	Variable	Data type		Name		
	_MC_AX[*].Obsr.Active	BOOL		Axis Observation Occurrence		
Cause and correction	Assumed cause	Correction		Prevention		
	An instruction was executed that is not supported during an actual position overflow or underflow.	Execute an error reset and then clear the overflow or underflow state by changing the current position or homing.		Write the program so that overflows and underflows do not occur.		
Attached information	None					
Precautions/Remarks	None					

Event name	Switch Structure Track Number Setting Out of Range		Event code	57230000 hex		
Meaning	The value of <i>TrackNumber</i> that is specified in the <i>Switches</i> in-out variable to a motion control instruction is out of range.					
Source	Motion Control Function Module	Source details	Axis	Detection timing	At instruction execution	
Error attributes	Level	Observation	Recovery	---	Log category	System
Effects	User program	Continues.	Operation	Not affected.		
System-defined variables	Variable	Data type		Name		
	_MC_AX[*].Obsr.Active	BOOL		Axis Observation Occurrence		
Cause and correction	Assumed cause	Correction		Prevention		
	The value of the member of the structure variable that was specified for the in-out variable of the instruction is out of range.	Correct the value of the member of the structure variable that is specified for the in-out variable of the relevant instruction so that it is in the valid range.		Make sure that the value of the member of the structure variable that is specified for the in-out variable of the relevant instruction is in the valid range.		
Attached information	None					
Precautions/Remarks	None					

3 Error Descriptions and Corrections

Event name	Switch Structure First ON Position Setting Out of Range		Event code	57240000 hex		
Meaning	The value of <i>FirstOnPosition</i> that is specified in the <i>Switches</i> in-out variable to a motion control instruction is out of range.					
Source	Motion Control Function Module		Source details	Axis	Detection timing	At instruction execution
Error attributes	Level	Observation	Recovery	---	Log category	System
Effects	User program	Continues.	Operation	Not affected.		
System-defined variables	Variable		Data type		Name	
	_MC_AX[*].Obsr.Active		BOOL		Axis Observation Occurrence	
Cause and correction	Assumed cause		Correction		Prevention	
	The value of the member of the structure variable that was specified for the in-out variable of the instruction is out of range.		Correct the value of the member of the structure variable that is specified for the in-out variable of the relevant instruction so that it is in the valid range.		Make sure that the value of the member of the structure variable that is specified for the in-out variable of the relevant instruction is in the valid range.	
Attached information	None					
Precautions/Remarks	None					

Event name	Switch Structure Last ON Position Setting Out of Range		Event code	57250000 hex		
Meaning	The value of <i>LastOnPosition</i> that is specified in the <i>Switches</i> in-out variable to a motion control instruction is out of range.					
Source	Motion Control Function Module		Source details	Axis	Detection timing	At instruction execution
Error attributes	Level	Observation	Recovery	---	Log category	System
Effects	User program	Continues.	Operation	Not affected.		
System-defined variables	Variable		Data type		Name	
	_MC_AX[*].Obsr.Active		BOOL		Axis Observation Occurrence	
Cause and correction	Assumed cause		Correction		Prevention	
	The value of the member of the structure variable that was specified for the in-out variable of the instruction is out of range.		Correct the value of the member of the structure variable that is specified for the in-out variable of the relevant instruction so that it is in the valid range.		Make sure that the value of the member of the structure variable that is specified for the in-out variable of the relevant instruction is in the valid range.	
Attached information	None					
Precautions/Remarks	None					

Event name	Switch Structure Axis Direction Out of Range		Event code	57260000 hex	
Meaning	The value of <i>AxisDirection</i> that is specified in the <i>Switches</i> in-out variable to a motion control instruction is out of range.				
Source	Motion Control Function Module		Source details	Axis	Detection timing At instruction execution
Error attributes	Level	Observation	Recovery	---	Log category System
Effects	User program	Continues.	Operation	Not affected.	
System-defined variables	Variable	Data type		Name	
	_MC_AX[*].Obsr.Active	BOOL		Axis Observation Occurrence	
Cause and correction	Assumed cause	Correction		Prevention	
	The value of the member of the structure variable that was specified for the in-out variable of the instruction is out of range.	Correct the value of the member of the structure variable that is specified for the in-out variable of the relevant instruction so that it is in the valid range.		Make sure that the value of the member of the structure variable that is specified for the in-out variable of the relevant instruction is in the valid range.	
Attached information	None				
Precautions/Remarks	None				

Event name	Switch Structure Cam Switch Mode Out of Range		Event code	57270000 hex	
Meaning	The value of <i>CamSwitchMode</i> that is specified in the <i>Switches</i> in-out variable to a motion control instruction is out of range.				
Source	Motion Control Function Module		Source details	Axis	Detection timing At instruction execution
Error attributes	Level	Observation	Recovery	---	Log category System
Effects	User program	Continues.	Operation	Not affected.	
System-defined variables	Variable	Data type		Name	
	_MC_AX[*].Obsr.Active	BOOL		Axis Observation Occurrence	
Cause and correction	Assumed cause	Correction		Prevention	
	The value of the member of the structure variable that was specified for the in-out variable of the instruction is out of range.	Correct the value of the member of the structure variable that is specified for the in-out variable of the relevant instruction so that it is in the valid range.		Make sure that the value of the member of the structure variable that is specified for the in-out variable of the relevant instruction is in the valid range.	
Attached information	None				
Precautions/Remarks	None				

Event name	Switch Structure Duration Setting Out of Range		Event code	57280000 hex	
Meaning	The value of <i>Duration</i> that is specified in the <i>Switches</i> in-out variable to a motion control instruction is out of range.				
Source	Motion Control Function Module		Source details	Axis	Detection timing At instruction execution
Error attributes	Level	Observation	Recovery	---	Log category System
Effects	User program	Continues.	Operation	Not affected.	
System-defined variables	Variable		Data type		Name
	_MC_AX[*].Obsr.Active		BOOL		Axis Observation Occurrence
Cause and correction	Assumed cause		Correction		Prevention
	The value of the member of the structure variable that was specified for the in-out variable of the instruction is out of range.		Correct the value of the member of the structure variable that is specified for the in-out variable of the relevant instruction so that it is in the valid range.		Make sure that the value of the member of the structure variable that is specified for the in-out variable of the relevant instruction is in the valid range.
Attached information	None				
Precautions/Remarks	None				

Event name	Track Option Structure ON Compensation Setting Out of Range		Event code	57290000 hex	
Meaning	The value of <i>OnCompensation</i> that is specified in the <i>TrackOptions</i> in-out variable to a motion control instruction is out of range.				
Source	Motion Control Function Module		Source details	Axis	Detection timing At instruction execution
Error attributes	Level	Observation	Recovery	---	Log category System
Effects	User program	Continues.	Operation	Not affected.	
System-defined variables	Variable		Data type		Name
	_MC_AX[*].Obsr.Active		BOOL		Axis Observation Occurrence
Cause and correction	Assumed cause		Correction		Prevention
	The value of the member of the structure variable that was specified for the in-out variable of the instruction is out of range.		Correct the value of the member of the structure variable that is specified for the in-out variable of the relevant instruction so that it is in the valid range.		Make sure that the value of the member of the structure variable that is specified for the in-out variable of the relevant instruction is in the valid range.
Attached information	None				
Precautions/Remarks	None				

Event name	Track Option Structure OFF Compensation Setting Out of Range		Event code	572A0000 hex	
Meaning	The value of <i>OffCompensation</i> that is specified in the <i>TrackOptions</i> in-out variable to a motion control instruction is out of range.				
Source	Motion Control Function Module		Source details	Axis	Detection timing At instruction execution
Error attributes	Level	Observation	Recovery	---	Log category System
Effects	User program	Continues.	Operation	Not affected.	
System-defined variables	Variable	Data type		Name	
	_MC_AX[*].Obsr.Active	BOOL		Axis Observation Occurrence	
Cause and correction	Assumed cause	Correction		Prevention	
	The value of the member of the structure variable that was specified for the in-out variable of the instruction is out of range.	Correct the value of the member of the structure variable that is specified for the in-out variable of the relevant instruction so that it is in the valid range.		Make sure that the value of the member of the structure variable that is specified for the in-out variable of the relevant instruction is in the valid range.	
Attached information	None				
Precautions/Remarks	None				

Event name	Number of Array Elements in Switch Structure Variable Out of Range		Event code	572B0000 hex	
Meaning	The number of elements in an array in the structure variable that is specified in the <i>Switches</i> in-out variable to a motion control instruction is out of range.				
Source	Motion Control Function Module		Source details	Axis	Detection timing At instruction execution
Error attributes	Level	Observation	Recovery	Error reset	Log category System
Effects	User program	Continues.	Operation	Not affected.	
System-defined variables	Variable	Data type		Name	
	_MC_AX[*].Obsr.Active	BOOL		Axis Observation Occurrence	
Cause and correction	Assumed cause	Correction		Prevention	
	The number of elements in an array of the structure variable that was specified for the in-out variable of the instruction is out of range.	Correct the number of elements in the array in the structure variable that is specified for the in-out variable of the relevant instruction so that it is in the valid range.		Make sure that the number of elements in the array in the structure variable that is specified for the in-out variable of the relevant instruction is in the valid range.	
Attached information	None				
Precautions/Remarks	None				

3 Error Descriptions and Corrections

Event name	Number of Array Elements in Output Signal Structure Variable Out of Range		Event code	572C0000 hex		
Meaning	The number of elements in an array in the structure variable that is specified in the <i>Outputs</i> in-out variable to a motion control instruction is out of range.					
Source	Motion Control Function Module		Source details	Axis	Detection timing	At instruction execution
Error attributes	Level	Observation	Recovery	---	Log category	System
Effects	User program	Continues.	Operation	Not affected.		
System-defined variables	Variable		Data type		Name	
	_MC_AX[*].Obsr.Active		BOOL		Axis Observation Occurrence	
Cause and correction	Assumed cause		Correction		Prevention	
	The number of elements in an array of the structure variable that was specified for the in-out variable of the instruction is out of range.		Correct the number of elements in the array in the structure variable that is specified for the in-out variable of the relevant instruction so that it is in the valid range.		Make sure that the number of elements in the array in the structure variable that is specified for the in-out variable of the relevant instruction is in the valid range.	
Attached information	None					
Precautions/Remarks	None					

Event name	Number of Array Elements in Track Option Structure Variable Out of Range		Event code	572D0000 hex		
Meaning	The number of elements in an array in the structure variable that is specified in the <i>TrackOptions</i> in-out variable to a motion control instruction is out of range.					
Source	Motion Control Function Module		Source details	Axis	Detection timing	At instruction execution
Error attributes	Level	Observation	Recovery	---	Log category	System
Effects	User program	Continues.	Operation	Not affected.		
System-defined variables	Variable		Data type		Name	
	_MC_AX[*].Obsr.Active		BOOL		Axis Observation Occurrence	
Cause and correction	Assumed cause		Correction		Prevention	
	The number of elements in an array of the structure variable that was specified for the in-out variable of the instruction is out of range.		Correct the number of elements in the array in the structure variable that is specified for the in-out variable of the relevant instruction so that it is in the valid range.		Make sure that the number of elements in the array in the structure variable that is specified for the in-out variable of the relevant instruction is in the valid range.	
Attached information	None					
Precautions/Remarks	None					

Event name	Numbers of Elements in Output Signals and Track Option Arrays Not Matched		Event code	572E0000 hex	
Meaning	The arrays in the structure variables that are specified for the <i>Outputs</i> and <i>TrackOptions</i> in-out variables to a motion control instruction do not have the same number of elements.				
Source	Motion Control Function Module		Source details	Axis	Detection timing At instruction execution
Error attributes	Level	Observation	Recovery	---	Log category System
Effects	User program	Continues.	Operation	Not affected.	
System-defined variables	Variable		Data type	Name	
	_MC_AX[*].Obsr.Active		BOOL	Axis Observation Occurrence	
Cause and correction	Assumed cause		Correction	Prevention	
	The arrays in the output signal structure variable and track option structure variable that are specified for the in-out variables to the instruction do not have the same number of elements.		Correct the output signal structure variable and track option structure variable that are specified for the in-out variables to the relevant instruction so that the arrays in them have the same number of elements.	Make sure that the arrays in the output signal structure variable and track option structure variable that are specified for the in-out variables to the relevant instruction have the same number of elements.	
Attached information	None				
Precautions/Remarks	None				

Event name	Same Track Number Setting in Switch Structure Out of Range		Event code	57310000 hex	
Meaning	The same track number was specified more than the allowable number of times for the <i>TrackNumber</i> in the <i>Switches</i> in-out variable to a motion control instruction.				
Source	Motion Control Function Module		Source details	Axis	Detection timing At instruction execution
Error attributes	Level	Observation	Recovery	---	Log category System
Effects	User program	Continues.	Operation	Not affected.	
System-defined variables	Variable		Data type	Name	
	_MC_AX[*].Obsr.Active		BOOL	Axis Observation Occurrence	
Cause and correction	Assumed cause		Correction	Prevention	
	The same track number was specified more than the allowable number of times for the <i>TrackNumber</i> in the <i>Switches</i> in-out variable to a motion control instruction.		Correct the values in the <i>TrackNumber</i> so that the same track number is not specified more than the maximum number of times.	Set the values in the <i>TrackNumber</i> so that the same track number is not specified more than the maximum number of times.	
Attached information	None				
Precautions/Remarks	None				

3-3-3 Other Troubles and Corrections

This section describes remedial actions to take when problems occur the first time you use the MC Function Module or after starting operation.

Preliminary Check Items

If an error occurs, check the items below to investigate the problem.

Category	Item to check
Installation conditions	Is there dust in the ambient environment?
	Are there conductive foreign matters (metal, carbon, etc.) in the ambient environment that might enter the Controller?
	Is the ambient temperature higher than the ambient operating temperature in the specifications?
	Is the ambient area humid (due to moisture in the air, use of water, etc.)?
	Does the ambient air contain corrosive gases (acid, salt, sulfur, etc.)?
	Are there sources of noise around the Controller (welders, inverters, etc.)?
Wiring	Are power supply lines wired in the same duct as the signal lines?
	Is the Controller grounded properly?
	Is there a noise filter in the power supply?
Changes	Was any extension work (welding work) done lately?
	Was any power supply facility added lately?
	Was the system (including its program) modified in any way (including additions)?
Accidents	Was there a lightning strike nearby?
	Was there a ground-fault accident or was the earth leakage breaker tripped?
	Was there a power outage?

Problems and Countermeasures

This section describes troubleshooting when the MC Function Module is used in combination with an OMRON 1S-series Servo Drive or G5-series Servo Drive.

If an unexpected operation is performed, data such as parameter settings or cam data may not have been transferred properly to the NY-series Controller from the Sysmac Studio.

Furthermore, variables may not be working properly between the user program and the MC Function Module.

Use the data tracing function of Sysmac Studio to check if variables are exchanged at the correct timings.

Problem	Cause	Item to check	Countermeasure
Motor does not lock.	The MC Function Module does not output operation commands to the Servo Drive.	Make sure that you execute the MC_Power instruction.	Correct the program.
	Servo Drive setting error	Check the Servo Drive settings.	Set the Servo Drives correctly.

Problem	Cause	Item to check	Countermeasure
Motor does not run.	The drive prohibit input of the Servo Drive is enabled.	Use the Servo Drive software to check the drive prohibit input.	Cancel the drive prohibit input of the Servo Drive. Change the setting so that you do not use the drive prohibit input of the Servo Drive.
	Servo Drive error	Check for a Servo Drive error.	If there is an error, follow troubleshooting procedures for it.
	Mechanical axis is locked.	Check for contact with mechanical limits and check to see if mechanical parts are caught on something.	Manually release the locked mechanical axis.
	NY-series Industrial PC failure	---	Replace the NY-series Industrial PC.
Homing cannot be performed.	Error	Check the nature of the error.	If there is an error, follow troubleshooting procedures for it.
	Incorrect wiring of the home proximity input.	Check the axis input information in the Axis Variables to see if the home proximity input sensor turns ON/OFF.	Wire all connections correctly.
	Incorrect wiring of the home input.	Check the wiring of the home input.	Wire all connections correctly.
	The rotation direction and limit input direction are inconsistent.	If the axis moves to the mechanical limit without reversing at the limit, check the axis input information in the Axis Variables to see if the limit input turns ON and OFF.	Wire the limit inputs correctly.
	Incorrect wiring of the limit input	Check the wiring of the limit inputs.	Wire all connections correctly.
	InPosWaiting does not change to FALSE.	Check to see if the Servo Drive gain is too low. Check to see if the in-position range is too narrow.	Increase the Servo Drive gain. Increase the in-position range.
	Homing approach velocity is too high.	Check the homing approach velocity.	Lower the homing approach velocity of the MC Function Module.
	Axis parameters are not set correctly.	Check the axis parameters in the Sysmac Studio.	After setting the axis parameters correctly, download them to the MC Function Module.
The position of home defined with homing changes occasionally.	NY-series Industrial PC failure	---	Replace the NY-series Industrial PC.
	Loose mechanical parts, such as couplings	Use a marker pen to mark the motor shafts, couplings, and other mechanical connections to check for shifting.	Securely tighten the connections that shifted.

Problem	Cause	Item to check	Countermeasure
	Insufficient leeway for Z phase Insufficient leeway for home input signal	If the value is close to the setting per Servomotor rotation (number of pulses per encoder rotation) or near zero, the home may be shifted by one motor rotation due to slight changes in the timing of reading the sensor input.	Remove the motor coupling and shift the position by around one-quarter of a turn so that the Z phase pulse occurs at around one half of a Servomotor rotation (number of pulses per encoder rotation), and then perform homing again.
Unstable motor rotation	Incorrect wiring of Servomotor power line/ encoder line, missing phase, etc.	Check the wiring of the motor power line and encoder line.	Wire all connections correctly.
	Load torque variation due to gear meshing or not tightening the coupling eccentric screw connecting the motor axis with the mechanical system	Check the machine. Turn the coupling under a no-load condition (with the mechanical part after the coupling removed).	Review and adjust the machine.
	Insufficient gain adjustment	---	Perform auto-tuning of the Servomotor. Manually adjust the Servomotor gain.
	Incorrect Servomotor selection (adjustment not possible)	Select another motor (check the torque and inertia ratio).	Change to an optimal motor.
	Damaged Servomotor bearings	Turn OFF the Servo Drive power supply, and also turn ON the brake power supply and release the brake if the motor comes with a brake. Then manually turn the motor output shaft with the motor power line disconnected (because the dynamic brake may be applied).	Replace the Servomotor.
	Broken Servomotor winding	Use a tester to check the resistance between phases U, V, and W of the motor power line. If the balance is off, there is a problem.	Replace the Servomotor.
Rotation direction is reversed.	The Servo Drive is set to the opposite rotation direction.	Jog the machine. If the rotation direction of the Servo Drive is opposite the jogging direction, the rotation direction of the Servo Drive is reversed. Also check for reversed feedback signals (phases A and B) and reverse rotation setting of the parameter.	Set the rotation direction of the Servo Drive correctly.

Problem	Cause	Item to check	Countermeasure
	(During homing) The axis parameters that set the polarity of the home proximity sensor and the polarity of the home proximity input do not match.	Check the axis parameters and sensor polarity again.	Set the correct axis parameters.
	(During homing) Incorrect wiring of the home proximity input	Check the axis input information in the Axis Variables to see if the home proximity input sensor turns ON/OFF.	Wire the home proximity input correctly.
Operation cannot be started, positioning is not completed, or positioning takes too much time to complete.	The in-position range of the Servo Drive is too narrow, and thus the current position does not enter the in-position range. (The current operation does not complete until the current position enters the in-position range, so you cannot start the next motion.)	---	Increase the in-position range.
	Servo Drive gain is low.	---	Adjust the Servo Drive gain.
	The axis does not remain in the in-position range due to an external force.	Check the axis input information for the Axis Variables to see if the difference between the command current position and the actual current position is within the in-position range.	If you stop the axis so that a position inside the inposition range is not achieved, such as holding control, you can use the following error reset output to forcibly achieve the inposition range.
Abnormal noise	Mechanical vibration	Check the moving parts of the machine for intrusion of foreign matter, damage, deformation, and loosening.	Correct the problem.
	Insufficient adjustment of the Servo Drive gain (high gain)	---	Perform auto-tuning. Manually lower the gain.
	Incorrect Servomotor selection (adjustment not possible).	Select another motor (check the torque and inertia ratio).	Change to an optimal motor.
	Misalignment of the coupling that connects the motor shaft and machine	---	Adjust the motor and machine installation.
Motor shaft shakes.	Insufficient adjustment of the gain (low gain)	---	Perform auto-tuning. Manually increase the gain.

Problem	Cause	Item to check	Countermeasure
	Gain cannot be adjusted due to low machine rigidity.	In particular, this condition occurs on vertical axes, SCARA robots, palletizers, and other systems whose axes are subject to bending or tensional loads.	Increase the machine rigidity. Readjust the gain.
	Mechanical configuration prone to stick slip (highly sticky static friction)	---	Perform auto-tuning. Manually adjust the gain.
	Incorrect Servomotor selection (adjustment not possible).	Select an appropriate motor (check the torque and inertia ratio).	Change to an optimal motor.
	Failure	---	Replace the Servo Drive. Replace the Servomotor.
Position shift	The home position was already shifted before positioning.	Refer to The position of home defined with homing changes occasionally.	Refer to The position of home defined with homing changes occasionally.
	Malfunction due to noise from a welder, inverter, etc.	Check if a welder, inverter, or other similar device is located nearby.	Isolate the Controller from any nearby welders, inverters, etc.
	Mechanical shift	Check if dimensional shifts accumulated. (Mark the mechanical connections to check for shifting.)	Securely tighten the mechanical tightening points.
An MC Test Run is not possible from the Sysmac Studio.	An MC Test Run is being executed from another installation of the Sysmac Studio.	Check to see if there is another installation of the Sysmac Studio connected to the same Controller.	End all MC Test Run operation for other installations of the Sysmac Studio.

3-4 Errors in the EtherNet/IP Function Module

3-4-1 Error Tables

Built-in EtherNet/IP Port

Event code	Event name	Meaning	Assumed cause	Level					Reference
				M a j	P r t	M i n	O b s	I n f o	
14220000 hex	EtherNet/IP Processing Error	A fatal error was detected in the EtherNet/IP Function Module.	<ul style="list-style-type: none"> Hardware has failed. 		○				page 3-456
04210000 hex	Communications Controller Failure	A hardware error was detected in the communications controller of the built-in EtherNet/IP port.	<ul style="list-style-type: none"> Hardware error in the communications controller 			○			page 3-456
14210000 hex	Identity Error	The CIP identity information in non-volatile memory was not read correctly.	<ul style="list-style-type: none"> Non-volatile memory failure 			○			page 3-457
14230000 hex	MAC Address Error	The MAC address in non-volatile memory was not read correctly.	<ul style="list-style-type: none"> Non-volatile memory failure 			○			page 3-457
34200000 hex	Tag Data Link Setting Error	An error was detected in the communications settings for tag data links.	<ul style="list-style-type: none"> Power was interrupted when a download was in progress for the data link settings. Memory error 			○			page 3-458
34230000 hex	IP Route Table Setting Error	An IP routing setting error was detected.	<ul style="list-style-type: none"> Setting error Power was interrupted when a download was in progress for the built-in EtherNet/IP port settings. Memory error 			○			page 3-459
34240000 hex	FTP Server Setting Error	An error was detected in the FTP server settings.	<ul style="list-style-type: none"> Setting error Power was interrupted when a download was in progress for the FTP server settings. Memory error 			○			page 3-460
34250000 hex	NTP Client Setting Error	An error was detected in the NTP client settings.	<ul style="list-style-type: none"> Setting error Power was interrupted when a download was in progress for the NTP client settings. Memory error 			○			page 3-461

Event code	Event name	Meaning	Assumed cause	Level					Reference
				M a j	P r t	M i n	O b s	I n f o	
34260000 hex	SNMP Setting Error	An error was detected in the SNMP agent/trap settings.	<ul style="list-style-type: none"> Setting error Power was interrupted when a download was in progress for the SNMP agent/trap settings. Memory error 			○			page 3-462
34270000 hex	Tag Name Resolution Error	Resolution of a tag used in a tag data link failed.	<ul style="list-style-type: none"> The size of the network variable is different from the tag settings. The I/O direction set for a tag data link and the I/O direction of the Controller variable do not match. There are no network variables for the Controller tag settings. A variable in the Controller that is set for a tag data link has the Network Publish attribute set to Input but also has the Constant attribute. 			○			page 3-463
34280000 hex	Basic Ethernet Setting Error	An error was detected in the Ethernet settings.	<ul style="list-style-type: none"> Parameter error Power was interrupted when a download was in progress for the built-in EtherNet/IP port settings. A memory error occurred. 			○			page 3-464
34290000 hex	IP Address Setting Error	An error was detected in the IP address settings.	<ul style="list-style-type: none"> Parameter error Power was interrupted when a download was in progress for the built-in EtherNet/IP port settings. The IP address acquired from BOOTP server is illegal. A memory error occurred. 			○			page 3-465
342A0000 hex	DNS Setting Error	An error was detected in the DNS settings or Hosts settings.	<ul style="list-style-type: none"> Parameter error Power was interrupted when a download was in progress for the built-in EtherNet/IP port settings. A memory error occurred. 			○			page 3-466
50010000 hex	Controller Insufficient Memory Warning	The amount of data for the EtherCAT slave configuration, network-published information, or other data exceeds the value that is specified for the CPU Unit. You may not be able to perform online editing or other operations.	<ul style="list-style-type: none"> The amount of data for the EtherCAT slave configuration, network-published information, or other data exceeds the value that is specified for the CPU Unit. 			○			page 3-467

Event code	Event name	Meaning	Assumed cause	Level					Reference
				M a j	P r t	M i n	O b s	I n f o	
84030000 hex	DNS Server Connection Error	Connection with the DNS server failed.	<ul style="list-style-type: none"> Parameter error Server is down. An error occurred in the communications path. 			○			page 3-468
84040000 hex	NTP Server Connection Error	Connection with the NTP server failed.	<ul style="list-style-type: none"> Parameter error Server is down. An error occurred in the communications path. 			○			page 3-469
84070000 hex	Tag Data Link Connection Failed	Establishing a tag data link connection failed.	<ul style="list-style-type: none"> The tag data link connection information is not the same for the originator and target. Insufficient connections 			○			page 3-470
84080000 hex	Tag Data Link Timeout	A timeout occurred in a tag data link.	<ul style="list-style-type: none"> The power supply to the target node is OFF. Communications with the target node stop. The Ethernet cable for EtherNet/IP is disconnected. The Ethernet cable for EtherNet/IP is broken. The link to the built-in EtherNet/IP port is OFF. The packet loss occurred on the path due to the network communications load. Noise 			○			page 3-471
84090000 hex	Tag Data Link Connection Timeout	A timeout occurred while trying to establish a tag data link connection.	<ul style="list-style-type: none"> The power supply to the target node is OFF. Communications at the target node are stopped. The Ethernet cable connector for EtherNet/IP is disconnected. The Ethernet cable for EtherNet/IP is broken. An error occurred in the communications path. 			○	◉		page 3-472
840A0000 hex	IP Address Duplication Error	The same IP address is used more than once.	<ul style="list-style-type: none"> The IP address of the built-in EtherNet/IP port is also used as the IP address of another node. 			○			page 3-473
840B0000 hex	BOOTP Server Connection Error	Connection with the BOOTP server failed.	<ul style="list-style-type: none"> Server setting error Server is down. An error occurred in the communications path. 			○			page 3-474

Event code	Event name	Meaning	Assumed cause	Level					Reference
				M a j	P r t	M i n	O b s	I n f o	
54E00000 hex	Access De- tected Out- side Range of Variable	Accessing a value that is out of range was detected for a tag variable that is used in a tag data link.	<ul style="list-style-type: none"> An out-of-range value was written by an EtherNet/IP tag data link for a variable with a specified range. A value that does not specify an enumerator was written by an EtherNet/IP tag data link for an enumeration variable. 				○		page 3-475
84050000 hex	Packet Dis- carded Due to Full Re- ception Buf- fer	A packet was dis- carded.	<ul style="list-style-type: none"> A network convergence occur- red. 				○		page 3-475
84060000 hex	Link OFF Detected	An Ethernet link OFF was detected.	<ul style="list-style-type: none"> An Ethernet cable is broken, disconnected, or loose. The Ethernet switch's power supply is turned OFF. Baud rate mismatch. Noise The Identity object was reset. Settings for EtherNet/IP were downloaded from the Network Configurator or Sysmac Stu- dio, or the Clear All Memory operation was performed. EtherNet/IP was restarted. 			⊙	○		page 3-476
94010000 hex	Tag Data Link Download Started	Changing the tag da- ta link settings start- ed.	<ul style="list-style-type: none"> Changing the tag data link set- tings started. 				○		page 3-477
94020000 hex	Tag Data Link Download Finished	Changing the tag da- ta link settings finish- ed.	<ul style="list-style-type: none"> Changing the tag data link set- tings finished. 				○		page 3-477
94030000 hex	Tag Data Link Stopped	Tag data links were stopped by the Net- work Configurator, Sysmac Studio, or manipulation of a sys- tem-defined variable. Or, the data link table was downloaded from the Network Configu- rator or Sysmac Stu- dio again.	<ul style="list-style-type: none"> Tag data links were stopped by the Network Configurator, Sys- mac Studio, or manipulation of a system-defined variable. 				○		page 3-478

Event code	Event name	Meaning	Assumed cause	Level					Reference
				M a j	P r t	M i n	O b s	I n f o	
94040000 hex	Tag Data Link Started	Tag data links were started by the Network Configurator, Sysmac Studio, or manipulation of a system-defined variable. Or, the data link table was downloaded from the Network Configurator or Sysmac Studio again.	<ul style="list-style-type: none"> Tag data links were started by the Network Configurator, Sysmac Studio, or manipulation of a system-defined variable. 					○	page 3-478
94050000 hex	Link Detected	Establishment of an Ethernet link was detected.	<ul style="list-style-type: none"> Establishment of an Ethernet link was detected. 					○	page 3-479
94060000 hex	Restarting Ethernet Port	The built-in EtherNet/IP port was restarted.	<ul style="list-style-type: none"> The built-in EtherNet/IP port was restarted. 					○	page 3-479
94070000 hex	Tag Data Link All Run	Tag data link connections to all nodes have been normally established.	<ul style="list-style-type: none"> Tag data link connections to all target nodes have been normally established. 					○	page 3-480
94080000 hex	IP Address Fixed	The correct IP address has been determined and Ethernet communications can start.	<ul style="list-style-type: none"> The correct IP address has been determined and Ethernet communications can start. 					○	page 3-480
94090000 hex	BOOTP Client Started	The BOOTP client started requesting an IP address.	<ul style="list-style-type: none"> The BOOTP client started requesting an IP address. 					○	page 3-481
940A0000 hex	FTP Server Started	The FTP agent started normally.	<ul style="list-style-type: none"> The FTP agent started normally. 					○	page 3-481
940B0000 hex	NTP Client Started	The NTP client started normally and a request for the NTP server to obtain the time started.	<ul style="list-style-type: none"> The NTP client started normally and a request for the NTP server to obtain the time started. 					○	page 3-482
940C0000 hex	SNMP Started	The SNMP agent started normally.	<ul style="list-style-type: none"> The SNMP agent started normally. 					○	page 3-482

3-4-2 Error Descriptions

Built-in EtherNet/IP Port

Event name	EtherNet/IP Processing Error		Event code	14220000 hex		
Meaning	A fatal error was detected in the EtherNet/IP Function Module.					
Source	EtherNet/IP Function Module		Source details	Communica- tions port	Detection tim- ing	Continuously
Error attributes	Level	Partial fault	Recovery	Cycle the power supply.	Log category	System
Effects	User program	Continues.	Operation	EtherNet/IP communications will not operate.		
Status	NET RUN		NET ERR		LINK	
	Stop		Critical Error		---	
System-de- fined variables	Variable		Data type		Name	
	None		---		---	
Cause and cor- rection	Assumed cause		Correction		Prevention	
	Hardware has failed.		Replace the CPU Unit.		None	
Attached infor- mation	None					
Precautions/ Remarks	None					

Event name	Communications Controller Failure		Event code	04210000 hex		
Meaning	A hardware error was detected in the communications controller of the built-in EtherNet/IP port.					
Source	EtherNet/IP Function Module		Source details	Communica- tions port 1	Detection tim- ing	Continuously
Error attributes	Level	Minor fault	Recovery	Cycle the power supply.	Log category	System
Effects	User program	Continues.	Operation	EtherNet/IP communications are not possible for the relevant communications port.		
Status	NET RUN		NET ERR		LINK	
	Stop		Critical Error		---	
System-de- fined variables	Variable		Data type		Name	
	_EIP1_LanHwErr		BOOL		Port1 Communications Controller Error	
Cause and cor- rection	Assumed cause		Correction		Prevention	
	Hardware error in the communica- tions controller		Replace the CPU Unit.		None	
Attached infor- mation	None					
Precautions/ Remarks	After the _EIP1_LanHwErr system-defined variable changes to TRUE, it will not change to FALSE unless the power supply to the Controller is cycled.					

Event name	Identity Error			Event code	14210000 hex
Meaning	The CIP identity information in non-volatile memory was not read correctly.				
Source	EtherNet/IP Function Module		Source details	CIP	Detection timing At power ON or Controller reset
Error attributes	Level	Minor fault	Recovery	Cycle the power supply.	Log category System
Effects	User program	Continues.	Operation	EtherNet/IP communications are not possible for the relevant communications port.	
Status	NET RUN		NET ERR		LINK
	---		Critical Error		---
System-defined variables	Variable		Data type		Name
	_EIP_IdentityErr		BOOL		Identity Error
Cause and correction	Assumed cause		Correction		Prevention
	Non-volatile memory failure		Replace the CPU Unit.		None
Attached information	None				
Precautions/Remarks	None				

Event name	MAC Address Error			Event code	14230000 hex
Meaning	The MAC address in non-volatile memory was not read correctly.				
Source	EtherNet/IP Function Module		Source details	Communications port 1	Detection timing At power ON or Controller reset
Error attributes	Level	Minor fault	Recovery	Cycle the power supply.	Log category System
Effects	User program	Continues.	Operation	EtherNet/IP communications are not possible for the relevant communications port.	
Status	NET RUN		NET ERR		LINK
	Stop		Critical Error		---
System-defined variables	Variable		Data type		Name
	_EIP1_MacAdrErr		BOOL		Port1 MAC Address Error
Cause and correction	Assumed cause		Correction		Prevention
	Non-volatile memory failure		Replace the CPU Unit.		None
Attached information	None				
Precautions/Remarks	After the _EIP1_MacAdrErr system-defined variable changes to TRUE, it will not change to FALSE unless the power supply to the Controller is cycled.				

Event name	Tag Data Link Setting Error		Event code	34200000 hex	
Meaning	An error was detected in the communications settings for tag data links.				
Source	EtherNet/IP Function Module		Source details	CIP	Detection timing At power ON or Controller reset
Error attributes	Level	Minor fault	Recovery	Automatic recovery (after downloading the tag data link settings), cycle the power supply, or reset Controller.	Log category System
Effects	User program	Continues.	Operation	Tag data link communications will not operate.	
Status	NET RUN		NET ERR		LINK
	Connecting		Error		---
System-defined variables	Variable		Data type		Name
	_EIP_TDLinkCfgErr		BOOL		Tag Data Link Setting Error
Cause and correction	Assumed cause		Correction		Prevention
	Power was interrupted when a download was in progress for the data link settings.		Implement one of the following measures. <ul style="list-style-type: none"> • Perform the Clear All Memory operation. • Download the tag data link settings again. • Clear the tag data link settings. 		Do not turn OFF the power supply to the Controller while a download is in progress for the tag data link settings.
	Memory error		If operation is not recovered by the above, replace the CPU Unit.		None
Attached information	Attached information 1: Type of errors (01 hex: Non-volatile memory access error, 02 hex: Inconsistency in settings)				
Precautions/Remarks	None				

Event name	IP Route Table Setting Error		Event code	34230000 hex	
Meaning	An IP routing setting error was detected.				
Source	EtherNet/IP Function Module		Source details	Communications port	Detection timing
					At power ON or Controller reset
Error attributes	Level	Minor fault	Recovery	Automatic recovery (after downloading the settings), cycle the power supply, or reset Controller.	Log category
					System
Effects	User program	Continues.	Operation	Communications that use the relevant IP routing settings are not possible.	
Status	NET RUN		NET ERR		LINK
	---		Error		---
System-defined variables	Variable		Data type		Name
	_EIP_IPRTblErr		BOOL		IP Route Table Error
Cause and correction	Assumed cause		Correction		Prevention
	Setting error		Identify the error from the attached information, correct the setting, and then download the settings again.		None
	Power was interrupted when a download was in progress for the built-in EtherNet/IP port settings.		Perform the Clear All Memory operation or download the settings again.		Do not turn OFF the power supply to the Controller while a download is in progress for the built-in EtherNet/IP port settings.
	Memory error		If operation is not recovered by the above, replace the CPU Unit.		None
Attached information	Attached information 1: Type of errors (01 hex: Non-volatile memory access error, 02 hex: Inconsistency in settings) Attached Information 2: Error Details (00 hex: Non-volatile memory access error) When the settings are inconsistent (11 hex: Illegal IP router table settings, 12 hex: Illegal Hosts setting, 13 hex: Invalid default gateway, 14 hex: Illegal IPForward settings, 15 hex: Illegal NAT settings, 16 hex: Illegal PacketFilter settings)				
Precautions/Remarks	The cause of error can be identified with the attached information.				

Event name	FTP Server Setting Error		Event code	34240000 hex		
Meaning	An error was detected in the FTP server settings.					
Source	EtherNet/IP Function Module		Source details	FTP	Detection timing	At power ON or Controller reset
Error attributes	Level	Minor fault	Recovery	Automatic recovery (after downloading the FTP settings), cycle the power supply, or reset Controller	Log category	System
Effects	User program	Continues.	Operation	FTP will not operate.		
Status	NET RUN		NET ERR		LINK	
	---		Error		---	
System-defined variables	Variable		Data type		Name	
	None		---		---	
Cause and correction	Assumed cause		Correction		Prevention	
	Setting error		Identify the error from the attached information, correct the setting, and then download the settings again.		None	
	Power was interrupted when a download was in progress for the FTP server settings.		Perform the Clear All Memory operation or download the settings again.		Do not turn OFF the power supply to the Controller while a download is in progress for the FTP server settings.	
	Memory error		If operation is not recovered by the above, replace the CPU Unit.		None	
Attached information	Attached information 1: Type of errors (01 hex: Non-volatile memory access error, 02 hex: Inconsistency in settings)					
Precautions/Remarks	The cause of error can be identified with the attached information.					

Event name	NTP Client Setting Error		Event code	34250000 hex	
Meaning	An error was detected in the NTP client settings.				
Source	EtherNet/IP Function Module		Source details	NTP	Detection timing At power ON or Controller reset
Error attributes	Level	Minor fault	Recovery	Automatic recovery (after downloading the NTP settings), cycle the power supply, or reset Controller	Log category System
Effects	User program	Continues.	Operation	NTP operation stops.	
Status	NET RUN		NET ERR		LINK
	---		Error		---
System-defined variables	Variable		Data type		Name
	None		---		---
Cause and correction	Assumed cause		Correction		Prevention
	Setting error		Identify the error from the attached information, correct the setting, and then download the settings again.		None
	Power was interrupted when a download was in progress for the NTP client settings.		Perform the Clear All Memory operation or download the settings again.		Do not turn OFF the power supply to the Controller while a download is in progress for the NTP client settings.
	Memory error		If operation is not recovered by the above, replace the CPU Unit.		None
Attached information	Attached information 1: Type of errors (01 hex: Non-volatile memory access error, 02 hex: Inconsistency in settings)				
Precautions/Remarks	The cause of error can be identified with the attached information.				

Event name	SNMP Setting Error		Event code	34260000 hex	
Meaning	An error was detected in the SNMP agent/trap settings.				
Source	EtherNet/IP Function Module		Source details	SNMP	Detection timing At power ON or Controller reset
Error attributes	Level	Minor fault	Recovery	Automatic recovery (after downloading the SNMP settings), cycle the power supply, or reset Controller.	Log category System
Effects	User program	Continues.	Operation	SNMP operation stops.	
Status	NET RUN		NET ERR		LINK
	---		Error		---
System-defined variables	Variable		Data type		Name
	None		---		---
Cause and correction	Assumed cause		Correction		Prevention
	Setting error		Identify the error from the attached information, correct the setting, and then download the settings again.		None
	Power was interrupted when a download was in progress for the SNMP agent/trap settings.		Perform the Clear All Memory operation or download the settings again.		Do not turn OFF the power supply to the Controller while a download is in progress for the SNMP agent/trap settings.
	Memory error		If operation is not recovered by the above, replace the CPU Unit.		None
Attached information	Attached information 1: Type of errors (01 hex: Non-volatile memory access error, 02 hex: Inconsistency in settings) Attached Information 2: Error Location, when there is an inconsistency in the settings (01 hex: SNMP agent settings, 02 hex: SNMP trap settings)				
Precautions/Remarks	The cause of error can be identified with the attached information.				

Event name	Tag Name Resolution Error		Event code	34270000 hex	
Meaning	Resolution of a tag used in a tag data link failed.				
Source	EtherNet/IP Function Module	Source details	CIP	Detection timing	At power ON, at Controller reset, when variables are changed from the Sysmac Studio, or when the data link table is changed from the Network Configurator
Error attributes	Level	Minor fault	Recovery	Automatic recovery (after downloading the tag settings)	Log category System
Effects	User program	Continues.	Operation	Data links will not operate for unresolved tags. Data links for other tags will operate.	
Status	NET RUN		NET ERR		LINK
	Connecting		Error		---
System-defined variables	Variable		Data type		Name
	_EIP_TagAdrErr		BOOL		Tag Name Resolution Error
Cause and correction	Assumed cause		Correction		Prevention
	The size of the network variable is different from the tag settings.		Correct the sizes in the tag settings to match the network variables.		Set the sizes in the tag settings to match the network variables.
	The I/O direction set for a tag data link and the I/O direction of the Controller variable do not match.		Correct the tag settings or the settings of the Controller variables so that the I/O direction for the tag data links match the I/O direction of the Controller variables.		Set the tag settings or the settings of the Controller variables so that the I/O directions for the tag data links match the I/O directions of the Controller variables.
	There are no network variables for the Controller tag settings.		Correct the tag settings so that existing network variables are set for the tags.		Set the tag settings so that existing network variables are set for the tags.
	A variable in the Controller that is set for a tag data link has the Network Publish attribute set to Input but also has the Constant attribute.		Remove the Constant attribute from the Controller variable that has the Network Publish attribute set to Input .		Do not set the Constant attribute for a Controller variable that has the Network Publish attribute set to Input .
Attached information	None				
Precautions/Remarks	None				

Event name	Basic Ethernet Setting Error		Event code	34280000 hex		
Meaning	An error was detected in the Ethernet settings.					
Source	EtherNet/IP Function Module		Source details	Communica- tions port 1	Detection tim- ing	At power ON or Controller reset
Error attributes	Level	Minor fault	Recovery	Automatic re- covery, cycle the power sup- ply, or reset Controller	Log category	System
Effects	User program	Continues.	Operation	EtherNet/IP communications are not possible for the relevant communications port.		
Status	NET RUN		NET ERR		LINK	
	Stop		Error		---	
System-de- fined variables	Variable		Data type		Name	
	_EIP1_EtnCfgErr		BOOL		Port1 Basic Ethernet Setting Error	
Cause and cor- rection	Assumed cause		Correction		Prevention	
	Parameter error		Identify the error from the attached information, correct the setting, and then download the settings again.		None	
	Power was interrupted when a download was in progress for the built-in EtherNet/IP port settings.		Perform the Clear All Memory op- eration or download the settings.		Do not turn OFF the power supply to the Controller while a download is in progress for the built-in Ether- Net/IP port settings.	
	A memory error occurred.		If operation is not recovered by the above, replace the CPU Unit.		None	
Attached infor- mation	Attached information 1: Type of errors (01 hex: Non-volatile memory access error, 02 hex: Inconsistency in set- tings) Attached information 2: Error details (00 hex: Non-volatile memory access error, 11 hex: Incorrect baud rate setting, 12 hex: Unsupported baud rate)					
Precautions/ Remarks	The cause of error can be identified with the attached information.					

Event name	IP Address Setting Error		Event code	34290000 hex	
Meaning	An error was detected in the IP address settings.				
Source	EtherNet/IP Function Module		Source details	Communications port 1/ Internal port 1	Detection timing At power ON or Controller reset
Error attributes	Level	Minor fault	Recovery	Automatic recovery (after downloading the settings), cycle the power supply, or reset Controller.	Log category System
Effects	User program	Continues.	Operation	EtherNet/IP communications are not possible for the relevant communications port.	
Status	NET RUN		NET ERR		LINK
	Stop		Error		---
System-defined variables	Variable		Data type		Name
	_EIP1_IPAdrCfgErr		BOOL		Port1 IP Address Setting Error
Cause and correction	Assumed cause		Correction		Prevention
	Parameter error		Identify the error from the attached information, correct the setting, and then download the settings again.		None
	Power was interrupted when a download was in progress for the built-in EtherNet/IP port settings.		Perform the Clear All Memory operation or download the settings again.		Do not turn OFF the power supply to the Controller while a download is in progress for the built-in EtherNet/IP port settings.
	The IP address acquired from BOOTP server is illegal.		Correct the IP address that was provided to this port by the BOOTP server so that it is within the range specified for an NX-series Controller.		Correct the IP address that was provided to this port by the BOOTP server so that it is within the range specified for an NX-series Controller.
	A memory error occurred.		If operation is not recovered by the above, replace the CPU Unit.		None
Attached information	Attached information 1: Type of errors (01 hex: Non-volatile memory access error, 02 hex: Inconsistency in settings) Attached information 2: Error details (00 hex: Non-volatile memory access error) When the settings are inconsistent (11 hex: Illegal IP address, 12 hex: Illegal subnet mask)				
Precautions/Remarks	The cause of error can be identified with the attached information.				

Event name	DNS Setting Error		Event code	342A0000 hex		
Meaning	An error was detected in the DNS settings or Hosts settings.					
Source	EtherNet/IP Function Module		Source details	Communica- tions port	Detection tim- ing	At power ON or Controller reset
Error attributes	Level	Minor fault	Recovery	Automatic re- covery (after downloading the settings), cycle the power sup- ply, or reset Controller.	Log category	System
Effects	User program	Continues.	Operation	EtherNet/IP communications will not operate.		
Status	NET RUN		NET ERR		LINK	
	Stop		Error		---	
System-de- fined variables	Variable		Data type		Name	
	_EIP_DNSCfgErr		BOOL		DNS Setting Error	
Cause and cor- rection	Assumed cause		Correction		Prevention	
	Parameter error		Identify the error from the attached information, correct the setting, and then download the settings again.		None	
	Power was interrupted when a download was in progress for the built-in EtherNet/IP port settings.		Perform the Clear All Memory op- eration or download the settings again.		Do not turn OFF the power supply to the Controller while a download is in progress for the built-in Ether- Net/IP port settings.	
	A memory error occurred.		If operation is not recovered by the above, replace the CPU Unit.		None	
Attached infor- mation	Attached information 1: Type of errors (01 hex: Non-volatile memory access error, 02 hex: Inconsistency in set- tings) Attached information 2: Error details (00 hex: Non-volatile memory access error) When the settings are inconsistent (14 hex: Preferred DNS setting error, 15 hex: Alternate DNS setting error, 16 hex: Illegal domain name)					
Precautions/ Remarks	The cause of error can be identified with the attached information.					

Event name	Controller Insufficient Memory Warning		Event code	50010000 hex		
Meaning	The amount of data for the EtherCAT slave configuration, network-published information, or other data exceeds the value that is specified for the CPU Unit. You may not be able to perform online editing or other operations.					
Source	EtherCAT Master Function Module or EtherNet/IP Function Module		Source details	Master or CIP	Detection timing	At power ON, download, or online editing
Error attributes	Level	Minor fault	Recovery	Automatic recovery	Log category	System
Effects	User program	Continues.	Operation	Not affected.		
Status	NET RUN		NET ERR		LINK	
	---		---		---	
System-defined variables	Variable		Data type		Name	
	None		---		---	
Cause and correction	Assumed cause		Correction		Prevention	
	The amount of data for the EtherCAT slave configuration, network-published information, or other data exceeds the value that is specified for the CPU Unit.		Reduce the number of PDOs that are used by the EtherCAT slaves. Reduce the number of data types that are used for network variables or reduce the length of the text strings that are used for names.		None	
Attached information	None					
Precautions/Remarks	You may not be able to perform online editing or other operations.					

Event name	DNS Server Connection Error		Event code	84030000 hex		
Meaning	Connection with the DNS server failed.					
Source	EtherNet/IP Function Module		Source details	Communica- tions port	Detection tim- ing	At DNS opera- tion
Error attributes	Level	Minor fault	Recovery	Automatic re- covery (after downloading the DNS settings)	Log category	System
Effects	User program	Continues.	Operation	Communications using DNS stop.		
Status	NET RUN		NET ERR		LINK	
	---		Error		---	
System-de- fined variables	Variable		Data type		Name	
	_EIP_DNSSrvErr		BOOL		DNS Server Connection Error	
Cause and cor- rection	Assumed cause		Correction		Prevention	
	Parameter error		If there is a mistake with the speci- fications of the connected server, correct the server specifications and download them again.		Make sure that the connected serv- er is specified correctly.	
	Server is down.		Check if the server at the remote connection is operating normally and set it to operate normally if it is not.		Check to make sure that the server at the remote connection is operat- ing normally.	
	An error occurred in the communi- cations path.		Check the communications path to the server and take corrective measures if there are any prob- lems.		None	
Attached infor- mation	None					
Precautions/ Remarks	None					

Event name	NTP Server Connection Error		Event code	84040000 hex	
Meaning	Connection with the NTP server failed.				
Source	EtherNet/IP Function Module		Source details	NTP	Detection timing At NTP operation
Error attributes	Level	Minor fault	Recovery	Automatic recovery (after downloading the NTP settings)	Log category System
Effects	User program	Continues.	Operation	Time cannot be acquired from NTP.	
Status	NET RUN		NET ERR		LINK
	---		Error		---
System-defined variables	Variable		Data type		Name
	_EIP_NTPSrvErr		BOOL		NTP Server Connection Error
Cause and correction	Assumed cause		Correction		Prevention
	Parameter error		If there is a mistake with the specifications of the connected server, correct the server specifications and download them again.		Make sure that the connected server is specified correctly.
	Server is down.		Check if the server at the remote connection is operating normally and set it to operate normally if it is not.		Check to make sure that the server at the remote connection is operating normally.
	An error occurred in the communications path.		Check the communications path to the server and take corrective measures if there are any problems.		None
Attached information	None				
Precautions/Remarks	If TCP Server Run is recorded in the event log after the correction is made, then the CPU Unit is correctly connected to the DNS server.				

Event name	Tag Data Link Connection Failed		Event code	84070000 hex	
Meaning	Establishing a tag data link connection failed.				
Source	EtherNet/IP Function Module		Source details	CIP	Detection timing When establishing tag data link connection
Error attributes	Level	Minor fault	Recovery	Automatic recovery	Log category System
Effects	User program	Continues.	Operation	Data links will not operate for connections that could not be established. Data links for other connections will operate.	
Status	NET RUN		NET ERR		LINK
	Connecting		Error		---
System-defined variables	Variable		Data type		Name
	_EIP_TDLinkOpnErr		BOOL		Tag Data Link Connection Failed
Cause and correction	Assumed cause		Correction		Prevention
	The tag data link connection information is not the same for the originator and target.		Correct the tag data link connection information, and then download the device parameters or connection settings from the Network Configurator or Sysmac Studio.		Before you use the tag data links, make sure that the tag data link connection information in the originator and target are suitable.
	Insufficient connections		Reduce the number of class-3 messages.		Reduce the number of data links and class-3 messages that are used.
Attached information	Attached information 1: Target node IP address (example: C0A8FA01 hex = address 192.168.250.1) Attached information 2: Connection instance No. 0 to 255 Attached information 3: Connection status (example: 010000117 hex for General Status 01 and Additional Status 0117)				
Precautions/Remarks	<ul style="list-style-type: none"> You can investigate a detailed cause from the connection status. Refer to the Connection Status Codes and Troubleshooting described in the <i>NY-series Industrial Panel PC / Industrial Box PC Built-inEtherNet/IP Port User's Manual (Cat. No. W563)</i>. This event occurs only once even if this error occurred simultaneously in several connections for the same target node. 				

Event name	Tag Data Link Timeout		Event code	84080000 hex	
Meaning	A timeout occurred in a tag data link.				
Source	EtherNet/IP Function Module		Source details	CIP	Detection timing Continuously after starting tag data link communications
Error attributes	Level	Minor fault	Recovery	Automatic recovery	Log category System
Effects	User program	Continues.	Operation	The relevant data link connection will stop. Reconnection processing is periodically repeated for the tag data link error target.	
Status	NET RUN		NET ERR		LINK
	Connecting		Error		---
System-defined variables	Variable		Data type		Name
	_EIP_TDLinkErr		BOOL		Tag Data Link Communications Error
Cause and correction	Assumed cause		Correction		Prevention
	The power supply to the target node is OFF.		Check the status of the target node and start it normally.		Use the tag data link after you confirm that the target node is normal.
	Communications with the target node stop.				
	The Ethernet cable for EtherNet/IP is disconnected.		Reconnect the connector and make sure it is mated correctly.		Connect the connector securely.
	The Ethernet cable for EtherNet/IP is broken.		Replace the Ethernet cable.		None
	Noise		Implement noise countermeasures if there is excessive noise.		Implement noise countermeasures if there is excessive noise.
	The link to the built-in EtherNet/IP port is OFF.		Refer to the Link OFF Detected error (84060000 hex) for the assumed causes and other information on link OFF.		Refer to the Link OFF Detected error (84060000 hex) for the assumed causes and other information on link OFF.
	The packet loss occurred on the path due to the network communications load.		Increase the timeout value or RPI. Or, review the network environment and network devices.		Design the network so that there is not too much load on the network.
Attached information	Attached information 1: Connection instance No. (0 to 255) Attached information 2: Target node IP address (example: C0A8FA01 hex = address 192.168.250.1)				
Precautions/Remarks	<ul style="list-style-type: none"> The following cases are not included in this error. Connections as a target This event occurs only once even if this error occurred simultaneously in several connections for the same target node. 				

Event name	Tag Data Link Connection Timeout		Event code	84090000 hex	
Meaning	A timeout occurred while trying to establish a tag data link connection.				
Source	EtherNet/IP Function Module		Source details	CIP	Detection timing When establishing tag data link connection
Error attributes	Level	Minor fault	Recovery	Automatic recovery	Log category System
Effects	User program	Continues.	Operation	Data links will not operate for connections that timed out. Reconnection processing is periodically repeated for the connection that timed out.	
Status	NET RUN		NET ERR		LINK
	Connecting		Error		---
System-defined variables	Variable		Data type		Name
	_EIP_TDLinkOpnErr		BOOL		Tag Data Link Connection Failed
Cause and correction	Assumed cause		Correction		Prevention
	The power supply to the target node is OFF.		Check the status of the target node and start it normally.		Use the tag data link after you confirm that the target node is normal.
	Communications at the target node are stopped.				
	The Ethernet cable for EtherNet/IP is disconnected.		Reconnect the connector and make sure it is mated correctly.		Connect the connector securely.
	The Ethernet cable for EtherNet/IP is broken.		Replace the Ethernet cable.		None
	An error occurred in the communications path.		Check the communications path and take corrective measures if there are any problems.		None
Attached information	Attached information 1: Target node IP address (example: C0A8FA01 hex = address 192.168.250.1)				
Precautions/Remarks	<ul style="list-style-type: none"> You can change the event level to the observation level. If you change the level to the observation level, the NET ERR column above will be changed to "---" (no change) and recovery will not be necessary. The following cases are not included in this error. <ul style="list-style-type: none"> Connections as a target Connection timeouts due to a Link OFF detection for an Ethernet switch This event occurs only once even if this error occurred simultaneously in several connections for the same target node. 				

Event name	IP Address Duplication Error		Event code	840A0000 hex	
Meaning	The same IP address is used more than once.				
Source	EtherNet/IP Function Module		Source details	Communications port 1/ Internal port 1	Detection timing After link is established
Error attributes	Level	Minor fault	Recovery	Automatic recovery (after downloading the IP address settings), cycle the power supply, or reset Controller.	Log category System
Effects	User program	Continues.	Operation	EtherNet/IP communications are not possible for the relevant communications port. Packets addressed to the local IP address of the relevant communications port are discarded.	
Status	NET RUN		NET ERR		LINK
	Stop		Error		---
System-defined variables	Variable		Data type		Name
	_EIP1_IPAdrDupErr		BOOL		Port1 IP Address Duplication Error
Cause and correction	Assumed cause		Correction		Prevention
	The IP address of the built-in EtherNet/IP port is also used as the IP address of another node.		Perform either of the following corrections. <ul style="list-style-type: none"> • Check the IP addresses of other nodes and correct the IP address settings so that the same address is not used by more than one node. • Remove the other node that has the duplicate IP address from the network and then cycle the power supply to the Controller or reset the Controller. 		Perform allocations so that IP addresses of nodes on the network are used for only one node.
Attached information	Attached information 1: Duplicated IP address (example: C0A8FA01 hex = address 192.168.250.1)				
Precautions/Remarks	A duplicated address error occurs if an ARP is sent with the set IP address and there is an ARP response.				

Event name	BOOTP Server Connection Error		Event code	840B0000 hex		
Meaning	Connection with the BOOTP server failed.					
Source	EtherNet/IP Function Module		Source details	Communica- tions port 1	Detection tim- ing	At BOOTP oper- ation
Error attributes	Level	Minor fault	Recovery	Automatic re- covery	Log category	System
Effects	User program	Continues.	Operation	EtherNet/IP communications are not possible for the relevant communications port. Requests to the BOOTP server will continue until there is a response from the BOOTP server. Data re- freshing with the PLC Function Module will continue. An IP address was not set for the EtherNet/IP port when it was supposed to be set from the BOOTP server.		
Status	NET RUN		NET ERR		LINK	
	Stop		Error		---	
System-de- fined variables	Variable		Data type		Name	
	_EIP1_BootpErr		BOOL		Port1 BOOTP Server Error	
Cause and cor- rection	Assumed cause		Correction		Prevention	
	Server setting error		Correct the server settings at the remote connection.		Check to make sure that the server settings at the remote connection are correct.	
	The server is down.		Check if the server at the remote connection is operating normally and set it to operate normally if it is not.		Check to make sure that the server at the remote connection is operating normally.	
	An error occurred in the communi- cations path.		Check the communications path to the server and take corrective measures if there are any prob- lems.		None	
Attached infor- mation	None					
Precautions/ Remarks	None					

Event name	Access Detected Outside Range of Variable		Event code	54E00000 hex		
Meaning	Accessing a value that is out of range was detected for a tag variable that is used in a tag data link.					
Source	EtherNet/IP Function Module		Source details	Communica- tions port	Detection tim- ing	When variable is written
Error attributes	Level	Observation	Recovery	---	Log category	System
Effects	User program	Continues.	Operation	Not affected.		
Status	NET RUN		NET ERR		LINK	
	---		---		---	
System-de- fined variables	Variable		Data type		Name	
	None		---		---	
Cause and cor- rection	Assumed cause		Correction		Prevention	
	An out-of-range value was written by an EtherNet/IP tag data link for a variable with a specified range. A value that does not specify an enumerator was written by an EtherNet/IP tag data link for an enumeration variable.		Correct the value that is written to the variable with a specified range so that the value is in the range. Correct the value that is written to the enumeration variable so that the value specifies an enumerator.		Write values that are in range for variables with specified ranges. Write values that specify enumerators to enumeration variables.	
Attached infor- mation	None					
Precautions/ Remarks	<ul style="list-style-type: none"> Write operations for out-of-range values or values that do not specify enumerators do not end normally. Write operations for in-range values or values that specify enumerators end normally. 					

Event name	Packet Discarded Due to Full Reception Buffer		Event code	84050000 hex		
Meaning	A packet was discarded.					
Source	EtherNet/IP Function Module		Source details	Communica- tions port 1	Detection tim- ing	After link is es- tablished
Error attributes	Level	Observation	Recovery	---	Log category	System
Effects	User program	Continues.	Operation	Not affected.		
Status	NET RUN		NET ERR		LINK	
	---		---		---	
System-de- fined variables	Variable		Data type		Name	
	None		---		---	
Cause and cor- rection	Assumed cause		Correction		Prevention	
	A network convergence occurred.		The load on the network is too high. Check whether there are nodes that send unnecessary broadcast frames on the network and remove them. After that, check that the received number of frames has reduced in the network statistical information.		Make sure that unnecessary broadcast frames are not sent on the network. Do not connect the Ethernet cable in a loop.	
Attached infor- mation	None					
Precautions/ Remarks	None					

Event name	Link OFF Detected		Event code	84060000 hex		
Meaning	An Ethernet link OFF was detected.					
Source	EtherNet/IP Function Module		Source details	Communica- tions port 1/ Internal port 1	Detection tim- ing	Continuously
Error attributes	Level	Observation	Recovery	---	Log category	System
Effects	User program	Continues.	Operation	EtherNet/IP communications will not operate.		
Status	NET RUN		NET ERR		LINK	
	---		---		---	
System-de- fined variables	Variable		Data type		Name	
	None		---		---	
Cause and cor- rection	Assumed cause		Correction		Prevention	
	An Ethernet cable is broken, dis- connected, or loose.		Connect the Ethernet cable se- curely. If the cable is broken, re- place it.		Connect the Ethernet cable se- curely. Check the cable to make sure that it is not disconnected.	
	The Ethernet switch's power sup- ply is turned OFF.		Turn ON the power supply to the Ethernet switch. Replace the Ethernet switch if it fails.		Do not turn OFF the power supply to the Ethernet switch.	
	Baud rate mismatch.		Correct the settings so that the same baud rate is used as for the remote communications nodes.		Set the same baud rate as for the remote communications nodes.	
	Noise		Implement noise countermeasures if there is excessive noise.		Implement noise countermeasures.	
	One of the following operations was performed. • The Identity object was reset. • Settings for EtherNet/IP were downloaded from the Network Configurator or Sysmac Studio, or the Clear All Memory opera- tion was performed. • EtherNet/IP was restarted.		None This error occurs when the operations on the left are per- formed.		None This error occurs when the operations on the left are per- formed.	
Attached infor- mation	None					
Precautions/ Remarks	You can change the event level to the minor fault level. If you change the level to the minor fault level, the Recovery column above will be changed to "Automatic recovery."					

Event name	Tag Data Link Download Started			Event code	94010000 hex	
Meaning	Changing the tag data link settings started.					
Source	EtherNet/IP Function Module		Source details	CIP	Detection timing	At user operation
Error attributes	Level	Information	Recovery	---	Log category	Access
Effects	User program	Continues.	Operation	Not affected.		
Status	NET RUN		NET ERR		LINK	
	Connecting		---		---	
System-defined variables	Variable		Data type		Name	
	None		---		---	
Cause and correction	Assumed cause		Correction		Prevention	
	Changing the tag data link settings started.		---		---	
Attached information	Attached information 1: Controller status (01 hex: PROGRAM mode, 02 hex: RUN mode)					
Precautions/Remarks	None					

Event name	Tag Data Link Download Finished			Event code	94020000 hex	
Meaning	Changing the tag data link settings finished.					
Source	EtherNet/IP Function Module		Source details	CIP	Detection timing	At user operation
Error attributes	Level	Information	Recovery	---	Log category	Access
Effects	User program	Continues.	Operation	Not affected.		
Status	NET RUN		NET ERR		LINK	
	Connecting		---		---	
System-defined variables	Variable		Data type		Name	
	None		---		---	
Cause and correction	Assumed cause		Correction		Prevention	
	Changing the tag data link settings finished.		---		---	
Attached information	Attached information 1: Controller status (01 hex: PROGRAM mode, 02 hex: RUN mode)					
Precautions/Remarks	None					

3 Error Descriptions and Corrections

Event name	Tag Data Link Stopped		Event code	94030000 hex	
Meaning	Tag data links were stopped by the Network Configurator, Sysmac Studio, or manipulation of a system-defined variable. Or, the data link table was downloaded from the Network Configurator or Sysmac Studio again.				
Source	EtherNet/IP Function Module		Source details	CIP	Detection timing At user operation
Error attributes	Level	Information	Recovery	---	Log category Access
Effects	User program	Continues.	Operation	Not affected.	
Status	NET RUN		NET ERR		LINK
	Connecting		---		---
System-defined variables	Variable		Data type		Name
	_EIP_TDLinkStopCmd		BOOL		Tag Data Link Communications Stop Switch
Cause and correction	Assumed cause		Correction		Prevention
	Tag data links were stopped by the Network Configurator, Sysmac Studio, or manipulation of a system-defined variable.		---		---
Attached information	Attached information 1: Controller status (01 hex: PROGRAM mode, 02 hex: RUN mode) Attached information 2: Operation method 01 hex: Operation from the Network Configurator or Sysmac Studio, 02 hex: Operation with a system-defined variable				
Precautions/Remarks	None				

Event name	Tag Data Link Started		Event code	94040000 hex	
Meaning	Tag data links were started by the Network Configurator, Sysmac Studio, or manipulation of a system-defined variable. Or, the data link table was downloaded from the Network Configurator or Sysmac Studio again.				
Source	EtherNet/IP Function Module		Source details	CIP	Detection timing At user operation
Error attributes	Level	Information	Recovery	---	Log category Access
Effects	User program	Continues.	Operation	Not affected.	
Status	NET RUN		NET ERR		LINK
	Connecting		---		---
System-defined variables	Variable		Data type		Name
	_EIP_TDLinkStartCmd		BOOL		Tag Data Link Communications Start Switch
Cause and correction	Assumed cause		Correction		Prevention
	Tag data links were started by the Network Configurator, Sysmac Studio, or manipulation of a system-defined variable.		---		---
Attached information	Attached information 1: Controller status 01 hex: PROGRAM mode, 02 hex: RUN mode Attached information 2: Operation method 01 hex: Operation from the Network Configurator or Sysmac Studio, 02 hex: Operation with system-defined variable				
Precautions/Remarks	None				

Event name	Link Detected			Event code	94050000 hex	
Meaning	Establishment of an Ethernet link was detected.					
Source	EtherNet/IP Function Module		Source details	Communica- tions port 1/ Internal port 1	Detection tim- ing	When establish- ing link
Error attributes	Level	Information	Recovery	---	Log category	System
Effects	User program	Continues.	Operation	Not affected.		
Status	NET RUN		NET ERR		LINK	
	---		---		---	
System-de- fined variables	Variable		Data type		Name	
	None		---		---	
Cause and cor- rection	Assumed cause		Correction		Prevention	
	Establishment of an Ethernet link was detected.		---		---	
Attached infor- mation	None					
Precautions/ Remarks	None					

Event name	Restarting Ethernet Port			Event code	94060000 hex	
Meaning	The built-in EtherNet/IP port was restarted.					
Source	EtherNet/IP Function Module		Source details	Communica- tions port 1/ Internal port 1	Detection tim- ing	At user opera- tion
Error attributes	Level	Information	Recovery	---	Log category	Access
Effects	User program	Continues.	Operation	Not affected.		
Status	NET RUN		NET ERR		LINK	
	---		---		---	
System-de- fined variables	Variable		Data type		Name	
	None		---		---	
Cause and cor- rection	Assumed cause		Correction		Prevention	
	The built-in EtherNet/IP port was restarted.		---		---	
Attached infor- mation	None					
Precautions/ Remarks	None					

3 Error Descriptions and Corrections

Event name	Tag Data Link All Run			Event code	94070000 hex
Meaning	Tag data link connections to all nodes have been normally established.				
Source	EtherNet/IP Function Module		Source details	CIP	Detection timing When establishing tag data link connection
Error attributes	Level	Information	Recovery	---	Log category System
Effects	User program	Continues.	Operation	Not affected.	
Status	NET RUN		NET ERR		LINK
	Running		---		---
System-defined variables	Variable		Data type		Name
	_EIP_TDLinkAllRunSta		BOOL		All Tag Data Link Communications Status
Cause and correction	Assumed cause		Correction		Prevention
	Tag data link connections to all target nodes have been established.		---		---
Attached information	None				
Precautions/Remarks	None				

Event name	IP Address Fixed			Event code	94080000 hex
Meaning	The correct IP address has been determined and Ethernet communications can start.				
Source	EtherNet/IP Function Module		Source details	Communications port 1/ Internal port 1	Detection timing At power ON or Controller reset
Error attributes	Level	Information	Recovery	---	Log category System
Effects	User program	Continues.	Operation	Not affected.	
Status	NET RUN		NET ERR		LINK
	Running		---		---
System-defined variables	Variable		Data type		Name
	None		---		---
Cause and correction	Assumed cause		Correction		Prevention
	The correct IP address has been determined and Ethernet communications can start.		---		---
Attached information	Attached Information 1: IP address (example: C0A8FA01 hex = address 192.168.250.1)				
Precautions/Remarks	None				

Event name	BOOTP Client Started			Event code	94090000 hex	
Meaning	The BOOTP client started requesting an IP address.					
Source	EtherNet/IP Function Module		Source details	Communica- tions port 1	Detection tim- ing	At power ON or Controller reset
Error attributes	Level	Information	Recovery	---	Log category	System
Effects	User program	Continues.	Operation	Not affected.		
Status	NET RUN		NET ERR		LINK	
	---		---		---	
System-de- fined variables	Variable	Data type		Name		
	None	---		---		
Cause and cor- rection	Assumed cause		Correction		Prevention	
	The BOOTP client started request- ing an IP address.		---		---	
Attached infor- mation	None					
Precautions/ Remarks	None					

Event name	FTP Server Started			Event code	940A0000 hex	
Meaning	The FTP agent started normally.					
Source	EtherNet/IP Function Module		Source details	FTP	Detection tim- ing	At power ON or Controller reset
Error attributes	Level	Information	Recovery	---	Log category	System
Effects	User program	Continues.	Operation	Not affected.		
Status	NET RUN		NET ERR		LINK	
	---		---		---	
System-de- fined variables	Variable	Data type		Name		
	None	---		---		
Cause and cor- rection	Assumed cause		Correction		Prevention	
	The FTP agent started normally.		---		---	
Attached infor- mation	None					
Precautions/ Remarks	None					

Event name	NTP Client Started			Event code	940B0000 hex
Meaning	The NTP client started normally and a request for the NTP server to obtain the time started.				
Source	EtherNet/IP Function Module		Source details	NTP	Detection timing At power ON or Controller reset
Error attributes	Level	Information	Recovery	---	Log category System
Effects	User program	Continues.	Operation	Not affected.	
Status	NET RUN		NET ERR		LINK
	---		---		---
System-defined variables	Variable	Data type		Name	
	None	---		---	
Cause and correction	Assumed cause		Correction		Prevention
	The NTP client started normally and a request for the NTP server to obtain the time started.		---		---
Attached information	None				
Precautions/Remarks	None				

Event name	SNMP Started			Event code	940C0000 hex
Meaning	The SNMP agent started normally.				
Source	EtherNet/IP Function Module		Source details	SNMP	Detection timing At power ON or Controller reset
Error attributes	Level	Information	Recovery	---	Log category System
Effects	User program	Continues.	Operation	Not affected.	
Status	NET RUN		NET ERR		LINK
	---		---		---
System-defined variables	Variable	Data type		Name	
	None	---		---	
Cause and correction	Assumed cause		Correction		Prevention
	The SNMP agent started normally.		---		---
Attached information	None				
Precautions/Remarks	None				

3-4-3 Other Troubles and Corrections

Problem	Correction
Tag data is not concurrent.	<p>Check the following items and correct the user program.</p> <ul style="list-style-type: none"> Data concurrency is maintained for each connection between the Controller and the built-in EtherNet/IP port. To maintain data concurrency for tag data links, set a refreshing task for the network variables that are assigned to tags. Refer to information on the Concurrency of Tag Data Link Data in the <i>NY-series Industrial Panel PC / Industrial Box PC Built-in EtherNet/IP Port User's Manual (Cat. No. W563)</i> for details. Refer to the product manuals for products from other manufacturers.
At startup, some of the receive data is FALSE when it should be TRUE.	<ul style="list-style-type: none"> If the user program uses receive data, make sure that the All Tag Data Link Communications Status in communications status 1 or the Controller Operating Mode for the target node is TRUE before you use the receive data. To use operation information from the Controller, use Controller status in the tag sets on both the sending and receiving nodes. If the Fault Action setting of the output (produce) tag is enabled, The output (produce) data changes to FALSE when a fatal error occurs in the Controller. Check the error status at the output (producing) Controller.
Tag data link communications are not stable.	<ul style="list-style-type: none"> Use a 1,000 Mbps Ethernet switch if 10 or 100 Mbps is set or if you are using a 10 Mbps repeater hub, a 100 Mbps repeater hub, or a 1,000 Mbps repeater hub. The performance of the tag data links assumes that an Ethernet switch is used to achieve a 20,000 pps bandwidth for full-duplex, 1,000 Mbps auto-negotiation communications. Refer to <i>NY-series Industrial Panel PC / Industrial Box PC Built-in EtherNet/IP Port User's Manual (Cat. No. W563)</i> to access the error counters and discarded packed counters on the Ethernet Information Tab Page. Use the information to check for noise on the communications path, non-standard cables, damaged cables/connectors, unexpectedly high communications traffic, and incorrect loops in connections between Ethernet switches. Contact the Ethernet switch manufacturer if there are problems with the transfer capacity of the Ethernet switches in the communications path. If Ethernet switches are cascaded, the load may be concentrated on the middle Ethernet switches. Change the network configuration so that the load is not concentrated. Also, refer to <i>NY-series Industrial Panel PC / Industrial Box PC Built-in EtherNet/IP Port User's Manual (Cat. No. W563)</i> and use the connection status on the Connections Tab Page to remove the cause of the error according to information in 15-3-2 Connection Status Codes and Troubleshooting.

3-5 Errors in the EtherCAT Master Function Module

3-5-1 Error Tables

Built-in EtherCAT Master

Event code	Event name	Meaning	Assumed cause	Level					Reference
				M a j	P r t	M i n	O b s	I n f o	
04400000 hex	Communications Controller Failure	An error was detected in the hardware test at startup.	<ul style="list-style-type: none"> The CPU Unit has failed. 		○				page 3-491
14400000 hex	MAC Address Error	The MAC address is incorrect.	<ul style="list-style-type: none"> The CPU Unit has failed. 		○				page 3-491
44010000 hex	EtherCAT Fault	A fatal error was detected in the EtherCAT Master Function Module.	<ul style="list-style-type: none"> Software is corrupted. 		○				page 3-492
84200000 hex	Link OFF Error	A Link OFF state occurred.	<ul style="list-style-type: none"> The Ethernet cable is broken between the master and slaves. The Ethernet cable connector is disconnected. The Ethernet cable is not connected. 		○				page 3-493
842E0000 hex	EtherCAT Frame Not Received	The sent EtherCAT frame was not received.	<ul style="list-style-type: none"> A Unit other than an EtherCAT slave is connected. A connector on the Ethernet cable is disconnected, the contact is faulty, or parts are faulty. Slave output ports are connected to each other. The master and slave are connected with the slave output port. Hardware failure of EtherCAT slave Hardware failure of EtherCAT master 		○				page 3-494
24200000 hex	Slave Node Address Duplicated	The same slave address is used for two nodes.	<ul style="list-style-type: none"> The same node address is set for more than one slave. 			○			page 3-496

Event code	Event name	Meaning	Assumed cause	Level					Reference
				M a j	P r t	M i n	O b s	I n f o	
34400000 hex	Network Configuration Information Error	There is an error in the network configuration information.	<ul style="list-style-type: none"> The power supply to the Controller was interrupted or communications with the Sysmac Studio were disconnected while downloading the network configuration information. 			○			page 3-497
34410000 hex	EtherCAT Communications Cycle Exceeded	Process data communications could not be performed with the specified communications cycle.	<ul style="list-style-type: none"> The transmission delay time in the actually connected configuration is longer than the transmission delay time calculated for the user-set cable length. The set task period or communications cycle is too short. 			○			page 3-498
50010000 hex	Controller Insufficient Memory Warning	The amount of data for the EtherCAT slave configuration, network-published information, or other data exceeds the value that is specified for the CPU Unit. You may not be able to perform online editing or other operations.	<ul style="list-style-type: none"> The amount of data for the EtherCAT slave configuration, network-published information, or other data exceeds the value that is specified for the CPU Unit. 			○			page 3-499
84210000 hex	Network Configuration Error	The EtherCAT network configuration is incorrect.	<ul style="list-style-type: none"> Slave output ports are connected to each other. The master and slave are connected with the slave output port. The number of connected slaves exceeded the maximum number of slaves for the EtherCAT master. 			○			page 3-500

Event code	Event name	Meaning	Assumed cause	Level					Reference
				M a j	P r t	M i n	O b s	I n f o	
84220000 hex	Network Configuration Verification Error	A slave that is in the network configuration information is not connected. Or, a slave that is not in the network configuration information is connected.	<ul style="list-style-type: none"> A slave that is in the network configuration information is not connected. There is a node address mismatch. A different slave from the one that is specified in the network configuration information is connected. A slave that is not in the network configuration information is connected. The hardware switches for the slave node address were changed to a value other than 0 after the Write Slave Node Address operation was performed from the Sysmac Studio. The Ethernet physical layer is broken between two slaves. 			○			page 3-503
84230000 hex	Slave Initialization Error	Slave initialization failed.	<ul style="list-style-type: none"> An error occurred in EtherCAT master processing. An initialization error occurred in the EtherCAT slave. An initialization error occurred in the EtherCAT Coupler Unit. A major fault level Controller error occurred. The Ethernet cable is broken or the specified cable is not being used. A connector on the Ethernet cable is disconnected, the contact is faulty, or parts are faulty. A general-purpose Ethernet hub is connected. The master failed. The slave failed. Noise 			○			page 3-505
84280000 hex	Slave Application Error	An error occurred in the slave application.	<ul style="list-style-type: none"> An error was detected in the slave's application layer status register. 			○			page 3-507
84290000 hex	Process Data Transmission Error	Sending process data failed.	<ul style="list-style-type: none"> It was not possible to send the EtherCAT frame during the EtherCAT communications period. The frame transmission jitter exceeded the limit. 			○			page 3-508

Event code	Event name	Meaning	Assumed cause	Level					Reference
				M a j	P r t	M i n	O b s	I n f o	
842B0000 hex	Process Data Reception Timeout	Process data reception timed out.	<ul style="list-style-type: none"> The Ethernet cable is broken or the specified cable is not being used. A connector on the Ethernet cable is disconnected, the contact is faulty, or parts are faulty. A general-purpose Ethernet hub is connected. The master failed. The slave failed. The Ethernet cable is too long. The CPU Unit task period is too short. Noise 			○			page 3-509
842C0000 hex	Process Data Communications Error	An error occurred in process data communications.	<ul style="list-style-type: none"> A slave left the network even though the disconnection operation or disable operation was not performed. Slave failure 			○			page 3-511
842F0000 hex (Ver. 1.14 or later)	Input Process Data Invalid Error	<p>Because the EtherCAT master could not perform process data communications normally when it was in the Operational state, the Input Data Invalid state continued for the following period.</p> <ul style="list-style-type: none"> When the task period is 10 ms or shorter: 100 ms When the task period is longer than 10 ms: 10 periods of the task 	<ul style="list-style-type: none"> Hardware failure of EtherCAT slave Noise 			○			page 3-513

Event code	Event name	Meaning	Assumed cause	Level					Reference
				M a j	P r t	M i n	O b s	I n f o	
102F0000 hex	EtherCAT Slave Backup Failed	The backup operation for an EtherCAT slave ended in an error.	<ul style="list-style-type: none"> There is no connection between the EtherCAT master and the slave (Link OFF). An error caused an incorrect EtherCAT master status. The EtherCAT network configuration information does not agree with the physical network configuration. The request to the EtherCAT slave failed. The EtherCAT master was temporarily unable to perform the processing because it was executing other processing. Initialization of the EtherCAT slave failed. It was not possible to read the backup parameters from the EtherCAT slave. Communications with an OMRON Communications Coupler Unit or NX Unit failed. 				○		page 3-515

Event code	Event name	Meaning	Assumed cause	Level					Reference
				M a j	P r t	M i n	O b s	I n f o	
10300000 hex	EtherCAT Slave Restore Operation Failed	The restore operation for an EtherCAT slave ended in an error.	<ul style="list-style-type: none"> There is no connection between the EtherCAT master and the slave (Link OFF). An error caused an incorrect EtherCAT master status. The EtherCAT network configuration information does not agree with the physical network configuration. The request to the EtherCAT slave failed. The EtherCAT master was temporarily unable to perform the processing because it was executing other processing. Initialization of the EtherCAT slave failed. It was not possible to write the backup parameters to the MX2/RX Series Inverter. (This applies only for unit version 1.10 or earlier of the CPU Unit.) It was not possible to write the backup parameters to the EtherCAT slave. Incorrect backup data was detected. The EtherCAT network configuration in the backup data does not agree with the physical network configuration. An error occurred at an OMRON Communications Coupler Unit. <p>The following causes are possible.</p> <ul style="list-style-type: none"> Reading a backup file failed at the Communications Coupler Unit (when attached information 4 is 1). Communications with the Communications Coupler Unit or NX Unit failed (when attached information 4 is 2). The Unit Configuration of the NX Units in the Communications Coupler Unit when data was backed up did not agree with the actual configuration of NX Units (when attached information 4 is 3). 						page 3-517

Event code	Event name	Meaning	Assumed cause	Level					Reference
				M a j	P r t	M i n	O b s	I n f o	
64200000 hex	Emergency Message Detected	An emergency message was detected.	<ul style="list-style-type: none"> An emergency message was received from a slave. 				○		page 3-520
842D0000 hex	EtherCAT Message Error	An error occurred in a message communications with the slave.	<ul style="list-style-type: none"> Refer to the attached information to check the error. 				○		page 3-521
94400000 hex	Slave Disconnected	A slave was disconnected for a disconnection command.	<ul style="list-style-type: none"> An operation to disconnect the slave was executed from the Sysmac Studio. The EC_DisconnectSlave instruction was executed. 				○		page 3-522
94410000 hex	Slave Connected	A slave was reconnected for a reconnection command.	<ul style="list-style-type: none"> An operation to reconnect the slave was executed from the Sysmac Studio. The EC_ConnectSlave instruction was executed. 				○		page 3-523
94430000 hex	Error Reset	A command was received to reset errors.	<ul style="list-style-type: none"> An error reset operation was performed from the Sysmac Studio. The ResetECError instruction was executed. 				○		page 3-524
94440000 hex	Slave Disabled	The EtherCAT Slave was disabled.	<ul style="list-style-type: none"> The EC_ChangeEnableSetting instruction was executed. 				○		page 3-525
94450000 hex	Slave Enabled	The EtherCAT Slave was enabled.	<ul style="list-style-type: none"> The EC_ChangeEnableSetting instruction was executed. 				○		page 3-525
94500000 hex	EtherCAT Diagnosis/Statistics Log Started	EtherCAT diagnosis/statistics log is started.	<ul style="list-style-type: none"> The value of the _EC_StatisticsLogEnable system-defined variable changed from FALSE to TRUE. 				○		page 3-526
94510000 hex	EtherCAT Diagnosis/Statistics Log Ended	EtherCAT diagnosis/statistics log is ended.	<ul style="list-style-type: none"> An error that causes EtherCAT diagnosis/statistics log to end occurred. 				○		page 3-527

3-5-2 Error Descriptions

Built-in EtherCAT Master

Event name	Communications Controller Failure		Event code	04400000 hex		
Meaning	An error was detected in the hardware test at startup.					
Source	EtherCAT Master Function Module		Source details	Communica- tions port	Detection tim- ing	At power ON or Controller reset
Error attributes	Level	Partial fault	Recovery	Cycle the power supply or reset the Controller.	Log category	System
Effects	User program	Continues.	Operation	Master: The master waits in the Init state. Slave: Parameter setting is not possible. Process data com- munications are not possible.		
Indicators	EtherCAT NET RUN		EtherCAT NET ERR		EtherCAT LINK/ACT	
	---		Lights.		---	
System-de- fined variables	Variable		Data type		Name	
	_EC_LanHwErr		BOOL		Communications Controller Error	
Cause and cor- rection	Assumed cause		Correction		Prevention	
	The CPU Unit has failed.		Replace the CPU Unit.		None	
Attached infor- mation	None					
Precautions/ Remarks	None					

Event name	MAC Address Error		Event code	14400000 hex		
Meaning	The MAC address is incorrect.					
Source	EtherCAT Master Function Module		Source details	Communica- tions port	Detection tim- ing	At power ON or Controller reset
Error attributes	Level	Partial fault	Recovery	Cycle the power supply or reset the Controller.	Log category	System
Effects	User program	Continues.	Operation	Master: The master waits in the Init state. Slave: Parameter setting is not possible. Process data com- munications are not possible.		
Indicators	EtherCAT NET RUN		EtherCAT NET ERR		EtherCAT LINK/ACT	
	---		Lights.		---	
System-de- fined variables	Variable		Data type		Name	
	_EC_MacAdrErr		BOOL		MAC Address Error	
Cause and cor- rection	Assumed cause		Correction		Prevention	
	The CPU Unit has failed.		Replace the CPU Unit.		None	
Attached infor- mation	None					
Precautions/ Remarks	None					

Event name	EtherCAT Fault		Event code	44010000 hex	
Meaning	A fatal error was detected in the EtherCAT Master Function Module.				
Source	EtherCAT Master Function Module		Source details	Master	Detection timing During communications
Error attributes	Level	Partial fault	Recovery	Cycle the power supply or reset the Controller.	Log category System
Effects	User program	Continues.	Operation	<p>Master: The EtherCAT Master Function Module stops.</p> <p>Slave: Parameter setting is not possible. Process data communications are not possible.</p> <p>If the error occurred during synchronized communications between the master and slave, then the error occurred at the slave. The error is processed according to settings in the slave.</p>	
Indicators	EtherCAT NET RUN		EtherCAT NET ERR		EtherCAT LINK/ACT
	---		Lights.		---
System-defined variables	Variable	Data type		Name	
	None	---		---	
Cause and correction	Assumed cause		Correction		Prevention
	Software is corrupted.		Replace the CPU Unit.		None
Attached information	<p>Attached information 1: System information 1</p> <p>Attached information 2: System information 2</p> <p>Attached information 3: System information 3</p> <p>Attached information 4: System information 4</p>				
Precautions/Remarks	None				

Event name	Link OFF Error		Event code	84200000 hex	
Meaning	A Link OFF state occurred.				
Source	EtherCAT Master Function Module	Source details	Communica- tions port	Detection tim- ing	At power ON, at Controller reset, or during com- munications
Error attributes	Level	Partial fault	Recovery	Error reset	Log category System
Effects	User program	Continues.	Operation	<p>Master: Other communications errors caused by this error are not detected.</p> <p>Slave: Parameter setting is not possible. Process data communications are not possible. If the error occurred during synchronized communications between the master and slave, then the error occurred at the slave. The error is processed according to settings in the slave.</p>	
Indicators	EtherCAT NET RUN		EtherCAT NET ERR		EtherCAT LINK/ACT
	---		Flashes at 1-s intervals.		---
System-de- fined variables	Variable		Data type		Name
	_EC_LinkOffErr		BOOL		Link OFF Error
	_EC_LinkStatus		BOOL		Link Status
Cause and cor- rection	Assumed cause		Correction		Prevention
	The Ethernet cable is broken between the master and slaves.		Check the Ethernet cable between the master and slave to see if they are damaged or disconnected and replace the cable if necessary.		Check the Ethernet cable to see if it is operating properly.
	The Ethernet cable connector is disconnected.		Reconnect the connector and make sure it is mated correctly.		Confirm that the Ethernet cable is connected securely.
	The Ethernet cable is not connected.		Confirm that all Ethernet cables are connected and connect any cables that are not connected.		
Attached infor- mation	None				
Precautions/ Remarks	None				

Event name	EtherCAT Frame Not Received		Event code	842E0000 hex		
Meaning	The sent EtherCAT frame was not received.					
Source	EtherCAT Master Function Module	Source details	Master/Slave	Detection timing	At power ON, at Controller reset, or when a cable is connected to EtherCAT master	
Error attributes	Level	Partial fault	Recovery	Error reset	Log category	System
Effects	User program	Continues.	Operation	Master: The master waits in the Init state. Slave: Parameter setting is not possible. Process data communications are not possible.		
Indicators	EtherCAT NET RUN		EtherCAT NET ERR		EtherCAT LINK/ACT	
	Not lit.		Flashes at 1-s intervals.		Flashing	
System-defined variables	Variable		Data type		Name	
	None		---		---	
Cause and correction	Assumed cause		Correction		Prevention	
	A Unit other than an EtherCAT slave is connected.		Confirm that the Unit connected to the relevant port of the slave or master which is shown in the attached information is an EtherCAT slave.		None	
	A connector on the Ethernet cable is disconnected, the contact is faulty, or parts are faulty.		Confirm the connection of the cable or slave that is connected to the relevant port of the slave or master which is shown in the attached information. If the cable used is the one not specified, replace it. Or, reconnect the connector and make sure it is mated correctly.		Make sure that the Ethernet cable is not broken and the specified cable is used. Confirm that the Ethernet cable connector is mated securely.	
	Slave output ports are connected to each other.		Correct the connection of the Ethernet cable that is connected to the relevant port of the slave or master which is shown in the attached information.		Confirm that there are no incorrect Ethernet cable connections.	
	The master and slave are connected with the slave output port.					
	Hardware failure of EtherCAT slave		Replace the slave that is connected to the output port of the slave or master which is shown in the attached information. Or, replace the slave itself which is shown in the attached information.		None	
	Hardware failure of EtherCAT master		If the attached information indicates the master and operation is not recovered by the above, replace the CPU Unit.		None	

Attached information	<p>Attached information 1: Error location diagnostic result</p> <ul style="list-style-type: none"> • 0: Error location is not identified • 1: Error location is identified <p>Attached information 2: Node address of the slave which the frame from the slave that is connected to the output port is not received. (Only if the attached information 1 is 1.)</p> <ul style="list-style-type: none"> • 0: Master • Not 0: Node address of the slave <p>Attached information 3: Port name of the slave output port which the frame from the slave that is connected is not received. (Only if the attached information 1 is 1.)</p> <ul style="list-style-type: none"> • If the network configuration information agrees with the physical network information of the relevant slave, the port name that is displayed on the Support Software is output. If they do not agree, any one of PortA, PortB, PortC, and PortD is output as the default of a port name. • If the attached information 2 is 0, 0 is output as the port name. <p>Attached information 4: System information</p>
Precautions/Remarks	<p>If the node address setting of an EtherCAT slave is not made, the node address cannot be identified from the attached information. Check that there is no error for each slave and cable.</p>

Event name	Slave Node Address Duplicated		Event code	24200000 hex		
Meaning	The same slave address is used for two nodes.					
Source	EtherCAT Master Function Module		Source details	Slave	Detection timing	At power ON, at Controller reset, or during communications
Error attributes	Level	Minor fault	Recovery	Error reset	Log category	System
Effects	User program	Continues.	Operation	<p>Master:</p> <ul style="list-style-type: none"> If the error is detected when the master is started: Communications stop. The master waits in the Init state. When the Fail-soft operation is set to <i>Fail-soft</i> and the error is detected during operation: Slaves that were normal continue to operate. Slaves after the new slave that caused the duplicated address error remain in the Init state. When the Fail-soft operation is set to <i>Stop</i> and the error is detected during operation: The slaves that were normal enter the Pre-operational state. Slaves after the new slave that caused the duplicated address error remain in the Init state. <p>Slave:</p> <ul style="list-style-type: none"> No error occurred. <p>Parameters other than the node address cannot be set and process data communications cannot be performed for the new slave that caused the duplicated address error and all slaves after it.</p>		
Indicators	EtherCAT NET RUN		EtherCAT NET ERR		EtherCAT LINK/ACT	
	---		Flashes at 1-s intervals.		---	
System-defined variables	Variable		Data type		Name	
	_EC_SlavAdrDupErr		BOOL		Slave Node Address Duplicated Error	
Cause and correction	Assumed cause		Correction		Prevention	
	The same node address is set for more than one slave.		Check the node address switch or node address set value of the slave, and change it to prevent address duplication.		Set the node address of the slave to prevent duplication.	
Attached information	None					
Precautions/Remarks	The slave cannot be used unless the slave node address is set.					

Event name	Network Configuration Information Error		Event code	34400000 hex	
Meaning	There is an error in the network configuration information.				
Source	EtherCAT Master Function Module		Source details	Master	Detection timing At power ON or Controller reset
Error attributes	Level	Minor fault	Recovery	Automatic recovery	Log category System
Effects	User program	Continues.	Operation	Master: The master waits in the Init state. Slave: Parameter setting is not possible. Process data communications are not possible.	
Indicators	EtherCAT NET RUN		EtherCAT NET ERR		EtherCAT LINK/ACT
	---		Flashes at 1-s intervals.		---
System-defined variables	Variable		Data type		Name
	_EC_NetCfgErr		BOOL		Network Configuration Information Error
Cause and correction	Assumed cause		Correction		Prevention
	The power supply to the Controller was interrupted or communications with the Sysmac Studio were disconnected while downloading the network configuration information.		Perform the Clear All Memory operation, set the network configuration information, and then save it in the master again.		Do not turn OFF the power supply to the Controller or disconnect communications with the Sysmac Studio while downloading the network configuration information.
Attached information	Attached Information 1: Error Details (0001 hex: Illegal parameter, 0014 hex: Error opening file)				
Precautions/Remarks	None				

Event name	EtherCAT Communications Cycle Exceeded		Event code	34410000 hex	
Meaning	Process data communications could not be performed with the specified communications cycle.				
Source	EtherCAT Master Function Module		Source details	Master	Detection timing At start of communications
Error attributes	Level	Minor fault	Recovery	Automatic recovery	Log category System
Effects	User program	Continues.	Operation	Master: The master waits in the Init state. Slave: Parameter setting is not possible. Process data communications are not possible.	
Indicators	EtherCAT NET RUN		EtherCAT NET ERR		EtherCAT LINK/ACT
	---		Flashes at 1-s intervals.		---
System-defined variables	Variable		Data type		Name
	_EC_CycleExceeded		BOOL		EtherCAT Communications Cycle Exceeded
Cause and correction	Assumed cause		Correction		Prevention
	The transmission delay time in the actually connected configuration is longer than the transmission delay time calculated for the user-set cable length.		Set the cable length so that it agrees with the actual configuration.		Set the cable length so that it agrees with the actual configuration.
	The set task period or communications cycle is too short.		Use the Simulator and set a task period (communications cycle) that enables communications.		Use the Simulator and set a task period (communications cycle) that enables communications.
Attached information	None				
Precautions/Remarks	None				

Event name	Controller Insufficient Memory Warning		Event code	50010000 hex	
Meaning	The amount of data for the EtherCAT slave configuration, network-published information, or other data exceeds the value that is specified for the CPU Unit. You may not be able to perform online editing or other operations.				
Source	EtherCAT Master Function Module or EtherNet/IP Function Module		Source details	Master or CIP	Detection timing At power ON, download, or online editing
Error attributes	Level	Minor fault	Recovery	Error reset	Log category System
Effects	User program	Continues.	Operation	Not affected.	
Indicators	EtherCAT NET RUN		EtherCAT NET ERR		EtherCAT LINK/ACT
	---		---		---
System-defined variables	Variable		Data type		Name
	None		---		---
Cause and correction	Assumed cause		Correction		Prevention
	The amount of data for the EtherCAT slave configuration, network-published information, or other data exceeds the value that is specified for the CPU Unit.		Reduce the number of PDOs that are used by the EtherCAT slaves. Reduce the number of data types that are used for network variables or reduce the length of the text strings that are used for names.		None
Attached information	None				
Precautions/Remarks	You may not be able to perform online editing or other operations.				

Event name	Network Configuration Error		Event code	84210000 hex		
Meaning	The EtherCAT network configuration is incorrect.					
Source	EtherCAT Master Function Module	Source details	Master	Detection timing	At power ON, at Controller reset, or during communications	
Error attributes	Level	Minor fault	Recovery	Error reset	Log category	System
Effects	User program	Continues.	Operation	Refer to Precautions/Remarks.		
Indicators	EtherCAT NET RUN		EtherCAT NET ERR		EtherCAT LINK/ACT	
	---		Flashes at 1-s intervals.		---	
System-defined variables	Variable	Data type	Name			
	_EC_NetTopologyErr	BOOL	Network Configuration Error			
Cause and correction	Assumed cause		Correction		Prevention	
	Slave output ports are connected to each other.		Correct the Ethernet cable connections.		Confirm that there are no incorrect Ethernet cable connections.	
	The master and slave are connected with the slave output port.					
	The number of connected slaves exceeded the maximum number of slaves for the EtherCAT master.		Disconnect unnecessary slaves and keep the number below the maximum number.		Confirm that no more than the maximum number of slaves are connected to the EtherCAT network.	
Attached information	Error Details: 0000 hex: Too many slaves, 0001 hex: Incorrect connections, such as a ring connection					

Precautions/ Remarks	<p>Operation</p> <p>Master:</p> <ul style="list-style-type: none"> • The following applies if fail-soft operation is set to <i>Fail-soft</i>, the event was detected when the power supply was turned ON or the Controller was reset, and the error details in the attached information is 0000 hex: The maximum number of slaves from the beginning will enter the Operational state and continue to operate. The slaves past the maximum number of slaves will remain in Init state and communications will stop. • The following applies if fail-soft operation is set to <i>Stop</i>, the event was detected when the power supply was turned ON or the Controller was reset, and the error details in the attached information is 0000 hex: The maximum number of slaves from the beginning will enter the Pre-operational state and only message communications will continue. The slaves past the maximum number of slaves will remain in Init state and communications will stop. • The following applies if the event was detected when the power supply was turned ON or the Controller was reset, and the error details in the attached information is 0001 hex: All slaves will remain in the Init state and communications will stop. • The following applies if fail-soft operation is set to <i>Fail-soft</i>, the event was detected during communications, and the error details in the attached information is 0000 hex: The maximum number of slaves from the beginning will enter the Operational state and continue to operate. The slaves past the maximum number of slaves will remain in Init state and communications will stop. • The following applies if fail-soft operation is set to <i>Stop</i>, the event was detected during communications, and the error details in the attached information is 0000 hex: The maximum number of slaves from the beginning will enter the Pre-operational state and communications will stop. The slaves past the maximum number of slaves will remain in Init state and communications will stop. • The following applies if fail-soft operation is set to <i>Fail-soft</i>, the event was detected during communications, and the error details in the attached information is 0001 hex: The slaves that are normal continue to operate. If you are using distributed clocks to synchronize the slaves, a Synchronization Error may occur between the slaves. <p>Slave:</p> <ul style="list-style-type: none"> • No error occurred. • The following applies if fail-soft operation is set to <i>Fail-soft</i>, the event was detected when the power supply was turned ON or the Controller was reset, and the error details in the attached information is 0000 hex: The maximum number of slaves from the beginning will enter the Operational state, it will be possible to set parameters, and process data communications will continue. The slaves past the maximum number of slaves will remain in the Init state and it will not be possible to set parameters or perform process data communications for them. • The following applies if fail-soft operation is set to <i>Stop</i>, the event was detected when the power supply was turned ON or the Controller was reset, and the error details in the attached information is 0000 hex: The maximum number of slaves from the beginning will enter the Pre-operational state, it will be possible to set parameters, but process data communications will not be possible. The slaves past the maximum number of slaves will remain in the Init state and it will not be possible to set parameters or perform process data communications for them. • The following applies if the event was detected when the power supply was turned ON or the Controller was reset, and the error details in the attached information is 0001 hex: All slaves will remain in the Init state and it will not be possible to set parameters or perform process data communications.
---------------------------------	--

	<ul style="list-style-type: none">• The following applies if fail-soft operation is set to <i>Fail-soft</i>, the event was detected during communications, and the error details in the attached information is 0000 hex: The slaves before the node where the error occurred will enter the Operational state, it will be possible to set parameters, and process data communications will continue. For the slave where the error occurred and all slaves after it, it will not be possible to set parameters or perform process data communications.• The following applies if fail-soft operation is set to <i>Stop</i>, the event was detected during communications, and the error details in the attached information is 0000 hex: It will be possible to set parameters but it will not be possible to perform process data communications for all slaves in the Pre-operational state. It will not be possible to set parameters or perform process data communications for all slaves in the Init state.• The following applies if fail-soft operation is set to <i>Fail-soft</i>, the event was detected during communications, and the error details in the attached information is 0001 hex: Process data communications will be possible for all slaves that are operating normally. If you are using distributed clocks to synchronize the slaves and a Synchronization Error is detected, only input refreshing is enabled. It will be possible to set parameters. <hr/> <p>There are restrictions on the number of slave node addresses, and not on the number of slaves. This is because there are slaves, such as Junction Slaves, that use more than one node. Also, if the maximum number of slaves are connected and an attempt is made to make a ring connection, a Too Many Slaves error (0000 hex) occurs.</p>
--	---

Event name	Network Configuration Verification Error		Event code	84220000 hex		
Meaning	A slave that is in the network configuration information is not connected. Or, a slave that is not in the network configuration information is connected.					
Source	EtherCAT Master Function Module		Source details	Master/Slave	Detection timing	At power ON, at Controller reset, or during communications
Error attributes	Level	Minor fault	Recovery	Error reset	Log category	System
Effects	User program	Continues.	Operation	<p>When Fail-soft Operation Is Set to <i>Fail-soft</i></p> <p>Master: Slaves that are consistent with the network configuration information enter the Operational state. Slaves that are not consistent with the network configuration information and all subsequent slaves remain in Init state.</p> <p>Slave: Depends on the slave communications status.</p> <p>When Fail-soft Operation Is Set to <i>Stop</i></p> <p>Master: Slaves that are consistent with the network configuration information enter the Pre-operational state. Slaves that are not consistent with the network configuration information and all subsequent slaves will remain in the Init state.</p> <p>Slave: Depends on the slave communications status.</p>		
Indicators	EtherCAT NET RUN		EtherCAT NET ERR		EtherCAT LINK/ACT	
	---		Flashes at 1-s intervals.		---	
System-defined variables	Variable	Data type	Name			
	_EC_NetCfgCmpErr	BOOL	Network Configuration Verification Error			
	When Inconsistencies Are Found in Verification _EC_CommErrTbl	Array [1..n] of BOOL *1	Communications Error Slave Table			

Cause and correction	Assumed cause	Correction	Prevention
	A slave that is in the network configuration information is not connected.	Connect the slaves that are in the network configuration information. Or, connect the Sysmac Studio and set and save the network configuration information with the slave deleted in the master.	Set and save the network configuration information for the configuration actually connected in the master.
	There is a node address mismatch.	Make the slave node address settings consistent with the network configuration information.	
	A different slave from the one that is specified in the network configuration information is connected.	Connect the slave that is specified in the network configuration information. Or, connect the Sysmac Studio and set and save the network configuration information with the correct slaves in the master.	
	A slave that is not in the network configuration information is connected.	Disconnect the slave that is not in the network configuration information from the network. Or, connect the Sysmac Studio and set and save the network configuration information with the slave added in the master.	
	The hardware switches for the slave node address were changed to a value other than 0 after the Write Slave Node Address operation was performed from the Sysmac Studio.	To use the value that is set on the hardware switches, reset the error. When the error is reset, there will be a disagreement between the hardware switches and the value that was written from the Sysmac Studio. A Slave Application Error (84280000 hex) will occur and you must then reset the error again. If this error occurs when the slave is disconnected or disabled, reset the error first and then connect or enable the slave. When you do, a Slave Application Error (84280000 hex) will occur. Reset the error again and then connect or enable the slave. To use the node address that was set in the Write Slave Node Address from the Sysmac Studio, set the hardware switches to a node address of 0 and cycle the power supply to the slave.	To use the value that is set on the hardware switches, reset the error. When the error is reset, there will be a disagreement between the hardware switches and the value that was written from the Sysmac Studio. A Slave Application Error (84280000 hex) will occur and you must then reset the error again. If this error occurs when the slave is disconnected or disabled, reset the error first and then connect or enable the slave. When you do, a Slave Application Error (84280000 hex) will occur. Reset the error again and then connect or enable the slave. To use the node address that was set in the Write Slave Node Address from the Sysmac Studio, set the hardware switches to a node address of 0 and cycle the power supply to the slave.
	The Ethernet physical layer is broken between two slaves.	In cases not caused by the above causes, confirm the location of the break in the Ethernet cable and replace the cable.	None
Attached information	None		
Precautions/Remarks	If you add check items in the options for network configuration verification, check whether the items match.		

*1. "n" is 512 for an NY-series Controller.

Event name	Slave Initialization Error		Event code	84230000 hex		
Meaning	Slave initialization failed.					
Source	EtherCAT Master Function Module	Source details	Master/Slave	Detection timing	At power ON, Controller reset, error reset, or major fault level Controller error	
Error attributes	Level	Minor fault	Recovery	Error reset	Log category	System
Effects	User program	Continues.	Operation	<p>When Fail-soft Operation Is Set to <i>Fail-soft</i></p> <p>Master:</p> <ul style="list-style-type: none"> When the master fails to enter Pre-operational state after initialization: Communications stop in the Init state at the slave where the error occurred. Slaves in topology up to the slave where the error occurred enter Operational state and continue to operate. When the master fails to enter states after Pre-operational state: Only the slave with the error will stop state transitions. The normal slaves enter the Operational state and continue to operate. <p>Slave: This depends on the slave communications status.</p> <p>When Fail-soft Operation Is Set to <i>Stop</i></p> <p>Master:</p> <ul style="list-style-type: none"> When the master fails to enter Pre-operational state after initialization: All slaves enter the Init state and communications stop. When the master fails to enter states after Pre-operational state: All slaves enter the Pre-operational state and communications stop. <p>Slave: This depends on the slave communications status.</p>		
Indicators	EtherCAT NET RUN	EtherCAT NET ERR	EtherCAT LINK/ACT			
	---	Flashes at 1-s intervals.	---			
System-defined variables	Variable	Data type	Name			
	_EC_SlavInitErr	BOOL	Slave Initialization Error			
	_EC_CommErrTbl	Array [1..n] of BOOL *1	Communications Error Slave Table			
Cause and correction	Assumed cause	Correction	Prevention			
	An error occurred in EtherCAT master processing.	Connect the Sysmac Studio and reconfigure and save the network configuration information in the master again. If this error occurs again, check that there are no errors in the slave synchronization settings and the PDO mapping information, and correct any errors that are found.	Correctly set the slave synchronization settings, PDO mapping information, and configure and save network configuration information in the master.			

	An initialization error occurred in the EtherCAT slave.	The Module config send method parameter is sometimes displayed for a slave in the EtherCAT network configuration on the Sysmac Studio even if a send method cannot be set. If that occurs, set the Module config send method parameter to Do not send and perform synchronization again. Or, cycle the power supply to the EtherCAT slave. If this error persists, replace the EtherCAT slave.	None	
	An initialization error occurred in the EtherCAT Coupler Unit.	Connect the Sysmac Studio to the USB port on the EtherCAT Coupler Unit, check the error details, and take suitable measures for the error.	None	
	A major fault level Controller error occurred.	If a major fault level Controller error occurs, process data communications stop. If a Slave Application Error (84280000 hex) occurs at this time, this event also occurs. Perform corrections for the major fault level Controller error.	Perform preventive measures for major fault level Controller errors.	
	The Ethernet cable is broken or the specified cable is not being used.	The causes given on the left are possible if the error occurs from when the system starts operation or if it always occurs after a specific time after the system starts operation. Use the diagnostic and statistical information from the Sysmac Studio and check the EtherCAT communications status. If the Ethernet cable between the master and slave is broken or if the specified cable was not used, replace the cable. Or, reconnect the connector and make sure it is mated correctly. If a general-purpose Ethernet hub is connected, replace it with an EtherCAT Junction Slave. If the CPU Unit or an EtherCAT slave fails, replace it.	Make sure that the cable is not broken and use the specified cable.	
	A connector on the Ethernet cable is disconnected, the contact is faulty, or parts are faulty.		Confirm that the Ethernet cable connector is mated securely.	
	A general-purpose Ethernet hub is connected.		When branching an EtherCAT network, use an EtherCAT Junction Slave.	
	The master failed.		None	
	The slave failed.		None	
	Noise		If this error occurs irregularly, implement noise countermeasures.	Implement noise countermeasures.
Attached information	Attached information 1: System information 1 Attached information 2: System information 2 Attached information 3: System information 3 Attached information 4: System information 4			
Precautions/Remarks	None			

*1. "n" is 512 for an NY-series Controller.

Event name	Slave Application Error		Event code	84280000 hex	
Meaning	An error occurred in the slave application.				
Source	EtherCAT Master Function Module		Source details	Slave	Detection timing During communications
Error attributes	Level	Minor fault	Recovery	Error reset	Log category System
Effects	User program	Continues.	Operation	<p>When Fail-soft Operation Is Set to <i>Fail-soft</i></p> <p>Master: The slave communications status is not manipulated, but operation continues. The status of slaves with an application layer status error is also not manipulated.</p> <p>Slave: An error occurred. Operation is according to the state transition behavior of the slave where the error occurred.</p> <p>When Fail-soft Operation Is Set to <i>Stop</i></p> <p>Master: All slaves enter the Pre-operational state when an application layer status error occurs.</p> <p>Slave: An error occurred. All slaves enter the Pre-operational state.</p>	
Indicators	EtherCAT NET RUN		EtherCAT NET ERR		EtherCAT LINK/ACT
	---		Flashes at 1-s intervals.		---
System-defined variables	Variable	Data type	Name		
	_EC_SlavAppErr	BOOL	Slave Application Error		
	_EC_CommErrTbl	Array [1..n] of BOOL *1	Communications Error Slave Table		
Cause and correction	Assumed cause		Correction		Prevention
	An error was detected in the slave's application layer status register.		Clear the error from the EtherCAT slave where the application error occurred. Use the procedure given in the slave documentation.		None
Attached information	Attached Information 1: AL status code for the slave where the error was detected.				
Precautions/Remarks	None				

*1. "n" is 512 for an NY-series Controller.

Event name	Process Data Transmission Error		Event code	84290000 hex	
Meaning	Sending process data failed.				
Source	EtherCAT Master Function Module	Source details	Master	Detection timing	During communications
Error attributes	Level	Minor fault	Recovery	Error reset	Log category
Effects	User program	Continues.	Operation	<p>When Fail-soft Operation Is Set to <i>Fail-soft</i></p> <p>Master: Operation continues. Slave: The error occurs only with synced slaves.</p> <p>When Fail-soft Operation Is Set to <i>Stop</i></p> <p>Master: All slaves enter the Pre-operational state. Slave: Errors only occur in synced slaves.</p>	
Indicators	EtherCAT NET RUN		EtherCAT NET ERR		EtherCAT LINK/ACT
	---		Flashes at 1-s intervals.		---
System-defined variables	Variable	Data type		Name	
	_EC_PDSEndErr	BOOL		Process Data Transmission Error	
Cause and correction	Assumed cause		Correction		Prevention
	It was not possible to send the EtherCAT frame during the EtherCAT communications period.		Connect the Sysmac Studio, increase the task period setting of the primary periodic task or priority-5 periodic task, and set and save the network configuration information in the EtherCAT master.		Set the task period of the primary periodic task or priority-5 periodic task to a value that provides sufficient processing time. Use the Simulator to check the necessary EtherCAT communications period.
	The frame transmission jitter exceeded the limit.				
Attached information	<p>Attached Information 1: Error Details</p> <ul style="list-style-type: none"> • Frame generation was late for the transmission timing: 0000 hex, • The transmission jitter exceeded the limit: 0001 hex <p>Attached information 2: System information</p>				
Precautions/Remarks	None				

Event name	Process Data Reception Timeout		Event code	842B0000 hex	
Meaning	Process data reception timed out.				
Source	EtherCAT Master Function Module		Source details	Master	Detection timing During communications
Error attributes	Level	Minor fault	Recovery	Error reset	Log category System
Effects	User program	Continues.	Operation	When Fail-soft Operation Is Set to <i>Fail-soft</i> Master: Operation continues. Slave: Errors only occur in synced slaves. Operational state continues. Safe-operational state is entered if the state transition is made at the slave. When Fail-soft Operation Is Set to <i>Stop</i> Master: All slaves enter the Pre-operational state. Slave: Errors only occur in synced slaves.	
Indicators	EtherCAT NET RUN		EtherCAT NET ERR		EtherCAT LINK/ACT
	---		Flashes at 1-s intervals.		---
System-defined variables	Variable		Data type		Name
	_EC_PDTimeoutErr		BOOL		Process Data Reception Timeout Error
Cause and correction	Assumed cause		Correction		Prevention
	The Ethernet cable is broken or the specified cable is not being used.		The causes given on the left are possible if the error occurs from when the system starts operation or if it always occurs after a specific time after the system starts operation. Use the diagnostic and statistical information from the Sysmac Studio and check the EtherCAT communications status. If the Ethernet cable between the master and slave is broken or if the specified cable was not used, replace the cable. Or, reconnect the connector and make sure it is mated correctly. If a general-purpose Ethernet hub is connected, replace it with an EtherCAT Junction Slave. If the CPU Unit or an EtherCAT slave fails, replace it.		Make sure that the cable is not broken and use the specified cable.
	A connector on the Ethernet cable is disconnected, the contact is faulty, or parts are faulty.				Confirm that the Ethernet cable connector is mated securely.
	A general-purpose Ethernet hub is connected.				When branching an EtherCAT network, use an EtherCAT Junction Slave.
	The master failed.				None
	The slave failed.				None
	The Ethernet cable is too long.		The causes given on the left are possible if the error occurs from when the system starts operation. If the Ethernet cable is too long, shorten it. If the error still occurs, connect the Sysmac Studio, increase the task period of the primary periodic task or priority-5 periodic task, and reconfigure the Controller.		Make the Ethernet cable as short as possible.
	The CPU Unit task period is too short.				If there is a large number of EtherCAT slaves connected, increase the task period of the primary periodic task or priority-5 periodic task .
	Noise				Implement noise countermeasures.

Attached information	Attached Information 1: Error Details <ul style="list-style-type: none">• 0001 hex: Occurred in the primary periodic task.• 0002 hex: Occurred in the priority-5 periodic task.
Precautions/Remarks	None

Event name	Process Data Communications Error		Event code	842C0000 hex	
Meaning	An error occurred in process data communications.				
Source	EtherCAT Master Function Module		Source details	Slave	Detection timing During communications
Error attributes	Level	Minor fault	Recovery	Error reset	Log category System
Effects	User program	Continues.	Operation	<p>When Fail-soft Operation Is Set to <i>Fail-soft</i></p> <p>Master: Operation continues. Slave: An error occurred. Operational state continues. If a PDI watchdog error occurs in a slave, the slave enters the Init state. Check for communications errors for each slave in system-defined variables <code>_EC_CommErrTbl[]</code>.</p> <p>When Fail-soft Operation Is Set to <i>Stop</i></p> <p>Master: All slaves enter the Pre-operational state. Slave: An error occurred. When operation stops, all slaves enter the Pre-operational state. If a PDI watchdog error occurs in a slave, the slave enters the Init state.</p>	
Indicators	EtherCAT NET RUN		EtherCAT NET ERR		EtherCAT LINK/ACT
	---		Flashes at 1-s intervals.		---
System-defined variables	Variable	Data type	Name		
	<code>_EC_PDCommErr</code>	BOOL	Process Data Communications Error		
	<code>_EC_CommErrTbl</code>	Array [1..n] of BOOL *1	Communications Error Slave Table		
	<code>_EC_PDActive</code>	BOOL	Process Data Communications Status		
Cause and correction	Assumed cause	Correction		Prevention	
	<p>A slave left the network even though the disconnection operation or disable operation was not performed.</p> <ul style="list-style-type: none"> The power supply of the slave is turned OFF. The Ethernet cable is removed. 	<ul style="list-style-type: none"> Perform the disconnection operation or disable operation before turning OFF the power supply of the slave. Perform the disconnection operation or disable operation before removing the Ethernet cable. 		Same as corrections that are given on the left.	
	<p>A slave left the network even though the disconnection operation or disable operation was not performed.</p> <ul style="list-style-type: none"> A connector on the Ethernet cable is disconnected, the contact is faulty, or parts are faulty. The Ethernet cable is broken. The specified cable is not being used. 	<p>The causes given on the left are possible if the error occurs from when the system starts operation or if it always occurs after a specific time after the system starts operation. Use the diagnostic and statistical information from the Sysmac Studio and check the EtherCAT communications status.</p> <p>If the Ethernet cable is broken or if the specified cable was not used, replace the cable. Or, reconnect the connector and make sure it is mated correctly.</p>		<ul style="list-style-type: none"> Confirm that the Ethernet cable connector is mated securely. Make sure that the Ethernet cable is not broken. Make sure that the specified cable is being used. 	
	Slave failure	If this error occurs again even after the above correction, replace the slave.		None	

Attached information	Attached Information 1: Error Details <ul style="list-style-type: none">• 0001 hex: Slave WDT error (Slave failure)• 0002 hex: Slave disconnected (A slave left the network even though the disconnection operation or disable operation was not performed.)
Precautions/Remarks	None

*1. "n" is 512 for an NY-series Controller.

Event name	Input Process Data Invalid Error		Event code	842F0000 hex *1		
Meaning	<p>Because the EtherCAT master could not perform process data communications normally when it was in the Operational state, the Input Data Invalid state continued for the following period.</p> <ul style="list-style-type: none"> • When the task period is 10 ms or shorter: 100 ms • When the task period is longer than 10 ms: 10 periods of the task 					
Source	EtherCAT Master Function Module	Source details	Slave	Detection timing	During communications	
Error attributes	Level	Minor fault	Recovery	Error reset	Log category	System
Effects	User program	Continues.	Operation	Not affected.		
Indicators	EtherCAT NET RUN		EtherCAT NET ERR		EtherCAT LINK/ACT	
	---		Flashes at 1-s intervals.		---	
System-defined variables	Variable	Data type		Name		
	_EC_InDataInvalidErr	BOOL		Input Process Data Invalid Error		
	_EC_InDataInvalid	BOOL		Input Data Invalid		
	_EC_InData1Invalid	BOOL		Input Data1 Invalid		
	_EC_InData2Invalid	BOOL		Input Data2 Invalid		
Cause and correction	Assumed cause		Correction		Prevention	
	Hardware failure of EtherCAT slave		<p>While disconnecting the slaves from the network one by one, correct the error until the <i>_EC_InDataInvalid</i> (Input Data Invalid), <i>_EC_InData1Invalid</i> (Input Data1 Invalid), and <i>_EC_InData2Invalid</i> (Input Data2 Invalid) system-defined variables change to FALSE. When any of these variables change from TRUE to FALSE, the slave disconnected at that time is considered as failed. Replace the slave.</p> <p>In addition, program the <i>_EC_InDataInvalid</i> (Input Data Invalid), <i>_EC_InData1Invalid</i> (Input Data1 Invalid), and <i>_EC_InData2Invalid</i> (Input Data2 Invalid) system-defined variables as an interlock condition in the user program to ensure that invalid input data does not cause unexpected operation.</p>		None	
	Noise		<p>Check the number of error frames in the slave diagnostic and statistical information. It is considered that the slave was affected by noise in each location where an error frame was counted. Implement appropriate noise countermeasures for all locations considered to be affected by noise. Then, make sure that error frames are no longer counted in the slave diagnostic and statistical information.</p>		<p>If error frames are still counted in the master diagnostic and statistical information, before you start operation, remove the noise source or implement noise countermeasures while checking the slave diagnostic and statistical information.</p>	

Attached information	Attached information 1: System-defined variables that changed to TRUE for a certain period. The value is 1 for a system-defined variable that changed to TRUE for a certain period. <ul style="list-style-type: none">• 1st bit from the least-significant bit: <i>_EC_InDataInvalid</i> (Input Data Invalid), <i>_EC_InData1Invalid</i> (Input Data1 Invalid)• 2nd bit from the least-significant bit: <i>_EC_InData2Invalid</i> (Input Data2 Invalid)
Precautions/Remarks	None

*1. This event code occurs for unit version 1.14 or later of the CPU Unit.

Event name	EtherCAT Slave Backup Failed		Event code	102F0000 hex		
Meaning	The backup operation for an EtherCAT slave ended in an error.					
Source	EtherCAT Master Function Module	Source details	Master	Detection timing	During backup operation	
Error attributes	Level	Observation	Recovery	---	Log category	System
Effects	User program	Continues.	Operation	Not affected.		
Indicators	EtherCAT NET RUN		EtherCAT NET ERR		EtherCAT LINK/ACT	
	---		---		---	
System-defined variables	Variable	Data type		Name		
	_EC_DisconnSlavTbl	Array [1..n] of BOOL *1		Disconnected Slave Table		
Cause and correction	Assumed cause		Correction		Prevention	
	There is no connection between the EtherCAT master and the slave (Link OFF).		Wire the EtherCAT master and slave securely.		Wire the EtherCAT master and slave securely and make sure that a connection is established before you attempt to back up the data.	
	An error caused an incorrect EtherCAT master status.		Use the Sysmac Studio or the Troubleshooter of an HMI to check for errors and eliminate any EtherCAT errors.		Back up the data when there are no EtherCAT errors.	
	The EtherCAT network configuration information does not agree with the physical network configuration.		Make sure that network configuration information agrees with the physical network configuration.		Back up the data only when the network configuration information agrees with the physical network configuration.	
	The request to the EtherCAT slave failed.		Connect the cable securely. Implement noise countermeasures if there is excessive ambient noise. If the situation does not improve, replace the EtherCAT slave.		Connect the cable securely. Implement noise countermeasures if there is excessive ambient noise.	
	The EtherCAT master was temporarily unable to perform the processing because it was executing other processing.		Try backing up the data again.		None	
	Initialization of the EtherCAT slave failed.		Connect any slaves that are disconnected. Use the Sysmac Studio or the Troubleshooter of an HMI to check for the following errors: Slave Initialization Error, Slave Application Error, and Process Data Communications Error. Eliminate any errors that you find.		Back up the data when the EtherCAT slave is participating in the network and there are no slaves that are disconnected from the network. Also, back up the data when there is no Process Data Communications Error.	
	It was not possible to read the backup parameters from the EtherCAT slave.		The ESI file may be incorrect. Ask the manufacturer of the slave if you can read all of the parameters that are set as backup parameters. If all of the backup parameters can be read, the EtherCAT slave is faulty. Replace the EtherCAT slave.		None	
	Communications with an OMRON Communications Coupler Unit or NX Unit failed.		Connect the cable securely. Mount the NX Unit securely. Implement noise countermeasures if there is excessive ambient noise. If the problem still exists, replace the Communications Coupler Unit or the NX Unit.		Connect the cable securely. Mount the NX Unit securely. Implement noise countermeasures if there is excessive ambient noise.	

Attached information	<p>Attached Information 1: Error Details (The following values are in the order of the causes of the error.)</p> <ul style="list-style-type: none"> • 0001 hex: Link OFF • 0002 hex: Incorrect master status • 0003 hex: Configuration information does not agree with network configuration. • 0004 hex: The request to the EtherCAT slave failed. • 0005 hex: Master status temporarily prevented processing. • 0006 hex: An error occurred in slave initialization or a slave is disconnected from the network. • 0007 hex: Reading the backup data failed. • 000B hex: Error at OMRON Communications Coupler Unit <p>Attached Information 2: Error Location</p> <ul style="list-style-type: none"> • 0: Master • 1 or higher: Slave node address <p>Attached Information 3: Error Location Details (only when attached information 1 is 000B hex).</p> <ul style="list-style-type: none"> • 0: Communications Coupler Unit • 1 to 63: Unit number of NX Unit <p>Attached Information 4: Cause of Error at OMRON Communications Coupler Unit (only when attached information 1 is 000B hex).</p> <ul style="list-style-type: none"> • 2: Communications with the Communications Coupler Unit or NX Unit failed.
Precautions/Remarks	<p>None</p>

*1. "n" is 512 for an NY-series Controller.

Event name	EtherCAT Slave Restore Operation Failed		Event code	10300000 hex	
Meaning	The restore operation for an EtherCAT slave ended in an error.				
Source	EtherCAT Master Function Module		Source details	Master	Detection timing During restore operation
Error attributes	Level	Observation	Recovery	---	Log category System
Effects	User program	Continues.	Operation	Not affected.	
Indicators	EtherCAT NET RUN		EtherCAT NET ERR		EtherCAT LINK/ACT
	---		---		---
System-defined variables	Variable		Data type	Name	
	None		---		---
Cause and correction	Assumed cause		Correction		Prevention
	There is no connection between the EtherCAT master and the slave (Link OFF).		Wire the EtherCAT master and slave securely.		Wire the EtherCAT master and slave securely, and make sure that a connection is established before you attempt to restore the data.
	An error caused an incorrect EtherCAT master status.		Use the Sysmac Studio or the Troubleshooter of an HMI to check for errors and eliminate any EtherCAT errors.		Restore the data when there are no EtherCAT errors.
	The EtherCAT network configuration information does not agree with the physical network configuration.		Make sure that network configuration information agrees with the physical network configuration. Always use a slave revision that is the same or higher than the slave revision that was used when the data was backed up even if you set <i>No check</i> for the Revision Check Method for backup. Set <i>No check</i> for the Serial Number Check Method and then back up the data. If you replace a slave with the Serial Number Check Method set to <i>Setting = Actual device</i> , do not use the restore function. Instead, change the network configuration from the Sysmac Studio, download the network configuration, and then transfer the slave parameters. If the node address is set on the hardware switches, use the same setting as when the data was backed up.		Restore the data only when the network configuration information agrees with the physical network configuration.

<p>The request to the EtherCAT slave failed. (When attached information 1 is 0004 hex)</p>	<p>Connect the cable securely. Implement noise countermeasures if there is excessive ambient noise. If the situation does not improve, execute the restore operation with restore function on the Sysmac Studio except for the EtherCAT slave. In this case, backup parameters are not restored to the EtherCAT slave. After the execution of the restore operation, transfer parameters to the EtherCAT slave with synchronization function on the Sysmac Studio. If the situation does not improve yet, replace the EtherCAT slave.</p>	<p>Connect the cable securely. Implement noise countermeasures if there is excessive ambient noise.</p>
<p>The EtherCAT master was temporarily unable to perform the processing because it was executing other processing.</p>	<p>Try restoring the data again.</p>	<p>None</p>
<p>Initialization of the EtherCAT slave failed.</p>	<p>Use the Sysmac Studio or the Troubleshooter of an HMI to check for the following errors: Slave Initialization Error, Slave Application Error, and Process Data Communications Error. Eliminate any errors that you find.</p>	<p>Restore the data when there is no Process Data Communications Error.</p>
<p>It was not possible to write the backup parameters to the MX2/RX Series Inverter. (This applies only for unit version 1.10 or earlier of the CPU Unit.)</p>	<p>Download the parameters to the Inverter using the "To Drive" menu of the Sysmac Studio.</p>	<p>Data is sometimes not restored due to Inverter restrictions. If that occurs, download the parameters to the Inverter using the "To Drive" menu of the Sysmac Studio.</p>
<p>It was not possible to write the backup parameters to the EtherCAT slave.</p>	<p>The ESI file may be incorrect. Ask the manufacturer of the slave if you can write all of the parameters that are set as backup parameters. If all of the backup parameters can be written, the slave is faulty. Replace the slave.</p>	<p>None</p>
<p>Incorrect backup data was detected.</p>	<p>Format the SD Memory Card with the Sysmac Studio and then place the backup file on it.</p>	<p>Do not remove the SD Memory Card or turn OFF the power supply while the SD BUSY indicator is lit. Or, replace the SD Memory Card periodically according to the write life of the SD Memory Card.</p>
<p>The EtherCAT network configuration in the backup data does not agree with the physical network configuration.</p>	<p>Make sure that the EtherCAT network configuration in the backup data agrees with the physical network configuration.</p>	<p>Make sure that the EtherCAT network configuration in the backup data agrees with the physical network configuration before you try to restore the data.</p>

	<p>An error occurred at an OMRON Communications Coupler Unit. The following causes are possible.</p> <ul style="list-style-type: none"> • Reading a backup file failed at the Communications Coupler Unit (when attached information 4 is 1). • Communications with the Communications Coupler Unit or NX Unit failed (when attached information 4 is 2). • The Unit Configuration of the NX Units in the Communications Coupler Unit when data was backed up did not agree with the actual configuration of NX Units (when attached information 4 is 3). 	<ul style="list-style-type: none"> • Try backing up the data again (when attached information 4 is 1). • Connect the cable securely. Mount the NX Unit securely. Implement noise countermeasures if there is excessive ambient noise. If the problem still exists, replace the Communications Coupler Unit or the NX Unit (when attached information 4 is 2). • Make the Unit Configuration of the NX Units in the Communications Coupler Unit when data was backed up agree with the actual configuration of NX Units (when attached information 4 is 2 or 3). • Correct the hardware switches on the Communications Coupler Unit so that they are the same as when the data was backed up (when attached information 4 is 3). 	<ul style="list-style-type: none"> • Format an SD Memory Card with the Sysmac Studio and then place the backup file on it. Also, do not remove the SD Memory Card or turn OFF the power supply while the SD BUSY indicator is lit (when attached information 4 is 1). • Connect the cable securely. Mount the NX Unit securely. Implement noise countermeasures if there is excessive ambient noise (when attached information 4 is 2). • Restore the data while the Unit Configuration of the NX Units in the Communications Coupler Unit agrees with the actual configuration of NX Units (when attached information 4 is 2 or 3). • Restore the data while the hardware switches on the Communications Coupler Unit are the same as when the data was backed up (when attached information 4 is 3).
<p>Attached information</p>	<p>Attached Information 1: Error Details (The following values are in the order of the causes of the error.)</p> <ul style="list-style-type: none"> • 0001 hex: Link OFF • 0002 hex: Incorrect master status • 0003 hex: Configuration information does not agree with network configuration. • 0004 hex: The request to the EtherCAT slave failed. • 0005 hex: Master status temporarily prevented processing. • 0006 hex: An error occurred in slave initialization. • 0007 hex: Writing the backup data failed. • 0008 hex: The backup data is not correct. • 0009 hex : The network configuration does not agree with the network configuration in the backup data. • 000A hex: The service is not supported • 000B hex: Error at OMRON Communications Coupler Unit <p>Attached Information 2: Error Location</p> <ul style="list-style-type: none"> • 0: Master • 1 or higher: Slave node address <p>Attached Information 3: Error Location Details (only when attached information 1 is 000B hex).</p> <ul style="list-style-type: none"> • 0: Communications Coupler Unit • 1 to 63: Unit number of NX Unit <p>Attached Information 4: Cause of Error at OMRON Communications Coupler Unit (only when attached information 1 is 000B hex).</p> <ul style="list-style-type: none"> • 1: Reading the backup file failed. • 2: Communications with the Communications Coupler Unit or NX Unit failed. • 3: The Unit Configuration does not agree with the Unit Configuration in the backup data. 		
<p>Precautions/Remarks</p>	<p>None</p>		

Event name	Emergency Message Detected		Event code	64200000 hex		
Meaning	An emergency message was detected.					
Source	EtherCAT Master Function Module	Source details	Slave	Detection timing	During communications	
Error attributes	Level	Observation	Recovery	---	Log category	System
Effects	User program	Continues.	Operation	Slave: An error occurred. Other operation is not affected.		
Indicators	EtherCAT NET RUN		EtherCAT NET ERR		EtherCAT LINK/ACT	
	---		---		---	
System-defined variables	Variable	Data type	Name			
	_EC_SlavEmergErr	BOOL	Emergency Message Detected			
Cause and correction	Assumed cause	Correction	Prevention			
	An emergency message was received from a slave.	Clear the error from the EtherCAT slave where the application error occurred. Use the procedure given in the slave documentation.	Refer to the information given in the manual for the slave and implement countermeasures to prevent the problem.			
Attached information	Attached Information 1: Slave emergency code Attached information 2: Slave error register object value Attached Information 3: Slave emergency data. Only the lower five bytes are valid.					
Precautions/Remarks	None					

Event name	EtherCAT Message Error		Event code	842D0000 hex		
Meaning	An error occurred in a message communications with the slave.					
Source	EtherCAT Master Function Module	Source details	Master	Detection timing	During communications	
Error attributes	Level	Observation	Recovery	---	Log category	System
Effects	User program	Continues.	Operation	Slave: An error occurred. Other operation is not affected.		
Indicators	EtherCAT NET RUN		EtherCAT NET ERR		EtherCAT LINK/ACT	
	---		---		---	
System-defined variables	Variable	Data type		Name		
	_EC_MsgErr	BOOL		EtherCAT Message Error		
Cause and correction	Assumed cause		Correction		Prevention	
	Refer to the attached information to check the error.		Send messages only to slaves that support the message protocol. Identify the error message with the error details that are given in the attached information, and correct the message.		Use messages that match the slave specifications. Also check to make sure that messages are addressed to the correct node.	
Attached information	<p>Attached Information 1: Error Details</p> <ul style="list-style-type: none"> 1st byte: 00 hex: Error message reception, 02 hex: Illegal or unsupported message discarded, 04 hex: Message with illegal destination address discarded 2nd byte: <ul style="list-style-type: none"> For Transmission: 00 hex: Error, 01 hex: VoE (AoE), 02 hex: EoE, 03 hex: CoE, 04 hex: FoE, 05 hex: SoE, 0F hex: VoE For Reception: 80 hex: Error, 81 hex: VoE (AoE), 82 hex: EoE, 83 hex: CoE, 84 hex: FoE, 85 hex: SoE, 8F hex: VoE <p>Attached information 2: Source node address. If the source is the master: 0 Attached Information 3: Transmission destination node address. If the destination is the master: 0 Attached information 4: Error service data. This data is valid only when byte 2 of attached information 1 is 00 or 80 hex.</p>					
Precautions/Remarks	None					

Event name	Slave Disconnected		Event code	94400000 hex	
Meaning	A slave was disconnected for a disconnection command.				
Source	EtherCAT Master Function Module	Source details	Slave	Detection timing	When slave disconnection is specified during communications
Error attributes	Level	Information	Recovery	---	Log category
Effects	User program	Continues.	Operation	Master: Process data communications are stopped for the slave and all slaves after it. Monitoring of topology changes is stopped for the slave and all slaves after it. Slave: The slaves will move to Init state. You can transfer the backup parameters with the Sysmac Studio. Process data communications are not possible.	
Indicators	EtherCAT NET RUN		EtherCAT NET ERR		EtherCAT LINK/ACT
	---		---		---
System-defined variables	Variable	Data type		Name	
	_EC_DisconnSlavTbl	Array [1..n] of BOOL *1		Disconnected Slave Table	
	_EC_PDSlavTbl	Array [1..n] of BOOL *1		Process Data Communicating Slave Table	
	_EC_MBXSlavTbl	Array [1..n] of BOOL *1		Message Communications Enabled Slave Table	
Cause and correction	Assumed cause		Correction		Prevention
	An operation to disconnect the slave was executed from the Sysmac Studio.		---		---
	The EC_DisconnectSlave instruction was executed.		---		---
Attached information	None				
Precautions/Remarks	None				

*1. "n" is 512 for an NY-series Controller.

Event name	Slave Connected		Event code	94410000 hex		
Meaning	A slave was reconnected for a reconnection command.					
Source	EtherCAT Master Function Module	Source details	Slave	Detection timing	When slave reconnection is specified during communications	
Error attributes	Level	Information	Recovery	---	Log category	System
Effects	User program	Continues.	Operation	Master: The slave enters the Operational state again, and process data communications restart. Slave: Enters Operational state.		
Indicators	EtherCAT NET RUN		EtherCAT NET ERR		EtherCAT LINK/ACT	
	---		---		---	
System-defined variables	Variable	Data type		Name		
	_EC_DisconnSlavTbl	Array [1..n] of BOOL *1		Disconnected Slave Table		
	_EC_PDslavTbl	Array [1..n] of BOOL *1		Process Data Communicating Slave Table		
	_EC_MBXslavTbl	Array [1..n] of BOOL *1		Message Communications Enabled Slave Table		
Cause and correction	Assumed cause		Correction		Prevention	
	An operation to reconnect the slave was executed from the Sysmac Studio.		---		---	
	The EC_ConnectSlave instruction was executed.		---		---	
Attached information	None					
Precautions/Remarks	None					

*1. "n" is 512 for an NY-series Controller.

Event name	Error Reset		Event code	94430000 hex	
Meaning	A command was received to reset errors.				
Source	EtherCAT Master Function Module		Source details	Master	Detection timing When errors are reset
Error attributes	Level	Information	Recovery	---	Log category System
Effects	User program	Continues.	Operation	Master: The current errors are reset and the network is verified again. If the error is not detected again, process data communications with the slave for which communications were stopped are restarted. Slave: The slave where the error occurred enters the Operational state.	
Indicators	EtherCAT NET RUN		EtherCAT NET ERR		EtherCAT LINK/ACT
	---		---		---
System-defined variables	Variable	Data type		Name	
	_EC_PDSlaveTbl	Array [1..n] of BOOL *1		Process Data Communicating Slave Table	
	_EC_MBXSlaveTbl	Array [1..n] of BOOL *1		Message Communications Enabled Slave Table	
Cause and correction	Assumed cause		Correction		Prevention
	An error reset operation was performed from the Sysmac Studio.		---		---
	The ResetECError instruction was executed.		---		---
Attached information	None				
Precautions/Remarks	None				

*1. "n" is 512 for an NY-series Controller.

Event name	Slave Disabled			Event code	94440000 hex	
Meaning	The EtherCAT Slave was disabled.					
Source	EtherCAT Master Function Module		Source details	Slave	Detection timing	At execution of setting instruction
Error attributes	Level	Information	Recovery	---	Log category	System
Effects	User program	Continues.	Operation	Master: Process data communications stop for the slave. Slave: Enters the Pre-operational state. It will be possible to set parameters. Process data communications are not possible.		
Indicators	EtherCAT NET RUN		EtherCAT NET ERR		EtherCAT LINK/ACT	
	---		---		---	
System-defined variables	Variable		Data type		Name	
	_EC_PDSlavTbl		Array [1..n] of BOOL *1		Process Data Communicating Slave Table	
	_EC_DisableSlavTbl		Array [1..n] of BOOL *1		Disabled Slave Table	
Cause and correction	Assumed cause		Correction		Prevention	
	The EC_ChangeEnableSetting instruction was executed.		---		---	
Attached information	None					
Precautions/Remarks	None					

*1. "n" is 512 for an NY-series Controller.

Event name	Slave Enabled			Event code	94450000 hex	
Meaning	The EtherCAT Slave was enabled.					
Source	EtherCAT Master Function Module		Source details	Slave	Detection timing	At execution of setting instruction
Error attributes	Level	Information	Recovery	---	Log category	System
Effects	User program	Continues.	Operation	Master: The slave enters the Operational state again, and process data communications restart. Slave: Enters Operational state.		
Indicators	EtherCAT NET RUN		EtherCAT NET ERR		EtherCAT LINK/ACT	
	---		---		---	
System-defined variables	Variable		Data type		Name	
	_EC_PDSlavTbl		Array [1..n] of BOOL *1		Process Data Communicating Slave Table	
	_EC_DisableSlavTbl		Array [1..n] of BOOL *1		Disabled Slave Table	
Cause and correction	Assumed cause		Correction		Prevention	
	The EC_ChangeEnableSetting instruction was executed.		---		---	
Attached information	None					
Precautions/Remarks	None					

*1. "n" is 512 for an NY-series Controller.

Event name	EtherCAT Diagnosis/Statistics Log Started		Event code	94500000 hex		
Meaning	EtherCAT diagnosis/statistics log is started.					
Source	EtherCAT Master Function Module	Source details	Master	Detection timing	When EtherCAT diagnosis/statistics log is started	
Error attributes	Level	Information	Recovery	---	Log category	Access
Effects	User program	Continues.	Operation	The response time to non-synchronous EtherCAT slaves will be extended.		
Indicators	EtherCAT NET RUN		EtherCAT NET ERR		EtherCAT LINK/ACT	
	---		---		---	
System-defined variables	Variable	Data type		Name		
	_EC_StatisticsLogEnable	BOOL		Diagnosis/Statistics Log Enable		
	_EC_StatisticsLogBusy	BOOL		Diagnosis/Statistics Log Busy		
Cause and correction	Assumed cause	Correction		Prevention		
	The value of the _EC_StatisticsLogEnable systemdefined variable changed from FALSE to TRUE.	---		---		
Attached information	Attached information 1: Automatic saving interval to the SD Memory Card for the diagnosis/statistics log <ul style="list-style-type: none"> • 0: One-shot Mode • Not 0: Interval (sec) 					
Precautions/Remarks	None					

Event name	EtherCAT Diagnosis/Statistics Log Ended		Event code	94510000 hex		
Meaning	EtherCAT diagnosis/statistics log is ended.					
Source	EtherCAT Master Function Module	Source details	Master	Detection timing	When EtherCAT diagnosis/statistics log is ended	
Error attributes	Level	Information	Recovery	---	Log category	Access
Effects	User program	Continues.	Operation	Not affected.		
Indicators	EtherCAT NET RUN		EtherCAT NET ERR		EtherCAT LINK/ACT	
	---		---		---	
System-defined variables	Variable	Data type		Name		
	_EC_StatisticsLogEnable	BOOL		Diagnosis/Statistics Log Enable		
	_EC_StatisticsLogBusy	BOOL		Diagnosis/Statistics Log Busy		
	_EC_StatisticsLogErr	BOOL		Diagnosis/Statistics Log Error End		
Cause and correction	Assumed cause		Correction		Prevention	
	An error that causes EtherCAT diagnosis/statistics log to end occurred.		---		---	
Attached information	<p>Attached information 1: Automatic saving interval to the SD Memory Card for the diagnosis/statistics log</p> <ul style="list-style-type: none"> • 0: One-shot Mode • Not 0: Interval (sec) <p>Attached information 2: Causes to end EtherCAT diagnosis/statistics log</p> <ul style="list-style-type: none"> • 1: The value of the _EC_StatisticsLogEnable changed from TRUE to FALSE. • 2: The 1000th record was saved in the log file. • 3: The SD Memory Card does not have sufficient available space to save another records in the log file. • 4: The SD Memory Card is write protected. • 5: The SD Memory Card cannot be recognized. • 6: Synchronizing (or downloading) • 7: An invalid value was specified to the automatic saving interval to the SD Memory Card for the diagnosis/statistics log. 					
Precautions/Remarks	None					



Appendix

The appendix provides tables of the other errors (events) that can occur in the Controllers, tables of errors (events) that can occur in the connected devices, and tables of all errors (events) in order of the event codes. The applicable range of the HMI Troubleshooter and the procedures to check for Windows errors and corrections are described as well.

A

A-1	Other Errors (Events) That Can Occur in the CPU Units.....	A-2
A-1-1	Errors in the CNC Function	A-2
A-2	Errors (Events) That Can Occur in Connected Devices	A-23
A-2-1	Errors in Slave Terminals	A-23
A-2-2	Errors in EtherCAT Slaves	A-79
A-3	Events in Order of Event Codes	A-127
A-3-1	Interpreting Error Descriptions	A-127
A-3-2	Events in Order of Event Codes.....	A-128
A-4	Applicable Range of the HMI Troubleshooter.....	A-174
A-4-1	HMI's on which Troubleshooter Can Be Used	A-174
A-4-2	System Configuration Elements Supported by the Troubleshooter.....	A-175
A-5	Checking Errors with Windows	A-176
A-5-1	Industrial PC Support Utility	A-176
A-5-2	Windows Issues and Troubleshooting.....	A-176

A-1 Other Errors (Events) That Can Occur in the CPU Units

This appendix provides tables of the errors (events) that can occur in models other than the standard NY-series Controllers. These errors are not listed in *Section 3 Error Descriptions and Corrections* on page 3-1. Refer to *3-1 Interpreting Tables* on page 3-2 for interpreting error tables. Refer to the manual for the specific product for details on errors.

A-1-1 Errors in the CNC Function

This section provides tables of the errors (events) that can occur in the CNC functions and CNC instructions.

You can use the CNC functions and CNC instructions with an NY532-5400 Controller. The unit version of the Controller is 1.16 or later.

CNC Function

The manual names are given below for the catalog numbers given in the Reference column of the event table.

Cat. No.	Manual name
0030	NJ/NY-series NC Integrated Controller User's Manual

Event code	Event name	Meaning	Assumed cause	Level					Reference
				M a j	P r t	M i n	O b s	I n f o	
47810000 hex	CNC Parameter Setting Invalid	A fatal error was detected during setting of the CNC Function Module.	<ul style="list-style-type: none"> The system failed to transfer the CNC parameter setting. Otherwise, an error occurred in the software. 	○					O030
17800000 hex	CNC Parameter Setting Error	The CNC parameters that were saved in non-volatile memory are missing.	<ul style="list-style-type: none"> The power supply to the Controller was interrupted or communications with the Sysmac Studio were disconnected while downloading the CNC parameter settings or clearing memory. Non-volatile memory failure 		○				O030
17810000 hex	Absolute Encoder Home Offset Read Error	The absolute encoder current position that is retained during power interruptions was lost.	<ul style="list-style-type: none"> When the retained variables are backed up with a battery, this event indicates that the life of the battery in the CPU Unit has expired. Backup memory failure 		○				O030

Event code	Event name	Meaning	Assumed cause	Level					Reference
				M a j	P r t	M i n	O b s	I n f o	
17820000 hex	CNC Motor Compensation Table Read Error	The CNC motor compensation table that was saved in non-volatile memory is missing.	<ul style="list-style-type: none"> The power supply to the Controller was interrupted or communications with the Sysmac Studio were disconnected while downloading the CNC parameter settings or clearing memory. Non-volatile memory failure 		○				O030
37800000 hex	Required Process Data Object Not Set	The object that is required for the assigned axis type in the CNC motor parameter settings is not allocated to PDO.	<ul style="list-style-type: none"> The required PDOs are not mapped when the assigned axis type in the CNC motor parameter settings is set to a servo axis or encoder axis. Non-volatile memory failure 		○				O030
47800000 hex	CNC Initialization Error	A fatal error occurred in the system and prevented initialization of the CNC Function Module.	<ul style="list-style-type: none"> Hardware failure 		○				O030
77800000 hex	CNC Control Period Exceeded	The primary periodic task processing has not been completed within two control cycles.	<ul style="list-style-type: none"> The processing load in the primary periodic task is too heavy. 		○				O030
37810000 hex	Process Data Object Setting Missing	The PDO mapping is not correct.	<ul style="list-style-type: none"> The relevant instruction was executed for a device that does not have an object that supports the instruction. 			○			O030
56000000 hex	Illegal CNC Coordinate System Specification	The CNC coordinate system specified for the <i>Coord</i> in-out variable to a CNC instruction does not exist.	<ul style="list-style-type: none"> CNC coordinate system does not exist for the variable specified for the <i>Coord</i> in-out variable to the instruction. 			○			O030
56010000 hex	Deceleration Setting Out of Range	The parameter specified for the <i>Deceleration</i> input variable to a CNC instruction is out of range.	<ul style="list-style-type: none"> Instruction input parameter exceeded the valid range of the input variable. 			○			O030
56020000 hex	Jerk Setting Out of Range	The parameter specified for the <i>Jerk</i> input variable to a CNC instruction is out of range.	<ul style="list-style-type: none"> Instruction input parameter exceeded the valid range of the input variable. 			○			O030
56030000 hex	CNC Instruction Re-execution Disabled	A CNC instruction that cannot be re-executed was re-executed.	<ul style="list-style-type: none"> A CNC instruction that cannot be re-executed was re-executed. 			○			O030

Event code	Event name	Meaning	Assumed cause	Level					Reference
				M a j	P r t	M i n	O b s	I n f o	
56040000 hex	CNC Multi-execution Disabled	Multiple functions that cannot be executed simultaneously were executed for the same target (CNC coordinate system).	<ul style="list-style-type: none"> Multiple functions that cannot be executed simultaneously were executed for the same target (CNC coordinate system). The CNC_LoadProgramFile instruction was executed when any of CNC coordinate system was Executing (Executing) or Hold (Holding). 			○			O030
56050000 hex	Unassigned Logical CNC Motor Number Specified	The CNC motor of the parameter specified for the <i>LogicalMotorNo</i> input variable to the CNC instruction is not assigned.	<ul style="list-style-type: none"> The logical CNC motor number for which the CNC motor is not assigned to the <i>LogicalMotorNo</i> input variable to the CNC instruction was specified, and the instruction was executed. 			○			O030
56060000 hex	Logical CNC Motor Number Out of Range	The parameter specified for the <i>LogicalMotorNo</i> input variable to a CNC instruction is out of range.	<ul style="list-style-type: none"> Instruction input parameter exceeded the valid range of the input variable. 			○			O030
56070000 hex	Target Position Setting Out of Range	The parameter specified for the <i>Position</i> input variable to a CNC instruction is out of range.	<ul style="list-style-type: none"> Instruction input parameter exceeded the valid range of the input variable. Or, there was an overflow/underflow in the target position. 			○			O030
56080000 hex	Impossible CNC Motor Operation Specified when the Servo is OFF	An operation instruction was executed for the CNC motor for which the Servo is OFF.	<ul style="list-style-type: none"> Home was preset with the CNC_Home or CNC_Home-WithParameter instruction for an axis for which EtherCAT process data communications are not established. 			○			O030
56090000 hex	Target Velocity Setting Out of Range	The parameter specified for the <i>Velocity</i> input variable to a CNC instruction is out of range.	<ul style="list-style-type: none"> Instruction input parameter exceeded the valid range of the input variable. 			○			O030
560A0000 hex	Acceleration/Deceleration Setting Out of Range	The parameter specified for the <i>Acceleration</i> input variable to a CNC instruction is out of range.	<ul style="list-style-type: none"> Instruction input parameter exceeded the valid range of the input variable. 			○			O030

Event code	Event name	Meaning	Assumed cause	Level					Reference
				M a j	P r t	M i n	O b s	I n f o	
560B0000 hex	Travel Mode Selection Out of Range	The parameter specified for the <i>MoveMode</i> input variable to a CNC instruction is out of range.	<ul style="list-style-type: none"> Instruction input parameter exceeded the valid range of the input variable. 			○			O030
560C0000 hex	Immediate Stop Instruction Executed	An Immediate Stop (CNC_CoordImmediateStop) instruction was executed.	<ul style="list-style-type: none"> An Immediate Stop instruction was executed. 			○			O030
560D0000 hex	Parameter Selection Out of Range	The parameter specified for the <i>ParameterNumber</i> input variable to a CNC instruction is out of range.	<ul style="list-style-type: none"> Instruction input parameter exceeded the valid range of the input variable. 			○			O030
560E0000 hex	CNC Parameter Setting Read/Write Setting Value Out of Range	The parameter specified for the <i>SettingValue</i> in-out variable to a CNC instruction is out of range.	<ul style="list-style-type: none"> Instruction input parameter exceeded the valid range of the in-out variable. 			○			O030
560F0000 hex	CNC Parameter Setting Read/Write Target Out of Range	The parameter specified for the <i>Target</i> in-out variable to a CNC instruction is out of range.	<ul style="list-style-type: none"> Instruction input parameter exceeded the valid range of the in-out variable. 			○			O030
56100000 hex	Cycle Start Error with Undefined Home	A cycle start was executed for a CNC coordinate system including the positioning axis with no defined home.	<ul style="list-style-type: none"> A cycle start was executed for a CNC coordinate system including the positioning axis with no defined home. 			○			O030
56110000 hex	Homing Parameter Setting Out of Range	The parameter specified for the <i>HomingParameter</i> in-out variable of the CNC instruction is out of range.	<ul style="list-style-type: none"> Instruction input parameter exceeded the valid range of the in-out variable. 			○			O030
56120000 hex	M Code Number Out of Range	The parameter specified for the <i>MCodeNo</i> input variable to a CNC instruction is out of range.	<ul style="list-style-type: none"> Instruction input parameter exceeded the valid range of the input variable. 			○			O030

Event code	Event name	Meaning	Assumed cause	Level					Reference
				M a j	P r t	M i n	O b s	I n f o	
56130000 hex	CNC Instruction Re-execution Disabled (CNC Coordinate System Specification)	An attempt was made to change the parameter for the <i>Coord</i> in-out variable when re-executing a CNC instruction. (This in-out variable cannot be changed when re-executing an instruction.)	<ul style="list-style-type: none"> A parameter for an in-out variable that cannot be changed for re-execution was changed. 			○			O030
56140000 hex	CNC Instruction Re-execution Disabled (Logical CNC Motor Number)	An attempt was made to change the parameter for the <i>LogicalMotorNo</i> input variable when re-executing a CNC instruction. (This input variable cannot be changed when re-executing an instruction.)	<ul style="list-style-type: none"> A parameter for an input variable that cannot be changed for re-execution was changed. 			○			O030
56150000 hex	Illegal NC Program	An error was detected in the NC program transferred from Sysmac Studio.	<ul style="list-style-type: none"> NC program transfer processing failed. 			○			O030
56160000 hex	Cycle Start Multi-execution Disabled	A cycle start was executed multiple times for the same target (CNC coordinate system).	<ul style="list-style-type: none"> A cycle start was executed while the CNC coordinate system is Executing (Executing), MovingOnHold (Manual Operation While Holding), or Moving (Moving). 			○			O030
56170000 hex	Impossible CNC Motor Cycle Start Specified when the Servo is OFF	A cycle start was executed for a CNC coordinate system including the CNC motor for which the Servo is OFF.	<ul style="list-style-type: none"> A cycle start was executed for the CNC motor for which Servo is turned OFF. 			○			O030
56180000 hex	Illegal NC Program Number Specification	The NC program specified for <i>ProgramNo</i> in the <i>ControlInputs</i> in-out variable to the CNC_CoordControl instruction is not loaded.	<ul style="list-style-type: none"> A cycle start was executed after an unloaded NC program is specified for <i>ProgramNo</i> in the <i>ControlInputs</i> in-out variable to the CNC_CoordControl instruction. 			○			O030

Event code	Event name	Meaning	Assumed cause	Level					Reference
				M a j	P r t	M i n	O b s	I n f o	
56190000 hex	Illegal Back Trace Specification	A cycle start was executed when the CNC coordinate system is Standby (Standby) while <i>BackTrace</i> in the <i>ControllInputs</i> in-out variable to the CNC_CoordControl instruction is set to TRUE.	<ul style="list-style-type: none"> A cycle start was executed when the CNC coordinate system is Standby (Standby) while <i>BackTrace</i> in the <i>ControllInputs</i> in-out variable to the CNC_CoordControl instruction is set to TRUE. 				○		O030
56250000 hex	Illegal CNC Motor Specification	The CNC motor specified for the <i>Target</i> input variable to a CNC instruction does not exist.	<ul style="list-style-type: none"> A CNC motor does not exist for the variable specified for the <i>Target</i> input variable to the instruction. 				○		O030
56260000 hex	Illegal CNC Motor Compensation Table Specification	The CNC motor compensation table specified for the <i>Target</i> input variable to a CNC instruction does not exist.	<ul style="list-style-type: none"> A CNC motor compensation table does not exist for the variable specified for the <i>Target</i> input variable to the instruction. 				○		O030
56290000 hex	NC Program Capacity Exceeded	Loading failed because the NC program downloaded from Sysmac Studio exceeded the maximum capacity.	<ul style="list-style-type: none"> The NC program that has a capacity above the maximum was downloaded from Sysmac Studio. 				○		O030
67800000 hex	Immediate Stop Input	The immediate stop input turned ON.	<ul style="list-style-type: none"> An immediate stop input signal was detected. The immediate stop input signal is not connected correctly or the logic setting for the immediate stop input is wrong. 				○		O030
67810000 hex	Positive Limit Input Detected	The positive limit input turned ON.	<ul style="list-style-type: none"> A positive limit input signal was detected. The positive limit input signal is not connected correctly or the logic setting for the positive limit input is wrong. 				○		O030
67820000 hex	Negative Limit Input Detected	The negative limit input turned ON.	<ul style="list-style-type: none"> A negative limit input signal was detected. The negative limit input signal is not connected correctly or the logic setting for the negative limit input is wrong. 				○		O030

Event code	Event name	Meaning	Assumed cause	Level					Reference
				M a j	P r t	M i n	O b s	I n f o	
67830000 hex	Target Position Positive Software Limit Exceeded	The specified position exceeds the positive software limit.	<ul style="list-style-type: none"> The parameter specified for the <i>Position</i> input variable to the instruction is beyond the positive software limit. The first position is beyond the positive software limit and an instruction that specifies motion in the opposite direction of the software limit was executed. 			○			O030
67840000 hex	Target Position Negative Software Limit Exceeded	The specified position exceeds the negative software limit.	<ul style="list-style-type: none"> The parameter specified for the <i>Position</i> input variable to the instruction is beyond the negative software limit. While the starting position is out of the negative software limit, an operation was specified in the opposite direction of the software limit. 			○			O030
67850000 hex	Command Position Overflow/Underflow	Positioning, an instruction in the underflow/overflow direction, or an instruction for which the direction is not specified was executed when there was an underflow/overflow in the command position.	<ul style="list-style-type: none"> One of the following was executed when there was a command position overflow/underflow. A positioning instruction A continuous control instruction in the underflow/overflow direction An instruction for which the direction is not specified (syncing) 			○			O030
67860000 hex	Positive Limit Input	An instruction was executed for a motion in the positive direction when the positive limit input was <i>ON</i> .	<ul style="list-style-type: none"> An instruction for a motion in the positive direction was executed when the positive limit input was <i>ON</i>, or an instruction for a motion with no direction specification was executed when the positive limit input was <i>ON</i>. 			○			O030
67870000 hex	Negative Limit Input	While the negative limit input is set to <i>ON</i> , an instruction that runs in the negative direction was executed.	<ul style="list-style-type: none"> While the negative limit input is set to <i>ON</i>, an instruction that runs in the negative direction was executed, or an instruction with no direction specified was executed. 			○			O030
67880000 hex	Positive Software Limit Exceeded	The position exceeded the positive software limit while the CNC motor was running.	<ul style="list-style-type: none"> The position exceeded the positive software limit. 			○			O030

Event code	Event name	Meaning	Assumed cause	Level					Reference
				M a j	P r t	M i n	O b s	I n f o	
67890000 hex	Negative Software Limit Exceeded	The position exceeded the negative software limit while the CNC motor was running.	<ul style="list-style-type: none"> The position exceeded the negative software limit. 			○			O030
678A0000 hex	In-position Check Time Exceeded	The in-position check was not completed within the monitoring time.	<ul style="list-style-type: none"> Time is required to complete positioning. 			○			O030
678B0000 hex	Following Error Limit Exceeded	The error between the command current position and actual current value exceeded the Following Error Over Value.	<ul style="list-style-type: none"> The positioning operation has poor following performance and the actual motion is slower than the command. 			○			O030
67910000 hex	Illegal Following Error	The difference between the command position and the actual current position exceeds the range of 30-bit data when converted to pulses.	<ul style="list-style-type: none"> The command current position was restricted so that the velocity of the CNC motor would not exceed the maximum velocity for the specified travel distance. The CNC motor's positioning operation has poor following performance and the actual motion is slower than the command. 			○			O030
67920000 hex	Absolute Encoder Current Position Calculation Failed	It was not possible to correctly restore the current position from the absolute encoder information that was saved when power was interrupted.	<ul style="list-style-type: none"> The position to restore when converted to pulses exceeded the range of signed 40-bit data. 			○			O030

Event code	Event name	Meaning	Assumed cause	Level					Reference
				M a j	P r t	M i n	O b s	I n f o	
67930000 hex	Home Undefined during Coordinated Motion	Home of the CNC motor became undefined while the status of CNC coordinate system is Executing (Executing), Hold (Holding), MovingOnHold (Manual Operation While Holding).	<ul style="list-style-type: none"> The command position or actual position overflowed or underflowed for a CNC motor while the status of CNC coordinate system is Executing (Executing), Hold (Holding), or MovingOnHold (Manual Operation While Holding), and the home definition was lost. A slave communications error occurred in the CNC motor and the home become undefined while the status of CNC coordinate system is Executing (Executing), Hold (Holding), or MovingOnHold (Manual Operation While Holding). A slave for a logical axis left the network or was disabled and home became undefined while the status of CNC coordinate system is Executing (Executing), Hold (Holding), or MovingOnHold (Manual Operation While Holding). 			○			O030
67940000 hex	Cycle Start Specified during Positive Software Limit Exceeded	The first position exceeds the positive software limit.	<ul style="list-style-type: none"> The command current position of the positioning cartesian axis or positioning rotational axis in the CNC coordinate system is out of range of the positive software limit. 			○			O030
67950000 hex	Cycle Start Specified during Negative Software Limit Exceeded	The first position exceeds the negative software limit.	<ul style="list-style-type: none"> The command current position of the positioning cartesian axis or positioning rotational axis in the CNC coordinate system is out of range of the negative software limit. 			○			O030
67960000 hex	Cycle Start Specified during Command Position Overflow (Underflow)	Positioning, an instruction in the underflow/overflow direction, or an instruction for which the direction is not specified was executed when there was an underflow/overflow in the command position.	<ul style="list-style-type: none"> One of the following was executed when there was a command position overflow/underflow. A positioning instruction A continuous control instruction in the underflow/overflow direction An instruction for which the direction is not specified (syncing) 			○			O030

Event code	Event name	Meaning	Assumed cause	Level					Reference
				M a j	P r t	M i n	O b s	I n f o	
67970000 hex	Cycle Start Specified during Positive Limit Input	A cycle start was executed when the positive limit input was ON.	<ul style="list-style-type: none"> A cycle start was executed when the positive limit input was ON. 			○			O030
67980000 hex	Cycle Start Specified during Negative Limit Input	A cycle start was executed when the negative limit input was ON.	<ul style="list-style-type: none"> A cycle start was executed when the negative limit input was ON. 			○			O030
67990000 hex	NC Program Execution Error	An error was detected while the NC program was running.	<p>An error was detected in the running NC program.</p> <ul style="list-style-type: none"> Refer to the Error Codes in Attached information for the error contents. 			○			O030
77820000 hex	CNC Coordinate System Composition CNC Motor Error	An error occurred for a composition CNC motor in a CNC coordinate system.	<ul style="list-style-type: none"> An error occurred for a composition CNC motor in a CNC coordinate system while it was moving. 			○			O030
77830000 hex	CNC Common Error Occurrence	A CNC common error occurred.	<ul style="list-style-type: none"> Partial fault level CNC common error occurred. 			○			O030
77840000 hex	Servo Main Circuits OFF	An attempt was made to turn ON the Servo when the main circuit power supply to the Servo Drive was OFF.	<ul style="list-style-type: none"> An attempt was made to turn ON the Servo when the main circuit power supply to the Servo Drive was OFF. 			○			O030
77850000 hex	Servo Main Circuit Power OFF	The main circuit power of the Servo Drive turned OFF while the Servo was ON.	<ul style="list-style-type: none"> The main circuit power of the Servo Drive was interrupted while the Servo was ON. 			○			O030
77860000 hex	Slave Error Detected	An error was detected for the EtherCAT slave or NX Unit that is allocated to the CNC motor.	<ul style="list-style-type: none"> An error was detected for the EtherCAT slave or NX Unit that is allocated to the CNC motor. 			○			O030
77880000 hex	Slave Disconnection during Servo ON	An EtherCAT slave or NX Unit that is allocated to the CNC motor was disconnected, replaced, or disabled while the Servo was ON.	<ul style="list-style-type: none"> An EtherCAT slave or NX Unit that is allocated to the CNC motor was disconnected, replaced, or disabled while the Servo was ON. 			○			O030

Event code	Event name	Meaning	Assumed cause	Level					Reference
				M a j	P r t	M i n	O b s	I n f o	
77890000 hex	Homing Opposite Direction Limit Input Detected	The limit signal in the direction opposite to the homing direction was detected during a homing operation.	<ul style="list-style-type: none"> The Operation Selection at Negative Limit Input or Operation Selection at Positive Limit Input parameter is set to <i>No reverse turn</i>. The location of the homing input signal sensors, homing settings, and homing start position cause a limit input to be reached. The input signal sensor wiring is incorrect or the sensor is faulty. 			○			O030
778A0000 hex	Homing Direction Limit Input Detected	The limit signal in the homing direction was detected during a homing operation.	<ul style="list-style-type: none"> The Operation Selection at Negative Limit Input or Operation Selection at Positive Limit Input parameter is set to <i>No reverse turn</i>. The location of the homing input signal sensors, homing settings, and homing start position cause a limit input to be reached. The input signal sensor wiring is incorrect or the sensor is faulty. 			○			O030
778B0000 hex	Homing Limit Inputs Detected in Both Directions	The limit signals in both directions were detected during a homing operation.	<ul style="list-style-type: none"> The wiring of the limit signal is incorrect. The limit sensor is installed in the wrong location. The contact logic of the limit signal is not correct. The limit sensor failed. 			○			O030
778C0000 hex	Home Proximity/Homing Opposite Direction Limit Input Detected	The home proximity input and the limit signal in the direction opposite to the homing direction were detected at the same time during a homing operation.	<ul style="list-style-type: none"> The wiring of the home proximity signal or limit signal is incorrect. The home proximity sensor or limit sensor is installed in the wrong location. The contact logic of the home proximity signal or limit signal is not correct. The home proximity sensor or limit sensor failed. 			○			O030

Event code	Event name	Meaning	Assumed cause	Level					Reference
				M a j	P r t	M i n	O b s	I n f o	
778D0000 hex	Home Proximity/Homing Direction Limit Input Detected	The home proximity input and the limit signal in the homing direction were detected at the same time during a homing operation.	<ul style="list-style-type: none"> The wiring of the home proximity signal or limit signal is incorrect. The home proximity sensor or limit sensor is installed in the wrong location. The contact logic of the home proximity signal or limit signal is not correct. The home proximity sensor or limit sensor failed. 			○			O030
778E0000 hex	Home Input/Homing Opposite Direction Limit Input Detected	The home input and the limit signal in the direction opposite to the homing direction were detected at the same time during a homing operation.	<ul style="list-style-type: none"> The wiring of the home input signal or limit signal is incorrect. The home input sensor or limit sensor is installed in the wrong location. The contact logic of the home input signal or limit signal is not correct. The home input signal output device or limit sensor failed. 			○			O030
778F0000 hex	Home Input/Homing Direction Limit Input Detected	The home input and the limit signal in the homing direction were detected at the same time during a homing operation.	<ul style="list-style-type: none"> The wiring of the home input signal or limit signal is incorrect. The home input sensor or limit sensor is installed in the wrong location. The contact logic of the home input signal or limit signal is not correct. The home input signal output device or limit sensor failed. 			○			O030
77900000 hex	Invalid Home Input Mask Distance	The setting of the home input mask distance is not suitable for the CNC_Home or CNC_HomeWithParameter instruction.	<ul style="list-style-type: none"> The set value of the home input mask distance when the operating mode of the MC_Home instruction is set to <i>Proximity Reverse Turn/Home Input Mask Distance</i> is insufficient to decelerate from the homing velocity to the homing approach velocity. 			○			O030
77910000 hex	No Home Input	There was no home signal input during the homing operation. Or, a limit signal was detected before there was a home input.	<ul style="list-style-type: none"> There was no home signal input during the homing operation. A limit signal was detected before there was a home input. 			○			O030

Event code	Event name	Meaning	Assumed cause	Level					Reference
				M a j	P r t	M i n	O b s	I n f o	
77920000 hex	No Home Proximity Input	There was no home proximity signal input during the homing operation.	<ul style="list-style-type: none"> There was no home proximity signal input during the homing operation when a <i>home proximity input signal</i> was specified. 			○			O030
87800000 hex	EtherCAT Slave Communications Error	A communications error occurred for the EtherCAT slave or NX Unit that is allocated to a CNC motor.	<ul style="list-style-type: none"> A communications error occurred for the EtherCAT slave or NX Unit that is allocated to the CNC motor. 			○			O030
561D0000 hex	SD Memory Card Access Failure	SD Memory Card access failed when an instruction was executed.	<ul style="list-style-type: none"> An SD Memory Card is not inserted. The SD Memory Card is damaged. The SD Memory Card slot is broken. 				○		O030
561E0000 hex	File Does Not Exist	The file specified for an instruction does not exist.	<ul style="list-style-type: none"> The specified file does not exist. 				○		O030
561F0000 hex	Illegal Load NC Program Number Specification	Loading has failed because an attempt was made to load the NC program with an invalid program number specified.	<ul style="list-style-type: none"> An attempt was made to load the NC program with an invalid program number specified. 				○		O030
56200000 hex	Too Many Files Open	The maximum number of open files was exceeded when opening a file for an instruction.	<ul style="list-style-type: none"> The maximum number of open files was exceeded when opening a file for an instruction. 				○		O030
56210000 hex	File or Directory Name Is Too Long	The file name or directory name that was specified for an instruction is too long.	<ul style="list-style-type: none"> The file name or directory name that was specified for the instruction to create is too long. 				○		O030
56220000 hex	SD Memory Card Access Failed	SD Memory Card access failed.	<ul style="list-style-type: none"> The SD Memory Card is damaged. The SD Memory Card slot is broken. 				○		O030
56230000 hex	Load NC Program Capacity Exceeded	Loading has failed because an attempt was made to load the NC program that has a capacity above the maximum.	<ul style="list-style-type: none"> An attempt was made to load the NC program that has a capacity above the maximum. 				○		O030
56240000 hex	Number of NC Program Exceeded	Loading failed because an attempt was made to load NC programs over the maximum number of NC programs.	<ul style="list-style-type: none"> A new NC program was loaded while the number of loaded NC programs reaches the maximum. 				○		O030

Event code	Event name	Meaning	Assumed cause	Level					Reference
				M a j	P r t	M i n	O b s	I n f o	
56280000 hex	Illegal Load NC Program	An error was detected in the loaded NC program.	<ul style="list-style-type: none"> A syntax error was detected in the NC program you attempted to load. 				○		O030
678C0000 hex	Following Error Warning	The following error exceeded the Following Error Warning Value.	<ul style="list-style-type: none"> The positioning operation has poor following performance and the actual motion is slower than the command. 				○		O030
678D0000 hex	Command Position Overflow	The number of pulses for the command position overflowed.	<ul style="list-style-type: none"> When the command position was converted to the pulse unit for the positioning cartesian axis or positioning rotational axis, the specified value exceeded the upper limit of the signed 40-bit data (signed 54-bit data for the spindle axis). 				○		O030
678E0000 hex	Command Position Underflow	The number of pulses for the command position exceeded the valid range. (It underflowed.)	<ul style="list-style-type: none"> When the command position was converted to the pulse unit for the positioning cartesian axis or positioning rotational axis, the specified value exceeded the lower limit of the signed 40-bit data (signed 54-bit data for the spindle axis). 				○		O030
678F0000 hex	Actual Position Overflow	The number of pulses for the actual position overflowed.	<ul style="list-style-type: none"> When the command position was converted to the pulse unit for the positioning cartesian axis or positioning rotational axis, the specified value exceeded the upper limit of the signed 40-bit data (signed 54-bit data for the spindle axis). 				○		O030
67900000 hex	Actual Position Underflow	The number of pulses for the actual position underflowed.	<ul style="list-style-type: none"> When the command position was converted to the pulse unit for the positioning cartesian axis or positioning rotational axis, the specified value exceeded the lower limit of the signed 40-bit data (signed 54-bit data for the spindle axis). 				○		O030
77810000 hex	CNC Planner Service Period Exceeded	CNC planner service processing was not finished within two periods.	<ul style="list-style-type: none"> The processing load of the NC program in a period of the CNC planner service is too heavy. 				○		O030
77870000 hex	Slave Observation Detected	A warning was detected for an EtherCAT slave or NX Unit.	<ul style="list-style-type: none"> A warning was detected for the EtherCAT slave or NX Unit that is allocated to a CNC motor. 				○		O030

Event code	Event name	Meaning	Assumed cause	Level					Reference
				M a j	P r t	M i n	O b s	I n f o	
97810000 hex	Software Limit Path Limited	The path exceeded the software limit was specified during Executing (Executing). Therefore, the path was limited within the software limit range.	<ul style="list-style-type: none"> The path exceeded the software limit was specified during Executing (Executing). 				○		O030
97830000 hex	Velocity Control Command Value Saturated	The velocity control command value for the servo drive is saturated.	<ul style="list-style-type: none"> The output value by feedback loop calculation exceeded Maximum Velocity defined in the CNC motor parameter, or the actual operation is slower than the commanded one because of the poor following performance of the positioning operation. The spindle rotation velocity (S) or spindle velocity override value was commanded over the Maximum Velocity defined in the CNC motor parameter. 				○		O030
97800000 hex	Slave Error Code Report	The error code was reported by the slave when a <i>Slave Error Detected</i> error occurred.	<ul style="list-style-type: none"> The error code was reported by the slave when a <i>Slave Error Detected</i> error (77860000 hex) occurred. 				○		O030
97820000 hex	CNC Function System Information	This event provides internal information from the CNC Function Module.	<ul style="list-style-type: none"> This event provides internal information from the CNC Function Module. It is recorded to provide additional information for another event. 				○		O030

CNC Instructions

This section shows lists of errors (events) that may occur in CNC instructions. The lower four digits of the event code represents the error code (ErrorID) for the instruction. For details of error codes, refer to the description of the corresponding event code. For example, when the error code of the target instruction is 16#3781, refer to the explanation of event code, 54013781 hex.

The manual names are given below for the catalog numbers given in the Reference column of the event table.

Cat. No.	Manual name
O030	NJ/NY-series NC Integrated Controller User's Manual

Event code	Event name	Meaning	Assumed cause	Level					Reference
				M a j	P r t	M i n	O b s	I n f o	
54013781 hex	Process Data Object Setting Missing	The PDO mapping is not correct.	<ul style="list-style-type: none"> The PDOs that are required for the CNC instruction are not mapped. The relevant instruction was executed for a device that does not have an object that supports the instruction. 					○	O030
54015600 hex	Illegal CNC Coordinate System Specification	The CNC coordinate system specified for the <i>Coord</i> in-out variable to a CNC instruction does not exist.	<ul style="list-style-type: none"> CNC coordinate system does not exist for the variable specified for the <i>Coord</i> in-out variable to the instruction. 					○	O030
54015601 hex	Deceleration Setting Out of Range	The parameter specified for the <i>Deceleration</i> input variable to a CNC instruction is out of range.	<ul style="list-style-type: none"> Instruction input parameter exceeded the valid range of the input variable. 					○	O030
54015602 hex	Jerk Setting Out of Range	The parameter specified for the Jerk input variable to a CNC instruction is out of range.	<ul style="list-style-type: none"> Instruction input parameter exceeded the valid range of the input variable. 					○	O030
54015603 hex	CNC Instruction Re-execution Disabled	A CNC instruction that cannot be re-executed was re-executed.	<ul style="list-style-type: none"> A CNC instruction that cannot be re-executed was re-executed. 					○	O030

Event code	Event name	Meaning	Assumed cause	Level					Reference
				M a j	P r t	M i n	O b s	I n f o	
54015604 hex	CNC Multi-execution Disabled	Multiple functions that cannot be executed simultaneously were executed for the same target (CNC coordinate system).	<ul style="list-style-type: none"> Multiple functions that cannot be executed simultaneously were executed for the same target (CNC coordinate system). The CNC_LoadProgramFile instruction was executed when any of CNC coordinate system was Executing (Executing) or Hold (Holding). 				○		O030
54015605 hex	Unassigned Logical CNC Motor Number Specified	The CNC motor of the parameter specified for the LogicalMotorNo input variable to the CNC instruction is not assigned.	<ul style="list-style-type: none"> The logical CNC motor number for which the CNC motor is not assigned to the LogicalMotorNo input variable to the CNC instruction was specified, and the instruction was executed. 				○		O030
54015606 hex	Logical CNC Motor Number Out of Range	The parameter specified for the LogicalMotorNo input variable to a CNC instruction is out of range.	<ul style="list-style-type: none"> Instruction input parameter exceeded the valid range of the input variable. 				○		O030
54015607 hex	Target Position Setting Out of Range	The parameter specified for the <i>Position</i> input variable to a CNC instruction is out of range.	<ul style="list-style-type: none"> Instruction input parameter exceeded the valid range of the input variable. Or, there was an overflow/underflow in the target position. 				○		O030
54015608 hex	Impossible CNC Motor Operation Specified when the Servo is OFF	An operation instruction was executed for the CNC motor for which the Servo is OFF.	<ul style="list-style-type: none"> An operation instruction was executed for the CNC motor for which the Servo is OFF. Home was preset with the CNC_Home or CNC_Home-WithParameter instruction for an axis for which EtherCAT process data communications are not established. 				○		O030
54015609 hex	Target Velocity Setting Out of Range	The parameter specified for the <i>Velocity</i> input variable to a CNC instruction is out of range.	<ul style="list-style-type: none"> Instruction input parameter exceeded the valid range of the input variable. 				○		O030
5401560A hex	Acceleration/Deceleration Setting Out of Range	The parameter specified for the <i>Acceleration</i> input variable to a CNC instruction is out of range.	<ul style="list-style-type: none"> Instruction input parameter exceeded the valid range of the input variable. 				○		O030

Event code	Event name	Meaning	Assumed cause	Level					Reference
				M a j	P r t	M i n	O b s	I n f o	
5401560B hex	Travel Mode Selection Out of Range	The parameter specified for the <i>MoveMode</i> input variable to a CNC instruction is out of range.	<ul style="list-style-type: none"> Instruction input parameter exceeded the valid range of the input variable. 				○		O030
5401560D hex	Parameter Selection Out of Range	The parameter specified for the <i>ParameterNumber</i> input variable to a CNC instruction is out of range.	<ul style="list-style-type: none"> Instruction input parameter exceeded the valid range of the input variable. 				○		O030
5401560E hex	CNC Parameter Setting Read/Write Setting Value Out of Range	The parameter specified for the <i>SettingValue</i> in-out variable to a CNC instruction is out of range.	<ul style="list-style-type: none"> Instruction input parameter exceeded the valid range of the in-out variable. 				○		O030
5401560F hex	CNC Parameter Setting Read/Write Target Out of Range	The parameter specified for the <i>Target</i> in-out variable to a CNC instruction is out of range.	<ul style="list-style-type: none"> Instruction input parameter exceeded the valid range of the in-out variable. 				○		O030
54015611 hex	Homing Parameter Setting Out of Range	The parameter specified for the <i>HomingParameter</i> in-out variable of the CNC instruction is out of range.	<ul style="list-style-type: none"> Instruction input parameter exceeded the valid range of the in-out variable. 				○		O030
54015612 hex	M Code Number Out of Range	The parameter specified for the <i>MCodeNo</i> input variable to a CNC instruction is out of range.	<ul style="list-style-type: none"> Instruction input parameter exceeded the valid range of the input variable. 				○		O030
54015613 hex	CNC Instruction Re-execution Disabled (CNC Coordinate System Specification)	An attempt was made to change the parameter for the <i>Coord</i> in-out variable when re-executing a CNC instruction. (This in-out variable cannot be changed when re-executing an instruction.)	<ul style="list-style-type: none"> A parameter for an in-out variable that cannot be changed for re-execution was changed. 				○		O030

Event code	Event name	Meaning	Assumed cause	Level					Reference
				M a j	P r t	M i n	O b s	I n f o	
54015614 hex	CNC Instruction Re-execution Disabled (Logical CNC Motor Number)	An attempt was made to change the parameter for the <i>LogicalMotorNo</i> input variable when re-executing a CNC instruction. (This input variable cannot be changed when re-executing an instruction.)	<ul style="list-style-type: none"> A parameter for an input variable that cannot be changed for re-execution was changed. 				○		O030
5401561D hex	SD Memory Card Access Failure	SD Memory Card access failed when an instruction was executed.	<ul style="list-style-type: none"> An SD Memory Card is not inserted. The SD Memory Card is damaged. The SD Memory Card slot is broken. 				○		O030
5401561E hex	File Does Not Exist	The file specified for an instruction does not exist.	<ul style="list-style-type: none"> The specified file does not exist. 				○		O030
5401561F hex	Illegal Load NC Program Number Specification	Loading has failed because an attempt was made to load the NC program with an invalid program number specified.	<ul style="list-style-type: none"> An attempt was made to load the NC program with an invalid program number specified. 				○		O030
54015620 hex	Too Many Files Open	The maximum number of open files was exceeded when opening a file for an instruction.	<ul style="list-style-type: none"> The maximum number of open files was exceeded when opening a file for an instruction. 				○		O030
54015621 hex	File or Directory Name Is Too Long	The file name or directory name that was specified for an instruction is too long.	<ul style="list-style-type: none"> The file name or directory name that was specified for the instruction to create is too long. 				○		O030
54015622 hex	SD Memory Card Access Failed	SD Memory Card access failed.	<ul style="list-style-type: none"> The SD Memory Card is damaged. The SD Memory Card slot is broken. 				○		O030
54015623 hex	Load NC Program Capacity Exceeded	Loading has failed because an attempt was made to load the NC program that has a capacity above the maximum.	<ul style="list-style-type: none"> An attempt was made to load the NC program that has a capacity above the maximum. 				○		O030
54015624 hex	Number of NC Program Exceeded	Loading failed because an attempt was made to load NC programs over the maximum number of NC programs.	<ul style="list-style-type: none"> A new NC program was loaded while the number of loaded NC programs reaches the maximum. 				○		O030

Event code	Event name	Meaning	Assumed cause	Level					Reference
				M a j	P r t	M i n	O b s	I n f o	
54015625 hex	Illegal CNC Motor Specification	The CNC motor specified for the <i>Target</i> input variable to a CNC instruction does not exist.	<ul style="list-style-type: none"> A CNC motor does not exist for the variable specified for the <i>Target</i> input variable to the instruction. 				○		O030
54015626 hex	Illegal CNC Motor Compensation Table Specification	The CNC motor compensation table specified for the <i>Target</i> input variable to a CNC instruction does not exist.	<ul style="list-style-type: none"> A CNC motor compensation table does not exist for the variable specified for the <i>Target</i> input variable to the instruction. 				○		O030
54015628 hex	Illegal Load NC Program	An error was detected in the loaded NC program.	<ul style="list-style-type: none"> A syntax error was detected in the NC program you attempted to load. 				○		O030
54016783 hex	Target Position Positive Software Limit Exceeded	The specified position exceeds the positive software limit.	<ul style="list-style-type: none"> The parameter specified for the <i>Position</i> input variable to the instruction is beyond the positive software limit. The first position is beyond the positive software limit and an instruction that specifies motion in the opposite direction of the software limit was executed. 				○		O030
54016784 hex	Target Position Negative Software Limit Exceeded	The specified position exceeds the negative software limit.	<ul style="list-style-type: none"> The parameter specified for the <i>Position</i> input variable to the instruction is beyond the negative software limit. While the first position is out of the negative software limit, an operation was specified in the opposite direction of the software limit. 				○		O030
54016785 hex	Command Position Overflow/Underflow	Positioning, an instruction in the underflow/overflow direction, or an instruction for which the direction is not specified was executed when there was an underflow/overflow in the command position.	<ul style="list-style-type: none"> One of the following was executed when there was a command position overflow/underflow. A positioning instruction A continuous control instruction in the underflow/overflow direction An instruction for which the direction is not specified (syncing) 				○		O030

Event code	Event name	Meaning	Assumed cause	Level					Reference
				M a j	P r t	M i n	O b s	I n f o	
54016786 hex	Positive Limit Input	An instruction was executed for a motion in the positive direction when the positive limit input was <i>ON</i> .	<ul style="list-style-type: none"> An instruction for a motion in the positive direction was executed when the positive limit input was <i>ON</i>, or an instruction for a motion with no direction specification was executed when the positive limit input was <i>ON</i>. 				○		O030
54016787 hex	Negative Limit Input	While the negative limit input is set to <i>ON</i> , an instruction that runs in the negative direction was executed.	<ul style="list-style-type: none"> While the negative limit input is set to <i>ON</i>, an instruction that runs in the negative direction was executed, or an instruction with no direction specified was executed. 				○		O030
54017784 hex	Servo Main Circuits OFF	An attempt was made to turn <i>ON</i> the Servo when the main circuit power supply to the Servo Drive was <i>OFF</i> .	<ul style="list-style-type: none"> An attempt was made to turn <i>ON</i> the Servo when the main circuit power supply to the Servo Drive was <i>OFF</i>. 				○		O030

A-2 Errors (Events) That Can Occur in Connected Devices

The section provides tables of the errors (events) that can occur in the devices connected to NY-series Controller. Refer to 3-1 *Interpreting Tables* on page 3-2 for interpreting error tables.

Refer to the manual for the specific product for details on errors.

A-2-1 Errors in Slave Terminals

The section provides tables of the errors (events) that can occur in the following Units in OMRON Slave Terminals.

- NX-series EtherCAT Coupler Units
- NX-series Digital I/O Units
- NX-series Analog I/O Units
- NX-series System Units
- NX-series Position Interface Units
- NX-series Communications Interface Unit
- NX-series Safety CPU Units
- NX-series Safety I/O Units
- NX-series Load Cell Input Units
- NX-series IO-Link Master Units
- NX-series Temperature Control Units

NX-series EtherCAT Coupler Units

The section provides a table of the errors (events) that can occur in the following Unit.

NX-ECC□□□

The manual names are given below for the catalog numbers given in the Reference column of the event table.

Cat. No.	Manual name
W519	NX-series EtherCAT Coupler Unit User's Manual

Event code	Event name	Meaning	Assumed cause	Level					Reference
				M a j	P r t	M i n	O b s	I n f o	
00210000 hex	Bus Controller Error	An internal bus error occurred.	<ul style="list-style-type: none"> • A Unit failed or an I/O communications error occurred between the Communications Coupler Unit and the NX Unit. 			○			W519
00220000 hex	Non-volatile Memory Hardware Error	An error occurred in non-volatile memory.	<ul style="list-style-type: none"> • Non-volatile memory failure 			○			W519

Event code	Event name	Meaning	Assumed cause	Level					Reference
				M a j	P r t	M i n	O b s	I n f o	
05010000 hex	ESC Error	An error occurred in the EtherCAT slave communications controller.	• An error occurred in the EtherCAT slave communications controller.			○			W519
05020000 hex	ESC Initialization Error	Initialization of the EtherCAT slave communications controller failed.	• An initialization error occurred in the EtherCAT slave communications controller.			○			W519
05030000 hex	Slave Unit Verification Error	An error occurred in Slave Unit verification.	• An error occurred in Slave Unit information.			○			W519
10420000 hex	Non-volatile Memory Control Parameter Error	An error occurred in the control parameters.	• The power supply to the Communications Coupler Unit was turned OFF or Support Software communications were disconnected while writing the Unit operation settings was in progress.			○			W519
10430000 hex	Memory Corruption Detected	Memory corruption was detected.	• Memory corruption was detected.			○			W519
24A00000 hex	Unit Configuration Error, Too Many Units	The number of connected NX Units exceeds the maximum value for the Communications Coupler Unit.	• More than the maximum number of NX Units is connected to the Communications Coupler Unit.			○			W519
24A10000 hex	Unit Configuration Error, Unsupported Configuration	An unsupported NX Unit is mounted. Or, the total byte size of all I/O data for the connected NX Units exceeds the predetermined maximum value for the Communications Coupler Unit.	• An unsupported NX Unit was detected. • The total byte size of all I/O data for the connected NX Units exceeds the predetermined maximum value for the Communications Coupler Unit.			○			W519
35000000 hex	Unit Configuration Information Error	An error occurred in the Unit configuration information in the Communications Coupler Unit.	• The power supply to the Communications Coupler Unit was turned OFF or Support Software communications were disconnected while downloading the Unit configuration information.			○			W519

Event code	Event name	Meaning	Assumed cause	Level					Reference
				M a j	P r t	M i n	O b s	I n f o	
35010000 hex	Unit Configuration Verification Error	There is an inconsistency between the Unit configuration information in the Communications Coupler Unit and the Units that are actually connected. Or, the Unit configuration was changed during operation while the Unit configuration information was not set in the Communications Coupler Unit.	<ul style="list-style-type: none"> An NX Unit that is registered in the Unit configuration information is not connected. A connected NX Unit does not agree with the NX Unit that is registered in the Unit configuration information. An NX Unit that is not registered in the Unit configuration information is connected. A mounted Unit is disabled in the NX Unit Mounting Setting for the Unit configuration information. An NX Unit became disconnected during operation. An NX Unit was connected during operation. The serial number of a Unit that is registered in the Unit configuration information does not agree with the serial number of the Unit that is connected. (The Serial Number Check Method is set to Setting = Actual device.) The version of a Unit that is registered in the Unit configuration information is newer than the version of the Unit that is connected. The power supply to the Additional NX Unit Power Supply Unit is not turned ON. 					○	W519
35020000 hex	NX Unit Minor Fault	A minor fault was detected in an NX Unit.	<ul style="list-style-type: none"> A minor fault level error occurred in a Unit where an error was detected. 					○	W519
35040000 hex	Mailbox Setting Error	An incorrect mailbox setting was detected for the Sync Manager. (AL-Status Code: 0016 hex)	<ul style="list-style-type: none"> An incorrect mailbox setting was detected for the Sync Manager. 					○	W519
35050000 hex	RxPDO Setting Error	An error was detected in the RxPDO settings. (AL-Status Code: 001D hex)	<ul style="list-style-type: none"> An error was detected in the RxPDO settings. 					○	W519
35060000 hex	TxPDO Setting Error	An error was detected in the TxPDO settings. (AL-Status Code: 001E hex)	<ul style="list-style-type: none"> An error was detected in the TxPDO settings. 					○	W519

Event code	Event name	Meaning	Assumed cause	Level					Reference
				M a j	P r t	M i n	O b s	I n f o	
35070000 hex	PDO WDT Setting Error	An incorrect PDO WDT setting was detected. (AL-Status Code: 001F hex)	<ul style="list-style-type: none"> An incorrect PDO WDT setting was detected. 			○			W519
35080000 hex	SM Event Mode Setting Error	An SM Event Mode that is not supported was set. (AL-Status Code: 0028 hex)	<ul style="list-style-type: none"> An SM Event Mode that is not supported was set. 			○			W519
35090000 hex	TxPDO Mapping Error	An incorrect TxPDO was set. (AL-Status Code: 0024 hex)	<ul style="list-style-type: none"> An incorrect TxPDO was set, e.g., the index, subindex, or size was outside of the allowable range. 			○			W519
350A0000 hex	RxPDO Mapping Error	An incorrect RxPDO was set. (AL-Status Code: 0025 hex)	<ul style="list-style-type: none"> An incorrect RxPDO was set, e.g., the index, subindex, or size was outside of the allowable range. 			○			W519
350B0000 hex	Illegal State Transition Request Received	An incorrect state transition request was received. (AL-Status Code: 0011 hex)	<ul style="list-style-type: none"> An incorrect state transition request was received. 			○			W519
350C0000 hex	Error State Transition Received	An incorrect state transition request was received. (AL-Status Code: 0012 hex)	<ul style="list-style-type: none"> An unclear state transition request was received. 			○			W519
350D0000 hex	Synchronization Cycle Setting Error	When DC Mode was confirmed, the cycle time was set to a value that made operation impossible. (AL-Status Code: 0035 hex)	<ul style="list-style-type: none"> When DC Mode was confirmed, the cycle time was set to a value that made operation impossible. 			○			W519
40200000 hex	NX Unit Processing Error	A fatal error occurred in an NX Unit.	<ul style="list-style-type: none"> An error occurred in the software. 			○			W519
84C00000 hex	NX Unit Communications Timeout	An error occurred in I/O data communications with the NX Units.	<ul style="list-style-type: none"> An NX Unit is not mounted properly. An NX Unit has failed. 			○			W519
84C10000 hex	NX Unit Initialization Error	Initializing an NX Unit failed.	<ul style="list-style-type: none"> An error occurred in processing the Communications Coupler Unit. An initialization error occurred in an NX Unit. The Enabled Channel Settings for all channels of the Analog Input Unit are set to Disable. The Enabled Channel Settings for all channels of the Analog Output Unit are set to Disable. 			○			W519

Event code	Event name	Meaning	Assumed cause	Level					Reference
				M a j	P r t	M i n	O b s	I n f o	
85000000 hex	Process Data WDT Error	Process data communications were stopped for more than the specified period of time.	<ul style="list-style-type: none"> The EtherCAT communications cable is disconnected or broken. There is an error in the host controller. 			○			W519
85010000 hex	Synchronization Interruption Error	A synchronization interruption error occurred.	<ul style="list-style-type: none"> The EtherCAT communications cable is disconnected or broken. There is a synchronization setting error in the EtherCAT Coupler Unit. There is a hardware error in the EtherCAT Coupler Unit. 			○			W519
85020000 hex	Synchronization Error	A synchronization error occurred.	<ul style="list-style-type: none"> The EtherCAT communications cable is disconnected or broken. There is a synchronization setting error in the EtherCAT master or EtherCAT Coupler Unit. There is a hardware error in the EtherCAT Coupler Unit. 			○			W519
85030000 hex	Communications Synchronization Error	The number of consecutive communications errors in receiving the synchronization data exceeded the value that is set for the Consecutive Communications Error Detection Count parameter in the Communications Error Settings.	<ul style="list-style-type: none"> Power to the host controller was interrupted during process data communications. The EtherCAT communications cable is disconnected or broken. Noise is entering on an EtherCAT communications cable. 			○			W519
84C50000 hex	NX Unit Startup Error	Starting an NX Unit failed.	<ul style="list-style-type: none"> A startup error occurred in an NX Unit. 			○			W519
35030000 hex	NX Unit Observation	An observation was detected in an NX Unit.	<ul style="list-style-type: none"> An observation level error occurred in a Unit where an error was detected. This event is recorded in the event log in the Communications Coupler Unit. 				○		W519
350E0000 hex	NX Bus Cycle Delay Detected	Exceeding the NX bus cycle was detected.	<ul style="list-style-type: none"> The NX bus cycle was exceeded. 				○		W519

Event code	Event name	Meaning	Assumed cause	Level					Reference
				M a j	P r t	M i n	O b s	I n f o	
80220000 hex	NX Message Communications Error	An error was detected in message communications and the message frame was discarded.	For the NX bus of CPU Units <ul style="list-style-type: none"> The message communications load is high. For Communications Coupler Units <ul style="list-style-type: none"> The message communications load is high. The communications cable is disconnected or broken. This cause does not apply if attached information 2 is 0 (NX bus). Message communications were cutoff in communications. 				○		W519
90400000 hex	Event Log Cleared	The event log was cleared.	<ul style="list-style-type: none"> The event log was cleared by the user. 					○	W519
90420000 hex	Restart Executed	A restart was executed.	<ul style="list-style-type: none"> A restart command was received. 					○	W519
90430000 hex	Memory All Cleared	The Unit settings were cleared.	<ul style="list-style-type: none"> The non-volatile memory in the EtherCAT Coupler Unit was cleared. 					○	W519
94600000 hex (Ver. 1.07 or later)	I/O Check Execution Started	I/O checking was started.	<ul style="list-style-type: none"> I/O checking was started. 					○	W519

NX-series Digital I/O Units

The section provides a table of the errors (events) that can occur in the following Units.

NX-ID□□□□

NX-OC□□□□

NX-OD□□□□

The manual names are given below for the catalog numbers given in the Reference column of the event table.

Cat. No.	Manual name
W521	NX-series Digital I/O Unit User's Manual

Event code	Event name	Meaning	Assumed cause	Level					Reference
				M a j	P r t	M i n	O b s	I n f o	
00200000 hex	Non-volatile Memory Hardware Error	An error occurred in non-volatile memory.	<ul style="list-style-type: none"> Non-volatile memory failure 			○			W521
10410000 hex	Control Parameter Error in Master	An error occurred in the control parameters that are saved in the master.	<p>For the NX bus of CPU Units</p> <ul style="list-style-type: none"> The power supply to the CPU Unit was turned OFF while writing the Unit operation settings was in progress. Or there is an error in the area of the non-volatile memory in the CPU Unit in which the Unit operation settings for the relevant NX Unit are saved. <p>For Communications Coupler Units</p> <ul style="list-style-type: none"> The power supply to the Communications Coupler Unit was turned OFF while writing the Unit operation settings was in progress. Or there is an error in the area of the non-volatile memory in the Communications Coupler Unit in which the Unit operation settings for the relevant NX Unit are saved. 			○			W521

Event code	Event name	Meaning	Assumed cause	Level					Reference
				M a j	P r t	M i n	O b s	I n f o	
80200000 hex	NX Unit I/O Communications Error	An I/O communications error occurred in an NX Unit.	<p>For the NX bus of CPU Units</p> <ul style="list-style-type: none"> An error that prevents normal NX bus communications occurred in a CPU Unit. An NX Unit is not mounted properly. The power cable for the Unit power supply is disconnected, or the wiring from the Unit power supply to the NX Units is incorrect. The power cable for the Unit power supply is broken. The voltage of the Unit power supply is outside the specified range, or the capacity of the Unit power supply is insufficient. There is a hardware error in an NX Unit. <p>For Communications Coupler Units</p> <ul style="list-style-type: none"> An error that prevents normal NX bus communications occurred in a Communications Coupler Unit. The NX Unit is not mounted properly. The power cable for the Unit power supply is disconnected. Or, the wiring from the Unit power supply to the NX Units is incorrect. The power cable for the Unit power supply is broken. The voltage of the Unit power supply is outside the specified range. Or, the capacity of the Unit power supply is insufficient. There is a hardware error in the NX Unit. 						W521

Event code	Event name	Meaning	Assumed cause	Level					Reference
				M a j	P r t	M i n	O b s	I n f o	
80210000 hex	NX Unit Output Synchronization Error	An output synchronization error occurred in the NX Unit.	For the NX bus of CPU Units <ul style="list-style-type: none"> I/O refreshing on the NX bus is not performed normally due to an error in the CPU Unit. For Communications Coupler Units <ul style="list-style-type: none"> The communications cable connected to the Communications Coupler Unit is broken or the connection is faulty. The communications cable is affected by noise. 				○		W521
80240000 hex	NX Unit Clock Not Synchronized Error	A time information error occurred in an NX Unit.	For the NX bus of CPU Units <ul style="list-style-type: none"> There is a hardware error in an NX Unit. There is a hardware error in a CPU Unit. For Communications Coupler Units <ul style="list-style-type: none"> There is a hardware error in an NX Unit. There is a hardware error in an EtherCAT Coupler Unit. 				○		W521
70010000 hex (Ver. 1.06)	Previous Time Specified	A previous time was specified for output refreshing with a specified time stamp.	For the NX bus of CPU Units <ul style="list-style-type: none"> A past time is specified due to an error in the user program. A Task Period Exceeded error occurred in a CPU Unit. For Communications Coupler Units <ul style="list-style-type: none"> A past time is specified due to an error in the user program. A Task Period Exceeded error occurred in a CPU Unit. The arrival of I/O data at an NX Unit was delayed due to a Communications Synchronization Error or other communications error. 				○		W521
90400000 hex	Event Log Cleared	The event log was cleared.	<ul style="list-style-type: none"> The event log was cleared by the user. 					○	W521

NX-series Analog I/O Units

The section provides a table of the errors (events) that can occur in the following Units.

NX-AD□□□□

NX-DA□□□□

NX-TS□□□□

NX-HB□□□□

The manual names are given below for the catalog numbers given in the Reference column of the event table.

Cat. No.	Manual name
W522	NX-series Analog I/O Units User's Manual for Analog Input Units and Analog Output Units
W566*1	NX-series Analog I/O Units User's Manual for Temperature Input Units and Heater Burnout Detection Units

*1. Temperature Input Units are introduced in Cat. No. W522 before Cat. No. W566 is released.

● Analog Input Units and Analog Output Units (NX-AD□□□□, NX-DA□□□□)

Event code	Event name	Meaning	Assumed cause	Level					Reference
				M a j	P r t	M i n	O b s	I n f o	
00200000 hex	Non-volatile Memory Hardware Error	An error occurred in non-volatile memory.	<ul style="list-style-type: none"> Non-volatile memory failure 			○			W522
10400000 hex	Analog Unit Calibration Parameter Error	An error occurred for the calibration data in the Analog Unit.	<ul style="list-style-type: none"> The power supply to the Analog Unit was turned OFF or Support Software communications were disconnected while writing the calibration values to the Analog Unit. 			○			W522
10410000 hex	Control Parameter Error in Master	An error occurred in the control parameters that are saved in the master.	For the NX bus of CPU Units <ul style="list-style-type: none"> The power supply to the CPU Unit was turned OFF while writing the Unit operation settings was in progress. Or there is an error in the area of the non-volatile memory in the CPU Unit in which the Unit operation settings for the relevant NX Unit are saved. 			○			W522
14C00000 hex	Unit Calibration Value Parity Error	An error occurred in the user calibration data in the NX Unit.	<ul style="list-style-type: none"> An error was detected in the calibration data. 			○			W522
65030000 hex	Unit I/O Disconnection Detected for Channel 1	A disconnected input was detected for channel 1.	<ul style="list-style-type: none"> Input wiring is broken. Input wiring is disconnected. 			○	⊙		W522

Event code	Event name	Meaning	Assumed cause	Level					Reference
				M a j	P r t	M i n	O b s	I n f o	
65040000 hex	Unit I/O Disconnection Detected for Channel 2	A disconnected input was detected for channel 2.	<ul style="list-style-type: none"> Input wiring is broken. Input wiring is disconnected. 			○	◉		W522
65050000 hex	Unit I/O Disconnection Detected for Channel 3	A disconnected input was detected for channel 3.	<ul style="list-style-type: none"> Input wiring is broken. Input wiring is disconnected. 			○	◉		W522
65060000 hex	Unit I/O Disconnection Detected for Channel 4	A disconnected input was detected for channel 4.	<ul style="list-style-type: none"> Input wiring is broken. Input wiring is disconnected. 			○	◉		W522
65070000 hex	Unit I/O Disconnection Detected for Channel 5	A disconnected input was detected for channel 5.	<ul style="list-style-type: none"> Input wiring is broken. Input wiring is disconnected. 			○	◉		W522
65080000 hex	Unit I/O Disconnection Detected for Channel 6	A disconnected input was detected for channel 6.	<ul style="list-style-type: none"> Input wiring is broken. Input wiring is disconnected. 			○	◉		W522
65090000 hex	Unit I/O Disconnection Detected for Channel 7	A disconnected input was detected for channel 7.	<ul style="list-style-type: none"> Input wiring is broken. Input wiring is disconnected. 			○	◉		W522
650A0000 hex	Unit I/O Disconnection Detected for Channel 8	A disconnected input was detected for channel 8.	<ul style="list-style-type: none"> Input wiring is broken. Input wiring is disconnected. 			○	◉		W522

Event code	Event name	Meaning	Assumed cause	Level					Reference
				M a j	P r t	M i n	O b s	I n f o	
80200000 hex	NX Unit I/O Communications Error	An I/O communications error occurred in an NX Unit.	<p>For the NX bus of CPU Units</p> <ul style="list-style-type: none"> • An error that prevents normal NX bus communications occurred in a CPU Unit. • An NX Unit is not mounted properly. • The power cable for the Unit power supply is disconnected, or the wiring from the Unit power supply to the NX Units is incorrect. • The power cable for the Unit power supply is broken. • The voltage of the Unit power supply is outside the specified range, or the capacity of the Unit power supply is insufficient. • There is a hardware error in an NX Unit. <p>For Communications Coupler Units</p> <ul style="list-style-type: none"> • An error that prevents normal NX bus communications occurred in a Communications Coupler Unit. • An NX Unit is not mounted properly. • The power cable for the Unit power supply is disconnected. Or, the wiring from the Unit power supply to the NX Units is incorrect. • The power cable for the Unit power supply is broken. • The voltage of the Unit power supply is outside the specified range. Or, the capacity of the Unit power supply is insufficient. • There is a hardware error in the NX Unit. 						W522

Event code	Event name	Meaning	Assumed cause	Level					Reference
				M a j	P r t	M i n	O b s	I n f o	
80210000 hex	NX Unit Output Synchronization Error	An output synchronization error occurred in the NX Unit.	For the NX bus of CPU Units <ul style="list-style-type: none"> I/O refreshing on the NX bus is not performed normally due to an error in the CPU Unit. For Communications Coupler Units <ul style="list-style-type: none"> The communications cable connected to the Communications Coupler Unit is broken or the connection is faulty. The communications cable is affected by noise. 			○			W522
80240000 hex	NX Unit Clock Not Synchronized Error	A time information error occurred in an NX Unit.	For the NX bus of CPU Units <ul style="list-style-type: none"> There is a hardware error in an NX Unit. There is a hardware error in a CPU Unit. For Communications Coupler Units <ul style="list-style-type: none"> There is a hardware error in an NX Unit. There is a hardware error in an EtherCAT Coupler Unit. 			○			W522
64F00000 hex	Unit Over Range for Channel 1	The analog input data for input channel 1 exceeded the upper limit of the input range. Or, the analog output data for output channel 1 exceeded the upper limit of the output range.	<ul style="list-style-type: none"> The analog input data exceeded the upper limit of the input range. Or, the analog output data exceeded the upper limit of the output range. 			⊙	○		W522
64F10000 hex	Unit Over Range for Channel 2	The analog input data for input channel 2 exceeded the upper limit of the input range. Or, the analog output data for output channel 2 exceeded the upper limit of the output range.	<ul style="list-style-type: none"> The analog input data exceeded the upper limit of the input range. Or, the analog output data exceeded the upper limit of the output range. 			⊙	○		W522
64F20000 hex	Unit Over Range for Channel 3	The analog input data for input channel 3 exceeded the upper limit of the input range. Or, the analog output data for output channel 3 exceeded the upper limit of the output range.	<ul style="list-style-type: none"> The analog input data exceeded the upper limit of the input range. Or, the analog output data exceeded the upper limit of the output range. 			⊙	○		W522

Event code	Event name	Meaning	Assumed cause	Level					Reference
				M a j	P r t	M i n	O b s	I n f o	
64F30000 hex	Unit Over Range for Channel 4	The analog input data for input channel 4 exceeded the upper limit of the input range. Or, the analog output data for output channel 4 exceeded the upper limit of the output range.	<ul style="list-style-type: none"> The analog input data exceeded the upper limit of the input range. Or, the analog output data exceeded the upper limit of the output range. 			○	○		W522
64F40000 hex	Unit Over Range for Channel 5	The analog input data for input channel 5 exceeded the upper limit of the input range. Or, the analog output data for output channel 5 exceeded the upper limit of the output range.	<ul style="list-style-type: none"> The analog input data exceeded the upper limit of the input range. Or, the analog output data exceeded the upper limit of the output range. 			○	○		W522
64F50000 hex	Unit Over Range for Channel 6	The analog input data for input channel 6 exceeded the upper limit of the input range. Or, the analog output data for output channel 6 exceeded the upper limit of the output range.	<ul style="list-style-type: none"> The analog input data exceeded the upper limit of the input range. Or, the analog output data exceeded the upper limit of the output range. 			○	○		W522
64F60000 hex	Unit Over Range for Channel 7	The analog input data for input channel 7 exceeded the upper limit of the input range. Or, the analog output data for output channel 7 exceeded the upper limit of the output range.	<ul style="list-style-type: none"> The analog input data exceeded the upper limit of the input range. Or, the analog output data exceeded the upper limit of the output range. 			○	○		W522
64F70000 hex	Unit Over Range for Channel 8	The analog input data for input channel 8 exceeded the upper limit of the input range. Or, the analog output data for output channel 8 exceeded the upper limit of the output range.	<ul style="list-style-type: none"> The analog input data exceeded the upper limit of the input range. Or, the analog output data exceeded the upper limit of the output range. 			○	○		W522

Event code	Event name	Meaning	Assumed cause	Level					Reference
				M a j	P r t	M i n	O b s	I n f o	
64F80000 hex	Unit Under Range for Channel 1	The analog input data for input channel 1 went below the lower limit of the input range. Or, the analog output data for output channel 1 went below the lower limit of the output range.	<ul style="list-style-type: none"> The analog input data went below the lower limit of the input range. Or, the analog output data went below the lower limit of the output range. 			○	○		W522
64F90000 hex	Unit Under Range for Channel 2	The analog input data for input channel 2 went below the lower limit of the input range. Or, the analog output data for output channel 2 went below the lower limit of the output range.	<ul style="list-style-type: none"> The analog input data went below the lower limit of the input range. Or, the analog output data went below the lower limit of the output range. 			○	○		W522
64FA0000 hex	Unit Under Range for Channel 3	The analog input data for input channel 3 went below the lower limit of the input range. Or, the analog output data for output channel 3 went below the lower limit of the output range.	<ul style="list-style-type: none"> The analog input data went below the lower limit of the input range. Or, the analog output data went below the lower limit of the output range. 			○	○		W522
64FB0000 hex	Unit Under Range for Channel 4	The analog input data for input channel 4 went below the lower limit of the input range. Or, the analog output data for output channel 4 went below the lower limit of the output range.	<ul style="list-style-type: none"> The analog input data went below the lower limit of the input range. Or, the analog output data went below the lower limit of the output range. 			○	○		W522
64FC0000 hex	Unit Under Range for Channel 5	The analog input data for input channel 5 went below the lower limit of the input range. Or, the analog output data for output channel 5 went below the lower limit of the output range.	<ul style="list-style-type: none"> The analog input data went below the lower limit of the input range. Or, the analog output data went below the lower limit of the output range. 			○	○		W522

Event code	Event name	Meaning	Assumed cause	Level					Reference
				M a j	P r t	M i n	O b s	I n f o	
64FD0000 hex	Unit Under Range for Channel 6	The analog input data for input channel 6 went below the lower limit of the input range. Or, the analog output data for output channel 6 went below the lower limit of the output range.	<ul style="list-style-type: none"> The analog input data went below the lower limit of the input range. Or, the analog output data went below the lower limit of the output range. 			○	○		W522
64FE0000 hex	Unit Under Range for Channel 7	The analog input data for input channel 7 went below the lower limit of the input range. Or, the analog output data for output channel 7 went below the lower limit of the output range.	<ul style="list-style-type: none"> The analog input data went below the lower limit of the input range. Or, the analog output data went below the lower limit of the output range. 			○	○		W522
64FF0000 hex	Unit Under Range for Channel 8	The analog input data for input channel 8 went below the lower limit of the input range. Or, the analog output data for output channel 8 went below the lower limit of the output range.	<ul style="list-style-type: none"> The analog input data went below the lower limit of the input range. Or, the analog output data went below the lower limit of the output range. 			○	○		W522
90400000 hex	Event Log Cleared	The event log was cleared.	<ul style="list-style-type: none"> The event log was cleared by the user. 					○	W522

● Temperature Input Units (NX-TS□□□□)

Event code	Event name	Meaning	Assumed cause	Level					Reference
				M a j	P r t	M i n	O b s	I n f o	
00200000 hex	Non-volatile Memory Hardware Error	An error occurred in non-volatile memory.	<ul style="list-style-type: none"> Non-volatile memory failure 			○			W566 (W522)
05100000 hex	A/D Converter Error	An error occurred in the A/D converter	<ul style="list-style-type: none"> Noise A/D Converter Error 			○			W566 (W522)
05110000 hex	Cold Junction Sensor Error	The temperature cannot be converted because the cold junction sensor is disconnected.	<ul style="list-style-type: none"> There is a faulty connection to the cold junction sensor. The cold junction sensor failed. 			○	◐		W566 (W522)
10410000 hex	Control Parameter Error in Master	An error occurred in the control parameters that are saved in the master.	<p>For the NX bus of CPU Units</p> <ul style="list-style-type: none"> The power supply to the CPU Unit was turned OFF while writing the Unit operation settings was in progress. Or there is an error in the area of the non-volatile memory in the CPU Unit in which the Unit operation settings for the relevant NX Unit are saved. <p>For Communications Coupler Units</p> <ul style="list-style-type: none"> The power supply to the Communications Coupler Unit was turned OFF while writing the Unit operation settings was in progress. Or there is an error in the area of the non-volatile memory in the Communications Coupler Unit in which the Unit operation settings for the relevant NX Unit are saved. 			○			W566 (W522)
40200000 hex	NX Unit Processing Error	A fatal error occurred in an NX Unit.	<ul style="list-style-type: none"> An error occurred in the software. 			○			W566 (W522)
65100000 hex	Sensor Disconnected Error	A disconnected temperature sensor was detected.	<ul style="list-style-type: none"> The temperature sensor is damaged or the wires are broken. An unused channel is not disabled. 			○	◐		W566 (W522)

Event code	Event name	Meaning	Assumed cause	Level					Reference
				M a j	P r t	M i n	O b s	I n f o	
80200000 hex	NX Unit I/O Communications Error	An I/O communications error occurred in an NX Unit.	<p>For the NX bus of CPU Units</p> <ul style="list-style-type: none"> An error that prevents normal NX bus communications occurred in a CPU Unit. An NX Unit is not mounted properly. The power cable for the Unit power supply is disconnected, or the wiring from the Unit power supply to the NX Units is incorrect. The power cable for the Unit power supply is broken. The voltage of the Unit power supply is outside the specified range, or the capacity of the Unit power supply is insufficient. There is a hardware error in the NX Unit. <p>For Communications Coupler Units</p> <ul style="list-style-type: none"> An error that prevents normal NX bus communications occurred in a Communications Coupler Unit. The NX Unit is not mounted properly. The power cable for the Unit power supply is disconnected. Or, the wiring from the Unit power supply to the NX Units is incorrect. The power cable for the Unit power supply is broken. The voltage of the Unit power supply is outside the specified range. Or, the capacity of the Unit power supply is insufficient. There is a hardware error in the NX Unit. 						W566 (W522)

Event code	Event name	Meaning	Assumed cause	Level					Reference
				M a j	P r t	M i n	O b s	I n f o	
80240000 hex	NX Unit Clock Not Synchronized Error	A time information error occurred in an NX Unit.	For the NX bus of CPU Units <ul style="list-style-type: none"> There is a hardware error in an NX Unit. There is a hardware error in a CPU Unit. For Communications Coupler Units <ul style="list-style-type: none"> There is a hardware error in an NX Unit. There is a hardware error in an EtherCAT Coupler Unit. 				○		W566 (W522)
65110000 hex	Process Value Over Range	The process temperature exceeded the upper limit of temperature conversion range.	<ul style="list-style-type: none"> The sensor is disconnected. The sensor or the compensating cables are not wired correctly. The sensor and the input type setting do not agree. The range of the input type is too narrow for the temperatures that need to be measured. An unused channel is not disabled. 			⊙	○		W566 (W522)
65120000 hex	Process Value Under Range	The process temperature went below the lower limit of temperature conversion range.	<ul style="list-style-type: none"> The sensor or the compensating cables are not wired correctly. The sensor and the input type setting do not agree. The range of the input type is too narrow for the temperatures that need to be measured. 			⊙	○		W566 (W522)
80220000 hex	NX Message Communications Error	An error was detected in message communications and the message frame was discarded.	For the NX bus of CPU Units <ul style="list-style-type: none"> The message communications load is high. For Communications Coupler Units <ul style="list-style-type: none"> The message communications load is high. The communications cable is disconnected or broken. This cause does not apply if attached information 2 is 0 (NX bus). Message communications were cutoff in communications. 				○		W566 (W522)
90400000 hex	Event Log Cleared	The event log was cleared.	<ul style="list-style-type: none"> The event log was cleared by the user. 					○	W566 (W522)

● Heater Burnout Detection Units (NX-HB□□□□)

Event code	Event name	Meaning	Assumed cause	Level					Reference
				M a j	P r t	M i n	O b s	I n f o	
00200000 hex	Non-volatile Memory Hardware Error	An error occurred in non-volatile memory.	<ul style="list-style-type: none"> Non-volatile memory failure 			○			W566
05100000 hex	A/D Converter Error	An error occurred in the A/D converter	<ul style="list-style-type: none"> Noise A/D Converter Error 			○			W566
10410000 hex	Control Parameter Error in Master	An error occurred in the control parameters that are saved in the master.	<p>For the NX bus of CPU Units</p> <ul style="list-style-type: none"> The power supply to the CPU Unit was turned OFF while writing the Unit operation settings was in progress. Or there is an error in the area of the non-volatile memory in the CPU Unit in which the Unit operation settings for the relevant NX Unit are saved. <p>For Communications Coupler Units</p> <ul style="list-style-type: none"> The power supply to the Communications Coupler Unit was turned OFF while writing the Unit operation settings was in progress. Or there is an error in the area of the non-volatile memory in the Communications Coupler Unit in which the Unit operation settings for the relevant NX Unit are saved. 			○			W566
40200000 hex	NX Unit Processing Error	A fatal error occurred in an NX Unit.	<ul style="list-style-type: none"> An error occurred in the software. 			○			W566
652C0000 hex	Heater Burnout Detected	A heater burnout was detected.	<ul style="list-style-type: none"> A heater was burned out or damaged. The setting of the Heater Burnout Detection Current is too high. A CT input that is not used is allocated to a control output in the CT Allocation setting. 			○	⊙		W566
652D0000 hex	SSR Failure Detected	An SSR failure was detected.	<ul style="list-style-type: none"> The SSR was short-circuited or damaged. The setting of the SSR Failure Detection Current is too small. A CT input that is not used is allocated to a control output in the CT Allocation setting. 			○	⊙		W566

Event code	Event name	Meaning	Assumed cause	Level					Reference
				M a j	P r t	M i n	O b s	I n f o	
80200000 hex	NX Unit I/O Communications Error	An I/O communications error occurred in an NX Unit.	<p>For the NX bus of CPU Units</p> <ul style="list-style-type: none"> An error that prevents normal NX bus communications occurred in a CPU Unit. An NX Unit is not mounted properly. The power cable for the Unit power supply is disconnected, or the wiring from the Unit power supply to the NX Units is incorrect. The power cable for the Unit power supply is broken. The voltage of the Unit power supply is outside the specified range, or the capacity of the Unit power supply is insufficient. There is a hardware error in an NX Unit. <p>For Communications Coupler Units</p> <ul style="list-style-type: none"> An error that prevents normal NX bus communications occurred in a Communications Coupler Unit. The NX Unit is not mounted properly. The power cable for the Unit power supply is disconnected. Or, the wiring from the Unit power supply to the NX Units is incorrect. The power cable for the Unit power supply is broken. The voltage of the Unit power supply is outside the specified range. Or, the capacity of the Unit power supply is insufficient. There is a hardware error in the NX Unit. 						W566

Event code	Event name	Meaning	Assumed cause	Level					Reference
				M a j	P r t	M i n	O b s	I n f o	
80240000 hex	NX Unit Clock Not Synchronized Error	A time information error occurred in an NX Unit.	<p>For the NX bus of CPU Units</p> <ul style="list-style-type: none"> • There is a hardware error in an NX Unit. • There is a hardware error in a CPU Unit. <p>For Communications Coupler Units</p> <ul style="list-style-type: none"> • There is a hardware error in an NX Unit. • There is a hardware error in an EtherCAT Coupler Unit. 			○			W566
80220000 hex	NX Message Communications Error	An error was detected in message communications and the message frame was discarded.	<p>For the NX bus of CPU Units</p> <ul style="list-style-type: none"> • The message communications load is high. <p>For Communications Coupler Units</p> <ul style="list-style-type: none"> • The message communications load is high. • The communications cable is disconnected or broken. • Message communications were cutoff in communications. 				○		W566
90400000 hex	Event Log Cleared	The event log was cleared.	<ul style="list-style-type: none"> • The event log was cleared by the user. 					○	W566

NX-series System Units

The section provides a table of the errors (events) that can occur in the following Units.

NX-PD1□□□

NX-PF0□□□

NX-PC0□□□

NX-TBX01

The manual names are given below for the catalog numbers given in the Reference column of the event table.

Cat. No.	Manual name
W523	NX-series System Unit User's Manual

Event code	Event name	Meaning	Assumed cause	Level					Reference
				M a j	P r t	M i n	O b s	I n f o	
00200000 hex	Non-volatile Memory Hardware Error	An error occurred in non-volatile memory.	<ul style="list-style-type: none"> Non-volatile memory failure 			○			W523
90400000 hex	Event Log Cleared	The event log was cleared.	<ul style="list-style-type: none"> The event log was cleared by the user. 					○	W523

NX-series Position Interface Units

The section provides a table of the errors (events) that can occur in the following Units.

NX-EC0□□□

NX-ECS□□□

NX-PG0□□□

The manual names are given below for the catalog numbers given in the Reference column of the event table.

Cat. No.	Manual name
W524	NX-series Position Interface Units User's Manual

Event code	Event name	Meaning	Assumed cause	Level					Reference
				M a j	P r t	M i n	O b s	I n f o	
00200000 hex	Non-volatile Memory Hardware Error	An error occurred in non-volatile memory.	<ul style="list-style-type: none"> Non-volatile memory failure 			○			W524
10410000 hex	Control Parameter Error in Master	An error occurred in the control parameters that are saved in the master.	<p>For the NX bus of CPU Units</p> <ul style="list-style-type: none"> The power supply to the CPU Unit was turned OFF while writing the Unit operation settings was in progress. Or there is an error in the area of the non-volatile memory in the CPU Unit in which the Unit operation settings for the relevant NX Unit are saved. <p>For Communications Coupler Units</p> <ul style="list-style-type: none"> The power supply to the Communications Coupler Unit was turned OFF while writing the Unit operation settings was in progress. Or there is an error in the area of the non-volatile memory in the Communications Coupler Unit in which the Unit operation settings for the relevant NX Unit are saved. 			○			W524
35100000 hex	External Input Setting Error	A setting for an external input is not correct.	<ul style="list-style-type: none"> The same function (other than a general-purpose input) is assigned to more than one of the external inputs (I0 to I2). 			○			W524

Event code	Event name	Meaning	Assumed cause	Level					Reference
				M a j	P r t	M i n	O b s	I n f o	
35110000 hex	SSI Data Setting Error	There is an error in the SSI data settings.	<ul style="list-style-type: none"> The sum of the values set for the Valid Data Length and the Leading Bits parameters exceeds 32. The sum of the values set for the Multi-turn Data Length, Single- turn Data Length, and the Status Data Length parameters exceeds 32. The sum of the value set for the start bit position and the data length of the SSI data exceeds the value set for the Valid Data Length parameter. The value set for the Encoder Resolution parameter exceeds the range expressed by the data length set for the Single-turn Data Length parameter. 			○			W524
40200000 hex	NX Unit Processing Error	A fatal error occurred in an NX Unit.	<ul style="list-style-type: none"> An error occurred in the software. 			○			W524
743D0000 hex	Incorrect Synchronization Command	Updating the target position data in the synchronization refresh failed consecutively for more than the specified number of times.	<ul style="list-style-type: none"> The communications cable that connects the Communications Coupler Unit is disconnected or a connection is faulty. Noise 			○	○		W524
743E0000 hex	Illegal Following Error	The difference between the command position and actual position exceeds the range expressed by 29 bits.	<ul style="list-style-type: none"> A command that exceeded the maximum velocity (for a model that allows maximum velocity setting, the set value applies to this maximum velocity) was output continuously, so the following error for the actual output, which is restricted by the maximum velocity, has increased. A command velocity that does not correspond to the command position was specified when a velocity-continuous pulse output was used, so the number of pulses that were actually output for the updated command position has increased. 			○			W524

Event code	Event name	Meaning	Assumed cause	Level					Reference
				M a j	P r t	M i n	O b s	I n f o	
743F0000 hex	Illegal State Transition	The EtherCAT master or EtherCAT Coupler Unit executed a command to change the communications status when the Pulse Output Unit is in the Operation Enabled status.	<ul style="list-style-type: none"> A communications command to change the current communications status was received from the communications master while the Unit is in the Operation Enabled status. 			○			W524
80200000 hex	NX Unit I/O Communications Error	An I/O communications error occurred in an NX Unit.	<p>For the NX bus of CPU Units</p> <ul style="list-style-type: none"> An error that prevents normal NX bus communications occurred in a CPU Unit. An NX Unit is not mounted properly. The power cable for the Unit power supply is disconnected, or the wiring from the Unit power supply to the NX Units is incorrect. The power cable for the Unit power supply is broken. The voltage of the Unit power supply is outside the specified range, or the capacity of the Unit power supply is insufficient. There is a hardware error in an NX Unit. <p>For Communications Coupler Units</p> <ul style="list-style-type: none"> An error that prevents normal NX bus communications occurred in a Communications Coupler Unit. The NX Unit is not mounted properly. The power cable for the Unit power supply is disconnected. Or, the wiring from the Unit power supply to the NX Units is incorrect. The power cable for the Unit power supply is broken. The voltage of the Unit power supply is outside the specified range. Or, the capacity of the Unit power supply is insufficient. There is a hardware error in an NX Unit. 			○			W524

Event code	Event name	Meaning	Assumed cause	Level					Reference
				M a j	P r t	M i n	O b s	I n f o	
80210000 hex	NX Unit Output Synchronization Error	An output synchronization error occurred in the NX Unit.	For the NX bus of CPU Units <ul style="list-style-type: none"> I/O refreshing on the NX bus is not performed normally due to an error in the CPU Unit. For Communications Coupler Units <ul style="list-style-type: none"> The communications cable connected to the Communications Coupler Unit is broken or the connection is faulty. The communications cable is affected by noise. 				○		W524
80240000 hex	NX Unit Clock Not Synchronized Error	A time information error occurred in an NX Unit.	For the NX bus of CPU Units <ul style="list-style-type: none"> There is a hardware error in an NX Unit. There is a hardware error in a CPU Unit. For Communications Coupler Units <ul style="list-style-type: none"> There is a hardware error in an NX Unit. There is a hardware error in an EtherCAT Coupler Unit. 				○		W524
80220000 hex	NX Message Communications Error	An error was detected in message communications and the message frame was discarded.	For the NX bus of CPU Units <ul style="list-style-type: none"> The message communications load is high. For Communications Coupler Units <ul style="list-style-type: none"> The message communications load is high. The communications cable is disconnected or broken. Message communications were cutoff in communications. 				○		W524
84D00000 hex	SSI Communications Error	An error occurred in SSI communications.	<ul style="list-style-type: none"> The SSI data settings do not agree with the SSI communications settings in the connected device. The wiring between the NX Unit and the connected device is not correct or disconnected. Noise 			○	○		W524
90400000 hex	Event Log Cleared	The event log was cleared.	<ul style="list-style-type: none"> The event log was cleared by the user. 					○	W524

NX-series Communications Interface Units

The section provides a table of the errors (events) that can occur in the following Units.

NX-CIF□□□

The manual names are given below for the catalog numbers given in the Reference column of the event table.

Cat. No.	Manual name
W540	NX-series Communications Interface Units User's Manual

Event code	Event name	Meaning	Assumed cause	Level					Reference
				M a j	P r t	M i n	O b s	I n f o	
00200000 hex	Non-volatile Memory Hardware Error	An error occurred in non-volatile memory.	<ul style="list-style-type: none"> Non-volatile memory failure 				○		W540
10410000 hex	Control Parameter Error in Master	An error occurred in the control parameters that are saved in the master.	<p>For the NX bus of CPU Units</p> <ul style="list-style-type: none"> The power supply to the CPU Unit was turned OFF while writing the Unit operation settings was in progress. Or there is an error in the area of the non-volatile memory in the CPU Unit in which the Unit operation settings for the relevant NX Unit are saved. <p>For Communications Coupler Units</p> <ul style="list-style-type: none"> The power supply to the Communications Coupler Unit was turned OFF while writing the Unit operation settings was in progress. Or there is an error in the area of the non-volatile memory in the Communications Coupler Unit in which the Unit operation settings for the relevant NX Unit are saved. 				○		W540
40200000 hex	NX Unit Processing Error	A fatal error occurred in an NX Unit.	<ul style="list-style-type: none"> An error occurred in the software. 				○		W540

Event code	Event name	Meaning	Assumed cause	Level					Reference
				M a j	P r t	M i n	O b s	I n f o	
80200000 hex	NX Unit I/O Communications Error	An I/O communications error occurred in an NX Unit.	<p>For the NX bus of CPU Units</p> <ul style="list-style-type: none"> An error that prevents normal NX bus communications occurred in a CPU Unit. An NX Unit is not mounted properly. The power cable for the Unit power supply is disconnected, or the wiring from the Unit power supply to the NX Units is incorrect. The power cable for the Unit power supply is broken. The voltage of the Unit power supply is outside the specified range, or the capacity of the Unit power supply is insufficient. There is a hardware error in an NX Unit. <p>For Communications Coupler Units</p> <ul style="list-style-type: none"> An error that prevents normal NX bus communications occurred in a Communications Coupler Unit. The NX Unit is not mounted properly. The power cable for the Unit power supply is disconnected. Or, the wiring from the Unit power supply to the NX Units is incorrect. The power cable for the Unit power supply is broken. The voltage of the Unit power supply is outside the specified range. Or, the capacity of the Unit power supply is insufficient. There is a hardware error in an NX Unit. 						W540

Event code	Event name	Meaning	Assumed cause	Level					Reference
				M a j	P r t	M i n	O b s	I n f o	
80240000 hex	NX Unit Clock Not Synchronized Error	A time information error occurred in an NX Unit.	For the NX bus of CPU Units <ul style="list-style-type: none"> There is a hardware error in an NX Unit. There is a hardware error in a CPU Unit. For Communications Coupler Units <ul style="list-style-type: none"> There is a hardware error in an NX Unit. There is a hardware error in an EtherCAT Coupler Unit. 			○			W540
85400000 hex	Data Discarded Due to Full Internal Buffer	The internal buffer is full. The input data is discarded.	<ul style="list-style-type: none"> If the internal buffer for received data is full, the Controller cannot read the received data. If the internal buffer for transmission data is full, the transmission data was too large or there are too many send requests. 			○	⊙		W540
80220000 hex	NX Message Communications Error	An error was detected in message communications and the message frame was discarded.	For the NX bus of CPU Units <ul style="list-style-type: none"> The message communications load is high. For Communications Coupler Units <ul style="list-style-type: none"> The message communications load is high. The communications cable is disconnected or broken. Message communications were cutoff in communications. 				○		W540
85410000 hex	Parity Error	A parity error occurred.	<ul style="list-style-type: none"> The communications settings and baud rate setting do not agree with those of the remote device. Noise 			⊙	○		W540
85420000 hex	Framing Error	A framing error occurred.	<ul style="list-style-type: none"> The communications settings and baud rate setting do not agree with those of the remote device. Noise 			⊙	○		W540
85430000 hex	Overrun Error	An overrun error occurred.	<ul style="list-style-type: none"> The next data was received during processing of received data because the baud rate is too high. 			⊙	○		W540
90400000 hex	Event Log Cleared	The event log was cleared.	<ul style="list-style-type: none"> The event log was cleared by the user. 					○	W540

NX-series Safety CPU Units

The section provides a table of the errors (events) that can occur in the following Safety Control Units.

NX-SL5□□□

NX-SL3□□□

The manual names are given below for the catalog numbers given in the Reference column of the event table.

Cat. No.	Manual name
Z930	NX-series Safety Control Unit User's Manual

● System Error

Event code	Event name	Meaning	Assumed cause	Level					Reference
				M a j	P r t	M i n	O b s	I n f o	
05200000 hex	System Error	A hardware error was detected during self-diagnosis of the hardware.	<ul style="list-style-type: none"> Hardware has failed. A memory error occurred due to a transient cause, such as a software error or excessive noise. 			○			Z930

● Communications Errors

Event code	Event name	Meaning	Assumed cause	Level					Reference
				M a j	P r t	M i n	O b s	I n f o	
35200001 hex	FSoE Master Connection Not Established Error	FSoE communications were not established with the FSoE slave.	<ul style="list-style-type: none"> The FSoE communications settings are not correct, the FSoE slave is not in the correct status, etc. The FSoE slave for FSoE communications is not connected. The FSoE slave set in the NX Unit Mounting Setting for FSoE communications is disabled. The version of the FSoE slave to be communicated is older than the configured version. 			○			Z930

Event code	Event name	Meaning	Assumed cause	Level					Reference
				M a j	P r t	M i n	O b s	I n f o	
80200000 hex	NX Unit I/O Communications Error	An I/O communications error occurred in an NX Unit.	<p>NX Bus of the CPU Unit</p> <ul style="list-style-type: none"> An error occurred in the CPU unit, which prevents the NX bus communications from being carried out normally. The NX Unit is not mounted properly. The power cable for the Unit power supply is disconnected. Or, the wiring from the Unit power supply to the NX Units is incorrect. The power cable for the Unit power supply is broken. The unit power voltage is out of the supported range, or the unit power capacity is not sufficient. There is a hardware error in the NX Unit. <p>Communications Coupler Unit</p> <ul style="list-style-type: none"> An error occurred in the communications coupler unit, which prevents the NX bus communications from being carried out normally. The NX Unit is not mounted properly. The power cable for the Unit power supply is disconnected. Or, the wiring from the Unit power supply to the NX Units is incorrect. The power cable for the Unit power supply is broken. The unit power voltage is out of the supported range, or the unit power capacity is not sufficient. There is a hardware error in the NX Unit. 			○			Z930

Event code	Event name	Meaning	Assumed cause	Level					Reference
				M a j	P r t	M i n	O b s	I n f o	
80300001 hex	FSoE Master Connection Timeout	A communication timeout occurred in FSoE communications with the FSoE slave.	<ul style="list-style-type: none"> A setting is not correct. The setting of the safety task period is too short. There is excessive noise. The Safety CPU Unit or FSoE slave entered a state where it could not continue FSoE communications. The process data communications were not performed correctly because an error or status change occurred in the NX bus master to which the Unit is connected. 			○			Z930
80310000 hex	CIP Safety Originator Connection Not Established Error	CIP safety originator connection was not established.	<ul style="list-style-type: none"> The target node is different. The target node is not configured. The target node status is invalid. 			○			Z930
80320000 hex	CIP Safety Originator Connection Timeout	A timeout occurred in CIP safety originator connection.	<ul style="list-style-type: none"> The communications cable is disconnected or broken. The target node entered a state where it could not accept the connection. The timeout value in the communications setup is too small. There is excessive noise. 			○			Z930
80330000 hex	CIP Safety Target Does Not Exist	The target node does not exist.	<ul style="list-style-type: none"> The communications cable is disconnected or broken. The target node entered a state where it could not accept the connection. The timeout value in the communications setup is too small. There is excessive noise. 			○			Z930
80340000 hex	CIP Safety Target Connection Timeout	A timeout occurred in the CIP Safety Target connection.	<ul style="list-style-type: none"> The communications cable is disconnected or broken. The originator device entered a state where it could not accept the connection. The timeout value for the communications settings is too small. There is excessive noise. 			○			Z930
84F00000 hex	NX Bus I/O Communications Stopped	An error occurred in I/O communications between the NX bus master and an NX Unit.	<ul style="list-style-type: none"> There is a hardware error in the NX bus master or an NX Unit. 			○			Z930

● Operation Continuation Error Related to Program Execution Function

Event code	Event name	Possible settings	Assumed cause	Level					Reference
				M a j	P r t	M i n	O b s	I n f o	
74A00000 hex	SF_Antivalent Error	An error was detected in execution of a safety function block.	Refer to information on the diagnostic code that is given for attached information 1 in the <i>NX-series Safety ControlUnit InstructionsReference Manual (Cat No. Z931)</i> .			○			Z930
74A10000 hex	SF_EDM Error	An error was detected in execution of a safety function block.	Refer to information on the diagnostic code that is given for attached information 1 in the <i>NX-series Safety ControlUnit InstructionsReference Manual (Cat No. Z931)</i> .			○			Z930
74A20000 hex	SF_EmergencyStop Error	An error was detected in execution of a safety function block.	Refer to information on the diagnostic code that is given for attached information 1 in the <i>NX-series Safety ControlUnit InstructionsReference Manual (Cat No. Z931)</i> .			○			Z930
74A30000 hex	SF_Enable-Switch Error	An error was detected in execution of a safety function block.	Refer to information on the diagnostic code that is given for attached information 1 in the <i>NX-series Safety ControlUnit InstructionsReference Manual (Cat No. Z931)</i> .			○			Z930
74A40000 hex	SF_Equivalent Error	An error was detected in execution of a safety function block.	Refer to information on the diagnostic code that is given for attached information 1 in the <i>NX-series Safety ControlUnit InstructionsReference Manual (Cat No. Z931)</i> .			○			Z930
74A50000 hex	SF_ESPE Error	An error was detected in execution of a safety function block.	Refer to information on the diagnostic code that is given for attached information 1 in the <i>NX-series Safety ControlUnit InstructionsReference Manual (Cat No. Z931)</i> .			○			Z930
74A60000 hex	SF_GuardLocking Error	An error was detected in execution of a safety function block.	Refer to information on the diagnostic code that is given for attached information 1 in the <i>NX-series Safety ControlUnit InstructionsReference Manual (Cat No. Z931)</i> .			○			Z930
74A70000 hex	SF_Guard-Monitoring Error	An error was detected in execution of a safety function block.	Refer to information on the diagnostic code that is given for attached information 1 in the <i>NX-series Safety ControlUnit InstructionsReference Manual (Cat No. Z931)</i> .			○			Z930

Event code	Event name	Possible settings	Assumed cause	Level					Reference
				M a j	P r t	M i n	O b s	I n f o	
74A80000 hex	SF_Mode-Selector Error	An error was detected in execution of a safety function block.	Refer to information on the diagnostic code that is given for attached information 1 in the <i>NX-series Safety ControlUnit InstructionsReference Manual (Cat No. Z931)</i> .			○			Z930
74A90000 hex	SF_Muting-Par Error	An error was detected in execution of a safety function block.	Refer to information on the diagnostic code that is given for attached information 1 in the <i>NX-series Safety ControlUnit InstructionsReference Manual (Cat No. Z931)</i> .			○			Z930
74AA0000 hex	SF_Muting-Par_2Sensor Error	An error was detected in execution of a safety function block.	Refer to information on the diagnostic code that is given for attached information 1 in the <i>NX-series Safety ControlUnit InstructionsReference Manual (Cat No. Z931)</i> .			○			Z930
74AB0000 hex	SF_Muting-Seq Error	An error was detected in execution of a safety function block.	Refer to information on the diagnostic code that is given for attached information 1 in the <i>NX-series Safety ControlUnit InstructionsReference Manual (Cat No. Z931)</i> .			○			Z930
74AC0000 hex	SF_OutControl Error	An error was detected in execution of a safety function block.	Refer to information on the diagnostic code that is given for attached information 1 in the <i>NX-series Safety ControlUnit InstructionsReference Manual (Cat No. Z931)</i> .			○			Z930
74AD0000 hex	SF_SafetyRequest Error	An error was detected in execution of a safety function block.	Refer to information on the diagnostic code that is given for attached information 1 in the <i>NX-series Safety ControlUnit InstructionsReference Manual (Cat No. Z931)</i> .			○			Z930
74AE0000 hex	SF_TestableSafety-Sensor Error	An error was detected in execution of a safety function block.	Refer to information on the diagnostic code that is given for attached information 1 in the .			○			Z930
74AF0000 hex	SF_Two-HandControlTypeII Error	An error was detected in execution of a safety function block.	Refer to information on the diagnostic code that is given for attached information 1 in the <i>NX-series Safety ControlUnit InstructionsReference Manual (Cat No. Z931)</i> .			○			Z930
74B00000 hex	SF_Two-HandControlTypeIII Error	An error was detected in execution of a safety function block.	Refer to information on the diagnostic code that is given for attached information 1 in the <i>NX-series Safety ControlUnit InstructionsReference Manual (Cat No. Z931)</i> .			○			Z930

● Operation Stop Error Related to Program Execution

Event code	Event name	Possible settings	Assumed cause	Level					Reference
				M a j	P r t	M i n	O b s	I n f o	
55000000 hex	Division by Zero	Division by zero was detected.	The divisor is zero.			○			Z930
55010000 hex	Cast Error	A casting error was detected.	A value was input that exceeded the range of the receiving variable.			○			Z930
55020000 hex	MUX Error	An MUX instruction error was detected.	The value of the selection input (K) to the MUX instruction is not correct.			○			Z930

● Setting Error

Event code	Event name	Possible settings	Assumed cause	Level					Reference
				M a j	P r t	M i n	O b s	I n f o	
10500000 hex	NX Bus Communications Settings Read Error	There is an error in the NX Bus communications settings that are saved in non-volatile memory.	<ul style="list-style-type: none"> A hardware failure occurred in the non-volatile memory. Power was turned OFF while saving data to the non-volatile memory. 			○			Z930
10510000 hex	Safety Application Data Read Error	There is an error in the safety application data that is saved in non-volatile memory.	<ul style="list-style-type: none"> A hardware failure occurred in the non-volatile memory. Power was turned OFF while saving data to the non-volatile memory. 			○			Z930
10520000 hex	NX Bus Communications Settings and Safety Application Data Mismatch	There is an error in the safety application data that is saved in non-volatile memory.	<ul style="list-style-type: none"> The NX bus communications settings that were transferred to the Safety CPU Unit do not match the safety application data. 			○			Z930
24AA0000 hex	DIP Switch Setting Error	The DIP switch setting is invalid.	<ul style="list-style-type: none"> The DIP switch setting was changed. 				○		Z930

● Restore Function Errors

Event code	Event name	Meaning	Assumed cause	Level					Reference
				M a j	P r t	M i n	O b s	I n f o	
35250000 hex	Safety Unit Restore Operation Failed to Start (SD Memory Card Access Failed)	Access to the SD Memory Card failed when you start the restore operation for a Safety Unit.	<ul style="list-style-type: none"> An SD Memory Card is not inserted. The SD Memory Card type is not correct. The format of the SD Memory Card is not correct. The SD Memory Card is damaged. 				○		Z930
35260000 hex	Safety Unit Restore Operation Failed to Start (Safety Unit Restore File Read Failure)	Reading the Safety Unit Restore File failed.	<ul style="list-style-type: none"> The Safety Unit Restore File is not stored in the specified folder. The Safety Unit Restore File is corrupted. 				○		Z930
35270000 hex	Safety Unit Restore Operation Failed to Start (Model Mismatch)	A model mismatch was detected during pre-execution checks for a restore operation for a Safety Unit.	<ul style="list-style-type: none"> The restore operation for a Safety Unit was performed on an incorrect unit. An incorrect Safety Unit Restore File was used. 				○		Z930
35280000 hex	Safety Unit Restore Operation Failed to Start (Version Mismatch)	A version mismatch was detected during pre-execution checks for a restore operation for a Safety Unit.	<ul style="list-style-type: none"> The restore operation for a Safety Unit was performed on an incompatible unit. An incorrect Safety Unit Restore File was used. 				○		Z930
35290000 hex	Safety Unit Restore Operation Failed to Start (Node Name Mismatch)	A node name mismatch was detected during pre-execution checks for a restore operation for a Safety Unit.	<ul style="list-style-type: none"> The restore operation for a Safety Unit was performed on an incorrect unit. An incorrect Safety Unit Restore File was used. The node name specified when the Safety Unit Restore File was generated is incorrect. 				○		Z930
352A0000 hex	Safety Unit Restore Operation Failed to Start (Safety Password Mismatch)	A safety password mismatch was detected during pre-execution checks for a restore operation for a Safety Unit.	<ul style="list-style-type: none"> The restore operation for a Safety Unit was performed on an incorrect unit. An incorrect Safety Unit Restore File was used. The safety password specified when the Safety Unit Restore File was generated is incorrect. 				○		Z930

Event code	Event name	Meaning	Assumed cause	Level					Reference
				M a j	P r t	M i n	O b s	I n f o	
352B0000 hex	Safety Unit Restore Operation Failed	The restore operation for a Safety Unit ended in an error.	<ul style="list-style-type: none"> The SD Memory Card was removed during a restore operation for a Safety Unit. Data was read from or written to the SD Memory Card via the Support Software or an FTP client during a restore operation for a Safety Unit. 				○		Z930

● Other Errors

Event code	Event name	Meaning	Assumed cause	Level					Reference
				M a j	P r t	M i n	O b s	I n f o	
80220000 hex	NX Message Communications Error	An error was detected in message communications for an NX Unit and the message frame was discarded.	<ul style="list-style-type: none"> The message communications load is high. The communications cable is disconnected or broken. This cause does not apply if attached information 2 is 0 (NX bus). Message communications were cut off as the result of executing a synchronization or restoration operation on the Sysmac Studio or as the result of disconnecting an EtherCAT slave. 				○		Z930
951E0000 hex	Sysmac Studio Communications Connection Timeout	A communications timeout occurred between the Sysmac Studio and the Safety CPU Unit.	<ul style="list-style-type: none"> The communications cable was disconnected. 				○		Z930
951F0000 hex	Clear All Memory Rejected	Clearing all of memory failed.	<ul style="list-style-type: none"> The Clear All Memory operation for a Controller or a Slave Terminal was performed. 				○		Z930

● User Access Log

Event code	Event name	Meaning	Assumed cause	Level					Reference
				M a j	P r t	M i n	O b s	I n f o	
90400000 hex	Event Log Cleared	The event log was cleared.	<ul style="list-style-type: none"> The event log was cleared by the user. 				○		Z930
90430000 hex	Memory All Cleared	The Unit settings were cleared.	<ul style="list-style-type: none"> The Clear All Memory operation was performed. 				○		Z930

NX-series Safety I/O Units (NX-SI□□□□/NX-SO□□□□)

The section provides a table of the errors (events) that can occur in the following Safety Control Units.

NX-SI□□□□

NX-SO□□□□

The manual names are given below for the catalog numbers given in the Reference column of the event table.

Cat. No.	Manual name
Z930	NX-series Safety Control Unit User's Manual

● System Error

Event code	Event name	Meaning	Assumed cause	Level					Reference
				M a j	P r t	M i n	O b s	I n f o	
05200000 hex	System Error	A hardware error was detected during self-diagnosis of the hardware.	<ul style="list-style-type: none"> Hardware has failed. A memory error occurred due to a transient cause, such as a software error or excessive noise. 			○			Z930

● Communications Errors

Event code	Event name	Meaning	Assumed cause	Level					Reference
				M a j	P r t	M i n	O b s	I n f o	
35210000 hex	Safety Process Data Communications Not Established - Incorrect Unit Parameter Error	Safety process data communications was not established with the Safety CPU Unit.	<ul style="list-style-type: none"> The model or safety I/O terminal settings are not correct. 			○			Z930
35230000 hex	Safety Process Data Communications Not Established, Incorrect FSoE Slave Address Error	Safety process data communications was not established with the Safety CPU Unit because of an incorrect FSoE slave address.	<ul style="list-style-type: none"> The setting of the FSoE slave address in the safety process data communications settings is different from the setting in the Unit. 			○			Z930

Event code	Event name	Meaning	Assumed cause	Level					Reference
				M a j	P r t	M i n	O b s	I n f o	
35240000 hex	Safety Process Data Communications Not Established, Incorrect Frame Error	Safety process data communications were not established with the Safety CPU Unit because an incorrect frame was received.	<ul style="list-style-type: none"> An incorrect frame was received in safety process data communications. There is excessive noise. 			○			Z930
80200000 hex	NX Unit I/O Communications Error		<ul style="list-style-type: none"> The NX Unit is not mounted properly. The power cable for the Unit power supply is disconnected. Or, the wiring from the Unit power supply to the NX Units is incorrect. The power cable for the Unit power supply is broken. The unit power voltage is out of the supported range, or the unit power capacity is not sufficient. There is a hardware error in the NX Unit. 			○			Z930
80300000 hex	Safety Process Data Communications Timeout	A communications timeout occurred in safety process data communications with the Safety Control Unit.	<ul style="list-style-type: none"> A setting is not correct. The setting of the safety task period is too short. There is excessive noise. The Safety CPU Unit or safety slave entered a status where it could not continue safety process data communications. The process data communications were not performed correctly because an error or status change occurred in the NX bus master to which the Unit is connected. 			○			Z930
84F10000 hex	NX Bus I/O Communications Stopped	An error occurred in I/O communications between the NX bus master and an NX Unit.	There is a hardware error in the NX bus master or an NX Unit.			○			Z930

● Safety I/O Errors

Event code	Event name	Meaning	Assumed cause	Level					Reference
				M a j	P r t	M i n	O b s	I n f o	
05210000 hex	Internal Circuit Error at Safety Input	A fault was detected in the internal circuit for the safety input terminal.	<ul style="list-style-type: none"> The internal circuit for the safety input terminal is faulty. A memory error or signal error occurred due to a transient cause, such as an excessive noise. 			○			Z930
05220000 hex	Internal Circuit Error at Test Output	A fault was detected in the internal circuit for the test output terminal.	<ul style="list-style-type: none"> The internal circuit for the test output terminal is faulty. A memory error or signal error occurred due to a transient cause, such as an excessive noise. 			○			Z930
05230000 hex	Internal Circuit Error at Safety Output	A fault was detected in the internal circuit for the safety output terminal.	<ul style="list-style-type: none"> The internal circuit for the safety output terminal is faulty. A memory error or signal error occurred due to a transient cause, such as an excessive noise. 			○			Z930
65200000 hex	I/O Power Supply Voltage Error	An incorrect I/O power supply voltage was detected.	<ul style="list-style-type: none"> The input power or output power is not supplied correctly. 			○			Z930
65210000 hex	Output Power Interrupt Circuit Error	An error was detected by the output power interruption test.	<ul style="list-style-type: none"> The wiring is not correct or there is a fault in the hardware. 			○			Z930
65220000 hex	External Test Signal Failure at Safety Input	An error was detected in test pulse evaluation of the safety input terminals.	<ul style="list-style-type: none"> The positive power supply wire is in contact with the input signal line. The input signal lines are shorted. The external device is faulty. 			○			Z930
65230000 hex	Discrepancy Error at Safety Input	An error was detected in discrepancy evaluation of safety input terminals.	<ul style="list-style-type: none"> There is a ground fault or disconnection in the input signal line. The connected device is faulty. The setting of the discrepancy time is not correct. Chattering occurred in the input signal from the external input device, such as a safety door. 			○			Z930
65240000 hex	Overload Detected at Test Output	An overcurrent was detected at the test output terminal.	<ul style="list-style-type: none"> There is a ground fault on the output signal line. The external device is faulty. 			○			Z930

Event code	Event name	Meaning	Assumed cause	Level					Reference
				M a j	P r t	M i n	O b s	I n f o	
65250000 hex	Stuck-at-high Detected at Test Output	It was detected that the test output terminal is stuck ON.	<ul style="list-style-type: none"> The positive power supply line is in contact with the output signal line. The internal circuit is faulty. A memory error or signal error occurred due to a transient cause, such as a software error or excessive noise. 			○			Z930
65270000 hex	Short Circuit Detected at Safety Output	A ground fault was detected on the safety output terminal.	<ul style="list-style-type: none"> There is a ground fault on the output signal line. 			○			Z930
65280000 hex	Stuck-at-high Detected at Safety Output	It was detected that the safety output terminal is stuck ON.	<ul style="list-style-type: none"> The positive power supply line is in contact with the output signal line. The output power supply is outside the specifications. The internal circuit is faulty. A memory error or signal error occurred due to a transient cause, such as a software error or excessive noise. 			○			Z930

● Other Errors

Event code	Event name	Meaning	Assumed cause	Level					Reference
				M a j	P r t	M i n	O b s	I n f o	
80220000 hex	NX Message Communications Error	An error was detected in message communications for an NX Unit and the message frame was discarded.	<ul style="list-style-type: none"> The message communications load is high. The communications cable is disconnected or broken. Message communications were cut off as the result of executing a synchronization or restoration operation on the Sysmac Studio or as the result of disconnecting an EtherCAT slave. 				○		Z930

● User Access Log

Event code	Event name	Meaning	Assumed cause	Level					Reference
				M a j	P r t	M i n	O b s	I n f o	
90400000 hex	Event Log Cleared	The event log was cleared.	The event log was cleared by the user.					○	Z930

Event code	Event name	Meaning	Assumed cause	Level					Reference
				M a j	P r t	M i n	O b s	I n f o	
90430000 hex	Memory All Cleared	The Unit settings were cleared.	The Clear All Memory operation was performed.					○	Z930

NX-series Load Cell Input Units

The section provides a table of errors (events) that can occur in the following Unit.

NX-RS□□□□

The manual names are given below for the catalog numbers given in the Reference column of the event table.

Cat. No.	Manual name
W565	NX-series Load Cell Input Unit User's Manual

Event code	Event name	Meaning	Assumed cause	Level					Reference
				M a j	P r t	M i n	O b s	I n f o	
00200000 hex	Non-volatile Memory Hardware Error	An error occurred in non-volatile memory.	<ul style="list-style-type: none"> Non-volatile memory failure 				○		W565
05120000 hex	A/D Conversion Error	AD conversion was not performed by the AD converter.	<ul style="list-style-type: none"> EXC+ terminal and EXC- terminal are short-circuited. Noise A/D converter failure 				○		W565
10410000 hex	Control Parameter Error in Master	An error occurred in the control parameters that are saved in the master.	<p>For the NX bus of CPU Units</p> <ul style="list-style-type: none"> The power supply to the CPU Unit was turned OFF while writing the Unit operation settings was in progress. Or there is an error in the area of the non-volatile memory in the CPU Unit in which the Unit operation settings for the relevant NX Unit are saved. <p>For Communications Coupler Units</p> <ul style="list-style-type: none"> The power supply to the Communications Coupler Unit was turned OFF while writing the Unit operation settings was in progress. Or there is an error in the area of the non-volatile memory in the Communications Coupler Unit in which the Unit operation settings for the relevant NX Unit are saved. 				○		W565
10440000 hex	Unit Calibration Value Error	There is an error in the area in which the Unit calibration values are saved.	<ul style="list-style-type: none"> There is an error in the area of the non-volatile memory in which the Unit calibration values are saved. 				○		W565
10450000 hex	Actual Load Calibration Value Error	There is an error in the area in which the actual load calibration values are saved.	<ul style="list-style-type: none"> There is an error in the area of the non-volatile memory in which the actual load calibration values are saved. 				○		W565

Event code	Event name	Meaning	Assumed cause	Level					Reference
				M a j	P r t	M i n	O b s	I n f o	
40200000 hex	NX Unit Processing Error	A fatal error occurred in an NX Unit.	<ul style="list-style-type: none"> An error occurred in the software. 			○			W565
65130000 hex	Sensor Disconnected Error	A disconnection with the load cell was detected.	<ul style="list-style-type: none"> Wiring with the load cell is not connected. Wiring with the load cell is broken. The input signal exceeds the input conversion range. Load cell failure. 			○			W565
80200000 hex	NX Unit I/O Communications Error	An I/O communications error occurred in an NX Unit.	<p>For the NX bus of CPU Units</p> <ul style="list-style-type: none"> An error that prevents normal NX bus communications occurred in a CPU Unit. An NX Unit is not mounted properly. The power cable for the Unit power supply is disconnected, or the wiring from the Unit power supply to the NX Units is incorrect. The power cable for the Unit power supply is broken. The voltage of the Unit power supply is outside the specified range, or the capacity of the Unit power supply is insufficient. There is a hardware error in an NX Unit. <p>For Communications Coupler Units</p> <ul style="list-style-type: none"> An error that prevents normal NX bus communications occurred in a Communications Coupler Unit. The NX Unit is not mounted properly. The power cable for the Unit power supply is disconnected. Or, the wiring from the Unit power supply to the NX Units is incorrect. The power cable for the Unit power supply is broken. The voltage of the Unit power supply is outside the specified range. Or, the capacity of the Unit power supply is insufficient. There is a hardware error in the NX Unit. 			○			W565

Event code	Event name	Meaning	Assumed cause	Level					Reference
				M a j	P r t	M i n	O b s	I n f o	
80210000 hex	NX Unit Output Synchronization Error	An output synchronization error occurred in the NX Unit.	<p>For the NX bus of CPU Units</p> <ul style="list-style-type: none"> I/O refreshing on the NX bus is not performed normally due to an error in the CPU Unit. <p>For Communications Coupler Units</p> <ul style="list-style-type: none"> The communications cable connected to the Communications Coupler Unit is broken or the connection is faulty. The communications cable is affected by noise. 			○			W565
80240000 hex	NX Unit Clock Not Synchronized Error	A time information error occurred in an NX Unit.	<p>For the NX bus of CPU Units</p> <ul style="list-style-type: none"> There is a hardware error in an NX Unit. There is a hardware error in a CPU Unit. <p>For Communications Coupler Units</p> <ul style="list-style-type: none"> There is a hardware error in an NX Unit. There is a hardware error in an EtherCAT Coupler Unit. 			○			W565
65140000 hex	Over Range	The input signal from the load cell exceeded the upper limit of the input conversion range.	<ul style="list-style-type: none"> Wiring with the load cell is not connected. Wiring with the load cell is broken. EXC+ terminal and EXC- terminal are short-circuited. Load cell failure. A load cell with which the rated output exceeds the input range of the Load Cell Input Unit is used. A load that exceeds the rated capacity is applied to the load cell. Noise 			⊙	○		W565

Event code	Event name	Meaning	Assumed cause	Level					Reference
				M a j	P r t	M i n	O b s	I n f o	
65150000 hex	Under Range	The input signal from the load cell went below the lower limit of the input conversion range.	<ul style="list-style-type: none"> Wiring with the load cell is not connected. Wiring with the load cell is broken. EXC+ terminal and EXC- terminal are short-circuited. Load cell failure. A load cell with which the rated output exceeds the input range of the Load Cell Input Unit is used. A load that exceeds the rated capacity is applied to the load cell. Noise 			○	○		W565
80220000 hex	NX Message Communications Error	An error was detected in message communications and the message frame was discarded.	<p>For the NX bus of CPU Units</p> <ul style="list-style-type: none"> The message communications load is high. <p>For Communications Coupler Units</p> <ul style="list-style-type: none"> The message communications load is high. The communications cable is disconnected or broken. Message communications were cutoff in communications. 				○		W565
90400000 hex	Event Log Cleared	The event log was cleared.	<ul style="list-style-type: none"> The event log was cleared by the user. 					○	W565

NX-series IO-Link Master Units

The section provides a table of errors (events) that can occur in the following Unit.

NX-ILM□□□

The manual name is given below for the catalog numbers given in the Reference column of the event table.

Cat. No.	Manual name
W570	IO-Link System User's Manual

Event code	Event name	Meaning	Assumed cause	Level					Reference
				M a j	P r t	M i n	O b s	I n f o	
00200000 hex	Non-volatile Memory Hardware Error	An error occurred in non-volatile memory.	<ul style="list-style-type: none"> Non-volatile memory failure 				○		W570
10410000 hex	Control Parameter Error in Master	An error occurred in the control parameters that are saved in the master.	<p>For the NX bus of CPU Units</p> <ul style="list-style-type: none"> The power supply to the CPU Unit was turned OFF while writing the Unit operation settings was in progress. Or there is an error in the area of the non-volatile memory in the CPU Unit in which the Unit operation settings for the relevant NX Unit are saved. <p>For Communications Coupler Units</p> <ul style="list-style-type: none"> The power supply to the Communications Coupler Unit was turned OFF while writing the Unit operation settings was in progress. Or there is an error in the area of the non-volatile memory in the Communications Coupler Unit in which the Unit operation settings for the relevant NX Unit are saved. 				○		W570
40200000 hex	NX Unit Processing Error	A fatal error occurred in an NX Unit.	An error occurred in the software.				○		W570

Event code	Event name	Meaning	Assumed cause	Level					Reference
				M a j	P r t	M i n	O b s	I n f o	
80200000 hex	NX Unit I/O Communications Error	An I/O communications error occurred in an NX Unit.	<p>For the NX bus of CPU Units</p> <ul style="list-style-type: none"> An error that prevents normal NX bus communications occurred in a CPU Unit. An NX Unit is not mounted properly. The power cable for the Unit power supply is disconnected, or the wiring from the Unit power supply to the NX Units is incorrect. The power cable for the Unit power supply is broken. The voltage of the Unit power supply is outside the specified range, or the capacity of the Unit power supply is insufficient. There is a hardware error in an NX Unit. <p>For Communications Coupler Units</p> <ul style="list-style-type: none"> An error that prevents normal NX bus communications occurred in a Communications Coupler Unit. The NX Unit is not mounted properly. The power cable for the Unit power supply is disconnected. Or, the wiring from the Unit power supply to the NX Units is incorrect. The power cable for the Unit power supply is broken. The voltage of the Unit power supply is outside the specified range. Or, the capacity of the Unit power supply is insufficient. There is a hardware error in the NX Unit. 						W570

Event code	Event name	Meaning	Assumed cause	Level					Reference
				M a j	P r t	M i n	O b s	I n f o	
80240000 hex	NX Unit Clock Not Synchronized Error	A time information error occurred in an NX Unit.	For the NX bus of CPU Units <ul style="list-style-type: none"> There is a hardware error in an NX Unit. There is a hardware error in a CPU Unit. For Communications Coupler Units <ul style="list-style-type: none"> There is a hardware error in an NX Unit. There is a hardware error in an EtherCAT Coupler Unit. 			○			W570
848F0000 hex	Device Configuration Verification Error	The connected device is different from the IO-Link device registered for a port of the IO-Link Master.	<ul style="list-style-type: none"> The connected device is different from the IO-Link device registered for a port of the IO-Link Master. 			○			W570
84970000 hex	I/O Cable Short-circuit	There is a short-circuit in the cable that connects the IO-Link master and device.	<ul style="list-style-type: none"> There is a short-circuit in the I/O cable. An IO-Link device has failed. 			○			W570
849A0000 hex	IO-Link Communications Module Processing Error	A hardware failure occurred in the IO-Link Communications Module.	<ul style="list-style-type: none"> A hardware failure occurred. 			○			W570
80220000 hex	NX Message Communications Error	An error was detected in message communications and the message frame was discarded.	For the NX bus of CPU Units <ul style="list-style-type: none"> The message communications load is high. For Communications Coupler Units <ul style="list-style-type: none"> The message communications load is high. The communications cable is disconnected or broken. Message communications were cutoff in communications. 			○			W570
848C0000 hex	Error-level Device Event	An error-level event occurred in the IO-Link device.	Use CX-Configurator FDT to confirm the event code of the IO-Link device.			○			W570
848D0000 hex	IO-Link Communications Error	An error occurred in IO-Link communications with a device.	<ul style="list-style-type: none"> The I/O cable is broken. IO-Link device failure. The communications were affected by noise. 			○			W570
84990000 hex	Warning-level Device Event Flag	A warning-level event occurred in the IO-Link device.	Use CX-Configurator FDT to confirm the event code of the IO-Link device.			○			W570
84950000 hex	IO-Link Device Configuration Information Created	IO-Link device configuration information was created.	IO-Link device configuration information was created.			○			W570

Event code	Event name	Meaning	Assumed cause	Level					Reference
				M a j	P r t	M i n	O b s	I n f o	
84980000 hex	I/O Power Supply ON Detected	The I/O power supply ON was detected in several times.	The I/O power supply ON was detected in several times.					○	W570
90400000 hex	Event Log Cleared	The event log was cleared.	The event log was cleared by the user.					○	W570

NX-series Temperature Control Units

The section provides a table of the errors (events) that can occur in the following Unit.

NX-TC□□□□

The manual names are given below for the catalog numbers given in the Reference column of the event table.

Cat. No.	Manual name
H228	NX-series Temperature Control Units User's Manual

Event code	Event name	Meaning	Assumed cause	Level					Reference
				M a j	P r t	M i n	O b s	I n f o	
00200000 hex	Non-volatile Memory Hardware Error	An error occurred in non-volatile memory.	<ul style="list-style-type: none"> Non-volatile memory failure 				○		H228
05100000 hex	A/D Converter Error	An error occurred in the A/D converter.	<ul style="list-style-type: none"> Noise A/D converter failure 				○		H228
05110000 hex	Cold Junction Sensor Error	The temperature cannot be converted because the cold junction sensor is disconnected.	<ul style="list-style-type: none"> There is a faulty connection to the cold junction sensor. The cold junction sensor failed. 				○	◐	H228
10410000 hex	Control Parameter Error in Master	An error occurred in the control parameters that are saved in the master.	<p>For the NX bus of CPU Units</p> <ul style="list-style-type: none"> The power supply to the CPU Unit was turned OFF while writing the Unit operation settings was in progress. Or there is an error in the area of the non-volatile memory in the CPU Unit in which the Unit operation settings for the relevant NX Unit are saved. <p>For Communications Coupler Units</p> <ul style="list-style-type: none"> The power supply to the Communications Coupler Unit was turned OFF while writing the Unit operation settings was in progress. Or there is an error in the area of the non-volatile memory in the Communications Coupler Unit in which the Unit operation settings for the relevant NX Unit are saved. 				○		H228

Event code	Event name	Meaning	Assumed cause	Level					Reference
				M a j	P r t	M i n	O b s	I n f o	
14C10000 hex	Invalid Tuning Parameters Saved in the Unit	Failed to write the tuning result to the non-volatile memory, the tuning parameters saved in the Unit became invalid.	<ul style="list-style-type: none"> Power was turned OFF during tuning. 			○			H228
40200000 hex	NX Unit Processing Error	A fatal error occurred in an NX Unit.	<ul style="list-style-type: none"> An error occurred in the software. 			○			H228
65100000 hex	Sensor Disconnected Error	A disconnected temperature sensor was detected.	<ul style="list-style-type: none"> The temperature sensor is damaged or the wires are broken. An unused channel is not disabled. The wiring to the temperature sensor is incorrect. The input type is not set correctly when this error occurs in the Temperature Control Unit. The measured value exceeds the input indication range when this error occurs in the Temperature Control Unit. The PV Input Shift or the PV Input Slope Coefficient is not set correctly when this error occurs in the Temperature Control Unit. 			○	◉		H228
652C0000 hex	Heater Burnout Detected	A heater burnout was detected.	<ul style="list-style-type: none"> A heater was burned out or damaged. The setting of the Heater Burnout Detection Current is too high. A CT input that is not used is allocated to a control output in the CT Allocation setting when this error occurs in the Heater Burnout Detection Unit. An unused channel is not disabled when this error occurs in the Temperature Control Unit. 			○	◉		H228

Event code	Event name	Meaning	Assumed cause	Level					Reference
				M a j	P r t	M i n	O b s	I n f o	
652D0000 hex	SSR Failure Detected	An SSR failure was detected.	<ul style="list-style-type: none"> The SSR was short-circuited or damaged. The setting of the SSR Failure Detection Current is too small. A CT input that is not used is allocated to a control output in the CT Allocation setting when this error occurs in the Heater Burnout Detection Unit. An unused channel is not disabled when this error occurs in the Temperature Control Unit. 			○	⊙		H228
652E0000 hex	Alarm Detected	The alarm set for the alarm type was detected.	<p>An alarm was detected, which was set to output in the following cases according to the alarm type:</p> <ul style="list-style-type: none"> - if a measured value deviates for the amount specified by the alarm upper limit and/or alarm lower limit, or - if a measured value is greater or smaller than the specified alarm value. <p>The following values that are set according to the alarm type do not conform to the alarm that is to be detected.</p> <ul style="list-style-type: none"> Alarm value Alarm upper limit and alarm lower limit 			○	⊙		H228

Event code	Event name	Meaning	Assumed cause	Level					Reference
				M a j	P r t	M i n	O b s	I n f o	
80200000 hex	NX Unit I/O Communications Error	An I/O communications error occurred in an NX Unit.	<p>For the NX bus of CPU Units</p> <ul style="list-style-type: none"> An error that prevents normal NX bus communications occurred in a CPU Unit. An NX Unit is not mounted properly. The power cable for the Unit power supply is disconnected, or the wiring from the Unit power supply to the NX Units is incorrect. The power cable for the Unit power supply is broken. The voltage of the Unit power supply is outside the specified range, or the capacity of the Unit power supply is insufficient. There is a hardware error in an NX Unit. <p>For Communications Coupler Units</p> <ul style="list-style-type: none"> An error that prevents normal NX bus communications occurred in a Communications Coupler Unit. The NX Unit is not mounted properly. The power cable for the Unit power supply is disconnected. Or, the wiring from the Unit power supply to the NX Units is incorrect. The power cable for the Unit power supply is broken. The voltage of the Unit power supply is outside the specified range. Or, the capacity of the Unit power supply is insufficient. There is a hardware error in an NX Unit. 						H228

Event code	Event name	Meaning	Assumed cause	Level					Reference
				M a j	P r t	M i n	O b s	I n f o	
80240000 hex	NX Unit Clock Not Synchronized Error	A time information error occurred in an NX Unit.	For the NX bus of CPU Units <ul style="list-style-type: none"> There is a hardware error in an NX Unit. There is a hardware error in a CPU Unit. For Communications Coupler Units <ul style="list-style-type: none"> There is a hardware error in an NX Unit. There is a hardware error in an EtherCAT Coupler Unit. 			○			H228
80220000 hex	NX Message Communications Error	An error was detected in message communications and the message frame was discarded.	For the NX bus of CPU Units <ul style="list-style-type: none"> The message communications load is high. For Communications Coupler Units <ul style="list-style-type: none"> The message communications load is high. The communications cable is disconnected or broken. Message communications were cutoff in communications. 				○		H228
90400000 hex	Event Log Cleared	The event log was cleared.	The event log was cleared by the user.					○	H228
94D00000 hex	Tuning Parameter Updated	The parameters were updated by tuning.	Tuning of one of the following functions by the user operation was completed normally and the tuning parameters were updated. <ul style="list-style-type: none"> AT Automatic filter adjustment PID update by Adaptive control with the Notification D-AT 					○	H228
94D10000 hex	Related Parameters Initialized	Related parameters were initialized by parameter changes.	<ul style="list-style-type: none"> The model parameters of adaptive control were initialized because either the input type parameter or the temperature unit parameter had been changed. 					○	H228
94F00000 hex	Tuning Parameter Automatically Updated	The parameters were automatically updated by tuning.	Tuning by automatic execution of the following functions was completed normally, and the tuning parameters were updated. <ul style="list-style-type: none"> Water-cooling output adjustment Adaptive control with the Automatic update 					○	H228

A-2-2 Errors in EtherCAT Slaves

This section provides tables of the errors (events) for which the following OMRON EtherCAT slaves provide notification to the NY-series Controller.

- GX-series EtherCAT Slave Units
- Servo 1S (1S-series AC Servo Drives with Built-in EtherCAT Communications)
R88M-1□, R88D-1SN□-ECT and R88D-1SAN□-ECT
- Servo G5 (G5-series AC Servo Drives with Built-in EtherCAT Communications)
and G5 Linear (G5-series Linear Motors/Drives with Built-in EtherCAT Communications Linear Motor Type)
- MX2/RX-series Inverters with EtherCAT Communications Units
- FH-series Vision Systems
- EtherCAT FQ-M-series Specialized Vision Sensors for Positioning
- E3X-series Fiber Sensors with EtherCAT Communications Unit for Digital Sensors
- E3NW-ECT EtherCAT Digital Sensor Communications Unit
- ZW-CE1□T Confocal Fiber Type Displacement Sensor

GX-series EtherCAT Slave Units

The manual names are given below for the catalog numbers given in the Reference column of the event table.

Cat. No.	Manual name
W488	GX-series EtherCAT Slave Units User's Manual
W570	IO-Link System User's Manual

● Block I/O

Event code	Event name	Meaning	Assumed cause	Level					Reference
				M a j	P r t	M i n	O b s	I n f o	
04A00000 hex	Expansion Unit Hardware Error	An Expansion Unit was disconnected during operation or a signal between the Slave Unit and Expansion Unit was broken.	<ul style="list-style-type: none"> • The Expansion Unit is disconnected. • The Expansion Unit is faulty. 			○			W488
04A20000 hex	Slave Hardware Error	A hardware error occurred in the Slave Unit.	<ul style="list-style-type: none"> • The Slave Unit is faulty. 			○			W488
14A00000 hex	Non-volatile Memory Checksum Error	An error occurred in the control parameters.	<ul style="list-style-type: none"> • Noise 			○			W488
24610000 hex	Switch Setting Error	The setting switch is set out of range.	<ul style="list-style-type: none"> • The analog range that is set on the switch is outside the setting range. 			○			W488

Event code	Event name	Meaning	Assumed cause	Level					Reference
				M a j	P r t	M i n	O b s	I n f o	
64CC0000 hex	I/O Disconnection Detected	An I/O signal line is disconnected.	<ul style="list-style-type: none"> I/O signal wiring is disconnected or has a faulty connection. An I/O signal line is disconnected. 			○			W488
84A00000 hex	Slave Unit Verification Error	A verification error occurred for the SII.	<ul style="list-style-type: none"> An error occurred in the control board. 			○			W488
04A10000 hex	Non-volatile Memory Hardware Error	An error occurred in non-volatile memory.	<ul style="list-style-type: none"> Non-volatile memory failure 				○		W488

● IO-Link Master Units

Event code	Event name	Meaning	Assumed cause	Level					Reference
				M a j	P r t	M i n	O b s	I n f o	
04A10000 hex	Non-volatile Memory Hardware Error	An error occurred in non-volatile memory.	<ul style="list-style-type: none"> Non-volatile memory failure 			○			W570
04A20000 hex	Slave Hardware Error	A hardware error occurred in the Slave Unit.	<ul style="list-style-type: none"> The slave unit failed. 			○			W570
14A00000 hex	Non-volatile Memory Checksum Error	An error occurred in the control parameters.	<ul style="list-style-type: none"> Noise 			○			W570
847C0000 hex	Device Configuration Verification Error	The connected device is different from the IO-Link device registered for a port of the IO-Link Master.	<ul style="list-style-type: none"> The connected device is different from the IO-Link device registered for a port of the IO-Link Master. 			○			W570
84840000 hex	I/O Cable Short-circuit	There is a short-circuit in the cable that connects the IO-Link master and device.	<ul style="list-style-type: none"> There is a short-circuit in the I/O cable. An IO-Link device has failed. 			○			W570
84870000 hex	IO-Link Communications Module Processing Error	A hardware failure occurred in the IO-Link Communications Module.	<ul style="list-style-type: none"> A hardware failure occurred. 			○			W570
84A00000 hex	Slave Unit Verification Error	An error occurred in Slave Unit verification.	<ul style="list-style-type: none"> An error occurred in the control board. 			○			W570
84790000 hex	Error-level Device Event	An error-level event occurred in the IO-Link device.	<ul style="list-style-type: none"> Use CX-Configurator FDT to confirm the event code of the IO-Link device. 				○		W570
847A0000 hex	IO-Link Communications Error	An error occurred in IO-Link communications with a device.	<ul style="list-style-type: none"> The I/O cable is broken. Or, the IO-Link device is disconnected from the port. The communications were affected by noise. IO-Link device failure. 				○		W570
84860000 hex	Warning-level Device Event Flag	A warning-level event occurred in the IO-Link device.	Use CX-Configurator FDT to confirm the event code of the IO-Link device.				○		W570
84820000 hex	IO-Link Device Configuration Information Created	IO-Link device configuration information was created.	<ul style="list-style-type: none"> IO-Link device configuration information was created. 					○	W570
84850000 hex	I/O Power Supply ON Detected	The I/O power supply ON was detected in several times.	<ul style="list-style-type: none"> The I/O power supply ON was detected in several times. 					○	W570

Servo 1S (1S-series AC Servo Drives with Built-in EtherCAT Communications) R88M-1□, R88D-1SN□-ECT, and R88D-1SAN□-ECT

The section provides a table of the errors (events) that can occur in R88M-1□ (AC Servomotors), R88D-1SN□-ECT (AC Servo Drives) and R88D-1SAN□-ECT (AC Servo Drives).

The manual name is given below for the catalog numbers given in the Reference column of the event table.

Cat. No.	Manual name
I586	AC Servomotors/Servo Drives 1S-series with Built-in EtherCAT Communications User's Manual
I621	AC Servomotors/Servo Drives 1S-series with Built-in EtherCAT Communications and Safety Functionality User's Manual

Event code	Event name	Meaning	Assumed cause	Level					Reference
				M a j	P r t	M i n	O b s	I n f o	
04B30000 hex	Regeneration Circuit Error Detected during Power ON	An error of the Regeneration Circuit was detected at power ON.	<ul style="list-style-type: none"> Power supply voltage is insufficient at power ON, or rising slowly. Power supply voltage fluctuated at power ON. L1, L2, and L3 terminals are not connected or disconnected. N1 and N2 terminals are opened. Servo Drive failure 			○			I586
04B50000 hex	Inrush Current Prevention Circuit Error	An error of inrush current prevention circuit was detected.	Inrush current prevention circuit failure			○			I586
04B60000 hex	Regeneration Circuit Error	An regeneration circuit error was detected.	<ul style="list-style-type: none"> There is a short circuit between B2 and N2/N3 Regeneration circuit failure Noise into wiring of the external regeneration resistor 			○			I586 I621
05430000 hex	ESC Error	An error occurred in the EtherCAT slave communications controller.	<ul style="list-style-type: none"> Error of the EtherCAT slave communications controller or false detection when the AL status code is 0051 hex Error access from the non-OMRON EtherCAT master when the AL status code is 0050 hex 			○			I586 I621

Event code	Event name	Meaning	Assumed cause	Level					Reference
				M a j	P r t	M i n	O b s	I n f o	
08390000 hex	Power Module Error	An error was detected in the power module.	<ul style="list-style-type: none"> There is a short-circuit, ground fault, or contact failure on the U, V, or W motor cable There is a short-circuit on the wiring of External Regeneration Resistor or the resistance value is small The insulation resistance failed between the U, V, or W motor cable and the motor ground wire Servo Drive failure 			○			1586 1621
083B0000 hex	Self-diagnosis Error	An error was detected by the self-diagnosis of the safety function.	<ul style="list-style-type: none"> False detection due to a data read error that was caused by excessive noise Hardware failure 			○			1586 1621
083C0000 hex	Main Circuit Temperature Monitoring Circuit Failure	A temperature monitoring circuit failure was detected on the main circuit.	Broken wiring of the thermistor, temperature monitoring circuit failure			○			1586 1621
083D0000 hex	Fan Error	The rotation speed of the fan is 40% or less of the rating and the cooling performance decreases.	<ul style="list-style-type: none"> There is a foreign matter in the cooling fan and it blocks the rotation Cooling fan failure 			○			1586 1621
083F0000 hex	Regeneration Processing Error	The regeneration processing was stopped to protect the Regeneration Resistor.	<ul style="list-style-type: none"> The regeneration processing is set inappropriately The Regeneration Resistor is selected inappropriately The Regeneration Resistor is used for continuous regenerative braking The applied power supply voltage is higher than the specified value Regeneration Resistor failure 			○			1586 1621
08410000 hex	Overvoltage Error	The main circuit power supply voltage (P-N voltage) exceeded the operation guarantee range.	<ul style="list-style-type: none"> The P-N voltage exceeded the specified value The input voltage increased The Regeneration Resistor wiring is broken The External Regeneration Resistor is set or selected inappropriately Servo Drive failure 			○			1586 1621
08420000 hex	Motor Overheat Error	The encoder detected the temperature that exceeded the protection level of motor.	<ul style="list-style-type: none"> The temperature is high around the motor The motor is overloaded Encoder failure 			○			1586

Event code	Event name	Meaning	Assumed cause	Level					Reference
				M a j	P r t	M i n	O b s	I n f o	
08430000 hex	1-rotation Counter Error	The encoder detected a one-rotation counter error.	<ul style="list-style-type: none"> There is excessive noise Failure due to vibration, impact, condensation, foreign matter, etc. 			○			I586 I621
08440000 hex	Overspeed Error	The encoder detected the overspeed.	<ul style="list-style-type: none"> The motor was rotated by external forces Encoder failure and false detection 			○			I586
08450000 hex	Encoder Memory Error	The encoder detected a nonvolatile memory error.	<ul style="list-style-type: none"> False detection due to a data read error that was caused by excessive noise Non-volatile memory failure 			○			I586 I621
08460000 hex	Absolute Position Detection Error	The encoder detected a multi-rotation counter error.	<ul style="list-style-type: none"> A detection error was detected in the multi-rotation detection section of the encoder There is excessive noise 			○			I586 I621
08480000 hex	Main Power Supply Undervoltage (insufficient voltage between P and N)	The main circuit power supply voltage fell below the operation guarantee range during Servo ON.	<ul style="list-style-type: none"> Incorrect wiring of the main circuit power supply The low power supply voltage is applied to the Servo Drive The long time was set in Momentary Hold Time and the voltage was decreased momentarily Servo Drive failure 			○			I586 I621
08490000 hex	Overcurrent Error	The current flowing to the motor exceeded the protection level.	<ul style="list-style-type: none"> There is a short-circuit, ground fault, or contact failure on the U, V, or W motor cable There is a short-circuit on the wiring of External Regeneration Resistor The insulation resistance failed between the U, V, or W motor cable and the motor ground wire False detection due to the noise Servo Drive failure 			○			I586 I621
084A0000 hex	Encoder Communications Disconnection Error	The communications disconnection was detected between the encoder and the Servo Drive.	<ul style="list-style-type: none"> Noise into the encoder cable Contact failure of the signal line, and disconnection of the encoder Power supply undervoltage to the encoder Encoder failure 			○			I586
084B0000 hex	Encoder Communications Error	Illegal data was received from the encoder the specified number of times.	<ul style="list-style-type: none"> Noise into the encoder cable Contact failure of the signal line, and disconnection of the encoder Power supply undervoltage to the encoder 			○			I586 I621

Event code	Event name	Meaning	Assumed cause	Level					Reference
				M a j	P r t	M i n	O b s	I n f o	
084D0000 hex	Non-volatile Memory Hardware Error	An error occurred in non-volatile memory.	<ul style="list-style-type: none"> False detection due to a data read error that was caused by excessive noise Non-volatile memory failure 			○			1586 1621
086D0000 hex	Motor Temperature Error	The encoder detected the temperature that exceeded the protection level of motor.	<ul style="list-style-type: none"> The temperature around the motor is not operating temperature The motor is overloaded Encoder failure 			○			1621
086E0000 hex	Encoder Error	The encoder detected the position information error.	<ul style="list-style-type: none"> Noise into the encoder Hardware failure from mechanical impact, and fault of power supply to the encoder. Contact failure of the signal line Encoder failure 			○			1621
086F0000 hex	Encoder power supply Error	Encoder power supply error was detected.	<ul style="list-style-type: none"> Noise into the encoder cable Contact failure of the signal line Power supply undervoltage to the encoder Encoder failure 			○			1621
08700000 hex	Encoder Self-diagnosis Error	An error was detected by the self-diagnosis of the encoder.	<ul style="list-style-type: none"> False detection due to a data read error that was caused by excessive noise Encoder failure 			○			1621
08710000 hex	Internal Circuit Error at SF Input	Internal circuit error at SF input terminal was detected.	<ul style="list-style-type: none"> Memory error or signal abnormality due to transient factors such as soft errors and excessive noise Failure of safety input circuit of Servo Drive 			○			1621
08720000 hex	Internal Circuit Error at SOPT Input	Internal circuit error was detected at SOPT input terminal.	<ul style="list-style-type: none"> Memory error or signal abnormality due to transient factors such as soft errors and excessive noise Failure of SOPT input circuit of Servo Drive 			○			1621
08730000 hex	Internal Circuit Error at Test Output	Internal circuit errors were detected at test output terminal.	<ul style="list-style-type: none"> Memory error or signal abnormality due to transient factors such as soft errors and excessive noise Failure of test output circuit of Servo Drive 			○			1621
08740000 hex	Internal Circuit Error at SBC Output	Internal circuit error was detected at SBC Output terminal.	<ul style="list-style-type: none"> Memory error or signal abnormality due to transient factors such as soft errors and excessive noise Failure of SBC output circuit of Servo Drive 			○			1621

Event code	Event name	Meaning	Assumed cause	Level					Reference
				M a j	P r t	M i n	O b s	I n f o	
08750000 hex	Overspeed Error	The encoder detected the overspeed.	<ul style="list-style-type: none"> The motor was rotated by external forces Encoder failure and the false detection 			○			I621
08760000 hex	Absolute Encoder Multi-rotation Counter Error	The encoder detected a multi-rotation counter error.	<ul style="list-style-type: none"> A temporary error occurred in the encoder multi-rotation detection function due to vibration, impact, or condensation Encoder failure 			○			I621
08780000 hex	Encoder Communications Disconnection Error	The communications disconnection was detected between the encoder and the Servo Drive.	<ul style="list-style-type: none"> Noise into the encoder cable Contact failure of the signal line, and No connection to the integrated cable Power supply undervoltage to the encoder Encoder failure 			○			I621
18230000 hex	Absolute Encoder Multi-rotation Counter Error	The encoder detected a multi-rotation counter error.	<ul style="list-style-type: none"> A temporary error occurred in the encoder multi-rotation detection function due to vibration, impact, or condensation Encoder failure 			○			I586
18380000 hex	System Error	A hardware error due to the self-diagnosis and a fatal software error were detected.	<ul style="list-style-type: none"> False detection due to a data read error that was caused by excessive noise A fatal software error was detected Hardware failure 			○			I586 I621
183A0000 hex	Non-volatile Memory Data Error	An error of data saved in the nonvolatile memory was detected.	<ul style="list-style-type: none"> Power interruption or noise occurred while parameters other than the safety were saved Power interruption or noise occurred while the motor identity information was saved Power interruption or noise occurred while safety parameters were saved 			○			I586 I621
246D0000 hex	Motor Non-conformity	The Servo Drive and motor combination is not correct.	<ul style="list-style-type: none"> The Servo Drive and motor combination is not correct 			○			I586 I621

Event code	Event name	Meaning	Assumed cause	Level					Reference
				M a j	P r t	M i n	O b s	I n f o	
28080000 hex	Main Circuit Power Supply Phase Loss Error	The phase loss of the main circuit power supply was detected.	<ul style="list-style-type: none"> Incorrect wiring, for example the single-phase power supply is input to a 3-phase input type Servo Drive In the case where the single-phase power supply is input to a single- and 3-phase input type Servo Drive, the phase loss detection is enabled. The power supply voltage is low or insufficient Broken wiring of the main circuit power supply input Servo Drive failure 			○			1586 1621
280D0000 hex	Runaway Detected	The motor rotated in the direction opposite to the command.	<ul style="list-style-type: none"> There is incorrect wiring of the motor cable or a broken cable. The motor rotated in the direction opposite to the command by external forces. 			○			1586 1621
357D0000 hex	DC Setting Error	A mistake was made in the DC Mode operation setting.	<ul style="list-style-type: none"> A mistake was made in the DC Mode operation setting 			○			1586 1621
357E0000 hex	Synchronization Cycle Setting Error	When the DC mode was established, the cycle time was set to the inoperable value.	<ul style="list-style-type: none"> The variable PDO mapping is used, and the number of objects is more than the maximum number of mapped objects for the cycle time The cycle time setting is incorrect 			○			1586 1621
357F0000 hex	Mailbox Setting Error	An incorrect mailbox setting of Sync Manager was detected.	<ul style="list-style-type: none"> An incorrect mailbox setting of Sync Manager was detected 			○			1586 1621
35800000 hex	RxPDO Setting Error	An RxPDO setting error was detected.	<ul style="list-style-type: none"> The RxPDO setting of EtherCAT master is incorrect Servo Drive failure 			○			1586 1621
35810000 hex	TxPDO Setting Error	A TxPDO setting error was detected.	<ul style="list-style-type: none"> The TxPDO setting of EtherCAT master is incorrect Servo Drive failure 			○			1586 1621
35820000 hex	RxPDO Mapping Error	An incorrect RxPDO was set.	<ul style="list-style-type: none"> An incorrect RxPDO was set, such as out of the allowable range of Index, Subindex, or size 			○			1586 1621
35830000 hex	TxPDO Mapping Error	An incorrect TxPDO was set.	<ul style="list-style-type: none"> An incorrect TxPDO was set, such as out of the allowable range of Index, Subindex, or size 			○			1586 1621
35840000 hex	PDO WDT Setting Error	An incorrect PDO WDT setting was detected.	<ul style="list-style-type: none"> An incorrect PDO WDT setting was detected 			○			1586 1621

Event code	Event name	Meaning	Assumed cause	Level					Reference
				M a j	P r t	M i n	O b s	I n f o	
35850000 hex	Node Address Updated	The node address is changed to a value of the ID switches.	<ul style="list-style-type: none"> The node address is changed from a set value in Sysmac Studio to a value of the ID switches 			○			I586 I621
35860000 hex	SM Event Mode Setting Error	The unsupported SM Event Mode was set.	<ul style="list-style-type: none"> The unsupported SM Event Mode was set 			○			I586 I621
38570000 hex	Function Setting Error	The function that was set does not support the communications period.	<ul style="list-style-type: none"> The electronic gear ratio was not 1:1 when the communications period was set to 125 μs. The Backlash Compensation was enabled when the communications period was set to 125 μs. 			○			I586 I621
38780000 hex	General Input Allocation Duplicate Error	More than one function input is allocated to one general input.	<ul style="list-style-type: none"> More than one function input is allocated to one general input 			○			I586 I621
38790000 hex	General Output Allocation Duplicate Error	More than one function output is allocated to one general output.	<ul style="list-style-type: none"> More than one function output is allocated to one general output 			○			I586 I621
387B0000 hex	Pulse Output Setting Error	The dividing numerator exceeded the dividing denominator when the Encoder Dividing Pulse Output - Dividing Denominator was set to a value other than 0.	<ul style="list-style-type: none"> The dividing numerator exceeded the dividing denominator when the Encoder Dividing Pulse Output - Dividing Denominator was set to a value other than 0 			○			I586 I621
387C0000 hex	Motor Replacement Detected	The connected motor is different from the motor that was connected the last time.	<ul style="list-style-type: none"> The motor was replaced The Servo Drive was replaced 			○			I586 I621
387F0000 hex	Electronic Gear Setting Error	The electronic gear ratio exceeded the allowable range.	<ul style="list-style-type: none"> The electronic gear ratio exceeded the allowable range 			○			I586 I621
38800000 hex	Servo Drive Overheat	The internal temperature of Servo Drive exceeded the circuit protection level.	<ul style="list-style-type: none"> The ambient temperature of the Servo Drive exceeded the specified value Overload 			○			I586 I621
38810000 hex	Overload Error	The Load Ratio of Servo Drive or motor (4150-81 hex) exceeded 100%.	<ul style="list-style-type: none"> Operation was continued for a long time with high load There is incorrect wiring of the motor cable or a broken cable Increase in friction 			○			I586 I621

Event code	Event name	Meaning	Assumed cause	Level					Reference
				M a j	P r t	M i n	O b s	I n f o	
38820000 hex	Regeneration Overload Error	The Regeneration Load Ratio (4310-81 hex) exceeded the regeneration overload ratio.	<ul style="list-style-type: none"> The regeneration processing is set inappropriately The Regeneration Resistor is selected inappropriately The Regeneration Resistor is used for continuous regenerative braking The applied power supply voltage is higher than the specified value Regeneration Resistor failure 			○			1586 1621
38830000 hex	Excessive Position Deviation Error	The position deviation is greater than or equal to the value set in the Following error window.	<ul style="list-style-type: none"> Motor operation does not follow the command The value of Following error window is small 			○			1586 1621
38840000 hex	Excessive Speed Deviation Error	The speed deviation is greater than or equal to the value set in the Excessive Velocity Deviation Detection Level.	<ul style="list-style-type: none"> The motor operation does not follow the command because a parameter value is inappropriate The output axis of motor is limited on the operation by external forces The value of the Excessive Velocity Deviation Detection Level is inappropriate 			○			1586 1621
38850000 hex	Excessive Speed Error	The feedback motor speed is greater than or equal to the value set in the Excessive Speed Detection Level.	<ul style="list-style-type: none"> The velocity command value is too large Overshooting occurred The motor was rotated by external forces 			○			1586 1621
38860000 hex	Following Error Counter Overflow	The following error value exceeded the range from -2147483648 to 2147483647.	<ul style="list-style-type: none"> The motor operation does not follow the command The motor is rotated or limited on the operation by external forces 			○			1586 1621
38870000 hex	Absolute Encoder Counter Overflow Error	The multi-rotation counter of the encoder exceeded the maximum number of rotations.	<ul style="list-style-type: none"> An inappropriate value was set in the Encoder - Operation Selection when Using Absolute Encoder (4510-01 hex) The multi-rotation number of the encoder exceeded the maximum number of rotations 			○			1586 1621

Event code	Event name	Meaning	Assumed cause	Level					Reference
				M a j	P r t	M i n	O b s	I n f o	
38880000 hex	Safety Communications Setting Error	Safety process data communications were not established with the Safety CPU Unit because of an incorrect communications setting.	<ul style="list-style-type: none"> The watchdog time was set incorrectly The processing was not completed within the watchdog time because communications were not established due to the noise 			○			I586 I621
38890000 hex	Safety Frame Error	Safety process data communications were not established with the Safety CPU Unit because an incorrect frame was received.	<ul style="list-style-type: none"> An incorrect frame was received in safety process data communications. There is excessive noise 			○			I586 I621
388A0000 hex	Safety Parameter Error	Safety process data communications were not established with the Safety CPU Unit because an incorrect parameter was received.	<ul style="list-style-type: none"> The set safety slave model is incorrect 			○			I586
388B0000 hex	FSoE Slave Address Error	Safety process data communications were not established with the Safety CPU Unit because of an incorrect FSoE slave address.	<ul style="list-style-type: none"> The setting of the FSoE slave address in the safety process data communications settings is different from the setting in the Unit 			○			I586 I621
38980000 hex	Safety Function Setting Error	Incorrect safety function setting was detected.	<ul style="list-style-type: none"> Safety function setting is broken Safety function setting is incorrect in the attached information 			○			I621
38990000 hex	Safety Parameter Error	Safety process data communications were not established with the Safety CPU Unit because an incorrect parameter was received.	<ul style="list-style-type: none"> The specified safety slave model is incorrect There is discrepancy between safety function setting downloaded to EtherCAT master and safety application data downloaded to safety controller 			○			I621
48080000 hex	FPGA WDT Error	An FPGA error was detected.	<ul style="list-style-type: none"> False detection due to a data read error that was caused by excessive noise Hardware failure 			○			I586 I621

Event code	Event name	Meaning	Assumed cause	Level					Reference
				M a j	P r t	M i n	O b s	I n f o	
64E30000 hex	Drive Prohibition Input Error	Both the Positive Drive Prohibition (POT) and the Negative Drive Prohibition Input (NOT) turned ON.	<ul style="list-style-type: none"> An error occurred on the switch, wire, power supply, and wiring that were connected to the Positive Drive Prohibition (POT) or Negative Drive Prohibition Input (NOT) False detection occurred because the control signal power supply was turned ON slowly 			○			1586 1621
68200000 hex	Drive Prohibition Detected	The operation was stopped according to the user setting because the motor ran in the prohibited direction when the Drive Prohibition was enabled.	<ul style="list-style-type: none"> Incorrect or broken wiring of Positive Drive Prohibition Input (POT) or Negative Drive Prohibition Input (NOT) Incorrect setting of the Drive Prohibition Input 			○			1586 1621
68210000 hex	Control Right Release Error	Communications between the Sysmac Studio and Servo Drive were interrupted while a specific function was used from the Sysmac Studio.	<ul style="list-style-type: none"> The USB cable or EtherCAT cable was disconnected during the connection with the Sysmac Studio There is excessive noise A command sent from the Sysmac Studio was not sent to the Servo Drive because the computer was in a busy state or the like 			○			1586 1621
68220000 hex	Error stop input	The Error Stop Input (ESTP) is active.	<ul style="list-style-type: none"> The Error Stop Input (ESTP) was input The Error Stop Input (ESTP) is incorrectly wired 			○			1586 1621
68230000 hex	Software Limit Exceeded	The Position actual value detected the position that exceeded the value set in the Software Position Limit, and stopped the operation according to the user setting.	<ul style="list-style-type: none"> Incorrect setting of Software Position Limit When the Software Position Limit - Stop Selection was set to Stop according to the setting of Fault reaction option code, the position exceeded the value set in the Software Position Limit 			○			1586 1621

Event code	Event name	Meaning	Assumed cause	Level					Reference
				M a j	P r t	M i n	O b s	I n f o	
68370000 hex	SOPT Input Monitoring Error	Improper installation of SOPT input device and the malfunction were detected.	<ul style="list-style-type: none"> Detected a gap of the installation positions of SOPT input devices The setting of Discrepancy Distance (4F00-05 hex) is inappropriate The setting of Safety Origin Position Offset (4F00-04 hex) is inappropriate The setting of Safety Origin Position Tolerance (4F00-06 hex) is inappropriate SOPT Input Terminal Setting is different from specification of input device Speed where a work passed SOPT1/SOPT2 exceeded 200 r/min Failure of input device Disconnection of input device connection cable 			○			I621
68380000 hex	Safety Function Error	A problem on use of safety functions is detected.	<ul style="list-style-type: none"> SLP function: Safety origin position is not determined SLP function: Discrepancy Distance is incorrectly set SLP function: Disconnection of cable for connection with SOPT input device SLS function: Operation of SLS command is not appropriate Safety Position/Velocity Validation Monitoring Function: A motor does not rotate as commanded or the overshooting occurs Safety Position/Velocity Validation Monitoring Function: External forces rotate a motor or limit the operation SOPT input device and encoder are broken 			○			I621
68390000 hex	Discrepancy Error at SF Input	Discrepancy between safety input1 and safety input2 was detected.	<ul style="list-style-type: none"> SF+ input contacts power line (+ side) with 24V DC Ground fault of SF+ input Disconnection of SF+ input or SF- input Short circuit of SF1+ input and SF2+ input Inappropriate safety controller setting or the failure 			○			I621

Event code	Event name	Meaning	Assumed cause	Level					Reference
				M a j	P r t	M i n	O b s	I n f o	
683A0000 hex	SBC Relay Diagnosis Error	Improper wiring of terminals between SBC RFB and an error of safety relay for SBC were detected.	<ul style="list-style-type: none"> Wrong wiring between a safety relay and SBC RFB terminals Safety Relay OFF Delay Time is inappropriate Safety Relay Activate is set inappropriately Wrong wiring of SBC RFB terminals Failure of safety relay 			○			1621
683B0000 hex	External Test Signal Failure at SOPT Input	An error was detected in test pulse diagnosis for SOPT input.	<ul style="list-style-type: none"> SOPT input wiring contacts IOV input wiring There is short circuit in the wiring of SOPT1 input and SOPT2 input Failure of externally connected equipment Test Pulse Diagnosis is set inappropriately 			○			1621
683C0000 hex	Overload Detected at Test Output	Overcurrent was detected at the test output terminals.	<ul style="list-style-type: none"> Ground fault of the test output to IOG input Failure of externally connected equipment 			○			1621
683D0000 hex	Stuck-at-high Detected at Test Output	Stuck ON was detected at test output terminals.	<ul style="list-style-type: none"> The wiring of the test output contacts the wiring of IOV input There is short circuit in SOPT1 input and SOPT2 input Memory abnormality or signal abnormality due to transient factors such as software errors and excessive noise Failure of the test output circuit of Servo Drive 			○			1621
683E0000 hex	Overload Detected at SBC Output	Overcurrent was detected at the SBC output terminal.	<ul style="list-style-type: none"> Ground fault of SBC+ output to SBC CM input The wiring of SBC- output contacts SBC PS input Output of a power supply is out of specifications Memory error or signal abnormality due to transient factors such as soft errors and excessive noise Failure of SBC circuit of Servo Drive 			○			1621

Event code	Event name	Meaning	Assumed cause	Level					Reference
				M a j	P r t	M i n	O b s	I n f o	
683F0000 hex	Stuck-at-high Detected at SBC Output	Stuck ON was detected at the SBC output terminals.	<ul style="list-style-type: none"> The wiring of SBC+ output contacts SBC PS input Ground fault of SBC- output to IOG input Memory error or signal abnormality due to transient factors such as soft errors and excessive noise Failure of SBC circuit of Servo Drive 			○			I621
68400000 hex	IOV Power Supply Voltage Error	Voltage error of IOV power supply was detected.	<ul style="list-style-type: none"> IOV power supply is not turned on Overvoltage of IOV power supply 			○			I621
68410000 hex	SBC Power Supply Voltage Error	Voltage error of SBC power supply was detected.	<ul style="list-style-type: none"> SBC power supply is not turned on Overvoltage of the SBC power supply 			○			I621

Event code	Event name	Meaning	Assumed cause	Level					Reference
				M a j	P r t	M i n	O b s	I n f o	
68420000 hex	Monitoring Limit Exceedance Error	A monitoring error was detected in safety monitoring functions.	<p>a. Each position and velocity exceeded a monitoring range/limit for safety monitoring functions</p> <ul style="list-style-type: none"> • SOS function: Safety Current Pulse Position exceeded SOS position zero window. Safety Current Motor Velocity exceeded SOS velocity zero window • SLS function: Safety Current Motor Velocity exceeded SLS velocity limit • SLP function: Safety Current Position exceeded a range from SLP Monitoring Upper Limit Position to SLP Monitoring Lower Limit Position • SDI function: Safety Current Motor Velocity exceeded SDI velocity zero window to rotation limit direction. And, Safety Current Pulse Position exceeded SDI position zero window to rotation limit direction <p>b. Safety Position/Velocity Validation Monitoring Function: The monitoring limit values/ranges for the safety functions are set lower than the allowable ranges of the safety position/the velocity appropriateness monitoring function</p>					○	1621
78200000 hex	Pulse Output Overspeed Error	The speed, which exceeded the frequency that could be output by the Encoder Dividing Pulse Output function, was detected.	<ul style="list-style-type: none"> • The dividing ratio setting is inappropriate for the actual usage condition 					○	1586 1621

Event code	Event name	Meaning	Assumed cause	Level					Reference
				M a j	P r t	M i n	O b s	I n f o	
78210000 hex	Brake Interlock Error	The Brake Interlock Output (BKIR) was output by the Timeout at Servo OFF.	<ul style="list-style-type: none"> The Brake Interlock Output (BKIR) was output because the motor rotation speed did not decrease to or less than the speed set in the Threshold Speed at Servo OFF within the time set in the Timeout at Servo OFF when Servo OFF was performed during the motor operation 			○			I586 I621
78230000 hex	Command Error	A mistake was made in using a command.	<ul style="list-style-type: none"> When bit 9 (Remote) of the Statusword was set to 1 (remote), and the Servo Drive was in Operation enabled state (Servo ON), the Servo Drive received a command to change the communications state from Operational to another state (Init, Pre-Operational, or Safe-Operational) A mode of operation other than the hm mode was set during the homing operation Modes of operation was set to pp, pv or hm mode when the communications period was set to shorter than 250 μs 			○			I586 I621
84B10000 hex	EtherCAT State Change Error	A communications state change command was received for which the current communications state could not be changed.	<ul style="list-style-type: none"> A communications state change command was received for which the current communications state could not be changed 			○			I586 I621
84B20000 hex	EtherCAT Illegal State Change Error	An undefined communications state change command was received.	<ul style="list-style-type: none"> An undefined communications state change command was received 			○			I586 I621
84B40000 hex	Synchronization Error	A signal for synchronous communications could not be detected.	<ul style="list-style-type: none"> Noise Error of the EtherCAT slave communications controller 			○			I586 I621
84B50000 hex	Sync Manager WDT Error	PDO communications were interrupted for the allowable period or longer.	<ul style="list-style-type: none"> An EtherCAT communications cable is disconnected, loose, or broken Host controller error 			○			I586 I621
84B60000 hex	ESC Initialization Error	Initialization of the EtherCAT slave communications controller failed.	<ul style="list-style-type: none"> Data was incorrectly overwritten in the non-volatile memory of the EtherCAT slave communications controller Failure of the EtherCAT slave communications controller 			○			I586 I621

Event code	Event name	Meaning	Assumed cause	Level					Reference
				M a j	P r t	M i n	O b s	I n f o	
84B70000 hex	SII Verifica- tion Error	An error occurred in SII data of the EtherCAT slave communications controller.	<ul style="list-style-type: none"> Data was incorrectly overwritten in the non-volatile memory of the EtherCAT slave communications controller Failure of the EtherCAT slave communications controller or false detection 				○		1586 1621
84B90000 hex	Synchroni- zation Inter- ruption Error	Synchronization inter- ruption did not occur within the specified period	<ul style="list-style-type: none"> Incorrect EtherCAT synchroni- zation setting of the host con- troller Failure of the EtherCAT slave communications controller or false detection 				○		1586 1621
84BA0000 hex	Bootstrap State Transi- tion Request Error	The state transition to unsupported Boot- strap was requested.	<ul style="list-style-type: none"> The EtherCAT master request- ed the transition of unsupport- ed Bootstrap 				○		1586 1621
88100000 hex	Communica- tions Syn- chronization Error	Communications were not established consecutively be- cause the synchroni- zation with the Ether- CAT Master could not be achieved.	<ul style="list-style-type: none"> The power supply to the host controller was interrupted dur- ing PDO communications An EtherCAT communications cable is disconnected, loose, broken, or has a contact failure Noise 				○		1586 1621
88120000 hex	Safety Com- munications Timeout	A communications timeout occurred in safety process data communications with the Safety CPU Unit.	<ul style="list-style-type: none"> A setting is not correct. The setting of the safety task peri- od of the Safety CPU Unit is too short There is excessive noise The Safety CPU Unit or safety slave entered a status where it could not continue safety pro- cess data communications 				○		1586 1621
98200000 hex	Absolute Value Cleared	The multi-rotation counter of the abso- lute encoder was cleared.	<ul style="list-style-type: none"> The multi-rotation counter of the absolute encoder was cleared 				○		1586 1621
081C0000 hex	Capacitor Lifetime Warning	The capacitor built in- to the Servo Drive reached the service life.	<ul style="list-style-type: none"> The operating time of the ca- pacitor in the Servo Drive ex- ceeded the service life 				○		1586 1621
081D0000 hex	Inrush Cur- rent Preven- tion Relay Lifetime Warning	The inrush current prevention relay built into the Servo Drive reached the service life.	<ul style="list-style-type: none"> The number of operating times of the inrush current preven- tion relay in the Servo Drive exceeded the service life 				○		1586 1621
081F0000 hex	Brake Inter- lock Output Relay Life- time Warn- ing	The brake interlock output (BKIR) relay built into the Servo Drive reached the service life.	<ul style="list-style-type: none"> The number of operating times of the brake interlock output in the Servo Drive exceeded the service life 				○		1586

Event code	Event name	Meaning	Assumed cause	Level					Reference
				M a j	P r t	M i n	O b s	I n f o	
083A0000 hex	Encoder Communications Warning	Encoder communications errors occurred in series more frequently than the specified value.	<ul style="list-style-type: none"> Power supply undervoltage to the encoder Noise into the encoder cable Contact failure of the encoder cable 				○		I586
08470000 hex	Encoder Lifetime Warning	The encoder lifetime is close to the end.	<ul style="list-style-type: none"> Temporary noise The end of the encoder life 				○		I586 I621
084C0000 hex	Fan Rotation Warning	The rotation speed of the fan is 80% or less of the rating and the cooling performance decreases.	<ul style="list-style-type: none"> There is a foreign matter in the cooling fan and it blocks the rotation Cooling fan failure 				○		I586 I621
084E0000 hex	Absolute Encoder Counter Overflow Warning	The multi-rotation counter of the encoder exceeded the value set in Encoder - Absolute Encoder Counter Overflow Warning Level (4510-02 hex).	<ul style="list-style-type: none"> An inappropriate value was set in the Encoder - Operation Selection (4510-01 hex) The multi-rotation number of the encoder exceeded the warning level 				○		I586 I621
08770000 hex	Safety Relay Lifetime Warning	A safety relay for SBC reached the lifetime counting.	Use numbers of safety relay for SBC surpassed Safety Relay Lifetime Warning Detection Threshold				○		I621
18390000 hex	Lifetime Information Corruption Warning	An error was detected in the saved lifetime information.	<ul style="list-style-type: none"> The lifetime information corruption was detected when the power supply was turned ON 				○		I586 I621
34E00000 hex	Data Setting Warning	The object set value is out of the range.	<ul style="list-style-type: none"> The object set value is out of the range 				○		I586 I621
387A0000 hex	Overload Warning	The Load Ratio of Servo Drive or motor (4150-81 hex) exceeded the level set in Overload - Warning Notification Level (4150-01 hex).	<ul style="list-style-type: none"> Operation was continued for a long time with high load. There is incorrect wiring of the motor cable or a broken cable Increase in friction 				○		I586 I621
387D0000 hex	Regeneration Overload Warning	The Regeneration Load Ratio (4310-81Hex) exceeded 85% of the regeneration overload ratio.	<ul style="list-style-type: none"> The regeneration processing is set inappropriately The Regeneration Resistor is selected inappropriately The Regeneration Resistor is used for continuous regenerative braking The applied power supply voltage is higher than the specified value Regeneration Resistor failure 				○		I586 I621

Event code	Event name	Meaning	Assumed cause	Level					Reference
				M a j	P r t	M i n	O b s	I n f o	
387E0000 hex	Motor Vibration Warning	The motor vibration, which was higher than or equal to the level set in the Vibration Detection - Detection Level (3B70-01 hex), was detected.	<ul style="list-style-type: none"> The control parameter is set inappropriately The rigidity decreased due to mechanical looseness or wear 				○		1586 1621
78220000 hex	Command Warning	A command could not be executed.	<ul style="list-style-type: none"> The Switch ON command was received The Enable operation command was received An operation command in the prohibition direction was received after the immediate stop by the Drive Prohibition Input or Software Position Limit Homing started The positioning start command was received in the Profile position mode 				○		1586 1621
84B00000 hex	EtherCAT Communications Warning	An EtherCAT communications error occurred more than one time.	<ul style="list-style-type: none"> An EtherCAT communications cable has a contact failure, or is connected incorrectly or broken Noise 				○		1586 1621
90A00000 hex	Unit Restarted	Restart was performed.	Restart was performed				○		1586 1621
98210000 hex	STO Detected	The safety input OFF state was detected via the safety input signal or EtherCAT communications.	<ul style="list-style-type: none"> The cable is disconnected or broken The STO input was turned OFF via EtherCAT communications 				○		1586
98220000 hex	Memory All Cleared	The Unit setting was cleared.	<ul style="list-style-type: none"> Clear All Memory was performed 				○		1586 1621
98230000 hex	Motor Rotation Direction Selection Non-conformity	Discrepancy of Motor Rotation Direction Selection and Safety Motor Rotation Direction Selection was detected.	Motor rotation settings are different between Motor Rotation Direction Selection and Safety Motor Rotation Direction Selection				○		1621
98240000 hex	Event Log Cleared	The event log was cleared.	Clear Event Log was performed				○		1586 1621

Event code	Event name	Meaning	Assumed cause	Level					Reference
				M a j	P r t	M i n	O b s	I n f o	
98250000 hex	STO Detect- ed	The safety input OFF state was detected via the safety input signal or EtherCAT communications.	<ul style="list-style-type: none"> • There are detached wires and the disconnection of safety input cable • Incorrect safety programming of safety controller • Torque off request was detected at safety input signal • Torque off request was detected by commands via EtherCAT communication 					○	I621

Servo G5 (G5-series AC Servo Drives with Built-in EtherCAT Communications) and G5 Linear (G5-series Linear Motors/Drives with Built-in EtherCAT Communications Linear Motor Type)

The manual names are given below for the catalog numbers given in the Reference column of the event table.

Cat. No.	Manual name
1576	AC Servomotors/Servo Drives G5-series with Built-in EtherCAT Communications User's Manual
1577	AC Servomotors/Servo Drives G5-series with Built-in EtherCAT Communications Linear Motor Type User's Manual

Event code	Event name	Meaning	Assumed cause	Level					Reference
				M a j	P r t	M i n	O b s	I n f o	
04A80000 hex	Control Power Supply Undervoltage	The voltage between the positive and negative terminals in the control power supply converter dropped below the specified value.	<ul style="list-style-type: none"> Power supply undervoltage. Or, the power supply voltage dropped because there was in-rush current when the main power supply was turned ON. A momentary power interruption occurred. The Servo Drive failed. 			○			1576 1577
04A90000 hex	Overvoltage	The power supply voltage exceeded the allowable input voltage range.	<ul style="list-style-type: none"> The voltage between the positive and negative terminals in the control power supply converter exceeded the specified value. The voltage was suddenly increased by the phase advance capacitor or the uninterruptible power supply (UPS). The Regeneration Resistor wiring is broken. The External Regeneration Resistor is not suitable. The Servo Drive failed. 			○			1576 1577

Event code	Event name	Meaning	Assumed cause	Level					Reference
				M a j	P r t	M i n	O b s	I n f o	
04AA0000 hex	Main Circuit Power Supply Undervoltage (Undervoltage between positive and negative terminals)	If the Undervoltage Error Selection (3508 hex) is set to 1, a momentary power interruption occurred between L1 and L3 for longer than the value specified for the Momentary Hold Time. The voltage between the positive and negative terminals in the main power supply converter dropped below the specified value while the Servo was ON.	<ul style="list-style-type: none"> Insufficient power supply capacity The electromagnetic contactor in the main circuit power supply was tripped. A momentary power interruption occurred. A Servo Drive with 3-phase input specifications was operated with a single-phase power supply. The Servo Drive failed. 			○			I576 I577
04AB0000 hex	Main Circuit Power Supply Undervoltage (AC Cutoff Detected)	If the Undervoltage Error Selection (3508 hex) is set to 1, a momentary power interruption occurred between L1 and L3 for longer than the value specified for the Momentary Hold Time. The voltage between the positive and negative terminals in the main power supply converter dropped below the specified value while the Servo was ON.	<ul style="list-style-type: none"> Insufficient power supply capacity The electromagnetic contactor in the main circuit power supply was tripped. A momentary power interruption occurred. A Servo Drive with 3-phase input specifications was operated with a single-phase power supply. The Servo Drive failed. 			○			I576 I577
04AC0000 hex	Overcurrent	The current flowing through the converter exceeded the specified value.	<ul style="list-style-type: none"> A short-circuit, line-to-ground fault, contact failure, or insulation failure occurred on the U, V, or W motor line. The Servo Drive failed. The relay for the dynamic brake has been welded due to frequent Servo ON/OFF operations. Motor windings are burned out. The Servomotor is not suitable for the Servo Drive. The command input timing is the same as or earlier than the Servo ON timing. 			○			I576 I577

Event code	Event name	Meaning	Assumed cause	Level					Reference
				M a j	P r t	M i n	O b s	I n f o	
04AD0000 hex	IPM Error	The current flowing through the converter exceeded the specified value.	<ul style="list-style-type: none"> A short-circuit, line-to-ground fault, contact failure, or insulation failure occurred on the U, V, or W motor line. The Servo Drive failed. The relay for the dynamic brake has been welded due to frequent Servo ON/OFF operations. Motor windings are burned out. The Servomotor is not suitable for the Servo Drive. The pulse input timing is the same as or earlier than the Servo ON timing. 			○			1576 1577
04AE0000 hex	Regeneration Tr Error	The Servo Drive regeneration drive Tr is faulty.	<ul style="list-style-type: none"> The Servo Drive regeneration drive Tr is faulty. 			○			1576 1577
04AF0000 hex	Encoder Phase-Z Error	A missing serial incremental encoder phase-Z pulse was detected.	<ul style="list-style-type: none"> The encoder is faulty. 			○			1576
04B00000 hex	Encoder CTS Signal Error	A missing serial incremental encoder CTS signal logic error was detected.	<ul style="list-style-type: none"> The encoder is faulty. 			○			1576
04B10000 hex	Node Address Setting Error	The node address that was read from the rotary switches was not between 00 and 99.	<ul style="list-style-type: none"> The Servo Drive failed. 			○			1576 1577
04B20000 hex	Other Errors	The Servo Drive malfunctioned, or an error occurred in the Servo Drive.	<ul style="list-style-type: none"> The control circuit malfunctioned temporarily due to excess noise. The Servo Drive's self-diagnosis function detected an error in the Servo Drive. 			○			1577
08080000 hex	Encoder Communications Disconnection Error	A disconnection was detected because communications between the encoder and the Servo Drive were stopped more frequently than the specified value.	<ul style="list-style-type: none"> The encoder is not wired correctly. 			○			1576
08090000 hex	Encoder Communications Error	There is a communications error for the encoder.	<ul style="list-style-type: none"> The power supply voltage of the encoder is low. Noise 			○			1576

Event code	Event name	Meaning	Assumed cause	Level					Reference
				M a j	P r t	M i n	O b s	I n f o	
080A0000 hex	Encoder Communications Data Error	There is an error in the communications data of the encoder.	<ul style="list-style-type: none"> The power supply voltage of the encoder is low. Noise 			○			I576
080B0000 hex	Safety Input Error	At least one of the input photocouplers for safety inputs 1 and 2 turned OFF.	<ul style="list-style-type: none"> The cable is disconnected or broken. 			○			I576 I577
080C0000 hex	External Encoder Connection Error	A disconnection was detected because communications between the external encoder and the Servo Drive were stopped more frequently than the specified value.	<ul style="list-style-type: none"> The wiring is incorrect. 			○			I576 I577
080D0000 hex	External Encoder Communications Data Error	There was a communications error in data from the external encoder.	<ul style="list-style-type: none"> There is insufficient external encoder power supply voltage. Noise 			○			I576 I577
080E0000 hex	External Encoder Status Error 0	Bit 00 of the external encoder error code (ALMC) was set to 1.	<ul style="list-style-type: none"> Bit 00 of the external encoder error code (ALMC) was set to 1. 			○			I576 I577
080F0000 hex	External Encoder Status Error 1	Bit 01 of the external encoder error code (ALMC) was set to 1.	<ul style="list-style-type: none"> Bit 01 of the external encoder error code (ALMC) was set to 1. 			○			I576 I577
08100000 hex	External Encoder Status Error 2	Bit 02 of the external encoder error code (ALMC) was set to 1.	<ul style="list-style-type: none"> Bit 02 of the external encoder error code (ALMC) was set to 1. 			○			I576 I577
08110000 hex	External Encoder Status Error 3	Bit 03 of the external encoder error code (ALMC) was set to 1.	<ul style="list-style-type: none"> Bit 03 of the external encoder error code (ALMC) was set to 1. 			○			I576 I577
08120000 hex	External Encoder Status Error 4	Bit 04 of the external encoder error code (ALMC) was set to 1.	<ul style="list-style-type: none"> Bit 04 of the external encoder error code (ALMC) was set to 1. 			○			I576 I577
08130000 hex	External Encoder Status Error 5	Bit 05 of the external encoder error code (ALMC) was set to 1.	<ul style="list-style-type: none"> Bit 05 of the external encoder error code (ALMC) was set to 1. 			○			I576 I577
08140000 hex	Phase-A Connection Error	An error such as broken wiring was detected in the external encoder phase-A connection.	<ul style="list-style-type: none"> An error such as broken wiring was detected in the external encoder phase-A connection. 			○			I576 I577
08150000 hex	Phase-B Connection Error	An error such as broken wiring was detected in the external encoder phase-B connection.	<ul style="list-style-type: none"> An error such as broken wiring was detected in the external encoder phase-B connection. 			○			I576 I577

Event code	Event name	Meaning	Assumed cause	Level					Reference
				M a j	P r t	M i n	O b s	I n f o	
08160000 hex	Phase-Z Connection Error	An error such as broken wiring was detected in the external encoder phase-Z connection.	<ul style="list-style-type: none"> An error such as broken wiring was detected in the external encoder phase-Z connection. 						1576 1577
08170000 hex	Encoder Data Restoration Error	Initialization of internal position data was not processed correctly in Semi-closed Control Mode and Absolute Value Mode.	<ul style="list-style-type: none"> There is insufficient power supply voltage for the encoder. Noise is entering on the encoder line. 						1576
08180000 hex	External Encoder Data Restoration Error	Initialization of internal position data was not processed correctly in Fully-closed Control Mode and Absolute Value Mode.	<ul style="list-style-type: none"> There is insufficient power supply voltage for the external encoder. Noise is entering on the external encoder line. 						1576
14A80000 hex	Object Error	The object area data in non-volatile memory is corrupted.	<ul style="list-style-type: none"> Noise Non-volatile memory failure 						1576 1577
14A90000 hex	Object Error	The object area data in non-volatile memory is corrupted.	<ul style="list-style-type: none"> Noise Non-volatile memory failure 						1576 1577
14AA0000 hex	Object Error	The object area data in non-volatile memory is corrupted.	<ul style="list-style-type: none"> Noise Non-volatile memory failure 						1576 1577
14AB0000 hex	Object Corrupted	The checksum data in non-volatile memory is corrupted.	<ul style="list-style-type: none"> Non-volatile memory failure 						1576 1577
14AC0000 hex	Object Corrupted	The checksum data in non-volatile memory is corrupted.	<ul style="list-style-type: none"> Non-volatile memory failure 						1576 1577
14AD0000 hex	Object Corrupted	The checksum data in non-volatile memory is corrupted.	<ul style="list-style-type: none"> Non-volatile memory failure 						1576 1577
18200000 hex	Absolute Encoder Over-speed Error	The Servomotor rotation speed exceeded the specified value when only the battery power supply was used during a power interruption.	<ul style="list-style-type: none"> There is insufficient power supply voltage for the encoder. The wiring of the CN2 connector is wrong. An external force is rotating the motor when the Servo is OFF. 						1576
18210000 hex	Encoder Initialization Error	An encoder initialization error was detected.	<ul style="list-style-type: none"> Servomotor failed. 						1576
18220000 hex	Absolute Encoder One-rotation Counter Error	The encoder detected a one-rotation counter error.	<ul style="list-style-type: none"> Servomotor failed. 						1576

Event code	Event name	Meaning	Assumed cause	Level					Reference
				M a j	P r t	M i n	O b s	I n f o	
18230000 hex	Absolute Encoder Multi-rotation Counter Error	The encoder detected a multi-rotation counter error.	<ul style="list-style-type: none"> Servomotor failed. 			○			I576
24680000 hex	Motor Non-conformity	The Servo Drive and Servomotor combination is not correct.	<ul style="list-style-type: none"> The Servo Drive and motor combination is not correct 			○			I576
24690000 hex	Motor Non-conformity	The Servo Drive and Servomotor combination is not correct.	<ul style="list-style-type: none"> The Servo Drive and motor combination is not correct 			○			I576
246A0000 hex	Motor Non-conformity	The Servo Drive and Servomotor combination is not correct.	<ul style="list-style-type: none"> The Servo Drive and Servomotor combination is not correct. 			○			I576
246B0000 hex	Motor Non-conformity	The Servo Drive and Servomotor combination is not correct.	<ul style="list-style-type: none"> The Servo Drive and Servomotor combination is not correct. 			○			I576
246C0000 hex	Motor Non-conformity	The Servo Drive and Servomotor combination is not correct.	<ul style="list-style-type: none"> The Servo Drive and Servomotor combination is not correct. 			○			I576
28010000 hex	Motor Setting Error	Settings associated with the motor and external encoder are missing.	Settings associated with the motor and external encoder are missing.			○			I577
28020000 hex	Motor Combination Error 1	The value set for the motor current exceeds the maximum motor capacity allowed for the Servo Drive.	The Motor Rated Rms Current/ Motor Peak Absolute Current exceeds the maximum motor capacity allowed for the Servo Drive.			○			I577
28030000 hex	Motor Combination Error 2	The value set for the motor exceeds the drive range of the motor.	<ul style="list-style-type: none"> The Motor Rated Rms Current is too low compared with the maximum motor capacity of the Servo Drive. The percentage of the Motor Coil Unit Mass to the Motor Rated Force is too high. The automatically adjusted Current Loop Proportional Gain/Current Loop Integral Gain is too high. The percentage of the Motor Peak Absolute Current to the Motor Rated Rms Current is greater than 500%. 			○			I577
34E10000 hex	Servo Drive Overheat	The temperature of the Servo Drive radiator or power elements exceeded the specified value.	<ul style="list-style-type: none"> The ambient temperature of the Servo Drive exceeded the specified value. Overload 			○			I576 I577

Event code	Event name	Meaning	Assumed cause	Level					Reference
				M a j	P r t	M i n	O b s	I n f o	
34E20000 hex	Overload	When the feedback value for torque/force command exceeds the overload level specified in the Overload Detection Level Setting (3512 hex), overload protection is performed according to the overload characteristics.	<ul style="list-style-type: none"> Operation was continued for a long time while overloaded. There is incorrect wiring of the motor line or a broken cable. 			○			1576 1577
34E30000 hex	Regeneration Overload	The regenerative energy exceeds the processing capacity of the Regeneration Resistor.	<ul style="list-style-type: none"> The load inertia/load mass is too large. Or, the Servomotor rotation speed/motor speed is too high to absorb the regenerative energy within the specified deceleration time. This Regeneration Resistor cannot be used for continuous regenerative braking. (The operating limit of the external resistor is limited to a 10% duty.) 			○			1576 1577
34E40000 hex	Error Counter Overflow	Position error pulses exceeded the setting of the Following error window (6065 hex).	<ul style="list-style-type: none"> Motor operation does not follow the command. The value of the Following error window (6065 hex) is small. The encoder/external encoder wiring is incorrect. 			○			1576 1577
34E50000 hex	Excessive Velocity Error	The difference between the internal position command velocity and the actual velocity (i.e., the velocity error) exceeded the Excessive Velocity Error Setting (3602 hex).	<ul style="list-style-type: none"> Motor operation does not follow the command. The setting of the Excessive Velocity Error Setting (3602 hex) is too small. 			○			1576 1577
34E60000 hex	Overspeed	The Servomotor rotation speed/motor speed exceeded the value set on the Overspeed Detection Level Setting (3513 hex).	<ul style="list-style-type: none"> The velocity command value is too large. There is overshooting. The wiring is incorrect. 			○			1576 1577

Event code	Event name	Meaning	Assumed cause	Level					Reference
				M a j	P r t	M i n	O b s	I n f o	
383F0000 hex	Excessive Hybrid Following Error	During fully-closed control, the difference between the load position from the external encoder and the Servomotor position from the encoder was larger than the number of pulses set as the Hybrid Following Error Counter Overflow Level (3328 hex).	<ul style="list-style-type: none"> • Connections are not correct. • The settings are not correct. 			○			I576
38400000 hex	Overspeed 2	The Servomotor rotation speed/motor speed exceeded the value set on Overspeed Detection Level Setting at Immediate Stop (3615 hex).	<ul style="list-style-type: none"> • The velocity command value is too large. • There is overshooting. • The wiring is incorrect. 			○			I576 I577
38410000 hex	Command Error	The position command variation after the electronic gear exceeded the specified value.	<ul style="list-style-type: none"> • The change in position command is too large. • The backlash compensation amount is too large. 			○			I576 I577
38420000 hex	Command Generation Error	During position command processing, an error such as a calculation range error occurred.	<ul style="list-style-type: none"> • During position command processing, an error such as a calculation range error occurred. 			○			I576 I577
38430000 hex	Error Counter Overflow 1	The absolute encoder position/ absolute scale position in pulses divided by the electronic gear ratio exceeded $\pm 2^{31}(2,147,483,648)$.	<ul style="list-style-type: none"> • The absolute encoder position/ absolute scale position in pulses divided by the electronic gear ratio exceeded $\pm 2^{31}(2,147,483,648)$. 			○			I576 I577
38440000 hex	Error Counter Overflow 2	The position following error in pulses exceeded $\pm 2^{29}(536,870,912)$. Or, the position following error in command units exceeded $\pm 2^{30}(1,073,741,824)$.	<ul style="list-style-type: none"> • There is insufficient torque/ force. • There is insufficient gain. • The encoder/external encoder wiring is incorrect. 			○			I576 I577
38450000 hex	Interface Input Duplicate Allocation Error 1	There is a duplicate setting in the input signal (IN1, IN2, IN3, and IN4) function allocations.	<ul style="list-style-type: none"> • There is a duplicate setting in the input signal (IN1, IN2, IN3, and IN4) function allocations. 			○			I576 I577

Event code	Event name	Meaning	Assumed cause	Level					Reference
				M a j	P r t	M i n	O b s	I n f o	
38460000 hex	Interface Input Duplicate Allocation Error 2	There is a duplicate setting in the input signal (IN5, IN6, IN7, and IN8) function allocations.	<ul style="list-style-type: none"> There is a duplicate setting in the input signal (IN5, IN6, IN7, and IN8) function allocations. 			○			1576 1577
38470000 hex	Interface Input Function Number Error 1	There is an undefined number specification in the input signal (IN1, IN2, IN3, and IN4) function allocations. Or, a logic setting error was detected.	<ul style="list-style-type: none"> There is an undefined number specification in the input signal (IN1, IN2, IN3, and IN4) function allocations. Different logic is set for the same function in the function assignments of the input signals (IN1, IN2, IN3, and IN4). 			○			1576 1577
38480000 hex	Interface Input Function Number Error 2	There is an undefined number specification in the input signal (IN5, IN6, IN7, and IN8) function allocations. Or, a logic setting error was detected.	<ul style="list-style-type: none"> There is an undefined number specification in the input signal (IN5, IN6, IN7, and IN8) function allocations. Different logic is set for the same function in the function assignments of the input signals (IN5, IN6, IN7, and IN8). 			○			1576 1577
38490000 hex	Interface Output Function Number Error 1	There is an undefined number specification in the output signal (OUTM1) function allocation.	<ul style="list-style-type: none"> There is an undefined number specification in the output signal (OUTM1) function allocation. 			○			1576 1577
384A0000 hex	Interface Output Function Number Error 2	There is an undefined number specification in the output signal (OUTM2) function allocation.	<ul style="list-style-type: none"> There is an undefined number specification in the output signal (OUTM2) function allocation. 			○			1576 1577
384B0000 hex	External Latch Input Allocation Error	There is an error in the latch input function allocation.	<ul style="list-style-type: none"> The latch input was allocated to an input signal other than IN5, IN6, or IN7. A latch input is assigned to an NC signal. The same latch input is not assigned to the same pin in all Control Modes. 			○			1576 1577
384C0000 hex	Overrun Limit Error	The Servomotor exceeded the allowable operating range set in the Overrun Limit Setting (3514 hex) with respect to the position command input range.	<ul style="list-style-type: none"> The gain or inertial ratio/mass ratio is not suitable. The set value of the Overrun Limit Setting (3514 hex) is too small. 			○			1576 1577

Event code	Event name	Meaning	Assumed cause	Level					Reference
				M a j	P r t	M i n	O b s	I n f o	
384D0000 hex	Absolute Encoder System Down Error	The voltage of the built-in capacitor dropped below the specified value because the power supply to the encoder or the battery power supply was down.	<ul style="list-style-type: none"> The voltage of the built-in capacitor dropped below the specified value because the power supply to the encoder or the battery power supply was down. 			○			I576
384E0000 hex	Absolute Encoder Counter Overflow Error	The multi-rotation counter of the encoder exceeded the specified value.	<ul style="list-style-type: none"> The set value for switching operation with the absolute encoder is too large. The traveling distance from home of the machine exceeded 32,767 revolutions. 			○			I576
384F0000 hex	Object Setting Error 1	The electronic gear ratio exceeded the allowable range.	<ul style="list-style-type: none"> The electronic gear ratio exceeded the allowable range 			○			I576 I577
38500000 hex	Object Setting Error 2	External encoder ratio exceeded the allowable range.	<ul style="list-style-type: none"> External encoder ratio exceeded the allowable range. 			○			I576 I577
38510000 hex	External Encoder Connection Error	The set value of the External Feedback Pulse Type Selection (3323 hex) differs from the external encoder type that is connected for serial communications.	<ul style="list-style-type: none"> The set value of the External Feedback Pulse Type Selection (3323 hex) differs from the external encoder type that is connected for serial communications. 			○			I576 I577

Event code	Event name	Meaning	Assumed cause	Level					Reference
				M a j	P r t	M i n	O b s	I n f o	
38520000 hex	Function Setting Error	The function that was set does not support the communications period.	<ul style="list-style-type: none"> The electronic gear object ratio was not 1:1 when the communications period was set to 500 μs. Modes of operation (6060 hex) was set to pp or hm when the communications period was set to 500 μs. More than 12 bytes were mapped for RxPDO in Fully-closed Control Mode (This applies only to Cylinder-type Servomotors.). Modes of operation (6060 hex) was set to pp or hm in Fully-closed Control Mode when the communications period was set to 1 ms and the electronic gear parameter ratio was not set to 1:1 (This applies only to Cylinder-type Servomotors.). No bytes (i.e., no objects) were mapped for RxPDO. More than 10 objects were mapped for RxPDO. More than 11 objects were mapped for TxPDO. CSP Switching Reference Position (4020 hex) was mapped for TxPDO when the communications period was set to 500 μs or when the electronic gear object ratio was not set to 1:1. 						1576 1577
38530000 hex	Magnetic Pole Position Estimation Error 1	Magnetic pole position estimation was not completed successfully.	<ul style="list-style-type: none"> Settings associated with the external encoder are incorrect. The command time or force command value for magnetic pole position estimation is too low. There is a large unbalanced load or friction. 						1577
38540000 hex	Magnetic Pole Position Estimation Error 2	Magnetic pole position estimation was not completed successfully because the motor did not stop within the Magnetic Pole Position Estimation Time Limit for Stop.	<ul style="list-style-type: none"> The value set for the Magnetic Pole Position Estimation Time Limit for Stop (3927 hex) is small compared with the actual stop time of the motor. The motor is moving when no force is applied. 						1577

Event code	Event name	Meaning	Assumed cause	Level					Reference
				M a j	P r t	M i n	O b s	I n f o	
38550000 hex	Magnetic Pole Position Estimation Error 3	Magnetic pole position restoration was not completed successfully.	<ul style="list-style-type: none"> The Magnetic Pole Detection Method (3920 hex) object was set to 3 (Magnetic pole position restoration method), although magnetic pole position estimation had never been executed. The Magnetic Pole Detection Method (3920 hex) was set to 3 (Magnetic pole position restoration method) when a non-absolute type external encoder was used. 			○			I577
38560000 hex	Motor Auto-setting Error	The current exceeded the limit when it was applied to the Motor when the Servo was locked or when FFT measurement preparations were performed.	The Current Loop Proportional Gain or the Current Loop Integral Gain was too large before auto-setting was performed.			○			I577
64E00000 hex	Drive Prohibition Input Error 1	When the Drive Prohibition Input Selection (3504 hex) was set to 0, both the Forward/ Positive Drive Prohibition Input (POT) and Reverse/Negative Drive Prohibition Input (NOT) turned ON. Or, when the Drive Prohibition Input Selection (3504 hex) was set to 2, either the Forward/ Positive Drive Prohibition Input (POT) or Reverse/Negative Drive Prohibition Input (NOT) turned ON.	<ul style="list-style-type: none"> A problem occurred with the switches, wires, and power supplies that are connected to the Forward/Positive Drive Prohibition Input (POT) and Reverse/Negative Drive Prohibition Input (NOT). 			○			I576 I577

Event code	Event name	Meaning	Assumed cause	Level					Reference
				M a j	P r t	M i n	O b s	I n f o	
64E10000 hex	Drive Prohibition Input Error 2	An operation command (such as a trial run of FFT) was received from the CX-Drive when the Drive Prohibition Input Selection (3504 hex) was set to 0, EtherCAT communications was interrupted, and either POT or NOT was ON. Or, POT or NOT turned ON while operation was being performed for a CX-Drive operation command.	<ul style="list-style-type: none"> A problem occurred with the switches, wires, and power supplies that are connected to the Forward/Positive Drive Prohibition Input (POT) and Reverse/Negative Drive Prohibition Input (NOT). 			○			1576 1577
64E20000 hex	Immediate Stop Input Error	An Immediate Stop (STOP) signal was input.	<ul style="list-style-type: none"> An Immediate Stop (STOP) signal was input. Incorrect wiring of the immediate stop input (STOP). 			○			1576 1577

Event code	Event name	Meaning	Assumed cause	Level					Reference
				M a j	P r t	M i n	O b s	I n f o	
74810000 hex	Command Error	A mistake was made in using a command.	<ul style="list-style-type: none"> When bit 09 (Remote) of the Statusword (6041 hex) was set to 1 (remote), and the Servo Drive was in operation enabled state (Servo ON), a command was received that changes the communications state from Operational to another state (Init, Pre-Operational, or Safe-Operational state). When bit 09 (Remote) of the Statusword (6041 hex) was set to 0 (local), a command was received during FFT or test run status that changes the ESM state from Operational, Safe-Operational, or Pre-Operational state to Init state. An unsupported number was set for 6060 hex (Operation Mode). During Fully-closed Control Mode, csv or cst was set for 6060 hex (Operation Mode) (This applies to Cylinder-type Servomotors.). The setting of 6060 hex (Operation Mode) was changed at an interval of less than 2 ms. Homing was started when 6098 hex (Homing Method) was set to a value other than 8, 12, 19, 20, 33, 34, or 35. Data setting warnings (B0 hex) occurred continuously for the number of data setting warnings that is set in 3781 hex (Data Setting Warning Detection Count). 						I576 I577
78010000 hex	Operation Command Competition	An attempt was made to establish EtherCAT communications or to turn ON the Servo from the Controller (enable operation) while executing an FFT that operates with the Servo Drive alone or a trial run.	<ul style="list-style-type: none"> EtherCAT communications (change from Init to Pre-Operational state) was established or an attempt to turn ON the Servo from the Controller (enable operation) was made while executing an FFT that operates with the Servo Drive trial run. 						I576 I577

Event code	Event name	Meaning	Assumed cause	Level					Reference
				M a j	P r t	M i n	O b s	I n f o	
78020000 hex	Absolute Encoder Status Error	The rotation of the encoder was higher than the specified value when the power supply was turned ON.	<ul style="list-style-type: none"> The rotation of the encoder was higher than the specified value when the power supply was turned ON. 			○			1576
84B10000 hex	EtherCAT State Change Error	A communications state change command was received for which the current communications state could not be changed.	<ul style="list-style-type: none"> A communications state change command was received for which the current communications state could not be changed 			○			1576 1577
84B20000 hex	EtherCAT Illegal State Change Error	An undefined communications state change command was received.	<ul style="list-style-type: none"> An undefined communications state change command was received 			○			1576 1577
84B30000 hex	Communications Synchronization Error	The number of consecutive errors in receiving data during the communication sync time exceeded the value specified for the Communications Error Setting (2200 hex).	<ul style="list-style-type: none"> Power to the host controller was interrupted during PDO communications. An EtherCAT communications cable is disconnected, broken, or incorrectly connected. Noise 			○			1576 1577
84B40000 hex	Synchronization Error	A synchronization error occurred.	<ul style="list-style-type: none"> Noise Control PCB error 			○			1576 1577
84B50000 hex	Sync Manager WDT Error	PDO communications were stopped for more than the specified period of time.	<ul style="list-style-type: none"> The EtherCAT communications cable is disconnected or broken. There is an error in the host controller. 			○			1576 1577
84B60000 hex	ESC Initialization Error	An error occurred in ESC initialization.	<ul style="list-style-type: none"> Control PCB error 			○			1576 1577
84B70000 hex	Slave Unit Verification Error	An error occurred in Slave Unit verification.	<ul style="list-style-type: none"> Control PCB error 			○			1576 1577
84B80000 hex	Communications Setting Error	There is an error in the communications settings.	<ul style="list-style-type: none"> An out-of-range value was set from the host controller. A command that changes the communications state to an unsupported state was received. 			○			1576 1577
84B90000 hex	Synchronization Interruption Error	A synchronization interruption error occurred.	<ul style="list-style-type: none"> Control PCB error 			○			1576 1577

Event code	Event name	Meaning	Assumed cause	Level					Reference
				M a j	P r t	M i n	O b s	I n f o	
98010000 hex	Absolute Value Cleared	The multi-rotation counter for the absolute encoder was cleared during USB communications by the CX-Drive.	<ul style="list-style-type: none"> The multi-rotation counter for the absolute encoder was cleared during USB communications by the CX-Drive. 			○			I576
98020000 hex	Position Data Initialized	A Config operation was performed or the multi-rotation counter was cleared for the absolute encoder during EtherCAT communications.	<ul style="list-style-type: none"> A Config operation was performed during EtherCAT communications. The multi-rotation counter was cleared for the absolute encoder. (This applies only to Cylinder-type Servomotors.) 			○			I576 I577
08010000 hex	Battery Warning	The battery voltage is 3.2 V or less.	<ul style="list-style-type: none"> The battery voltage is 3.2 V or lower. 				○		I576
08020000 hex	Fan Warning	The fan stop state continued for 1 second.	<ul style="list-style-type: none"> There is foreign matter in the fan. The Servo Drive failed. 				○		I576 I577
08030000 hex	Encoder Communications Warning	Encoder communications errors occurred in series more frequently than the specified value.	<ul style="list-style-type: none"> There is insufficient power supply voltage for the encoder. Noise is entering on the encoder line. 				○		I576
08040000 hex	Encoder/Serial Conversion Unit Overheating Warning	The encoder temperature exceeded the specified value or an overheating warning was detected for the Serial Conversion Unit.	<ul style="list-style-type: none"> The ambient temperature is too high. Servomotor/Linear Motor failed. 				○		I576 I577
08050000 hex	Life Expectancy Warning	The remaining life of the capacitor or the fan is shorter than the specified value.	<ul style="list-style-type: none"> The life expectancy of the capacitor or the fan is shorter than the specified value. 				○		I576 I577
08060000 hex	External Encoder Error Warning	The external encoder detected a warning.	<ul style="list-style-type: none"> There is insufficient power supply voltage for the external encoder. Noise is entering on the external encoder connector cable. The external encoder failed. 				○		I576 I577
08070000 hex	External Encoder Communications Warning	The external encoder had more communications errors than the specified value.	<ul style="list-style-type: none"> There is insufficient power supply voltage for the external encoder. Noise is entering on the external encoder connector cable. 				○		I576 I577
34E00000 hex	Data Setting Warning	An object setting is out of range.	<ul style="list-style-type: none"> The object set value is out of the range 				○		I576 I577
383C0000 hex	Overload Warning	The load ratio is 85% or more of the protection level.	<ul style="list-style-type: none"> Overload There is incorrect wiring of the motor line or a broken cable. 				○		I576 I577

Event code	Event name	Meaning	Assumed cause	Level					Reference
				M a j	P r t	M i n	O b s	I n f o	
383D0000 hex	Excessive Regeneration Warning	The regeneration load ratio is 85% or more of the level.	<ul style="list-style-type: none"> There is excessive regeneration. This Regeneration Resistor cannot be used for continuous regenerative braking. 				○		1576 1577
383E0000 hex	Vibration Detection Warning	Vibration was detected.	<ul style="list-style-type: none"> The gain or inertial ratio/mass ratio setting is not suitable. 				○		1576 1577
74800000 hex	Command Warning	A command could not be executed.	<ul style="list-style-type: none"> The absolute multi-rotation counter was cleared when the Servo was not OFF when using an absolute encoder for semi-closed control (This applies only to Cylinder-type Servomotors.). A forced brake operation request was sent while the Servo was ON. A Switch ON command was sent when the main power was OFF. (When 3508 hex = 0) An Enable Operation command was sent to request turning ON the Servo when the Servomotor was operating at 30 r/min or 30 mm/s, or higher. A latch operation was started under the following conditions. An absolute external encoder was used and phase Z was selected as the trigger for fully-closed control (This applies only to Cylinder-type Servomotors.). The absolute multi-rotation data was being cleared or the Config operation was being performed. The Statusword (6041 hex) bit 09 (remote) was 0 (local). An operation command is given in the prohibited direction after the motor made an immediate stop due to a drive prohibition input. 				○		1576 1577
84B00000 hex	EtherCAT Communications Warning	An EtherCAT communications error occurred one or more times.	<ul style="list-style-type: none"> The EtherCAT communications cable is disconnected or broken. Noise 				○		1576 1577

MX2/RX-series Inverters with EtherCAT Communications Units

The manual names are given below for the catalog numbers given in the Reference column of the event table.

Cat. No.	Manual name
I574	MX2/RX Series Inverter EtherCAT Communication Unit User's Manual

Event code	Event name	Meaning	Assumed cause	Level					Reference
				M a j	P r t	M i n	O b s	I n f o	
04A10000 hex	Non-volatile Memory Hardware Error	An error occurred in non-volatile memory.	<ul style="list-style-type: none"> Non-volatile memory failure 			○			I574
04BA0000 hex	Connection Error between Inverter and Communications Unit	An error occurred in the connection between the Inverter and the EtherCAT Communications Unit for the Inverter.	<ul style="list-style-type: none"> Contact failure between the Inverter and the EtherCAT Communications Unit for the Inverter. Inverter trip was reset. The Inverter was initialized or the mode was changed. The EtherCAT Communications Unit for the Inverter failed. 			○			I574
04BB0000 hex	Inverter Warning	An Inverter warning was detected.	<ul style="list-style-type: none"> An Inverter warning was detected. 			○			I574
04BC0000 hex	Inverter Trip	An Inverter trip was detected.	<ul style="list-style-type: none"> An Inverter trip was detected. 			○			I574
34F00000 hex	PDO Setting Error	There is an illegal setting value in the PDO mapping.	<ul style="list-style-type: none"> The PDO mapping or SyncManager settings are incorrect. 			○			I574

FH/FZ5 Series Vision System

The manual names are given below for the catalog numbers given in the Reference column of the event table.

Cat. No.	Manual name
Z342	FH/FZ5 Vision System FH/FZ5 Series User's Manual for Communications Settings

Event code	Event name	Meaning	Assumed cause	Level					Reference
				M a j	P r t	M i n	O b s	I n f o	
08210000 hex	Fan/Power Supply Error	An error occurred in the fan or power supply.	<ul style="list-style-type: none"> A foreign object is interfering with fan operation. A suitable power supply voltage is not being used, resulting in an overvoltage or under-voltage. 						Z342
08220000 hex	Camera Overcurrent Detected	An overcurrent flowed to the Camera.	<ul style="list-style-type: none"> There is a short circuit inside the Camera cable or in a circuit inside the Controller. 						Z342
08230000 hex	Parallel I/O Overcurrent Detected	An overcurrent occurred in the parallel I/O interface.	<ul style="list-style-type: none"> A parallel I/O interface line is short-circuited. 						Z342
182D0000 hex	Setting Data Load Error	Loading the scene group data failed.	<ul style="list-style-type: none"> The data is corrupted because the power supply was turned OFF while saving the previous scene data. As the result of changing the operation mode, the required amount of memory increased, resulting in insufficient memory. 						Z342
38590000 hex	Camera Connection Error	The Camera connection is wrong.	<ul style="list-style-type: none"> A Camera is not connected to the Controller. The Camera cable is broken. The Camera Selection settings are not correct in the Camera Image Input and Camera Switching processing items. A Camera is not connected to the Camera port on the Controller according to the Camera Selection settings in the Camera Image Input and Camera Switching processing items. 						Z342
385A0000 hex	Change in Connected Camera	The Camera that is connected is different from when data was last saved.	<ul style="list-style-type: none"> The Camera connection information in the scene data does not agree with the connection information for the Camera connected to the Controller. 						Z342

Event code	Event name	Meaning	Assumed cause	Level					Reference
				M a j	P r t	M i n	O b s	I n f o	
385B0000 hex	Light installation error	The Light installation is incorrect.	<ul style="list-style-type: none"> The power consumption of the light installed onto a camera with a Lighting Controller is incorrect. The lighting mode of the light installed onto a camera with a Lighting Controller is incorrect. No external power supply is connected to the camera with a Lighting Controller. 			○			Z342
48020000 hex	System Error	An error occurred in the system.	<ul style="list-style-type: none"> A serious error occurred in the system in the Controller. 			○			Z342
58210000 hex	Output Control Timeout for Parallel I/O, PLC Link, or EtherNet/ IP	A timeout occurred in data output handshaking control for measurement results.	<ul style="list-style-type: none"> The data output handshaking controls in the program (i.e., the ON/OFF timing of the DSA signal) are not correct. The output control timeout time is too short in comparison with the program processing time. The parallel I/O DSA or Result Notification signal is not wired correctly. 			○			Z342
58220000 hex	Output Control Timeout for EtherCAT	A timeout occurred in data output handshaking control for measurement results.	<ul style="list-style-type: none"> The data output handshaking controls in the program (i.e., the ON/OFF timing of the Result Set Request signal) are not correct. The output control timeout time is too short in comparison with the program processing time. 			○			Z342
58230000 hex	Initial scene group error	Initial scene group setting is incorrect.	<ul style="list-style-type: none"> The external storage specified as the scene group destination by the Scene Group Saving Destination Settings tool is not connected at the time of start-up. The destination directory is not detected at the time of startup. Initial scene group number is not within the range of scene group accepted by the system. 			○			Z342
58240000 hex	Initial scene number error	Initial scene number setting is incorrect.	<ul style="list-style-type: none"> Initial scene number is not within the range of scenes accepted by the system. 			○			Z342
78190000 hex	Image Logging Disk Write Error	Writing data to the image logging disk failed.	<ul style="list-style-type: none"> A logging disk is not inserted. The available space on the logging disk is not sufficient. There is no logging folder. Security restrictions are set on the logging disk. 			○			Z342

Event code	Event name	Meaning	Assumed cause	Level					Reference
				M a j	P r t	M i n	O b s	I n f o	
781A0000 hex	Setting Data Transfer Error	An error occurred while transferring the scene data.	<ul style="list-style-type: none"> Scene data was edited when there was little available space on the RAM disk and the operation mode was Double Speed Multiinput. The data transfer button was clicked when there was little available space on the RAM disk and the operation mode was Non-stop Adjustment Mode. 			○			Z342
781B0000 hex	Output Buffer Error (EtherCAT)	The data output buffer for measurement data is full.	<ul style="list-style-type: none"> Data measurements are being performed on a period that is shorter than the time that is required for data output handshake controls in the program. 			○			Z342
88080000 hex	PLC Link Communications Error	A PLC Link cannot be established.	<ul style="list-style-type: none"> There is a mistake in the PLC or Vision Sensor communications settings. The Ethernet or RS-232C cable is damaged. 			○			Z342

EtherCAT FQ-M-series Specialized Vision Sensors for Positioning

The manual names are given below for the catalog numbers given in the Reference column of the event table.

Cat. No.	Manual name
Z314	FQ-M-series Specialized Vision Sensor for Positioning User's Manual

Event code	Event name	Meaning	Assumed cause	Level					Reference
				M a j	P r t	M i n	O b s	I n f o	
78080000 hex	TRIG Input Error	A TRIG signal was input when the BUSY signal for Sensor measurement was ON.	<ul style="list-style-type: none"> A TRIG signal was input when the BUSY signal for Sensor measurement was ON. Chattering occurred for a contact input. 				○		Z314
780A0000 hex	Scene Data Error	The scene data to switch to is corrupted.	<ul style="list-style-type: none"> The power supply was interrupted when the scene data to switch to was saved. 				○		Z314
780B0000 hex	Model Error	A model was re-registered with an image with low contrast.	<ul style="list-style-type: none"> A model was re-registered with an image with low contrast. 				○		Z314
780C0000 hex	Logging Error	Some data was not saved when logging data to files on an SD card.	<ul style="list-style-type: none"> Too much data to log in files occurred in a short period of time, and writing to the SD card could not keep up. 				○		Z314
780D0000 hex	Output Timeout	A timeout occurred in data output handshaking control for measurement results.	<ul style="list-style-type: none"> The data output handshaking controls in the program (i.e., the ON/OFF timing of the DSA signal) are not correct. The output control timeout time is too short in comparison with the program processing time. 				○		Z314
780E0000 hex	Output Size Error	The data output size setting and the PDO mapping setting do not agree.	<ul style="list-style-type: none"> The EtherCAT data output size setting in the Sensor and the PDO mapping setting in the EtherCAT master do not agree. 				○		Z314

E3X-series Fiber Sensors with EtherCAT Communications Unit for Digital Sensors

The manual names are given below for the catalog numbers given in the Reference column of the event table.

Cat. No.	Manual name
E413	EtherCAT Digital-type Sensor Communication Unit Operation Manual

Event code	Event name	Meaning	Assumed cause	Level					Reference
				M a j	P r t	M i n	O b s	I n f o	
04C40000 hex	Sensor Communications Error	An error occurred in a Sensor connection.	<ul style="list-style-type: none"> The Sensor is disconnected. 			○			E413
04C50000 hex	Sensor Communications Has Not Been Established	Communications has not been established with the Sensor.	<ul style="list-style-type: none"> A Sensor is not connected. 			○			E413
14A00000 hex	Non-volatile Memory Checksum Error	An error occurred in the control parameters.	<ul style="list-style-type: none"> Noise 			○			E413
24780000 hex	Number of Sensors Verify Error	The number of Sensors that is connected does not agree with the settings.	<ul style="list-style-type: none"> The set value does not match the number of Sensors that are actually connected. 			○			E413
24790000 hex	Number of Sensors Over Limit	Too many Sensors are connected.	<ul style="list-style-type: none"> More than the maximum number of Sensors are connected. 			○			E413
34F80000 hex	Dummy Sensors Setting Error	Too many Dummy Units are set.	<ul style="list-style-type: none"> There are too many Dummy Units set, so some Sensors are not assigned logical unit numbers. 			○			E413
04A10000 hex	Non-volatile Memory Hardware Error	An error occurred in non-volatile memory.	<ul style="list-style-type: none"> Non-volatile memory failure 				○		E413

E3NW-ECT EtherCAT Digital Sensor Communications Unit

The manual names are given below for the catalog numbers given in the Reference column of the event table.

Cat. No.	Manual name
E429	EtherCAT Digital-type Sensor Communication Unit Operation Manual

Event code	Event name	Meaning	Assumed cause	Level					Reference
				M a j	P r t	M i n	O b s	I n f o	
04C40000 hex	Sensor Communications Error	An error occurred in a Sensor connection.	<ul style="list-style-type: none"> The Sensor is disconnected. 				○		E429
04C50000 hex	Sensor Communications Has Not Been Established	Communications has not been established with the Sensor.	<ul style="list-style-type: none"> A sensor is not connected. 				○		E429
14A00000 hex	Non-volatile Memory Checksum Error	An error occurred in the control parameters.	<ul style="list-style-type: none"> Noise 				○		E429
247A 0000 hex	Number of Distributed Sensor Unit Verify Error	The number of Distributed Sensor Unit that is checked at power up is decreased.	<ul style="list-style-type: none"> The Distributed Sensor Unit is disconnected 				○		E429
247B 0000 hex	Number of Sensors Over Limit	Too many Sensors are connected.	<ul style="list-style-type: none"> More than the maximum number of Sensors are connected. 				○		E429
247C 0000 hex	Number of Sensors Verify Error	The number of Sensors that is connected does not agree with the settings.	<ul style="list-style-type: none"> The set value does not match the number of Sensors that are actually connected. 				○		E429
247D 0000 hex	Number of Sensors Over at Distributed Sensor Unit	Too many Sensors are connected at Distributed Sensor Unit.	<ul style="list-style-type: none"> More than the maximum number of Sensors are connected at Distributed Sensor Unit. 				○		E429
34F80000 hex	Dummy Sensors Setting Error	Too many Dummy Units are set.	<ul style="list-style-type: none"> There are too many Dummy Units set, so some Sensors are not assigned logical unit numbers. 				○		E429
04A10000 hex	Non-volatile Memory Hardware Error	An error occurred in non-volatile memory.	<ul style="list-style-type: none"> Non-volatile memory failure 					○	E429

ZW-CE1□T Confocal Fiber Type Displacement Sensor

The manual names are given below for the catalog numbers given in the Reference column of the event table.

Cat. No.	Manual name
Z332	ZW-CE1□T Confocal Fiber Type Displacement Sensor User's Manual

Event code	Event name	Meaning	Assumed cause	Level					Reference
				M a j	P r t	M i n	O b s	I n f o	
04D00000 hex	Hardware error	Some abnormality occurred on the displacement sensor hardware.	<ul style="list-style-type: none"> Hardware damage 			○			Z332
14B00000 hex	Linearity correction data error	The linearity correction data of the displacement sensor is damaged.	<ul style="list-style-type: none"> Calibration ROM damage 			○			Z332
14B10000 hex	Linearity correction data read error	Reading of the displacement sensor linearity correction data was not executed correctly.	<ul style="list-style-type: none"> Calibration ROM not inserted Calibration ROM damage 			○			Z332
14B20000 hex	System setting error	The system settings saved to the displacement sensor are corrupt.	<ul style="list-style-type: none"> The displacement sensor power was turned OFF during saving/loading of system settings. 			○			Z332
14B30000 hex	Bank data error	The bank data saved to the displacement sensor is corrupt.	<ul style="list-style-type: none"> The displacement sensor power was turned OFF during saving/loading of bank data. 			○			Z332
24810000 hex	Ethernet communication parameter error	An invalid IP address is set for the displacement sensor.	<ul style="list-style-type: none"> Invalid IP address setting 			○			Z332
74900000 hex	Multiple control signal input error	Multiple control signals turned ON in the same cycle.	<ul style="list-style-type: none"> Multiple control signals turned ON in the same cycle. 			○			Z332
74910000 hex	EXE input error	EXE input processing was not executed correctly.	<ul style="list-style-type: none"> EXE input turned ON in the FUN mode. EXE input turned ON with READY output OFF. 			○			Z332
74920000 hex	SYNC input error	SYNC input processing was not executed correctly.	<ul style="list-style-type: none"> SYNC input turned ON in the FUN mode. 			○			Z332

Event code	Event name	Meaning	Assumed cause	Level					Reference
				M a j	P r t	M i n	O b s	I n f o	
74930000 hex	TIMING input error	TIMING input processing was not executed correctly.	<ul style="list-style-type: none"> TIMINGx input turned ON in the FUN mode. TIMINGx input turned ON or OFF while RESETx input was ON. TIMINGx input turned ON in a non-measurement state. TIMINGx input turned ON before the "delay time + sampling time" elapsed. 			○			Z332
74940000 hex	RESET input error	RESET input processing was not executed correctly.	<ul style="list-style-type: none"> RESETx input turned ON in the FUN mode. 			○			Z332
74950000 hex	ZERO input error	ZERO input processing was not executed correctly.	<ul style="list-style-type: none"> ZEROx input turned ON in the FUN mode. ZEROx input turned ON in a non-measurement state. ZEROx input turned ON for a task whose status is OFF. 			○			Z332
74960000 hex	ZEROCLR input error	ZEROCLR input processing was not executed correctly.	<ul style="list-style-type: none"> ZEROCLRx input turned ON in the FUN mode. 			○			Z332

A-3 Events in Order of Event Codes

This section provides a table of all events in order of the event codes. Events that are not errors are also given in the tables.

A-3-1 Interpreting Error Descriptions

The contents of the error table is described below.

Item	Description
Event code	The event code of the error in the NY-series Controller is given. The codes are given in eight hexadecimal digits.
Event name	The name of the event is given.
Functional classification	A functional classification of the source is given.
Reference	The catalog number of the manual that provides details on the event are given.

Refer to information for the specified functional classification of the error in the error descriptions in the manual given in the Reference column in the tables for detailed information on an error.

The manual names are given below for the catalog numbers.

Cat. No.	Manual name
W521	NX-series Digital I/O Units User's Manual
W522	NX-series Analog I/O Units User's Manual for Analog Input Units and Analog Output Units
W523	NX-series System Units User's Manual
W540	NX-series Communications Interface Units User's Manual
W564	NY-series Troubleshooting Manual
W565	NX-series Load Cell Input Unit User's Manual
W566	NX-series Analog I/O Units User's Manual for Temperature Input Units and Heater Burnout Detection Units
W488	GX-series EtherCAT Slave Units User's Manual
W519	NX-series EtherCAT Coupler Unit User's Manual
W570	IO-Link System User's Manual
I574	MX2/RX Series Inverter EtherCAT Communication Unit User's Manual
I576	AC Servomotors/Servo Drives G5-series with Built-in EtherCAT Communications User's Manual
I577	AC Servomotors/Servo Drives G5-series with Built-in EtherCAT Communications Linear Motor Type User's Manual
W524	NX-series Position Interface Units User's Manual
I586	AC Servomotors/Servo Drives 1S-series with Built-in EtherCAT Communications User's Manual
O030	NJ/NY-series NC Integrated Controller User's Manual
I621	AC Servomotors/Servo Drives 1S-series with Built-in EtherCAT Communications and Safety Functionality User's Manual
E413	EtherCAT Digital-type Sensor Communications Unit Operation Manual
E429	EtherCAT Digital Sensor Communications Unit Operation Manual
Z314	FQ-M-series Specialized Vision Sensor for Positioning User's Manual
Z342	FH/FZ5 Vision System FH/FZ5 Series User's Manual for Communications Settings

Cat. No.	Manual name
Z332	ZW-CE1□T Confocal Fiber Type Displacement Sensor User's Manual
Z930	NX-series Safety Control Unit User's Manual
H228	NX-series Temperature Control Units User's Manual

A-3-2 Events in Order of Event Codes

Event code	Event name	Functional classification	Reference
000B0000 hex	Low Battery Voltage	Errors for Self Diagnosis	W564
000C0000 hex	CPU Unit Overheat	Errors for Self Diagnosis	W564
000D0000 hex	Internal Bus Check Error	Errors for Self Diagnosis	W564
000E0000 hex	Non-volatile Memory Life Exceeded	Errors for Self Diagnosis	W564
00110000 hex	CPU Unit Overheat (Operation Stopped)	Errors for Self Diagnosis	W564
00120000 hex	Slow Fan	Errors for Self Diagnosis	W564
00200000 hex	Non-volatile Memory Hardware Error	NX-series Digital I/O Units, NX-series Analog I/O Units, NX-series System Units, NX-series Position Interface Units, NX-series Communications Interface Units, NX-series Load Cell Input Units, NX-series IO-Link Master Units, and NX-series Temperature Control Units	W521 W522 W566 W523 W524 W540 W565 W570 H228
00210000 hex	Bus Controller Error	NX-series EtherCAT Coupler Unit	W519
00220000 hex	Non-volatile Memory Hardware Error	NX-series EtherCAT Coupler Unit	W519
04210000 hex	Communications Controller Failure	Built-in EtherNet/IP Port on CPU Unit	W564
04400000 hex	Communications Controller Failure	Built-in EtherCAT Master in CPU Unit	W564
04A00000 hex	Expansion Unit Hardware Error	GX-series EtherCAT Slave Units	W488
04A10000 hex	Non-volatile Memory Hardware Error	GX-series EtherCAT Slave Units, MX2/RX-series Inverters with Ether-CAT Communications Units, Ether-CAT M3X Photoelectric Fiber Amplifiers, E3X-series Fiber Sensors with EtherCAT Communications Unit for Digital Sensors, and Ether-CAT Digital Sensor Communications Units	W488 I574 E413 E429 W570
04A20000 hex	Slave Hardware Error	GX-series EtherCAT Slave Units	W488 W570
04A80000 hex	Control Power Supply Undervoltage	Servo G5 and G5 Linear	I576 I577
04A90000 hex	Overvoltage	Servo G5 and G5 Linear	I576 I577

Event code	Event name	Functional classification	Reference
04AA0000 hex	Main Circuit Power Supply Undervoltage (Undervoltage between positive and negative terminals)	Servo G5 and G5 Linear	1576 1577
04AB0000 hex	Main Circuit Power Supply Undervoltage (AC Cutoff Detected)	Servo G5 and G5 Linear	1576 1577
04AC0000 hex	Overcurrent	Servo G5 and G5 Linear	1576 1577
04AD0000 hex	IPM Error	Servo G5 and G5 Linear	1576 1577
04AE0000 hex	Regeneration Tr Error	Servo G5 and G5 Linear	1576 1577
04AF0000 hex	Encoder Phase-Z Error	Servo G5	1576
04B00000 hex	Encoder CTS Signal Error	Servo G5	1576
04B10000 hex	Node Address Setting Error	Servo G5 and G5 Linear	1576 1577
04B20000 hex	Other Errors	G5 Linear	1577
04B30000 hex	Regeneration Circuit Error Detected during Power ON	Servo 1S	1586
04B50000 hex	Inrush Current Prevention Circuit Error	Servo 1S	1586
04B60000 hex	Regeneration Circuit Error	Servo 1S	1586 1621
04BA0000 hex	Connection Error between Inverter and Communications Unit	MX2/RX-series Inverters with EtherCAT Communications Units	1574
04BB0000 hex	Inverter Warning	MX2/RX-series Inverters with EtherCAT Communications Units	1574
04BC0000 hex	Inverter Trip	MX2/RX-series Inverters with EtherCAT Communications Units	1574
04C40000 hex	Sensor Communications Error	E3X-series Fiber Sensors with EtherCAT Communications Unit for Digital Sensors and EtherCAT Digital Sensor Communications Units	E413 E429
04C50000 hex	Sensor Communications Has Not Been Established	E3X-series Fiber Sensors with EtherCAT Communications Unit for Digital Sensors and EtherCAT Digital Sensor Communications Units	E413 E429
04D00000 hex	Hardware error	ZW-CE1□T Confocal Fiber Type Displacement Sensor	Z332
05010000 hex	ESC Error	NX-series EtherCAT Coupler Unit	W519
05020000 hex	ESC Initialization Error	NX-series EtherCAT Coupler Unit	W519
05030000 hex	Slave Unit Verification Error	NX-series EtherCAT Coupler Unit	W519

Event code	Event name	Functional classification	Reference
05100000 hex	A/D Converter Error	NX-series Analog I/O Units and NX-series Temperature Control Units	W566 H228
05110000 hex	Cold Junction Sensor Error	NX-series Analog I/O Units and NX-series Temperature Control Units	W566 H228
05120000 hex	A/D Conversion Error	NX-series Load Cell Input Units	W565
05200000 hex	System Error	NX-series Safety Control Unit	Z930
05210000 hex	Internal Circuit Error at Safety Input	NX-series Safety Control Unit	Z930
05220000 hex	Internal Circuit Error at Test Out- put	NX-series Safety Control Unit	Z930
05230000 hex	Internal Circuit Error at Safety Output	NX-series Safety Control Unit	Z930
05430000 hex	ESC Error	Servo 1S	I586 I621
08010000 hex	Battery Warning	Servo G5	I576
08020000 hex	Fan Warning	Servo G5 and G5 Linear	I576 I577
08030000 hex	Encoder Communications Warn- ing	Servo G5	I576
08040000 hex	Encoder/Serial Conversion Unit Overheating Warning	Servo G5 and G5 Linear	I576 I577
08050000 hex	Life Expectancy Warning	Servo G5 and G5 Linear	I576 I577
08060000 hex	External Encoder Error Warning	Servo G5 and G5 Linear	I576 I577
08070000 hex	External Encoder Communica- tions Warning	Servo G5 and G5 Linear	I576 I577
08080000 hex	Encoder Communications Dis- connection Error	Servo G5	I576
08090000 hex	Encoder Communications Error	Servo G5	I576
080A0000 hex	Encoder Communications Data Error	Servo G5	I576
080B0000 hex	Safety Input Error	Servo G5 and G5 Linear	I576 I577
080C0000 hex	External Encoder Connection Error	Servo G5 and G5 Linear	I576 I577
080D0000 hex	External Encoder Communica- tions Data Error	Servo G5 and G5 Linear	I576 I577
080E0000 hex	External Encoder Status Error 0	Servo G5 and G5 Linear	I576 I577
080F0000 hex	External Encoder Status Error 1	Servo G5 and G5 Linear	I576 I577
08100000 hex	External Encoder Status Error 2	Servo G5 and G5 Linear	I576 I577
08110000 hex	External Encoder Status Error 3	Servo G5 and G5 Linear	I576 I577
08120000 hex	External Encoder Status Error 4	Servo G5 and G5 Linear	I576 I577

Event code	Event name	Functional classification	Reference
08130000 hex	External Encoder Status Error 5	Servo G5 and G5 Linear	1576 1577
08140000 hex	Phase-A Connection Error	Servo G5 and G5 Linear	1576 1577
08150000 hex	Phase-B Connection Error	Servo G5 and G5 Linear	1576 1577
08160000 hex	Phase-Z Connection Error	Servo G5 and G5 Linear	1576 1577
08170000 hex	Encoder Data Restoration Error	Servo G5	1576
08180000 hex	External Encoder Data Restoration Error	Servo G5	1576
081C0000 hex	Capacitor Lifetime Warning	Servo 1S	1586 1621
081D0000 hex	Inrush Current Prevention Relay Lifetime Warning	Servo 1S	1586 1621
081F0000 hex	Brake Interlock Output Relay Lifetime Warning	Servo 1S	1586
08210000 hex	Fan/Power Supply Error	FH/FZ5 Series Vision System	Z342
08220000 hex	Camera Overcurrent Detected	FH/FZ5 Series Vision System	Z342
08230000 hex	Parallel I/O Overcurrent Detected	FH/FZ5 Series Vision System	Z342
08390000 hex	Power Module Error	Servo 1S	1586 1621
083A0000 hex	Encoder Communications Warning	Servo 1S	1586
083B0000 hex	Self-diagnosis Error	Servo 1S	1586 1621
083C0000 hex	Main Circuit Temperature Monitoring Circuit Failure	Servo 1S	1586 1621
083D0000 hex	Fan Error	Servo 1S	1586 1621
083F0000 hex	Regeneration Processing Error	Servo 1S	1586 1621
08410000 hex	Overvoltage Error	Servo 1S	1586 1621
08420000 hex	Motor Overheat Error	Servo 1S	1586
08430000 hex	1-rotation Counter Error	Servo 1S	1586 1621
08440000 hex	Overspeed Error	Servo 1S	1586
08450000 hex	Encoder Memory Error	Servo 1S	1586 1621
08460000 hex	Absolute Position Detection Error	Servo 1S	1586 1621
08470000 hex	Encoder Lifetime Warning	Servo 1S	1586 1621
08480000 hex	Main Power Supply Undervoltage (insufficient voltage between P and N)	Servo 1S	1586 1621
08490000 hex	Overcurrent Error	Servo 1S	1586 1621

Event code	Event name	Functional classification	Reference
084A0000 hex	Encoder Communications Disconnection Error	Servo 1S	I586
084B0000 hex	Encoder Communications Error	Servo 1S	I586 I621
084C0000 hex	Fan Rotation Warning	Servo 1S	I586 I621
084D0000 hex	Non-volatile Memory Hardware Error	Servo 1S	I586 I621
084E0000 hex	Absolute Encoder Counter Overflow Warning	Servo 1S	I586 I621
086D0000 hex	Motor Temperature Error	Servo 1S	I621
086E0000 hex	Encoder Error	Servo 1S	I621
086F0000 hex	Encoder Power Supply Error	Servo 1S	I621
08700000 hex	Encoder Self-diagnosis Error	Servo 1S	I621
08710000 hex	Internal Circuit Error at SF Input	Servo 1S	I621
08720000 hex	Internal Circuit Error at SOPT Input	Servo 1S	I621
08730000 hex	Internal Circuit Error at Test Output	Servo 1S	I621
08740000 hex	Internal Circuit Error at SBC Output	Servo 1S	I621
08750000 hex	Overspeed Error	Servo 1S	I621
08760000 hex	Absolute Encoder Multirotation Counter Error	Servo 1S	I621
08770000 hex	Safety Relay Lifetime Warning	Servo 1S	I621
08780000 hex	Encoder Communications Disconnection Error	Servo 1S	I621
10010000 hex	Non-volatile Memory Restored or Formatted	Errors for Self Diagnosis	W564
10020000 hex	Non-volatile Memory Data Corrupted	Errors for Self Diagnosis	W564
10080000 hex	Main Memory Check Error	Errors for Self Diagnosis	W564
100B0000 hex	Non-volatile Memory Data Corrupted	Errors for Self Diagnosis	W564
100C0000 hex	Event Level Setting Error	Errors for Self Diagnosis	W564
100F0000 hex	Present Values of Retained Variables Restoration Error	Errors for Self Diagnosis	W564
10100000 hex	Present Values of Retained Variables Not Saved	Errors for Self Diagnosis	W564
10120000 hex	Firmware Configuration Mismatch	Errors for Self Diagnosis	W564
10200000 hex	User Program/Controller Configurations and Setup Transfer Error	Errors Related to Controller Operation	W564
10210000 hex	Illegal User Program Execution ID	Errors Related to Controller Operation	W564
10230000 hex	Event Log Save Error	Errors Related to Controller Operation	W564
10240000 hex	Illegal User Program	Errors Related to Controller Operation	W564

Event code	Event name	Functional classification	Reference
10250000 hex	Illegal User Program/Controller Configurations and Setup	Errors Related to Controller Operation	W564
10260000 hex	Trace Setting Transfer Failure	Errors Related to Controller Operation	W564
102F0000 hex	EtherCAT Slave Backup Failed	Built-in EtherCAT Master in CPU Unit	W564
10300000 hex	EtherCAT Slave Restore Operation Failed	Built-in EtherCAT Master in CPU Unit	W564
10350000 hex	Backup Failed to Start	Errors Related to Controller Operation	W564
10360000 hex	Backup Failed	Errors Related to Controller Operation	W564
10370000 hex	Restore Operation Failed to Start	Errors Related to Controller Operation	W564
10380000 hex	Restore Operation Failed	Errors Related to Controller Operation	W564
10390000 hex	Shared Folder Recognition Failed	Errors Related to Controller Operation	W564
103A0000 hex	Shared Folder Recognition Cancel Failed	Errors Related to Controller Operation	W564
103B0000 hex	Shared Folder Recognition Cancel Completed	Errors Related to Controller Operation	W564
10400000 hex	Analog Unit Calibration Parameter Error	NX-series Analog I/O Units	W522
10410000 hex	Control Parameter Error in Master	NX-series Digital I/O Units, NX-series Analog I/O Units, NX-series Position Interface Units, NX-series Communications Interface Units, NX-series Load Cell Input Units, NX-series IO-Link Master Units, and NX-series Temperature Control Units	W521 W522 W566 W524 W540 W565 W570 H228
10420000 hex	Non-volatile Memory Control Parameter Error	NX-series EtherCAT Coupler Unit	W519
10430000 hex	Memory Corruption Detected	NX-series EtherCAT Coupler Unit	W519
10440000 hex	Unit Calibration Value Error	NX-series Load Cell Input Units	W565
10450000 hex	Actual Load Calibration Value Error	NX-series Load Cell Input Units	W565
10500000 hex	NX Bus Communications Settings Read Error	NX-series Safety Control Unit	Z930
10510000 hex	Safety Application Data Read Error	NX-series Safety Control Unit	Z930
10520000 hex	NX Bus Communications Settings and Safety Application Data Mismatch	NX-series Safety Control Unit	Z930
10530000 hex	Non-volatile Memory Access Error	NX-series Safety Control Unit	Z930
14210000 hex	Identity Error	Built-in EtherNet/IP Port on CPU Unit	W564

Event code	Event name	Functional classification	Reference
14220000 hex	EtherNet/IP Processing Error	Built-in EtherNet/IP Port on CPU Unit	W564
14230000 hex	MAC Address Error	Built-in EtherNet/IP Port on CPU Unit	W564
14400000 hex	MAC Address Error	Built-in EtherCAT Master in CPU Unit	W564
14600000 hex	Absolute Encoder Home Offset Read Error	General Motion Control	W564
14610000 hex	Motion Control Parameter Setting Error	General Motion Control	W564
14620000 hex	Cam Data Read Error	General Motion Control	W564
14630000 hex	Cam Table Save Error	General Motion Control	W564
14A00000 hex	Non-volatile Memory Checksum Error	GX-series EtherCAT Slave Units, E3X-series Fiber Sensors with EtherCAT Communications Unit for Digital Sensors, and EtherCAT Digital Sensor Communications Units	W488 E413 E429 W570
14A80000 hex	Object Error	Servo G5 and G5 Linear	I576 I577
14A90000 hex	Object Error	Servo G5 and G5 Linear	I576 I577
14AA0000 hex	Object Error	Servo G5 and G5 Linear	I576 I577
14AB0000 hex	Object Corrupted	Servo G5 and G5 Linear	I576 I577
14AC0000 hex	Object Corrupted	Servo G5 and G5 Linear	I576 I577
14AD0000 hex	Object Corrupted	Servo G5 and G5 Linear	I576 I577
14B00000 hex	Linearity Correction Data Error	ZW-CE1□T Confocal Fiber Type Displacement Sensor	Z332
14B10000 hex	Linearity Correction Data Read Error	ZW-CE1□T Confocal Fiber Type Displacement Sensor	Z332
14B20000 hex	System Setting Error	ZW-CE1□T Confocal Fiber Type Displacement Sensor	Z332
14B30000 hex	Bank Data Error	ZW-CE1□T Confocal Fiber Type Displacement Sensor	Z332
14C00000 hex	Unit Calibration Value Parity Error	NX-series Analog I/O Units	W522
14C10000 hex	Invalid Tuning Parameters Saved in the Unit	NX-series Temperature Control Units	H228
17800000 hex	CNC Parameter Setting Error	CNC Function	O030
17810000 hex	Absolute Encoder Home Offset Read Error	CNC Function	O030
17820000 hex	CNC Motor Compensation Table Read Error	CNC Function	O030
18200000 hex	Absolute Encoder Overspeed Error	Servo G5	I576
18210000 hex	Encoder Initialization Error	Servo G5	I576

Event code	Event name	Functional classification	Reference
18220000 hex	Absolute Encoder One-rotation Counter Error	Servo G5	I576
18230000 hex	Absolute Encoder Multi-rotation Counter Error	Servo G5 and Servo 1S	I576 I586
182D0000 hex	Setting Data Load Error	FH/FZ5 Series Vision System	Z342
18380000 hex	System Error	Servo 1S	I586 I621
18390000 hex	Lifetime Information Corruption Warning	Servo 1S	I586
183A0000 hex	Non-volatile Memory Data Error	Servo 1S	I586 I621
24200000 hex	Slave Node Address Duplicated	Built-in EtherCAT Master in CPU Unit	W564
24610000 hex	Switch Setting Error	GX-series EtherCAT Slave Units	W488
24680000 hex	Motor Non-conformity	Servo G5	I576
24690000 hex	Motor Non-conformity	Servo G5	I576
246A0000 hex	Motor Non-conformity	Servo G5	I576
246B0000 hex	Motor Non-conformity	Servo G5	I576
246C0000 hex	Motor Non-conformity	Servo G5	I576
246D0000 hex	Motor Non-conformity	Servo 1S	I586 I621
24780000 hex	Number of Sensors Verify Error	E3X-series Fiber Sensors with EtherCAT Communications Unit for Digital Sensors	E413
24790000 hex	Number of Sensors Over Limit	E3X-series Fiber Sensors with EtherCAT Communications Unit for Digital Sensors	E413
247A 0000 hex	Number of Distributed Sensor Unit Verify Error	EtherCAT Digital Sensor Communications Units	E429
247B 0000 hex	Number of Sensors Over Limit	EtherCAT Digital Sensor Communications Units	E429
247C 0000 hex	Number of Sensors Verify Error	EtherCAT Digital Sensor Communications Units	E429
247D 0000 hex	Number of Sensors Over at Distributed Sensor Unit	EtherCAT Digital Sensor Communications Units	E429
24810000 hex	Ethernet Communications Parameter Error	ZW-CE1□T Confocal Fiber Type Displacement Sensor	Z332
24A00000 hex	Unit Configuration Error, Too Many Units	NX-series EtherCAT Coupler Unit	W519
24A10000 hex	Unit Configuration Error, Unsupported Configuration	NX-series EtherCAT Coupler Unit	W519
28010000 hex	Motor Setting Error	G5 Linear	I577
28020000 hex	Motor Combination Error 1	G5 Linear	I577
28030000 hex	Motor Combination Error 2	G5 Linear	I577
28080000 hex	Main Circuit Power Supply Phase Loss Error	Servo 1S	I586 I621
280D0000 hex	Runaway Detected	Servo 1S	I586 I621
34200000 hex	Tag Data Link Setting Error	Built-in EtherNet/IP Port on CPU Unit	W564

Event code	Event name	Functional classification	Reference
34230000 hex	IP Route Table Setting Error	Built-in EtherNet/IP Port on CPU Unit	W564
34240000 hex	FTP Server Setting Error	Built-in EtherNet/IP Port on CPU Unit	W564
34250000 hex	NTP Client Setting Error	Built-in EtherNet/IP Port on CPU Unit	W564
34260000 hex	SNMP Setting Error	Built-in EtherNet/IP Port on CPU Unit	W564
34270000 hex	Tag Name Resolution Error	Built-in EtherNet/IP Port on CPU Unit	W564
34280000 hex	Basic Ethernet Setting Error	Built-in EtherNet/IP Port on CPU Unit	W564
34290000 hex	IP Address Setting Error	Built-in EtherNet/IP Port on CPU Unit	W564
342A0000 hex	DNS Setting Error	Built-in EtherNet/IP Port on CPU Unit	W564
34400000 hex	Network Configuration Information Error	Built-in EtherCAT Master in CPU Unit	W564
34410000 hex	EtherCAT Communications Cycle Exceeded	Built-in EtherCAT Master in CPU Unit	W564
34600000 hex	Required Process Data Object Not Set	General Motion Control	W564
34610000 hex	Process Data Object Setting Missing	Motion Control Instructions	W564
34630000 hex	Axis Slave Disabled	General Motion Control	W564
34640000 hex	Network Configuration Information Missing for Axis Slave	General Motion Control	W564
34E00000 hex	Data Setting Warning	Servo G5, G5 Linear, and Servo 1S	I576 I577 I586
34E10000 hex	Servo Drive Overheat	Servo G5 and G5 Linear	I576 I577
34E20000 hex	Overload	Servo G5 and G5 Linear	I576 I577
34E30000 hex	Regeneration Overload	Servo G5 and G5 Linear	I576 I577
34E40000 hex	Error Counter Overflow	Servo G5 and G5 Linear	I576 I577
34E50000 hex	Excessive Velocity Error	Servo G5 and G5 Linear	I576 I577
34E60000 hex	Overspeed	Servo G5 and G5 Linear	I576 I577
34F00000 hex	PDO Setting Error	MX2/RX-series Inverters with EtherCAT Communications Units	I574
34F80000 hex	Dummy Sensors Setting Error	E3X-series Fiber Sensors with EtherCAT Communications Unit for Digital Sensors and EtherCAT Digital Sensor Communications Units	E413 E429

Event code	Event name	Functional classification	Reference
35000000 hex	Unit Configuration Information Error	NX-series EtherCAT Coupler Unit	W519
35010000 hex	Unit Configuration Verification Error	NX-series EtherCAT Coupler Unit	W519
35020000 hex	NX Unit Minor Fault	NX-series EtherCAT Coupler Unit	W519
35030000 hex	NX Unit Observation	NX-series EtherCAT Coupler Unit	W519
35040000 hex	Mailbox Setting Error	NX-series EtherCAT Coupler Unit	W519
35050000 hex	RxPDO Setting Error	NX-series EtherCAT Coupler Unit	W519
35060000 hex	TxPDO Setting Error	NX-series EtherCAT Coupler Unit	W519
35070000 hex	PDO WDT Setting Error	NX-series EtherCAT Coupler Unit	W519
35080000 hex	SM Event Mode Setting Error	NX-series EtherCAT Coupler Unit	W519
35090000 hex	TxPDO Mapping Error	NX-series EtherCAT Coupler Unit	W519
350A0000 hex	RxPDO Mapping Error	NX-series EtherCAT Coupler Unit	W519
350B0000 hex	Illegal State Transition Request Received	NX-series EtherCAT Coupler Unit	W519
350C0000 hex	Error State Transition Received	NX-series EtherCAT Coupler Unit	W519
350D0000 hex	Synchronization Cycle Setting Error	NX-series EtherCAT Coupler Unit	W519
350E0000 hex	NX Bus Cycle Delay Detected	NX-series EtherCAT Coupler Unit	W519
35100000 hex	External Input Setting Error	NX-series Position Interface Units	W524
35110000 hex	SSI Data Setting Error	NX-series Position Interface Units	W524
35200000 hex	Safety Process Data Communications Not Established Error	NX-series Safety Control Unit	Z930
35210000 hex	Safety Process Data Communications Not Established - Incorrect Unit Parameter Error	NX-series Safety Control Unit	Z930
35230000 hex	Safety Process Data Communications Not Established, Incorrect FSoE Slave Address Error	NX-series Safety Control Unit	Z930
35240000 hex	Safety Process Data Communications Not Established, Incorrect Frame Error	NX-series Safety Control Unit	Z930
357D0000 hex	DC Setting Error	Servo 1S	I586 I621
357E0000 hex	Synchronization Cycle Setting Error	Servo 1S	I586 I621
357F0000 hex	Mailbox Setting Error	Servo 1S	I586 I621

Event code	Event name	Functional classification	Reference
35800000 hex	RxPDO Setting Error	Servo 1S	I586 I621
35810000 hex	TxPDO Setting Error	Servo 1S	I586 I621
35820000 hex	RxPDO Mapping Error	Servo 1S	I586 I621
35830000 hex	TxPDO Mapping Error	Servo 1S	I586 I621
35840000 hex	PDO WDT Setting Error	Servo 1S	I586 I621
35850000 hex	Node Address Updated	Servo 1S	I586 I621
35860000 hex	SM Event Mode Setting Error	Servo 1S	I586 I621
37800000 hex	Required Process Data Object Not Set	CNC Function	O030
37810000 hex	Process Data Object Setting Missing	CNC Function	O030
383C0000 hex	Overload Warning	Servo G5 and G5 Linear	I576 I577
383D0000 hex	Excessive Regeneration Warning	Servo G5 and G5 Linear	I576 I577
383E0000 hex	Vibration Detection Warning	Servo G5 and G5 Linear	I576 I577
383F0000 hex	Excessive Hybrid Following Error	Servo G5	I576
38400000 hex	Overspeed 2	Servo G5 and G5 Linear	I576 I577
38410000 hex	Command Error	Servo G5 and G5 Linear	I576 I577
38420000 hex	Command Generation Error	Servo G5 and G5 Linear	I576 I577
38430000 hex	Error Counter Overflow 1	Servo G5 and G5 Linear	I576 I577
38440000 hex	Error Counter Overflow 2	Servo G5 and G5 Linear	I576 I577
38450000 hex	Interface Input Duplicate Allocation Error 1	Servo G5 and G5 Linear	I576 I577
38460000 hex	Interface Input Duplicate Allocation Error 2	Servo G5 and G5 Linear	I576 I577
38470000 hex	Interface Input Function Number Error 1	Servo G5 and G5 Linear	I576 I577
38480000 hex	Interface Input Function Number Error 2	Servo G5 and G5 Linear	I576 I577
38490000 hex	Interface Output Function Number Error 1	Servo G5 and G5 Linear	I576 I577
384A0000 hex	Interface Output Function Number Error 2	Servo G5 and G5 Linear	I576 I577
384B0000 hex	External Latch Input Allocation Error	Servo G5 and G5 Linear	I576 I577

Event code	Event name	Functional classification	Reference
384C0000 hex	Overrun Limit Error	Servo G5 and G5 Linear	1576 1577
384D0000 hex	Absolute Encoder System Down Error	Servo G5	1576
384E0000 hex	Absolute Encoder Counter Overflow Error	Servo G5	1576
384F0000 hex	Object Setting Error 1	Servo G5 and G5 Linear	1576
38500000 hex	Object Setting Error 2	Servo G5 and G5 Linear	1576
38510000 hex	External Encoder Connection Error	Servo G5 and G5 Linear	1576
38520000 hex	Function Setting Error	Servo G5 and G5 Linear	1576
38530000 hex	Magnetic Pole Position Estimation Error 1	G5 Linear	1577
38540000 hex	Magnetic Pole Position Estimation Error 2	G5 Linear	1577
38550000 hex	Magnetic Pole Position Estimation Error 3	G5 Linear	1577
38560000 hex	Motor Auto-setting Error	G5 Linear	1577
38570000 hex	Function Setting Error	Servo 1S	1586 1621
38590000 hex	Camera Connection Error	FH/FZ5 Series Vision System	Z342
385A0000 hex	Change in Connected Camera	FH/FZ5 Series Vision System	Z342
385B0000 hex	Light installation error	FH/FZ5 Series Vision System	Z342
38780000 hex	General Input Allocation Duplicate Error	Servo 1S	1586 1621
38790000 hex	General Output Allocation Duplicate Error	Servo 1S	1586 1621
387A0000 hex	Overload Warning	Servo 1S	1586
387B0000 hex	Pulse Output Setting Error	Servo 1S	1586 1621
387C0000 hex	Motor Replacement Detected	Servo 1S	1586 1621
387D0000 hex	Regeneration Overload Warning	Servo 1S	1586
387E0000 hex	Motor Vibration Warning	Servo 1S	1586
387F0000 hex	Electronic Gear Setting Error	Servo 1S	1586 1621
38800000 hex	Servo Drive Overheat	Servo 1S	1586 1621
38810000 hex	Overload Error	Servo 1S	1586 1621
38820000 hex	Regeneration Overload Error	Servo 1S	1586 1621
38830000 hex	Excessive Position Deviation Error	Servo 1S	1586 1621
38840000 hex	Excessive Speed Deviation Error	Servo 1S	1586 1621
38850000 hex	Excessive Speed Error	Servo 1S	1586 1621
38860000 hex	Following Error Counter Overflow	Servo 1S	1586 1621

Event code	Event name	Functional classification	Reference
38870000 hex	Absolute Encoder Counter Overflow Error	Servo 1S	I586 I621
38880000 hex	Safety Communications Setting Error	Servo 1S	I586 I621
38890000 hex	Safety Frame Error	Servo 1S	I586 I621
388A0000 hex	Safety Parameter Error	Servo 1S	I586
388B0000 hex	FSoE Slave Address Error	Servo 1S	I586 I621
38980000 hex	Safety Function Setting Error	Servo 1S	I621
38990000 hex	Safety Parameter Error	Servo 1S	I621
40010000 hex	PLC System Processing Error	Errors for Self Diagnosis	W564
40030000 hex	PLC System Processing Error	Errors for Self Diagnosis	W564
40040000 hex	PLC System Processing Error	Errors for Self Diagnosis	W564
40110000 hex	PLC Function Processing Error	Errors Related to Controller Operation	W564
40120000 hex	PLC Function Processing Error	Errors Related to Controller Operation	W564
40130000 hex	PLC Function Processing Error	Errors Related to Controller Operation	W564
40140000 hex	PLC System Information	Errors Related to Controller Operation	W564
40150000 hex	PLC System Information	Errors Related to Controller Operation	W564
40170000 hex	Safe Mode	Errors Related to Controller Operation	W564
40200000 hex	NX Unit Processing Error	NX-series EtherCAT Coupler Units, NX-series Analog I/O Units, NX-series Position Interface Units, NX-series Communications Interface Units, NX-series Load Cell Input Units, NX-series IO-Link Master Units, and NX-series Temperature Control Units	W519 W566 W524 W540 W565 W570 H228
44010000 hex	EtherCAT Fault	Built-in EtherCAT Master in CPU Unit	W564
44200000 hex	Motion Control Initialization Error	General Motion Control	W564
44210000 hex	Motion Control Function Processing Error	General Motion Control	W564
44420000 hex	PLC Function Processing Error	Errors Related to Controller Operation	W564
44430000 hex	PLC System Information	Errors Related to Controller Operation	W564
44600000 hex	OS Processing Error	Errors Related to Controller Operation	W564
47800000 hex	CNC Initialization Error	CNC Function	O030
47810000 hex	CNC Parameter Setting Invalid	CNC Function	O030
48020000 hex	System Error	FH/FZ5 Series Vision System	Z342

Event code	Event name	Functional classification	Reference
48080000 hex	FPGA WDT Error	Servo 1S	I586 I621
50010000 hex	Controller Insufficient Memory Warning	Built-in EtherCAT Master in CPU Unit and Built-in EtherNet/IP Port on CPU Unit	W564
54010400 hex	Input Value Out of Range	Instructions	W564
54010401 hex	Input Mismatch	Instructions	W564
54010402 hex	Floating-point Error	Instructions	W564
54010403 hex	BCD Error	Instructions	W564
54010404 hex	Signed BCD Error	Instructions	W564
54010405 hex	Illegal Bit Position Specified	Instructions	W564
54010406 hex	Illegal Data Position Specified	Instructions	W564
54010407 hex	Data Range Exceeded	Instructions	W564
54010409 hex	No Errors to Clear	Instructions	W564
5401040B hex	No User Errors to Clear	Instructions	W564
5401040C hex	Limit Exceeded for User-defined Errors	Instructions	W564
54010410 hex	Text String Format Error	Instructions	W564
54010411 hex	Illegal Program Specified	Instructions	W564
54010414 hex	Stack Underflow	Instructions	W564
54010416 hex	Illegal Number of Array Elements or Dimensions	Instructions	W564
54010417 hex	Specified Task Does Not Exist	Instructions	W564
54010418 hex	Unallowed Task Specification	Instructions	W564
54010419 hex	Incorrect Data Type	Instructions	W564
5401041A hex	Multi-execution of Instructions	Instructions	W564
5401041B hex	Data Capacity Exceeded	Instructions	W564
5401041C hex	Different Data Sizes	Instructions	W564
5401041D hex	Exceeded Simultaneous Instruction Executed Resources	Instructions	W564
54010C02 hex	Port Setup Already Busy	Instructions	W564
54010C03 hex	Full Reception Buffer	Instructions	W564
54010C04 hex	Multi-execution of Ports	Instructions	W564
54010C05 hex	Parity Error	Instructions	W564
54010C06 hex	Framing Error	Instructions	W564
54010C07 hex	Overrun Error	Instructions	W564
54010C08 hex	CRC Mismatch	Instructions	W564
54010C0B hex	Serial Communications Timeout	Instructions	W564
54010C0C hex	Instruction Executed to Inapplicable Port	Instructions	W564
54010C0D hex	CIF Unit Initialized	Instructions	W564
54010C10 hex	Exceptional Modbus Response	Instructions	W564
54010C11 hex	Invalid Modbus Response	Instructions	W564
54011403 hex	File Does Not Exist	Instructions	W564
54011405 hex	File Already in Use	Instructions	W564
54011406 hex	Open Mode Mismatch	Instructions	W564
54011407 hex	Offset Out of Range	Instructions	W564
54011408 hex	Directory Not Empty	Instructions	W564

Event code	Event name	Functional classification	Reference
54011409 hex	That File Name Already Exists	Instructions	W564
5401140A hex	Write Access Denied	Instructions	W564
5401140B hex	Too Many Files Open	Instructions	W564
5401140C hex	Directory Does Not Exist	Instructions	W564
5401140F hex	Backup Operation Already in Progress	Instructions	W564
54011410 hex	Cannot Execute Backup	Instructions	W564
54011800 hex	EtherCAT Communications Error	Instructions	W564
54011801 hex	EtherCAT Slave Does Not Respond	Instructions	W564
54011802 hex	EtherCAT Timeout	Instructions	W564
54011803 hex	Reception Buffer Overflow	Instructions	W564
54011804 hex	SDO Abort Error	Instructions	W564
54011805 hex	Saving Packet Monitor File	Instructions	W564
54011806 hex	Packet Monitoring Function Not Started	Instructions	W564
54011807 hex	Packet Monitoring Function in Operation	Instructions	W564
54011808 hex	Communications Resource Overflow	Instructions	W564
54011809 hex	Packet Monitoring Function Not Supported	Instructions	W564
54011C00 hex	Explicit Message Error	Instructions	W564
54011C01 hex	Incorrect Route Path	Instructions	W564
54011C02 hex	CIP Handle Out of Range	Instructions	W564
54011C03 hex	CIP Communications Resource Overflow	Instructions	W564
54011C04 hex	CIP Timeout	Instructions	W564
54011C05 hex	Class-3 Connection Not Established	Instructions	W564
54011C06 hex	CIP Communications Data Size Exceeded	Instructions	W564
54012000 hex	Local IP Address Setting Error	Instructions	W564
54012001 hex	TCP/UDP Port Already in Use	Instructions	W564
54012002 hex	Address Resolution Failed	Instructions	W564
54012003 hex	Socket Status Error	Instructions	W564
54012004 hex	Local IP Address Not Set	Instructions	W564
54012006 hex	Socket Timeout	Instructions	W564
54012007 hex	Socket Handle Out of Range	Instructions	W564
54012008 hex	Socket Communications Resource Overflow	Instructions	W564
54012400 hex	No Execution Right	Instructions	W564
54012401 hex	Settings Update Failed	Instructions	W564
54012402 hex	Too Many Simultaneous Instruction Executions	Instructions	W564
54012403 hex	FTP Client Execution Limit Exceeded	Instructions	W564
54012404 hex	File Number Limit Exceeded	Instructions	W564
54012405 hex	Directory Does Not Exist (FTP)	Instructions	W564

Event code	Event name	Functional classification	Reference
54012406 hex	FTP Server Connection Error	Instructions	W564
54012407 hex	Destination FTP Server Execution Failure	Instructions	W564
54012408 hex	SD Memory Card Access Failed for FTP	Instructions	W564
54012409 hex	Specified File Does Not Exist	Instructions	W564
5401240A hex	Specified File Is Write Protected	Instructions	W564
5401240B hex	Failed To Delete Specified File	Instructions	W564
5401240C hex	Specified File Access Failed	Instructions	W564
5401240D hex	IP Address Setting Invalid	Instructions	W564
54012C00 hex	NX Message Error	Instructions	W564
54012C01 hex	NX Message Resource Overflow	Instructions	W564
54012C02 hex	NX Message Timeout	Instructions	W564
54012C03 hex	Incorrect NX Message Length	Instructions	W564
54012C05 hex	NX Message EtherCAT Network Error	Instructions	W564
54012C06 hex	External Restart Already Executed for Specified NX Units	Instructions	W564
54012C07 hex	Unapplicable Unit Specified for Instruction	Instructions	W564
54012C08 hex	Invalid Total Power ON Time Record	Instructions	W564
54013461 hex	Process Data Object Setting Missing	Instructions	W564
54013781 hex	Process Data Object Setting Missing	CNC Instructions	O030
54014000 hex	OS Timeout	Instructions	W564
54014001 hex	OS Shutdown Execution Error	Instructions	W564
54014002 hex	OS Reboot Execution Error	Instructions	W564
54014400 hex	Shared Folder Access Failure	Instructions	W564
54014402 hex	Shared Folder Insufficient Capacity	Instructions	W564
54014404 hex	Too Many Files/Directories	Instructions	W564
5401440D hex	File or Directory Name Is Too Long	Instructions	W564
5401440E hex	Shared Folder Access Failed	Instructions	W564
54014411 hex	Slave Backup Failed	Instructions	W564
54014800 hex	Device Error Received	Instructions	W564
54014801 hex	Specified Unit Does Not Exist	Instructions	W564
54014802 hex	Message Processing Limit Exceeded	Instructions	W564
54014803 hex	Specified Unit Status Error	Instructions	W564
54014804 hex	Too Many Simultaneous Instruction Executions	Instructions	W564
54014805 hex	Communications Timeout	Instructions	W564
54014806 hex	Invalid Mode	Instructions	W564
54014807 hex	I/O Power OFF Status	Instructions	W564
54014808 hex	Verification Error	Instructions	W564

Event code	Event name	Functional classification	Reference
54015420 hex	Electronic Gear Ratio Numerator Setting Out of Range	Instructions	W564
54015421 hex	Electronic Gear Ratio Denominator Setting Out of Range	Instructions	W564
54015422 hex	Target Velocity Setting Out of Range	Instructions and Robot Instructions	W564 W539
54015423 hex	Acceleration Setting Out of Range	Instructions and Robot Instructions	W564 W539
54015424 hex	Deceleration Setting Out of Range	Instructions and Robot Instructions	W564 W539
54015425 hex	Jerk Setting Out of Range	Instructions	W564
54015427 hex	Torque Ramp Setting Out of Range	Instructions	W564
54015428 hex	Master Coefficient Scaling Out of Range	Instructions	W564
54015429 hex	Slave Coefficient Scaling Out of Range	Instructions	W564
5401542A hex	Feeding Velocity Setting Out of Range	Instructions	W564
5401542B hex	Buffer Mode Selection Out of Range	Instructions and Robot Instructions	W564 W539
5401542C hex	Coordinate System Selection Out of Range	Instructions and Robot Instructions	W564 W539
5401542D hex	Circular Interpolation Mode Selection Out of Range	Instructions	W564
5401542E hex	Direction Selection Out of Range	Instructions and Robot Instructions	W564 W539
5401542F hex	Path Selection Out of Range	Instructions	W564
54015430 hex	Position Type Selection Out of Range	Instructions	W564
54015431 hex	Travel Mode Selection Out of Range	Instructions	W564
54015432 hex	Transition Mode Selection Out of Range	Instructions and Robot Instructions	W564 W539
54015433 hex	Continue Method Selection Out of Range	Instructions	W564
54015434 hex	Combine Mode Selection Out of Range	Instructions	W564
54015435 hex	Synchronization Start Condition Selection Out of Range	Instructions	W564
54015436 hex	Master and Slave Defined as Same Axis	Instructions	W564
54015437 hex	Master and Auxiliary Defined as Same Axis	Instructions	W564
54015438 hex	Master/Slave Axis Numbers Not in Ascending Order	Instructions	W564
54015439 hex	Incorrect Cam Table Specification	Instructions	W564
5401543A hex	Synchronization Stopped	Instructions	W564

Event code	Event name	Functional classification	Reference
5401543B hex	Motion Control Instruction Re-execution Disabled	Instructions and Robot Instructions	W564 W539
5401543C hex	Motion Control Instruction Multi-execution Disabled	Instructions and Robot Instructions	W564 W539
5401543D hex	Instruction Not Allowed for Encoder Axis Type	Instructions	W564
5401543E hex	Instruction Cannot Be Executed during Multi-axes Coordinated Control	Instructions and Robot Instructions	W564 W539
5401543F hex	Multi-axes Coordinated Control Instruction Executed for Disabled Axes Group	Instructions and Robot Instructions	W564 W539
54015440 hex	Axes Group Cannot Be Enabled	Instructions	W564
54015441 hex	Impossible Axis Operation Specified when the Servo is OFF	Instructions and Robot Instructions	W564 W539
54015442 hex	Composition Axis Stopped Error	Instructions and Robot Instructions	W564 W539
54015443 hex	Motion Control Instruction Multi-execution Buffer Limit Exceeded	Instructions and Robot Instructions	W564 W539
54015444 hex	Insufficient Travel Distance	Instructions	W564
54015445 hex	Insufficient Travel Distance to Achieve Blending Transit Velocity	Instructions	W564
54015446 hex	Move Link Constant Velocity Insufficient Travel Distance	Instructions	W564
54015447 hex	Positioning Gear Operation Insufficient Target Velocity	Instructions	W564
54015448 hex	Same Start Point and End Point for Circular Interpolation	Instructions	W564
54015449 hex	Circular Interpolation Center Specification Position Out of Range	Instructions	W564
5401544A hex	Instruction Execution Error Caused by Count Mode Setting	Instructions	W564
5401544C hex	Parameter Selection Out of Range	Instructions	W564
5401544D hex	Stop Method Selection Out of Range	Instructions	W564
5401544E hex	Latch ID Selection Out of Range for Trigger Input Condition	Instructions	W564
5401544F hex	Setting Out of Range for Writing MC Setting	Instructions	W564
54015450 hex	Trigger Input Condition Mode Selection Out of Range	Instructions	W564
54015451 hex	Drive Trigger Signal Selection Out of Range for Trigger Input Condition	Instructions	W564
54015453 hex	Motion Control Instruction Re-execution Disabled (Axis Specification)	Instructions	W564

Event code	Event name	Functional classification	Reference
54015454 hex	Motion Control Instruction Re-execution Disabled (Buffer Mode Selection)	Instructions	W564
54015455 hex	Motion Control Instruction Re-execution Disabled (Direction Selection)	Instructions	W564
54015456 hex	Motion Control Instruction Re-execution Disabled (Execution Mode)	Instructions	W564
54015457 hex	Motion Control Instruction Re-execution Disabled (Axes Group Specification)	Instructions	W564
54015458 hex	Motion Control Instruction Re-execution Disabled (Jerk Setting)	Instructions	W564
54015459 hex	Motion Control Instruction Re-execution Disabled (Master Axis)	Instructions	W564
5401545A hex	Motion Control Instruction Re-execution Disabled (MasterOffset)	Instructions	W564
5401545B hex	Motion Control Instruction Re-execution Disabled (MasterScaling)	Instructions	W564
5401545C hex	Motion Control Instruction Re-execution Disabled (MasterStartDistance)	Instructions	W564
5401545D hex	Motion Control Instruction Re-execution Disabled (Continuous)	Instructions	W564
5401545E hex	Motion Control Instruction Re-execution Disabled (MoveMode)	Instructions	W564
5401545F hex	Illegal Auxiliary Axis Specification	Instructions	W564
54015460 hex	Illegal Axis Specification	Instructions	W564
54015461 hex	Illegal Axes Group Specification	Instructions and Robot Instructions	W564 W539
54015462 hex	Illegal Master Axis Specification	Instructions	W564
54015463 hex	Motion Control Instruction Re-execution Disabled (SlaveOffset)	Instructions	W564
54015464 hex	Motion Control Instruction Re-execution Disabled (SlaveScaling)	Instructions	W564
54015465 hex	Motion Control Instruction Re-execution Disabled (StartPosition)	Instructions	W564
54015466 hex	Instruction Execution Error with Undefined Home	Instructions and Robot Instructions	W564 W539
54015467 hex	Motion Control Instruction Re-execution Disabled (Position Type)	Instructions	W564

Event code	Event name	Functional classification	Reference
54015468 hex	Unused Axis Specification for Master Axis	Instructions	W564
54015469 hex	First Position Setting Out of Range	Instructions	W564
5401546A hex	Last Position Setting Out of Range	Instructions	W564
5401546B hex	Illegal First/Last Position Size Relationship (Linear Mode)	Instructions	W564
5401546C hex	Master Sync Start Position Setting Out of Range	Instructions	W564
5401546D hex	Slave Sync Start Position Setting Out of Range	Instructions	W564
5401546E hex	Duplicate Latch ID for Trigger Input Condition	Instructions	W564
5401546F hex	Jerk Override Factor Out of Range	Instructions	W564
54015470 hex	Acceleration/Deceleration Override Factor Out of Range	Instructions	W564
54015471 hex	First Position Method Specification Out of Range	Instructions	W564
54015472 hex	Motion Control Instruction Re-execution Disabled (First Position Method)	Instructions	W564
54015474 hex	Unused Axis Specification for Auxiliary Axis	Instructions	W564
54015475 hex	Position Gear Value Error	Instructions	W564
54015476 hex	Position Gear Master Axis Zero Velocity	Instructions	W564
54015478 hex	Target Position Setting Out of Range	Instructions and Robot Instructions	W564 W539
54015479 hex	Travel Distance Out of Range	Instructions	W564
5401547A hex	Cam Table Start Point Setting Out of Range	Instructions	W564
5401547B hex	Cam Master Axis Following First Position Setting Out of Range	Instructions	W564
5401547C hex	Circular Interpolation Radius Setting Error	Instructions	W564
5401547D hex	Circular Interpolation Radius Overflow	Instructions	W564
5401547E hex	Circular Interpolation Setting Out of Range	Instructions	W564
5401547F hex	Auxiliary/Slave Axis Numbers Not in Ascending Order	Instructions	W564
54015480 hex	Cam Table Property Ascending Data Error at Update	Instructions	W564
54015481 hex	MC_Write Target Out of Range	Instructions	W564
54015482 hex	Master Travel Distance Specification Out of Range	Instructions	W564
54015483 hex	Master Distance in Acceleration Specification Out of Range	Instructions	W564

Event code	Event name	Functional classification	Reference
54015484 hex	Master Distance in Deceleration Specification Out of Range	Instructions	W564
54015487 hex	Execution Mode Selection Out of Range	Instructions	W564
54015488 hex	Permitted Following Error Out of Range	Instructions	W564
54015489 hex	Border Point/Center Position/Radius Specification Out of Range	Instructions	W564
5401548A hex	End Point Specification Out of Range	Instructions	W564
5401548B hex	Slave Travel Distance Specification Out of Range	Instructions	W564
5401548C hex	Phase Shift Amount Out of Range	Instructions	W564
5401548D hex	Feeding Distance Out of Range	Instructions	W564
5401548E hex	Auxiliary and Slave Defined as Same Axis	Instructions	W564
5401548F hex	Relative Position Selection Out of Range	Instructions	W564
54015490 hex	Cam Transition Specification Out of Range	Instructions	W564
54015491 hex	Synchronized Control End Mode Selection Out of Range	Instructions	W564
54015492 hex	Enable External Latch Instruction Execution Disabled	Instructions	W564
54015493 hex	Master Axis Offset Out of Range	Instructions	W564
54015494 hex	Slave Axis Offset Out of Range	Instructions	W564
54015495 hex	Command Current Position Count Selection Out of Range	Instructions	W564
54015496 hex	Master Axis Gear Ratio Numerator Out of Range	Instructions	W564
54015497 hex	Master Axis Gear Ratio Denominator Out of Range	Instructions	W564
54015498 hex	Auxiliary Axis Gear Ratio Numerator Out of Range	Instructions	W564
54015499 hex	Auxiliary Axis Gear Ratio Denominator Out of Range	Instructions	W564
5401549A hex	Master Axis Position Type Selection Out of Range	Instructions	W564
5401549B hex	Auxiliary Axis Position Type Selection Out of Range	Instructions	W564
5401549C hex	Target Position Ring Counter Out of Range	Instructions	W564
5401549D hex	Axes Group Composition Axis Setting Out of Range	Instructions	W564
5401549E hex	Axis Use Setting Out of Range	Instructions	W564
54015600 hex	Illegal CNC Coordinate System Specification	CNC Instructions	O030

Event code	Event name	Functional classification	Reference
54015601 hex	Deceleration Setting Out of Range	CNC Instructions	O030
54015602 hex	Jerk Setting Out of Range	CNC Instructions	O030
54015603 hex	CNC Instruction Re-execution Disabled	CNC Instructions	O030
54015604 hex	CNC Multi-execution Disabled	CNC Instructions	O030
54015605 hex	Unassigned Logical CNC Motor Number Specified	CNC Instructions	O030
54015606 hex	Logical CNC Motor Number Out of Range	CNC Instructions	O030
54015607 hex	Target Position Setting Out of Range	CNC Instructions	O030
54015608 hex	Impossible CNC Motor Operation Specified when the Servo is OFF	CNC Instructions	O030
54015609 hex	Target Velocity Setting Out of Range	CNC Instructions	O030
5401560A hex	Acceleration/Deceleration Setting Out of Range	CNC Instructions	O030
5401560B hex	Travel Mode Selection Out of Range	CNC Instructions	O030
5401560D hex	Parameter Selection Out of Range	CNC Instructions	O030
5401560E hex	CNC Parameter Setting Read/Write Setting Value Out of Range	CNC Instructions	O030
5401560F hex	CNC Parameter Setting Read/Write Target Out of Range	CNC Instructions	O030
54015611 hex	Homing Parameter Setting Out of Range	CNC Instructions	O030
54015612 hex	M Code Number Out of Range	CNC Instructions	O030
54015613 hex	CNC Instruction Re-execution Disabled (CNC Coordinate System Specification)	CNC Instructions	O030
54015614 hex	CNC Instruction Re-execution Disabled (Logical CNC Motor Number)	CNC Instructions	O030
5401561D hex	SD Memory Card Access Failure	CNC Instructions	O030
5401561E hex	File Does Not Exist	CNC Instructions	O030
5401561F hex	Illegal Load NC Program Number Specification	CNC Instructions	O030
54015620 hex	Too Many Files Open	CNC Instructions	O030
54015621 hex	File or Directory Name Is Too Long	CNC Instructions	O030
54015622 hex	SD Memory Card Access Failed	CNC Instructions	O030
54015623 hex	Load NC Program Capacity Exceeded	CNC Instructions	O030
54015624 hex	Number of NC Program Exceeded	CNC Instructions	O030

Event code	Event name	Functional classification	Reference
54015625 hex	Illegal CNC Motor Specification	CNC Instructions	O030
54015626 hex	Illegal CNC Motor Compensation Table Specification	CNC Instructions	O030
54015628 hex	Illegal Load NC Program	CNC Instructions	O030
54015700 hex	Homing Parameter Setting Out of Range	Instructions	W564
54015702 hex	Axis Use Change Error	Instructions	W564
54015703 hex	Cannot Change Axis Use	Instructions	W564
54015720 hex	Motion Control Parameter Setting Error When Changing Axis Use	Instructions	W564
54015721 hex	Required Process Data Object Not Set When Changing Axis Use	Instructions	W564
54015722 hex	Actual Position Overflow/Underflow	Instructions	W564
54015723 hex	Switch Structure Track Number Setting Out of Range	Instructions	W564
54015724 hex	Switch Structure First ON Position Setting Out of Range	Instructions	W564
54015725 hex	Switch Structure Last ON Position Setting Out of Range	Instructions	W564
54015726 hex	Switch Structure Axis Direction Out of Range	Instructions	W564
54015727 hex	Switch Structure Cam Switch Mode Out of Range	Instructions	W564
54015728 hex	Switch Structure Duration Setting Out of Range	Instructions	W564
54015729 hex	Track Option Structure ON Compensation Setting Out of Range	Instructions	W564
5401572A hex	Track Option Structure OFF Compensation Setting Out of Range	Instructions	W564
5401572B hex	Number of Array Elements in Switch Structure Variable Out of Range	Instructions	W564
5401572C hex	Number of Array Elements in Output Signal Structure Variable Out of Range	Instructions	W564
5401572D hex	Number of Array Elements in Track Option Structure Variable Out of Range	Instructions	W564
5401572E hex	Numbers of Elements in Output Signals and Track Option Arrays Not Matched	Instructions	W564
5401572F hex	Motion Control Instruction Multi-execution Disabled (Master Axis)	Instructions	W564
54015730 hex	Motion Control Instruction Multi-execution Disabled (Position Type Selection)	Instructions	W564

Event code	Event name	Functional classification	Reference
54015731 hex	Same Track Number Setting in Switch Structure Out of Range	Instructions	W564
5401573A hex	Cannot Write Axis Parameters	Instructions	W564
5401573B hex	Axis Parameter Setting Out of Range	Instructions	W564
5401573C hex	Cam Property Setting Out of Range	Instructions	W564
5401573D hex	Cam Node Setting Out of Range	Instructions	W564
5401573E hex	Incorrect Cam Node Type Specification	Instructions	W564
5401573F hex	Insufficient Nodes in Cam Table	Instructions	W564
54015740 hex	Cam Node Master Axis Phase Not in Ascending Order	Instructions	W564
54015741 hex	Too Many Data Points in Cam Table	Instructions	W564
54015742 hex	Cam Table Displacement Overflow	Instructions	W564
54015743 hex	Aborted Cam Table Used	Instructions	W564
54015749 hex	Execution ID Setting Out of Range	Instructions	W564
5401574A hex	Position Offset Out of Range	Instructions	W564
5401574B hex	PDS State Transition Command Selection Out of Range	Instructions	W564
54015751 hex	Cam Monitor Mode Selection Out of Range	Instructions	W564
54015752 hex	Data Type of Cam Monitor Values Mismatch	Instructions	W564
54016440 hex	Target Position Positive Software Limit Exceeded	Instructions	W564
54016441 hex	Target Position Negative Software Limit Exceeded	Instructions	W564
54016442 hex	Command Position Overflow/Underflow	Instructions	W564
54016443 hex	Positive Limit Input	Instructions and Robot Instructions	W564 W539
54016444 hex	Negative Limit Input	Instructions and Robot Instructions	W564 W539
54016783 hex	Target Position Positive Software Limit Exceeded	CNC Instructions	O030
54016784 hex	Target Position Negative Software Limit Exceeded	CNC Instructions	O030
54016785 hex	Command Position Overflow/Underflow	CNC Instructions	O030
54016786 hex	Positive Limit Input	CNC Instructions	O030
54016787 hex	Negative Limit Input	CNC Instructions	O030
54017422 hex	Servo Main Circuits OFF	Instructions	W564
54017784 hex	Servo Main Circuits OFF	CNC Instructions	O030
54200000 hex	Electronic Gear Ratio Numerator Setting Out of Range	Motion Control Instructions	W564

Event code	Event name	Functional classification	Reference
54210000 hex	Electronic Gear Ratio Denominator Setting Out of Range	Motion Control Instructions	W564
54220000 hex	Target Velocity Setting Out of Range	Motion Control Instructions NJ Robotics Function	W564 W539
54230000 hex	Acceleration Setting Out of Range	Motion Control Instructions NJ Robotics Function	W564 W539
54240000 hex	Deceleration Setting Out of Range	Motion Control Instructions NJ Robotics Function	W564 W539
54250000 hex	Jerk Setting Out of Range	Motion Control Instructions	W564
54270000 hex	Torque Ramp Setting Out of Range	Motion Control Instructions	W564
54280000 hex	Master Coefficient Scaling Out of Range	Motion Control Instructions	W564
54290000 hex	Slave Coefficient Scaling Out of Range	Motion Control Instructions	W564
542A0000 hex	Feeding Velocity Setting Out of Range	Motion Control Instructions	W564
542B0000 hex	Buffer Mode Selection Out of Range	Motion Control Instructions NJ Robotics Function	W564 W539
542C0000 hex	Coordinate System Selection Out of Range	Motion Control Instructions NJ Robotics Function	W564 W539
542D0000 hex	Circular Interpolation Mode Selection Out of Range	Motion Control Instructions	W564
542E0000 hex	Direction Selection Out of Range	Motion Control Instructions NJ Robotics Function	W564 W539
542F0000 hex	Path Selection Out of Range	Motion Control Instructions	W564
54300000 hex	Position Type Selection Out of Range	Motion Control Instructions	W564
54310000 hex	Travel Mode Selection Out of Range	Motion Control Instructions	W564
54320000 hex	Transition Mode Selection Out of Range	Motion Control Instructions NJ Robotics Function	W564 W539
54330000 hex	Continue Method Selection Out of Range	Motion Control Instructions	W564
54340000 hex	Combine Mode Selection Out of Range	Motion Control Instructions	W564
54350000 hex	Synchronization Start Condition Selection Out of Range	Motion Control Instructions	W564
54360000 hex	Master and Slave Defined as Same Axis	Motion Control Instructions	W564
54370000 hex	Master and Auxiliary Defined as Same Axis	Motion Control Instructions	W564
54380000 hex	Master/Slave Axis Numbers Not in Ascending Order	Motion Control Instructions	W564
54390000 hex	Incorrect Cam Table Specification	Motion Control Instructions	W564
543A0000 hex	Synchronization Stopped	Motion Control Instructions	W564
543B0000 hex	Motion Control Instruction Re-execution Disabled	Motion Control Instructions NJ Robotics Function	W564 W539

Event code	Event name	Functional classification	Reference
543C0000 hex	Motion Control Instruction Multi-execution Disabled	Motion Control Instructions NJ Robotics Function	W564 W539
543D0000 hex	Instruction Not Allowed for Encoder Axis Type	Motion Control Instructions	W564
543E0000 hex	Instruction Cannot Be Executed during Multi-axes Coordinated Control	Motion Control Instructions NJ Robotics Function	W564 W539
543F0000 hex	Multi-axes Coordinated Control Instruction Executed for Disabled Axes Group	Motion Control Instructions NJ Robotics Function	W564 W539
54400000 hex	Axes Group Cannot Be Enabled	Motion Control Instructions	W564
54410000 hex	Impossible Axis Operation Specified when the Servo is OFF	Motion Control Instructions NJ Robotics Function	W564 W539
54420000 hex	Composition Axis Stopped Error	Motion Control Instructions NJ Robotics Function	W564 W539
54430000 hex	Motion Control Instruction Multi-execution Buffer Limit Exceeded	Motion Control Instructions NJ Robotics Function	W564 W539
54440000 hex	Insufficient Travel Distance	Motion Control Instructions	W564
54450000 hex	Insufficient Travel Distance to Achieve Blending Transit Velocity	Motion Control Instructions	W564
54460000 hex	Move Link Constant Velocity Insufficient Travel Distance	Motion Control Instructions	W564
54470000 hex	Positioning Gear Operation Insufficient Target Velocity	Motion Control Instructions	W564
54480000 hex	Same Start Point and End Point for Circular Interpolation	Motion Control Instructions	W564
54490000 hex	Circular Interpolation Center Specification Position Out of Range	Motion Control Instructions	W564
544A0000 hex	Instruction Execution Error Caused by Count Mode Setting	Motion Control Instructions	W564
544C0000 hex	Parameter Selection Out of Range	Motion Control Instructions	W564
544D0000 hex	Stop Method Selection Out of Range	Motion Control Instructions	W564
544E0000 hex	Latch ID Selection Out of Range for Trigger Input Condition	Motion Control Instructions	W564
544F0000 hex	Setting Out of Range for Writing MC Setting	Motion Control Instructions	W564
54500000 hex	Trigger Input Condition Mode Selection Out of Range	Motion Control Instructions	W564
54510000 hex	Drive Trigger Signal Selection Out of Range for Trigger Input Condition	Motion Control Instructions	W564
54530000 hex	Motion Control Instruction Re-execution Disabled (Axis Specification)	Motion Control Instructions	W564

Event code	Event name	Functional classification	Reference
54540000 hex	Motion Control Instruction Re-execution Disabled (Buffer Mode Selection)	Motion Control Instructions	W564
54550000 hex	Motion Control Instruction Re-execution Disabled (Direction Selection)	Motion Control Instructions	W564
54560000 hex	Motion Control Instruction Re-execution Disabled (Execution Mode)	Motion Control Instructions	W564
54570000 hex	Motion Control Instruction Re-execution Disabled (Axes Group Specification)	Motion Control Instructions NJ Robotics Function	W564 W539
54580000 hex	Motion Control Instruction Re-execution Disabled (Jerk Setting)	Motion Control Instructions	W564
54590000 hex	Motion Control Instruction Re-execution Disabled (Master Axis)	Motion Control Instructions	W564
545A0000 hex	Motion Control Instruction Re-execution Disabled (MasterOffset)	Motion Control Instructions	W564
545B0000 hex	Motion Control Instruction Re-execution Disabled (MasterScaling)	Motion Control Instructions	W564
545C0000 hex	Motion Control Instruction Re-execution Disabled (MasterStartDistance)	Motion Control Instructions	W564
545D0000 hex	Motion Control Instruction Re-execution Disabled (Continuous)	Motion Control Instructions	W564
545E0000 hex	Motion Control Instruction Re-execution Disabled (MoveMode)	Motion Control Instructions	W564
545F0000 hex	Illegal Auxiliary Axis Specification	Motion Control Instructions	W564
54600000 hex	Illegal Axis Specification	Motion Control Instructions	W564
54610000 hex	Illegal Axes Group Specification	Motion Control Instructions NJ Robotics Function	W564 W539
54620000 hex	Illegal Master Axis Specification	Motion Control Instructions	W564
54630000 hex	Motion Control Instruction Re-execution Disabled (SlaveOffset)	Motion Control Instructions	W564
54640000 hex	Motion Control Instruction Re-execution Disabled (SlaveScaling)	Motion Control Instructions	W564
54650000 hex	Motion Control Instruction Re-execution Disabled (StartPosition)	Motion Control Instructions	W564
54660000 hex	Instruction Execution Error with Undefined Home	Motion Control Instructions NJ Robotics Function	W564 W539
54670000 hex	Motion Control Instruction Re-execution Disabled (Position Type)	Motion Control Instructions	W564

Event code	Event name	Functional classification	Reference
54680000 hex	Unused Axis Specification for Master Axis	Motion Control Instructions	W564
54690000 hex	First Position Setting Out of Range	Motion Control Instructions	W564
546A0000 hex	Last Position Setting Out of Range	Motion Control Instructions	W564
546B0000 hex	Illegal First/Last Position Size Relationship (Linear Mode)	Motion Control Instructions	W564
546C0000 hex	Master Sync Start Position Setting Out of Range	Motion Control Instructions	W564
546D0000 hex	Slave Sync Start Position Setting Out of Range	Motion Control Instructions	W564
546E0000 hex	Duplicate Latch ID for Trigger Input Condition	Motion Control Instructions	W564
546F0000 hex	Jerk Override Factor Out of Range	Motion Control Instructions	W564
54700000 hex	Acceleration/Deceleration Override Factor Out of Range	Motion Control Instructions	W564
54710000 hex	First Position Method Specification Out of Range	Motion Control Instructions	W564
54720000 hex	Motion Control Instruction Re-execution Disabled (First Position Method)	Motion Control Instructions	W564
54740000 hex	Unused Axis Specification for Auxiliary Axis	Motion Control Instructions	W564
54750000 hex	Position Gear Value Error	Motion Control Instructions	W564
54760000 hex	Position Gear Master Axis Zero Velocity	Motion Control Instructions	W564
54770000 hex	Cam Table Data Error during Cam Motion	General Motion Control	W564
54780000 hex	Target Position Setting Out of Range	Motion Control Instructions NJ Robotics Function	W564 W539
54790000 hex	Travel Distance Out of Range	Motion Control Instructions	W564
547A0000 hex	Cam Table Start Point Setting Out of Range	Motion Control Instructions	W564
547B0000 hex	Cam Master Axis Following First Position Setting Out of Range	Motion Control Instructions	W564
547C0000 hex	Circular Interpolation Radius Setting Error	Motion Control Instructions	W564
547D0000 hex	Circular Interpolation Radius Overflow	Motion Control Instructions	W564
547E0000 hex	Circular Interpolation Setting Out of Range	Motion Control Instructions	W564
547F0000 hex	Auxiliary/Slave Axis Numbers Not in Ascending Order	Motion Control Instructions	W564
54800000 hex	Cam Table Property Ascending Data Error at Update	Motion Control Instructions	W564
54810000 hex	MC_Write Target Out of Range	Motion Control Instructions	W564
54820000 hex	Master Travel Distance Specification Out of Range	Motion Control Instructions	W564

Event code	Event name	Functional classification	Reference
54830000 hex	Master Distance in Acceleration Specification Out of Range	Motion Control Instructions	W564
54840000 hex	Master Distance in Deceleration Specification Out of Range	Motion Control Instructions	W564
54850000 hex	Immediate Stop Instruction Executed	General Motion Control	W564
54860000 hex	Axes Group Immediate Stop Instruction Executed	General Motion Control	W564
54870000 hex	Execution Mode Selection Out of Range	Motion Control Instructions	W564
54880000 hex	Permitted Following Error Out of Range	Motion Control Instructions	W564
54890000 hex	Border Point/Center Position/Radius Specification Out of Range	Motion Control Instructions	W564
548A0000 hex	End Point Specification Out of Range	Motion Control Instructions	W564
548B0000 hex	Slave Travel Distance Specification Out of Range	Motion Control Instructions	W564
548C0000 hex	Phase Shift Amount Out of Range	Motion Control Instructions	W564
548D0000 hex	Feeding Distance Out of Range	Motion Control Instructions	W564
548E0000 hex	Auxiliary and Slave Defined as Same Axis	Motion Control Instructions	W564
548F0000 hex	Relative Position Selection Out of Range	Motion Control Instructions	W564
54900000 hex	Cam Transition Specification Out of Range	Motion Control Instructions	W564
54910000 hex	Synchronized Control End Mode Selection Out of Range	Motion Control Instructions	W564
54920000 hex	Enable External Latch Instruction Execution Disabled	Motion Control Instructions	W564
54930000 hex	Master Axis Offset Out of Range	Motion Control Instructions	W564
54940000 hex	Slave Axis Offset Out of Range	Motion Control Instructions	W564
54950000 hex	Command Current Position Count Selection Out of Range	Motion Control Instructions	W564
54960000 hex	Master Axis Gear Ratio Numerator Out of Range	Motion Control Instructions	W564
54970000 hex	Master Axis Gear Ratio Denominator Out of Range	Motion Control Instructions	W564
54980000 hex	Auxiliary Axis Gear Ratio Numerator Out of Range	Motion Control Instructions	W564
54990000 hex	Auxiliary Axis Gear Ratio Denominator Out of Range	Motion Control Instructions	W564
549A0000 hex	Master Axis Position Type Selection Out of Range	Motion Control Instructions	W564
549B0000 hex	Auxiliary Axis Position Type Selection Out of Range	Motion Control Instructions	W564
549C0000 hex	Target Position Ring Counter Out of Range	Motion Control Instructions	W564

Event code	Event name	Functional classification	Reference
549D0000 hex	Axes Group Composition Axis Setting Out of Range	Motion Control Instructions	W564
549E0000 hex	Axis Use Setting Out of Range	Motion Control Instructions	W564
54E00000 hex	Access Detected Outside Range of Variable	Built-in EtherNet/IP Port on CPU Unit	W564
55000000 hex	Division by Zero	NX-series Safety Control Unit	Z930
55010000 hex	Cast Error	NX-series Safety Control Unit	Z930
55020000 hex	MUX Error	NX-series Safety Control Unit	Z930
56000000 hex	Illegal CNC Coordinate System Specification	CNC Function	O030
56010000 hex	Deceleration Setting Out of Range	CNC Function	O030
56020000 hex	Jerk Setting Out of Range	CNC Function	O030
56030000 hex	CNC Instruction Re-execution Disabled	CNC Function	O030
56040000 hex	CNC Multi-execution Disabled	CNC Function	O030
56050000 hex	Unassigned Logical CNC Motor Number Specified	CNC Function	O030
56060000 hex	Logical CNC Motor Number Out of Range	CNC Function	O030
56070000 hex	Target Position Setting Out of Range	CNC Function	O030
56080000 hex	Impossible CNC Motor Operation Specified when the Servo is OFF	CNC Function	O030
56090000 hex	Target Velocity Setting Out of Range	CNC Function	O030
560A0000 hex	Acceleration/Deceleration Setting Out of Range	CNC Function	O030
560B0000 hex	Travel Mode Selection Out of Range	CNC Function	O030
560C0000 hex	Immediate Stop Instruction Executed	CNC Function	O030
560D0000 hex	Parameter Selection Out of Range	CNC Function	O030
560E0000 hex	CNC Parameter Setting Read/Write Setting Value Out of Range	CNC Function	O030
560F0000 hex	CNC Parameter Setting Read/Write Target Out of Range	CNC Function	O030
56100000 hex	Cycle Start Error with Undefined Home	CNC Function	O030
56110000 hex	Homing Parameter Setting Out of Range	CNC Function	O030
56120000 hex	M Code Number Out of Range	CNC Function	O030
56130000 hex	CNC Instruction Re-execution Disabled (CNC Coordinate System Specification)	CNC Function	O030

Event code	Event name	Functional classification	Reference
56140000 hex	CNC Instruction Re-execution Disabled (Logical CNC Motor Number)	CNC Function	O030
56150000 hex	Illegal NC Program	CNC Function	O030
56160000 hex	Cycle Start Multi-execution Disabled	CNC Function	O030
56170000 hex	Impossible CNC Motor Cycle Start Specified when the Servo is OFF	CNC Function	O030
56180000 hex	Illegal NC Program Number Specification	CNC Function	O030
56190000 hex	Illegal Back Trace Specification	CNC Function	O030
561D0000 hex	SD Memory Card Access Failure	CNC Function	O030
561E0000 hex	File Does Not Exist	CNC Function	O030
561F0000 hex	Illegal Load NC Program Number Specification	CNC Function	O030
56200000 hex	Too Many Files Open	CNC Function	O030
56210000 hex	File or Directory Name Is Too Long	CNC Function	O030
56220000 hex	SD Memory Card Access Failed	CNC Function	O030
56230000 hex	Load NC Program Capacity Exceeded	CNC Function	O030
56240000 hex	Number of NC Program Exceeded	CNC Function	O030
56250000 hex	Illegal CNC Motor Specification	CNC Function	O030
56260000 hex	Illegal CNC Motor Compensation Table Specification	CNC Function	O030
56280000 hex	Illegal Load NC Program	CNC Function	O030
56290000 hex	NC Program Capacity Exceeded	CNC Function	O030
57000000 hex	Homing Parameter Setting Out of Range	Motion Control Instructions	W564
57020000 hex	Axis Use Change Error	Motion Control Instructions	W564
57030000 hex	Cannot Change Axis Use	Motion Control Instructions	W564
57200000 hex	Motion Control Parameter Setting Error When Changing Axis Use	Motion Control Instructions	W564
57210000 hex	Required Process Data Object Not Set When Changing Axis Use	Motion Control Instructions	W564
57220000 hex	Actual Position Overflow/Underflow	Motion Control Instructions	W564
57230000 hex	Switch Structure Track Number Setting Out of Range	Motion Control Instructions	W564
57240000 hex	Switch Structure First ON Position Setting Out of Range	Motion Control Instructions	W564
57250000 hex	Switch Structure Last ON Position Setting Out of Range	Motion Control Instructions	W564
57260000 hex	Switch Structure Axis Direction Out of Range	Motion Control Instructions	W564

Event code	Event name	Functional classification	Reference
57270000 hex	Switch Structure Cam Switch Mode Out of Range	Motion Control Instructions	W564
57280000 hex	Switch Structure Duration Setting Out of Range	Motion Control Instructions	W564
57290000 hex	Track Option Structure ON Compensation Setting Out of Range	Motion Control Instructions	W564
572A0000 hex	Track Option Structure OFF Compensation Setting Out of Range	Motion Control Instructions	W564
572B0000 hex	Number of Array Elements in Switch Structure Variable Out of Range	Motion Control Instructions	W564
572C0000 hex	Number of Array Elements in Output Signal Structure Variable Out of Range	Motion Control Instructions	W564
572D0000 hex	Number of Array Elements in Track Option Structure Variable Out of Range	Motion Control Instructions	W564
572E0000 hex	Numbers of Elements in Output Signals and Track Option Arrays Not Matched	Motion Control Instructions	W564
572F0000 hex	Motion Control Instruction Multi-execution Disabled (Master Axis)	Motion Control Instructions	W564
57300000 hex	Motion Control Instruction Multi-execution Disabled (Position Type Selection)	Motion Control Instructions	W564
57310000 hex	Same Track Number Setting in Switch Structure Out of Range	Motion Control Instructions	W564
573A0000 hex	Cannot Write Axis Parameters	Motion Control Instructions	W564
573B0000 hex	Axis Parameter Setting Out of Range	Motion Control Instructions	W564
573C0000 hex	Cam Property Setting Out of Range	Motion Control Instructions	W564
573D0000 hex	Cam Node Setting Out of Range	Motion Control Instructions	W564
573E0000 hex	Incorrect Cam Node Type Specification	Motion Control Instructions	W564
573F0000 hex	Insufficient Nodes in Cam Table	Motion Control Instructions	W564
57400000 hex	Cam Node Master Axis Phase Not in Ascending Order	Motion Control Instructions	W564
57410000 hex	Too Many Data Points in Cam Table	Motion Control Instructions	W564
57420000 hex	Cam Table Displacement Overflow	Motion Control Instructions	W564
57430000 hex	Aborted Cam Table Used	Motion Control Instructions	W564
57490000 hex	Execution ID Setting Out of Range	Motion Control Instructions	W564
574A0000 hex	Position Offset Out of Range	Motion Control Instructions	W564
574B0000 hex	PDS State Transition Command Selection Out of Range	Motion Control Instructions	W564

Event code	Event name	Functional classification	Reference
57510000 hex	Cam Monitor Mode Selection Out of Range	Motion Control Instructions	W564
57520000 hex	Data Type of Cam Monitor Values Mismatch	Motion Control Instructions	W564
58210000 hex	Output Control Timeout for Parallel I/O, PLC Link, or EtherNet/IP	FH/FZ5 Series Vision System	Z342
58220000 hex	Output Control Timeout for EtherCAT	FH/FZ5 Series Vision System	Z342
58230000 hex	Initial scene group error	FH/FZ5 Series Vision System	Z342
58240000 hex	Initial scene number error	FH/FZ5 Series Vision System	Z342
60010000 hex	Task Period Exceeded	Errors Related to Tasks	W564
60020000 hex	Task Execution Timeout	Errors Related to Tasks	W564
60030000 hex	I/O Refreshing Timeout Error	Errors Related to Tasks	W564
60050000 hex	Task Period Exceeded	Errors Related to Tasks	W564
64200000 hex	Emergency Message Detected	Built-in EtherCAT Master in CPU Unit	W564
64400000 hex	Target Position Positive Software Limit Exceeded	Motion Control Instructions	W564
64410000 hex	Target Position Negative Software Limit Exceeded	Motion Control Instructions	W564
64420000 hex	Command Position Overflow/Underflow	Motion Control Instructions	W564
64430000 hex	Positive Limit Input	Motion Control Instructions NJ Robotics Function	W564 W539
64440000 hex	Negative Limit Input	Motion Control Instructions NJ Robotics Function	W564 W539
64450000 hex	Positive Software Limit Exceeded	General Motion Control	W564
64460000 hex	Negative Software Limit Exceeded	General Motion Control	W564
64470000 hex	In-position Check Time Exceeded	General Motion Control	W564
64480000 hex	Following Error Limit Exceeded	General Motion Control	W564
64490000 hex	Immediate Stop Input	General Motion Control	W564
644A0000 hex	Positive Limit Input Detected	General Motion Control	W564
644B0000 hex	Negative Limit Input Detected	General Motion Control	W564
644C0000 hex	Following Error Warning	General Motion Control	W564
644D0000 hex	Velocity Warning	General Motion Control	W564
644E0000 hex	Acceleration Warning	General Motion Control	W564
644F0000 hex	Deceleration Warning	General Motion Control	W564
64500000 hex	Positive Torque Warning	General Motion Control	W564
64510000 hex	Negative Torque Warning	General Motion Control	W564
64520000 hex	Command Position Overflow	General Motion Control	W564
64530000 hex	Command Position Underflow	General Motion Control	W564
64540000 hex	Actual Position Overflow	General Motion Control	W564
64550000 hex	Actual Position Underflow	General Motion Control	W564
64560000 hex	Illegal Following Error	General Motion Control	W564
64570000 hex	Servo OFF Error	General Motion Control	W564

Event code	Event name	Functional classification	Reference
64580000 hex	Absolute Encoder Current Position Calculation Failed	General Motion Control	W564
64590000 hex	Home Undefined during Coordinated Motion	General Motion Control NJ Robotics Function	W564 W539
64CC0000 hex	I/O Disconnection Detected	GX-series EtherCAT Slave Units	W488
64E00000 hex	Drive Prohibition Input Error 1	Servo G5 and G5 Linear	I576 I577
64E10000 hex	Drive Prohibition Input Error 2	Servo G5 and G5 Linear	I576 I577
64E20000 hex	Immediate Stop Input Error	Servo G5 and G5 Linear	I576 I577
64E30000 hex	Drive Prohibition Input Error	Servo 1S	I586 I621
64F00000 hex	Unit Over Range for Channel 1	NX-series Analog I/O Units	W522
64F10000 hex	Unit Over Range for Channel 2	NX-series Analog I/O Units	W522
64F20000 hex	Unit Over Range for Channel 3	NX-series Analog I/O Units	W522
64F30000 hex	Unit Over Range for Channel 4	NX-series Analog I/O Units	W522
64F40000 hex	Unit Over Range for Channel 5	NX-series Analog I/O Units	W522
64F50000 hex	Unit Over Range for Channel 6	NX-series Analog I/O Units	W522
64F60000 hex	Unit Over Range for Channel 7	NX-series Analog I/O Units	W522
64F70000 hex	Unit Over Range for Channel 8	NX-series Analog I/O Units	W522
64F80000 hex	Unit Under Range for Channel 1	NX-series Analog I/O Units	W522
64F90000 hex	Unit Under Range for Channel 2	NX-series Analog I/O Units	W522
64FA0000 hex	Unit Under Range for Channel 3	NX-series Analog I/O Units	W522
64FB0000 hex	Unit Under Range for Channel 4	NX-series Analog I/O Units	W522
64FC0000 hex	Unit Under Range for Channel 5	NX-series Analog I/O Units	W522
64FD0000 hex	Unit Under Range for Channel 6	NX-series Analog I/O Units	W522
64FE0000 hex	Unit Under Range for Channel 7	NX-series Analog I/O Units	W522
64FF0000 hex	Unit Under Range for Channel 8	NX-series Analog I/O Units	W522
65030000 hex	Unit I/O Disconnection Detected for Channel 1	NX-series Analog I/O Units	W522
65040000 hex	Unit I/O Disconnection Detected for Channel 2	NX-series Analog I/O Units	W522
65050000 hex	Unit I/O Disconnection Detected for Channel 3	NX-series Analog I/O Units	W522
65060000 hex	Unit I/O Disconnection Detected for Channel 4	NX-series Analog I/O Units	W522
65070000 hex	Unit I/O Disconnection Detected for Channel 5	NX-series Analog I/O Units	W522
65080000 hex	Unit I/O Disconnection Detected for Channel 6	NX-series Analog I/O Units	W522
65090000 hex	Unit I/O Disconnection Detected for Channel 7	NX-series Analog I/O Units	W522
650A0000 hex	Unit I/O Disconnection Detected for Channel 8	NX-series Analog I/O Units	W522
65100000 hex	Sensor Disconnected Error	NX-series Analog I/O Units and NX-series Temperature Control Units	W566 H228
65110000 hex	Process Value Over Range	NX-series Analog I/O Units	W566

Event code	Event name	Functional classification	Reference
65120000 hex	Process Value Under Range	NX-series Analog I/O Units	W566
65130000 hex	Sensor Disconnected Error	NX-series Load Cell Input Units	W565
65140000 hex	Over Range	NX-series Load Cell Input Units	W565
65150000 hex	Under Range	NX-series Load Cell Input Units	W565
65200000 hex	I/O Power Supply Voltage Error	NX-series Safety Control Unit	Z930
65210000 hex	Output Power Interrupt Circuit Error	NX-series Safety Control Unit	Z930
65220000 hex	External Test Signal Failure at Safety Input	NX-series Safety Control Unit	Z930
65230000 hex	Discrepancy Error at Safety Input	NX-series Safety Control Unit	Z930
65240000 hex	Overload Detected at Test Output	NX-series Safety Control Unit	Z930
65250000 hex	Stuck-at-high Detected at Test Output	NX-series Safety Control Unit	Z930
65270000 hex	Short Circuit Detected at Safety Output	NX-series Safety Control Unit	Z930
65280000 hex	Stuck-at-high Detected at Safety Output	NX-series Safety Control Unit	Z930
652C0000 hex	Heater Burnout Detected	NX-series Analog I/O Units and NX-series Temperature Control Units	W566 H228
652D0000 hex	SSR Failure Detected	NX-series Analog I/O Units and NX-series Temperature Control Units	W566 H228
652E0000 hex	Alarm Detected	NX-series Temperature Control Units	H228
67800000 hex	Immediate Stop Input	CNC Function	O030
67810000 hex	Positive Limit Input Detected	CNC Function	O030
67820000 hex	Negative Limit Input Detected	CNC Function	O030
67830000 hex	Target Position Positive Software Limit Exceeded	CNC Function	O030
67840000 hex	Target Position Negative Software Limit Exceeded	CNC Function	O030
67850000 hex	Command Position Overflow/Underflow	CNC Function	O030
67860000 hex	Positive Limit Input	CNC Function	O030
67870000 hex	Negative Limit Input	CNC Function	O030
67880000 hex	Positive Software Limit Exceeded	CNC Function	O030
67890000 hex	Negative Software Limit Exceeded	CNC Function	O030
678A0000 hex	In-position Check Time Exceeded	CNC Function	O030
678B0000 hex	Following Error Limit Exceeded	CNC Function	O030
678C0000 hex	Following Error Warning	CNC Function	O030
678D0000 hex	Command Position Overflow	CNC Function	O030
678E0000 hex	Command Position Underflow	CNC Function	O030
678F0000 hex	Actual Position Overflow	CNC Function	O030

Event code	Event name	Functional classification	Reference
67900000 hex	Actual Position Underflow	CNC Function	O030
67910000 hex	Illegal Following Error	CNC Function	O030
67920000 hex	Absolute Encoder Current Position Calculation Failed	CNC Function	O030
67930000 hex	Home Undefined during Coordinated Motion	CNC Function	O030
67940000 hex	Cycle Start Specified during Positive Software Limit Exceeded	CNC Function	O030
67950000 hex	Cycle Start Specified during Negative Software Limit Exceeded	CNC Function	O030
67960000 hex	Cycle Start Specified during Command Position Overflow (Underflow)	CNC Function	O030
67970000 hex	Cycle Start Specified during Positive Limit Input	CNC Function	O030
67980000 hex	Cycle Start Specified during Negative Limit Input	CNC Function	O030
67990000 hex	NC Program Execution Error	CNC Function	O030
68200000 hex	Drive Prohibition Detected	Servo 1S	I586 I621
68210000 hex	Control Right Release Error	Servo 1S	I586 I621
68220000 hex	Error stop input	Servo 1S	I586 I621
68230000 hex	Software Limit Exceeded	Servo 1S	I586 I621
68370000 hex	SOPT Input Monitoring Error	Servo 1S	I621
68380000 hex	Safety Function Error	Servo 1S	I621
68390000 hex	Discrepancy Error at SF Input	Servo 1S	I621
683A0000 hex	SBC Relay Diagnosis Error	Servo 1S	I621
683B0000 hex	External Test Signal Failure at SOPT Input	Servo 1S	I621
683C0000 hex	Overload Detected at Test Output	Servo 1S	I621
683D0000 hex	Stuck-at-high Detected at Test Output	Servo 1S	I621
683E0000 hex	Overload Detected at SBC Output	Servo 1S	I621
683F0000 hex	Stuck-at-high Detected at SBC Output	Servo 1S	I621
68400000 hex	IOV Power Supply Voltage Error	Servo 1S	I621
68410000 hex	SBC Power Supply Voltage Error	Servo 1S	I621
68420000 hex	Monitoring Limit Exceedance Error	Servo 1S	I621
70010000 hex	Previous Time Specified	NX-series Digital I/O Units	W521
74200000 hex	Motion Control Period Exceeded	General Motion Control	W564
74210000 hex	Servo Main Circuit Power OFF	General Motion Control	W564

Event code	Event name	Functional classification	Reference
74220000 hex	Servo Main Circuits OFF	Motion Control Instructions	W564
74230000 hex	Interrupt Feeding Interrupt Signal Missing	General Motion Control	W564
74240000 hex	Homing Opposite Direction Limit Input Detected	General Motion Control	W564
74250000 hex	Homing Direction Limit Input Detected	General Motion Control	W564
74260000 hex	Homing Limit Inputs Detected in Both Directions	General Motion Control	W564
74270000 hex	Home Proximity/Homing Opposite Direction Limit Input Detected	General Motion Control	W564
74280000 hex	Home Proximity/Homing Direction Limit Input Detected	General Motion Control	W564
74290000 hex	Home Input/Homing Opposite Direction Limit Input Detected	General Motion Control	W564
742A0000 hex	Home Input/Homing Direction Limit Input Detected	General Motion Control	W564
742B0000 hex	Invalid Home Input Mask Distance	General Motion Control	W564
742C0000 hex	No Home Input	General Motion Control	W564
742D0000 hex	No Home Proximity Input	General Motion Control	W564
742F0000 hex	Slave Error Detected	General Motion Control	W564
74300000 hex	Axes Group Composition Axis Error	General Motion Control NJ Robotics Function	W564 W539
74320000 hex	Slave Observation Detected	General Motion Control	W564
74330000 hex	MC Common Error Occurrence	General Motion Control	W564
74340000 hex	Latch Position Overflow	General Motion Control	W564
74350000 hex	Latch Position Underflow	General Motion Control	W564
74360000 hex	Master Sync Direction Error	General Motion Control	W564
74370000 hex	Slave Disconnection during Servo ON	General Motion Control	W564
74380000 hex	Feed Distance Overflow	General Motion Control	W564
74390000 hex	Error in Changing Servo Drive Control Mode	General Motion Control	W564
743A0000 hex	Master Axis Position Read Error	General Motion Control	W564
743B0000 hex	Auxiliary Axis Position Read Error	General Motion Control	W564
743C0000 hex	Cannot Execute Save Cam Table Instruction	General Motion Control	W564
743D0000 hex	Incorrect Synchronization Command	NX-series Position Interface Units	W524
743E0000 hex	Illegal Following Error	NX-series Position Interface Units	W524
743F0000 hex	Illegal State Transition	NX-series Position Interface Units	W524
74800000 hex	Command Warning	Servo G5 and G5 Linear	I576 I577
74810000 hex	Command Error	Servo G5 and G5 Linear	I576 I577

Event code	Event name	Functional classification	Reference
74900000 hex	Multiple control signal input error	ZW-CE1□T Confocal Fiber Type Displacement Sensor	Z332
74910000 hex	EXE input error	ZW-CE1□T Confocal Fiber Type Displacement Sensor	Z332
74920000 hex	SYNC input error	ZW-CE1□T Confocal Fiber Type Displacement Sensor	Z332
74930000 hex	TIMING input error	ZW-CE1□T Confocal Fiber Type Displacement Sensor	Z332
74940000 hex	RESET input error	ZW-CE1□T Confocal Fiber Type Displacement Sensor	Z332
74950000 hex	ZERO input error	ZW-CE1□T Confocal Fiber Type Displacement Sensor	Z332
74960000 hex	ZEROCLR input error	ZW-CE1□T Confocal Fiber Type Displacement Sensor	Z332
74A00000 hex	SF_Antivalent Error	NX-series Safety Control Unit	Z930
74A10000 hex	SF_EDM Error	NX-series Safety Control Unit	Z930
74A20000 hex	SF_EmergencyStop Error	NX-series Safety Control Unit	Z930
74A30000 hex	SF_EnableSwitch Error	NX-series Safety Control Unit	Z930
74A40000 hex	SF_Equivalent Error	NX-series Safety Control Unit	Z930
74A50000 hex	SF_ESPE Error	NX-series Safety Control Unit	Z930
74A60000 hex	SF_GuardLocking Error	NX-series Safety Control Unit	Z930
74A70000 hex	SF_GuardMonitoring Error	NX-series Safety Control Unit	Z930
74A80000 hex	SF_ModeSelector Error	NX-series Safety Control Unit	Z930
74A90000 hex	SF_MutingPar Error	NX-series Safety Control Unit	Z930
74AA0000 hex	SF_MutingPar_2Sensor Error	NX-series Safety Control Unit	Z930
74AB0000 hex	SF_MutingSeq Error	NX-series Safety Control Unit	Z930
74AC0000 hex	SF_OutControl Error	NX-series Safety Control Unit	Z930
74AD0000 hex	SF_SafetyRequest Error	NX-series Safety Control Unit	Z930
74AE0000 hex	SF_TestableSafetySensor Error	NX-series Safety Control Unit	Z930
74AF0000 hex	SF_TwoHandControlTypeII Error	NX-series Safety Control Unit	Z930
74B00000 hex	SF_TwoHandControlTypeIII Error	NX-series Safety Control Unit	Z930
77800000 hex	CNC Control Period Exceeded	CNC Function	O030
77810000 hex	CNC Planner Service Period Exceeded	CNC Function	O030
77820000 hex	CNC Coordinate System Composition CNC Motor Error	CNC Function	O030
77830000 hex	CNC Common Error Occurrence	CNC Function	O030
77840000 hex	Servo Main Circuits OFF	CNC Function	O030
77850000 hex	Servo Main Circuit Power OFF	CNC Function	O030
77860000 hex	Slave Error Detected	CNC Function	O030
77870000 hex	Slave Observation Detected	CNC Function	O030
77880000 hex	Slave Disconnection during Servo ON	CNC Function	O030
77890000 hex	Homing Opposite Direction Limit Input Detected	CNC Function	O030
778A0000 hex	Homing Direction Limit Input Detected	CNC Function	O030

Event code	Event name	Functional classification	Reference
778B0000 hex	Homing Limit Inputs Detected in Both Directions	CNC Function	O030
778C0000 hex	Home Proximity/Homing Opposite Direction Limit Input Detected	CNC Function	O030
778D0000 hex	Home Proximity/Homing Direction Limit Input Detected	CNC Function	O030
778E0000 hex	Home Input/Homing Opposite Direction Limit Input Detected	CNC Function	O030
778F0000 hex	Home Input/Homing Direction Limit Input Detected	CNC Function	O030
77900000 hex	Invalid Home Input Mask Distance	CNC Function	O030
77910000 hex	No Home Input	CNC Function	O030
77920000 hex	No Home Proximity Input	CNC Function	O030
78010000 hex	Operation Command Competition	Servo G5 and G5 Linear	I576 I577
78020000 hex	Absolute Encoder Status Error	Servo G5	I576
78080000 hex	TRIG Input Error	EtherCAT FQ-M-series Specialized Vision Sensors for Positioning	Z314
780A0000 hex	Scene Data Error	EtherCAT FQ-M-series Specialized Vision Sensors for Positioning	Z314
780B0000 hex	Model Error	EtherCAT FQ-M-series Specialized Vision Sensors for Positioning	Z314
780C0000 hex	Logging Error	EtherCAT FQ-M-series Specialized Vision Sensors for Positioning	Z314
780D0000 hex	Output Timeout	EtherCAT FQ-M-series Specialized Vision Sensors for Positioning	Z314
780E0000 hex	Output Size Error	EtherCAT FQ-M-series Specialized Vision Sensors for Positioning	Z314
78190000 hex	Image Logging Disk Write Error	FH/FZ5 Series Vision System	Z342
781A0000 hex	Setting Data Transfer Error	FH/FZ5 Series Vision System	Z342
781B0000 hex	Output Buffer Error (EtherCAT)	FH/FZ5 Series Vision System	Z342
78200000 hex	Pulse Output Overspeed Error	Servo 1S	I586 I621
78210000 hex	Brake Interlock Error	Servo 1S	I586 I621
78220000 hex	Command Warning	Servo 1S	I586
78230000 hex	Command Error	Servo 1S	I586 I621

Event code	Event name	Functional classification	Reference
80200000 hex	NX Unit I/O Communications Error	NX-series Digital I/O Units, NX-series Analog I/O Units, NX-series Position Interface Units, NX-series Communications Interface Units, NX-series Safety Control Units, NX-series Load Cell Input Units, NX-series IO-Link Master Units, and NX-series Temperature Control Units	W521 W522 W566 W524 W540 Z930 W565 W570 H228
80210000 hex	NX Unit Output Synchronization Error	NX-series Digital I/O Units, NX-series Analog I/O Units, NX-series Position Interface Units, and NX-series Load Cell Input Units	W521 W522 W524 W565
80220000 hex	NX Message Communications Error	NX-series EtherCAT Coupler Units, NX-series Analog I/O Units, NX-series Position Interface Units, NX-series Communications Interface Units, NX-series Safety Control Unit, NX-series Load Cell Input Units, NX-series IO-Link Master Units, and NX-series Temperature Control Units	W522 W566 W524 W540 Z930 W565 W570 H228
80230000 hex	NX Message Communications Error	Errors Related to Controller Operation	W564
80240000 hex	NX Unit Clock Not Synchronized Error	NX-series Digital I/O Units, NX-series Analog I/O Units, NX-series Position Interface Units, NX-series Communications Interface Units, NX-series Load Cell Input Units, NX-series IO-Link Master Units, and NX-series Temperature Control Units	W521 W522 W566 W524 W540 W565 W570 H228
80300000 hex	Safety Process Data Communications Timeout	NX-series Safety Control Unit	Z930
84030000 hex	DNS Server Connection Error	Built-in EtherNet/IP Port on CPU Unit	W564
84040000 hex	NTP Server Connection Error	Built-in EtherNet/IP Port on CPU Unit	W564
84050000 hex	Packet Discarded Due to Full Reception Buffer	Built-in EtherNet/IP Port on CPU Unit	W564
84060000 hex	Link OFF Detected	Built-in EtherNet/IP Port on CPU Unit	W564
84070000 hex	Tag Data Link Connection Failed	Built-in EtherNet/IP Port on CPU Unit	W564
84080000 hex	Tag Data Link Timeout	Built-in EtherNet/IP Port on CPU Unit	W564
84090000 hex	Tag Data Link Connection Timeout	Built-in EtherNet/IP Port on CPU Unit	W564
840A0000 hex	IP Address Duplication Error	Built-in EtherNet/IP Port on CPU Unit	W564

Event code	Event name	Functional classification	Reference
840B0000 hex	BOOTP Server Connection Error	Built-in EtherNet/IP Port on CPU Unit	W564
84200000 hex	Link OFF Error	Built-in EtherCAT Master in CPU Unit	W564
84210000 hex	Network Configuration Error	Built-in EtherCAT Master in CPU Unit	W564
84220000 hex	Network Configuration Verification Error	Built-in EtherCAT Master in CPU Unit	W564
84230000 hex	Slave Initialization Error	Built-in EtherCAT Master in CPU Unit	W564
84280000 hex	Slave Application Error	Built-in EtherCAT Master in CPU Unit	W564
84290000 hex	Process Data Transmission Error	Built-in EtherCAT Master in CPU Unit	W564
842B0000 hex	Process Data Reception Timeout	Built-in EtherCAT Master in CPU Unit	W564
842C0000 hex	Process Data Communications Error	Built-in EtherCAT Master in CPU Unit	W564
842D0000 hex	EtherCAT Message Error	Built-in EtherCAT Master in CPU Unit	W564
842E0000 hex	EtherCAT Frame Not Received	Built-in EtherCAT Master in CPU Unit	W564
842F0000 hex	Input Process Data Invalid Error	Built-in EtherCAT Master in CPU Unit	W564
84400000 hex	EtherCAT Slave Communications Error	General Motion Control	W564
84790000 hex	Error-level Device Event	GX-series EtherCAT Slave Units	W570
847A0000 hex	IO-Link Communications Error	GX-series EtherCAT Slave Units	W570
847C0000 hex	Device Configuration Verification Error	GX-series EtherCAT Slave Units	W570
84820000 hex	IO-Link Device Configuration Information Created	GX-series EtherCAT Slave Units	W570
84840000 hex	I/O Cable Short-circuit	GX-series EtherCAT Slave Units	W570
84850000 hex	I/O Power Supply ON Detected	GX-series EtherCAT Slave Units	W570
84860000 hex	Warning-level Device Event Flag	GX-series EtherCAT Slave Units	W570
84870000 hex	IO-Link Communications Module Processing Error	GX-series EtherCAT Slave Units	W570
848C0000 hex	Error-level Device Event	NX-series IO-Link Master Units	W570
848D0000 hex	IO-Link Communications Error	NX-series IO-Link Master Units	W570
848F0000 hex	Device Configuration Verification Error	NX-series IO-Link Master Units	W570
84950000 hex	IO-Link Device Configuration Information Created	NX-series IO-Link Master Units	W570
84970000 hex	I/O Cable Short-circuit	NX-series IO-Link Master Units	W570
84980000 hex	I/O Power Supply ON Detected	NX-series IO-Link Master Units	W570
84990000 hex	Warning-level Device Event Flag	NX-series IO-Link Master Units	W570
849A0000 hex	IO-Link Communications Module Processing Error	NX-series IO-Link Master Units	W570
84A00000 hex	Slave Unit Verification Error	GX-series EtherCAT Slave Units	W488 W570

Event code	Event name	Functional classification	Reference
84B00000 hex	EtherCAT Communications Warning	Servo G5, G5 Linear, and Servo 1S	I576 I577 I586
84B10000 hex	EtherCAT State Change Error	Servo G5, G5 Linear, and Servo 1S	I576 I577 I586 I621
84B20000 hex	EtherCAT Illegal State Change Error	Servo G5, G5 Linear, and Servo 1S	I576 I577 I586 I621
84B30000 hex	Communications Synchronization Error	Servo G5 and G5 Linear	I576 I577
84B40000 hex	Synchronization Error	Servo G5, G5 Linear, and Servo 1S	I576 I577 I586 I621
84B50000 hex	Sync Manager WDT Error	Servo G5, G5 Linear, and Servo 1S	I576 I577 I586 I621
84B60000 hex	ESC Initialization Error	Servo G5, G5 Linear, and Servo 1S	I576 I577 I586 I621
84B70000 hex	Slave Unit Verification Error	Servo G5, G5 Linear, and Servo 1S	I576 I577 I586 I621
84B80000 hex	Communications Setting Error	Servo G5 and G5 Linear	I576 I577
84B90000 hex	Synchronization Interruption Error	Servo G5, G5 Linear, and Servo 1S	I576 I577 I586 I621
84BA0000 hex	Bootstrap State Transition Request Error	Servo 1S	I586 I621
84C00000 hex	NX Unit Communications Timeout	NX-series EtherCAT Coupler Unit	W519
84C10000 hex	NX Unit Initialization Error	NX-series EtherCAT Coupler Unit	W519
84C50000 hex	NX Unit Startup Error	NX-series EtherCAT Coupler Unit	W519
84D00000 hex	SSI Communications Error	NX-series Position Interface Units	W524
84F00000 hex	NX Bus I/O Communications Stopped	NX-series Safety Control Unit	Z930
84F10000 hex	NX Bus I/O Communications Stopped	NX-series Safety Control Unit	Z930
85000000 hex	Process Data WDT Error	NX-series EtherCAT Coupler Unit	W519

Event code	Event name	Functional classification	Reference
85010000 hex	Synchronization Interruption Error	NX-series EtherCAT Coupler Unit	W519
85020000 hex	Synchronization Error	NX-series EtherCAT Coupler Unit	W519
85030000 hex	Communications Synchronization Error	NX-series EtherCAT Coupler Unit	W519
85400000 hex	Data Discarded Due to Full Internal Buffer	NX-series Communications Interface Units	W540
85410000 hex	Parity Error	NX-series Communications Interface Units	W540
85420000 hex	Framing Error	NX-series Communications Interface Units	W540
85430000 hex	Overrun Error	NX-series Communications Interface Units	W540
87800000 hex	EtherCAT Slave Communications Error	CNC Function	O030
88080000 hex	PLC Link Communications Error	FH/FZ5 Series Vision System	Z342
88100000 hex	Communications Synchronization Error	Servo 1S	I586 I621
88120000 hex	Safety Communications Timeout	Servo 1S	I586 I621
90050000 hex	User Program/Controller Configurations and Setup Downloaded	Errors Related to Controller Operation	W564
90070000 hex	Online Edits Transferred	Errors Related to Controller Operation	W564
90080000 hex	Variable Changed to TRUE with Forced Refreshing	Errors Related to Controller Operation	W564
90090000 hex	Variable Changed to FALSE with Forced Refreshing	Errors Related to Controller Operation	W564
900A0000 hex	All Forced Refreshing Cleared	Errors Related to Controller Operation	W564
900B0000 hex	Memory All Cleared	Errors Related to Controller Operation	W564
900C0000 hex	Event Log Cleared	Errors Related to Controller Operation	W564
90110000 hex	Power Turned ON	Errors Related to Controller Operation	W564
90120000 hex	Power Interrupted	Errors Related to Controller Operation	W564
90130000 hex	Operation Started	Errors Related to Controller Operation	W564
90140000 hex	Operation Stopped	Errors Related to Controller Operation	W564
90150000 hex	Reset Executed	Errors Related to Controller Operation	W564
90160000 hex	User Program Execution ID Write	Errors Related to Controller Operation	W564
90180000 hex	All Controller Errors Cleared	Errors Related to Controller Operation	W564

Event code	Event name	Functional classification	Reference
90190000 hex	Forced Refreshing Cleared	Errors Related to Controller Operation	W564
90230000 hex	Forced Shutdown	Errors Related to Controller Operation	W564
90240000 hex	Backup Started	Errors Related to Controller Operation	W564
90250000 hex	Backup Completed	Errors Related to Controller Operation	W564
90260000 hex	Restore Operation Started	Errors Related to Controller Operation	W564
90270000 hex	Restore Operation Completed	Errors Related to Controller Operation	W564
90280000 hex	Shared Folder Recognition Completed	Errors Related to Controller Operation	W564
90400000 hex	Event Log Cleared	NX-series EtherCAT Coupler Units, NX-series Digital I/O Units, NX-series Analog I/O Units, NX-series System Units, NX-series Position Interface Units, NX-series Communications Interface Units, NX-series Safety Control Unit, NX-series Load Cell Input Units, NX-series IO-Link Master Units, and NX-series Temperature Control Units	W519 W521 W522 W566 W523 W524 W540 Z930 W565 W570 H228
90420000 hex	Restart Executed	NX-series EtherCAT Coupler Unit	W519
90430000 hex	Memory All Cleared	NX-series EtherCAT Coupler Unit and NX-series Safety Control Unit	W519 Z930
90A00000 hex	Unit Restarted	Servo 1S	I586
94010000 hex	Tag Data Link Download Started	Built-in EtherNet/IP Port on CPU Unit	W564
94020000 hex	Tag Data Link Download Finished	Built-in EtherNet/IP Port on CPU Unit	W564
94030000 hex	Tag Data Link Stopped	Built-in EtherNet/IP Port on CPU Unit	W564
94040000 hex	Tag Data Link Started	Built-in EtherNet/IP Port on CPU Unit	W564
94050000 hex	Link Detected	Built-in EtherNet/IP Port on CPU Unit	W564
94060000 hex	Restarting Ethernet Port	Built-in EtherNet/IP Port on CPU Unit	W564
94070000 hex	Tag Data Link All Run	Built-in EtherNet/IP Port on CPU Unit	W564
94080000 hex	IP Address Fixed	Built-in EtherNet/IP Port on CPU Unit	W564
94090000 hex	BOOTP Client Started	Built-in EtherNet/IP Port on CPU Unit	W564

Event code	Event name	Functional classification	Reference
940A0000 hex	FTP Server Started	Built-in EtherNet/IP Port on CPU Unit	W564
940B0000 hex	NTP Client Started	Built-in EtherNet/IP Port on CPU Unit	W564
940C0000 hex	SNMP Started	Built-in EtherNet/IP Port on CPU Unit	W564
94200000 hex	Notice of Insufficient Travel Distance to Achieve Blending Transit Velocity	General Motion Control	W564
94210000 hex	Error Clear from MC Test Run Tab Page	General Motion Control	W564
94220000 hex	Slave Error Code Report	General Motion Control	W564
94400000 hex	Slave Disconnected	Built-in EtherCAT Master in CPU Unit	W564
94410000 hex	Slave Connected	Built-in EtherCAT Master in CPU Unit	W564
94430000 hex	Error Reset	Built-in EtherCAT Master in CPU Unit	W564
94440000 hex	Slave Disabled	Built-in EtherCAT Master in CPU Unit	W564
94450000 hex	Slave Enabled	Built-in EtherCAT Master in CPU Unit	W564
94500000 hex	EtherCAT Diagnosis/Statistics Log Started	Built-in EtherCAT Master in CPU Unit	W564
94510000 hex	EtherCAT Diagnosis/Statistics Log Ended	Built-in EtherCAT Master in CPU Unit	W564
94600000 hex	I/O Check Execution Started	NX-series EtherCAT Coupler Unit	W519
94D00000 hex	Tuning Parameter Updated	NX-series Temperature Control Units	H228
94D10000 hex	Related Parameters Initialized	NX-series Temperature Control Units	H228
94F00000 hex	Tuning Parameter Automatically Updated	NX-series Temperature Control Units	H228
951E0000 hex	Sysmac Studio Communications Connection Timeout	NX-series Safety Control Unit	Z930
951F0000 hex	Clear All Memory Rejected	NX-series Safety Control Unit	Z930
95700000 hex	OS Started	Errors Related to Controller Operation	W564
95710000 hex	OS Shut Down	Errors Related to Controller Operation	W564
97800000 hex	Slave Error Code Report	CNC Function	O030
97810000 hex	Software Limit Path Limited	CNC Function	O030
97820000 hex	CNC Function System Information	CNC Function	O030
97830000 hex	Velocity Control Command Value Saturated	CNC Function	O030
98010000 hex	Absolute Value Cleared	Servo G5	I576
98020000 hex	Position Data Initialized	Servo G5 and G5 Linear	I576 I577

Event code	Event name	Functional classification	Reference
98200000 hex	Absolute Value Cleared	Servo 1S	I586 I621
98210000 hex	STO Detected	Servo 1S	I586
98220000 hex	Memory All Cleared	Servo 1S	I586
98230000 hex	Motor Rotation Direction Selection Nonconformity	Servo 1S	I621
98240000 hex	Event Log Cleared	Servo 1S	I586
98250000 hex	STO Detected	Servo 1S	I621

A-4 Applicable Range of the HMI Troubleshooter

Whether the HMI Troubleshooter can be used depends on the combination of the HMI model and the system version.

Also, the system configuration elements that are supported by the HMI Troubleshooter are different for each Troubleshooter function.

A-4-1 HMIs on which Troubleshooter Can Be Used

Whether the HMI Troubleshooter can be used depends on the combination of the HMI model and the system version.

● NA-series HMIs

The models of HMIs on which the Troubleshooter can be used are given in the following table.

HMI	Model
NA5	NA5-□

Whether the Troubleshooter can be used for specific system versions of the above HMI models is given in the following table.

HMI system version	Applicable
Version 1.02 or higher	Can be used.
Version 1.01 or lower	The HMI does not have a Troubleshooter.

● NS-series HMIs

The models of HMIs on which the Troubleshooter can be used are given in the following table.

HMI	Model
NS8, NS10, NS12, and NS15	NS□-T□01-V2 (The V2 versions have an Ethernet port.)
NS5	NS5-□Q11-V2 (These models have expanded memory and an Ethernet port.)
NSJ8, NSJ10, and NSJ12	All models
NSJ5	NSJ5-□Q11-□ (These models have expanded memory and an Ethernet port.)

Whether the Troubleshooter can be used for specific system versions of the above HMI models is given in the following table.

HMI system version	Applicable
Version 8.9 or higher	Can be used.
Version 8.5 to 8.8	Cannot be used.
Ver. 8.4 or lower	The HMI does not have a Troubleshooter.

A-4-2 System Configuration Elements Supported by the Troubleshooter

The troubleshooting functions that you can use on the HMI depend on the system configuration element.

Refer to the following manuals for the NA-series HMIs and NS-series HMIs for the system configuration elements that are supported by the HMI Troubleshooter.

- *NA-series Programmable Terminal Hardware User's Manual (Cat. No. V117)*
- *NS-series Programmable Terminals Programming Manual (Cat No. V073)*

A-5 Checking Errors with Windows

This section describes how to use Windows to check errors that occur in the NY-series Industrial PC or Windows. Take necessary measures if an error occurs.

A-5-1 Industrial PC Support Utility

You can check status of the NY-series Industrial PC with the Industrial PC Support Utility.



Additional Information

For details on the Industrial PC Support Utility, refer to the *NY-series Industrial Panel PC / Industrial Box PC Setup User's Manual (Cat. No. W568)*.

System Status Tab Page

The following table shows errors and corrections you can check with the **System Status** Tab Page of the Industrial PC Support Utility.

Item	Error	Correction
Internal temperature	The temperature inside the Industrial PC exceeded the specified value.	Improve the environment so that the ambient operating temperature does not exceed the specified value.
Fan revolution	The speed of the fan dropped.	If there is any material that is interfering with fan operation, remove it. Replace the fan if the speed dropped while there is no obstacle.
Fan status	The message Low Revolution Speed is displayed.	
Battery status	The voltage of the Battery has dropped.	Replace the Battery.

For how to replace the fan or battery, refer to *NY-series Industrial Box PC Hardware User's Manual (Cat. No. W556)* or *NY-series Industrial Panel PC Hardware User's Manual (Cat. No. W557)*.

Controller Status Tab Page

With the Controller Status Tab Page of the Industrial PC Support Utility, you can check Controller errors and error status of the EtherNet/IP port. Refer to *1-3-2 Checking for Non-fatal Errors* on page 1-19.

A-5-2 Windows Issues and Troubleshooting

Issues and errors that occur in Windows are reported by the Windows Action Center, Pop Up windows, etc. You can check Windows events with the Windows Event Viewer.

Windows Action Center

The Windows Action Center indicates security and maintenance issues. Take necessary measures if a warning or error is displayed.

Windows Pop Up Window

Windows Pop Up windows provide information on Windows issues. Take necessary measures if a message is displayed.

● Measure to Take When the Message Close Programs to Prevent Information Loss Appears

The Windows memory can become low when adding applications and/or updates. When the memory is low, a new window with the message, "Close programs to prevent information loss" will appear. Increase the paging file size to solve this problem.

Use the following procedure to increase the page file size.

- 1** Type **Advanced system settings** in the Windows search box.
- 2** Select **View advanced system settings**.
The **Advanced** tab page in the Windows System properties will appear.
- 3** In the group **Performance**, select the **Settings** Button.
The **Performance options** window will appear.
- 4** Select the **Advanced** tab page.
- 5** In the group **Virtual memory**, select the **Change** Button.
- 6** Select the checkbox **Automatically manage paging file size for all drives**.

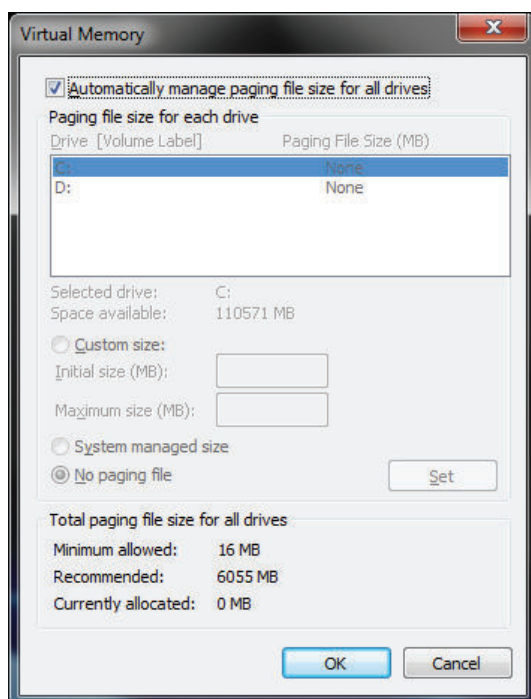

- 7** Select the **OK** Button to save this setting.



Precautions for Safe Use

Virtual memory settings can affect the performance of the system. Disable the paging file after installation of applications or updates.

Windows Event Viewer

The Windows Event Viewer displays logged events. These logged events can support you in troubleshooting.

- 1 Type **Event** in the Windows search box.
- 2 Select **View event logs**.
The Event Viewer opens.

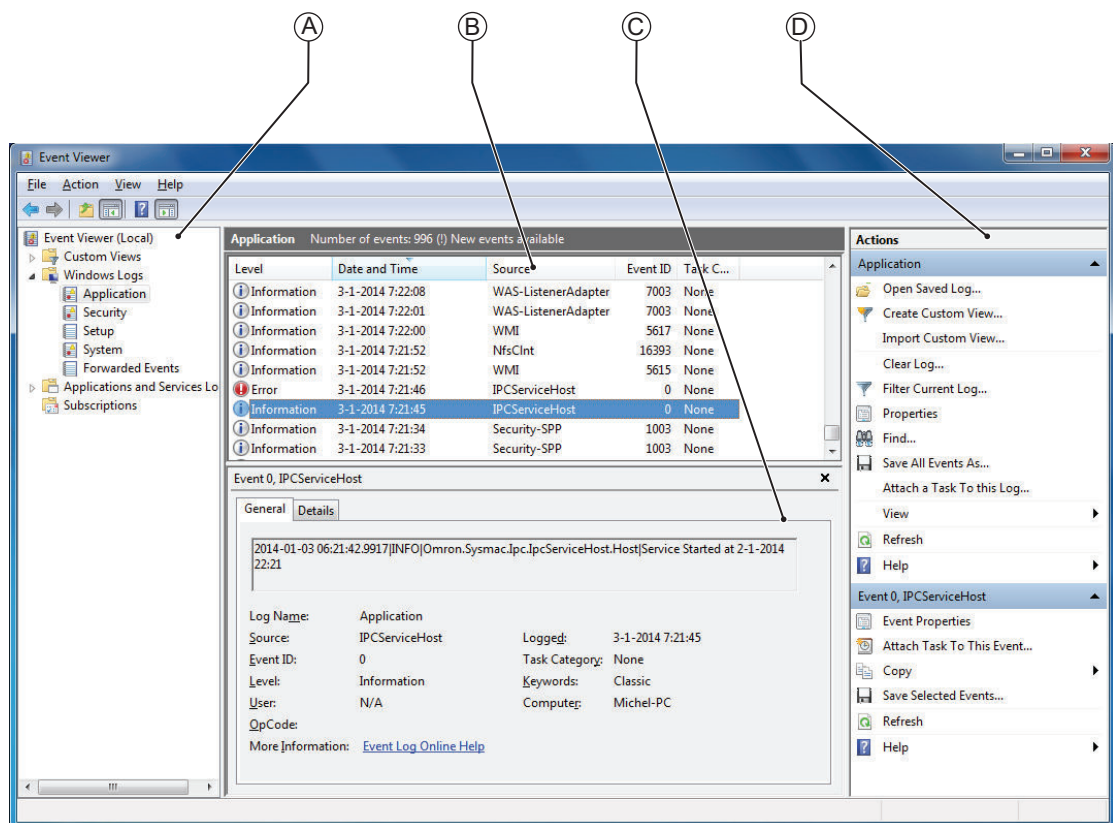

Item	Description
(A)	Console tree
(B)	Event list
(C)	Event details
(D)	Action list

- 3 In the Selection tree, expand **Windows Logs** and select **Application**.
The Event list will display the events.
- 4 Select the heading **Source** to sort the event messages per application.

- 5 Scroll to the event you want to investigate.
The events of the Industrial Box PC start with "IPC".
- 6 Select the event to display details in the Event details window or to take action in the Action overview window.

● Event Filtering and Event Details

This procedure explains how to filter events in the Windows event log. Use the following procedure to filter the events.

- 1 Open the Windows Event Viewer.
- 2 In the **Action list**, select **Filter Current Log**.
The **Filter Current Log** page opens.

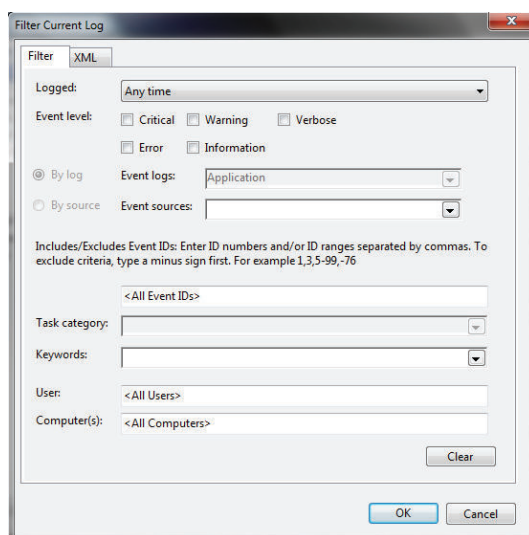

- 3 Input the desired filters and select **OK**.
The filtered events will appear in the Event list of the Event Viewer.
- 4 Select an event in the Event list.
The details on the event is displayed in the Event details part of the Event Viewer.

The filtered events can be checked including the details per event.

Windows Blue Screens

A blue screen will appear if Windows crashes. Possible solutions for repetitive blue screens are given below.

- 1 Install the latest updates of Windows.
- 2 Install the latest device drivers.

- 3** If changes to the system were made: Undo recent hardware changes, undo recent driver updates and then roll back system to latest working state.



Additional Information

For details, access the following Microsoft official web site:
<https://support.microsoft.com/en-us/help/17074/windows-7-resolving-stop-blue-screen-errors>, or
<https://support.microsoft.com/en-us/help/14238/windows-10-troubleshoot-blue-screen-errors>.



Index



Index

Numerics

1S-series..... A-82

A

Action Center..... A-176
 Assumed cause..... 3-4
 Attached information..... 3-4
 Axes Group Errors..... 1-25
 Axis Error..... 1-25

B

Back up function..... 3-488
 Battery status..... A-176
 Blue Screens..... A-179

C

Checking for errors..... 1-7, 1-19, 2-15
 CIP communications errors..... 1-29
 Communications port 1 errors..... 1-29
 communications port errors..... 1-31
 Controller errors..... 1-11
 Controller Event Times..... 1-10
 Controller events..... 1-8
 Controller events sources..... 1-10
 Controller information..... 1-11
 Correction..... 3-4
 CPU Unit Error..... 2-4
 CPU Unit Reset..... 2-4

D

Detection timing..... 3-4

E

E3NW-ECT..... A-124
 E3X..... A-123
 error code
 basic instructions..... 3-16, 3-105
 motion control instruction..... 3-283, 3-350
 error codes..... 1-18
 Error during Industrial PC System Boot..... 2-4
 error status..... 2-14
 Error Status variable..... 1-21, 2-15
 ErrorID
 basic instructions..... 3-16, 3-105
 motion control instruction..... 3-283, 3-350
 EtherCAT master errors..... 1-31
 EtherCAT slave errors..... 1-31
 event code..... 1-17
 Event code..... 3-4
 event log..... 1-8

Event name..... 3-4
 Event Viewer..... A-178
 events..... 1-2

F

Fan revolution..... A-176
 Fan status..... A-176
 Fatal Errors..... 1-4, 1-7
 Fatal Errors in the Controller..... 2-4
 FH-Series..... A-119
 FQ-M-series..... A-122

G

G5 Series..... A-101
 Get EtherCAT Error Status..... 1-21, 2-14
 Get EtherNet/IP Error Status..... 1-21, 2-14
 Get Motion Control Error Status..... 1-21, 2-14
 Get PLC Controller Error Status 1-21, 2-14
 GetECError (Get EtherCAT Error Status)..... 1-21, 2-14
 GetEIPError (Get EtherNet/IP Error Status)..... 1-21, 2-14
 GetMCError (Get Motion Control Error Status)..... 1-21, 2-14
 GetPLCError (Get PLC Controller Error Status)..... 1-21, 2-14
 GX-series..... A-79

H

HMI..... A-174

I

identifying and resetting errors..... 2-6
 indicators..... 1-19
 Indicators..... 1-5
 Industrial PC Support Utility..... A-176
 Information level..... 1-11
 instructions reading function module error status..... 1-21
 Internal port 1 errors..... 1-29
 Internal temperature..... A-176

L

Level..... 3-4
 levels..... 1-11
 Log category..... 3-4
 Low memory..... A-177

M

major fault level..... 1-11, 1-16
 MC Common Errors..... 1-25
 minor fault level..... 1-11
 MX2/RX-series..... A-118

N

Non-fatal errors.....	1-4
Non-fatal Errors in the Controller.....	1-8, 2-6
NX-AD□□□□.....	A-32
NX-CIF□□□□.....	A-50
NX-DA□□□□.....	A-32
NX-EC0□□□□.....	A-46
NX-ECC□□□□.....	A-23
NX-ECS□□□□.....	A-46
NX-HB□□□□.....	A-32
NX-ID□□□□.....	A-29
NX-ILM□□□□.....	A-70
NX-OC□□□□.....	A-29
NX-OD□□□□.....	A-29
NX-PC0□□□□.....	A-45
NX-PD1□□□□.....	A-45
NX-PF0□□□□.....	A-45
NX-PG0□□□□.....	A-46
NX-RS□□□□.....	A-66
NX-series Analog I/O Units.....	A-32
NX-series Digital I/O Units.....	A-29
NX-series EtherCAT Coupler Unit.....	A-23
NX-series IO-Link Master Units.....	A-70
NX-series Load Cell Input Units.....	A-66
NX-series Position Interface Units.....	A-46, A-50
NX-series Safety Control Unit.....	A-53, A-61
NX-series Safety CPU Unit.....	A-53
NX-series Safety I/O Unit.....	A-61
NX-series System Units.....	A-45
NX-series Temperature Control Units.....	A-74
NX-SI□□□□.....	A-61
NX-SL3□□□□.....	A-53
NX-SL5□□□□.....	A-53
NX-SO□□□□.....	A-61
NX-TBX01.....	A-45
NX-TC□□□□.....	A-74
NX-TS□□□□.....	A-32

O

Observation level.....	1-11
Online.....	2-17
Other Troubles and Corrections.....	3-483

P

partial fault level.....	1-11
Power Supply Failure.....	2-4
Prevention.....	3-4
Production Information.....	19

R

Recovery.....	3-4
Reset EtherCAT Error.....	2-15
Reset Motion Control Error.....	2-15
Reset PLC Controller Error.....	2-15
ResetECError (Reset EtherCAT Error).....	2-15
ResetMCError (Reset Motion Control Error).....	2-15

ResetPLCError (Reset PLC Controller Error).....	2-15
resetting errors.....	1-23, 2-11, 2-14
Resetting errors.....	2-14
Restore function.....	3-489

S

security errors.....	3-271
source details.....	1-10
Source details.....	3-4
sources.....	1-25, 1-31
System Initialization Error.....	2-5
system-defined variables.....	1-21, 2-15

T

TCP application errors.....	1-29
Troubleshooter.....	1-20, 2-11, A-174
troubleshooting.....	1-20
Troubleshooting Functions.....	2-6

U

User-defined events.....	1-8
--------------------------	-----

V

version.....	18
--------------	----

Z

ZW-CE1.....	A-125
-------------	-------

OMRON Corporation Industrial Automation Company
Kyoto, JAPAN

Contact: www.ia.omron.com

Regional Headquarters

OMRON EUROPE B.V.

Wegalaan 67-69, 2132 JD Hoofddorp
The Netherlands
Tel: (31)2356-81-300/Fax: (31)2356-81-388

OMRON ELECTRONICS LLC

2895 Greenspoint Parkway, Suite 200
Hoffman Estates, IL 60169 U.S.A.
Tel: (1) 847-843-7900/Fax: (1) 847-843-7787

OMRON ASIA PACIFIC PTE. LTD.

No. 438A Alexandra Road # 05-05/08 (Lobby 2),
Alexandra Technopark,
Singapore 119967
Tel: (65) 6835-3011/Fax: (65) 6835-2711

OMRON (CHINA) CO., LTD.

Room 2211, Bank of China Tower,
200 Yin Cheng Zhong Road,
PuDong New Area, Shanghai, 200120, China
Tel: (86) 21-5037-2222/Fax: (86) 21-5037-2200

Authorized Distributor:

© OMRON Corporation 2016-2021 All Rights Reserved.
In the interest of product improvement,
specifications are subject to change without notice.

Cat. No. W564-E1-06

0321