

SYSMAC CJ Series
CJ1W-TC □□□

Temperature Control Units

OPERATION MANUAL

OMRON

CJ1W-TC□□□

Temperature Control Units

Operation Manual

Revised December 2005

Notice:

OMRON products are manufactured for use according to proper procedures by a qualified operator and only for the purposes described in this manual.

The following conventions are used to indicate and classify precautions in this manual. Always heed the information provided with them. Failure to heed precautions can result in injury to people or damage to property.

 **DANGER** Indicates an imminently hazardous situation which, if not avoided, will result in death or serious injury. Additionally, there may be severe property damage.

 **WARNING** Indicates a potentially hazardous situation which, if not avoided, could result in death or serious injury. Additionally, there may be severe property damage.

 **Caution** Indicates a potentially hazardous situation which, if not avoided, may result in minor or moderate injury, or property damage.

OMRON Product References

All OMRON products are capitalized in this manual. The word “Unit” is also capitalized when it refers to an OMRON product, regardless of whether or not it appears in the proper name of the product.

The abbreviation “Ch,” which appears in some displays and on some OMRON products, often means “word” and is abbreviated “Wd” in documentation in this sense.

The abbreviation “PLC” means Programmable Controller. “PC” is used, however, in some Programming Device displays to mean Programmable Controller.

Visual Aids

The following headings appear in the left column of the manual to help you locate different types of information.

Note Indicates information of particular interest for efficient and convenient operation of the product.

1,2,3... 1. Indicates lists of one sort or another, such as procedures, checklists, etc.

© OMRON, 2001

All rights reserved. No part of this publication may be reproduced, stored in a retrieval system, or transmitted, in any form, or by any means, mechanical, electronic, photocopying, recording, or otherwise, without the prior written permission of OMRON.

No patent liability is assumed with respect to the use of the information contained herein. Moreover, because OMRON is constantly striving to improve its high-quality products, the information contained in this manual is subject to change without notice. Every precaution has been taken in the preparation of this manual. Nevertheless, OMRON assumes no responsibility for errors or omissions. Neither is any liability assumed for damages resulting from the use of the information contained in this publication.

TABLE OF CONTENTS

PRECAUTIONS	XV
1 Intended Audience	xvi
2 General Precautions	xvi
3 Safety Precautions.....	xvi
4 Operating Environment Precautions	xvii
5 Application Precautions	xviii
6 Conformance to EC Directives	xxi

SECTION 1

Features and System Configuration	1
1-1 Introduction and Features	2
1-2 System Configuration	6
1-3 Comparison to C200H Temperature Control Units	10

SECTION 2

Specifications and Functions	11
2-1 Specifications	12
2-2 Application Procedure.....	18
2-3 Part Names and Functions.....	21
2-4 Wiring	25
2-5 Data Exchange with the CPU Unit	29
2-6 Data Ranges	49

SECTION 3

Settings Required for Temperature Control	51
3-1 Setting the Input Type	52
3-2 Selecting the Temperature Units.....	53
3-3 Setting the Data Format	53
3-4 Selecting the Control Operation (Forward/Reverse).....	54
3-5 Selecting PID Control or ON/OFF Control	55
3-6 Setting the Control Period.....	55
3-7 Setting the Set Point	56
3-8 Using ON/OFF Control.....	56
3-9 Setting the PID Constants	57
3-10 Using the Alarm Output Function.....	60
3-11 Using the Heater Burnout Alarm	63
3-12 Starting and Stopping Temperature Control	66
3-13 Precautions for Operation	66

TABLE OF CONTENTS

SECTION 4

Optional Settings. 67

- 4-1 Shifting the Input Value (Input Compensation). 68
- 4-2 Recovering from Sensor Not Connected Errors 69
- 4-3 Application without a Cycle Refresh with the CPU Unit 69

SECTION 5

Error and Alarm Processing 71

- 5-1 Error and Alarm Processing. 72
- 5-2 Troubleshooting. 76

Appendices

- A Dimensions 83
- B Sample Programs 85

Index. 89

Revision History 91

About this Manual:

This manual describes the installation and operation of the CJ1W-TC□□□ Temperature Control Units and includes the sections described on the following page.

Please read this manual and all related manuals listed in the following table carefully and be sure you understand the information provided before attempting to install or operate the MC Unit. Be sure to read the precautions provided in the following section.

Name	Cat. No.	Contents
SYSMAC CJ Series CJ1W-TC□□□ Temperature Control Units Operation Manual	W396	Describes the application methods for the CJ-series Temperature Control Units. (This manual)
SYSMAC CJ Series CJ1G/H-CPU□□H, CJ1M-CPU□□, CJ1G-CPU□□ Programmable Controllers Operation Manual	W393	Provides an outlines of and describes the design, installation, maintenance, and other basic operations for the CJ-series PLCs.
SYSMAC CS/CJ Series CJ1G/H-CPU□□H, CJ1M-CPU□□, CS1G/H-CPU□□-EV1, CJ1G-CPU□□ Programmable Controllers Programming Manual	W394	This manual describes programming and other methods to use the functions of the CS/CJ-series PLCs.
SYSMAC CS/CJ-series CQM1H-PRO01-E, C200H-PRO27-E, CQM1-PRO01-E Programming Consoles Operation Manual	W341	Provides information on how to program and operate CS/CJ-series PLCs using a Programming Console.
SYSMAC CS/CJ-series CS1G/H-CPU□□H, CS1G/H-CPU□□-EV1, CS1D-CPU□□H, CS1D-CPU□□S, CJ1M-CPU□□, CS1W-SCB21-V1/41-V1/SCU21-V1, CJ1G/H-CPU□□H, CJ1G-CPU□□, CJ1W-SCU21/SCU41 Communications Commands Reference Manual	W342	Describes the C-series (Host Link) and FINS communications commands used with CS/CJ-series PLCs.
SYSMAC CX-Programmer Ver.5.0 WS02-CXPC1-E-V5 Operation Manual	W437	Provide information on how to use the CX-Programmer, a programming device that supports the CS/CJ-series PLCs, and the CX-Net contained within CX-Programmer.
SYSMAC CS/CJ-series CS1W-SCB21-V1/41-V1, CS1W-SCU21-V1, CJ1W-SCU21/41 Serial Communications Boards and Serial Communications Units Operation Manual	W336	Describes the use of Serial Communications Unit and Boards to perform serial communications with external devices, including the usage of standard system protocols for OMRON products.
SYSMAC WS02-PSTC1-E CX-Protocol Operation Manual	W344	Describes the use of the CX-Protocol to create protocol macros as communications sequences to communicate with external devices.

 **WARNING** Failure to read and understand the information provided in this manual may result in personal injury or death, damage to the product, or product failure. Please read each section in its entirety and be sure you understand the information provided in the section and related sections before attempting any of the procedures or operations given.

Precautions provides general precautions for using the Temperature Control Unit, Programmable Controller, and related devices.

Section 1 describes the features of the Temperature Control Unit and its basic system configuration.

Section 2 describes the functions and specifications of the Temperature Control Unit, including technical specifications, Unit parts, wiring, and data allocations.

Section 3 explains the various settings required for temperature control.

Section 4 explains how to use the input compensation value.

Section 5 provides information on troubleshooting and error processing.

The Appendices provide Unit dimensions and sample programming.

Read and Understand this Manual

Please read and understand this manual before using the product. Please consult your OMRON representative if you have any questions or comments.

Warranty and Limitations of Liability

WARRANTY

OMRON's exclusive warranty is that the products are free from defects in materials and workmanship for a period of one year (or other period if specified) from date of sale by OMRON.

OMRON MAKES NO WARRANTY OR REPRESENTATION, EXPRESS OR IMPLIED, REGARDING NON-INFRINGEMENT, MERCHANTABILITY, OR FITNESS FOR PARTICULAR PURPOSE OF THE PRODUCTS. ANY BUYER OR USER ACKNOWLEDGES THAT THE BUYER OR USER ALONE HAS DETERMINED THAT THE PRODUCTS WILL SUITABLY MEET THE REQUIREMENTS OF THEIR INTENDED USE. OMRON DISCLAIMS ALL OTHER WARRANTIES, EXPRESS OR IMPLIED.

LIMITATIONS OF LIABILITY

OMRON SHALL NOT BE RESPONSIBLE FOR SPECIAL, INDIRECT, OR CONSEQUENTIAL DAMAGES, LOSS OF PROFITS OR COMMERCIAL LOSS IN ANY WAY CONNECTED WITH THE PRODUCTS, WHETHER SUCH CLAIM IS BASED ON CONTRACT, WARRANTY, NEGLIGENCE, OR STRICT LIABILITY.

In no event shall the responsibility of OMRON for any act exceed the individual price of the product on which liability is asserted.

IN NO EVENT SHALL OMRON BE RESPONSIBLE FOR WARRANTY, REPAIR, OR OTHER CLAIMS REGARDING THE PRODUCTS UNLESS OMRON'S ANALYSIS CONFIRMS THAT THE PRODUCTS WERE PROPERLY HANDLED, STORED, INSTALLED, AND MAINTAINED AND NOT SUBJECT TO CONTAMINATION, ABUSE, MISUSE, OR INAPPROPRIATE MODIFICATION OR REPAIR.

Application Considerations

SUITABILITY FOR USE

OMRON shall not be responsible for conformity with any standards, codes, or regulations that apply to the combination of products in the customer's application or use of the products.

At the customer's request, OMRON will provide applicable third party certification documents identifying ratings and limitations of use that apply to the products. This information by itself is not sufficient for a complete determination of the suitability of the products in combination with the end product, machine, system, or other application or use.

The following are some examples of applications for which particular attention must be given. This is not intended to be an exhaustive list of all possible uses of the products, nor is it intended to imply that the uses listed may be suitable for the products:

- Outdoor use, uses involving potential chemical contamination or electrical interference, or conditions or uses not described in this manual.
- Nuclear energy control systems, combustion systems, railroad systems, aviation systems, medical equipment, amusement machines, vehicles, safety equipment, and installations subject to separate industry or government regulations.
- Systems, machines, and equipment that could present a risk to life or property.

Please know and observe all prohibitions of use applicable to the products.

NEVER USE THE PRODUCTS FOR AN APPLICATION INVOLVING SERIOUS RISK TO LIFE OR PROPERTY WITHOUT ENSURING THAT THE SYSTEM AS A WHOLE HAS BEEN DESIGNED TO ADDRESS THE RISKS, AND THAT THE OMRON PRODUCTS ARE PROPERLY RATED AND INSTALLED FOR THE INTENDED USE WITHIN THE OVERALL EQUIPMENT OR SYSTEM.

PROGRAMMABLE PRODUCTS

OMRON shall not be responsible for the user's programming of a programmable product, or any consequence thereof.

Disclaimers

CHANGE IN SPECIFICATIONS

Product specifications and accessories may be changed at any time based on improvements and other reasons.

It is our practice to change model numbers when published ratings or features are changed, or when significant construction changes are made. However, some specifications of the products may be changed without any notice. When in doubt, special model numbers may be assigned to fix or establish key specifications for your application on your request. Please consult with your OMRON representative at any time to confirm actual specifications of purchased products.

DIMENSIONS AND WEIGHTS

Dimensions and weights are nominal and are not to be used for manufacturing purposes, even when tolerances are shown.

PERFORMANCE DATA

Performance data given in this manual is provided as a guide for the user in determining suitability and does not constitute a warranty. It may represent the result of OMRON's test conditions, and the users must correlate it to actual application requirements. Actual performance is subject to the OMRON Warranty and Limitations of Liability.

ERRORS AND OMISSIONS

The information in this manual has been carefully checked and is believed to be accurate; however, no responsibility is assumed for clerical, typographical, or proofreading errors, or omissions.

PRECAUTIONS

This section provides general precautions for using the Temperature Control Unit, Programmable Controller, and related devices.

The information contained in this section is important for the safe and reliable application of the Temperature Control Unit. You must read this section and understand the information contained before attempting to set up or operate a Temperature Control Unit and PC system.

1	Intended Audience	xvi
2	General Precautions	xvi
3	Safety Precautions	xvi
4	Operating Environment Precautions	xvii
5	Application Precautions	xviii
6	Conformance to EC Directives	xxi

1 Intended Audience

This manual is intended for the following personnel, who must also have knowledge of electrical systems (an electrical engineer or the equivalent).

- Personnel in charge of installing FA systems.
- Personnel in charge of designing FA systems.
- Personnel in charge of managing FA systems and facilities.

2 General Precautions

The user must operate the product according to the performance specifications described in the operation manuals.

Before using the product under conditions which are not described in the manual or applying the product to nuclear control systems, railroad systems, aviation systems, vehicles, combustion systems, medical equipment, amusement machines, safety equipment, and other systems, machines, and equipment that may have a serious influence on lives and property if used improperly, consult your OMRON representative.

Make sure that the ratings and performance characteristics of the product are sufficient for the systems, machines, and equipment, and be sure to provide the systems, machines, and equipment with double safety mechanisms.

This manual provides information for installing and operating OMRON Temperature Control Units. Be sure to read this manual before operation and keep this manual close at hand for reference during operation.

 **WARNING** It is extremely important that a PLC and all PLC Units be used for the specified purpose and under the specified conditions, especially in applications that can directly or indirectly affect human life. You must consult with your OMRON representative before applying a PLC system to the above mentioned applications.

3 Safety Precautions

 **WARNING** Do not attempt to take any Unit apart while the power is being supplied. Doing so may result in electric shock.

 **WARNING** Do not touch any of the terminals or terminal blocks while the power is being supplied. Doing so may result in electric shock.

 **WARNING** Provide safety measures in external circuits (i.e., not in the Programmable Controller), including the following items, to ensure safety in the system if an abnormality occurs due to malfunction of the PLC or another external factor affecting the PLC operation. Not doing so may result in serious accidents.

- Emergency stop circuits, interlock circuits, limit circuits, and similar safety measures must be provided in external control circuits.
- The PLC will turn OFF all outputs when its self-diagnosis function detects any error or when a severe failure alarm (FALS) instruction is executed. As a countermeasure for such errors, external safety measures must be provided to ensure safety in the system.
- The PLC outputs may remain ON or OFF due to deposition or burning of the output relays or destruction of the output transistors. As a counter-

measure for such problems, external safety measures must be provided to ensure safety in the system.

- When the 24-V DC output (service power supply to the PLC) is overloaded or short-circuited, the voltage may drop and result in the outputs being turned OFF. As a countermeasure for such problems, external safety measures must be provided to ensure safety in the system.

- ⚠ Caution** Confirm safety before transferring data files stored in the file memory (Memory Card or EM file memory) to the I/O area (CIO) of the CPU Unit using a Programming Device. Otherwise, the devices connected to the output unit may malfunction regardless of the operation mode of the CPU Unit.
- ⚠ Caution** Execute online edit only after confirming that no adverse effects will be caused by extending the cycle time. Otherwise, the input signals may not be readable.
- ⚠ Caution** Do not touch the Power Supply Unit while power is being supplied or immediately after power is turned OFF. Doing so may result in electric shock.
- ⚠ Caution** Confirm safety at the destination node before transferring a program to another node or changing contents of the I/O memory area. Doing either of these without confirming safety may result in injury.
- ⚠ Caution** Tighten the screws on the terminal block of the AC Power Supply Unit to the torque specified in the operation manual. The loose screws may result in burning or malfunction.
- ⚠ Caution** To provide for safe operation even in the event that the Temperature Control Unit malfunctions, provide safety measures to prevent abnormal temperature rise in a separate system outside the PLC system. If proper safety measures are not taken, serious accidents could result from Unit failure resulting in loss of control.
- ⚠ Caution** At least approximately 4 seconds are required for control or heater burnout outputs to be made from the Temperature Control Unit after power is turned ON to the PLC. When using the Temperature Control Unit in an external sequence circuit, allow for this time delay in the system design.
- ⚠ Caution** Do not turn OFF the power supply while data is being written to the EEPROM in the Temperature Control Unit. Confirm that the Save Completed Flag turns ON after the data write operation has been completed before turning OFF the power supply. If power is turned OFF during a write operation, the data saved in the EEPROM may be destroyed.

4 Operating Environment Precautions

- ⚠ Caution** Do not operate the control system in the following locations:

- Locations subject to direct sunlight.
- Locations subject to temperatures or humidity outside the range specified in the specifications.

- Locations subject to condensation as the result of severe changes in temperature.
- Locations subject to corrosive or flammable gases.
- Locations subject to dust (especially iron dust) or salts.
- Locations subject to exposure to water, oil, or chemicals.
- Locations subject to shock or vibration.

 **Caution** Take appropriate and sufficient countermeasures when installing systems in the following locations:

- Locations subject to static electricity or other forms of noise.
- Locations subject to strong electromagnetic fields.
- Locations subject to possible exposure to radioactivity.
- Locations close to power supplies.

 **Caution** The operating environment of the PLC System can have a large effect on the longevity and reliability of the system. Improper operating environments can lead to malfunction, failure, and other unforeseeable problems with the PLC System. Be sure that the operating environment is within the specified conditions at installation and remains within the specified conditions during the life of the system.

5 Application Precautions

 **WARNING** Always heed these precautions. Failure to abide by the following precautions could lead to serious or possibly fatal injury.

- Always connect to a ground of 100 Ω or less when installing the Units. Not connecting to a ground of 100 Ω or less may result in electric shock.
- Always turn OFF the power supply to the PLC before attempting any of the following. Not turning OFF the power supply may result in malfunction or electric shock.
 - Mounting or dismounting Power Supply Units, I/O Units, CPU Units, or any other Units.
 - Assembling the Units.
 - Setting DIP switches or rotary switches.
 - Connecting cables or wiring the system.
 - Connecting or disconnecting the connectors.

 **Caution** Failure to abide by the following precautions could lead to faulty operation of the PLC or the system, or could damage the PLC or PLC Units. Always heed these precautions.

- Do not attempt to take any Units apart, to repair any Units, or to modify any Units in any way.
- Do not drop the Temperature Control Unit or subject it to abnormal shock or vibration.
- Always turn ON power to the PLC before turning ON power to the I/O circuits. If the PLC power supply is turned ON after the I/O power supply, correct operation may not be possible for a period of time.

- Fail-safe measures must be taken by the customer to ensure safety in the event that outputs from Output Units remain ON as a result of internal circuit failures, which can occur in relays, transistors, and other elements.
- Fail-safe measures must be taken by the customer to ensure safety in the event of incorrect, missing, or abnormal signals caused by broken signal lines, momentary power interruptions, or other causes.
- Interlock circuits, limit circuits, and similar safety measures in external circuits (i.e., not in the Programmable Controller) must be provided by the customer.
- Do not turn OFF the power supply to the PLC when data is being transferred.
- If the I/O Hold Bit is turned ON, the outputs from the PLC will not be turned OFF and will maintain their previous status when the PLC is switched from RUN or MONITOR mode to PROGRAM mode. Make sure that the external loads will not produce dangerous conditions when this occurs. (When operation stops for a fatal error, including those produced with the FALS(007) instruction, all outputs from Output Unit will be turned OFF and only the internal output status will be maintained.)
- Always use the power supply voltages specified in the operation manuals. An incorrect voltage may result in malfunction or burning.
- Take appropriate measures to ensure that the specified power with the rated voltage and frequency is supplied. Be particularly careful in places where the power supply is unstable. An incorrect power supply may result in malfunction.
- Install external breakers and take other safety measures against short-circuiting in external wiring. Insufficient safety measures against short-circuiting may result in burning.
- Separate the Temperature Control Unit from devices that generate short harmonics.
- Always be sure that the power supply voltage and loads are within specifications and ratings.
- Disconnect the LG terminal on the Power Supply Unit from the GR terminal when performing withstand voltage tests or insulation resistance tests. Not disconnecting the functional ground terminal may result in burning.
- Install the Units properly as specified in the operation manuals. Improper installation of the Units may result in malfunction.
- Be sure that all the terminal screws, and cable connector screws are tightened to the torque specified in the relevant manuals. Incorrect tightening torque may result in malfunction.
- Leave the label attached to the Unit when wiring. Removing the label may result in malfunction if foreign matter enters the Unit.
- Remove the label after the completion of wiring to ensure proper heat dissipation. Leaving the label attached may result in malfunction.
- Use crimp terminals for wiring. Do not connect bare stranded wires directly to terminals. Connection of bare stranded wires may result in burning.
- Wire all connections correctly as specified in this manual.
- Check the polarity before wiring terminals.
- Double-check all wiring and switch settings before turning ON the power supply. Incorrect wiring may result in burning.

- Mount Units only after checking terminal blocks and connectors completely.
- Be sure that the terminal blocks, Memory Units, expansion cables, and other items with locking devices are properly locked into place. Improper locking may result in malfunction.
- Check the user program for proper execution before actually running it on the Unit. Not checking the program may result in an unexpected operation.
- Confirm that no adverse effect will occur in the system before attempting any of the following. Not doing so may result in an unexpected operation.
 - Changing the operating mode of the PLC (including the Startup Mode)
 - Force-setting/force-resetting any bit in memory.
 - Changing the present value of any word or any set value in memory.
- Do not pull on the cables or bend the cables beyond their natural limit. Doing either of these may break the cables.
- Do not place objects on top of the cables or other wiring lines. Doing so may break the cables.
- When replacing parts, be sure to confirm that the rating of a new part is correct. Not doing so may result in malfunction or burning.
- Before touching a Unit, be sure to first touch a grounded metallic object in order to discharge any static build-up. Not doing so may result in malfunction or damage.
- When transporting or storing circuit boards, cover them in antistatic material to protect them from static electricity and maintain the proper storage temperature.
- When transporting Units, pack them in the packing boxes designed for them. Do not subject to excessive shock or vibration, or drop them, during transport.
- Store the Unit between -20 and 75 °C and 10% to 90% humidity (with no icing or condensation).
- Do not drop the Unit or allow it to fall during installation.
- Always use the specified wiring material when connecting the Unit.
Terminal block on the Temperature Control Unit: AWG22 to AWG18 (0.32 to 8.2 mm²).
- When not using temperature input terminals, connect between 100 and 200 Ω between terminals A and B, as well as B and B' for platinum resistance thermometer and short the input terminals for thermocouples. Do not connect anything to terminals that are not being used.
- To prevent blocking heat distribution, do not block the exterior of the Temperature Control Unit with other object or block the ventilation holes on the Unit.
- Be sure that the rated voltage is reached within 2 seconds of turning ON the power supply.
- Set the parameters of the Temperature Control Unit so that they are appropriate for the system being controlled. Inappropriate settings can lead to unexpected operation, which in turn can damage the product or cause accidents.
- Turn ON the power supply to the load (e.g., heater) at the same time or before turn ON the power supply to the Temperature Control Unit. Optimum control may not be achieved if power is turned ON in the wrong order.

- Warm up the Unit for at least 30 minutes to ensure accurate operation. The indicated temperature error will be larger if the Unit is not warmed up.
- Do not use the Unit in locations where it will be subject to direct radiant heat from a heater.
- Always use round crimp terminals on the AC power terminals of the Power Supply Unit. Never connect twisted wires to the terminals.
- Do not install the Unit in locations subject to excessive noise. Noise can cause malfunctions.
- Wire signal lines in separate ducts from high-voltage or power supply lines.
- Abide by all applicable laws, ordinances, and regulations when disposing of the Unit.
- Confirm that ratings are correct before replacing any part.

6 Conformance to EC Directives

6-1 Applicable Directives

- EMC Directives
- Low Voltage Directive

6-2 Concepts

EMC Directives

OMRON devices that comply with EC Directives also conform to the related EMC standards so that they can be more easily built into other devices or the overall machine. The actual products have been checked for conformity to EMC standards (see the following note). Whether the products conform to the standards in the system used by the customer, however, must be checked by the customer.

EMC-related performance of the OMRON devices that comply with EC Directives will vary depending on the configuration, wiring, and other conditions of the equipment or control panel on which the OMRON devices are installed. The customer must, therefore, perform the final check to confirm that devices and the overall machine conform to EMC standards.

Note Applicable EMC (Electromagnetic Compatibility) standards for the CS-series and CJ-series PLCs are as follows:

EMS (Electromagnetic Susceptibility): EN61000-6-2
EMI (Electromagnetic Interference): EN61000-6-4
(Radiated emission: 10-m regulations)

Low Voltage Directive

Always ensure that devices operating at voltages of 50 to 1,000 V AC and 75 to 1,500 V DC meet the required safety standards for the PLC (EN61131-2).

6-3 Conformance to EC Directives

The CS/CJ-series PLCs comply with EC Directives. To ensure that the machine or device in which the CS/CJ-series PLC is used complies with EC Directives, the PLC must be installed as follows:

- 1,2,3...** 1. The CS/CJ-series PLC must be installed within a control panel.

2. You must use reinforced insulation or double insulation for the DC power supplies used for the communications power supply and I/O power supplies.
3. CS/CJ-series PLCs complying with EC Directives also conform to the Common Emission Standard (EN61000-6-4). Radiated emission characteristics (10-m regulations) may vary depending on the configuration of the control panel used, other devices connected to the control panel, wiring, and other conditions. You must therefore confirm that the overall machine or equipment complies with EC Directives.

6-4 Relay Output Noise Reduction Methods

The CS/CJ-series PLCs conforms to the Common Emission Standards (EN61000-6-4) of the EMC Directives. However, noise generated by relay output switching may not satisfy these Standards. In such a case, a surge suppressor must be connected to the load side or other appropriate countermeasures must be provided external to the PLC.

Countermeasures taken to satisfy the standards vary depending on the devices on the load side, wiring, configuration of machines, etc. Following are examples of countermeasures for reducing the generated noise.

Countermeasures

(Refer to EN61000-6-4 for more details.)

Countermeasures are not required if the frequency of load switching for the whole system with the PLC included is less than 5 times per minute.

Countermeasures are required if the frequency of load switching for the whole system with the PLC included is 5 times or more per minute.

Countermeasure Examples

When switching an inductive load, connect an surge protector, diodes, etc., in parallel with the load or contact as shown below.

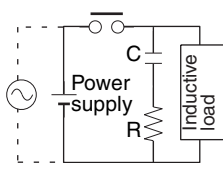
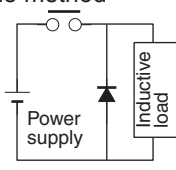
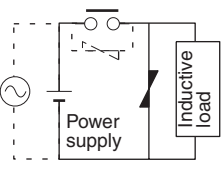
Circuit	Current		Characteristic	Required element
	AC	DC		
<p>CR method</p> 	Yes	Yes	<p>If the load is a relay or solenoid, there is a time lag between the moment the circuit is opened and the moment the load is reset.</p> <p>If the supply voltage is 24 or 48 V, insert the surge protector in parallel with the load. If the supply voltage is 100 to 200 V, insert the surge protector between the contacts.</p>	<p>The capacitance of the capacitor must be 1 to 0.5 μF per contact current of 1 A and resistance of the resistor must be 0.5 to 1 Ω per contact voltage of 1 V. These values, however, vary with the load and the characteristics of the relay. Decide these values from experiments, and take into consideration that the capacitance suppresses spark discharge when the contacts are separated and the resistance limits the current that flows into the load when the circuit is closed again.</p> <p>The dielectric strength of the capacitor must be 200 to 300 V. If the circuit is an AC circuit, use a capacitor with no polarity.</p>
<p>Diode method</p> 	No	Yes	<p>The diode connected in parallel with the load changes energy accumulated by the coil into a current, which then flows into the coil so that the current will be converted into Joule heat by the resistance of the inductive load.</p> <p>This time lag, between the moment the circuit is opened and the moment the load is reset, caused by this method is longer than that caused by the CR method.</p>	<p>The reversed dielectric strength value of the diode must be at least 10 times as large as the circuit voltage value. The forward current of the diode must be the same as or larger than the load current.</p> <p>The reversed dielectric strength value of the diode may be two to three times larger than the supply voltage if the surge protector is applied to electronic circuits with low circuit voltages.</p>
<p>Varistor method</p> 	Yes	Yes	<p>The varistor method prevents the imposition of high voltage between the contacts by using the constant voltage characteristic of the varistor. There is time lag between the moment the circuit is opened and the moment the load is reset.</p> <p>If the supply voltage is 24 or 48 V, insert the varistor in parallel with the load. If the supply voltage is 100 to 200 V, insert the varistor between the contacts.</p>	---

When switching a load with a high inrush current such as an incandescent lamp, suppress the inrush current as shown below.

Countermeasure 1

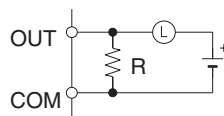

Providing a dark current of approx. one-third of the rated value through an incandescent lamp

Countermeasure 2

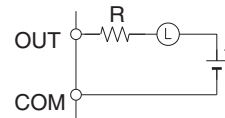

Providing a limiting resistor

SECTION 1

Features and System Configuration

This section describes the features of the Temperature Control Unit and its basic system configuration.

1-1	Introduction and Features	2
1-1-1	Introduction.	2
1-1-2	Features.	3
1-2	System Configuration	6
1-2-1	Basic System Configuration	6
1-2-2	Mounting the Unit.	6
1-3	Comparison to C200H Temperature Control Units	10

1-1 Introduction and Features

1-1-1 Introduction

The CJ1W-TC□□□ Temperature Control Units are Special I/O Units that receive inputs directly from thermocouple or platinum resistance thermometers, perform PID control with two degrees of freedom, and output results through open collector outputs.

There are two main types of Unit: One provides four control loops and the other provides two control loops with a heater burnout detection function. Each of these has one model that is compatible with thermocouples (R, S, K, J, T, B, or L) and another model that is compatible with platinum resistance thermometers (JPt100 or Pt100). Both NPN outputs and PNP outputs are available.

Autotuning of the PID control is also possible.

Available Units

I/O type		Output type	
		NPN outputs	PNP outputs
Four control loops	Thermocouple	CJ1W-TC001	CJ1W-TC002
	Platinum resistance thermometer	CJ1W-TC101	CJ1W-TC102
Two control loops (with heater burnout detection function)	Thermocouple	CJ1W-TC003	CJ1W-TC004
	Platinum resistance thermometer	CJ1W-TC103	CJ1W-TC104

Temperature Ranges

Item	Thermocouple										Platinum resistance thermometer		
	K(CA)	K(CA)	J(IC)	J(IC)	T(CC)	L	L	R	S	B	Pt100	JPt100	---
Usable temperature range (°C)	1300 -200	500.0 0.0	850 -100	400.0 0.0	400.0 -200.0	850 -100	400.0 0.0	1700 0	1700 0	1800 100	650.0 -200.0	650.0 -200.0	Settings 2 to 9 are not allowed.
Input Type Setting	0	1	2	3	4	5	6	7	8	9	0	1	2 to 9
Minimum Units	1°C	0.1°C	1°C	0.1°C	0.1°C	1°C	0.1°C	1°C	1°C	1°C	0.1°C	0.1°C	---

K (CA): Chromel-alumel
 J (IC): Iron-constantan
 T (CC): Copper-constantan
 L: Iron-constantan

R: Platinum 13% Rhodium-Platinum
 S: Platinum 10% Rhodium-Platinum
 B: Platinum 30% Rhodium-Platinum 6% Rhodium

Word Allocation

Data is exchanged between the CPU Unit and the Temperature Control Unit through the PLC's memory areas. A part of the CIO Area (the Special I/O Unit Area) and part of the DM Area are reserved for the Special I/O Units.

The Temperature Control Unit requires 20 words in the CIO Area and 100 words in the DM Area. (The unit number set on the front of the Unit determines which words are actually allocated to the Unit.)

1-1-2 Features

Use ON/OFF Control or PID Control with 2 or 4 Control Loops

The Temperature Control Unit can perform basic ON/OFF control as well as PID control of two or four control loops. The PID control function has two degrees of freedom and an autotuning function that can be used to autotune the PID value.

Connect Temperature Sensors Directly

Temperature sensors can be connected directly to the Temperature Control Unit (two or four inputs). There are two models that support thermocouples (R, S, K, J, T, B, and L thermocouples) and two models that support platinum resistance thermometers.

500-ms Sampling Cycle

PID control is performed with a sampling cycle of 500 ms, regardless of the CPU Unit's cycle time.

Unrestricted CPU Unit Cycle Time

There are no restrictions on the CPU Unit's cycle time.

RUN/STOP Control from CPU Unit

Commands can be sent from the CPU Unit to switch the Temperature Control Unit's PID control between RUN and STOP.

Independent Operation in PROGRAM Mode

A switch on the front of the Unit (pin 1 of the DIP switch) selects whether the Temperature Control Unit will continue operation or stop when the CPU Unit is in PROGRAM mode.

Terminal Block Connections

Both inputs and outputs are connected through a terminal block.

Store and Display Data in BCD or Hexadecimal

A switch on the front of the Unit (pin 3 of the DIP switch) selects whether the Temperature Control Unit's data is handled as 4-digit BCD or binary (i.e., 4-digit hexadecimal.) This switch setting controls both the display format and the storage format in the memory areas (CIO and DM Areas) used to exchange data between the CPU Unit and Temperature Control Unit.

Example	Data storage/display format	
	Binary (4-digit hexadecimal)	4-digit BCD
K: -200 to 1,300°C	FF38 to FFFF to 0514 (-200 to -1 to 1,300)	F200 to 1300 (-200 to 1,300)

Select ON/OFF Control or PID Control

A switch on the front of the Unit (pin 6 of the DIP switch) selects whether the Temperature Control Unit operates with ON/OFF control or PID control with 2 degrees of freedom.

Note The setting on pin 6 sets the control method for all of the Unit's control loops. The factory setting is PID control.

Control Methods

- ON/OFF Control
With ON/OFF control, the control output will be ON when the PV is below the SV. The control output will be OFF when the PV is at or above the SV. (This control method is used when the Unit is set for reverse operation.)
- PID Control with Two Degrees of Freedom
In earlier versions of PID control, the same controller section controlled both the response to the SV and the response to disturbances. The weak-

ness in this design was that both responses could not be satisfied at the same time.

1. If the disturbance response were emphasized (i.e., P and I were reduced and D was increased), the SV response would oscillate and overshoot.
2. If the SV response were emphasized (i.e., P and I were increased and D was reduced), the disturbance response would be delayed.

To overcome these problems, PID control with two degrees of freedom was used for this Temperature Control Unit to take advantage of the strengths of PID control and improve both disturbance and target response as shown in 3, below.

■ **Earlier PID Control Method**

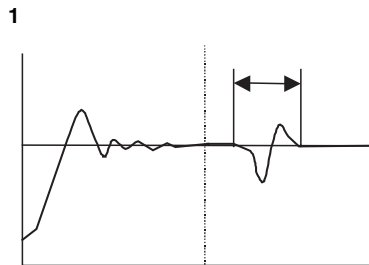

The disturbance response is good, but the SV response is delayed.

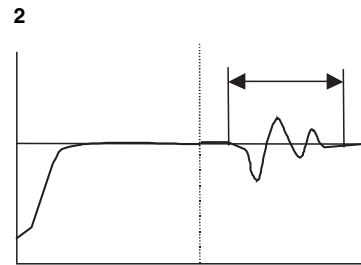

The SV response is good, but the disturbance response is not.

■ **PID Control with Two Degrees of Freedom**

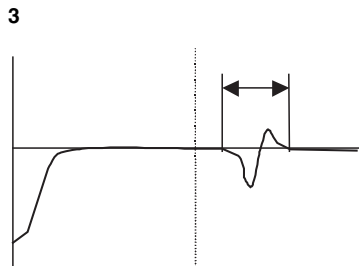

Both the SV response and disturbance response are good.

■ **Autotuning (AT) Function**

The Temperature Control Unit is equipped with an autotuning (AT) function that uses the “limit-cycle method” to calculate the optimum PID constant for the controlled system. (The SV cannot be written for a loop if the loop is being autotuned.)

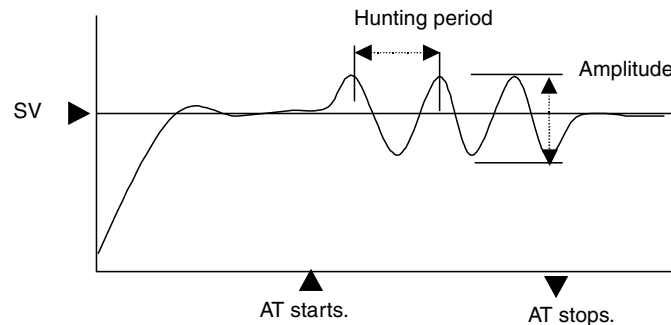

Note The “limit-cycle method” uses ON/OFF operation to cause hunting around the SV, measures the amplitude and hunting period, and calculates the optimum PID constants.

Control Operation (Forward and Reverse)

The Temperature Control Unit’s control can be set to reverse operation or forward operation with pins 4 and 5 of the Unit’s DIP switch. The factory setting is for reverse operation (heating).

One forward/reverse setting controls the operation of loops 1 and 3, and the other forward/reverse setting controls the operation of loops 2 and 4.

With forward operation (cooling), the manipulated variable is increased as the PV increases. With reverse operation (heating), the manipulated variable is increased as the PV decreases.

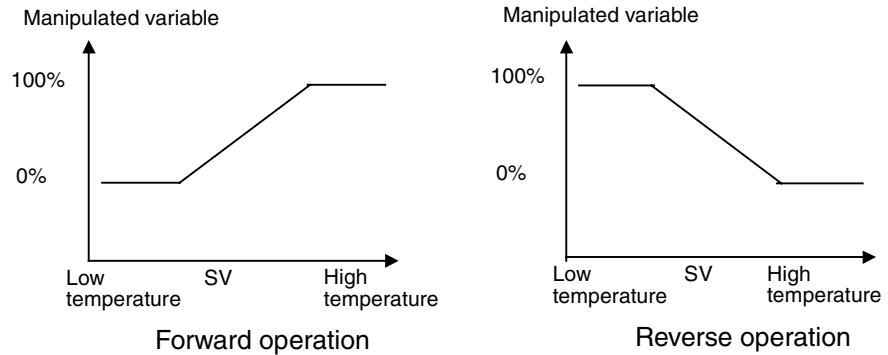

For example, when heating control is being performed and the present temperature (PV) is lower than the target temperature (SP), the manipulated variable is increased as the difference between the PV and SP increases. Consequently, heating control uses “reverse operation” and cooling control uses “forward operation.”

Input Compensation Function

This function adjusts the PV by adding an input compensation value to the temperature measured by the sensor.

If you have an application where you want to control and display the temperature at a point that is offset from the sensor’s measurement point, use this function to control the temperature at a value near the desired point.

Heater Burnout Detection (Single-phase Operation Only)

When a Two-loop Temperature Control Unit is being used, a Current Transformer (CT) can be connected to each loop to detect a heater burnout.

Two Internal Alarms for Each Loop

There are two internal alarms per loop. Alarms can be output to the allocated areas in the CPU Unit’s memory areas and any one of the following 9 alarm modes can be used:

Upper and lower-limit alarm, upper-limit alarm, lower-limit alarm, upper and lower-limit alarm with standby sequence, upper-limit alarm with standby sequence, lower-limit alarm with standby sequence, absolute-value upper-limit alarm, and absolute-value lower-limit alarm

Store Settings in EEPROM

Various Temperature Control Unit settings, such as the alarm SVs and PID constants, can be stored in the Unit’s EEPROM using a control bit in the CPU Unit’s allocated memory area.

Also, it is possible to set the Temperature Control Unit so that the settings stored in EEPROM are automatically written to the appropriate area in the CPU Unit when the power is turned ON or the Unit is restarted. This automatic transfer function is controlled by a switch (pin 8 of the DIP switch) on the front of the Temperature Control Unit.

Once the settings have been stored in the Temperature Control Unit and the Unit is set for automatic transfer, the Unit will always start with those settings whether the power has been turned OFF or not. (The settings can be changed after startup if necessary.)

To simplify Temperature Control Unit operation, pin 8 on the DIP switch can be turned ON to enable operation by merely turning ON the power supply and setting Operation Data (the SP). All other settings can be used at their default values. (Refer to 2-6-1 Settings for the default settings.)

1-2 System Configuration

1-2-1 Basic System Configuration

The following diagram shows a basic system with a CJ1W-TC001 Temperature Control Unit (4 control loops, thermocouple inputs, and NPN outputs) and a CJ1W-TC103 Temperature Control Unit (2 control loops with heater burnout detection, platinum resistance thermometer inputs, and NPN outputs).

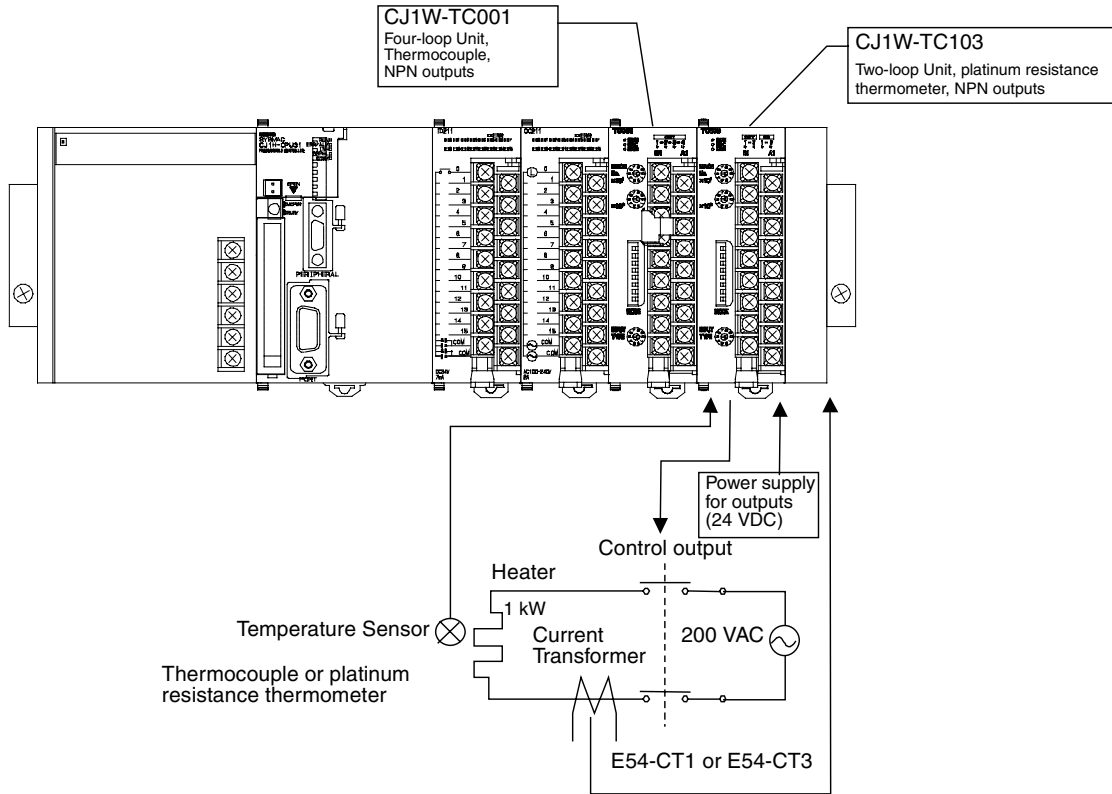

- Note**
1. An OMRON E54-CT1 or E54-CT3 Current Transformer must be used as the Current Transformer (CT). Do not use any other Current Transformer.
 2. Turn ON the Stop Bit for the loop to stop temperature control. If PID control is being used and the heater is turned OFF using an operation switch input to the heater, PID control performance will be adversely affected.

1-2-2 Mounting the Unit

The CJ1W-TC□□□ Temperature Control Units are CJ-series Special I/O Units, so they can be mounted in a CJ-series CPU Rack or Expansion Rack.

The number of Units that can be mounted in a CPU Rack or Expansion Rack depends on the capacity of the Rack's Power Supply Unit and the current consumption of the other Units in the Rack.

The following table shows the maximum number of CJ1W-TC□□□ Temperature Control Units that can be mounted in a Rack if the Temperature Control Units are the only Units being used in the Rack.

Power Supply Unit	CJ1W-TC□□□
CJ1W-PA205R	10 Units

Note I/O words are allocated to the Special I/O Units based on the unique unit number set on the front of each Unit.

Installation Procedure

Use the following procedure to install the Temperature Control Unit. The PLC must be removed from the DIN Track in order to connect a Temperature Control Unit.

- 1,2,3...** 1. Align the Units and connect them together so that the connectors join smoothly and completely.

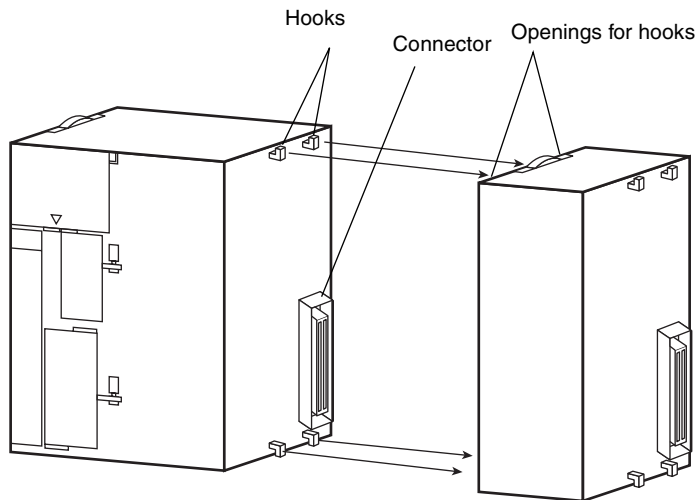

2. Slide the yellow latches on the top and bottom of the Unit until you hear the latches click and lock the Units together.

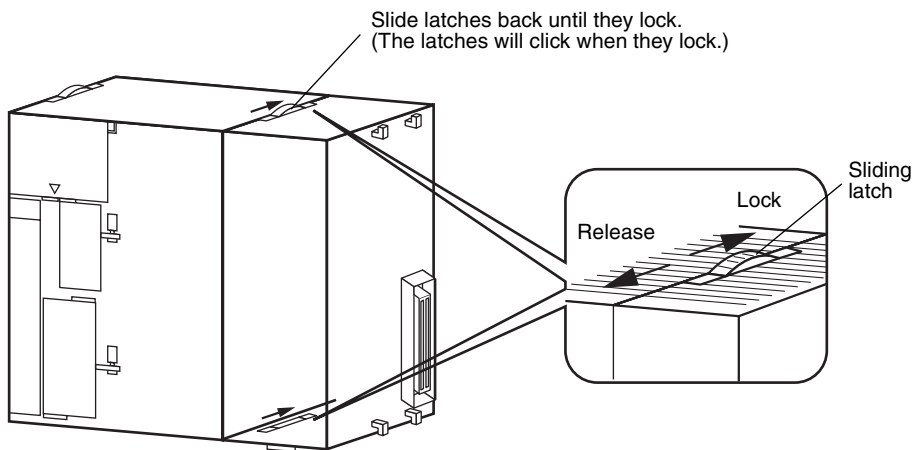

3. Install an End Cover on the rightmost Unit.

Precautions

The Unit's functions may not be completely operational if the latches are not locked securely.

An End Cover is provided with the CPU Unit. Always install this End Cover on the rightmost Unit in the PLC. The CJ-series PLC will not operate properly if the End Cover is not installed.

Handling Precautions

- Always turn OFF the PLC's power supply before connecting or disconnecting wiring to the Unit.
- To avoid problems with noise, route the I/O wiring in a separate duct or conduit that does not carry any high-voltage lines or power lines.
- Leave the protective label in place during wiring to prevent stray wire strands from falling into the Unit during wiring. After wiring is completed, remove the protective label so that air can flow through the Unit and provide proper cooling.

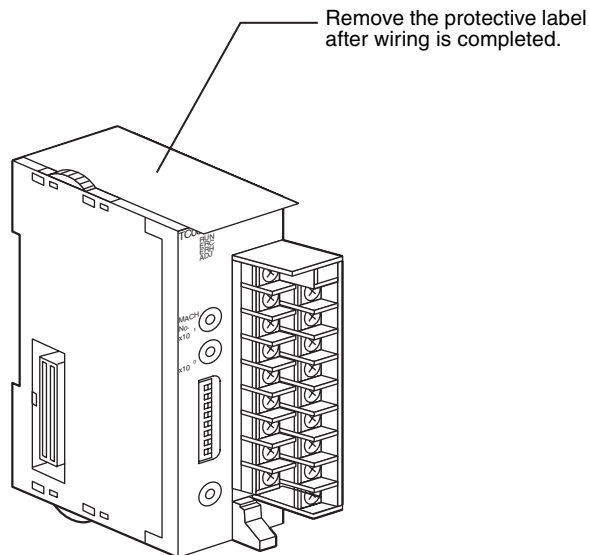

Precautions on Removable Terminal Blocks

The terminal block can be removed by pressing down on the lever at the bottom of the terminal block. Always confirm that this lever is up in the locked position before starting operation.

⚠ Caution A cold-junction compensator is attached to the terminal block for Temperature Control Units with thermocouples. The accuracy ratings are given for the Temperature Control Unit used in a set with the cold-junction compensator. Always use the Unit and terminal block in a set. There are labels with serial numbers attached to the terminal blocks and Units to help keep track of the sets. When returning a thermocouple-type Temperature Control Unit for repair, always return the Unit and the terminal block (with the cold-junction compensator) as a set.

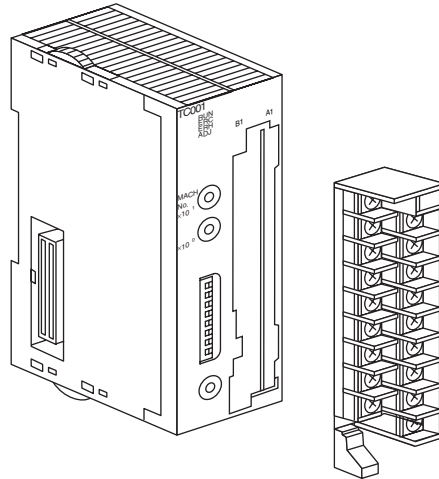

1-3 Comparison to C200H Temperature Control Units

Item		CJ-series Temperature Control Units	C200H Temperature Control Units
Model number		CJ1W-TC00□/10□	C200H-TC00□/10□
Unit type		CJ-series Special I/O Unit	C200H Special I/O Unit
Compatible PLCs		CJ-series PLCs	CS-series, C200HX/HG/HE, C200HS, and C200H PLCs
Number of control loops		2 loops (with heater burnout detection) or 4 loops	2 loops
Allocated I/O words		20 words (6 output and 14 input)	10 words (3 output and 7 input)
Control inputs		Thermocouple (R, S, K, J, T, B, or L) or platinum resistance thermometers (JPt100 or Pt100)	Thermocouple (R, S, K, J, T, E, B, N, L, or U) or platinum resistance thermometers (JPt100 or Pt100)
Control modes		PID control or ON/OFF control (PID control features two degrees of freedom and autotuning.)	
Control outputs		CJ1W-TC□01/□03: Open collector NPN outputs (pulse), external 24-VDC power supply CJ1W-TC□02/□04: Open collector PNP outputs (pulse), external 24-VDC power supply	C200H-TC□01: Open collector NPN outputs (pulse), external 24-VDC power supply C200H-TC□02: Voltage outputs (pulse), 12-VDC outputs C200H-TC□03: Current outputs (linear), 4 to 20 mA DC
Setting accuracy, indicator accuracy	Thermocouple input	±0.3% or ±1°C (whichever is larger) ± 1 digit max.	±0.5% or ±2°C (whichever is larger) ± 1 digit max.
	Platinum resistance thermometer input	±0.3% or ±0.8°C (whichever is larger) ± 1 digit max.	±0.5% or ±1°C (whichever is larger) ± 1 digit max.
Storage/display data format for data exchanged with CPU Unit		BCD or binary (selectable)	BCD only
RUN/STOP control		Supported (Controlled from the CPU Unit through a bit allocated in the Special I/O Unit area.)	
Operation when CPU Unit is in PROGRAM mode		The Temperature Control Unit can be set to continue operating or stop operating when the CPU Unit is in PROGRAM mode. (Selectable)	
Auto/Manual switch for operational output		Not supported.	
Autotuning (AT) of PID constant		Can be started and stopped from the CPU Unit through bits allocated in the Special I/O Unit area.	Can be started and stopped from the CPU Unit through bits allocated in the I/O Unit area or from the Data Setting Console.
Sampling period		500 ms	
Input compensation value		-99.9 to 999.9 °C or °F	
Data setting banks		None	8 banks max.
Output wiring method		Terminal block	Connector
Data Setting Console		Not supported (Cannot be used.)	Supported (Can be used.)
Heater Burnout Detection		Yes (Two-loop Units only)	Yes
CT heater detection current		0.0 to 50.0 A	0.0 to 5.0 A
SV write memory		EEPROM (100,000 writes) or RAM	
Effect on the CPU Unit's cycle time		0.4 ms	2.6 ms
CPU Unit's required cycle time		Unrestricted	Restricted (8 ms minimum cycle time)
Dimensions		90 × 31 × 65 mm (H × W × D)	130 × 34.5 × 120.5 mm (H × W × D)

SECTION 2

Specifications and Functions

This section describes the functions and specifications of the Temperature Control Unit, including technical specifications, Unit parts, wiring, and data allocations.

2-1	Specifications	12
2-1-1	Specifications	12
2-1-2	Input Function Block Diagrams	15
2-1-3	Input Specifications	16
2-2	Application Procedure	18
2-2-1	Example Operating Procedure	19
2-3	Part Names and Functions	21
2-3-1	Part Names	21
2-3-2	Indicators	21
2-3-3	Unit Number Switches	22
2-3-4	DIP Switch Setting Functions	23
2-3-5	Setting the Input Type	24
2-4	Wiring	25
2-4-1	Terminal Wiring Examples	25
2-4-2	Output Circuits	26
2-4-3	I/O Wiring Examples	27
2-5	Data Exchange with the CPU Unit	29
2-5-1	Overview	29
2-5-2	Data Exchange Settings	30
2-5-3	Memory in the Temperature Control Unit	31
2-5-4	Operation Data	32
2-5-5	Initialization Data	44
2-5-6	Operating Parameters	46
2-6	Data Ranges	49
2-6-1	Settings	49
2-6-2	Monitored Values	50

2-1 Specifications

2-1-1 Specifications

General Specifications

Item	Specification			
Unit classification	CJ-series Special I/O Unit			
Compatible Racks	CJ-series CPU Rack or CJ-series Expansion Rack			
Max. number of Units	10 Units/Rack max. (CPU Rack or Expansion Rack)			
CPU Unit data areas for data storage/exchange	Special I/O Unit Area (960 words) CIO 2000 to CIO 2959	20 words/Unit for constant data exchange (6 output words and 14 input words)	CPU Unit to Temperature Control Unit	<ul style="list-style-type: none"> • Set point (SP) • Operating commands • RUN/STOP control • Start/Stop AT • Write commands • Heater burnout current setting
			Temperature Control Unit to CPU Unit	<ul style="list-style-type: none"> • Process value (PV) • Set point (SP) • Status • Heater current monitor
	DM words allocated to Special I/O Units (9,600 words) D20000 to D29599	10 words/Unit transferred when power is turned ON or Unit is restarted	CPU Unit to Temperature Control Unit	<ul style="list-style-type: none"> • Alarm mode • Alarm hysteresis
			90 words/Unit for regular data exchange	Two-way transfer between CPU Unit and Temperature Control Unit
Insulation resistance	20 MΩ min. (at 500 VDC) between the following points: <ul style="list-style-type: none"> • Output terminals/NC terminals and external AC terminals (Power Supply Unit) • Input terminals and external AC terminals (Power Supply Unit) • Input terminals and output terminals • External DC terminals (inputs, outputs, and NC) and the FG plate • Between input terminals (sensor and CT inputs) • Between the I/O terminals and NC terminals 			
Dielectric strength	2,000 VAC 50/60 Hz for 1 min., detected current: 1 mA <ul style="list-style-type: none"> • Between the output terminals/NC terminals and external AC terminals (Power Supply Unit) 1,000 VAC 50/60 Hz for 1 min., detected current: 1 mA <ul style="list-style-type: none"> • Input terminals and external AC terminals (Power Supply Unit) • Input terminals and output terminals • External DC terminals (inputs, outputs, and NC) and the FG plate 500 VAC 50/60 Hz for 1 min., detected current: 1 mA <ul style="list-style-type: none"> • Between input terminals (sensor and CT inputs) • Between the I/O terminals and NC terminals 			
Internal current consumption	250 mA max., 5 VDC			
Other	Other general specifications conform to the CJ-series general specifications.			

Item	Specification
Dimensions	31 × 90 × 65 mm (W × H × D)
Weight	150 g max.

Characteristics

Item	Specification	
Model number	CJ1W-TC00□	CJ1W-TC10□
Temperature sensor	Thermocouple: Types R, S, K, J, T, L, and B	Platinum resistance thermometer: Types Pt100 and JPt100
Number of loops	There are two types of Unit available: Four-loop Units and Two-loop Unit with heater burnout detection. (See note 1.)	
Control output and heater burnout alarm output	NPN or PNP outputs, both with short-circuit protection (See note 1.) Externally supplied power supply voltage: 24 VDC +10%/-15% Maximum switching capacity: 100 mA (per output) Leakage current: 0.3 mA max. Residual voltage: 3 V max.	
Temperature control method	ON/OFF control or PID control with two degrees of freedom (Set with pin 6 on the Unit's DIP switch.)	
Control operation	Forward or reverse operation (Set with pins 4 and 5 on the Unit's DIP switch.)	
RUN/STOP control	Supported (Controlled from the CPU Unit through bits allocated in the Special I/O Unit area.)	
Operation with CPU Unit in PROGRAM mode	The Temperature Control Unit can be set to continue operating or stop operating when the CPU Unit is in PROGRAM mode. (Set with pin 1 on the Unit's DIP switch.)	
Auto/Manual switch for operational output	None	
Autotuning (AT) of PID constant	Supported (Controlled from the CPU Unit through bits allocated in the Special I/O Unit area.)	
Indication accuracy	Centigrade: $\pm 0.3\%$ PV or $\pm 1^\circ\text{C}$ (whichever is larger) ± 1 digit max. Fahrenheit: $\pm 0.3\%$ PV or $\pm 2^\circ\text{F}$ (whichever is larger) ± 1 digit max. <ul style="list-style-type: none"> The accuracy will be $\pm 2^\circ\text{C} \pm 1$ digit max. when using an L-type thermocouple or using a K or T-type thermocouple below -100°C. The accuracy will be $\pm 3^\circ\text{C} \pm 1$ digit max. when using an R or S-type thermocouple below 200°C. The B-type thermocouples may not be accurate below 400°C. (See note 2.) 	Centigrade: $\pm 0.3\%$ PV or $\pm 0.8^\circ\text{C}$ (whichever is larger) ± 1 digit max. Fahrenheit: $\pm 0.3\%$ PV or $\pm 1.6^\circ\text{F}$ (whichever is larger) ± 1 digit max.
Sensitivity (when using ON/OFF control)	0.0 to 999.9 $^\circ\text{C}$ or $^\circ\text{F}$ (0.1 $^\circ\text{C}$ or $^\circ\text{F}$ units)	
Proportional band	0.1 to 999.9 $^\circ\text{C}$ or $^\circ\text{F}$ (0.1 $^\circ\text{C}$ or $^\circ\text{F}$ units)	
Integral (reset) time	0 to 9,999 s (one-second units)	
Derivative (rate) time	0 to 9,999 s (one-second units)	
Control period	1 to 99 s (one-second units)	
Sampling period	500 ms (4 loops)	
Output refresh period	500 ms (4 loops)	
Display refresh period	500 ms (4 loops)	
Input compensation value	-99.9 to 999.9 $^\circ\text{C}$ or $^\circ\text{F}$ (0.1 $^\circ\text{C}$ or $^\circ\text{F}$ units)	
Alarm output setting range	-999 to $9,999$ $^\circ\text{C}$ or $^\circ\text{F}$ (1 $^\circ\text{C}$ or $^\circ\text{F}$ units) The setting range will be -99.9 to 999.9 $^\circ\text{C}$ or $^\circ\text{F}$ (0.1 $^\circ\text{C}$ or $^\circ\text{F}$ units) when using a platinum resistance thermometer or using a K or J-type thermocouple in decimal-point mode.	

Item	Specification
External terminal connections	Removable terminal block with 18 points (M3 screws)
Effect on the CPU Unit's cycle time	0.4 ms

Note 1. The last three digits of the model number indicate the Unit's features:

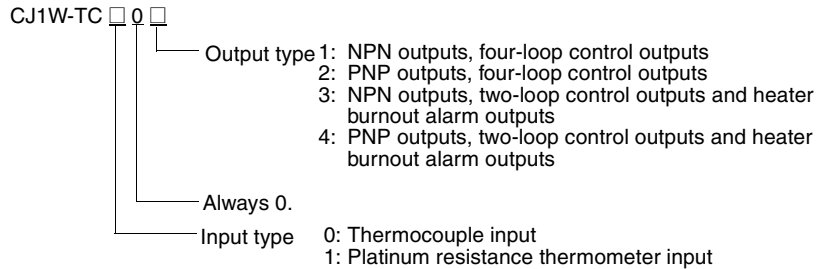

2. Indication accuracy of thermocouples

- Accuracy ratings are given for the Temperature Control Unit used in a set with a cold-junction compensator (on the terminal block). Always use the Unit and terminal block in a set. There are labels with serial numbers attached to the terminal blocks and Units to help keep track of the sets.
- When returning a thermocouple-type Temperature Control Unit for repair, always return the Unit and the terminal block (with the cold-junction compensator) as a set.

Heater Burnout (HB) Alarm

Item	Specification
Maximum heater current	Single-phase AC, 50 A
Indication accuracy of input current	±5% of full scale ± 1 digit max.
Heater burnout alarm setting range	0.1 to 49.9 A (0.1 A units) The heater burnout detection function will not operate if the set value is set to 0.0 A or 50.0 A. (When the SV is 0.0 A, the heater burnout alarm will be OFF. When the SV is 50.0 A, the heater burnout alarm will be ON.)
Min. detectable ON time (See note.)	200 ms

Note If the control output is ON for less than 200 ms, the heater burnout detection function will not operate and heater current measurement will not be performed.

Current Transformer (CT) Ratings

Item	E54-CT1	E54-CT3
Max. continuous heater current	50 A	120 A (See note 1.)
Dielectric strength	1,000 VAC (1 min.)	
Vibration resistance	50 Hz, 98 m/s ²	
Weight	Approx. 11.5 g	Approx. 50 g
Accessories	None	Contacts (2) Plugs (2)

- Note**
1. The maximum continuous heater current that can be detected at a CJ1W-TC□□□ Temperature Control Unit is 50 A.
 2. Do not use any Current Transformer (CT) other than the OMRON E54-CT1 or E54-CT3 Current Transformer.

2-1-2 Input Function Block Diagrams

Four-loop Units

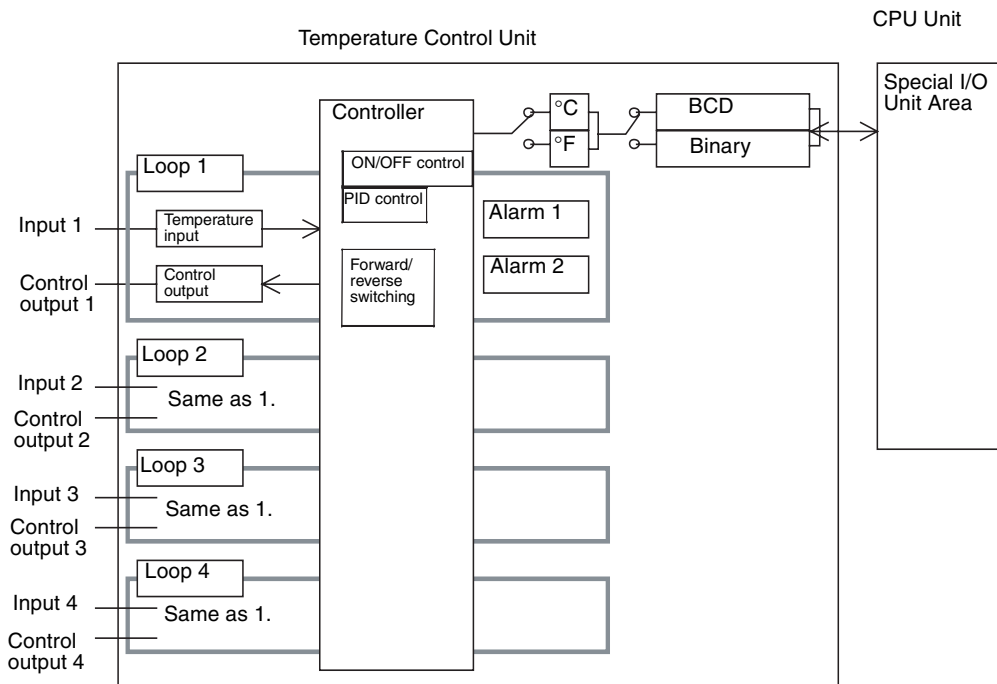

Two-loop Units with Heater Burnout Alarm

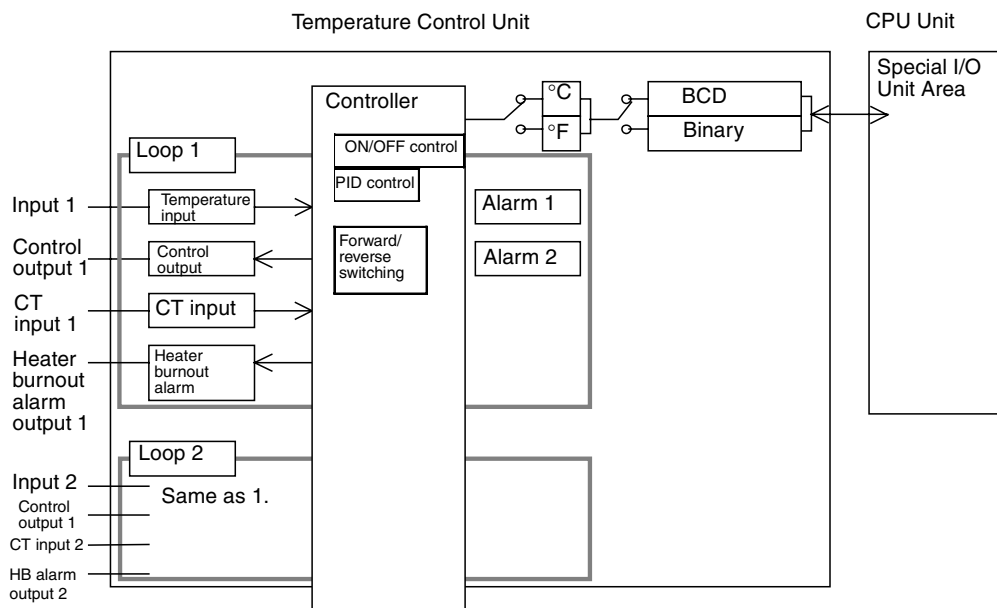

2-1-3 Input Specifications

A switch on the front of the Unit (pin 3 of the DIP switch) selects whether the Temperature Control Unit's data is stored and indicated as 4-digit BCD or binary (i.e., 4-digit hexadecimal). Pin 2 of the DIP switch selects whether the temperature is indicated in °C or °F.

The indicated range will be within ±20°C or ±20°F of the setting ranges shown in the following table. (See note 1.)

Thermocouple Input Setting Ranges

No.	Thermocouple type	Range in °C		Range in °F	
		Binary (4-digit Hex)	4-digit BCD	Binary (4-digit Hex)	4-digit BCD
0	K: -200 to 1,300°C (-300 to 2,300°F)	FF38 to FFFF to 0514 (-200 to -1 to 1,300)	F200 to 1300 (-200 to 1,300)	FED4 to FFFF to 08FC (-300 to -1 to 2,300)	F300 to 2300 (-300 to 2,300)
1	K: 0.0 to 500°C (0.0 to 900.0°F)	0000 to 1388 (0.0 to 500.0)	0000 to 5000 (0.0 to 500.0)	0000 to 2328 (0.0 to 900.0)	0000 to 9000 (0.0 to 900.0)
2	J: -100 to 850°C (-100 to 1,500°F)	FF9C to FFFF to 0352 (-100 to -1 to 850)	F100 to 0850 (-100 to 850)	FF9C to FFFF to 05DC (-100 to -1 to 1,500)	F100 to 1500 (-100 to 1,500)
3	J: 0.0 to 400°C (0.0 to 750.0°F)	0000 to 0FA0 (0.0 to 400.0)	0000 to 4000 (0.0 to 400.0)	0000 to 1D4C (0.0 to 750.0)	0000 to 7500 (0.0 to 750.0)
4	T: -200.0 to 400.0°C (-300.0 to 700.0°F)	F830 to FFFF to 0FA0 (-200.0 to -0.1 to 400.0)	F999 to 4000 (-99.9 to 400.0) See note 3.	F448 to FFFF to 1B58 (-300.0 to -0.1 to 700.0)	F999 to 7000 (-99.9 to 700.0) See note 3.
5	L: -100 to 850°C (-100 to 1,500°F)	FF9C to FFFF to 0352 (-100 to -1 to 850)	F100 to 0850 (-100 to 850)	FF9C to FFFF to 05DC (-100 to -1 to 1,500)	F100 to 1500 (-100 to 1,500)
6	L: 0.0 to 40 °C (0.0 to 750.0°F)	0000 to 0FA0 (0.0 to 400.0)	0000 to 4000 (0.0 to 400.0)	0000 to 1D4C (0.0 to 750.0)	0000 to 7500 (0.0 to 750.0)
7	R: 0 to 1,700°C (0 to 3,000 °F)	0000 to 06A4 (0 to 1,700)	0000 to 1700 (0.0 to 1,700)	0000 to 0BB8 (0 to 3,000)	0000 to 3000 (0.0 to 3,000)
8	S: 0 to 1,700°C (0 to 3,000 °F)	0000 to 06A4 (0 to 1,700)	0000 to 1700 (0.0 to 1,700)	0000 to 0BB8 (0 to 3,000)	0000 to 3000 (0.0 to 3,000)
9	B: 100 to 1,800°C (300 to 3,200 °F) See note 2.	0064 to 0708 (100 to 1,800)	0100 to 1800 (100 to 1,800)	012C to 0C80 (300 to 3,200)	0300 to 3200 (300 to 3,200)

Platinum Resistance Thermometer Input Setting Ranges

No.	Thermocouple type	Range in °C		Range in °F	
		Binary (4-digit Hex)	4-digit BCD	Binary (4-digit Hex)	4-digit BCD
0	Pt100: -200.0 to 650.0°C (-300.0 to 1,200.0 °F)	F830 to FFFF to 1964 (-200.0 to -0.1 to 650.0)	F999 to 6500 (-99.9 to 650.0) See note 3.	F448 to FFFF to 2EE0 (-300.0 to -0.1 to 1,200.0)	F999 to 9999 (-99.9 to 999.9) See note 3.
1	JPt100: -200.0 to 650.0°C (-300.0 to 1,200.0 °F)	F830 to FFFF to 1964 (-200.0 to -0.1 to 650.0)	F999 to 6500 (-99.9 to 650.0) See note 3.	F448 to FFFF to 2EE0 (-300.0 to -0.1 to 1,200.0)	F999 to 9999 (-99.9 to 999.9) See note 3.
2 to 9	---	Settings 2 through 9 are not allowed.		Settings 2 through 9 are not allowed.	

- Note** 1. If the allowed indication range is exceeded, a sensor error will occur, the corresponding Sensor Error Flag will be turned ON, and the PV will contain the data "CCCC." When a sensor error occurs, that control loop's control output will be turned OFF. The alarm function will operate because the PV indicates an abnormally high temperature.

2. The lower-limit indication for B-type thermocouples is 0°C or 0°F.
3. When the data format is BCD, the indicated temperature will remain fixed at the lower limit value or upper limit value when the temperature exceeds the allowed indication range but does not exceed the setting range.

When the display units are 0.1°C or 0.1°F, the display's lower limit value is -99.9 and the upper limit value is 999.9.

4. When the input type setting switch has been changed, the SV and input compensation values will change as follows:
 - If the SV exceeds the setting range, it will be fixed at the lower limit or upper limit of the setting range.
 - The position of the decimal point will change if necessary.

For example, when the temperature range is changed by changing the input type setting switch from 0 (K-type thermocouple with a temperature range of -200 to 1,300°C) to 1 (K-type thermocouple with a temperature range of 0.0 to 500.0°C), an SV of 200°C would be changed to 20.0°C.

2-2 Application Procedure

The procedure for installing and setting up the Temperature Control Unit is illustrated below.

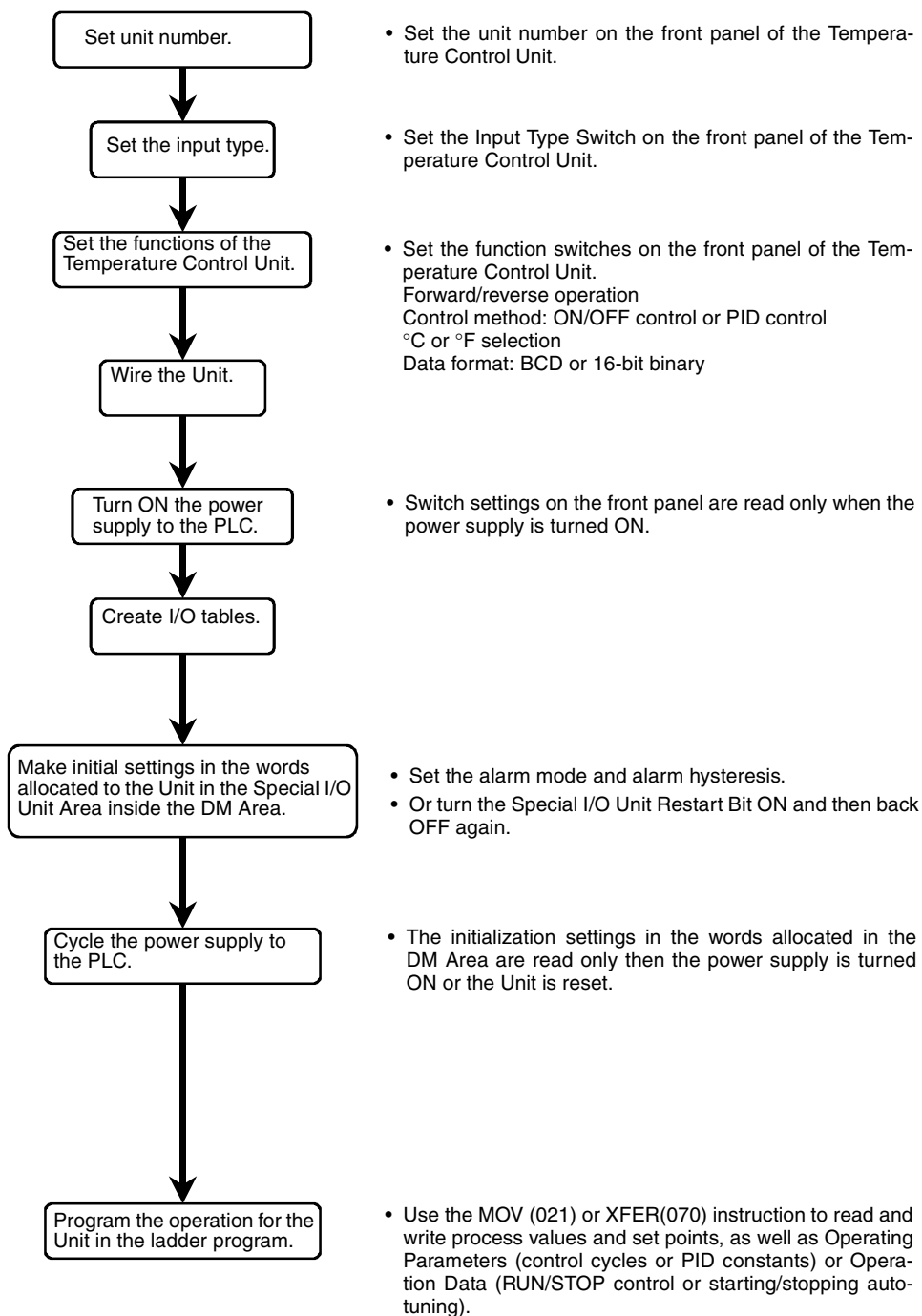

2-2-1 Example Operating Procedure

The following settings are used in this example for a Four-loop Temperature Control Unit.

Input type: Thermocouple
 Input: K thermocouple (0.0 to 500.0 °C)
 Data format: BCD

The operating procedure through reading the process value for each loop is given in this section.

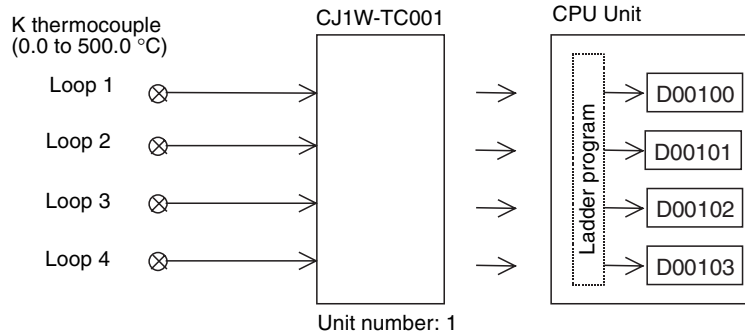

Settings

- 1,2,3... 1. Set the Unit number referring to 2-3-3 Unit Number Switches. If the unit number is set to 1, CIO 2010 to CIO 2029 and D20100 to D20199 will be allocated to the Unit as a Special I/O Unit.

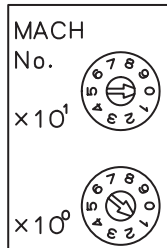

2. Set the input type referring to 2-3-5 Setting the Input Type. Set the switch on the front panel of the Unit to 1 for a K thermocouple (0.0 to 500.0 °C).

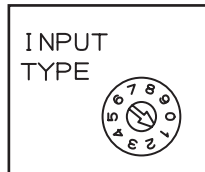

3. Set the Unit's functions referring to 2-3-4 DIP Switch Setting Functions. Be sure that pin 2 is OFF to select centigrade and that pin 3 is OFF to select BCD.

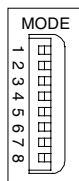

4. Mount and wire the Unit, referring to *1-2-2 Mounting the Unit*.
5. Turn ON the power supply to the PLC.

Creating I/O Tables

There two different methods that can be used to create I/O tables with the CJ-series PLCs. Refer to the *CJ Series Programmable Controllers Operation Manual (W393)* for details.

Automation Creation

The PLC can be set to automatically create I/O tables at startup. If this is done, the user does not need to create the I/O tables.

Use-set I/O Tables

After turning ON the PLC, create the I/O tables. The key sequence for creating I/O tables from a Programming Console is shown below.

```

Clear
FUN Shift CH/*DM
CHG
9 7 1 3
Write
0 or 1
Clear
    
```

Program

In this example, the process value (PV) output to the words allocated in the CIO Area to the Temperature Control Unit as a Special I/O Unit are stored in memory for four loops. The words n+3, n+4, n+13, and n+14 will contain the PV and are CIO 2013, CIO 2014, CIO 2023, and CIO 2024 in this example.

Input type	Loop	PV address (n = CIO 2010) (See note 1.)	Storage addresses (See note 2.)
K thermocouple (0.0 to 500.0 °C)	1	n+3 = CIO 2013	D00100
	2	n+4 = CIO 2014	D00101
	3	n+13 = CIO 2023	D00102
	4	n+14 = CIO 2024	D00103

- Note**
1. Determined by the unit number that is set for the Temperature Control Unit as a Special I/O Unit. (Refer to *2-3-3 Unit Number Switches*.)
 2. Set as desired in programming.
 3. Sensor Error Flags are allocated to bit 14 of n+8, n+9, n+18, and n+19. (Refer to *Four-loop Units* on page 33.)

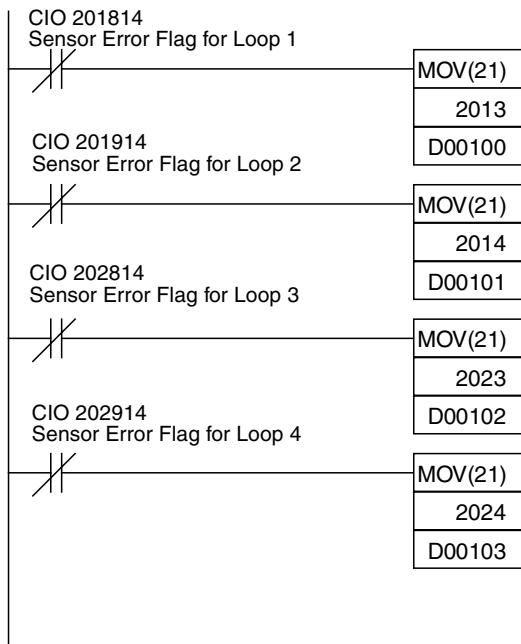

2-3 Part Names and Functions

2-3-1 Part Names

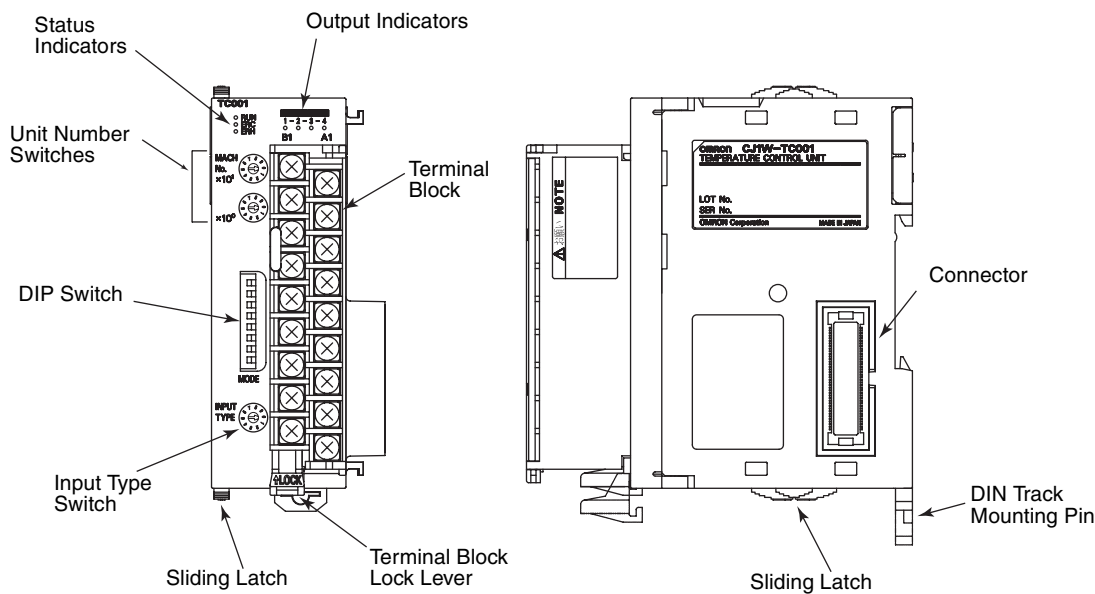

2-3-2 Indicators

Status Indicators

The Status Indicators indicate the operating status of the Temperature Control Unit, as explained in the following table.

Indicator	Name	Color	Status	Meaning
RUN	RUN Indicator	Green	Lit	Normal operating status
			Not lit	Temperature control is stopped.
ERC	Temperature Control Unit Error	Red	Lit	An error occurred in the Temperature Control Unit itself, such as a Sensor Error or Initialization Error.
			Not lit	Normal operating status

Indicator	Name	Color	Status	Meaning
ERH	CPU Unit Error	Red	Lit	An error occurred in the CPU Unit.
			Not lit	Normal operating status

Output Indicators

The Output Indicators light to indicate when the corresponding Temperature Control Unit output is ON.

2-3-3 Unit Number Switches

The CPU Unit and the Temperature Control Unit exchange data through the parts of the CPU Unit's CIO and DM Areas that are reserved for Special I/O Units. The Temperature Control Unit's unit setting determines which words are allocated.

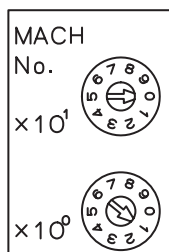

Switch setting	Unit number	Words allocated in Special I/O Unit Area in CIO Area	Words allocated in Special I/O Unit Area in DM Area
0	0	CIO 2000 to CIO 2019	D20000 to D20099
1	1	CIO 2010 to CIO 2029	D20100 to D20199
2	2	CIO 2020 to CIO 2039	D20200 to D20299
3	3	CIO 2030 to CIO 2049	D20300 to D20399
4	4	CIO 2040 to CIO 2059	D20400 to D20499
5	5	CIO 2050 to CIO 2069	D20500 to D20599
6	6	CIO 2060 to CIO 2079	D20600 to D20699
7	7	CIO 2070 to CIO 2089	D20700 to D20799
8	8	CIO 2080 to CIO 2099	D20800 to D20899
9	9	CIO 2090 to CIO 2109	D20900 to D20999
:	:	:	:
n	n	CIO 2000 + (n x 10) to CIO 2000 + (n x 10) + 19	D20000 + (n x 100) to D20000 + (n x 100) + 99
:	:	:	:
94	94	CIO 2940 to CIO 2959	D29400 to D29499

The Temperature Control Unit occupies 20 words in the Special I/O Unit Area, so do not set the same unit number or the next unit number on another Special I/O Unit. Since the Temperature Control Unit occupies the words for two unit numbers, the maximum unit number allowed is 94 (unlike most other Special I/O Units that can be set to unit number 95.)

Note If two or more Special I/O Units are assigned the same unit number, a "UNIT No. DPL ERR" error (in the Programming Console) will be generated (A40113 will turn ON) and the PLC will not operate.

2-3-4 DIP Switch Setting Functions

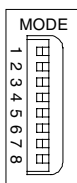

ON is to the right.

Pin	Function	ON	OFF	Factory setting
1	Operation when CPU Unit is in PROGRAM mode	Continue	Stop	OFF
2	Temperature units (°C/°F)	°F	°C	
3	Data format	16-bit binary	4-digit BCD	
4	Control operation (loops 1 and 3)	Forward (cooling)	Reverse (heating)	
5	Control operation (loops 2 and 4)	Forward (cooling)	Reverse (heating)	
6	Control method	ON/OFF control	PID control	
7	Initialize settings in EEPROM	Initialize	Do not initialize	
8	Transfer settings in EEPROM	Transfer	Do not transfer	ON

Operation in PROGRAM mode (Pin 1)

The following table shows how the Temperature Control Unit will operate when the CPU Unit's operating mode is changed.

Temperature Control Unit settings		Operation of Temperature Control Unit when CPU Unit's operating mode is changed	
Pin 1	Stop Bit	From RUN or MONITOR to PROGRAM	From PROGRAM to RUN or MONITOR
OFF (Stop)	Run	Stop operation	Continue operation
	Stop	Stop operation	Stop operation
ON (Continue)	Run	Continue operation	Continue operation
	Stop	Stop operation	Stop operation

Temperature Units (Pin 2)

Select either °C display (centigrade) or °F display (fahrenheit). When °F is selected, the temperature is converted using the following equation:

$$°F = (°C \times 1.8) + 32$$

Data Format (Pin 3)

Pin 3 selects whether the data exchanged between the Temperature Control Unit and CPU Unit is handled as 4-digit BCD or binary (i.e., 4-digit hexadecimal.) This switch setting controls the data format for the various settings such as SPs, PVs, alarm settings in both the CIO and DM Areas.

Pin 3 setting	Data format	Example (SP: -200 to 1,300°C)
ON	Binary (4-digit Hexadecimal)	FF38 to FFFF to 0514 (-200 to -1 to 1,300)
OFF	4-digit BCD	F200 to 1300 (-200 to 1,300)

Note If BCD format is selected, it isn't necessary to convert the data (Binary to BCD conversion) in the program when displaying the actual temperature so the ladder program load can be reduced. However, parts of some temperature ranges cannot be displayed in BCD so it will be necessary to use the binary format in those cases.

Control Operation for Loops 1 and 3 (Pin 4)

Pin 4 selects forward (cooling) operation (ON) or reverse (heating) operation (OFF) for control loops 1 and 3.

Control Operation for Loops 2 and 4 (Pin 5)

Pin 5 selects either forward (cooling) operation (ON) or reverse (heating) operation (OFF) for control loops 2 and 4.

Control Method (Pin 6)

Pin 6 selects either ON/OFF control (ON) or PID control (OFF).

- If ON/OFF control is being used, the width of the hysteresis loop (hysteresis) can be set to adjust the control sensitivity.
- If PID control (PID control with two degrees of freedom) is being used, the PID constants can be set automatically with the autotuning function.

Initialize EEPROM Settings (Pin 7)

If pin 7 is ON, the settings in EEPROM will be initialized to their factory defaults when the Temperature Control Unit is turned ON or restarted. (Initialize EEPROM only when a Hardware Check Error has occurred. Refer to 5-1-3 *Alarms Detected by the Temperature Control Unit* for details.)

Transfer EEPROM Settings (Pin 8)

If pin 8 is ON, the settings in the Temperature Control Unit's EEPROM will be transferred to the corresponding words in the CPU Unit's DM Area when the Temperature Control Unit is turned ON or restarted. Turn ON pin 8 if you want the Temperature Control Unit to operate with settings stored in EEPROM.

The settings in the Temperature Control Unit's RAM can be saved to EEPROM by turning ON the corresponding loop's Save Bit. Refer to 2-5-3 *Memory in the Temperature Control Unit* for details on the settings.

2-3-5 Setting the Input Type

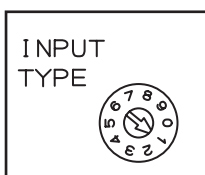

Thermocouple Temperature Control Units

Input type setting	Type	Temperature ranges	
		Centigrade	Farenheit
0	K	-200 to 1,300°C	-300 to 2,300°F
1	K	0.0 to 500.0°C	0.0 to 900.0°F
2	J	-100 to 850°C	-100 to 1,500°F
3	J	0.0 to 400.0°C	0.0 to 750.0°F
4	T	-200.0 to 400.0°C	-300.0 to 700.0°F
5	L	-100 to 850°C	-100 to 1,500°F
6	L	0.0 to 400.0 °C	0.0 to 750.0°F
7	R	0 to 1,700°C	0 to 3,000 °F
8	S	0 to 1,700°C	0 to 3,000 °F
9	B	100 to 1,800°C	300 to 3,200 °F

Platinum Resistance Thermometer Temperature Control Units

Input type setting	Type	Temperature ranges	
		Centigrade	Farenheit
0	Pt100	-200.0 to 650.0°C	-300.0 to 1,200.0°F
1	JPt100	-200.0 to 650.0°C	-300.0 to 1,200.0°F
2 to 9	Do not set 2 through 9.		

2-4 Wiring

2-4-1 Terminal Wiring Examples

Thermocouple Temperature Control Units

CJ1W-TC001 (4 loops, NPN outputs)				CJ1W-TC002 (4 loops, PNP outputs)			
Input 2 -	B1	A1	Input 1 -	Input 2 -	B1	A1	Input 1 -
Input 2 +	B2	A2	Input 1 +	Input 2 +	B2	A2	Input 1 +
Cold-junction comp.	B3	A3	N.C.	Cold-junction comp.	B3	A3	N.C.
Cold-junction comp.	B4	A4	N.C.	Cold-junction comp.	B4	A4	N.C.
Input 4 -	B5	A5	Input 3 -	Input 4 -	B5	A5	Input 3 -
Input 4 +	B6	A6	Input 3 +	Input 4 +	B6	A6	Input 3 +
Output 2	B7	A7	Output 1	Output 2	B7	A7	Output 1
Output 4	B8	A8	Output 3	Output 4	B8	A8	Output 3
0 V COM (-)	B9	A9	24 V	0 V	B9	A9	24 V COM (+)
CJ1W-TC003 (2 loops, NPN outputs, HB alarm)				CJ1W-TC004 (2 loops, PNP outputs, HB alarm)			
Input 2 -	B1	A1	Input 1 -	Input 2 -	B1	A1	Input 1 -
Input 2 +	B2	A2	Input 1 +	Input 2 +	B2	A2	Input 1 +
Cold-junction comp.	B3	A3	N.C.	Cold-junction comp.	B3	A3	N.C.
Cold-junction comp.	B4	A4	N.C.	Cold-junction comp.	B4	A4	N.C.
CT input 2	B5	A5	CT input 1	CT input 2	B5	A5	CT input 1
CT input 2	B6	A6	CT input 1	CT input 2	B6	A6	CT input 1
Output 2	B7	A7	Output 1	Output 2	B7	A7	Output 1
HB output 2	B8	A8	HB output 1	HB output 2	B8	A8	HB output 1
0 V COM (-)	B9	A9	24 V	0 V	B9	A9	24 V COM (+)

Note Do not connect any wiring to the N.C. terminals.

Platinum Resistance Thermometer Temperature Control Units

CJ1W-TC101 (4 loops, NPN outputs)				CJ1W-TC102 (4 loops, PNP outputs)			
Input 2 B'	B1	A1	Input 1 B'	Input 2 B'	B1	A1	Input 1 B'
Input 2 B	B2	A2	Input 1 B	Input 2 B	B2	A2	Input 1 B
Input 2 A	B3	A3	Input 1 A	Input 2 A	B3	A3	Input 1 A
Input 4 B'	B4	A4	Input 3 B'	Input 4 B'	B4	A4	Input 3 B'
Input 4 B	B5	A5	Input 3 B	Input 4 B	B5	A5	Input 3 B
Input 4 A	B6	A6	Input 3 A	Input 4 A	B6	A6	Input 3 A
Output 2	B7	A7	Output 1	Output 2	B7	A7	Output 1
Output 4	B8	A8	Output 3	Output 4	B8	A8	Output 3
0 V COM (-)	B9	A9	24 V	0 V COM (-)	B9	A9	24 V COM (+)
CJ1W-TC103 (2 loops, NPN outputs, HB alarm)				CJ1W-TC104 (2 loops, PNP outputs, HB alarm)			
Input 2 B'	B1	A1	Input 1 B'	Input 2 B'	B1	A1	Input 1 B'
Input 2 B	B2	A2	Input 1 B	Input 2 B	B2	A2	Input 1 B
Input 2 A	B3	A3	Input 1 A	Input 2 A	B3	A3	Input 1 A
N.C.	B4	A4	N.C.	N.C.	B4	A4	N.C.
CT input 2	B5	A5	CT input 1	CT input 2	B5	A5	CT input 1
CT input 2	B6	A6	CT input 1	CT input 2	B6	A6	CT input 1
Output 2	B7	A7	Output 1	Output 2	B7	A7	Output 1
HB output 2	B8	A8	HB output 1	HB output 2	B8	A8	HB output 1
0 V COM (-)	B9	A9	24 V	0 V	B9	A9	24 V COM (+)

Note Do not connect any wiring to the N.C. terminals.

2-4-2 Output Circuits

The following diagrams show the internal output circuits.

Output Circuits

NPN Outputs
(CJ1W-TC□01 and
CJ1W-TC□03)

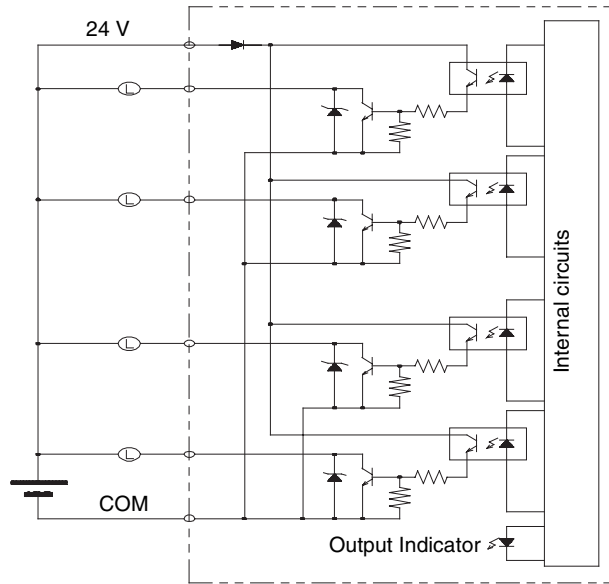

NPN Outputs
(CJ1W-TC□02 and
CJ1W-TC□04)

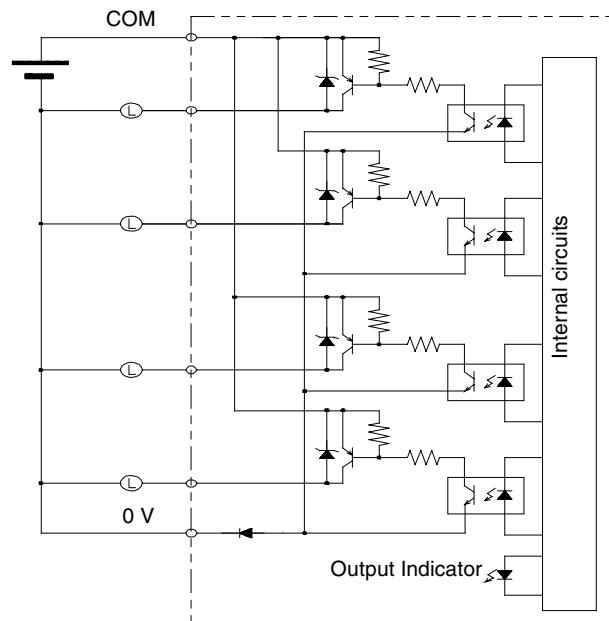

2-4-3 I/O Wiring Examples

Thermocouple Temperature Control Units

CJ1W-TC001

(4 loops, NPN outputs)

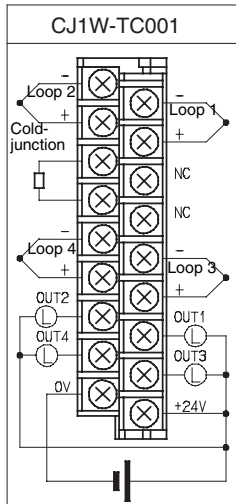

CJ1W-TC002

(4 loops, PNP outputs)

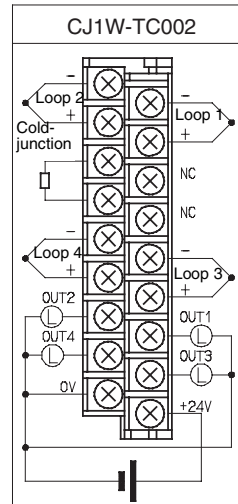

CJ1W-TC003

(2 loops, HB alarm, NPN outputs)

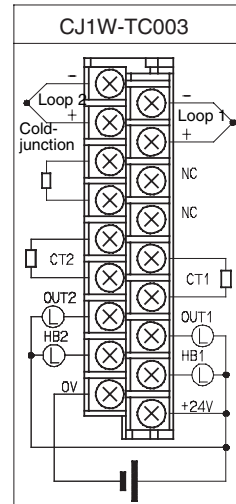

CJ1W-TC004

(2 loops, HB alarm, PNP outputs)

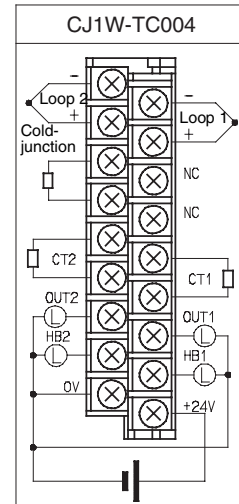

- Do not touch or remove the cold-junction compensator.
- Use the type of sensor selected on the Input Type Switch.
- The Temperature Control Unit and Terminal Block are a matched set, so use the Temperature Control Unit and Terminal Block with matching serial numbers.
- Do not connect anything to the N.C. terminals. (The N.C. terminals cannot even be used as junction terminals.)
- Do not connect any Current Transformer to the CT input terminals other than an OMRON E54-CT1 or E54-CT3.

**Platinum Resistance
Thermometer
Temperature Control Units**

CJ1W-TC101
(4 loops, NPN outputs)

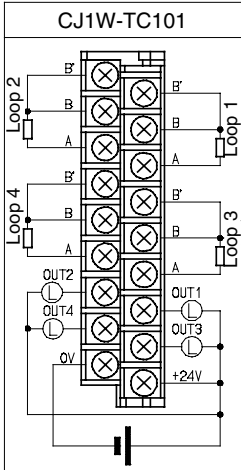

CJ1W-TC102
(4 loops, PNP outputs)

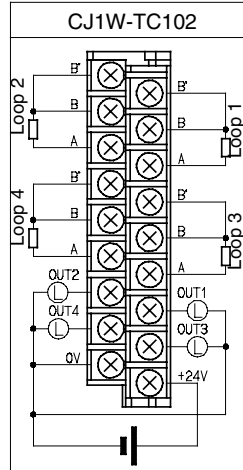

CJ1W-TC103
(2 loops, HB alarm, NPN outputs)

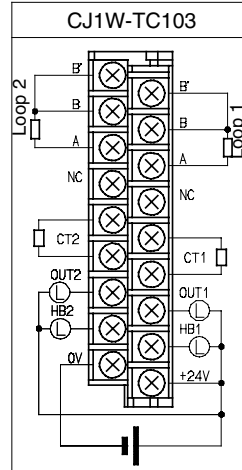

CJ1W-TC104
(2 loops, HB alarm, PNP outputs)

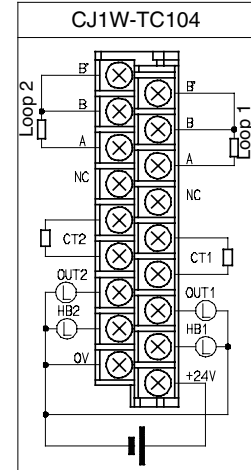

Note

1. Use the type of sensor selected on the Input Type Switch.
2. Do not connect anything to the N.C. terminals. (The N.C. terminals cannot even be used as junction terminals.)
3. Do not connect any Current Transformer to the CT input terminals other than an OMRON E54-CT1 or E54-CT3.
4. Always attach crimp terminals to the wiring that connects to the terminal block and tighten the terminal screws securely. The terminal screws are M3 screws and need to be tightened to a torque of 0.5 N·m.
5. Use wire that is AWG 22 to AWG 18.

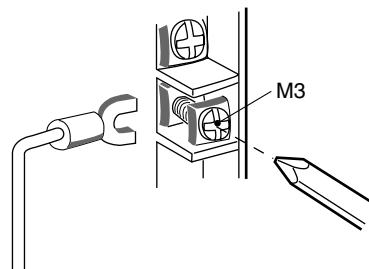

Fork terminal

Round terminal

6.0 mm max.

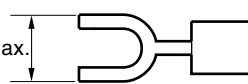

6.0 mm max.



6. Observe the following precautions when wiring to minimize noise and optimize the Temperature Control Unit's operation.
 - Use twisted-pair shielded wire for the output wiring.
 - Keep the I/O lines away from power lines including AC power supply lines and high-power lines. Do not run the I/O lines in the same duct or conduit as power lines.

- Noise from the power supply line may be superimposed on I/O signals if equipment that generates high frequency noise is used nearby or the Temperature Control Unit's power line is shared with electrical welding equipment or discharging equipment. In this case, install a noise filter at the power supply inputs.

2-5 Data Exchange with the CPU Unit

2-5-1 Overview

The Temperature Control Unit exchanges the following data with the CPU Unit.

- Operation Data
- Initialization Data
- Operating Parameters

Data exchange between the CPU Unit and the Temperature Control Unit is performed through the words allocated to the Temperature Control Unit as a Special I/O Unit in the CIO and DM Areas of the CPU Unit. The Operation Data is in the Special I/O Unit Area in the CIO Area and the Initialization Data and Operating Parameters are in the Special I/O Unit Area in the DM Area.

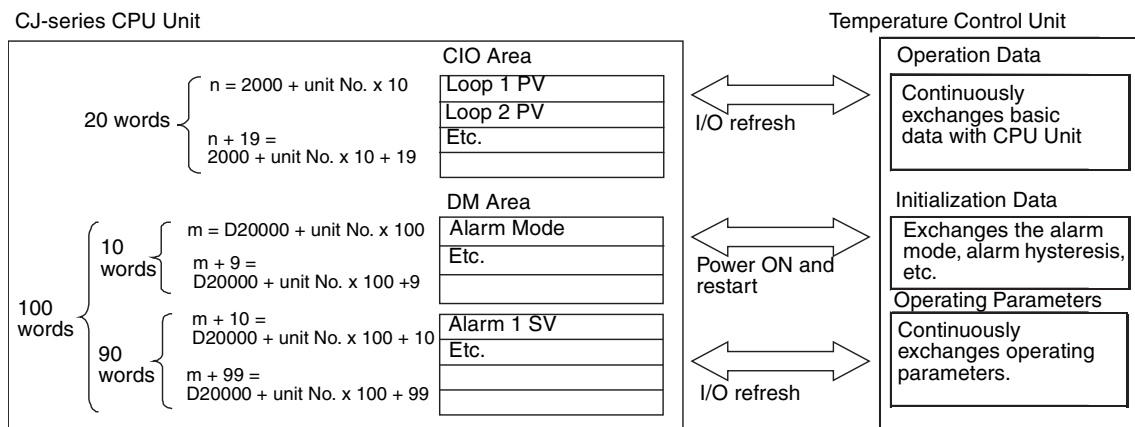

As shown in the above diagram, Special I/O Unit Areas are allocated for the three types of data in the CIO and DM Areas according to the unit number set for the Temperature Control Unit as a Special I/O Unit.

Operation Data

The basic data used to operate the Temperature Control Unit is exchanged with the CPU Unit as Operation Data during the CPU Unit's I/O refresh period. Operation Data includes the Process Values, Set Points, Stop Bits, Start AT Bits, Stop AT Bits, and other data.

Initialization Data

The data used to initialize the Temperature Control Unit is exchanged with the CPU Unit as Initialization Data when the PC is turned ON or the Temperature Control Unit is restarted. Initialization Data includes the Alarm Modes, Alarm Hysteresis, and other data.

Operating Parameters

The parameters that control Temperature Control Unit operation are exchanged with the CPU Unit as Operating Parameters during the CPU Unit's I/O refresh period. Operating Parameters include the Alarm SVs, Control Cycles, Proportional Bands, Integral Times, and other parameters.

2-5-2 Data Exchange Settings

Data Format

The format used to store data during data exchange between the CPU Unit and Temperature Control Unit in the words allocated to the Temperature Control Unit in the CIO and DM Areas must be set in advance. The data format is set using pin 3 on the DIP switch for function settings. It can be set to either 4-digit BCD or 16-bit binary. The same format is used for user-set and system-set data and for the Special I/O Areas in both the CIO and DM Area.

Pin 3	Data storage format
ON	16-bit binary
OFF (default)	4-digit BCD

Unit Number

The words allocated to the Temperature Control Unit in the CIO and DM Areas are determined by the unit number set for the Temperature Control Unit as a Special I/O Unit.

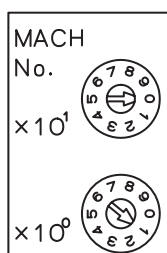

Switch setting	Unit number	Words allocated in Special I/O Unit Area in CIO Area	Words allocated in Special I/O Unit Area in DM Area
0	0	CIO 2000 to CIO 2019	D20000 to D20099
1	1	CIO 2010 to CIO 2029	D20100 to D20199
2	2	CIO 2020 to CIO 2039	D20200 to D20299
3	3	CIO 2030 to CIO 2049	D20300 to D20399
4	4	CIO 2040 to CIO 2059	D20400 to D20499
5	5	CIO 2050 to CIO 2069	D20500 to D20599
6	6	CIO 2060 to CIO 2079	D20600 to D20699
7	7	CIO 2070 to CIO 2089	D20700 to D20799
8	8	CIO 2080 to CIO 2099	D20800 to D20899
9	9	CIO 2090 to CIO 2109	D20900 to D20999
:	:	:	:
n	n	CIO 2000 + (n x 10) to CIO 2000 + (n x 10) + 19	D20000 + (n x 100) to D20000 + (n x 100) + 99
:	:	:	:
94	94	CIO 2940 to CIO 2959	D29400 to D29499

- Note**
1. If two or more Special I/O Units are assigned the same unit number, an "UNIT No. DPL ERR" error (in the Programming Console) will be generated (A40113 will turn ON) and the PLC will not operate.
 2. Each Temperature Control Unit is allocated the words for two unit numbers. Do not use assign the unit number after one assigned to a Temperature Control Unit to any other Unit. For example, if unit number 5 is allocated to a Temperature Control Unit, the words for both unit number 5 and 6 will be allocated to it, and unit number 6 must not be assigned to any other Unit.

**Special I/O Unit
Restart Bits**

To restart the Unit after changing the contents of the DM Area or correcting an error, turn ON the power to the PLC again or turn the Special I/O Unit Restart Bit ON and then OFF again.

Special I/O Unit Area word address	Function	
A50200	Unit No. 0 Restart Bit	Restarts the Unit when turned ON and then OFF again.
A50201	Unit No. 1 Restart Bit	
:	:	
A50215	Unit No. 15 Restart Bit	
A50300	Unit No. 16 Restart Bit	
:	:	
A50715	Unit No. 95 Restart Bit	

Note If the error is not corrected by restarting the Unit or turning the Special I/O Unit Restart Bit ON and then OFF again, refer to *SECTION 5 Error and Alarm Processing*.

2-5-3 Memory in the Temperature Control Unit

The Temperature Control Unit has two types of memory: RAM and EEPROM. As shown in the following table and illustration, data for the Temperature Control Unit is written from the words allocated in the CPU Unit to the RAM in the Temperature Control Unit. Some of this data can be written from the RAM to EEPROM by turning ON a Save Bit.

If pin 8 on the DIP switch is ON, the data stored in the EEPROM will automatically be transferred to the DM Area in the CPU Unit when power is turned ON or the Temperature Control Unit is restarted, enabling operation with the data stored in the EEPROM.

Memory allocations in CPU Unit		Main settings	Transfer from CPU Unit areas to RAM in Temperature Control Unit	Transfer from RAM to EEPROM	Transfer from EEPROM in Temperature Control Unit to CPU Unit areas
CIO Area	Operation Data	Set Point Heater Burnout Current	I/O refresh period	Not transferred.	
DM Area	Initialization Data	Alarm Mode Alarm Hysteresis	Power ON or Unit restart	Not transferred.	
	Operating Parameters	Alarm SV Input Compensation Control Period Sensitivity	I/O refresh period	When Save Bit in Special I/O Unit Area is turned ON.	When power is turned ON or the Unit is restarted with pin 8 on the DIP switch turned ON.
		Proportional Band Integral Time Derivative Time	I/O refresh period as long as PID Constants Changed Flag is OFF (See note.)		

- Note**
1. The PID constants resulting from autotuning are automatically written to RAM at the end of autotuning.
 2. The EEPROM has a life of 100,000 writes.

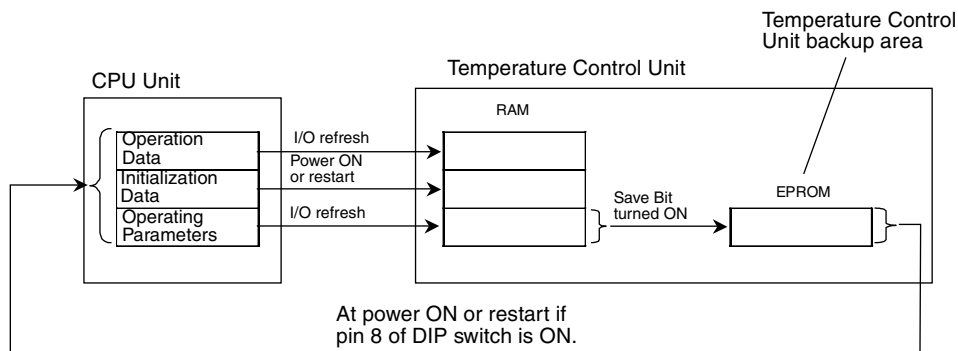

2-5-4 Operation Data

Operation Data is exchanged between the words allocated to the Temperature Control Unit in the Special I/O Unit Area in the CIO Area of the CPU Unit and the Temperature Control Unit. The Operation Data includes the Process Values, Set Points, Stop Bits, Start AT Bits, Stop AT Bits, and other basic data.

Operation data is exchanged each cycle time during the I/O refresh period. Input data is transferred from the Temperature Control Unit to the CPU Unit and output data is transferred from the CPU Unit to the Temperature Control Unit.

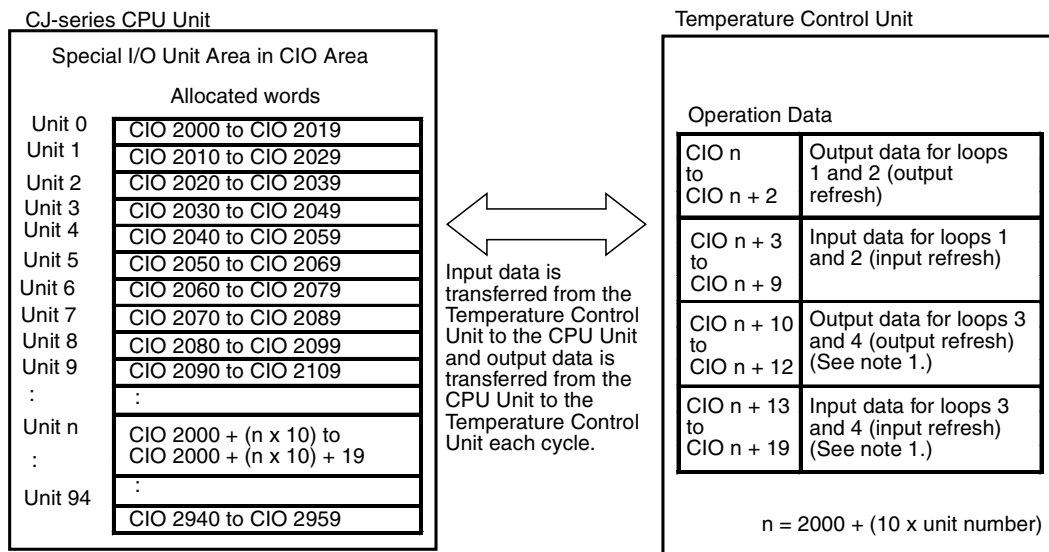

- Note**
1. For Two-loop Temperature Control Units, the read and write values for the heater burnout alarm are transferred.
 2. The Special I/O Unit Area words that are allocated to the Temperature Control Unit in the CIO Area are determined by the setting of the unit number switch on the front panel of the Unit. Refer to 2-3-3 Unit Number Switches for details on the method used to set the unit number switch.
 3. If two or more Special I/O Units are assigned the same unit number, an "UNIT No. DPL ERR" error (in the Programming Console) will be generated (A40113 will turn ON) and the PLC will not operate.

Operation Data Contents

The following tables show the specific applications of the bits and words in the Operation Data.

Four-loop Units

I/O	Word	Bit															
		15	14	13	12	11	10	09	08	07	06	05	04	03	02	01	00
Out-put	n	Loop 1 Set Point (SP)															
	n+1	Loop 2 SP															
	n+2	Loop 1	Loop 2	Loop 1	Loop 2	0	0	0	0	Loop 1		Loop 2		Loop 1		Loop 2	
		Save	Save	Change PID Constants	Change PID Constants					0	Stop	0	Stop	Stop AT	Start AT	Stop AT	Start AT
Input	n+3	Loop 1 PV															
	n+4	Loop 2 PV															
	n+5	Loop 1 SP															
	n+6	Loop 2 SP															
	n+7	Loop 1 Decimal Point				Loop 2 Decimal Point				Loop 1 Setting Error Number				Loop 2 Setting Error Number			
	n+8	Loop 1 Status															
		Save Completed	Sensor Error	0	Fatal Control Error	Stand-by	PID Constants Calculated	Setting Error	Stop	0	0	0	Control Output	AT	0	AL1	AL2
	n+9	Loop 2 Status															
Save Completed		Sensor Error	0	Fatal Control Error	Stand-by	PID Constants Calculated	Setting Error	Stop	0	0	0	Control Output	AT	0	AL1	AL2	
Out-put	n+10	Loop 3 SP															
	n+11	Loop 4 SP															
	n+12	Loop 3	Loop 4	Loop 3	Loop 4	0	0	0	0	Loop 3		Loop 4		Loop 3		Loop 4	
		Save	Save	Change PID Constants	Change PID Constants					0	Stop	0	Stop	Stop AT	Start AT	Stop AT	Start AT
Input	n+13	Loop 3 PV															
	n+14	Loop 4 PV															
	n+15	Loop 3 SP															
	n+16	Loop 4 SP															
	n+17	Loop 3 Decimal Point				Loop 4 Decimal Point				Loop 3 Setting Error Number				Loop 4 Setting Error Number			
	n+18	Loop 3 Status															
		Save Completed	Sensor Error	0	Fatal Control Error	Stand-by	PID Constants Calculated	Setting Error	Stop	0	0	0	Control Output	AT	0	AL1	AL2
n+19	Loop 4 Status																
	Save Completed	Sensor Error	0	Fatal Control Error	Stand-by	PID Constants Calculated	Setting Error	Stop	0	0	0	Control Output	AT	0	AL1	AL2	

$$n = 2000 + (10 \times \text{unit number})$$

Two-loop Units

I/O	Word	Bit															
		15	14	13	12	11	10	09	08	07	06	05	04	03	02	01	00
Output	n	Loop 1 Set Point (SP)															
	n+1	Loop 2 SP															
	n+2	Loop 1	Loop 2	Loop 1	Loop 2	0	0	0	0	Loop 1		Loop 2		Loop 1		Loop 2	
		Save	Save	Change PID Constants	Change PID Constants					0	Stop	0	Stop	Stop AT	Start AT	Stop AT	Start AT
Input	n+3	Loop 1 PV															
	n+4	Loop 2 PV															
	n+5	Loop 1 SP															
	n+6	Loop 2 SP															
	n+7	Loop 1 Decimal Point				Loop 2 Decimal Point				Loop 1 Setting Error Number				Loop 2 Setting Error Number			
	n+8	Loop 1 Status															
		Save Completed	Sensor Error	CT Overflow	Fatal Control Error	Stand-by	PID Constants Calculated	Setting Error	Stop	0	0	0	Control Output	AT	HB	AL1	AL2
	n+9	Loop 2 Status															
	Save Completed	Sensor Error	CT Overflow	Fatal Control Error	Stand-by	PID Constants Calculated	Setting Error	Stop	0	0	0	Control Output	AT	HB	AL1	AL2	
Output	n+10	Heater Burnout Set Value for Loop 1															
	n+11	Heater Burnout Set Value for Loop 2															
	n+12	Not used.															
Input	n+13	Heater Current for Loop 1															
	n+14	Heater Current for Loop 2															
	n+15	Heater Burnout Set Value for Loop 1															
	n+16	Heater Burnout Set Value for Loop 2															
	n+17	Not used.															
	n+18	Not used.															
	n+19	Not used.															

$$n = 2000 + (10 \times \text{unit number})$$

**Operation Data
Details**

Details on the Operation Data are provided in the following table. Refer to 2-6 *Data Ranges* for the ranges of data that can be used.

Four-loop Units

I/O	Address		Loop	Name	Function
	Word	Bits			
Outputs (CPU Unit to Temperature Control Unit)	n	00 to 15	Loop 1	Set Point	Set the Set Point for the loop as 4-digit BCD or 16-bit binary. For negative BCD values, set the most significant digit to F. The values set here are transferred to RAM.
	n+1	00 to 15	Loop 2	Set Point	
	n+2	15	Loop 1	Save Bit	Operating Parameters are written from RAM to EEPROM in the Temperature Control Unit when a Save Bit is turned ON. Refer to 2-6 <i>Data Ranges</i> for a list of the specific parameters that are written. DO NOT turn OFF the power supply when data is being written from RAM to EEPROM. Confirm that the Save Completed Flag has turned ON before turning OFF the power supply.
		14	Loop 2	Save Bit	
		13	Loop 1	Change PID Constants Bit	When a Change PID Constants Bit is turned ON, the corresponding PID Constants Calculated Flag will turn OFF and the PID constants stored as Operating PID Constants will be retransferred to the Temperature Control Unit.
		12	Loop 2	Change PID Constants Bit	
		08 to 11	---	---	Leave set to all zeros.
		7	---	---	Leave set to 0.
		6	Loop 1	Stop Bit	Turn OFF the Stop Bit to perform temperature control for loop 1 and turn it ON to stop temperature control for loop 1. The Stop Bit will not function if pin 1 on the DIP switch is OFF and the CPU Unit is in PROGRAM mode.
		5	---	---	Leave set to 0.
		4	Loop 2	Stop Bit	Turn OFF the Stop Bit to perform temperature control for loop 2 and turn it ON to stop temperature control for loop 2. The Stop Bit will not function if pin 1 on the DIP switch is OFF and the CPU Unit is in PROGRAM mode.
		3	Loop 1	Stop AT Bit	Turn ON the Stop AT Bit to stop autotuning for loop 1. The status of the Stop AT Bit is ignored if autotuning is not being performed.
		2	Loop 1	Start AT Bit	Turn ON the Start AT Bit to start autotuning for loop 1. The status of the Stop AT Bit is ignored if the Stop AT Bit for loop 1 is ON.
		1	Loop 2	Stop AT Bit	Turn ON the Stop AT Bit to stop autotuning for loop 2. The status of the Stop AT Bit is ignored if autotuning is not being performed.
	0	Loop 2	Start AT Bit	Turn ON the Start AT Bit to start autotuning for loop 2. The status of the Stop AT Bit is ignored if the Stop AT Bit for loop 2 is ON.	

I/O	Address		Loop	Name	Function
	Word	Bits			
Inputs (Temperature Control Unit to CPU Unit)	n+3	00 to 15	Loop 1	Process Value	The current process value is stored in 4-digits BCD or 16-bits binary. For negative BCD values, the most significant digit will be F. A sensor error will occur if the specified range is exceeded, the Sensor Error Flag will turn ON, and the process value will be CCCC.
	n+4	00 to 15	Loop 2	Process Value	
	n+5	00 to 15	Loop 1	Set Point	The current set point is stored in 4-digits BCD or 16-bits binary. For negative BCD values, the most significant digit will be F.
	n+6	00 to 15	Loop 2	Set Point	
	n+7	12 to 15	Loop 1	Decimal Point	The use of a decimal places is specified for the process value and set point.
		08 to 11	Loop 2	Decimal Point	
		04 to 07	Loop 1	Setting Error Number	The number of the setting in which a setting error exists is stored in hexadecimal. Refer to 5-1 Error and Alarm Processing for details.
		00 to 03	Loop 2	Setting Error Number	
	n+8	15	Loop 1	Save Completed Flag	The Save Completed Flag turns ON when writing data from RAM to EEPROM has been completed. The write is started by turning ON bit 15 of CIO (n+2), the Save Bit. The Save Completed Flag turns OFF when the Save Bit turns ON. (It is also OFF immediately after power is turned ON.)
		14		Sensor Error Flag	The Sensor Error Flag turns ON for the following: A sensor is not connected. The connection to sensor is broken. A temperature exceeding the specified temperature range has been input.
		13		---	Leave set to 0.
		12		Fatal Control Error Flag	The Fatal Control Error Flag turns ON for the following: Cold-junction compensator error, CPU Unit WDT error
		11		Standby Flag	The Standby Flag turns ON when the Temperature Control Unit is waiting for I/O refreshing after power is turned ON or the Unit is restarted.
		10		PID Constants Calculated Flag	The PID Constants Calculated Flag turns ON when the PID constants calculated for autotuning have been updated. When this flag is ON, the PID constants in the Operating Parameters Output Area have not been output to the Temperature Control Unit. When this flag is OFF, the PID constants in the Operating Parameters Output Area have been output to the Temperature Control Unit.
		09		Setting Error Flag	The Setting Error Flag turns ON when there is a setting error in the settings in the I/O memory of the CPU Unit.
		08		Stop Flag	When the Stop Flag is OFF, the Temperature Control Unit is controlling temperature. When it is ON, the Temperature Control Unit is not controller temperature.
		05 to 07		---	Leave set to all zeros.
04		Control Output Flag		The Control Output Flag is ON when the control output is ON.	
03	AT Flag	The AT Flag is ON when autotuning is being performed. The AT Flag is OFF when autotuning is not being performed.			
02	---	Leave set to 0.			
01	AL1 Flag	The AL1/AL2 Flag is ON when the temperature is within the alarm range set for the input value. The flag is OFF when the temperature is not within the alarm range set for the input value.			
00	AL2 Flag				

I/O	Address		Loop	Name	Function
	Word	Bits			
Inputs (Temperature Control Unit to CPU Unit)	n+9	15	Loop 2	Save Completed Flag	The Save Completed Flag turns ON when writing data from RAM to EEPROM has been completed. The write is started by turning ON bit 14 of CIO (n+2), the Save Bit. The Save Completed Flag turns OFF when the Save Bit turns ON. (It is also OFF immediately after power is turned ON.)
		14		Sensor Error Flag	The Sensor Error Flag turns ON for the following: A sensor is not connected. The connection to sensor is broken. A temperature exceeding the specified temperature range has been input.
		13		---	Leave set to 0.
		12		Fatal Control Error Flag	The Fatal Control Error Flag turns ON for the following: Cold-junction compensator error, CPU Unit WDT error
		11		Standby Flag	The Standby Flag turns ON when the Temperature Control Unit is waiting for I/O refreshing after power is turned ON or the Unit is restarted.
		10		PID Constants Calculated Flag	The PID Constants Calculated Flag turns ON when the PID constants calculated for autotuning have been updated. When this flag is ON, the PID constants in the Operating Parameters Output Area have not been output to the Temperature Control Unit. When this flag is OFF, the PID constants in the Operating Parameters Output Area have been output to the Temperature Control Unit.
		09		Setting Error Flag	The Setting Error Flag turns ON when there is a setting error in the settings in the I/O memory of the CPU Unit.
		08		Stop Flag	When the Stop Flag is OFF, the Temperature Control Unit is controlling temperature. When it is ON, the Temperature Control Unit is not controller temperature.
		05 to 07		---	Leave set to all zeros.
		04		Control Output Flag	The Control Output Flag is ON when the control output is ON.
		03		AT Flag	The AT Flag is ON when autotuning is being performed. The AT Flag is OFF when autotuning is not being performed.
		02		---	Leave set to 0.
		01		AL1 Flag	The AL1/AL2 Flag is ON when the temperature is within the alarm range set for the input value. The flag is OFF when the temperature is not within the alarm range set for the input value.
		00		AL2 Flag	

I/O	Address		Loop	Name	Function
	Word	Bits			
Outputs (CPU Unit to Temperature Control Unit)	n+10	00 to 15	Loop 3	Set Point	Set the Set Point for the loop as 4-digit BCD or 16-bit binary. For negative BCD values, set the most significant digit to F. The values set here are transferred to RAM.
	n+11	00 to 15	Loop 4	Set Point	
	n+12	15	Loop 3	Save Bit	Operating Parameters are written from RAM to EEPROM in the Temperature Control Unit when a Save Bit is turned ON. Refer to 2-6 <i>Data Ranges</i> for a list of the specific parameters that are written. DO NOT turn OFF the power supply when data is being written from RAM to EEPROM. Confirm that the Save Completed Flag has turned ON before turning OFF the power supply.
		14	Loop 4	Save Bit	
		13	Loop 3	Change PID Constants Bit	When a Change PID Constants Bit is turned ON, the corresponding PID Constants Calculated Flag will turn OFF and the PID constants stored as Operating Parameters will be retransferred to the Temperature Control Unit.
		12	Loop 4	Change PID Constants Bit	
		08 to 11	---	---	Leave set to all zeros.
		7	---	---	Leave set to 0.
		6	Loop 3	Stop Bit	Turn OFF the Stop Bit to perform temperature control for loop 3 and turn it ON to stop temperature control for loop 3. The Stop Bit will not function if pin 1 on the DIP switch is OFF and the CPU Unit is in PROGRAM mode.
		5	---	---	Leave set to 0.
		4	Loop 4	Stop Bit	Turn OFF the Stop Bit to perform temperature control for loop 4 and turn it ON to stop temperature control for loop 4. The Stop Bit will not function if pin 1 on the DIP switch is OFF and the CPU Unit is in PROGRAM mode.
		3	Loop 3	Stop AT Bit	Turn ON the Stop AT Bit to stop autotuning for loop 3. The status of the Stop AT Bit is ignored if autotuning is not being performed.
		2	Loop 3	Start AT Bit	Turn ON the Start AT Bit to start autotuning for loop 3. The status of the Stop AT Bit is ignored if the Stop AT Bit for loop 3 is ON.
		1	Loop 4	Stop AT Bit	Turn ON the Stop AT Bit to stop autotuning for loop 4. The status of the Stop AT Bit is ignored if autotuning is not being performed.
	0	Loop 4	Start AT Bit	Turn ON the Start AT Bit to start autotuning for loop 4. The status of the Stop AT Bit is ignored if the Stop AT Bit for loop 4 is ON.	

I/O	Address		Loop	Name	Function
	Word	Bits			
Inputs (Temperature Control Unit to CPU Unit)	n+13	00 to 15	Loop 3	Process Value	The current process value is stored in 4-digits BCD or 16-bits binary. For negative BCD values, the most significant digit will be F. A sensor error will occur if the specified range is exceeded, the Sensor Error Flag will turn ON, and the process value will be CCCC.
	n+14	00 to 15	Loop 4	Process Value	
	n+15	00 to 15	Loop 3	Set Point	The current set point is stored in 4-digits BCD or 16-bits binary. For negative BCD values, the most significant digit will be F.
	n+16	00 to 15	Loop 4	Set Point	
	n+17	12 to 15	Loop 3	Decimal Point	The use of a decimal places is specified for the process value and set point. 0: No decimal places 1: One decimal place
		08 to 11	Loop 4	Decimal Point	
		04 to 07	Loop 3	Setting Error Number	The number of the setting in which a setting error exists is stored in hexadecimal. Refer to <i>5-1 Error and Alarm Processing</i> for details.
		00 to 03	Loop 4	Setting Error Number	
	n+18	15	Loop 3	Save Completed Flag	The Save Completed Flag turns ON when writing data from RAM to EEPROM has been completed. The write is started by turning ON bit 15 of CIO (n+2), the Save Bit. The Save Completed Flag turns OFF when the Save Bit turns ON. (It is OFF immediately after power is turned ON.)
		14		Sensor Error Flag	The Sensor Error Flag turns ON for the following: A sensor is not connected. The connection to sensor is broken. A temperature exceeding the specified temperature range has been input.
		13		---	Leave set to 0.
		12		Fatal Control Error Flag	The Fatal Control Error Flag turns ON for the following: Cold-junction compensator error, CPU Unit WDT error
		11		Standby Flag	The Standby Flag turns ON when the Temperature Control Unit is waiting for I/O refreshing after power is turned ON or the Unit is restarted.
		10		PID Constants Calculated Flag	The PID Constants Calculated Flag turns ON when the PID constants calculated for autotuning have been updated. When this flag is ON, the PID constants in the Operating Parameters Output Area have not been output to the Temperature Control Unit. When this flag is OFF, the PID constants in the Operating Parameters Output Area have been output to the Temperature Control Unit.
		09		Setting Error Flag	The Setting Error Flag turns ON when there is a setting error in the settings in the I/O memory of the CPU Unit.
		08		Stop Flag	When the Stop Flag is OFF, the Temperature Control Unit is controlling temperature. When it is ON, the Temperature Control Unit is not controller temperature.
		05 to 07		---	Leave set to all zeros.
		04		Control Output Flag	The Control Output Flag is ON when the control output is ON.
		03		AT Flag	The AT Flag is ON when autotuning is being performed. The AT Flag is OFF when autotuning is not being performed.
		02		---	Leave set to 0.
01	AL1 Flag	The AL1/AL2 Flag is ON when the temperature is within the alarm range set for the input value. The flag is OFF when the temperature is not within the alarm range set for the input value.			
00	AL2 Flag				

I/O	Address		Loop	Name	Function
	Word	Bits			
Inputs (Temperature Control Unit to CPU Unit)	n+19	15	Loop 4	Save Completed Flag	The Save Completed Flag turns ON when writing data from RAM to EEPROM has been completed. The write is started by turning ON bit 14 of CIO (n+12), the Save Bit. The Save Completed Flag turns OFF when the Save Bit turns ON. (It is OFF immediately after power is turned ON.)
		14		Sensor Error Flag	The Sensor Error Flag turns ON for the following: A sensor is not connected. The connection to sensor is broken. A temperature exceeding the specified temperature range has been input.
		13		---	Leave set to 0.
		12		Fatal Control Error Flag	The Fatal Control Error Flag turns ON for the following: Cold-junction compensator error, CPU Unit WDT error
		11		Standby Flag	The Standby Flag turns ON when the Temperature Control Unit is waiting for I/O refreshing after power is turned ON or the Unit is restarted.
		10		PID Constants Calculated Flag	The PID Constants Calculated Flag turns ON when the PID constants calculated for autotuning have been updated. When this flag is ON, the PID constants in the Operating Parameters Output Area have not been output to the Temperature Control Unit. When this flag is OFF, the PID constants in the Operating Parameters Output Area have been output to the Temperature Control Unit.
		09		Setting Error Flag	The Setting Error Flag turns ON when there is a setting error in the settings in the I/O memory of the CPU Unit.
		08		Stop Flag	When the Stop Flag is OFF, the Temperature Control Unit is controlling temperature. When it is ON, the Temperature Control Unit is not controller temperature.
		05 to 07		---	Leave set to all zeros.
		04		Control Output Flag	The Control Output Flag is ON when the control output is ON.
		03		AT Flag	The AT Flag is ON when autotuning is being performed. The AT Flag is OFF when autotuning is not being performed.
		02		---	Leave set to 0.
		01		AL1 Flag	The AL1/AL2 Flag is ON when the temperature is within the alarm range set for the input value. The flag is OFF when the temperature is not within the alarm range set for the input value.
		00		AL2 Flag	

Two-loop Units

I/O	Address		Loop	Name	Function
	Word	Bits			
Outputs (CPU Unit to Temperature Control Unit)	n	00 to 15	Loop 1	Set Point	Set the Set Point for the loop as 4-digit BCD or 16-bit binary. For negative BCD values, set the most significant digit to F. The values set here are transferred to RAM.
	n+1	00 to 15	Loop 2	Set Point	
	n+2	15	Loop 1	Save Bit	Operating Parameters are written from RAM to EEPROM in the Temperature Control Unit when a Save Bit is turned ON. Refer to 2-6 Data Ranges for a list of the specific parameters that are written. DO NOT turn OFF the power supply when data is being written from RAM to EEPROM. Confirm that the Save Completed Flag has turned ON before turning OFF the power supply.
		14	Loop 2	Save Bit	
		13	Loop 1	Change PID Constants Bit	When a Change PID Constants Bit is turned ON, the corresponding PID Constants Calculated Flag will turn OFF and the PID constants stored as Operating Parameters will be retransferred to the Temperature Control Unit.
		12	Loop 2	Change PID Constants Bit	
		08 to 11	---	---	Leave set to all zeros.
		7	---	---	Leave set to 0.
		6	Loop 1	Stop Bit	Turn OFF the Stop Bit to perform temperature control for loop 1 and turn it ON to stop temperature control for loop 1. The Stop Bit will not function if pin 1 on the DIP switch is OFF and the CPU Unit is in PROGRAM mode.
		5	---	---	Leave set to 0.
		4	Loop 2	Stop Bit	Turn OFF the Stop Bit to perform temperature control for loop 2 and turn it ON to stop temperature control for loop 2. The Stop Bit will not function if pin 1 on the DIP switch is OFF and the CPU Unit is in PROGRAM mode.
		3	Loop 1	Stop AT Bit	Turn ON the Stop AT Bit to stop autotuning for loop 1. The status of the Stop AT Bit is ignored if autotuning is not being performed.
		2	Loop 1	Start AT Bit	Turn ON the Start AT Bit to start autotuning for loop 1. The status of the Stop AT Bit is ignored if the Stop AT Bit for loop 1 is ON.
		1	Loop 2	Stop AT Bit	Turn ON the Stop AT Bit to stop autotuning for loop 2. The status of the Stop AT Bit is ignored if autotuning is not being performed.
	0	Loop 2	Start AT Bit	Turn ON the Start AT Bit to start autotuning for loop 2. The status of the Stop AT Bit is ignored if the Stop AT Bit for loop 2 is ON.	

I/O	Address		Loop	Name	Function
	Word	Bits			
Inputs (Temperature Control Unit to CPU Unit)	n+3	00 to 15	Loop 1	Process Value	The current process value is stored in 4-digits BCD or 16-bits binary. For negative BCD values, the most significant digit will be F. A sensor error will occur if the specified range is exceeded, the Sensor Error Flag will turn ON, and the process value will be CCCC.
	n+4	00 to 15	Loop 2	Process Value	
	n+5	00 to 15	Loop 1	Set Point	The current set point is stored in 4-digits BCD or 16-bits binary. For negative BCD values, the most significant digit will be F.
	n+6	00 to 15	Loop 2	Set Point	
	n+7	12 to 15	Loop 1	Decimal Point	The use of a decimal places is specified for the process value and set point. 0: No decimal places 1: One decimal place
		08 to 11	Loop 2	Decimal Point	
	n+7	04 to 07	Loop 1	Setting Error Number	The number of the setting in which a setting error exists is stored in hexadecimal. Refer to <i>5-1 Error and Alarm Processing</i> for details.
		00 to 03	Loop 2	Setting Error Number	
	n+8	15	Loop 1	Save Completed Flag	The Save Completed Flag turns ON when writing data from RAM to EEPROM has been completed. The write is started by turning ON bit 15 of CIO (n+2), the Save Bit. The Save Completed Flag turns OFF when the Save Bit turns ON. (It is OFF immediately after power is turned ON.)
		14		Sensor Error Flag	The Sensor Error Flag turns ON for the following: A sensor is not connected. The connection to sensor is broken. A temperature exceeding the specified temperature range has been input.
		13		CT Overflow Flag	The CT Overflow Flag turns ON if the heater current detected by the CT (Current Transformer) exceeds 55.0 A.
		12		Fatal Control Error Flag	The Fatal Control Error Flag turns ON for the following: Cold-junction compensator error, CPU Unit WDT error
		11		Standby Flag	The Standby Flag turns ON when the Temperature Control Unit is waiting for I/O refreshing after power is turned ON or the Unit is restarted.
		10		PID Constants Calculated Flag	The PID Constants Calculated Flag turns ON when the PID constants calculated for autotuning have been updated. When this flag is ON, the PID constants in the Operating Parameters Output Area have not been output to the Temperature Control Unit. When this flag is OFF, the PID constants in the Operating Parameters Output Area have been output to the Temperature Control Unit.
		09		Setting Error Flag	The Setting Error Flag turns ON when there is a setting error in the settings in the I/O memory of the CPU Unit.
		08		Stop Flag	When the Stop Flag is OFF, the Temperature Control Unit is controlling temperature. When it is ON, the Temperature Control Unit is not controller temperature.
05 to 07		---		Leave set to all zeros.	
04		Control Output Flag		The Control Output Flag is ON when the control output is ON.	
03	AT Flag	The AT Flag is ON when autotuning is being performed. The AT Flag is OFF when autotuning is not being performed.			
02	HB Flag	The HB (heater burnout) Flag turns ON if the detected heater current reaches or exceeds the value set as the Heater Burnout Current.			

I/O	Address		Loop	Name	Function
	Word	Bits			
Inputs (Temperature Control Unit to CPU Unit)	n+8	01	Loop 1	AL1 Flag	The AL1/AL2 Flag is ON when the temperature is within the alarm range set for the input value. The flag is OFF when the temperature is not within the alarm range set for the input value.
		00		AL2 Flag	
	n+9	15	Loop 2	Save Completed Flag	The Save Completed Flag turns ON when writing data from RAM to EEPROM has been completed. The write is started by turning ON bit 14 of CIO (n+2), the Save Bit. The Save Completed Flag turns OFF when the Save Bit turns ON. (It is OFF immediately after power is turned ON.)
		14		Sensor Error Flag	The Sensor Error Flag turns ON for the following: A sensor is not connected. The connection to sensor is broken. A temperature exceeding the specified temperature range has been input.
		13		CT Overflow Flag	The CT Overflow Flag turns ON if the heater current detected by the CT (Current Transformer) exceeds 55.0 A.
		12		Fatal Control Error Flag	The Fatal Control Error Flag turns ON for the following: Cold-junction compensator error, CPU Unit WDT error
		11		Standby Flag	The Standby Flag turns ON when the Temperature Control Unit is waiting for I/O refreshing after power is turned ON or the Unit is restarted.
		10		PID Constants Calculated Flag	The PID Constants Calculated Flag turns ON when the PID constants calculated for autotuning have been updated. When this flag is ON, the PID constants in the Operating Parameters Output Area have not been output to the Temperature Control Unit. When this flag is OFF, the PID constants in the Operating Parameters Output Area have been output to the Temperature Control Unit.
		09		Setting Error Flag	The Setting Error Flag turns ON when there is a setting error in the settings in the I/O memory of the CPU Unit.
		08		Stop Flag	When the Stop Flag is OFF, the Temperature Control Unit is controlling temperature. When it is ON, the Temperature Control Unit is not controller temperature.
		05 to 07		---	Leave set to all zeros.
		04		Control Output Flag	The Control Output Flag is ON when the control output is ON.
		03		AT Flag	The AT Flag is ON when autotuning is being performed. The AT Flag is OFF when autotuning is not being performed.
		02		HB Flag	The HB (heater burnout) Flag turns ON if the detected heater current reaches or exceeds the value set as the Heater Burnout Current.
		01		AL1 Flag	The AL1/AL2 Flag is ON when the temperature is within the alarm range set for the input value. The flag is OFF when the temperature is not within the alarm range set for the input value.
		00		AL2 Flag	

I/O	Address		Loop	Name	Function
	Word	Bits			
Outputs (CPU Unit to Temperature Control Unit)	n+10	00 to 15	Loop 1	Heater Burn-out Current	Set the heater burnout current in 4-digits BCD or 16-bits binary. If the value is set to 0.0, heater burnouts will not be detected.
	n+11	00 to 15	Loop 2	Heater Burn-out Current	If the value is set to 50.0, the heater burnout output will always be ON. (This can be used to test wiring.)
	n+12	00 to 15	---	---	Leave set to all zeros.
	n+13	00 to 15	Loop 1	Heater Current	The current heater current is stored in 4-digits BCD or 16-bits binary.
	n+14	00 to 15	Loop 2	Heater Current	If the measured heater current exceeds 55.0 A, the CT Overflow Flag will turn ON and the heater current will be stored as CCCC.
	n+15	00 to 15	Loop 1	Heater Burn-out Current	The current heater burnout current is stored in 4-digits BCD or 16-bits binary.
	n+16	00 to 15	Loop 2	Heater Burn-out Current	
	n+17	00 to 15	---	---	Leave set to all zeros.
	n+18	00 to 15	---	---	Leave set to all zeros.
	n+19	00 to 15	---	---	Leave set to all zeros.

2-5-5 Initialization Data

The Temperature Control Unit is initialized by the transfer of data settings from the DM Area words that are allocated to the Temperature Control Unit as a Special I/O Unit. If you are using the temperature alarm function, the alarm mode setting and alarm hysteresis setting must be written to the appropriate DM words.

Settings in these DM words are read only when the power is turned ON or the Temperature Control Unit is restarted. Always turn the power ON or restart the Temperature Control Unit after changing any of these settings.

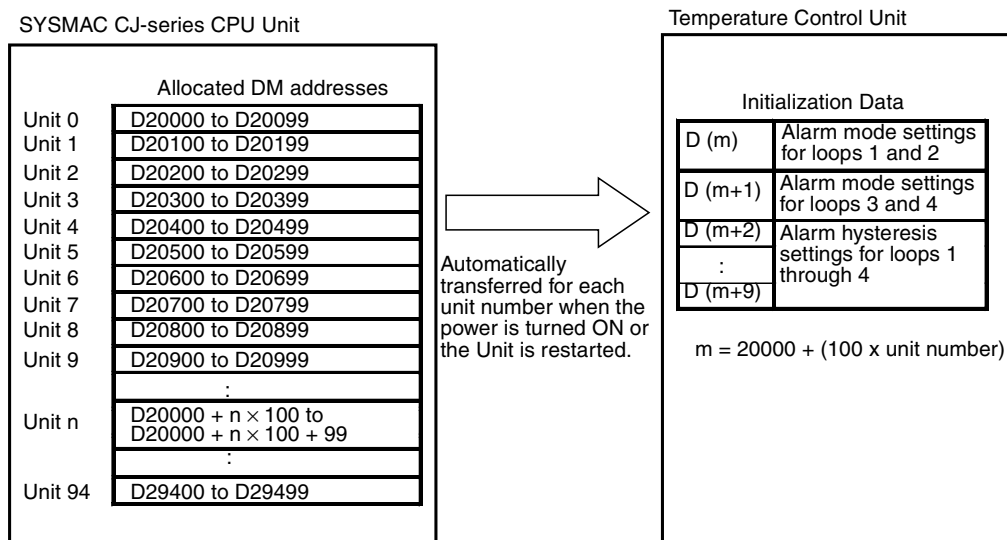

- Note**
1. Loops 3 and 4 are applicable to Temperature Control Units with four control loops only. If a Temperature Control Unit with two control loops is being used, the alarm mode and alarm hysteresis settings for loops 3 and 4 will not be used and will be ineffective even if they are set.
 2. The Special I/O Unit Area words that are allocated to the Temperature Control Unit in the DM Area are determined by the setting of the unit number switch on the front panel of the Unit. Refer to 2-3-3 Unit Number Switches for details on the method used to set the unit number switch.

- If two or more Special I/O Units are assigned the same unit number, a “UNIT No. DPL ERR” error (in the Programming Console) will be generated (A40113 will turn ON) and the PLC will not operate.

Initialization Data Contents

The following table shows the specific applications of the bits and words in the Initialization Data.

DM word	Bit															
	15	14	13	12	11	10	09	08	07	06	05	04	03	02	01	00
D (m+0)	Loop 1								Loop 2							
	Alarm 1 mode				Alarm 2 mode				Alarm 1 mode				Alarm 2 mode			
	2 ³	2 ²	2 ¹	2 ⁰	2 ³	2 ²	2 ¹	2 ⁰	2 ³	2 ²	2 ¹	2 ⁰	2 ³	2 ²	2 ¹	2 ⁰
D (m+1)	Loop 3 (See note 1.)								Loop 4 (See note 1.)							
	Alarm 1 mode				Alarm 2 mode				Alarm 1 mode				Alarm 2 mode			
	2 ³	2 ²	2 ¹	2 ⁰	2 ³	2 ²	2 ¹	2 ⁰	2 ³	2 ²	2 ¹	2 ⁰	2 ³	2 ²	2 ¹	2 ⁰
D (m+2)	Loop 1: Alarm 1 hysteresis															
D (m+3)	Loop 1: Alarm 2 hysteresis															
D (m+4)	Loop 2: Alarm 1 hysteresis															
D (m+5)	Loop 2: Alarm 2 hysteresis															
D (m+6)	Loop 3: Alarm 1 hysteresis (See note 1.)															
D (m+7)	Loop 3: Alarm 2 hysteresis (See note 1.)															
D (m+8)	Loop 4: Alarm 1 hysteresis (See note 1.)															
D (m+9)	Loop 4: Alarm 2 hysteresis (See note 1.)															

- Note**
- Loops 3 and 4 are applicable to Temperature Control Units with four control loops only. If a Temperature Control Unit with two control loops is being used, the alarm mode and alarm hysteresis settings for loops 3 and 4 will not be used and will be ineffective even if they are set.
 - The alarm modes can be set to “FF” to disable the alarms for the corresponding loop. In this case, the loop’s control operation will stop and the ERC Indicator will not light to indicate alarms.
For example, write “FFFF” to D (m+1) to disable loops 3 and 4.

Starting DM Area Word

The starting DM Area word (m) for a Special I/O Unit is:
 $m = 20000 + (100 \times \text{unit number})$

Initialization Data Details

The following table provides details of the Initialization Data settings. For more details, refer to 2-6 Data Ranges. These words are output from the CPU Unit to the Temperature Control Unit.

DM address		Loop	Setting	Units
Word	Bits			
D (m+0)	12 to 15	Loop 1	Alarm 1 mode	Set each loop’s alarm modes in BCD (0 to 9), as follows: 0: No alarm 1: Upper and lower-limit alarm 2: Upper-limit alarm 3: Lower-limit alarm 4: Upper and lower-limit range alarm 5: Upper and lower-limit alarm with standby sequence 6: Upper-limit alarm with standby sequence 7: Lower-limit alarm with standby sequence 8: Absolute-value upper-limit alarm 9: Absolute-value lower-limit alarm The values written here are written to RAM.
	08 to 11		Alarm 2 mode	
	04 to 07	Loop 2	Alarm 1 mode	
	00 to 03		Alarm 2 mode	
D (m+1)	12 to 15	Loop 3	Alarm 1 mode	
	08 to 11		Alarm 2 mode	
	04 to 07	Loop 4	Alarm 1 mode	
	00 to 03		Alarm 2 mode	

DM address		Loop	Setting	Units
Word	Bits			
D (m+2)	00 to 15	Loop 1	Alarm 1 hysteresis	Set each alarm's hysteresis in 4-digit BCD or 16-bit binary, according to the Data Format set on the Temperature Control Unit's DIP switch. The values written here are written to RAM.
D (m+3)	00 to 15		Alarm 2 hysteresis	
D (m+4)	00 to 15	Loop 2	Alarm 1 hysteresis	
D (m+5)	00 to 15		Alarm 2 hysteresis	
D (m+6)	00 to 15	Loop 3	Alarm 1 hysteresis	
D (m+7)	00 to 15		Alarm 2 hysteresis	
D (m+8)	00 to 15	Loop 4	Alarm 1 hysteresis	
D (m+9)	00 to 15		Alarm 2 hysteresis	

Starting DM Area Word The starting DM Area word (m) for a Special I/O Unit is:
 $m = 20000 + (100 \times \text{unit number})$

2-5-6 Operating Parameters

The Temperature Control Unit's Operating Parameters are set in the DM words allocated to the Temperature Control Unit as a Special I/O Unit. Operating Parameters include the Alarm SVs, Control Periods, Proportional Bands, Integral Times, and other parameters.

Operating Parameters are exchanged each cycle during the I/O refresh period. Input data is transferred from the Temperature Control Unit to the CPU Unit and output data is transferred from the CPU Unit to the Temperature Control Unit.

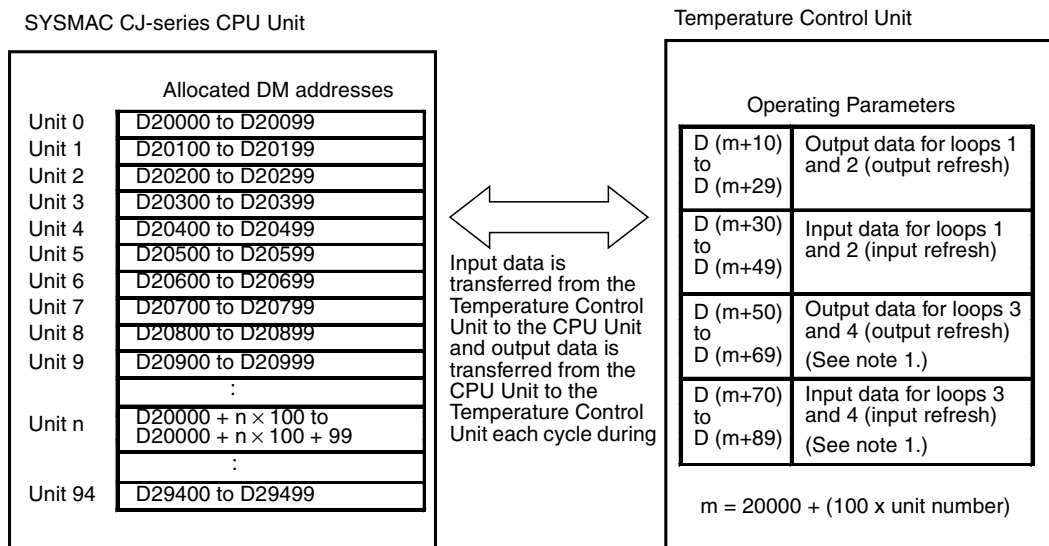

- Note**
1. Loops 3 and 4 are applicable to Temperature Control Units with four control loops only. If a Temperature Control Unit with two control loops is being used, the settings for loops 3 and 4 will not be used and will be ineffective even if they are set.
 2. The Special I/O Unit Area words that are allocated to the Temperature Control Unit in the DM Area are determined by the setting of the unit number switch on the front panel of the Unit. Refer to 2-3-3 *Unit Number Switches* for details on the method used to set the unit number switch.
 3. If two or more Special I/O Units are assigned the same unit number, a "UNIT No. DPL ERR" error (in the Programming Console) will be generated (A40113 will turn ON) and the PLC will not operate.

Operating Parameters Contents

The following tables show the specific applications of the bits and words in the Operating Parameters.

I/O	DM word	Loop	Setting	I/O	DM word	Loop	Setting
Output (CPU to Temperature Control Unit)	D (m+10)	Loop 1	Alarm 1 SV	Output (CPU to Temperature Control Unit)	D (m+50)	Loop 3 (See note.)	Alarm 1 SV
	D (m+11)		Alarm 2 SV		D (m+51)		Alarm 2 SV
	D (m+12)		Input Compensation Value		D (m+52)		Input Compensation Value
	D (m+13)		Control Period		D (m+53)		Control Period
	D (m+14)		Control Sensitivity		D (m+54)		Control Sensitivity
	D (m+15)		Proportional Band		D (m+55)		Proportional Band
	D (m+16)		Integral Time		D (m+56)		Integral Time
	D (m+17)		Derivative Time		D (m+57)		Derivative Time
	D (m+18)		(Not allocated.)		D (m+58)		(Not allocated.)
	D (m+19)		(Not allocated.)		D (m+59)		(Not allocated.)
	D (m+20)	Loop 2	Alarm 1 SV	Output (CPU to Temperature Control Unit)	D (m+60)	Loop 4 (See note.)	Alarm 1 SV
	D (m+21)		Alarm 2 SV		D (m+61)		Alarm 2 SV
	D (m+22)		Input Compensation Value		D (m+62)		Input Compensation Value
	D (m+23)		Control Period		D (m+63)		Control Period
	D (m+24)		Control Sensitivity		D (m+64)		Control Sensitivity
	D (m+25)		Proportional Band		D (m+65)		Proportional Band
	D (m+26)		Integral Time		D (m+66)		Integral Time
	D (m+27)		Derivative Time		D (m+67)		Derivative Time
	D (m+28)		(Not allocated.)		D (m+68)		(Not allocated.)
	D (m+29)		(Not allocated.)		D (m+69)		(Not allocated.)
Input (Temperature Control Unit to CPU)	D (m+30)	Loop 1	Alarm 1 SV	Input (Temperature Control Unit to CPU)	D (m+70)	Loop 3 (See note.)	Alarm 1 SV
	D (m+31)		Alarm 2 SV		D (m+71)		Alarm 2 SV
	D (m+32)		Input Compensation Value		D (m+72)		Input Compensation Value
	D (m+33)		Control Period		D (m+73)		Control Period
	D (m+34)		Control Sensitivity		D (m+74)		Control Sensitivity
	D (m+35)		Proportional Band		D (m+75)		Proportional Band
	D (m+36)		Integral Time		D (m+76)		Integral Time
	D (m+37)		Derivative Time		D (m+77)		Derivative Time
	D (m+38)		Manipulated variable monitor		D (m+78)		Manipulated variable monitor
	D (m+39)		(Not allocated.)		D (m+79)		(Not allocated.)
	D (m+40)	Loop 2	Alarm 1 SV	Input (Temperature Control Unit to CPU)	D (m+80)	Loop 4 (See note.)	Alarm 1 SV
	D (m+41)		Alarm 2 SV		D (m+81)		Alarm 2 SV
	D (m+42)		Input Compensation Value		D (m+82)		Input Compensation Value
	D (m+43)		Control Period		D (m+83)		Control Period
	D (m+44)		Control Sensitivity		D (m+84)		Control Sensitivity
	D (m+45)		Proportional Band		D (m+85)		Proportional Band
	D (m+46)		Integral Time		D (m+86)		Integral Time
	D (m+47)		Derivative Time		D (m+87)		Derivative Time
	D (m+48)		Manipulated variable monitor		D (m+88)		Manipulated variable monitor
	D (m+49)		(Not allocated.)		D (m+89)		(Not allocated.)

Note Loops 3 and 4 are applicable to Temperature Control Units with four control loops only. If a Temperature Control Unit with two control loops is being used, the settings for loops 3 and 4 will not be used and will be ineffective even if they are set.

Starting DM Area Word

The starting DM Area word (m) for a Special I/O Unit is:
 $m = 20000 + (100 \times \text{unit number})$

Operating Parameters Details

The following table provides details of the Initialization Data settings. For more details, refer to 2-6 Data Ranges.

I/O	DM word	Loop	Setting	Description	
Output (CPU to Temperature Control Unit)	D (m+10)	Loop 1	Alarm 1 SV	Set in 4-digit BCD or 16-bit binary.	
	D (m+11)		Alarm 2 SV	The values written here are written to RAM. When the BCD data format is being used, the most significant digit indicates the sign. (F represents the “-” sign.)	
	D (m+12)		Input Compensation Value	Set in 4-digit BCD or 16-bit binary. The values written here are written to RAM. When the BCD data format is being used, the most significant digit indicates the sign. (F represents the “-” sign.)	
	D (m+13)		Control Period	Set in 4-digit BCD or 16-bit binary. The values written here are written to RAM.	
	D (m+14)		Control Sensitivity	Set in 4-digit BCD or 16-bit binary. The values written here are written to RAM. This setting is valid with ON/OFF control only.	
	D (m+15)		Proportional Band	Set in 4-digit BCD or 16-bit binary.	
	D (m+16)		Integral Time	The values written here are not written to RAM while the PID Constants Calculated Flag is ON.	
	D (m+17)		Derivative Time	The values written here are written to RAM. These settings are valid with PID control only	
	D (m+18)		---	Always set to 0000.	
	D (m+19)		---	Always set to 0000.	
	D (m+20) to D (m+29)		Loop 2	Same as the settings for loop 1.	These settings are the same as the settings for loop 1. (See the description for D (m+10) through D (m+19).)
	D (m+50) to D (m+59)		Loop 3	Same as the settings for loop 1.	These settings are valid in Temperature Control Units with four control loops and are the same as the settings for loop 1. (See the description for D (m+10) through D (m+19).)
	D (m+60) to D (m+69)		Loop 4	Same as the settings for loop 1.	These settings are valid in Temperature Control Units with four control loops and are the same as the settings for loop 1. (See the description for D (m+10) through D (m+19).)
	Input (Temperature Control Unit to CPU)		D (m+30)	Loop 1	Alarm 1 SV
D (m+31)		Alarm 2 SV			
D (m+32)		Input Compensation Value			
D (m+33)		Control Period			
D (m+34)		Control Sensitivity			
D (m+35)		Proportional Band			
D (m+36)		Integral Time			
D (m+37)		Derivative Time			
D (m+38)		Manipulated variable monitor	Output in 4-digit BCD or 16-bit binary. When ON/OFF control is being used, this value will be 100% for ON and 0% for OFF.		
D (m+39)		---	Always set to 0000.		
D (m+40) to D (m+49)		Loop 2	Same as the settings for loop 1.		These values are the same as the ones for loop 1. (See the description for D (m+30) through D (m+39).)
D (m+70) to D (m+79)		Loop 3	Same as the settings for loop 1.		These values are valid in Temperature Control Units with four control loops and are the same as the ones for loop 1. (See the description for D (m+30) through D (m+39).)
D (m+80) to D (m+89)		Loop 4	Same as the settings for loop 1.		These values are valid in Temperature Control Units with four control loops and are the same as the ones for loop 1. (See the description for D (m+30) through D (m+39).)

Starting DM Area Word The starting DM Area word (m) for a Special I/O Unit is:
 $m = 20000 + (100 \times \text{unit number})$

2-6 Data Ranges

- Starting CIO word: $n = 2000 + (10 \times \text{unit number})$
- Starting DM word: $m = 20000 + (100 \times \text{unit number})$

2-6-1 Settings

Allocated word(s)	Setting	BCD range	Binary range	Units	Default value	Memory protection
Loop 1: n Loop 2: n+1 Loop 3: n+10 Loop 4: n+11	SP (set point)	Depends on the Input Type setting. Refer to 2-1-3 <i>Input Specifications</i> for details.		°C or °F	0 or 0.0	RAM (Protect the contents of memory in the CPU Unit.)
Two-loop Temperature Control Units only: Loop 1: n+10 Loop 2: n+11	Heater Burn-out Current (See note 4.)	0000 to 0500	0000 to 01F4	A	0.0	
Loops 1 and 2: D (m+0) Loops 3 and 4: D (m+1)	Alarm Mode	0000 to 9999	0000 to 9999	---	0	RAM (Protect the contents of memory in the CPU Unit.)
		0: No alarm 1: Upper and lower-limit alarm 2: Upper-limit alarm 3: Lower-limit alarm 4: Upper and lower-limit range alarm 5: Upper and lower-limit alarm with standby sequence 6: Upper-limit alarm with standby sequence 7: Lower-limit alarm with standby sequence 8: Absolute-value upper-limit alarm 9: Absolute-value lower-limit alarm				
Loop 1: D (m+2), D (m+3) Loop 2: D (m+4), D (m+5) Loop 3: D (m+6), D (m+7) Loop 4: D (m+8), D (m+9)	Alarm hysteresis	0000 to 9999	0000 to 270F	°C or °F	0.0	
Loop 1: D (m+10) Loop 2: D (m+20) Loop 3: D (m+50) Loop 4: D (m+60)	Alarm 1 SV	F999 to 9999	C3D8 to 3C28	°C or °F	0 or 0.0	The Temperature Control Unit's settings are written to RAM. When the Save Bit is turned ON, the settings are written to EEPROM. (See notes 2 and 3.) If DIP switch pin 8 is ON, the settings are automatically transferred from EEPROM to the CPU Unit when the power is turned ON or the Temperature Control Unit is restarted.
Loop 1: D (m+11) Loop 2: D (m+21) Loop 3: D (m+51) Loop 4: D (m+61)	Alarm 2 SV	F999 to 9999	C3D8 to 3C28	°C or °F	0 or 0.0	
Loop 1: D (m+12) Loop 2: D (m+22) Loop 3: D (m+52) Loop 4: D (m+62)	Input Compensation Value	F999 to 9999	FC19 to 270F	°C or °F	0 or 0.0	

Allocated word(s)	Setting	BCD range	Binary range	Units	Default value	Memory protection
Loop 1: D (m+13) Loop 2: D (m+23) Loop 3: D (m+53) Loop 4: D (m+63)	Control Period	0001 to 0099	0001 to 0063	Sec- onds	20	The Temperature Control Unit's settings are written to RAM. When the Save Bit is turned ON, the settings are written to EEPROM. (See notes 2 and 3.) If DIP switch pin 8 is ON, the settings are automatically transferred from EEPROM to the CPU Unit when the power is turned ON or the Temperature Control Unit is restarted.
Loop 1: D (m+14) Loop 2: D (m+24) Loop 3: D (m+54) Loop 4: D (m+64)	Control Sensitivity	0000 to 9999	0000 to 270F	°C or °F	0.8	
Loop 1: D (m+15) Loop 2: D (m+25) Loop 3: D (m+55) Loop 4: D (m+65)	Proportional Band	0001 to 9999	0001 to 270F	°C or °F	8.0	
Loop 1: D (m+16) Loop 2: D (m+26) Loop 3: D (m+56) Loop 4: D (m+66)	Integral Time	0000 to 9999	0000 to 270F	Sec- onds	233	
Loop 1: D (m+17) Loop 2: D (m+27) Loop 3: D (m+57) Loop 4: D (m+67)	Derivative Time	0000 to 9999	0000 to 270F	Sec- onds	40	

- Note**
1. If a setting is out-of-range, the Setting Error Flag will be turned ON and the incorrect setting will be identified by the Setting Error Number. (The incorrect setting will be invalid and the Temperature Control Unit will operate with the previous setting.)
 2. When a loop's Save Bit is turned ON, that loop's settings will be saved to the Temperature Control Unit's EEPROM.
 3. Do not write the settings to EEPROM more than 100,000 times.
 4. The Heater Burnout Detection function will be disabled if the Heater Burnout Current is set to 0.0 A or 50.0 A. The HB Alarm Output will be OFF when the HB Current is set to 0.0 A; it will be ON when the HB Current is set to 50.0 A.

2-6-2 Monitored Values

Allocated word	Setting	BCD range	Binary range	Units	Initial value	Memory protection
Loop 1: n+3 Loop 2: n+4 Loop 3: n+13 Loop 4: n+14	PV (Process Value) (Indicates the present temperature.)	Depend on the input type. Refer to <i>2-1-3 Input Specifications</i> .		°C or °F	---	---
Two-loop Temperature Control Units only: Loop 1: n+13 Loop 2: n+14	Heater Current Monitor	0000 to 0550 (See note 2.)	0000 to 0226 (See note 2.)	A	---	---
Loop 1: D (m+18) Loop 2: D (m+28) Loop 3: D (m+78) Loop 4: D (m+88)	Manipulated Variable Monitor (See note 1.)	0000 to 1000	0000 to 03E8	%	---	

- Note**
1. The Manipulated Variable Monitor indicates the manipulated variable that is presently being output.
When ON/OFF control is being used, this value will be 100% for ON and 0% for OFF.
 2. If the heater current exceeds 55.0 A, the monitor value will indicate CCCC.

SECTION 3

Settings Required for Temperature Control

This section explains the various settings required for temperature control.

3-1	Setting the Input Type	52
3-1-1	Setting the Input Type Switch.	52
3-2	Selecting the Temperature Units	53
3-2-1	Temperature Unit Setting (Pin 2)	53
3-3	Setting the Data Format	53
3-3-1	Setting the Data Format (Pin 3)	53
3-4	Selecting the Control Operation (Forward/Reverse)	54
3-4-1	Forward (Cooling)/Reverse (Heating)	54
3-4-2	Setting the Control Operation (Pins 4 and 5)	54
3-5	Selecting PID Control or ON/OFF Control	55
3-5-1	Setting the Control Method (Pin 6)	55
3-6	Setting the Control Period.	55
3-6-1	Control Period Settings.	55
3-7	Setting the Set Point	56
3-7-1	Setting the SP	56
3-8	Using ON/OFF Control.	56
3-8-1	ON/OFF Control Operation	56
3-8-2	Required Settings	57
3-9	Setting the PID Constants	57
3-9-1	Setting PID Constants with Autotuning	57
3-9-2	Setting PID Constants Manually	58
3-9-3	Example PID Control Application	58
3-10	Using the Alarm Output Function.	60
3-10-1	Setting the Alarm Mode	60
3-10-2	Setting the Alarm Hysteresis	61
3-10-3	Setting the Alarm SVs	61
3-10-4	Example Alarm Settings.	62
3-10-5	Summary of Alarm Output Function Settings	63
3-11	Using the Heater Burnout Alarm	63
3-11-1	Heater Burnout Detection.	63
3-11-2	Operating Conditions	64
3-11-3	Determining the Heater Burnout Current	65
3-11-4	Example Applications.	65
3-12	Starting and Stopping Temperature Control	66
3-12-1	Run/Stop Control	66
3-13	Precautions for Operation	66

3-1 Setting the Input Type

Set the input type of the temperature sensor being used. There are two types of Temperature Control Units available: One accepts thermocouple inputs and the other accepts platinum resistance thermometer inputs. Both types have an "INPUT TYPE" rotary switch on the front of the Unit to set the input type. Set the Input Type Switch to the correct setting for sensor and temperature range being used.

The input type setting applies to all of the Unit's control loops. It is not possible to set different input types for the different control loops.

3-1-1 Setting the Input Type Switch

Set the input type with the rotary switch on the front of the Unit. If this setting is changed, the new setting will not become effective until the power is turned ON or the Unit is restarted.

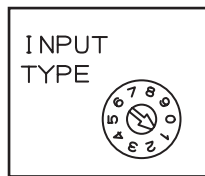

The diagram above shows the input type set for a K-type thermocouple with a temperature range of 0.0 to 500.0°C.

Input Type Settings

Thermocouple Input Types

Sensor	Type	Input type setting	Temperature ranges	
			Centigrade	Farenheit
Thermocouple	K	0	-200 to 1,300°C	-300 to 2,300°F
		1	0.0 to 500.0°C	0.0 to 900.0°F
	J	2	-100 to 850°C	-100 to 1,500°F
		3	0.0 to 400.0°C	0.0 to 750.0°F
	T	4	-200.0 to 400.0°C	-300.0 to 700.0°F
	L	5	-100 to 850°C	-100 to 1,500°F
		6	0.0 to 400.0 °C	0.0 to 750.0°F
	R	7	0 to 1,700°C	0 to 3,000 °F
	S	8	0 to 1,700°C	0 to 3,000 °F
B	9	100 to 1,800°C	300 to 3,200 °F	

The factory setting is 0.

Platinum Resistance Thermometer Input Types

Sensor	Type	Input type setting	Temperature ranges	
			Centigrade	Farenheit
Platinum resistance thermometer	Pt100	0	-200.0 to 650.0°C	-300.0 to 1,200.0°F
	JPt100	1	-200.0 to 650.0°C	-300.0 to 1,200.0°F
	----	2 to 9	Do not set 2 through 9.	

3-2 Selecting the Temperature Units

The Temperature Control Unit can operate in °C or °F. Select the desired temperature units with pin 2 of the DIP switch on the front of the Unit.

The temperature unit setting applies to all of the Unit's control loops. It is not possible to set different temperature unit settings for the control loops.

3-2-1 Temperature Unit Setting (Pin 2)

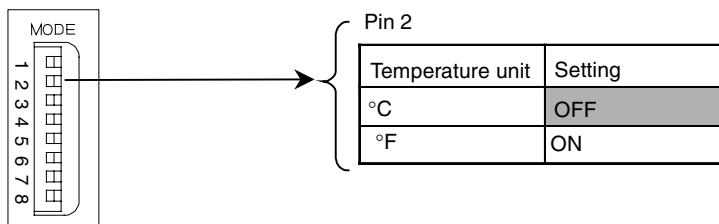

The factory setting is OFF (°C), as shown by the shading in the diagram above. If this setting is changed, the new setting will not become effective until the power is turned ON or the Unit is restarted.

3-3 Setting the Data Format

A switch on the front of the Unit (pin 3 of the DIP switch) selects whether the Temperature Control Unit's data is handled as 4-digit BCD or binary (i.e., 4-digit hexadecimal.) This switch setting controls the data format for both user-set and system-set data stored in the words allocated in the memory areas (CIO and DM Areas) used to exchange data between the CPU Unit and Temperature Control Unit.

3-3-1 Setting the Data Format (Pin 3)

Selecting Binary Format

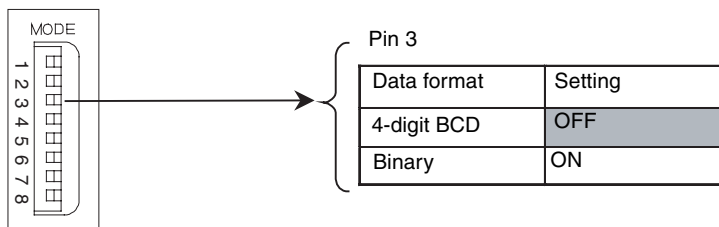

The factory setting is OFF (4-digit BCD), as shown by the shading in the diagram above.

If this setting is changed, the new setting will not become effective until the power is turned ON or the Unit is restarted.

3-4 Selecting the Control Operation (Forward/Reverse)

3-4-1 Forward (Cooling)/Reverse (Heating)

With forward operation (cooling), the manipulated variable is increased as the PV increases. With reverse operation (heating), the manipulated variable is increased as the PV decreases.

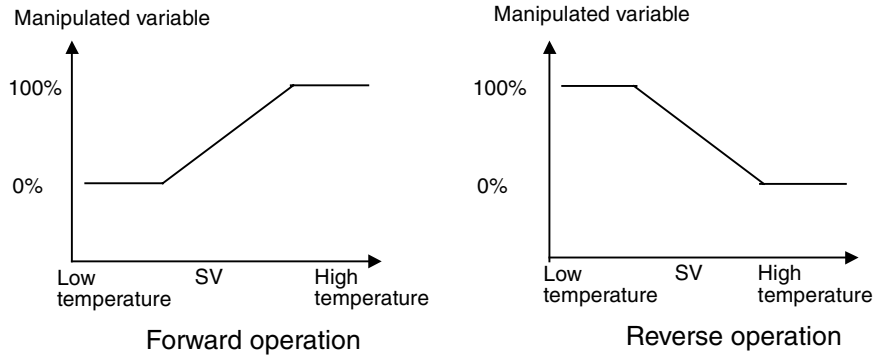

For example, when heating control is being performed and the present temperature (PV) is lower than the set point (SP), the manipulated variable is increased proportionally as the difference between the PV and SP increases. Consequently, heating control uses “reverse operation” and cooling control uses “forward operation.”

Set reverse operation or forward operation with pins 4 and 5 of the Unit’s DIP switch. Pin 4 controls the operation of loops 1 and 3; pin 5 controls the operation of loops 2 and 4.

3-4-2 Setting the Control Operation (Pins 4 and 5)

Example Setting

If pin 4 is turned OFF and pin 5 is turned ON, loops 1 and 3 will be set for reverse operation (heating) and loops 2 and 4 will be set for forward operation (cooling).

The following diagram shows pins 4 and 5 set to their factory settings (OFF), which sets reverse operation (heating) for all loops.

If this setting is changed during operation, the new setting will not become effective until the power is turned ON or the Unit is restarted.

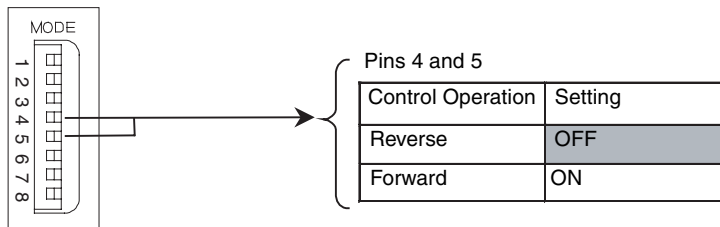

3-5 Selecting PID Control or ON/OFF Control

A switch on the front of the Unit (pin 6 of the DIP switch) selects whether the Temperature Control Unit uses ON/OFF control or PID control with 2 degrees of freedom.

The control method setting applies to all of the Unit’s control loops. It is not possible to set different control method settings for the control loops.

If the control method setting is changed during operation, the new setting will not become effective until the power is turned OFF and ON again.

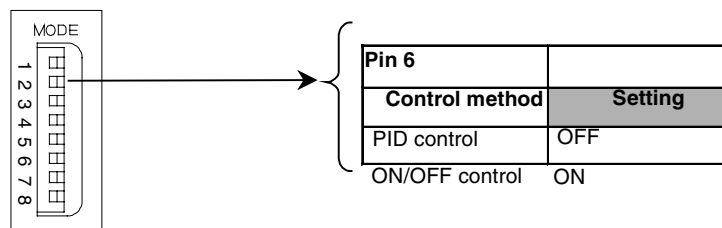

The factory setting is OFF (PID control), as shown in the diagram above.

3-5-1 Setting the Control Method (Pin 6)

PID Control with Two Degrees of Freedom

With PID control, it is necessary to set the proportional band (P), integral time (I), and derivative time (D). These settings can be made automatically with autotuning or manually. Refer to 3-9 *Setting the PID Constants* for more details on the PID constants.

ON/OFF Control

With ON/OFF control, the control output will be ON when the PV is below the SV. The control output will be OFF when the PV is at or above the SV. (This is the operation when the Unit is set for reverse operation. This operation will work in the opposite way for forward operation.)

3-6 Setting the Control Period

- This setting determines the output period (control period) for PID control. System control will improve with a shorter control period, but if you are using relays for heater control, we recommend setting a control period of at least 20 s to increase the relay’s lifetime. If necessary, the control period can be adjusted during trial operation.
- Set the control period in the corresponding word of the Operating Parameters in the DM words allocated to the Unit. (See the following table.) A standard setting is 2 s, but the default setting is 20 s.
- Each control loop has a separate control period setting.

3-6-1 Control Period Settings

Setting the Loop 1 Control Period to 2 s

To set the control period for loop 1 to 2 s, set word DM (m+13) to 0002. The control periods are set in seconds and the default setting is 20 s.

DM word	Setting	Setting ranges	
		BCD	Binary
D (m+13)	Loop 1 control period	0001 to 0099	0001 to 0063
D (m+23)	Loop 2 control period	0001 to 0099	0001 to 0063
D (m+53)	Loop 3 control period	0001 to 0099	0001 to 0063
D (m+63)	Loop 4 control period	0001 to 0099	0001 to 0063

Starting DM Area Word The starting DM Area word (m) for a Special I/O Unit is:
 $m = 20000 + (100 \times \text{unit number})$

3-7 Setting the Set Point

3-7-1 Setting the SP

Set the set point (SP) in the corresponding word of the Operation Data in the CIO words allocated to the Unit. (See the following table.)

When setting the set point, use the data format set with pin 3 of the DIP switch on the front of the Unit. The temperature units are set on pin 2 of the DIP switch and the default setting is 0 s or 0.0 s.

CIO word	Setting	Setting ranges	
		BCD	Binary
CIO (n)	Loop 1 SP (set point)	The setting ranges depend on the input type set with the Input Type Switch on the front of the Unit. Refer to 2-3-5 <i>Setting the Input Type</i> .	
CIO (n+1)	Loop 2 SP (set point)		
CIO (n+10)	Loop 3 SP (set point)		
CIO (n+11)	Loop 4 SP (set point)		

Example

To change the loop 1 set point from 0 to 200°C, write a value of 0200 to CIO word n if the Unit's data format is set to BCD or write a value of 00C8 to CIO word n if the Unit's data format is set to binary.

Note Changing the set point is not enough to start temperature control, it is also necessary for the Stop Bit for that loop to be OFF. See 3-12 *Starting and Stopping Temperature Control* for details.

Starting CIO Area Word The starting CIO Area word (n) for a Special I/O Unit is:
 $n = 2000 + (10 \times \text{unit number})$

3-8 Using ON/OFF Control

With ON/OFF control, you set a set point in advance. During reverse operation, the Temperature Controller will turn OFF the control output when the set point is reached. When the control output goes OFF, the system temperature will begin to drop and the control output will be turned ON again when the system temperature falls below the set point. This ON/OFF operation is repeated around the set point.

The control sensitivity setting determines how far the system temperature has to fall below the set point before the control output is turned ON again. Also, the control operation setting determines whether the Unit operates with forward operation (cooling) or reverse operation (heating). With forward operation, the manipulated variable increases as the PV increases; with reverse operation, the manipulated variable decreases as the PV increases.

3-8-1 ON/OFF Control Operation

Pin 6 of the DIP switch on the front of the Unit selects whether the Temperature Control Unit uses ON/OFF control or PID control with 2 degrees of freedom. The Unit will use PID control if pin 6 is OFF; it will use ON/OFF control if pin 6 is ON. The factory setting is PID control.

Control Sensitivity

In ON/OFF control, the ON and OFF switching creates a stable hysteresis loop. The width of the hysteresis loop is called the control sensitivity.

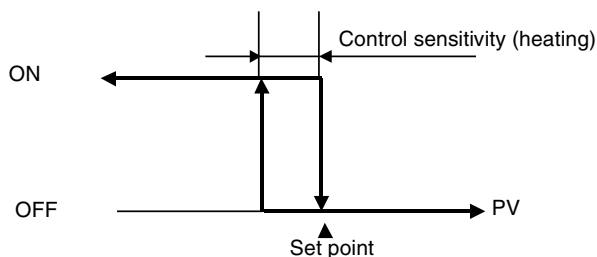

3-8-2 Required Settings

The control method, set point, and control sensitivity must be set to use ON/OFF control.

Example Settings

In this example, ON/OFF control is used for loop 1. The set point is 200°C and the control sensitivity is 2°C.

- Turn ON pin 6 of the DIP switch on the front of the Unit. (The new setting will be read when the power is turned ON.)
- Set the loop 1 SP to 0200 in CIO word n. See 3-7 *Setting the Set Point* for details.
- Set the loop 1 control sensitivity to 2°C in DM word m+14. (Set D (m+14) to 0020 if the Unit is set for BCD data; set D (m+14) to 0014 if the Unit is set for binary data.)

The control sensitivity is set in °C or °F and the default setting is 0.8°.

DM word	Setting	Setting ranges	
		BCD	Binary
D (m+14)	Loop 1 control sensitivity	0000 to 9999	0000 to 270F
D (m+24)	Loop 2 control sensitivity	0000 to 9999	0000 to 270F
D (m+54)	Loop 3 control sensitivity	0000 to 9999	0000 to 270F
D (m+64)	Loop 4 control sensitivity	0000 to 9999	0000 to 270F

Starting DM Area Word

The starting DM Area word (m) for a Special I/O Unit is:
 $m = 20000 + (100 \times \text{unit number})$

3-9 Setting the PID Constants

3-9-1 Setting PID Constants with Autotuning

The autotuning (AT) function can be used to automatically calculate the optimal PID constants for the set point during operation. This Temperature Control Unit uses the limit cycle method, which determines the controlled system's characteristics by forcibly changing the manipulated variable.

Using the Autotuning Function

Starting Autotuning

- To start autotuning, turn the Start AT Bit from OFF to ON. The Start AT Bit is in the Special I/O Unit Area words allocated to the Temperature Control Unit in the CIO Area.
- When autotuning is completed, you must replace the current PID constants with the calculated PID constants in order for the Unit to operate with the calculated PID constants. The Unit stores the calculated PID constants in the input area of the Operating Parameters in the DM words allocated to the Unit and turns ON the PID Constants Calculated Flag at the

same time. Use this flag as an input condition in the CPU Unit's ladder program and transfer the PID constants from the Operating Parameters' input area to the word in the output area where the PID constants are stored.

After the PID constants have been transferred, turn the Change PID Constants Bit from OFF to ON. Toggling this control bit causes the Temperature Controller's PID constants to be refreshed with the new PID constants in the output area.

Note Autotuning cannot be started if the Unit is stopped or using ON/OFF control operation.

Stopping Autotuning

- To stop autotuning, turn the Stop AT Bit from OFF to ON. The Stop AT Bit is in the Special I/O Unit Area words allocated to the Temperature Control Unit in the CIO Area.
- Only the Stop Bit and Stop AT Bit settings can be changed while autotuning is being executed. Settings changed during autotuning will be enabled when autotuning is completed.
- If the Stop Bit is turned ON while autotuning is being executed, autotuning will be interrupted and operation will stop. Autotuning will not restart when operation is restarted with the Stop Bit.

3-9-2 Setting PID Constants Manually

The PID constants can be set manually by setting the desired values for the proportional band (P), integral time (I), and derivative time (D) in the corresponding words of the Operating Parameters in the DM words allocated to the Unit.

- Note**
1. When you already know the system's control characteristics, set the PID constants directly to adjust the control characteristics. Set the three PID constants: The proportional band (P), integral time (I), and derivative time (D).
 2. The Unit will operate with basic proportional operation if the integral time (I) and derivative time (D) are set to 0. If the default settings are used, the proportional band will produce a manipulated variable of 0.0% at the set point.

3-9-3 Example PID Control Application

Procedure

In this example, autotuning is executed for loop 1 and loop 1 operates using PID control with two degrees of freedom.

- 1,2,3...**
1. Start autotuning by turning ON the Loop 1 Start AT Bit (bit 02 of CIO (n+2)).
 2. When autotuning is completed, the calculated PID constants are stored in the input area of the Operating Parameters in the DM words allocated to the Unit. (The calculated PID constants are transferred from Temperature Control Unit to CPU Unit.) At the same time, the PID Constants Calculated Flag (bit 10 of CIO (n+8)) is turned ON.

Use the PID Constants Calculated Flag as an input condition in the ladder program and copy the calculated PID constants to the output area of the DM words allocated to the Unit.

3. After the PID constants have been transferred to the output area by the ladder program, turn ON the Change PID Constants Bit (bit 13 of CIO (n+2)). The PID constants in the output area will be read by the Temperature Control Unit.

The PID Constants Calculated Flag will be turned OFF automatically when you turn ON the Change PID Constants Bit.

Refer to *Appendix B Sample Programs* for an example ladder program that performs the steps outlined above.

Timing Chart

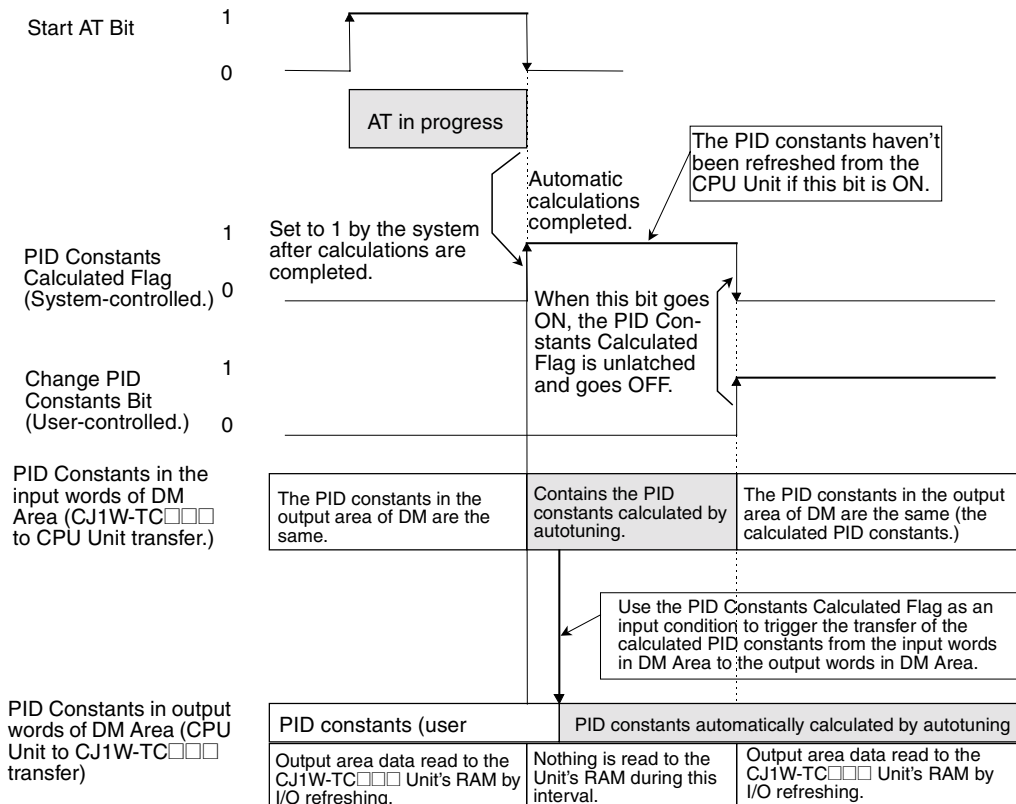

Effects of Changes to the PID Constants

The following tables show the effects on the PV when each PID constant is changed (increased or decreased.)

• Changing P (The Proportional Band)

Increasing P	SP	It will take longer to reach the set point (SP), but the process value (PV) will not overshoot.
Decreasing P	SP	The PV will overshoot and there will be hunting, but the PV will reach the SP quickly.

• Changing I (The Integral Time)

Increasing I	SP	Increases the time required to reach the SP, but reduces hunting, overshooting, and undershooting.
Decreasing I	SP	Overshooting and undershooting will occur. Hunting will occur. The PV will rise quickly.

• Changing D (The Derivative Time)

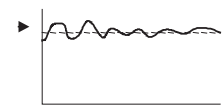
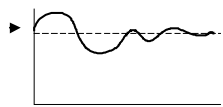
Increasing D	SP 	Overshooting, undershooting, and the set time are reduced, but hunting will occur from small changes in the system itself.
Decreasing D	SP 	Overshooting and undershooting are increased. It takes time to return to the SP.

3-10 Using the Alarm Output Function

This section explains the alarm modes, standby sequence, and alarm values.

3-10-1 Setting the Alarm Mode



There are two alarm outputs for each loop and any of the following nine alarm modes can be selected for each alarm's operation.

To use the alarm output function, set the corresponding alarm mode setting in the Initialization Data words allocated in the DM Area to the Temperature Control Unit.

Note If the alarm mode setting is changed, the new setting will not become effective until the power is turned ON again or the Unit is restarted. Always turn the power supply OFF and ON again or restart the Unit after changing the alarm mode.

Alarm Modes

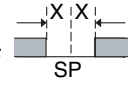
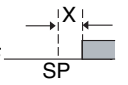
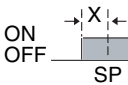
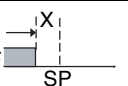
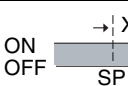
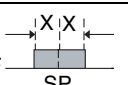
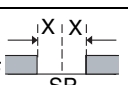
In the following diagrams, the "X" indicates the alarm SV. The initial value is "0."

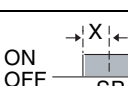
Setting	Alarm mode	Alarm output function	
		Alarm SV (X) is positive	Alarm SV (X) is negative
0	No alarm	Output OFF	
1	Upper and lower-limit alarm	ON OFF 	Always ON
2	Upper-limit alarm	ON OFF 	ON OFF 
3	Lower-limit alarm	ON OFF 	ON OFF 
4	Upper and lower-limit range alarm	ON OFF 	Always OFF
5	Upper and lower-limit alarm with standby sequence	ON OFF 	Always OFF
6	Upper-limit alarm with standby sequence	ON OFF 	ON OFF 

Setting	Alarm mode	Alarm output function	
		Alarm SV (X) is positive	Alarm SV (X) is negative
7	Lower-limit alarm with standby sequence		
8	Absolute-value upper-limit alarm		
9	Absolute-value lower-limit alarm		

3-10-2 Setting the Alarm Hysteresis

The hysteresis setting controls the ON/OFF switching of the alarm output, as shown in the following diagram. This setting can be changed in the Initialization Data words allocated in the DM Area to the Temperature Control Unit.

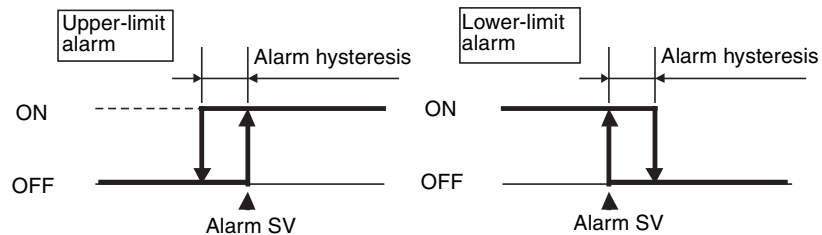

The alarm hysteresis can be set independently for each loop's alarms (alarm 1 and alarm 2) in the Initialization Data Area allocated to the Unit. The standard setting is 0.2 s.

Note If the alarm hysteresis settings are changed, the new settings will not become effective until the power is turned ON again or the Unit is restarted. Always turn the power supply OFF and ON again or restart the Unit after changing these settings.

3-10-3 Setting the Alarm SVs

The alarm SVs are indicated by "X" in the *Alarm Modes* table on page 60. Set the alarm SVs in the corresponding words in the output area of the DM Area words allocated to the Unit. (See 3-10-5 *Summary of Alarm Output Function Settings* for the actual DM addresses of these words.)

■ About the Standby Sequence

The "standby sequence" disables the alarm output during Unit initialization, i.e., until the PV leaves the alarm range. The alarm output will function the next time the PV enters the alarm range.

For example with the standard "lower-limit alarm" mode, the PV is usually lower than the set point when the power is turned ON, so the PV is within the alarm range and the alarm output goes ON immediately. If Lower-limit Alarm with Standby Sequence Mode is selected, the alarm will not be output until after the PV rises above the alarm SP, leaves the alarm range, and then falls below the alarm SP again.

■ **Restarting the Standby Sequence**

The standby sequence will be cleared once the PV leaves the alarm range, but the standby sequence will restart (reset) in the following situations:

- At the start of operation (when power is turned ON or the Unit is restarted)
- When the alarm SV, input calculated values, or set point is changed
- When the Output OFF Bit turns OFF

■ **Summary of Alarm Operation**

The following timing chart shows the operation of alarms with a standby sequence. In this example, the alarm mode is Upper and Lower-limit Alarm with Standby Sequence.

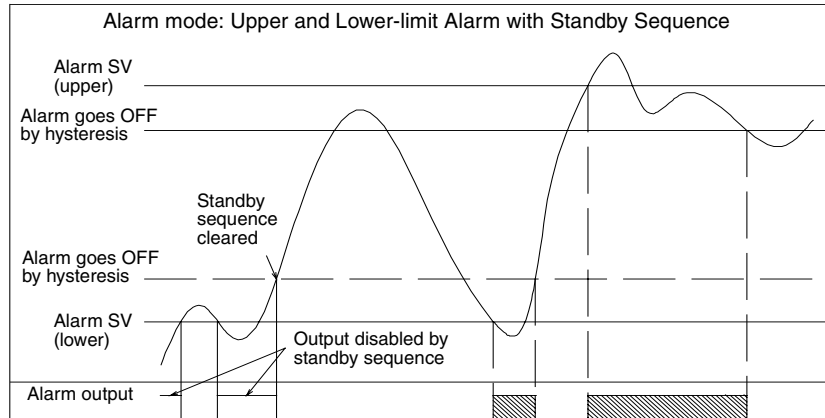

3-10-4 Example Alarm Settings

Alarm Mode and Alarm Hysteresis

The alarm mode and alarm hysteresis for loops 1 and 2 are set as shown in the following table.

Loop	Alarm	Alarm mode	Hysteresis
Loop 1	Alarm 1	3: Lower-limit alarm	2.0°C
	Alarm 2	2: Upper-limit alarm	0.5°C
Loop 2	Alarm 1	1: Upper and lower-limit alarm	1.0°C
	Alarm 2	8: Absolute-value lower-limit alarm	2.0°C

- 1,2,3...
1. DM Area word m contains the loop 1 alarm mode and loop 2 alarm mode. Set D (m) to 3218.
 2. DM Area words m+2 through m+5 contain the alarm hysteresis settings for loop 1 and loop 2. Set the appropriate values for the hysteresis based on the data format (BCD or binary) set for the Unit.
 3. To enable the new settings, restart the Unit or turn the power OFF and then ON again.

Loop 2, Alarm 1 SV

DM Area word m+20 contains the loop 2 alarm 1 SV. To set this alarm SV to 20°C, set this word to 0020 if the data format is BCD or 0014 if the data format is binary.

3-10-5 Summary of Alarm Output Function Settings

DM address		Loop	Setting	Data format		Units	Initial value
Word	Bits			BCD	Binary		
D (m+0)	12 to 15	Loop 1	Alarm 1 mode	0 to 9	---	---	0000
	08 to 11		Alarm 2 mode	0 to 9	---		
	04 to 07	Loop 2	Alarm 1 mode	0 to 9	---		
	00 to 03		Alarm 2 mode	0 to 9	---		
D (m+1)	12 to 15	Loop 3	Alarm 1 mode	0 to 9	---	---	0000
	08 to 11		Alarm 2 mode	0 to 9	---		
	04 to 07	Loop 4	Alarm 1 mode	0 to 9	---		
	00 to 03		Alarm 2 mode	0 to 9	---		
D (m+2)	00 to 15	Loop 1	Alarm 1 hysteresis	0000 to 9999	0000 to 270F	°C or °F	0.0
D (m+3)	00 to 15		Alarm 2 hysteresis	0000 to 9999	0000 to 270F		
D (m+4)	00 to 15	Loop 2	Alarm 1 hysteresis	0000 to 9999	0000 to 270F		
D (m+5)	00 to 15		Alarm 2 hysteresis	0000 to 9999	0000 to 270F		
D (m+6)	00 to 15	Loop 3	Alarm 1 hysteresis	0000 to 9999	0000 to 270F		
D (m+7)	00 to 15		Alarm 2 hysteresis	0000 to 9999	0000 to 270F		
D (m+8)	00 to 15	Loop 4	Alarm 1 hysteresis	0000 to 9999	0000 to 270F		
D (m+9)	00 to 15		Alarm 2 hysteresis	0000 to 9999	0000 to 270F		
D (m+10)	00 to 15	Loop 1	Alarm 1 SV	F999 to 9999	C3D8 to 3C28		
D (m+11)	00 to 15		Alarm 2 SV	F999 to 9999	C3D8 to 3C28		
D (m+20)	00 to 15	Loop 2	Alarm 1 SV	F999 to 9999	C3D8 to 3C28	°C or °F	0 or 0.0
D (m+21)	00 to 15		Alarm 2 SV	F999 to 9999	C3D8 to 3C28		
D (m+50)	00 to 15	Loop 3	Alarm 1 SV	F999 to 9999	C3D8 to 3C28	°C or °F	0 or 0.0
D (m+51)	00 to 15		Alarm 2 SV	F999 to 9999	C3D8 to 3C28		
D (m+60)	00 to 15	Loop 4	Alarm 1 SV	F999 to 9999	C3D8 to 3C28	°C or °F	0 or 0.0
D (m+61)	00 to 15		Alarm 2 SV	F999 to 9999	C3D8 to 3C28		

Starting DM Area Word

The starting DM Area word (m) for a Special I/O Unit is calculated as follows:

$$m = 20000 + (100 \times \text{unit number})$$

3-11 Using the Heater Burnout Alarm

3-11-1 Heater Burnout Detection

- Follow this procedure to detect heater burnout (an open heating wire).

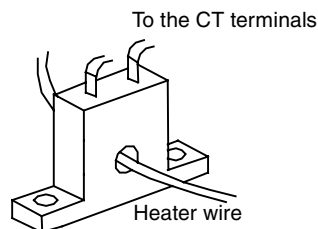

- 1,2,3...**
- Pass the heater wire through the hole in the Current Transformer (CT). Refer to *Current Transformer (CT) Ratings* on page 14 and *Appendix A Dimensions* for details on the Current Transformer's specifications, model numbers, and dimensions.
 - When current flows through the heater wire, it induces an AC current in the Current Transformer (CT) that is proportional to the current in the heater

wire. The current flowing through the heater can be determined from the current induced in the CT.

3. The current will drop if there is a heater burnout and the heater burnout alarm (HB output) will be turned ON if the current falls below the preset heater burnout current.
4. The HB output is a latched output. To release the latch (i.e., turn OFF the HB output), either set the heater burnout current to 0.0, turn the power OFF and ON again, or restart the Temperature Control Unit.

- Note**
1. Do not use any CT other than the OMRON E54-CT1 or E54-CT3 Current Transformer.
 2. Set the desired heater burnout detection current in the Heater Burnout Current word. The value in the Heater Current Monitor word can be used to check the CT's current.
 3. Set the heater burnout current to 0.0 if you are not using the heater burnout detection function.
 4. The heater burnout current is set independently for each loop.

3-11-2 Operating Conditions

- Connect the CT and pass the heater wire through the CT in advance.
- Turn ON the heater's power supply before the Temperature Control Unit or turn ON both at the same time. The heater burnout alarm will be output if the heater's power supply is turned ON after the Temperature Control Unit.
- Temperature control will continue even if a heater burnout is detected, so that the Unit can continue controlling heaters that have not burned out.
- Heater burnout detection will operate when the control output has been ON continuously for more than 200 ms.
- Sometimes the heater's rated current does not match the current that actually flows through the heater. Use the heater current monitor to check the current during actual use.
- Heater burnout detection will be unstable if there is only a small difference between the normal current and heater burnout current. For stable operation, set a minimum difference of 1.0 A with heaters drawing less than 10.0 A or a minimum difference of 2.5 A with heaters drawing more than 10.0 A
- The heater burnout detection function cannot be used if the heater is being controlled with the position control method or cycle control method. Also, the heater burnout detection function cannot be used with three-phase heaters.

Note To detect heater burnout in a three-phase heater, use a K2CU-F□□A-□GS (with gate input terminals). Refer to the catalog for more details.

3-11-3 Determining the Heater Burnout Current

- Use the following equation to calculate the average of the normal current and the current with a heater burnout:

$$SV = \frac{\text{Current in normal operation} + \text{current after heater burnout}}{2}$$

- If more than one heater is connected through the CT, set the heater burnout current to the current induced when the heater with the smallest current consumption is burned out. If the heaters all consume the same current, set the heater burnout current to the current induced when one of the heaters is burned out.
- The difference between the normal current and the heater burnout current must meet the following minimum levels:
 - Heaters drawing less than 10.0 A:
Normal current – current with heater burnout ≥ 1.0 A
(Operation will be unstable with a difference less than 1.0 A.)
 - Heaters drawing 10.0 A or more:
Normal current – current with heater burnout ≥ 2.5 A
(Operation will be unstable with a difference less than 2.5 A.)
- The setting range for the heater burnout current is 0.1 to 49.9 A. Heater burnout will not be detected if the heater burnout current is set to 0.0 or 50.0 A. The heater burnout alarm will be OFF if the heater burnout current is set to 0.0; it will be ON if the heater burnout current is set to 50.0.
- The total heater current during normal operation must not exceed 50.0 A.

3-11-4 Example Applications

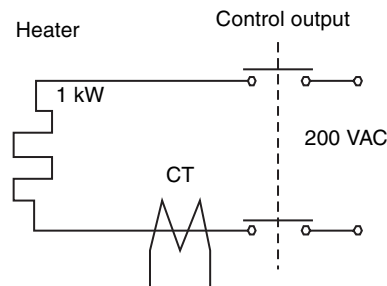

Example 1:

In this example, a single 1-kW 200-VAC heater is controlled through OUT1.

$$\text{Normal current} = \frac{1,000}{200} = 5 \text{ A } (< 10 \text{ A})$$

$$\text{Current when control output is OFF} = 0 \text{ A}$$

$$SV = \frac{5 + 0}{2} = 2.5 \text{ A}$$

Normal current - control-OFF current = 5 - 0 A = 5 A
(Operation will be stable with difference ≥ 1.0 A.)

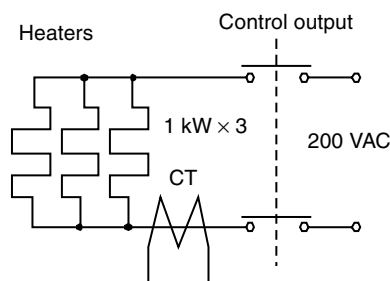

Example 2:

In this example, three 1-kW 200-VAC heaters are controlled through OUT2.

$$\text{Normal current} = \frac{1,000 \times 3}{200} = 15 \text{ A } (\geq 10 \text{ A})$$

$$\text{Current with 1 burnout} = \frac{1,000 \times 2}{200} = 10 \text{ A}$$

$$SV = \frac{15 + 10}{2} = 12.5 \text{ A}$$

Normal current - control-OFF current = 15 - 10 A = 5 A
(Operation will be stable with difference ≥ 2.5 A.)

3-12 Starting and Stopping Temperature Control

3-12-1 Run/Stop Control

To start temperature control for a loop that has been stopped, turn OFF the corresponding Stop Bit in the output area of the CIO Area words allocated to the Temperature Control Unit. To stop temperature control for the loop, turn ON the Stop Bit.

- The initial setting of the bits is OFF (running).
- There is a separate Stop Bit for each loop.

Starting Loop 1 and Stopping Loop 2

To start control in loop 1 and stop control in loop 2, turn OFF the Loop 1 Stop Bit (bit 06 of CIO word n+2) and turn ON the Loop 2 Stop Bit (bit 04 of CIO word n+2).

Bit	CIO word			
	CIO n+2		CIO n+12	
15	Loop 1	Save Bit	Loop 3	Save Bit
14	Loop 2	Save Bit	Loop 4	Save Bit
13	Loop 1	Change PID Constants Bit	Loop 3	Change PID Constants Bit
12	Loop 2	Change PID Constants Bit	Loop 4	Change PID Constants Bit
11	0		0	
10	0		0	
09	0		0	
08	0		0	
07	Loop 1	0	Loop 3	0
06		Stop Bit		Stop Bit
05	Loop 2	0	Loop 4	0
04		Stop Bit		Stop Bit
03	Loop 1	Stop AT Bit	Loop 3	Stop AT Bit
02		Start AT Bit		Start AT Bit
01	Loop 2	Stop AT Bit	Loop 4	Stop AT Bit
00		Start AT Bit		Start AT Bit

3-13 Precautions for Operation

When the IOM Hold Bit is ON, consider the status of external loads because the output bits will not be cleared when the PLC is switched to PROGRAM mode from RUN or MONITOR mode.

 **Caution** It takes approximately 4 seconds for outputs from the Temperature Control Unit (control outputs and heater burnout alarm output) to go ON after the PLC is turned ON. This delay must be taken into account if the Temperature Control Unit is being incorporated in an external sequence circuit.

SECTION 4

Optional Settings

This section explains how to use the input compensation value.

4-1	Shifting the Input Value (Input Compensation)	68
4-2	Recovering from Sensor Not Connected Errors	69
4-3	Application without a Cycle Refresh with the CPU Unit	69

4-1 Shifting the Input Value (Input Compensation)

- The input value is shifted by the “input compensation value” for all points in the sensor’s range. For example, if the input compensation value is set to 1.2°C and the original process value is 200°C, the value after compensation will be 201.2°C.

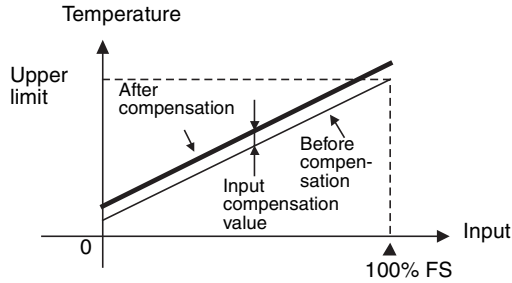

- The initial setting of the input compensation value is 0.0 for all loops.

Example Application

1,2,3...

1. In the following diagram, the temperature sensor is some distance from the workpiece that is being controlled and the reading from the temperature sensor must be adjusted to reflect the actual temperature at the workpiece. (The reading from thermometer (B) shows the true temperature at the workpiece (C).)
 2. The input compensation value is just the difference between the workpiece’s temperature (B) and the Temperature Control Unit’s reading (A). Figure 2 shows the process values before and after compensation.
- Input Compensation Value = Workpiece’s temp. (B) - Unit’s reading (A)
3. After setting the input compensation value, compare the temperature displayed on the Unit (A) with the temperature indicated by thermometer (B). The input compensation value is correct if the two readings are approximately equal.

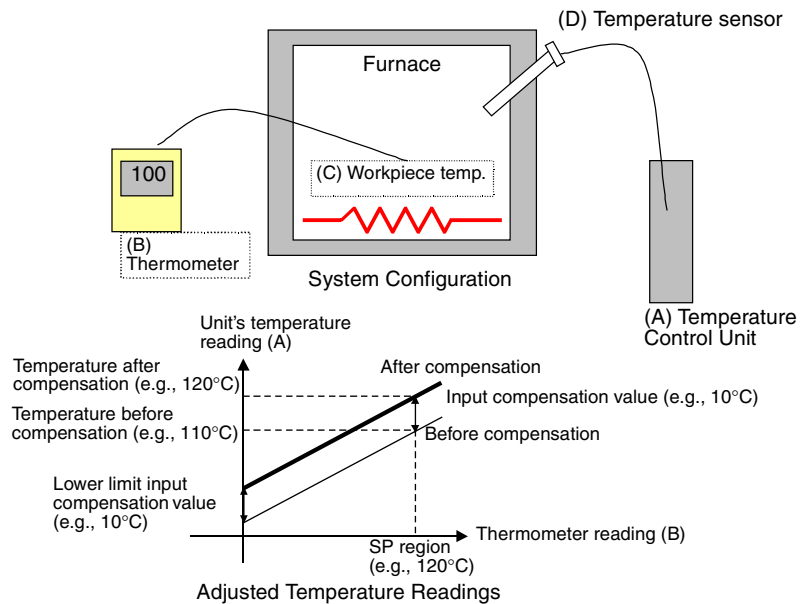

4-2 Recovering from Sensor Not Connected Errors

If a sensor is not connected for any loop, a sensor error will occur and the ERC indicator on the front panel of the Unit will light. When necessary, the control and alarm functions for any loop can be disabled. The following status will result.

- The ERC indicator will not light to indicate sensor errors for the loop. (Refer to *ERC Indicator Lit and RUN Indicator Lit* on page 73.)
- Control will not be performed for the loop.
- Alarms will not be given for the loop.
- Temperatures will not be input for the loop.

To disable both the control and alarm functions for one or more loops, set the alarm modes 1 and 2 both to F Hex for each loop to be disabled in the Initialization Data in the DM Area as shown in the following table.

DM Area address	Bits															
	15	14	13	12	11	10	09	08	07	06	05	04	03	02	01	00
D (m)	Loop 1								Loop 2							
	Alarm mode 1				Alarm mode 2				Alarm mode 1				Alarm mode 2			
D (m+1)	Loop 3								Loop 4							
	Alarm mode 1				Alarm mode 2				Alarm mode 1				Alarm mode 2			

Example: Set bits 00 to 07 to FF Hex of D (m) to disable loop 2

Note The above settings are designed to be used to prevent the ERC indicator from lighting as a result of a sensor error caused by not connecting a sensor for a loop. If it is necessary to disable only the control function for a loop while leaving the alarm function enabled, set the alarm modes for the loop and then turn ON the Stop Bit for the same loop.

4-3 Application without a Cycle Refresh with the CPU Unit

Cyclic refreshing of the Temperature Control can be disabled in the cyclic refresh settings for Special I/O Units in the PLC Setup in the CPU Unit for the following reasons:

- To shorten the CPU Unit cycle time
- To refresh Operation Data or Operating Parameters using interrupt tasks or other processing from the ladder program in the CPU Unit.

If cyclic refreshing of Special I/O Units is disabled in the PLC Setup, refresh I/O for the Unit at least once every 11 seconds using the I/O REFRESH instruction (IORF), being sure to take into consideration the increase in the cycle time when IORF is executed.

If the I/O data for the Temperature Control Unit is not refreshed at least every 11 seconds, a CPU Unit monitor error will occur in the Temperature Control Unit (the ERH and RUN indicators will be lit). Control from the Temperature Control Unit will continue even if a CPU Unit monitor error occurs.

SECTION 5

Error and Alarm Processing

This section provides information on troubleshooting and error processing.

5-1	Error and Alarm Processing	72
5-1-1	Identifying Errors with the LED Indicators	72
5-1-2	Error Processing Flowchart	72
5-1-3	Alarms Detected by the Temperature Control Unit	73
5-1-4	Errors Originating in the CPU Unit	75
5-1-5	Special I/O Unit Restart Bits	75
5-2	Troubleshooting	76
5-2-1	Troubleshooting from Symptoms: Measurement Errors	77
5-2-2	Troubleshooting from Symptoms: Temperature Control Errors.	79
5-2-3	Troubleshooting from Symptoms: Output Errors.	81
5-2-4	Troubleshooting from Symptoms: HB Alarm Errors	81

5-1 Error and Alarm Processing

5-1-1 Identifying Errors with the LED Indicators

The ERC Indicator or ERH Indicator will light if an alarm or error occurs in the Temperature Control Unit.

(Front of Temperature Control Unit)

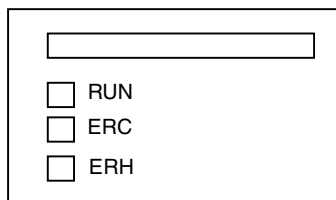

Indicator	Name	Color	Status	Meaning
RUN	RUN Indicator	Green	Lit	The Temperature Control Unit is operating normally.
			Not lit	The Temperature Control Unit is stopped.
ERC	Temperature Control Unit Error	Red	Lit	An error occurred in the Temperature Control Unit itself.
			Not lit	There is no error in the Temperature Control Unit.
ERH	CPU Unit Error	Red	Lit	An error occurred in the CPU Unit.
			Not lit	There is no error in the CPU Unit.

5-1-2 Error Processing Flowchart

Use the following flowchart to identify the error when an error has occurred in the Temperature Control Unit.

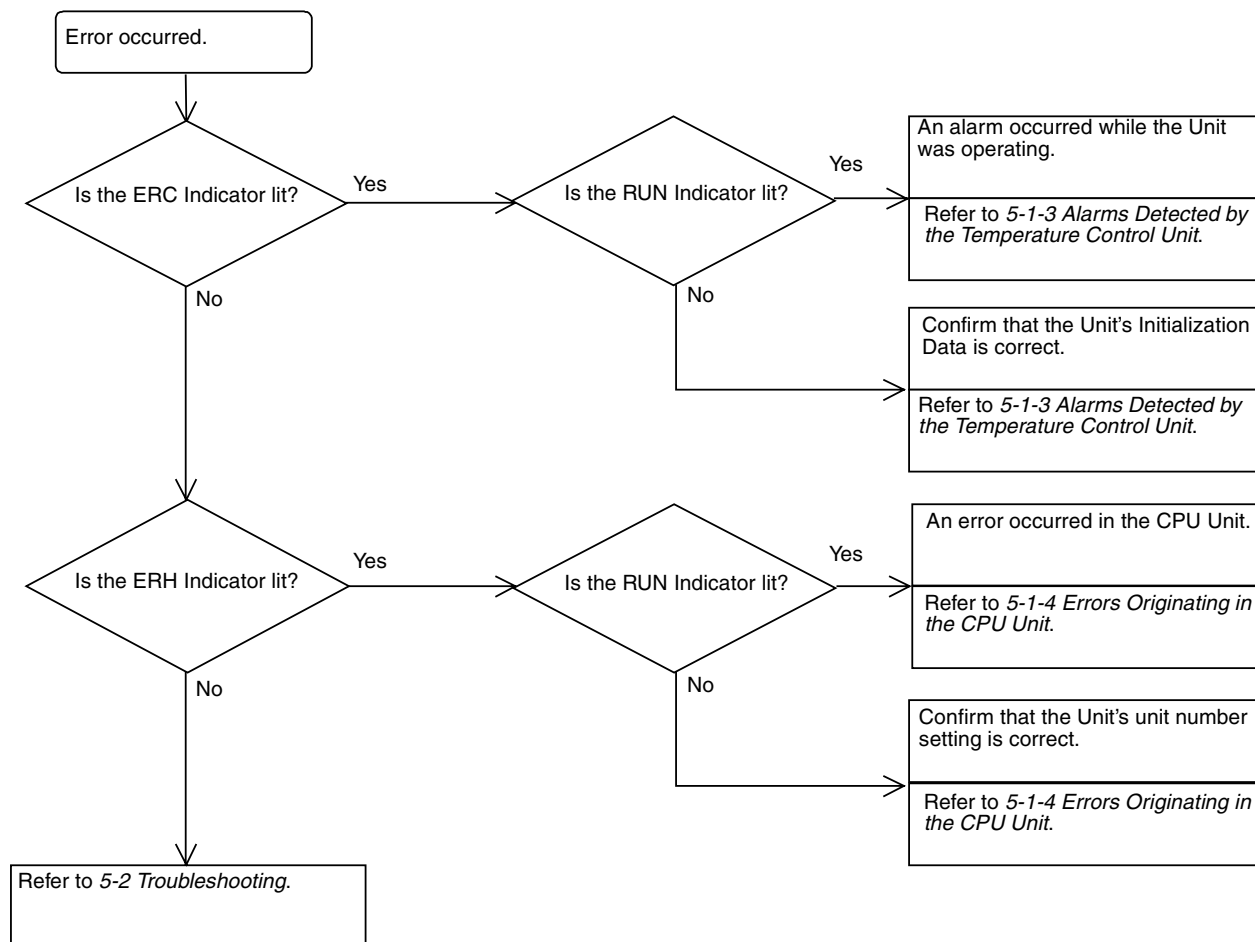

5-1-3 Alarms Detected by the Temperature Control Unit

The ERC Indicator will light when an alarm occurs that is detected by the Temperature Control Unit itself. The corresponding error flag will be turned ON in the Unit's Special I/O Unit Area. A separate CIO word is allocated to each loop, as shown in the following table.

Bit	CIO word							
	n+8		n+9		n+18		n+19	
15	Loop 1 status	Save Completed	Loop 2 status	Save Completed	Loop 3 status	Save Completed	Loop 4 status	Save Completed
14		Sensor Error		Sensor Error		Sensor Error		Sensor Error
13		CT Overflow		CT Overflow		0		0
12		Fatal Control Error		Fatal Control Error		Fatal Control Error		Fatal Control Error
11		Standby		Standby		Standby		Standby
10		PID Constants Calculated		PID Constants Calculated		PID Constants Calculated		PID Constants Calculated
09		Setting Error		Setting Error		Setting Error		Setting Error
08		Stop		Stop		Stop		Stop
07		0		0		0		0
06		0		0		0		0
05		0		0		0		0
04		Control Output		Control Output		Control Output		Control Output
03		AT		AT		AT		AT
02		HB		HB		0		0
01		AL1		AL1		AL1		AL1
00		AL2		AL2		AL2		AL2

ERC Indicator Lit and RUN Indicator Lit

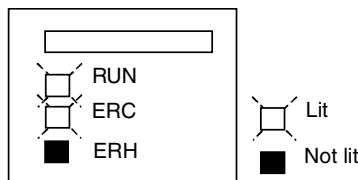

These alarms indicate that an incorrect operation was performed while the Unit was operating normally. These alarms are cleared automatically when the cause of the alarm is corrected.

If pin 1 of the Temperature Control Unit's DIP Switch is OFF (stop operation when CPU Unit is in PROGRAM mode), the RUN Indicator will be OFF when the CPU Unit is in PROGRAM mode.

Bit	Alarm name	Cause	Control status	Processing
Bit 14	Sensor Error	An input error has occurred.	Control operation continues. (Output OFF.) Alarm operates as if the temperature is out of range.	Check the corresponding loop for incorrect input wiring, short circuit, and incorrect input type setting.
Bit 13	CT Overflow	The heater current is above 55.0 A.	Control operation continues.	The corresponding loop's heater current value will be correct when the current is within range.
Bit 09	Setting Error	There is an error in a setting.	The incorrect setting will be ignored and operation will continue with the settings retained in the Unit.	Check the corresponding loop's "Setting Error Number" in CIO (n+7) or CIO (n+17). Correct the indicated setting.
Bit 02	Heater Burnout	A heater circuit has burned out.	Control operation continues.	Check the corresponding loop's heater and repair the heater where the burnout occurred.

Starting CIO Area Word

The starting CIO Area word (n) for a Special I/O Unit is:
 $n = 2000 + (10 \times \text{unit number})$

■ **Setting Error Numbers**

Setting error number	Setting name	Priority
0	No incorrect settings	-
1	Alarm mode 1	1
2	Alarm mode 2	2
3	Alarm 1 hysteresis	3
4	Alarm 2 hysteresis	4
5	Set point	5
6	Alarm 1 SV	6
7	Alarm 2 SV	7
8	Input compensation value	8
9	Control period	9
A	Control sensitivity	10
B	Proportional band	11
C	Integral time	12
D	Derivative time	13
E	Heater burnout current	14
F	Not allocated.	15

When there are errors in two or more settings, the setting error number with the highest priority will be stored.

ERC Indicator Lit and RUN Indicator Not Lit

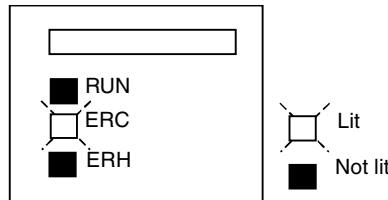

These alarms indicate that there is an error in the Unit's Initialization Data. When one of these alarms occurs, correct the cause of the alarm and then clear the alarm by turning the power ON again or turning ON and OFF the Temperature Control Unit's Restart Bit.

Error	Cause	Control status	Processing
Hardware Check Error	An error occurred in the Unit's peripheral hardware.	Control operation will stop.	Turn the power ON again or restart the Unit. If the error is in EEPROM, turn ON pin 7 of the Unit's DIP Switch to initialize the settings. If these steps do not clear the error, repair or replace the Unit.
Temperature Control Stopped Error	An error occurred in the cold-junction compensator.	Control operation will stop.	Check the connections at the cold-junction compensator on the terminal block and turn the power ON again or restart the Unit.
DM Setting Error (Initialization Data)	There is an error in the Initialization Data settings.	Control operation will stop.	Check the location of the error in word n+7 or n+17, correct the initialization data (alarm mode or alarm hysteresis), and then turn the power ON again or restart the Unit.

5-1-4 Errors Originating in the CPU Unit

The ERH Indicator will light when the Temperature Control Unit cannot operate normally because I/O refreshing is not being performed properly with Special I/O Units. An error in the CPU Unit or I/O bus can interfere with I/O refreshing.

ERH Indicator Lit and RUN Indicator Lit

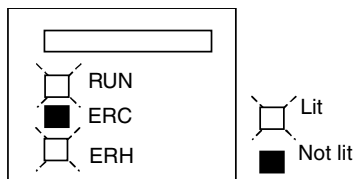

The ERH and RUN Indicators will both be lit when I/O refreshing is not being performed properly. Refer to the *CJ-series Programmable Controllers Operation Manual (W393)* for details.

Error	Cause	Control status	Processing
CPU Unit Monitor Error	A response was not returned from the CPU Unit within the fixed interval.	Control operation will continue.	Check the I/O refreshing interval.

ERH Indicator Lit and RUN Indicator Not Lit

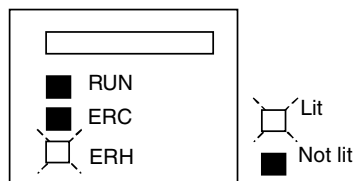

If a WDT (watchdog timer) error occurred in the CPU Unit because the Temperature Control Unit's unit number was set incorrectly or there was an error in the I/O bus, the ERH Indicator will light since I/O refreshing will not be performed properly with the Temperature Control Unit.

Error	Cause	Control status	Processing
Unit Number Duplication Error	The Temperature Control Unit's unit number is duplicated on another Special I/O Unit or is not within the allowed range (00 to 94). (The Temperature Control Unit occupies 20 words in the Special I/O Unit Area, so it is also possible that these allocated words overlap.)	Control operation will stop.	Correct the unit number settings. Turn the power ON again or restart the Unit.
Special I/O Unit Setup Error	An installed Special I/O Unit does not match the Special I/O Unit registered in the I/O table.		
I/O Bus Error	An error occurred in the transfer of data between the CPU Unit and another Unit.		Check that the sliding latches connect all of the Units securely and the End Cover is locked. Turn the power ON again or restart the Unit.
CPU Unit WDT Error	An error occurred in the CPU Unit		

5-1-5 Special I/O Unit Restart Bits

After changing the contents of DM settings or eliminating the cause of an error, the Unit must be restarted by turning the PLC's power ON again or toggling (OFF→ON→OFF) the corresponding Special I/O Unit Restart Bit.

Special I/O Unit Restart Bits

Bit	Function	Remarks
A50200	Unit 0 Restart Bit	The corresponding Special I/O Unit will restart when its Restart Bit is turned ON and OFF.
A50201	Unit 1 Restart Bit	
:	:	
:	:	
A50215	Unit 15 Restart Bit	
A50300	Unit 16 Restart Bit	
:	:	
:	:	
A50714	Unit 94 Restart Bit	

Note When an error cannot be cleared by turning ON the PLC or toggling the Unit's Special I/O Unit Restart Bit, refer to *5-1 Error and Alarm Processing* for details on correcting the cause of the error.

5-2 Troubleshooting

If some problem develops with the Temperature Control Unit, use the following procedure to isolate and correct the problem.

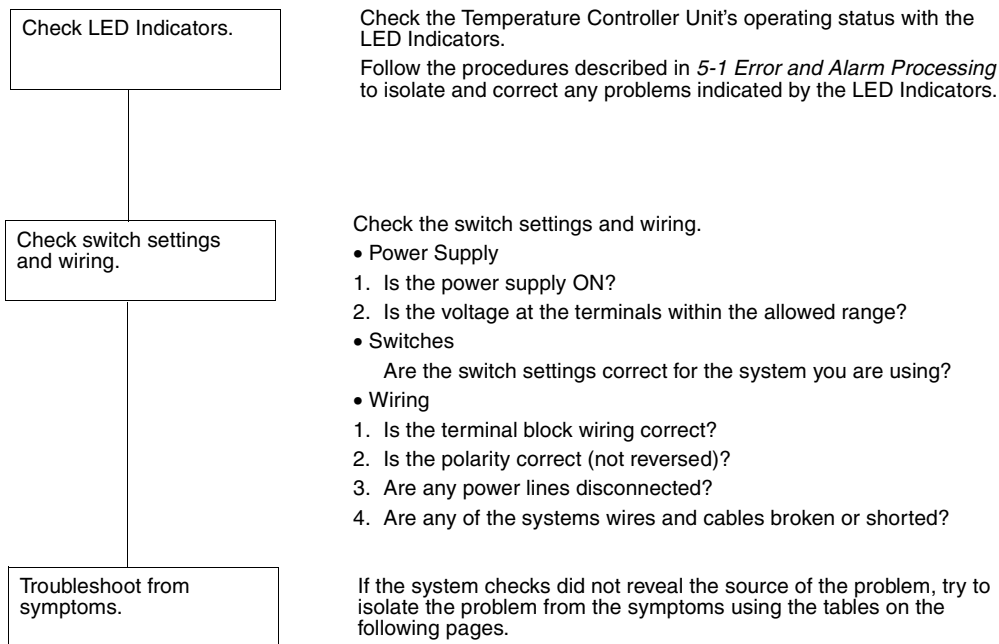

5-2-1 Troubleshooting from Symptoms: Measurement Errors

Incorrect Measurement or No Measurement

Step	Possible Cause	Remedy
Connection	The temperature sensor is connected to the wrong terminals or polarity is reversed.	Wire temperature sensor correctly.
	The temperature sensor connected to the Temperature Control Unit is not compatible with the Unit.	Replace the temperature sensor with one that is compatible with the Temperature Control Unit.
	The temperature sensor wires are broken, short-circuited, or damaged.	Replace the temperature sensor with a good one.
	No temperature sensor is connected.	Connect a temperature sensor.
	The compensating conductor being used is not compatible with the thermocouple.	<ul style="list-style-type: none"> • Directly connect a thermocouple with long lead wires. • Use a compensating conductor that is compatible with the thermocouple.
	Some equipment is connected between the thermocouple and Temperature Control Unit that uses metal different than the metal in the compensating conductor or thermocouple.	The equipment used for connections must be made specifically for use with thermocouples.
	The terminal screws are loose so there is poor contact between the wires and terminals.	Tighten the terminal screws.
	The thermocouple's lead wires or the compensating conductors are too long, so the resistance in the wires is affecting operation.	<ul style="list-style-type: none"> • Use thicker compensating conductors. • Change the wiring location to reduce the length of the wiring.
	The conductors between the temperature sensor and the Temperature Control Unit's terminals have three different conductive resistances.	Use conductors with the same resistance for the A, B, and B' terminals.
Installation	Noise from electric equipment around the Temperature Control Unit is affecting operation.	<ul style="list-style-type: none"> • Move the Temperature Control Unit away from the equipment that is generating the noise. • Install surge protectors or noise filters on the equipment that is generating the noise.
	The temperature sensor's leads run close to power lines, so noise is being induced from the power lines.	<ul style="list-style-type: none"> • Separate the temperature sensor's leads from the power lines. • Run the temperature sensor's leads in a conduit or duct separate from the one carrying the power lines. • Do not run the temperature sensor's leads parallel to the power lines. • Reduce the length of the temperature sensor's leads. • Use shielded wire for the temperature sensor's leads.
	The temperature sensor is installed too far from the point being controlled, so the response to temperature changes is delayed.	Install the temperature sensor in a protective tube closer to the point being controlled.
	The ambient temperature where the Temperature Control Unit is installed exceeds the Unit's ratings.	Install the Temperature Control Unit in a location with an ambient temperature between 0 and 55°C.
	Wireless equipment is being used near the Temperature Control Unit.	Shield the Temperature Control Unit.
	The temperature around the Temperature Control Unit is not uniform because of heat-generating equipment near the Unit.	Move the Temperature Control Unit to a location where it won't be affected by heat-generating equipment.
	There is a draft (breeze) on the Temperature Control Unit's terminal block.	Eliminate or block the draft.
	Settings	The Input Type setting is incorrect.
The Temperature Units setting is incorrect.		Set the Temperature Units correctly.
The measured temperature appears to be shifted because of the Input Compensation Value setting.		Set the Input Compensation Value to 0.0.
The Data Format setting is incorrect.		Check the Data Format set on pin 2 of the DIP switch and correct the ladder program if necessary.
The host's ladder program is incorrect.		

Step	Possible Cause	Remedy
Usage	There is a thermocouple input and the input terminals are shorted.	Connect a thermocouple.
	The temperature sensor was replaced or switch settings were changed while the power was ON.	Turn the power OFF and then ON again.

Here is a simple method to check the temperature sensor inputs:

With a resistance-thermometer Unit, connect a 100-Ω resistor to the A-B temperature sensor input terminals and short the B-B terminals. The Temperature Control Unit is operating normally if the measured temperature is at the 0.0°C or 32.0°F level.

With a thermocouple Unit, short the temperature sensor input terminals. The Temperature Control Unit is operating normally if the measured temperature is the temperature in the vicinity of the terminal block.

5-2-2 Troubleshooting from Symptoms: Temperature Control Errors

Temperature Does Not Rise

Step	Possible Cause	Remedy
Connection	The measured temperature is incorrect.	Refer to <i>5-2-1 Troubleshooting from Symptoms: Measurement Errors</i> for troubleshooting directions.
	There is no load connected to the control output terminals.	Connect a load.
	The load's polarity is reversed or the load is wired to the wrong terminals.	Wire the load correctly.
	The terminal screws are loose so there is poor contact between the wires and terminals.	Tighten the terminal screws.
	The heater's power supply is not ON.	Turn ON the heater's power supply.
	The heater circuit is burned out or damaged.	Replace the heater with a good one.
	The heater's heat output is insufficient.	<ul style="list-style-type: none"> • Replace the heater with one that has a higher output. • When using two or more heaters, check whether one is burned out. Replace if necessary.
	An overheating protection device is operating.	Increase the overheating protection device's temperature setting so it is higher than the Temperature Controller Unit's set point.
Settings	The forward operation/reverse operation setting is incorrect	Correct the setting.
	The PID constant settings are not correct.	<ul style="list-style-type: none"> • Perform autotuning. • Make the correct PID constant settings manually.
	Temperature control has not been started.	Start temperature control.
	A cooling fan is operating.	Turn OFF the cooling fan.

Measured Temperature Higher than Control Temperature

Step	Possible Cause	Remedy
Connection	The measured temperature is incorrect.	Refer to <i>5-2-1 Troubleshooting from Symptoms: Measurement Errors</i> for troubleshooting directions.
	The load is connected to the wrong control loop, so the heater is being controlled by another loop's control output.	Wire the load correctly.
	The contacts are fused in the relay operated by the control output.	Replace the relay with a good one.
	There is a short circuit in the relay operated by the control output.	Replace the relay with a good one.
	Current is flowing to the heater because of leakage current through the relay operated by the control output.	Connect a bleeder resistor to prevent operation due to the leakage current.
Settings	The forward operation/reverse operation setting is incorrect.	Correct the setting.
	The PID constant settings are not correct.	<ul style="list-style-type: none"> • Perform autotuning. • When autotuning is completed, refresh the PID constants properly so that the Unit operates with the calculated PID constants. • Make the correct PID constant settings manually.
Usage	There is excessive overshooting.	Refer to <i>Excessive Overshooting or Undershooting</i> on page 80 for troubleshooting directions.

Excessive Overshooting or Undershooting

Step	Possible Cause	Remedy
Connection	The measured temperature is incorrect.	Refer to <i>5-2-1 Troubleshooting from Symptoms: Measurement Errors</i> for troubleshooting directions.
	A general-purpose temperature sensor is being used in a system with a very fast heating response.	Change to a sheathed sensor.
Settings	The proportional band is narrow because PID constant P is too small.	<ul style="list-style-type: none"> • Increase the P constant to a level that produces an acceptable response delay. • Perform autotuning.
	The integral time is short because PID constant I is too small.	<ul style="list-style-type: none"> • Increase the I constant to a level that produces an acceptable response delay. • Perform autotuning.
	The derivative time is short because PID constant D is too small.	<ul style="list-style-type: none"> • Increase the D constant to a level that produces acceptable stability. • Perform autotuning.
	ON/OFF control is being used.	Use P (proportional) control or PID control.
	A long control period has been set in a system with a very fast heating response.	Reduce the control period.
	Autotuning was performed, but the Temperature Control Unit's PID constants were not refreshed with the calculated PID constants.	Refresh the Temperature Control Unit's PID constants with the calculated PID constants. Refer to <i>3-9 Setting the PID Constants</i> for details.

Excessive Hunting

The same connection and settings problems can cause overshooting, undershooting, and hunting. Refer to *Excessive Overshooting or Undershooting* on page 80 for details on possible connection and settings problems.

Step	Possible Cause	Remedy
Usage	The heater's output is too large for the controlled system.	Use a heater that is suitable for the controlled system.
	Something disturbs the system periodically and changes its heating requirement.	Arrange the controlled system to minimize external disturbances.
	Autotuning is in progress.	The hunting will stop when autotuning is completed.

5-2-3 Troubleshooting from Symptoms: Output Errors

No Control Output or No Alarm Output

Step	Possible Cause	Remedy
Connection	The measured temperature is incorrect.	Refer to 5-2-1 <i>Troubleshooting from Symptoms: Measurement Errors</i> for troubleshooting directions.
	The load's polarity is reversed or the load is wired to the wrong terminals.	Wire the load correctly.
	The connected load exceeds the output ratings.	<ul style="list-style-type: none"> Use a load within the output's ratings. Repair the load if it is malfunctioning.
	A load power supply is not connected to the transistor output.	Provide a power supply that is suitable for the output ratings and load.
	The polarity is reversed to the transistor output's load power supply.	Wire the power supply correctly.
Settings	Temperature control has not been started.	Turn OFF the Stop Bit.
	The wrong loop number is specified.	Make settings for the correct loop number.
	The loop is disabled. (Alarm mode 1 and alarm mode 2 are set to FF.)	Set an alarm mode. Refer to 2-5-5 <i>Initialization Data</i> for details.
	The set point is incorrect.	Set the correct set point.
	The alarm mode is set to 0 (no alarm).	Set the correct alarm mode.
	An alarm with a standby sequence has been set.	Set an alarm mode without a standby sequence.
	A deviation alarm or absolute value alarm has been set incorrectly.	Set the correct alarm mode.

5-2-4 Troubleshooting from Symptoms: HB Alarm Errors

Heater Burnout Not Detected

Step	Possible Cause	Remedy
Connection	A Current Transformer (CT) is not connected.	Connect a CT.
	The CT is connected to the wrong channel.	Input the CT correctly.
	The heater is being operating with another output, i.e., one from an Output Unit.	Change the wiring to control output that corresponds to the CT input.
	The connected CT is not an OMRON E54-CT1 or E54-CT3.	CTs other than the OMRON E54-CT1 and E54-CT3 cannot be used. Connect an E54-CT1 or E54-CT3.
Settings	Temperature control has not been started.	Start temperature control.
	The control output's ON time is less than 200 ms.	The heater burnout alarm will operate when the control output's ON time is longer than 200 ms.
	The heater's power supply was turned ON after temperature control was started.	Start temperature control after the heater's power supply has been turned ON.
	The heater burnout current is set to 0.0 or 50.0 A.	Set the appropriate heater burnout current between 0.1 and 49.9 A
	The heater burnout current is based on the heater's rated current.	Take an actual measurement of the heater's current to determine the appropriate heater burnout current.
	The heater burnout current from the actual measurement is not appropriate.	Consider the voltage range of the heater's power supply and current measurement error. Set the heater burnout current again.
Usage	The heater current exceeds 50.0 A.	Use a heater current of 50.0 A or less.
	The heater current is DC.	The heater burnout alarm cannot be used with a DC heater.
	A pure metallic heater is being used.	Take an actual measurement of the heater's current to determine the appropriate heater burnout current.

Appendix A

Dimensions

All dimensions are in mm.

CJ1W-TC□□□□

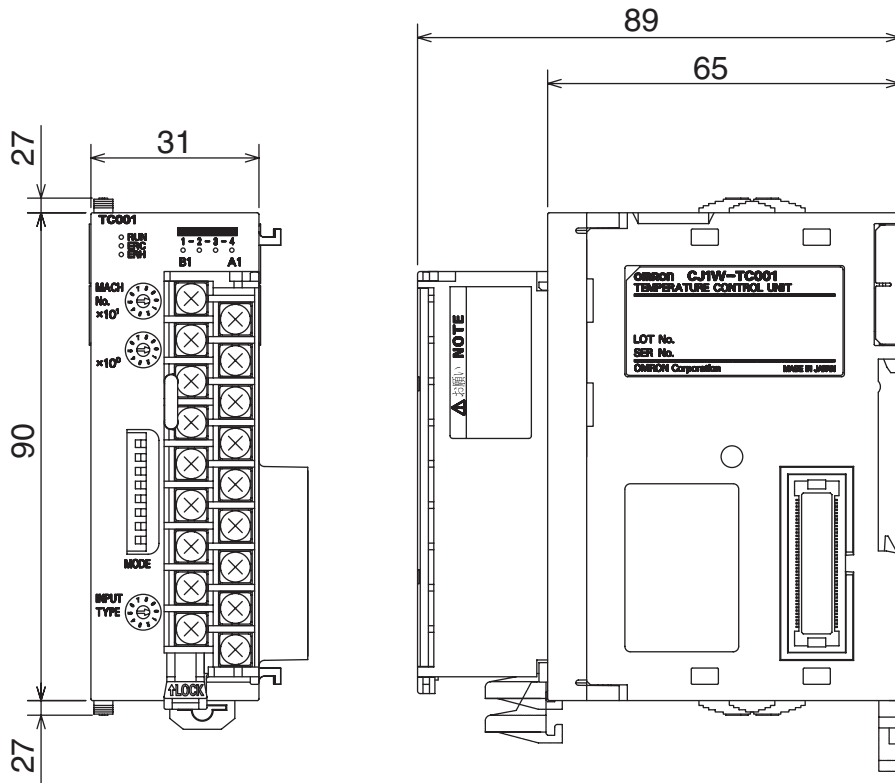

Current Transformer (Sold Separately)

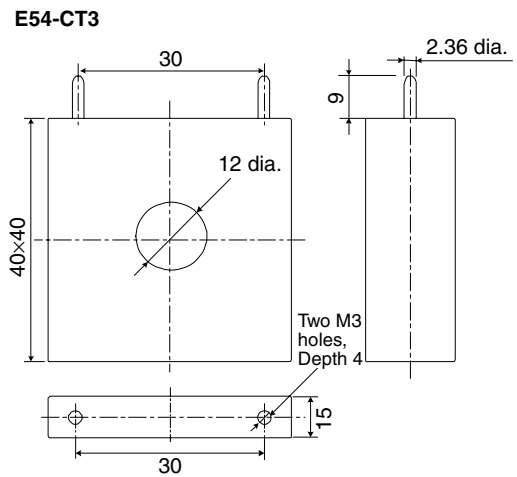
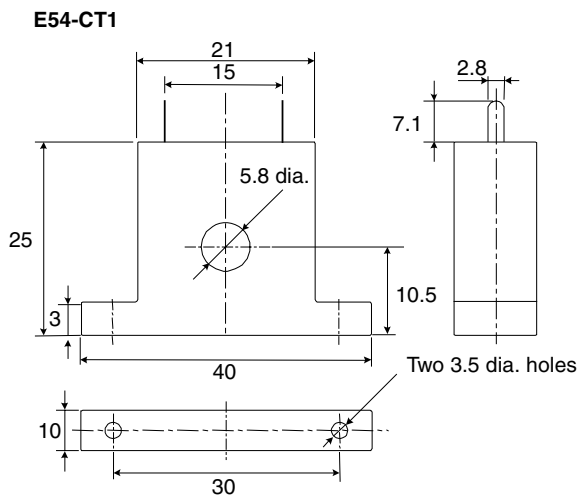

Appendix B

Sample Programs

Reading the Process Value

Summary

This program reads each loop's process value (PV) data and stores the data in a DM Area word (D00100 to D00103 for loops 1 to 4). Each loop's input value is read by the MOV Instruction when the loop's Sensor Error Flag is OFF.

Example Unit Settings

- Unit: CJ1W-TC001 Temperature Control Unit
- Unit number: 00

Note The unit number switches are on the front of the Unit. Refer to *2-3-3 Unit Number Switches* for details.

Example Program

The Sensor Error Flags are in bit 14 of CIO (n+8), CIO (n+9), CIO (n+18), and CIO (n+19).

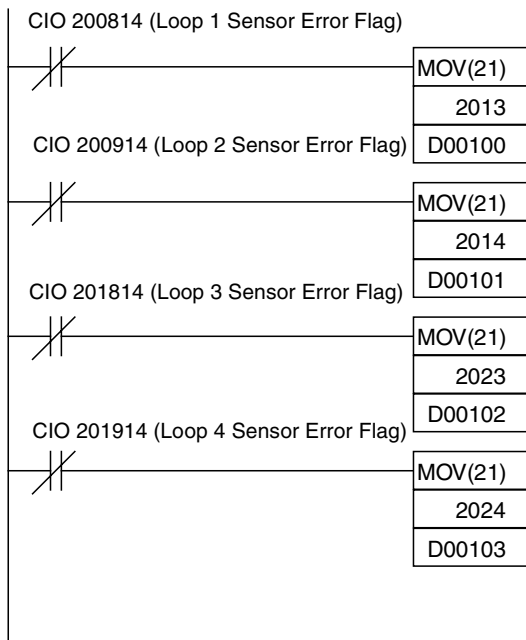

Writing the Set Point

Summary

This program writes the set point (SP) for loop 1.

Example Unit Settings

- Unit: CJ1W-TC001 Temperature Control Unit
- Unit number: 00

Note The unit number switches are on the front of the Unit. Refer to *2-3-3 Unit Number Switches* for details.

Example Program

The Setting Error Flag for loop 1 is bit 09 of CIO (n+8).

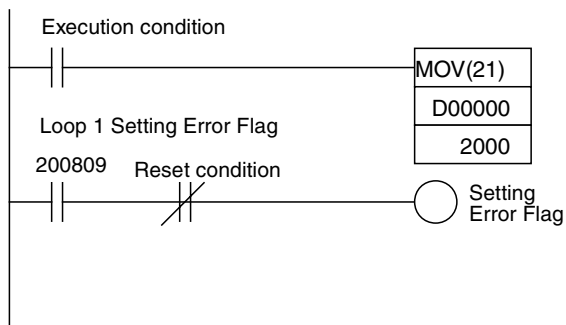

Performing Autotuning and Refreshing the PID Constants

Summary

This program performs autotuning for loop 1 and refreshes the Temperature Control Unit's PID constants with the calculated PID constants.

Example Unit Settings

- Unit: CJ1W-TC001 Temperature Control Unit
- Unit number: 00

Note The unit number switches are on the front of the Unit. Refer to 2-3-3 Unit Number Switches for details.

Example Program

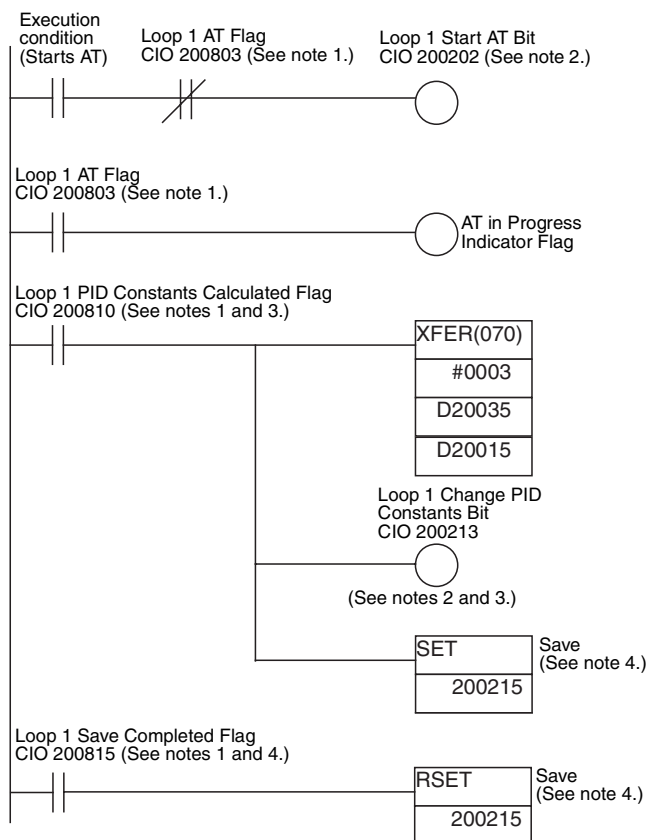

- Note**
1. The Loop 1 AT Flag is bit 03 of CIO (n+8), the Loop 1 PID Constants Calculated Flag is bit 10 of CIO (n+8), and the Loop 1 Save Completed Flag is bit 15 or CIO (n+8).
 2. The Loop 1 Start AT Bit is bit 02 of CIO (n+2) and the Loop 1 Change PID Constants Bit is bit 13 of CIO (n+2).
 3. The PID Constants Calculated Flag will go OFF when the Change PID Constants Bit is turned ON.
 4. If pin 8 of the DIP Switch is set to ON so that the settings in the Unit's EEPROM are transferred to the CPU Unit during initialization, always turn ON the loop's Save Bit to save the new settings to Temperature Control Unit's EEPROM.

Converting Data from Signed Binary to Signed BCD

Summary

This program converts binary setting/monitor values from signed binary (4 digits) to signed BCD (8 digits).

- When the most significant bit (leftmost bit) in a word is 1, that word is treated as 2's complement binary data.
- With signed BCD, the leftmost digit indicates the sign (0 for +, F for -) and the remaining 7 digits contain the BCD value.

Example Unit Settings

- Unit: CJ1W-TC001 Temperature Control Unit
- Unit number: 00 (See note 1.)
- Data format: 16-bit binary (See note 2.)

Note 1. The unit number switches are on the front of the Unit. Refer to *2-3-3 Unit Number Switches* for details.
 2. Turn ON pin 3 of the DIP switch to select the binary data format.

Example Program

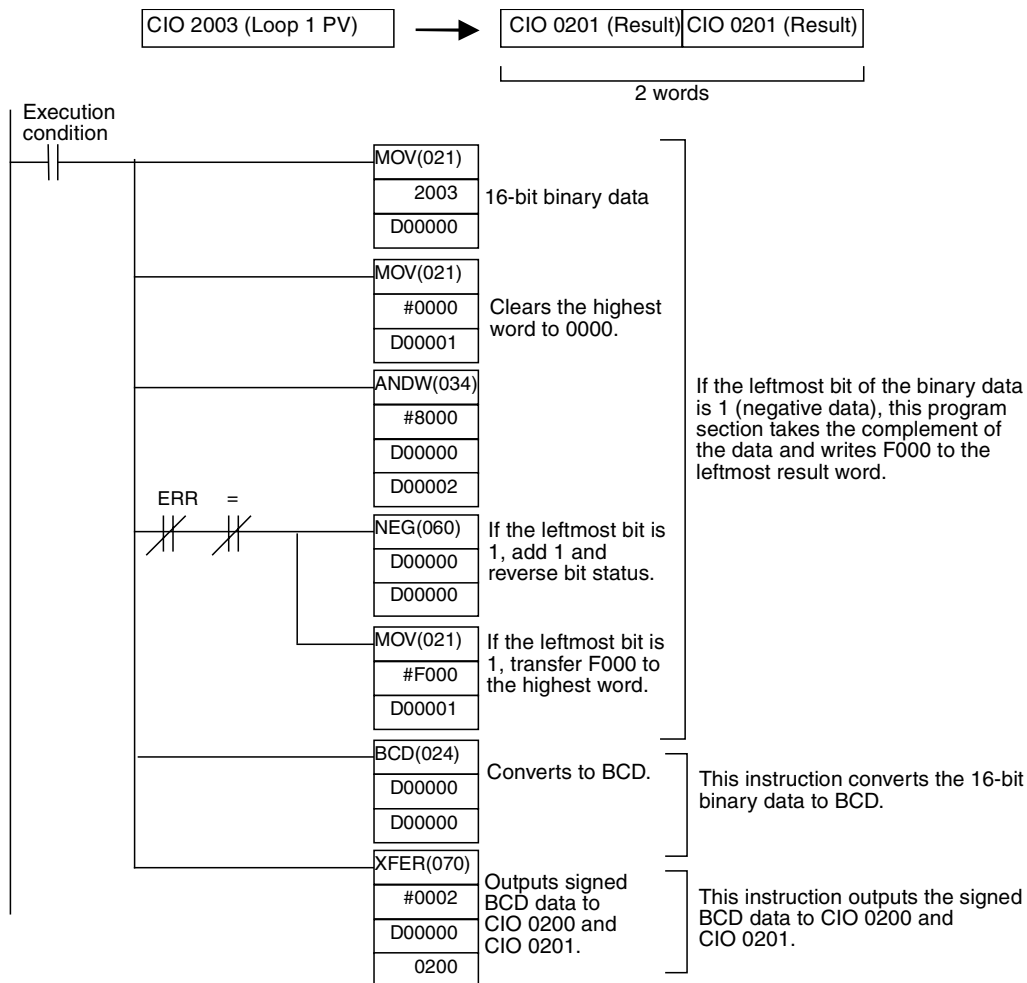

Index

A

applications
precautions, xviii

E

EC Directives, xxi
errors
UNIT No. DPL ERR
Analog Output Unit, 32, 45, 46

O

operating environment
precautions, xvii

P

precautions
applications, xviii
operating environment, xvii
Programming Console
errors
Analog Output Unit, 32, 45, 46

S

Special I/O Unit Restart Bits
Analog Output Unit, 31

U

UNIT No. DPL ERR
Analog Output Unit, 32, 45, 46

Revision History

A manual revision code appears as a suffix to the catalog number on the front cover of the manual.

Cat. No. W396-E1-03

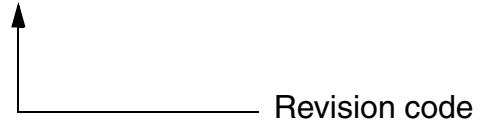

The following table outlines the changes made to the manual during each revision. Page numbers refer to the previous version.

Revision code	Date	Revised content
1	June 2001	Original production
02	December 2004	<p>“PC” globally changed to “PLC” in the sense of “Programmable Controller”</p> <p>Page ix: Model numbers added and entries for CX-Programmer changed.</p> <p>Page 20: Manual name changed.</p> <p>Page 36: Setting for n+7 removed.</p> <p>Page 66: “Stop Bits” changed to “bits”</p> <p>Page 75: Manual name changed and catalog number added.</p>
03	December 2005	<p>Page v: Information on general precautions notation added.</p> <p>Page xi: Information on liability and warranty added.</p> <p>Page xiv: Precaution added toward bottom of page.</p> <p>Page xv: Precaution added in middle of page and precaution changed in middle of page.</p> <p>Page xvi: Precaution changed toward top of page.</p>

OMRON Corporation

Control Devices Division H.Q.

Shiokoji Horikawa, Shimogyo-ku,
Kyoto, 600-8530 Japan
Tel: (81)75-344-7109/Fax: (81)75-344-7149

Regional Headquarters

OMRON EUROPE B.V.

Wegalaan 67-69, NL-2132 JD Hoofddorp
The Netherlands
Tel: (31)2356-81-300/Fax: (31)2356-81-388

OMRON ELECTRONICS LLC

1 East Commerce Drive, Schaumburg, IL 60173
U.S.A.
Tel: (1)847-843-7900/Fax: (1)847-843-8568

OMRON ASIA PACIFIC PTE. LTD.

83 Clemenceau Avenue,
#11-01, UE Square,
Singapore 239920
Tel: (65)6835-3011/Fax: (65)6835-2711

OMRON (CHINA) CO., LTD.

Room 2211, Bank of China Tower,
200 Yin Cheng Zhong Road,
PuDong New Area, Shanghai, 200120 China
Tel: (86)21-5037-2222/Fax: (86)21-5037-2200

OMRON

Authorized Distributor: