

Programmable Terminal NA-series

# Replace Guide From NS to NA

NA5-15□101□(-V1)

NA5-12□101□(-V1)

NA5-9□001□(-V1)

NA5-7□001□(-V1)



Replace  
Guide

## ■ Introduction

This guide provides reference information for creating NA pages but no safety information. Be sure to obtain the manuals for NA Series Programmable Terminal, read and understand the safety points and other information required for use, and test sufficiently before actual use of the equipment.

All rights reserved. No part of this publication may be reproduced, stored in a retrieval system, or transmitted, in any form, or by any means, mechanical, electronic, photocopying, recording, or otherwise, without the prior written permission of OMRON.

No patent liability is assumed with respect to the use of the information contained herein. Moreover, because OMRON is constantly striving to improve its high-quality products, the information contained in this manual is subject to change without notice.

Every precaution has been taken in the preparation of this manual. Should you notice any errors or other problems, please feel free to contact us about them.

### Trademarks

Sysmac and SYSMAC are trademarks or registered trademarks of OMRON Corporation in Japan and other countries for OMRON factory automation products.

Microsoft, Windows, Visual Basic, and Excel are either registered trademarks or trademarks of Microsoft Corporation in the United States and other countries.

ODVA, CIP, CompoNet, DeviceNet, and EtherNet/IP are trademarks of ODVA.

The SD and SDHC logos are trademarks of SD-3C, LLC.

Other company names and product names in this document are the trademarks or registered trademarks of their respective companies.

### Copyrights

- Microsoft product screen shots used with permission from Microsoft.

The product photos and diagrams in this manual are included solely for illustrative purposes and may differ from actual ones.

# Terms and Conditions Agreement

---

Thank you for your usage of products of Omron Corporation (“Omron”). Without any special agreements, these terms and conditions shall apply to all transactions regardless of who sells.

## ● Definitions of Terms

Omron product(s): Omron’s factory automation system devices, general control devices, sensing devices, and electronic/mechanical components.

- Catalogs: Any and all catalogs (including “Best Components” and other catalogs), specifications, instructions and manuals relating to Omron products, including electronically provided data.
- Conditions: Use conditions, rating, performance, operating environment, handling procedure, precautions and/or prohibited use of Omron products described in the catalogs.
- User application(s): Application of Omron products by a customer, including but not limited to embedding/using Omron products into customer’s components, electronic circuit boards, devices, equipment or systems.
- Conformity: (a) conformity, (b) performance, (c) no infringement of intellectual property of third party, (d) compliance with laws and regulations, and (e) conformity to various standards of Omron products in user applications.

## ● Note about Descriptions

- Rating and performance is tested separately. Combined conditions are not warranted.
- Reference data is intended to be used just for reference. Omron does NOT guarantee that the Omron Product can work properly in the range of reference data.
- Examples are intended for reference. Omron does not warrant the conformity in usage of the examples.
- Omron may discontinue Omron products or change specifications of them because of improvements or other reasons.

## ● Note about Use

Adopt and use Omron products considering the following cautions.

- Use the product in conformance to the conditions, including rating and performance.
- Check the conformity and decide whether or not Omron products are able to be adopted. Omron makes no guarantees about the conformity.
- Make sure in advance that electricity is properly supplied to Omron products and they are set up rightly in your system for intended use.
- When you use Omron products, ensure the followings: (i) allowance in aspect of rating and performance, (ii) safety design which can minimize danger of the application when the product does not work properly, (iii) systematic safety measures to notify danger to users, and (iv) periodical maintenance of Omron products and the user application.
- Omron assumes no responsibility for any direct or indirect loss, damage and expense resulting from infection of our products, installed software, any computer devices, computer programs, network, and databases with the followings: DDoS attack (distributed

DoS attack); computer virus and other technically harmful program; and unauthorized access.

Please conduct the followings by yourself: (i) antivirus software, (ii) data input/output, (iii) lost data recovery, (iv) protections against computer virus that contaminate Omron products or the installed software, and (v) measures to protect Omron products from unauthorized access.

- Omron products are designed and manufactured as commodity for general industrial products. For this reason, the usages (a) to (d) are to be unintended. Omron makes no guarantees on Omron products, if you use Omron products for those purposes. However, special applications that Omron expects or usages with especial agreement are excluded.
  - (a) Applications requiring high-level safety (e.g. nuclear control facilities, combustion facilities, aerospace and aviation facilities, railroad facilities, elevating facilities, amusement facilities, medical facilities, safety devices or other applications which has possibility to influence lives or bodies)
  - (b) Applications requiring high reliability (e.g. gas/water/electricity supply system, 24-hour operating system, applications handling with rights/property, such as payment system)
  - (c) Applications in a harsh condition or environment (e.g. outdoor facilities, facilities with potential of chemical contamination or electromagnetic interference, facilities with vibration or impact, facilities on continual operation for a long period).
  - (d) Applications under conditions or environment which are not described in the catalogs
- Omron products in the catalogs are not intended to be used in automotive applications (including two-wheel vehicles). Please DO NOT use Omron products in automotive applications. Contact our sales personnel for automotive products.

#### ● Warranty

Warranty of Omron products is subject to followings.

- Warranty Period: One year after your purchase.  
However, except when there is a separate statement in the catalogs.
- Coverage: Omron will provide one of the services listed below, on the basis of Omron's decision.
  - (a) Free repairing of the malfunctioning Omron products (except electronic/mechanical components) at Omron maintenance service sites.
  - (b) Free replacement of the malfunctioning Omron products with the same number of substitutes.
- Exceptions: This warranty does not cover malfunctions caused by any of the followings.
  - (a) Usage in the manner other than its original purpose
  - (b) Usage out of the conditions
  - (c) Usage out of Note about Use in these conditions
  - (d) Remodeling/repairing by anyone except Omron
  - (e) Software program by anyone except Omron
  - (f) Causes which could not be foreseen by the level of science and technology at the time of shipment of the products.
  - (g) Causes outside Omron or Omron products, including force majeure such as disasters

#### ● Limitation of Liability

The warranty described in this Terms and Conditions Agreements is a whole and sole

liability for Omron products. There are no other warranties, expressed or implied. Omron and its distributors are not liable for any damages arisen from or relating to Omron products.

- **Export Control**

Customers of Omron products shall comply with all applicable laws and regulations of other relevant countries regarding security export control, in exporting Omron products and/or technical documents or in providing such products and/or documents to a non-resident. Omron products and/or technical documents may not be provided to customers if they violate the laws and regulations.

## Table of Contents

<b>Terms and Conditions Agreement</b> .....	<b>2</b>
<b>Related Manuals</b> .....	<b>9</b>
<b>1 How to Replace NS to NA5</b> .....	<b>10</b>
<b>2 Select NA Model</b> .....	<b>11</b>
2-1 Communication Protocols and External Devices.....	11
2-2 Display Size.....	12
2-3 SD Card (or USB Stick Memory).....	12
<b>3 Install the NA Unit</b> .....	<b>13</b>
3-1 Panel cutout.....	13
3-1-1 Differences in Front Size and Panel Cutout Dimensions.....	13
3-1-2 Differences of Panel Cutout.....	13
3-1-3 Differences of Front Size .....	14
3-2 Precautions for Connecting to a Power Source.....	15
3-2-1 Differences in Power Circuit .....	15
3-2-2 Change in Supply Terminals.....	16
<b>4 Create NA HMI Project Data</b> .....	<b>17</b>
4-1 Major Differences Between NS and NA .....	17
4-2 Differences in Ethernet Host Connection .....	19
4-3 Host Addresses and Variables.....	19
4-3-1 How to Assign Data.....	19
4-3-2 Variable Data Type Conversion.....	20
4-3-3 Processing BCD Type .....	22
4-3-4 Specify Device Address of NS.....	22
4-3-5 How to Connect to CJ Series Unit .....	23
4-3-6 Where to Register NS Variables.....	24
4-3-7 Import CX-Programmer Variable Table to NA Device Variables .....	25
4-3-8 Import NS Variable Table to NA Global Variable .....	25
4-3-9 Import NS Variable Table to NA Device Variables .....	26
4-4 Project Settings and Functional Objects .....	27
4-4-1 Appendix 1: Project Common Settings .....	27
4-4-2 Appendix 2: Object Common Settings .....	27
4-4-3 Appendix 3: Buttons .....	28
4-4-4 Appendix 4: Lamps.....	29

4-4-5	Appendix 5: Graphs .....	29
4-4-6	Appendix 6: Alarms .....	30
4-5	System Memory .....	30
4-5-1	System Memory: Variable Mapping.....	31
4-5-2	System Memory: Global Event.....	33
4-5-3	System Memory: Supported by VB .....	40
4-5-4	System Memory: Array.....	46
4-6	About Macro.....	51
4-6-1	Macro Execution Conditions .....	51
4-6-2	Variables Used in NS Macros .....	53
4-6-3	About PT Memory .....	53
4-6-4	About Host Address (Argument for READCMEM and WRITECMEM) .....	54
4-6-5	Different Behaviors from NS Macros .....	54
4-6-6	Replacing NS Macro Function.....	54
4-6-7	Sample Alternate Functions for NS Macro Functions .....	58

## **5 Replacement Examples: Common Settings..... 62**

---

5-1	Project Properties.....	62
5-1-1	Switch Label Tab .....	62
5-1-2	Macro Tab.....	63
5-1-3	Language Selection Tab .....	65
5-2	System Setting .....	65
5-2-1	PT Tab.....	65
5-2-2	Initial Tab .....	66
5-2-3	History Tab .....	67
5-2-4	Function Key Tab (For NS15) .....	67
5-3	Variable Table .....	68
5-4	Alarm/ Event Settings.....	68
5-4-1	How to Replace.....	70
5-4-2	Non-replaceable Functionalities .....	74
5-5	Data Log Settings.....	75
5-5-1	How to Replace.....	76
5-6	Broken-line Graph Group Settings.....	77
5-6-1	Functionality Correspondence Table.....	78
5-6-2	How to Replace.....	78
5-7	Data Block Settings .....	82
5-7-1	How to Replace.....	82
5-8	String Table Setting.....	84
5-8-1	Example of Indirect Reference .....	84
5-9	Password .....	87
5-10	Unit/Scale Settings.....	88
5-11	Dialog Setting .....	88
5-12	Device Data Transfer Setting .....	88

5-13	Troubleshooter Setting.....	90
------	-----------------------------	----

## **6 Replacement Examples: Functional Objects ..... 91**

6-1	Functional Difference Between NS and NA: Common in Objects.....	91
6-1-1	Behaviors of Overlapped Objects .....	91
6-1-2	Behaviors of Hidden Objects .....	91
6-1-3	Appearance of Non-Enterable Object .....	91
6-1-4	Where to Use Macros in Object Settings .....	92
6-2	Non-replaceable Functionalities: Common in Objects.....	93
6-3	ON/OFF Button.....	93
6-3-1	Button Types .....	95
6-3-2	Non-replaceable Functionalities .....	95
6-4	Word Button.....	96
6-4-1	Button Actions .....	96
6-4-2	Non-replaceable Functionalities .....	97
6-5	Command Button.....	98
6-5-1	Non-replaceable Functionalities .....	99
6-6	Bit Lamp .....	100
6-6-1	Non-replaceable Functionalities .....	100
6-7	Word Lamp.....	101
6-7-1	Non-replaceable Functionalities .....	101
6-8	Multifunction .....	101
6-8-1	Double Pressing and ON and OFF Delay Functions.....	103
6-8-2	Non-replaceable Functionalities .....	104
6-9	Text .....	104
6-10	Numeral Display and Input.....	105
6-10-1	Non-replaceable Functionalities .....	106
6-11	String Display and Input.....	107
6-11-1	StartIndex and TextLength .....	108
6-11-2	Non-replaceable Functionalities .....	108
6-12	List Selection .....	109
6-12-1	Non-replaceable Functionalities .....	109
6-13	Analogue Meter .....	110
6-13-1	Non-replaceable Functionalities .....	110
6-14	Level Meter.....	110
6-14-1	Non-replaceable Functionalities .....	110
6-14-2	Realizing the Same Appearance as NS Object .....	110
6-15	Broken-line Graph.....	110
6-15-1	Non-replaceable Functionalities .....	111
6-16	Bitmap .....	111
6-16-1	Non-replaceable Functionalities .....	111
6-17	Alarm/Event Display .....	111
6-18	Alarm/Event Summary and History .....	114



6-18-1	Non-replaceable Functionalities .....	114
6-18-2	Replacing Icons .....	114
6-18-3	Setting for Distinguishing Occurrence and Cancellation of Alarms .....	116
6-18-4	Alternative for Page Transition When Selecting an Alarm .....	117
6-19	Date and Time.....	117
6-20	Data Log Graph.....	118
6-20-1	Non-replaceable Functionalities .....	118
6-20-2	Replacing Icons .....	118
6-21	Data Block Table.....	119
6-21-1	Non-replaceable Functionalities .....	119
6-21-2	Replacing Icons .....	119
6-22	Frame.....	120
6-22-1	Functional Differences .....	120
6-22-2	Workaround When You Cannot Arrange an Object on Tab Control Object.....	120
6-23	Table.....	121
6-24	Thumbwheel Switch .....	121
6-24-1	Replace Thumbwheel Switch: Arrange Objects.....	121
6-24-2	Replace Thumbwheel Switch: Define a Structure.....	121
6-24-3	Replace Thumbwheel Switch: Register the Structure.....	122
6-24-4	Replace Thumbwheel Switch: Configure Global Subroutine .....	122
6-24-5	Replace Thumbwheel Switch: Configure Page Subroutine.....	123
6-24-6	Replace Thumbwheel Switch: Configure Page Switching Event .....	124
6-24-7	Replace Thumbwheel Switch: Configure Button Event.....	124
6-24-8	Replace Thumbwheel Switch: Configure Data Display Object .....	124
6-25	Temporary Input.....	124
6-26	Consecutive Line Drawing.....	124
6-27	Contents Display .....	124
6-28	Video Display .....	124

**7 Other Important Points..... 125**

**8 Change Controller Program..... 127**

8-1	Example of Changing Controller Program .....	127
-----	--	-----

**9 Revision History..... 129**

# Related Manuals

The followings are the manuals and practice guides related to this document.

No.	Model	Title
W504	SYSMAC-SE2□□□	Sysmac Studio Version 1 Operation Manual
V117	NA5-15W□□□□ NA5-12W□□□□ NA5-9W□□□□ NA5-7W□□□□	NA-series Programmable Terminal Hardware User's Manual
V125	NA5-15W□□□□-V1 NA5-12W□□□□-V1 NA5-9W□□□□-V1 NA5-7W□□□□-V1	NA-series Programmable Terminal Hardware (- V1) User's Manual
V118	NA5-15W□□□□(-V1) NA5-12W□□□□(-V1) NA5-9W□□□□(-V1) NA5-7W□□□□(-V1)	NA-series Programmable Terminal Software User's Manual
V119	NA5-15W□□□□(-V1) NA5-12W□□□□(-V1) NA5-9W□□□□(-V1) NA5-7W□□□□(-V1)	NA-series Programmable Terminal Device Connection User's Manual
V120	NA5-15W□□□□ NA5-12W□□□□ NA5-9W□□□□ NA5-7W□□□□	NA-series Programmable Terminal Startup Guide
V117	NS5-□Q□□(-V□) NS8-TV□□(-V□) NS10-TV□□(-V□) NS12-TS□□(-V□) NS15-TX□□(-V□)	NS-series Programmable Terminals SETUP MANUAL
V073	NS5-□Q□□(-V□) NS8-TV□□(-V□) NS10-TV□□(-V□) NS12-TS□□(-V□) NS15-TX□□(-V□)	NS-series Programmable Terminals PROGRAMMING MANUAL
V075	NS5-□Q□□(-V□) NS8-TV□□(-V□) NS10-TV□□(-V□) NS12-TS□□(-V□) NS15-TX□□(-V□)	NS-Series Programmable Terminals Macro Reference

# 1 How to Replace NS to NA5

The following diagram illustrates the procedure for replacing an NS series unit to an NA series unit.

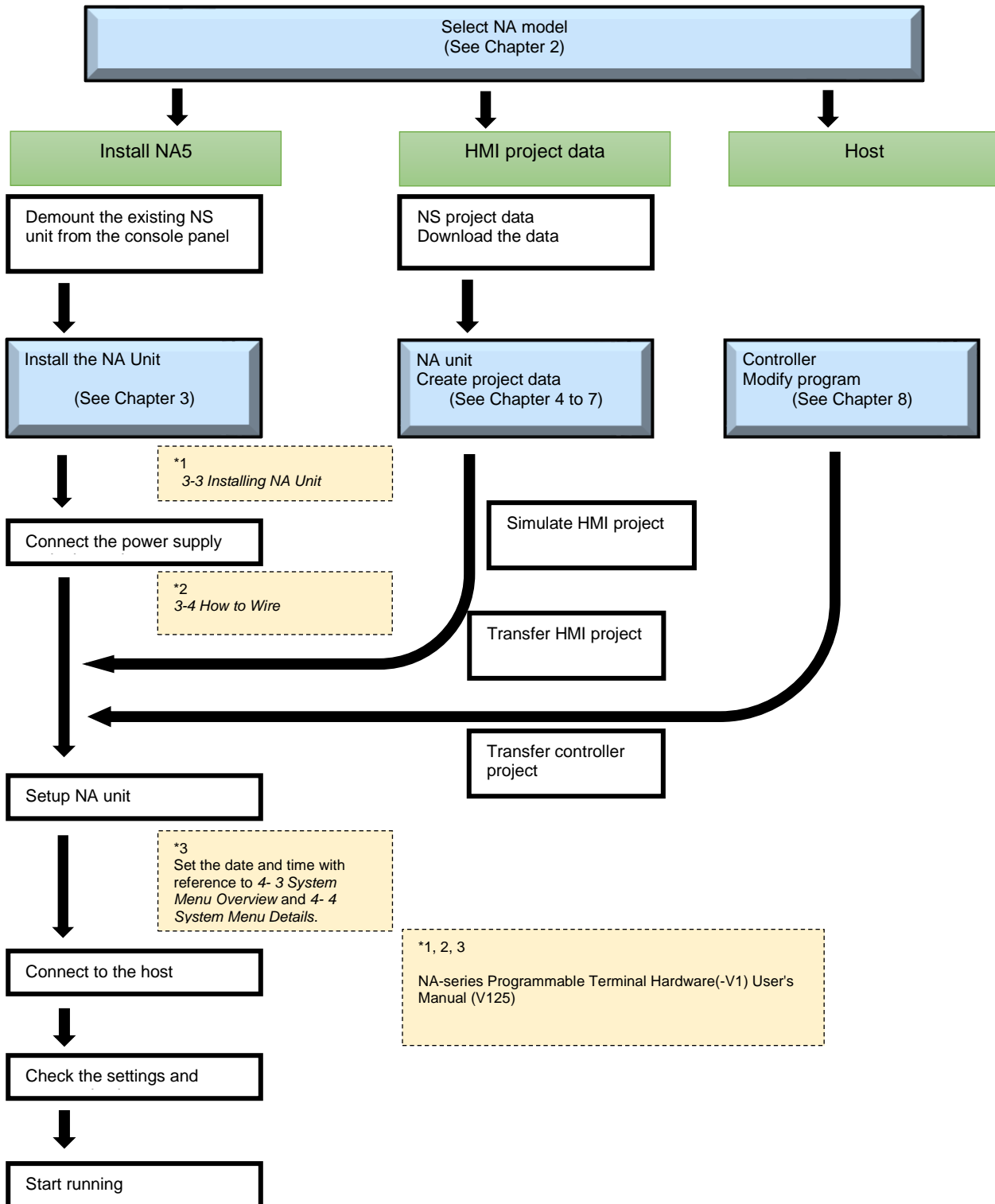

## 2 Select NA Model

### 2-1 Communication Protocols and External Devices

The table below shows communication protocols and host configurations for a NA system, which depending on the unit model and communication protocol in your NS system. Refer to “NA-series Programmable Terminal Device Connection User's Manual” (V119) for available PLCs for each communication protocol.

NS Port	NS host configuration		Change in host configuration for NA			
	Connect to	Protocol	Protocol	What to do with host unit		
Ethernet	OMR	CV series	FINS	N/A	Replacement of the PLC is recommended.	
		ON PLC	CS1H/CS1G/CS1D	FINS	N/A	Connection with CS and CP series CPU Units will be supported soon. Please contact our sales representative for details.
	EtherNet/IP					
	CP1H/CP1L/CP2E		FINS			
	ON PLC	CJ1M Built-in ETN	FINS	FINS Ethernet	No change in the host configuration.	
		CJ1H/CJ1G/CJ1M + CJ1W- ETN21/CJ1W-EIP21	FINS			
			CJ2H/CJ2M	FINS		FINS Ethernet
		CJ2H/CJ2M	EtherNet/IP	CIP Ethernet		
			NJ5/ NJ3/NJ1	EtherNet/IP		Ethernet
		NX7/ NX1/NX1P				
	Delta Tau Power PMAC EtherLite	Modbus/TC P	Modbus/TCP	Replacing with OMRON CK3E or CK3M series CPU Unit enables communications via Modbus/TCP. Please consider this proposal.		
Serial port A/B	OMRON PLC	Host Link	Change to the connection via Ethernet port	N/A	--	
		1:1 NT Link				
		1:N NT Link				
	OMRON Temperature Controller					
	Other PLC					
	Memory Link					
Modem						
Barcode Reader						
Controller Link	Controller Link device					
Video input RGB input	Video camera and other video equipment					

## 2-2 Display Size

Select an NA series unit according to the display size of your NS unit.

NS series units are equipped with 4:3 displays, but NA series units are equipped with 16:10 wide-type displays. An NA5 that has “W” in its model number is the wide display type.

NS Units to be Replaced				Recommended NA5 Units		
	Display Size	Resolution (Dots)			Panel size	Resolution (dot)
NS15	15.0 inches	1024 x 768	⇒	NA5-15W□□□□-V1	15.4 W	1280 x 800
NS12	12.1”	800 x 600	⇒	NA5-12W□□□□-V1	12.1 W	1280 x 800
NS10	10.4”	640 x 480				
NS8	8.1”	640 x 480	⇒	NA5-9W□□□□-V1	9.0 W	800 x 480
NS5	5.7”	320 x 240	⇒	NA5-7W□□□□-V1	7.0 W	800 x 480

## 2-3 SD Card (or USB Stick Memory)

The data logging function in the NA series stores the collected log data to an SD card or USB stick memory. Therefore, an SD card or USB stick memory must be mounted on the NA unit during the operation.

Note that you cannot use a USB stick memory in a high-vibrational environment. Also, the NA-series units are not equipped with a feature to fix the mounted stick memory. We recommend the SD card to store a long-time log data.

You need to consider the room for inserting and ejecting the SD card when installing an NA unit.

# 3 Install the NA Unit

Refer to “3-3 Installing NA Units” in “Programmable Terminal NA Series Hardware (-V1) User’s Manual” (V125) for details.

## 3-1 Panel cutout

### 3-1-1 Differences in Front Size and Panel Cutout Dimensions

The following is a comparison table of NS series and NA series.

(Units: mm)

NS				NA5			
NS	Thickness	Front dimensions	Panel cutout	NA5	Thickness	Front dimensions	Panel cutout
NS15	75.8	405 x 304	383.5 x 282.5	NA5-15W□□□□-V1	69	420 x 291	(392 + 1.0) x (268 + 1.0)
NS12	48.5	315 x 241	302 x 228	NA5-12W□□□□-V1		340 x 244	(310 + 1.0) x (221 + 1.0)
NS10		232 x 177	220.5 x 165.5	NA5-9W□□□□-V1		290 x 190	(261 + 1.0) x (166 + 1.0)
NS8	54.0	195 x 142	184 x 131	NA5-7W□□□□-V1		236 x 165	(197 + +0.5) x (141 + +0.5)

### 3-1-2 Differences of Panel Cutout

If the larger panel cutout size is necessary, you must enlarge the window in your control panel. Replacement from an NS15, NS12, or NS10 unit will leave a gap in height, which requires an adjustment plate. We do not provide dedicated plates because any replacements require widening the panel cutout. Please prepare one for yourself.

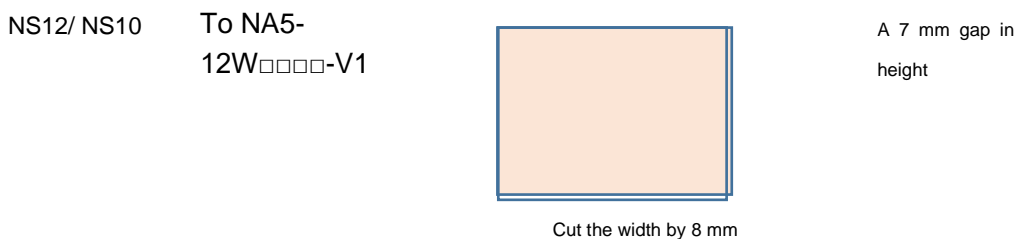
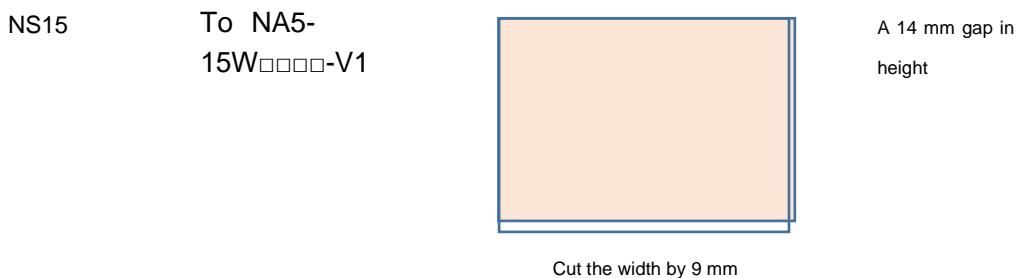

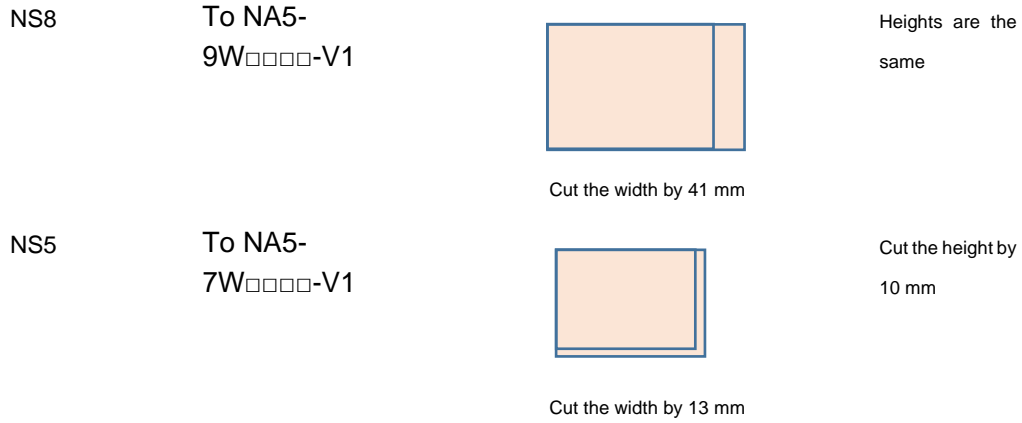

### 3-1-3 Differences of Front Size

Increase in the front size may cause an interference with devices around the panel.  
The degree of interference depends on the cut in the panel cutout: same cuts in right/left or top/bottom, either of right/left, or either of top/bottom.

NS	NA5	Changes in front size	
		Width	Height
NS15	NA5-15W□□□□-V1	+20	-14
NS12	NA5-12W□□□□-V1	+25	+3
NS10			
NS8	NA5-9W□□□□-V1	+58	+13
	NA5-7W□□□□-V1	+4	-12
NS5	NA5-7W□□□□-V1	+41	+23

## 3-2 Precautions for Connecting to a Power Source

### 3-2-1 Differences in Power Circuit

The internal power supply of the NS series units is an isolated circuit, but in the NA series units, internal power supply is a non-isolated DC power supply.

## WARNING

Replacing an NS unit that is positively grounded to 24 V supply power with an NA unit as is will cause a short circuit and damage the device, as illustrated below. Ground the negative side or add an isolation transformer.

Also, to use a power supply that does not contain a protection circuit, supply power to the NA unit through a fuse or other protective element.

24 V Grounding Power Supply

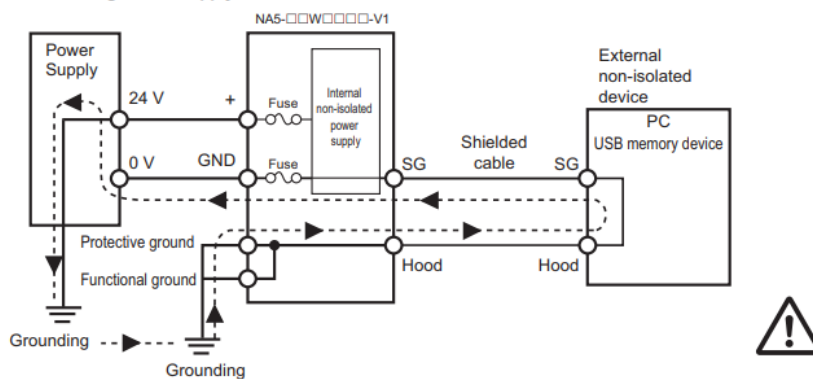

NA5-□□W□□□□-V1 grounding diagram

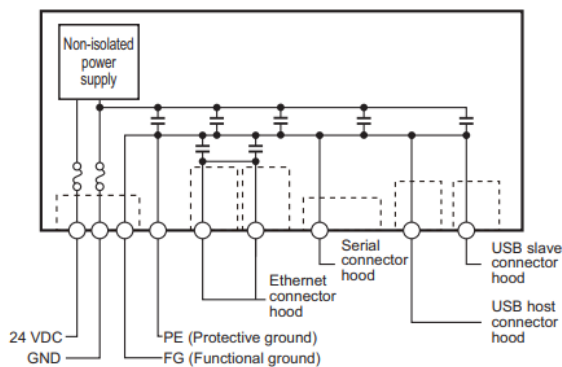



### 3-2-2 Change in Supply Terminals

NS series units are equipped with a screwed supply terminal block, but NA series units' supply terminal block is a connector-type.

Change the power cable, if necessary.

---

Do not place heavy goods on the cable or pull the cable with force because the connector is mounted in the joint.

---

# 4 Create NA HMI Project Data

You cannot reuse NS project data for NA series units.

Open a NS project data in CX-Designer to see your system configuration and settings of functional object properties. Then, create an NA project data by using Sysmac Studio.

## 4-1 Major Differences Between NS and NA

The following table shows major differences between NS and NA that you need to know in creating an NA project data.

Item	NS series	NA
Display resolution	4:3 display	16:9 wide-type display. Based on the object layout in the NS unit, objects will be arranged on the upper left of the NA screen, and a blank space will be left on the right side.
Serial port	Two serial ports for a PLC, bar code reader, and Memory Link device.	Serial 1 port is reserved for future expansion and not for PLC. Use an Ethernet port for connection to the host PLC.
Video input	The video input object can display video inputs from a video input board attached on the expansion I/F or RGB input board on the user screen.	You cannot connect an I/F board usable in NS series units. Video inputs are not available.
Project data	NS series-specific project data. No compatibility with NA series project data.	NA series-specific project data. No compatibility with NS series project data.
Support tool	You can edit and transfer project data with CX-Designer, which included in CX-One.	You can edit and transfer HMI project data with Sysmac Studio.
Memory on a host device	You can directly assign device addresses of a host PLC. Also, you can use variables. Tags are available while connecting via EtherNet/IP.	To specify the data for an HMI object, you can use a global variable. Also, you can specify a device address for a device variable where the global variable is assigned. Note that only tags are available while connecting via CIP Ethernet, and you cannot use device addresses.
The maximum sheets for one screen *A sheet is called as background page in NA.	10 sheets	1 sheet (page) However, you can use a base screen, to which a sheet is applied, as sheet in NA series units. Therefore, you can use more than one sheet.
PT clock setting	You can set or change the internal clock from the system menu, the date and time objects, and the system memory.	You cannot set the clock with the DateTime object. Use the system menu or a subroutine.
Pressing multiple points on the touch-screen at a time	You can press multiple points on the touch-screen at a time except in NS15 units.	NA units do not support pressing multiple points on the touch-screen at a time. However, pressing a function key at the bottom of the NA unit and a point on the touch-screen together is possible.  Also, you can press more than one Na's function key simultaneously.  Please consider modifying the implementation as needed.
System ten-key	Japanese language input, including single Kanji input, is available with a string input ten-key pad.	The IME input function enables Hiragana and Kanji input using Roman characters. You can input Chinese and other languages.
User-made keypad	You can create a user keypad using command buttons or <b>Key Button</b> of Multifunction, and the pop-up function. You can specify a keypad for each functional object.	The custom keypad function allows you to create a user keypad. Keypads are determined depending on what you input: the numeral and the hexadecimal keypads for numerical values, and the string keypad for character strings.
The number of pop-ups	Up to 3 pop-ups at a time	Only 1 pop-up
Macro (Called as Subroutine in NA)	You use NS-specific scripts. Macro set conditions are grouped by project, screen, and functional object. Project: Loading a project, alarm/event occurring, alarm/event cleared, bit changing, and value changing	Visual Basic 2008 (VB hereafter) is adopted. There are limited or extended functions. Subroutine descriptions in this document conform to Visual Basic. A subroutine is defined as either of global subroutine or page subroutine, and unlike NS series, you cannot

	Screen: Loading a screen and unloading a screen	create a subroutine for each object. Set conditions for subroutines are consolidated in Events. Some macros for NS series can be substituted with the Events and Actions feature of NA series. Please consider the macro behavior in replacing.
Password authentication for manipulating objects	You can create a password authentication, which requires a password for manipulating an object.	Please consider employing the account security method, which requires user authentication with a password on the login page and enables you to switch access to an object by the security level. See the alternative VB code in Chapter 5-9 for your reference.

## 4-2 Differences in Ethernet Host Connection

All NA series units connect to a host unit in an Ethernet port.

NS series units specifies all SYSMAC-NJ series units as “SYSMAC-NJ”, but in NA series, controllers are set by models, such as NJ, NX, and other. Change settings for the model of the controller to connect.

NS series		NA		
Communication Settings - Host Type	Communication Settings - Protocol	Device References - External Device - Device Configuration		
		Device Vendor	Device Series	[Communication Driver]
SYSMAC-CJ1	FINS	Omron	CJ	FINS Ethernet
SYSMAC-CJ2				
SYSMAC-CJ2	EtherNet/IP	Omron	CJ	CIP Ethernet
SYSMAC-NJ	EtherNet/IP	Omron	NJ	Ethernet
			NX7	
			NY	
			NX1P2	
			NX102	
			NX-CSG320	

## 4-3 Host Addresses and Variables

### 4-3-1 How to Assign Data

For NS series units, information about the contacts and channels of a host, which is assigned to a functional object or alarm, is specified by using a device address, variable, or tag (network variable). Device address is referred as just “address” in CX-Designer.

Device to Connect	Data	Data Type Assignment in NS
CJ1/CJ2	Device address	The data type will be automatically selected for a functional object using a device address.
CJ2/NJ	Tag (Network variable)	The data type selected for a variable will be used.
NJ	Global variable	

In NA series, data are assigned to objects with NA *Global Variables* or *System Variables* in all cases.

You need to map host addresses of connecting devices, variables, and tags (network variables) to global variables of the NA series.

Device to Connect	Data	Variable mapping	Data Type Assignment in NA	Remarks
CJ1/CJ2	Device address	Required	Though device addresses do not require data types, you need to	Select a data type according to a functional object used in

			select adequate data types in the NA series.	the NS unit.
CJ2/NJ	Tag (Network variable)	Required	The data type set for the variable will be used.	
NJ	Global variable	Required		
-	Global variable	Not required	You can map the global variables.	NA's internal variables
-	System variable	Not required	Use the data types given by the system.	

### Precautions for Correct Use

When mapping a host address of a connecting device to an NA global variable, pay particular attention to the size of the global variable. For instance, mapping the whole DM area to an array may burden the data transmission and impair the NA unit's responsiveness.

### 4-3-2 Variable Data Type Conversion

NS series units comply with data types of CJ series and NJ/NX series.

In NA series units, data types of global variables and device variables are VB data type and data types depending on devices, respectively.

When you enter a device variable in **AT** of the **Global Variables** tab page and their data types are different, the data acquired from the device will be automatically converted according to the data type. The data that changed in the HMI will be reversibly converted. Data types other than BCD will be converted to the same types, but named differently.

NS Data Type				NA Data Type		
Data Type	Size	Data Type	Location	Device Variable		Global variable
				CJ	NJ	
Boolean	1-bit	BOOL	Format for storing functional object value, variable, and tag	BOOL		Boolean
Signed integer	1 bytes	SINT		-	SINT	SByte
Unsigned integer	1 bytes	BYTE USINT		-	BYTE USINT	Byte
Signed integer	2-byte	INT		INT		Short
Unsigned integer		WORD UINT CHANNEL		WORD UINT		UShort
Signed integer	4-byte	DINT		DINT		Integer
Unsigned integer		UDINT DWORD		UDINT DWORD		UInteger
Floating point		REAL		REAL		Single

Signed integer	8-byte	LINT		LINT		Long
Unsigned integer		ULINT LWORD		ULINT LWORD		ULong
Floating point		LREAL		LREAL		Double
Character string	Variable length	STRING		STRING		String
Date & Time		-		TIME	-	TIME
	DATE		-	DATE		
	TIME_OF_DAY		-	TIME_OF_DAY		
	DATE_AND_TIME		-	DATE_AND_TIME		

The following shows data types of BCD variables.

Because BCD type is not available in [Global Variables], use a signed or unsigned integer type for signed or unsigned NS data type, respectively.

NS Data Type				NA Data Type		
Data Type	Size	Data Type	Location	Device Variable		Global variable
				CJ	NJ	
Unsigned BCD integer (For CJ only)	2-byte	UINT_BCD	Variable and tag	UINT_BCD	-	UShort
	4-byte	UDINT_BCD		UDINT_BCD	-	UInteger
	8-byte	ULINT_BCD		ULINT_BCD	-	ULong
Unsigned BCD integer	4-byte	BDC2 (Unsigned 1-WORD)	Value storing format for functional objects	UINT_BCD	-	UInteger
	8-byte	BDC2 (Unsigned 2-WORD)		UDINT_BCD	-	ULong
Signed BCD integer	4-byte	BCD1 (Signed 1-WORD, highest-order digit is F)	Value storing format for functional objects	Convert the data type with the PLC program because the signed BCD integer is unavailable in the NA series.		
		BCD2 (Signed 1-WORD, upper1-bit)				
	8-byte	BCD1 (Signed 2-WORD, highest-order digit is F)				
		BCD2 (Signed 1-WORD, upper 1-bit)				

When you use a structure or a union, pay attention to the member structure and data type consistency of member variables.

### 4-3-3 Processing BCD Type

If your HMI is connected to a PLC older than the CJ series, in some cases, most of the data in the PLC are treated as the BCD type integer values.

In NS series units, you can determine whether to handle the integers as BCD type or BIN type integer by specifying in the property of a function or functional object. If the data in the PLC are BCD type, they are handled as BCD integers.

On the other hand, in NA series units, only BIN integers are available in internal processing but not BCD integers. However, if data is set to a BCD type integer, such as UINT\_BCD, DINT\_BCD, LINT\_BCD, in the **Data Type** field of the **Device Variables** pane and it is mapped to a global variable, the PLC will handle the data as the BCD type integer and NA can automatically convert BCD-BIN internally. Just after being imported, the data type of the imported device variable is either of CHANNEL, DWORD, or LWORD. Change the data type to UINT\_BCD, DINT\_BCD, or LINT\_BCD, respectively.

This auto-conversion function is not available for a signed BCD integer. You must set variables in the NA series with variable types according to the number of bytes stored, and must convert the BCD and BIN types using a VB program on the NA or a program on the PLC.

### 4-3-4 Specify Device Address of NS

In the NA series, specify device addresses in the **Device Variables** pane. Enter a device address

in the **AT** field.

You can use a device address directly for specifying the functional object data in the NS series. On the other hand, device address specification method in NA is an indirect way using a device variable and global variable: you specify the with a global variable and specify a device Variables for the AT, and a device address for the AT of the device variable. Also, the global variable and device variable have variable types. You need to specify correct types for each variable.

Replace data specification with the initial address and the number of access points, which used for a broken-line graph and macro in NS, with the method using an array containing the same number of elements as the access points.

Specified device addresses in the NS series unit are registered to the CX-Designer’s variable table with names “AutoGen + number.” Only the initial address of the contact data is registered as **BOOL**, and the numeral or string data as **CHANNEL**, respectively. The variable table does not include information of how to handle as other data types, such as signed or unsigned, BCD, array, and others. Check the settings of the functional object to which the address or variable is assigned to select a correct variable type.

#### 4-3-5 How to Connect to CJ Series Unit

For data assignment in connecting to a CJ series PLC via CIP Ethernet, you can use tags only. Therefore, you may need to change the data assignment method or connection method depending on the current data assignment.

		Where to be assigned in NS	Connection in NA	
			FINS Ethernet	CIP Ethernet
NS Connection in	FINS	Device address	With no change	<b>To tags</b>
		Variable		
	EtherNet/IP	Device address	With no change	<b>To tags</b>
		Variable		
		Tag	<b>Tags to variables</b>	With no change

Connection via CIP Ethernet	<p>Replace all the variables and device addresses used for data specification with tags. In addition, register the tags to a CJ series CPU Unit as network variables. Conduct the following procedure.</p> <p><b>To Tags</b></p> <ol style="list-style-type: none"> <li>1. Import variables to device variables following the procedures in “4-3-7 Import CX-Programmer Variable Table to NA Device Variables” and “4-3-9 Import NS Variable Table to NA Device Variables.”</li> <li>2. Click the header <b>AT</b> of the <b>Device Variables</b> pane in Sysmac Studio to sort the variables by AT.</li> <li>3. Select the variables whose AT fields are filled and copy them with the Ctrl + C keys.</li> <li>4. Paste them with the Ctrl + V on the Symbol Table edit pane of CX-Programmer. The <b>Paste Symbol</b> dialog appears. Select the <b>Comment</b> column and click the <b>Left</b> button to move an AT specification to the <b>Address</b> column. Click <b>OK</b> to finalize variable pasting.</li> </ol>
-----------------------------	--



	<ol style="list-style-type: none"> <li>5. Double-click each pasted variable to display the <b>New Symbol</b> dialog, then check the <b>Net. Variable</b> box and click <b>OK</b> to handle the variables as network variables.</li> <li>6. Return to the <b>Device Variables</b> edit pane and delete AT of the variable whose <b>AT</b> is set to treat it as tag.</li> </ol>
Connection via FINS Ethernet	<p>The network configuration will change following the change in communications from Ether IP. Therefore, you need to change the FINS network configuration, such as FINS node address and FINS routing table.</p> <p>If you are using tags for data assignment, replace the tags with variables.</p> <p><b>Tags to variables</b></p> <ol style="list-style-type: none"> <li>1. First, import variables to device variables following the procedures in “4-3-7 Import CX-Programmer Variable Table to NA Device Variables” and “4-3-9 Import NS Variable Table to NA Device Variables.”</li> <li>2. Click the header <b>AT</b> of the <b>Device Variables</b> pane in Sysmac Studio to sort the variables by AT. Then extract tags whose <b>AT</b> fields are empty. Perform the following for the extracted tags.</li> <li>3. Search for tags with the same names in the variable table edit pane of CX-Programmer. Check the <b>Address/Value</b> column.</li> <li>4. Set the values of <b>Address/Value</b> in CX-Programmer to the <b>AT</b> fields of the tags in the <b>Device Variables</b> pane of Sysmac Studio.</li> </ol>

Refer to “NA-series Programmable Terminal Device Connection User's Manual” (V119) for details.

#### 4-3-6 Where to Register NS Variables

In the NS series, device address specifications, variables, and tags are registered to the variable table of CX-Designer. Variables in the NA series are registered as shown in the table below.

NS Connecting Host	Import to
NS internal memory (PTMEM)	Global Variables HMI – Data – Global Variables
Serial connection	Device Variables Configurations and Setup - Device References - External Device - Variable  *Select the host name for <b>External Device</b> .
FINS connection host	
Ethernet/IP connection host	

Refer to Section 3 “Connecting an OMRON NJ/NX/NY-series Controller” in “NA-series Programmable Terminal Device Connection User’s Manual” (V119) for details on importing the variable table while connecting to an NJ series unit.

You can import the data from the CX-Designer variable table following the procedures in “4-3-8 Import NS Variable Table to NA Global Variables” and “4-3-9 Import NS Variable Table to NA Device Variables,” though it is not an intuitive operation like the one Sysmac Studio or CX-Programmer provides.

#### 4-3-7 Import CX-Programmer Variable Table to NA Device Variables

Refer to Section 4 “Connecting an OMRON CJ-series PLC” in “NA-series Programmable Terminal Device Connection User’s Manual” (V119) for details on importing data from the CX-Programmer variable table while connecting to a CJ series unit.

#### 4-3-8 Import NS Variable Table to NA Global Variable

Import the variables assigned to the internal NS memory (PTMEM) to NA’s global variables.

1. Open the Symbol (variable) Table in CX-Designer.
2. Press the **All** button under **Host** to filter hosts.

Symbol Table

Host	Name	Type	Address Type/Number	I/O Comment	Tag
All		All	All		All
PTMEM	AutoGen1	BOOL	\$B0		None
PTMEM	AutoGen2	CHANNEL	\$W0		None
PTMEM	AutoGen3	BOOL	\$SB0		None
PTMEM	AutoGen4	BOOL	\$SB11		None
PTMEM	AutoGen5	CHANNEL	\$SW6		None
PTMEM	AutoGen6	CHANNEL	\$SW7		None
PTMEM	AutoGen7	CHANNEL	\$SW8		None
PTMEM	AutoGen8	CHANNEL	\$SW12		None
PTMEM	AutoGen9	BOOL	\$SB9		None
PTMEM	AutoGen10	BOOL	\$B1		None
HOST3	AutoGen11	CHANNEL	00000i0		None
HOST3	AutoGen12	CHANNEL	00000i4		None
HOST4	TAG_Z	CHANNEL[10]			Network Variable

3. Select **PTMEM** to display PTMEM (Internal NS memory) variables only.

Symbol Table

Host	Name	Type	Address Type/Number	I/O Comment	Tag
PTMEM		All	All		All
PTMEM	AutoGen1	BOOL	\$B0		None
PTMEM	AutoGen2	CHANNEL	\$W0		None
PTMEM	AutoGen3	BOOL	\$SB0		None
PTMEM	AutoGen4	BOOL	\$SB11		None
PTMEM	AutoGen5	CHANNEL	\$SW6		None
PTMEM	AutoGen6	CHANNEL	\$SW7		None
PTMEM	AutoGen7	CHANNEL	\$SW8		None
PTMEM	AutoGen8	CHANNEL	\$SW12		None
PTMEM	AutoGen9	BOOL	\$SB9		None
PTMEM	AutoGen10	BOOL	\$B1		None

4. Press the Ctrl + A keys to select all and the Ctrl + C keys to copy to the buffer.
5. Paste into an empty Excel sheet.
6. Move column E (I/O comment) to column I.
7. Fill up columns E and F in all the rows with data with “FALSE.” In the same way, enter “0” and “” in columns G and H, respectively.
8. If a string in column D, Address Type/Number, begins with “\$H,” change column E to “TRUE.”
9. Insert a column to the left of column D.
10. Delete column A (Host).
11. Select columns from A to H of the rows with data and press the Ctrl + C keys to copy.
12. Select **Data - Global Variables** in Sysmac Studio and paste.

Name	Data Type	Initial Value	AT	Retain	Constant	Update Rate	Scaling	Comment
AutoGen1	BOOL		\$B0	<input type="checkbox"/>	<input type="checkbox"/>	None	None	
AutoGen2	CHANNEL		\$W0	<input type="checkbox"/>	<input type="checkbox"/>	None	None	
AutoGen3	BOOL		\$SB0	<input type="checkbox"/>	<input type="checkbox"/>	None	None	
AutoGen4	BOOL		\$SB11	<input type="checkbox"/>	<input type="checkbox"/>	None	None	
AutoGen5	CHANNEL		\$SW6	<input type="checkbox"/>	<input type="checkbox"/>	None	None	
AutoGen6	CHANNEL		\$SW7	<input type="checkbox"/>	<input type="checkbox"/>	None	None	
AutoGen7	CHANNEL		\$SW8	<input type="checkbox"/>	<input type="checkbox"/>	None	None	
AutoGen8	CHANNEL		\$SW12	<input type="checkbox"/>	<input type="checkbox"/>	None	None	
AutoGen9	BOOL		\$SB9	<input type="checkbox"/>	<input type="checkbox"/>	None	None	
AutoGen10	BOOL		\$B1	<input type="checkbox"/>	<input type="checkbox"/>	None	None	

13. Unusable Data Type and AT will be shown in pink. Modify them in the next step.

Refer to “4-3-2 Variable Data Type” for how to replace data types.

In this example, change BOOL to Boolean and CHANNEL to Ushort, respectively.

Data in AT column are displayed as error because the letter “\$” at the top is not allowed by the Na series variable naming rules.

If a device is assigned to the system memory \$SB or \$SW, refer to “4-5 System Memory” to replace with a system variable or other.

#### 4-3-9 Import NS Variable Table to NA Device Variables

Import the variables assigned to a host device connected to the Ethernet port or serial port to NA device variables.

If you have imported the variables of the host from the CX-Programmer’s symbol table, variables you are going to import may have the same name and get duplicated.

1. Open the Symbol (variable) Table in CX-Designer.
2. Press the **All** button under **Host** to filter hosts.
3. Press the Ctrl + A keys to select all and the Ctrl + C keys to copy.
4. Paste into an Excel sheet.
5. Delete column A.
6. Insert a column to column C.
7. Select columns from A to D of the rows with data and press the Ctrl + C keys to copy.
8. Select **Device References - External Device - Variables** in Sysmac Studio. Then Select **Paste** from the right-click menu to import variables.
9. Unusable Data Type and AT will be shown in pink. Modify them in the next step.

Refer to the table in “4-3-2 Variable Data Type” for replacing data types.

For example, importing a variable whose type is SINT or CHANNEL results in an error. Modify the data type to WORD or UINT according to the original data type.

## 4-4 Project Settings and Functional Objects

This section provides comparative tables of functions of NS series and NA series.  
Refer to appendices for details of properties.

### 4-4-1 Appendix 1: Project Common Settings

NS	NA	Remarks	Item in Appendix
System Memory	System Variable	-	System Memory
Alarm/Event	HMI - User Alarms	-	Alarm
Unit/Scale	HMI - Scale Transformations	Only scale transformation is supported. Unit transformation is not available.	Scale
Broken-line Graph	HMI - Data Group	-	Broken-line Graph
Data Block	HMI - Recipe	Resources is the corresponding function but settings and features are quite different.	Data Block
Data Log	HMI - Data Logging	-	Data Log
Operation Log	Configurations and Setup - Operation Log Settings	-	-
Dialog Setting	No corresponding function	-	-
String Table	HMI - Resources	Resources is the corresponding function but settings and features are quite different.	-

→ Appendix 1: Project Common Settings

### 4-4-2 Appendix 2: Object Common Settings

NS	NA	Remarks	Item in Appendix
Frame	Standard Controls - Tab Control	-	Frame
Common Setting of Object: Frame	No corresponding function	-	-
Common Setting of Object: Flicker	No corresponding function	-	-
Common Setting of Object: Text Attributes	Object - Properties - Appearance - Font	-	Text Attributes
Common Setting of Object: Control Flag	Object - Properties - Behavior Object - Animations - Enable Object - Animations - Visibility	-	Common of Parts
Common Setting of Object: Size/Position	Object - Properties - Layout	-	

→ Appendix 2: Object Common Settings

### 4-4-3 Appendix 3: Buttons

NS	NA	Remarks	Item in Appendix
ON/OFF Button (Momentary)	Buttons - MomentaryButton	-	ON/OFF Button ON/OFF Button_Shape
ON/OFF Button (Alternate)	Buttons - ToggleButton	To group objects into a radio button, go Standard Controls - Radio Button.	
ON/OFF Button (SET)	Buttons - SetButton	-	
ON/OFF Button (RESET)	Buttons - ResetButton	-	
Word Button (Set Value)	Buttons - Button	Select <b>SetVariable</b> from <b>Events and Actions</b> to set an input value.	Word Button Word Button_Shape
Word Button (Increment/Decrement)	Button - Button	Select <b>IncreaseVariable</b> or <b>DecreaseVariable</b> from <b>Events and Actions</b> , to set increase/decrease value.	
Word Button (Display Pop-up Menu)	Standard Controls - DropDown	-	
Command Button (Switch Screen)	Buttons - Button	Select <b>ShowPage</b> from <b>Events and Actions</b> to specify an destination screen.	Command Button Command Button_Function Command Button_DB
Command Button (Backward)	Button - Button	Select <b>ShowPreviousPage</b> from <b>Events and Actions</b> .	
Command Button (Key Button)	-	This function cannot be substitute by a part. A subroutine can partly perform the function.	
Command Button (Control Pop-up Screen - Close pup-up screen)	Button - Button	Select <b>ClosePage</b> from <b>Events and Actions</b> to specify the page name to close.	
Multifunction	Button - Button	No dedicated part. Setting more than one event or action in <b>Events and Actions</b> enables to perform multiple functions with one part.	Multifunction Multifunction_Function

→ Appendix 3: Buttons

#### 4-4-4 Appendix 4: Lamps

NS	NA	Remarks	Item in Appendix
Bit Lamp	Lamps - Bit Lamp	-	Bit Lamp Bit Lamp_Shape
Word Lamp	Lamps - Data Lamp	-	Word Lamp Word Lamp_Shape
Text	Standard Controls - Label or Standard Controls - TextBox	-	Text
Text (Message Display)	Lamps - Data Lamp	Unlike NS series units, you cannot change the font type and size for every state. Colors of backgrounds and texts are changeable.	-
Numeral Display & Input/ String Display Input (Input Enable)	Standard Controls - Data Edit	-	Numeral Display String Display
Numeral Display & Input/ String Display Input (Input Disable)	Standard Controls - Data Display	-	
List Selection	Standard Controls - ListBox	-	List
Thumbwheel Switch	No corresponding function	There is no replaceable single object. You can create a similar function by combining data display parts and event/action of a button.	-
Date Object	Standard Controls - DateTime	Displaying date and time are performed in one setting. You can display date only or time only by configuring the display format. In NA series units, the date/time setting is not available in the form of functional object.	DateTime DateTime_Format
Time Object			
Bitmap	Standard Controls - Image	-	BMP

→ Appendix 4: Lamps

#### 4-4-5 Appendix 5: Graphs

NS	NA	Remarks	Item in Appendix
Level Meter	Gauges - Linear Gauge (Horizontal/Vertical)	-	Level Meter
Analogue Meter	Gauges - Rotational Gauge	-	Analogue Meter
Broken-line Graph	HMI Controls - Broken-line Graph	-	Broken-line Graph
Data Log Graph	HMI Controls - Trend Graph	-	Data Log DateTime_Format

→ Appendix 5: Graphs

## 4-4-6 Appendix 6: Alarms

NS	NA	Remarks	Item in Appendix
Alarm/Event Display	No corresponding function	-	-
Alarm/Event Summary and History	HMI Controls - User Alarms Viewer	<i>HistoricalMode</i> is selected	Alarm History
Data Block Table	HMI Controls - Recipe Viewer	-	Data Block
Contents Display	Lamps - Data Lamp	You cannot change the color or font of texts for every state.	Contents Display
Video Display	No corresponding function	-	-
Temporary Input	No corresponding function	-	-
Consecutive Line Drawing	No corresponding function	-	-

→ Appendix 6: Alarms

## 4-5 System Memory

NS series units has bits and integers for states of system operation in the range of \$SB0 to 63 and \$SW0 to 40 in the PT Memory.

In the NA series, you can duplicate the system memory functions of the NS series with system variables, Events and Actions function, and subroutines.

There are no system variables for the functions unavailable in NA series, e.g., Video Input.

A system variable that has a corresponding function may have different behavior or value, e.g., beginning with 0 or 1.

Refer to System Memory in “4-4-1 Appendix 1: Project Common Settings” for details.

For the system memories \$SB54 to 58 and \$SW39, regarding the password function, see “5-9 Password.”

## 4-5-1 System Memory: Variable Mapping

This section shows how to replace system memories, supported by variable mapping in the System Memory sheet in “Appendix 1: Project Common Settings.”

The procedure depends on whether you have assigned the system memory to a connecting host unit or used inside the NS unit.

The following provides how to replace the system memory that has been assigned to a connecting host unit.

This is an example of the system memory \$SB0 assigned to WR0.00 in the host unit.

1. Create a variable of WR0.0 in the Variables tab in Device References.
2. In the Variable Mapping tab, assign the system variable `_HMI_RunSignal` to the variable you have created in Step 1.

### Step 1

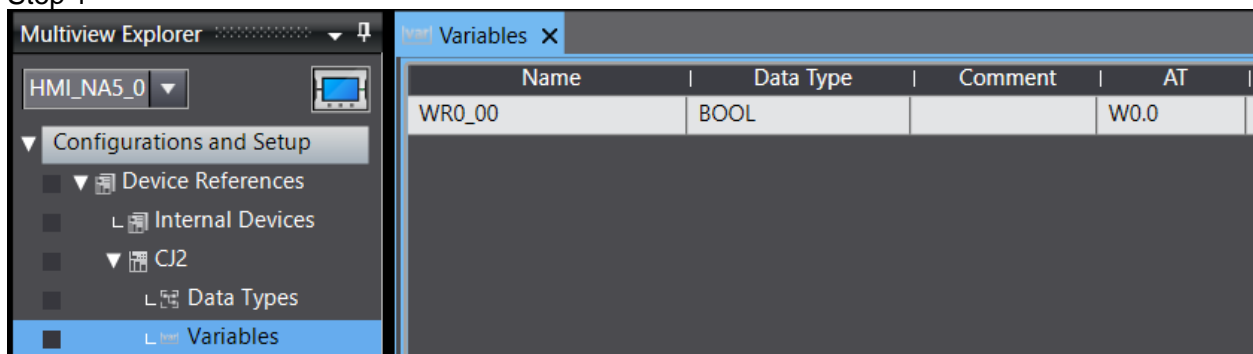

### Step 2

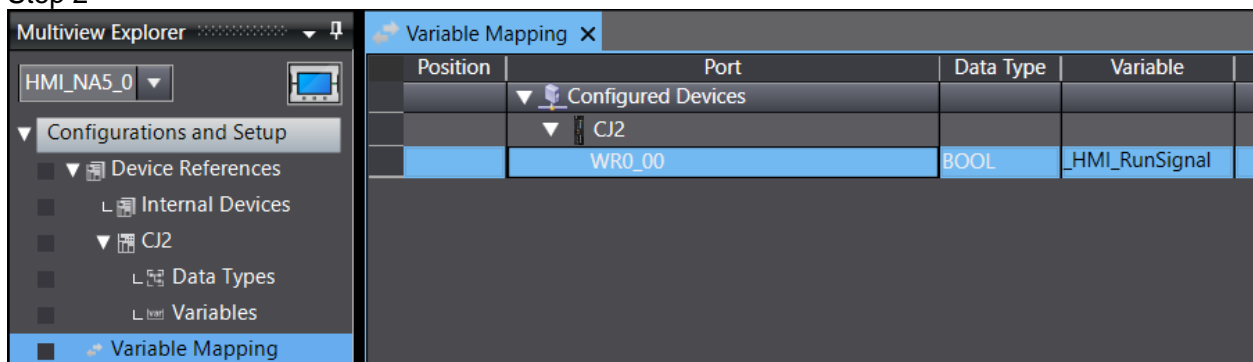

The following describes how to replace the system memory that you have used inside the NS unit. This is an example of the system memory \$SB0 assigned to the display address of a Bit Lamp Object.

1. Enter `_HMI_RunSignal` in the Expression property of the Bit Lamp Object.

### Property Setting





Other system memories, which are supported by variable mapping, can be replaced in the same manner.

## 4-5-2 System Memory: Global Event

This section shows how to replace system memories, supported by global event in the System Memory sheet in “Appendix 1: Project Common Settings.”

The following describes how to replace the system memory that you have used inside the NS unit. A variable name is either SB\*\* or SW\*\*.

If you have assigned the system memory to the connecting host unit, map the system memory to a variable in advance.

Then, replace \$SB\*\* or \$SW\*\* with the mapped variable name.

1. Write a subroutine that will be executed when \$SB\*\* turns ON or OFF, according to the table below.
2. In **Condition of Events** under **Events and Actions** of the global event, Enter *Variable 1* in the **Expression** box and any event in the **Actions**.

Enter *Not Variable 1* in the **Expression** box and any event in the **Actions**.

This event will be executed only once when the condition is met.

You use Global Subroutines in this chapter.

This chapter describes the procedure using a global subroutine group *SystemMemoryAction* to add subroutines. Prepare the global subroutine group *SystemMemoryAction* in advance.

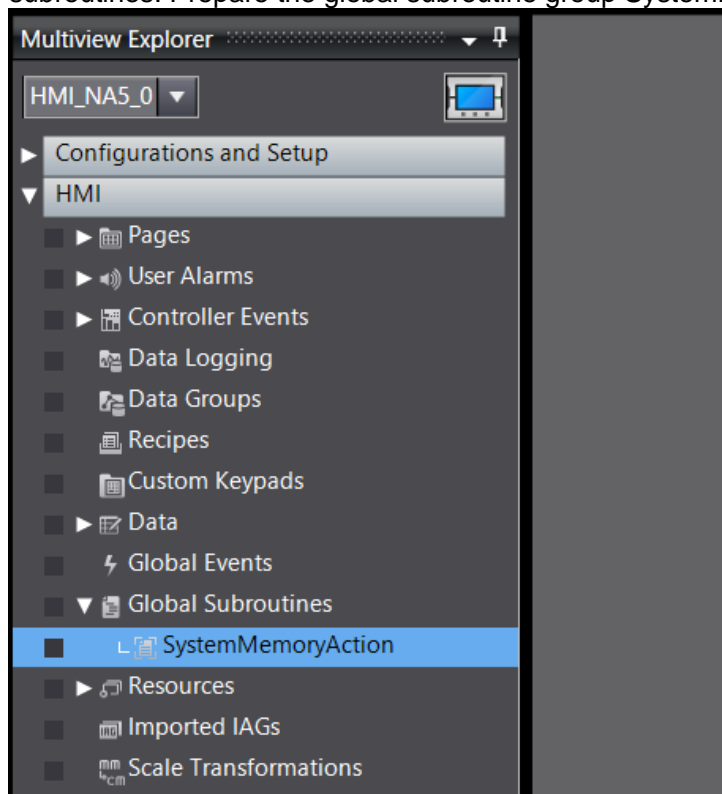

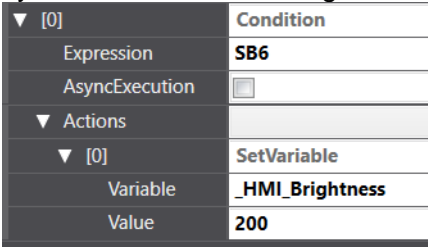
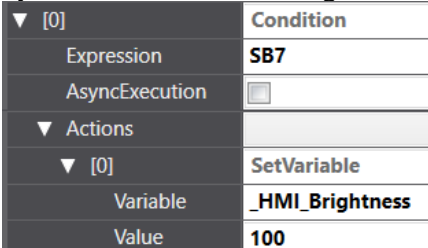
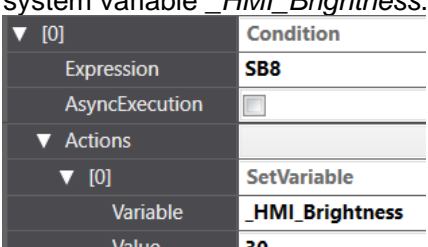
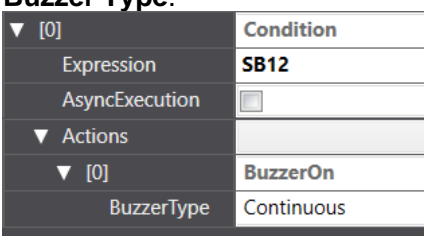
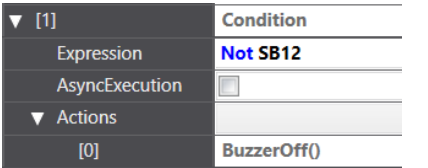
NS System Memory		How to Reproduce in NA	
		Execution Condition	Setting Up Global Events
\$SB6	Brightness Adjust (High) *1	ON	<p>Click <b>Actions - SetVariable</b>, and enter a value for the system variable <u>HMI_Brightness</u>.</p> 
\$SB7	Brightness Adjust (Middle) *1	ON	<p>Click <b>Actions - SetVariable</b>, and enter a value for the system variable <u>HMI_Brightness</u>.</p> 
\$SB8	Brightness Adjust (Low) *1	ON	<p>Click <b>Actions - SetVariable</b>, and enter a value for the system variable <u>HMI_Brightness</u>.</p> 
\$SB12	Continuous Buzzer	ON	<p>Click <b>Actions - BuzzerOn</b>, and select <i>Continuous</i> in <b>Buzzer Type</b>.</p> 
		OFF	<p>Select <i>BuzzerOff</i> in <b>Actions</b>.</p> 
\$SB13	Short Intermittent Buzzer	ON	<p>Click <b>Actions - BuzzerOn</b>, and select <i>Intermittent Short Pulse</i> in <b>Buzzer Type</b>.</p>

			<table border="1"> <tr><td>▼ [0]</td><td>Condition</td></tr> <tr><td>Expression</td><td><b>SB13</b></td></tr> <tr><td>AsyncExecution</td><td><input type="checkbox"/></td></tr> <tr><td>▼ Actions</td><td></td></tr> <tr><td>▼ [0]</td><td>BuzzerOn</td></tr> <tr><td>BuzzerType</td><td><b>Intermittent Short Pulse</b></td></tr> </table>	▼ [0]	Condition	Expression	<b>SB13</b>	AsyncExecution	<input type="checkbox"/>	▼ Actions		▼ [0]	BuzzerOn	BuzzerType	<b>Intermittent Short Pulse</b>
▼ [0]	Condition														
Expression	<b>SB13</b>														
AsyncExecution	<input type="checkbox"/>														
▼ Actions															
▼ [0]	BuzzerOn														
BuzzerType	<b>Intermittent Short Pulse</b>														
		OFF	<p>Select <i>BuzzerOff</i> in <b>Actions</b>.</p> <table border="1"> <tr><td>▼ [1]</td><td>Condition</td></tr> <tr><td>Expression</td><td><b>Not SB13</b></td></tr> <tr><td>AsyncExecution</td><td><input type="checkbox"/></td></tr> <tr><td>▼ Actions</td><td></td></tr> <tr><td>[0]</td><td>BuzzerOff()</td></tr> </table>	▼ [1]	Condition	Expression	<b>Not SB13</b>	AsyncExecution	<input type="checkbox"/>	▼ Actions		[0]	BuzzerOff()		
▼ [1]	Condition														
Expression	<b>Not SB13</b>														
AsyncExecution	<input type="checkbox"/>														
▼ Actions															
[0]	BuzzerOff()														
\$SB14	Long Intermittent Buzzer	ON	<p>Click <b>Actions - BuzzerOn</b>, and select <i>Intermittent Long Pulse</i> in <b>Buzzer Type</b>.</p> <table border="1"> <tr><td>▼ [0]</td><td>Condition</td></tr> <tr><td>Expression</td><td><b>SB14</b></td></tr> <tr><td>AsyncExecution</td><td><input type="checkbox"/></td></tr> <tr><td>▼ Actions</td><td></td></tr> <tr><td>▼ [0]</td><td>BuzzerOn</td></tr> <tr><td>BuzzerType</td><td><b>Intermittent Long Pulse</b></td></tr> </table>	▼ [0]	Condition	Expression	<b>SB14</b>	AsyncExecution	<input type="checkbox"/>	▼ Actions		▼ [0]	BuzzerOn	BuzzerType	<b>Intermittent Long Pulse</b>
		▼ [0]	Condition												
Expression	<b>SB14</b>														
AsyncExecution	<input type="checkbox"/>														
▼ Actions															
▼ [0]	BuzzerOn														
BuzzerType	<b>Intermittent Long Pulse</b>														
OFF	<p>Select <i>BuzzerOff</i> in <b>Actions</b>.</p> <table border="1"> <tr><td>▼ [1]</td><td>Condition</td></tr> <tr><td>Expression</td><td><b>Not SB14</b></td></tr> <tr><td>AsyncExecution</td><td><input type="checkbox"/></td></tr> <tr><td>▼ Actions</td><td></td></tr> <tr><td>[0]</td><td>BuzzerOff()</td></tr> </table>	▼ [1]	Condition	Expression	<b>Not SB14</b>	AsyncExecution	<input type="checkbox"/>	▼ Actions		[0]	BuzzerOff()				
▼ [1]	Condition														
Expression	<b>Not SB14</b>														
AsyncExecution	<input type="checkbox"/>														
▼ Actions															
[0]	BuzzerOff()														
\$SB19	Prohibit Input *2	ON	<p>Check the Enable box for <b>Actions - EnableInputOperation</b>.</p> <table border="1"> <tr><td>▼ [0]</td><td>Condition</td></tr> <tr><td>Expression</td><td><b>SB19</b></td></tr> <tr><td>AsyncExecution</td><td><input type="checkbox"/></td></tr> <tr><td>▼ Actions</td><td></td></tr> <tr><td>▼ [0]</td><td>EnableInputOperation</td></tr> <tr><td>Enable</td><td><input type="checkbox"/></td></tr> </table>	▼ [0]	Condition	Expression	<b>SB19</b>	AsyncExecution	<input type="checkbox"/>	▼ Actions		▼ [0]	EnableInputOperation	Enable	<input type="checkbox"/>
		▼ [0]	Condition												
Expression	<b>SB19</b>														
AsyncExecution	<input type="checkbox"/>														
▼ Actions															
▼ [0]	EnableInputOperation														
Enable	<input type="checkbox"/>														
OFF	<p>Uncheck the Enable box for <b>Actions - EnableInputOperation</b>.</p> <table border="1"> <tr><td>▼ [0]</td><td>Condition</td></tr> <tr><td>Expression</td><td><b>Not SB19</b></td></tr> <tr><td>AsyncExecution</td><td><input type="checkbox"/></td></tr> <tr><td>▼ Actions</td><td></td></tr> <tr><td>▼ [0]</td><td>EnableInputOperation</td></tr> <tr><td>Enable</td><td><input checked="" type="checkbox"/></td></tr> </table>	▼ [0]	Condition	Expression	<b>Not SB19</b>	AsyncExecution	<input type="checkbox"/>	▼ Actions		▼ [0]	EnableInputOperation	Enable	<input checked="" type="checkbox"/>		
▼ [0]	Condition														
Expression	<b>Not SB19</b>														
AsyncExecution	<input type="checkbox"/>														
▼ Actions															
▼ [0]	EnableInputOperation														
Enable	<input checked="" type="checkbox"/>														
\$SB25	Start Printing/Capture Screen	ON	<p>Select <i>SaveScreenshot</i> for <b>Actions</b> and specify the destination in the <b>RootFolder</b> box.</p> <table border="1"> <tr><td>▼ [0]</td><td>Condition</td></tr> <tr><td>Expression</td><td><b>SB25</b></td></tr> <tr><td>AsyncExecution</td><td><input type="checkbox"/></td></tr> <tr><td>▼ Actions</td><td></td></tr> <tr><td>▼ [0]</td><td>SaveScreenshot</td></tr> <tr><td>RootFolder</td><td>SD Card</td></tr> </table>	▼ [0]	Condition	Expression	<b>SB25</b>	AsyncExecution	<input type="checkbox"/>	▼ Actions		▼ [0]	SaveScreenshot	RootFolder	SD Card
▼ [0]	Condition														
Expression	<b>SB25</b>														
AsyncExecution	<input type="checkbox"/>														
▼ Actions															
▼ [0]	SaveScreenshot														
RootFolder	SD Card														

\$SB32	Initialize Alarm/Event History	ON	<p>Substitute this with the NA function <i>ClearUserAlarmLog()</i>. Copy and paste the following subroutine in the global subroutine in advance.</p> <pre>Sub SB32Action   'Initialize Alarm/Event history   ClearUserAlarmLog()   'Automatically off SB32   SB32 = False End Sub</pre> <p>Then, create an event, select CallSubroutine in Actions, and register the subroutine. The following is an example.</p> <table border="1" data-bbox="699 640 1305 831"> <tr> <td>▼ [0]</td> <td>Condition</td> </tr> <tr> <td>Expression</td> <td>SB32</td> </tr> <tr> <td>AsyncExecution</td> <td><input type="checkbox"/></td> </tr> <tr> <td>▼ Actions</td> <td></td> </tr> <tr> <td>▼ [0]</td> <td>CallSubroutine</td> </tr> <tr> <td>SubroutineName</td> <td>SystemMemoryAction.SB32Action</td> </tr> </table>	▼ [0]	Condition	Expression	SB32	AsyncExecution	<input type="checkbox"/>	▼ Actions		▼ [0]	CallSubroutine	SubroutineName	SystemMemoryAction.SB32Action
▼ [0]	Condition														
Expression	SB32														
AsyncExecution	<input type="checkbox"/>														
▼ Actions															
▼ [0]	CallSubroutine														
SubroutineName	SystemMemoryAction.SB32Action														
\$SB33	Save Alarm/Event History	ON	<p>Select <i>SaveUserAlarmLogToFile</i> for <b>Actions</b>. Since \$SB33 automatically turns OFF after the execution, add an action for the process of turning OFF \$SB33. In the following settings, the log data will be saved as <i>UserAlarmLog.csv</i> in the Root folder in the SD card.</p> <table border="1" data-bbox="699 1055 1305 1267"> <tr> <td>▼ [0]</td> <td>Condition</td> </tr> <tr> <td>Expression</td> <td>SB33</td> </tr> <tr> <td>AsyncExecution</td> <td><input type="checkbox"/></td> </tr> <tr> <td>▼ Actions</td> <td></td> </tr> <tr> <td>▼ [0]</td> <td>SaveUserAlarmLogToFile</td> </tr> <tr> <td>FileName</td> <td>"\SDCard\UserAlarmLog.csv"</td> </tr> </table>	▼ [0]	Condition	Expression	SB33	AsyncExecution	<input type="checkbox"/>	▼ Actions		▼ [0]	SaveUserAlarmLogToFile	FileName	"\SDCard\UserAlarmLog.csv"
▼ [0]	Condition														
Expression	SB33														
AsyncExecution	<input type="checkbox"/>														
▼ Actions															
▼ [0]	SaveUserAlarmLogToFile														
FileName	"\SDCard\UserAlarmLog.csv"														
\$SB35	Initialize Data Log	ON	<p>Substitute this with the NA function <i>ClearDataLogBuffer(DataSetName)</i>. Copy and paste the following subroutine in the global subroutine in advance.</p> <pre>Sub SB35Action   'Initialize data log   'Specify data set to initialize as argument   ClearDataLogBuffer("DataSetName")   'Automatically off SB35   SB35 = False End Sub</pre> <p>Then, create an event, select CallSubroutine in Actions, and register the subroutine. The following is an example.</p> <table border="1" data-bbox="699 1783 1305 1973"> <tr> <td>▼ [0]</td> <td>Condition</td> </tr> <tr> <td>Expression</td> <td>SB35</td> </tr> <tr> <td>AsyncExecution</td> <td><input type="checkbox"/></td> </tr> <tr> <td>▼ Actions</td> <td></td> </tr> <tr> <td>▼ [0]</td> <td>CallSubroutine</td> </tr> <tr> <td>SubroutineName</td> <td>SystemMemoryAction.SB35Action</td> </tr> </table>	▼ [0]	Condition	Expression	SB35	AsyncExecution	<input type="checkbox"/>	▼ Actions		▼ [0]	CallSubroutine	SubroutineName	SystemMemoryAction.SB35Action
▼ [0]	Condition														
Expression	SB35														
AsyncExecution	<input type="checkbox"/>														
▼ Actions															
▼ [0]	CallSubroutine														
SubroutineName	SystemMemoryAction.SB35Action														
\$SB36	Save Data Log	ON	<p>Substitute this with the NA function <i>ExportDataLogBuffer(DataSetName)</i>.</p>												

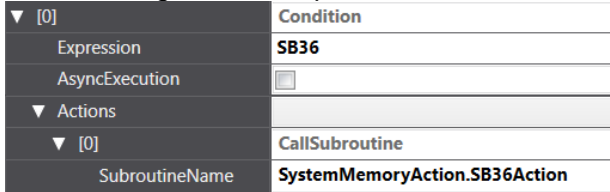
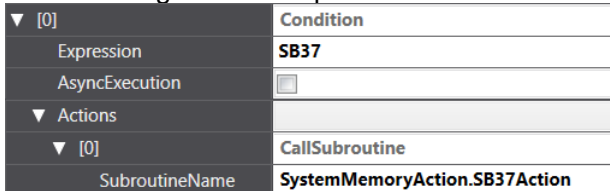
			<p>Copy and paste the following subroutine in the global subroutine in advance.</p> <pre>Sub SB36Action 'Save data log 'Save data set specified as argument ExportDataLogBuffer("DataSetName") 'Automatically off SB36 SB36 = False End Sub</pre> <p>Then, create an event, select CallSubroutine in Actions, and register the subroutine. The following is an example.</p> 
\$SB37	Initialize Operation Log	ON	<p>Substitute this with the NA function <i>ClearOperationLogBuffer()</i>. Copy and paste the following subroutine in the global subroutine in advance.</p> <pre>Sub SB37Action 'Initialize operation log ClearOperationLogBuffer() 'Automatically off SB37 SB37 = False End Sub</pre> <p>Then, create an event, select CallSubroutine in Actions, and register the subroutine. The following is an example.</p> 
\$SB38	Save Operation Log	ON	<p>Substitute this with the NA function <i>SaveOperationLogToFile(FileName)</i>. Copy and paste the following subroutine in the global subroutine in advance.</p> <pre>Sub SB38Action 'Save operation log 'Specify path to save as argument SaveOperationLogToFile("%SDCard%OperationLog.csv") 'Automatically off SB38 SB38 = False End Sub</pre> <p>Then, create an event, select CallSubroutine in Actions, and register the subroutine. The following is an example.</p>

			<table border="1"> <tr><td>▼ [0]</td><td>Condition</td></tr> <tr><td>Expression</td><td><b>SB38</b></td></tr> <tr><td>AsyncExecution</td><td><input type="checkbox"/></td></tr> <tr><td>▼ Actions</td><td></td></tr> <tr><td>▼ [0]</td><td>CallSubroutine</td></tr> <tr><td>SubroutineName</td><td><b>SystemMemoryAction.SB38Action</b></td></tr> </table>	▼ [0]	Condition	Expression	<b>SB38</b>	AsyncExecution	<input type="checkbox"/>	▼ Actions		▼ [0]	CallSubroutine	SubroutineName	<b>SystemMemoryAction.SB38Action</b>																
▼ [0]	Condition																														
Expression	<b>SB38</b>																														
AsyncExecution	<input type="checkbox"/>																														
▼ Actions																															
▼ [0]	CallSubroutine																														
SubroutineName	<b>SystemMemoryAction.SB38Action</b>																														
\$SB49	Stop Memory Card	ON	<p>Substitute this with the NA function <i>EjectSDMemory()</i>. Copy and paste the following subroutine in the global subroutine in advance.</p> <pre>Sub SB49Action   'Make SD card removable    EjectSDMemory()   'Automatically off SB49   SB49 = False End Sub</pre> <p>Then, create an event, select CallSubroutine in Actions, and register the subroutine.</p> <p>The following is an example.</p> <table border="1"> <tr><td>▼ [0]</td><td>Condition</td></tr> <tr><td>Expression</td><td><b>SB49</b></td></tr> <tr><td>AsyncExecution</td><td><input type="checkbox"/></td></tr> <tr><td>▼ Actions</td><td></td></tr> <tr><td>▼ [0]</td><td>CallSubroutine</td></tr> <tr><td>SubroutineName</td><td><b>SystemMemoryAction.SB49Action</b></td></tr> </table>	▼ [0]	Condition	Expression	<b>SB49</b>	AsyncExecution	<input type="checkbox"/>	▼ Actions		▼ [0]	CallSubroutine	SubroutineName	<b>SystemMemoryAction.SB49Action</b>																
▼ [0]	Condition																														
Expression	<b>SB49</b>																														
AsyncExecution	<input type="checkbox"/>																														
▼ Actions																															
▼ [0]	CallSubroutine																														
SubroutineName	<b>SystemMemoryAction.SB49Action</b>																														
\$SW10	Current Label No.	When changing value	<p>Set <i>SetLanguage</i> in <b>Actions</b>. Specify the value of SW10 in <b>Expression</b> to display the label in the corresponding language. In the following configuration, the label will be displayed in Japanese when SW10 = 0, and in English when SW10 = 1.</p> <table border="1"> <tr><td>▼ [0]</td><td>Condition</td></tr> <tr><td>Expression</td><td><b>SW10 = 0</b></td></tr> <tr><td>AsyncExecution</td><td><input type="checkbox"/></td></tr> <tr><td>▼ Actions</td><td></td></tr> <tr><td>▼ [0]</td><td>SetLanguage</td></tr> <tr><td>Language</td><td><b>Japanese (Japan)</b></td></tr> <tr><td>Persist</td><td><input checked="" type="checkbox"/></td></tr> <tr><td>▼ [1]</td><td>Condition</td></tr> <tr><td>Expression</td><td><b>SW10 = 1</b></td></tr> <tr><td>AsyncExecution</td><td><input type="checkbox"/></td></tr> <tr><td>▼ Actions</td><td></td></tr> <tr><td>▼ [0]</td><td>SetLanguage</td></tr> <tr><td>Language</td><td><b>English (United States)</b></td></tr> <tr><td>Persist</td><td><input checked="" type="checkbox"/></td></tr> </table> <p>Checking the <b>Persist</b> box retains the display language settings after turning OFF and ON the NA unit.</p>	▼ [0]	Condition	Expression	<b>SW10 = 0</b>	AsyncExecution	<input type="checkbox"/>	▼ Actions		▼ [0]	SetLanguage	Language	<b>Japanese (Japan)</b>	Persist	<input checked="" type="checkbox"/>	▼ [1]	Condition	Expression	<b>SW10 = 1</b>	AsyncExecution	<input type="checkbox"/>	▼ Actions		▼ [0]	SetLanguage	Language	<b>English (United States)</b>	Persist	<input checked="" type="checkbox"/>
▼ [0]	Condition																														
Expression	<b>SW10 = 0</b>																														
AsyncExecution	<input type="checkbox"/>																														
▼ Actions																															
▼ [0]	SetLanguage																														
Language	<b>Japanese (Japan)</b>																														
Persist	<input checked="" type="checkbox"/>																														
▼ [1]	Condition																														
Expression	<b>SW10 = 1</b>																														
AsyncExecution	<input type="checkbox"/>																														
▼ Actions																															
▼ [0]	SetLanguage																														
Language	<b>English (United States)</b>																														
Persist	<input checked="" type="checkbox"/>																														
\$SW14 to 17	Current Date and Time	Interval	<p>Copy and paste the following subroutine in the global subroutine in advance.</p> <pre>Sub SW14_17Action   'Convert second and minute   Dim second = _HMI_Second   Dim minute = _HMI_Minute   SW14 = ((minute &lt;&lt; 8) Or second)</pre>																												

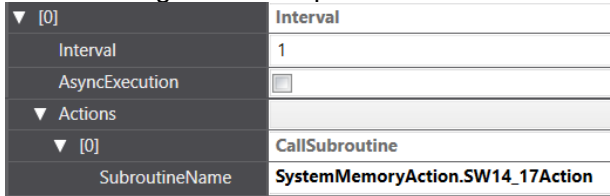
			<pre> 'Convert date and time Dim hour = _HMI_Hour Dim day = _HMI_DateTime.Day SW15 = ((day &lt;&lt; 8) Or hour)  'Convert year and month Dim month = _HMI_DateTime.Month Dim year = _HMI_DateTime.Year year = year Mod 100 SW16 = ((year &lt;&lt; 8) Or month)  'Convert day of the week SW17 = _HMI_DateTime.DayOfWeek End Sub </pre> <p>Then, create an event, select CallSubroutine in Actions, and register the subroutine.</p> <p>The following is an example.</p> 
--	--	--	---

\*1: In the NS series, if the backlight brightness adjustment system bits turned ON at the same time, the higher brightness bit has the priority.

In the NA series, the brightness adjustment setting of the system bit that turned on last is enabled.

\*2: In NS series units, you are allowed to operate a dialog shown by the system, but in NA series, all the touch-screen operations are prohibited.

If the above system memories are assigned to the connecting host unit, you can replace the process of controlling the system memories from the connecting host unit by mapping the system memories following the method in "4-5-1 System Memory: Variable Mapping" and assigning them to expressions in the global event.



### 4-5-3 System Memory: Supported by VB

This section shows how to replace system memories, supported by VB in the System Memory sheet in “Appendix 1: Project Common Settings.”

Replace the system memories \$SW0 (Current screen number) and \$SW1 (Current pop-up screen number) using the procedure shown below.

In this example, \$SW0 is assigned to DM0 in the connecting host unit, and \$SW1 is assigned to DM1.

If other addresses have been assigned, please read as above.

The control method of current screen numbers differs in the NS and NA series. Therefore, the behavior cannot be duplicated perfectly.

For example, the connecting host unit can specify a pop-up page number to display on the NA unit, but the NA unit does not notify the pop-up page number to the connecting host unit.

1. Create variables DM0 and DM1, to which the connecting host unit is assigned, in the Variables tab in Device References.

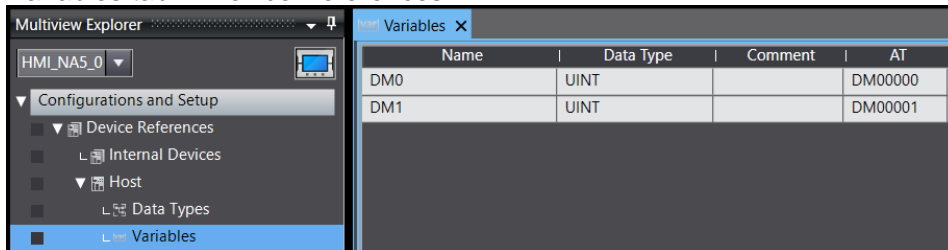

2. Map the variables created in Step 1.

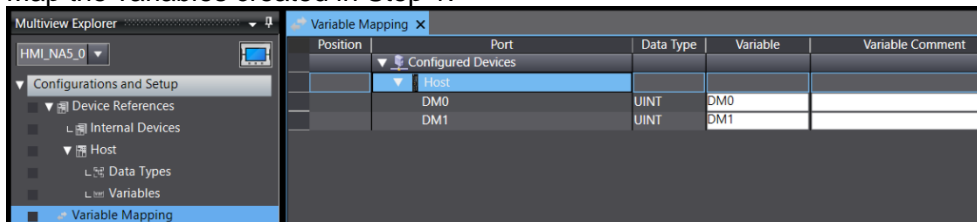

3. Copy and paste the following to the global subroutine.

```
Dim switchingPage As Boolean
```

```
'Page number in Host to NA
```

```
Sub ConvertHostPageNoToNAPageNo  
  If switchingPage Then Exit Sub  
  switchingPage = True
```

```
  BeforePageNo = DM0  
  _HMI_CurrentPageIndex = DM0
```

```
  switchingPage = False
```

```
End Sub
```

```
'Page number in NA to Host
```

```
Sub ConvertNAPageNoToHostPageNo  
  If switchingPage Then Exit Sub  
  switchingPage = True
```

```
  BeforePageNo = CType(_HMI_CurrentPageIndex, UShort)  
  DM0 = CType(_HMI_CurrentPageIndex, UShort)
```

```
  switchingPage = False
```

```
End Sub
```

```
'Pop-up page number in Host to NA
```

```
'Pop-up page number is notified from Host to NA only
```

```
Sub ConvertHostPageNoToNAPageNoPopupPage  
  If switchingPage Then Exit Sub  
  switchingPage = True
```

```
  If DM1 = 0 Then  
    ClosePage(_HMI_CurrentPage)  
    BeforePopupPageNo = DM1  
    switchingPage = False  
    Exit Sub
```

```
  End If
```

```
  BeforePopupPageNo = DM1  
  _HMI_CurrentPageIndex = DM1
```

```
  switchingPage = False
```

```
End Sub
```

4. Rename the global subroutine group you have edit in Step 3 as *SystemMemoryAction*.

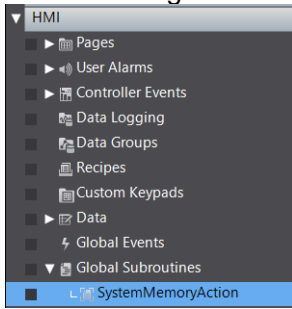

5. Register *BeforePageNo* and *BeforePopupPageNo* in the global variable table.

Name	Data Type	Initial Value	AT	Retain	Constant	Update Rate	Scaling	Comment
DM0	UShort		Host.DM0	<input type="checkbox"/>	<input type="checkbox"/>	500 Milliseconds	None	
DM1	UShort		Host.DM1	<input type="checkbox"/>	<input type="checkbox"/>	500 Milliseconds	None	
BeforePageNo	UShort			<input type="checkbox"/>	<input type="checkbox"/>	None	None	
BeforePopupPageNo	UShort			<input type="checkbox"/>	<input type="checkbox"/>	None	None	

6. Add the following events in the Global Events tab page.

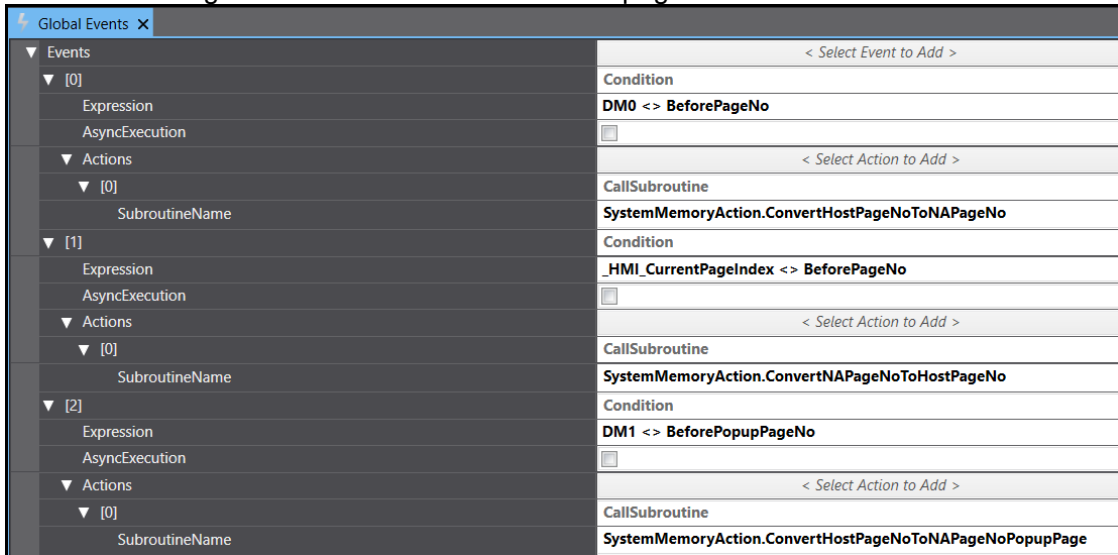

The table provides expressions and subroutines for events described in Step 6. You can copy and paste them for adding events.

Event No.	Expression	Subroutine
0	DM0 <> BeforePageNo	SystemMemoryAction.ConvertHostPageNoToNAPageNo
1	_HMI_CurrentPageIndex <> BeforePageNo	SystemMemoryAction.ConvertNAPageNoToHostPageNo
2	DM1 <> BeforePopupPageNo	SystemMemoryAction.ConvertHostPageNoToNAPageNoPopupPage

Note: Setting a screen number 10,000 or greater will cause an error in the above method.  
Do not set 10,000 or greater for the screen number.  
In addition, if you use the pop-up screen number currently displayed as the input condition in the ladder diagram of the connecting host unit, the ladder diagram may not run properly.  
Change the input condition of the ladder to the current screen number, or other workaround is necessary.

You can duplicate \$SW12, Backlight Brightness Control (32 levels), using the following procedure. In this example, \$SW12 is assigned to DM12 in the connecting host unit. If other addresses have been assigned, please read as above.

1. Create a variable of DM12 in the Variables tab in Device References.

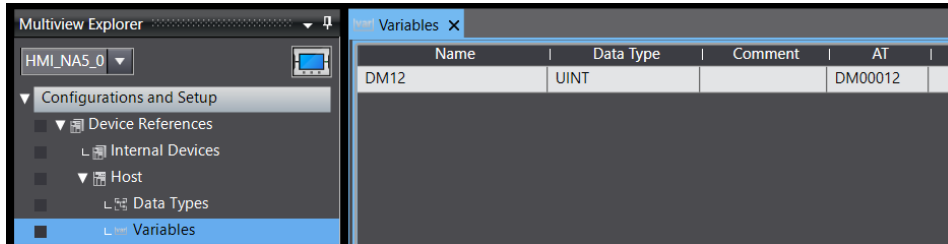

2. Map the variables created in Step 1.

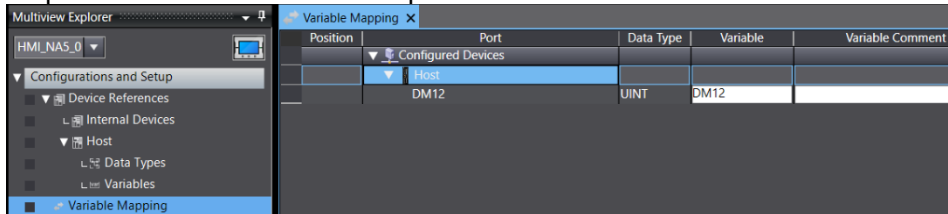

3. Copy and paste the following to the global subroutine.

```

Const MaxBrightness As Integer = 200
Const MaxBrightnessLevel As Integer = 32
Const BrightnessInterval As Double = CType(MaxBrightness, Double) /
CType(MaxBrightnessLevel, Double)
Dim RequiredBrightness As Integer = MaxBrightness 'Default value

Sub ChangeBrightness
    BeforeBrightness = DM12
    _HMI_Brightness = TranslateBrightnessLevel(DM12)
End Sub

'1->1
'.....
'32->200
Function TranslateBrightnessLevel(brightnessLevel As Integer) As Integer
    If brightnessLevel < 1 Then
        Return 1
    Else If brightnessLevel >= MaxBrightnessLevel Then
        Return MaxBrightness
    End If

    Return Math.Round(BrightnessInterval * brightnessLevel)
End Function

```

4. Rename the global subroutine group you have edit in Step 3 as *SystemMemoryAction*.

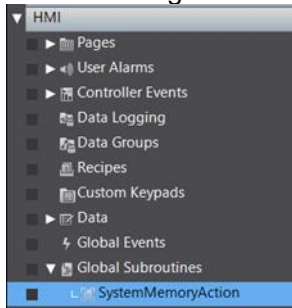

5. Register *BeforeBrightness* in the global variable table.

Name	Data Type	Initial Value	AT	Retain	Constant	Update Rate	Scaling	Comment
DM12	UShort		Host.DM12	<input type="checkbox"/>	<input type="checkbox"/>	500 Milliseconds	None	
BeforeBrightness	UShort			<input type="checkbox"/>	<input type="checkbox"/>	None	None	

6. Add the following events in the Global Events tab page.

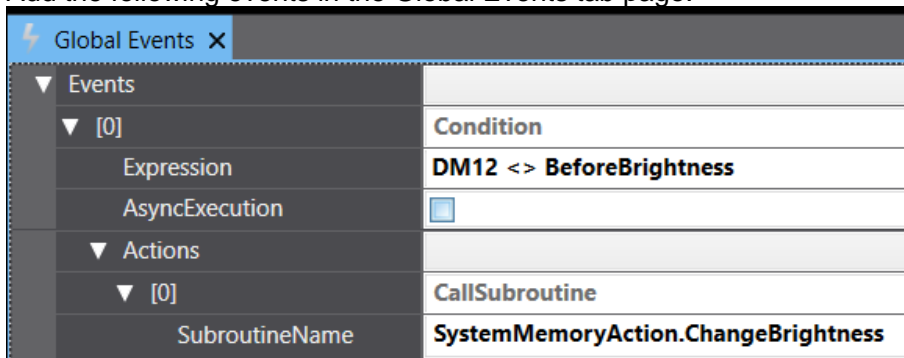

The table provides expressions and subroutines for events described in Step 6. You can copy and paste them for adding events.

Event No.	Expression	Subroutine
0	DM12 <> BeforeBrightness	SystemMemoryAction.ChangeBrightness

## 4-5-4 System Memory: Array

This section shows how to replace system memories, Array in the System Memory sheet in “Appendix 1: Project Common Settings.”

You can replace the system memories \$SW27 to 36 (offset value for index I0 to I9) using the following procedure.

You will use \$SW27 to 36 for the indirect reference of address. Therefore, look up the address range for the indirect reference in advance, using the cross reference or another method.

- Example of indirect reference with ON/OFF Button Object (bit data)

This section describes the replacing method using the following setting.

Object used	ON/OFF Button Object
Address used for	Output and Display addresses
Indirect reference address range	D0.00 to 0.16
System memory	SW27

1. Create an array, which is assigned to DM0.00 in the connecting host unit and has 16 elements, in the Variables tab in Device References.

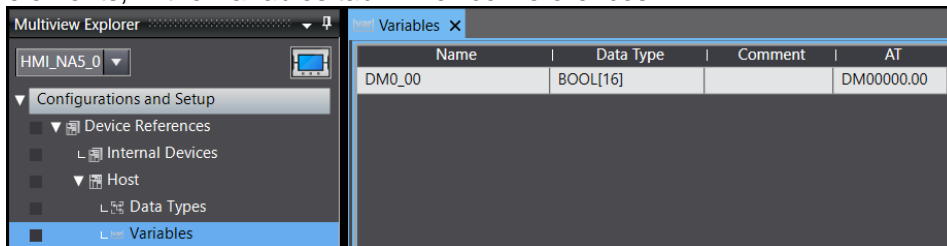

2. Map the variables created in Step 1.

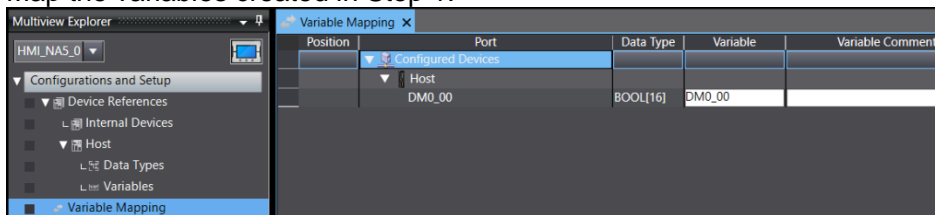

3. Register SW27 in Global Variables.

Name	Data Type	Initial Value	AT	Retain	Constant	Update Rate	Scaling	Comment
DM0_00	Boolean(15)		Host.DM0...	<input type="checkbox"/>	<input type="checkbox"/>	500 Milliseconds	None	
SW27	UShort			<input type="checkbox"/>	<input type="checkbox"/>	None	None	

4. Open the page and place a momentary button.

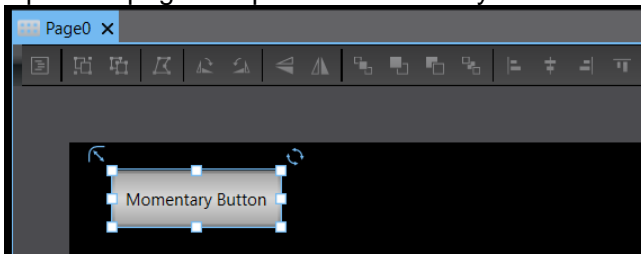

5. Open the Properties pane while selecting the momentary button created in Step 4. Then, select *Feedback (Button)* in **VisualFeedback**.

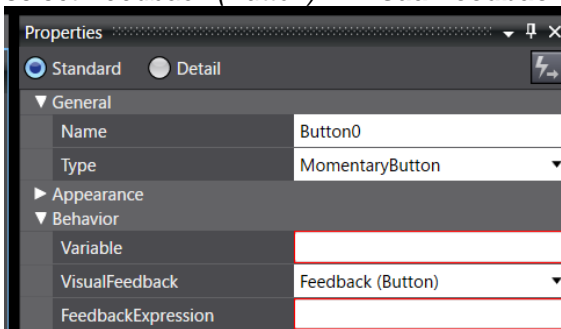

6. Enter *DM0\_00(SW27)* in **FeedbackExpression**.

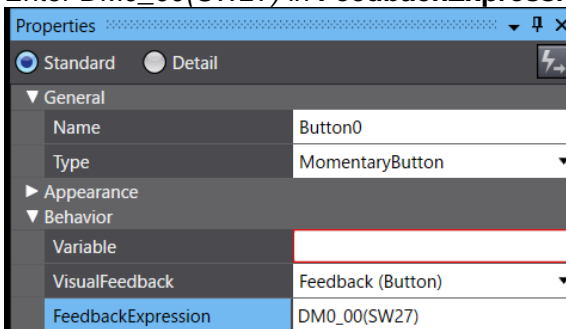

7. Open Page Subroutines to copy and paste the following.

```
Sub TouchEvent
  DM0_00(SW27) = True
End Sub
```

```
Sub ReleaseEvent
  DM0_00(SW27) = False
End Sub
```



8. In **Events and Actions** of the button, add *Press* and *Release* events. Then, assign the subroutines created in Step 7.

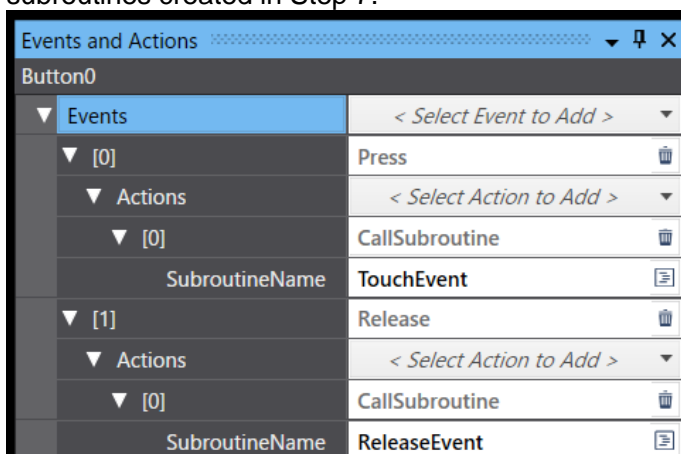

Note: When setting the Variable property, you cannot specify a variable as an index for an array. Therefore, the elements of the array that turns ON/OFF are indirectly referenced in the subroutine.

In the Expression property, you can specify variable as an index for an array. You can specify an expression as an index to move the offset position.

- Example of indirect reference with Numeral Display/ Input Object (word data)  
This section describes the replacing method using the following setting.

Object used	Numeral Display and Input
Address used for	Address
Indirect reference address range	D10 to 19
System Memory	SW27

1. Create an array, which is assigned to DM10 in the connecting host unit and has 10 elements, in the Variables tab in Device References.

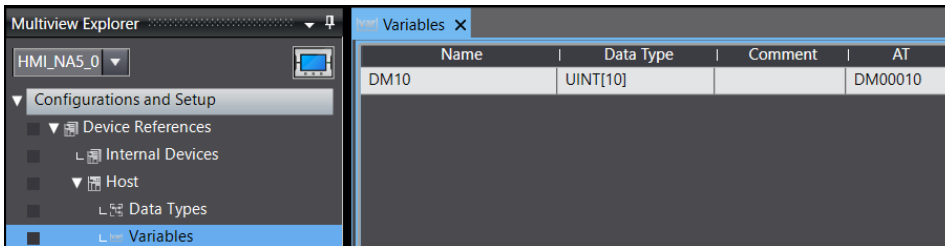

2. Map the variables created in Step 1.

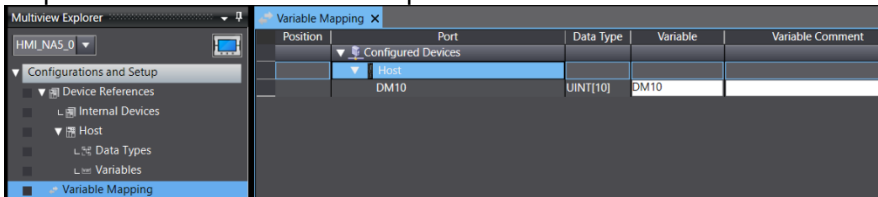

3. Register SW27 in Global Variables.

Name	Data Type	Initial Value	AT	Retain	Constant	Update Rate	Scaling	Comment
DM10	UShort(9)		Host.DM10	<input type="checkbox"/>	<input type="checkbox"/>	500 Milliseconds	None	
SW27	UShort			<input type="checkbox"/>	<input type="checkbox"/>	None	None	

- Open the page and place a Data Display Object.

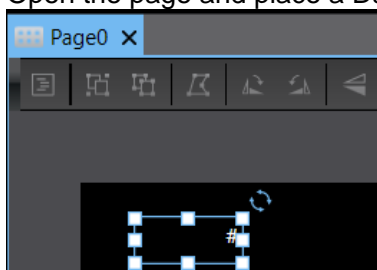

- Open the Properties pane while selecting the Data Display Object created in Step 4. Then, enter `DM10(SW27)` in **Expression**.

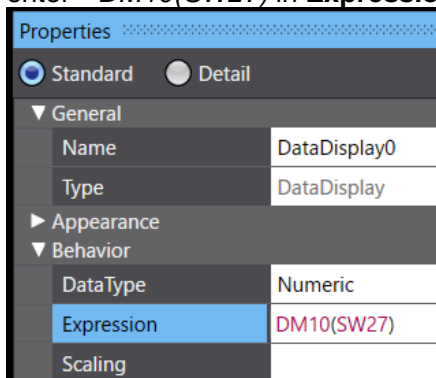

- Open Page Subroutines to copy and paste the following.

```
Sub EditValue
  Dim val As String = "DM10(" & SW27 & ")"
  EditVariable(val, , , , , , , , )
End Sub
```

- In **Events and Actions** of the Data Display Object, add *Press* event. Then, assign the subroutine created in Step 6.

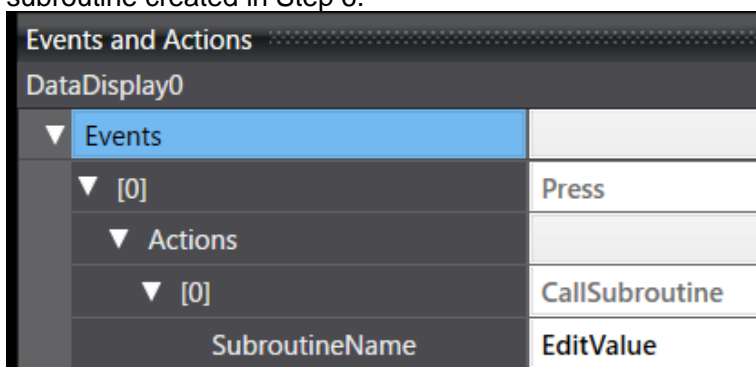

## 4-6 About Macro

The Macro Functionality of the NS series enables you to add a new function to the basic functions by writing a program.

Macros can be replaced with subroutines in the NA series. You can write codes with VB, but a part of features and library functions is supported. Refer to Subroutine Reference Manual for usable functionalities and library functions.

You can register a functionality common with screens as Global Subroutine and a functionality run on the currently displayed screen only as Page Subroutine.

It is possible to call and execute a subroutine from a global event, object event, and button or lamp on the screen.

If a functionality you want is prepared as an Action, you do not have to write a subroutine; you can select the action to execute an event since executing a subroutine is one of the actions. In addition, you can specify more than one action to an event to combine formatted processing and subroutines.

Also, NA subroutines run on Visual Basic. Refer to information from Microsoft and third-party vendors for basic knowledge like syntax, grammar, and variables of Visual Basic.

### 4-6-1 Macro Execution Conditions

The table below shows the relations of NS macro execution conditions and NA subroutine execution conditions.

NS Macro Execution Condition		NA Subroutine Execution Condition		
Classification	Macro Execution Condition	Location	Execution Condition	
Project	When loading a project	Global event	ProjectInitialization	
	Alarm/Event ON	User alarm	Raised	
	Alarm/Event OFF		Acknowledged Cleared	
	Bit change: ON/OFF	Global event	* 2	
	Bit change: Rise			
	Bit change: Fall			
	Value change: Value change			
	Value change: Value = Set value			Condition: <Variable> = <Set value>
	Value change: Value > Set value			Condition: <Variable> > <Set value>
Value change: Value < Set value	Condition: <Variable> < <Set value>			
Screen	When loading a screen	Page	PageDisplayed	
	When unloading a screen		PageHidden	
Part object	When pressing a display area Touch ON	Button, Shape, Image, Data display, Text box	Press	
	Touch OFF		Click Release	
	When selecting a list	List box DropDown	SelectionChanged	

Before inputting numeral Before inputting string Before inputting numeral and string	Global event or Page	No equivalent execution condition (*1)	
Before writing numeral Before writing string Before writing numeral and string			
When changing numeral or string			* 2
Value change: Numerical value = Set value			Condition: <Variable> = <Set value>
Value change: Numerical value > Set value			Condition: <Variable> > <Set value>
Value change: Numerical value < Set value			Condition: <Variable> < <Set value>
When changing value : Execute when ON/OFF			Condition: <Variable> = <Set value>
When changing value : Execute when ON			
When changing value : Execute when OFF			
Alarm/Event selected	-	No equivalent execution condition	

\*1: Register HMI\_IsDataInput\_before (variable type: Boolean) to global variables. Then, detect a change of the system variable, \_HMI\_IsDataInput, with the following expression in **Events and Actions - Event - Condition** and **Events and Actions - Action - Subroutine**, in **Global Events or Page**.

Event	Condition	_HMI_IsDataInput <> HMI_IsDataInput_before
Action	CallSubroutine	OnChangeDataInput

In the subroutine OnChangeDataInput:

```

Sub OnChangeDataInput
  If _HMI_IsDataInput_before
    Write to REM
  Else
    Start input to REM
  End if
  HMI_IsDataInput_before = _HMI_IsDataInput
End Sub

```

You can get changes in numeric or string data input. However, Macro execution conditions of the NA series are not the same as those of the NS series: for example, before inputting and after starting inputting, and before writing and during writing to after finishing writing.

\* 2: With the NS series, changes in numerical values and character strings that are mainly monitored by each part can execute macros. However, the NA series does not have similar execution conditions for each object, and you must configure them for a global event or page.

In addition, you need to prepare a variable to save the previous value separately from the monitored variable. Compare the monitored variable with the previous value in the subroutine, and if they do not match, detect a change of value and assign the variable value to the previous value.

You can detect a value change without preparing the previous value if it is a bit change rather than a change in a numeral or character string. In other words, when the latest value is True, the bit is considered raised; when the latest value is False, the bit is considered fell.

Also, you can use **Standard Controls - CheckBox** for an execution condition on the bit change. The event **Checked** in **Events and Actions** of a check box object corresponds to **ON** (up-differentiated), and **Unchecked** corresponds to **OFF** (down-differentiated).

#### 4-6-2 Variables Used in NS Macros

NS-series macros use PT Memories as storage destinations for calculated values and as arguments. Variables are not allowed.

On the contrary, only variables are available in the NA series. Replace the PT memories with global variables or variables defined in a VB program. However, the sample functions described later use array variables representing the virtually defined PT memories. In other words, we are using the number of array indexes as an argument.

#### 4-6-3 About PT Memory

For the PT memories used in the NS-series macros, define the following global variables as arguments of sample functions that substitute macro functions, and describe them. If you do not use a sample function, you do not have to define the global variables.

If you have used \$W and \$HW in the 2-word or longer data type, the following variables are not available. Prepare new variables.

NS	NA		
	Variable Name	Data type	Retain Attribute
\$B	NS_Memory_B	Boolean(32768)	<input type="checkbox"/>
\$W	NS_Memory_W	Ushort(32768)	<input type="checkbox"/>
\$HB	NS_Memory_HB	Boolean(8192)	<input checked="" type="checkbox"/>
\$HW	NS_Memory_HW	UShort(8192)	<input checked="" type="checkbox"/>

- **PT Memory Size Adornment**  
 You can specify the word size by adding the letter "W" or "L" at the end of a PT memory. For the NA series, use variable types.
- **Access to Numerals by Bit-type PT Memory**  
 In the NS series, by specifying the number of bits following ":" after the Bit-type PT memory in the macro, you can handle up to 32 bits collectively as an Integer-type value in units of 4 bits. The NA series does not have a corresponding functionality.
- **Indexed Variable**  
 In the NS series, by adding either of "I0" to "I9" after the PT memory, you can reference the PT memory address numbers relatively slid by the amount specified with the index registers \$SW27 to \$SW36.  
 Though you cannot use indexed variables in the NA series, PT memories defined above can achieve the equivalents: PT memories use array number for accessing, and adding/subtracting an offset value to/from an array number works similarly as index specification.

#### 4-6-4 About Host Address (Argument for READCMEM and WRITECMEM)

A host address can be the argument for the NS macro functions, READCMEM and WRITECMEM. Because these macro functions are difficult to replace, a replacing method for this argument is omitted.

#### 4-6-5 Different Behaviors from NS Macros

##### ■ Overflow on variable assignment

NS	Variables are assigned to the extent possible, truncating the high-order digits. The running program will not stop and continue.
NA	An overflow exception occurs and the subroutine function terminates at the point. The error message will appear at the bottom of the screen. To have the same behavior as NS, enclose the assignment location with “Try” and “End Try” to ignore the exception.

##### ■ Assigning a decimal number to an integer

NS	Omit decimals and assign the integer part only.
NA	Round-off the decimals to assign.  For example, there are Integer-type variables A, B, and C and the original expression is: $A = B / C$ The calculated value will be rounded, so describe as the following: $A = B / C : IF A > (B / C) Then A = A - 1$ You can assign the value rounding the decimals as in NS.

#### 4-6-6 Replacing NS Macro Function

This section provides a correspondence table for replacing the NS macro functions with NA VB.

Here we use the codes shown in the table to explain arguments.

Variable Type in NS	Argument Code	Variable Type in NA
Bit	B	Boolean
WORD	w, w1, w2	Short, UShort
DWORD	D	Long, ULong
FLOAT	f, f1, f2	Single, Double
Internal memory	M, M1, M2	Integer: Array number of the array NS_Memory □(m)
Object ID/ Page number	n	String (Object name/ page name)

The table below provides the NS macro functions and their alternate VB functions and expressions.

The grayed cells represent Math class library functions that are not mentioned in Subroutine Reference Manual. Their operations are not guaranteed.

NS Macro Function	Argument and Return Value	NA VB Function and Expression
Numerical Operation and Value Conversion		
ACOS	FLOAT ACOS(f)	Math.Acos(f)

ASIN	FLOAT ASIN(f)	Math.Asin(f)
ATAN	FLOAT ATAN(f)	Math.Atan(f)
ATAN2	FLOAT ATAN2(f1, f2)	Math.Atan2(f1, f2)
BCD	DWORD BCD(d)	*See sample functions
BITSET	BITSET(P, b, w)	*See sample functions
CEIL	FLOAT CEIL(f)	Math.Ceiling(f) Function CEIL(f As Single) As Integer Dim ret As Integer = f If (ret < f) Then ret = ret + 1 Return ret End Function
COS	FLOAT COS(f)	Math.Cos(s)
DEG2RAD	FLOAD DEG2RAD(f)	Math.PI / 180.0 * f
EXP	FLOAT EXP(f)	Math.Exp(s)
FADD	FLOAT FADD(f1, f2)	f1 + f2
FCOMP	WORD FCOMP(f1, f2)	Function FCOMP(f1 As Single, f2 As Single) As Single If (f1 < f2) Then Return -1 If (f1 > f2) Then Return 1 Return 0 End Function
FDIV	FLOAT FDIV(f1, f2)	(f1 / f2)
FSET	FLOAT FSET(d)	f = d
FSUB	FLOAD FSUB(f1, f2)	(f1 – f2)
FLOOR	FLOAT FLOOR(f)	Math.Floor(f) Function FLOOR(f As Single) As Integer Dim ret As Integer = f If (ret > f) Then ret = ret - 1 Return ret End Function
FMUL	FLOAT FMUL(f1, f2)	(f1 * f2)
LOG	FLOAT LOG(f)	Math.Log(f, Math.E)
LOG10	FLOAT LOG10(f)	Math.Log10(f)
POW	FLOAT POW(f1, f2)	Math.Pow(f1, f2)
RAD2DEG	FLOAT RAD2DEG(f)	180.0 / Math.PI * f
SIN	FLOAT SIN(f)	Math.Sin(f)
SQRT	FLOAT SQRT(f)	Math.Sqrt(f)
TAN	FLOAT TAN(f)	Math.Tan(f)
Operations of Memory, String, and Time		
LOCALTIME	WORD LOCALTIME(M1,M2)	Prepare the difference between the local time and UTC. A DateTime-type variable must include the difference. To use a value on a PT memory in another processing, you need to convert the value into a DateTime-type variable. If the data is handled in the DateTime-type in the



		NS unit, conversion is not necessary.
MEMCOPY	MEMCOPY(M1, M2, w)	*See sample functions
MEMSET	MEMSET(M, w1, w2)	*See sample functions
SETTIME	SETTIME(M)	SetDateTime() You must convert the original numeric data into a Date-type variable because a Date-type variable is required for argument.
STRCPY	STRCPY(M1, M2)	*See sample functions
STRCPYW	STRCPYW(M1, M2)	*See sample functions
STRM2W	STRM2W(M1, M2)	Difficult to substitute.
STRW2M	STRW2M(M1, M2)	Difficult to substitute.
SWAP		*See sample functions
SWAPL		*See sample functions
Operations of Screens and Objects		
CLOSEPOPW	CLOSEPOPW(PageNumber)	ClosePage(PageName)
GETNUMVAL	GETNUMVAL()	Difficult to realize.
GETPARTS	GETPARTS(n,Left,Top,Right,Bottom)	Difficult to realize.
MOVEPARTS	MOVEPARTS(n, X, Y)	Object's properties Left and Top represent the display coordinates of the object. Assign the arguments to them.
MOVEPOPW	MOVEPOPW(n, X, Y)	Difficult to substitute.
MOVEPOPWDOWN	MOVEPOPWDOWN(n, Y)	Difficult to substitute.
MOVEPOPWLEFT	MOVEPOPWLEFT(n, X)	Difficult to substitute.
MOVEPOPWRIGHT	MOVEPOPWRIGHT(n, X)	Difficult to substitute.
MOVEPOPWUP	MOVEPOPWUP(n Y)	Difficult to substitute.
MSGBOX	MSGBOX(message, title, iconType)	*See sample functions Microsoft.VisualBasic.MsgBox(message, [ buttoNS, ], [ title, ] [ helpfile, context ] )  Note: To realize a corresponding setting to NS series argument iconType, use the argument "buttons" to set the button feature and displayed icon. Button feature is the same as the NS series, but the icon is different. The return value represents a push button. The combination of the push button and value is different.
RELEASEFOCUS	RELEASEFOCUS()	Moving the focus on a hidden DataEdit object will release the focus.
RSTALARMCNT	RSTALARMCNT(sw)	Difficult to substitute.
SETFOCUS	SETFOCUS(n)	SetInputFocus()
SHOWPAGE	SHOWPAGE(n)	_HMI_CurrentPageIndex = n
SHOWPAGEBCD	SHOWPAGEBCD(n)	_HMI_CurrentPageIndex = BCD(n)  *Use the sample function for BCD(n).
External Memory and Interface		
READCF	READCF(D,n,"FNAME",Dev)	Difficult to substitute.

READCMEM	READCMEM(D, [a] ,w)	Difficult to substitute.
READHOSTB	READHOSTB(D,h,ch,addr,r,n)	Difficult to substitute.
READHOSTW	READHOSTW(D,h,ch,addr,r,n)	Difficult to substitute.
WRITECF	WRITECF(S,n,"FNAME",Dev)	Difficult to substitute.
WRITEMEM	WRITECMEM([a],S,n)	Difficult to substitute.
WRITEHOSTB	WRITEHOSTB(h,ch,addr,r,S,n)	Difficult to substitute.
WRITEHOSTW	WRITEHOSTW(h,ch,addr,r,S,n)	Difficult to substitute.

## 4-6-7 Sample Alternate Functions for NS Macro Functions

Among the NS series macro functions, some can be realized by VB programs even though they cannot be realized with existing library functions. Sample codes are shown below. The value range check for arguments is omitted, so please add code as necessary.

NS Function	Alternate Sample Function
BCD	<pre>Function BCD(ByVal iNum As ULong) As ULong     Dim f1 As Boolean = False     If (iNum &lt; 0) Or (99999999L &lt; iNum)         Throw New ApplicationException("Out of range parameter on BCD()")     End If     REM Workaround for VAL function since an exception occurs in the ranges of 8000 to 9999 and     80000000 to 99999999.     If (8000L&lt;= iNum) And (iNum &lt;= 9999)         iNum = iNum + 10000         f1 = True     End If     If (80000000L&lt;= iNum) And (iNum &lt;= 99999999L)         iNum = iNum - 30000000L         f2 = True     End If     Dim ret As ULong = Microsoft.VisualBasic.Val( "&amp;H" &amp; iNum.ToString )     If f1 Then ret = ret - 65536     If f2 Then ret = ret + &amp;H30000000L     Return ret End Function</pre>
BIN	<pre>Function BIN(iNum As Integer) As Integer     If (iNum &lt; 0) Or (&amp;H99999999L &lt; iNum)         Throw New ApplicationException("Out of range parameter on BIN()")     End If     Dim sNum As String = iNum.ToString("X")     If Not Microsoft.VisualBasic.IsNumeric(sNum) Then Return 0     Return Microsoft.VisualBasic.Val( sNum ) End Function</pre>
BITSET	<pre>REM The 1st argument is the offset number of \$B. Sub BITSET(m As UShort, b As UShort, w As UShort)     Dim bv As Boolean = True     If (0 = b) Then bv = False     Dim ww As UShort     For ww = 1 To w         PTMEM_B(m) = bv         m = m + 1     Next End Sub</pre>
MEMCOPY	<pre>Sub MEMCOPY(ByVal M1 As Integer, ByVal M2 As Integer, d As Integer)     Dim n As Integer</pre>

	<pre> For n = 1 to d     PT_Memory_W(M2) = PT_Memory_W(M1)     M1 = M1 + 1     M2 = M2 + 1 Next End Sub </pre>
--	--

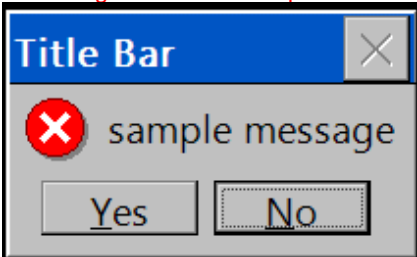
NS Function	Alternate Sample Function
MEMSET	<pre> Sub MEMCOPY(ByVal M1 As Integer, w1 As Integer, w2 As Integer)     Dim n As Integer     For n = 1 to w2         PT_Memory_W(M1) = w1         M1 = M1 + 1     Next End Sub </pre>
MSGBOX	<pre> Sub MSGBOX     Dim msg As String     Dim title As String     Dim style As Microsoft.VisualBasic.MsgBoxStyle     Dim response As Microsoft.VisualBasic.MsgBoxResult     Dim Res1 As String      msg = "sample message"     style = Microsoft.VisualBasic.MsgBoxStyle.DefaultButton2 Or Microsoft.VisualBasic.MsgBoxStyle.Critical Or Microsoft.VisualBasic.MsgBoxStyle.YesNo     title = "Title Bar"     response = Microsoft.VisualBasic.MsgBox(msg, style, title)     If response = Microsoft.VisualBasic.MsgBoxResult.Yes Then         'Describe behavior when Yes button pressed         Res1 = "Yes_Click"     Else         'Describe behavior when the button other than Yes pressed         Res1 = "No_Click"     End If End Sub </pre> <p>Executing the above sample code displays this message box.</p> 
STRCPY	<pre> Sub STRCOPY(ByVal M1 As Integer, M2 As Integer)     Dim wd As UShort </pre>

	<pre> Dim lp As Boolean = True Do While lp     wd = PTMEM_W(M2)     If 0 = (wd And &amp;HFF00)         wd = PTMEM_W(M1) And &amp;hFF         lp = False     Else If 0 = (wd And &amp;HFF)         wd = wd And &amp;hFF00         lp = False     End If     PTMEM_W(M1) = wd     M1 = M1 + 1     M2 = M2 + 1 Loop End Sub </pre>
STRCPYW	<pre> Sub STRCOPY(ByVal M1 As Integer, M2 As Integer)     While PTMEM_W(M2) &lt;&gt; 0         PTMEM_W(M1) = PTMEM_W(M2)         M1 = M1 + 1         M2 = M2 + 1     End While     PTMEM_W(M1) = 0 End Sub </pre>
SWAP	<pre> Sub SWAP(ByVal M As Integer, w As Integer)     Dim n As Integer     Dim wH As Integer     Dim wL As Integer     For n = 1 to w         wH = (PT_Memory_W(M) &gt;&gt; 8) And &amp;hFF         wL = PT_Memory_W(M) And &amp;HFF         PT_Memory_W(M) = (wL &lt;&lt; 8) Or wH         M = M + 1     Next End Sub </pre>
SWAPL	<pre> Sub SWAPL(ByVal M As Integer, w As Integer)     Dim n As Integer     Dim ww As Integer     For n = 1 to w         ww = PT_Memory_W(M)         PT_Memory_W(M) = PT_Memory_W(M+1)         PT_Memory_W(M) = ww         M = M + 2     Next End Sub </pre>

NS Function	Alternate Sample Function
SETTIME	<pre> REM SetDateTime() does not work in a simulation. Sub SETTIME(M As Integer)   Dim DateString As String   Dim wYear As UShort = 2000 + (NS_Memory_W(M+2) And &amp;HFF )   Dim wMonth As UShort = (NS_Memory_W(M+2) &gt;&gt; 8) And &amp;HFF   Dim wDay As UShort = (NS_Memory_W(M+1) &gt;&gt;8) And &amp;HFF   Dim wHour As UShort = (NS_Memory_W(M+1) And &amp;HFF )   Dim wMinute As UShort = (NS_Memory_W(M) And &amp;HFF )   Dim wSecond As UShort = (NS_Memory_W(M) &gt;&gt; 8) And &amp;HFF   DateString = wYear.ToString() &amp; "-" &amp; wMonth.ToString() &amp; "-" &amp; wDay.ToString() _     &amp; " " &amp; wHour.ToString() &amp; ":" &amp; wMinute.ToString() &amp; ":" + wSecond.ToString()   SetDateTime( Date.Parse( DateString ) ) End Sub </pre>

# 5 Replacement Examples: Common Settings

This chapter describes the examples for replacing common settings such as project properties and system settings.

## 5-1 Project Properties

To show the Project Properties dialog box of an NS project, click **Project Properties** in Project Workspace window. The following sections describes replacement examples for each tab on the top of the dialog box.

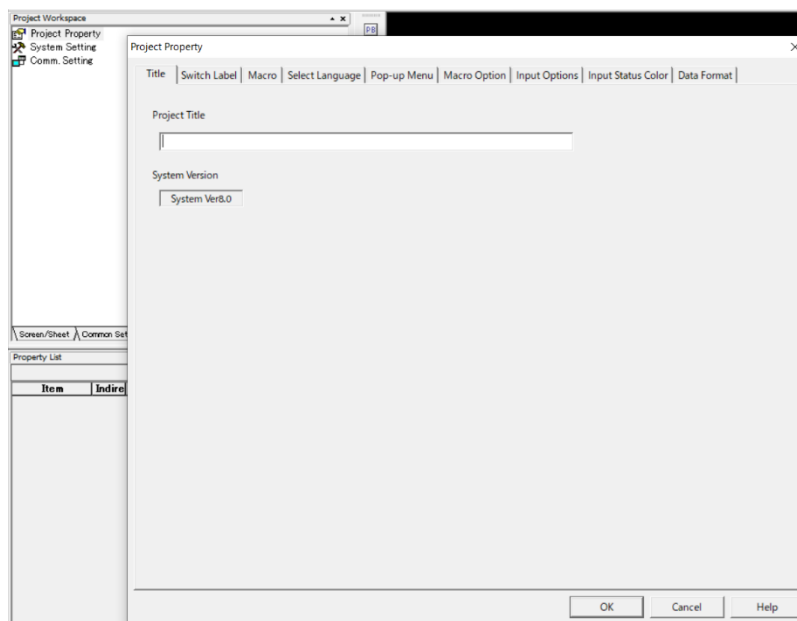

### 5-1-1 Switch Label Tab

Select **Configurations and Setup - Language Settings** to setup labels.

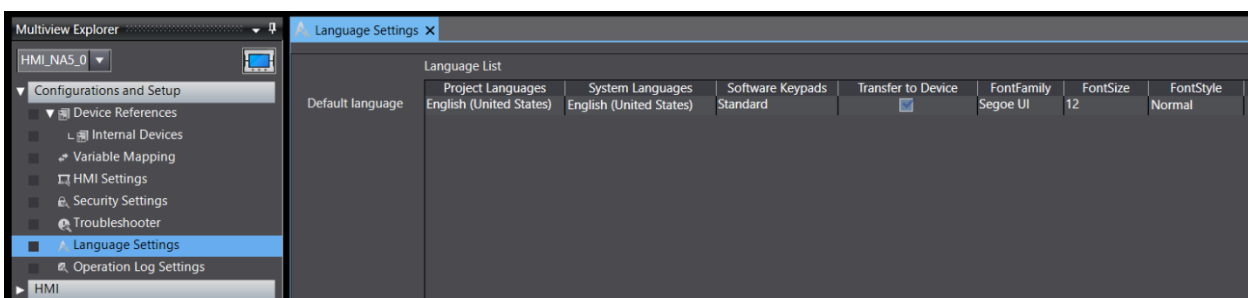

Every click on the  button increases a language. Click the button as many as languages you use.

**Project Languages** corresponds to **Label name** in the NS series.

You can also specify the system language and default fonts for each project language.

If you display characters that are not compatible with the specified font, such as displaying Kanji characters while specifying an English font, the display on Sysmac Studio and the display on the NA unit will not match. Therefore, specifying default fonts in this tab is useful.

Language List							
Default language	Project Languages	System Languages	Software Keypads	Transfer to Device	FontFamily	FontSize	FontStyle
	English (United States)	English (United States)	Standard	<input checked="" type="checkbox"/>	Segoe UI	12	Normal
	Japanese (Japan)	Japanese (Japan)	Standard	<input checked="" type="checkbox"/>	Segoe UI	12	Normal
	Chinese (Simplified, PRC)	Chinese (Simplified)	Standard	<input checked="" type="checkbox"/>	Segoe UI	12	Normal

This table provides the recommended fonts for languages.

Language	Recommended Font Family
Japanese	Meiryo, MS Gothic
Simplified Chinese	Microsoft YaHei, SimSun
Traditional Chinese	Microsoft JhengHei, MingLiU
Korean	Malgun Gothic, Gulim, GulimChe

- **Toggle Display Language During the Operation**

In the NS series, changing the value of the system memory \$SW10 enables to toggle the languages to display.

IN the NA series, select **SetLanguage** in **Events and Actions** to switch languages.

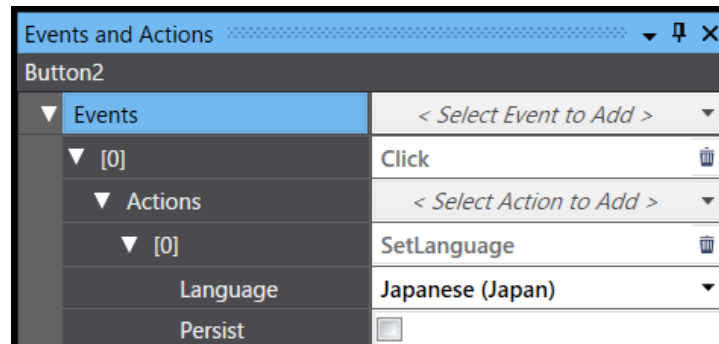

Or use SetLanguage function in a subroutine. In that case, you cannot specify an argument for the subroutine that is set in **Actions** in **Events and Actions**. Therefore, create a function without an argument and give an argument to SetLanguage function within the prepared function.

Refer to NA-series Subroutine Reference Manual for details of SetLanguage function.

## 5-1-2 Macro Tab

- **When Loading a Project**

Select **HMI - Global Events**. Then, select **Events - ProjectInitialization**, and click **Actions - CallSubroutine - SubroutineName** to set the subroutine you want to run.

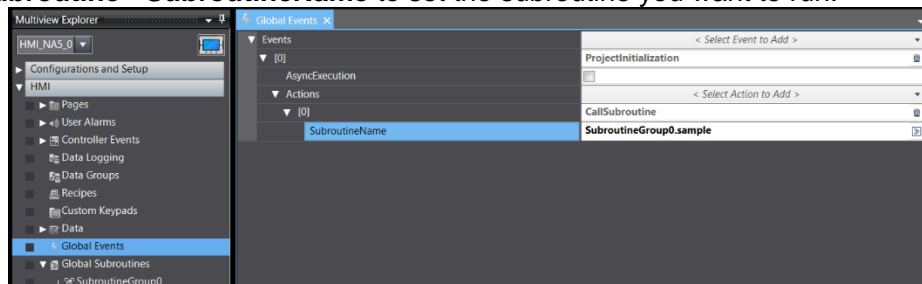

- **On timing Alarm/Event occurred/On timing Alarm/Event is canceled**

For the NS series, you can set macros for all alarm occurrences and cancels, but for the NA series, you need to configure for each alarm.



Click **HMI - User Alarms** to select an alarm which executes a subroutine. Then, select **Raised** or **Cleared** from the options of **Events**. And select **CallSubroutine** from the options of **Actions** to specify a subroutine you want to execute in **SubroutineName**.

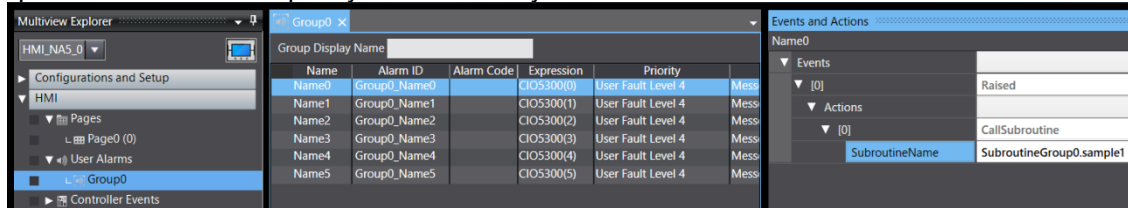

- When a bit changed

Click **HMI - Global Events**. Then select **Condition** from the options of **Events** to describe a condition in **Expression**. Then, click **Actions - CallSubroutine**. -Specify a subroutine's name you want to run in **SubroutineName**.

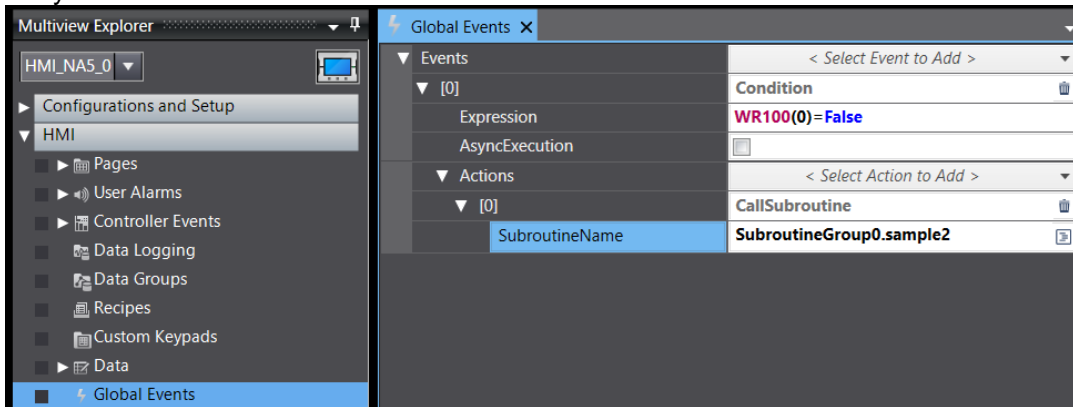

### 5-1-3 Language Selection Tab

NA system language depends on the currently running project's language.  
Set an initial project language in **Configurations and Setup - Device Settings - Setup Language**.

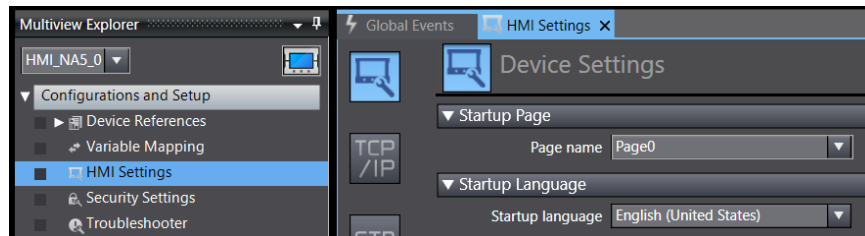

## 5-2 System Setting

To show the System Setting dialog box of an NS project, click **System Setting** in the Project Workspace window. The following sections describes replacement examples for each tab on the top of the dialog box.

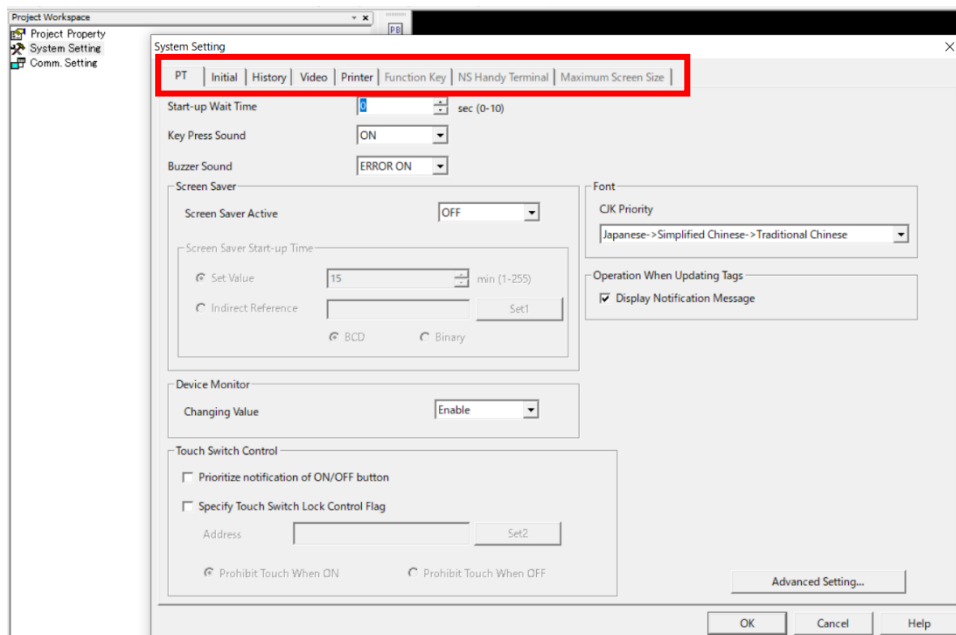

### 5-2-1 PT Tab

- Key Press Sound/ Buzzer Sound

Configure the sound in **Configurations and Setup - Device Settings - Sound**.

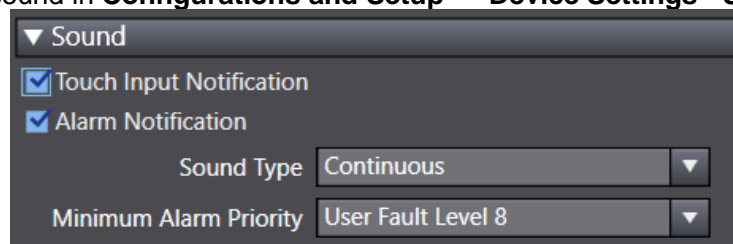

- Screen Saver

Configure a screen saver in **Configurations and Setup - Device Settings - Screen Saver**.

The screen saver activates in an NS unit after 255 minutes of inactivity at the maximum, but 60 minutes in an NA unit. Also, NA units do not have the indirect reference of the wait time. You must specify a fixed value.

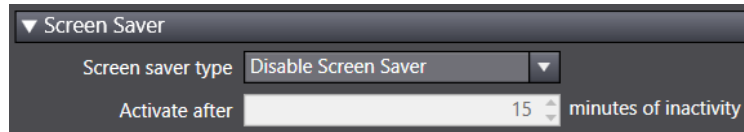

## 5-2-2 Initial Tab

- Initial Screen

Set the page number in **Configurations and Setup - Device Settings - Startup Page**.

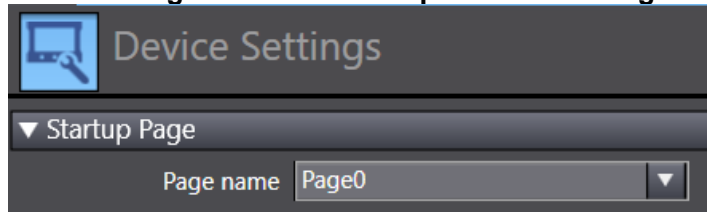

- System Memory

Add system-defined variables of the “Supported” items in the “System Memory” sheet in “Appendix 1: Project Common Settings” to Variable Mapping, following the procedure below.

1. Create a controller variable to be assigned to an NA system variable in the Controller side. Select the same data type as the system-defined variable to be mapped.

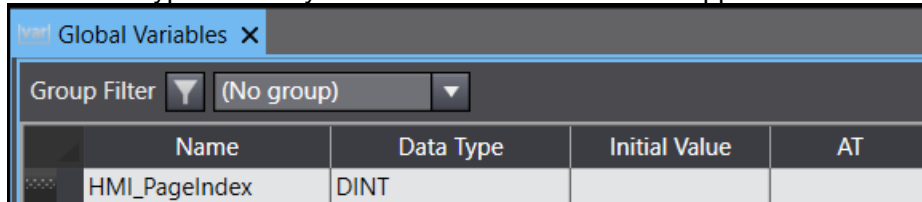

2. Move to the HMI side. Click **Configurations and Setup – Variable Mapping**. Manually enter a system-defined variable that is mapped to the controller variable created in the previous step.

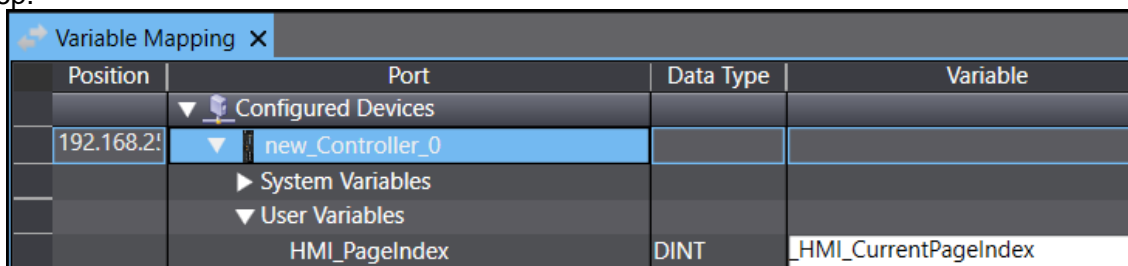

### 5-2-3 History Tab

#### ● Operation Log

Set the upper limit of logging in **Configurations and Setup– Operation Log Settings**. When logs reach to the limit, a new log file will be created to continue logging.

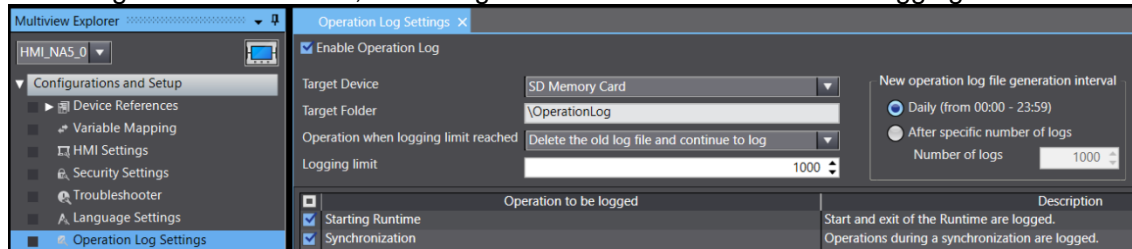

### 5-2-4 Function Key Tab (For NS15)

Click **HMI - Global Events**. In the Global Events tab, select **F1KeyPress** to **F3KeyRelease** from the options of **Events**. Then, select functionalities for each event from **Actions** to perform actions related to pressing and releasing keys. In NS15, function keys can only write addresses, but in the NA series units, they can take screen shots and execute subroutines.

Because NA series units have fewer function keys than the NSH5, you must reassign actions to Touch Switches.

Also, while NS15 units have function keys on the left side of the screen, in the NA series units the function keys are located at the bottom of the screen. Therefore, if you use function keys in association with the screen, you may have to change the screen configuration.

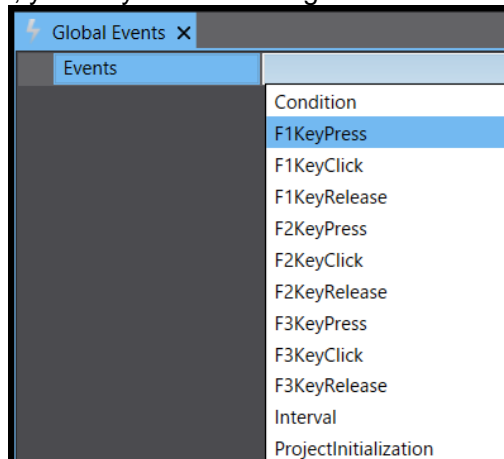

## 5-3 Variable Table

Import the variable table in an NS unit to the NA series variables.

Refer to “4-3-6 Specify Device Address of NS” to “4-3-9 Import NS Variable Table to NA Device Variables” for detailed import procedure.

For device addresses or variables set as “start address + number of monitor points” in the Broken-line Graph Group, only the start addresses will be imported. Follow the procedure in “5-6 Broken-line Graph Group Setting” to set correct arrays.

## 5-4 Alarm/ Event Settings

NS series Alarm/Event Settings consists of the Alarm/Event, Alarm/Event Details, Details, and Alarm/Event Parameter dialogs.

Alarm/Event Dialog

No.	Str#	Message	Address	Pri	Onsp	Off	Auto Switc	Auto Spri	Occur	Release	Auto	Cont
1	OFF	message	\$B0	1	H	0	OFF	0	OFF	ON	0	
2	OFF	This is message	\$B1	1	H	0	OFF	0	OFF	ON	0	

Alarm/Event Details Dialog

Details Dialog

Alarm/Event Parameter Dialog

The table below provides the relation of NS and NA Alarm/Event settings.

NS	Supported/Unsupported in NA	Remarks
Occurred Text	Partly supported	You can select the display color in a user alarms viewer object. Because the object uses the same colors in all alarms, you are not allowed to set display colors depending on each alarm, like for the NS series.
Released Text	Partly supported	
Message	Supported	
Address	Supported	Both rising and falling of a bit variable are supported.
Detection Type	Supported	
Priority	Partly supported	The NS series offers 9999 levels of priority, but in the NA series, 9 levels: User Fault Level 1 to 8 and User Information. The NA series has the narrower setting range, so use <b>Alarm Code</b> as compensation.
Display Type	Unsupported	No corresponding function
Group	Supported	The NS series registers groups by numbers 0 to 99, but the NA series group names are given by strings. There is the item <b>Group</b> in the alarm settings, but a user alarms viewer object cannot display only a designated group on the HMI screen.
Switch Screen	Partly supported	After selecting an alarm and performing the operation on the dialog box that appears, the displayed screen switches to the screen set for the alarm. Unlike the NS series, NA screens are not switched just after being selected on an alarm object.
Switch Contents	Unsupported	No corresponding function
Save to History	Partly supported	You cannot have the option not to save because the alarm and event history is mandatorily saved.
Delete when Alarm/Event is canceled	Partly supported	Alarms and events will be disappeared after cancellation.
Add Info	Partly supported	You can register up to 3 additional information in an entire project of the NS series. In the NA series, you can register 1 additional information for each alarm.
Icon	Partly supported	The NA series does not have dedicated icons such as the alarm/event summary and history object icons. Create processes corresponding to the original icons by using buttons and other objects. Note that some original icons cannot be realized.

## 5-4-1 How to Replace

1. Double-click **Group0** under **HMI – User Alarms** in Multiview Explorer.

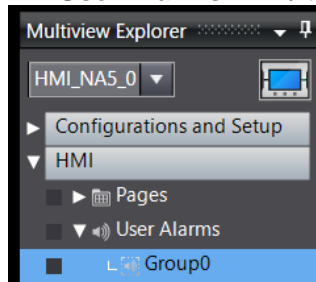

2. Click the  button at the bottom of the tab page to add a new alarm row.

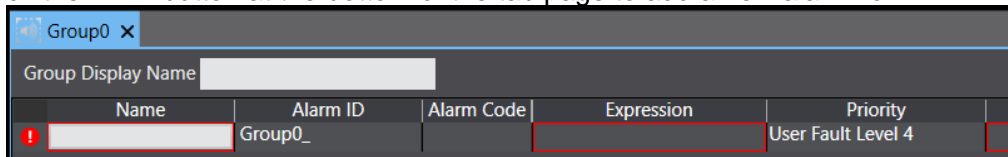

3. Make the settings for the added row following this table. Items not in the table are set to defaults.

Item	Setting
Name	The NS series does not have this item. Leaving this field blank causes an error, so entering a name is required. Names must be unique.
Alarm Code	If you are filtering alarms by group in NS, enter a value of the group name in this field. This item can perform as the alternate functionality for display filtering by group, which is not supported by the NA series. Leave this field empty if you are not using the filtering by group.
Expression	Enter a variable name that corresponds to the original address. When the Detection Type is “Up”, enter the variable name, and for “Down,” enter “variable name = False.”
Priority	Select from the 9 options of User Fault Level 1 to 8 and User Information. As mentioned before, since the setting range in the NA series is narrower than the NS series, you need to re-asses the priority if you have set 10 levels or more for your NS.
Message	Set a message. You can set the message here in the default language only. If you want to set in more than one language, you need to make the setting in <b>HMI - Resources - Alarm Strings</b> .
Popup	Uncheck the box.
Acknowledge	Check this box only if you need confirmation of alarm display.
Page	Enter a name of the destination page if selecting the alarm switches the currently displayed page. If the original project does not include the page switching action, leave this field empty.

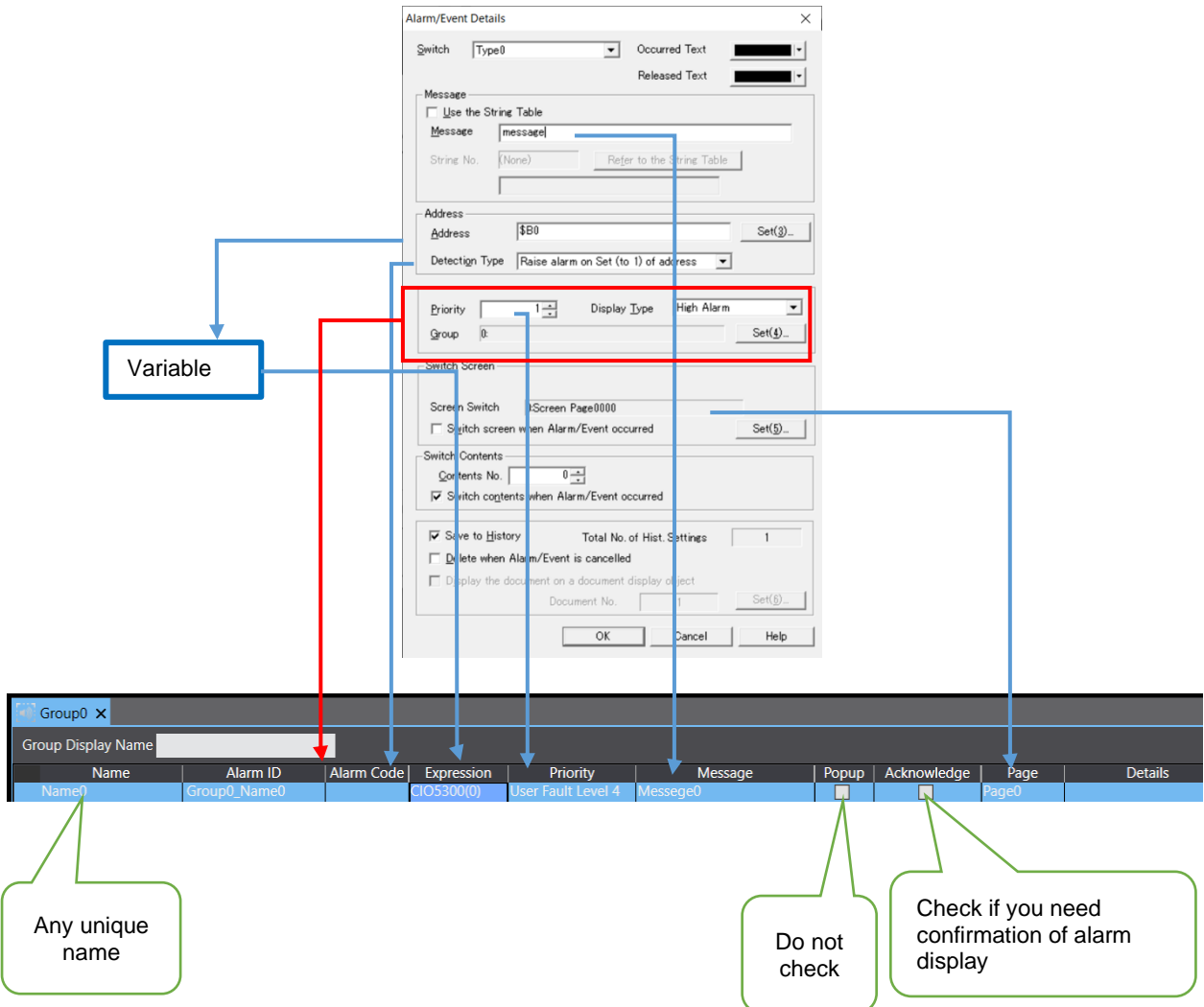

Alarm/Event Details

Switch: Type0 Occurred Text: [ ] Released Text: [ ]

Message:  Use the String Table  
 Message: message  
 String No.: (None) Refer to the String Table

Address: Address: \$B0 Set(\$)\_  
 Detection Type: Raise alarm on Set (to 1) of address

Priority: 1 Display Type: High Alarm  
 Group: 0 Set(\$)\_

Switch Screen: Screen Switch: Screen Page0000  
 Switch screen when Alarm/Event occurred Set(\$)\_

Switch Contents: Contents No.: 0  
 Switch contents when Alarm/Event occurred

Save to History Total No. of Hist. Settings: 1  
 Delete when Alarm/Event is cancelled  
 Display the document on a document display object  
 Document No.: Set(\$)\_

OK Cancel Help

Name	Alarm ID	Alarm Code	Expression	Priority	Message	Popup	Acknowledge	Page	Details
Name0	Group0_Name0		CIO5300(0)	User Fault Level 4	Messege0	<input type="checkbox"/>	<input type="checkbox"/>	Page0	



- Configure **AdditionalInformation** in the **Properties** tab.  
Click **Events** in the **Events and Actions** tab page. You can set actions for the events, **Acknowledged**, **Cleared**, and **Raised**. The following example shows the setting of **CallSubroutine**.  
Make settings as required.

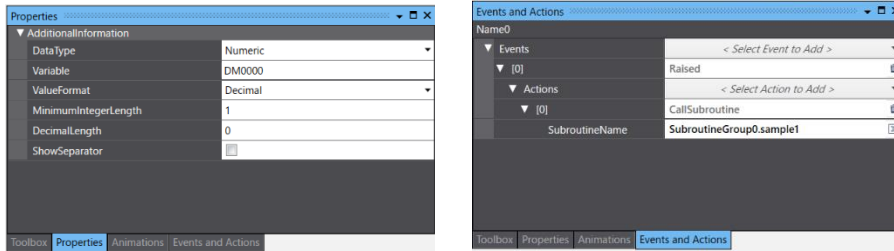

- Conduct these settings for all the alarms registered to the original project.

Name	Alarm ID	Alarm Code	Expression	Priority	Message	Popup	Acknowledge	Page
lame0	Group0_Name0		CIO5300(0)	User Fault Level 4	Messege0	<input type="checkbox"/>	<input type="checkbox"/>	
lame1	Group0_Name1		CIO5300(1)	User Fault Level 4	Messege1	<input type="checkbox"/>	<input type="checkbox"/>	
lame2	Group0_Name2		CIO5300(2)	User Fault Level 4	Messege2	<input type="checkbox"/>	<input type="checkbox"/>	
lame3	Group0_Name3		CIO5300(3)	User Fault Level 4	Messege3	<input type="checkbox"/>	<input type="checkbox"/>	
lame4	Group0_Name4		CIO5300(4)	User Fault Level 4	Messege4	<input type="checkbox"/>	<input type="checkbox"/>	
lame5	Group0_Name5		CIO5300(5)	User Fault Level 4	Messege5	<input type="checkbox"/>	<input type="checkbox"/>	
lame6	Group0_Name6		CIO5300(6)	User Fault Level 4	Messege6	<input type="checkbox"/>	<input type="checkbox"/>	
lame7	Group0_Name7		CIO5300(7)	User Fault Level 4	Messege7	<input type="checkbox"/>	<input type="checkbox"/>	
lame8	Group0_Name8		CIO5300(8)	User Fault Level 4	Messege8	<input type="checkbox"/>	<input type="checkbox"/>	
lame9	Group0_Name9		CIO5300(9)	User Fault Level 4	Messege9	<input type="checkbox"/>	<input type="checkbox"/>	

It is possible to export the alarm setting data to an Excel file, edit the file, and import the edited data.

The second icon from the right exports the setting data , and the rightmost icon imports.



- Put a user alarms viewer object on the page, then configure the displayed column in **Properties - Appearance - Column**.

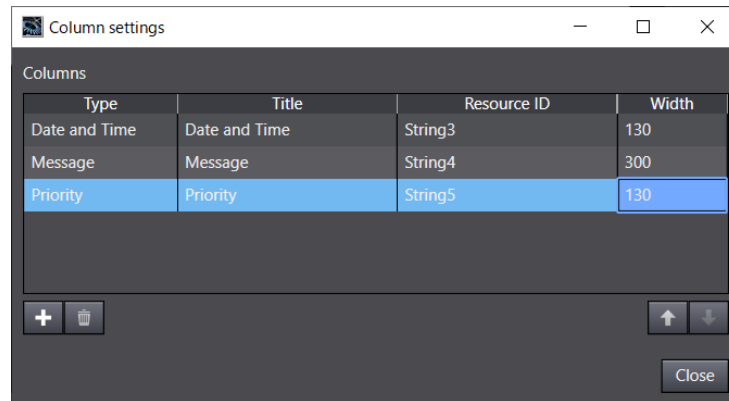



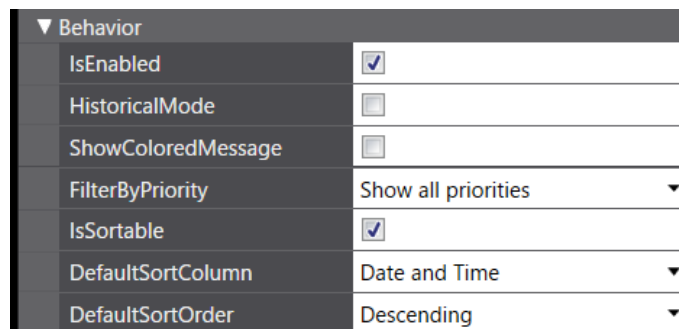

- You can configure **DefaultSortColumn** and **DefaultSortOrder** in **Behavior** in the **Property** tab.  
 Checking **HistoricalMode** displays the **Alarm History** data, and unchecking displays the **Currently Occurred Alarms** data.



## 5-4-2 Non-replaceable Functionalities

- Occurred Text/ Released Text

For the NA series, you can set text colors for each state such as occurrence or release, and those colors are common with all the alarms shown on Alarm Objects. It is not allowed to set different colors for each alarm in the same manner as the NS series. If you are designating different colors for each alarm, you need to reconsider the text colors.

▼ Appearance	
RaisedUnacknowledgedColor	 Red ▼
RaisedAcknowledgedColor	 Orange ▼
ClearedUnacknowledgedColor	 Yellow ▼
ClearedAcknowledgedColor	 Green ▼

- Priority with 10 or more levels

9999 levels are available in the alarm priority in the NS series, but 9 levels in the NA series. If you have set 10 levels or more for your NS unit, reconsider the priority.

- Display Type

The NA series does not have a corresponding setting. In addition to fewer priority levels, the NA series does not provide a minute data classification as compared to the NS series. To display a specific type only, classify the display data by priority, group, or alarm code, and then, filter the data.

- Additional Information (More Than One)

The NS series allows you to register up to three additional information messages, display and record a designated address's value when an alarm rises. However, you can set only one additional information message in the NA series. If you have set more than one additional information message in your NS unit, you must delete the information other than the top-priority one.

## 5-5 Data Log Settings

NS series Data Log Settings consists of the Data Log Group Setting and Data Log Address Setting dialogs.

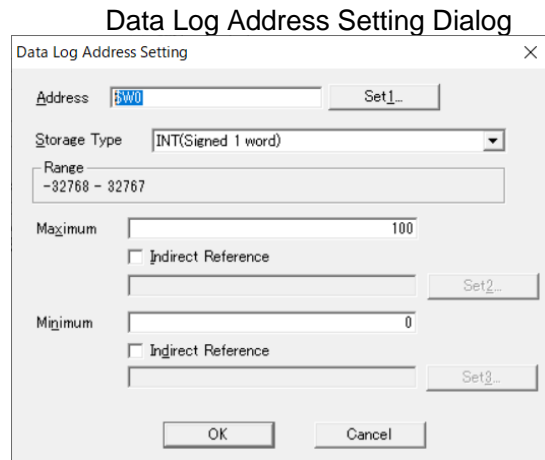
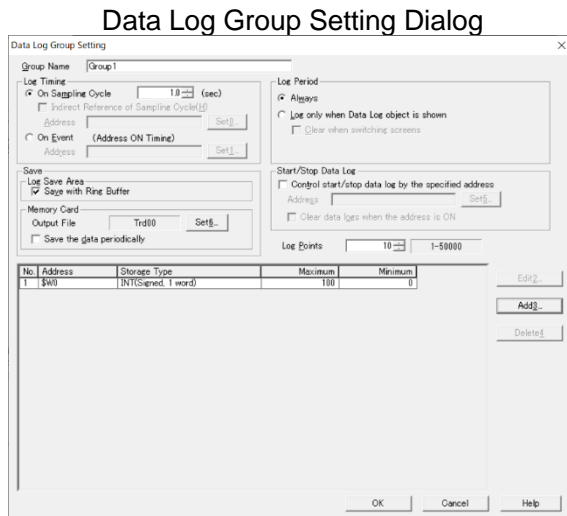

The table below provides the relation of NS and NA data log settings.

	NS	Supported/Unsupported in NA	Remarks
Data Log Group	Log Timing	Partly supported	Indirect reference of sampling cycle is not supported.
	Save	Partly supported	The NA series units create a new file automatically to continue logging when the number of logs reach a set limit.
	Memory Card	Partly supported	You can specify a device where you save the data but not a file name. The file will be named automatically based on the date and time of file creation.
	Log Period	Unsupported	Data logging is not available only while an object is being displayed.
	Start/Stop Data Log	Partly supported	ON and OFF of an address (variable) can control starting and stopping logging, but not clearing logs when the address is ON.
	Log Points	Partly supported	The NA series units create a new file automatically to continue logging when the number of logs reach a set limit. Therefore, you cannot set your NA unit to stop logging when logs reach the specified limit. A real logging limit is the maximum capacity of an external memory designated as storage.
Data Log Address Setting	Maximum/Minimum	Partly supported	You can set the maximum and minimum values with fixed values only. Indirect reference is not available.

## 5-5-1 How to Replace

1. Right-click **HMI - Data Logging** in Multiview Explorer and select **Add - Data Set**.

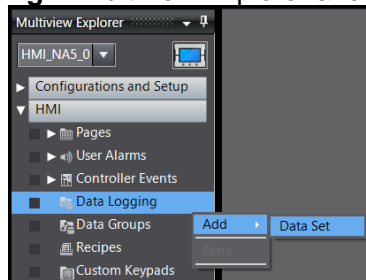

2. Double-click **Dataset0**, which was added to the tree.

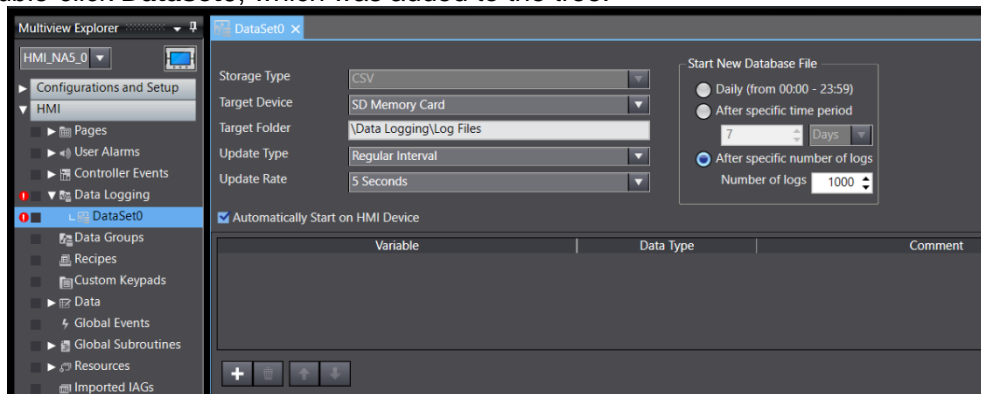

3. Conduct the following settings.

Item	Setting
Target Device	Select either of the SD card or USB stick memory to save logs.
Target Folder	Specify the folder to save log files. The files will be named automatically based on the date and time of file creation.
Update Type	Regular Interval: Logs are saved regularly. On Condition: Logs are saved by condition with variables.
Update Rate	Logs are saved at a fixed interval configured in this field. Indirect reference supported by the NS series is not available. You can use fixed values only.
Expression	Logs are saved when a condition expression in this field is met.
Start New Database File	Specifies the conditions for generating new log files.
Automatically Start on HMI Device	Checking this box saves logs automatically when you boot up the HMI. If you uncheck it, logs will not be saved unless you perform an action to start saving logs.
Variable	Specify global variables to log. Data types and comments are displayed automatically for the specified global variables.

4. After setting the data logging, add a Trend Graph Object on the page.

Select **Data - Data Set** in the Properties tab and specify the data group name you have created in the previous step for **Data Set**.

Then, click the **+** button in the **AnalogTraces** or **DigitalTraces** field to open the trace setting dialog. Enter the global variable you want to display in the **Variable** field.

▼ Data	
DataSet	DataSet0
AnalogTraces	1 <b>+</b>
DigitalTraces	0 <b>+</b>

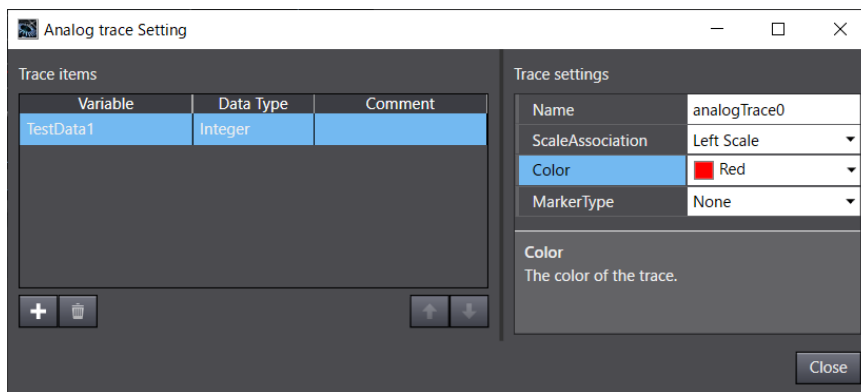

5. Configure settings of line, scale, and other items for each axis.

## 5-6 Broken-line Graph Group Settings

NS series Broken-line Graph Settings consists of the Broken-line Graph Group Setting and Line Setting dialogs.

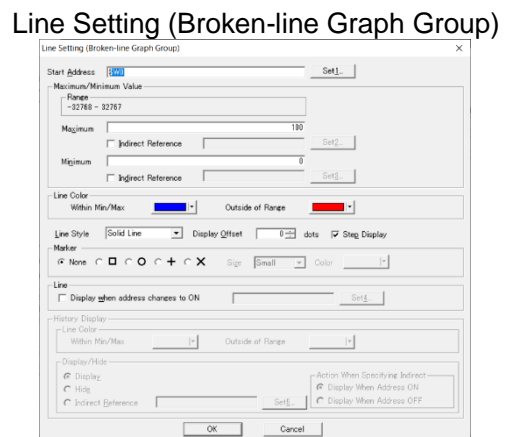
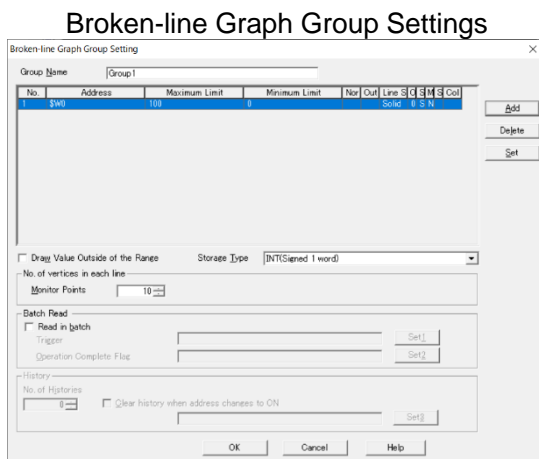

In the NA series, the setting that **DataSeries** of **DataGroup** is set to *Array* is the corresponding feature.

The NS series broken-line graph settings include settings related to graph drawing, e.g., line color. However, in the NA series, the **DataGroup** setting has setting items for global variables and data type only, and those for graph drawing are in Properties of a broken-line graph object.

Therefore, this section describes not only settings of a data group but broken-line graph object and variable settings.

## 5-6-1 Functionality Correspondence Table

The table below provides the relation of NS and NA Broken-line graph settings.

NS		Supported/Unsupported in NA	Location	Remarks
Broken-line Graph Group	Draw Value Outside of the Range	Not supported	-	Values outside of the range are not displayed.
	Read in Batch	Not supported		Always reads values in batch.
	History	Not supported		You cannot save the broken-line graph history.
	Storage Type	Supported	Global Variables and Device Variables	Select a correct variable type when defining an array, according to the storage format.
	Monitor Points	Partly supported		The NS series units can monitor up to 1000 points, but the NA series units can monitor 800. To monitor the 801st point and more, modify the offset, which determines the beginning of monitoring, in <b>Data - Offset</b> of the broken-line graph object.
Line Setting	Start Address	Partly supported		Set an array that has as many as the monitor points of the start address.
			DataGroup	Add the registered array to <b>Data Series</b> in DataGroup tab.
	Line Setting: Maximum/Minimum Value	Partly supported	Broken-line graph object	Only fixed values are available for the maximum and minimum values. Indirect reference is not supported.
	Line Setting: Line Color	Partly supported		Only colors for <b>Within</b> supported. You cannot use colors out of the range.
	Line Setting: Line Style	Partly supported		The NA series supports solid line only. Dash line and dot line are not supported. Step display is not supported.
	Line Setting: Line	Supported		This item is not available. You can control displaying/hiding a line with a subroutine. To hide the line, use HideTraceInGraph function, and use ShowTraceInGraph function to show the line.

## 5-6-2 How to Replace

1. Register arrays in the global and device variables, respectively, according to the setting of the start address of the NS series Broken-line Graph Group.

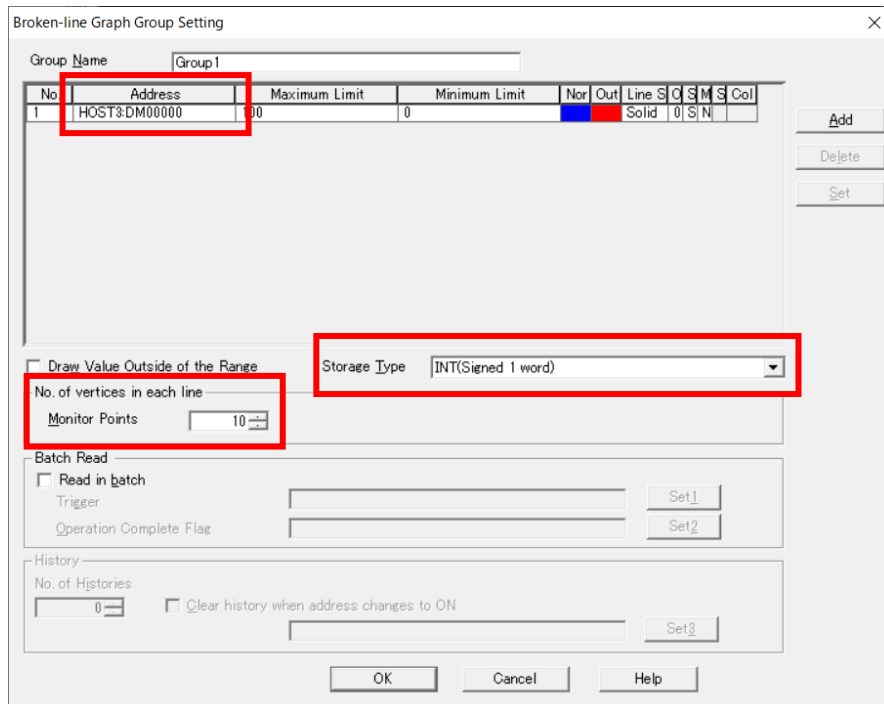

- PT Internal Memory
  - ① Double-click **Global Variables** under **HMI** to open the Global Variables edit pane.
  - ② Select **New** from the right-click menu. Enter any variable name. The variable's data type must correspond to the **Storage Type** of the NS series Broken-line Graph Group, and the variable must have as many elements as **Monitor Points**.
- Device Address
  - ① Follow the same steps as 1) and 2) in "PT Internal Memory."
  - ② Select the added array and open the right-click menu. Then select **Register To Controller**. A dialog box that allows you to associate a global variable and device variable appears.
  - ③ Select a device from the **Device** drop-down list in **Controller Variable Details**. Then press the **Add Global Variable** button.
- Variable
  - ① Only the start address is registered as variable.  
If the variable is used outside of the Broken-line Graph Group Setting, copy and paste the variable and use the added variable in the Data Group Setting.
  - ② Select **HMI - Global Variables**. Choose the target variable on the edit pane, then set the variable's data type to the corresponding type to the **Storage Type** of the NS series Broken-line Graph Group, and the variable must have as many elements as **Monitor Points**.
- Tag  
It is not necessary to register a variable.

2. Right-click **HMI - Data Groups** in the Multiview Explorer and select **Add - Data Group**.

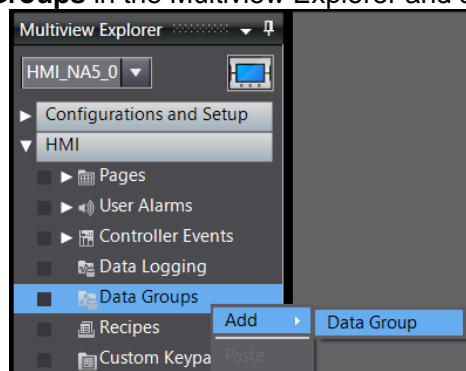



3. Double-click **DataGroup0**, which was added to the tree.

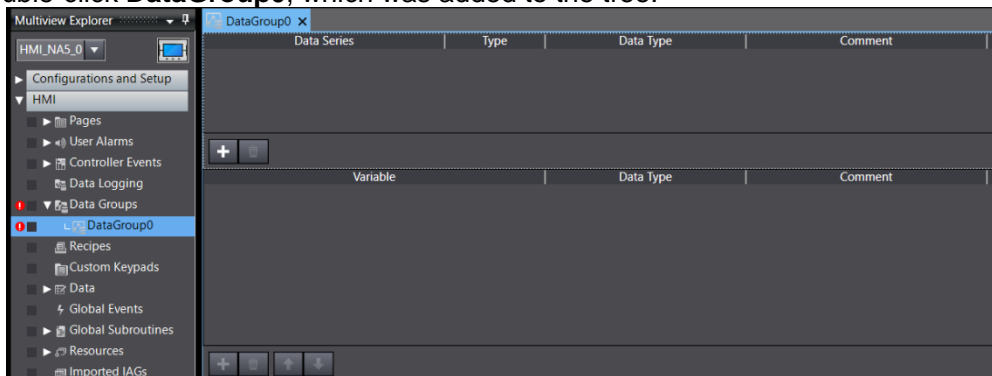

4. Click the  button to create a new data series.

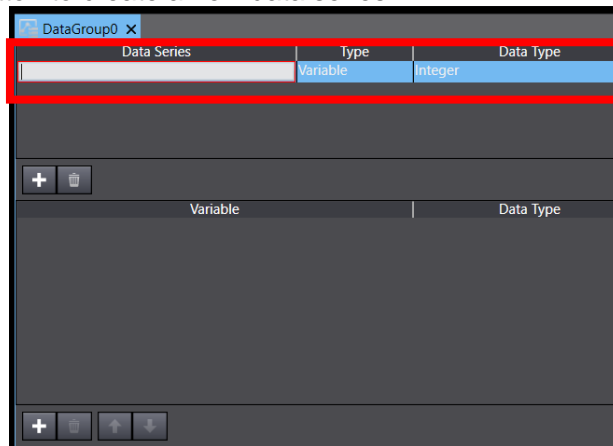

5. Configure the following for the data series.

One graph line is drawn per data series, so create as many data series as you want to display on a single graph.

Item	Setting
Data Series	Enter any name.
Type	Select <i>Array</i> .
Data Type	Select the variable type corresponding to the storage type of the NS-line Graph Group Setting.

6. Configure attributes of the data series.

Item	Setting
Variable	Specify an array to display. The <b>Data Type</b> field will be automatically filled depending on the array that was specified in the variable setting.
Data Type	
Target Dimension	Default value of 0.
Target Index	This field is used for a multidimensional array only. Set the first index of the target. If you use a 1D array, leave this field blank, the default.
Target Member	This field is used for a structure array only. Enter the member names.

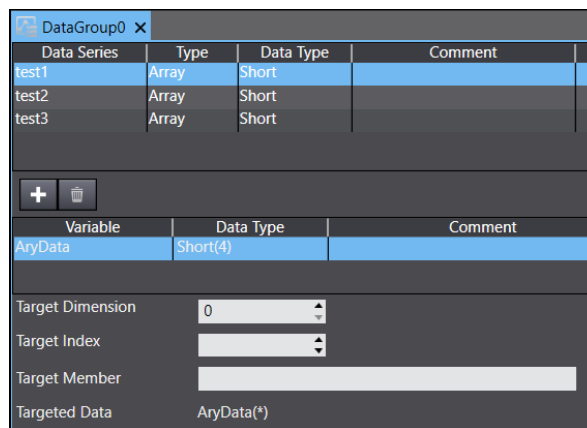

7. Add the broken-line graph object on the page.

Enter the name of the data group you have created in **DataGroup** under **Data** in the Properties tab.

Then, click the **+** button in the **Traces** field to open the Trace Setting window. Enter the data series name (= line to display) in **Data Series**.

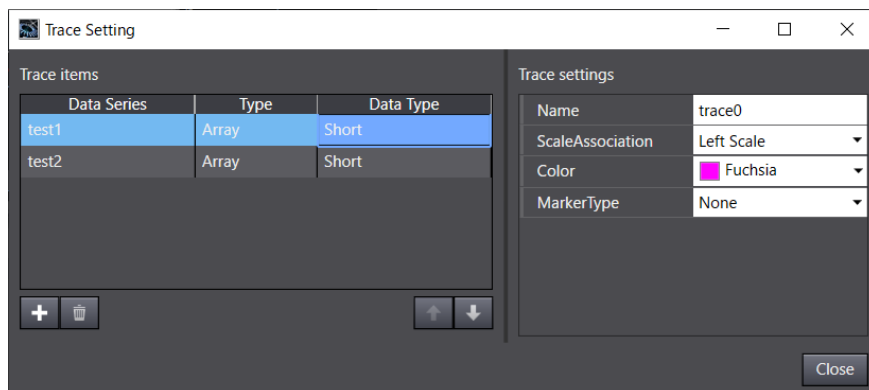
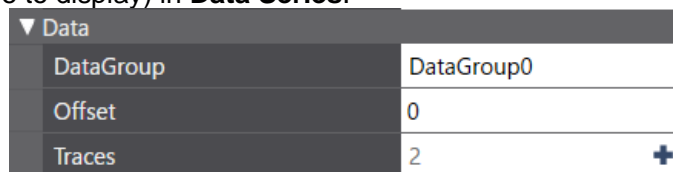

8. Configure settings of line, scale, and other items for each axis.

## 5-7 Data Block Settings

You can replace Data Blocks with Recipes.  
However, settings and features are quite different.

NS	Supported/Unsupported in NA	Remarks
Record Setting	Partly supported	You can set the number of maximum records only.
Specify Interlock	Not supported	Input interlock with variable conditions is not possible.
Record Label Setting	Not supported	Character code setting is not available.
Field Name	Supported	
Address	Supported	
Data Format	Supported	The data types of registered variables are automatically applied.
Record Label	Supported	
Recipe Data	Supported	

### 5-7-1 How to Replace

1. Right-click **HMI - Recipes** in Multiview Explorer and select **Add - Recipe Template**.

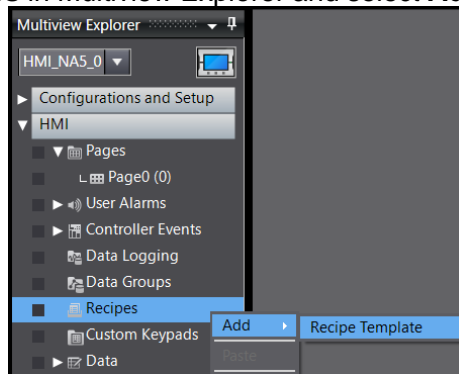

2. Double-click **Recipe0**, which was added to the tree.

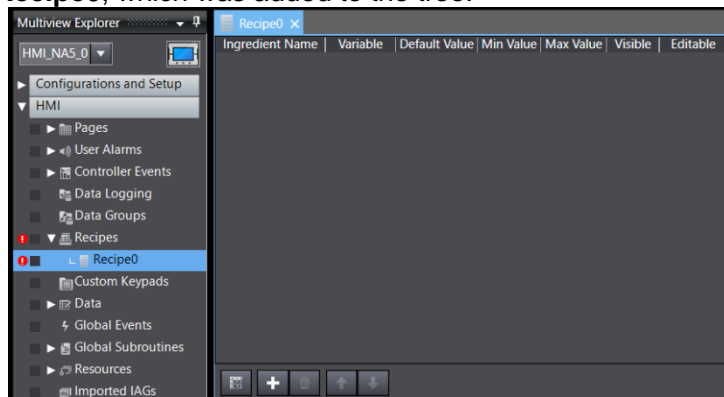

- Click the  button to add a field. Then configure the settings.

**Field Name** and **Address** of an NS series data block are corresponding to **Ingredient Name** and **Variable**, respectively.

Recipe0 X						
Ingredient Name	Variable	Default Value	Min Value	Max Value	Visible	Editable
NewField1	TestData1	123			<input checked="" type="checkbox"/>	<input checked="" type="checkbox"/>
NewField2	TestData2	456			<input checked="" type="checkbox"/>	<input checked="" type="checkbox"/>

- Click the  button to register values for recipes.

These are corresponding to the fields where values are registered for each data block record.

Recipe0 X			
Recipe Name	NewField1	NewField2	
Data1	123	456	
Data2	1	2	
Data3	-123	-456	

- Add a recipe viewer object on the page.

To display all registered recipes, leave the fields **DisplayedTemplate** and **DisplayedRecipe** blank, the default. Set these fields only when you want to select display items.

▼ Behavior	
IsEnabled	<input checked="" type="checkbox"/>
DisplayedTemplate	
DisplayedRecipe	

- Configure the background color, text, and other settings.

## 5-8 String Table Setting

You can replace the String Table Setting with **Resources** in **HMI**.

While the NA series has one string table per language, the NA series has five string groups, including General Strings, Alarm Strings, Images, and others.

Use General Strings, Alarm Strings, and Images for replacement of the NS series.

In the NS series, a string table is applied to alarm/event strings, whereas in the NA series, **Alarm Strings** in **Resources** is applied.

In addition, the NS series manages strings by string number in the string table, whereas the NA series manages by resource ID.

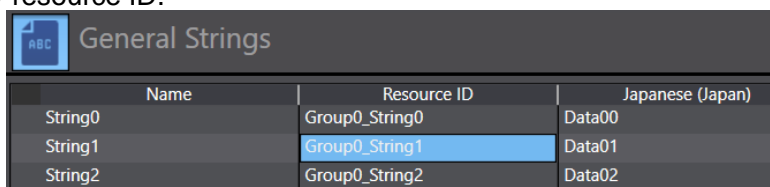

Name	Resource ID	Japanese (Japan)
String0	Group0_String0	Data00
String1	Group0_String1	Data01
String2	Group0_String2	Data02

Enter the ID registered in **Resources** into **Resource ID** of the object to display the string registered in **Resources**.

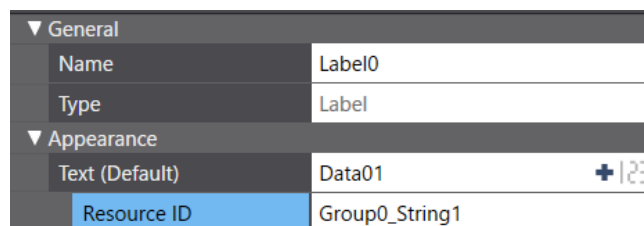

▼ General	
Name	Label0
Type	Label
▼ Appearance	
Text (Default)	Data01 + 123
Resource ID	Group0_String1

### 5-8-1 Example of Indirect Reference

You can specify Resource IDs for label and text box objects using conditional expressions. In this way, you can achieve the similar behavior as if the string number were set to Indirect Reference in the NS series.

1. Right-click **HMI - Resources** in Multiview Explorer and select **Add - Group**.  
The group Root exits by default, but we recommend creating a new group for management reason.

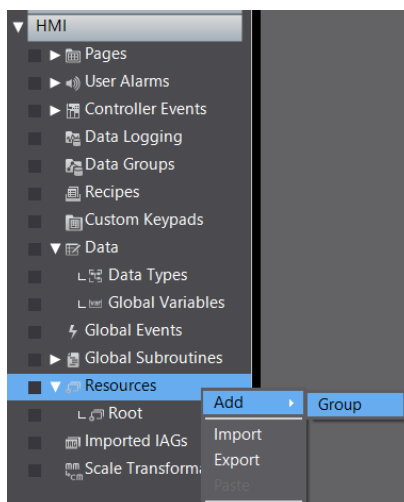

2. Register texts in **General Strings** of the newly added group.

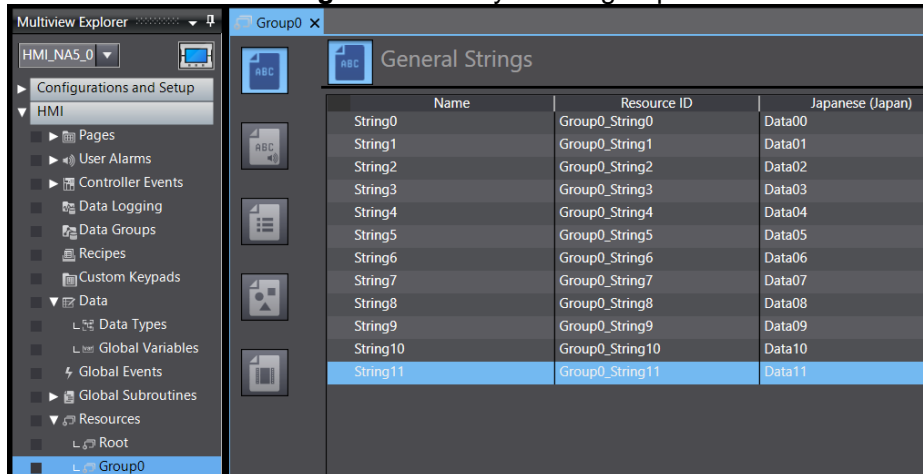

3. After completing entering the texts, create a label or text box object. Then click the  button.

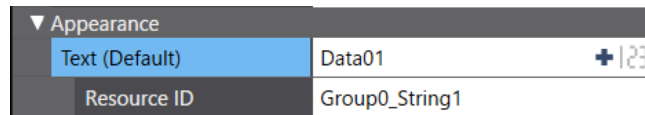

4. Selecting *Dynamic* for **Resource Link Type** allows you to enter in the **Expression** field.

Enclose the part to be fixed in double quotation marks, followed by & and then a numeric-type variable.

In the example show below, up to Group0\_String is fixed, and the string can be switched according to the value of the numeric type variable TableNum.

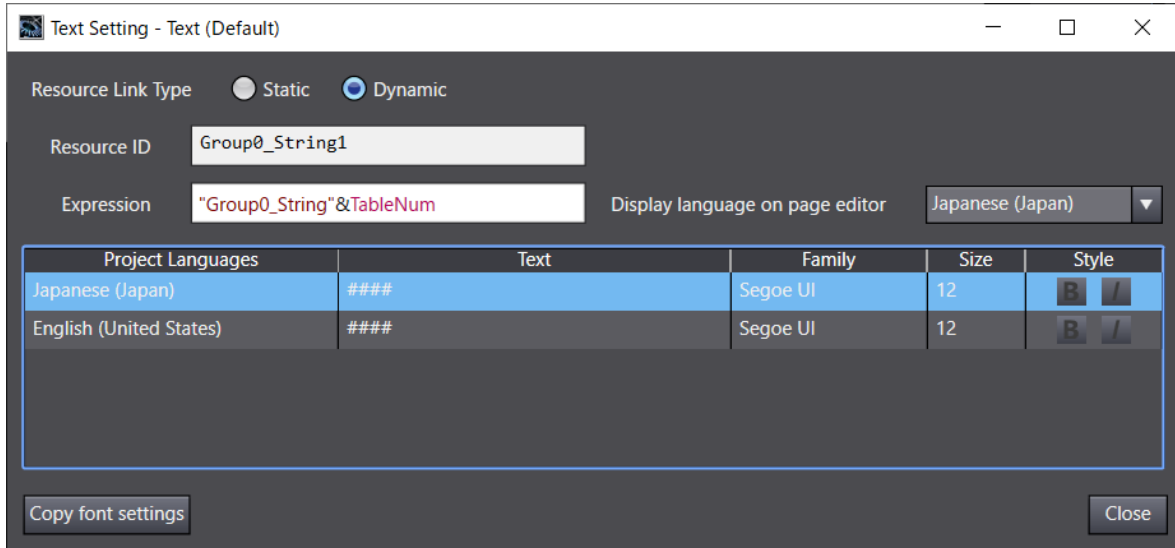

## 5-9 Password

The password function of the NS series allows you to enter a password to operate a functional object and has up to five passwords and operation levels.

For the NA series, the security function is available. This function controls whether an entry to an object is allowed/prohibited and whether the object is shown/hidden, depending on the privilege of the logged-in user. In the NA series, instead of entering a password at the time of operating the object as in the NS series, the user logs in with a username and password before operating the object.

To enter the password at the point of operating an object as in the NS series, follow this procedure.

1. Define five String type variables, NS\_passwords1 to NS\_passwords5, to store the password string as global variables.
2. In addition, define Boolean type variables NS\_SB54 to 58, which are substituted for the NS system memories \$SB54 to 58 and Integer type variable NS\_SW39, which is substituted for \$SW39, as global variables.
3. Create a subroutine NS\_checkPassword().

```
Sub NS_checkPassword()
    Dim lvl As Integer = 0
    Dim pwd As String
    pwd = Microsoft.VisualBasic.InputBox("Enter the password")
    select pwd
    case NS_passwords1:
        lvl = 1
    case NS_passwords2:
        lvl = 2
    case NS_passwords3:
        lvl = 3
    case NS_passwords4:
        lvl = 4
    case NS_passwords5:
        lvl = 5
    End Select
    If lvl > 0
        NS_SW39 = lvl
        NS_SB54 = True
    End if
    If lvl > 1 Then NS_SB55 = True
    If lvl > 2 Then NS_SB56 = True
    If lvl > 3 Then NS_SB57 = True
    If lvl > 4 Then NS_SB58 = True
End Sub
```

4. Select **Press** from the Events options in **Events and Actions** of the object. Then select **CallSubroutine** from the options of Actions, and specify the subroutine NS\_checkPassword() in SubroutineName.



## 5-10 Unit/Scale Settings

Double-click **Scale Transformations** under **HMI** in Multiview Explorer to open the **Scale Transformations** edit pane. Configure multiplier and offset values. Unlike in the NS series, you cannot configure units in the NA series.

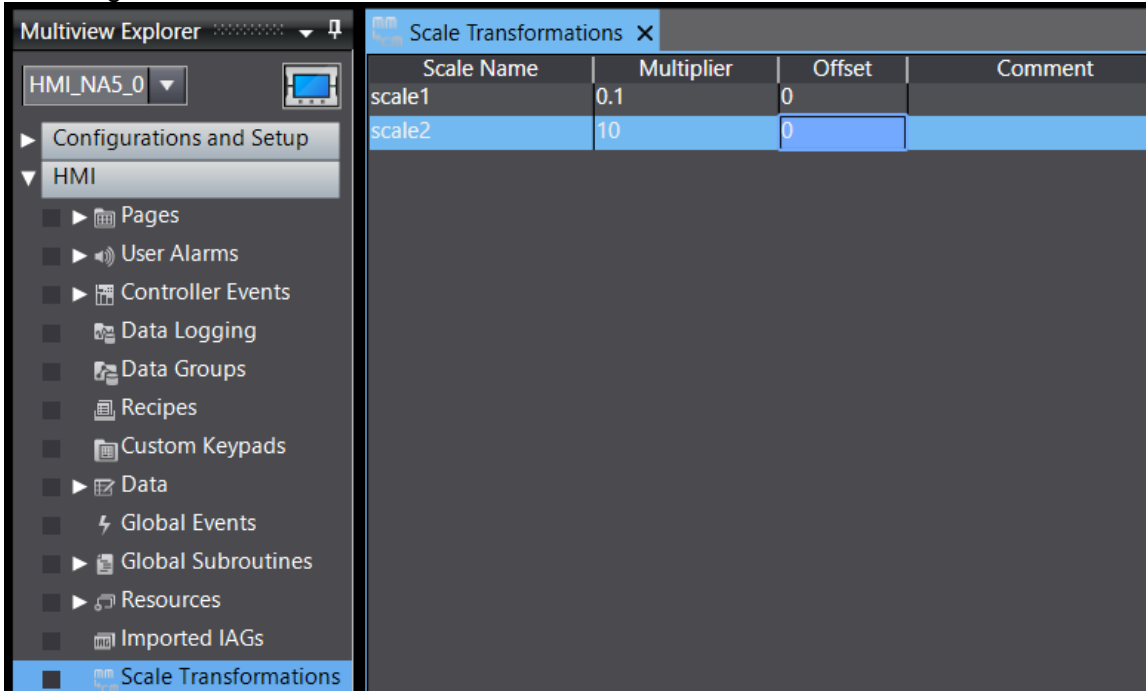

Enter the registered scale transformations in the **Scaling** field in Properties of a data display or data input object.

▼ Behavior	
IsEnabled	<input checked="" type="checkbox"/> [i]
DataType	Numeric ▼
Variable	DM100
Scaling	scale1

## 5-11 Dialog Setting

The NA series does not have a corresponding functionality. To realize the same behaviors as the NS series, you need to utilize pup-ups.

Since the NA series can only display one pop-up screen at a time, the following method is useful to display additional confirmation dialog, etc. on the pop-up.

1. Place a button object the same size as the screen size at the very front of the page. Make inputs disabled on this button object. By hiding this button object normally and making the object visible when displaying the confirmation dialog, the currently displayed window will be covered by this object, and all buttons there will get non-enterable.
2. Arrange objects for the confirmation dialog in front of the button object. These objects should also be normally hidden so that they will be displayed and operated when the confirmation dialog is displayed.

## 5-12 Device Data Transfer Setting

The NA series does not have a corresponding functionality.  
The following describes how to achieve the function with a subroutine.

1. Define transfer source address and transfer destination address of a transfer entry in Global Variables. If the transfer entry has more than one data element, define as an array with as many members as the elements.
2. Define the bit address of a device data transfer trigger as a Boolean variable in Global Variables.
3. Create a function NS\_DataTransfer in Global Subroutines. You need as many functions as device data transfer triggers.

```

Sub NS_DataTraNSfer1
  Dim I As Integer
  DestinationVariable1 = SourceVariable1
  DestinationVariable2 = SourceVariable2
  DestinationVariable3 = SourceVariable3
  ...
  For I = 0 To SourceArray4.Length - 1
    DestinationArray4(i) = SourceArray4(i)
  Next
  For I = 0 To SourceArray5.Length - 1
    DestinationArray5(i) = SourceArray5(i)
  Next
  ...
End Sub

```

4. Register the data transfer triggers in Global Events.  
Events must be the same number of triggers, and you need to specify corresponding functions for them.

Trigger Type	Event	Action
Rising Edge	Enter <i>Variable</i> in <b>Condition - Expression</b> Specify the function <i>NS_DataTraansfer**</i> in <b>CallSubroutine</b>	
Falling Edge	Enter <i>Not Variable</i> in <b>Condition - Expression</b>	
Cycle	Select <i>Interval</i> in <b>Interval.</b>	

## 5-13 Troubleshooter Setting

The table below provides the relation of NS and NA troubleshooter settings.

NS	Supported/Unsupported in NA	Remarks
Screen Setting	Partly supported	While in the NS series, you need to copy the screen settings from Sysmac Studio or import via a CSV file, in the NA series, you can reuse events set in the controller, cooperating in Sysmac Studio. However, you cannot display a screen you want to show while pressing the Show Detail button.
Theme	Not supported	The theme to be displayed is fixed.
Language Assignment	Supported	Configure the language assignment in the <b>Language Mapping</b> area.
User Authentication	Supported	Configure user authentications in the <b>Security Settings</b> area.
Monitor Errors	Supported	Check the <b>Launch on System Event</b> and <b>Launch on User Event</b> check boxes.

Double-click **Troubleshooter** under **Configurations and Setup** to open the Troubleshooter setting tab page.

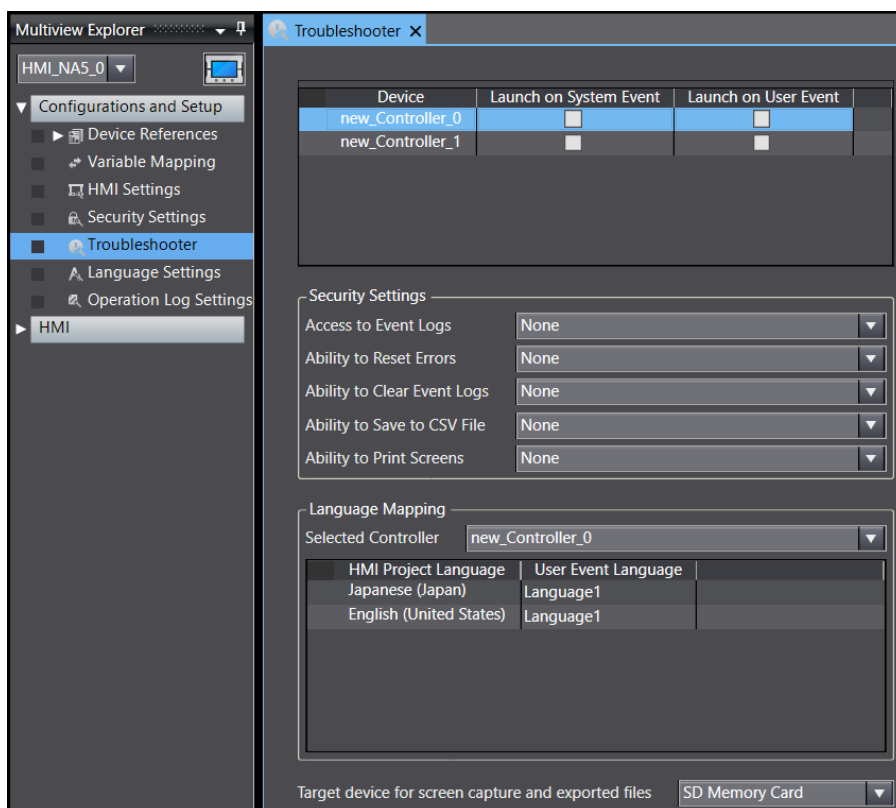

# 6 Replacement Examples: Functional Objects

This chapter describes examples of replacing functional objects such as ON/OFF buttons and bit lamps.

## 6-1 Functional Difference Between NS and NA: Common in Objects

This section provides items common in components but have different features in the NS and NA series.

### 6-1-1 Behaviors of Overlapped Objects



In the NS series, objects without input function, e.g., shape, lamp, and label, do not prevent press inputs into objects behind. You can operate a button even when those objects are front of it. However, all objects do not allow you to operate objects behind them. For example, you cannot press a button if you have put another shape object in front of the button. Therefore, do not place an object in front of a button. Or remove a button behind and set the behavior of the button in **Events and Actions - Press** of the front object.

### 6-1-2 Behaviors of Hidden Objects

You can operate hidden objects, except Numeral Display and Input, and String Display and Input objects in the NS series.

In the NA series, if you uncheck the **IsVisible** check box to hide an object, you are not allowed to operate the object.

To create an operable invisible object, check the **IsVisible** and **Transparent** check boxes.

TextColor	<input type="checkbox"/> Transparent
BackgroundColor	<input type="checkbox"/> Transparent  
BorderColor	<input type="checkbox"/> Transparent

### 6-1-3 Appearance of Non-Enterable Object

The Na series objects will be forcibly grayed-out when they are in the non-enterable state.

(Left: Object in the enterable state. Right: Object in the non-enterable state)

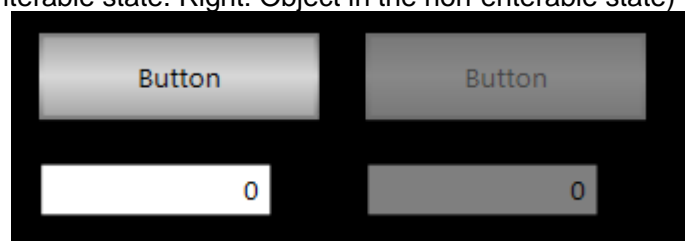

To prohibit operations without changing the object's appearance, overlay another shape object on the object, not controlling inputs. Make the overlaid shape transparent. Then, show it while input is prohibited and hide while input is allowed.

## 6-1-4 Where to Use Macros in Object Settings

The table below shows where you can set subroutines in the NA series for replacing macros executed in the NS series object settings.

NS Functionality	NA Setting
Touch ON	Display <b>Events and Actions</b> of the object and select <i>Press</i> from the options in <b>Events</b> . Then, select <i>CallSubroutine</i> in <b>Actions</b> .
Touch OFF	Display <b>Events and Actions</b> of the object and select <i>Click</i> or <i>Release</i> from the options in <b>Events</b> . Then, select <i>CallSubroutine</i> in <b>Actions</b> .
Execute when ON	Display <b>Events and Actions</b> of the page and select <i>Condition</i> from the options in <b>Events</b> to enter [ <i>Variable name = True</i> ] in <b>Expression</b> . Then, select <i>CallSubroutine</i> in <b>Actions</b> .
Execute when OFF	Display <b>Events and Actions</b> of the page and select <i>Condition</i> from the options in <b>Events</b> to enter [ <i>Variable name = False</i> ] in <b>Expression</b> . Then, select <i>CallSubroutine</i> in <b>Actions</b> . Execute when OFF
Execute when ON/OFF	Display <b>Events and Actions</b> of the page and select <i>Condition</i> from the options in <b>Events</b> to enter [ <i>Variable name = True</i> ] and [ <i>Variable name = False</i> ] in <b>Expression</b> , respectively. Then, select <i>CallSubroutine</i> in <b>Actions</b> .  Execute when OFF
Before inputting numeral	No corresponding function
Before writing numeral	No corresponding function
When changing value	No corresponding function
When an address value changed	No corresponding function
Set Value = Address Value	Display <b>Events and Actions</b> of the page and select <i>Condition</i> from the options in <b>Events</b> to enter [ <i>Variable name = Set value</i> ] in <b>Expression</b> . Then, select <i>CallSubroutine</i> in <b>Actions</b> .
Set Value != Address Value	Display <b>Events and Actions</b> of the page and select <i>Condition</i> from the options in <b>Events</b> to enter [ <i>Variable name &lt;&gt; Set value</i> ] in <b>Expression</b> . Then, select <i>CallSubroutine</i> in <b>Actions</b> .
Set Value < Address Value	Display <b>Events and Actions</b> of the page and select <i>Condition</i> from the options in <b>Events</b> to enter [ <i>Variable name &lt; Set value</i> ] in <b>Expression</b> . Then, select <i>CallSubroutine</i> in <b>Actions</b> .
Set Value <= Address Value	Display <b>Events and Actions</b> of the page and select <i>Condition</i> from the options in <b>Events</b> to enter [ <i>Variable name &lt;= Set value</i> ] in <b>Expression</b> . Then, select <i>CallSubroutine</i> in <b>Actions</b> .
Set Value > Address Value	Display <b>Events and Actions</b> of the page and select <i>Condition</i> from the options in <b>Events</b> to enter [ <i>Variable name &gt; Set value</i> ] in <b>Expression</b> . Then, select <i>CallSubroutine</i> in <b>Actions</b> .
Set Value >= Address Value	Display <b>Events and Actions</b> of the page and select <i>Condition</i> from the options in <b>Events</b> to enter [ <i>Variable name &gt;= Set value</i> ] in <b>Expression</b> . Then, select <i>CallSubroutine</i> in <b>Actions</b> .

## 6-2 Non-replaceable Functionalities: Common in Objects

The following table shows the functionalities common in the NS series functional objects that cannot be replaced in the NA series.

NS Functionality	Remarks
Indirect reference of color/ Indirect reference of text color	The functions change the color of objects, such as ON/OFF buttons, bit lamps, and labels, and texts according to the value of an address. The NA series does not have corresponding functionalities and use the color code of the NS series.
Three-dimensional Frame	Simple frame only. Three-dimensional frame is not available.
Frame ON/OFF Display	This functionality is not supported because three-dimensional frame is not available.
Flicker	The NA series has the flicker functionality, but you cannot modify the flickering point and rate.
Turn ON the specified address when the value is confirmed	No corresponding function.
Display Write Confirmation Dialog	No corresponding function is available because the NA series does not have the dialog setting function.
Record to Operation Log - Message	The NA series cannot record messages for each object in the operation log.
Password	You can display a password input dialog box while pressing an object following the tangled procedure in "5-9 Password," but the behavior differs from the NS series. Instead, we recommend using the NA security function and logging in with authorized username in advance.

## 6-3 ON/OFF Button

In the NA series, button objects are classified into different objects: Button, Set Button, Toggle Button, Momentary Button, and Reset Button. Lay out an object for an action you want to create. Buttons are divided into different objects, but you can change the button type in **General - Type** in the Properties tab after placing the object.

Different objects in Toolbox

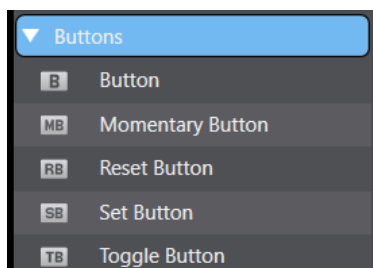

Change the button type in **General - Type** in the object's Properties tab

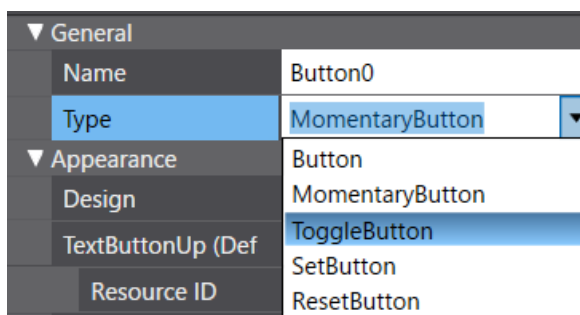

### Precautions for Correct Use

There are some differences in the behavior of the momentary button between the NS and NA series. When communication with the controller is disconnected while you are pressing the momentary button, the NS unit checks the button state when communication is restored and writes the value to the allocation memory if there is a difference. Still, the NA unit does not write to the memory but only

reads the value of the allocated memory. Therefore, depending on the settings, the display may differ from the operation state, so please debug it when replacing it to ensure that unexpected behavior does not occur.

---

## 6-3-1 Button Types

The NS series ON/OFF button has various display statuses, e.g., write destination, display bit data, etc.

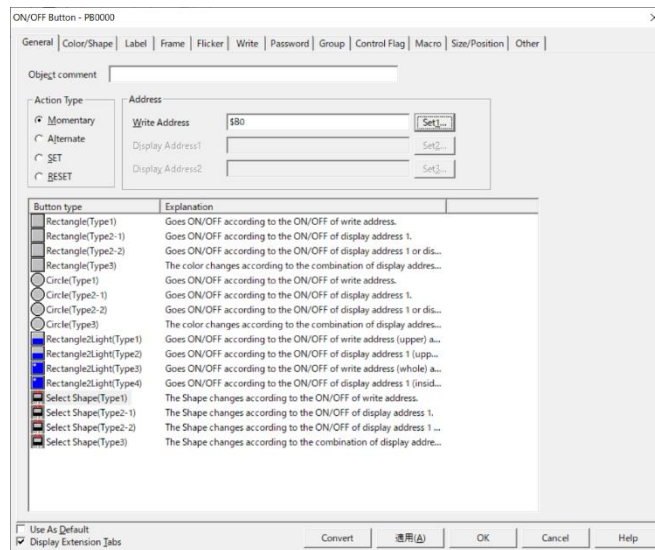

This section describes replacement procedure for each button type.

In the NA series, you can perform settings in **Behavior - VisualFeedback** in the **Properties** tab, which corresponds to Button type in the NS series. Some ON/PFF button types supported in the NS series have no functionalities in the NA series.

NS Action Type	NA Setting	Remarks
Rectangle/Circle/Select Shape (Type1)	Variable (Button)	
Rectangle/Circle/Select Shape (Type2-1)	Feedback (Button)	Enter an expression for changing the state in <b>FeedbackExpression</b> .
Rectangle/Circle/Select Shape (Type2-2)	Touch (Button) + Feedback (Button)	Enter an expression for changing the state in <b>FeedbackExpression</b> .
Rectangle/Circle/Select Shape (Type3)	No corresponding setting	This type does not have a functionality as a button itself, but you can create a similar display by overlaying buttons, lamps, and shapes.
Rectangle2Light(Type1)	Variable (Button) + Feedback (Indicator)	Select <i>Bottom</i> or <i>Custom</i> for <b>IndicatorPosition</b> to adjust the width, height, and position of the indicator.
Rectangle2Light(Type2)	No corresponding setting	
Rectangle2Light(Type4)	Variable (Button) + Feedback (Indicator)	In the NA series, the indicator corresponds to the ○ in an NS series object, but its shape is rectangle.
Rectangle2Light(Type4)	No corresponding setting	

## 6-3-2 Non-replaceable Functionalities

NS Tab	NS Functionality	Remarks
Label	Link with the Specified Address ON/OFF	In the NS series, you can change the status of objects and labels with different addresses, respectively, but in the NA series, the status of an object and that of a label is linked.
Group Specification	Group Specification	No corresponding function. You need create an action that when you press a button, it turns all the variables assigned to other buttons in the group OFF by using a subroutine.



Other	Do not allow sound for this object	No corresponding function.
-------	------------------------------------	----------------------------

## 6-4 Word Button

The NA series does not have a specific button with corresponding functionality. However, you can realize the functionality using a simple Button object in the following way: select *Press* from the **Events** options in **Events and Actions**. Then, select an appropriate action from the **Actions** options.

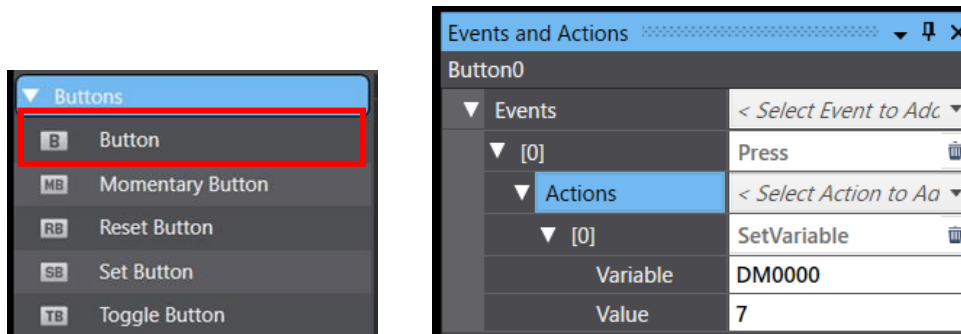

### 6-4-1 Button Actions

The table below provides alternate settings in the NA series for the button action settings of NS series word lamps.

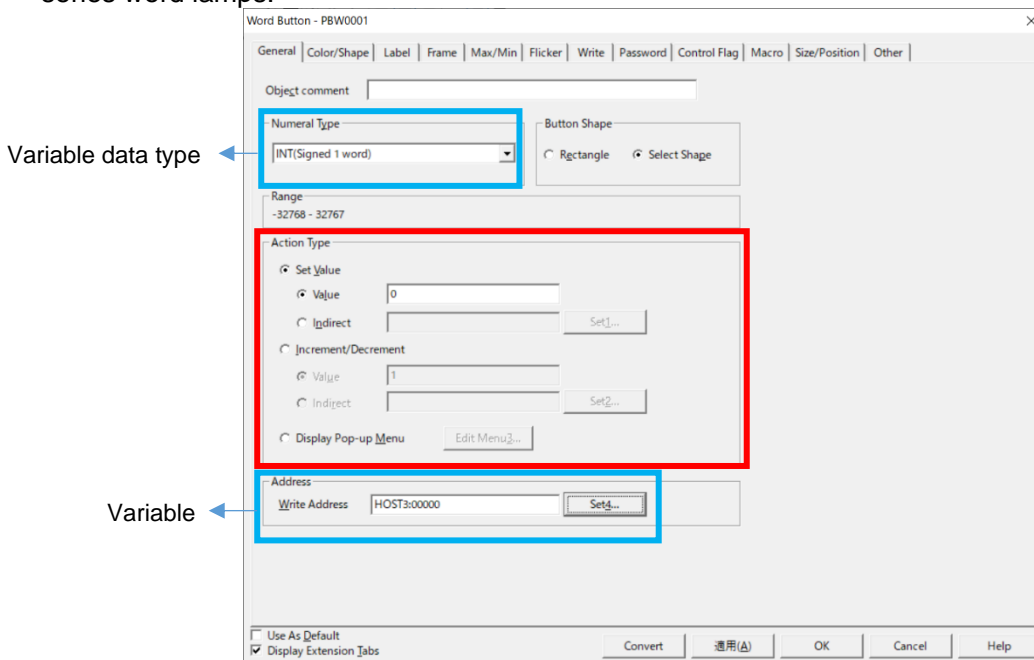

NS Action Type	NA Action	Remarks
Set Value - Value	SetVariable	Enter a value in the <b>Value</b> box.
Set Value - Indirect	SetVariable	Enter a variable name for indirect reference in the <b>Value</b> box.
Increment/Decrement - Value	IncreaseVariable DecreaseVariable	Enter a value to add or subtract in the <b>Value</b> box.

Increment/Decrement - Indirect	IncreaseVariable DecreaseVariable	Enter a variable name for indirect reference in the <b>Variable</b> box.
Display Pop-up Menu	No corresponding function	

● **Set Value Match Color**

You can select the set value match color when you choose **Set Value** in the Action Type area in the NS series. In the NA series, since buttons do not have a feedback expression, it is impossible to change a status using variables.

If you want to set the set value match color, prepare a momentary button and configure it to change when the value comes to the set value. For this example, the state changes when the value of the variable DM0000 comes to 10.

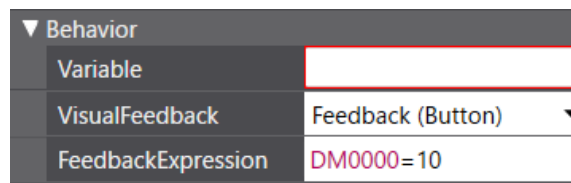

Leaving the Variable box blank will issue a warning at a build.

If you do not want the warning, create a dummy variable, and enter it in the Variable box.

#### 6-4-2 Non-replaceable Functionalities

NS Tab	NS Functionality	Remarks
Max/Min	Maximum Limit/ Minimum Limit	Configure the action so that a button works within the range of limits of inputs. You need a subroutine to replace these settings including the options, Return to the minimum/maximum value when the maximum/minimum value is exceeded.
Other	Do not allow sound for this object	No corresponding function.

## 6-5 Command Button

The NA series does not have a specific button with corresponding functionality. However, you can realize the following settings The selected standard Button object in the following way: select *Click* from the **Events** options in **Events and Actions**. Then, perform an appropriate setting in the **Actions** fields. Note that some functionalities cannot be replaced.

NS Functionality	NA Action	Remarks
Switch Screen - Specified Screen	ShowPage	Enter a destination page name in <b>PageName</b> .
Switch Screen - Indirect Specification of Screen No.	SetVariable	Enter the system-defined variable <code>_HMI_CurrentPageIndex</code> in the <b>Variable</b> box, and the indirect referencing variable name in the <b>Value</b> box, respectively.
Switch Screen - Selection by Pop-up Menu	No corresponding function	
Switch Screen - Backward	ShowPreviousPage	
Switch Screen - Forward	No corresponding function	
Switch Screen - Write Screen No. when Pressing the button	SetVariable	Enter the write destination variable name in the <b>Variable</b> box, and the system-defined variable <code>_HMI_CurrentPageIndex</code> in the <b>Value</b> box, respectively.
Key Button	No corresponding function	
Control Pop-up Screen - Close Local Pop-up Screen	ClosePage	Enter the name of the page you want to close in <b>PageName</b> .
Control Pop-up Screen - Close Specified Pop-up Screen	ClosePage	Enter the name of the page you want to close in <b>PageName</b> .
Control Pop-up Screen - Move Local Pop-up Screen	No corresponding function	
Display System Menu - System menu Top Page (Initialize Tab)	ShowSystemMenu	
Display System Menu - Switch Box Function	No corresponding function	
Display System Menu - Display Captured Data	No corresponding function	
Stop Buzzer	BuzzerOff	
None	No corresponding function	You can realize the same action by leaving <b>Events</b> settings empty. If another functionality, e.g., the Touch ON macro, is registered, configure a corresponding functionality.
Video Control - Video Capture	No corresponding function	
Video Control - Contrast Adjustment	No corresponding function	

Video Control - Vision Sensor Console Output	No corresponding function	
Data Block Control - Read data from CSV file to PLC Data Block	No corresponding function	
Data Block Control - Write data from PLC Data Block to CSV file	No corresponding function	
Data Block Control - Read data from CSV file to NS PT Memory	No corresponding function	
Data Block Control - Write data from NS Data Block to CSV file	No corresponding function	
Data Block Control - Read data from NS PT Memory to PLC Data Block	No corresponding function	
Data Block Control - Write data from PLC Data Block to NS PT Memory	No corresponding function	
Data Block Control - Read record label	No corresponding function	
Data Block Control - Delete record	No corresponding function	
Authentication Cancellation	Logout	

### 6-5-1 Non-replaceable Functionalities

NS Tab	NS Functionality	Remarks
Other	Do not allow sound for this object	No corresponding function.

## 6-6 Bit Lamp

The NS series bit lamps are replaceable with Bit Lamp Objects in the NA series.

NS Series	NA Series
<p><b>General Tab</b></p>	<p><b>Properties</b></p>
<p><b>Label Tab</b></p>	<p><b>Properties</b></p>

When you select Ellipse or Rectangle in **Appearance - Design** and choose a color, the upper-right part of the object will be forcibly colored gradationally, and the appearance will differ from an NS series bit lamp. If you want the same appearance, select *Image* in **Appearance - Design** to use an image file for the lamp's appearance. No gradation on the lamp. Note that you need to prepare an image file.

Left: Rectangle in **Appearance - Design**, forcibly gradation colored.  
 Right: Image in **Appearance - Design**, not gradation colored.

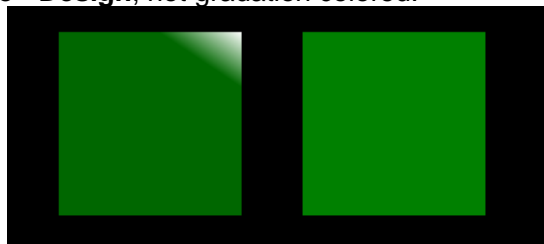

### 6-6-1 Non-replaceable Functionalities

NS Tab	NS Functionality	Remarks
General	Double-line Circle	The NA series has only single-line frame.
General	Double-line Rectangle	The NA series has only single-line frame.
Macro	Macro Execution Condition	In the NA series, you cannot register an action to a lamp. Set a subroutine in <b>Events and Actions</b> of a page or global event.

## 6-7 Word Lamp

The NS series bit lamps are replaceable with Data Lamp Objects in the NA series. Just like bit lamps, when you select Ellipse or Rectangle in **Appearance - Design** and choose a color, the upper-right part of the object will be forcibly colored gradationally.

### 6-7-1 Non-replaceable Functionalities

NS Tab	NS Functionality	Remarks
General	Double-line Circle	The NA series has only single-line frame.
General	Double-line Rectangle	The NA series has only single-line frame.
Label	Switch label according to the address value	It is impossible to read strings from a file. Enter a label directly in <b>Behavior - ColorRanges</b> in Properties.
Macro	Macro Execution Condition	In the NA series, you cannot register an action to a lamp. Set a subroutine in <b>Events and Actions</b> of a page or global event.

## 6-8 Multifunction

The NA series does not have a directly-corresponding object, but you can achieve a similar functionality by registering multiple **Events and Actions** settings for a button object.

In the following example, a single object assigns a value to a variable and switches pages.

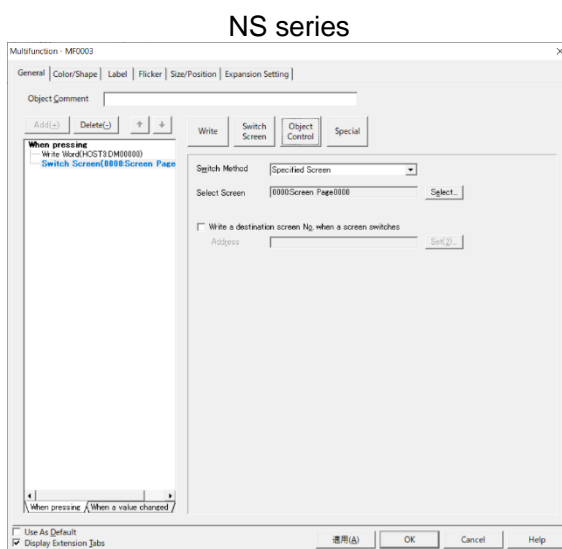

NA

Events	
> [0]	Press
> Actions	< Select Action to Add >
> [0]	SetVariable
Variable	DM0000
Value	10
> [1]	ShowPage
PageName	Page1
Left	No value
Top	No value

The table below provides relations between NS functionalities by a Multifunction object and NA actions.

Functionalities that can be replaced with a command button are omitted.

NS Functionality	NA Action	Remarks
Switch Screen - Next Page	No corresponding action	
Switch Screen - Previous Page	No corresponding action	
Object Control - Contents Control	No corresponding action	
Object Control - Alarm/Event Control - Clear	ClearUserAlarmLog	
Object Control - Alarm/Event Control - Save	SaveUserAlarmLogToFile	
Object Control - Alarm/Event Control - Home/End	CallSubroutine	Execute ScrollAlarmViewerList. The number of scrolling rows cannot be greater than the maximum of history records.
Object Control - Alarm/Event Control - Next/Previous	No corresponding action	
Object Control - Alarm/Event Control - From New Date & Time	CallSubroutine	Execute SortViewer.
Object Control - Alarm/Event Control - From Old Date & Time	CallSubroutine	Execute SortViewer.
Object Control - Alarm/Event Control - From High Priority	CallSubroutine	Execute SortViewer.
Object Control - Alarm/Event Control - From Low Priority	CallSubroutine	Execute SortViewer.
Object Control - Alarm/Event Control - From High Frequency	No corresponding action	The NA series alarm does not support frequency of occurrence.
Object Control - Alarm/Event Control - From Low Frequency	No corresponding action	The NA series alarm does not support frequency of occurrence.
Object Control - Alarm/Event Control - Check Selected Alarm	CallSubroutine	Execute AcknowledgeUserAlarm.
Object Control - Alarm/Event Control - Delete Selected Alarm	No corresponding action	The NA series alarm does not have a functionality to delete individual alarms.
Object Control - Alarm/Event Control - Check All Alarms	CallSubroutine	Execute AcknowledgeAllUserAlarms.
Object Control - Alarm/Event Control - Cancel All Alarms' Checks	No corresponding action	You cannot cancel the confirmed alarm.
Object Control - Alarm/Event Control - Change Display Type	CallSubroutine	Execute FilterByText. Configure the target column or text filtering, as needed.

NS Functionality	NA Action	Remarks
Object Control - Data Log Control - Start	StartDataLogging	
Object Control - Data Log Control - Stop	StopDataLogging	
Object Control - Data Log Control - Log Clear	No corresponding action	
Object Control - Data Log Control - Save to File	CallSubroutine	Execute ExportDataLogBuffer.
Object Control - Data Log Control - Read File	No corresponding action	
Object Control - Data Log Control - Pause	No corresponding action	
Object Control - Data Log Control - Move the cursor forward	CallSubroutine	Execute the function MoveTrendCursor.
Object Control - Data Log Control - Move the cursor backward	CallSubroutine	Execute the function MoveTrendCursor.
Object Control - Scroll Object	No corresponding function	
Special - Password Setting	No corresponding action	
Special - Confirmation Dialog Box	No corresponding action	
Special - Macro	CallSubroutine	Describe the processing, which is defined in Macro, in the subroutine.
Special - Initialize Operation Log	No corresponding action	
Special - Save Operation Log	CallSubroutine	Execute the function SaveOperationLogToFile.

### 6-8-1 Double Pressing and ON and OFF Delay Functions

In the NS series, Double Pressing and ON/OFF Delay functionalities are only supported by the Multifunction Object. These functionalities are available on Momentary Button, Toggle Button, Button, Set Button, and Reset Button in the NA series.

However, settable value range is narrower than the NS series.

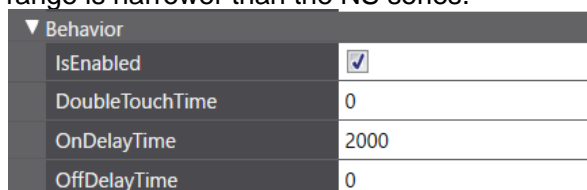

NS Functionality	NS Setting Range	NA Setting Range
Double Pressing	0.5 to 30.0 s	0 to 2000 ms
On Delay	0.5 to 15.0 s	0 to 2000 ms
OFF Delay	0.5 to 15.0 s	0 to 2000 ms



## 6-8-2 Non-replaceable Functionalities

NS Tab	NS Functionality	Remarks
General	Prohibiting Simultaneous Pressing	Simultaneous pressing is not supported.
Color/Shape	Double-line Rectangle	The NA series has only single-line frame.
Color/Shape	Double-line Circle	The NA series has only single-line frame.
Color/Shape	Polygon	It is impossible to make a Button Object's appearance polygon. Instead, create a Polygon Object in <b>Shapes - Polygon</b> , then configure an action in <b>Events and Actions</b> .
Color/Shape	Sector	You cannot create a sector shape object.
Expansion Setting	Wait for completion of communication (Synchronous communication)	

## 6-9 Text

The NS series Text Objects are replaceable with Label Objects in the NA series.

To display a fixed character string on a label object, select *Static* for **Resource Link Type** in **Behavior - Text (Default)** in Properties of the object. Double-click a Label Object to display this setting dialog.

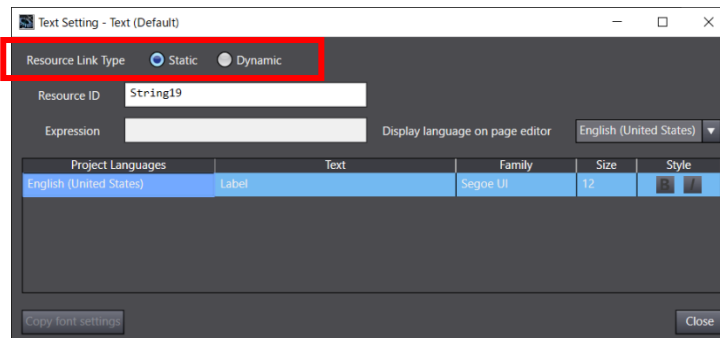

If you have selected the option, Use as a Message Display, or indirectly referenced a string for the NS text object, select *Dynamic* for **Resource Link Type** in **Behavior - Text (Default)** in Properties of the label object. Refer to 5-8-1 *How to Replace* for the setting procedure.

## 6-10 Numeral Display and Input

You can replace a String Display and Input Object with a Data Display Object or a Data Input Object. If you want only to display numerals, use a data display object, and also need to input, use a data input object.

Put an object on the page, then select *Numeric* and *Text* in **Behavior - DataType** in Properties.

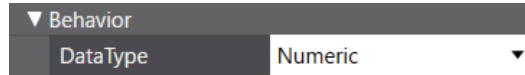

NS series Numeral Display and Input General Tab	NA series Data Display Object Properties
<p>Numeral Display &amp; Input - NUM004</p> <p>General   Text</p> <p>Object Comment</p> <p>Numeral Display Type: Decimal</p> <p>Storage Type: INT(Signed 1 word)</p> <p>Range: -32768 - 32767</p> <p>Unit&amp;Scale: Set Unit&amp;Scale No., Unit, Scale, Offset</p> <p>Address: SW0</p> <p>Display on entry: <input type="checkbox"/> Display input values by *</p>	<p>Properties</p> <p>Standard   Detail</p> <p>General</p> <p>Appearance</p> <p>Font English (United States): Segoe UI, 12, Normal</p> <p>HorizontalAlignment: Right</p> <p>VerticalAlignment: Top</p> <p>Margins (L,T,R,B): 2, 2, 2, 2</p> <p>WordWrap: <input checked="" type="checkbox"/></p> <p>TextColor: White</p> <p>BackgroundColor: Transparent</p> <p>BorderColor: White</p> <p>BorderThickness: 0</p> <p>CornerRadius (X,Y): 0, 0</p> <p>IsVisible: <input checked="" type="checkbox"/></p> <p>Behavior</p> <p>DataType: Numeric</p> <p>Expression: [Redacted]</p> <p>Scaling: [Redacted]</p> <p>ValueFormat: Decimal</p> <p>DisplayFormat: #</p> <p>LeadingZeros: <input type="checkbox"/></p> <p>ShowSeparator: <input type="checkbox"/></p> <p>Layout</p> <p>Security</p>
Max/Min Tab	Data Input Object Properties
<p>Numeral Display &amp; Input - NUM004</p> <p>General   Text   Background   Keypad   Frame   Max/Min   Flicker   Write   Password   Control Flag   Macro   Size/Position</p> <p>Range: -32768 - 32767</p> <p>Type of Value: <input checked="" type="radio"/> Immediate Value</p> <p>Maximum Input Limit: Value: 0</p> <p>Minimum Input Limit: Value: 0</p> <p>Watch Maximum Limit: Value: 0</p> <p>Watch Minimum Limit: Value: 0</p> <p>To specify a fixed value in hexadecimal, type "H" as a prefix.</p>	<p>Properties</p> <p>Standard   Detail</p> <p>General</p> <p>Appearance</p> <p>Font English (United States): Segoe UI, 12, Normal</p> <p>HorizontalAlignment: Right</p> <p>VerticalAlignment: Top</p> <p>Margins (L,T,R,B): 2, 2, 2, 2</p> <p>WordWrap: <input checked="" type="checkbox"/></p> <p>TextColor: Black</p> <p>BackgroundColor: White</p> <p>BorderColor: Transparent</p> <p>BorderThickness: 2</p> <p>CornerRadius (X,Y): 0, 0</p> <p>IsVisible: <input checked="" type="checkbox"/></p> <p>Behavior</p> <p>IsEnabled: <input checked="" type="checkbox"/></p> <p>DataType: Numeric</p> <p>Variable: [Redacted]</p> <p>Scaling: [Redacted]</p> <p>MinimumValue: 0</p> <p>MaximumValue: 100</p> <p>ValueFormat: Decimal</p> <p>DisplayFormat: #</p> <p>LeadingZeros: <input type="checkbox"/></p> <p>ShowSeparator: <input type="checkbox"/></p> <p>DataInputOrder: 0</p> <p>Layout</p> <p>Security</p>

## 6-10-1 Non-replaceable Functionalities

NS Tab	NS Functionality	Remarks
General	Display Type - Binary	
General	Display Type - Octal	
General	Storage Type - All BCD types	
General	Ignore exceeded digits	
General	Display input values by *	Only a character string can hide numerals and strings currently being entered.
Keypad	Input Method	The keypad is fixed to what you select in the Language Settings tab page. To display a desired keypad, set a subroutine in <b>Events and Actions</b> of the Data Display Object to run the subroutine EditVariable.
Keypad	Display Position of Keypad/Pop-up Screen	The keypad display position is automatically determined. You cannot display it at the desired position.
Max/Min	Type of Value - Difference from Current Value	
Max/Min	Watch Maximum Limit/ Watch Minimum Limit	You can change the colors in <b>Animations - ColorChange</b> . Note that only the numeral color in data display, and the background color in data input, are changeable. You are not allowed to change the both colors of numerals and background.
Control Flag	Display/Hide (Numeral display)	
Macro	Before inputting numeral	
Macro	Before writing numeral	
Macro	When changing value	
Macro	Value = Set Value	Set a subroutine in <b>Events and Actions</b> of a page or global event.
Macro	Value > Set Value	
Macro	Value < Set Value	
Macro	Value < Set Value	

## 6-11 String Display and Input

You can replace a String Display and Input Object with a Data Display Object or a Data Input Object. If you have disabled inputs, use a Data Display Object, and if not, use a Data Input Object.

Put the object on the page, then select *Numeric* and *Text* in **Behavior - DataType** in Properties.

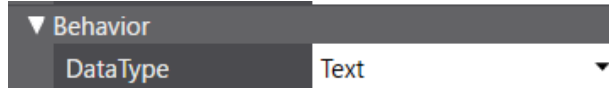

You can select a character code in the String Display Type area for a String Display Object and an String Input Objects of NS series.

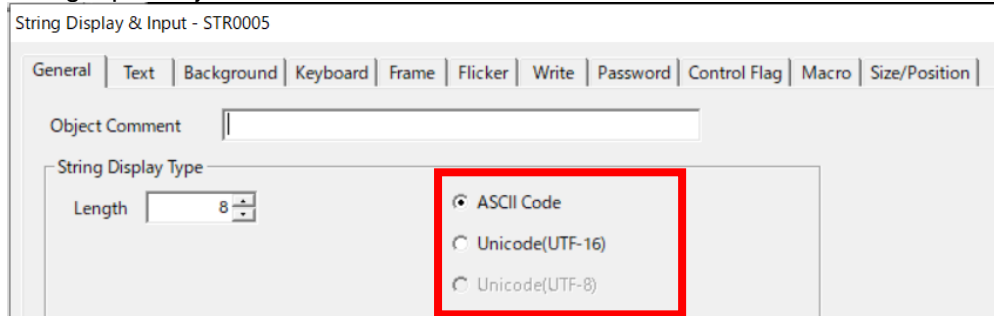

You do not have to consider the character code if you use NS internal addresses to display strings. However, if you are using CJ host addresses, selecting an appropriate character encoding scheme in Sysmac Studio for the replacement is necessary.

The following shows the setting in Sysmac Studio. You can select a encoding scheme in the setting Encoding for all strings.

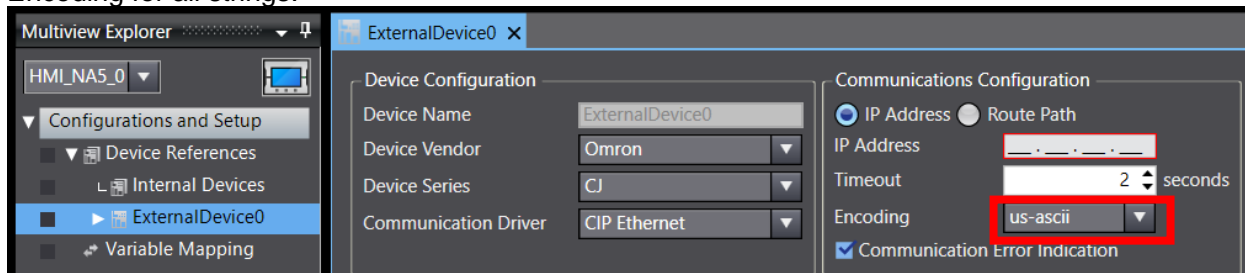

The table below provides the character code conversions.

	NS	NA
System Language	String Display Type	Character Encoding Scheme
Japanese	ASCII code (Shift-JIS)	Shift-JIS
Chinese (Simplified and Traditional)	ASCII code (GB2312)	GB18030
English, Italian, Spanish, German, and French	ASCII code (Latin1)	ISO-8859-1
All Languages	Unicode (UTF-8)	UTF-8
All Languages	Unicode (UTF-16)	UTF-16

### 6-11-1 StartIndex and TextLength

**StartIndex** and **TextLength**, the data input object properties, are available only when specifying a numerical-type array for **Variable** and handling the array value as ASCII. Entering values in **StartIndex** and **TextLength** will result in an error if you have set a string type variable in **Variable**. **TextLength** is not for setting the maximum length of input.

▼ Behavior		
IsEnabled	<input checked="" type="checkbox"/>	<input type="checkbox"/>
DataType	Text	▼
Variable	WR000	
StartIndex	0	
TextLength	8	
CharacterEncoding	us_ascii_LE	▼
InputMethod	QwertyKeypad	▼

### 6-11-2 Non-replaceable Functionalities

NS Tab	NS Functionality	Remarks
General	String Display Type	The text length cannot be configured while a string type variable is used.
General	Pop-up Menu	
General	Address Information	It is not allowed to set different variables to reference for each language.
General	Input Process	
Keyboard	Input Method	The keypad is fixed to what you select in the Language Settings tab page. To display a desired keypad, set a subroutine in <b>Events and Actions</b> of the Data Display Object to run the subroutine EditVariable.
Keyboard	Display Position of Keypad/Pop-up Screen	The desired position of a keypad is determined automatically. You cannot display it at the desired position.
Keyboard	String Input	Fixed to <b>Add to the current string</b> .
Macro	Before inputting string	
Macro	Before writing string	
Macro	When changing string	

## 6-12 List Selection

Only an action that the option **Store the selected line No. in the specified address** is enabled can be replaced with a ListBox object.

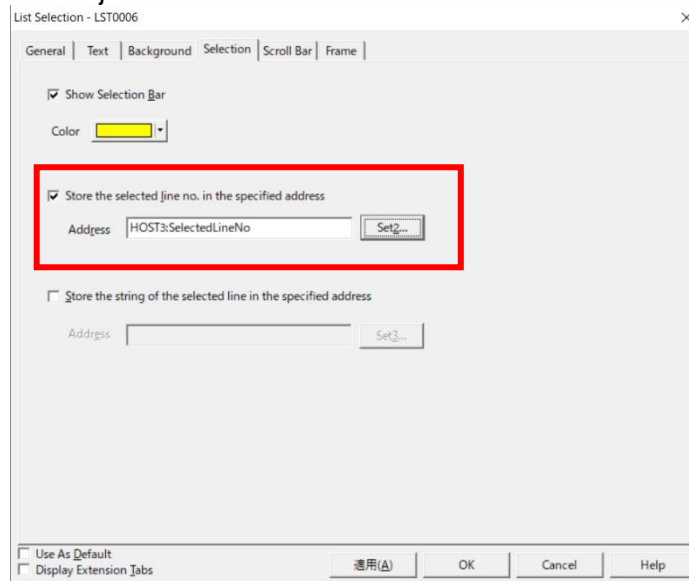

### 6-12-1 Non-replaceable Functionalities

NS Tab	NS Functionality	Remarks
General	List Data	The NA series cannot have the list data in an internal variable or a file. The data is stored statically in <b>Behavior - Items</b> in Properties of the ListBox object. Edit fixed strings, which are managed by resource ID, in <b>Resources - General Strings</b> . You are not allowed to switch a displayed string dynamically during the operation because strings in the ListBox object are fixed.
General	Character Code	
General	List Size	
Selection	Show selection bar	The selection bar is always displayed. The bar color is not changeable.
Selection	Store the selected line No. in specified address	A selection in the ListBox Object is to be output to a numeral only.
Scroll Bar		The scroll bar is mandatory. The scroll bar is displayed automatically on the object with too many options considering its size.
External Control	Block	
External Control	Start Line	
External Control	Update	

## 6-13 Analogue Meter

The NS Analogue Meter Object can be replaced with an NA Gauge Object: Full Gauge or Half Gauge.

Only **Needle** is available for indication.

### 6-13-1 Non-replaceable Functionalities

NS Tab	NS Functionality	Remarks
General	Width Rate	
General	Shape - Quarter circle	Configure <b>StartAngle</b> and <b>EndAngle</b> in <b>Properties - Appearance</b> of the object to realize a similar appearance.
General	Color inside a meter	
General	Display Type	The option <i>Fill</i> is not supported.
Range	Indirect	Only fixed values are supported.

## 6-14 Level Meter

The NS Level Meter Object can be replaced with an NA Gauge Object: Vertical Gauge or Horizontal Gauge.

However, the appearances differ significantly: the NS level meter looks like a bar chart, and in the NA linear gauge, the marker moves to indicate a value as illustrated below.

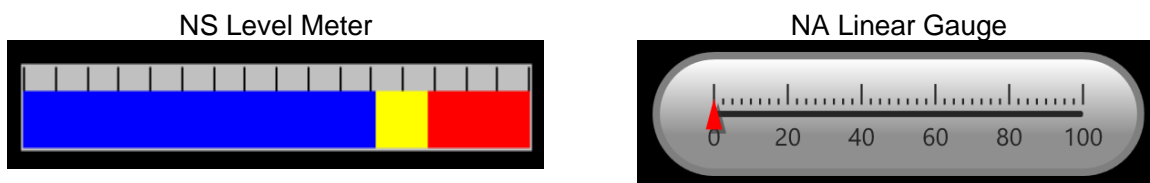

### 6-14-1 Non-replaceable Functionalities

NS Tab	NS Functionality	Remarks
Range	Indirect	Only fixed values are supported.

### 6-14-2 Realizing the Same Appearance as NS Object

To get the same bar chart appearance as the NS level meter object, use a Rectangle Object from **Shapes**, not a Vertical/Horizontal Linear Gauge Object. Specify a variable in **Animations - ResizeWidth** for a graph whose indicator increases/decreases in the horizontal direction, and **Animations - ResizeHeight** if the indicator moves vertically, to adjust the size of the rectangle. Another object is required to create the scale. In addition, if you want different colors for levels, multiple rectangle objects are necessary.

## 6-15 Broken-line Graph

The NS Broken-line Graph Object can be replaced with the NA Broken-line Graph Object.

Functionalities not supported by the NA broken-line graph object, e.g., zooming in/out the graph, moving the cursor, can be realized with subroutines.

We offer the IAG Library for the NA series, which include basic function features.

You can get an NA IAG library from the OMRON website. Visit the following link. <https://asset.s.omron.com/m/5bf56e1c1780d236/original/IAG-Software.zip>

## 6-15-1 Non-replaceable Functionalities

This table shows the functionality not supported by the object settings.

NS Tab	NS Functionality	Remarks
General	Direction	Fixed to the setting corresponding to the NS setting Right.
General	Line Style	Only the solid line is supported in both of the vertical and horizontal directions.
General	Indirect reference of showing scale line	Not available in both of the vertical and horizontal directions.
General	Specify the No. of points shown	
Graph	Draw Value Outside of the Range	If a value exceeds the upper or lower limit, it will be displayed as the maximum or minimum value.
Scroll Bar		A scroll bar is not displayed.
-	Test Function	Broken-line graphs are displayed as fixed images on the simulator. To test a graph display, transfer the project to the NA unit.

The NA series has the following restrictions on the number of graphs you can put on a page:

- 1) One graph object, including a trend graph object, per page
  - 2) Up to eight graph objects, including a trend graph object, per HMI project
- The limits are total of broken-line graph objects and trend graph objects.

## 6-16 Bitmap

The NS series Bitmaps are replaceable with Image Objects in the NA series.

### 6-16-1 Non-replaceable Functionalities

This table shows the functionality not supported by the object settings.

NS Tab	NS Functionality	Remarks
General	Indirect Reference of Display File	

## 6-17 Alarm/Event Display

The NA series does not have an alternate functionality, but you can realize it following the method below.

1. Define a String type global variable, NS\_alarmMessage.
2. Name the alarm as [fixed string + serial number] in the user alarm setting. For this example, the fixed string is "Group0\_alm."
3. Create a subroutine NS\_getAlarmMessage as a global subroutine.

```
Sub NS_getAlarmMessage
  Dim almID As String
  Dim almMsg As String
  Dim almDt As Date
  Dim almMsg_Newest As String
  Dim almDt_Newest As Date
  Dim i As Integer
```



'Repeats as many times as set alarms. In this example, 22 alarms are set.

```
For i = 0 To 21
    almID = "Group0_alm" + i.ToString
    If IsUserAlarmActive(almID)
        GetAlarmInfo( almID, , , , almMsg, , almDt, , )
        If DateTime.Compare( almDt, almDt_Newest ) > 0
            almDt_Newest = almDt
            almMsg_Newest = almMsg
        End if
    End If
Next

If almMsg_Newest <> ""
    NS_alarmMessage = almMsg_Newest + " " + almDt_Newest
Else
    NS_alarmMessage = ""
End If
End Sub
```

When assigning a string to the variable NS\_alarmMessage, you can change display contents by adding various alarm setting information that GetAlarmInfo() acquired.

4. Select *Interval* for **Events** and *CallSubroutine* for **Actions** of the global event to call NS\_getAlarmMessage.
5. Put a data display object on a page where you display an alarm object. Then, select *String* for **Data Type** in **Behavior** in Properties and NS\_alarmMessage for **Expression**.

Follow this procedure to realize the flowing string.

1. Add the integer type global variable, before\_Second.
2. Add the subroutine nagare() in Actions - CallSubroutine of the page.

The data display object's **Name** attribute is DataDisplay0.

The value used in the IF statement depends on the width of the data display object and the screen size.

```
Sub nagare()
    DataDisplay0.Left = DataDisplay0.Left - 16
    If DataDisplay0.Left < -200 Then DataDisplay0.Left = 800
    before_Second = _HMI_Second
End Sub
```

3. Select *Condition* from the **Events** options in **Events and Actions** of the page. Then, enter \_HMI\_Second<> in **Expression**. And select *CallSubroutine* from the options of **Actions** and specify nagare() in **SubroutineName**.
4. Arrange the data display object as much as behind because a flowing string will be displayed without relation to other objects on the right and left sides of the display area. Then, put a rectangle object, which cover the string, in front of the data display object.

The Data Display Object moves to the left by 16 dots per second.

However, the display position moves sideways regardless of the coordinates of the data display object on Sysmac Studio. Therefore, you need to modify values for VB functions to adjust the display position.

For another method, edit the string to be displayed as flowing string, not hanging the position of the data display object.

Execution condition for a subroutine is the same as mentioned above, but describe the subroutine as the following.

Enter *strAlarmMove* into **Expression**, the Data Display Object's property.

```
Dim pos As Integer

Sub nagare
  Dim px As Integer = NS_alarmMessage.Length

  If (px > 0)
    Dim strMove As String = NS_alarmMessage + "      "
    px = px + 8

    pos = pos - 1
    If (pos > px) Or (pos < 1)
      pos = px
    End If

    strAlarmMove = Microsoft.VisualBasic.Right(strMove, pos) _
      + "      " _
      + Microsoft.VisualBasic.Left(strMove, px - pos)
  Else
    strAlarmMove = ""
  End If

  before_Second_13 = _HMI_Second
End Sub
```

## 6-18 Alarm/Event Summary and History

You can replace an Alarm/Event Summary and History Object with a User Alarms Viewer Object.

### 6-18-1 Non-replaceable Functionalities

This table shows the functionality not supported by the object settings.

NS Tab	NS Functionality	Remarks
General	Group Specification	
General	Display Type	
General	Default Display Order (Frequency)	The NA series does not have a functionality to record the frequency.
General	Date and Time Display Format	The date and time display format is fixed.
General	Display in the Same Line	The NA series always displays alarm occurrence and clearance in the same row.
General	Movement when Alarm/Event is Selected	
Display	Line Height	Automatically tuned depending to text size.
Display	Display Optimization	
Display	Display a title	Header cannot be hidden. Setting the lowest value, 1, for the height makes the header as if it were hidden.
Display	Message box display	
Display	Ruled Line	
Display	History Display Type	You cannot display occurrence and cancellation in the same row.
Icon		Subroutines can substitute some functions. Assign a corresponding functionality to a button or other object.
Vertical Scroll Bar	Use Scroll Bar	The scroll bar is displayed automatically on the object when the display contents exceed the object size. It cannot be hidden.
Horizontal Scroll Bar	Use Scroll Bar	The scroll bar is displayed automatically on the object when the display contents exceed the object size. It cannot be hidden.
Macro		Pressing an icon does not start an action including macro.

### 6-18-2 Replacing Icons

In the NS series, you can sort and delete displayed alarms with icons.

The NA series alarm objects do not have these icons, but you can realize some icons functionalities with subroutines.

Functionality of Icon	Alternate Subroutine	Remarks
From New Date & Time	SortViewer	If sorting targets are not in the columns, an error occurs when you run a subroutine. It is possible to sort alarms by touching the header. Every time you touch the header, sorting order, ascending or descending, switches.
From Old Date & Time	SortViewer	
From High Priority	SortViewer	
From Low Priority	SortViewer	

From High Frequency	-	
From Low Frequency	-	
Delete Selected Alarm	-	
Check Selected Alarm	AcknowledgeUserAlarm	
Check All Alarms	AcknowledgeAllUserAlarms	
Cancel All Alarms' Check	-	
Change Display Type	-	

### 6-18-3 Setting for Distinguishing Occurrence and Cancellation of Alarms

User alarm viewer objects of the NA series cannot display an alarm occurrence and cancellation in the same row. Depending on the setting, you cannot differentiate them.

Date and Time	Message
2022/06/04 20:22:36	Alarm0
2022/06/04 20:22:20	Alarm0

The following method enables you to distinguish the information.

- Coloring Messages

Check the **ShowColoredMessage** box in **Behavior**. The color of an alarm string will change according to the color set in the **RaisedUnacknowledgedColor** or **RaisedAcknowledgedColor** field in **Appearance**.

▼ Behavior	
IsEnabled	<input checked="" type="checkbox"/>
HistoricalMode	<input checked="" type="checkbox"/>
ShowColoredMessage	<input checked="" type="checkbox"/>

The following illustrates an alarm occurrence message shown in red and cancellation in green.

Date and Time	Message
2022/06/04 20:22:36	Alarm0
2022/06/04 20:22:20	Alarm0

- Adding Status to Display Items

Add "Status" to the display items in **Appearance - Columns**.

Columns			
Type	Title	Resource ID	Width
Date and Time	Date and Time	String1	250
Message	Message	String2	200
Priority	Priority	String3	200

An occurrence and a cancellation will be displayed as "Alarm Raised" and "Alarm Cleared" in the Status column.

Messages displayed in the Status column are fixed and non-editable.

Date and Time	Message	Status
2022/06/04 20:22:36	Alarm0	Alarm Cleared
2022/06/04 20:22:20	Alarm0	Alarm Raised

## 6-18-4 Alternative for Page Transition When Selecting an Alarm

This section describes an alternative for the functionality to go to a page after selecting a displayed alarm.

In the NS series, selecting an alarm switches the currently displayed page to the page you set. However, in the NA series, additional action is required after selecting an alarm for page transition.

1. Enter destination page names in the **Page** field for each alarm in the User Alarm Group setting tab page.

Acknowledge	Page	Details
<input type="checkbox"/>	Page3	
<input type="checkbox"/>	Page1	

2. Create an object. Then select *Click* from **Events** and *ShowAlarmPage* from **Actions** in **Events and Actions**.

Enter the page name where the user alarm viewer object is in **PageName** and the name of the user alarm viewer object in **AlarmViewerName**.

Button0	
▼ Events	< Select Event to Add >
▼ [0]	Click
▼ Actions	< Select Action to Add >
▼ [0]	ShowAlarmPage
PageName	Page3
AlarmViewerName	UserAlarmsViewer0
Left	No value
Top	No value

This setting enables you to go to the set page when you press the object while selecting the alarm on the user alarm object.

## 6-19 Date and Time

The NS series Date Object and Time Object are replaceable with a DateTime Object in the NA series.

In the NS series, the date and time are displayed separately with a date object and time object, respectively. In the NA series, the date and time is displayed with a single object. By changing the display format, you can display either date or time alone.

In the NS series, you press an object to edit the date and time settings to change the system clock. However, in the NA series, a DateTime object only displays data and does not change the system clock setting.

Change the system clock setting from the system menu or use a subroutine.

To use the subroutine, you must combine button objects and data input objects to input date and time data.

## 6-20 Data Log Graph

The NS series Data Log Graph is replaceable with Trend Graph Object in the NA series. Trend graph objects do not support zooming in/out of a graph and moving the cursor. You can use subroutines to substitute these functionalities. We offer the IAG Library for the NA series, which include subroutines used in combination with a trend graph object.. You can get an NA IAG library from the OMRON website. Visit the following link.

<https://assets.omron.com/m/5bf56e1c1780d236/original/IAG-Software.zip>

### 6-20-1 Non-replaceable Functionalities

This table shows the functionality not supported by the object settings.

NS Tab	NS Functionality	Remarks
General	Direction	Fixed to the setting corresponding to the NS setting Right.
General	Draw Value Outside of the Range	If a value exceeds the upper or lower limit, it will be displayed as the maximum or minimum value.
General	Line Style	Only the solid line is supported in both of the vertical and horizontal directions.
Time Axis	Scale	Indirect reference is not supported.
Time Axis	Use Cursor	Use of cursor is selectable, but the feature to store values of the color or cursor position is not available.
Time Axis	Graph Display Position	
Numeral Value Axis	Scale Settings	Only the functionality of setting the maximum and minimum values as fixed values is supported.
Icon		Subroutines can substitute some functions. Assign a corresponding functionality to a button or other object.
Scroll Bar		A scroll bar is not displayed.
-	Test Function	Trend graphs are displayed as fixed images on the simulator. To test a graph display, transfer the project to the NA unit.

The NA series has the following restrictions on the number of graphs you can put on a page:

- 1) One graph object, including a broken-line graph and trend graph, per page
- 2) Up to eight graph objects, including a broken-line graph and trend graph, per HMI project

### 6-20-2 Replacing Icons

For the NS series data log graphs, you can use icons to stop or restart drawing a graph, but the NA series trend graph objects do not have those icons. You can substitute subroutines for some functionalities.

Functionality of Icon	Alternate Subroutine	Remarks
Stop	StopDataLogging	<b>StopDataLogging</b> in <b>Events and Actions</b> works in the same way.
Restart	StartDataLogging	<b>StartDataLogging</b> in <b>Events and Actions</b> works in the same way.
Status	-	Difficult to replace
Log Clear	-	Executing ClearDataLogBuffer alone does not delete all the data. You must delete log files stored in the external memory.
Pause	-	Difficult to replace
Save to File	ExportDataLogBuffer(DataSetName)	
Read File	-	Difficult to replace

## 6-21 Data Block Table

Recipe Viewer is corresponding to Data Block Table in the NA series, though the feature is largely different.

In the NA series, you use subroutines to read or write the data.

We offer the IAG Library for the NA series, which include basic function features. You can get an NA IAG library from the OMRON website. Visit the following link.

<https://assets.omron.com/m/5bf56e1c1780d236/original/IAG-Software.zip>

### 6-21-1 Non-replaceable Functionalities

This table shows the functionality not supported by the object settings.

NS Tab	NS Functionality	Remarks
General	Display No. of rows	
Background	Color of Odd Rows	You cannot set different colors for each row.
Background	Color of Even Rows	You cannot set different colors for each row.
Vertical Scroll Bar		A scroll bar is not displayed.
Horizontal Scroll Bar		A scroll bar is not displayed.
Macro		Pressing an icon does not start an action including macro.

### 6-21-2 Replacing Icons

NS Data Blocks allow you to read or write data with icons, but in NA recipes, you cannot use those icons. You can substitute subroutines for some functionalities.

Functionality of Icon	Alternate Subroutine	Remarks
Read Data File	ImportRecipes	
Write Data File	-	Use "Export_recipe" in the AN series IAG Library.
Write to the address	WriteRecipeToController	
Read from the address	ReadRecipeFromController	
Add the record	AddRecipe	
Delete the record	DeleteRecipe	



## 6-22 Frame

Replaceable with Tab Control Object.

### 6-22-1 Functional Differences

The table below shows functional differences you should consider.

Functionality	Difference
Tab page arrangement	NS series: Four edges of the screen NA series: Top and bottom of the screen You cannot place a tab page on the right and left sides.
Origins of coordinates of an object inside the frame	NS series: Coordinates of the upper-left corner of the frame NA series: Coordinates of the upper-left corner of the page
Object frame	Both of the NS series and NA series do not have the setting field for object frame. However, frames are forcibly given on the NA series objects. (See the illustration below)

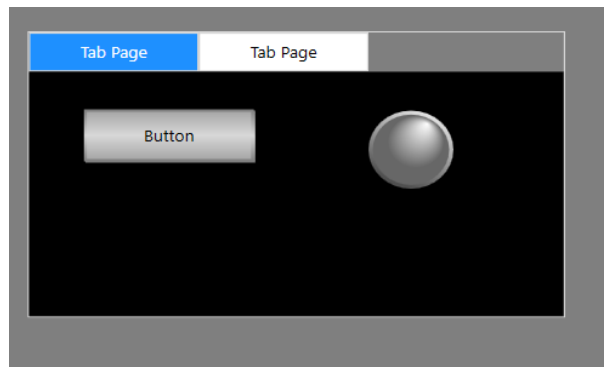

### 6-22-2 Workaround When You Cannot Arrange an Object on Tab Control Object

When you attempt to arrange an object on a tab control object on the Edit Pane, sometimes you may fail, and the object is placed on the base screen. In that case, try to manipulate the objects on Page Explorer, where you can edit easier.

See the screen shots below. To put the object Button2 on the tab control object, select *Button2* in Page Explorer then drag and drop on a desired tab page in the tab control object.

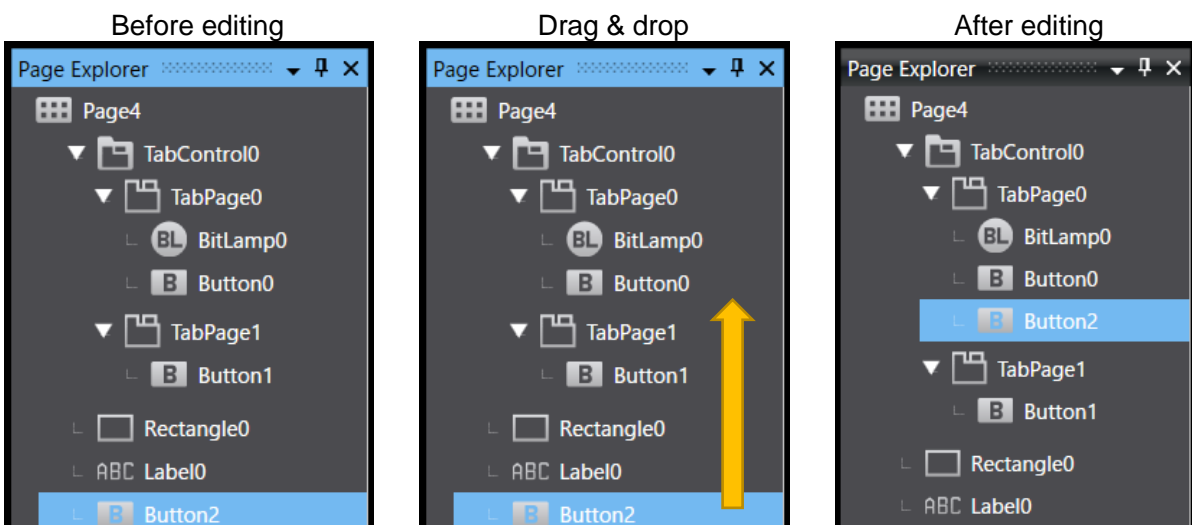

## 6-23 Table

No functionality for direct replacement.

Replace a table with Button, Lamp, Data Display, or Data Input Object according to the type of functional object in the pull-down menu **Table Type**. To copy an object and paste it tiled in the vertical or horizontal direction, select the object and right-click to choose **Create Duplicate Objects...** from the menu.

## 6-24 Thumbwheel Switch

There is no features for replacement.

However, combination of data display objects, objects such as buttons, and subroutines can achieve a thumbwheel switch. This section provides the replacement procedure. Details of the procedure depends on digits and numerical notation system. In this example, replace a thumbwheel switch of unsigned 4-digit decimal.

### 6-24-1 Replace Thumbwheel Switch: Arrange Objects

In the page editor, arrange button objects and data display objects to represent a thumbwheel switch.

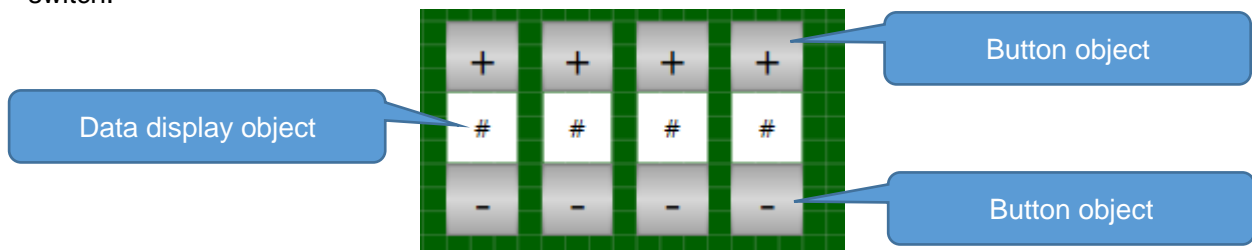

### 6-24-2 Replace Thumbwheel Switch: Define a Structure

Select [Data] - [Data Type] to define a structure of the thumbwheel switch.

The screenshot shows the Data Types window with a tree view on the left and a table of structures on the right. The tree view shows 'root' expanded to 'Structures'. The table lists two structures: ThumbWheelDec and ThumbWheelHex. Each structure has five fields: value, max, min, col, and digit.

	Name	Base Type	Comment
▼	ThumbWheelDec	STRUCT	Thumbwheel Switch for unsigned decimal
	value	Integer	Value
	max	Integer	Maximum
	min	Integer	Minimum
	col	Integer	Each digits
	digit	Integer(16)	Value of each digits(the rightmost digit is 0 and increments by one to left.)
▼	ThumbWheelHex	STRUCT	Thumbwheel Switch for signed decimal
	value	Integer	Value
	max	Integer	Maximum
	min	Integer	Minimum
	col	Integer	Each digits
	digit	Integer(16)	Value of each digits(the rightmost digit is 0 and increments by one to left.)

### 6-24-3 Replace Thumbwheel Switch: Register the Structure

Register the thumbwheel switch structure as a global variable. Basically, one structure is prepared for one thumbwheel switch. If you want to more than one thumbwheel switches in a page, register the same number of structures as the switches.

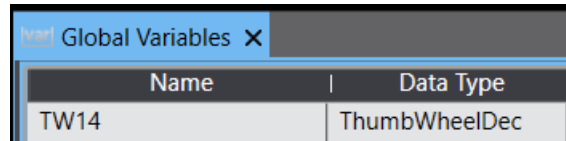

Name	Data Type
TW14	ThumbWheelDec

### 6-24-4 Replace Thumbwheel Switch: Configure Global Subroutine

Create a subroutine that commonalizes the operations of the + and - buttons in each digits of the thumbwheel switch as a global subroutine.

The function WheelDec\_init reflect the value of variable “value”, which is the member variable of the thumbwheel switch structure, on the elements of the member variable “digit.” You need to initialize other member variables than “digit” in advance.

The function WheelDecSw is for the processes pressing the + and - buttons in each digit. Specify the thumbwheel switch structure, a digit number (the rightmost digit is 0 and increments by one to left.), and True for the + button and False for the - button, for the first, second, and third argument, respectively.

For unsigned decimal

```
Dim Wheel_mulDec() As Integer = { 1, 10, 100, 1000, 10000, _  
    100000, 1000000, 10000000, 100000000 }  
  
Sub WheelDec_init(tw As ThumbWheelDec)  
    Dim i As Integer  
    Dim v As Integer = tw.value  
    For i = 0 To 7  
        tw.digit(i) =v Mod 10  
        v = v / 10  
    Next  
End Sub  
  
Sub WheelDecSw(tw As ThumbWheelDec, col As Integer, up As Boolean)  
    Dim m As Integer = Wheel_mulDec(col)  
    Dim d As Integer = tw.digit(col)  
    Dim x As Integer = tw.value  
  
    x = x - (m * d)  
    If ( up )  
        If d >= 9 Then d = 0 Else d = d + 1  
    Else  
        If d <= 0 Then d = 9 Else d = d - 1  
    End If  
    x = x + (m * d)  
  
    If (x < tw.min) Or (x > tw.max) Then Exit Sub
```

```
tw.digit(col) = d
tw.value = x
```

End Sub

### 6-24-5 Replace Thumbwheel Switch: Configure Page Subroutine

For a button object, you cannot specify an argument in a function that specifies CallSubroutine for an action of the Click event. In other words, you are not allowed to specify a function with an argument that is defined in a global subroutine. Therefore, define the page subroutine in the code view of the page as shown below.

The function Wheel\_init14 sets initial values of members in the thumbwheel switch structure.

The functions Wheel\_u1 and the followings are for the processes after pressing the + and - buttons. In this example, the letter “u” stands for “up (+)” and “d” for “down (-)”, and numbers from 1 to 1000 stands for the ones place to the thousands place, respectively.

```
Sub Wheel_init14
```

```
    TW14.value = 2345
```

```
    TW14.max = 8765
```

```
    TW14.min = 12
```

```
    TW14.col = 4
```

```
    WheelDec_init(TW14)
```

End Sub

```
Sub Wheel_u1()
```

```
    WheelDecSw(TW14, 0, True)
```

End Sub

```
Sub Wheel_u10()
```

```
    WheelDecSw(TW14, 1, True)
```

End Sub

```
Sub Wheel_u100()
```

```
    WheelDecSw(TW14, 2, True)
```

End Sub

```
Sub Wheel_u1000()
```

```
    WheelDecSw(TW14, 3, True)
```

End Sub

```
Sub Wheel_d1()
```

```
    WheelDecSw(TW14, 0, False)
```

End Sub

```
Sub Wheel_d10()
```

```
    WheelDecSw(TW14, 1, False)
```

End Sub

```
Sub Wheel_d100()  
  WheelDecSw(TW14, 2, False)  
End Sub
```

```
Sub Wheel_d1000()  
  WheelDecSw(TW14, 3, False)  
End Sub
```

#### 6-24-6 Replace Thumbwheel Switch: Configure Page Switching Event

Select PageDisplayed from the [Events] under [Events and Actions] and CallSubroutine from [Actions]. Then, enter the page subroutine Wheel\_init14 in SubroutineName.

#### 6-24-7 Replace Thumbwheel Switch: Configure Button Event

In the page editor, select Click from [Events] for the + and - buttons. Then select CallSubroutine from [Actions] to enter the page subroutines from Wheel\_u1 to Wheel\_u1000, and Wheel\_d1 to Wheel\_u1 in SubroutineName, respectively.

#### 6-24-8 Replace Thumbwheel Switch: Configure Data Display Object

In the page editor, enter *TW14.digit(0)*, *TW14.digit(1)* and so on, from the right, in **Expression** for the data display objects of each digit. Select Decimal for [ValueFormat], and “#” for [DisplayFormat].

#### 6-25 Temporary Input

No corresponding function.

#### 6-26 Consecutive Line Drawing

No corresponding function.

#### 6-27 Contents Display

No corresponding function.

#### 6-28 Video Display

No corresponding function.

# 7 Other Important Points

This chapter provides the additional information you should know to convert NS screen data to NA screen data.

- The text size differs between Sysmac Studio and an NA unit  
Segoe UI, the default of the text family, is an English font. Therefore, a Japanese or Chinese character may cause this issue.  
Change the test family according to your language, following the table below.

Language	Recommended Font Family
Japanese	Meiryo, MS Gothic
Simplified Chinese	Microsoft YaHei, SimSun
Traditional Chinese	Microsoft JhengHei, MingLiU
Korean	Malgun Gothic, Gulim, GulimChe

- How to specify a path to save the log file  
The formats to specify a path to save the user alarm log are shown below.  
A file name must include an extension.

Save to	Format
SD card	¥SDCard¥file name
USB stick memory	¥USBDisk¥file name

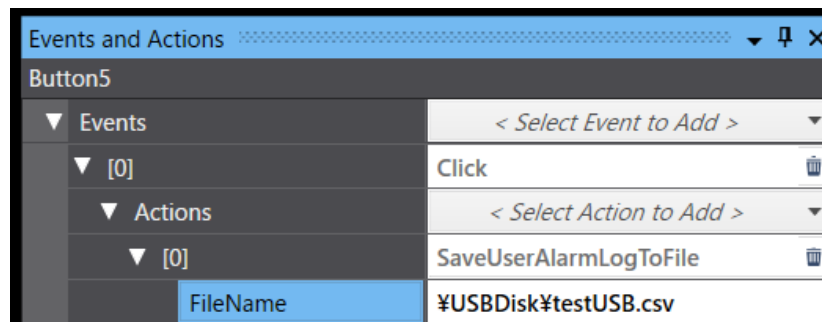

- Japanese Hiragana and Katakana cannot be input through a character keypad. To enter Japanese, you need to select Japanese for the system language of NA. If you use Korean, Simplified Chinese, or Traditional Chinese, select a corresponding system language. Because the system language corresponds to a user language, changing the user language changes the system language. Select **Events and Actions - SetLanguage** then select the language you want to set in the **Language** selection.

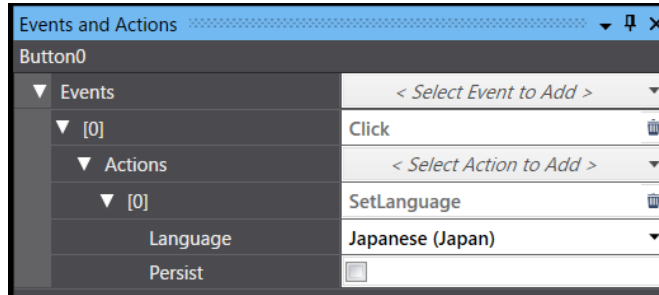

Language List			
Default language	Project Languages	System Languages	Software Keypads
	English (United States)	English (United States)	Standard
	Japanese (Japan)	Japanese (Japan)	Standard
	Chinese (Simplified, PRC)	Chinese (Simplified)	Standard

# 8 Change Controller Program

There are differences in system functionalities and functional objects between NA series units and NS series units. Some of these differences can be resolved with VB programs, but some cannot be migrated to NA units due to performance or functional issues. In those cases, you need to change programs in the controller.

## 8-1 Example of Changing Controller Program

To create a screen that monitors 200 channels at a time from addresses D1000 to D2999, use the index register, *i0*, to assign addresses to the numeric display objects as follows. The numeric display objects and host communication processing of NS units achieve monitoring with less load. Index register values range from 0 to 2700.

D1000 <i>i0</i>	D1001 <i>i0</i>	D1002 <i>i0</i>	...	D1009 <i>i0</i>
D1010 <i>i0</i>	D1011 <i>i0</i>	D1012 <i>i0</i>	...	D1019 <i>i0</i>
D1020 <i>i0</i>	D1021 <i>i0</i>	D1022 <i>i0</i>	...	D1029 <i>i0</i>
...	...	...	...	
D1190 <i>i0</i>	D1191 <i>i0</i>	D1192 <i>i0</i>		D1199 <i>i0</i>

To achieve this using an NA unit, you need to replace an assigned address with an array variable, and also, use VB for processing. In this example, define a numerical type variable *idx*, which refers to the first channel, and an array numeric variable DD(200). Then, lay out a data display object assigning conditional expressions to the variables in the range of DDisp(0) to Ddisp(199). Also, define an array type network variable Dmon(2000) to monitor a value in the PLC. Direct assigning to the data display object, like Dmon(22+*idx*), would be the same manner as NS, but it is impossible. Therefore, copy the monitoring variables to the display variables by using a VB program.

Ddisp(0)	Ddisp(1)	Ddisp(2)	...	Ddisp(9)
Ddisp(10)	Ddisp(11)	Ddisp(12)	...	Ddisp(19)
Ddisp(20)	Ddisp(21)	Ddisp(22)	...	Ddisp(29)
...	...	...	...	
Ddisp(190)	Ddisp(191)	Ddisp(192)	...	Ddisp(199)

```

Sub Monitor_E_Mem
  Dim i as Integer
  If _HMI_CurrentPageIndex <> page number of the monitor screen Then Exit Sub
  For i = 0 to 199
    DDisp(i) = DMon(idx + i)
  Next
End Sub

```

Select **Events - Interval - 1 Second** in the global event to run this subroutine. Because running this subroutine on screens other than the monitor screen does not make sense, use the system variable *\_HMI\_CurrentPageIndex*, which shows a currently displayed screen index, to prevent copying.

Now you can achieve the similar monitoring function as NS, but the subroutine has an issue: it may issue read commands for one channel per For loop. Usually, 1 to 10 read commands are required to get all the data in one screen. In this example, there are 200 loops, so the number of read



commands increases by 200. Therefore, the monitoring interval will extend 20 times or more. For instance, a screen that used to refresh every 0.2 seconds will refresh every 4 seconds.

To avoid this issue, copy the memory in the PLC, using the variables idx(DM200) and EDisp (200 channels from DM20000). It is not necessary to add VB functions and Events attributes to global events in the NA series.

[Sample ladder diagram]



## 9 Revision History

---

Revision History	Date	Revised Content and Page
01	August 2022	First edition
02	April 2023	Error corrections

## Appendix 1: Project Common Settings

### ◆Models

#### Models

CX-Designer		Sysmac Studio		
Model Name	Screen size	Model Name	Screen size	Percentage zoom
NS5-SQ0□-V1	320x240	NA5-7W001□-V1	800x480	2
NS5-SQ0□-V2				
NS5-TQ0□-V2				
NS5-MQ0□-V2				
NS5-SQ1□-V2				
NS5-TQ1□-V2				
NS5-MQ1□-V2				
NS7-SV0□	640 x 480	NA5-7W001□-V1	800 x 480	1
NS8-TV0□-V1				
NS8-TV0□-V2				
NS8-TV1□-V1				
NS10-TV0□		NA5-9W001□-V1	800 x 480	1
NS10-TV0□-V1				
NS10-TV0□-V2				
NS12-TS0□	800 x 600	NA5-12W101□-V1	1280 x 800	1.3
NS12-TS0□-V1				
NS12-TS0□-V2				
NS15-TX0□-V2	1024 x 768	NA5-15W101□-V1	1280 x 800	1

◆Project Properties

Project Properties

CX-Designer				Sysmac Studio				
Tab	1st Level	2nd Level	Value	1st Level	2nd Level	3rd Level	4th Level	Set Value
Title	Project Title			Project Properties	Comment			
Switch	No. of Labels			Refer to the "Switch Label" sheet.				
	Switch No.			-	-	-	-	-
	Label Name			-	-	-	-	-
	Initial Label	Label Name		HMI Settings	Device Settings	Startup Language	Startup Language	The same value as the value of Initial Label in NS
Macro	Project	When Loading a Project		Global Events	ProjectInitialization	Subroutines	-	Subroutine name
	Alarm/Event	On timing Alarm /Event occurred		-	-	-	-	-
		On timing Alarm /Event is		-	-	-	-	-
	On changing of an address value	When a bit changed		-	-	-	-	-
When a value changed			-	-	-	-	-	
Select	Language			See "Switch Label."				
Pop-up	Pop-up Menu	Text Color	Color	-	-	-	-	-
		Background Color2	Color	-	-	-	-	-
		Font Size	...	-	-	-	-	-
		Show Delimiter	Checked/ Unchecked	-	-	-	-	-
Macro Option	MSGBOX	Recognize "¥n" in the message	Checked/ Unchecked	-	-	-	-	-
Input Options	Numeral Input Options		Clear the input field when the input focus	-	-	-	-	-
			Show the current values when the input focus	-	-	-	-	-
	Input Pad Options		Bar-code and input pas are both enabled.	-	-	-	-	-
			Only input pad is enabled.	-	-	-	-	-
Input Status	Text Color		Color	-	-	-	-	-
	Background		Color	-	-	-	-	-
Data Format	Screen/ Page		Binary/ BCD	-	-	-	-	-
	Specifying the File Line		Binary/ BCD	-	-	-	-	-
	Alarm ID No.		Binary/ BCD	-	-	-	-	-
	Alarm/Event Info.		Binary/ BCD	-	-	-	-	-
	Data Log		Binary/ BCD	-	-	-	-	-
	Macro		Binary/ BCD	-	-	-	-	-
	Consecutive Line Drawing		Binary/ BCD	-	-	-	-	-
	Specifying Contents No.		Binary/ BCD	-	-	-	-	-

◆System Setting

System Setting

(1/2)

CX-Designer				Sysmac Studio					
Tab	1st Level	2nd Level		1st Level	2nd Level	3rd Level	4th Level	Value	
PT	Start-up Wait Time			-	-	-	-	-	
	Key Press Sound		OFF	HMI Settings	Device Settings	Touch Input Notification		Unchecked	
			ON	HMI Settings	Device Settings	Touch Input Notification		Checked	
	Buzzer Sound		OFF	HMI Settings	Device Settings	Alarm Notification		Unchecked	
			ON	HMI Settings	Device Settings	Alarm Notification		Checked	
			ERROR ON	HMI Settings	Device Settings	Alarm Notification		Checked	
	Screen Saver Active		None	HMI Settings	Device Settings	Screen Saver	Screen saver type	OFF	
			Display Erased	-	-	-	-	Blank	
	Screen Saver Start-up Time	Set Value			HMI Settings	Device Settings	Screen Saver	Active After [ # ] minutes of inactivity	Set the value of NS setting
		Indirect Reference	Address	-	-	-	-	-	
			Binary/ BCD	-	-	-	-	-	
	Device Monitor	Changing Value	Enable/ Disable	-	-	-	-	-	
	Touch Switch Control	Prioritize notification of ON/OFF button	Checked/ Unchecked	-	-	-	-	-	
			Specify Touch Switch Lock Control Flag	...	-	-	-	-	
Font	CJK Priority	...	-	-	-	-	-		
Operation When Updating Tags	Display Notification Message	Checked/ Unchecked	-	-	-	-	-		
Advanced Setting	Switch screen as high speed	Checked/ Unchecked	-	-	-	-	-		
Initial	Initial Screen			HMI Settings	Device Settings	Startup Page	Page name	Set the page name corresponding the startup screen of NS setting	
	System Memory	\$SB Allocation Address	Address	-	-	-	-	-	
		\$SW Allocation Address	Address	-	-	-	-	-	
		Allow System Memory Compatibility with NT	Unchecked	-	-	-	-	-	
			Checked	-	-	-	-	-	
			NT30/ 620 Series	-	-	-	-	-	
			NT31/ 631 Series	-	-	-	-	-	
	Option	System Memory Update Cycle		-	-	-	-	-	
		Intervals of RUN signal (Pulse)		-	-	-	-	-	
		Initialize System Memory at startup		-	-	-	-	-	
	Enable	Disable	-	-	-	-	-		
	Memory Card Free Space Check Flag		-	-	-	-	-		
System Memory List			-	-	-	-	-		

System Setting

(2/2)

CX-Designer				Sysmac Studio				
Tab	1st Level	2nd Level		1st Level	2nd Level	3rd Level	4th Level	Value
History	Operation Log	No. of Records		Operation Log Settings	Logging limit	-	-	Set the same value as setting in NS. Set 100 if the original value is 99 and less.
		Use Ring Buffer	Checked	Operation Log Settings	Operation when logging limit reached	-	-	Set as "Delete the old log file and continue to log."
			Unchecked	Operation Log Settings	Operation when logging limit reached	-	-	Set as "Stop logging."
	Character Code		ASCII Code	-	-	-	-	-
			Unicode	-	-	-	-	-
	Logfile Output Format		Vertical Axis: Address / Horizontal Axis: Time	-	-	-	-	-
			Vertical Axis: Time / Horizontal Axis: Address	-	-	-	-	-
		Save the data with offset time display format	Checked/ Unchecked	-	-	-	-	-
	Data Log/			-	-	-	-	-
	Save Destination of history data			-	-	-	-	-
	Set the save cycle for Internal Holding Memory		Unchecked	-	-	-	-	-
			Checked	-	-	-	-	-
		hour/ min/ sec	Intermediate Number	-	-	-	-	-
Video	Video Board		...	-	-	-	-	-
	Color which fills		Color	-	-	-	-	-
	Video Input Method		...	-	-	-	-	-
	Save in a file if memory card is full		...	-	-	-	-	-
Printer	Printer Type		...	-	-	-	-	-
	Mode		...	-	-	-	-	-
	Orientation		...	-	-	-	-	-
Function Key (NS15 only)	Key Status	F1	Address	-	-	-	-	-
		F2	Address	-	-	-	-	-
		F3	Address	-	-	-	-	-

◆Switch Label

Switch Label

Language Settings

CX-Designer		Sysmac Studio		Remarks
Switch No.	Label Name	Project Languages	System Languages	
0	Type0	Language selected in CX-Designer	Language selected in CX-Designer	NS label names are user-changeable. Select the language of the text on the original label.
1	Type1	Language selected in CX-Designer	Language selected in CX-Designer	
2	Type2	Language selected in CX-Designer	Language selected in CX-Designer	
3	Type3	Language selected in CX-Designer	Language selected in CX-Designer	
4	Type4	Language selected in CX-Designer	Language selected in CX-Designer	
5	Type5	Language selected in CX-Designer	Language selected in CX-Designer	
6	Type6	Language selected in CX-Designer	Language selected in CX-Designer	
7	Type7	Language selected in CX-Designer	Language selected in CX-Designer	
8	Type8	Language selected in CX-Designer	Language selected in CX-Designer	
9	Type9	Language selected in CX-Designer	Language selected in CX-Designer	
10	Type10	Language selected in CX-Designer	Language selected in CX-Designer	
11	Type11	Language selected in CX-Designer	Language selected in CX-Designer	
12	Type12	Language selected in CX-Designer	Language selected in CX-Designer	
13	Type13	Language selected in CX-Designer	Language selected in CX-Designer	
14	Type14	Language selected in CX-Designer	Language selected in CX-Designer	
15	Type15	Language selected in CX-Designer	Language selected in CX-Designer	

Language Selection

System Language

CX-Designer	Sysmac Studio
Japanese	Japanese (Japan)
English	English (United States)
Italian	Italian (Italy)
Spanish	Spanish (Spain)
German	German (Germany)
French	French (France)
Chinese (Simplified)	Chinese (Simplified, PRC)
Chinese (Traditional)	Chinese (Traditional, Taiwan)

◆Comm. Setting

Comm. Setting

Device References: External Device, HMI Settings

CX-Designer		Sysmac Studio					Remarks
Comm. - All	Comm. Time Out	External Devices	Device Configuration	Timeout			
	Retry Count	-	-	-	-	-	-
	Comm. Auto-return	-	-	-	-	-	-
	Intervals of Message-Comm.	-	-	-	-	-	-
	Routing Table Setting	HMI Settings	FINS Settings	Remote Network Table			
Connect except for a serial port where a communication error occurs	-	-	-	-	-	-	-
Ethernet	Ethernet	-	-	-	-	-	-
	Network Address	HMI Settings	FINS Settings	FINS Address	Ethernet port #1	Network	
	Node Address	HMI Settings	FINS Settings	FINS Address	Ethernet port #1	Node	Auto-setup only
	UDP Port No.	HMI Settings	FINS Settings	FINS/UDP	FINS/UDP port no		Fixed setting
	LAN Speed		-	-	-	-	Auto-identification only
	IP Address	HMI Settings	TCP/IP Settings	Ethernet Port 1 - IP Address	IP Address		
	Sub-net Mask	HMI Settings	TCP/IP Settings	Ethernet Port 1 - IP Address	Subnet mask		
	Default Gateway	HMI Settings	TCP/IP Settings	Ethernet Port 1 - IP Address	Default gateway		
	IP Proxy Address	-	-	-	-	-	-
Conversion Table	-	-	-	-	-	-	
Host	Host Number	-	-	-	-	-	-
	Host Name	External Devices	Device Configuration	Device Name			
	Host Type	External Devices	Device Configuration	Device Vendor			See the "Comm Path" sheet
	Protocol	External Devices	Device Configuration	Connection Driver			See the "Comm Path" sheet
	Network Address	External Devices	Communications Configuration	Network Address			
	Node Address	External Devices	Communications Configuration	Node Address			
	Use	-	-	-	-	-	-
	IP Address	External Devices	Communications Configuration	IP Address			
Route Path	External Devices	Communications Configuration	Route Path				



◆Comm Path

Communication Path

Communication Path	Comm. Protocol			NA			Remarks	
	Serial Port	Host Type	Protocol	Device Vendor	Device Series	Comm. Driver		
Serial Port A Serial Port B	PLC	SYSMAC-PLC	NT Link (1:N)	-	-	-		
			NT Link (1:1)	-	-	-		
			Host Link	-	-	-		
		MELSEC-A	Computer Link	-	-	-		
		MELSEC-F	Computer Link	-	-	-		
		SIMATIC S7-300	3964(R)	-	-	-		
		SYSMAC-CS1	Host Link	-	-	-	-	
			Toolbus	-	-	-	-	
		SYSMAC-CJ1/CP1	Host Link	Omron	CJ	FINS Ethernet	For CJ1 units, changing a connected device to an Ethernet device enables the If there is not Ethernet unit in the system, you need to add one.	
			Toolbus	Omron	CJ	FINS Ethernet		
		SYSMAC-CV	Host Link	-	-	-	-	
			Toolbus	-	-	-	-	
		SYSMAC-CJ2	Host Link	Omron	CJ	FINS Ethernet	Changing a connected device to an Ethernet device enables the replacement.	
			Toolbus	-	-	-		-
	Temperature Controller	E5ZN	(CompoWay/F)	-	-	-		
			(CompoWay/F)	-	-	-		
			(CompoWay/F)	-	-	-		
			(CompoWay/F)	-	-	-		
	Memory Link			-	-	-		
				-	-	-		
	Bar-Code Reader			-	-	-		
	Modem for Data Transfer			-	-	-		
	Generic Protocol	YASKAWA MP	Modbus (Memobus) RTU	-	-	-		
			Modbus (Memobus) RTU	-	-	-		
			Modbus Machine (Modicon Address Style)	-	-	-		
			Modbus Machine (ISO61131 Address Style)	-	-	-		
			Melsec Communication Protocol	-	-	-		
Allen-Bradley DF1			-	-	-			
Allen-Bradley DF1			-	-	-			
Allen-Bradley DF1			-	-	-			
FA-M3 PC Link			-	-	-			
Ethernet	SYSMAC-CS1/CJ1/CP1	FINS	Omron	CJ	FINS Ethernet			
		EtherNet/IP	Omron	CJ	CIP Ethernet			
	SYSMAC-CV	FINS	-	-	-			
	SYSMAC-CJ2	FINS	Omron	CJ	FINS Ethernet			
		EtherNet/IP	Omron	CJ	CIP Ethernet			
	Trajexia	FINS	-	-	-			
	SYSMAC-NJ	EtherNet/IP	Omron	NJ	CIP Ethernet			
	Modbus Machine (Modicon Address Style)	Modbus/TCP	-	-	-			
	Modbus Machine (IEC61131 Address Style)	Modbus/TCP	-	-	-			
	Controller Link	SYSMAC-CS1/CJ1/CP1	FINS	-	-	-		
FINS			-	-	-			
FINS			-	-	-			

◆System Memory

System Memory

System Variables/ User Variables

(1/4)

CX-Designer			Sysmac Studio						
Address	Description	R/W	Supported by:	Variable Type	Variable Name	Data Type	Variable Represents:	Description	R/W
\$SB0	RUN Signal (Pulse)	R	Variable mapping	System variable	.HMI_RunSignal	Boolean	Run Signal	Changes periodically while the HMI is operating. The change interval differs from NS.	R
\$SB1	RUN Signal (Always ON)	R	Unsupported	-	-	-	-	-	-
\$SB2	Screen Switch Strobe	R	Variable mapping	System variable	.HMI_IsPageSwitching	Boolean	Page Switch Strobe	The value is True while a page is switching and becomes False after completing switching the page.	R
\$SB3	Prohibit Shifting to System Menu	R/W (Ext Control)	Unsupported	-	-	-	-	-	-
\$SB4	Battery Low	R	Variable mapping	System variable	.HMI_IsBatteryLow	Boolean	Battery Low	Gives True if the battery voltage has dropped below a specific level.	R
\$SB5	Data Input Detector	R	Variable mapping	System variable	.HMI_IsDataInput	Boolean	Data Entry in Progress	Gives True when a data entry object is focused.	R
\$SB6	Brightness Adjust, High	R/W (Ext Control)	Global event	System variable	.HMI_Brightness	Integer	Brightness	Specifies the brightness of the screen. Specifying 0 turns off the backlight.	R/W
\$SB7	Brightness Adjust, Middle	R/W (Ext Control)	Global event	System variable	.HMI_Brightness	Integer			R/W
\$SB8	Brightness Adjust, Low	R/W (Ext Control)	Global event	System variable	.HMI_Brightness	Integer			R/W
\$SB9	Backlight Control (Screen Saver Start/Cancel)	R/W (Ext Control)	Variable mapping	System variable	.HMI_IsScreenSaverActive	Boolean	Whether Screen Saver is Active or not	Tells whether the screen saver is active. True: Active, False: Not active	R/W
\$SB10	Control Backlight Flashing	R/W (Ext Control)	VB	System variable	.HMI_Brightness	Integer	Brightness	Sets the brightness of the screen.	R/W
\$SB11	Backlight Status	R	Variable mapping	System variable	.HMI_IsScreenSaverActive	Boolean	Whether Screen Saver is Active or not	Tells whether the screen saver is active. True: Active, False: Not active	R/W
\$SB12	Continuous Buzzer	R/W (Ext Control)	Global event	-	-	-	-	-	-
\$SB13	Short Intermittent Buzzer	R/W (Ext Control)	Global event	-	-	-	-	-	-
\$SB14	Long Intermittent Buzzer	R/W (Ext Control)	Global event	-	-	-	-	-	-
\$SB15	Notification/Control of Video	R/W	Unsupported	-	-	-	-	-	-
\$SB16	Processing Priority Registration for PortA (NT Link 1:N)	R/W (Ext Control)	Unsupported	-	-	-	-	-	-
\$SB17	Processing Priority Registration for PortB (NT Link 1:N)	R/W (Ext Control)	Unsupported	-	-	-	-	-	-
\$SB18	Display Keypad with Temporary Input	R/W (Ext Control)	Unsupported	-	-	-	-	-	-
\$SB19	Prohibit Input	R/W (Ext Control)	Global event	-	-	-	-	-	-
\$SB20	Contrast Adjust (NSS Only)	R/W (Ext Control)	Unsupported	-	-	-	-	-	-
\$SB21	Contrast Adjust (NSS Only)	R/W (Ext Control)	Unsupported	-	-	-	-	-	-
\$SB22	Contrast Adjust (NSS Only)	R/W (Ext Control)	Unsupported	-	-	-	-	-	-
\$SB23	Contrast Adjust (NSS Only)	R/W (Ext Control)	Unsupported	-	-	-	-	-	-
\$SB24	Video Capture Trigger	R/W	Unsupported	-	-	-	-	-	-
\$SB25	Start Printing/Capture Screen	R/W (Ext Control)	Global event	-	-	-	-	-	-
\$SB26	Stop Printing	R/W (Ext Control)	Unsupported	-	-	-	-	-	-
\$SB27	Test Pattern Printing	R/W (Ext Control)	Unsupported	-	-	-	-	-	-
\$SB28	Printer Head Cleaning	R/W (Ext Control)	Unsupported	-	-	-	-	-	-
\$SB29	Update Printer Status	R/W (Ext Control)	Unsupported	-	-	-	-	-	-
\$SB30	Printer Busy Status/Capture Busy Status	R	Unsupported	-	-	-	-	-	-
\$SB31	Notification of Printer Error/Capture Screen Error	R	Unsupported	-	-	-	-	-	-
\$SB32	Initialize Alarm/Event History	R/W	Global event	-	-	-	-	-	-
\$SB33	Save Alarm/Event History	R/W	Unsupported	-	-	-	-	-	-

System Memory

System Variables/ User Variables

(2/4)

CX-Designer			Sysmac Studio						
Address	Description	R/W	Supported by:	Variable Type	Variable Name	Data type	Variable Represents:	Description	R/W
\$SB34	Internal Holding Memory (\$HB/\$HW) Initialization	R/W	Unsupported	User variable	-	-	-	-	
\$SB35	Initialize Data Log	R/W	Global event	User variable	-	-	-	-	
\$SB36	Save Data Log	R/W	Global event	User variable	-	-	-	-	
\$SB37	Initialize Operation Log	R/W	Global event	User variable	-	-	-	-	
\$SB38	Save Operation Log	R/W	Global event	User variable	-	-	-	-	
\$SB39	Log Functional Object Operation and Address Operation	R/W (Ext Control)	Unsupported	User variable	-	-	-	-	
\$SB40	Log Switch Screen Operation	R/W (Ext Control)	Unsupported	User variable	-	-	-	-	
\$SB41	Log Macro Operation	R/W (Ext Control)	Unsupported	User variable	-	-	-	-	
\$SB42	Initialize Error Log	R/W	Unsupported	User variable	-	-	-	-	
\$SB43	Save Error Log	R/W	Unsupported	User variable	-	-	-	-	
\$SB44	-	-	Unsupported	User variable	-	-	-	-	
\$SB45	Macro Error Dialog Control	R/W (Ext Control)	Unsupported	User variable	-	-	-	-	
\$SB46	Notification of Macro Error	R	Unsupported	User variable	-	-	-	-	
\$SB47	Logging Process Error Flag	R	Unsupported	User variable	-	-	-	-	
\$SB48	Memory Free Space Check	R	Unsupported	User variable	-	-	-	-	
\$SB49	Stop Memory Card	R/W	Global event	User variable	-	-	-	-	
\$SB50	Memory Card Removing Status (Power OFF)	R	Variable mapping	System variable	.HMI_CanEjectSDCard	Boolean	The status flag whether you can safely eject SD Card	Shows whether you can safely eject the SD card.	R
\$SB51	Periodical Data Log Save in Process Flag	R	Unsupported	User variable	-	-	-	-	
\$SB52	Data Block Operation Complete Flag	R	Unsupported	User variable	-	-	-	-	
\$SB53	Prohibit Screen Saver Startup	R/W	Unsupported	User variable	-	-	-	-	
\$SB54	Password Level 1 Operable Status	R	VB	System variable	.HMI_CurrentUserRole	String	The role of Current Login User	Shows the role of user currently logging in.	R
\$SB55	Password Level 2 Operable Status	R							
\$SB56	Password Level 3 Operable Status	R							
\$SB57	Password Level 4 Operable Status	R							
\$SB58	Password Level 5 Operable Status	R							
\$SB59	-	-	Unsupported	User variable	-	-	-	-	
\$SB60	-	-	Unsupported	User variable	-	-	-	-	
\$SB61	-	-	Unsupported	User variable	-	-	-	-	
\$SB62	-	-	Unsupported	User variable	-	-	-	-	
\$SB63	-	-	Unsupported	User variable	-	-	-	-	
\$SW0	Current Screen No. (Screen is switched when it is changed)	R/W	VB	System variable	.HMI_CurrentPageIndex	Integer	Current Page Index	Specifies the page number of currently displayed page. While a pop-up screen is displayed, specifies the number of the pop-up. While a pop-up is displayed, writing the value to the memory displays a new pop-up. If a normal page is displayed, the page switches. If the value is the number of a non-existent page, the memory gets the previous value. Because NS system memory's data size is 1-word but NA system variable's size is 2-word, data size conversion is required.	R/W
\$SW1	Current Pop-up Screen 1 Number	R/W							VB *1
\$SW2	Position of Pop-up Screen 1 (Top left X coordinate)	R/W	Unsupported	User variable	-	-	-	-	
\$SW3	Position of Pop-up Screen 1 (Top left Y coordinate)	R/W	Unsupported	User variable	-	-	-	-	
\$SW4	Current Pop-up Screen 2 Number	R/W	Unsupported	User variable	-	-	-	-	
\$SW5	Position of Pop-up Screen 2 (Top left X coordinate)	R/W	Unsupported	User variable	-	-	-	-	

\*1: A modification may be required in the PLC.

## System Memory

## System Variables/ User Variables

(3/4)

CX-Designer			Sysmac Studio						
Address	Description	R/W	Supported by:	Variable Type	Variable Name	Data Type	Variable Represents:	Description	R/W
\$\$SW6	Position of Pop-up Screen 2 (Top left Y coordinate)	R/W	Unsupported	User variable	-	-	-	-	
\$\$SW7	Current Pop-up Screen 3 Number	R/W	Unsupported	User variable	-	-	-	-	
\$\$SW8	Position of Pop-up Screen 3 (Top left X coordinate)	R/W	Unsupported	User variable	-	-	-	-	
\$\$SW9	Position of Pop-up Screen 3 (Top left Y coordinate)	R/W	Unsupported	User variable	-	-	-	-	
\$\$SW10	Urrrent Label Number	R/W	Global event	User variable	-	-	-	-	
\$\$SW11	Destination (0:Printer/1:Memory Card)	R/W (Ext Control)	Unsupported	User variable	-	-	-	-	
\$\$SW12	Backlight Brightness Control	R/W (Ext Control)	VB	System variable	HMI_Brightness	Integer	Brightness	Specifies the brightness of the screen.	R/W
\$\$SW13	Password Number for Canceling Input Prohibition	R/W (Ext Control)	Unsupported	User variable	-	-	-	-	
\$\$SW14	Current Date and Time (Min, Sec)	R	Global event	System variable	_HMI_Minute	Integer	System Clock	To represent minute and second, _HMI_Minute and _HMI_Second are available, respectively. To get the storage type of \$\$SW14, use a VB function.	R
\$\$SW15	Current Date and Time (Date, Hour)	R	Global event	System variable	_HMI_DateTime	DateTime	System Clock	To represent date and hour, _HMI_DateTime.Day and _HMI_Hour are available, respectively. To get the storage type of \$\$SW15, use a VB function.	R
\$\$SW16	Current Date and Time (Year, Month)	R	Global event	System variable	_HMI_DateTime	DateTime	System Clock	To represent year and month, _HMI_DateTime.Year and _HMI_DateTime.Month are available, respectively. To get the storage type of \$\$SW16, use a VB function.	R
\$\$SW17	Current Date and Time (Day of the Week)	R	Global event	System variable	_HMI_DateTime	DateTime	System Clock	HMI_DateTime.DayOfWeek has the same value as the NS.	R
\$\$SW18	No. of Alarms/Events Occurred	R	Supported	System variable	_HMI_AlarmsRaised	Integer	The alarms currently occurring	The number of alarms currently occurring.	R
\$\$SW19	Occurred Alarm/Event ID	R	Unsupported	User variable	-	-	-	-	
\$\$SW20	Cancelled Alarm/Event ID	R	Unsupported	User variable	-	-	-	-	
\$\$SW21	Alram/Event ID of Alarm/Event Object Macro	R	Unsupported	User variable	-	-	-	-	
\$\$SW22	-	-	-	User variable	-	-	-	-	
\$\$SW23	Macro Error Number	R	Unsupported	User variable	-	-	-	-	
\$\$SW24	Screen No. Having Macro Error	R	Unsupported	User variable	-	-	-	-	
\$\$SW25	Object ID Having Macro Error	R	Unsupported	User variable	-	-	-	-	
\$\$SW26	Macro Timing Having Error	R	Unsupported	User variable	-	-	-	-	
\$\$SW27	Offset for Index I0	R/W (Ext Control)	Array	User variable	PTMEM_SW27	Integer	The index of an array	Specify this variable as array element.	R/W
\$\$SW28	Offset for Index I1	R/W (Ext Control)	Array	User variable	PTMEM_SW28	Integer	The index of an array	Specify this variable as array element.	R/W
\$\$SW29	Offset for Index I2	R/W (Ext Control)	Array	User variable	PTMEM_SW29	Integer	The index of an array	Specify this variable as array element.	R/W
\$\$SW30	Offset for Index I3	R/W (Ext Control)	Array	User variable	PTMEM_SW30	Integer	The index of an array	Specify this variable as array element.	R/W
\$\$SW31	Offset for Index I4	R/W (Ext Control)	Array	User variable	PTMEM_SW31	Integer	The index of an array	Specify this variable as array element.	R/W
\$\$SW32	Offset for Index I5	R/W (Ext Control)	Array	User variable	PTMEM_SW32	Integer	The index of an array	Specify this variable as array element.	R/W
\$\$SW33	Offset for Index I6	R/W (Ext Control)	Array	User variable	PTMEM_SW33	Integer	The index of an array	Specify this variable as array element.	R/W
\$\$SW34	Offset for Index I7	R/W (Ext Control)	Array	User variable	PTMEM_SW34	Integer	The index of an array	Specify this variable as array element.	R/W
\$\$SW35	Offset for Index I8	R/W (Ext Control)	Array	User variable	PTMEM_SW35	Integer	The index of an array	Specify this variable as array element.	R/W
\$\$SW36	Offset for Index I9	R/W (Ext Control)	Array	User variable	PTMEM_SW36	Integer	The index of an array	Specify this variable as array element.	R/W
\$\$SW37	Data Log Group Number	R/W (Ext Control)	Unsupported	User variable	-	-	-	-	
\$\$SW38	Data Block Error Number	R	Unsupported	User variable	-	-	-	-	

**System Memory**

**System Variables/ User Variables**

(4/4)

CX-Designer			Sysmac Studio							
Address	Description	R/W	Supported by:	Variable Type	Variable Name	Data type	Variable Represents:	Description	R/W	
\$SW39	Authentication Level	R	VB	System variable	HMI.CurrentUserRole	String	The right of a user	Shows the right of a user currently logging in.	R	
\$SW40	Range for Initializing Alarm/ Event History	R/W (Ext Control)	Unsupported	User variable	-	-	-	-		

**How to Replace**

To realize the NS system memory in NA, PLC program modification will be required in many cases.

Supported	The NA system variable works equally with the NS system memory without a PLC program modification.
Variable mapping	The NA system variable works equally with the NS system memory without a PLC program modification.
VB	Using a subroutine can perform the same function as NS.
Unsupported	No corresponding function is available in NA.

**Variable Type**

User variable	Define user variables, PTMEM_SB# and PTMEM_SW#, which assigned to addresses.
---------------	--

◆Alarm

Alarm/Event Settings

CX-Designer				Sysmac Studio				
Function	1st Level	2nd Level	Set Value	Category	Group	Property		Set Value
Alarm/ Event Parameter	Alarm/ Event History	No. of Alarm Hist. Rec.		HMI Settings	Device Settings	Internal Retained Memory Settings	Maximum Number of User Alarm Logs	The minimum value of "No. of Alarm Hist. Rec." plus "No. of Event Hist. Rec."
		No. of Event Hist. Rec.						
		Use Ring Buffer	Checked/ Unchecked	-	-	-	-	-
Add Alarm/ Event Info	Info1 Address			-	-	-	-	-
	Info2 Address			-	-	-	-	-
	Info3 Address			-	-	-	-	-
Icons	Specify "Bitmap displayed as From New Date & Time" icon			-	-	-	-	-
	Specify "Bitmap displayed as From Old Date & Time" icon			-	-	-	-	-
	Specify "Bitmap displayed as From High Priority" icon			-	-	-	-	-
	Specify "Bitmap displayed as From Low Priority" icon			-	-	-	-	-
	Specify "From High Frequency" icon			-	-	-	-	-
	Specify "From Low Frequency" icon			-	-	-	-	-
	Specify "Delete Selected Item" icon			-	-	-	-	-
	Specify "Check Selected Item" icon			-	-	-	-	-
	Specify "Check All Alarm" icon			-	-	-	-	-
	Specify "Cancel All Alarm's Checks" icon			-	-	-	-	-
Specify "Change Display Type" icon			-	-	-	-	-	

Alarm/Event Settings: Alarm/Event Details

CX-Designer				Sysmac Studio					
1st Level	2nd Level	3rd Level	Set Value	Category	Group	Property		Set Value	
	Occurred Text		Color	-	-	-	-	-	
	Released Text		Color	-	-	-	-	-	
Message	Use the String Table		Unchecked	-	-	-	-	-	
		Message	Fixed string	User Alarms	Group***	Message		The original text registered as a resource	
			Checked						
	String No.		String table number	User Alarms	Group***	Message		The original text registered as a resource	
Address	Address		Address	User Alarms	Group***	Expression		A variable mapped to the address	
	Detection Type		Raise alarm on Set (to 1) of address/Raise alarm on Reset (to 0) of address	-	-	-	-	-	
	Priority			-	-	-	-	-	
	Display Type			High Alarm	User Alarms	Group***	Priority		User Fault Level 1
				Middle Alarm	User Alarms	Group***	Priority		User Fault Level 2
				Low Alarm	User Alarms	Group***	Priority		User Fault Level 3
			Event	User Alarms	Group***	Priority		User Information	
Group			Group number	User Alarms	Group name			Group.[Group No]. [Group name]	
Switch Screen	Screen Switch		Screen number	User Alarms	Group***	Page		Page name	
		Switch screen when Alarm/Event occurred	Checked/ Unchecked	-	-	-	-	-	
Switch Contents		Contents No.	Contents number	-	-	-	-	-	
		Delete when Alarm/Event is canceled	Checked/ Unchecked	-	-	-	-	-	
		Save to History	Checked/ Unchecked	-	-	-	-	-	
		Delete when Alarm/Event is canceled	Checked/ Unchecked	-	-	-	-	-	
		Display the document on a document display object	Checked/ Unchecked	-	-	-	-	-	

◆Broken-line Graph

Broken-line Graph: Broken-line Graph Group Setting

Data Groups

CX-Designer				Sysmac Studio											
Function	1st Level	2nd Level	Set Value	Category	Group	Property		Set Value							
Group Name			Group name	Data Groups	Data series name	Data Series		Data series name							
Draw Value Outside of the Range			Checked/ Unchecked	-	-	-	-	-							
Storage Type			INT (Signed 1 word)	Data Groups	Data series name	Data Series	Data Type	Short							
			UINT (Unsigned 1 word)					Ushort							
			DINT (Signed 2 words)					Integer							
			UDINT (Unsigned 2 words)					UInteger							
			REAL (Real Number)					Single							
			BDC2 (Unsigned 1 word)					-							
			BDC2 (Unsigned 2 words)					-							
			BCD1 (Signed [leftmost digit:F] 1 word)					-							
			BCD2 (Signed [leftmost digit:F] 2 words)					-							
			BCD2 (Signed [leftmost bit:1] 1 word)					-							
			BCD2 (Signed [leftmost bit:1] 2 words)					-							
			No. of vertices in each line					Monitor Points		Fixed value	-	-	-	-	-
			Batch Read					Read in batch		Unchecked	-	-	-	-	-
Checked	-	-		-	-	-									
Trigger Address	-	-		-	-	-									
Operation Address Complete Flag	-	-		-	-	-									
History	No. of Histories			-	-	-	-	-							
	Clear history when address changes to ON		Unchecked Checked Address	-	-	-	-	-							



**Broken-line Graph: Broken-line Graph Group Set**

CX-Designer				Sysmac Studio				
Function	1st Level	2nd Level	Set Value	Category	Group	Property		Set Value
Start Address			Address	Data Groups	Data series name	Variable		A variable mapped to the address
Maximum/Minimum Value	Maximum	Indirect Reference	Unchecked	-	-	-	-	-
			Fixed value	-	-	-	-	-
			Checked	-	-	-	-	-
	Minimum	Indirect Reference	Address	-	-	-	-	-
			Unchecked	-	-	-	-	-
			Fixed value	-	-	-	-	-
		Address	-	-	-	-	-	
Line Color	Within		Color	-	-	-	-	-
	Outside		Color	-	-	-	-	-
Line Style			Solid line, Dotted line, Broken line, 1-dot chain line, or 2-dot chain line	-	-	-	-	-
Display Offset			Fixed value	-	-	-	-	-
Step Display			Checked/ Unchecked	-	-	-	-	-
Marker			None, □, ○, +, or ×	-	-	-	-	-
	Size		Large, medium, or small	-	-	-	-	-
	Color			-	-	-	-	-
Line	Display when address changes to ON		Unchecked or Checked: Address	-	-	-	-	-
History Display	Line Color	Normal	Color	-	-	-	-	-
		Outside	Color	-	-	-	-	-
	Display/Hide		Display	-	-	-	-	-
			Hide	-	-	-	-	-
			Indirect Reference: Address	-	-	-	-	-
	Action When Specifying		Display When Address ON or Display When Address OFF	-	-	-	-	-

◆Data Log

Data Log Setting

Data Logging

CX-Designer					Sysmac Studio				
1st Level	2nd Level	3rd Level	4th Level	Set Value	Category	Data Set	Property		Set Value
Group Name					Data Logging				Data set name
Log Timing	On Sampling Cycle				Data Logging	Data set name	Update Type		Regular Interval
					Data Logging	Data set name	Update Rate		A value less than the set value on NS
		Indirect Reference of Sampling Cycle		Unchecked	-	-	-	-	-
			Checked	-	-	-	-	-	-
		Address	Address	-	-	-	-	-	-
	On Event					Data Logging	Data set name	Update Type	
	Address		Address	Address	Data Logging	Data set name	Expression		A variable mapped to the address
Save	Log Save Area	Save with Ring Buffer		Checked/ Unchecked	-	-	-	-	-
Memory Card	Output File			File name	-	-	-	-	-
	Save the data periodically			Checked	Data Logging	Data set name	Start New Database File		After specific number of logs
				Unchecked	-	-	-	-	-
Log Period	Always				Data Logging	Data set name	Automatically Start on HMI Device		Checked
	Log only when Data Log object is shown				-	-	-	-	-
		Clear when switching screens		Checked/ Unchecked	-	-	-	-	-
Start/Stop Data Log	Control start/stop data log by the specified address			Unchecked	-	-	-	-	-
				Checked	-	-	-	-	-
	Clear data logs when the address is ON	Address	Address	Address	-	-	-	-	-
				Checked/ Unchecked	-	-	-	-	-
Log Points					Data Logging	Data set name	After specific number of logs	The number of logs	The original value set in the NS

Data Log: Data Log Address Setting

Data Logging: Data Set

CX-Designer					Sysmac Studio				
1st Level	2nd Level			Set Value	Category	Data Set	Property		Set Value
Address				Address	Data Logging	Data set name	Variable		A variable mapped to the address
Storage Type					-	-	-	-	-
Maximum	Indirect Reference			Unchecked	-	-	-	-	-
				Fixed value	-	-	-	-	-
			Checked	-	-	-	-	-	-
		Address	Address	Address					
Minimum	Indirect Reference			Unchecked	-	-	-	-	-
				Fixed value	-	-	-	-	-
			Checked	-	-	-	-	-	-
		Address	Address	Address					

◆Data Block

Data Block

Recipe

CX-Designer			Sysmac Studio			
Function	1st Level	Set Value	Category	Group	Property	Set Value
Parameter		ASCII code	-	-	-	-
		Unicode	-	-	-	-
Icons		Read data file	-	-	-	-
		Write data file	-	-	-	-
		Write to the address	-	-	-	-
		Read from the address	-	-	-	-
		Add the record	-	-	-	-
		Delete the record	-	-	-	-

Data Block: Field

Recipe: Recipe Template, Recipe

CX-Designer		Sysmac Studio			
Number in the Table	Function	Category	Group	Property	Set Value
①	Field Name	Recipes	Field	Field name	The original value
②	Address	Recipes	Field	Variable	A variable mapped to the address
③	Data Format	-	-	-	-
④	Record label	Recipes	Recipe	Recipe name	The original value
⑤	Recipe data	Recipes	Recipe	Field name	The original value

	No.	0
①	Field Name	New Field
②	Address	SERIALA:0000
③	Data Format	Numeral
	0	
	1	④
	2	
	3	⑤

**Data Block: Record**

**Data Groups: Data Series**

CX-Designer			Sysmac Studio			
Function	1st Level	Set Value	Category	Group	Property	Set Value
Data Block Name			Data Groups	Data series name	Variable	A variable mapped to the address
Record Setting	File Name	File name	-	-	-	-
	The maximum number of Records		-	-	-	-
Specify Interlock (Data updating prohibition flag)		Checked	-	-	-	-
		Unchecked	-	-	-	-
	Interlock Address	Address	-	-	-	-
Record Label Setting	String Length		-	-	-	-
	Storage	ASCII code	-	-	-	-
	String Type	Unicode	-	-	-	-

◆Scale

Unit & Scale      Scale

CX-Designer	Sysmac Studio		
Function	Category	Group	Remarks
No.	Scale Name	Scale[Set value]	
Comment	Comment	[Unit][Comment]	
Unit name			CX-Designer identifies by No.
Scale	Multiplier	The original value	
Offset	Offset	The original value	

◆ Troubleshooter

Troubleshooter

Troubleshooter

(1/2)

CX-Designer				Sysmac Studio				
Function				Category	Group	Item 1	Set Value	
Screen Setting	PLC Setting	Event Codes		Controller Events	User Events	Event Code	The original value for NS	
		Short Message		-	-	-	-	
	NS Setting	Troubleshooting Screen		Controller Events	User Events	Troubleshooter Associated Page	The page name that has been set for NS	
Theme	Select a theme		Checked	-	-	-	-	
			Unchecked	-	-	-	-	
		File name		-	-	-	-	
Language Assignment		NS Label Name		Troubleshooter	Language Mapping	HMI Project Language	An adequate language selected from the language setting	
		PLC Setting		Troubleshooter	Language Mapping	User Event Language	An adequate language based on the original language setting	
	Language setting for Controller troubles and Controller event log	Conform to the system log		Checked	-	-	-	-
				Unchecked	-	-	-	-
		NS Label Name		-	-	-	-	
		PLC Setting		-	-	-	-	
User	Restrict error cancellation		Checked	-	-	-	-	
			Unchecked	-	-	-	-	
			Restrict always	Troubleshooter	Security Settings	Ability to Reset Errors	None	
			Restrict at canceling authentication	Troubleshooter	Security Settings	Ability to Reset Errors	Level 1	
			Restrict at Level 1 or lower	Troubleshooter	Security Settings	Ability to Reset Errors	Level 1	
			Restrict at Level 2 or lower	Troubleshooter	Security Settings	Ability to Reset Errors	Level 2	
			Restrict at Level 3 or lower	Troubleshooter	Security Settings	Ability to Reset Errors	Level 3	
			Restrict at Level 4 or lower	Troubleshooter	Security Settings	Ability to Reset Errors	Level 4	
	Restrict log clear			Checked	-	-	-	-
				Unchecked	Troubleshooter	Security Settings	Ability to Clear Event Logs	None
				Restrict always	Troubleshooter	Security Settings	Ability to Clear Event Logs	Level 1
				Restrict at canceling authentication	Troubleshooter	Security Settings	Ability to Clear Event Logs	Level 1
				Restrict at Level 1 or lower	Troubleshooter	Security Settings	Ability to Clear Event Logs	Level 1
				Restrict at Level 2 or lower	Troubleshooter	Security Settings	Ability to Clear Event Logs	Level 2
				Restrict at Level 3 or lower	Troubleshooter	Security Settings	Ability to Clear Event Logs	Level 3
				Restrict at Level 4 or lower	Troubleshooter	Security Settings	Ability to Clear Event Logs	Level 4
	Restrict switching into Event log screen			Checked	-	-	-	-
				Unchecked	Troubleshooter	Security Settings	Access to Event Logs	None
				Restrict always	Troubleshooter	Security Settings	Access to Event Logs	Level 1
				Restrict at canceling authentication	Troubleshooter	Security Settings	Access to Event Logs	Level 1
			Restrict at Level 1 or lower	Troubleshooter	Security Settings	Access to Event Logs	Level 1	
			Restrict at Level 2 or lower	Troubleshooter	Security Settings	Access to Event Logs	Level 2	
			Restrict at Level 3 or lower	Troubleshooter	Security Settings	Access to Event Logs	Level 3	
			Restrict at Level 4 or lower	Troubleshooter	Security Settings	Access to Event Logs	Level 4	

Troubleshooter

Troubleshooter

(2/2)

CX-Designer				Sysmac Studio					
Function				Category	Group	Item 1	Set Value		
User Authentication	Restrict screen capture			Checked	-	-	-		
				Unchecked	Troubleshooter	Security Settings	Ability to Print Screens	None	
				Restrict always	Troubleshooter	Security Settings	Ability to Print Screens	Level 1	
				Restrict at canceling authentication	Troubleshooter	Security Settings	Ability to Print Screens	Level 1	
				Restrict at Level 1 or lower	Troubleshooter	Security Settings	Ability to Print Screens	Level 1	
				Restrict at Level 2 or lower	Troubleshooter	Security Settings	Ability to Print Screens	Level 2	
				Restrict at Level 3 or lower	Troubleshooter	Security Settings	Ability to Print Screens	Level 3	
				Restrict at Level 4 or lower	Troubleshooter	Security Settings	Ability to Print Screens	Level 4	
	Restrict saving into csv				Checked	-	-	-	
					Unchecked	Troubleshooter	Security Settings	Ability to Save to CSV File	None
					Restrict always	Troubleshooter	Security Settings	Ability to Save to CSV File	Level 1
					Restrict at canceling authentication	Troubleshooter	Security Settings	Ability to Save to CSV File	Level 1
					Restrict at Level 1 or lower	Troubleshooter	Security Settings	Ability to Save to CSV File	Level 1
					Restrict at Level 2 or lower	Troubleshooter	Security Settings	Ability to Save to CSV File	Level 2
					Restrict at Level 3 or lower	Troubleshooter	Security Settings	Ability to Save to CSV File	Level 3
					Restrict at Level 4 or lower	Troubleshooter	Security Settings	Ability to Save to CSV File	Level 4
Monitor Error	Host				Troubleshooter	Device	-		
					Troubleshooter	Launch on System Event	-	Unchecked	
	Monitor Target					Troubleshooter	Launch on User Event	-	Unchecked
						Troubleshooter	Launch on System Event	-	Unchecked
						Troubleshooter	Launch on User Event	-	Checked
						Troubleshooter	Launch on System Event	-	Checked
						Troubleshooter	Launch on User Event	-	Unchecked
						Troubleshooter	Launch on System Event	-	Checked
User trouble and					Troubleshooter	Launch on System Event	-	Checked	
					Troubleshooter	Launch on User Event	-	Checked	

◆Password

Password

Security Settings

CX-Designer					Sysmac Studio				
Function	1st Level	2nd Level	3rd Level	Set Value	Category	Group	Item 1	Set Value	
Password	Indirect Reference			None	-	-	-	-	
				Level 1	-	-	-	-	
				Level 2	-	-	-	-	
				Level 3	-	-	-	-	
				Level 4	-	-	-	-	
				Level 5	-	-	-	-	
	Level 1 to Level 5	Password				Security Settings	User Accounts	Password	The original value for NS
								Name	User Level1, User Level2, ...
								Role	Authority1, Authority2,...
							Roles and Access Levels	Role/Access Level	Authority1, Authority2,...
								Level 1	Checked
								Level 2	Unchecked
								Level 3	Unchecked
Input Pad								System Keypad	-
								Specified Pop-up Screen	-
Function Mode	Password				-	-	-	-	
	Password (with level)	Cancel authentication if no operation is done for a set period	Time-out time	Checked	-	-	-	-	
				Unchecked	-	-	-	-	
					-	-	-	-	
	Switch screen when canceling the authentication	PLC Language Setting	Checked	-	-	-	-		
	Restrict error cancellation		Unchecked	-	-	-	-		
		Switch Screen No.		-	-	-	-		



◆String Table

String Table      Resource

CX-Designer		Sysmac Studio				
Function	Label	Category	Group	Item 1	Item 2	Set Value
No.		Resources	NS_StringTable	String	Name	String[Setvalue]
String	Type0	Resources	NS_StringTable	String	The 1st language	The string that has been set for NS
	...	Resources	NS_StringTable	String	The 2nd to 15th language	The string that has been set for NS
	Type15	Resources	NS_StringTable	String	The 16th language	The string that has been set for NS

**Appendix 2: Object Common Settings**

◆Screen

Screen

Page

(1/2)

CX-Designer				Sysmac Studio				
Tab	1st Level	2nd Level	Set Value	Category	Group	Property	Set Value	Remarks
	Screen/Sheet No.			Properties	General	PageIndex	The original page number for NS	
Title	Screen Title			Properties	General	Name		
Size/Pop-up	Screen Size	Width		Properties	Layout	Width	Scaled value from NS	Disabled if "Use as Pop-up Screen" has been unchecked.
		Height		Properties	Layout	Height	Scaled value from NS	Disabled if "Use as Pop-up Screen" has been unchecked.
		Use as Default Screen Size	Checked Unchecked	- -	- -	- -	- -	- -
	Use as Pop-up Screen		Checked Unchecked	Properties Properties	Behavior Behavior	PageType PageType	Popup Main	
		Pop-up Screen Display Position	Center of Screen		Properties	Layout	Position	Center
	Top Left of Screen			Properties	Layout	Position	TopLeft	
	Bottom Left of Screen			Properties	Layout	Position	BottomLeft	
	Top Right of Screen			Properties	Layout	Position	TopRight	
	Bottom Right of Screen			Properties	Layout	Position	BottomRight	
	Any Position			Properties	Layout	Position	Custom	
	X			Properties	Layout	Position (Left, Top) - Top	Scaled value from NS	
	Y		Properties	Layout	Position (Left, Top) - Top	Scaled value from NS		
	Pop-up Screen Setting	Enable input on other screens	Checked Unchecked	Properties Properties	Behavior Behavior	DisplayMode DisplayMode	Modeless Modal	
			Close when base screen switches	Checked Unchecked	Properties Properties	Behavior Behavior	CloseOnPageChange CloseOnPageChange	Checked Unchecked
		No title bar		Checked Unchecked	- -	- -	- -	- -
			Background/Others	Background Color	Use as Default Background	Properties	Appearance	BackgroundColor
Checked Unchecked	- -	- -			- -	- -		
Background File	Select File Name	Checked Unchecked			- -	- -	- -	- -
	Select			-	-	-	-	
Compression	Compress Screen Data File	Checked Unchecked		- -	- -	- -	- -	

Screen

Page

(2/2)

CX-Designer				Sysmac Studio				
Tab	1st Level	2nd Level	Set Value	Category	Group	Property	Set Value	Remarks
Background/Others	The order of display		Display all objects at once	-	-	-	-	
			Display frames and fixed objects first	-	-	-	-	
Function Key	Key Status Address	F1		-	-	-	-	
		F2		-	-	-	-	
		F3		-	-	-	-	
Macro	Macro Execution Condition	When loading a screen		Events and Actions	Event	PageDisplayed	-	
				Events and Actions	Action	CallSubroutine	Subroutine name	
		When unloading a screen		Events and Actions	Event	PageHidden	-	
				Events and Actions	Action	CallSubroutine	Subroutine name	
Comm. Details	Smart Active Parts Communication Interval			-	-	-	-	

◆Frame

Frame

CX-Designer					Sysmac Studio					
Tab	1st Level	2nd Level	3rd Level	Set Value	Category	Group	Property	Set Value		
	Object ID				Properties	General	Name	The original Object ID		
General	Frame Page	No. of Frames			Properties	Behavior	TabPages	Add as much as the frames		
		Page No. Edited			-	-	-			
		Set Background Color		Checked		-	-	-		
				Unchecked		-	-	-		
		Tab color				Properties	Appearance	BackgroundColor	See the table below	
						Properties	Appearance	SelectedItemBackgroundColor	See the table below	
					Properties	Behavior	TabPages-[*]-BackgroundColor	See the table below		
	Address	Frame Page Ref.			Properties	Behavior	Variable	A variable mapped to the address		
	Frame with a Tab	Attach a Tab to the Frame		Checked		Properties	Appearance	TabHeaderVisible	Checked	
				Unchecked					Unchecked	
			Tab Height			Properties	Appearance	TabHeaderHeight	The set value multiplied by 18	
			Tab position	Top			Properties	Appearance	TabHeaderPosition	Top
				Below			Properties	Appearance	TabHeaderPosition	Bottom
Left				Properties	Appearance	TabHeaderPosition	Top			
		Right					Top			

Frame: Tab Color

CX-Designer		Sysmac Studio			
Attach a Tab to the Frame	Set Background Color	Category	Group	Property	Set Value
Unchecked	Unchecked	Properties	Appearance	BackgroundColor	Transparent
		Properties	Appearance	SelectedItemBackgroundColor	Transparent
		Properties	Behavior	TabPages-[*]-BackgroundColor	Transparent
Checked	Checked	Properties	Appearance	BackgroundColor	The same color as NS
		Properties	Appearance	SelectedItemBackgroundColor	The same color as NS
		Properties	Behavior	TabPages-[*]-BackgroundColor	The same color as NS

◆Text Attributes

Text Attributes

(1/2)

CX-Designer			Sysmac Studio					
Switch	Item	Category	Group	Property	Sub-property	Language	Set Value	
Type0	OFF	Label	Properties	Appearance	TextButtonUp (Default)	-	Language selected in CX-Designer	**
		Font Name			Font	Family	See "Text Family" sheet	
		Size			Size	See "Text Size" sheet		
		Font Style			Style	See the table "Font Style"		
		Color Setting			TextColor			
		Vertical Position			VerticalAlignment	See the table "Vertical Position"		
		Horizontal Position			HorizontalAlignment	See the table "Horizontal Position"		
		Horiz. Scale (only Scalable Gothic)			-	-		
	ON	Label			TextButtonDown (Default)	-	Language selected in CX-Designer	**
		Font Name			Font	Family	See "Text Family" sheet	
		Size			Size	See "Text Size" sheet		
		FontStyle			Style	See the table "Font Style"		
		Color Setting			TextColor			
		VerticalAlignment			VerticalAlignment	See the table "Vertical Position"		
		HorizontalAlignment			HorizontalAlignment	See the table "Horizontal Position"		
		Horiz. Scale (only Scalable Gothic)			-	-		
Type1	Same as above	Same as above	Same as above	Same as above	Language selected in CX-Designer	Same as above		
Type2	Same as above	Same as above	Same as above	Same as above	Language selected in CX-Designer	Same as above		
Type3	Same as above	Same as above	Same as above	Same as above	Language selected in CX-Designer	Same as above		
Type4	Same as above	Same as above	Same as above	Same as above	Language selected in CX-Designer	Same as above		
Type5	Same as above	Same as above	Same as above	Same as above	Language selected in CX-Designer	Same as above		
Type6	Same as above	Same as above	Same as above	Same as above	Language selected in CX-Designer	Same as above		
Type7	Same as above	Same as above	Same as above	Same as above	Language selected in CX-Designer	Same as above		
Type8	Same as above	Same as above	Same as above	Same as above	Language selected in CX-Designer	Same as above		
Type9	Same as above	Same as above	Same as above	Same as above	Language selected in CX-Designer	Same as above		
Type10	Same as above	Same as above	Same as above	Same as above	Language selected in CX-Designer	Same as above		
Type11	Same as above	Same as above	Same as above	Same as above	Language selected in CX-Designer	Same as above		
Type12	Same as above	Same as above	Same as above	Same as above	Language selected in CX-Designer	Same as above		
Type13	Same as above	Same as above	Same as above	Same as above	Language selected in CX-Designer	Same as above		
Type14	Same as above	Same as above	Same as above	Same as above	Language selected in CX-Designer	Same as above		
Type15	Same as above	Same as above	Same as above	Same as above	Language selected in CX-Designer	Same as above		

A name in [Switch] is shown in the default value. Names can be editable. The order takes preference over the name.

\*\* : Register the string of each Type# as resource texts in the default language. Then, register resources in other languages. Select the resource.

**Text Attributes**

(2/2)

**Vertical Position**

CX-Designer	Sysmac Studio
Center	Center
Up	Top
Down	Bottom

**Horizontal Position**

CX-Designer	Sysmac Studio
Center	Center
Left	Left
Right	Right

**Font Style**

CX-Designer		Sysmac Studio			
Item 1	Item 2	Category	Group	Property	Set Value
Font Style	Italic	Properties	Appearance	Font - Style	Italic
	Bold				Bold
	Italic + Bold				Bold Italic

◆Common

Frame, Flicker, Control Flag, and Size/Position

CX-Designer					Sysmac Studio					
Tab	1st Level	2nd Level	3rd Level	Set Value	Category	Group	Property	Set Value	Remarks	
Frame	Three-dimensional Frame			Checked	-	-	-	-		
				Unchecked	-	-	-	-		
		Color (Top/Left)			-	-	-	-		
		Color (Bottom/Right)			-	-	-	-		
	Draw Border	Frame Size			-	-	-	-		
		Color (Border)			-	-	-	-		
	Frame ON/OFF Display	Link with the Specified Address ON/OFF			-	-	-	-		
		Address		-	-	-	-			
Flicker	Flicker No.			(None)	-	-	-	-		
	Flicker Timing			Other than (None)	-	-	-	-		
					Always	-	-	-	-	
					When Address ON	-	-	-	-	
		Address		-	-	-	-			
Control Flag	Input			Enabled	Properties	Behavior	IsEnabled	Checked		
				Disable				Unchecked		
				Indirect	Animations	Enable				
	Address						Variable mapped to the address			
	Display				Display	Properties	Appearance	IsVisible	Checked	
					Hide				Unchecked	
				Indirect	Animations	Visibility				
Address							Variable mapped to the address			
Size/Position	Size	Width			Properties	Layout	Width	The same value as NS		
		Height			Properties	Layout	Height	The same value as NS		
	Position from the Upper Left of Screen/Frame/Table	X				Properties	Layout	Left	The same value as NS	The coordinates are to be converted to absolute coordinates when existing inside a frame or table.
		Y				Properties	Layout	Top	The same value as NS	

◆Text\_Family

Text: Font Family

Type	CX-Designer	Sysmac Studio
Embedded Font	Fine	Courier New
	Standard	Segoe UI
	Rough	Courier New
	7-segment Numeral	DF7segHMI
	Scalable Gothic	Segoe UI
	Gothic Numeral	Segoe UI
Windows Font	Arial	Arial
	Arial Black	Arial Black
	Arial Narrow	Arial Narrow
	Comic Sans MS	Comic Sans MS
	Courier New	Courier New
	DF7segHMI	DF8segHMI
	Ebrima	Ebrima
	Estrangelo Edessa	Estrangelo Edessa
	Euphemia	Euphemia
	Gautami	Gautami
	Georgia	Georgia
	Gulim	Gulim
	GulimChe	GulimChe
	Impact	Impact
	Iskoola Pota	Iskoola Pota
	Kalinga	Kalinga
	Khmer UI	Khmer UI
	Lao UI	Lao UI
	Latha	Latha
	Lucida Sans Unicode	Lucida Sans Unicode
	Malgun Gothic	Malgun Gothic
	Mangal	Mangal
	Meiryo	Meiryo
	Meiryo UI	Meiryo UI
	Microsoft Himalaya	Microsoft Himalaya
	Microsoft JhengHei	Microsoft JhengHei
	Microsoft JhengHei	Microsoft JhengHei
	Microsoft New Tai Lue	Microsoft New Tai Lue
	Microsoft PhagsPa	Microsoft PhagsPa
	Microsoft Sans Serif	Microsoft Sans Serif
	Microsoft Tai Le	Microsoft Tai Le
	Microsoft Uighur	Microsoft Uighur
Microsoft YaHei	Microsoft YaHei	
Microsoft YaHei	Microsoft YaHei	
Microsoft Yi Baiti	Microsoft Yi Baiti	
MingLiU	MingLiU	

Type	CX-Designer	Sysmac Studio
Windows Font	MingLiU_HKSCS	MingLiU_HKSCS
	MingLiU_HKSCS-ExtB	MingLiU_HKSCS-ExtB
	MingLiU-ExtB	MingLiU-ExtB
	Mongolian Baiti	Mongolian Baiti
	MS Gothic	MS Gothic
	MS Mincho	MS Mincho
	MS PGothic	MS PGothic
	MS PMincho	MS PMincho
	MS UI Gothic	MS UI Gothic
	MV Boli	MV Boli
	NSimSun	NSimSun
	Nyala	Nyala
	Plantagenet Cherokee	Plantagenet Cherokee
	PMingLiU	PMingLiU
	PMingLiU-ExtB	PMingLiU-ExtB
	Raavi	Raavi
	Segoe UI	Segoe UI
	Segoe UI Light	Segoe UI Light
	Segoe UI Semibold	Segoe UI Semibold
	Shruti	Shruti
	SimSun	SimSun
	SimSun-ExtB	SimSun-ExtB
	Sylfaen	Sylfaen
	Symbol	Symbol
	Tahoma	Tahoma
	Times New Roman	Times New Roman
	Trebuchet MS	Trebuchet MS
	Tunga	Tunga
	Verdana	Verdana
	Vrinda	Vrinda
	Webdings	Webdings
	Others than above	Segoe UI



◆ Macro

Macros for Functional Objects

Events and Actions

CX-Designer	Sysmac Studio							
Macro Execution Condition	Target	Tab	Category	Events/Actions	Set Value	Set Value		
When Display Area is Pressed	Object or shape	Events and Actions	Event	Press	-	-		
Touch ON timing			Action	CallSubroutine	Subroutine name	-		
			Event	Press	-	-		
Touch OFF timing			Action	CallSubroutine	Subroutine name	-		
			Event	Release	-	-		
Execute when ON/OFF			Action	CallSubroutine	Subroutine name	-		
			Event	Condition	Expression	[Variable mapped to the address] = True		
			Action	CallSubroutine	Subroutine name	-		
			Event	Condition	Expression	[Variable mapped to the address] = False		
Execute when ON			Action	CallSubroutine	Subroutine name	-		
			Event	Condition	Expression	[Variable mapped to the address] = True		
Execute when OFF			Action	CallSubroutine	Subroutine name	-		
			Event	Condition	Expression	[Variable mapped to the address] = False		
Before inputting numeral			-	-	-	-	-	-
Before writing numeral	-	-	-	-	-	-		
When changing value	-	-	-	-	-	-		
When an address value changed	-	-	-	-	-	-		
Value = Set Value	Page on which an object exists	Events and Actions	Event	Condition	Expression	[Variable mapped to the address] = set value		
Value != Set Value			Action	CallSubroutine	Subroutine name	-		
			Event	Condition	Expression	[Variable mapped to the address] != set value		
Value < Set Value			Action	CallSubroutine	Subroutine name	-		
			Event	Condition	Expression	[Variable mapped to the address] < set value		
Value <= Set Value			Action	CallSubroutine	Subroutine name	-		
			Event	Condition	Expression	[Variable mapped to the address] <= set value		
Value > Set Value			Action	CallSubroutine	Subroutine name	-		
			Event	Condition	Expression	[Variable mapped to the address] > set value		
Value >= Set Value			Action	CallSubroutine	Subroutine name	-		
			Event	Condition	Expression	[Variable mapped to the address] >= set value		
					Action	CallSubroutine	Subroutine name	-

### Appendix 3: Buttons

#### ◆Button\_Common

#### ON/OFF Buttons: General

#### Buttons

CX-Designer				Sysmac Studio				
Tab	1st Level	2nd Level	Set Value	Category	Group	Property	Set Value	
General	Object Comment			-	-	-	-	
	Button type			See the "ONOFF Button_Shape" sheet				
Color/Shape	Button type			See the "ONOFF Button_Shape" sheet				
Label	Label	OFF		Properties	Appearance	DefaultText (Default)	The original text set for NS	
		ON		-	-	-	-	
	Text Attribute	OFF		Refer to the "Text Attributes" sheet in "Appendix 2: Object Common Settings."				
		ON		-	-	-	-	
		Indirect Reference of Text Color	Checked	-	-	-	-	
	Switch Label for Address ON/OFF		Unchecked		Properties	Behavior	VisualFeedback	Variable
			Checked		-	-	-	-
		Checked	Link with the Write Address ON/OFF		-	-	-	-
			Link with the Display Address ON/OFF		-	-	-	-
			Link with the Specified Address ON/OFF		-	-	-	-
	Address		-	-	-	-		
	Use the String Table		Unchecked		-	-	-	-
		Checked		Properties	Appearance	DefaultText (Default)	The original text set for NS	
Write	Display Write Confirmation Dialog	Unchecked		-	-	-	-	
		Checked		-	-	-	-	
		Checked	Standard Message		-	-	-	-
			Use Specified Message		-	-	-	-
		Message		-	-	-	-	
	Record to Operation Log	Unchecked		Properties	Security	Operation Log	Unchecked	
		Checked		Properties	Security	Operation Log	Checked	
Message		-	-	-	-			
Group	Group Setting			-	-	-	-	
Other	Key Press Sound Control	Do not allow sound for this object		-	-	-	-	

◆ON/OFF Button

ON/OFF Button: General

Button

CX-Designer					Sysmac Studio				
Tab	1st Level	2nd Level	3rd Level	Set Value	Category	Group	Property	Set Value	Remarks
General	Action Type			Momentary	Properties	General	Behavior	MomentaryButton	
General	Action Type			Alternate	Properties			ToggleButton	
General	Action Type			SET	Properties			SetButton	
General	Action Type			RESET	Properties			ResetButton	
General	Address	Write Address			See the "ONOFF Button_Shape" sheet				
General	Address	Display Address1			See the "ONOFF Button_Shape" sheet				
General	Address	Display Address2			See the "ONOFF Button_Shape" sheet				
Group	Group Setting				-	-	-	-	

◆Word Button

Word Button

Button

CX-Designer					Sysmac Studio				
Tab	1st Level	2nd Level	3rd Level	Set Value	Category	Group	Property	Set Value	
General	Object comment				-	-	-	-	
	Numeral Type				-	-	-	-	
	Button Shape			Rectangle	Properties	Appearance	Design	Rectangle	
				Select Shape	Properties	Appearance	Design	Image	
	Action Type			Set Value	See the "Word Button_Shape" sheet				
				Increment/Decrement					
Display Pop-up Menu									
Address	Write Address								
Max/Min	Maximum Limit			Value	-	-	-	-	
				Indirect Reference	-	-	-	-	
				Address	-	-	-	-	
				Return to the Minimum Value when the Maximum vale is Exceeded					
	Minimum Limit				Value	-	-	-	-
					Indirect Reference	-	-	-	-
					Address	-	-	-	-
Return to the Maximum Value when the Minimum vale is Exceeded									

◆ Command Button

Command Button

Button

CX-Designer					Sysmac Studio			
Tab	1st Level	2nd Level	3rd Level	Set Value	Category	Group	Property	Set Value
General	Function				See the "Command Button_Function" sheet			
	Button Shape			Rectangle	Properties	Appearance	Design	Rectangle
				Circle	Properties	Appearance	Design	Ellipse
Select Shape				Properties	Appearance	Design	Image	
Color/Shape					See the "Command Button_Shape" sheet			

◆ Multifunction

Multifunction Objects

No Dedicated Objects: Assign Action and Event to a button or lamp object

(1/2)

CX-Designer				Sysmac Studio			
Tab	1st Level	2nd Level	Set Value	Category	Group	Property	Set Value
General				Events and Actions	-	-	See the "Multifunction_Function" sheet
	Perform an action when pressing the object		Checked	Properties	Behavior	IsEnabled	Checked
			Unchecked	Properties	Behavior	IsEnabled	Unchecked
	Double Press		Checked	-	-	-	-
			Unchecked	Properties	Behavior	DoubleTouchTime	0
		Reception start time		-	-	-	-
		Reception closing time		Properties	Behavior	DoubleTouchTime	Value converted to the time unit of ms
	ON-delay		Checked	-	-	-	-
			Unchecked	Properties	Behavior	OnDelayTime	0
		Set Time		Properties	Behavior	OnDelayTime	Value converted to the time unit of ms
	OFF-delay		Checked	-	-	-	-
			Unchecked	Properties	Behavior	OffDelayTime	0
		Set Time		Properties	Behavior	OffDelayTime	Value converted to the time unit of ms
	Input		Disable input	Properties	Behavior	IsEnabled	Unchecked
			Enable input	Properties	Behavior	IsEnabled	Checked
			Enable Input When Indirect Address ON	Animations	Enable	Expression	[Variable mapped to the indirect reference address] = True
			Enable Input When Indirect Address OFF	Animations	Enable	Expression	[Variable mapped to the indirect reference address] = False
		Indirect Reference		-	-	-	-
	Prohibiting simultaneous pressing		Checked	-	-	-	-
			Unchecked	-	-	-	-
	Record to operation log		Checked	Properties	Security	Operation Log	Checked
			Unchecked	Properties	Security	Operation Log	Unchecked
		Message		-	-	-	-
	Do not allow sound for this object		Checked	-	-	-	-
			Unchecked	-	-	-	-
	Group Setting		None	-	-	-	-
			Group 1	-	-	-	-
		Group 2	-	-	-	-	
		Group 3	-	-	-	-	
		Group 4	-	-	-	-	
		Group 5	-	-	-	-	
		Group 6	-	-	-	-	
		Group 7	-	-	-	-	
		Group 8	-	-	-	-	
		Group 9	-	-	-	-	
		Group 10	-	-	-	-	
		Group 11	-	-	-	-	
		Group 12	-	-	-	-	
	Group 13	-	-	-	-		

**Multifunction Objects**

**No Dedicated Objects: Assign Action and Event to a button or lamp object**

(2/2)

CX-Designer				Sysmac Studio			
Tab	1st Level	2nd Level	Set Value	Category	Group	Property	Set Value
General	Group Specification		Group 14	-	-	-	-
			Group 15	-	-	-	-
			Group 16	-	-	-	-
	When a value changed		Checked	-	-	-	-
			Unchecked	-	-	-	-
Expansion Setting	Wait for completion of communication (Synchronous communication)		Unchecked	-	-	-	-
			Checked				
	Continue the operation even when an error occurs	Checked/ Unchecked	-	-	-	-	

◆ONOFF Button\_Shape

ON/OFF Button Type Conversion Table

Button

CX-Designer				Sysmac Studio			
Button Types	Tab	1st Level	2nd Level	Category	Property	Set Value	
Rectangle (Type 1)				Appearance	Design	Rectangle	
				Behavior	VisualFeedback	Variable (Button)	
	General	Write Address	Display Address1	Display Address2	Behavior	Variable	Variable
					-	-	-
					-	-	-
	Color/Shape	OFF color	Color	Indirect reference of color	Appearance	BackgroundColorButtonUp	The same color as NS
					-	-	-
		ON color	Color	Indirect reference of color	Appearance	BackgroundColorButtonDown	The same color as NS
-					-	-	
Rectangle (Type 2-1)				Appearance	Design	Rectangle	
				Behavior	VisualFeedback	Feedback (Button)	
	General	Write Address	Display Address1	Display Address2	Behavior	Variable	Variable
					Behavior	FeedbackExpression	Variable
					-	-	-
	Color/Shape	OFF color	Color	Indirect reference of color	Appearance	BackgroundColorButtonUp	The same color as NS
					-	-	-
		ON color	Color	Indirect reference of color	Appearance	BackgroundColorButtonDown	The same color as NS
-					-	-	
Rectangle (Type 2-2)				Appearance	Design	Rectangle	
				Behavior	VisualFeedback	Touch (Button) + Feedback (Button)	
	General	Write Address	Display Address1	Display Address2	Behavior	Variable	Variable
					Behavior	FeedbackExpression	Variable
					-	-	-
	Color/Shape	OFF color	Color	Indirect reference of color	Appearance	BackgroundColorButtonUp	The same color as NS
					-	-	-
		ON color	Color	Indirect reference of color	Appearance	BackgroundColorButtonDown	The same color as NS
-					-	-	



ON/OFF Button Type Conversion Table

Button

(2/6)

CX-Designer				Sysmac Studio			
Button Types	Tab	1st Level	2nd Level	Category	Property	Set Value	
Rectangle (Type 3)				Appearance	Design	Rectangle	
				Behavior	VisualFeedback	Touch (Button) + Feedback (Button)	
	General	Write Address			Behavior	Variable	Variable
		Display Address1			Behavior	FeedbackExpression	Variable
		Display Address2			-	-	-
	Color/Shape	Display Address1 (OFF) Display Address2 (OFF)	Color	Appearance	BackgroundColorButtonUp	The same color as NS	
			Indirect reference of color	-	-	-	
		Display Address1 (ON) Display Address2 (OFF)	Color	Appearance	BackgroundColorButtonDown	The same color as NS	
			Indirect reference of color	-	-	-	
		Display Address1 (OFF) Display Address2 (ON)	Color	-	-	-	
			Indirect reference of color	-	-	-	
	Display Address1 (ON) Display Address2 (ON)	Color	-	-	-		
Indirect reference of color		-	-	-			
Circle (Type 1)				Appearance	Design	Ellipse	
				Behavior	VisualFeedback	Variable (Button)	
	General	Write Address			Behavior	Variable	Variable
		Display Address1			-	-	-
		Display Address2			-	-	-
	Color/Shape	OFF color	Color	Appearance	BackgroundColorButtonUp	The same color as NS	
			Indirect reference of color	-	-	-	
		ON color	Color	Appearance	BackgroundColorButtonDown	The same color as NS	
Indirect reference of color			-	-	-		
Circle (Type 2-1)				Appearance	Design	Rectangle	
				Behavior	VisualFeedback	Feedback (Button)	
	General	Write Address			Behavior	Variable	Variable
		Display Address1			Behavior	FeedbackExpression	Variable
		Display Address2			-	-	-
	Color/Shape	OFF color	Color	Appearance	BackgroundColorButtonUp	The same color as NS	
			Indirect reference of color	-	-	-	

ON/OFF Button Type Conversion Table

Button

CX-Designer				Sysmac Studio		
Button Types	Tab	1st Level	2nd Level	Category	Property	Set Value
Circle (Type 2-1)	Color/Shape	ON color	Color	Appearance	BackgroundColorButtonDown	The same color as NS
			Indirect reference of	-	-	-
Circle (Type 2-2)	General	Write Address		Appearance	Design	Rectangle
				Behavior	VisualFeedback	Touch (Button) + Feedback (Button)
			Display Address1	Behavior	Variable	Variable
			Display Address2	-	-	-
	Color/Shape	OFF color	Color	Appearance	BackgroundColorButtonUp	The same color as NS
			Indirect reference of color	-	-	-
		ON color	Color	Appearance	BackgroundColorButtonDown	The same color as NS
			Indirect reference of color	-	-	-
Circle (Type 3)	General	Write Address		Appearance	Design	Rectangle
				Behavior	VisualFeedback	Touch (Button) + Feedback (Button)
				Behavior	Variable	Variable
	Color/Shape	Display Address1 (OFF) Display Address2 (OFF)	Color	Appearance	BackgroundColorButtonUp	The same color as NS
			Indirect reference of color	-	-	-
			Color	Appearance	BackgroundColorButtonDown	The same color as NS
	Color/Shape	Display Address1 (ON) Display Address2 (OFF)	Color	Appearance	BackgroundColorButtonDown	The same color as NS
			Indirect reference of color	-	-	-
			Color	-	-	-
	Color/Shape	Display Address1 (OFF) Display Address2 (ON)	Color	-	-	-
			Indirect reference of color	-	-	-
			Color	-	-	-
Color/Shape	Display Address1 (ON) Display Address2 (ON)	Color	-	-	-	
		Indirect reference of color	-	-	-	
		Color	-	-	-	
Rectangle 2 Light (Type1)	General	Write Address		Appearance	Design	Rectangle
				Behavior	VisualFeedback	Variable (Button) + Feedback (Indicator)
				Behavior	IndicatorPosition	Bottom
	General	Display Address1		Behavior	Variable	Variable
			Display Address2	-	-	-

ON/OFF Button Type Conversion Table

Button

CX-Designer				Sysmac Studio			
Button Types	Tab	1st Level	2nd Level	Category	Property	Set Value	
Rectangle 2 Light (Type1)	Color/Shape	OFF color	Color	Appearance	IndicatorColorOff	The same color as NS	
			Indirect reference of color	-	-	-	
		ON color	Color	Appearance	IndicatorColorOn	The same color as NS	
			Indirect reference of color	-	-	-	
		OFF color	Color	Behavior	BackgroundColorButtonUp	The same color as NS	
			Indirect reference of color	-	-	-	
		ON color	Color	Behavior	BackgroundColorButtonDown	The same color as NS	
			Indirect reference of color	-	-	-	
Rectangle2Light(Type2)				Appearance	Design	Rectangle	
				Behavior	VisualFeedback	Touch (Button) + Feedback (Indicator)	
				Behavior	IndicatorPosition	Bottom	
	General	Write Address	Display Address1	Display Address2	Behavior	Variable	Variable
					Behavior	FeedbackExpression	Variable
					-	-	-
	Color/Shape	OFF color	Color	Indirect reference of color	Appearance	IndicatorColorOff	The same color as NS
					-	-	-
		ON color	Color	Indirect reference of color	Appearance	IndicatorColorOn	The same color as NS
					-	-	-
		OFF color	Color	Indirect reference of color	Behavior	BackgroundColorButtonUp	The same color as NS
					-	-	-
ON color	Color	Indirect reference of color	Behavior	BackgroundColorButtonDown	The same color as NS		
			-	-	-		
Rectangle 2 Light (Type3)				Appearance	Design	Rectangle	
				Behavior	VisualFeedback	Variable (Button) + Feedback (Indicator)	
				Behavior	IndicatorPosition	Top Left	
	General	Write Address	Display Address1	Display Address2	Behavior	Variable	Variable
					Behavior	FeedbackExpression	Variable
					-	-	-
					-	-	-

ON/OFF Button Type Conversion Table

Button

CX-Designer				Sysmac Studio			
Button Types	Tab	1st Level	2nd Level	Category	Property	Set Value	
Rectangle 2 Light (Type3)	Color/Shape	OFF color	Color	Appearance	IndicatorColorOff	The same color as NS	
			Indirect reference of color	-	-	-	
		ON color	Color	Appearance	IndicatorColorOn	The same color as NS	
			Indirect reference of color	-	-	-	
		OFF color	Color	Behavior	BackgroundColorButtonUp	The same color as NS	
			Indirect reference of color	-	-	-	
		ON color	Color	Behavior	BackgroundColorButtonDown	The same color as NS	
			Indirect reference of color	-	-	-	
Rectangle 2 Light (Type4)				Appearance	Design	Rectangle	
				Behavior	VisualFeedback	Touch (Button) + Feedback(Indicator)	
				Behavior	IndicatorPosition	Top Left	
	General	Write Address	Display Address1	Display Address2	Behavior	Variable	Variable
					Behavior	FeedbackExpression	Variable
					-	-	-
	Color/Shape	OFF color	Color	Indirect reference of color	Appearance	IndicatorColorOff	The same color as NS
					-	-	-
		ON color	Color	Indirect reference of color	Appearance	IndicatorColorOn	The same color as NS
					-	-	-
		OFF color	Color	Indirect reference of color	Behavior	BackgroundColorButtonUp	The same color as NS
					-	-	-
ON color		Color	Indirect reference of color	Behavior	BackgroundColorButtonDown	The same color as NS	
				-	-	-	
Select Shape (Type 1)				Appearance	Design	Image	
				Behavior	VisualFeedback	Variable (Button)	
				Behavior	Variable	Variable	
	General	Write Address	Display Address1	Display Address2	-	-	-
					-	-	-
					-	-	-
	Color/Shape	On shape	Shape Shape1	Appearance	ImageFileButtonDown	Image registered as resource	
		On shape	Shape Shape2	Appearance	ImageFileButtonUp	Image registered as resource	

ON/OFF Button Type Conversion Table

Buttons

CX-Designer				Sysmac Studio		
Button Types	Tab	1st Level	2nd Level	Category	Property	Set Value
Select Shape (Type 2-1)				Appearance	Design	Image
	General	Write Address		Behavior	VisualFeedback	Variable (Button)
		Display Address1		-	-	-
		Display Address2		-	-	-
	Color/Shape	On shape	Shape Shape1	Appearance	ImageFileButtonDown	Image registered as resource
		On shape	Shape Shape2	Appearance	ImageFileButtonUp	Image registered as resource
Select Shape (Type 2-2)				Appearance	Design	Image
	General	Write Address		Behavior	VisualFeedback	Touch (Button) + Feedback (Button)
		Display Address1		Behavior	Variable	Variable
		Display Address2		-	-	-
	Color/Shape	On shape	Shape Shape1	Appearance	ImageFileButtonDown	Image registered as resource
		On shape	Shape Shape2	Appearance	ImageFileButtonUp	Image registered as resource
Select Shape (Type 3)				Appearance	Design	Rectangle
	General	Write Address		Behavior	VisualFeedback	Touch (Button) + Feedback (Button)
		Display Address1		Behavior	Variable	Variable
		Display Address2		-	-	-
	Color/Shape	Display Address1 (ON) Display Address2 (OFF)	Shape Shape1	Appearance	ImageFileButtonDown	Image registered as resource
		Display Address1 (OFF) Display Address2 (OFF)	Shape Shape2	Appearance	ImageFileButtonUp	Image registered as resource
		Display Address1 (ON) Display Address2 (ON)	Shape Shape3	-	-	-
		Display Address1 (OFF) Display Address2 (ON)	Shape Shape4	-	-	-
					-	-

◆Word Button\_Shape

Word Button: Shape

Button

(1/2)

CX-Designer					Sysmac Studio								
Button Shape	Action	Tab	1st Level	2nd Level	Category	Property	Set Value	Remarks					
Rectangle	Set Value				Behavior	VisualFeedback	Variable (Button) + Feedback (Indicator)						
						IndicatorPosition	Custom						
						IndicatorLeft	1						
						IndicatorTop	1						
						IndicatorWidth	Width - 2						
						IndicatorHeight	Height - 2						
		General	Action Type	Set Value		Indirect	Properties	FeedbackExpression	Variable mapped to Write Address =Set value				
							Events and Actions	Click>SetVariable>Value	The original value				
			Address	Write Address			Properties	FeedbackExpression	Variable mapped to Write Address = Variable mapped to the set address				
							Events and Actions	Click>SetVariable>Value	Variable mapped to the set address				
		Color/Shape	Normal Color				Appearance	BackgroundColorButtonUp	The same color as NS				
	Behavior						IndicatorColorOff	The same color as NS					
	Indirect reference				Address	-	-	-	No corresponding function				
						-	-	-	No corresponding function				
	Increment/Decrement	General				Behavior	VisualFeedback	Touch ( Button)					
						Button Actions	Value	Events and Actions	Click>IncreaseVariable>Value	The original value			
							Indirect	Events and Actions	Click>IncreaseVariable>Value	Variable mapped to the set address			
						Address	Write Address			Events and Actions	Click>IncreaseVariable>Variable	Variable mapped to Write Address	
										Appearance	BackgroundColorButtonUp	The same color as NS	
						Indirect reference			Address	-	-	-	No corresponding function
		-	-	-	No corresponding function								
		Color when Pressed					Appearance	BackgroundColorButtonDown	The same color as NS				
							-	-	-	No corresponding function			
Display Pop-up Menu						-	-	-	No corresponding function				

Word Buttons: Shape

Button

(2/2)

CX-Designer					Sysmac Studio					
Button Shape	Button Actions	Tab	1st Level	2nd Level	Category	Property	Set Value	Remarks		
Select Shape	Set Value				Behavior	VisualFeedback	Variable (Button) + Feedback (Indicator)			
						IndicatorPosition	Custom			
						IndicatorLeft	1			
						IndicatorTop	1			
						IndicatorWidth	Width - 2			
				General	Button Actions	Set Value	Properties	FeedbackExpression	[Variable mapped to Write Address] = [Set value]	
						Indirect	Events and Actions	Click>SetVariable>Value	The original value	
							Properties	FeedbackExpression	Variable mapped to Write Address = Variable mapped to the set address	
							Events and Actions	Click>SetVariable>Value	Variable mapped to the set address	
					Address	Write Address	Events and Actions	Click>SetVariable>Variable	Variable mapped to Write Address	
		Color/Shape	Normal shape			Appearance	ImageFileButtonUp	Image registered as resource		
			Same as value			-	-	-		
	Increment/ Decrement	General		Button Actions	Value	Events and Actions	Click>IncreaseVariable>Value	The original value		
					Indirect	Events and Actions	Click>IncreaseVariable>Value	Variable mapped to the set address		
					Address	Write Address	Events and Actions	Click>IncreaseVariable>Variable	Variable mapped to Write Address	
Color/Shape					Normal shape		Appearance	ImageFileButtonUp	Image registered as resource	
		Pressed		Appearance	ImageFileButtonDown	Image registered as resource				
Display Pop-up Menu						-	-	-	No corresponding function	

◆Command Button\_Shape

Multifunction: Select Shape

Button

(1/8)

CX-Designer					Sysmac Studio					
Shape	Display Method	Tab	1st Level	Set Value	Category	Group	Property	Set Value		
Select Shape					Properties	Appearance	Design	Image		
	Normal shape				Properties	Behavior	VisualFeedback	Touch ( Button)		
		Display Address1			-	-	-	-		
		Display Address2			-	-	-	-		
		Normal shape			Properties	Appearance	ImageFileButtonUp	The same image file		
				Properties	Appearance	ImageFileButtonDown				
	When Pressed					Properties	Behavior	VisualFeedback	Touch ( Button)	
		Display Address1			-	-	-	-		
		Display Address2			-	-	-	-		
		Normal Shape			Properties	Appearance	ImageFileButtonUp	Image file that has been set for NS		
	Shape when pressed					Properties	Appearance	ImageFileButtonDown	Image file that has been set for NS	
		Bit Address				Properties	Behavior	VisualFeedback	Feedback (Button)	
		Display Address1			Properties	Behavior	FeedbackExpression	Variable		
		Display Address2			-	-	-	-		
	OFF shape					Properties	Appearance	ImageFileButtonUp	Image file that has been set for NS	
		ON shape				Properties	Appearance	ImageFileButtonDown	Image file that has been set for NS	
		Bit Address/ When Pressed					Properties	Behavior	VisualFeedback	Touch (Button) + Feedback (Button)
			Display Address1			Properties	Behavior	FeedbackExpression	Variable	
	Display Address2				-	-	-	-		
	OFF shape				Properties	Appearance	ImageFileButtonUp	Image file that has been set for NS		
	ON shape					Properties	Appearance	ImageFileButtonDown	Image file that has been set for NS	
		Same Value				Properties	Behavior	VisualFeedback	Feedback (Button)	
			Display Address1			Properties	Behavior	FeedbackExpression	Enter in the Direct Reference or Indirect Reference box.	
			Display Address2			-	-	-	-	
	Set Value		Storage Format		-	-	-	-		
			Direct Reference		Properties	Behavior	FeedbackExpression	Variable mapped to Display Address = Direct Reference value		
			Indirect Reference		Properties	Behavior	FeedbackExpression	Variable mapped to Display Address = Indirect Reference value		
	Normal shape				Properties	Appearance	ImageFileButtonUp	Image file that has been set for NS		
	Same as Value				Properties	Appearance	ImageFileButtonDown	Image file that has been set for NS		
	Bit Address 1, 2 (4 shapes)					Properties	Behavior	VisualFeedback	Feedback (Button)	
		Display Address1			Properties	Behavior	FeedbackExpression	Variable		
		Display Address2			-	-	-	-		
Display Address1 (OFF) Display Address2 (OFF) Shape				Properties	Appearance	ImageFileButtonUp	Image file that has been set for NS			
Display Address1 (ON) Display Address2 (OFF) Shape				Properties	Appearance	ImageFileButtonDown	Image file that has been set for NS			



Multifunction: Select Shape

Button

		CX-Designer			Sysmac Studio				
Shape	Display Method	Tab	1st Level	Set Value	Category	Group	Property	Set Value	
Select Shape	Bit Address 1, 2 (4 shapes)	Display Address1 (OFF) Display Address2 (ON) Shape			-	-	-	-	
		Display Address1 (ON) Display Address2 (ON) Shape			-	-	-	-	
Select Shape	Word Address (16 shapes)				Properties	Behavior	VisualFeedback	Feedback (Button)	
		Display Address1			Properties	Behavior	FeedbackExpression	Variable	
		Shape1 (Value0)				-	-	-	-
		Shape2 (Value1)			Properties	Appearance	ImageFileButtonUp	Image file that has been set for NS	
		Shape3 (Value2)			Properties	Appearance	ImageFileButtonDown	Image file that has been set for NS	
		Shape4 (Value3)				-	-	-	-
		Shape5 (Value4)				-	-	-	-
		Shape6 (Value5)				-	-	-	-
		Shape7 (Value6)				-	-	-	-
		Shape8 (Value7)				-	-	-	-
		Shape9 (Value8)				-	-	-	-
		Shape10 (Value9)				-	-	-	-
		Shape11 (Value10)				-	-	-	-
		Shape12 (Value11)				-	-	-	-
		Shape13 (Value12)				-	-	-	-
		Shape14 (Value13)				-	-	-	-
		Shape15 (Value14)				-	-	-	-
Shape16 (Value15)				-	-	-	-		
Single-lined Circle Double-lined Circle Sector					Properties	Appearance	Design	Ellipse	
Single-lined Rectangle Double-lined Rectangle Polygon					Properties	Appearance	Design	Rectangle	
Single-lined Circle Double-lined Circle Single-lined Rectangle Double-lined Rectangle Polygon Sector	Normal Color				Properties	Behavior	VisualFeedback	Touch ( Button)	
		Display Address1			-	-	-	-	
		Display Address2				-	-	-	-
		No Tiling		Checked	Properties	Appearance	BackgroundColorButtonUp	Transparent	
				Unchecked	Properties	Appearance	BackgroundColorButtonDown	Transparent	
		Normal Color			Properties	Appearance	BackgroundColorButtonUp	The same color as NS	
		Indirect reference of color			Properties	Appearance	BackgroundColorButtonDown	-	

Multifunction: Select Shape

Button

		CX-Designer			Sysmac Studio				
Shape	Display Method	Tab	1st Level	Set Value	Category	Group	Property	Set Value	
Single-lined Circle Double-line Circle Single-lined Rectangle Double-line Rectangle Polygon Sector	When Pressed				Properties	Behavior	VisualFeedback	Touch ( Button)	
		Display Address1			-	-	-	-	
		Display Address2				-	-	-	-
		No Tiling		Checked		Properties	Appearance	BackgroundColorButtonUp	Transparent
				Unchecked		Properties	Appearance	BackgroundColorButtonDown	Transparent
		Normal Color				Properties	Appearance	BackgroundColorButtonUp	The same color as NS
				Indirect reference of color		-	-	-	-
		Color when Pressed				Properties	Appearance	BackgroundColorButtonDown	The same color as NS
				Indirect reference of color		-	-	-	-
		Bit Address					Properties	Behavior	VisualFeedback
	Display Address1					Properties	Behavior	FeedbackExpression	Variable
	Display Address2					-	-	-	-
	No Tiling			Checked		Properties	Appearance	BackgroundColorButtonUp	Transparent
				Unchecked		Properties	Appearance	BackgroundColorButtonDown	Transparent
	OFF color					Properties	Appearance	BackgroundColorButtonUp	The same color as NS
				Indirect reference of color		-	-	-	-
	ON color					Properties	Appearance	BackgroundColorButtonDown	The same color as NS
			Indirect reference of color		-	-	-	-	
	Bit Address/ When Pressed					Properties	Behavior	VisualFeedback	Touch (Button) + Feedback (Button)
		Display Address1				Properties	Behavior	FeedbackExpression	Variable
		Display Address2				-	-	-	-
		No Tiling		Checked		Properties	Appearance	BackgroundColorButtonUp	Transparent
				Unchecked		Properties	Appearance	BackgroundColorButtonDown	Transparent
		OFF color				Properties	Appearance	BackgroundColorButtonUp	The same color as NS
			Indirect reference of color		-	-	-	-	
ON color					Properties	Appearance	BackgroundColorButtonDown	The same color as NS	
		Indirect reference of color		-	-	-	-		

Multifunction: Select Shape

Button

CX-Designer					Sysmac Studio				
Shape	Display Method	Tab	1st Level	Set Value	Category	Group	Property	Set Value	
Single-lined Circle Double-line Circle	Same Value				Properties	Behavior	VisualFeedback	Feedback (Button)	
		Display Address1			Properties	Behavior	FeedbackExpression	Enter in the Direct Reference or Indirect Reference box.	
Single-lined Rectangle Double-line Rectangle Polygon Sector	Same Value	Display Address2			-	-	-	-	
		No Tiling		Checked	Properties	Appearance	BackgroundColorButtonUp	Transparent	
				Unchecked	Properties	Appearance	BackgroundColorButtonDown	Transparent	
					-	-	-	-	
		Set Value	Storage Format			-	-	-	-
			Direct Reference			Properties	Behavior	FeedbackExpression	Variable mapped to Display Address = Direct Reference value
			Indirect Reference			Properties	Behavior	FeedbackExpression	Variable mapped to Display Address = Indirect Reference value
		Normal Color				Properties	Appearance	BackgroundColorButtonUp	The same color as NS
			Indirect reference of color			-	-	-	-
		Same as				Properties	Appearance	BackgroundColorButtonDown	The same color as NS
			Indirect reference of color			-	-	-	-
						Properties	Behavior	VisualFeedback	Feedback (Button)
						Properties	Behavior	FeedbackExpression	Variable
						-	-	-	-
				Checked	Properties	Appearance	BackgroundColorButtonUp	Transparent	
				Unchecked	Properties	Appearance	BackgroundColorButtonDown	Transparent	
					-	-	-	-	
				Display Address1 (OFF)	Properties	Appearance	BackgroundColorButtonUp	The same color as NS	
				Indirect reference of color	-	-	-	-	
				Display Address1 (ON)	Properties	Appearance	BackgroundColorButtonDown	The same color as NS	
				Indirect reference of color	-	-	-	-	
				Display Address1 (OFF)	-	-	-	-	
				Indirect reference of color	-	-	-	-	
				Display Address1 (ON)	-	-	-	-	
				Indirect reference of color	-	-	-	-	

Multifunction: Select Shape

Button

		CX-Designer			Sysmac Studio				
Shape	Display Method	Tab	1st Level	Set Value	Category	Group	Property	Set Value	
Single-lined Circle	Word Address (16 shapes)				Properties	Behavior	VisualFeedback	Feedback (Button)	
Double-line Circle		Display Address1			Properties	Behavior	FeedbackExpression	Variable	
Single-lined Rectangle		Display Address2			-	-	-	-	
Double-line Rectangle		No Tiling			Checked	Properties	Appearance	BackgroundColorButtonUp	Transparent
Polygon					Unchecked	Properties	Appearance	BackgroundColorButtonDown	Transparent
Sector						-	-	-	-
		Color1 (Value0)				Properties	Appearance	BackgroundColorButtonUp	The same color as NS
			Indirect reference of color			-	-	-	-
		Color2 (Value1)				Properties	Appearance	BackgroundColorButtonDown	The same color as NS
			Indirect reference of color			-	-	-	-
		Color3 (Value2)				-	-	-	-
			Indirect reference of color			-	-	-	-
		Color4 (Value3)				-	-	-	-
			Indirect reference of color			-	-	-	-
		Color5 (Value4)				-	-	-	-
			Indirect reference of color			-	-	-	-
	Color6 (Value5)				-	-	-	-	
		Indirect reference of color			-	-	-	-	
	Color7 (Value6)				-	-	-	-	
		Indirect reference of color			-	-	-	-	
	Color8 (Value7)				-	-	-	-	
		Indirect reference of color			-	-	-	-	
	Color9 (Value8)				-	-	-	-	
		Indirect reference of color			-	-	-	-	
	Color10 (Value9)				-	-	-	-	
		Indirect reference of color			-	-	-	-	

Multifunction: Select Shape

Button

(6/8)

		CX-Designer			Sysmac Studio					
Shape	Display Method	Tab	1st Level	Set Value	Category	Group	Property	Set Value		
Single-lined Circle Double-lined Circle Single-lined Rectangle Double-lined Rectangle Polygon Sector	Word Address (16 shapes)	Color11 (Value10)			-	-	-	-		
			Indirect reference of color		-	-	-	-		
		Color12 (Value11)			-	-	-	-		
			Indirect reference of color		-	-	-	-		
		Color13 (Value12)			-	-	-	-		
			Indirect reference of color		-	-	-	-		
		Color14 (Value13)			-	-	-	-		
			Indirect reference of color		-	-	-	-		
Rectangle 2 Light	Bit Address 1, 2 (Upper/Lower)				Properties	Appearance	Design	Rectangle		
					Properties	Behavior	VisualFeedback	Touch (Button) + Feedback (Indicator)		
					Properties	Behavior	IndicatorPosition	Bottom		
		Display Address1			-	-	-	-		
		Display Address2			-	-	-	-		
		No Tiling				Checked	Properties	Appearance	BackgroundColorButtonUp	Transparent
							Properties	Appearance	BackgroundColorButtonDown	Transparent
							Properties	Appearance	IndicatorColorOff	Transparent
							Properties	Appearance	IndicatorColorOn	Transparent
			Unchecked		-	-	-	-		
		OFF color	Color				Properties	Appearance	IndicatorColorOff	The same color as NS
								-	-	-
		Upper ON color	Color				Properties	Appearance	IndicatorColorOn	The same color as NS
								-	-	-
Lower OFF color	Color				Properties	Behavior	BackgroundColorButtonUp	The same color as NS		
						-	-	-	-	

Multifunction: Select Shape

Button

CX-Designer					Sysmac Studio			
Shape	Display Method	Tab	1st Level	Set Value	Category	Group	Property	Set Value
Rectangle 2 Light	Bit Address 1, 2 (Upper/Lower)	Lower ON color	Color		Properties	Behavior	BackgroundColorButtonDown	The same color as NS
			Indirect reference of color		-	-	-	-
Rectangle 2 Light	Bit Address 1, 2 (Circle/Whole)				Properties	Appearance	Design	Rectangle
					Properties	Behavior	VisualFeedback	Touch (Button) + Feedback (Indicator)
					Properties	Behavior	IndicatorPosition	Top Left
			Display Address1		-	-	-	-
			Display Address2		-	-	-	-
			No Tiling	Checked	Properties	Appearance	BackgroundColorButtonUp	Transparent
					Properties	Appearance	BackgroundColorButtonDown	Transparent
					Properties	Appearance	IndicatorColorOff	Transparent
					Properties	Appearance	IndicatorColorOn	Transparent
				Unchecked	-	-	-	-
			OFF color inside the circle	Color	Properties	Appearance	IndicatorColorOff	The same color as NS
				Indirect reference of color	-	-	-	-
			ON color inside the circle	Color	Properties	Appearance	IndicatorColorOn	The same color as NS
				Indirect reference of color	-	-	-	-
OFF color for the whole button	Color	Properties	Behavior	BackgroundColorButtonUp	The same color as NS			
	Indirect reference of color	-	-	-	-			
ON color for the whole button	Color	Properties	Behavior	BackgroundColorButtonDown	The same color as NS			
	Indirect reference of color	-	-	-	-			
Select Shape Single-lined Circle Double-lined Circle Single-lined Rectangle Double-line Rectangle Rectangle 2 Light Rectangle 2 Light	Object frame	Three-dimensional Frame		Checked	-	-	-	-
				Unchecked	Properties	Appearance	BorderThickness	0
			Color (Left/Top)		Properties	Appearance	BorderColorButtonUp	The same color as NS
			Color (Right/Bottom)		-	-	-	-
		Draw Border	Frame Size	Properties	Appearance	BorderThickness	The same value as NS	
			Color (Border)	-	-	-	-	
		Frame ON/OFF Display	Link with the Specified Address ON/OFF	-	-	-	-	
			Address	-	-	-	-	

Multifunction: Select Shape

Button

CX-Designer					Sysmac Studio					
Shape	Display Method	Tab	1st Level	Set Value	Category	Group	Property	Set Value		
Select Shape Single-lined Circle Double-lined Circle Single-lined Rectangle Double-lined Rectangle Rectangle 2 Light (Upper/Lower) Rectangle 2 Light (Circle/Whole)	Frame	Draw Border			-	-	-	-		
			Color (Border)		-	-	-	-		
Polygon Sector	Line	No Line		Checked	-	-	-	-		
				Unchecked	Properties	Appearance	BorderThickness	0		
		Color			Properties	Appearance	BorderColorButtonUp	The same color as NS		
						Appearance	BorderColorButtonDown	The same color as NS		
		Style	Thickness			-	-	-	-	
				Line Style	Solid Line	-	-	-	-	
				Dotted Line	-	-	-	-		
				Broken Line	-	-	-	-		
				DashDot	-	-	-	-		
				DashDotDot	-	-	-	-		
		Shade	Shade			Checked	-	-	-	-
						Unchecked	-	-	-	-
			Shade	Color			-	-	-	-
Depth					-	-	-	-		
Color when Pressed	Direction		Top Left			-	-	-	-	
			Top Right			-	-	-	-	
			BottomLeft			-	-	-	-	
		BottomRight			-	-	-	-		
Sector	Angle	Start Point			-	-	-	-		
		End Point			-	-	-	-		

◆Command Button\_Function

Command Button: Function

CX-Designer				Sysmac Studio				
Function	1st Level	2nd Level	2nd Level		Category	Property	Set Value	
Switch Screen	Specified Screen			Events and Actions	ShowPage	Page name	Screen title	
	Indirect Specification of Screen No.			Events and Actions	SetVariable	Variable	_HMI_Current_PageIndex	
		Address		Events and Actions	SetVariable	Value	Variable mapped to the address	
	Selection by Pop-up Menu			-	-	-	-	
	Backward			Events and Actions	ShowPreviousPage	-	-	
	Forward			-	-	-	-	
	Write Screen No. when Pressing the button		Checked	Events and Actions	SetVariable	Variable	Variable mapped to the address	
			Unchecked		-	-	-	-
	Address		Events and Actions	SetVariable	Value	_HMI_Current_PageIndex		
Key Button	Transmit to	Input field with focus		-	-	-	-	
		Specified input field		-	-	-	-	
	Transmit Type		Object ID		-	-	-	-
		Label string		-	-	-	-	
		Control code		-	-	-	-	
		Specified string		-	-	-	-	
			String		-	-	-	-
		Indirectly specification of string		-	-	-	-	-
	Transmit from		-	-	-	-		
	No. of Words		-	-	-	-		
Control Pop-up Screen	Action	Close Local pop-up screen		Events and Actions	ClosePage	Page name	Page where the object is placed	
		Close specified pop-up screen		Events and Actions	ClosePage	Page name	Page that is to be closed	
			Screen No.		-	-	-	-
	Move Local pop-up screen		-	-	-	-		
Display System Menu	System Menu Top Page (Initialize Tab)			Events and Actions	ShowSystemMenu	-	-	
	Switch Box Function			-	-	-	-	
	Display Captured Data			-	-	-	-	
Stop Buzzer				Events and Actions	BuzzerOff	-	-	
None				-	-	-	-	
Video Control - Video Capture	File name			-	-	-	-	
	Save in a file (If memory card is full)			-	-	-	-	



**Command Button: Function**

(2/2)

CX-Designer				Sysmac Studio			
Function	1st Level	2nd Level	2nd Level		Category	Property	Set Value
Video Control – Contrast Adjustment	Video Input Adjustment	Contrast		-	-	-	-
		Brightness		-	-	-	-
		Depth		-	-	-	-
		Tone		-	-	-	-
	RGB Control Value	Red		-	-	-	-
		Green		-	-	-	-
		Blue		-	-	-	-
Video Control – Vision Sensor Console Output	Signal type			-	-	-	
Data Block Control				See the "Command Button_DB" sheet.			
Authentication Cancellation				Events and Actions	Logout	-	-

◆Command Button\_DB  
 Command Button: DB Control

Button

CX-Designer	Sysmac Studio			
Function	Event	Action	VB Function	
Read data from CSV file to PLC Data Block	Press	Subroutine	WriteReicipeToController	
Write data from PLC Data Block to CSV file			ReadReicipeToController	
Read data from CSV file to NS PT Memory			ImportReicipes	
Write data from NS PT Memory to CSV file			SaveReicipe	
Read data from NS PT Memory to PLC Data Block			WriteReicipeToController	
Write data from PLC Data Block to NS PT Memory			ReadReicipeToController	
Read record label			GetReicipeName	
Delete record			DeleteReicipe	

The NS functions seem to be substituted by VB functions. However, since the Recipe feature of NA differs from the Data Block feature of NS, some NS functions may not be available in NA.

◆ Multifunction\_Function

Multifunction: Function

Events and Actions of Objects and Shapes

(1/7)

CX-Designer				Sysmac Studio					
Function	1st Level	2nd Level		Category	Action	Option	Set Value	Remarks	
Write Bit	Write Address			Properties	Behavior	Variable	Variable mapped to the address		
	Action		Momentary	Properties	General	Type	MomentaryButton		
			Alternate				ToggleButton		
			SET				SetButton		
RESET	ResetButton								
Write Word	Write Address			Events and Actions	SetVariable	Variable	Variable mapped to the address	Set Value has been selected in [Action] field.	
				Events and Actions	IncreaseVariable	Variable	Variable mapped to the address	Increment/Decrement has been selected in [Action] field.	
	Numeral Type			-	-	-	-		
	Action			Set Value	Events and Actions	SetVariable	-	-	
				Increment/Decrement	Events and Actions	IncreaseVariable	-	-	
				Display Pop-up Menu	-	-	-	-	
				AND	-	-	-	-	
				OR	-	-	-	-	
	XOR	-	-	-	-				
	Value				Events and Actions	SetVariable	Value	The original value	Set Value has been selected in [Action] field.
					Events and Actions	IncreaseVariable	Value	The original value	Increment/Decrement has been selected in [Action] field.
	Indirect				Events and Actions	SetVariable	Value	Variable mapped to the address	Set Value has been selected in [Action] field.
					Events and Actions	IncreaseVariable	Value	Variable mapped to the address	Increment/Decrement has been selected in [Action] field.
	Maximum Limit	Fixed Value	Indirect		-	-	-	-	
				Return to the Minimum Value when the Maximum vale is Exceeded	-	-	-	-	
					-	-	-	-	
	Minimum Limit	Fixed Value	Indirect		-	-	-	-	
				Return to the Maximum Value when the Minimum vale is Exceeded	-	-	-	-	
					-	-	-	-	
Write String	Write Address			Events and Actions	SetVariable	Variable	Variable mapped to the address		
	String			Events and Actions	SetVariable	Value	Value in quotes		
	Max. No. of Characters			-	-	-	-		
	Character Code			ASCII code	-	-	-	-	
				Unicode (UTF-16)	-	-	-	-	
				Unicode (UTF-8)	-	-	-	-	
	Swap the high-byte and the low-byte			Checked	-	-	-	-	
Unchecked				-	-	-	-		

Multifunction: Function

Events and Actions of Objects and Shapes

(2/7)

CX-Designer				Sysmac Studio				
Function	1st Level	2nd Level		Category	Action	Option	Set Value	Remarks
Write String	Input Process	Fill the blank characters with a specified character	Checked	-	-	-	-	
			Unchecked	-	-	-	-	
			Space	-	-	-	-	
			NULL	-	-	-	-	
Switch Screen	Specified Screen			Events and Actions	ShowPage	Page name	Screen title	
	Indirect Specification of Screen No.			Events and Actions	SetVariable	Variable	_HMI_Current_PageIndex	
		Address		Events and Actions	SetVariable	Value	Variable mapped to the address	
	Selection by Pop-up Menu			-	-	-	-	
	Backward			Events and Actions	ShowPreviousPage	-	-	
	Forward			-	-	-	-	
	Next Page			-	-	-	-	
	Previous Page			-	-	-	-	
	Write a destination screen No. when a screen switches		Checked		Events and Actions	SetVariable	Variable	Variable mapped to the address
Unchecked				-	-	-	-	
	Address			Events and Actions	SetVariable	Value	_HMI_Current_PageIndex	
Control Pop-up Screen	Action	Close Local pop-up screen		Events and Actions	ClosePage	Page name	Page where the object is placed	
		Close specified pop-up screen		Events and Actions	ClosePage	Page name	Page that is to be closed	
			Screen No.		-	-	-	-
	Move Local pop-up screen			-	-	-	-	
Display System Menu	System Menu Top Page (Initialize Tab)			Events and Actions	ShowSystemMenu	-	-	
	Switch Box Function			-	-	-	-	
	Display Captured Data			-	-	-	-	
	Programming Console (CS Series)			-	-	-	-	
	Programming Console (C Series)			-	-	-	-	
	Operation Log (sort by occurrence)			Events and Actions	ShowOperationLogViewer	-	-	
	Operation Log (sort by frequency)			Events and Actions	ShowOperationLogViewer	-	-	

Multifunction: Function

Events and Actions of Objects and Shapes

(3/7)

CX-Designer				Sysmac Studio					
Function	1st Level	2nd Level		Category	Action	Option	Set Value	Remarks	
Troubleshooter (NJ-series)	Host Selection			Events and Actions	ShowTroubleshooter	Controller Name	The same value as NS		
	Initial Screen Display		User trouble	Events and Actions	ShowTroubleshooter	StartPage	Active User Events		
			User-defined Event Log	Events and Actions	ShowTroubleshooter	StartPage	User Event Logs		
			Controller error (Function module)	Events and Actions	ShowTroubleshooter	StartPage	Active Controller Events		
			Controller Event Log	Events and Actions	ShowTroubleshooter	StartPage	Controller Event Logs		
Key Button	Transmit to	Input field with focus		-	-	-	-		
		Specified input field		-	-	-	-		
			Object ID	-	-	-	-		
	Transmit Type	Label string			-	-	-	-	
		Control code			-	-	-	-	
		Specified string			-	-	-	-	
			String			-	-	-	
		Indirectly specification of string			-	-	-	-	
		Transmit from		-	-	-	-		
		No. of Words		-	-	-	-		
Data Block Control				-	-	-	-	See the "Command Button_DB" sheet.	
Contents Control	Switch to the specified			-	-	-	-		
		Contents No.		-	-	-	-		
	Switch to the indirect reference contents No.			-	-	-	-		
		Address			-	-	-	-	
Switch to the next contents No.				-	-	-			
Switch to the previous contents No.				-	-	-			

Multifunction: Function

Events and Actions of Objects and Shapes

(4/7)

CX-Designer				Sysmac Studio					
Function	1st Level	2nd Level		Category	Action	Option	Set Value	Remarks	
Alarm/	Clear			Events and Actions	ClearUserAlarmLog	-	-		
	Save			Events and Actions	SaveUserAlarmLog ToFile	-	-		
	Home				-	-	-	-	
		Alarm/Event Summary and History Object ID			-	-	-	-	
	End				-	-	-	-	
		Alarm/Event Summary and History Object ID			-	-	-	-	
	Next				-	-	-	-	
		Alarm/Event Summary and History Object ID			-	-	-	-	
	Previous				-	-	-	-	
		Alarm/Event Summary and History Object ID			-	-	-	-	
	From New Date & Time				-	-	-	-	
		Alarm/Event Summary and History Object ID			-	-	-	-	
	From Old Date & Time				-	-	-	-	
		Alarm/Event Summary and History Object ID			-	-	-	-	
	From High Priority				-	-	-	-	
		Alarm/Event Summary and History Object ID			-	-	-	-	
	From Low Priority				-	-	-	-	
		Alarm/Event Summary and History Object ID			-	-	-	-	
	From High Frequency				-	-	-	-	
		Alarm/Event Summary and History Object ID			-	-	-	-	
From Low Frequency				-	-	-	-		
	Alarm/Event Summary and History Object ID			-	-	-	-		
Check Selected Alarm				-	-	-	-		
	Alarm/Event Summary and History Object ID			-	-	-	-		

Multifunction: Function

Events and Actions of Objects and Shapes

(5/7)

CX-Designer				Sysmac Studio					
Function	1st Level	2nd Level		Category	Action	Option	Set Value	Remarks	
Alarm/	Delete Selected Alarm			-	-	-	-		
		Alarm/Event Summary and History Object ID		-	-	-	-		
	Check All Alarms			-	-	-	-		
		Alarm/Event Summary and History Object ID		-	-	-	-		
	Cancel All Alarms' Check			-	-	-	-		
Change Display Type				-	-	-	-		
	Alarm/Event Summary and History Object ID			-	-	-	-		
Data Log Control	Stop	Data log group No.		Events and Actions	StopDataLogging	DataSet Name	Data set name corresponding to the data group No.		
		Data log group No.							
	Start	Data log group No.		Events and Actions	StartDataLogging	DataSet Name	Data set name corresponding to the data group No.		
	Log Clear	Data log group No.		-	-	-	-		
	Pause	Data Log Graph Object ID		-	-	-	-		
	Save to File	Data log group No.		-	-	-	-		
	Read File				-	-	-	-	
		Data Log Graph Object ID			-	-	-	-	
		Options for showing the read file	Show the file read data only		-	-	-	-	
			Cascade the read data to a graph		-	-	-	-	
Move the cursor forward				-	-	-	-		
	Data Log Graph Object ID			-	-	-	-		
Move the cursor backward				-	-	-	-		
	Data Log Graph Object ID			-	-	-	-		

Multifunction: Function

Events and Actions of Objects and Shapes

(6/7)

CX-Designer				Sysmac Studio					
Function	1st Level	2nd Level		Category	Action	Option	Set Value	Remarks	
Video Control – Video Capture	File name			-	-	-	-		
	Save in a file (If memory card is full)		Update Stop	- -	- -	- -	- -		
Video Control – Contrast Adjustment	Video Input Adjustment	Contrast		-	-	-	-		
		Brightness		-	-	-	-		
		Depth		-	-	-	-		
		Tone		-	-	-	-		
	RGB Control Value	Red			-	-	-	-	
		Green			-	-	-	-	
Blue				-	-	-	-		
Video Control – Vision Sensor Console Output	Signal type			-	-	-	-		
Scroll Object	Scroll Down			-	-	-	-		
		Object ID		-	-	-	-		
		Scroll Amount	1 Page		-	-	-	-	
			1/2 Page		-	-	-	-	
	Specified No. of Lines/Dots/Items			-	-	-	-		
	Scroll Down				-	-	-	-	
		Object ID			-	-	-	-	
		Scroll Amount	1 Page		-	-	-	-	
			1/2 Page		-	-	-	-	
	Specified No. of Lines/Dots/Items			-	-	-	-		
	Scroll Down				-	-	-	-	
		Object ID			-	-	-	-	
		Scroll Amount	1 Page		-	-	-	-	
			1/2 Page		-	-	-	-	
	Specified No. of Lines/Dots/Items			-	-	-	-		
	Scroll Down				-	-	-	-	
Object ID				-	-	-	-		
Scroll Amount		1 Page		-	-	-	-		
		1/2 Page		-	-	-	-		
	Specified No. of Lines/Dots/Items		-	-	-	-			



Multifunction: Function

Events and Actions of Objects and Shapes

(7/7)

CX-Designer			Sysmac Studio					
Function	1st Level	2nd Level		Category	Action	Option	Set Value	Remarks
Password Setting			None	Properties	Security	Access Levels	None	
			Level 1	Properties	Security	Access Levels	Level1	
				Events and Actions	Login	-	-	
			Level 2	Properties	Security	Access Levels	Level2	
				Events and Actions	Login	-	-	
			Level 3	Properties	Security	Access Levels	Level3	
				Events and Actions	Login	-	-	
			Level 4	Properties	Security	Access Levels	Level4	
				Events and Actions	Login	-	-	
			Level 5	Properties	Security	Access Levels	Level5	
				Events and Actions	Login	-	-	
			Authentication Cancellation				Events and Actions	Click
Confirmation	Standard Message			-	-	-	-	
	Use Specified Message			-	-	-	-	
	Message	Message		-	-	-	-	
Buzzer			Stop Buzzer	Events and Actions	BuzzerOff	-	-	
			Continuous Buzzer	Events and Actions	BuzzerOn	BuzzerType	Continuous	
			Short Intermittent Buzzer	Events and Actions	BuzzerOn	BuzzerType	Intermittent Short Pulse	
			Long Intermittent Buzzer	Events and Actions	BuzzerOn	BuzzerType	Intermittent Long Pulse	
Operation Log Control	Initialize Operation Log			-	-	-	-	
	Save Operation Log			-	-	-	-	

## Appendix 4: Lamps

### ◆ Bit Lamp

#### Bit Lamp

#### Bit Lamp

CX-Designer				Sysmac Studio					
Tab	1st Level	2nd Level	3rd Level	Category	Group	Property	Set Value	Remarks	
General	Object Comment			-	-	-	-		
	Address	Display Address		Properties	Behavior	Expression	Variable mapped to the address		
	Lamp Type	Single-lined Circle			Properties	Appearance	Design	Ellipse	See the "Bit Lamp_Shape" sheet
		Single-lined Rectangle						Rectangle	See the "Bit Lamp_Shape" sheet
		Double-line Circle						Ellipse	See the "Bit Lamp_Shape" sheet
		Double-line Rectangle						Rectangle	See the "Bit Lamp_Shape" sheet
Select Shape						Image	See the "Bit Lamp_Shape" sheet		
Color/Shape				-	-	-	-	See the "Bit Lamp_Shape" sheet	
Label	Label			Refer to the "Text Attributes" sheet in "Appendix 2: Object Common"					
	Text Attribute	Text Attributes		Refer to the "Text Attributes" sheet in "Appendix 2: Object Common"					
		Indirect Reference of Text Color		-	-	-	-		
	Switch Label for Address ON/OFF	Link with the Write Address ON/OFF			-	-	-	-	
		Link with the Display Address ON/OFF			-	-	-	-	
		Link with the Specified Address ON/OFF			-	-	-	-	
	Use the String Table	Address	Unchecked		-	-	-	-	
Checked				Properties	Appearance	DefaultText (Default)	The original text set for NS		
Other	Key Press Sound Control	Do not allow sound for this object		-	-	-	-		

◆Bit Lamp\_Shape

Bit Lamp: Select Shape

CX-Designer				Sysmac Studio		
Button Shape	Tab	1st Level	2nd Level	Category	Property	Set Value
Single-lined Circle Double-lined Circle Single-lined Rectangle Double-lined Rectangle	Color/Shape	Color1 (OFF)		Appearance	BackgroundColorButtonUp	The same color as NS
		Indirect		-	-	-
			Address	-	-	-
		Color2 (ON)		Appearance	BackgroundColorButtonDown	The same color as NS
Select Shape	Color/Shape	Indirect		-	-	-
			Address	-	-	-
		Color2 (ON)		Appearance	ImageFileButtonDown	Image registered as resource
		Indirect		-	-	-
Address	-		-	-		

◆ Word Lamp

Word Lamp

Data Lamp

CX-Designer			Sysmac Studio			
Tab	1st Level	2nd Level	Category	Group	Property	Set Value
General	Object Comment		-	-	-	-
	Numeral Type		-	-	-	-
	Button Shape	Rectangle	Properties	Appearance	Design	Rectangle
		Select Shape				Image
	Button Actions	Set Value	See the "Word Lamp_Shape" sheet			
		Increment/Decrement	See the "Word Lamp_Shape" sheet			
Display Pop-up Menu		See the "Word Lamp_Shape" sheet				
Address	Write Address	See the "Word Lamp_Shape" sheet				
Color/Shape		See the "Word Lamp_Shape" sheet				
Label	Label		-	-	-	-
	Text Attribute	Text Attributes	Refer to the "Text Attributes" sheet in "Appendix 2: Object Common Settings."			
		Auto resize text	-	-	-	-
	Indirect Reference of Text Color	-	-	-	-	

◆Word Lamp\_Shape

Word Lamp: Select Shape

(1/2)

CX-Designer				Sysmac Studio				
Lamp Shape	Tab	1st Level	2nd Level	Category	Property	Setting Item	Set Value	
Single-lined Circle Double-lined Circle Single-lined Rectangle Double-lined Rectangle	Color/Shape			Appearance	DefaultLampColor		Color specified in Color1 (Value0)	
		Color1 (Value0)		Behavior	ColorRanges	LampColor	The same color as NS	
						StartValue	>= 0	
		Indirect		-	-	-	-	-
			Address	-	-	-	-	-
		Color2 (Value1)		Behavior	ColorRanges	LampColor	The same color as NS	
						StartValue	>= 1	
		Indirect		-	-	-	-	-
			Address	-	-	-	-	-
		Color3 (Value2)		Behavior	ColorRanges	LampColor	The same color as NS	
						StartValue	>= 2	
		Indirect		-	-	-	-	-
			Address	-	-	-	-	-
		Color4 (Value3)		Behavior	ColorRanges	LampColor	The same color as NS	
						StartValue	>= 3	
		Indirect		-	-	-	-	-
			Address	-	-	-	-	-
		Color5 (Value4)		Behavior	ColorRanges	LampColor	The same color as NS	
						StartValue	>= 4	
		Indirect		-	-	-	-	-
	Address	-	-	-	-	-		
Color6 (Value5)		Behavior	ColorRanges	LampColor	The same color as NS			
				StartValue	>= 5			
Indirect		-	-	-	-	-		
	Address	-	-	-	-	-		
Color7 (Value6)		Behavior	ColorRanges	LampColor	The same color as NS			
				StartValue	>= 6			
Indirect		-	-	-	-	-		
	Address	-	-	-	-	-		
Color8 (Value7)		Behavior	ColorRanges	LampColor	The same color as NS			
				StartValue	>= 7			
Indirect		-	-	-	-	-		
	Address	-	-	-	-	-		
Color9 (Value8)		Behavior	ColorRanges	LampColor	The same color as NS			
				StartValue	>= 8			
Indirect		-	-	-	-	-		
	Address	-	-	-	-	-		
Color10 (Value9)		Behavior	ColorRanges	LampColor	The same color as NS			
				StartValue	>= 9			
Indirect		-	-	-	-	-		
	Address	-	-	-	-	-		

Word Lamp: Select Shape

(2/2)

CX-Designer				Sysmac Studio			
Lamp Shape	Tab	1st Level	2nd Level	Category	Property	Setting Item	Set Value
Select Shape	Color/Shape			Behavior	DefaultImageFile		Image specified in Shape1 (Value0)
		Shape1 (Value0)		Behavior	ColorRanges	ImageFile	Image file registered as resource
						StartValue	>= 0
		Shape2 (Value1)		Behavior	ColorRanges	ImageFile	Image file registered as resource
						StartValue	>= 1
		Shape3 (Value2)		Behavior	ColorRanges	ImageFile	Image file registered as resource
						StartValue	>= 2
		Shape4 (Value3)		Behavior	ColorRanges	ImageFile	Image file registered as resource
						StartValue	>= 3
		Shape5 (Value4)		Behavior	ColorRanges	ImageFile	Image file registered as resource
						StartValue	>= 4
		Shape6 (Value5)		Behavior	ColorRanges	ImageFile	Image file registered as resource
						StartValue	>= 5
		Shape7 (Value6)		Behavior	ColorRanges	ImageFile	Image file registered as resource
				StartValue	>= 6		
Shape8 (Value7)		Behavior	ColorRanges	ImageFile	Image file registered as resource		
				StartValue	>= 7		
Shape9 (Value8)		Behavior	ColorRanges	ImageFile	Image file registered as resource		
				StartValue	>= 8		
Shape10 (Value9)		Behavior	ColorRanges	ImageFile	Image file registered as resource		
				StartValue	>= 9		

◆Label

Label Object

Label

CX-Designer				Sysmac Studio				Remarks	
Tab	1st Level	2nd Level	3rd Level	Category	Group	Property	Set Value		
General	Object Comment			-	-	-	-		
	Use as Message Display			-	-	-	-	*	
Background	Tile Background		Unchecked	Properties	Appearance	BackgroundColor	Transparent		
			Checked						
	Color			Properties	Appearance	BackgroundColor	The same color as NS		
	Indirect Reference of Color				-	-	-	-	
Address				-	-	-	-		
Label	Label			Refer to the "Text Attributes" sheet in "Appendix 2: Object Common Settings."					
	String No.			Properties	Appearance	Resource ID	Resource corresponding to the string No.		
	Indirect			-	-	-	-	*	
	Text Attribute	Text Attributes			Refer to the "Text Attributes" sheet in "Appendix 2: Object Common Settings."				
		Auto resize text			-	-	-	-	No corresponding function
		Indirect Reference of Text Color			-	-	-	-	No corresponding function
	Indirect Reference of String				-	-	-	-	*
		File Name			-	-	-	-	
		Address for Specifying File Line			-	-	-	-	
		Clear display when the address value is 0			-	-	-	-	
Use the String Table			-	-	-	-	*		
Message	No. of Statuses			-	-	-	-		
	Address for switching status			-	-	-	-		
	Label			-	-	-	-		
	String No.			-	-	-	-		
	Text Attribute	Text Attributes		-	-	-	-		
	BackgroundColor	Tile Background	Checked		-	-	-	-	
			Unchecked		-	-	-	-	
			Color		-	-	-	-	
Use the String Table			-	-	-	-			

\*These functions can be possible using dynamic resource linking, but modification of PLC programs are also necessary.

◆ Numeral Display

Numeral Display and Input Objects

(1/3)

CX-Designer					Sysmac Studio					
Tab	1st Level	2nd Level	3rd Level	Set Value	Category	Group	Property	Set Value		
General	Object Comment				Properties	Behavior	Data Type	Numeric		
	Numeral Display Type	Display Type	Decimal			Properties	Behavior	ValueFormat	Decimal	
			Hexadecimal			Properties	Behavior	ValueFormat	Hexadecimal	
			Binary			-	-	-	-	
			Octal			-	-	-	-	
		Storage Type				-	-	-	-	
		Format	Integer			Properties	Behavior	DisplayFormat	Select the format according to the number of digits	
			Decimal			Properties	Behavior	DisplayFormat	Select the format according to the number of digits	
		Fill blank digits with zeros			Checked	Properties	Behavior	LeadingZeros	Checked	
					Unchecked	Properties	Behavior	LeadingZeros	Unchecked	
		Ignore exceeded digits			Checked	-	-	-	-	
				Unchecked						
	Display commas			Checked	Properties	Behavior	ShowSeparator	Checked		
				Unchecked	Properties	Behavior	ShowSeparator	Unchecked		
	Unit and Scale	Set Unit & Scale No.				Properties	Behavior	Scaling	Scale name registered in Scaling	
		Indirect Specification of Unit & Scale No.				-	-	-	-	
			Address				-	-	-	-
	Perform Max/Min Limit Check after Scale Conversion				-	-	-	-		
Address	Address				Properties	Behavior	Variable	Variable mapped to the address		
Display on entry	Display input values by *				-	-	-	-		
Text	Text Attribute	Text Attributes			Refer to the "Text Attributes" sheet in "Appendix 2: Object Common Settings."					
		Indirect Reference of Text Color			-	-	-	-		
Background	Tile Background			Unchecked	Properties	Appearance	BackgroundColor	Transparent		
				Checked						
		Color			Properties	Appearance	BackgroundColor	The same color as NS		
	Indirect Reference of Color				-	-	-	-		
		Address			-	-	-	-		
Keypad	Input Method	System Keypad			-	-	-	-		
		Large System Keypad			-	-	-	-		
		Input from Pop-up Screen			-	-	-	-		
		Other Input Method			-	-	-	-	-	
			Input Restriction	No Restriction			-	-	-	-
				Prohibit input from Functional Object			-	-	-	-
			Prohibit input from Bar-Code Reader			-	-	-	-	
Use Temporary Input object			Checked	-	-	-	-			
			Unchecked	-	-	-	-			



Numeral Display and Input Objects

(2/3)

CX-Designer				Sysmac Studio				
Tab	1st Level	2nd Level	3rd Level	Set Value	Category	Group	Property	Set Value
Keypad	Display Position of Keypad/ Pop-up Screen	Above this Object			-	-	-	-
		Below this Object			-	-	-	-
		Top Left of Screen			-	-	-	-
		Bottom Left of Screen			-	-	-	-
		Top Right of Screen			-	-	-	-
		Bottom Right of Screen			-	-	-	-
		Center of Screen			-	-	-	-
		Any Position	X		-	-	-	-
		Y		-	-	-	-	
		Input Order				Properties	Behavior	DataInputOrder
Max/Min	Type of Value	Immediate Value			-	-	-	-
		Difference from Current Value			-	-	-	-
	Maximum Input Limit			Checked	-	-	-	-
				Unchecked	Properties	Behavior	MaximumValue	The max value of the set variable data type
		Value			Properties	Behavior	MaximumValue	Value
	Indirect Reference							
		Address			Properties	Behavior	MaximumValue	Variable mapped to the address
	Minimum Input Limit			Checked	-	-	-	-
				Unchecked	Properties	Behavior	MinimumValue	The min value of the set variable data type
		Value			Properties	Behavior	MinimumValue	Value
		Indirect Reference						
	Watch Maximum Limit			Checked	-	-	-	-
				Unchecked	-	-	-	-
		Value			-	-	-	-
		Indirect Reference			-	-	-	-
			Address		-	-	-	-
		Text Color for Exceeding Value			-	-	-	-
	Watch Minimum Limit			Checked	-	-	-	-
				Unchecked	-	-	-	-
		Value			-	-	-	-
Indirect Reference				-	-	-	-	
		Address		-	-	-	-	
Text Color for Exceeding Value				-	-	-	-	
Background Color for Exceeding Value				-	-	-	-	

**Numeral Display and Input Objects**

(3/3)

CX-Designer				Sysmac Studio				
Tab	1st Level	2nd Level	3rd Level	Set Value	Category	Group	Property	Set Value
Write	Display Write Confirmation Dialog				-	-	-	-
				Standard Message	-	-	-	-
		Message		User Specified Message	-	-	-	-
	Turn ON the specified address when the value is written				-	-	-	-
		Address			-	-	-	-
	Record to operation log			Checked	Properties	Security	Operation Log	Checked
				Unchecked	Properties	Security	Operation Log	Unchecked
	Message			-	-	-	-	
Control Flag	Display ( Numeral Display)			Display	-	-	-	-
				Hide	-	-	-	-
				Indirect	-	-	-	-
		Address		-	-	-	-	
Macro	Macro Execution Condition				See the table below			

**Numeral Display: Macro**

CX-Designer	Sysmac Studio				
Item	Tab	Category	Events/Actions	Event Option	Set Value
Before inputting numeral	-	-	-	-	-
Before writing numeral	-	-	-	-	-
When changing value	-	-	-	-	-
Value = Set Value	Events and Actions*	Event	Condition	Expression	[Variable mapped to the address] = Set value
		Action	CallSubroutine	-	Subroutine name
Value > Set Value	Events and Actions*	Event	Condition	Expression	[Variable mapped to the address] > Set value
		Action	CallSubroutine	-	Subroutine name
Value < Set Value	Events and Actions*	Event	Condition	Expression	[Variable mapped to the address] < Set value
		Action	CallSubroutine	-	Subroutine name

Events and Actions of the page where the object is placed

◆String Display

String Display and Input Objects

(1/2)

CX-Designer					Sysmac Studio				
Tab	1st Level	2nd Level	3rd Level	Set Value	Category	Group	Property	Set Value	
General	Object Comment				-	-	-	-	
	String Display Type	TextLength			-	-	-	-	
			ASCII		-	-	-	-	
			Unicode (UTF-16)		-	-	-	-	
			Unicode (UTF-8)		-	-	-	-	
	Pop-up Menu	Use Pop-up Menu		Checked	-	-	-	-	
				Unchecked	-	-	-	-	
			Menu Button Width		-	-	-	-	
	Address Information	Address			Properties	Behavior	Variable	Address set to the default label in NS	
	Input Process	Fill the blank characters with a specified character		Checked	-	-	-	-	
				Unchecked	Default				
		Space			-	-	-	-	
Display on entry	Display input characters by *		Checked	Properties	Behavior	MaskedDisplay	Checked		
			Unchecked	Default					
		NULL		-	-	-	-		
Text	Text Attribute	Text Attributes			Refer to the "Text Attributes" sheet in "Appendix 2: Object Common Settings."				
		Indirect Reference of Text Color			-	-	-	-	
Background	Tile Background			Unchecked	Properties	Appearance	BackgroundColor	Transparent	
				Checked	Default				
		Color			Properties	Appearance	BackgroundColor	The same color as NS	
		Indirect Reference of Color			-	-	-	-	
Keypad	Input Method	System Keypad			-	-	-	-	
		Large System Keypad			-	-	-	-	
		Input from Pop-up Screen			-	-	-	-	
		Other Input Method				-	-	-	-
			Input Restriction	No Restriction		-	-	-	-
				Prohibit input from Functional Object		-	-	-	-
				Prohibit input from Bar-Code Reader		-	-	-	-
		Use Temporary Input object			Checked	-	-	-	-
			Unchecked	-	-	-	-		

String Display and Input Objects

CX-Designer					Sysmac Studio				
Tab	1st Level	2nd Level	3rd Level	Set Value	Category	Group	Property	Set Value	
Keypad	Display Position of Keypad/ Pop-up Screen	Above this Object			-	-	-	-	
		Below this Object			-	-	-	-	
		Top Left of Screen			-	-	-	-	
		Bottom Left of Screen			-	-	-	-	
		Top Right of Screen			-	-	-	-	
		Bottom Right of Screen			-	-	-	-	
		Center of Screen			-	-	-	-	
		Any Position		X Y		-	-	-	-
	String Input	Add to the current string.				Default			
		Enter the new string. (Monitor the current string when the input focus has been set.)				-	-	-	-
		Enter the new string. (Clear the current string when the input focus has been set.)				-	-	-	-
		Add to the current string. (Move the cursor to front of string when setting the input focus been set.)				-	-	-	-
	Input Order				Properties	Behavior	DataInputOrder	The same value as NS	
	Write	Display Write Confirmation Dialog				-	-	-	-
Standard Message					-	-	-	-	
User Specified Message					-	-	-	-	
Turn ON the specified address when the value is written		Message				-	-	-	-
		Address				-	-	-	-
		Record to operation log			Checked	Properties	Security	Operation Log	Checked
				Unchecked	Properties	Security	Operation Log	Unchecked	
Password	Password			None	Properties	Security	Access Levels	None	
				Level 1				Level1	
				Level 2				Level2	
				Level 3				Level3	
				Level 4				Level4	
				Level 5				Level5	
Macro	Macro Execution Condition	Before inputting string			-	-	-	-	
		Before writing string			-	-	-	-	
		When changing string			-	-	-	-	

◆List

List Selection Object

(1/2)

CX-Designer				Sysmac Studio				
Tab	1st Level	2nd Level	3rd Level	Category	Group	Property	Set Value	
General	Object Comment			-	-	-	-	
	List Data	Collect from \$W		-	-	-	-	
		Collect from a File		Properties	Behavior	Items	Get the list from the file to assign resources	
	Character Code		Use a File for Indirect Reference		-	-	-	-
			ASCII code		-	-	-	-
			Unicode (UTF-16)		-	-	-	-
	List Size	Characters/Line	Unicode (UTF-8)		-	-	-	-
Max Lines				-	-	-	-	
Text	Text Attribute	Text Attributes		Refer to the "Text Attributes" sheet in "Appendix 2: Object Common Settings."				
Background	Tile Background		Unchecked	Properties	Appearance	BackgroundColor	Transparent	
			Checked	Default				
	Color			Properties	Appearance	BackgroundColor	The same color as NS	
	Indirect Reference of Color			-	-	-	-	
Selection	Show selection bar		Address		-	-	-	
			Checked		-	-	-	
	Store the selected line No. in the specified address		Unchecked		-	-	-	
			Checked		-	-	-	
	Store the string of the selected line in the specified address	Address	Address		Properties	Behavior	Variable	Variable mapped to the address
			Checked		-	-	-	-
Scroll Bar	Use Scroll Bar		Unchecked		-	-	-	
			Checked		-	-	-	
	Buttons for Scrolling One Line		Checked		-	-	-	
			Unchecked		Default	-	-	-
	Buttons for Scrolling Multiple Lines	Scroll Amount	Checked		-	-	-	
			Unchecked		Default	-	-	-
			Lines in 1 Page		-	-	-	-
			Lines in 1/2 Page		-	-	-	-
	Button Size	Width	Specified No. of Lines		-	-	-	
			Height		-	-	-	
Password	Password		None	Properties	Security	Access Levels	None	
			Level 1				Level1	
			Level 2				Level2	
			Level 3				Level3	
			Level 4				Level4	
			Level 5				Level5	

List Selection Objects

(2/2)

CX-Designer				Sysmac Studio			
Tab	1st Level	2nd Level	3rd Level	Category	Group	Property	Set Value
Macro	Macro Execution Condition	When selecting a list		-	-	-	-
External Control	Block	Max No. of Blocks		-	-	-	-
		Switching the Display Block	Checked	-	-	-	-
			Unchecked	-	-	-	-
		Address for Switching the Display Block		-	-	-	-
	Start Line	Switching the Display Start Line	Checked	-	-	-	-
			Unchecked	-	-	-	-
			Address for Switching the Display Start Line	-	-	-	-
	Update	Update a List	Checked	-	-	-	-
			Unchecked	-	-	-	-
Address for Updating a List			-	-	-	-	

◆DateTime

Date Objects and Time Objects

DateTime

CX-Designer					Sysmac Studio				
Tab	1st Level	2nd Level	3rd Level	Set Value	Category	Group	Property	Set Value	Remarks
					Properties	Behavior	Variable	_HMI_DateTime	
General	Object Comment				-	-	-	-	-
	Display Format				Properties	Appearance	Format	Value converted based on the conversion table	See the "DateTime_Format" sheet
	Use Large Keypad			Checked	-	-	-	-	-
Unchecked				-	-	-	-	-	-
Text	Text Attribute				Refer to the "Text Attributes" sheet in "Appendix 2: Object Common Settings."				
Background	Tile Background			Unchecked	Properties	Appearance	BackgroundColor	Transparent	-
				Checked	-	-	-	-	-
	Indirect Reference of Color				Properties	Appearance	BackgroundColor	The same color as NS	-
					Properties	Appearance	HeaderBackgroundColor	The same color as NS	-
					-	-	-	-	-
Address				-	-	-	-	-	

◆Date Time Format

Date and Time: Display Format

CX-Designer		Sysmac Studio			
Switch	Item	Category	Group	Property	Set Value
Type0	Display Format	Properties	Appearance	Format	Value according to the tables right and below
Type1					Settings for each user language are not available.
Type2					Format will be switched depending on the project language specified as user language.
Type3					
Type4					
Type5					
Type6					
Type7					
Type8					
Type9					
Type10					
Type11					
Type12					
Type13					
Type14					
Type15					

Time Display Format

CX-Designer		Sysmac Studio	
Display Format	Format	CustomFormat	
xxxx hh時mm分ss秒	CustomFormat	tt hh時mm分ss秒	
xxxx hh時mm分	CustomFormat	tt hh時mm分	
hh時mm分ss秒	CustomFormat	hh時mm分ss秒	
hh時mm分	CustomFormat	hh時mm分	
xxxx hh:mm:ss	CustomFormat	tt hh:mm:ss	
xxxx hh:mm	CustomFormat	tt hh:mm	
hh:mm:ss	LongTimePattern	-	
hh:mm	ShortTimePattern	-	
hh:mm:ss XXXX	CustomFormat	hh:mm:ss tt	
hh:mm XXXX	CustomFormat	hh:mm tt	

Date and Time Format

CX-Designer		Sysmac Studio	
Display Format	Format	CustomFormat	
yyyy年mm月dd日 dddd	CustomFormat	yyyy年MM月dd日 dddd	
yy年mm月dd日 dddd	CustomFormat	yy年MM月dd日 dddd	
yyyy年mm月dd日 (dddd)	CustomFormat	yyyy年MM月dd日 (dddd)	
yy年mm月dd日 (dddd)	CustomFormat	yy年MM月dd日 (dddd)	
yyyy年mm月dd日	CustomFormat	yyyy年MM月dd日	
yy年mm月dd日	CustomFormat	yy年MM月dd日	
yyyy/mm/dd dddd	CustomFormat	yyyy/MM/dd dddd	
yy/mm/dd dddd	CustomFormat	yy/MM/dd dddd	
yyyy/mm/dd (dddd)	CustomFormat	yyyy/MM/dd (dddd)	
yy/mm/dd (dddd)	CustomFormat	yy/MM/dd (dddd)	
yyyy/mm/dd	CustomFormat	yyyy/MM/dd	
yy/mm/dd	CustomFormat	yy/MM/dd	
ddd mm/dd/yyyy	CustomFormat	ddd MM/dd/yyyy	
ddd mm/dd/yy	CustomFormat	ddd MM/dd/yy	
(ddd) mm/dd/yyyy	CustomFormat	(ddd) MM/dd/yyyy	
(ddd) mm/dd/yy	CustomFormat	(ddd) MM/dd/yy	
yyyy.mm.dd dddd	CustomFormat	yyyy.MM.dd dddd	
yy.mm.dd dddd	CustomFormat	yy.MM.dd dddd	
yyyy.mm.dd (dddd)	CustomFormat	yyyy.MM.dd (dddd)	
yy.mm.dd (dddd)	CustomFormat	yy.MM.dd (dddd)	
yyyy.mm.dd	CustomFormat	yyyy.MM.dd	
yy.mm.dd	CustomFormat	yy.MM.dd	
ddd mm.dd.yyyy	CustomFormat	ddd MM.dd.yyyy	
ddd mm.dd.yy	CustomFormat	ddd MM.dd.yy	
(ddd) mm.dd.yyyy	CustomFormat	(ddd) MM.dd.yyyy	
(ddd) mm.dd.yy	CustomFormat	(ddd) MM.dd.yy	
yyyy-mm-dd	ShortDatePattern (Numeral)	-	
mm/dd/yyyy	CustomFormat	MM/dd/yyyy	
mm/dd/yy	CustomFormat	MM/dd/yy	
DDD/mm/dd/yyyy	CustomFormat	ddd/MM/dd/yyyy	
DDD/mm/dd/yy	CustomFormat	ddd/mm/dd/yy	
DDD.MMMM dd.yyyy	CustomFormat	ddd.MMMM dd.yyyy	
MMMM dd.yyyy	CustomFormat	MMMM dd.yyyy	
DDD.MMM dd.yy	CustomFormat	ddd.MMM dd.yy	
MMM dd.yy	CustomFormat	MMM dd.yy	
dd/mm/yyyy	CustomFormat	dd/MM/yyyy	
dd/mm/yy	CustomFormat	dd/MM/yy	
DDD/dd/mm/yyyy	CustomFormat	ddd/dd/MM/yyyy	
DDD/dd/mm/yy	CustomFormat	ddd/dd/MM/yy	
DDD.dd MMMM.yyyy	CustomFormat	ddd.dd MMMM.yyyy	
dd MMMM.yyyy	CustomFormat	dd MMMM.yyyy	
DDD.dd MMM.yy	CustomFormat	ddd.dd MMM.yy	
dd MMM.yy	CustomFormat	dd MMM.yy	
dd.mm.yy	CustomFormat	dd.mm.yy	
DDD.dd.mm.yy	CustomFormat	ddd.dd.mm.yy	



◆BMP

Bitmap Object

Image Object

CX-Designer					Sysmac Studio			
Tab	1st Level	2nd Level	3rd Level	Set Value	Category	Group	Property	Set Value
General	Object Comment				-	-	-	
	Display File				Properties	Appearance	ImageFile	Image registered in resources
	Indirect Reference of Display File			Checked	-	-	-	-
				Unchecked	-	-	-	-
		Text file for referencing display image			-	-	-	-
		Address for Specifying File Line			-	-	-	-
		Clear the image when the value is 0		Checked	-	-	-	-
	Unchecked			-	-	-	-	

## Appendix 5: Graphs

### ◆ Level Meter

#### Level Meter

#### Vertical Gauge and Horizontal Gauge

CX-Designer				Sysmac Studio				
Tab	1st Level	2nd Level	Set Value	Category	Group	Property	Set Value	Remarks
General	Object Comment			-	-	-	-	
	Display Direction		Up	Properties	Appearance	IsReversed	Unchecked	Vertical gauge
			Down	Properties	Appearance	IsReversed	Checked	Vertical gauge
			Right	Properties	Appearance	IsReversed	Unchecked	Horizontal gauge
			Left	Properties	Appearance	IsReversed	Checked	Horizontal gauge
	Scale	Scale	Checked	Properties	Tick Major	MajorTickVisibility	Checked	
			Unchecked	Properties	Tick Major	MajorTickVisibility	Unchecked	
		No. of Division		Properties	Appearance	MajorInterval	(Max value in the range - min value in the range) / number of divisions	
		Scale Color		Properties	Appearance	TextColor	The same color as NS	
	Horizontal Size			Properties	Tick Major	MajorTickExtent	The original value	
	Set 0 as the origin		Checked	-	-	-	-	
			Unchecked	-	-	-	-	
	Storage Type			-	-	-	-	
Address	Address		Properties	Behavior	Expression	Variable mapped to the address		
Range	Range1	Maximum (J)		Properties	Ranges	EndValue	The original value	Range1
			Indirect	-	-	-	-	
		Color		-	-	-	-	
			Indirect	-	-	-	-	
		Background Color		Properties	Ranges	BackgroundColor	The same color as NS	
			Indirect	-	-	-	-	
	Border (L)		Properties	Ranges	StartValue	The original value		
		Indirect	-	-	-	-		
	Range2	Border (L)		Properties	Ranges	EndValue	The original value	Range2
			Indirect	-	-	-	-	
		Color		-	-	-	-	
			Indirect	-	-	-	-	
		Background Color		Properties	Ranges	BackgroundColor	The same color as NS	
			Indirect	-	-	-	-	
	Border (N)		Properties	Ranges	StartValue	The original value		
		Indirect	-	-	-	-		
	Range3	Border (N)		Properties	Ranges	EndValue	The original value	Range1
			Indirect	-	-	-	-	
		Color		-	-	-	-	
			Indirect	-	-	-	-	
Background Color			Properties	Ranges	BackgroundColor	The same color as NS		
		Indirect	-	-	-	-		
Minimum (P)		Properties	Ranges	StartValue	The original value			
	Indirect	-	-	-	-			
Background	Color		Properties	Appearance	BackgroundColor	The same color as NS		
		Indirect Reference of Color	-	-	-	-		

◆Analogue Meter

Analogue Meter

Rotational Gauge and Semicircular Gauge

(1/2)

CX-Designer				Sysmac Studio			
Tab	1st Level	2nd Level	Set Value	Category	Group	Property	Set Value
General	Object Comment			-	-	-	-
	Shape	Display Direction		Use another object depending on the setting			
		Increment Direction	Clockwise	Properties	Appearance	IsReversed	Unchecked
			Anti-clockwise	Properties	Appearance	IsReversed	Checked
		Width Rate		-	-	-	-
	Scale	Shape		Use another object depending on the setting			
		Scale	Checked	Properties	Tick Major	MajorTickVisibility	Checked
			Unchecked				Unchecked
		No. of Division		Properties	Appearance	MajorInterval	(Max value in the range - min value in the range) / number of divisions
		Scale Color		Properties	Appearance	TextColor	The same color as NS
		Scale Length		Properties	Tick Major	MajorTickExtent	Length of scale / (Long side of the object / 2)
		Position		Properties	Scale Bar	ScaleBarExtent	Position / (Long side of the object / 2)
	Color	RimColor		Properties	Scale Bar	ScaleBackgroundColor	Check the IsBarVisible box
		Color inside a meter		-	-	-	-
	Display Type	Fill		-	-	-	A needle indicates the current value in any settings
		Needle		-	-	-	A needle indicates the current value in any settings
		Set 0 as the origin	Checked	-	-	-	-
	Address	Address		-	-	-	-
		Storage Type		Properties	Behavior	Expression	Variable mapped to the address
	Needle	Needle Drawing Method	Type1	-	-	-	-
Type2			-	-	-	-	
Style		Type	Straight Line	Properties	Needle	NeedleType	Rectangle
			Arrow	Properties	Needle	NeedleType	SwordSharp
		Triangular Arrow	Properties	Needle	NeedleType	TriangleSharp	
Width			Properties	Needle	NeedleAscent	Width / Larger value of the object size Default value for a triangular arrow	
Color			Properties	Needle	NeedleBackgroundColor		
Range	Range1		Add a range with the [+] button in Properties-Ranges, depending on ranges you need.				
		Maximum (J)		Properties	Ranges	EndValue	The original value
		Color	Indirect	-	-	-	-
			Indirect	-	-	-	-
		Background Color	Indirect	Properties	Ranges	Background Color	The same color as NS
			Indirect	-	-	-	-
		Border (L)		Properties	Ranges	StartValue	The original value
Indirect	-	-	-	-	-		

Analogue Meter

Rotational Gauge and Semicircular Gauge

(2/2)

CX-Designer				Sysmac Studio			
Tab	1st Level	2nd Level	Set Value	Category	Group	Property	Set Value
Range	Range2	Border (L)		Range2			
			Indirect	Properties	Ranges	EndValue	The original value
		Color		-	-	-	-
			Indirect	-	-	-	-
		Background Color		Properties	Ranges	BackgroundColor	The same color as NS
			Indirect	-	-	-	-
		Border (N)		Properties	Ranges	StartValue	The original value
			Indirect	-	-	-	-
	Range3	Border (N)		Range3			
			Indirect	Properties	Ranges	EndValue	The original value
		Color		-	-	-	-
			Indirect	-	-	-	-
		Background Color		Properties	Ranges	BackgroundColor	The same color as NS
			Indirect	-	-	-	-
Background	Color	Minimum (P)		Properties	Ranges	StartValue	The original value
			Indirect	-	-	-	-
		Indirect Reference of Color		Properties	Appearance	BackgroundColor	The same color as NS
				-	-	-	-

◆Broken-line Graph

Broken-line Graph

Broken-line Graph

(1/2)

CX-Designer				Sysmac Studio							
Tab	1st Level	2nd Level	3rd Level	Set Value	Category	Group	Property	Set Value			
General	Object Comment				-	-	-	-			
	Display Direction				-	-	-	-			
	Scale (Vertical)	Scale			Checked	Properties	Left Scale	IsLeftAxisVisible	Check the box of the property if the Scale option has been checked.		
					Unchecked	Default					
		No. of Division				Properties	Left Scale	LeftAxisNumberOfMajorTicks	2 for the value less than 2, and 11 for the value 12 and larger.		
		Scale Color				Properties	Appearance	GridForegroundColor	*2		
		Size				-	-	-	-		
		Show Scale Line					Properties	Left Scale	LeftAxisGridMajorLinesVisible	Check the box of the property if the Scale option has been checked.	
						Line Style	Solid line	-	-	-	-
							Dotted line	-	-	-	-
							Broken line	-	-	-	-
							1-dot chain line	-	-	-	-
		2-dot chain line	-	-	-	-					
	Indirect reference of showing scale line				-	-	-	-			
	Scale (Horizontal)	Scale			Checked	Properties	Horizontal Axis	IsHorizontalAxisVisible	Check the box of the property if the Scale option has been checked.		
					Unchecked	Default					
		No. of Division				Properties	Horizontal Axis	ViewportLength	No. of Division *5		
		Scale Color				Properties	Appearance	GridForegroundColor	*2		
		Size				-	-	-	-		
		Show Scale Line					Properties	Horizontal Axis	HorizontalAxisGridLinesVisible	Check the box this property.	
						Line Style	Solid line	-	-	-	-
							Dotted line	-	-	-	-
							Broken line	-	-	-	-
							1-dot chain line	-	-	-	-
	2-dot chain line	-	-	-	-						
	Indirect reference of showing scale line				-	-	-	-			
	Display Update	Specify Display Update Bit			Checked	Properties	Behavior	DisplayUpdateType	Condition		
Unchecked					Properties	Behavior	DisplayUpdateType	Interval			
Specify the No. of Points Shown					Address	Properties	Behavior	Expression	Variable mapped to the address		
					Checked	-	-	-	-		
					Unchecked	-	-	-	-		
Address				-	-	-	-				
Graph	Use the graph of a broken-line graph group			Checked	-	-	-	-			
				Unchecked	*1						
	Graph List				-	-	-	-			
	Draw Value Outside of the Range				-	-	-	-			
	Storage Type				-	-	-	-			
	Group Name				Properties	Data	Data Group	The group that has been set.			

\*1: Register the data of Graph List, Draw Value Outside of the Range, and Storage Type in a data group to reference. Before to the Broken-line Graph Group Setting Table in "Appendix 1: Project Common Settings."

\*2: Because only one color can be set for scales, the setting for the vertical scale will be used.

Broken-line Graph

Broken-line Graph

(2/2)

CX-Designer					Sysmac Studio			
Tab	1st Level	2nd Level	3rd Level	Set Value	Category	Group	Property	Set Value
Graph	No. of points in each line	Monitor Points			-	-	-	-
		Display Points	No. of Points		Properties	Horizontal Axis	ViewportLength	The original value
			Indirect Reference		-	-	-	-
		Display Start Position	Position		-	-	-	-
		Indirect Reference			-	-	-	
Background	Color				Properties	Appearance	GridBackgroundColor	The same color as NS
		Indirect Reference of Color			-	-	-	-
Scroll Bar	Use Scroll Bar				-	-	-	-
	Buttons for Scrolling One Line				-	-	-	-
	Buttons for Scrolling Multiple Lines				-	-	-	-
	Button Size				-	-	-	-

◆Data Log

Data Log Object

Trend Graph

CX-Designer					Sysmac Studio					
Tab	1st Level	2nd Level	3rd Level	Set Value	Category	Group	Property	Set Value	Remarks	
General	Object Comment				Properties	Right Axis	IsRightAxisVisible	Unchecked		
	Group Name				Properties	Data	DataSet	Converted data group		
	Log Timing									
	Direction									
	Draw Value Outside of the Range									
	Display								Unchecked data will not be registered in Traces	
Time Axis	Scale	The following settings are available only when Scale is checked.		Unchecked	Default					
				Checked	Properties	Time Scale	IsTimescaleVisible	Checked		
		Line		Checked	Properties	Time Scale	TimeScaleGridLinesVisible	Checked		
		No. of Division		Unchecked	Default					
		Scale Length								
		Sub-scale	The following settings are available only when Scale is checked.		Unchecked	Default				
	Sub-scale Line			Checked						
	No. of Division			Unchecked	Default					
	Scale	Time				Properties	Time Scale	ViewportLength	Set a value in the numeral field of ViewportLength. If the value is less than 1minute, enter 1. If the value is 745 hours or longer, enter 31 days.	
			Indirect Reference							
		Unit	Sec			Properties	Time Scale	ViewportLength	Set a unit in the unit field of ViewportLength. Select Minutes because the unit of second is not available	
			Min			Properties	Time Scale	ViewportLength	Set a Unit in the numeral field of ViewportLength. Select Minutes	
	Hour			Properties	Time Scale	ViewportLength	Set a unit in the unit field of ViewportLength. Select Hour			
	Date & Time Display	Date ON			Checked	Refer to the "DateTime Format" sheet in "Appendix 4: Lamps."				
					Unchecked					
Time ON				Checked	Refer to the "DateTime Format" sheet in "Appendix 4: Lamps."					
Switch	Text Color			Unchecked					Appearance - GridForegroundColor	
	Text Attribute				Refer to the "Text Attributes" sheet in "Appendix 2: Object Common Settings."					

CX-Designer				Sysmac Studio							
Tab	1st Level	2nd Level	3rd Level	Set Value	Category	Group	Property	Set Value	Remarks		
Time Axis	Use Cursor	The following settings are available only when Scale is checked.		Unchecked	Properties	Behavior	IsCursorVisible	Unchecked			
				Checked	Properties	Behavior	IsCursorVisible	Checked			
		Cursor Color			-	-	-	-	-	The color is fixed.	
		Transmit Numeral Data to				-	-	-	-		
		Data Enable/Disable Bit				-	-	-	-		
		Transfer Date & Time			Checked/Unchecked	-	-	-	-		
	Graph Display Position	Position end of scrolling at the center of data log graph			Checked/Unchecked	-	-	-	-		
			Transfer Date & Time to			Checked/Unchecked	-	-	-	-	
			Transmit the data with offset time display format			Checked/Unchecked	-	-	-	-	
		Set Address for Updating Display	The following settings are available only when Scale is checked.		Unchecked	Default	-	-	-	-	
					Checked	-	-	-	-	-	
			Scroll Control Flag			-	-	-	-	-	
			Address for Specifying Scroll Interval			-	-	-	-	-	
			Unit			Sec	-	-	-	-	
Numeral Value Axis	Scale	The following settings are available only when Scale is checked.		Unchecked	Properties	Left Scale	IsLeftAxisVisible	Unchecked			
				Checked	Properties	Left Scale	IsLeftAxisVisible	Checked			
		Line			Checked	Properties	Left Scale	LeftAxisGridMajorLinesVisible	Checked		
					Unchecked	Properties	Left Scale	LeftAxisGridMajorLinesVisible	Unchecked		
		Color				Properties	Appearance	GridForegroundColor	The same color as NS	The color set for the Time Axis is reflected in Numeral Value Axis	
		No. of Division				-	-	-	-		
		Scale Length				-	-	-	-		
		Sub-scale	The following settings are available only when Scale is checked.		Unchecked	Default	-	-	-	-	
					Checked	-	-	-	-	-	
			Sub-scale Line		Checked	Properties	Left Scale	LeftAxisGridMinorLinesVisible	Checked		
				Unchecked	Properties	Left Scale	LeftAxisGridMinorLinesVisible	Unchecked			
		No. of Division			-	-	-	-	-		
	Scale Settings	The following settings are available only when Scale is checked.			Unchecked	Default	-	-	-	-	
					Checked	-	-	-	-	-	
Storage Type					-	-	-	-	-		
Maximum					Properties	Left Scale	LeftAxisMaximumValue	The same value as NS			
	Indirect Reference			Checked/Unchecked	-	-	-	-			
Minimum				Properties	Left Scale	LeftAxisMinimumValue	The same value as NS				
	Indirect Reference			Checked/Unchecked	-	-	-	-			



CX-Designer				Sysmac Studio							
Tab	1st Level	2nd Level	3rd Level	Set Value	Category	Group	Property	Set Value	Remarks		
Numeral Value Axis	Scale Settings	Show values	Format	Checked/Unchecked	-	-	-	-			
			Text Attribute		-	-	-	-	The color set for the Time Axis is reflected in Numeral Value Axis		
			Text		-	-	-	-	Appearance - GridForegroundColor		
		Set the threshold	Threshold H	Line Color		-	-	-	-		
				Threshold L	Checked/Unchecked	-	-	-	-		
				Line Color		-	-	-	-		
				Threshold L	Checked/Unchecked	-	-	-	-		
				Line Color		-	-	-	-		
				Line Style	Solid line		-	-	-	-	
					Dotted line		-	-	-	-	
		Broken line			-	-	-	-			
		Background	Tile Background	The following settings are available only when Scale is checked.	Color	Unchecked	Properties	Appearance	GridBackgroundColor	Transparent	
					Indirect Reference of Color	Checked	-	-	-	-	
Address	Color				Checked/Unchecked	Properties	Appearance	GridBackgroundColor	The same color as NS		
	Indirect Reference of Color				Checked/Unchecked	-	-	-	-		
	Address				Checked/Unchecked	-	-	-	-		
	Address				Checked/Unchecked	-	-	-	-		
Icon	Icons	Stop		Checked/Unchecked	-	-	-	-			
		Restart		Checked/Unchecked	-	-	-	-			
		Status		Checked/Unchecked	-	-	-	-			
		Log Clear		Checked/Unchecked	-	-	-	-			
		Pause		Checked/Unchecked	-	-	-	-			
		Save to File		Checked/Unchecked	-	-	-	-			
		Read File		Checked/Unchecked	-	-	-	-			
		Read File		Checked/Unchecked	-	-	-	-			
	Icon Size	Width			-	-	-	-			
		Height			-	-	-	-			
	Options	Show Confirmation Dialog when Stopping			Checked/Unchecked	-	-	-	-		
		Show Confirmation Dialog when Restarting			Checked/Unchecked	-	-	-	-		
		Show Confirmation Dialog when Deleting Log Data			Checked/Unchecked	-	-	-	-		
		Show Confirmation Dialog when Pausing			Checked/Unchecked	-	-	-	-		
		Show Confirmation Dialog when Saving to a File			Checked/Unchecked	-	-	-	-		

Data Log Objects

Trend Graph

CX-Designer				Sysmac Studio						
Tab	1st Level	2nd Level	3rd Level	Set Value	Category	Group	Property	Set Value	Remarks	
Icon	Options	Show Confirmation Dialog when Reading a CSV File		Checked/Unchecked	-	-	-	-		
		Options for showing the read file		Show the read data only	-	-	-	-		
				Cascade the read data to a graph	-	-	-	-		
Scroll Bar	Use Scroll Bar			Unchecked	Default					
				Checked						
	Buttons for Scrolling One			Checked/Unchecked	-	-	-	-		
	Buttons for Scrolling Multiple Lines	Use Buttons for Scrolling Multiple Lines	Lines to Scroll	Checked/Unchecked	-	-	-	-	-	
				Lines in 1 Page	-	-	-	-	-	
				Lines in 1/2 Page	-	-	-	-	-	
				Specified Lines	-	-	-	-		
Button Size	Width				-	-	-	-		
	Height				-	-	-	-		

## Appendix 6: Alarm and Others

### ◆Alarm History

#### Alarm/Event Summary and History Object

#### User Alarms Viewer

(1/3)

CX-Designer				Sysmac Studio					
Tab	1st Level	2nd Level	3rd Level	Set Value	Category	Group	Property	Set Value	
General	Object Comment				-	-	-	-	
	Display Data	Currently Occurred Alarms			Properties	Behavior	HistoricalMode	Unchecked	
		Alarm History			Properties	Behavior	HistoricalMode	Checked	
	Group Specification	Display Only the Specified Group		Checked/ Unchecked	-	-	-	-	
	Date and Time	Date			Checked/ Unchecked	-	-	-	
		Display Format			Checked/ Unchecked	-	-	-	
	Display Type	High Alarm			Checked/ Unchecked	-	-	-	
		Middle Alarm			Checked/ Unchecked	-	-	-	
		Low Alarm			Checked/ Unchecked	-	-	-	
		Event			Checked/ Unchecked	-	-	-	
	Default Display Order	From New Date & Time				Properties	Behavior	DefaultSortColumn	Date and Time The default sort order is Descending.
		From Old Date & Time				Properties	Behavior	DefaultSortColumn	Date and Time The default sort order is Ascending.
		From High Priority				Properties	Behavior	DefaultSortColumn	Priority The default sort order is Descending.
		From Low Priority				Properties	Behavior	DefaultSortColumn	Priority The default sort order is Ascending.
		From High Frequency				-	-	-	-
		From Low Frequency				-	-	-	-
	Display in the Same Line	Display the same alarm/event in the same line when displaying by frequency			Checked/ Unchecked	-	-	-	-
	Movement when Alarm/Event is Selected	Write the Alarm ID to the Specified Address			Checked/ Unchecked	-	-	-	-
			Address			-	-	-	-
		Switch Screen to the Specified Page Set with Alarm/Event Setting			Checked/ Unchecked	-	-	-	-
Switch to the Specified Contents Display Set with Alarm/Event Setting				Checked/ Unchecked	-	-	-	-	
Display	Selection Bar	Color			Properties	Appearance	SelectedItemColor	The same color as NS	
	Line Height				-	-	-	-	
	Display Optimization	Minimize column space			Checked/ Unchecked	-	-	-	-
					Checked/ Unchecked	-	-	-	-
		Date Display Optimization			Checked/ Unchecked	-	-	-	-
					Checked/ Unchecked	-	-	-	-
	Title Line				Checked/ Unchecked	-	-	-	
					Checked/ Unchecked	-	-	-	
	Message box display	Show alarm message			Checked/ Unchecked	-	-	-	
	Display Items	Group No.			Checked	Properties	Appearance	Column	Select Group.
					Unchecked	Properties	Appearance	Column	Not select Group.
		Display Type			Checked	Properties	Appearance	Column	Select Priority.
				Unchecked	Properties	Appearance	Column	Not select Priority.	
Priority				Checked	Properties	Appearance	Column	Select Priority.	
				Unchecked	Properties	Appearance	Column	Not select Priority.	

Alarm/Event Summary and History Object

User Alarms Viewer

CX-Designer				Sysmac Studio					
Tab	1st Level	2nd Level	3rd Level	Set Value	Category	Group	Property	Set Value	
Display	Display Items	Checked Time (Date&Time)		Checked/ Unchecked	-	-	-	-	
		No. of Occurrences		Checked/ Unchecked	-	-	-	-	
		Time of Occur.		Checked	Properties	Appearance	Column	Select Date and Time.	
				Unchecked	Properties	Appearance	Column	Not select Date and Time.	
		Time of Cancel		Checked/ Unchecked	-	-	-	-	
		Info1		Checked	Properties	Appearance	Column	Select Additional Information.	
				Unchecked	Properties	Appearance	Column	Not select Additional Information.	
		Info2		Checked/ Unchecked	-	-	-	-	
		Info3		Checked/ Unchecked	-	-	-	-	
	Ruled Line	Display Ruled Line		Checked/ Unchecked	-	-	-	-	
	History Display Type	Display Time of Occurrence/ Cancellation in the Same Line		Checked/ Unchecked	-	-	-	-	
		Display Time of Occurrence/ Cancellation in the Separated Line		Checked/ Unchecked	-	-	-	-	
	Colors for Showing Statuses	Occurring Unchecked			Properties	Appearance	RaisedUnacknowledgedColor	The same color as NS	
		Occurring Checked			Properties	Appearance	RaisedAcknowledgedColor	The same color as NS	
Cancelled Unchecked				Properties	Appearance	ClearedUnacknowledgedColor	The same color as NS		
Cancelled Checked				Properties	Appearance	ClearedAcknowledgedColor	The same color as NS		
Text	Text Attribute			Refer to the "Text Attributes" sheet in "Appendix 2: Object Common Settings."					
	Use Text Color/Font of Alarm/Event Setting			Checked/ Unchecked	-	-	-	-	
Background	Tile Background			Checked	-	-	-	-	
				Unchecked	Properties	Appearance	BackgroundColor	Transparent	
	Color			Properties	Appearance	BackgroundColor	The same color as NS		
	Indirect Reference of Color	Address		Properties	Appearance	HeaderBackgroundColor	The same color as NS		
Icon	Icons	From New Date & Time		Checked/ Unchecked	-	-	-	-	
		From Old Date & Time		Checked/ Unchecked	-	-	-	-	
		From High Priority		Checked/ Unchecked	-	-	-	-	
		From Low Priority		Checked/ Unchecked	-	-	-	-	
		From High Frequency		Checked/ Unchecked	-	-	-	-	
		From Low Frequency		Checked/ Unchecked	-	-	-	-	
		Delete Selected Alarm		Checked/ Unchecked	-	-	-	-	
		Check Selected Alarm		Checked/ Unchecked	-	-	-	-	
		Check All Alarms		Checked/ Unchecked	-	-	-	-	
		Cancel All Alarms' Check		Checked/ Unchecked	-	-	-	-	
		Change Display Type		Checked/ Unchecked	-	-	-	-	
		Options	Enable Deletion of Unchecked Alarms		Checked/ Unchecked	-	-	-	-
			Enable Deletion of Currently Occurred Alarms		Checked/ Unchecked	-	-	-	-
	Display Confirmation Dialog When Deleting Alarms			Checked/ Unchecked	-	-	-	-	
	Display Confirmation Box When Canceling Checks			Checked/ Unchecked	-	-	-	-	

Alarm/Event Summary and History Objects

User Alarms Viewer

(3/3)

CX-Designer				Sysmac Studio				
Tab	1st Level	2nd Level	3rd Level	Set Value	Category	Group	Property	Set Value
Icon	Icon Size	Width			-	-	-	-
		Height			-	-	-	-
Vertical Scroll Bar	Use Scroll Bar			Checked/ Unchecked	-	-	-	-
		Buttons for Scrolling One Line			Checked/ Unchecked	-	-	-
	Buttons for Scrolling Multiple Lines	Use Buttons for Scrolling Multiple Lines			Checked/ Unchecked	-	-	-
			Lines to Scroll	Lines in 1 Page	-	-	-	-
			Lines in 1/2 Page	-	-	-	-	
	Specified Lines	-	-	-	-			
Button Size	Width				-	-	-	-
		Height			-	-	-	-
Horizontal Scroll Bar	Use Scroll Bar			Checked/ Unchecked	-	-	-	-
		Buttons for Scrolling One Row			Checked/ Unchecked	-	-	-
	Buttons for Scrolling Multiple Rows	Use Buttons for Scrolling Multiple Rows			Checked/ Unchecked	-	-	-
			Rows to Scroll	Rows in 1 Page	-	-	-	-
			Rows in 1/2 Page	-	-	-	-	
Specified No. of Rows	-	-	-	-				
Macro	Macro Execution Condition	When Selecting an Alarm/Event			-	-	-	-

◆Data Block

Alarm History

Recipe

(1/2)

CX-Designer					Sysmac Studio				
Tab	1st Level	2nd Level	3rd Level	Set Value	Category	Group	Property	Set Value	Remarks
General	Object Comment				-	-	-	-	
	Data Block Selection	Data block			Properties	Behavior	DisplayedTemplate	Group name	
	Display No. of rows				-	-	-	-	
	Field Settings				-	-	-	-	
Text	Text Attribute				Refer to the "Text Attributes" sheet in "Appendix 2: Object Common Settings."				
	Indirect Reference of Text Color			Checked/ Unchecked	-	-	-	-	
Background	Color 1				Properties	Appearance	IngredientsHeader BackgroundColor	The same color as NS	
	Color 2				-	-	-	-	Colors cannot be selected for lines.
	Color 3				-	-	-	-	Odd lines and even lines are the same color.
	Color 4				-	-	-	-	Odd lines and even lines are the same color.
	Color 5				Properties	Appearance	Ingredients BackgroundColor	The same color as NS	
Icon	Icons	Read Data File		Checked/ Unchecked	-	-	-	-	
		Write Data File		Checked/ Unchecked	-	-	-	-	
		Write to the address		Checked/ Unchecked	-	-	-	-	
		Read from the address		Checked/ Unchecked	-	-	-	-	
		Add the record		Checked/ Unchecked	-	-	-	-	
		Delete the record		Checked/ Unchecked	-	-	-	-	
	Options	Display confirmation dialog box when reading data file		Checked/ Unchecked	-	-	-	-	
		Display confirmation dialog box when writing data file		Checked/ Unchecked	-	-	-	-	
		Display confirmation dialog box when writing to the address		Checked/ Unchecked	-	-	-	-	
		Display confirmation dialog box when reading from the address		Checked/ Unchecked	-	-	-	-	
		Display confirmation dialog box when adding to the record		Checked/ Unchecked	-	-	-	-	
		Display confirmation dialog box when deleting from the record		Checked/ Unchecked	-	-	-	-	
	Icon Size	Width				-	-	-	-
Height					-	-	-	-	

Data Block

Recipe

(2/2)

CX-Designer				Sysmac Studio					
Tab	1st Level	2nd Level	3rd Level	Set Value	Category	Group	Property	Set Value	Remarks
Vertical Scroll Bar	Use Scroll Bar			Checked/ Unchecked	-	-	-	-	
	Buttons for Scrolling One Line			Checked/ Unchecked	-	-	-	-	
				Unchecked	-	-	-	-	
	Buttons for Scrolling Multiple Lines	Use Buttons for Scrolling Multiple Lines	Lines to Scroll	Checked/ Unchecked	-	-	-	-	
				Lines in 1 Page	-	-	-	-	
				Lines in 1/2 Page	-	-	-	-	
	Button Size	Width			Specified Lines	-	-	-	-
Height					-	-	-	-	
Horizontal Scroll Bar	Use Scroll Bar			Checked/ Unchecked	-	-	-	-	
	Buttons for Scrolling One Row			Checked/ Unchecked	-	-	-	-	
				Unchecked	-	-	-	-	
	Buttons for Scrolling Multiple Rows	Use Buttons for Scrolling Multiple Rows	Rows to Scroll	Checked/ Unchecked	-	-	-	-	
				Rows in 1 Page	-	-	-	-	
				Rows in 1/2 Page	-	-	-	-	
		Address			Address	Animations	Visibility		Variable mapped to the address
Macro	Before inputting numeral/string				-	-	-		
	Before writing numeral/string				-	-	-		

**Note: Do not use this document to operate the Unit.**

**OMRON Corporation Industrial Automation Company**

**Kyoto, JAPAN**

**Contact : [www.ia.omron.com](http://www.ia.omron.com)**

**Regional Headquarters**

**OMRON EUROPE B.V.**

Wegalaan 67-69, 2132 JD Hoofddorp  
The Netherlands  
Tel: (31) 2356-81-300 Fax: (31) 2356-81-388

**OMRON ELECTRONICS LLC**

2895 Greenspoint Parkway, Suite 200  
Hoffman Estates, IL 60169 U.S.A.  
Tel: (1) 847-843-7900 Fax: (1) 847-843-7787

**OMRON ASIA PACIFIC PTE. LTD.**

438B Alexandra Road, #08-01/02 Alexandra  
Technopark, Singapore 119968  
Tel: (65) 6835-3011 Fax: (65)6835-3011

**OMRON (CHINA) CO., LTD.**

Room 2211, Bank of China Tower,  
200 Yin Cheng Zhong Road,  
PuDong New Area, Shanghai, 200120, China  
Tel: (86)21-6023-0333 Fax: (86)21-5037-2388

**Authorized Distributor:**

©OMRON Corporation 2023 All Rights Reserved.  
In the interest of product improvement,  
specifications are subject to change without notice.

**Cat. No. V469-E1-02** 0423 (0423)