

Programmable Terminal

NA-series

Device Connection

User's Manual

NA5-15□101□ (-V1)

NA5-12□101□ (-V1)

NA5-9□001□ (-V1)

NA5-7□001□ (-V1)

NA-RTL□□



NOTE

All rights reserved. No part of this publication may be reproduced, stored in a retrieval system, or transmitted, in any form, or by any means, mechanical, electronic, photocopying, recording, or otherwise, without the prior written permission of OMRON.

No patent liability is assumed with respect to the use of the information contained herein. Moreover, because OMRON is constantly striving to improve its high-quality products, the information contained in this manual is subject to change without notice. Every precaution has been taken in the preparation of this manual. Nevertheless, OMRON assumes no responsibility for errors or omissions. Neither is any liability assumed for damages resulting from the use of the information contained in this publication.

Trademarks

- Sysmac and SYSMAC are trademarks or registered trademarks of OMRON Corporation in Japan and other countries for OMRON factory automation products.
- Microsoft, Windows, Windows Vista, Excel, and Visual Basic are either registered trademarks or trademarks of Microsoft Corporation in the United States and other countries.
- EtherCAT® is registered trademark and patented technology, licensed by Beckhoff Automation GmbH, Germany.
- ODVA, CIP, CompoNet, DeviceNet, and EtherNet/IP are trademarks of ODVA.
- The SD and SDHC logos are trademarks of SD-3C, LLC. 
- Portions of this software are copyright 2014 The FreeType Project (www.freetype.org). All rights reserved.
- Celeron, Intel, Intel Core and Intel Atom are trademarks of Intel Corporation in the U.S. and / or other countries.

Other company names and product names in this document are the trademarks or registered trademarks of their respective companies.

Copyrights

Microsoft product screen shots used with permission from Microsoft.

Introduction

Thank you for purchasing an NA-series Programmable Terminal.

This manual contains information that is necessary to use the NA-series Programmable Terminal. Please read this manual and make sure you understand the functionality and performance of the NA-series Programmable Terminal before you attempt to use it in a control system.

Keep this manual in a safe place where it will be available for reference during operation.

Intended Audience

This manual is intended for the following personnel, who must also have knowledge of electrical systems (an electrical engineer or the equivalent).

- Personnel in charge of introducing FA systems.
- Personnel in charge of designing FA systems.
- Personnel in charge of installing and maintaining FA systems.
- Personnel in charge of managing FA systems and facilities.

Applicable Products

This manual covers the following products.

- NA-series Programmable Terminals^{*1}

*1. Unless otherwise specified, the descriptions for the NA5-□□W□□□□ apply to the NA5-□□U□□□□ as well.

Relevant Manuals

The basic information required to use an NA-series PT is provided in the following four manuals.

- *NA-series Programmable Terminal Hardware User's Manual* (Cat. No. V117)
- *NA-series Programmable Terminal Hardware(-V1) User's Manual* (Cat. No. V125)
- *NA-series Programmable Terminal Software User's Manual* (Cat. No. V118)
- *NA-series Programmable Terminal Device Connection User's Manual* (Cat. No. V119)
- *NA-series Programmable Terminal Soft-NA User's Manual* (Cat. No. V126)

Operations are performed from the Sysmac Studio Automation Software.

Refer to the *Sysmac Studio Version 1 Operation Manual* (Cat. No. W504) for information on the Sysmac Studio.

Other manuals are necessary for specific system configurations and applications.

The following manual is also available to walk you through installations and operations up to starting actual operation using simple examples.

Refer to it as required.

- *NA-series Programmable Terminal Startup Guide Manual* (Cat. No. V120)

Manual Structure

Page Structure and Markings

The following page structure is used in this manual.

Level 1 heading
3 Installation and Wiring

Level 2 heading
3-3 Installing NA-series PTs

Level 3 heading
3-3-1 Installation in a Control Panel

Level 3 heading
Installation in a Control Panel

Level 3 heading
Give the current headings.

Page tab
3
Gives the number of the main section.

A step in a procedure
Indicates a procedure.

Special information
Icons indicate precautions, additional information, or reference information.

Manual name
NA Series Programmable Terminal Hardware User's Manual (V117)

3 - 5

Note This illustration is provided only as a sample. It may not literally appear in this manual.

Special Information

Special information in this manual is classified as follows:



Precautions for Safe Use

Precautions on what to do and what not to do to ensure safe usage of the product.



Precautions for Correct Use

Indicates precautions on what to do and what not to do to ensure proper operation and performance.



Additional Information

Additional information to read as required.

This information is provided to increase understanding or make operation easier.



Version Information

Information on differences in specifications and functionality with different versions is given.

Sections in this Manual

1	Supported Devices	1
2	Connection Methods	2
3	Connecting an OMRON NJ/NX/NY-series Controller	3
4	Connecting to an OMRON CJ-series PLC	4
5	Connecting an OMRON NX-series Safety Controller	5
6	Connecting to an OMRON Programmable Multi-Axis Controller	6
A	Appendices	A
I	Index	I

CONTENTS

Introduction.....	1
Relevant Manuals.....	2
Manual Structure.....	3
Sections in this Manual.....	5
Terms and Conditions Agreement	9
Safety Precautions.....	11
Precautions for Safe Use	15
Precautions for Correct Use	18
Regulations and Standards	19
Related Manuals.....	21
Terminology.....	32
Revision History.....	33

Section 1 Supported Devices

1-1 Supported Devices	1-2
-----------------------------	-----

Section 2 Connection Methods

2-1 System Configuration	2-2
2-2 System Configuration Using Ethernet.....	2-3
2-2-1 System Configuration Using Ethernet.....	2-3
2-2-2 Outline of Settings for Connected Devices and HMIs.....	2-4
2-2-3 Devices Required for Network Configuration.....	2-5
2-2-4 Network Installation	2-8
2-3 System Configuration Using Serial	2-11
2-3-1 System Configuration Using Serial	2-11
2-3-2 Outline of Settings for Connected Devices and HMIs.....	2-12
2-3-3 Devices Required for Network Configuration.....	2-12

Section 3 Connecting an OMRON NJ/NX/NY-series Controller

3-1	Connecting via Ethernet	3-2
3-1-1	NJ/NX/NY-series Controller Settings.....	3-3
3-1-2	HMI Settings.....	3-5

Section 4 Connecting to an OMRON CS/CJ/CP-series PLC

4-1	Connecting via Ethernet (FINS).....	4-2
4-1-1	Making Settings for the CS/CJ/CP-series PLC	4-2
4-1-2	Settings for the HMI	4-5
4-2	Connecting via EtherNet/IP	4-13
4-2-1	EtherNet/IP.....	4-13
4-2-2	Settings for the CJ-series PLC.....	4-13
4-2-3	Settings for the HMI	4-15
4-3	Connecting via Serial	4-22
4-3-1	Making Settings for the CS/CJ/CP-series PLC	4-22
4-3-2	Settings for the HMI	4-23

Section 5 Connecting an OMRON NX-series Safety Controller

5-1	Connecting via Ethernet	5-2
5-1-1	NX-series Safety Controller Settings.....	5-2
5-1-2	HMI Settings.....	5-3

Section 6 Connecting to an OMRON Programmable Multi-Axis Controller

6-1	Connection via Modbus/TCP	6-2
6-1-1	Making Settings for the Programmable Multi-Axis Controller.....	6-2
6-1-2	HMI Settings.....	6-3

Appendix

A-1	Clipboard Format for Device Variable Table Data.....	A-2
A-2	Making a Serial Connection Cable	A-3
A-2-1	Connecting the Wires to RS-232C Connectors.....	A-3
A-2-2	Connecting the Wires to RS-422A Connectors.....	A-6
A-2-3	Making a Cable for Connecting with a Connected Device	A-7
A-3	Handling of CJ1W-CIF11	A-8
A-3-1	Dimensions	A-8
A-3-2	Installation and Removal Procedures	A-9
A-3-3	Specifications	A-10
A-3-4	DIP Switch Settings.....	A-11
A-3-5	Pin Arrangement	A-12
A-3-6	Block Diagram.....	A-12
A-3-7	RS-422A Cable Shield Preparation.....	A-14
A-3-8	Connection Example	A-15

Index

Terms and Conditions Agreement

Warranty, Limitations of Liability

Warranties

● Exclusive Warranty

Omron's exclusive warranty is that the Products will be free from defects in materials and workmanship for a period of twelve months from the date of sale by Omron (or such other period expressed in writing by Omron). Omron disclaims all other warranties, express or implied.

● Limitations

OMRON MAKES NO WARRANTY OR REPRESENTATION, EXPRESS OR IMPLIED, ABOUT NON-INFRINGEMENT, MERCHANTABILITY OR FITNESS FOR A PARTICULAR PURPOSE OF THE PRODUCTS. BUYER ACKNOWLEDGES THAT IT ALONE HAS DETERMINED THAT THE PRODUCTS WILL SUITABLY MEET THE REQUIREMENTS OF THEIR INTENDED USE.

Omron further disclaims all warranties and responsibility of any type for claims or expenses based on infringement by the Products or otherwise of any intellectual property right.

● Buyer Remedy

Omron's sole obligation hereunder shall be, at Omron's election, to (i) replace (in the form originally shipped with Buyer responsible for labor charges for removal or replacement thereof) the non-complying Product, (ii) repair the non-complying Product, or (iii) repay or credit Buyer an amount equal to the purchase price of the non-complying Product; provided that in no event shall Omron be responsible for warranty, repair, indemnity or any other claims or expenses regarding the Products unless Omron's analysis confirms that the Products were properly handled, stored, installed and maintained and not subject to contamination, abuse, misuse or inappropriate modification. Return of any Products by Buyer must be approved in writing by Omron before shipment. Omron Companies shall not be liable for the suitability or unsuitability or the results from the use of Products in combination with any electrical or electronic components, circuits, system assemblies or any other materials or substances or environments. Any advice, recommendations or information given orally or in writing, are not to be construed as an amendment or addition to the above warranty.

See <http://www.omron.com/global/> or contact your Omron representative for published information.

Limitation on Liability; Etc

OMRON COMPANIES SHALL NOT BE LIABLE FOR SPECIAL, INDIRECT, INCIDENTAL, OR CONSEQUENTIAL DAMAGES, LOSS OF PROFITS OR PRODUCTION OR COMMERCIAL LOSS IN ANY WAY CONNECTED WITH THE PRODUCTS, WHETHER SUCH CLAIM IS BASED IN CONTRACT, WARRANTY, NEGLIGENCE OR STRICT LIABILITY.

Further, in no event shall liability of Omron Companies exceed the individual price of the Product on which liability is asserted.

Application Considerations

Suitability of Use

Omron Companies shall not be responsible for conformity with any standards, codes or regulations which apply to the combination of the Product in the Buyer's application or use of the Product. At Buyer's request, Omron will provide applicable third party certification documents identifying ratings and limitations of use which apply to the Product. This information by itself is not sufficient for a complete determination of the suitability of the Product in combination with the end product, machine, system, or other application or use. Buyer shall be solely responsible for determining appropriateness of the particular Product with respect to Buyer's application, product or system. Buyer shall take application responsibility in all cases.

NEVER USE THE PRODUCT FOR AN APPLICATION INVOLVING SERIOUS RISK TO LIFE OR PROPERTY OR IN LARGE QUANTITIES WITHOUT ENSURING THAT THE SYSTEM AS A WHOLE HAS BEEN DESIGNED TO ADDRESS THE RISKS, AND THAT THE OMRON PRODUCT(S) IS PROPERLY RATED AND INSTALLED FOR THE INTENDED USE WITHIN THE OVERALL EQUIPMENT OR SYSTEM.

Programmable Products

Omron Companies shall not be responsible for the user's programming of a programmable Product, or any consequence thereof.

Disclaimers

Performance Data

Data presented in Omron Company websites, catalogs and other materials is provided as a guide for the user in determining suitability and does not constitute a warranty. It may represent the result of Omron's test conditions, and the user must correlate it to actual application requirements. Actual performance is subject to the Omron's Warranty and Limitations of Liability.

Change in Specifications

Product specifications and accessories may be changed at any time based on improvements and other reasons. It is our practice to change part numbers when published ratings or features are changed, or when significant construction changes are made. However, some specifications of the Product may be changed without any notice. When in doubt, special part numbers may be assigned to fix or establish key specifications for your application. Please consult with your Omron's representative at any time to confirm actual specifications of purchased Product.

Errors and Omissions

Information presented by Omron Companies has been checked and is believed to be accurate; however, no responsibility is assumed for clerical, typographical or proofreading errors or omissions.

Safety Precautions

Definition of Precautionary Information

The following notation is used in this manual to provide precautions required to ensure safe usage of the NA-series Programmable Terminal. The safety precautions that are provided are extremely important to safety. Always read and heed the information provided in all safety precautions.

The following notation is used.



WARNING

Indicates a potentially hazardous situation which, if not avoided, could result in mild or moderate injury or at the worst, serious injury or death. Additionally, there may be severe property damage.



Caution

Indicates a potentially hazardous situation which, if not avoided, may result in minor or moderate injury, or property damage.



Precautions for Safe Use

Indicates precautions on what to do and what not to do to ensure safe usage of the product.



Precautions for Correct Use

Indicates precautions on what to do and what not to do to ensure proper operation and performance.

Symbols



The circle and slash symbol indicates operations that you must not do.
The specific operation is shown in the circle and explained in text.
This example indicates prohibiting disassembly.











The triangle symbol indicates precautions (including warnings).
The specific operation is shown in the triangle and explained in text.
This example indicates a general precaution.



The filled circle symbol indicates operations that you must do.
The specific operation is shown in the circle and explained in text.
This example shows a general precaution for something that you must do.

Warnings

 WARNING	
Do not attempt to take the NA Unit apart and do not touch the product inside while the power is being supplied. Otherwise it may result in electric shock.	
Always ensure that the personnel in charge confirm that installation, inspection, and maintenance were properly performed for the NA Unit. "Personnel in charge" refers to individuals qualified and responsible for ensuring safety during machine design, installation, operation, maintenance, and disposal.	
Ensure that installation and post-installation checks are performed by personnel in charge who possess a thorough understanding of the machinery to be installed.	
Do not use the input functions such as the touch panel or function keys of the NA Unit, in applications that involve human life, in applications that may result in serious injury, or for emergency stop switches.	
Do not attempt to disassemble, repair, or modify the NA Unit. It may cause NA Unit to lose its safety function.	
Never press two points or more on the touch panel of the NA Unit at a time. Touching two points or more interrupts normal touch panel operations.	
To conform to UL Type 4X standards, always use the NA5-□□W□□□□ (-V1) with a High-pressure Waterproof Attachment (PWA). If you do not use a PWA, there is a risk of water entry, which may cause severe equipment damage.	
Always pay attention to the inside dimensions when you mount a PWA on the NA5-□□W□□□□ (-V1). If you do not mount the PWA correctly, there is a risk of water entry, which may cause severe equipment damage.	

Security Measures

Anti-virus protection

Install the latest commercial-quality antivirus software on the computer connected to the control system and maintain to keep the software up-to-date.



Security measures to prevent unauthorized access

Take the following measures to prevent unauthorized access to our products.

- Install physical controls so that only authorized personnel can access control systems and equipment.
- Reduce connections to control systems and equipment via networks to prevent access from untrusted devices.
- Install firewalls to shut down unused communications ports and limit communications hosts and isolate control systems and equipment from the IT network.
- Use a virtual private network (VPN) for remote access to control systems and equipment.
- Adopt multifactor authentication to devices with remote access to control systems and equipment.
- Set strong passwords and change them frequently.
- Scan virus to ensure safety of USB drives or other external storages before connecting them to control systems and equipment.



Data input and output protection

Validate backups and ranges to cope with unintentional modification of input/output data to control systems and equipment.

- Checking the scope of data
- Checking validity of backups and preparing data for restore in case of falsification and abnormalities
- Safety design, such as emergency shutdown and fail-soft operation in case of data tampering and abnormalities



Data recovery

Backup data and keep the data up-to-date periodically to prepare for data loss.



When using an intranet environment through a global address, connecting to an unauthorized terminal such as a SCADA, HMI or to an unauthorized server may result in network security issues such as spoofing and tampering. You must take sufficient measures such as restricting access to the terminal, using a terminal equipped with a secure function, and locking the installation area by yourself.



When constructing an intranet, communication failure may occur due to cable disconnection or the influence of unauthorized network equipment. Take adequate measures, such as restricting physical access to network devices, by means such as locking the installation area.



When using a device equipped with the SD Memory Card function, there is a security risk that a third party may acquire, alter, or replace the files and data in the removable media by removing the removable media or unmounting the removable media.

Please take sufficient measures, such as restricting physical access to the Controller or taking appropriate management measures for removable media, by means of locking the installation area, entrance management, etc., by yourself.



Precaution



Wiring

Observe the following precautions when wiring the NA5-□□W□□□□-V1.

The internal power supply in the NA5-□□W□□□□-V1 is a non-isolated DC power supply. Never ground the 24 V side. If the 24 V power supply to the NA is grounded positively, a short circuit will occur as shown below and may result in damage to the device.

24 V Grounding Power Supply

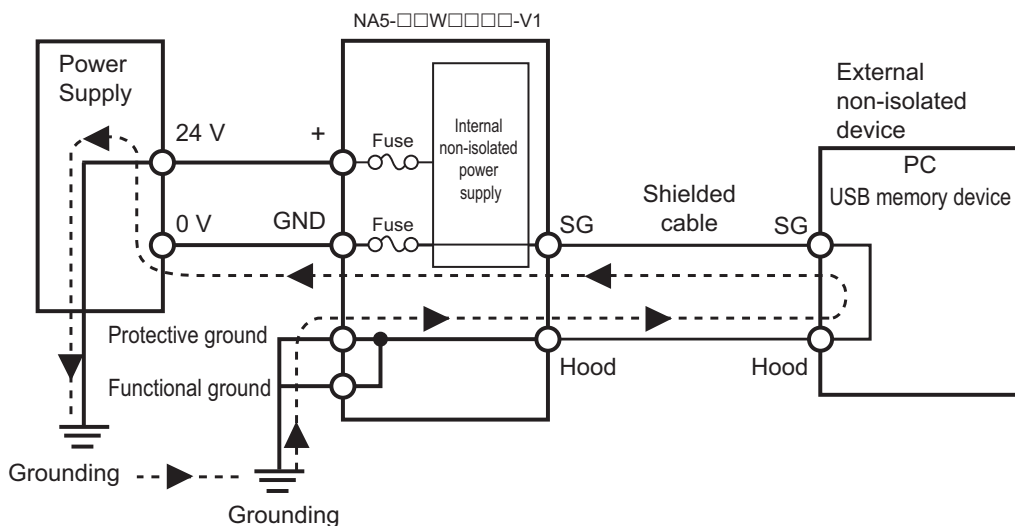

NA5-□□W□□□□-V1 grounding diagram

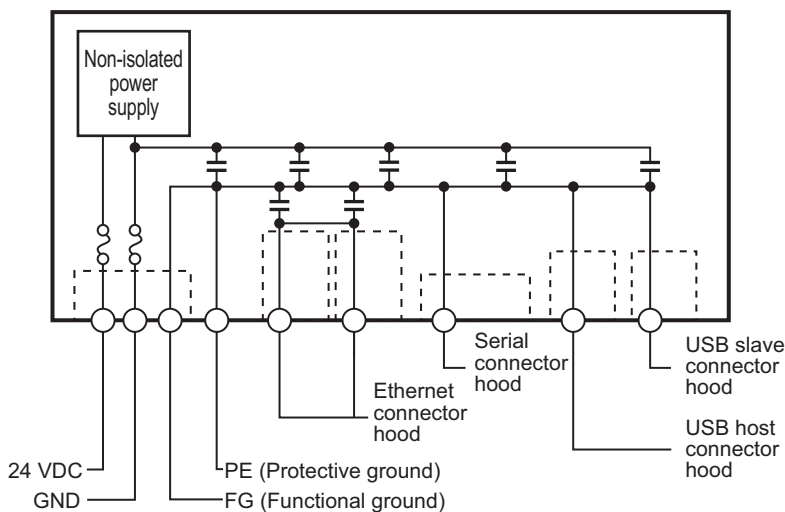

Additional Information

The internal power supply of the NA5-□□W□□□□ Product uses an isolated DC power supply, and therefore is not susceptible to the effects of grounding of the 24 V side.

Precautions for Safe Use

- When unpacking the NA Unit, check carefully for any external scratches or other damages. Also, shake the NA Unit gently and check for any abnormal sound.
- The NA Unit must be installed in a control panel.
- To conform to UL Type 1 standards, the mounting panel thickness must be 1.6 to 6.0 mm. To conform to UL Type 4X standards, the thickness must be 1.6 to 4.5 mm. To conform to UL Type 4X standards, always use the NA5-□□W□□□□ (-V1) with a High-pressure Waterproof Attachment (PWA). If you do not use a PWA, there is a risk of water entry, which may cause severe equipment damage. Do not use the NA Unit outdoors. Tighten the Mounting Brackets evenly to a torque of between 0.5 and 0.6 N·m to maintain water and dust resistance. If the tightening torque exceeds the specified value, or the tightening is not even, deformation of the front panel may occur. What is more, make sure the panel is not dirty or warped, that the front surface is smooth, and that the panel is strong enough to hold the NA Unit.
- Do not let metal particles enter the NA Unit when preparing the panel.
- Turn OFF the power supply before connecting or disconnecting cables.
- Periodically check the installation conditions in applications where the NA Unit is subject to contact with oil or water.
- Be certain to use the cables with lock mechanism such as serial cable or the Ethernet cable after confirming if it is securely locked.
- Do not touch the packaging part of the circuit board with your bare hands. Discharge any static electricity from your body before handling the board.
- Do not use volatile solvents such as benzene and thinners or chemical cloths.
- Water and oil resistance will be lost if the front sheet is torn or is peeling off. Do not use the NA Unit, if the front sheet is torn or is peeling off.
- As the rubber packing will deteriorate, shrink, or harden depending on the operating environment, periodical inspection is necessary.
- Confirm the safety of the system before turning ON or OFF the power supply, or pressing the reset switch.
- The whole system may stop depending on how the power supply is turned ON or OFF. Turn ON/OFF the power supply according to the specified procedure.
- Operate DIP switch according to the following way.

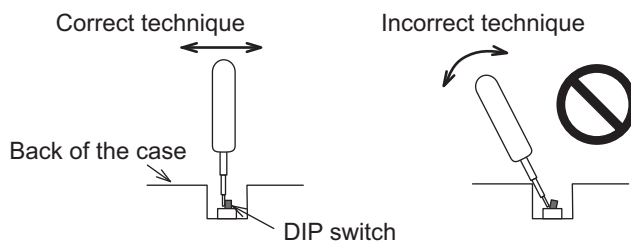

The DIP switch may break if it is levered with a tool against the case as shown in the figure.

- Once the DIP switch settings are changed, reset by pressing the reset switch, or restart the power supply.
- Initialize the project, after confirming that existing project is backed up at the Sysmac Studio.
- When changing the password, do not reset or turn OFF the power supply until the writing is completed. A failure to store the password may cause the project to fail to function.
- While uploading or downloading a project or a system program, do not perform the operations as follows. Such operations may corrupt the project or the system program:
 - Turning OFF the power supply of the NA Unit
 - Resetting the NA Unit.
 - Removing the USB devices or SD card.

- Disconnecting the cable between a support tool and the NA Unit.
- Do not connect an AC power supply to the DC power terminals.
- Do not perform a dielectric strength test.
- Use a DC power with a slight voltage fluctuation and that will provide a stable output even if the input is momentarily interrupted for 10 ms. Also use the one with reinforced insulation or double insulation.
Rated Power Supply Voltage: 24 VDC (Allowable range 19.2 to 28.8 VDC)
- Use a power cable with AWG#12 to #22 thick (0.35mm² to 3.31mm²). Peel the coating 7 mm length and tighten the terminal screw with the torque in the range of 0.5 to 0.6 N·m. Also confirm if the terminal screw is tighten appropriately.
- Ground the NA Unit correctly.
- When using the NA5-□□W□□□□-V1, to help prevent electrical shock, ground to 100 Ω or less by using dedicated ground wires (with cross-section area of 2 mm² or larger) and tighten the terminal screw on the protective ground terminal to a torque of 1.0 to 1.2 N·m.
- Do not use any battery if strong impact is applied to it (e.g. by dropping on the floor) because such a battery may cause a leakage.
- Confirm the type of the battery to install the battery properly.
- Apply power for at least five minutes before changing the battery. Mount a new battery within five minutes after turning OFF the power supply. If power is not supplied for at least five minutes, the clock data may be lost. Check the clock data after changing the battery.
- Do not dismantle a battery nor let it short-circuit.
- Do not apply an impact with the lithium battery, charge it, dispose it into a fire, or heat it. Doing either of them may cause an ignition or a bursting.
- Dispose of the NA Units and batteries according to local ordinances as they apply.



廢電池請回收

- The following precaution must be displayed on all products containing lithium primary batteries with a perchlorate content of 6 ppb or higher when exporting them to or shipping them through California, USA.

Perchlorate Material - special handling may apply.

See www.dtsc.ca.gov/hazardouswaste/perchlorate

The NA-Series contains a lithium primary battery with a perchlorate content of 6 ppb or higher. When exporting a product containing the NA-Series to or shipping such a product through California, USA, label all packing and shipping containers appropriately.

- Do not connect the USB devices in the environment subject to the strong vibration.
- Use a USB memory device for temporary purposes such as data transfer.
- Do not connect USB devices which are not allowed to connect to NA Unit.
- Start actual system application only after checking normal operation of the system including storage devices such as USB memory and SD card.
- When connecting peripheral devices which do not meet the performance level of the NA Unit for noise and static electricity, ensure sufficient countermeasures against noise and static electricity during installation of the peripheral devices to the NA Unit.
- Do not carry out the following operations when accessing USB devices or SD card:
 - Turning OFF the power supply of the NA Unit
 - Press the Reset switch of the NA Unit
 - Pull out the USB devices or SD card
- When using the No. 6 pin of the serial port connector for a voltage of DC+5 V, make sure the supply equipment's current capacity is below 250 mA before using it. The DC+5 V voltage output of the NA Unit is +5 V±5%, and the maximum current is 250 mA.

- To ensure the system's safety, make sure to incorporate a program that call periodically signals during the operation at connected device side and can confirm the normal functionality of the NA Unit before running the system.
- Start actual system application only after sufficiently checking project, subroutine and the operation of the program at the connected device side.
- To execute a subroutine with multiple threads, fully check the operation of the program that takes multithreads into consideration, before starting actual system application.
- To use numeric input functions safely, always make maximum and minimum limit settings.
- Do not press the touch panel with a force greater than 30 N.
- Do not use hard or pointed objects to operate or scrub the screen, otherwise the surface of the screen may be damaged.
- The deterioration over time may cause the touch points to move on the touch panel. Calibrate the touch panel periodically.
- A touch position detection error of approximately 20 pixels may occur due to the precision of the touch panel. Always take this into account when positioning objects on the panel so adjoining objects will not be activated by mistake.
- Confirm the safety of the system before pressing the touch panel.
- Do not accidentally press the touch panel when the backlight is not lit or when the display does not appear or is too dark to identify visually.
- You can change the brightness by changing the setting such as in the system menu or by downloading project.
If the brightness is set to very dark, it causes flickering or unreadable screen. Additionally, the brightness can be restored by transferring the project again after setting the property of the brightness appropriately.
In a case of the applications where end users can control the brightness, create the applications so as keeping on operations by such as assigning the function which restores the brightness to one of function keys, if necessary.
- Signals from the touch panel may not be entered if the touch panel is pressed consecutively at high speed. Make sure to go on the next operation after confirming that the NA Unit has detected the input of the touch panel.
- The function keys have the restrictions as follows:
 - When you use gloves or others, the function keys may not work correctly depending on the material and thickness of the gloves. Take actual conditions of the gloves usage into considerations prior to the system startup to perform the confirmation.
 - The function keys do not work when covered with water. Remove the water completely before use.

Precautions for Correct Use

- **Do not install or store the NA Unit in any of the following locations:**

- Locations subject to severe changes in temperature
- Locations subject to temperatures or humidity outside the range specified in the specifications
- Locations subject to condensation as the result of high humidity
- Locations subject to corrosive or flammable gases
- Locations subject to strong shock or vibration
- Locations outdoors subject to direct wind and rain
- Locations subject to strong ultraviolet light
- Locations subject to dust
- Locations subject to direct sunlight
- Locations subject to splashing oil or chemicals

- **Take appropriate and sufficient countermeasures when installing systems in the following locations:**

- Locations subject to static electricity or other forms of noise
- Locations subject to strong electric field or magnetic field
- Locations close to power supply lines
- Locations subject to possible exposure to radioactivity

- **Mounting Panel**

- To conform to UL Type 1 standards, the mounting panel thickness must be 1.6 to 6.0 mm.
- To conform to UL Type 4X standards, the thickness must be 1.6 to 4.5 mm.
To conform to UL Type 4X standards, always use the NA5-□□W□□□□ (-V1) with a High-pressure Waterproof Attachment (PWA). If you do not use a PWA, there is a risk of water entry, which may cause severe equipment damage.
- Tighten the Mounting Brackets evenly to a torque of between 0.5 and 0.6 N·m to maintain water and dust resistance. If the tightening torque exceeds the specified range or the tightening is not even, deformation of the front panel may occur. Make sure the panel is not dirty or warped, that the front surface is smooth, and that the panel is strong enough to hold the NA Unit.

Regulations and Standards

Conformance to EMC Regulations

Concepts

NA-series PTs are industrial electrical devices that are incorporated into various types of machines and manufacturing equipment. The products conform to the relevant standards so that the machines and equipment incorporating the Omron products can comply with EMC Regulations more easily.

Refer to the OMRON website (www.ia.omron.com) or ask your OMRON representative for the most recent standards to which our products conform.

To ensure that your machine or equipment complies with EMC regulations, please observe the following precautions.

- The NA Unit is defined as an in-panel device and must be installed within a control panel.
- NA-series PTs complies with the emission standards. For the radiated emission requirements, in particular, please note that the actual emission varies depending on the configuration of the control panel to be used, the connected devices, and wiring methods. Therefore, customers themselves must confirm that the entire machine or equipment conforms to EMC regulations, even you are using a device that conforms to EMC regulations.
- You must use reinforced insulation or double insulation for the DC power supplies connected to the NA Unit.

Caution:

This equipment is not intended for use in residential environments and may not provide adequate protection to radio reception in such environments.

Conformance to KC Standards

When you use this product in South Korea, observe the following precautions.

사 용 자 안 내 문

이 기기는 업무용 환경에서 사용할 목적으로 적합성평가를 받은 기기로서 가정용 환경에서 사용하는 경우 전파간섭의 우려가 있습니다.

This product meets the electromagnetic compatibility requirements for business use. There is a risk of radio interference when this product is used in home.

Related Manuals

The following manuals are related to the NA-series PTs. Use these manuals for reference.

Manual name	Cat. No.	Models	Applications	Description
NA-series Programmable Terminal Hardware User's Manual	V117	NA5-□W□□□□	Learning the specifications and settings required to install an NA-series PT and connect peripheral devices.	Information is provided on NA-series PT specifications, part names, installation procedures, and procedures to connect an NA Unit to peripheral devices. Information is also provided on maintenance after operation and troubleshooting.
NA-series Programmable Terminal Hardware(-V1) User's Manual	V125	NA5-□W□□□□-V1	Learning the specifications and settings required to install an NA-series PT and connect peripheral devices.	Information is provided on NA-series PT specifications, part names, installation procedures, and procedures to connect an NA Unit to peripheral devices. Information is also provided on maintenance after operation and troubleshooting.
NA-series Programmable Terminal Software User's Manual	V118	NA5-□W□□□□ (-V1)	Learning about NA-series PT pages and object functions.	NA-series PT pages and object functions are described.
NA-series Programmable Terminal Device Connection User's Manual	V119	NA5-□W□□□□ (-V1)	Learning the specifications required to connect devices to an NA-series PT.	Information is provided on connection procedures and setting procedures to connect an NA-series PT to a Controller or other device.
NA-series Programmable Terminal Soft-NA User's Manual	V126	NA-RTLD□□	Learning about the procedure to install the Soft-NA and differences from the NA5 series.	Information is provided on the specifications of the Soft-NA and differences from the NA5 series. Information is also provided on maintenance after operation and troubleshooting.
NA-series Programmable Terminal Startup Guide	V120	NA5-□W□□□□	Learning in concrete terms information required to install and start the operation of an NA-series PT.	The part names and installation procedures are described followed by page creation and transfer procedures with the Sysmac Studio. Also operation, maintenance, and inspection procedures after the project is transferred are described. Sample screen captures are provided as examples.

Manual name	Cat. No.	Models	Applications	Description
NX-series CPU Unit Hardware User's Manual	W535	NX701-□□□□	Learning the basic specifications of the NX-series CPU Units, including introductory information, designing, installation, and maintenance. Mainly hardware information is provided.	An introduction to the entire NX-series system is provided along with the following information on the CPU Unit. <ul style="list-style-type: none"> • Features and system configuration • Introduction • Part names and functions • General specifications • Installation and wiring • Maintenance and inspection Use this manual together with the <i>NJ/NX-series CPU Unit Software User's Manual</i> (Cat. No.W501).
NJ-series CPU Unit Hardware User's Manual	W500	NJ501-□□□□ NJ301-□□□□ NJ101-□□□□	Learning the basic specifications of the NJ-series CPU Units, including introductory information, designing, installation, and maintenance. Mainly hardware information is provided.	An introduction to the entire NJ-series system is provided along with the following information on a Controller built with a CPU Unit. <ul style="list-style-type: none"> • Features and system configuration • Introduction • Part names and functions • General specifications • Installation and wiring • Inspection and maintenance Use this manual together with the <i>NJ-series CPU Unit Software User's Manual</i> (Cat. No. W501).
NJ/NX-series CPU Unit Software User's Manual	W501	NX701-□□□□ NX502-□□□□ NX102-□□□□ NX1P2-□□□□ NJ501-□□□□ NJ301-□□□□ NJ101-□□□□	Learning how to program and set up an NJ/NX-series CPU Unit. Mainly software information is provided.	Provides the following information on a Controller built with an NJ/NX-series CPU Unit. <ul style="list-style-type: none"> • CPU Unit operation • CPU Unit features • Initial settings • Programming based on IEC 61131-3 language specifications
NJ/NX-series Instructions Reference Manual	W502	NX701-□□□□ NX102-□□□□ NX1P2-□□□□□□ NJ501-□□□□ NJ301-□□□□ NJ101-□□□□	Learning detailed specifications on the basic instructions of an NJ/NX-series CPU Unit.	The instructions in the instruction set (IEC 61131-3 specifications) are described.
NJ/NX-series Troubleshooting Manual	W503	NX701-□□□□ NX102-□□□□ NX1P2-□□□□□□ NJ501-□□□□ NJ301-□□□□ NJ101-□□□□	Learning about the errors that may be detected in an NJ/NX-series Controller.	Concepts on managing errors that may be detected in an NJ/NX-series Controller and information on individual errors are described.

Manual name	Cat. No.	Models	Applications	Description
CJ Series Programmable Controllers Operation Manual	W393	CJ1H-CPU□□H-R CJ1G/H-CPU□□H CJ1G-CPU□□P CJ1M-CPU□□ CJ1G-CPU□□	Learning the basic specifications of the CJ-series PLCs, including introductory information, designing, installation, and maintenance.	The following information is provided on a CJ-series PLC. <ul style="list-style-type: none"> • Introduction and features • System configuration design • Installation and wiring • I/O memory allocation • Troubleshooting Use this manual together with the <i>Programming Manual</i> (Cat. No. W394).
CS/CJ/NSJ-series Programmable Controllers Operation Manual	W394	CS1G/H-CPU□□H CS1G/H-CPU□□-V1 CS1D-CPU□□H CS1D-CPU□□S CJ1H-CPU□□H-R CJ1G/H-CPU□□H CJ1G-CPU□□P CJ1M-CPU□□ CJ1G-CPU□□ NSJ□-□□□□(B)-G5D NSJ□-□□□□(B)-M3D	Learning about the functions of the CS/CJ-series and NSJ-series PLCs.	The following information is provided on a CS/CJ-series or NSJ-series PLC. <ul style="list-style-type: none"> • Programming • Master function • File memory • Other functions Use this manual together with the <i>Operation Manual</i> (CS-series PLCs: W339, CJ-series PLCs: W393).
CS/CJ/NJ-series Instructions Reference Manual	W340	CS1□-CPU-□□□-□□ CJ1□-CPU-□□□-□□□ CJ2H-CPU-□□□-□□□ NSJ□□-□□□□□-□□□	Learning detailed information on programming instructions.	Instructions are described in detail. When programming, use this manual together with the <i>Operation Manual</i> (CS-series PLCs: W339, CJ-series PLCs: W393) and the <i>Programming Manual</i> (W394).
CS/CJ Series Programming Consoles Operation Manual	W341	CQM1H-PRO01 CQM1-PRO01 C200H-PRO27 +CS1W-KS001	Learning the operating procedures of the Programming Consoles.	The operating procedures of the Programming Consoles are described. When programming, use this manual together with the <i>Operation Manual</i> (CS-series PLCs: W339, CJ-series PLCs: W393), the <i>Programming Manual</i> (W394), and the <i>Instructions Reference Manual</i> (W340).

Manual name	Cat. No.	Models	Applications	Description
CS/CJ/NSJ Series Communications Commands Reference Manual	W342	CS1G/H-CPU□□H CS1G/H-CPU□□-V1 CS1D-CPU□□H CS1D-CPU□□S CS1W-SCU□□-V1 CS1W-SCB□□-V1 CJ1G/H-CPU□□H CJ1G-CPU□□P CJ1M-CPU□□ CJ1G-CPU□□ CJ1W-SCU□□-V1	Learning detailed specifications on the communications instructions addressed to CS/CJ-series CPU Units and NSJ-series PLCs.	1) C-mode commands and 2) FINS commands are described in detail. Refer to this manual for information on communications commands (C-mode commands and FINS commands) addressed to CPU Units. Note This manual describes communications commands that are addressed to a CPU Unit. The communications path is not relevant. (The communications commands can be sent through the serial communications port of the CPU Unit, the communications port of a Serial Communications Board/Unit, or a communications port on another Communications Unit.)
CJ-series CJ2 CPU Unit Hardware User's Manual	W472	CJ2H-CPU6□-EIP CJ2H-CPU6□ CJ2M-CPU□□	Learning the hardware specifications of CJ2 CPU Units.	The following information is provided on a CJ2 CPU Unit. <ul style="list-style-type: none"> • Introduction and features • Basic system configuration • Part names and functions • Installation and setting procedures • Troubleshooting Use this manual together with the <i>Software User's Manual</i> (Cat. No. W473).
CJ-series CJ2 CPU Unit Software User's Manual	W473	CJ2H-CPU6□-EIP CJ2H-CPU6□ CJ2M-CPU□□	Learning the software specifications of CJ2 CPU Units.	The following information is provided on a CJ2 CPU Unit. <ul style="list-style-type: none"> • CPU Unit operation • Internal memory • Programming • Settings • Functions built into the CPU Unit Use this manual together with the <i>Hardware User's Manual</i> (Cat. No. W472).
Ethernet Units Operation Manual Construction of Networks	W420	CS1W-ETN21 CJ1W-ETN21	Learning how to use an Ethernet Unit.	Information is provided on the Ethernet Units. Information is provided on the basic setup and FINS communications. Refer to the <i>Communications Commands Reference Manual</i> (Cat. No. W342) for details on FINS commands that can be sent to CS/CJ-series CPU Units when using the FINS communications service.
Ethernet Units Operation Manual Construction of Applications	W421	CS1W-ETN21 CJ1W-ETN21	Learning how to use an Ethernet Unit.	Information is provided on constructing host applications, including functions for sending/receiving mail, socket service, automatic clock adjustment, FTP server functions, and FINS communications.

Manual name	Cat. No.	Models	Applications	Description
CS/CJ-series EtherNet/IP™ Units Operation Manual	W465	CJ2H-CPU6□-EIP CJ2M-CPU3□ CS1W-EIP21 CJ1W-EIP21	Learning how to use the built-in EtherNet/IP port of the CJ2 CPU Units.	Information is provided on the built-in EtherNet/IP port and EtherNet/IP Units. Basic settings, tag data links, FINS communications, and other functions are described.
Sysmac Studio Version 1 Operation Manual	W504	SYSMAC-SE2□□□	Learning about the operating procedures and functions of the Sysmac Studio.	The operating procedures of the Sysmac Studio are described.
CX-Programmer Operation Manual	W446	CXONE-AL□□C-V4 CXONE-AL□□D-V4	Learning about the CX-Programmer except for information on function blocks, ST programming, and SFC programming.	The operating procedures of the CX-Programmer are described.
NY-Series Industrial Box PC User's Manual	W553	NYB□□-□1□□□	Learning the basic specifications of the NY-series Industrial Box PCs, including introductory information, designing, installation, and maintenance.	An introduction to the entire NY-series system is provided along with the following information on the Industrial Box PC. <ul style="list-style-type: none"> • Features and system configuration • Introduction • Part names and functions • General specifications • Installation and wiring • Maintenance and inspection
NY-Series Industrial Panel PC User's Manual	W555	NYP□□-□1□□□-□□W C100□	Learning the basic specifications of the NY-series Industrial Panel PCs, including introductory information, designing, installation, and maintenance.	An introduction to the entire NY-series system is provided along with the following information on the Industrial Panel PC. <ul style="list-style-type: none"> • Features and system configuration • Introduction • Part names and functions • General specifications • Installation and wiring • Maintenance and inspection
NY-Series IPC Machine Controller Industrial Box PC Hardware User's Manual	W556	NY512-1□□□	Learning the basic specifications of the NY-series Industrial Box PCs, including introductory information, designing, installation, and maintenance. Mainly hardware information is provided.	An introduction to the entire NY-series system is provided along with the following information on the Industrial Box PC. <ul style="list-style-type: none"> • Features and system configuration • Introduction • Part names and functions • General specifications • Installation and wiring • Maintenance and inspection

Manual name	Cat. No.	Models	Applications	Description
NY-Series IPC Machine Controller Industrial Panel PC Hardware User's Manual	W557	NY532-1□□□	Learning the basic specifications of the NY-series Industrial Panel PCs, including introductory information, designing, installation, and maintenance. Mainly hardware information is provided.	An introduction to the entire NY-series system is provided along with the following information on the Industrial Panel PC. <ul style="list-style-type: none"> • Features and system configuration • Introduction • Part names and functions • General specifications • Installation and wiring • Maintenance and inspection
NY-Series IPC Machine Controller Industrial Panel PC / Industrial Box PC Software User's Manual	W558	NY532-1□□□ NY512-1□□□	Learning how to program and set up the Controller functions of an NY-series Industrial PC.	The following information is provided on the NY-series Controller functions. <ul style="list-style-type: none"> • Controller operation • Controller features • Controller settings • Programming based on IEC 61131-3 language specifications
NY-Series Instructions Reference Manual	W560	NY532-1□□□ NY512-1□□□	Learning detailed specifications on the basic instructions of an NY-series Industrial PC.	The instructions in the instruction set (IEC 61131-3 specifications) are described.
NY-Series Troubleshooting Manual	W564	NY532-1□□□ NY512-1□□□	Learning about the errors that may be detected in an NY-series Industrial PC.	Concepts on managing errors that may be detected in an NY-series Controller and information on individual errors are described.
NX-series NX1P2 CPU Unit Hardware User's Manual	W578	NX1P2-□□□□	Learning the basic specifications of the NX-series NX1P2 CPU Units, including introductory information, designing, installation, and maintenance. Mainly hardware information is provided.	An introduction to the entire NX1P2 system is provided along with the following information on the NX1P2 CPU Unit. <ul style="list-style-type: none"> • Features and system configuration • Introduction • Part names and functions • General specifications • Installation and wiring • Maintenance and inspection

Manual name	Cat. No.	Models	Applications	Description
NX-series NX1P2 CPU Unit Built-in I/O and Option Board User's Manual	W579	NX1P2-□□□□	Learning about the details of functions only for an NX-series NX1P2 CPU Unit and an introduction of functions for an NJ/NX-series CPU Unit.	Of the functions for an NX1P2 CPU Unit, the following information is provided. <ul style="list-style-type: none"> • Built-in I/O • Serial Option Boards • Analog Option Boards An introduction of following functions for an NJ/NX-series CPU Unit is also provided. <ul style="list-style-type: none"> • Motion control functions • EtherNet/IP communications functions • EtherCAT communications functions
NX-series NX102 CPU Unit Hardware User's Manual	W593	NX102-□□□□	Learning the basic specifications of NX102 CPU Units, including introductory information, design, installation, and maintenance. Mainly hardware information is provided.	An introduction to the entire NX102 system is provided along with the following information on the CPU Unit. <ul style="list-style-type: none"> • Features and system configuration • Introduction • Part names and functions • General specifications • Installation and wiring • Maintenance and inspection
NX-series Safety Control Unit / Communication Control Unit User's Manual	Z395	NX-SL5□□□ NX-SI□□□□ NX-SO□□□□ NX-CSG□□□	Learning how to use the NX-series Safety Control Units and Communications Control Units.	Describes the hardware, setup methods, and functions of the NX-series Safety Control Units and Communications Control Units.
NX-series Communication Control Unit Built-in Function User's Manual	Z396	NX-CSG□□□	Learning about the built-in functions of an NX-series Communications Control Unit.	Describes the software setup methods and communications functions of an NX-series Communications Control Unit.
CK3E-series Programmable Multi-Axis Controller Hardware User's Manual	I610	CK3E-1□10	Learning the basic specifications of the CK3E-series Programmable Multi-Axis Controller, including introductory information, design, installation, and maintenance. Mainly hardware information is provided.	An introduction to the entire CK3E-series system is provided along with the following information. <ul style="list-style-type: none"> • Features and system configuration • Introduction • Part names and functions • General specifications • Installation and wiring • Maintenance and inspection

Manual name	Cat. No.	Models	Applications	Description
CK3M-series Programmable Multi-Axis Controller Hardware User's Manual	O036	CK3M-CPU1□1	Learning the basic specifications of the CK3M-series Programmable Multi-Axis Controller, including introductory information, design, installation, and maintenance. Mainly hardware information is provided.	An introduction to the entire CK3M-series system is provided along with the following information. <ul style="list-style-type: none"> • Features and system configuration • Introduction • Part names and functions • General specifications • Installation and wiring • Maintenance and inspection
Power PMAC User's Manual	O014	CK3E-1□10 CK3M-CPU1□1	Learning the features and usage examples of the CK3E-series Programmable Multi-Axis Controller.	The following information is provided on a CK3E-series Programmable Multi-Axis Controller. <ul style="list-style-type: none"> • Basic features of the motion controller Power Programmable Multi-Axis Controller possessed by the Programmable Multi-Axis Controller. <ul style="list-style-type: none"> • Setup examples • Programming examples
Power PMAC Software Reference Manual	O015	CK3E-1□10 CK3M-CPU1□1	Learning how to program a CK3E-series Programmable Multi-Axis Controller.	The following information is provided on a CK3E-series Programmable Multi-Axis Controller. <ul style="list-style-type: none"> • Details of commands • Details of data structure
Power PMAC IDE User Manual	O016	CK3E-1□10 CK3M-CPU1□1	Learning how to operate Power PMAC IDE, the integrated development environment of the Controller.	Describes the operating procedures of Power PMAC IDE, and examples of how to start the system.
NJ-series Robot Integrated CPU Unit User's Manual	O037	NJ501-R□□□	Using the NJ-series Robot Integrated CPU Unit.	Describes the settings and operation of the CPU Unit and programming concepts for OMRON robot control.
CS Series Programmable Controllers Operation Manual	W339	CS1G-CPU□□H CS1H-CPU□□H	Learning the basic specifications of the CS-series PLCs, including introductory information, designing, installation, and maintenance.	The following information is provided on a CS-series PLC. <ul style="list-style-type: none"> • Introduction and features • System configuration design • Installation and wiring • I/O memory allocation • Troubleshooting Use this manual together with the Programming Manual (Cat. No. W394).

Manual name	Cat. No.	Models	Applications	Description
CS Series Duplex System Operation Manual	W405	CS1D-CPU□□H(A) CS1D-CPU□□S(A)	Learning the basic specifications of the CS-series Duplex System, including introductory information, designing, installation, and maintenance.	The following information is provided on a CS-series Duplex System. <ul style="list-style-type: none"> • Introduction and features • System configuration design • Installation and wiring • I/O memory allocation • Troubleshooting Use this manual together with the Programming Manual (Cat. No. W394).
CP Series CP1H CPU Unit Operation Manual	W450	CP1H-□□□□□-□	Learning the basic specifications of the CP1H CPU Unit, including introductory information, designing, installation, and maintenance.	Provide the following information on the CP Series: <ul style="list-style-type: none"> • Overview, design, installation, maintenance, and other basic specifications • Features • System configuration • Mounting and wiring • I/O memory allocation • Troubleshooting Use this manual together with the CP1H Programmable Controllers Programming Manual (W451).
CP Series CP1L CPU Unit Operation Manual	W462	CP1L-L□□□□-□ CP1L-M□□□□-□	Learning the basic specifications of the CP1L CPU Unit, including introductory information, designing, installation, and maintenance.	Provides the following information on the CP Series: <ul style="list-style-type: none"> • Overview, design, installation, maintenance, and other basic specifications • Features • System configuration • Mounting and wiring • I/O memory allocation • Troubleshooting Use this manual together with the CP1L Programmable Controllers Programming Manual (W451).
CP Series CP1L-EL/EM CPU Unit Operation Manual	W516	CP1L-E□□□□-□	Learning the basic specifications of the CP1L-EL/EM CPU Unit, including introductory information, designing, installation, and maintenance.	Provides the following information on the CP Series: <ul style="list-style-type: none"> • Overview, design, installation, maintenance, and other basic specifications • Features • System configuration • Mounting and wiring • I/O memory allocation • Troubleshooting Use this manual together with the CP1L Programmable Controllers Programming Manual (W451).
CP Series CP1H and CP1L CPU Unit Programming Manual	W451	CP1H-□□□□□-□ CP1L-□□□□□-□	Learning about the functions of the CP Series CP1H CPU Units.	Provides the following information on the CP Series: <ul style="list-style-type: none"> • Programming instructions • Programming methods • Tasks • File memory • Functions Use this manual together with the CP Series CP1H CPU Units Operation Manual (W450) and CP Series CP1L CPU Units Operation Manual (W462).

Manual name	Cat. No.	Models	Applications	Description
CP Series CP2E CPU Unit Hardware User's Manual	W613	CP2E-□□□□□-□	To learn the hardware specifications of the CP Series CP2E CPU Unit.	Describes the following information for CP2E PLCs. <ul style="list-style-type: none"> • Overview and features • Basic system configuration • Part names and functions • Installation and settings • Troubleshooting Use this manual together with the CP2E CPU Unit Software User's Manual (Cat. No. W614) and Instructions Reference Manual (Cat. No.W483).
CP Series CP2E CPU Unit Software User's Manual	W614	CP2E-□□□□□-□	To learn the software specifications of the CP Series CP2E CPU Unit.	Describes the following information for CP2E PLCs. <ul style="list-style-type: none"> • CPU Unit operation • Internal memory • Programming • Settings • CPU Unit built-in functions • Interrupts • High-speed counter inputs • Pulse outputs • Serial communications • Ethernet • Other functions Use this manual together with the CP2E CPU Unit Hardware User's Manual (Cat. No. W613) and Instructions Reference Manual (Cat. No.W483).
CP Series CP1E/CP2E CPU Unit Instructions Reference Manual	W483	CP2E-□□□□□-□	To learn programming instructions in detail.	Describes each programming instruction in detail. When programming, use this manual together with the CP2E CPU Unit Software User's Manual (Cat. No. W614).
CS/CJ Series Serial Communications Boards/Units Operation Manual	W336	CS1W-SCB□1-V1 CS1W-SCU□1-V1 CJ1W-SCU□1-V1 CJ1W-SCU□2	To learn the specifications of the hardware and serial communication mode of a serial communication board/unit.	Describes the use of Serial Communications Unit and Boards to perform serial communications with external devices, including the use of standard system protocols for OMRON products. <p>Note Refer to the CS/CJ Series Communications Commands Reference Manual (W342) for details on sending commands in host link mode from a Serial Communications Board or Unit's port.</p>

Manual name	Cat. No.	Models	Applications	Description
NX-series NX502 CPU Unit Hardware User's Manual	W629	NX502- □□□□	<p>Learning the basic specifications of NX502 CPU Units, including introductory information, design, installation, and maintenance.</p> <p>Mainly hardware information is provided.</p>	<p>An introduction to the entire NX502 system is provided along with the following information on the CPU Unit.</p> <ul style="list-style-type: none"> • Features and system configuration • Introduction • Part names and functions • General specifications • Installation and wiring • Maintenance and inspection

Terminology

Term	Description
HMI	A general term for interface devices that indicates both hardware and software elements. In this manual, "HMI" refers to an OMRON Sysmac-brand product unless otherwise specified.
PT	The hardware elements of the HMI.
NA Series	The NA Series of Programmable Terminals and peripheral devices.
NA5 Series	NA5-□W□□□□-V1 and NA5-□□□□□□.
HMI Project	A Sysmac Studio project for an HMI.
NA Unit	An NA-series Programmable Terminal.
Download	Transferring data from the Sysmac Studio to an HMI.
Upload	Transferring data from an HMI to the Sysmac Studio.
IAG collection	When you provide IAGs, you provide them as IAG collections. IAGs are also imported as IAG collections. An IAG collection contains one or more IAGs.

Revision History

A manual revision code appears as a suffix to the catalog number on the front and back covers of the manual.

Cat. No. V119-E1-14

↑ Revision code

Revision code	Date	Revised content
01	June 2014	Original production
02	April 2015	Added information on the NX701-□□□□ and NJ101-□□□□.
03	October 2015	Made revisions accompanying version upgrade.
04	December 2015	Made revisions accompanying version upgrade.
05	October 2016	Made revisions accompanying support of NX1/NY series.
06	April 2018	Made revisions accompanying support of the NX102 series.
07	July 2018	Made revisions accompanying support of the NX-series Safety Network Controller.
08	January 2019	Made revisions accompanying support of the Programmable Multi-Axis Controller.
09	April 2020	Made revisions accompanying the addition of Units.
10	April 2021	Error correction
11	July 2022	Made revisions accompanying support for secure communication with the NJ/NX series.
12	October 2022	Revisions for adding safety precautions regarding security.
13	April 2023	Support for CS-series Controllers, CP-series Controllers and NX502 series. Made revisions accompanying support for serial communication.
14	July 2023	Error correction



Supported Devices

This section lists the models that can be connected to the NA-series Programmable Terminals.

1-1 Supported Devices 1-2

1-1 Supported Devices

This section lists the devices that can be connected to the NA-series Programmable Terminals.

NA5-□□□□□□□□

Manufacturer	Models	Connection method	Communications driver
OMRON	NX102-□□□□ NX1P2-□□□□ NX502-□□□□ NX701-□□□□ NJ501-□□□□ NJ301-□□□□ NJ101-□□□□ NY512-□□□□ NY532-□□□□ NX-CSG320	Built-in EtherNet/IP port	Ethernet
	NX502-□□□□	NX-EIP201	
	CJ2H-CPU64/65/66/67/68-EIP CJ2M-CPU31/32/33/34/35	Built-in EtherNet/IP port	CIP Ethernet
	CJ2H-CPU64/65/66/67/68-EIP CJ2M-CPU31/32/33/34/35	CJ1W-EIP21	
	CJ2H-CPU64/65/66/67/68-EIP CJ2M-CPU31/32/33/34/35	Built-in EtherNet/IP port	FINS Ethernet
	CJ1H-CPU65H/66H/67H CJ1H-CPU65H/66H/67H-R CJ1G-CPU42H/43H/44H/45H CJ1M-CPU11/12/13/21/22/23 CJ2H-CPU64/65/66/67/68(-EIP) CJ2M-CPU11/12/13/14/15 CJ2M-CPU31/32/33/34/35	CJ1W-ETN21 CJ1W-EIP21	
	CK3E-1□10 CK3M-CPU1□1	Built-in Ethernet port	Modbus/TCP

NA5-□□□□□□□□-V1

Manufacturer	Models	Connection method	Communications driver
OMRON	NX102-□□□□ NX1P2-□□□□ NX502-□□□□ NX701-□□□□ NJ501-□□□□ NJ301-□□□□ NJ101-□□□□ NY512-□□□□ NY532-□□□□ NX-CSG320	Built-in EtherNet/IP port	Ethernet
	NX502-□□□□	NX-EIP201	

Manu- facturer	Models	Connection method	Communications driver	
OMRON	CJ2H-CPU64/65/66/67/68-EIP CJ2M-CPU31/32/33/34/35	Built-in EtherNet/IP port	CIP Ethernet	
	CJ2H-CPU64/65/66/67/68-EIP CJ2M-CPU31/32/33/34/35	CJ1W-EIP21		
	CJ2H-CPU64/65/66/67/68-EIP CJ2M-CPU31/32/33/34/35	Built-in EtherNet/IP port	FINS Ethernet	
	CJ1H-CPU65H/66H/67H CJ1H-CPU65H/66H/67H-R CJ1G-CPU42H/43H/44H/45H CJ1M-CPU11/12/13/21/22/23 CJ2H-CPU64/65/66/67/68(-EIP) CJ2M-CPU11/12/13/14/15 CJ2M-CPU31/32/33/34/35	CJ1W-ETN21 CJ1W-EIP21		
	CS1G-CPU42H/43H/44H/45H CS1H-CPU63H/64H/65H/66H/67H	Built-in Ethernet port CS1W-ETN21 CS1W-EIP21		
	CS1D-CPU65H/67H/67HA/68HA/44SA/67SA	Built-in Ethernet port CS1W-ETN21 CS1D-ETN21D CS1W-EIP21		
	CP1H-□□□□□-□	CP1W-CIF41		
	CP1L-□□□□□-□ CP2E-N□□D□-□	Built-in Ethernet port CP1W-CIF41		
	CK3E-1□10 CK3M-CPU1□1	Built-in Ethernet port		Modbus/TCP
	CS1G-CPU42H/43H/44H/45H CS1H-CPU63H/64H/65H/66H/67H CS1D-CPU65H/67H/67HA/68HA/44SA/67SA	Built-in RS-232C port CS1W-SCB21-V1 CS1W-SCB41-V1 CS1W-SCU21-V1 CS1W-SCU31-V1		Host Link
	CJ2H-CPU64/65/66/67/68(-EIP) CJ2M-CPU11/12/13/14/15/31/32/33/34/35	Built-in RS-232C port CJ1W-SCU22 CJ1W-SCU32 CJ1W-SCU42		
	CP1L-□□□□□-□ CP1H-□□□□□-□	CP1W-CIF01 CP1W-CIF11 CP1W-CIF12-V1		
	CP2E-□□□D□-□	Built-in RS-232C port CP1W-CIF01 CP1W-CIF11 CP1W-CIF12-V1 CP2W-CIFD1 CP2W-CIFD2		

NA-RTLDD□□

Manu-facturer	Models	Connection method	Communications driver
OMRON	NX102- □□□□	Built-in EtherNet/IP port	Ethernet
	NX1P2- □□□□		
	NX502- □□□□		
	NX701- □□□□		
	NJ501- □□□□		
	NJ301- □□□□		
	NJ101- □□□□		
	NY512- □□□□		
	NY532- □□□□		
	NX-CSG320		
NX502- □□□□	NX-EIP201		

This section lists the supported versions of Runtime.

Runtime	Models	Connection method	Communications driver
1.00	NJ501- □□□□	Built-in EtherNet/IP port	Ethernet
	NJ301- □□□□		
	CJ2H-CPU64/65/66/67/68-EIP	Built-in EtherNet/IP port	CIP Ethernet
	CJ2M-CPU31/32/33/34/35		
	CJ2H-CPU64/65/66/67/68-EIP	CJ1W-EIP21	
	CJ2M-CPU31/32/33/34/35		
1.02	CJ2H-CPU64/65/66/67/68-EIP	Built-in EtherNet/IP port	FINS Ethernet
	CJ2M-CPU31/32/33/34/35		
	CJ1H-CPU65H/66H/67H	CJ1W-ETN21	
	CJ1H-CPU65H/66H/67H-R		
	CJ1G-CPU42H/43H/44H/45H		
	CJ1M-CPU11/12/13/21/22/23		
	CJ2H-CPU64/65/66/67/68(-EIP)		
	CJ2M-CPU11/12/13/14/15		
CJ2M-CPU31/32/33/34/35			
1.07	NX701- □□□□	Built-in EtherNet/IP port	Ethernet
	NJ101- □□□□		
1.09	NX1P2- □□□□	Built-in EtherNet/IP port	Ethernet
	NY512-□□□□		
	NY532- □□□□		
1.10	NX102-□□□□	Built-in EtherNet/IP port	Ethernet
	CK3E-1□10	Built-in Ethernet port	Modbus/TCP
	CK3M-CPU1□1		
1.16	NX-CSG320	Built-in EtherNet/IP port	Ethernet
	NJ101-□□□□	Built-in EtherNet/IP port (secure communication)	Ethernet
	NJ301-□□□□		
	NJ501-□□□□		
	NX102-□□□□		
	NX1P2-□□□□		
NX701-□□□□			

Runtime	Models	Connection method	Communications driver
1.17	NX502-□□□□	Built-in Ethernet port NX-EIP201	Ethernet
	CS1G-CPU42H/43H/44H/45H CS1H-CPU63H/64H/65H/66H/67H	Built-in Ethernet port CS1W-ETN21 CS1W-EIP21	FINS Ethernet
	CS1D-CPU65H/67H/67HA/68HA/44SA/67SA	Built-in Ethernet port CS1W-ETN21 CS1D-ETN21D CS1W-EIP21	
	CP1H-□□□□□-□	CP1W-CIF41	
	CP1L-□□□□□-□ CP2E-N□□D□-□	Built-in Ethernet port CP1W-CIF41	
	CS1G-CPU42H/43H/44H/45H CS1H-CPU63H/64H/65H/66H/67H CS1D-CPU65H/67H/67HA/68HA/44SA/67SA	Built-in RS-232C port CS1W-SCB21-V1 CS1W-SCB41-V1 CS1W-SCU21-V1 CS1W-SCU31-V1	Host Link
	CJ2H-CPU64/65/66/67/68(-EIP) CJ2M-CPU11/12/13/14/15/31/32/33/34/35	Built-in RS-232C port CJ1W-SCU41 CJ1W-SCU21	
	CP1L-□□□□□-□ CP1H-□□□□□-□	CP1W-CIF01 CP1W-CIF11 CP1W-CIF12-V1	
	CP2E-□□□D□-□	Built-in RS-232C port CP1W-CIF01 CP1W-CIF11 CP1W-CIF12-V1 CP2W-CIFD1 CP2W-CIFD2	

2

Connection Methods

This section describes the required settings for each connection method and the common specifications for network installation.

2-1	System Configuration	2-2
2-2	System Configuration Using Ethernet	2-3
2-2-1	System Configuration Using Ethernet	2-3
2-2-2	Outline of Settings for Connected Devices and HMIs	2-4
2-2-3	Devices Required for Network Configuration	2-5
2-2-4	Network Installation	2-8
2-3	System Configuration Using Serial	2-11
2-3-1	System Configuration Using Serial	2-11
2-3-2	Outline of Settings for Connected Devices and HMIs	2-12
2-3-3	Devices Required for Network Configuration	2-12

2-1 System Configuration

The system configuration differs between when configured using Ethernet and when configured using serial. For details on each of the system configurations, refer to [□□ 2-2 System Configuration Using Ethernet](#) on page 2-3 and [□□ 2-3 System Configuration Using Serial](#) on page 2-11.

These configurations can also be made to coexist.



Additional Information

If processing such as that requiring communication with the HMI is executed while communication is disconnected, the retry and communication commands will not be reissued by the NA series.

For example, if the process to write True to the Boolean Var1 variable in a subroutine is executed while communication is disconnected, communication processing cannot be executed. Even if communication is restored afterwards, communication processing will not be executed again by the NA series. Therefore, a state where Var1 will be True on the NA unit and the value will still be that before the subroutine was executed on the connected device occurs.

When communication is restored after the disconnection, be careful because the above phenomenon may occur.

2-2 System Configuration Using Ethernet

This section provides brief descriptions of the system configurations. These system configurations are independent of the connected devices.

2-2-1 System Configuration Using Ethernet

You can use the following methods to connect HMIs to devices:

- Connect the HMI directly to a connected device without an Ethernet switch.
- Connect the HMI to connected devices with an Ethernet switch.

With both of the above methods, the connected device is connected via Ethernet port 1.



Additional Information

The system configuration is the same as when using the Soft-NA. The difference is that a personal computer is used instead of the HMI.

Equipment used differs according to the computer used. Refer to the manual of the relevant computer and other materials.

Connecting the HMI Directly to a Connected Device without an Ethernet Switch

You can connect the HMI to the connected device with a twisted-pair cross cable.

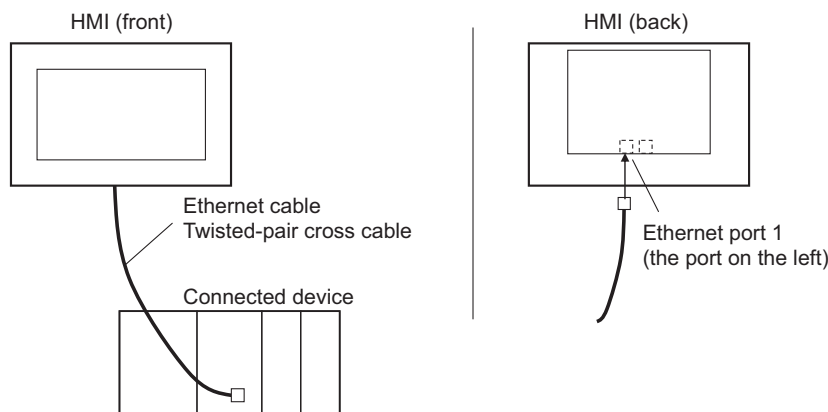

Connecting the HMI to Connected Devices with an Ethernet Switch

You can connect multiple HMIs and connected devices using a twisted-pair straight cable and an Ethernet switch.

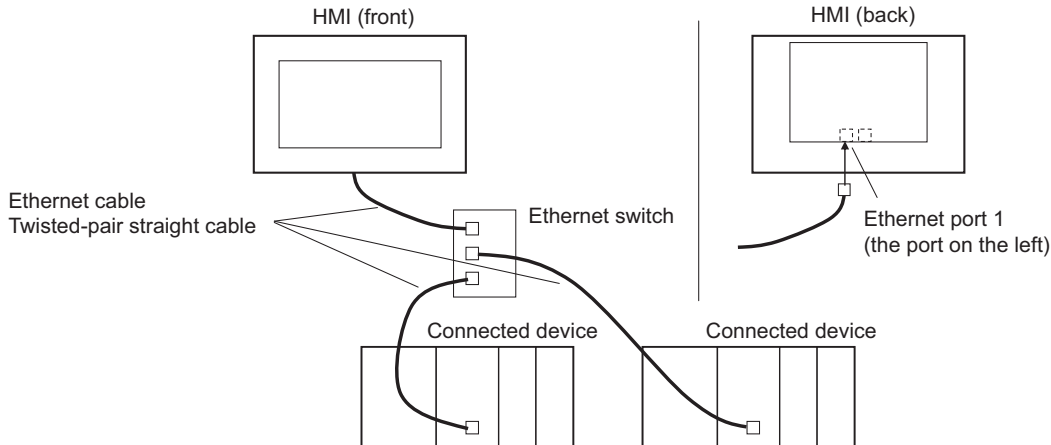

2-2-2 Outline of Settings for Connected Devices and HMIs

The following settings must be made. Detailed definitions vary with each connected device. Refer to Section 3 and later for detailed connected device descriptions.

Connected Device Settings

Set the required parameters, such as the IP addresses, using the setting tools for the connected devices.

Also register required variables if the connected devices support using variables.

Settings for Connection to the HMI

For the Sysmac Studio, you must set parameters for communications, such as the settings for Ethernet port 1, connected device registration, and variable mappings.

● Connecting to an NJ/NX/NY-series Controller, NX-series Safety Network Controller That Is Registered in the Current Project

When connecting to an NJ/NX/NY-series Controller, NX-series Safety Network Controller registered in a project, registration of connected devices is not necessary. Make the settings required only for communications and variable mapping.

● Connecting to an External Connected Device That Is Not Registered in the Current Project

- Make the settings for communications using the HMI Settings of the Sysmac Studio.
- Register the connected devices using the Device References of the Sysmac Studio. If the connected devices use variables, import the variables and register them as device variables.
- With the Variable Mappings of the Sysmac Studio, allocate the device variables to the global variables.

2-2-3 Devices Required for Network Configuration

The following devices are also required in advance to configure the network using Ethernet and must be purchased separately.

Always use products that conform to the IEEE802.3i, IEEE802.3u, and IEEE802.3ab standards for all network configuration devices.

Network configuration device	Description
Connected device that supports Ethernet	A connected device must support an Ethernet connection.
Ethernet switch	A network device that serves as a central wiring point for multiple terminals
Twisted-pair cable	Cable consisting of four twisted pairs of thin, copper wires in a cross cable or a straight cable.

Recommended Devices for Network Configuration

The following products are recommended for configuring the network using Ethernet.

● Ethernet Switches

- Ethernet Switches Manufactured by OMRON

Model	Specifications ○: Supported, ×: Not supported		
	Description	Number of ports	Failure detection output
W4S1-03B	Packet priority control (QoS): Ether-Net/IP control data priority	3	×
W4S1-05B		5	×
W4S1-05C	Failure detection: Broadcast storm, LSI error detection, 10BASE-T/100BASE-TX, auto-negotiation	5	○

- Ethernet Switches Manufactured by Other Companies

Manufacturer	Model
Cisco Systems, Inc	Consult the manufacturer.
CONTEC USA Inc	Consult the manufacturer.
Phoenix Contact USA	Consult the manufacturer.

● **Twisted-pair Cables (100BASE-TX) and Connectors (Modular Plugs and STP Plugs)**

Product name		Manufacturer	Model
Sizes and conductor pairs: AWG24 × 4P	Cables	Tonichi Kyosan Cable, Ltd.	NETSTAR-C5E SAB 0.5 × 4P
		Kuramo Electric Co., Ltd.	KETH-SB
	RJ45 Connector	Panduit Corporation	MPS588
Sizes and conductor pairs: 0.5 mm × 4P	Cables	Fujikura Ltd.	F-LINK-E 0.5mm × 4P
	RJ45 Connector	Panduit Corporation	MPS588

● **Boots**

Manufacturer	Model
TSUKO	MK Boots (IV) LB



Additional Information

Types of Ethernet Switches

- Unmanaged Layer 2 (L2) Ethernet Switches

This type of Ethernet switch uses the Ethernet addresses to switch ports. Most Ethernet switches provide this function. You cannot switch the functions or change the set values of this type of Ethernet switch.

- Managed Layer 2 (L2) Ethernet Switches

This type of Ethernet switch uses Ethernet addresses to switch ports. However, with this type of Ethernet switch, you can switch functions and change settings with special software tools running on a network node. You can also collect analytical data. This type of Ethernet switch provides more-advanced functions than unmanaged layer 2 Ethernet switches.

Ethernet Switch Functions

This section outlines the Ethernet switch functions that are important for an EtherNet/IP network.

For an EtherNet/IP network, consider whether the Ethernet switch supports these functions when you select an Ethernet switch.

- Presence or absence of multicast filtering
- Presence or absence of QoS (quality of service) for TCP/UDP port numbers (L4)

Multicast Filtering

Multicast filtering transfers multicast packets to the specific nodes only. This function is implemented in the Ethernet switch as IGMP snooping or GMRP. "Specific nodes" are the nodes equipped with an IGMP client that have made transfer requests to the Ethernet switch. (OMRON built-in EtherNet/IP ports are equipped with an IGMP client.) When the Ethernet switch does not use multicast filtering, multicast packets are sent to all nodes, just like broadcast packets, which increases the traffic on the network. Settings must be made in the Ethernet switch to enable this function. There must be enough multicast filters for the network.

QoS (Quality of Service) Function for TCP/UDP Port Numbers (L4)

This function controls the priority of packet transmissions so that packets can be sent with higher priority to a particular IP address or TCP (UDP) port. The TCP and UDP protocols are called transport layer protocols, leading to the name L4 (layer 4) QoS function.

Support for the above two functions is as follows for the different types of Ethernet switches:

Type of Ethernet switch	Multicast filtering	L4 QoS	Remarks
Unmanaged L2 Ethernet switch	None	None	---
Managed L2 Ethernet switch	Provided.	Provided.	Both functions must be set with a special software tool.
OMRON W4S1-series Ethernet Switch	None	Provided.	L4 QoS is set with a switch. No software tool is necessary.

2-2-4 Network Installation



Additional Information

When using the Soft-NA, refer to the manual of the computer used for network wiring and other materials.

Basic Installation Precautions

- Take the greatest care when you install the Ethernet system. Be sure to follow ISO/IEC 8802-3 specifications. Be sure you understand them before attempting to install an Ethernet system.
- Unless you are already experienced in installation of communications systems, we strongly recommend that you employ a professional familiar with safety measures and standards to install your system.
- Do not install Ethernet equipment near sources of noise. If a noisy environment is unavoidable, take adequate measures against noise interference, such as installation of network components in metal cases or the use of optical cable in the system.

Precautions on Laying Twisted-pair Cable

Connect to the shield connector hood as indicated below.

Physical layer	Connection methods
10Base-T	<ul style="list-style-type: none"> • Connection to both ends or • Connection to the switching hub only
100Base-TX	
1000Base-T	<ul style="list-style-type: none"> • Connection to both ends

- Press the cable connector in firmly until it locks into place at both the Ethernet switch and the Ethernet port on the NA Unit.
- Lay and wire the twisted-pair cable separately from high-voltage lines.
- Do not install the network or network devices near devices that generate noise.
- Do not install the network or network devices in locations subject to high temperatures or high humidity.
- Do not install the network or network devices in locations subject to excessive dirt and dust or to oil mist or other contaminants.

Connect the cable shields to the connector hoods as shown in either (a) or (b) below.

(a) Connecting both ends

Connect each shield to the connector hoods at both ends of each cable.

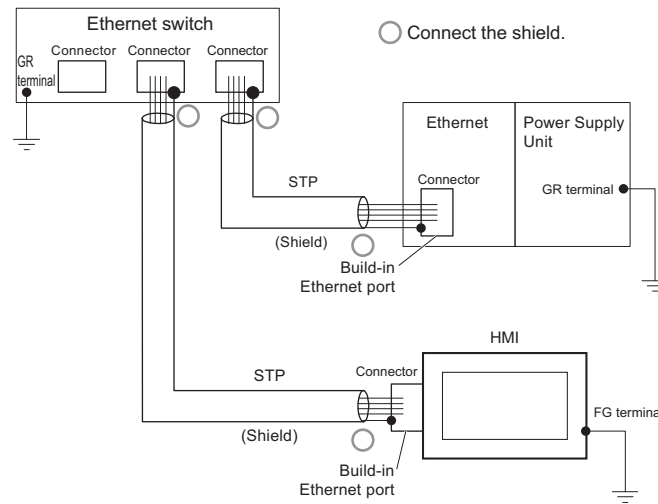

(b) Connecting each shield only to the switching hub side

Connect each shield to the connector hood only at the switching hub end of the cable.

- Noise immunity may be reduced by ground loops, which can occur due to improper shield connections and grounding. Ground the shield at one location, as shown in the following diagram.
- Do not connect the shield to the connector on the HMI.
- If a cable connects two Ethernet switches, connect the shield at only one end.

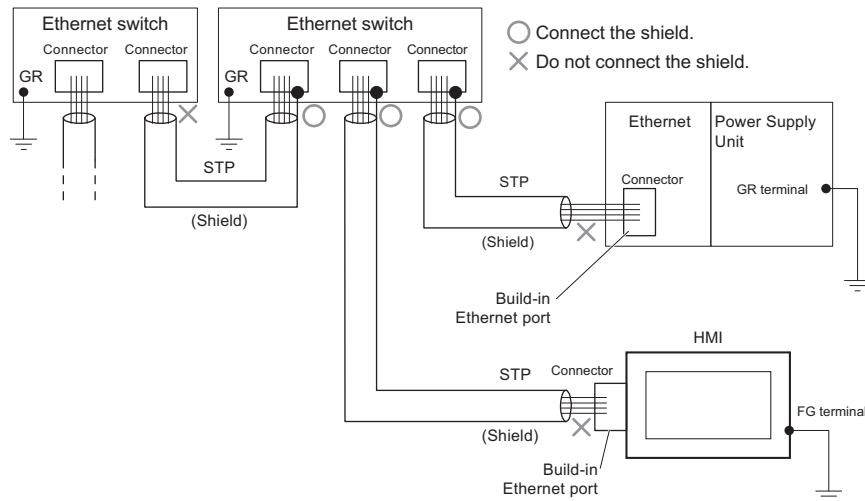

Ethernet Switch Installation Environment Precautions

- Do not ground the Ethernet switch in the same location as a drive system component, such as an inverter.
- Always use a dedicated power supply for the Ethernet switch's power supply. Do not use the same power supply for other equipment, such as an I/O power supply, motor power supply, or control power supply.
- Before installation, check the Ethernet switch's environmental resistance specifications, and use an Ethernet switch that is appropriate for the ambient conditions. Contact the Ethernet switch manufacturer for details on Ethernet switch's environmental resistance specifications.

Ethernet Switch Connection Methods

- Connect two Ethernet switches to each other as follows: Connect an MDI port to an MDI-X port with a straight cable. Connect two MDI ports or two MDI-X ports with a cross cable.

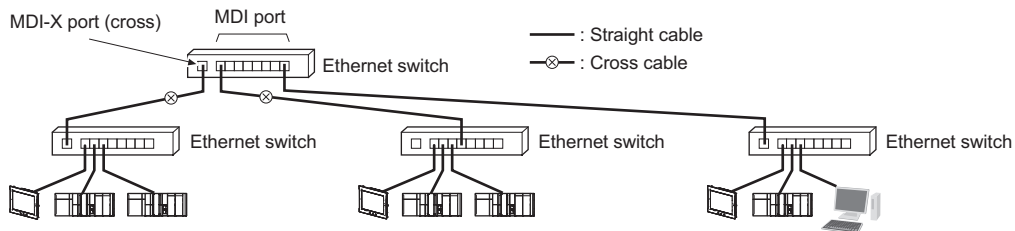

- Some Ethernet switches can automatically distinguish between MDI and MDI-X. When this kind of Ethernet switch is used, straight cable can be used between Ethernet switches.

2-3 System Configuration Using Serial

You can use any of the following methods to connect HMIs to devices:

- Connect the HMI to a connected device using RS-232C
- Connect the HMI to a connected device using RS-422A



Additional Information

Refer to *A-2 Making a Serial Connection Cable* on page A-3 and *A-3 Handling of CJ1W-CIF11* on page A-8 for information on the method for making a cable and how to use the conversion unit, etc.

2-3-1 System Configuration Using Serial

Connecting the HMI to a Connected Device Using RS-232C

You can directly connect the HMI to the connected device with an RS-232C cable.

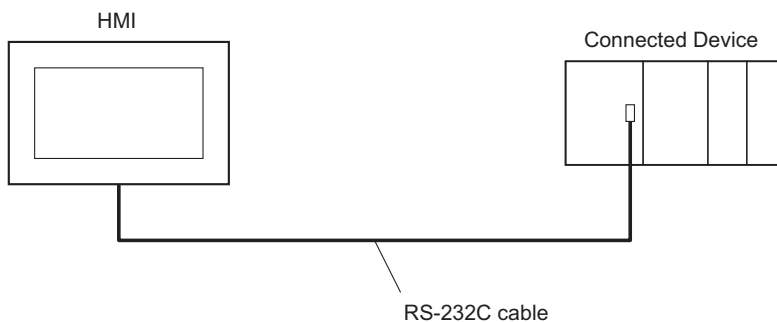

Connecting the HMI to a Connected Device Using RS-422A

You can connect the HMI to the connected device via a conversion unit with an RS-422A cable.

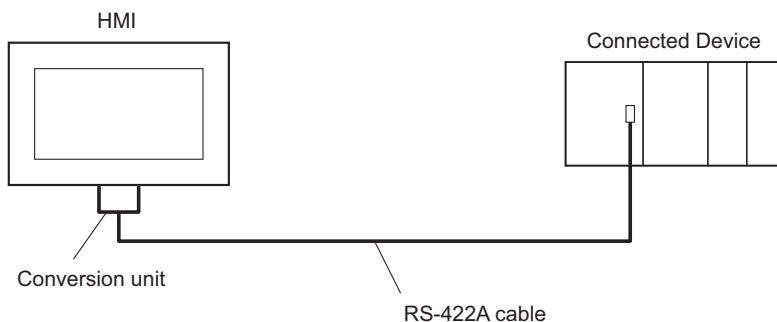



Additional Information

When connecting with a CS-series duplex system, connect the HMI to the active CPU. If you want the HMI to be always connected to a CPU duplex system to perform monitoring, connect it to both the active CPU unit and standby CPU unit as shown below.

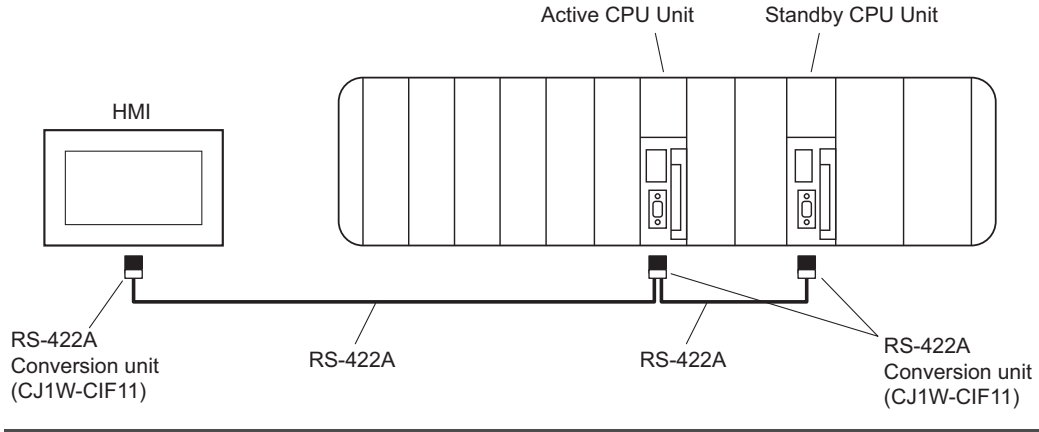

2-3-2 Outline of Settings for Connected Devices and HMIs

Configure mainly the following settings. The details differ for each connected device, so refer to Section 3 and the subsequent sections which contain the details for each of the connected devices used.

Settings for the Connected Device

Set the communications speed and other parameters required for connecting with the HMI using the setting tools for the connected device.

Settings for the HMI

In the Sysmac Studio, you must set the parameters for communication, connected device registration, and variable mapping.

- Make the settings for the serial port in the HMI settings of the Sysmac Studio.
- Register the connected device in the device references of the Sysmac Studio. When doing so, register the address used by the connected device as a device variable.
- Map the device variables to the global variable in variable mapping of the Sysmac Studio.

2-3-3 Devices Required for Network Configuration

The following devices are also required in advance to configure the system to connect using serial and must be purchased separately.

Network configuration device	Description
RS-232C cable	This is required when connecting with a connected device using RS-232C.
RS-422A cable	This is required when connecting with a connected device using RS-422A.
Conversion unit	This needs to be connected to the HMI when connecting using RS-422A.

Recommended Devices for Configuration

The following products are recommended for configuration.

● RS-232C cable

- When using existing products

Model	Cable length	Connector specifications
XW2Z-200T	2 m	D-SUB 9-pin plug - D-SUB 9-pin plug
XW2Z-500T	5 m	D-SUB 9-pin plug - D-SUB 9-pin plug
XW2Z-200T-3	2 m	D-SUB 9-pin plug - Discrete wire
XW2Z-500T-3	5 m	D-SUB 9-pin plug - Discrete wire

- When making a cable

Product name		Manufacturer
Connector	XM3A-0921	OMRON
Connector hood	XM2S-0911-E (millimeter thread pitch)	OMRON
	XM2S-0913 (inch thread pitch)	OMRON
Cable	AWG28×5P IFVV-SB	Fujikura
	CO-MA-VV-SB 5P×28AWG	Hitachi Metals

● RS-422A cable

- <Cable>

Product name		Manufacturer
Cable	CO-HC-ESV-3P×7/0.2	Hirakawa Hewtech

- Crimp terminal for 2-wire type

Product name		Manufacturer
Crimp terminal	AI-series AI-0.5-8WH-B (Product No. 3201369)	Phoenix Contact
Dedicated crimp tool	CRIMPFOX 6 (Product No. 1212034)	

- Crimp terminal for 4-wire type

Product name		Manufacturer
Crimp terminal	AI-series AI-TWIN2×0.5-8WH (Product No. 3200933)	Phoenix Contact
Dedicated crimp tool	CRIMPFOX 10T-F (Product No. 1134913)	

3

Connecting an OMRON NJ/NX/NY-series Controller

This section provides details on connecting an OMRON NJ/NX/NY-series Controller via Ethernet.

3-1	Connecting via Ethernet	3-2
3-1-1	NJ/NX/NY-series Controller Settings	3-3
3-1-2	HMI Settings	3-5

3-1 Connecting via Ethernet

You can connect an NA-series Programmable Terminal to an NJ/NX/NY-series Controller via Ethernet.

You make the settings for the NJ/NX/NY-series Controller and HMI with the Sysmac Studio.



Precautions for Correct Use

- You must connect to the built-in EtherNet/IP port on an NJ/NX/NY-series CPU Unit. You cannot connect to Ethernet ports on EtherNet/IP Units.
- NJ-series Controller version 1.01 or later is required.



Additional Information

When online edit is performed on a connected device using Sysmac Studio, a process runs to apply changes regarding the connected device onto HMI. While this process is in progress, variables of the connected device cannot be accessed.

In the case of combinations of HMI of Runtime Ver.1.13 or later and the connected devices of versions listed on the following table or later, however, this process will be omitted if there is no need to apply changes made on the online edit to HMI. In that case, access to variables of the connected device continues.

Models	Unit version
NJ101-□□00	Ver.1.41
NJ301-1□□0	Ver.1.41
NJ501-1□□0	Ver.1.41
NX1P2-□□□□□□□□	Ver.1.41
NX102-□□□0	Ver.1.41
NX102-□□□20	Ver.1.34
NX502-□□□□	Ver.1.60
NX701-□□□0	Ver.1.22
NX701-□□□20	Ver.1.22

3-1-1 NJ/NX/NY-series Controller Settings

When you connect the HMI to an NJ/NX/NY-series Controller, you can make all of the settings with the Sysmac Studio.

Making Settings with the Sysmac Studio

You need to set the following items in **Built-in EtherNet/IP Port Settings** under **Configurations** and **Setup – Controller Setup** in the Multiview Explorer of the Sysmac Studio.

- **Built-in EtherNet/IP Port Settings – TCP/IP Settings** dialog box

Open the TCP/IP Settings Display. You must set the IP address of the NJ/NX/NY-series built-in EtherNet/IP port to connect the HMI. Other items are set as required.

IP Address Settings

Item	Setting for the NJ/NX/NY-series Controller
IP address setting method	Sets the method to use to set the IP address of the built-in EtherNet/IP port. Use the default setting method (fixed setting) for the IP address.
IP address	Sets the IP address of the built-in EtherNet/IP port. Set the required IP address.
Subnet mask	Sets the subnet mask of the built-in EtherNet/IP port. Set it according to the network configuration.
Default gateway	Sets the default gateway IP address of the built-in EtherNet/IP. Set it according to the network configuration.
Packet Filter	Sets the Packet Filter of the built-in EtherNet/IP port. Set this to allow communication with the HMI.

- LINK Settings Display

Item	Setting for the NJ/NX/NY-series Controller
LINK settings	Sets the baud rate of the built-in Ethernet/IP port. The default setting (Auto) is recommended.



Additional Information

If the Controller is set to Secure communication, use Runtime Ver.1.16 or later.

With Runtime Ver.1.16 and later, whether the HMI is performing secure communication can be checked in the System Menu.

The current status is displayed in (a) of **Project System Menu – External Device Settings**.

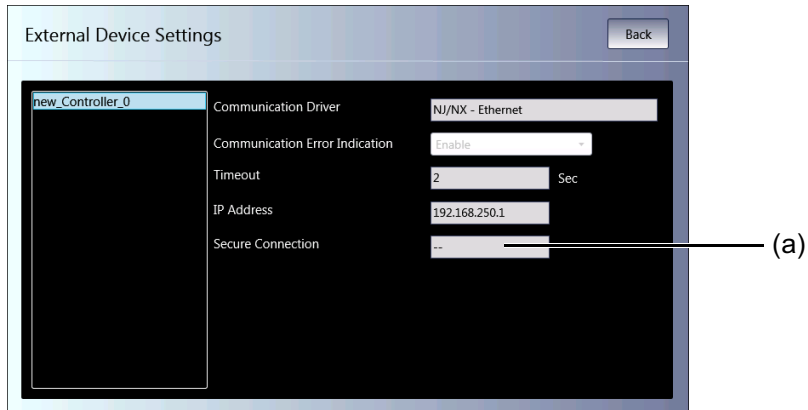

Enable: Secure communication is performed.

Disable: Secure communication is not performed.

--: Unconnected state.

Since secure communication is not supported in Runtime Ver.1.15 and earlier, communication with Controllers set to Secure communication will not be possible.

3-1-2 HMI Settings

The following settings must be made for the HMI with the Sysmac Studio.

- Communications settings in the HMI Settings
- Registering the NJ/NX/NY-series Controller as a connected device in the Device References

Communications Settings

- 1 Double-click **HMI Settings** under **Configurations and Setup** in the Multiview Explorer.

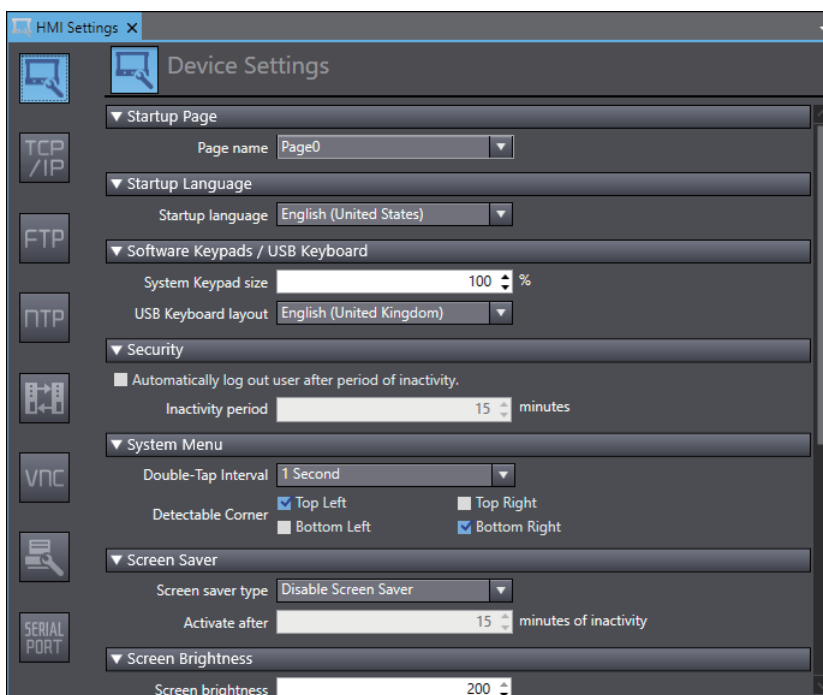

- 2 Click the **TCP/IP Settings** Button and set the IP address for Ethernet port 1 in the TCP/IP Settings. Also set the subnet mask and default gateway as required.

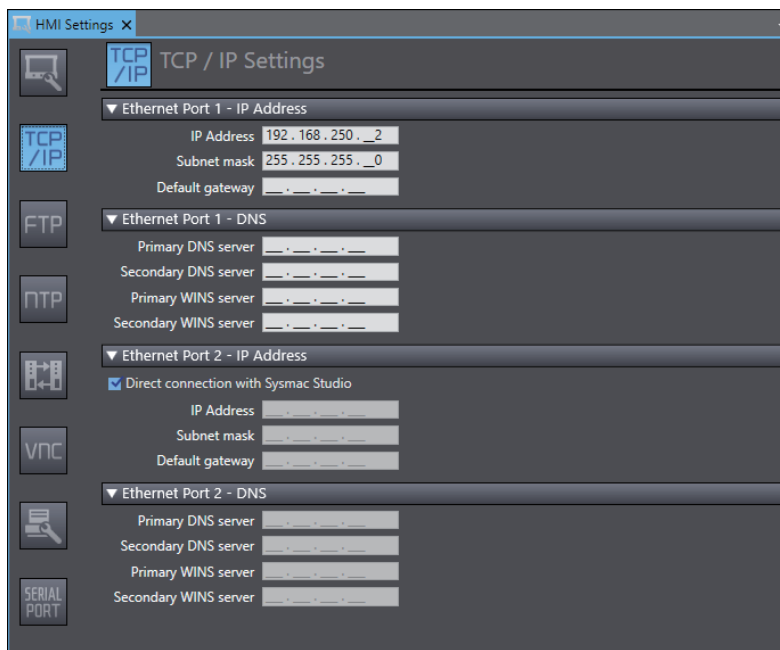

Registering the NJ/NX/NY-series Controller as a Connected Device in the Device References

Different registration methods are used to connect to a Controller that is registered in the current project and to connect to a Controller that is not registered in the current project.

● Connecting an NJ/NX/NY-series Controller Registered in the Current Project:

Registration is not necessary. The Controller is registered automatically in the Device References.



Additional Information

If using a port other than port 1 in the CPU unit, configure the settings as follows.

Open the device settings, clear the selection of the **Use the IP address configured on the internal device** check box, and set the IP address of the port you want to connect to in **IP Address**.

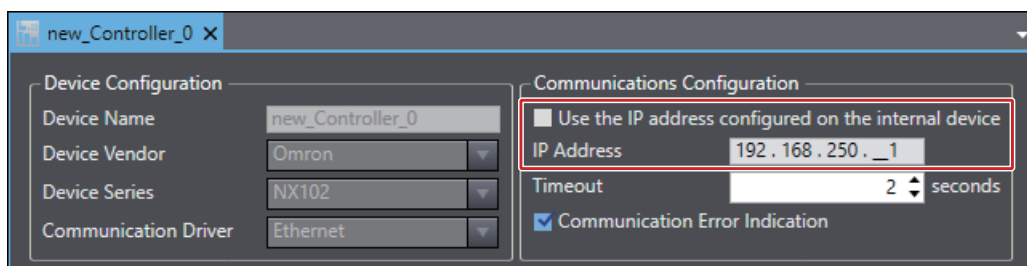

● Connecting an NJ/NX/NY-series Controller Not Registered in the Current Project:

- 1 Right-click **Device References** under **Configurations and Setup** in the Multiview Explorer and add an external connected device.

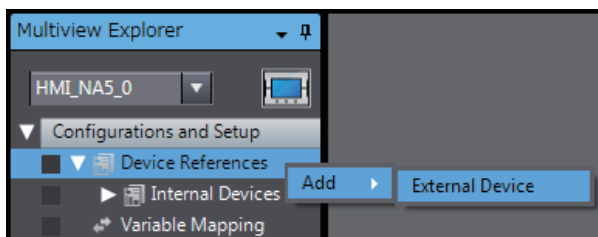

2 Double-click the added external connected device.

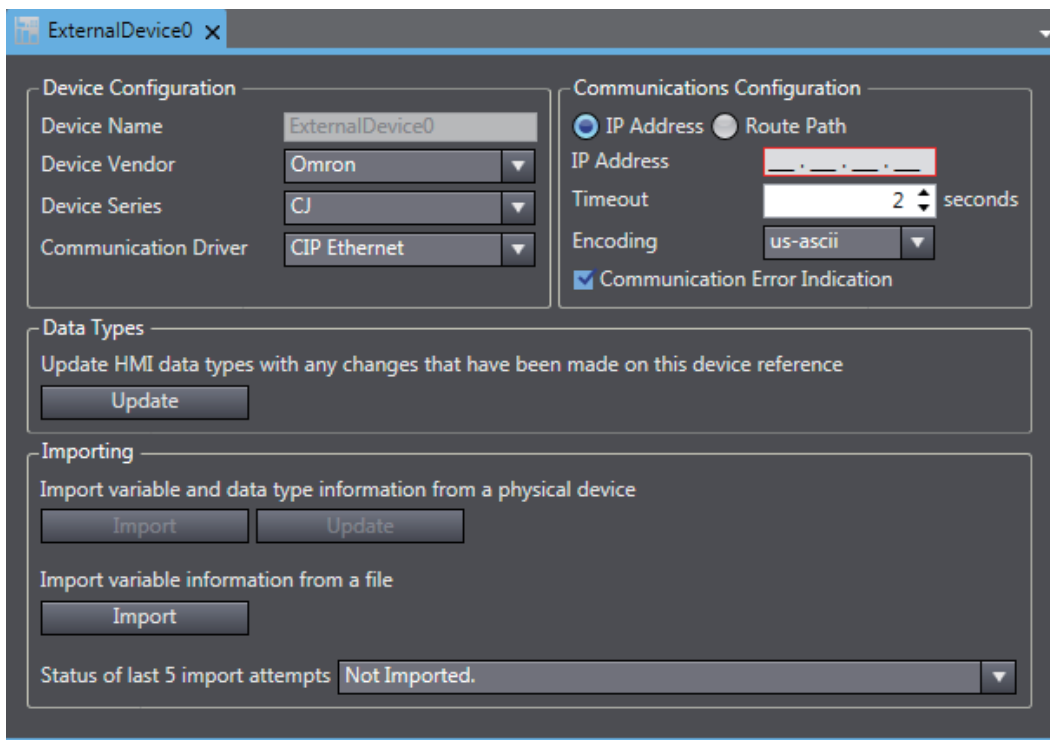

3 Make the following settings for the external connected device.

Device Configuration

- Device Vendor: Select “Omron”.
- Device Series: Select device to be used.
- Communication Driver: Select “Ethernet.”

Communications Configuration

- IP Address: Set the IP address of the connected device.
- Timeout: Set the time for timeouts during communications.
- Communication Error Indication: Clear the selection of the check box if you do not need to display an error dialog when a communications error occurs.

The screenshot shows a software window titled "ExternalDevice0" with the following configuration options:

Device Configuration		Communications Configuration	
Device Name	ExternalDevice0	IP Address	192 . 168 . 250 . _1
Device Vendor	Omron	Timeout	2 seconds
Device Series	NJ	<input checked="" type="checkbox"/> Communication Error Indication	
Communication Driver	Ethernet		

Data Types
Update HMI data types with any changes that have been made on this device reference
[Update]

Importing
Import variable and data type information from a physical device
[Import] [Update]

Import variable information from a file
[Import]

Status of last 5 import attempts: Not Imported.

Registering Device Variables

There are three methods to register device variables.



Precautions for Correct Use

You cannot copy and paste a structure variable from the global variable table of another project or import it from Excel files. If you need to register a structure variable, import it from the NJ/NX/NY-series Controller.

To use “Importing Device Variables from an NJ/NX/NY-series Controller” with Controllers set to Secure communication, the project must be a Runtime version 1.16 project or later.

● Importing Device Variables from an NJ/NX/NY-series Controller

Use the following procedure to connect to an NJ/NX/NY-series Controller and import variables from it.

- 1 Enables the controller to connect to Sysmac Studio in a network configuration that conforms to [Communication Configuration] in the external device settings.
- 2 Click the **Import** Button.

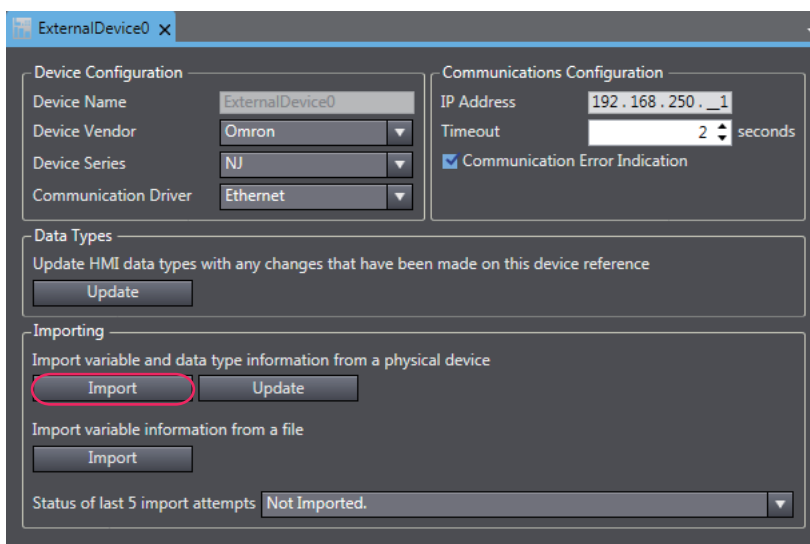

- 3 The global variables are transferred from the Controller and registered as device variables.

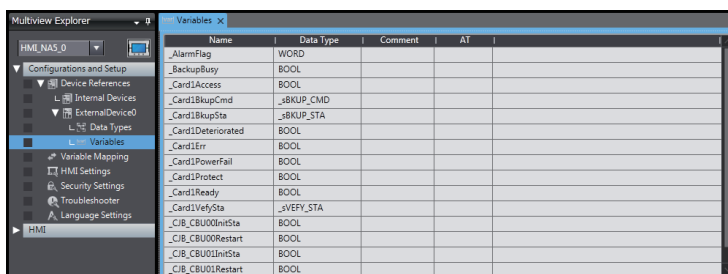

● **Copying Variables from the Global Variable Table of Another Project**

Use the following procedure to copy variables from the global variable table of another project.

- 1 Open a project in which a Controller is registered as an external connected device. Open the global variable table and copy the required variables.

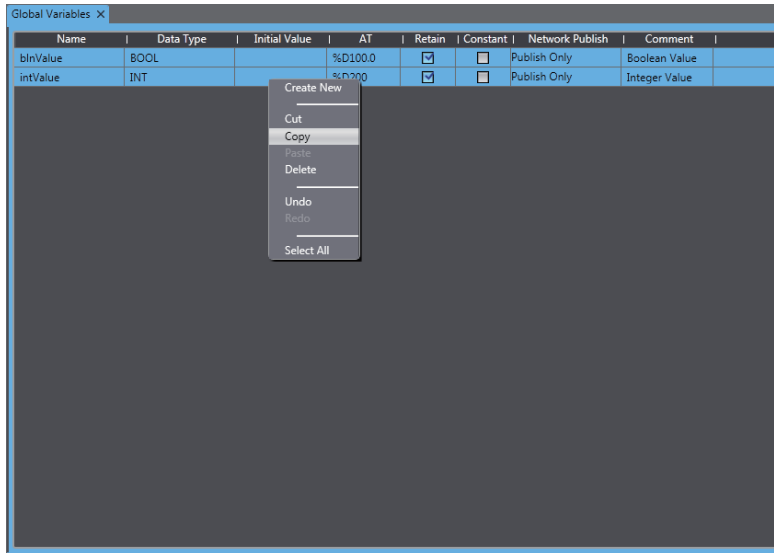

- 2 Paste the device variables in a spreadsheet, delete unnecessary rows, and sort and copy the remaining rows. Refer to *A-1 Clipboard Format for Device Variable Table Data* on page A-2 for information on the order of the rows.

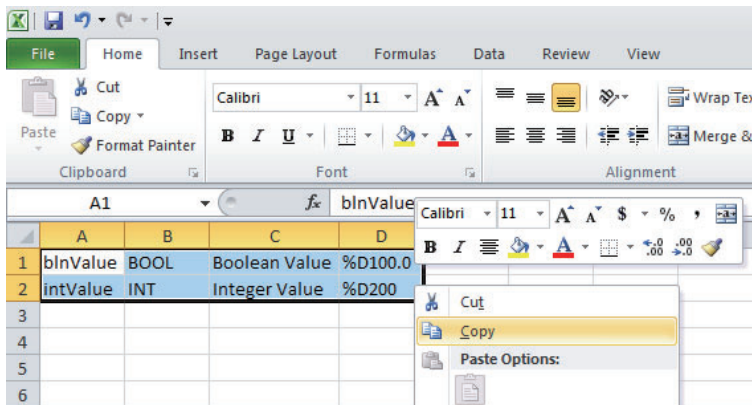

- 3 Paste the variables in the device variable table of the HMI project.

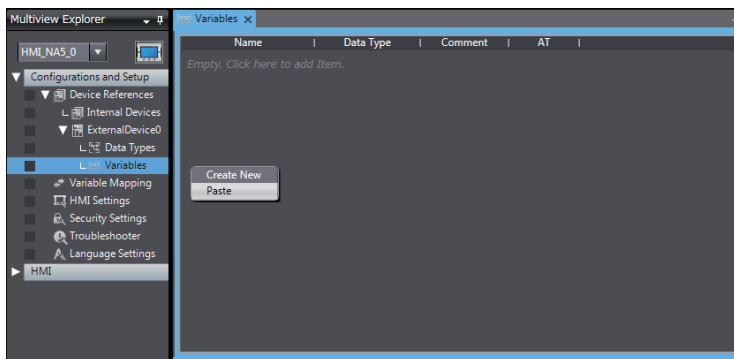

● Importing Device Variables from Excel Files

- 1 Prepare an Excel file that contains the device variable setting, such as a copy of the contents of another HMI device variable table. Refer to *A-1 Clipboard Format for Device Variable Table Data* on page A-2 for information on the order of the columns.
- 2 Click the **Import** Button.

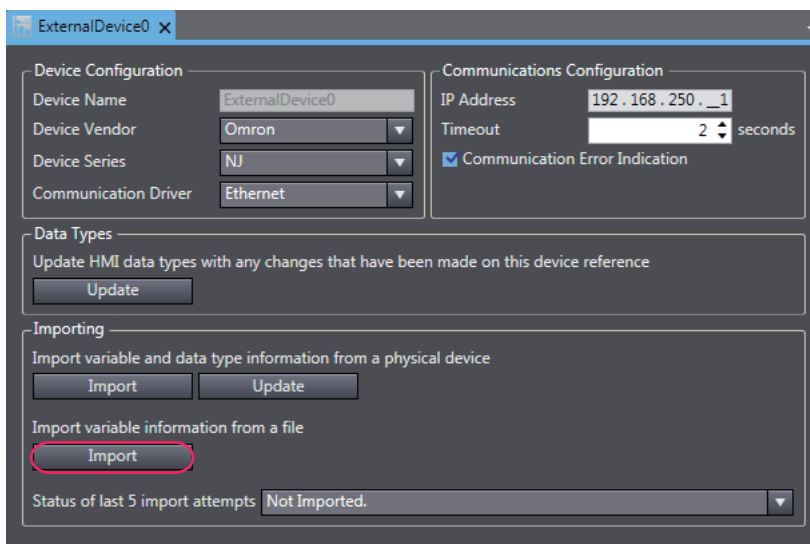

The variables are copied to the device variable table of the HMI project.

Mapping Variables

Conform the following specifications when you assign the variables of the NJ/NX/NY-series Controller to the global variables.

● Supported Data Types

You can assign the following NJ/NX/NY-series data types to the global variables.

BOOL, BYTE, WORD, DWORD, LWORD, SINT, INT, DINT, LINT, USINT, UINT, UDINT, ULINT, REAL, LREAL, TIME, DATE, TIME_OF_DAY, DATE_AND_TIME, and STRING

You can also access array elements, structure and union members^{*1}, and enumerated variables^{*1} that have any of the above data types. The minimum value of the subscript of an array is always 0. The maximum value of the subscript is the maximum value for the array registered in the NJ/NX/NY-series Controller.

Range type specification is not supported. Variables with a range type specified are treated as variables without a range type specified.

*1. Runtime version 1.03 or higher is required.

● Data Types Supported by the NJ/NX/NY-series Controllers and the HMIs

The following table shows the corresponding data types of the NJ/NX/NY-series Controllers and the HMIs.

NJ/NX/NY-series data type	HMI data type
BOOL	Boolean
INT	Short
DINT	Integer
LINT	Long
UINT	UShort
WORD	
UDINT	UInteger
DWORD	
ULINT	
LWORD	Ulong
REAL	
LREAL	Single
STRING	Double
SINT	String
USINT	SByte
BYTE	Byte
TIME	TimeSpan
DATE	Date
DATE_AND_TIME	
TIME_OF_DAY	

4

Connecting to an OMRON CS/CJ/CP-series PLC

This section describes connection methods for an OMRON CS/CJ/CP-series PLC.

4

4-1	Connecting via Ethernet (FINS)	4-2
4-1-1	Making Settings for the CS/CJ/CP-series PLC	4-2
4-1-2	Settings for the HMI	4-5
4-2	Connecting via EtherNet/IP	4-13
4-2-1	EtherNet/IP	4-13
4-2-2	Settings for the CJ-series PLC	4-13
4-2-3	Settings for the HMI	4-15
4-3	Connecting via Serial	4-22
4-3-1	Making Settings for the CS/CJ/CP-series PLC	4-22
4-3-2	Settings for the HMI	4-23

4-1 Connecting via Ethernet (FINS)

You can connect an NA-series Programmable Terminal to a CS/CJ/CP-series PLC using Ethernet (FINS).

Make the settings for the CS/CJ/CP-series PLC from the CX-Programmer.

Make the settings for the HMI from the Sysmac Studio.

4-1-1 Making Settings for the CS/CJ/CP-series PLC

The Unit used for Ethernet communications depends on the model of the OMRON PLC that you use.

When connecting through Ethernet, check the model of the PLC at the destination and the Unit mounted to the PLC.

For details on Units that can be connected to the NA-series Programmable Terminals via the Ethernet, refer to *Section 1 Supported Devices*.



Additional Information

In the case of the CP-series PLC, set from a web browser instead of from the front panel switches. For details, refer to the explanation regarding the Ethernet option port in each CPU manual.

Setting the Front Panel Switches

Set the unit number and FINS node address with the front panel switches.



Precautions for Safe Use

- Always turn OFF the power to the PLC before setting the rotary switches.
- Create I/O tables for the CPU Unit when setting the unit number for the first time or when changing the settings.

● Setting the Unit Number

Always set unique unit numbers for all of the CPU Bus Units mounted to the same CPU Unit. Use a small screwdriver to set the rotary switch. Be careful not to damage it. The switch is set to 0 at the factory.



Setting range

0 to F

● Setting the Node Number

Use the node number switches to set the node number to a unique hexadecimal value. Do not set it to the same value as any other Ethernet Unit or built-in port on the same Ethernet network. As long as it does not use the same number as another Ethernet Unit or built-in port, the node address can be set from 01 to 7E in hex (1 to 126 in decimal).

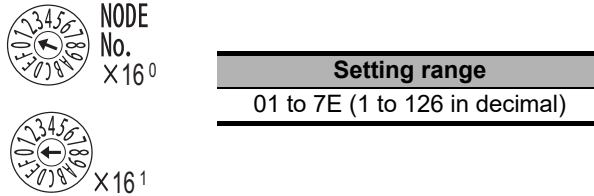

Set the upper digit using the top rotary switch and the lower digit using the bottom rotary switch. The switches are set to 01 at the factory. Automatic generation must be selected as the address conversion method when connecting to an HMI. Therefore, set the rightmost byte of the local IP address to the same value as that of the node number.

Making Settings with the CX-Programmer

Make the Unit settings and register the variables.

● Unit Settings

The following items must be set in the Unit Settings of the CX-Programmer.

TCP/IP Tab Page

Item	Settings
IP address	Sets the IP address of the Ethernet port. Set the required IP address.
Subnet mask	Sets the subnet mask of the Ethernet port. Make the setting according to the network configuration.
Default gateway	Sets the default gateway of the Ethernet port. Make the setting according to the network configuration.

Ethernet Tab Page

Item	Settings
LINK setting	Sets the baud rate. Using the default value (Auto) is recommended.

FINS/UDP Tab Page

Item	Settings
FINS/UDP Port No.	Sets the local UDP port number that is used for the FINS communications service. Use the default setting (9600).
IP address conversion	Set one of the following methods of the address conversion to obtain the IP address from the FINS node address. <ul style="list-style-type: none"> • Automatic generation, dynamic • Automatic generation, static
IP address table	The IP address table indicates the relation between FINS node addresses and IP addresses. The IP address table is not used for the HMI. Automatic generation must be used.
Dynamically change remote IP	Sets whether to dynamically change remote IP addresses for FINS/UDP. Clear the selection of the check box. Dynamically changing remote IP addresses must be disabled.

Set the routing tables on the CX-Integrator as required.

For details on setting routing tables, refer to the *CX-Integrator Ver. 2. □ Operation Manual* (Cat. No. W464).

● Registering Variables

Register variables as global variables on the CX-Programmer.

- Set the addresses of the registered variables manually or automatically.

4-1-2 Settings for the HMI

The following settings must be made for the HMI with the Sysmac Studio.

- Communications Settings in the HMI Settings
- Registering the CS/CJ/CP-series PLC as a connected device in the Device References

Communications Settings

- 1 Double-click **HMI Settings** under **Configurations and Setup** in the Multiview Explorer.

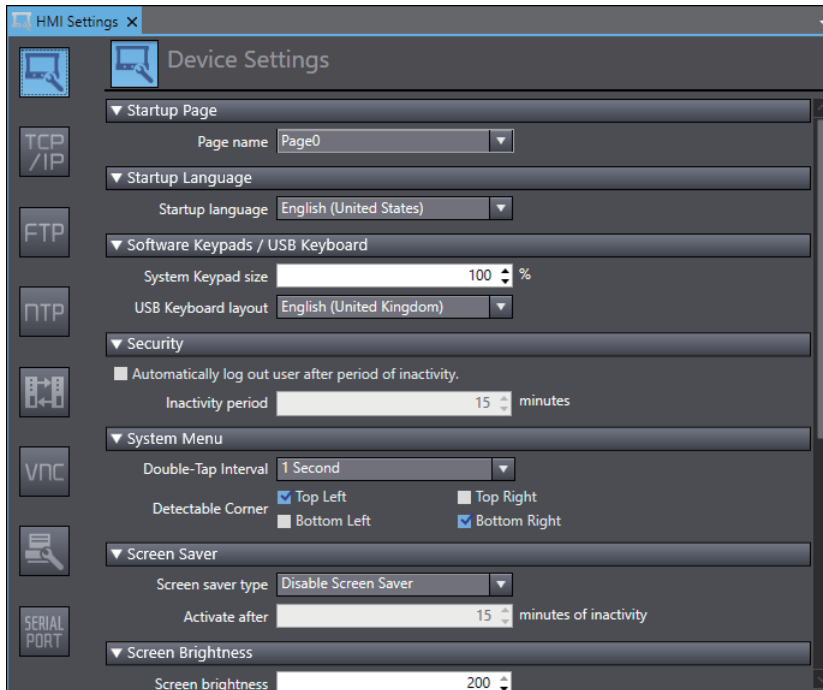

- 2 Click the **TCP/IP Settings** Button and set the IP address and other settings for Ethernet port 1 on the TCP/IP Settings Display. Also set the subnet mask and default gateway as required.

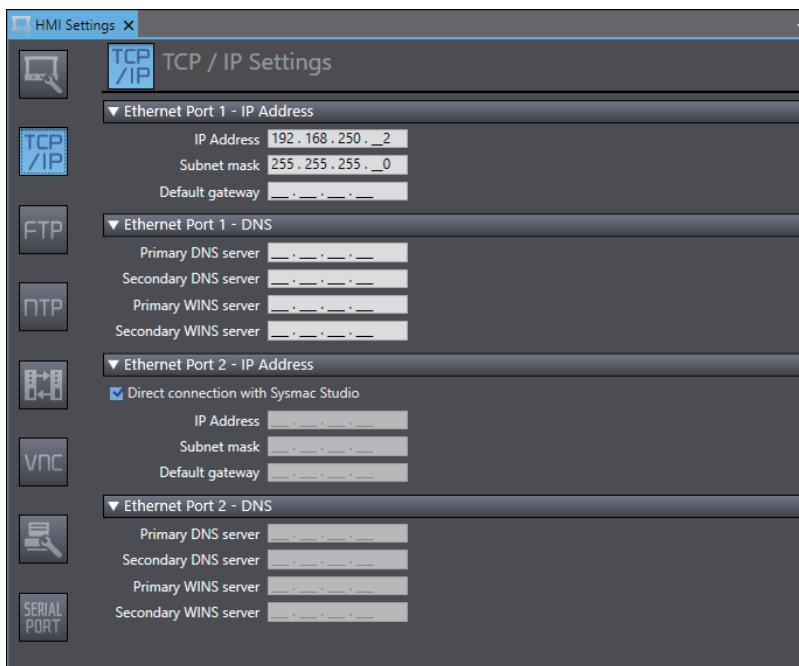

- 3 Click the **FINS Settings** Button and set the network address for Ethernet port 1. Set the routing table as required.

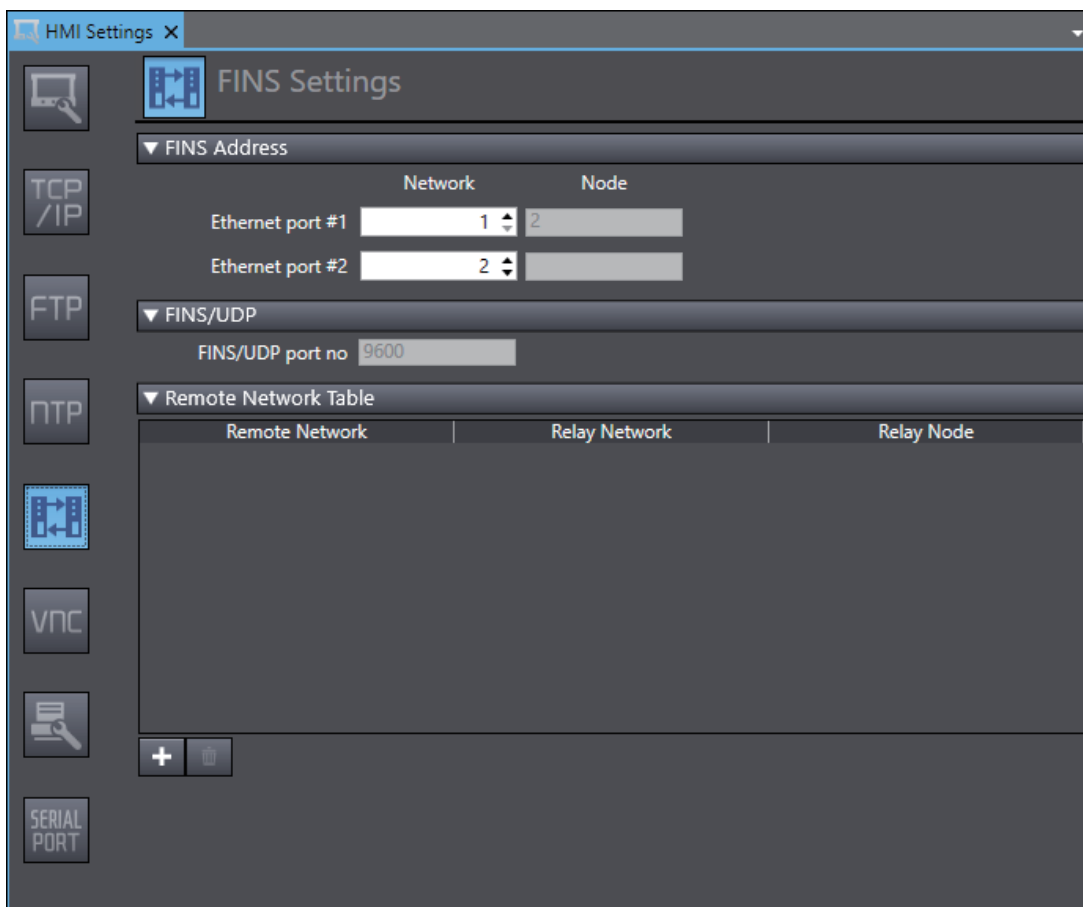

Additional Information

Node addresses are generated automatically from the IP addresses. The node address is the same as the lowest digit of the IP address.

Registering the CS/CJ/CP-series PLC as a Connected Device in the Device References

The following procedure describes an example of connecting with a CJ-series PLC. When connecting with a CS-series PLC or CP-series PLC, change the settings of the device to the corresponding settings.

- 1 Right-click **Device References** under **Configurations and Setup** in the Multiview Explorer and add an external connected device.

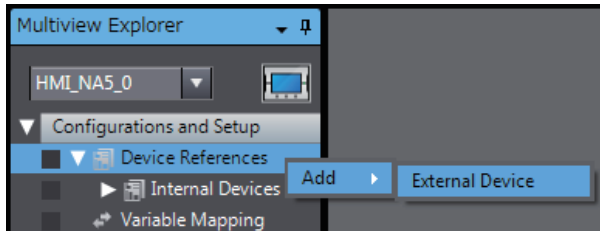

- 2 Double-click the added external connected device.

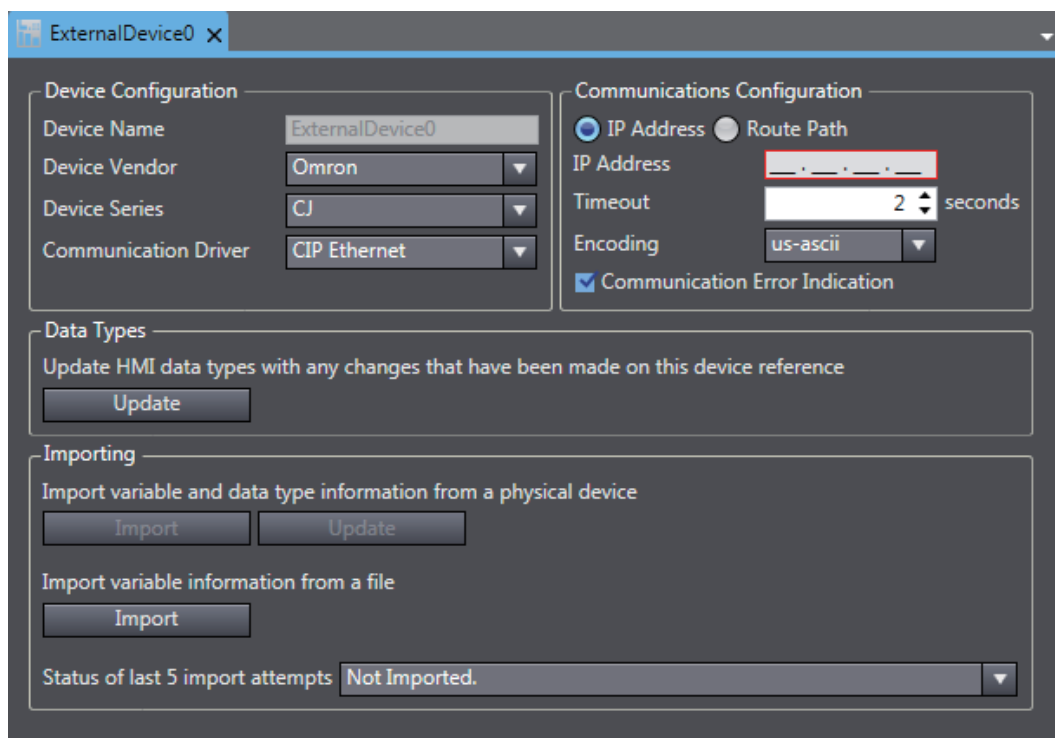

3 Make the following settings for the external connected device.

Device Configuration

- Device Vendor: Select “Omron”.
- Device Series: Select “CJ.”
- Communication Driver: Select “FINS Ethernet.”

Communications Configuration

- Network Address: Set the network address for FINS.
- Node Address: Set the node address for FINS.
- Frame Length: Set the frame length for FINS.
- Timeout: Set the time for timeouts during communications.
- Encoding: Select the encoding for character strings in String variables on the connected device.
- Communication Error Indication: Clear the selection of the check box if you do not need to display an error dialog when a communications error occurs.

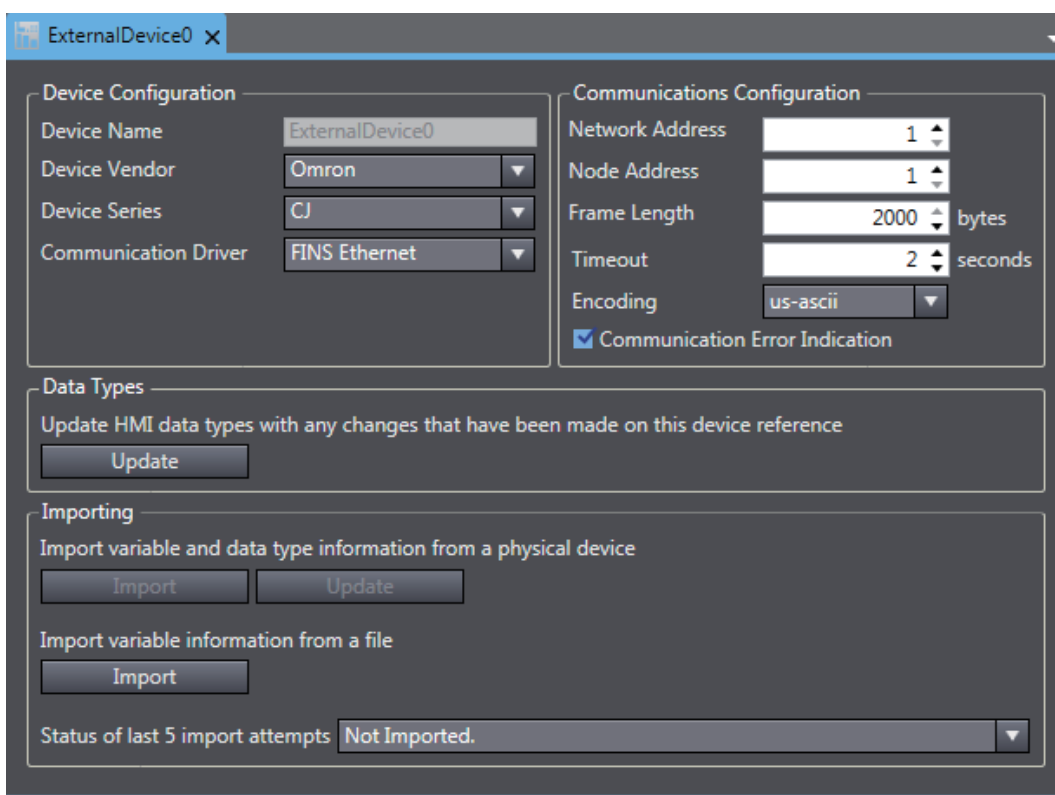

Additional Information

When using the CP series, set the frame length to 1016 or less.

Registering Device Variables

There are two methods to register device variables.

● Copying Device Variables with the CX-Programmer

- 1 Select the necessary global variables with the CX-Programmer and copy them.

Name	Data Type	Address / Value	Net. Variable	Rack Location	Usage	Comment
blnValue	BOOL	D100.00			Work	Boolean Value
IntValue	INT	D200			Work	Integer value
P_0_01s	BOOL	CF105			Work	0.01 second clock pulse
P_0_02s	BOOL	CF103			Work	0.02 second clock pulse
P_0_1ms	BOOL	CF107			Work	0.1 millisecond clock pulse
P_0_1s	BOOL	CF100			Work	0.1 second clock pulse
P_0_2s	BOOL	CF101			Work	0.2 second clock pulse
P_1min	BOOL	CF104			Work	1 minute clock pulse
P_1ms	BOOL	CF106			Work	1 millisecond clock pulse
P_1s	BOOL	CF102			Work	1.0 second clock pulse
P_AER	BOOL	CF011			Work	Access Error Flag
P_CIO	WORD	A450			Work	CIO Area Parameter
P_CY	BOOL	CF004			Work	Carry (CY) Flag
P_Cycle_Time_Error	BOOL	A401.08			Work	Cycle Time Error Flag
P_Cycle_Time_Value	UDINT	A264			Work	Present Scan Time
P_DM	WORD	A460			Work	DM Area Parameter
P_EM0	WORD	A461			Work	EM0 Area Parameter
P_EM1	WORD	A462			Work	EM1 Area Parameter
P_EM2	WORD	A463			Work	EM2 Area Parameter
P_EM3	WORD	A464			Work	EM3 Area Parameter
P_EM4	WORD	A465			Work	EM4 Area Parameter
P_EM5	WORD	A466			Work	EM5 Area Parameter

- 2 Paste the variables in the device variable table of the HMI project.

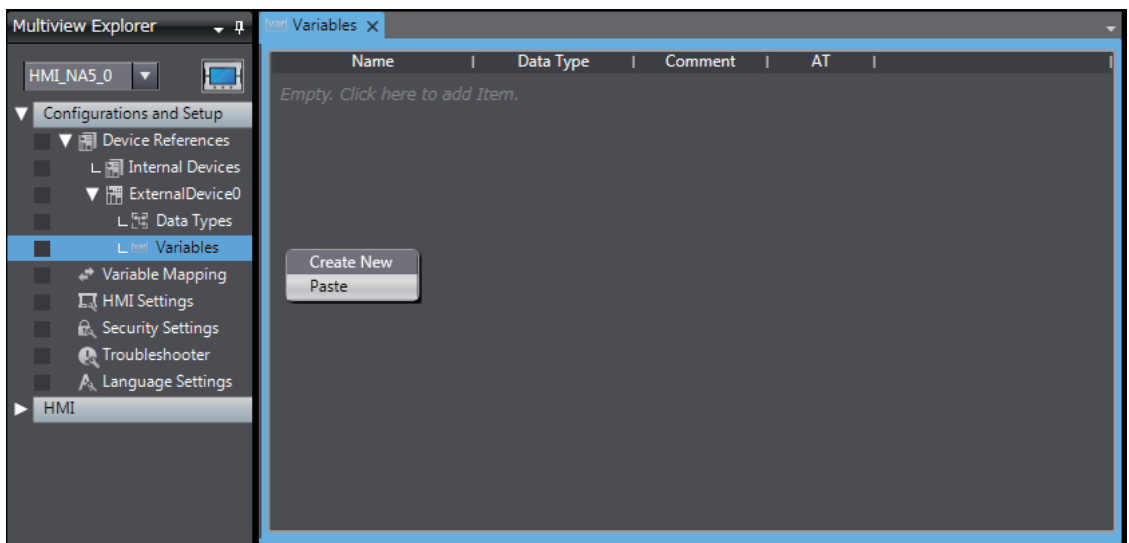

● Importing Device Variables from CXT or Excel Files

1 Obtain a CXT file created with the CX-Programmer, or an Excel file that contains the device variable settings, such as a copy of the contents of another HMI device variable table. For Excel files, refer to *A-1 Clipboard Format for Device Variable Table Data* on page A-2 for information on the order of the columns.

2 Click the **Import** Button.

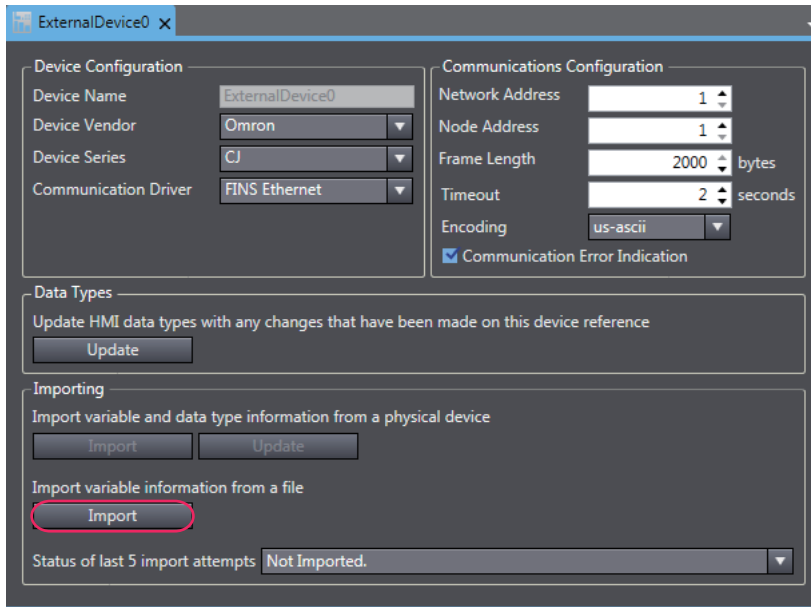

The variables are copied to the device variable table of the HMI project.

Mapping Variables

Conform the following specifications when you assign variables of the CS/CJ/CP-series PLC to the global variables.

● Range of Accessible Addresses

The following table gives the ranges of addresses that you can assign. The upper limits, area ranges, and attributes of the addresses depend on the model. For details, refer to the manual for your PLC.

Area name	Description of area	Range	Word access		Bit access		Restrictions and remarks
			Read	Write	Read	Write	
CIO	I/O Area	00000 to 06143	Yes	Yes	Yes	Yes	
HR	Holding Area	00000 to 00511	Yes	Yes	Yes	Yes	
AR	Auxiliary Area	00000 to 01471 10000 to 11535	Yes	Condi- tional	Yes	Condi- tional	
T	Timer PVs	00000 to 04095	Yes	Yes	No	No	
C	Counter PVs	00000 to 04095	Yes	Yes	No	No	
DM	DM Area	00000 to 32767	Yes	Yes	Yes	Yes	
EM	EM Area (current bank)	00000 to 32767	Yes	Yes	Yes ^{*1}	Yes ^{*1}	
EM0 to EM18	EM Area	00000 to 32767	Yes	Yes	Yes ^{*1}	Yes ^{*1}	
WR	Work Area	00000 to 00511	Yes	Yes	Yes	Yes	
TU	Time Completion Flags	00000 to 04095	No	No	Yes	No	
CU	Counter Completion Flags	00000 to 04095	No	No	Yes	No	

*1. Supported only for CJ2 PLCs.

● Supported Data Types

You can assign the following CS/CJ/CP-series data types to global variables.

BOOL, INT, DINT, LINT, UINT, WORD, UINT_BCD, UDINT, DWORD, UDINT_BCD, ULINT, LWORD, ULINT_BCD, REAL, LREAL, and STRING

You can also access array members that have the supported data types.

● Data Types Supported by the CS/CJ/CP-series PLCs and the HMIs

The following table shows the corresponding data types of the CS/CJ/CP-series PLCs and the HMIs.

CS/CJ/CP-series data type	HMI data type
BOOL	Boolean
INT	Short
DINT	Integer
LINT	Long
UINT	UShort
WORD	
UINT_BCD	
UDINT	UInteger
DWORD	
UDINT_BCD	
ULINT	Ulong
LWORD	
ULINT_BCD	
REAL	Single
LREAL	Double
STRING	String

4-2 Connecting via EtherNet/IP

You can connect an NA-series Programmable Terminal to a CJ-series PLC using EtherNet/IP.

Make the settings for the CJ-series PLC with the CX-Programmer.

Make the settings for the HMI with the Sysmac Studio.

4-2-1 EtherNet/IP

EtherNet/IP is a multi-vendor industrial network protocol that uses Ethernet. It is an open standard managed by the ODVA (Open DeviceNet Vendor Association) and is used for a variety of industrial devices.

It is possible to perform tag message communications when using a CPU Unit with a built-in EtherNet/IP port. The CPU Units with built-in EtherNet/IP ports contain a tag name server, so if tag names and an address table are stored in advance in the CPU Unit, it is possible to perform access from the HMI using only the tag names.

The NA-series Programmable Terminal can communicate with a CJ-series EtherNet/IP Unit or CPU Unit with a built-in EtherNet/IP port using the tag names. However, communications using addresses is not supported.

4-2-2 Settings for the CJ-series PLC

When connecting through EtherNet/IP, check the model of the PLC at the destination and the Unit mounted to the PLC.

Refer to *Section 1 Supported Devices* for the PLC models and Units that you can connect to the NA-series Programmable Terminal.

Setting the Front Panel Switch

Set the unit number with the front panel switch.



Precautions for Safe Use

- Always turn OFF the power to the PLC before setting the rotary switch.
- Create I/O tables for the CPU Unit when setting the unit number for the first time or when changing the settings.

● **Setting the Unit Number**

Always set unique unit numbers for all of the CPU Bus Units mounted to the same CPU Unit. Use a small screwdriver to set the rotary switch. Be careful not to damage it. The switch is set to 0 at the factory.



Setting range
0 to F

Making Settings with CX-Programmer

Make the Unit settings and register the variables.

● **Unit Settings**

The following items must be set in the Unit Settings of the CX-Programmer.

TCP/IP Tab Page

Item	Setting for the CJ series PLC
IP address	Sets the IP address of the EtherNet/IP port.
Subnet mask	Sets the subnet mask of the EtherNet/IP port. Make the setting according to the network configuration.
Default gateway	Sets the IP address of the default gateway of the EtherNet/IP port. Make the setting according to the network configuration.

Ethernet Tab Page

Item	Setting for the CJ series PLC
LINK setting	Sets the baud rate. Using the default value (Auto) is recommended.

● **Registering Variables**

Register global variables with the CX-Programmer.

- Set the addresses of the registered variables manually or automatically.
- Variables must be registered as network variables to use CIP message communications with tags. When you register the variables, select the *Network Variable* and *Open Only* Check Boxes.

Note Select either *Input* or *Output*. (It does not matter which one you select.)

4-2-3 Settings for the HMI

The following settings must be made for the HMI with the Sysmac Studio.

- Communications settings in the HMI Settings
- Registering the CJ-series PLC as a connected device in the Device References

Communications Settings

- 1 Double-click **HMI Settings** under **Configurations and Setup** in the Multiview Explorer.

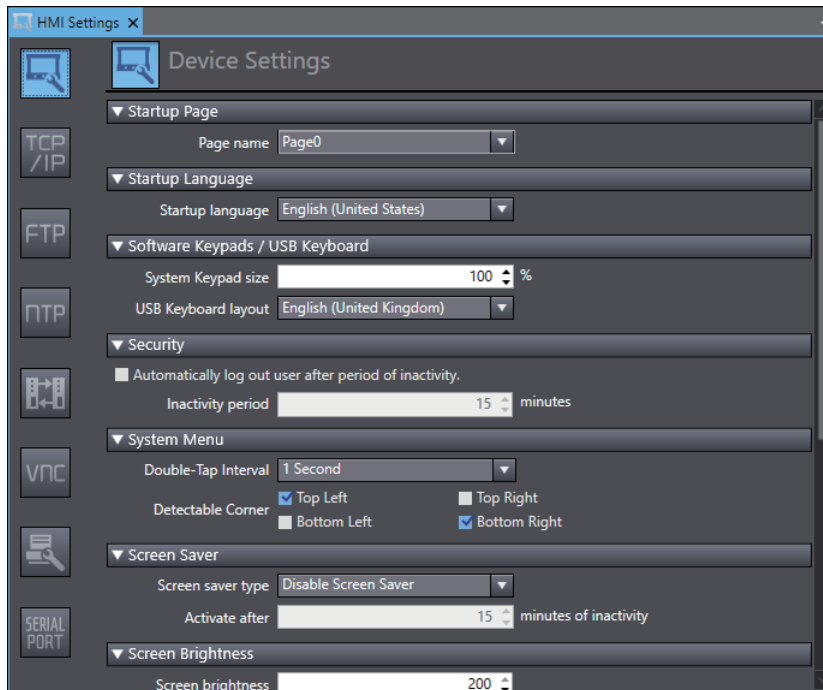

- 2 Click the **TCP/IP Settings** Button and set the IP address and other settings for Ethernet port 1 on the TCP/IP Settings Display. Also set the subnet mask and default gateway if necessary.

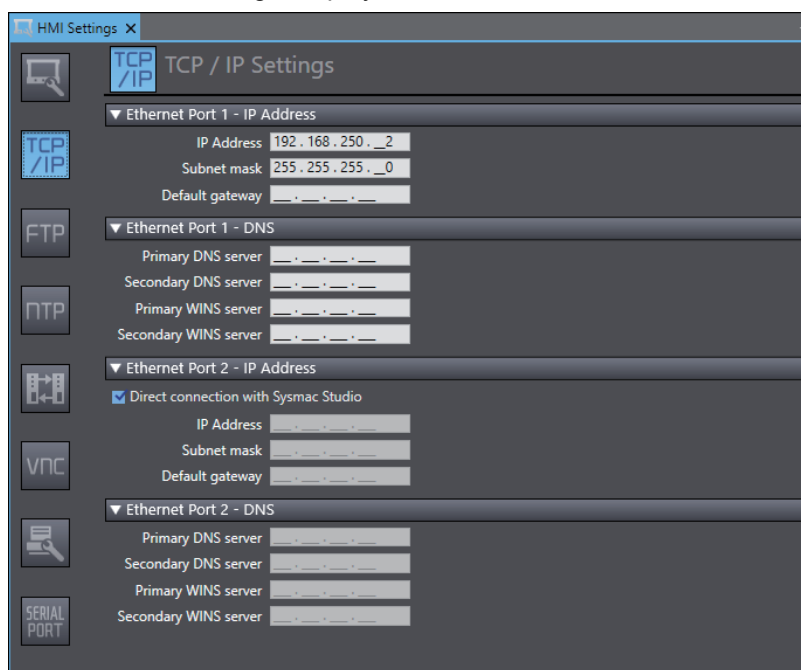

Registering the CJ-series PLC as a Connected Device in the Device References

- 1 Right-click **Device References** under **Configurations and Setup** in the Multiview Explorer and add an external connected device.

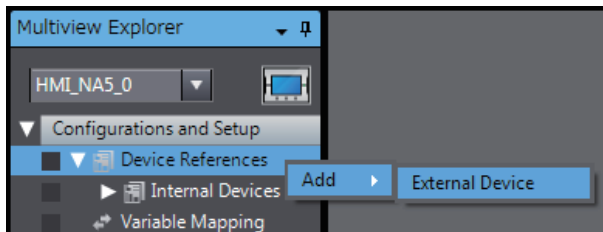

- 2 Double-click the added external connected device.

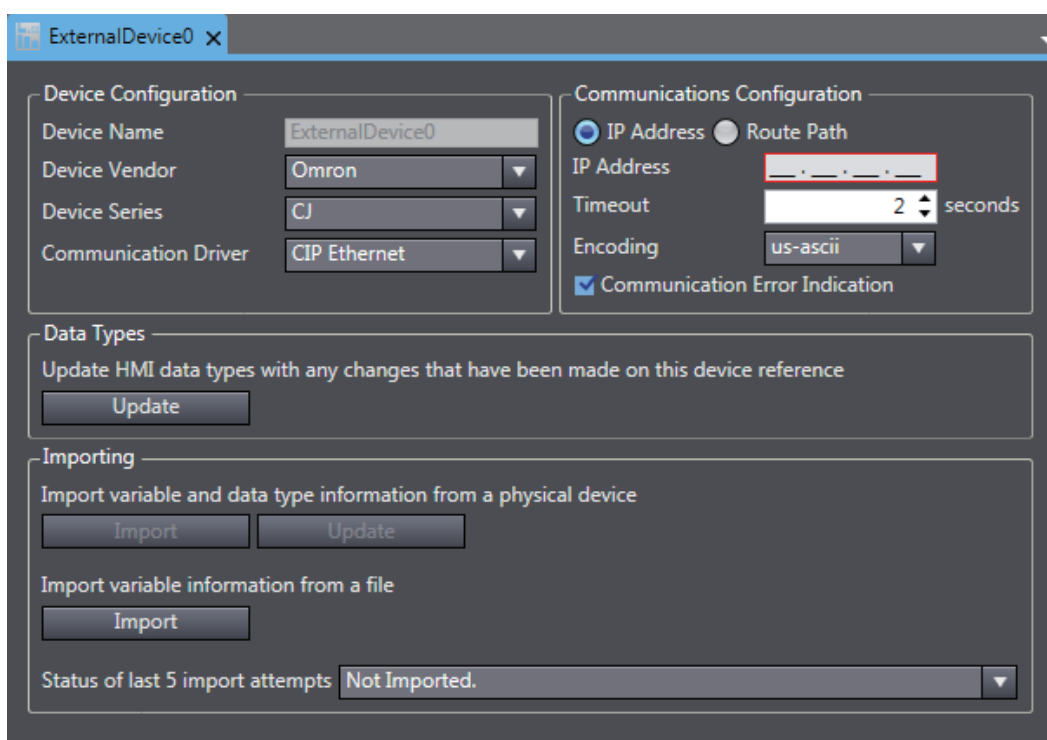

3 Make the following settings for the external connected device.

Device Configuration

- Device Vendor: Select “Omron”.
- Device Series: Select “CJ.”
- Communication Driver: Select “CIP Ethernet.”

Communications Configuration

- IP Address/Routing Path: Select either an IP address or a route path and then set it.
- Timeout: Set the time for Timeouts during communications.
- Encoding: Select the encoding for character strings in String variables on the connected device.
- Communication Error Indication: Clear the selection of the check box if you do not need to display an error dialog when a communications error occurs.

The screenshot shows the 'ExternalDevice0' configuration window. It is divided into several sections:

- Device Configuration:**
 - Device Name: ExternalDevice0
 - Device Vendor: Omron
 - Device Series: CJ
 - Communication Driver: CIP Ethernet
- Communications Configuration:**
 - IP Address: 192.168.250._1
 - Timeout: 2 seconds
 - Encoding: us-ascii
 - Communication Error Indication:
- Data Types:**
 - Update HMI data types with any changes that have been made on this device reference
 - Update button
- Importing:**
 - Import variable and data type information from a physical device
 - Import and Update buttons
 - Import variable information from a file
 - Import button
 - Status of last 5 import attempts: Not Imported.

Registering Device Variables

There are three methods to register device variables.

● Importing Device Variables from the CJ-series PLC

- 1 Enables the CJ-series PLC to connect to Sysmac Studio in a network configuration that conforms to [Communication Configuration] in the external device settings.
- 2 Click the **Import** Button.

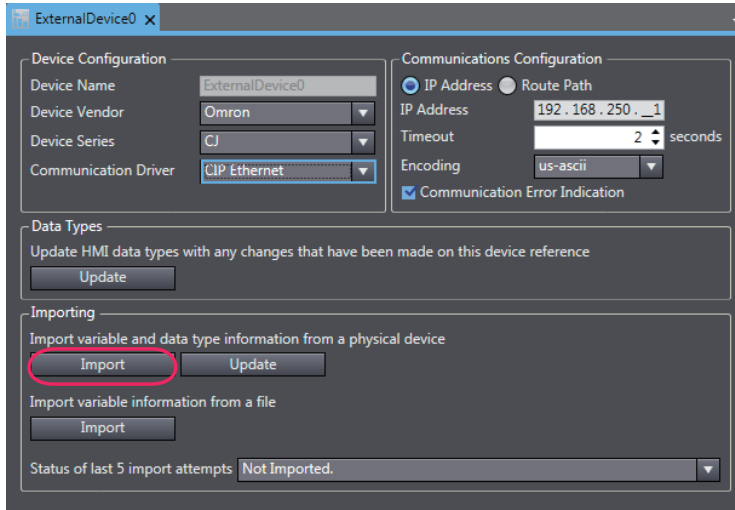

- 3 The global variables of the CJ-series PLC are transferred and registered as device variables.

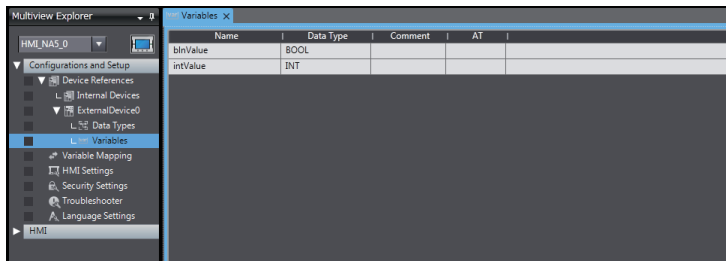

● Copying Device Variables with the CX-Programmer

1 Select the necessary global variables with the CX-Programmer and copy them.

Name	Data Type	Address / Value	Net. Variable	Rack Location	Usage	Comment
binValue	BOOL	D100.00	Publication		Work	Boolean Value
intValue	INT	D200	Publication		Work	Integer value
▾ P_0_01s	BOOL	CF105			Work	0.01 second clock pulse
▾ P_0_02s	BOOL	CF103			Work	0.02 second clock pulse
▾ P_0_1ms	BOOL	CF107			Work	0.1 millisecond clock pulse
▾ P_0_1s	BOOL	CF100			Work	0.1 second clock pulse
▾ P_0_2s	BOOL	CF101			Work	0.2 second clock pulse
▾ P_1min	BOOL	CF104			Work	1 minute clock pulse bit
▾ P_1ms	BOOL	CF106			Work	1 millisecond clock pulse
▾ P_1s	BOOL	CF102			Work	1.0 second clock pulse
▾ P_AER	BOOL	CF011			Work	Access Error Flag
▾ P_CIO	WORD	A450			Work	CIO Area Parameter
▾ P_CY	BOOL	CF004			Work	Carry (CY) Flag
▾ P_Cycle_Time_Error	BOOL	A401.08			Work	Cycle Time Error Flag
▾ P_Cycle_Time_Value	UDINT	A264			Work	Present Scan Time
▾ P_DM	WORD	A460			Work	DM Area Parameter
▾ P_EM0	WORD	A461			Work	EM0 Area Parameter
▾ P_EM1	WORD	A462			Work	EM1 Area Parameter
▾ P_EM2	WORD	A463			Work	EM2 Area Parameter
▾ P_EM3	WORD	A464			Work	EM3 Area Parameter
▾ P_EM4	WORD	A465			Work	EM4 Area Parameter
▾ P_EM5	WORD	A466			Work	EM5 Area Parameter

2 Paste the variables in the device variable table of the HMI project.

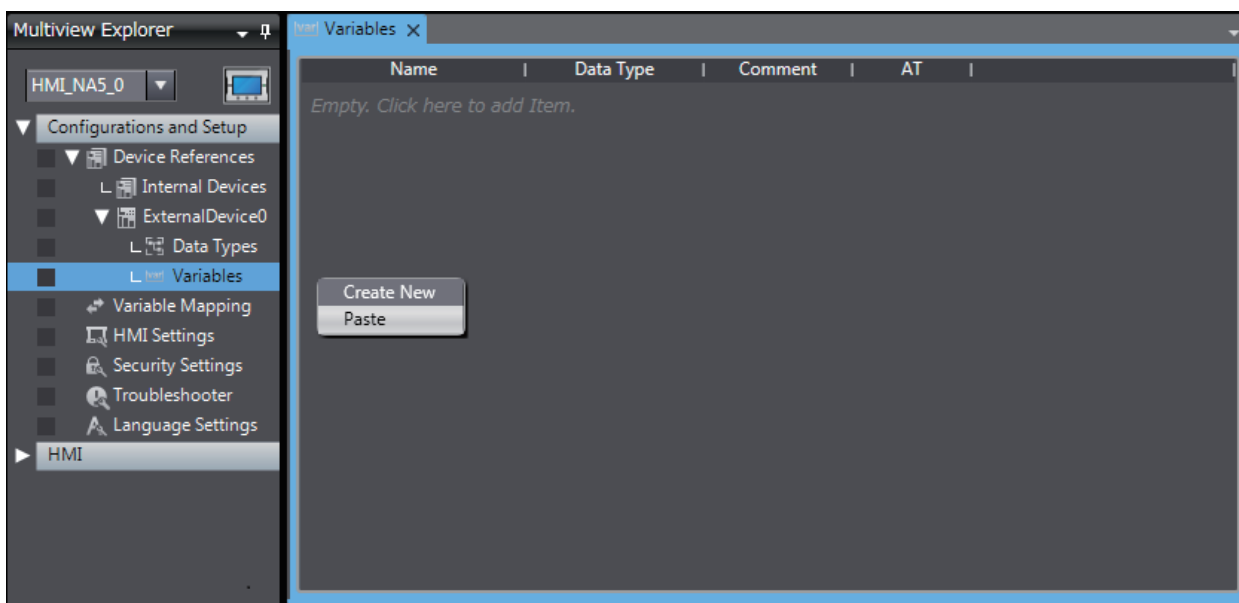

● Importing Device Variables from CXT or Excel Files

- 1 Obtain a CXT file created with the CX-Programmer, or an Excel file that contains the device variable settings, such as a copy of the contents of another HMI device variable table. For Excel files, refer to *A-1 Clipboard Format for Device Variable Table Data* on page A-2 for information on the order of the columns.
- 2 Click the **Import** Button.

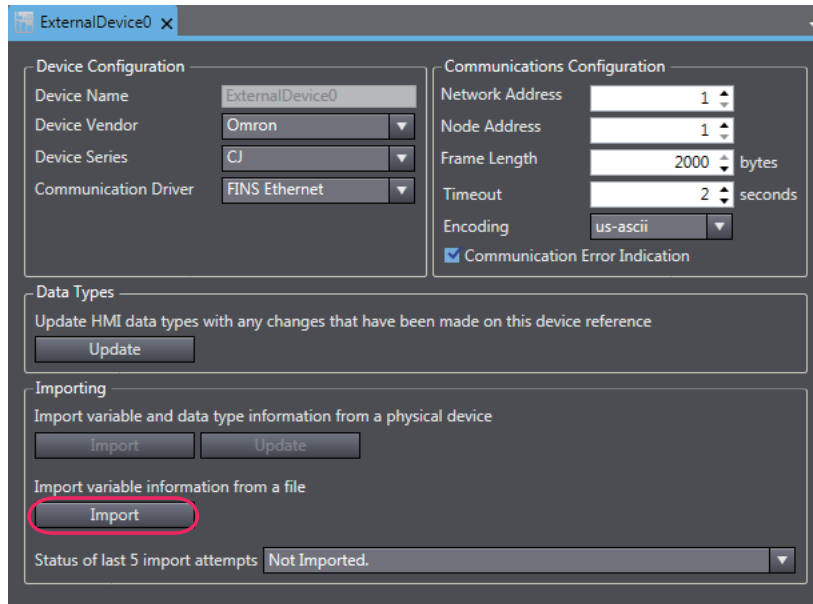

The variables are copied to the device variable table of the HMI project.

Mapping Variables

Conform the following specifications when you assign variables of the CJ-series PLC to the global variables.

● Supported Data Types

You can assign the following CJ-series data types to global variables.

BOOL, INT, DINT, LINT, UINT, WORD, UINT_BCD, UDINT, DWORD, UDINT_BCD, ULINT, LWORD, ULINT_BCD, REAL, LREAL, and STRING

You can also access array and structure members that have any of the above data types.

● Data Types Supported by the CJ-series Controllers and the HMIs

The following table shows the corresponding data types supported by the CJ-series PLCs and the HMIs.

CJ-series data type	HMI data type
BOOL	Boolean
INT	Short
DINT	Integer
LINT	Long
UINT	UShort
WORD	
UINT_BCD	
UDINT	UInteger
DWORD	
UDINT_BCD	
ULINT	Ulong
LWORD	
ULINT_BCD	
REAL	Single
LREAL	Double
STRING	String

4-3 Connecting via Serial

You can connect an NA-series Programmable Terminal to a CS/CJ/CP-series PLC by using a serial port.

Make the settings for the CS/CJ/CP-series PLC with the CX-Programmer. Make the settings for the HMI with the Sysmac Studio.



Additional Information

The speed of the serial circuit is slow, so if a large array or structure is used as it is, the performance may be affected.

If a large array or structure is used, verify the performance, and optimize the system if necessary.

- Eliminate mapping of unnecessary variables.
- Do not use large arrays or structures (as a guide, 2000 bytes or more) that are only partially used, but separately define and use variables that access the same address.
- Make arrays of objects, such as alarms, that access consecutive addresses.
- When accessing a large array or structure is unavoidable, such as in a subroutine, create the user interface taking into consideration the reduction in performance.

4-3-1 Making Settings for the CS/CJ/CP-series PLC

The Unit used for serial communications depends on the model of the OMRON PLC that you use. When connecting through serial, check the model of the PLC at the destination and the Unit mounted to the PLC.

For details on Units of the PLC that can be connected to the NA-series Programmable Terminals via serial, refer to *Section 1 Supported Devices*.

Making Settings with the CX-Programmer

Make the PLC system settings and register the variables.

● PLC System Settings

The following items must be set in the **PLC Settings** of the CX-Programmer.

Serial Port Tab Page

Item	Description
Communications speed	Set the communications speed. Set this to the same setting as that of the serial port settings in the Sysmac Studio.
Parameters	Set the parameters for serial communication. Set "7, 2, E".
Mode	Select the communications mode. Set this to host link .

● Registering Variables

Register variables as global variables on the CX-Programmer.

- Set the addresses of the registered variables manually or automatically.

4-3-2 Settings for the HMI

The following settings must be made for the HMI with the Sysmac Studio.

- **Serial port settings** in the HMI Settings
- Registering the CS/CJ/CP-series PLC as a connected device in the Device References

Communication Settings

- 1 Double-click **HMI Settings** under **Configuration and Setup** in the Multiview Explorer.

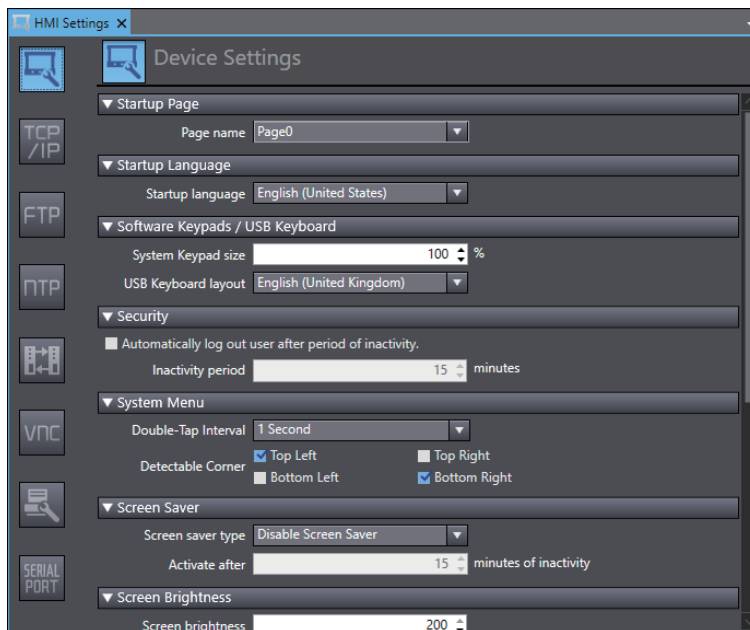

- 2 Click the **Serial port settings** Button and set the settings configured in CX-Programmer on the **Serial port settings** dialog box. Select **Connection with external devices** for application.

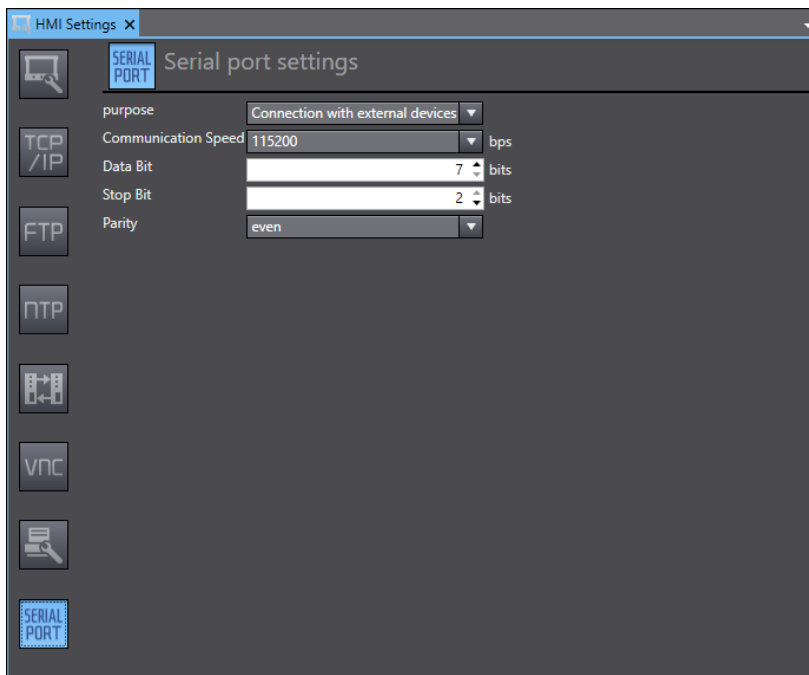

Registering the CS/CJ/CP-series PLC as a connected device in the Device References

The following procedure describes an example of connecting with a CJ-series PLC. When connecting with a CS-series PLC or CP-series PLC, change the settings of the device to the corresponding settings.

- 1 Right-click **Device References** under **Configurations and Setup** in the Multiview Explorer and add an external connected device.

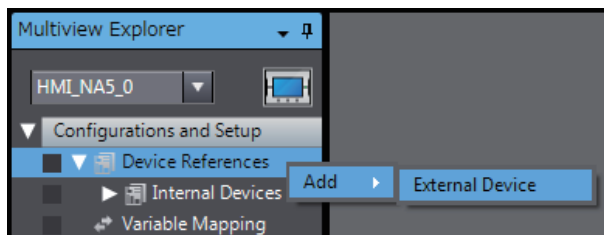

- 2 Double-click the added external device.

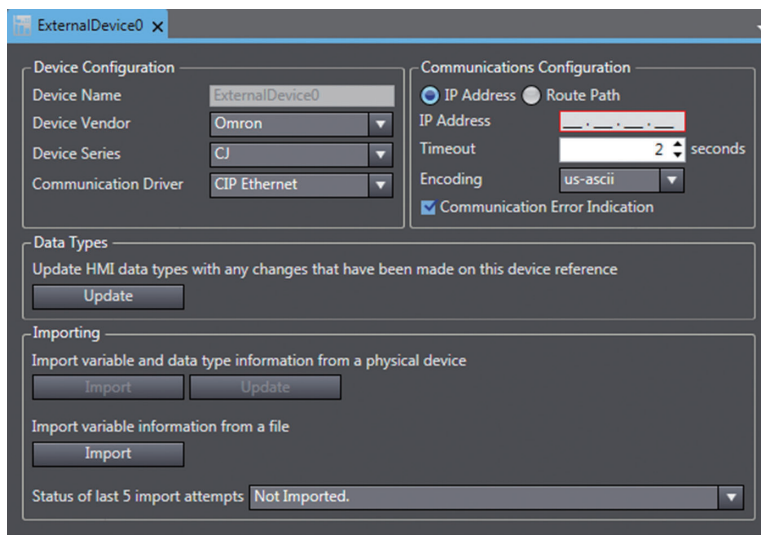

3 Make the following settings for the external connected device.

Device Configuration

- Device Vendor: Select "Omron".
- Device Series: Select "CJ".
- Communication Driver: Select "Host Link".

Communications Configuration

- Timeout: Set the time for timeouts during communication.
- Encoding: Select the encoding for character strings in String variables on the connected device.
- Communication Error Indication: Clear the selection of the check box if you do not need to display an error dialog when a communications error occurs.

The screenshot shows the configuration window for 'ExternalDevice0'. It is organized into four main sections:

- Device Configuration:** Contains dropdown menus for Device Name (ExternalDevice0), Device Vendor (Omron), Device Series (CJ), and Communication Driver (Host Link).
- Communications Configuration:** Contains a spin box for Timeout (2 seconds), a dropdown for Encoding (us-ascii), and a checked checkbox for Communication Error Indication.
- Data Types:** Includes the text 'Update HMI data types with any changes that have been made on this device reference' and an 'Update' button.
- Importing:** Includes the text 'Import variable and data type information from a physical device' with 'Import' and 'Update' buttons, and 'Import variable information from a file' with an 'Import' button. At the bottom, there is a status field for 'Status of last 5 import attempts' which displays 'Not Imported'.

Registering Device Variables

There are two methods to import device variables.

● Copying Device Variables with the CX-Programmer

- 1 Select the necessary global variables with the CX-Programmer and copy them.

Name	Data Type	Address / Value	Net. Variable	Rack Location	Usage	Comment
binValue	BOOL	D100.00	Publication		Work	Boolean Value
intValue	INT	D200	Publication		Work	Integer value
P_0_01s	BOOL	CF105			Work	0.01 second clock pulse
P_0_02s	BOOL	CF103			Work	0.02 second clock pulse
P_0_1ms	BOOL	CF107			Work	0.1 millisecond clock pulse
P_0_1s	BOOL	CF100			Work	0.1 second clock pulse
P_0_2s	BOOL	CF101			Work	0.2 second clock pulse
P_1min	BOOL	CF104			Work	1 minute clock pulse bit
P_1ms	BOOL	CF106			Work	1 millisecond clock pulse
P_1s	BOOL	CF102			Work	1.0 second clock pulse
P_AER	BOOL	CF011			Work	Access Error Flag
P_CIO	WORD	A450			Work	CIO Area Parameter
P_CY	BOOL	CF004			Work	Carry (CY) Flag
P_Cycle_Time_Error	BOOL	A401.08			Work	Cycle Time Error Flag
P_Cycle_Time_Value	UDINT	A264			Work	Present Scan Time
P_DM	WORD	A460			Work	DM Area Parameter
P_EM0	WORD	A461			Work	EM0 Area Parameter
P_EM1	WORD	A462			Work	EM1 Area Parameter
P_EM2	WORD	A463			Work	EM2 Area Parameter
P_EM3	WORD	A464			Work	EM3 Area Parameter
P_EM4	WORD	A465			Work	EM4 Area Parameter
P_EM5	WORD	A466			Work	EM5 Area Parameter

- 2 Paste the variables in the device variable table of the HMI project.

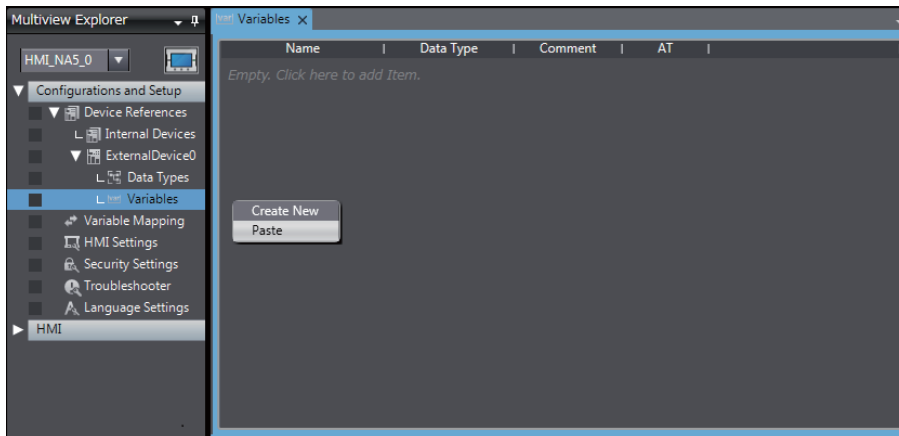

● Importing Device Variables from CXT or Excel Files

- 1 Obtain a CXT file created with the CX-Programmer, or an Excel file that contains the device variable settings, such as a copy of the contents of another HMI device variable table. For Excel files, refer to *A-1 Clipboard Format for Device Variable Table Data* on page A-2 for information on the order of the columns.
- 2 Click the **Import** Button.

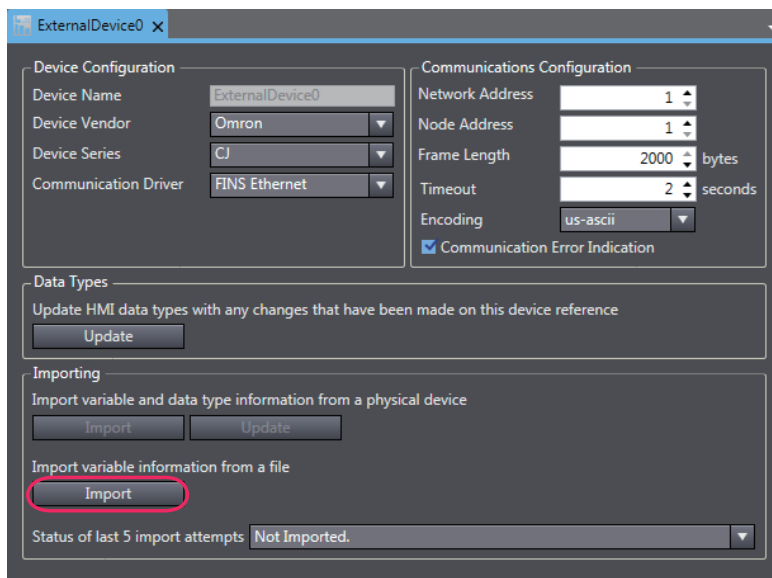

- 3 The variables are copied to the device variable table of the HMI project.

Mapping Variables

Conform to the following specifications when you assign the variables of the CS/CJ/CP-series PLC to the global variables.

● Usable Address Range

The usable address range is indicated. The upper limit of the address, the range of the area, and the attributes vary by model. For details, refer to the manual for the PLC.

Area name	Description of area	Range	Word access		Bit access		Restrictions and remarks
			Read	Write	Read	Write	
CIO	Relay Area	00000 to 06143	Yes	Yes	Yes	Yes	
HR	Holding Area	00000 to 00511	Yes	Yes	Yes	Yes	
AR	Auxiliary Area	00000 to 01471 10000 to 11535	Yes	Condi- tional	Yes	Condi- tional	
T	Timer PVs	00000 to 04095	Yes	Yes	No	No	
C	Counter PVs	00000 to 04095	Yes	Yes	No	No	
DM	DM Area	00000 to 32767	Yes	Yes	Yes	Yes	
EM	EM Area (current bank)	00000 to 32767	Yes	Yes	Yes ^{*1}	Yes ^{*1}	
EM0 to EM18	EM Area	00000 to 32767	Yes	Yes	Yes ^{*1}	Yes ^{*1}	
WR	Work Area	00000 to 00511	Yes	Yes	Yes	Yes	
TU	Time Completion Flags	00000 to 04095	No	No	Yes	No	
CU	Counter Completion Flags	00000 to 04095	No	No	Yes	No	

*1. Supported only for CJ2 PLCs.

● Supported Data Types

You can assign the following CS/CJ/CP-series PLC data types to the global variables.

BOOL, INT, DINT, LINT, UINT, WORD, UINT_BCD, UDINT, DWORD, UDINT_BCD, ULINT, LWORD, ULINT_BCD, REAL, LREAL, and STRING

You can also access array elements that have the supported data types.

● Data Types Supported by the CS/CJ/CP-series PLCs and the HMIs

The following table shows the corresponding data types of the CS/CJ/CP-series PLCs and the HMIs.

CJ-series data type	HMI data type
BOOL	Boolean
INT	Short
DINT	Integer
LINT	Long
UINT	UShort
WORD	
UINT_BCD	
UDINT	UInteger
DWORD	
UDINT_BCD	
ULINT	Ulong
LWORD	
ULINT_BCD	
REAL	Single
LREAL	Double
STRING	String

5

Connecting an OMRON NX-series Safety Controller

This section provides details on connecting an OMRON NX-series Safety Controller via Ethernet.

5-1	Connecting via Ethernet	5-2
5-1-1	NX-series Safety Controller Settings	5-2
5-1-2	HMI Settings	5-3

5-1 Connecting via Ethernet

You can connect an NA-series Programmable Terminal to an NX-series Safety Controller via Ethernet.

You make the settings for the NX-series Safety Controller and HMI with the Sysmac Studio.



Precautions for Correct Use

You must connect to the built-in EtherNet/IP port on Network gateway. You cannot connect to Ethernet ports on EtherNet/IP Units.

5-1-1 NX-series Safety Controller Settings

When you connect the HMI to an NX-series Safety Controller, you can make all of the settings with the Sysmac Studio.

Making Settings with the Sysmac Studio

You need to set the following items in the **Built-in EtherNet/IP Port Settings** under **Configurations and Setup – Controller Setup** in the Multiview Explorer of the Sysmac Studio.

- TCP/IP Settings Display

Open the TCP/IP Settings Display. You must set the IP address of the Network gateway built-in EtherNet/IP port to connect the HMI. Other items are set as required.

IP Address Settings

Item	Setting for the NX-series Safety Controller
IP address setting method	Sets the method to use to set the IP address of the built-in EtherNet/IP port. Use the default setting method (fixed setting) for the IP address.
IP address	Sets the IP address of the built-in EtherNet/IP port. Set the required IP address.
Subnet mask	Sets the subnet mask of the built-in EtherNet/IP port. Set it according to the network configuration.
Default gateway	Sets the default gateway IP address of the built-in EtherNet/IP. Set it according to the network configuration.

- LINK Settings Display

Item	Setting for the NX-series Safety Controller
LINK settings	Sets the baud rate of the built-in Ethernet/IP port. The default setting (Auto) is recommended.

5-1-2 HMI Settings

The following settings must be made for the HMI with the Sysmac Studio.

- Communications settings in the HMI Settings
- Registering the NX-series Safety Controller as a connected device in the Device References

Communications Settings

- 1 Double-click **HMI Settings** under **Configurations and Setup** in the Multiview Explorer.

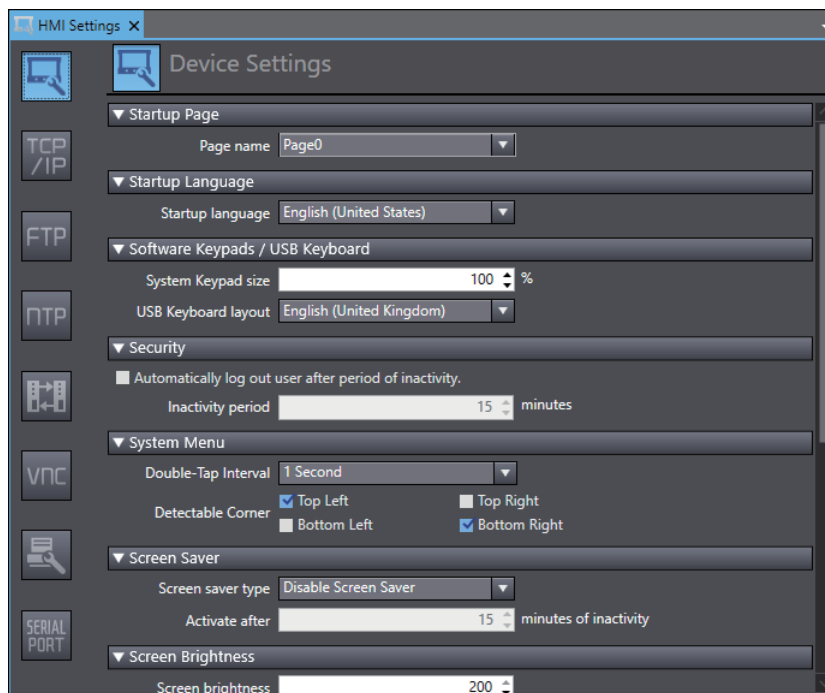

- 2 Click the **TCP/IP Settings** Button and set the IP address for Ethernet port 1 in the TCP/IP Settings. Also set the subnet mask and default gateway as required.

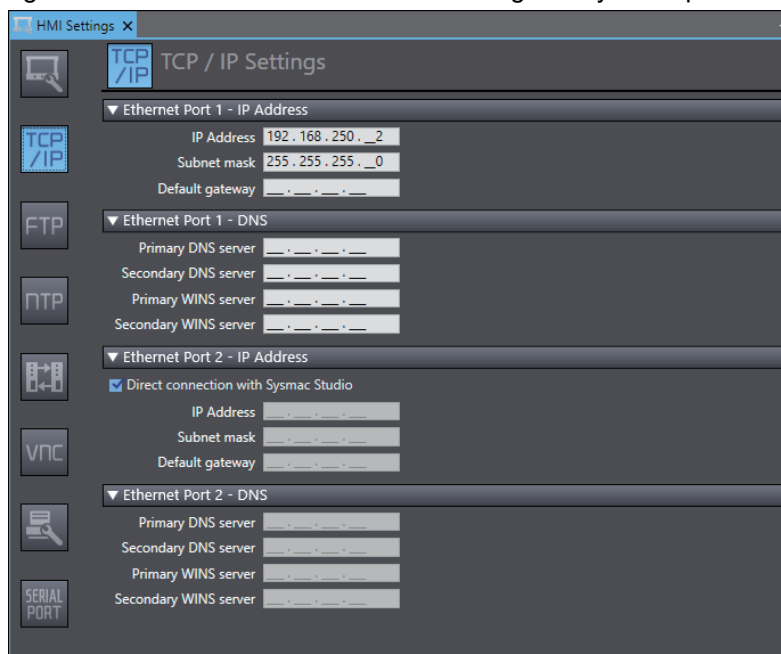

Registering the NX-series Safety Controller as a Connected Device in the Device References

Different registration methods are used to connect to a Safety Controller that is registered in the current project and to connect to a Safety Controller that is not registered in the current project.

- **Connecting an NX-series Safety Controller Registered in the Current Project:**

Registration is not necessary. The Safety Controller is registered automatically in the Device References.

- **Connecting an NX-series Safety Controller Not Registered in the Current Project:**

- 1 Right-click **Device References** under **Configurations and Setup** in the Multiview Explorer and add an external connected device.

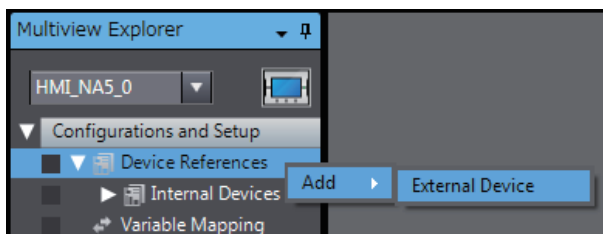

- 2 Double-click the added external connected device.

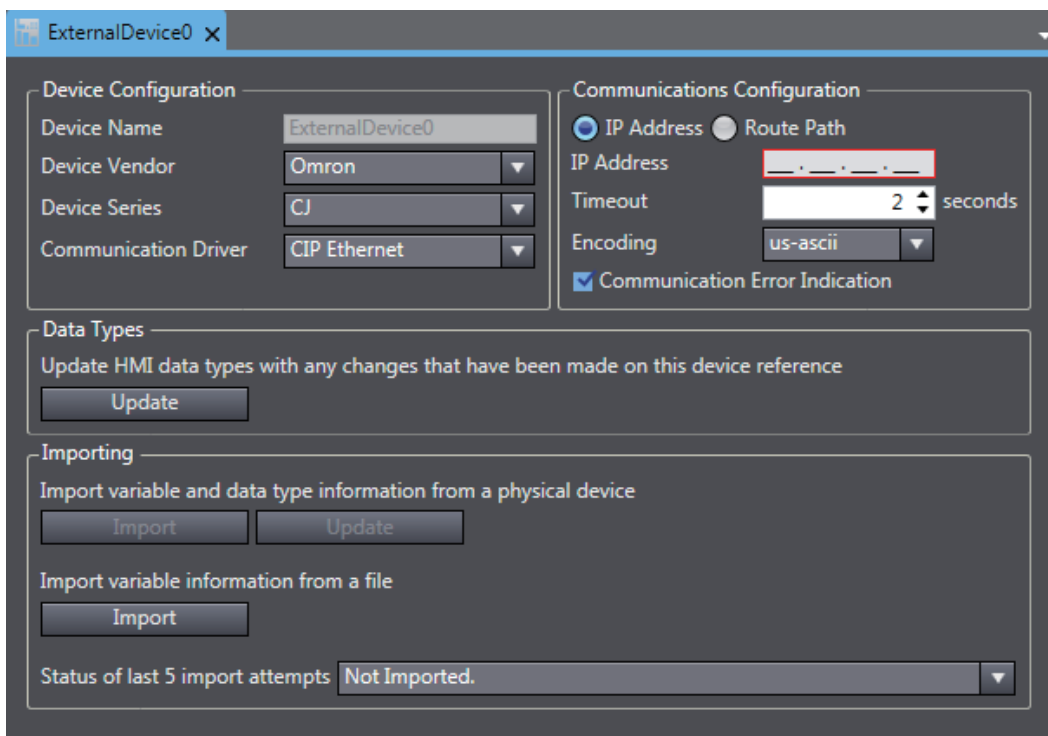

3 Make the following settings for the external connected device.

Device Configuration

- Device Vendor: Select “Omron”.
- Device Series: Select device to be used.
- Communication Driver: Select “Ethernet.”

Communications Configuration

- IP Address: Set the IP address of the connected device.
- Timeout: Set the time for timeouts during communications.
- Communication Error Indication: Clear the selection of the check box if you do not need to display an error dialog when a communications error occurs.

The screenshot shows the configuration window for 'ExternalDevice0'. It is divided into several sections:

- Device Configuration:**
 - Device Name: ExternalDevice0
 - Device Vendor: Omron
 - Device Series: NX-CSG320
 - Communication Driver: Ethernet
- Communications Configuration:**
 - IP Address: 192.168.250.1
 - Timeout: 2 seconds
 - Communication Error Indication
- Data Types:**
 - Update HMI data types with any changes that have been made on this device reference
 - Update button
- Importing:**
 - Import variable and data type information from a physical device
 - Import button
 - Update button
 - Import variable information from a file
 - Import button
 - Status of last 5 import attempts: Not Imported.

Registering Device Variables

There are three methods to register device variables.



Precautions for Correct Use

You cannot copy and paste a structure variable from the global variable table of another project or import it from Excel files. If you need to register a structure variable, import it from the NX-series Safety Controller.

● Importing Device Variables from an NX-series Safety Controller

Use the following procedure to connect to an NX-series Safety Controller and import variables from it.

- 1 Enables the controller to connect to Sysmac Studio in a network configuration that conforms to [Communication Configuration] in the external device settings.
- 2 Click the **Import Variables** Button.

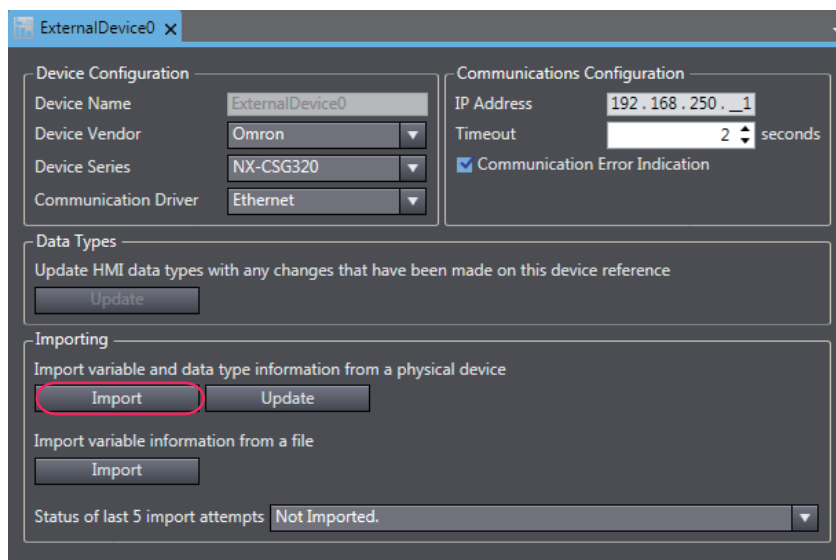

- 3 The global variables are transferred from the Controller and registered as device variables.

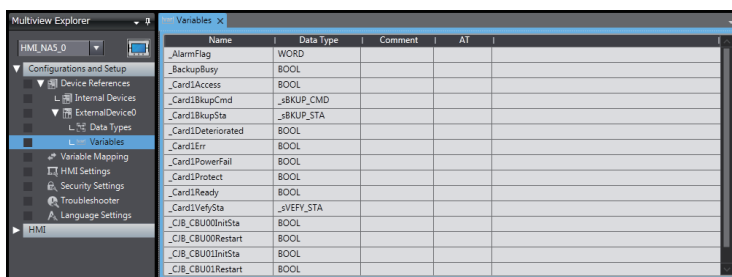

● **Copying Variables from the Global Variable Table of Another Project**

Use the following procedure to copy variables from the global variable table of another project.

- 1 Open a project in which a Controller is registered as an external connected device. Open the global variable table and copy the required variables.

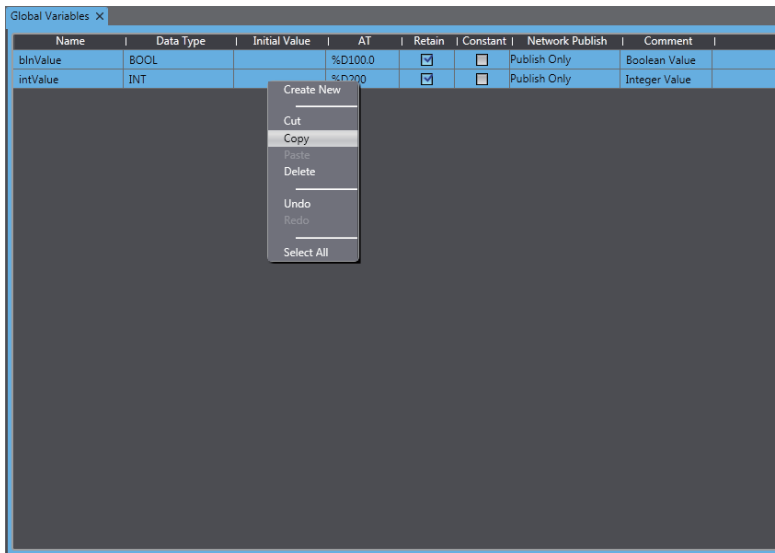

- 2 Paste the device variables in a spreadsheet, delete unnecessary rows, and sort and copy the remaining rows. Refer to *A-1 Clipboard Format for Device Variable Table Data* on page A-2 for information on the order of the rows.

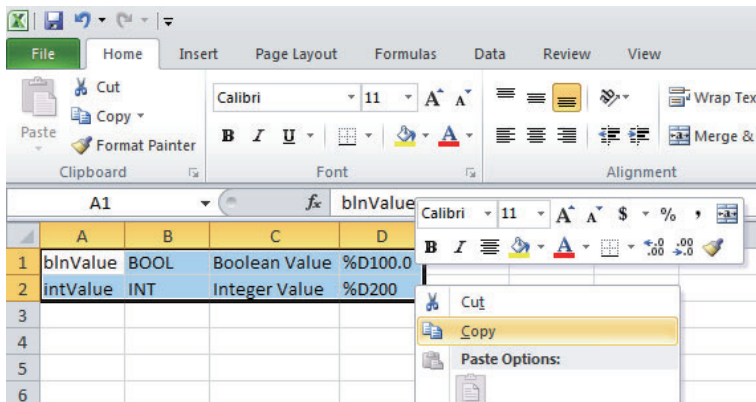

- 3 Paste the variables in the device variable table of the HMI project.

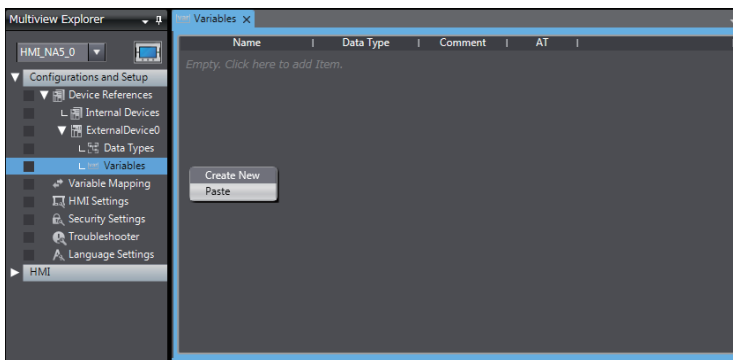

● Importing Device Variables from Excel Files

- 1 Prepare an Excel file that contains the device variable setting, such as a copy of the contents of another HMI device variable table. Refer to *A-1 Clipboard Format for Device Variable Table Data* on page A-2 for information on the order of the columns.
- 2 Click the **Import** Button.

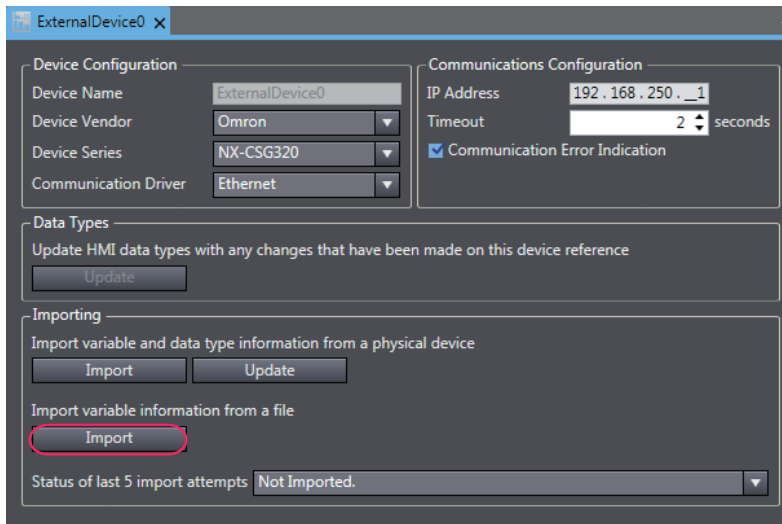

The variables are copied to the device variable table of the HMI project.

Mapping Variables

Conform the following specifications when you assign the variables of the NX-series Safety Controller to the global variables.

● Supported Data Types

You can assign the following NX-series Safety Controller data types to the global variables.

BOOL, BYTE, WORD, DWORD, LWORD, SINT, INT, DINT, LINT, USINT, UINT, UDINT, ULINT, REAL, LREAL, TIME, DATE, TIME_OF_DAY, DATE_AND_TIME, and STRING

You can also access array elements, structure and union members, and enumerated variables that have any of the above data types. The minimum value of the subscript of an array is always 0. The maximum value of the subscript is the maximum value for the array registered in the NX-series Safety Controller.

● Data Types Supported by the NX-series Safety Controllers and the HMIs

The following table shows the corresponding data types of the NX-series Safety Controllers and the HMIs.

NX-series Safety Controller data type	HMI data type
BOOL	Boolean
INT	Short
DINT	Integer
LINT	Long
UINT	UShort
WORD	
UDINT	UInteger
DWORD	
ULINT	Ulong
LWORD	
REAL	Single
LREAL	Double
STRING	String
SINT	SByte
USINT	Byte
BYTE	
TIME	TimeSpan
DATE	Date
DATE_AND_TIME	
TIME_OF_DAY	

6

Connecting to an OMRON Programmable Multi-Axis Controller

This section describes connection methods for an OMRON Programmable Multi-Axis Controller.

6-1	Connection via Modbus/TCP	6-2
6-1-1	Making Settings for the Programmable Multi-Axis Controller	6-2
6-1-2	HMI Settings	6-3

6-1 Connection via Modbus/TCP

You can connect a NA-series Programmable Terminal to a Programmable Multi-Axis Controller using Modbus/TCP.

Make the settings for the Programmable Multi-Axis Motion Controller from PowerPMAC IDE. Make the settings for the HMI from the Sysmac Studio.

6-1-1 Making Settings for the Programmable Multi-Axis Controller

Use Modbus/TCP to connect to an OMRON Programmable Multi-Axis Controller

For Programmable Multi-Axis Controllers that can be connected to the NA-series Programmable Terminal, refer to *Section 1 Supported Devices*.

PowerPMAC IDE Settings

Use PowerPMAC IDE to configure the following settings.

● IP Address Settings

You need to set the following items in PowerPMAC - Network Settings of Tools - Options of PowerPMAC IDE.

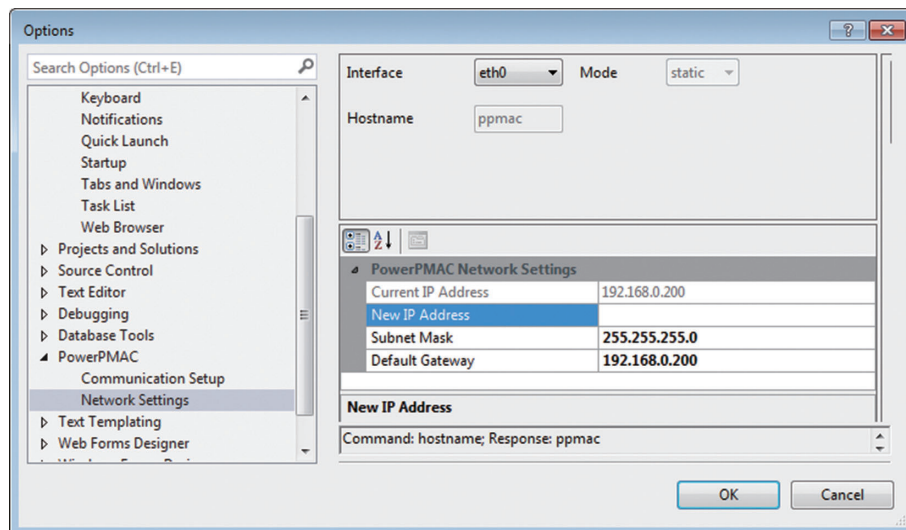

Item	Description
IP address	Sets the IP address of the built-in Ethernet port. Set the required IP address.
Subnet mask	Set the subnet mask of the Ethernet port. Configure the setting required for your network configuration.
Default gateway	Set the default gateway of the Ethernet port. Set it according to the network configuration.

● Modbus/TCP Settings

The following command must be entered from the PowerPMAC IDE terminal.

Sys.ModbusServerEnable=1

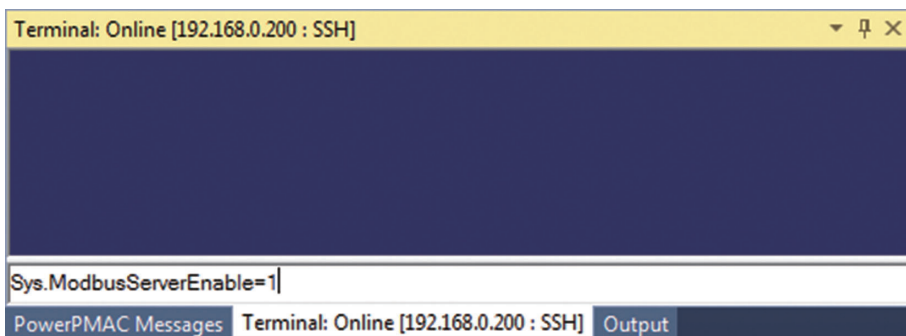

6-1-2 HMI Settings

The following settings must be made for the HMI with the Sysmac Studio.

- Communication Settings in the HMI Settings
- Registering the Programmable Multi-Axis Controller as a connected device in the Device References.

Communication Settings

- 1 Double-click **HMI Settings** under **Configuration and Setup** in the Multiview Explorer.

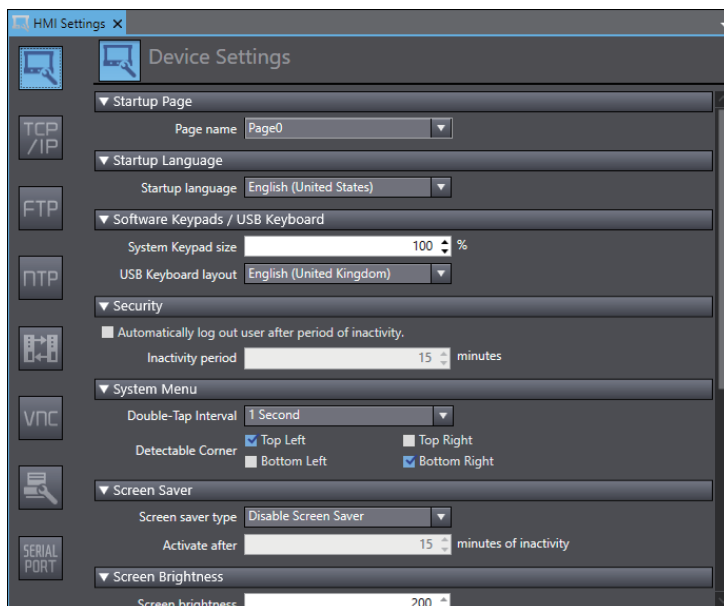

- Click the TCP/IP Settings Button and set the IP address for Ethernet port 1 in the TCP/IP Settings. Also set the subnet mask and default gateway as required.

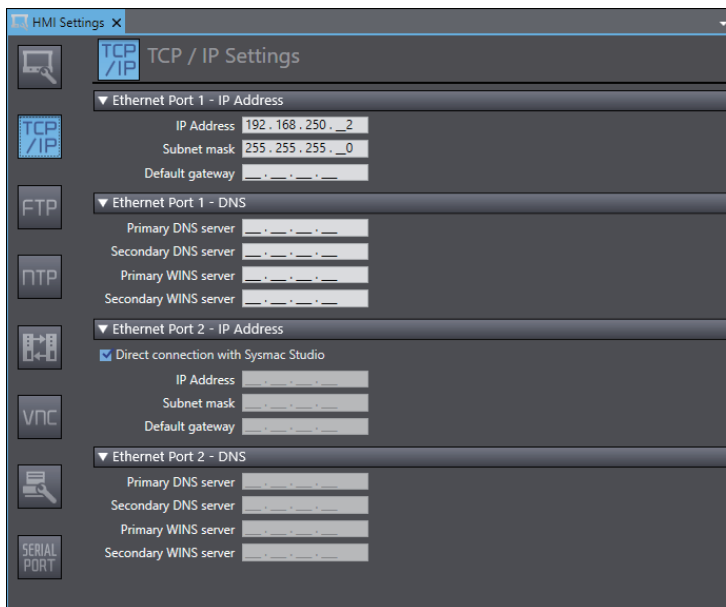

Registering the Programmable Multi-Axis Controller as a Connected Device in the Device References

- Right-click **Device References** under **Configurations and Setup** in the Multiview Explorer and add an external connected device.

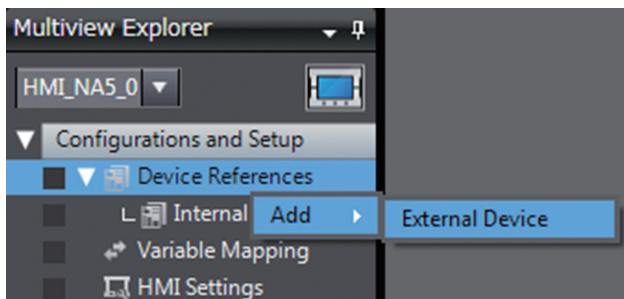

- 2 Double-click the added external device.

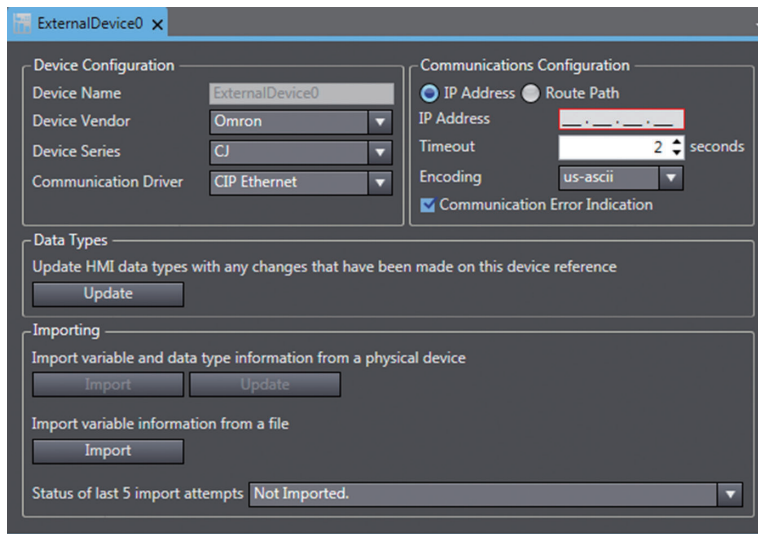

- 3 Make the following settings for the external connected device.

Device Configuration

- **Device Vendor:** Select "Omron".
- **Device Series:** Select "CK3", the model connected.
- **Communication Driver:** Select "Modbus/TCP".

Communications Configuration

- **IP Address:** Set the IP address of the connected device.
- **Timeout:** Set the time for timeouts during communication.
- **Communication start wait time:** Set the amount of time until communication starts after the NA unit is turned on.
- **Communication Error Indication:** If you do not want an error dialog box to appear when a communication error occurs, remove the checkmark.

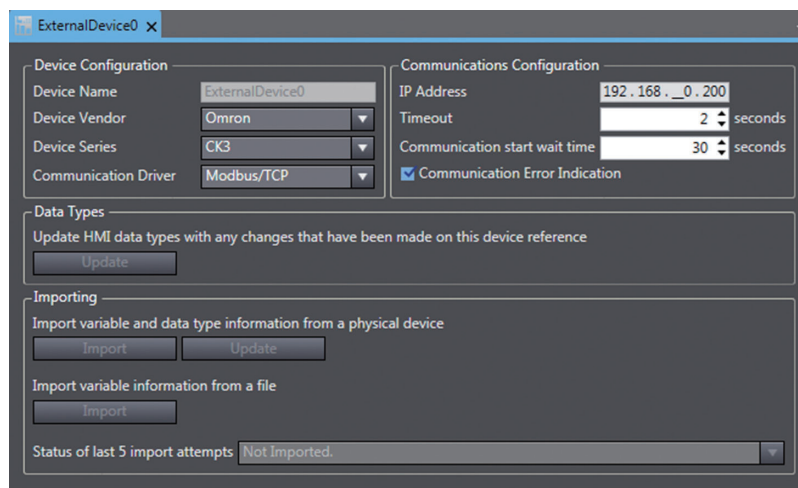

Registering Device Variables

Register device variables.

- 1 Open the device variable table of the HMI project.

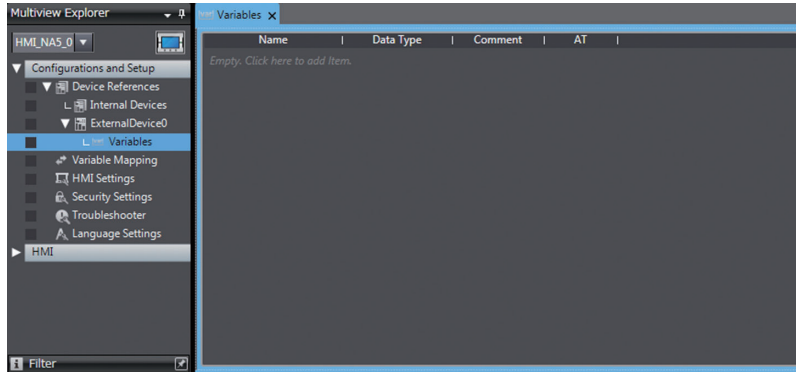

- 2 Register the addresses of the devices as variables.

- **Name:** Set a desired name.
- **Data Type:** Set FLOAT for the data type.
- **Comment:** Enter any comment.
- **AT:** Set the address of the device.

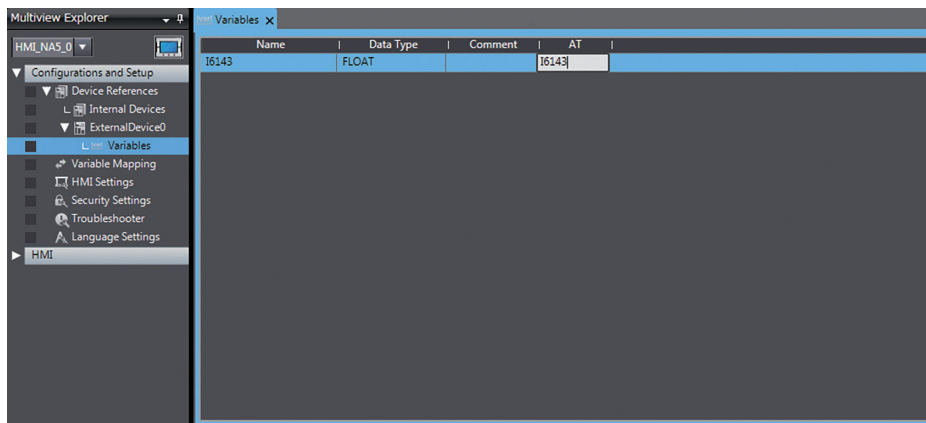

Mapping Variables

Conform the following specifications when you assign the variables of the Programmable Multi-Axis Controller to the global variables.

● Usable Address Range

The usable address range is indicated. The upper limit of the address, the range of the area, and the attributes vary by model. For details, refer to the manual for the Programmable Multi-Axis Controller.

Area name	Description	Range	Data type	Restrictions/Cautions
I		0 to 6143	32-bit float	
M		0 to 8191	32-bit float	
P		0 to 8191	32-bit float	
Q		[0 to 5].0 to 1023	32-bit float	

● Supported Data Types

Because Modbus/TCP is used to connect to a Programmable Multi-Axis Controller, all data is treated as 32-bit float data.

● Programmable Multi-Axis Controller and HMI Data Type Correspondence Table

Correspondences between Programmable Multi-Axis Motion Controller data types and HMI data types are shown below.

Programmable Multi-Axis Controller data type	HMI data type
Float	Single



Appendix

This appendix provides reference information for connecting devices.

A-1	Clipboard Format for Device Variable Table Data	A-2
A-2	Making a Serial Connection Cable	A-3
A-2-1	Connecting the Wires to RS-232C Connectors	A-3
A-2-2	Connecting the Wires to RS-422A Connectors	A-6
A-2-3	Making a Cable for Connecting with a Connected Device	A-7
A-3	Handling of CJ1W-CIF11	A-8
A-3-1	Dimensions	A-8
A-3-2	Installation and Removal Procedures	A-9
A-3-3	Specifications	A-10
A-3-4	DIP Switch Settings	A-11
A-3-5	Pin Arrangement	A-12
A-3-6	Block Diagram	A-12
A-3-7	RS-422A Cable Shield Preparation	A-14
A-3-8	Connection Example	A-15

A-1 Clipboard Format for Device Variable Table Data

The following format is supported.

Format name	Character code	Delimiter	Remarks
UNICODE TEXT	UTF-16LE	Tab (0x0900)	NULL must be used for termination.

1st column	2nd column	3rd column	4th column
Name	Data Type	Comment	AT

A-2 Making a Serial Connection Cable

Use the following procedure to make a serial connection cable.

A-2-1 Connecting the Wires to RS-232C Connectors

Use the following procedure to perform the connector wiring.

Cable Preparation

For the length in each step, refer to the figure below.

● End with Shield Connected to the Shell (FG)

- 1 Cut the cable to the required length.



- 2 Strip off the sheath using a razor blade.

Take care not to damage the shield (braided mesh) when doing so.

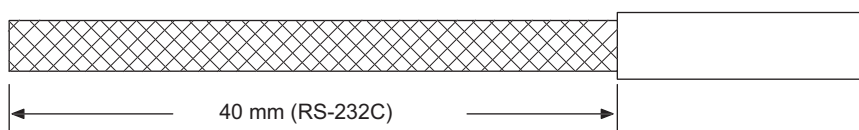

- 3 Trim off the shield using scissors.

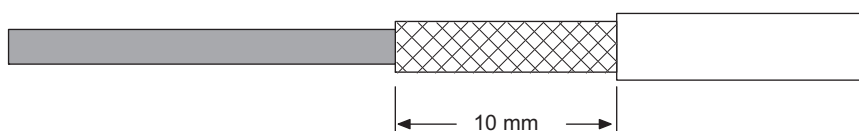

- 4 Strip to the core of each wire using a stripper.

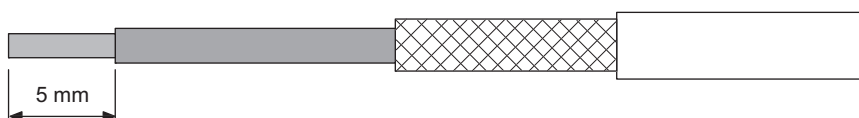

- 5 Fold back the shield.



- 6 Wrap aluminum foil tape around the folded back shield.



● **End with Shield Not Connected to the Shell (FG)**

- 1** Cut the cable to the required length.



- 2** Strip off the sheath using a razor blade.

Take care not to damage the shield (braided mesh) when doing so.

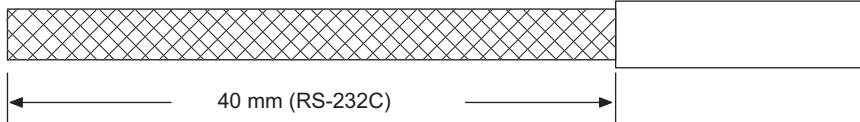

- 3** Trim off all the shield using scissors.

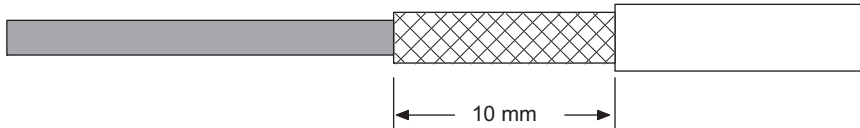

- 4** Strip to the core of each wire using a stripper.

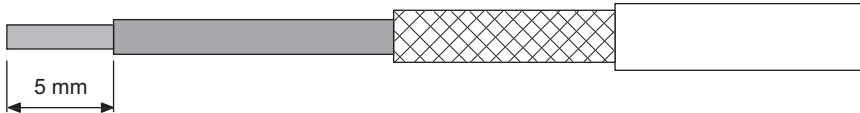

- 5** Wrap vinyl tape around the cut part of the shield.

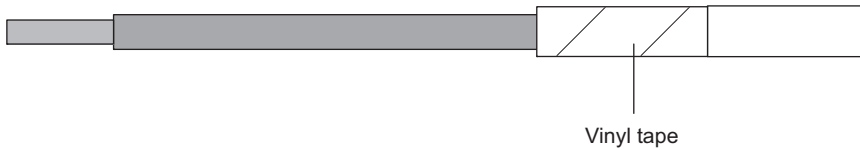

● **Soldering**

- 1** Slide a heat-shrinkable tube over each wire.
- 2** Pre-solder each wire and the connector terminal.
- 3** Solder each wire.

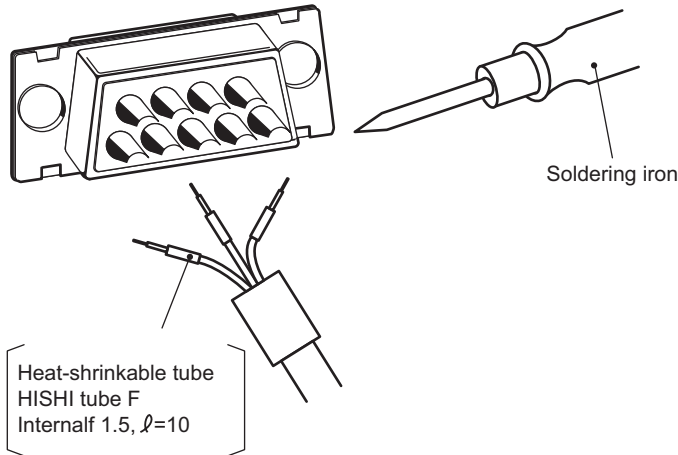
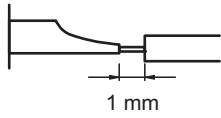

- 4** Push the heat-shrinkable tubes back over the soldered joints, then heat them using a jetter to shrink them in place.

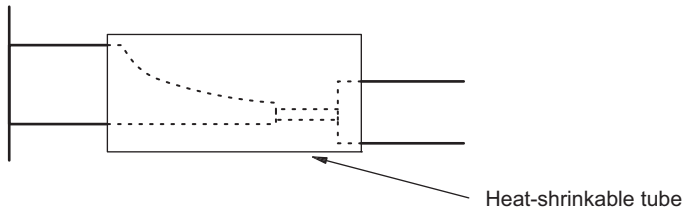

● **Hood Assembly**

Assemble the connector hood.

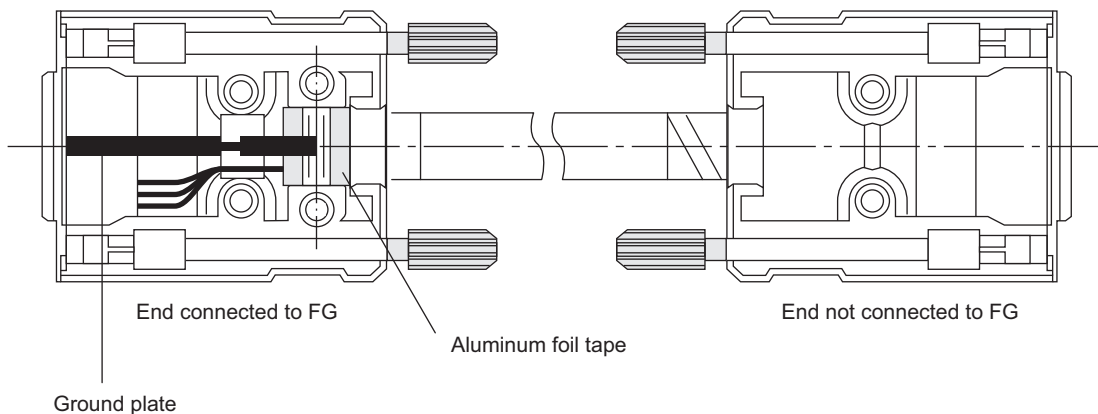

A-2-2 Connecting the Wires to RS-422A Connectors

Use the following procedure to perform the connector wiring.

- 1 Strip between about 30 and 80 mm of sheath from the communication cable while taking care not to damage the shield braided mesh.

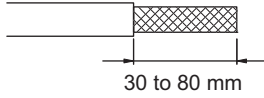

- 2 Carefully disentangle the shield braided mesh and then twist it together.

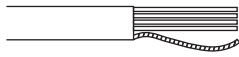

Carefully trim away the cable packing and any unnecessary conductor.

- 3 Strip the sheath of the signal lines to the correct length for the crimp terminals. Cover the exposed communication wires with vinyl tape or heat-shrinkable tubes.



- 4 Attach the ferrule crimp terminals to the ends of the signal lines and shields, and crimp them using a dedicated tool.

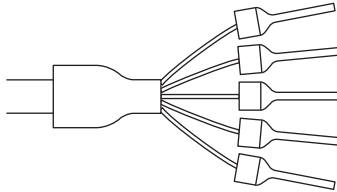

When wiring a 4-wire cable, insert two signal lines into one crimp terminal at the same time and then crimp them.

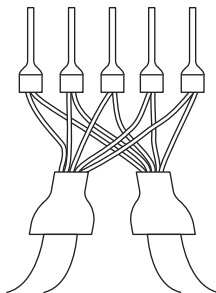

A-2-3 Making a Cable for Connecting with a Connected Device

Make a cable for connecting an HMI and connected device in reference to the following.

HMI - Connected Device Wiring Diagram (RS-232C)

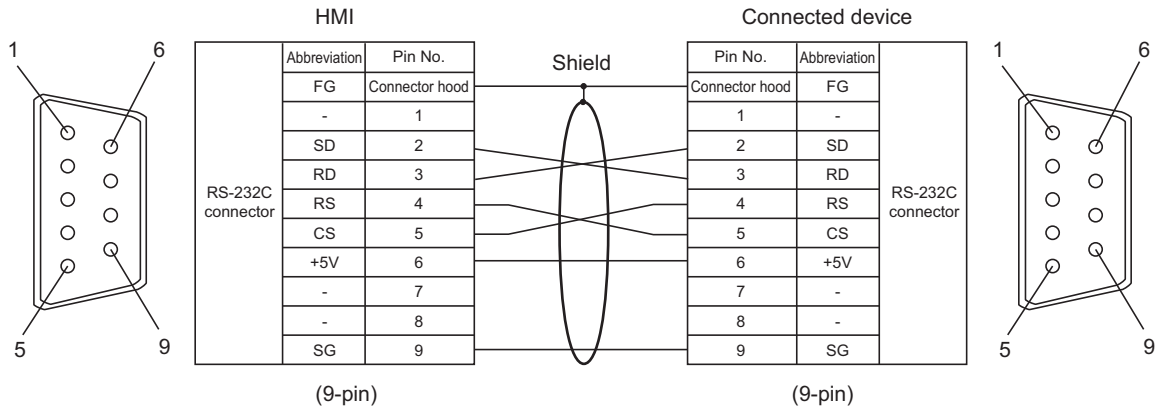

CJ1W-CIF11 - Connected Device Wiring Diagram (RS-422A)

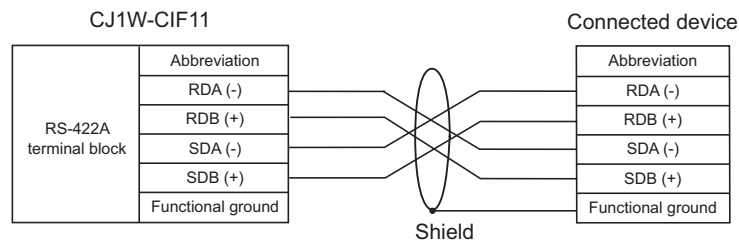

When connecting each of the signals with a twisted-pair cable, make the connections so that the RDA and RDB and the SDA and SDB become pairs of the twisted-pair cable. If the pair combinations are incorrect, a communication error may occur.

A-3 Handling of CJ1W-CIF11

The RS-422A conversion unit (CJ1W-CIF11) is a unit that connects directly to the serial port of the HMI and converts RS-232C to RS-422A. This section provides the dimensions, installation and removal procedures, and specifications of the CJ1W-CIF11. Refer to it when designing the control panel. When you will use an RS-422A conversion unit, refer to the instruction manual supplied with the conversion unit to be used.



Precautions for Correct Use

The CJ1W-CIF11 is a non-isolated RS-232C/422A conversion unit. Therefore, normal operation may not be possible in an environment where there are concerns about the influence of ground potential differences or noise.

A-3-1 Dimensions

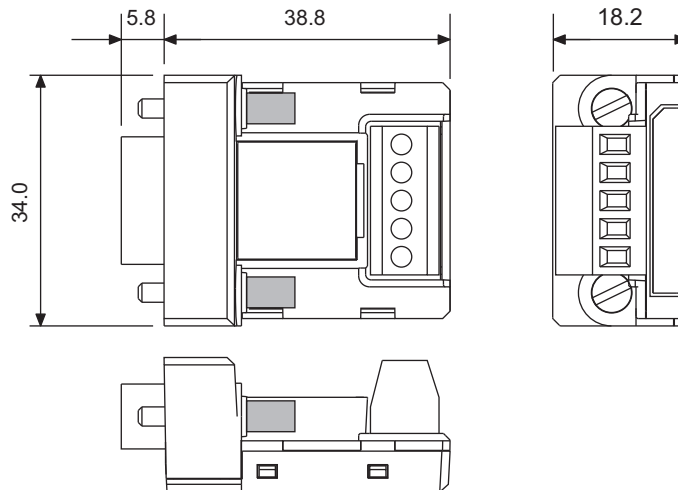

A-3-2 Installation and Removal Procedures

Directly connect the CJ1W-CIF11 to the serial port of the HMI.

When connecting the adapter, firmly tighten the mounting screws at both sides of the D-SUB connector. The proper tightening torque is 0.3 N·m. Also, the proper tightening torque for the terminal block is 0.5 N·m. When removing the adapter, loosen the screws and then pull out the adapter.

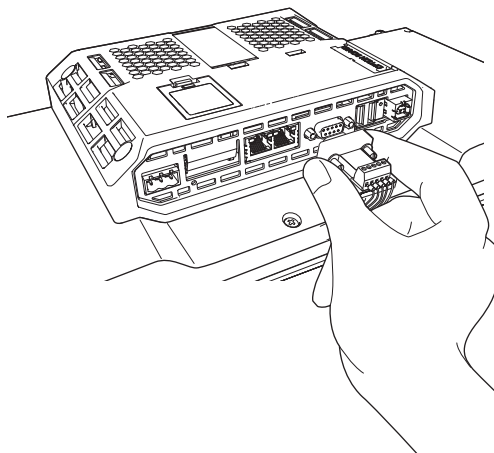

Precautions for Safe Use

- Always turn OFF the power supply of the HMI before installing or removing the adapter.
- Do not touch the surface or mounted components of the circuit board with bare hands. Discharge any static electricity from your body before handling the board.



Precautions for Correct Use

Fix the cable to the terminal block before attaching the adapter to the HMI. Always firmly tighten the mounting screws at both sides of the D-SUB connector. If the screws are not tightened, the FG of the HMI and FG of the CJ1W-CIF11 will not be connected.

A-3-3 Specifications

This section provides the general specifications and communication specifications of the converter unit.

General specifications

Item	Specifications	
Dimensions	18.2 × 34.0 × 38.8 mm (W × H × D)	
Weight	20 g max.	
Ambient operating temperature	0 to 55°C	
Ambient storage temperature	-20 to 75°C	
Ambient operating humidity	10 to 90% (with no condensation)	
Rated supply voltage	+5 V	Use the No. 6 pin of the RS-232C connector.
Power consumption	40 mA max.	
Atmosphere	Must be free from corrosive gases.	
Vibration resistance	Conforms to HMI to which installed	
Shock resistance	Conforms to HMI to which installed	
Isolation method	Not isolated	
Transmission distance	50 m	

A-3-4 DIP Switch Settings

The conversion unit (CJ1W-CIF11) has a DIP switch for setting the communication conditions for RS-422A. Before connecting the cable to the conversion unit, make the settings of the DIP switch in accordance with the following:

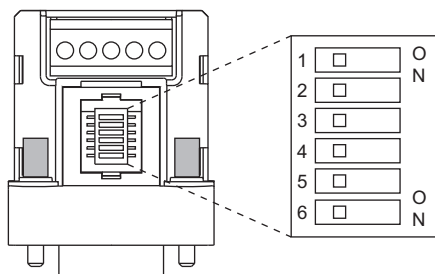

The factory default settings are all OFF.

Pin No.	Description	Setting
1	Select whether there is terminating resistance	Terminal resistance: ON No terminal resistance: OFF
2	Switch between 2-wire type and 4-wire type	OFF (4-wire type)
3	Switch between 2-wire type and 4-wire type	OFF (4-wire type)
4	Not used	OFF
5	Whether there is RS control for RD	OFF (No)
6	Whether there is RS control for SD	ON (Yes)

- If the CJ1W-CIF11 is used, the transmission distance will be the total length of 50 m.
- Refer to *Appendix* in SYSMAC CJ Series CJ1H-CPU□□H-R, CJ1G/H-CPU□□H, CJ1G-CPU□□P, CJ1G-CPU□□, CJ1M-CPU□□ Programmable Controllers OPERATION MANUAL (Cat. No. V393) for details.

A-3-5 Pin Arrangement

The conversion unit has a connector for an RS-232C interface connection and a terminal block for an RS-422A/485 interface connection.

The pin arrangement for each of the RS-232C connector and RS-422A/485 terminal block is as follows:

RS-232C Connector

RS-232Cconnector pin arrangement		Pin No.	Signal name
		1	FG
		2	RD
		3	SD
		4	CS
		5	RS
+5V	6	6	+5 V
-	7	7, 8	NC
-	8	9	SG (0 V)
SG (0V)	9	Hood	NC (Note)

Note The hood will have the same electric potential as the connector hood of the connection destination.

RS-422A/485 Terminal Block

Signal name
RDA-
RDB+
SDA-
SDB+
FG

A-3-6 Block Diagram

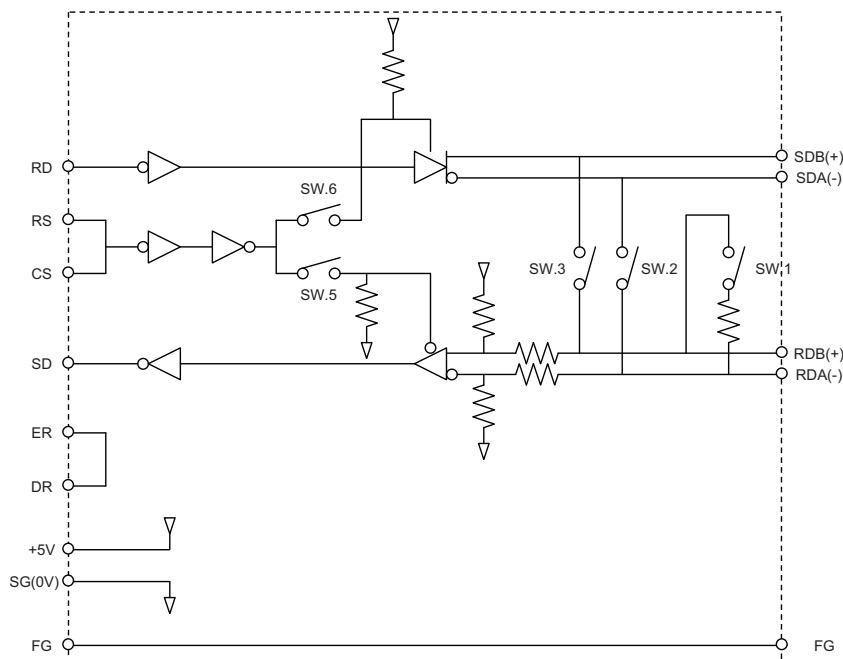

Wiring the RS-422A/485 Terminal Block

● Recommended Cable for RS-422A

For RS-422A, we recommend that you use the following wiring method to ensure transmission quality.

- Use either a 2-wire or 4-wire shielded cable for the communications cable.
- Connect the shield at both ends of the communications cable to the shell (FG) of the RS-422A/485 terminal block of this unit. Also, connect the ground terminal of the device to which installed to a ground of 100 Ω or less.

● Wiring Procedure

Connect the signal lines and shields of the cable that you made in reference to *A-2 Making a Serial Connection Cable* on page A-3 to the terminal block of the RS-422A conversion unit.

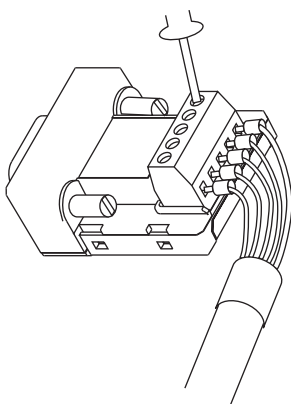

A-3-7 RS-422A Cable Shield Preparation

In a communication system using the CJ1W-CIF11, perform the following connection, shield preparation, and grounding work. If the connection is not correct, communications with the connected device may malfunction.

Connecting the D-SUB Connector of the CJ1W-CIF11

Always firmly tighten the mounting screws at both sides of the D-SUB connector. If the screws are not tightened, the functional ground terminal () of the HMI and FG of the CJ1W-CIF11 will not be connected.

Wiring the Ground

The HMI has a functional ground terminal ().

(1) Perform grounding as shown in Figure (a) for normal grounding.

- Connect the ground (GR) terminal of the devices to the functional ground terminal () and ground each signal line at one point to 100 Ω or less.
- Short the LG terminal of the connected device to the GR terminal.
- Use AWG14-20 wire for the ground wire.
- For details on the connection method, refer to the manual for the corresponding communication unit.

(2) If the HMI is mounted to the same panel as devices that generate noise, such as motors or inverters, do not ground the functional ground terminal () of the HMI as shown in Figure (b).

RS-422A Cable Shield Preparation

Always prepare RS-422A cable shields. If the shield are not prepared, communications with the connected device may malfunction.

When the ground (GR) terminal of the devices are connected to the functional ground terminal (\oplus) and each signal line is grounded at one point to 100 Ω or less, shield one end as shown in Figure (a).

When not grounding the functional ground terminal (\oplus) of the HMI, shield both ends as shown in Figure (b).

Be sure to perform the connection, shield preparation, and grounding work as shown in Figure (b).

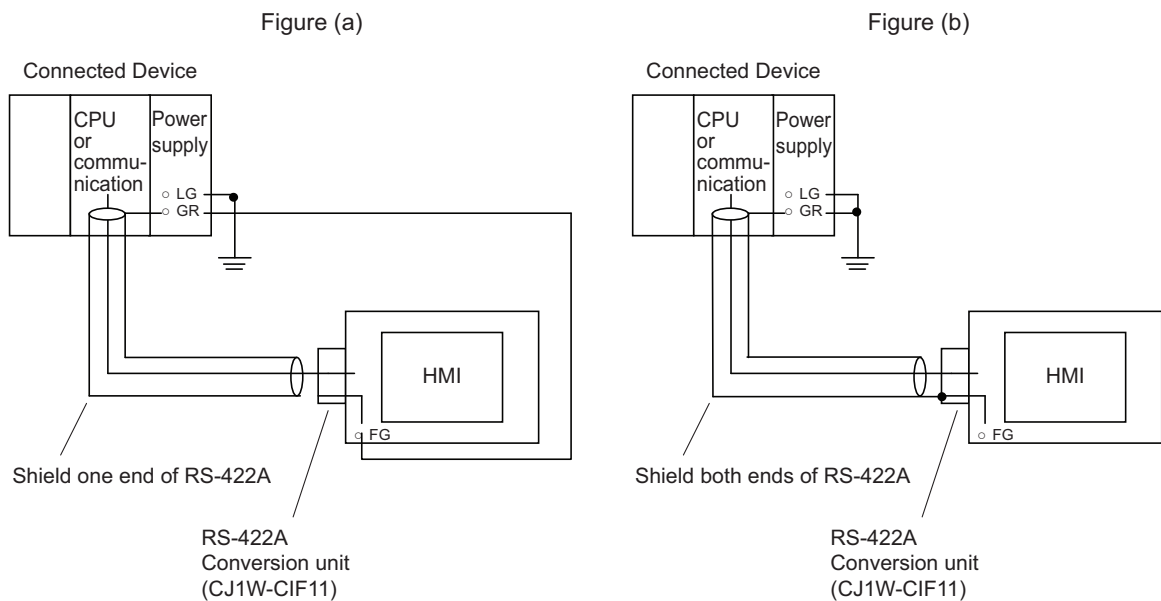

A-3-8 Connection Example

An example of connecting an HMI and a connected device using an RS-232C/422A conversion unit is shown below. When wiring, perform the work correctly using the wiring example as a reference.

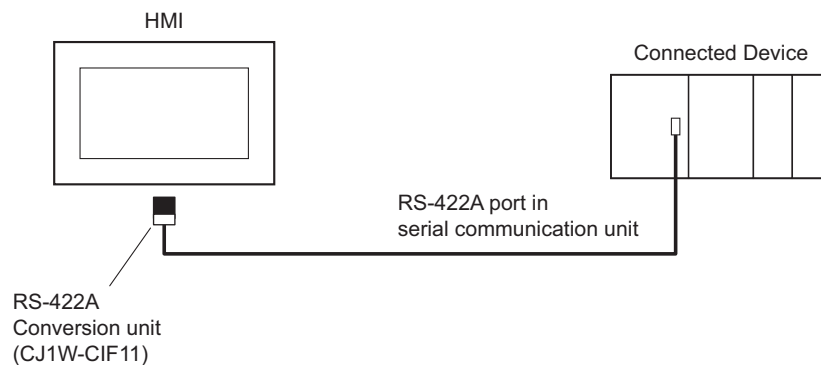

Wiring Example

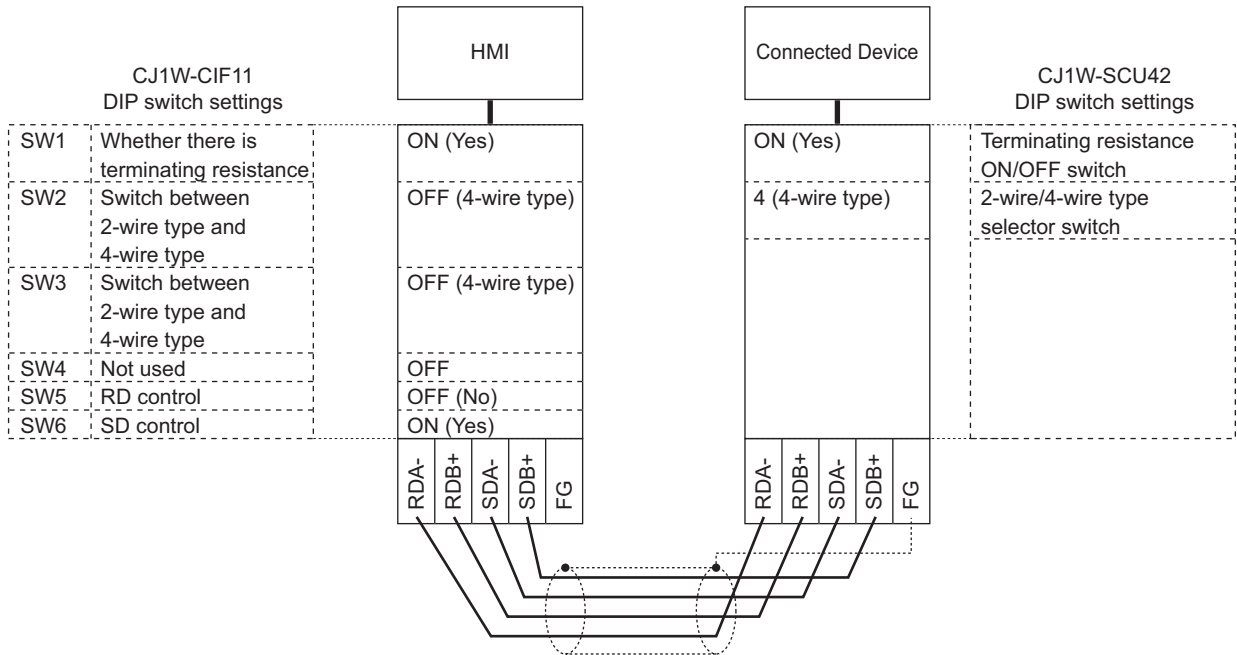



Index



C

CJ1W-CIF11A-8

D

data types3-12, 4-12, 4-21, 5-9
 device references 3-6, 4-7, 4-16, 5-4, 6-4
 device variables 3-9, 4-9, 4-18, 5-6, 6-6

E

Ethernet switches 2-5
 EtherNet/IP 4-13

M

mapping variables 3-12, 4-11, 4-21, 5-9, 6-7

N

network installation 2-8

O

OMRON CJ-series PLC 4-1
 OMRON NJ-series Controller 3-1
 OMRON NX-series Safety Controller 5-1
 OMRON Programmable Multi-Axis Controller 6-1

R

range of accessible addresses 4-11
 RS-232CA-3
 RS-422AA-6

S

Serial 4-22
 supported data types 4-12
 supported devices 1-2

T

twisted-pair cables 2-6

OMRON Corporation Industrial Automation Company

Kyoto, JAPAN

Contact : www.ia.omron.com

Regional Headquarters

OMRON EUROPE B.V.

Wegalaan 67-69, 2132 JD Hoofddorp
The Netherlands
Tel: (31) 2356-81-300 Fax: (31) 2356-81-388

OMRON ELECTRONICS LLC

2895 Greenspoint Parkway, Suite 200
Hoffman Estates, IL 60169 U.S.A.
Tel: (1) 847-843-7900 Fax: (1) 847-843-7787

OMRON ASIA PACIFIC PTE. LTD.

438B Alexandra Road, #08-01/02 Alexandra
Technopark, Singapore 119968
Tel: (65) 6835-3011 Fax: (65) 6835-3011

OMRON (CHINA) CO., LTD.

Room 2211, Bank of China Tower,
200 Yin Cheng Zhong Road,
PuDong New Area, Shanghai, 200120, China
Tel: (86) 21-6023-0333 Fax: (86) 21-5037-2388

Authorized Distributor:

©OMRON Corporation 2014-2023 All Rights Reserved.
In the interest of product improvement,
specifications are subject to change without notice.

Cat. No. V119-E1-14 0723