

**NS-Series
NS-NSDC1-V6**

NS-Designer



OPERATION MANUAL

OMRON

Notice:

OMRON products are manufactured for use according to proper procedures by a qualified operator and only for the purposes described in this manual.

The following conventions are used to indicate and classify precautions in this manual. Always heed the information provided with them. Failure to heed precautions can result in injury to people or damage to property.

-  **DANGER** Indicates an imminently hazardous situation which, if not avoided, will result in death or serious injury. Additionally, there may be severe property damage.
-  **WARNING** Indicates a potentially hazardous situation which, if not avoided, could result in death or serious injury. Additionally, there may be severe property damage.
-  **Caution** Indicates a potentially hazardous situation which, if not avoided, may result in minor or moderate injury, or property damage.

OMRON Product References

All OMRON products are capitalized in this manual. The word "Unit" is also capitalized when it refers to an OMRON product, regardless of whether or not it appears in the proper name of the product.

The abbreviation "Ch," which appears in some displays and on some OMRON products, often means "word" and is abbreviated "Wd" in documentation in this sense.

Visual Aids

The following headings appear in the left column of the manual to help you locate different types of information.

- Note** Indicates information of particular interest for efficient and convenient operation of the product.
- 1, 2, 3...** 1. Indicates lists of one sort or another, such as procedures, checklists, etc.

© OMRON, 2002

All rights reserved. No part of this publication may be reproduced, stored in a retrieval system, or transmitted, in any form, or by any means, mechanical, electronic, photocopying, recording, or otherwise, without the prior written permission of OMRON.

No patent liability is assumed with respect to the use of the information contained herein. Moreover, because OMRON is constantly striving to improve its high-quality products, the information contained in this manual is subject to change without notice. Every precaution has been taken in the preparation of this manual. Nevertheless, OMRON assumes no responsibility for errors or omissions. Neither is any liability assumed for damages resulting from the use of the information contained in this publication.

Introduction

Thank you for purchasing the NS-Designer.

The NS-Designer is a software package that enables creating and maintaining screen data for OMRON NS-series Programmable Terminals.

To take full advantage of the NS-series Programmable Terminals, please be sure that you understand the functions and performance of the NS-Designer before attempting to use it. When using an NS-series PT, please also refer to the *NS Series Setup Manual* and the *NS Series Programming Manual*.

Intended Audience

This manual is intended for the following personnel, who must also have knowledge of electrical systems (an electrical engineer or the equivalent).

- Personnel in charge of introducing FA systems into production facilities.
- Personnel in charge of designing FA systems.
- Personnel in charge of installing and connecting FA systems.
- Personnel in charge of managing FA systems and facilities.

Precaution

- The user must operate the product according to the performance specifications described in the operation manuals.
- Do not use the PT touch switch input functions for applications where danger to human life or serious property damage is possible, or for emergency switch applications.
- Before using the product under conditions which are not described in the manual or applying the product to nuclear control systems, railroad systems, aviation systems, vehicles, combustion systems, medical equipment, amusement machines, safety equipment, and other systems, machines and equipment that may have a serious influence on lives and property if used improperly, consult your OMRON representative.
- Make sure that the ratings and performance characteristics of the product are sufficient for the systems, machines, and equipment, and be sure to provide the systems, machines, and equipment with double safety mechanisms.
- This manual provides information for using the NS-Designer. Be sure to read this manual before attempting to use the NS-Designer and keep this manual close at hand for reference during installation and operation.

Notation and Terminology

The following notation and terminology are used in this manual.

Notation

The following notation is used in this manual.

Note

Indicates additional information on operation, descriptions, or settings.

Note

◆

Terminology

PT	In this manual, indicates an NS-series Programmable Terminal.
PLC	Indicates OMRON Programmable Controllers.
Host	Indicates the PLC, FA computer, or personal computer functioning as the control device and interfaced with the NS-series PT.

Related Manuals

The following manuals are used for NS-series PTs. (The boxes at the end of the catalog numbers indicate the revision code.)

NS-Designer Operating Procedures:

This manual

- **NS-Designer Operation Manual**V074-E1-□

Describes operating procedures for the NS-Designer, which is used to create the screens displayed on the PT and transfer them to the PT. It includes screen creation and transfer procedures. Refer to this manual for information on operating methods and detailed operating procedures.

This manual deals with details of NS-Designer operation. Refer to the following manuals for information on NS-series PT operation.

Detailed Setting Methods for Functional Objects and Other Objects:

- **NS Series Programming Manual**.....V073-E1-□

Describes the screen configurations, object functions, and host communications for the PT.

Basic NS-series PT Functions, Operations, and Limitations:

- **NS series -V1/-V2 Setup Manual**V083-E1-□

Provides information on NS Series -V1 models (i.e., NS12-V1, NS10-V1, NS8-V1, and NS5-V1), and NS Series -V2 models (i.e., NS5-V2).

Describes how to connect the PT to the host and peripheral devices, methods to setup communications and operation, and procedures for maintenance.

Refer to the *NS Series Programming Manual* (V073-E1-□) for information on PT functions and specific operating procedures.

First-time Users of NS-series Programmable Terminals:

- **Tutorial (Installed from NS-Designer CD-ROM.)**

This tutorial is designed for first-time users of NS-series PTs. It provides examples of operations from creating a simple screen through starting actual operation. When the NS-Designer is installed, the tutorial is installed on the hard disk as PDF files.

NS-series Macro Function:

- **Macro Reference (Installed from NS-Designer CD-ROM.)**

The online help for the NS-Designer contains detailed information on the NS-series macro functions. The *Macro Reference* contains essentially the same information, and it is installed on the hard disk as PDF Files when the NS-Designer is installed. Use either the online help or the *Macro Reference*, whichever is more convenient.

Confirming PLC Functions and Operation:

- **PLC Operation Manuals**

Refer to the operation manuals for individual PLC Units (e.g., the CPU Unit, Special I/O Units, CPU Bus Units, Communications Units, etc) to obtain information on PLC functions and operation.

Read and Understand This Manual

Please read and understand this manual before using the product. Please consult your OMRON representative if you have any questions or comments.

Warranty and Limitations of Liability

WARRANTY

OMRON's exclusive warranty is that the products are free from defects in materials and workmanship for a period of one year (or other period if specified) from date of sale by OMRON.

OMRON MAKES NO WARRANTY OR REPRESENTATION, EXPRESS OR IMPLIED, REGARDING NON-INFRINGEMENT, MERCHANTABILITY, OR FITNESS FOR PARTICULAR PURPOSE OF THE PRODUCTS. ANY BUYER OR USER ACKNOWLEDGES THAT THE BUYER OR USER ALONE HAS DETERMINED THAT THE PRODUCTS WILL SUITABLY MEET THE REQUIREMENTS OF THEIR INTENDED USE. OMRON DISCLAIMS ALL OTHER WARRANTIES, EXPRESS OR IMPLIED.

LIMITATIONS OF LIABILITY

OMRON SHALL NOT BE RESPONSIBLE FOR SPECIAL, INDIRECT, OR CONSEQUENTIAL DAMAGES, LOSS OF PROFITS OR COMMERCIAL LOSS IN ANY WAY CONNECTED WITH THE PRODUCTS, WHETHER SUCH CLAIM IS BASED ON CONTRACT, WARRANTY, NEGLIGENCE, OR STRICT LIABILITY.

In no event shall the responsibility of OMRON for any act exceed the individual price of the product on which liability is asserted.

IN NO EVENT SHALL OMRON BE RESPONSIBLE FOR WARRANTY, REPAIR, OR OTHER CLAIMS REGARDING THE PRODUCTS UNLESS OMRON'S ANALYSIS CONFIRMS THAT THE PRODUCTS WERE PROPERLY HANDLED, STORED, INSTALLED, AND MAINTAINED AND NOT SUBJECT TO CONTAMINATION, ABUSE, MISUSE, OR INAPPROPRIATE MODIFICATION OR REPAIR.

Application Considerations

SUITABILITY FOR USE

OMRON shall not be responsible for conformity with any standards, codes, or regulations that apply to the combination of products in the customer's application or use of the products.

At the customer's request, OMRON will provide applicable third party certification documents identifying ratings and limitations of use that apply to the products. This information by itself is not sufficient for a complete determination of the suitability of the products in combination with the end product, machine, system, or other application or use.

The following are some examples of applications for which particular attention must be given. This is not intended to be an exhaustive list of all possible uses of the products, nor is it intended to imply that the uses listed may be suitable for the products:

- Outdoor use, uses involving potential chemical contamination or electrical interference, or conditions or uses not described in this manual.
- Nuclear energy control systems, combustion systems, railroad systems, aviation systems, medical equipment, amusement machines, vehicles, safety equipment, and installations subject to separate industry or government regulations.
- Systems, machines, and equipment that could present a risk to life or property.

Please know and observe all prohibitions of use applicable to the products.

NEVER USE THE PRODUCTS FOR AN APPLICATION INVOLVING SERIOUS RISK TO LIFE OR PROPERTY WITHOUT ENSURING THAT THE SYSTEM AS A WHOLE HAS BEEN DESIGNED TO ADDRESS THE RISKS, AND THAT THE OMRON PRODUCTS ARE PROPERLY RATED AND INSTALLED FOR THE INTENDED USE WITHIN THE OVERALL EQUIPMENT OR SYSTEM.

PROGRAMMABLE PRODUCTS

OMRON shall not be responsible for the user's programming of a programmable product, or any consequence thereof.

Disclaimers

CHANGE IN SPECIFICATIONS

Product specifications and accessories may be changed at any time based on improvements and other reasons. It is our practice to change model numbers when published ratings or features are changed, or when significant construction changes are made. However, some specifications of the products may be changed without any notice. When in doubt, special model numbers may be assigned to fix or establish key specifications for your application on your request. Please consult with your OMRON representative at any time to confirm actual specifications of purchased products.

DIMENSIONS AND WEIGHTS

Dimensions and weights are nominal and are not to be used for manufacturing purposes, even when tolerances are shown.

PERFORMANCE DATA

Performance data given in this manual is provided as a guide for the user in determining suitability and does not constitute a warranty. It may represent the result of OMRON's test conditions, and the users must correlate it to actual application requirements. Actual performance is subject to the OMRON Warranty and Limitations of Liability.

ERRORS AND OMISSIONS

The information in this manual has been carefully checked and is believed to be accurate; however, no responsibility is assumed for clerical, typographical, or proofreading errors, or omissions.

Contents

Notice	1
Introduction	2
Notation and Terminology	3
Related Manuals	4
Read and Understand This Manual	5
Application Considerations	6
Disclaimers	7

Section 1 Overview

1-1 The NS-Designer.....	1-1
1-2 System Requirements.....	1-3
1-2-1 Hardware.....	1-3
1-2-2 Equipment Required to Transfer Screen Data.....	1-3
1-3 Basic Configuration and Functions	1-4
1-3-1 Project Overview.....	1-4
1-3-2 Manipulating Data on the PLC	1-5
1-3-3 PT Memory	1-6
1-3-4 Host Registration and Address.....	1-7
1-3-5 Screen Types and Applications.....	1-7
1-3-6 Object Types	1-8
1-3-7 Functions Used to Create Screens.....	1-10
1-3-8 Data Log.....	1-13
1-3-9 Alarms/Events.....	1-13
1-3-10 Data Blocks	1-14
1-3-11 Video Display	1-15
1-3-12 Importing and Exporting CSV Files.....	1-16
1-3-13 Validating.....	1-16
1-4 Outline of Operational Flow	1-17
1-5 Menu Commands	1-18
1-6 Functions Added in Version 3.0.....	1-21
1-7 Functions Added in Version 4.0.....	1-22
1-8 Functions Added in Version 5.0.....	1-22
1-9 Functions Added in Version 6.0.....	1-22
1-10 Functions Added in Version 6.2.....	1-23

Section 2 Setup, Starting, and Exiting

2-1 Before Installing the NS-Designer	2-1
2-2 Installing the NS-Designer	2-2
2-2-1 Basic Installation Operations	2-2
2-2-2 Installation Procedure	2-3
2-2-3 Uninstalling.....	2-7
2-2-4 Installing USB Drivers for NS-Series PTs.....	2-9
2-3 Starting the NS-Designer	2-14
2-4 Exiting the NS-Designer	2-15
2-5 User Interface	2-16
2-5-1 Basic Screen Functions	2-16
2-5-2 Dialog Box Main Functions.....	2-21

Section 3 Manipulating Project Files

3-1 Projects..... 3-1

3-2 Creating New Projects..... 3-2

3-3 Opening Existing Projects..... 3-3

3-4 Saving Projects..... 3-5

3-5 Saving a Project Under a Different Name..... 3-7

3-6 Opening Recent Projects..... 3-8

3-7 Opening Template Projects..... 3-9

 3-7-1 Specifying Template Projects (Flowchart Step 1)..... 3-10

 3-7-2 Reusing Screens (Flowchart Steps 2 to 4)..... 3-10

 3-7-3 Canceling Template Projects..... 3-11

3-8 Project Maintenance..... 3-12

 3-8-1 Procedures..... 3-12

3-9 Project Properties..... 3-17

 3-9-1 Procedure..... 3-17

3-10 Changing the PT Model..... 3-21

Section 4 Screen Types and Operations

4-1 Basic Operations..... 4-1

 4-1-1 Setting Screen Properties..... 4-1

 4-1-2 Grid Setting..... 4-4

 4-1-3 Switching Items Displayed for Objects..... 4-5

 4-1-4 Changing the Display..... 4-14

 4-1-5 Switch Label..... 4-15

 4-1-6 Show Touch Points..... 4-16

 4-1-7 Zoom..... 4-16

 4-1-8 Refreshing..... 4-17

4-2 Creating and Saving Screens..... 4-18

 4-2-1 Creating New Screens..... 4-18

 4-1-2 Screen Maintenance..... 4-22

 4-1-3 Procedure..... 4-23

4-3 Sheets..... 4-24

 4-3-1 Creating New Sheets..... 4-24

 4-3-2 Opening Existing Sheets..... 4-25

 4-3-3 Closing Sheets..... 4-25

 4-3-4 Saving Sheets..... 4-26

 4-3-5 Applying Sheets..... 4-26

 4-3-6 Sheet Maintenance..... 4-27

4-4 Frames..... 4-28

 4-4-1 Creating Frame Tab Names..... 4-30

 4-4-2 Switching Frame Pages..... 4-31

Section 5 Object Operations

5-1 Creating Functional Objects..... 5-1

 5-1-1 Creating One Object at a Time..... 5-1

 5-1-2 Property Settings..... 5-2

 5-1-3 Creating Functional Objects Using Tables..... 5-3

5-2	Creating Fixed Objects.....	5-8
5-2-1	Drawing New Fixed Objects.....	5-8
5-3	Pop-up Menus	5-12
5-4	Editing	5-13
5-4-1	Undo.....	5-13
5-4-2	Redo	5-13
5-4-3	Cut.....	5-14
5-4-4	Copy.....	5-15
5-4-5	Paste	5-16
5-4-6	Delete	5-17
5-4-7	Find	5-17
5-4-8	Replace.....	5-20
5-4-9	Select All.....	5-22
5-4-10	Repeat	5-24
5-5	Layout Functions.....	5-25
5-5-1	Changing Size	5-25
5-5-2	Moving Objects.....	5-25
5-5-3	Aligning and Distributing Objects	5-26
5-5-4	Make Same Size	5-27
5-5-5	Ordering Objects	5-29
5-5-6	Nudging Objects	5-29
5-5-7	Rotating and Flipping Objects	5-30
5-5-8	Modifying Objects	5-31
5-5-9	Grouping and Ungrouping Objects	5-33
5-6	Colors	5-35
5-7	Address Settings.....	5-36
5-7-1	Setting Addresses.....	5-37
5-7-2	Registering Hosts	5-38
5-8	Displaying and Searching Functional Object Lists	5-42
5-8-1	Redisplaying Lists.....	5-45
5-9	Listing Functional Objects Used	5-46
5-9-1	Displaying Lists of Used Functional Objects.....	5-46
5-9-2	Jumping to Screens, Tables, and Frames	5-48
5-10	Batch Settings.....	5-49
5-11	Listing Addresses Used.....	5-55
5-12	Cross-referencing Addresses.....	5-59
5-13	Library Registration and Sharing Objects	5-63
5-13-1	Registering Library Objects	5-63
5-14	Object Defaults.....	5-68
5-14-1	Registering Defaults.....	5-68
5-14-2	Resetting Defined Defaults	5-68
5-15	Editing Background Bitmaps	5-70
5-16	Options.....	5-71
5-16-1	Color Dialog.....	5-71
5-16-2	Edit/Disp.	5-71
5-16-3	Editor.....	5-72
5-16-4	Labels.....	5-72

Section 6 Programming Macros

6-1 Registering Macros 6-1
 6-1-1 Registering Macros to Projects 6-2
 6-1-2 Registering Macros to Functional Objects 6-5
 6-2 List of Error Messages 6-8

Section 7 System Settings

7-1 Settings 7-1
 7-1-1 Common Procedure 7-1
 7-1-2 PT Operations 7-1
 7-1-3 Initial 7-2
 7-1-4 History 7-4
 7-1-5 Comm-All 7-5
 7-1-6 Detailed 7-10
 7-1-7 Printer 7-16
 7-1-8 Video 7-17

Section 8 Testing

8-1 Test Function 8-1
 8-2 Test Tool 8-6
 8-2-1 Display Formats 8-6
 8-2-2 Setting Values 8-7

Section 9 Validation

9-1 Validation Settings 9-1
 9-2 Validation Results 9-2
 9-2-1 No Error Detected 9-2
 9-2-2 Error Detected 9-2
 9-3 List of Validation Items 9-4

Section 10 Transferring Data

10-1 Transferring Data to the PT 10-1
 10-1-1 Preparations and Procedures before Connecting 10-2
 10-1-2 Communications Settings for NS-Designer 10-14
 10-1-3 Transferring Project Data 10-20
 10-1-4 Transferring Screen Data 10-23
 10-1-5 Transferring the System Program 10-25
 10-2 Transferring Data to and from a Memory Card 10-29
 10-2-1 Preparations for Transferring to a Memory Card in PT 10-29
 10-2-2 Procedure for Transferring Data to a Memory Card in the PT 10-31
 10-3 Data Transfer Using SPMA 10-33
 10-3-1 Overview of SPMA 10-33
 10-3-2 SPMA Features 10-33
 10-3-3 System Configuration 10-34
 10-3-4 Procedural Example 10-36

Section 11 Printing

11-1 Printing Project Information..... 11-1
 11-1-1 Printing Samples 11-2
 11-2 Printing Page Information 11-4
 11-2-1 Printing Samples 11-6
 11-3 Previews 11-8
 11-4 Outputting to an RTF File 11-9
 11-5 Headers and Footers 11-10
 11-6 Margins 11-12

Section 12 Importing/Exporting CSV Files

12-1 Exporting CSV Files 12-1
 12-2 Editing CSV Files 12-2
 12-3 Importing CSV Files 12-3

Section 13 Multi-language Display

13-1 Overview 13-1
 13-2 Creating Multi-language Display Screens 13-2
 13-2-1 Inputting Multi-language Characters in NS-Designer Property Settings 13-2
 13-2-2 Displaying Multi-language Characters Using Indirect Object Specification 13-9
 13-2-3 Creating Multi-language Display Screens Using the CSV Import/Export Function 13-11

Appendices

Appendix 1 Quick Reference A-1
 Appendix 2 Objects A-12
 Appendix 3 Shortcut Keys A-16
 Appendix 4 Version Information A-17
 Appendix 5 Resource Report A-18
 Appendix 6 Error Messages A-19
 Appendix 7 Connecting Cable Specifications A-26
 Appendix 8 Details of CLK Status A-28
 Appendix 9 Converting Data between Different Versions of NS-series Products A-31

Section 1 Overview

This section describes the specifications and functions of the NS-Designer to provide a basic understanding of the capabilities of the NS-Designer for first-time users.

1-1	The NS-Designer	1-1
1-2	System Requirements	1-3
1-3	Basic Configuration and Functions.....	1-4
1-4	Outline of Operational Flow	1-17
1-5	Menu Commands.....	1-18
1-6	Functions Added in Version 3.0	1-21
1-7	Functions Added in Version 4.0	1-22
1-8	Functions Added in Version 5.0	1-22
1-9	Functions Added in Version 6.0	1-22
1-10	Functions Added in Version 6.2	1-23

1-1 The NS-Designer

The NS-Designer is an application software package that can be run on Windows 95, 98, NT, Me, 2000, or XP to create screen data for NS-series Programmable Terminals (referred to as "PTs").

The NS-Designer enables using a graphic Windows interface and Windows operating environment so that screens can be created simply and easily by practically anyone.

The data created on the NS-Designer consists of the following objects.

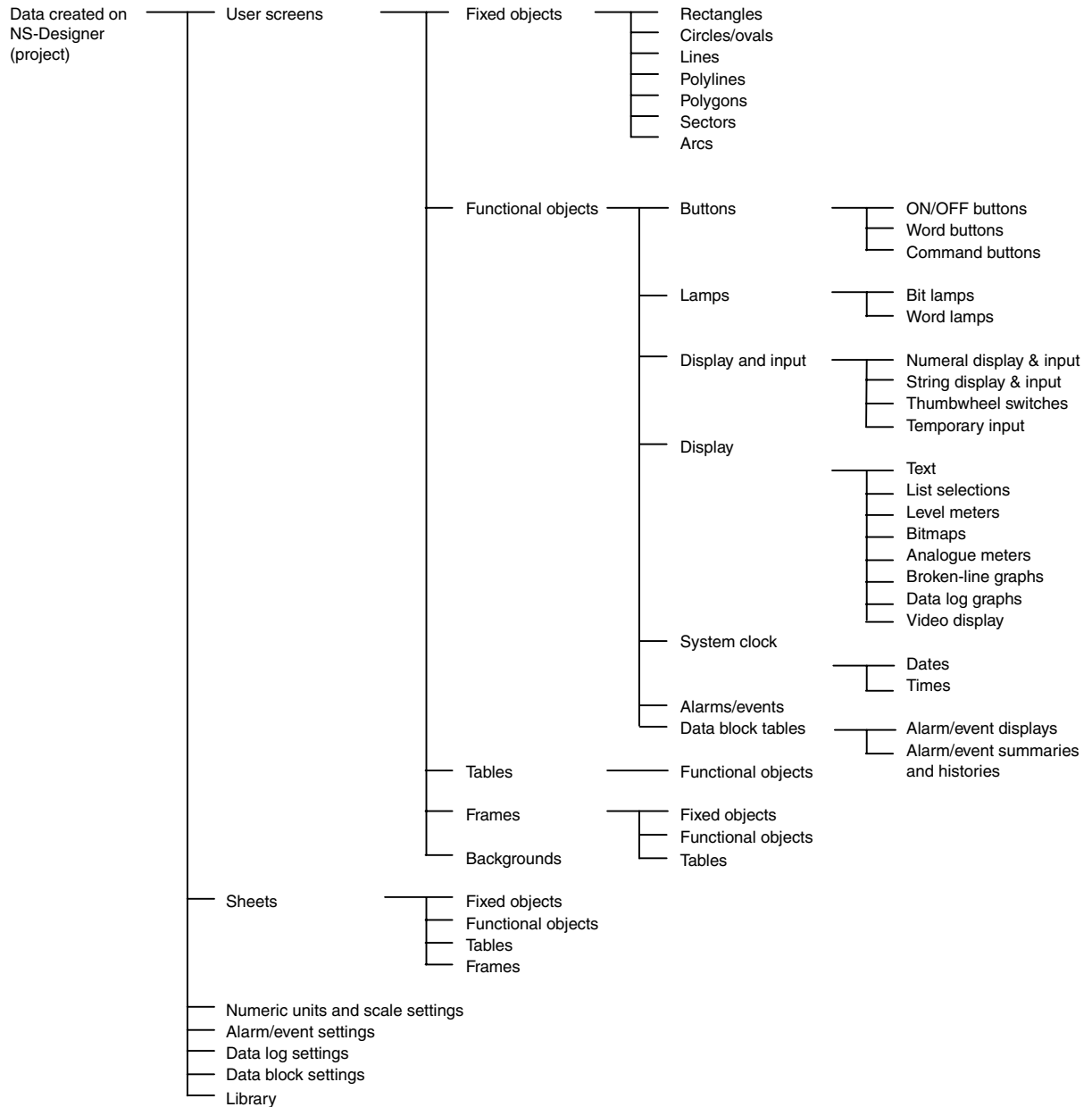

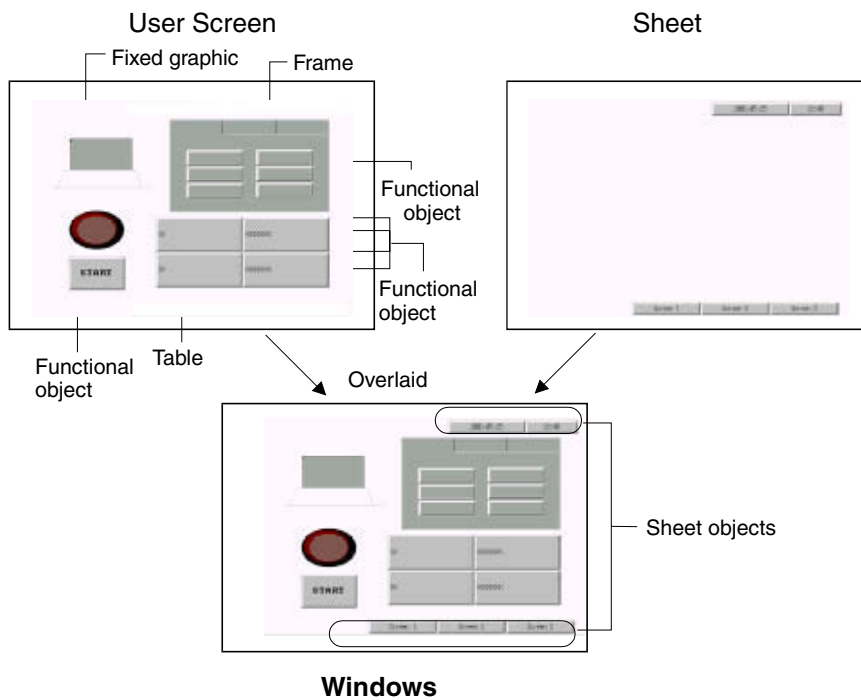

Product Components

The following software and data are included with the NS-NSDC1-V□.

- NS-Designer Software
- Transfer Program
Tool for transferring systems, projects, screens, and settings files.
- Memory Card Transfer Tool
Tool for exchanging data with the Memory Card mounted to the PT.
- NT631C Conversion Support Tool
- CX-Server
- PT System Program (replacement program)
- Operation Manuals
The operation manuals include an *NS-series Macro Reference*, an *NS-Series Tutorial Manual*, and a *Host Connection Manual*.
- Sample Data
Sample data of the screens created in the NS-series tutorial is included.
- Switch Box Utility
Tool for helping to debug the operation of PLCs.
- SAP (Smart Active Parts) Data
Libraries containing setting/monitor screens (e.g., for Position Control Units and Temperature Controllers).

1-2 System Requirements

The following are required to use the NS-Designer.

1-2-1 Hardware

Recommended Processor

Intel Celeron 400 MHz or better required.

Computer

IBM PC/AT or compatible capable of running the required OS.

Recommended Memory

64 Mbytes or more required. (Be sure to provide sufficient capacity, observing the recommend values for the OS.)

Available Disk Space

200 Mbytes or more recommended.

CD-ROM Drive

Required to install the NS-Designer.

Monitor

VGA monitor required for DOS computers. A resolution of 800 x 600 pixels or higher is recommended. If the display resolution in the Windows screen properties is set to a lower setting, such as 640 x 480 pixels, portions of the NS-Designer windows may not be displayed. If this happens, increase the resolution. If large display fonts are used, not all of the text may fit in dialog boxes, preventing correct display. If this happens, use the small display fonts.

Mouse

A mouse supported by the OS must be used.

Operating System

Any of the following operating systems can be used: Microsoft Windows 95, Microsoft Windows 98, Microsoft Windows Me, or Microsoft Windows NT (version 4.0, service pack 6a or higher), Microsoft Windows 2000 (service pack 3 or higher), or Microsoft XP. Microsoft Windows 3.1 is not supported. Internet Explorer version 5.5 or higher is required.

1-2-2 Equipment Required to Transfer Screen Data

RS-232C connection cable

Ethernet cable

Memory Cards

Refer to *Appendix 7 Connecting Cable Specifications* for cable specifications.

1-3 Basic Configuration and Functions

1-3-1 Project Overview

A project contains all of the objects and settings required for a group of user screens.

The project name is specified to access data when editing on the NS-Designer or transferring data to PT.

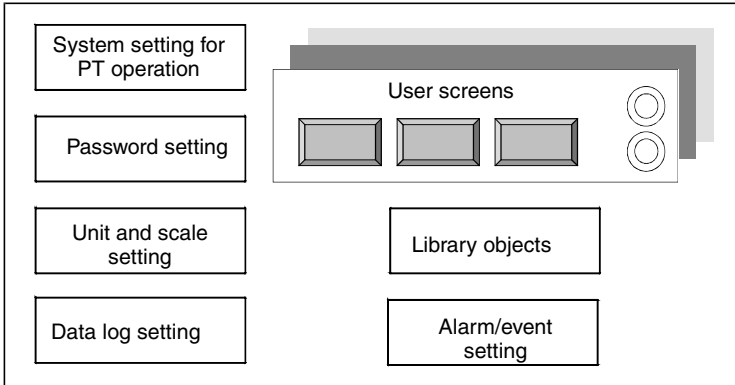

A wide variety of objects can be used as required to create screens. Some of the objects that can be used are described below.

Fixed Objects

Fixed objects, which do not provide any input functions, can be created on a screen.

Although fixed objects can be set to flicker, they are otherwise displayed on the screen in a constant state.

Functional Objects

Functional objects can be used to communicate with internal memory in the PT or with a PLC. Functional objects have both graphic and operational properties. The display of functional objects can be changed according to the status of the PT or PLC, and they can be used to input data through operations from the PT.

Table

A table object provides multiple functional objects in a single table format.

Frame

A frame object enables the creation of areas on a screen so that only part of the screen can be switched to another page. Frames consist of more than one page, and the displayed contents of the functional objects configuring each page can be switched based on PT or PLC status. Frames can contain fixed objects, functional objects, and tables.

Background

A background is a graphic screen that is displayed as the background of other screens.

Bitmap files and JPEG files can be displayed as backgrounds.

Registering Created Objects

Created objects can be registered in a library so that they can be easily reused at many different locations or on different screens.

The following objects can be registered in the library.

Fixed objects, functional objects, tables, and frames

1-3-2 Manipulating Data on the PLC

Data can be input to and output from a PLC using the following objects, enabling values in memory to be set or the screen data to be updated according to changes in memory.

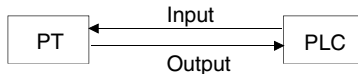

Object	Input	Output
ON/OFF Button	OK	OK
Word Button	OK	OK
Command Button	_____	_____
Switch Screen	OK Indirect Specification of Screens	OK (Writing Screen Page Numbers)
Key Button	OK Indirect Specification of Character Strings to Send	_____
Bit Lamp	OK	_____
Word Lamp	OK	_____
Numeral Display & Input	OK	OK
String Display & Input	OK	OK
Thumbwheel Switch	OK	OK
Text	OK (Indirect Reference of Display Strings)	_____
List Selection	OK (Address for specifying the File Lines)	OK (Writing Selected Line Number) (Writing Selected Character Strings)
Level Meter	OK	_____
Bitmap	OK (Indirect Specification of Display Data)	_____
Analogue Meter	OK	_____
Video Display	_____	_____
Broken-line Graph	OK (Specifying Display Update Bits) (Specifying Number of Display Re- freshes) (Broken-line Monitor Address)	_____
Data Log Graph	OK (Monitor Address) (Log Timing) (Scale for Time Axis) (Address for updating Display)	_____
Date/Time	_____	_____
Alarm/Event Display	OK	_____
Alarm/Event Summary & History	OK	OK (Writing Alarm Ids)
Data Block Table	OK	OK
Frames	OK	_____
Temporary input	_____	_____

1-3-3 PT Memory

PT memory is made up of internal memory and system memory.

Internal Memory

The internal memory contained in the PT can be read and written by the user. Internal memory can be allocated as required for settings, such as the communications addresses of functional objects.

The internal memory is divided into two sections.

Memory	Contents
\$B	<p>Bit Memory</p> <p>Bit memory is used for I/O flags and signal information.</p> <p>Up to 32 Kbits (32,768 bits) can be used.</p>
\$W	<p>Word Memory</p> <p>Word memory is used to store numeral and character string data.</p> <p>Each word contains 16 bits, but consecutive words can be used as required for character strings and 32-bit data.</p> <p>Up to 32 Kwords (32,768 words) can be used.</p>
\$HB	<p>Holding Bit Memory</p> <p>Holding bit memory is used for I/O flags and signal information.</p> <p>Up to 8 Kbits (8,192 bits) of data can be held in this area even if the PT power is turned OFF.</p>
\$HW	<p>Holding Word Memory</p> <p>Holding word memory is used to save numerical values and character-string data.</p> <p>Each word consists of 16 bits, but consecutive words can be used as required for character strings with a user-defined length and 32-bit data.</p> <p>Up to 8 Kwords (8,192 words) of data can be held in this area even if the PT power is turned OFF.</p>

System Memory

System memory is used to change information between the host and the PT, such as controlling the PT and notifying the host of PT status.

The system memory is divided into two sections.

Memory	Contents
\$SB	<p>System Bit Memory</p> <p>The system bit memory contains 52 bits with predefined functions.</p>
\$SW	<p>System Word Memory</p> <p>The system word memory contains 38 words with predefined functions.</p>

1-3-4 Host Registration and Address

PLC words and bits can be allocated as communications addresses for functional objects and other objects. To enable this, a name is registered for each PLC. This setting is called the host registration. Refer to *1-3 Communicating with the Host* in the *NS series Programming Manual* for details on the host.

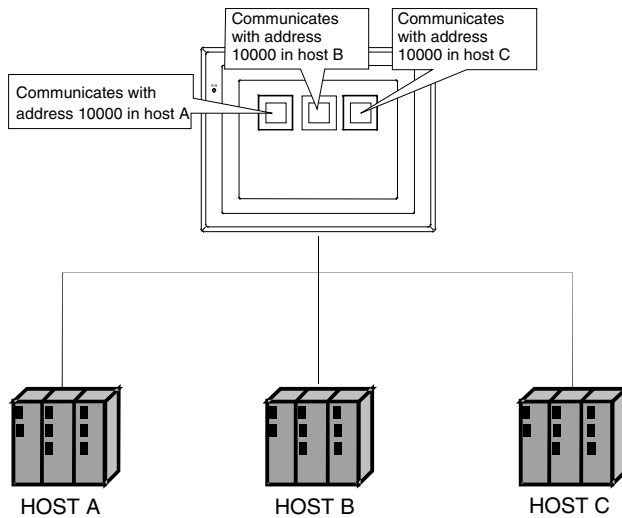

1-3-5 Screen Types and Applications

The following screens can be displayed on the PT: User screens with objects configured as required by the user, sheets, and system screens with predefined functions.

Screen type	Contents
User Screen	Used to create normal screens.
Base Screen	Basic screens displayed during PT operation.
Pop-up Screen	Pop-up screens can be displayed overlapping other screens. Up to 3 pop-up screens can be displayed at the same time.
Sheet	Sheets are screens used when the same images are to be displayed on more than one screen. They are used together with other screens, such as base screens and pop-up screens. Up to 10 sheets can be created in each project.
System Menu	The System Menu Screen is predefined and cannot be changed by the user. It is used to set or confirm various special functions of the PT, such as to initialize data or to access various histories.

1-3-6 Object Types

Some details on the types of object that can be positioned on a screen are described below.

Fixed Objects

The following fixed objects can be used.

Rectangle



Circle/Oval

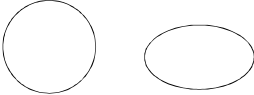

Straight Line or Arrow



Polyline



Polygon

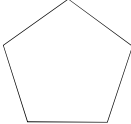

Sector

























Arc



Functional Objects

The following functional objects can be used.

Icon	Name	Contents
	ON/OFF Button	Control the ON/OFF status of the specified write address. Any of four action types can be selected.
	Word Button	Set numeric data at the specified address. Values can also be increased and decreased.
	Command Button	Perform special processing, such as switching screens, controlling pop-up screens, controlling video, etc.
	Bit Lamp	Turn ON and OFF according to the ON/OFF status of the specified address.
	Word Lamp	Light in 10 steps according to the value in the specified address (0 to 9).
	Text	Display the registered character string.
	Numeral Display & Input	Numerically display the word data from the specified address and input data from a tenkey pad.
	String Display & Input	Display the character string from the word data from the specified address and input data from a keyboard.
	List Selection	Display the registered characters string in a list for selection.
	Thumbwheel Switch	Numerically display the word data from the specified address and increment and decrement the data when increment/decrement buttons are pressed.
	Analogue Meter	Display graphs in three colors in circles, semi-circles or quarter circles for the word data at the specified address.
	Level Meter	Display levels in three colors for the word data at the specified address.
	Broken-line Graph	Display a broken-line graph for the word data at the specified address.
	Bitmap	Display bitmaps.
	Video Display	Display images from video cameras and Vision Sensors.
	Alarm/Event Display	Display alarms or events that have occurred in order of priority.
	Alarm/Event Summary and History	Display summaries or histories of alarms or events that have occurred.
	Date	Display and set date.
	Time	Display and set time.
	Data Log Graph	Display trend graphs for the word data at specified addresses.
	Data Block Table	Writes to and reads from PLC preset recipe data, such as instructions for manufacturing process.
	Temporary Input	Display numerical values and character strings that have been input during creation of a tenkey or keyboard for Numeral Display & Input and String Display & Input objects using command buttons.

1-3-7 Functions Used to Create Screens

The following functions can be conveniently used to make screens more effective.

Creating Tables

Functional objects of the same type can be created as a group in a table.

Functional objects can be easily created and organized in a table simply by specifying the type of functional object, the number of rows, and the number of columns. Item names (text) can also be added to the cells of the table.

The properties of the functional objects can be set as a group, and addresses can be automatically allocated by setting offsets.

Refer to *Creating Tables* under *5-1 Creating Functional Objects* for more information.

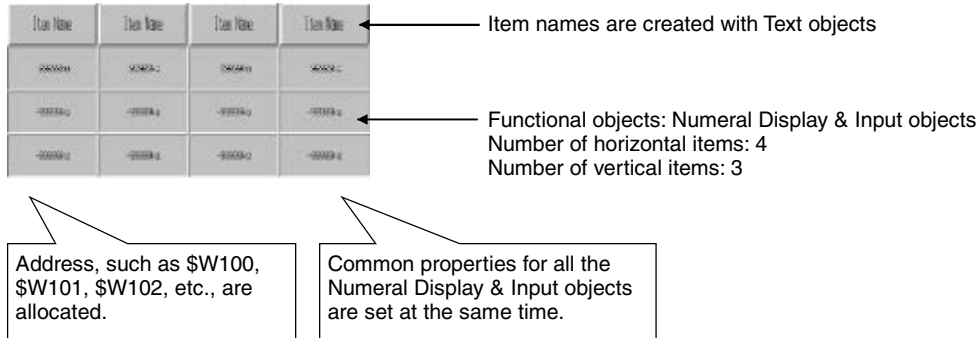

Creating Frames

A frame object enables the creation of areas on a screen so that only part of the screen can be switched to another page. Frames consist of more than one page, and the displayed contents of the functional objects configuring each page can be switched using the page switching function of the frame. A frame can contain up to 256 frame pages, and objects can be pasted as required within each frame page.

Refer to *4-4 Frames* for details.

Groups

More than one functional object or fixed object can be defined as a group.

The group, which contains more than one functional or fixed object, can be rotated, flipped, or sized as if it were just one object.

Grouped objects can also be created with other functional or fixed objects or placed in other groups.

Refer to *Grouping and Ungrouping Objects* under *5-5 Layout Functions* for more information.

Object Library

An object and all of its property settings can be registered as one object. Created objects registered in a library can be easily reused at many different locations or on different screens. Refer to *5-13 Library Registration and Sharing Objects* for details.

Smart Active Parts

Setting and monitor screens (such as setting screens for Position Control Units and Temperature Controllers) are pre-installed as standard library objects for the NS-Designer. For details, refer to *How to use Smart Active Parts* (PDF) included with the NS-Designer.

Selecting Fixed Objects for Buttons and Lamps

Specified fixed objects can be displayed for ON/OFF buttons, word buttons, bit lamps, and word lamps to create more graphic displays.



Drawing Fixed Objects

Fixed objects, which do not provide any functions themselves, can be drawn on a screen. The following fixed objects can be drawn. Rectangles, circles, ovals, straight lines, polylines, polygons, sectors, and arcs

Creating Backgrounds

General-purpose image data can be used as backgrounds for user screens. The following file types can be used.

- Bitmap files (.BMP)
- JPEG files (.JPG)

Switching Displays

Displays can be switched to check the operation of screens created offline.

The following switching functions can be used.

Switching Screens

- Switching Frame Pages
Edited frame pages can be switched forward and backward.
Refer to *Switching Frame Pages* under *4-4 Frames* for details.
- Switching Screens
Edited screens can be switched forward and backward.
Refer to *Switching Screens* under *4-1 Basic Operations* for details.
- Zooming
Screens can be zoomed in and out.
Refer to *Zoom* under *4-1 Basic Operations* for details.

Switching Object Displays

- ID Displays
Object ID numbers can be displayed.
Refer to *Switching Items Displayed for Objects* under *4-1 Basic Operations* for details.



- Error Object Displays
Objects for which errors were detected in validating are displayed with red borders.
Refer to *Show ID* under *4-1 Basic Operations* for details.



NS-Designer Operation Manual

- **Displaying Sheet Objects**
 The sheet objects overlapped on base screens can be displayed.
 Refer to *Show Sheet Object* under *Switching Items Displayed for Objects* under 4-1 Basic Operations for details.

Sheet Objects Hidden Sheet Objects Displayed

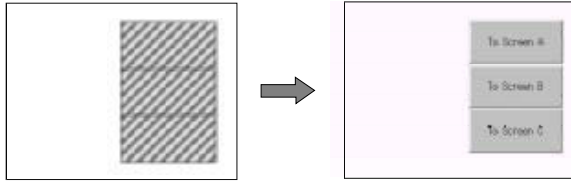

- **Displaying Switch Labels**
 The specified switch labels can be displayed.
 Refer to *Switch Label* under 4-1 Basic Operations for details.

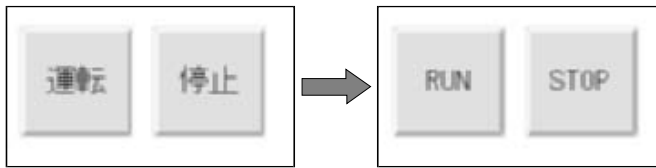

- **Simulating ON/OFF Status**
 The functional objects can be displayed in their ON status.
 Refer to *Displaying ON Status* under *Switching Items Displayed for Objects* under 4-1 Basic Operations for details.

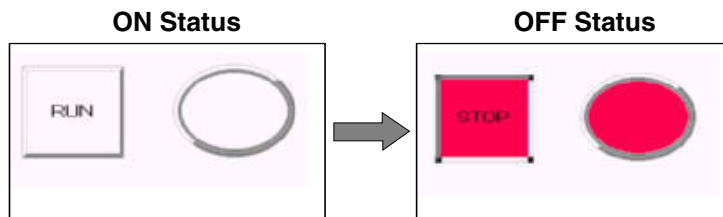

- **Displaying Addresses**
 The communications addresses set for each functional object can be displayed. Refer to *Show Address* under *Switching Items Displayed for Objects* under 4-1 Basic Operations for details.

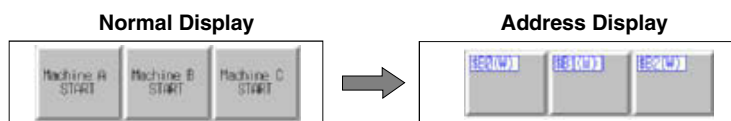

1-3-8 Data Log

The stored data for specified addresses is displayed as a graph.

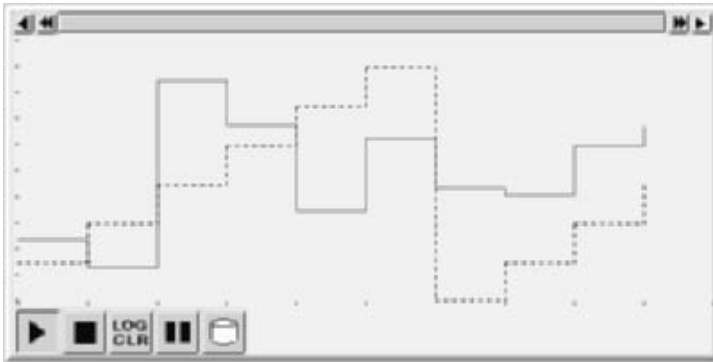

Up to 100 groups can be registered for each project. Up to 16 addresses can be registered for each group.

Up to 50 addresses can be registered for constant logging.

1-3-9 Alarms/Events

Addresses can be registered for alarm monitoring to provide notification for alarms from the specified addresses. Registration can also be used to display events, such as operation startup.

Alarm-related functional objects can be used to display alarms and events that have occurred or to display alarm/event histories.

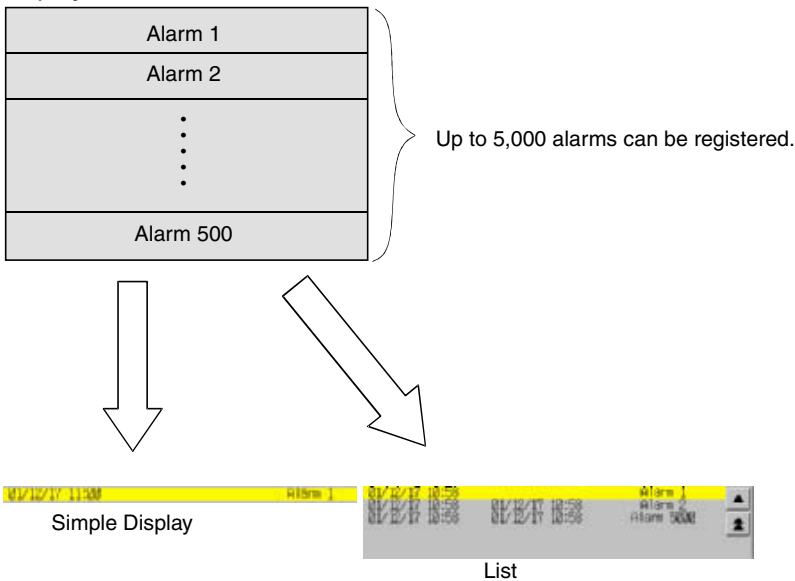

1-3-10 Data Blocks

Data blocks (recipes) enable reading/writing numeric values and character strings from/to memory areas, such as those in a PLC. Data blocks can be used to easily change the arrangement of the system. Create the data in CSV files and store them in the PT beforehand. The created data can be used to make changes while operating the PT.

Examples: Setting the width (numeric value), height (numeric values), and color (character string) in the PLC (Refer to the figure shown below.)

Set width: 150, height: 54, and color: blue for product B.

Just by selecting product B, these three items can be set for the PLC. If product A is selected, a width of 100, height setting of 52, and a color setting of red will be set for the PLC.

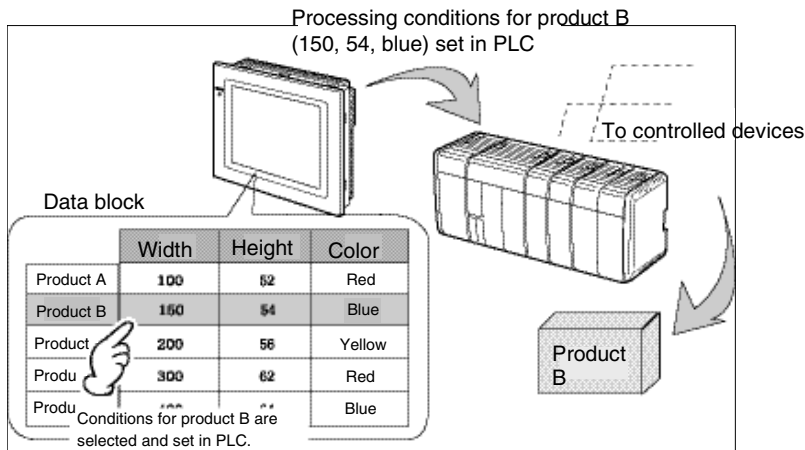

Using data block, the user does not need to save the data in the PLC beforehand, so that memory of the PLC can be saved and ladder program can be reduced. Data blocks also have the following features.

- Data in CSV format can be edited and managed on a personal computer.
- Data can be edited on the PT.
- Data can be written to a Memory Card.
- Data can be read from a Memory Card.
- Processes values and character strings can be handled.
- Maximum number of rows: 1,000. Maximum number of columns: 500. Data blocks with both 1,000 rows and 500 columns, however, cannot be set.

Refer to 2-16 Data Blocks - Restrictions for Data Blocks in the Programming Manual for details.

1-3-11 Video Display

Install a Video Input Unit (NS-CA001) on the PT to display the picture output from video devices such as a video camera or Vision Sensor on the PT. Up to four video devices can be connected to the PT. There are two input methods: NTSC and PAL.

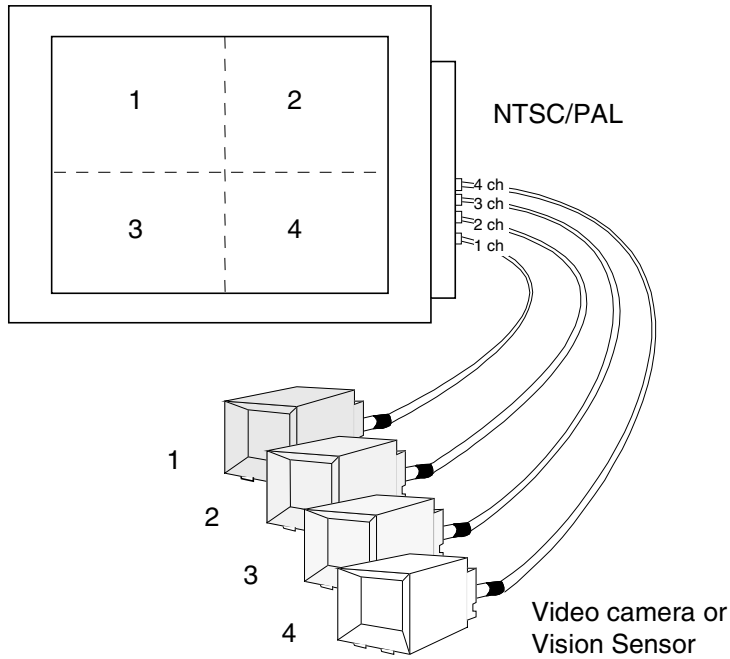

1-3-12 Importing and Exporting CSV Files

The property settings of functional objects can be edited as CSV files.

Export property settings to CSV files, edit them with a standard spreadsheet program or other editing tool, and then import them back into the NS-Designer to set the properties of functional objects.

Refer to *Section 12 Importing/Exporting CSV Files* for details.

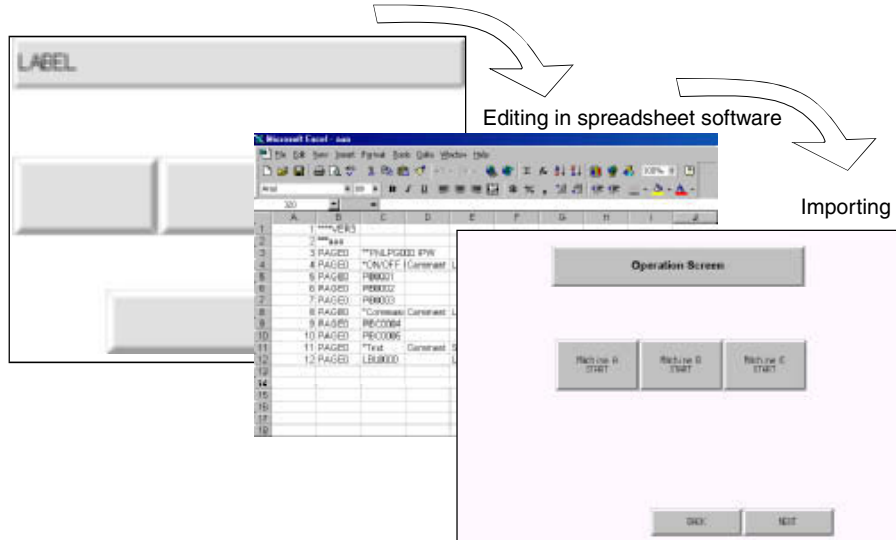

1-3-13 Validating

Functional object settings are checked according to validation items to see if any mistakes have been made.

Any errors that are detected are displayed in a list. The functional or fixed objects where errors exist can also be displayed.

Refer to *Section 9 Validation* for details.

1-4 Outline of Operational Flow

Screen data is created with the NS-Designer as follows:

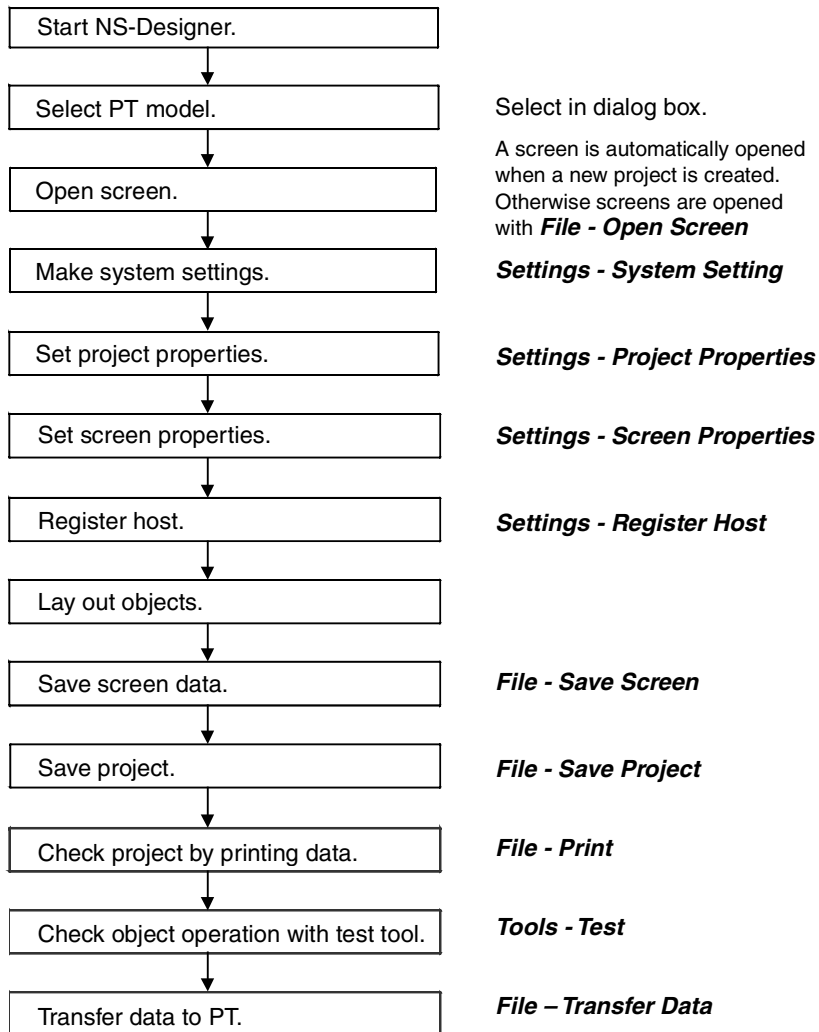

Note

- ◆ Start actual operation only after sufficiently checking the operation of the screen data and host programming.

1-5 Menu Commands

The commands that appear on the pull-down menus of the NS-Designer and their functions are described in the following tables.

File Menu

Command	Function
New Project	Creates a new project.
Open Project	Opens an existing project.
Save Project	Saves the current project (overwrites the existing file).
Save Project As	Saves the current project under a specified name.
Template	Specifies a template project.
Project Maintenance	Copies, deletes, backs up, and restores projects.
New Screen	Creates a new screen under the current project.
Open Screen	Opens an existing screen in the current project.
Close Screen	Closes the screen currently being edited.
Save Screen	Saves the current screen.
Save All	Saves (overwrites) all of the data for the current project.
Open Sheet	Creates new sheet or edits a sheet.
Apply Sheet	Sets a screen with overlapping sheets.
Import CSV File	Imports project or screen data saved in CSV format to the current project or screen.
Export CSV File	Exports the current project or screen data to a file in CSV format.
Transfer Data	Downloads screen data created on the NS-Designer to the PT or uploads screen data from the PT to the NS-Designer.
Print	Outputs current project or screen information to a printer or to a file. Select Print to display a preview.
Recent Projects	Displays a list of currently edited projects. (Up to four projects are displayed.)
Exit	Ends the NS-Designer.

Edit Menu

Command	Function
Undo	Discards changes and restores the previous status.
Redo	Restores the changes discarded with Undo .
Cut	Deletes the selected objects and places them in the internal buffer.
Copy	Copies the selected objects and places them in the internal buffer.
Paste	Pastes objects that have been cut or copied.
Offset Paste	Pastes objects that have been cut or copied with offset addresses.
Delete	Deletes the selected objects.
Find	Searches for functional objects using addresses or character strings as keywords.
Replace	Replaces addresses set for functional objects.
Select All	Selects all objects on a screen or all functional or fixed objects of a specific type.
Repeat	Copies the specified object the specified number of times horizontally or vertically.

View Menu

Command	Function
Toolbars	Displays and hides the toolbars. (Standard, functional object, fixed object, operation, formatting, color, and address settings)
Status Bar	Displays and hides the status bar.
Switch Label	Switches to the specified label display.
Previous Screen	Displays the previous screen.
Next Screen	Displays the next screen.
Previous Frame Page	Displays the previous frame page.
Next Frame Page	Displays the next frame page.
Simulate ON/OFF	Switches functional objects between ON and OFF status displays.
Show ID	Displays and hides ID numbers for objects.
Show Address	Displays and hides address displays for functional objects.
Show Error Object	Displays and hides error marks for objects.
Show Sheet Object	Switches the display of objects registered in sheets.
Show Touch Points	Displays the touch points on the PT.
Zoom	Zooms the display in and out.
Refresh	Redraws the screen.

Functional Objects Menu

Command	Function
ON/OFF Button	Starts creation of an ON/OFF button.
Word Button	Starts creation of a word button.
Command Button	Starts creation of a command button.
Bit Lamp	Starts creation of a bit lamp.
Word Lamp	Starts creation of a word lamp.
Text	Starts creation of text.
Numeral Display & Input	Starts creation of a number display and input object.
String Display & Input	Starts creation of a string display and input object.
List Selection	Starts creation of a list selection object.
Thumbwheel Switch	Starts creation of a thumbwheel switch.
Analogue Meter	Starts creation of an analogue meter.
Level Meter	Starts creation of a level meter.
Broken-line Graph	Starts creation of a broken-line graph.
Bitmap	Starts creation of a bitmap.
Alarm/Event Display	Starts creation of an alarm/event display object.
Alarm/Event Summary & History	Starts creation of an alarm/event summary & history.
Date	Starts creation of a data object.
Time	Starts creation of a time lamp.
Data Log Graph	Starts creation of a data log graph.
Data Block Table	Starts creation of a data block table.
Video Display	Starts creation of a video display.
Frame	Starts creation of a frame region.
Table	Starts creation of a table on a table creation screen.
Temporary Input	Starts creation of a temporary input.

Fixed Objects Menu

Command	Function
Rectangle	Starts creation of a rectangle.
Circle/Oval	Starts creation of a circle or oval.
Straight line	Starts creation of a straight line.
Polyline	Starts creation of a continuous straight line.
Polygon	Starts creation of a polygon.
Sector	Starts creation of a pie-shaped sector.
Arc	Starts creation of an arc.

Settings Menu

Command	Function
Object Properties	Sets the properties of the selected functional object.
Edit Label	Enables direct editing of labels on the screen without opening a property dialog box.
Change Settings at Once	Enables editing the basic properties of the selected functional objects in a table. Functional objects can be added and deleted as well.
Flicker Setting	Sets the flicker operation parameters.
Password Setting	Sets the password.
Unit/Scale Setting	Displays the unit and scale conversions for a numeral display.
Alarm/Event Setting	Set the alarm function (addresses, messages, etc.).
Data Log Setting	Set the data log function (e.g., data log groups).
Data Block Setting	Performs registration and correction of data blocks.
Change Input Order	Sets the order for shifting the focus for objects that can be input.
Project Properties	Sets the project properties.
Screen Properties	Sets the screen properties.
System Setting	Sets the PT operating parameters.
Reset Defined Default	Resets all of the settings made for an object. (Functional and fixed objects)
Change PT Model	Sets the model of the NS-series PT.
Register Host	Registers the host.

Layout Menu

Command	Function
Align/ Distribution	Aligns the position of more than one selected object. (Left, Center in a Column, Right, Top, Center in a Row, Bottom, Distribute Horizontally, or Distribute Vertically)
Make Same Size	Sizes all selected objects horizontally and vertically to the same size as that of the largest or smallest object.
Order	Moves the selected object to the front or back.
Nudge	Moves the selected object one bit or one grid unit up, down, right, or left.
Rotate/Flip	Rotates or flips an object. (90 Degrees Clockwise, 90 Degrees Counterclockwise, Flip Vertical, Flip Horizontal, Rotate Right 90 Degrees Around Center of Screen/Frame, Rotate Left 90 Degrees Around Center of Screen/Frame, Flip Horizontal Around Center of Screen/Frame, or Flip Vertical Around Center of Screen/Frame)
Modify	Edits the shape of a fixed object. (Edits, adds, or deletes nodes.)
Group	Groups objects.
Ungroup	Ungroups a group of objects.
Grid	Sets the grid.

Tools Menu

Command	Function
Screen Maintenance	Changes the titles of, copies, deletes, or replaces screen page numbers for screens in a project.
Sheet Maintenance	Changes the titles of, copies, deletes, or replaces sheet page numbers for sheets in a project.
Validation	Performs an error check on object settings.
Validation Result	Displays the results of validation.
Functional Object List	Displays a list of functional objects on screen with property settings.
List Up Functional Objects Used	Displays the number of times functional objects are used in screens, screen pages that are not used, and frame pages in a tree format.
List Up Addresses Used	Displays a list of addresses that are used.
Address Cross Reference	Displays a list of functional object IDs when addresses are used.
Edit Background Bitmap	Edits the background.
Register Library	Registers functional objects in the library and performs maintenance.
Use Library	Paste functional objects registered in the library.
Test	Performs operating test on the computer without connecting to a PLC.
Resource Report	Displays a report on the resources that have been used.
Options	Sets optional functions.

Window Menu

Command	Function
Cascade	Cascades the screen editing windows.
Tile	Tiles the screen editing windows.
Arrange Icons	Arranges the minimized window icons.

Help Menu

Command	Function
Contents	Displays the contents for the online help.
Search for Help on	Displays a search dialog box for help topics.
How to Use Help	Displays information on using Help.
About NT631 Conversion Support Tool	Displays information on the version of NS-Designer.

1-6 Functions Added in Version 3.0

The NS-Designer Version 3.0 is supplemented and enhanced by the following functions.

Supplement/Enhancement	Function
Screen data transfer through PLCs	Enables transferring screen data to NS Hardware through a PLC and transferring ladder program to the PLC through the NS Hardware.
Switch Box Screen	Displays I/O status of addresses on the NS Hardware. Addresses and their comments can be reused from a ladder program using the Switch Box Utility.
Multiple language support	Multiple languages (Simplified Chinese, Korean, Traditional Chinese, etc.) can be displayed on user screens.
Video capture using a PLC trigger	Enables performing video captures using system memory (\$SW24) as a trigger.
Enhanced parts List	Vastly increased library objects for use as buttons and lamps.
Reading CLK status	Displays status of CLK Board attached with NS Hardware on the screen.
Macro to set time	Automatically sets the time, which as set manually before.
Screen data can be transferred using Ethernet directly the first time	Screen data can be transferred using Ethernet directly the first time.

1-7 Functions Added in Version 4.0

The NS-Designer Version 4.0 is supplemented and enhanced by the following functions.

Supplement/ Enhancement	Function
Equipped with USB port as a standard feature.	Equipped with a USB port as a standard feature enabling display contents to be printed using USB-compatible general-purpose color printers (e.g., Canon or Epson printers).
Display possible in up to 32,000 colors.	BMP and JPEG images can now be displayed using up to 32,000 colors.
Screen data capacity greatly increased.	The data capacity has increased from 4 Mbytes to 20Mbytes.
High-speed drawing	The drawing speed is twice that of existing OMRON products.

1-8 Functions Added in Version 5.0

The NS-Designer Version 5.0 is supplemented and enhanced by the following functions.

Supplement/ Enhancement	Function
NS5-series models added.	Added NS5-SQ0□ (B) -V1 with compact 5.7-inch STN color display.
Object forms can be selected by user.	The forms of ON/OFF Button, Word Button, Bit Lamp, and Word Lamp objects can now be specified as BMP or JPEG image files.
Windows fonts can be used in Button and Lamp objects.	The labels used in ON/OFF Button, Word Button, Bit Lamp, Word Lamp, and Command Button objects can now be specified using Windows fonts.
Continuous input can be received from Bar Code Reader.	Input order of numeric values and character strings can now be controlled, allowing continuous input from a bar code reader.
Ver. 1.X projects can be created and edited.	NS-Designer Ver. 5.0 can be used to create and edit projects for NS System Ver. 1.X.

1-9 Functions Added in Version 6.0

The NS-Designer Version 6.0 is supplemented and enhanced by the following functions.

Supplement/ Enhancement	Function
A PT model added.	Added NS8-TV1□ (B)-V1.
Transfer program functions added.	Screen data can be transferred from a personal computer to the PT via modem. Installing a CLK board in the personal computer enables screen data to be transferred. CX-Server compatibility has also simplified settings required for data transfer.
Data log function expanded.	The number of always logging points has been increased from 5,000 to 50,000 points, and logging data can be automatically saved to the memory card. Saved CSV files can be read and displayed overlapping the log graph with a reference.
Video captures can be read from the memory card.	Image data saved in the memory card can be specified from a list and displayed. The list can be called using the command buttons or from the system menu.
Appearance of command buttons can be specified.	The appearance of command buttons can be specified as round buttons. BMP and JPEG image files can be specified for button appearance. Write confirmation messages can also be set.
Temporary input object added.	Objects for temporarily displaying input numerical values or character strings are provided for use when creating tenkeys or keyboards for Numerical Display & Input and String Display & Input objects using command buttons. Temporary input objects can also be used to display maximum and minimum values.
The storage format of numeric values in system memory can be selected.	The numerical value storage format for system memory can be selected from BCD and binary.

Supplement/ Enhancement	Function
The data format for specifying line numbers in indirectly specified files for functional objects can be selected.	The data format for specifying line numbers in indirectly specified files set using functional object properties can be selected from BCD and binary.
The number of alarms has been increased.	The maximum number of alarms that can be registered has been increased to 5,000.
Macros FOR, NEXT, CONTINUE, and BREAK have been added.	Loop processing can be performed using macros. This improves efficiency of macro creation.
Label application function for importing CSV files has been added.	When importing CSV files, the character properties for a specified label name can be applied to the character properties for another label. This function is useful when setting multiple labels.
System memory functions have been added.	The following flags have been added: PT battery low flag PT memory card free space check flag Memory card power OFF bit Memory card removing status Video capture start bit Video capture executing flag Video capture results flag Periodical Data Log Save in process flag Print screen/video capture switching bit

1-10 Functions Added in Version 6.2

The NS-Designer Version 6.2 is supplemented and enhanced by the following main functions.

Supplement/ Enhancement	Function
PT models added	Added NS5-SQ0□-V2, NS5-TQ0□-V2, and NS5-MQ0□-V2.
Project trigger macro added	Setting the macro to execute when the bit or value at a specified address changes has been enabled.
Data block control functions added to command buttons	Data block control functions have been added to command buttons to enable reading/writing between CSV files and PLC memory, CVS files and PT memory, and PT memory and PLC memory when a button is pressed or a specified address turns ON while the command button is displayed.
Added items to system memory	The following have been added to system memory: data block control complete flag, internal holding bit/word memory (\$HB/\$HW) initialization flag, and data block error number.
Added arrows	Arrow heads can be added to the start and/or end of straight lines.
Expanded Alarm/Event Summary & History	The titles of each display item can now be displayed on the top line. Also, alarm messages that are not completely displayed can be touched to display them in a message box.
Added program transfer function	Screen data transfer to the PT from a personal computer has been enabled using a USB cable.
Added installation method	NS-Designer can be installed from the CX-One FA Integrated Tool Package.
Added startup method	Startup has been enabled by right-clicking the NS-series PT in the CX-Integrator Network Configuration Window and selecting <i>Start Special Application</i> . If <i>Start with Settings Inherited</i> is selected, startup through to new project creation will be automatically executed.

Section 2 Setup, Starting, and Exiting

The NS-Designer software must be installed in the computer when using the NS-Designer for the first time.

The NS-Designer is application software designed to be operated on Microsoft Windows 95, 98, NT, Me, 2000, or XP.

Use the following procedure to install, start, and exit the NS-Designer when Microsoft Windows 95, 98, NT, Me, 2000, or XP is already installed in the computer.

2-1	Before Installing the NS-Designer.....	2-1
2-2	Installing the NS-Designer.....	2-2
2-3	Starting the NS-Designer.....	2-14
2-4	Exiting the NS-Designer.....	2-15
2-5	User Interface.....	2-16

2-1 Before Installing the NS-Designer

Before installing the NS-Designer, check that the following requirements have been met.

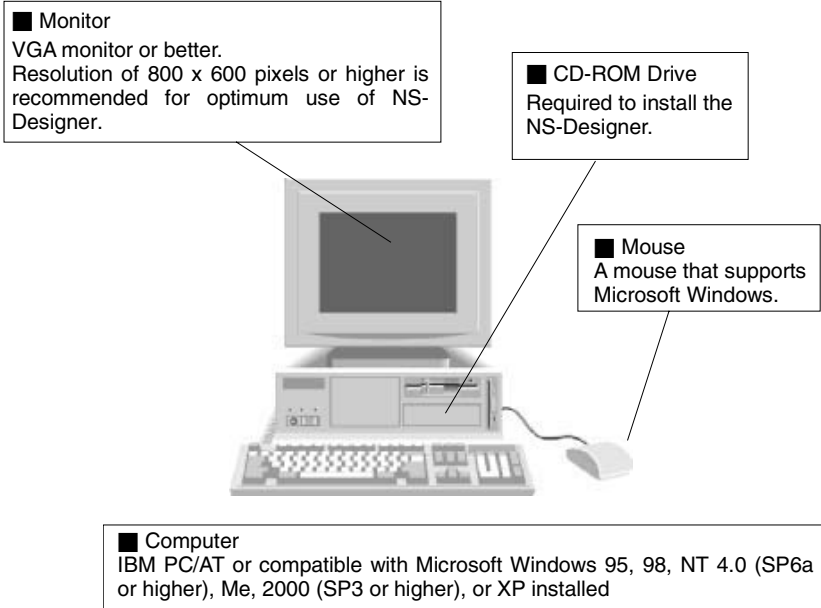

System Requirements

- | | |
|----------------------|---|
| • CPU | Intel Celeron 400 MHz or better |
| • Recommended memory | 64 Mbytes or more |
| • Hard disk | 200 Mbytes or more available disk space |
| • Internet Explorer | Version 5.5 or higher |

2-2 Installing the NS-Designer

Install the NS-Designer in the hard disk.

To install the NS-Designer, execute the installation program provided.

For details on procedures for installing the NS-Designer from CX-One FA Integrated Tool Package, refer to the *CX-One Setup Manual* provided with CX-One.

Cat. No.	Model	Manual name	Contents
W444	CXONE-AL□□C-E	CX-One Setup Manual	Installation and overview of CX-One FA Integrated Tool Package.

Reference

- ◆ If the NS-Designer was previously installed from the CX-One and it's necessary to install it from the individual NS-Designer CD-ROM, always uninstall the NS-Designer using the following procedure before installing it from its individual CD-ROM. The NS-Designer will not operate properly if it is installed without first uninstalling it.
 1. Insert the CX-One installation disk 1 into the CD-ROM drive.
 2. Select the *Modify* Option to enable modifying the Support Software that is installed.
 3. In the Select Features Dialog Box, clear the selection of only the NS-Designer. Do not change any other selections.
 4. Continue by following the instructions in the dialog boxes to modify the installation and uninstall NS-Designer.
 5. Once the NS-Designer uninstallation process has been completed, place the individual CD-ROM disk for the NS-Designer into the CD-ROM drive and install the NS-Designer. (See note.)

Note: If the version of the CX-Server bundled on the individual NS-Designer CD-ROM is lower than the version of the CX-Server bundled with the CX-One, install only the NS-Designer and NOT the CX-Server. (A message will be displayed if the version is lower.) If a version of CX-Server that is lower than the version with the CX-One is installed, the CX-One will not operate properly.

2-2-1 Basic Installation Operations

The main buttons that are displayed during installation are as follows:



Confirms the settings in the window displayed and moves to the next window.



Cancels the settings in the window displayed and returns to the previous window.



Closes the window currently being displayed. The settings in the window are cancelled.

Installation can be cancelled by pressing this button in the installation window. A confirmation message will be displayed.

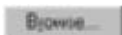

The actual folder configuration is displayed in a tree format, from which the folders where installation files are to be installed can be selected.

2-2-2 Installation Procedure

1. Start up Windows 95, 98, NT, Me, 2000, or XP.
2. Close all applications before executing installation. Place the NS-Designer CD-ROM in the CD-ROM drive. The setup program is started automatically. If the setup program does not start automatically, such as after executing uninstall, locate Setup.exe in the CD-ROM using Windows Explorer, and then double-click the file to execute the setup program.

Reference

- ◆ If NS-Designer Ver. 2.X, 3.X, 4.X, 5.X, or 6.X is already installed, a dialog box to confirm deletion of this version will be displayed. Click the OK Button to start deleting this version. To exit the setup program, click the Cancel Button and then click the Exit Button. FinsGateway and CX-Server will not be uninstalled by this operation.

3. The NS-Designer Setup Wizard will be displayed. Install the NS-Designer by following the instructions in the Setup Wizard.

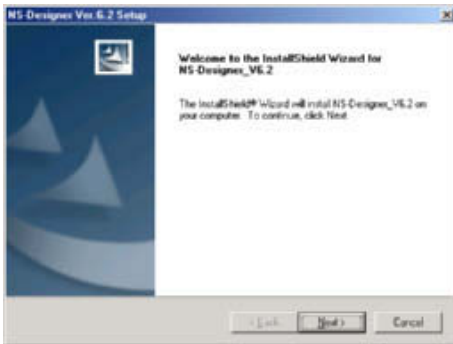

4. During installation, the installation progress is displayed as a percentage.
5. When NS-Designer installation has been completed, a message to confirm installation of Smart Active Parts will be displayed. Click the **Yes** Button to start the installation. If Smart Active Parts installation is not required, click the **No** Button and proceed to step 10.

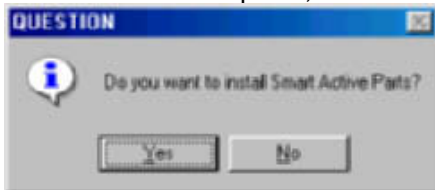

Smart Active Parts are libraries containing setting/monitoring screens (e.g., Position Control Unit setting screens and Temperature Controller monitoring screens).

6. The following dialog box will be displayed. Click the **Next** Button.

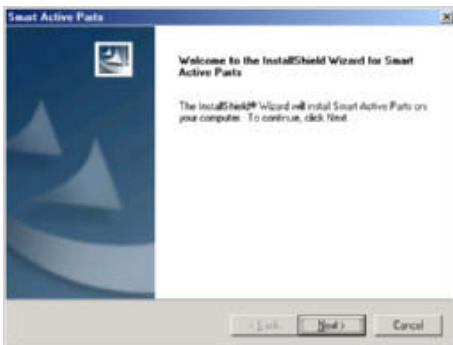

7. The Setup Type Dialog Box will be displayed. Select the setup type and click the **Next** Button. If *Complete* is selected, proceed to step 9.

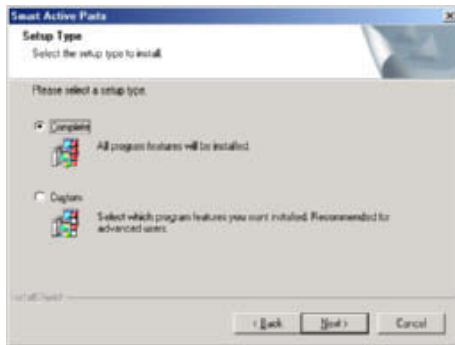

8. The dialog box for selecting features will be displayed. Select the Smart Active Parts to be installed and click the **Next** Button.



9. During installation, the installation progress is displayed as a percentage. When installation has been completed, the following dialog box will be displayed. Click the **Finish** Button.
10. A message will be displayed to confirm installation of the CX-Server. Click the **Yes** Button.

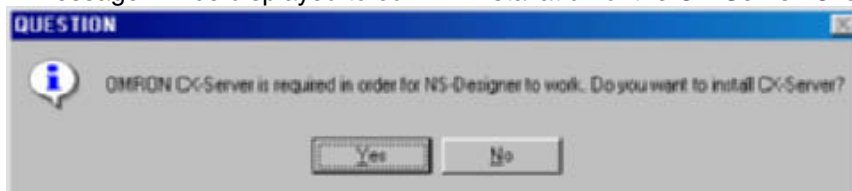

11. The following screen for installing the CX-Server will be displayed.

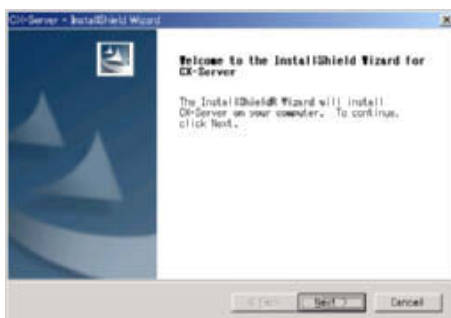

12. Click the **Next** Button. The screen for specifying the installation destination will be displayed.

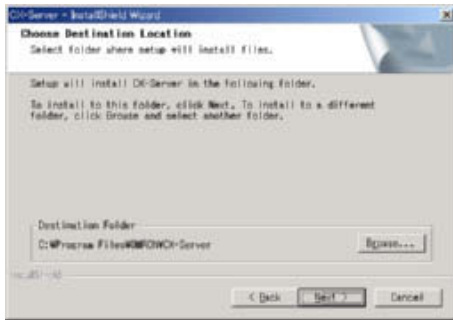

13. Click the **Next** Button. If the following message is displayed, click the **OK** Button to continue installation.



CX-Server installation followed by installation of CX-Server Driver management tools will begin, and the installation program will automatically copy the CX-Server and CX-Server Driver management tools files to the specified directory.

14. When installation has been completed, the following dialog box will be displayed. Select whether or not to restart the computer immediately, and click the **Finish** Button to complete the installation. Always restart the computer before using NS-Designer.

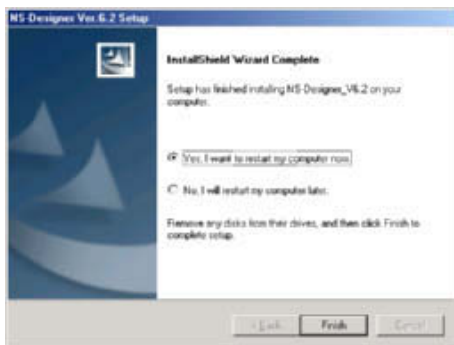

Reference

- ◆ When installing NS-Designer in Windows NT, 2000, or XP, log onto the computer as the administrator to ensure that system DLL files can be overwritten. If overwriting system DLL files fails, NS-Designer may not operate properly.
- ◆ When adding Smart Active Parts after installation of NS-Designer, double-click the CD-ROM directory \SmartActiveParts\Setup.exe from Windows Explorer to execute the setup program. Select all the Smart Active Parts to be used in the dialog box for selecting components.
- ◆ Refer to the *How to manage after conversion* file in the Programs Folder under the Windows Start Menu for details after NT31C/NT631C Conversion Support Tool conversion.
- ◆ Internet Explorer Ver 5.5 or higher is required to transfer data.

NS-Designer Operation Manual

The folder structure after installation is as follows:

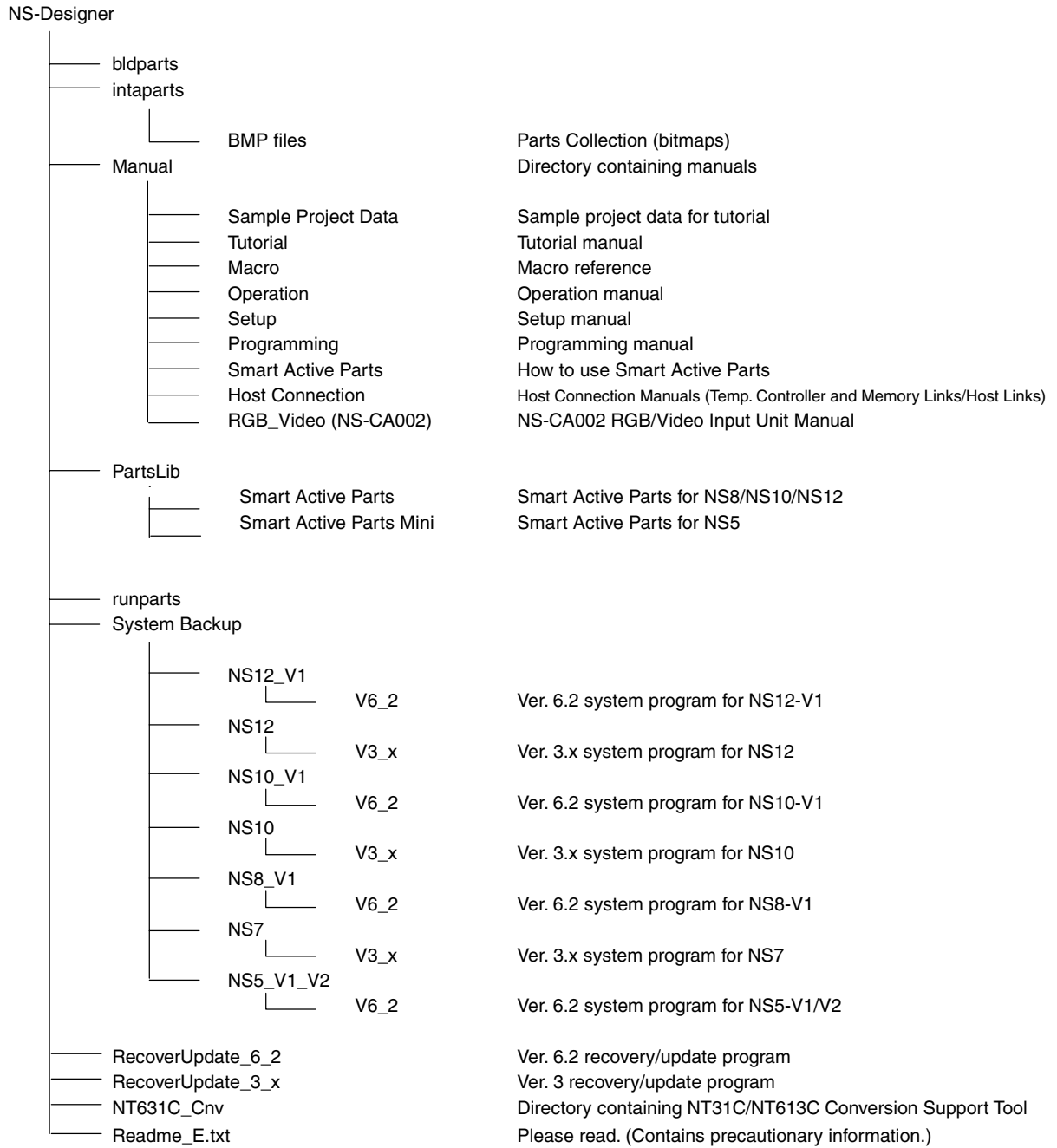

2-2-3 Uninstalling

1. When uninstalling the NS-Designer or CX-Server, click the Windows **Start** Button and select **Settings - Control Panel**.

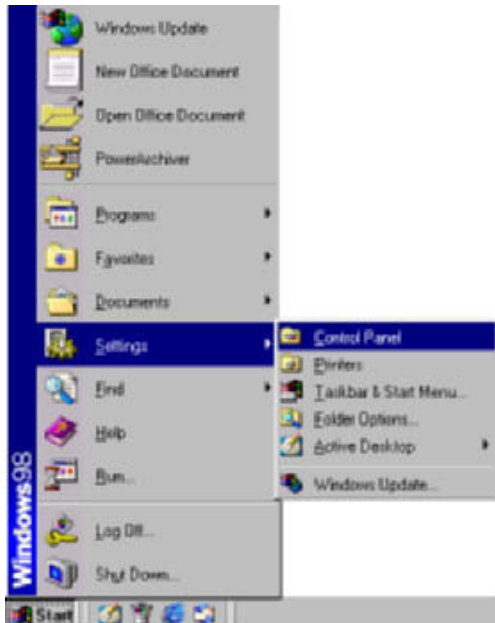

2. Double-click **Add/Remove Applications**.

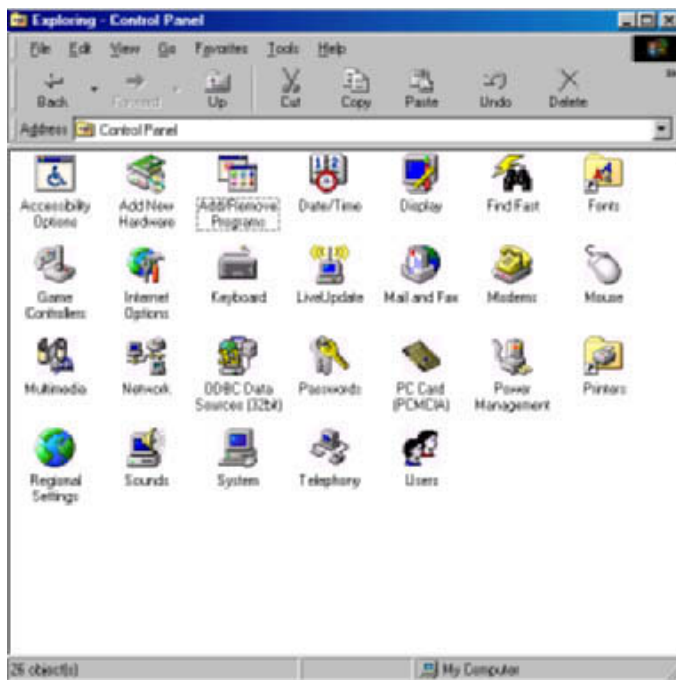

NS-Designer Operation Manual

3. Select NS-Designer or CX-Server from the displayed list of applications, and click the **Add/Remove Button**.



4. When the NS-Designer has finished being uninstalled, a message will be displayed indicating that the uninstall operation has been completed. Check the message and then click the **OK Button**.

2-2-4 Installing USB Drivers for NS-Series PTs.

Install the NS-series USB driver in the personal computer. After installation, data can be transferred between the personal computer and NS-series PT via USB.

Reference

- ◆ With NS-V1 Series models, make sure that the PT has a lot number that supports USB transmission. The system program version of the NS-series PT must also support USB transmission. For details, refer to 3-3-2 *Connecting via USB* in the *NS series Setup Manual* (Cat. No. V083).

Compatible Personal Computers

Windows 98, Windows Me, Windows 2000, and Windows XP

Operation Procedure

Windows 2000 and Windows XP:

1. Start Windows 2000 or Windows XP.
2. Connect the personal computer to the NS-series PT USB slave connector using the USB cable. The following Add New Hardware Wizard will be displayed. Click the **Next** Button.



3. The following dialog box will be displayed. Select **Search for the best driver for my device (Recommended)**. Click the **Next** Button.

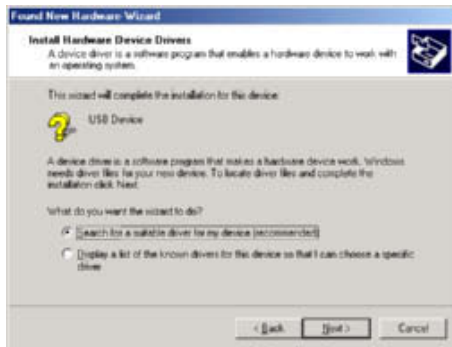

4. Select **Specify a location** only and then click the **Next** Button.



- Click the **Browse** Button, and specify the following file.
NS-Designer installation directory
\\USBHostDriver\Win2k_XP\Omron_NS.inf



- Click the **OK** Button to display the following dialog box. Click the **Next** Button to start installing the USB driver.

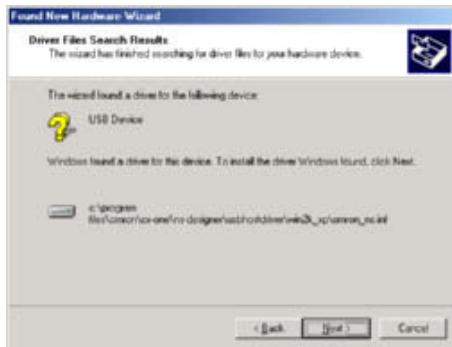

- When installation is completed, the following dialog box will be displayed. Click the **Finish** Button.



NS-Designer Operation Manual

Windows 98 and Windows Me:

1. Start Windows 98 or Windows Me.
2. Connect the personal computer to the NS-series PT USB slave connector using the USB cable. The following Add New Hardware Wizard will be displayed. Click the **Next** Button.



3. The following dialog box will be displayed. Select **Search for the best driver for your device (Recommended)**. Click the **Next** Button.

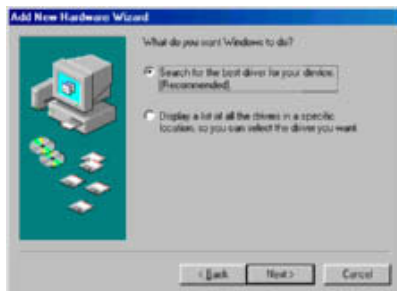

4. Select **Specify a location** only and then click the **Browse** Button and specify the following file. NS-Designer installation directory
 \USBHostDriver\Win98_Me\NS_DEV.inf

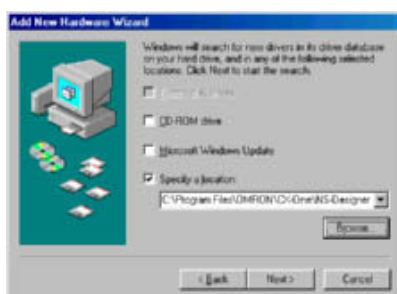

5. Click the **Next** Button.

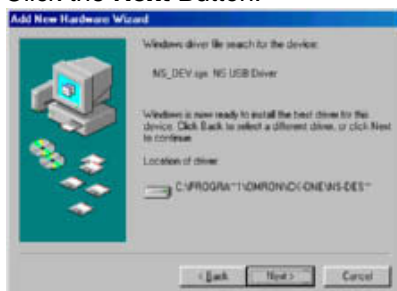

NS-Designer Operation Manual

- 6. Click the **Next** Button to start installation.
When installation is completed, the following dialog box will be displayed. Click the **Finish** Button.

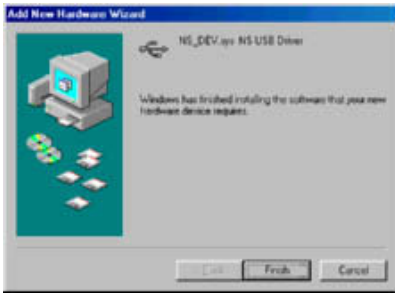

- 7. The Add New Hardware Wizard will be displayed again. Click the **Next** Button.

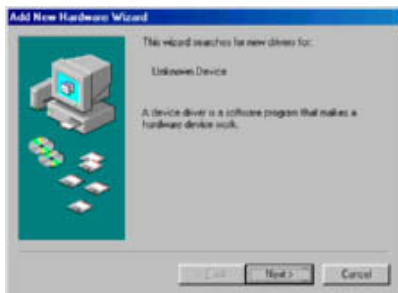

- 8. The following dialog box will be displayed. Check that **Search for the best driver for your device (Recommended)** is selected, and then click the **Next** Button.

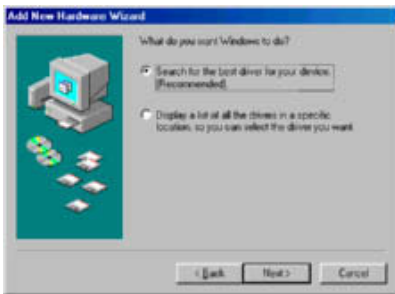

- 9. Select **Specify a location** only and then click the **Browse** Button and specify the following file.
NS-Designer installation directory
\\USBHostDriver\\Win98_Me\\NS_COM.inf

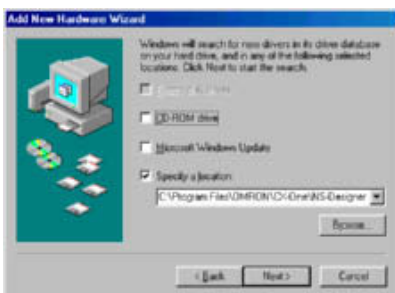

- 10. Click the **Next** Button.

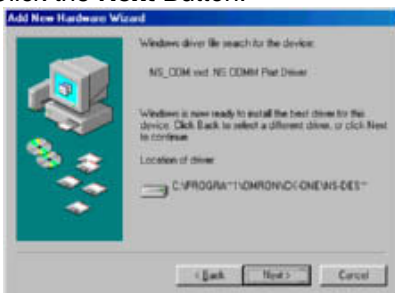

NS-Designer Operation Manual

11. Click the **Next** Button to start installation.

When installation is completed, the following dialog box will be displayed. Click the **Finish** Button.

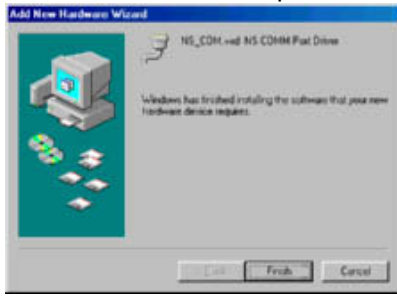

2-3 Starting the NS-Designer

To start the NS-Designer, click the Windows **Start** Button, and then select **Programs - Omron - CX-One - NS-Designer - NS-Designer Ver X** (The items displayed may vary according to the program folder specified during installation.), right-click the NS-series PT in the Network Configuration Window of CX-Integrator, and select **Start Special Application - Start Only**.

When the NS-Designer startup is completed, the Main Window will be displayed, as follows:

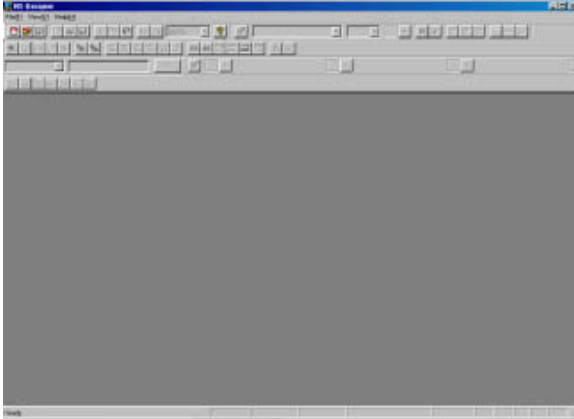

Reference

- ◆ More than one copy of the NS-Designer application can be run at the same time.
- ◆ To start NS-Designer, log in as the administrator when using a personal computer running Windows NT, 2000, or XP.

2-4 Exiting the NS-Designer

Use one of the following operations to exit the NS-Designer.

- Select **Exit** from the File Menu.
- Click the **Close** Button  at the top right of the Main Window.
- Double-click the NS-Designer icon at the top left of the Main Window.
- Click the NS-Designer icon at the top left of the Main Window and select **Close** from the Control Menu Box.
- Press the **Alt + F4** Keys.

If the project data that is open has not been saved, a confirmation message will be displayed.

When the NS-Designer is exited, the system will return to the Windows screen.

2-5 User Interface

2-5-1 Basic Screen Functions

The configuration and names and functions of the components in the NS-Designer operation screen are described here.

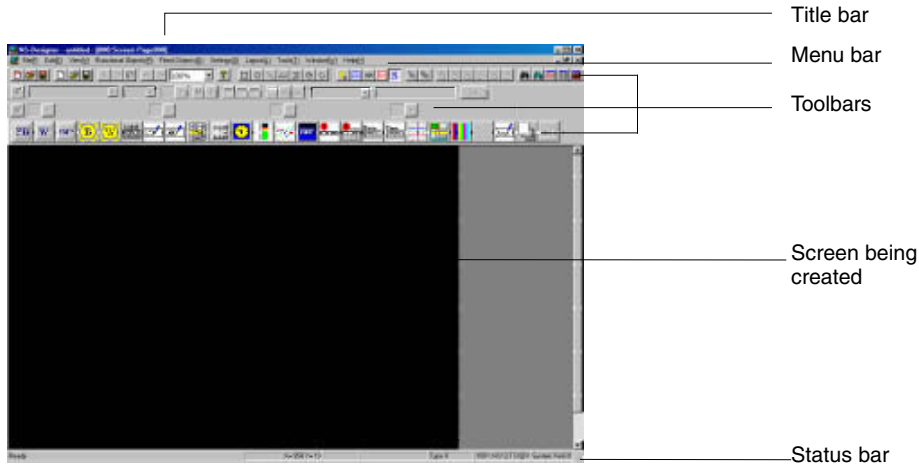

Title Bar

The title bar displays the application name, project name, and screen number.

Menu Bar

Separates the functions into related groups.

Each group name is displayed in the menu bar and the functions are displayed in pull-down menus under each group name.

Toolbars

Standard Toolbar

This toolbar displays frequently used functions as icons.

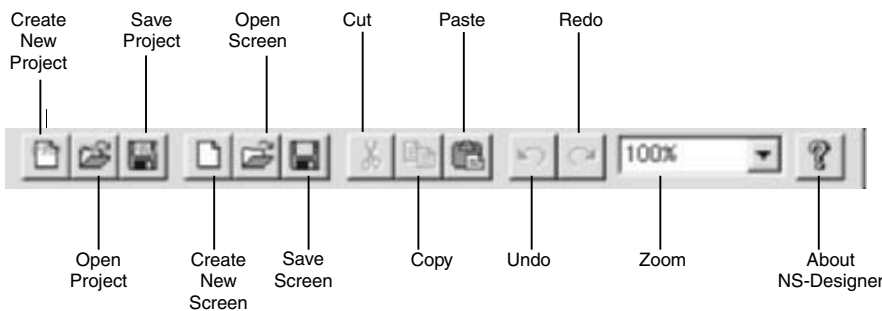

Functional Objects Toolbar

Displays screen creation functions for functional objects as icons. Select the icon button of the functional object to be used in creating the screen to start screen creation.

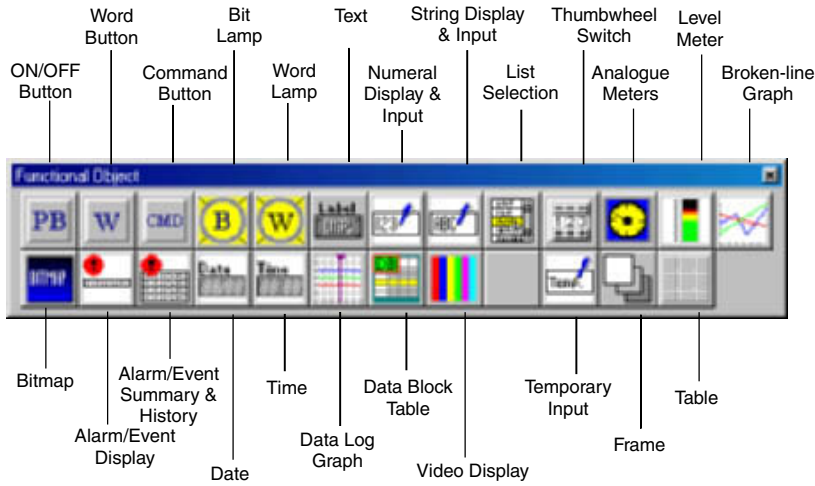

Fixed Objects Toolbar

Displays fixed object drawing functions as icons. Select the icon button for the fixed object to be drawn and start drawing.

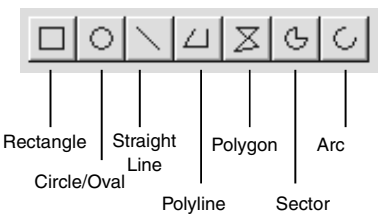

Operations Toolbar

Displays frequently used functions from the View and Tools Menus as icons.

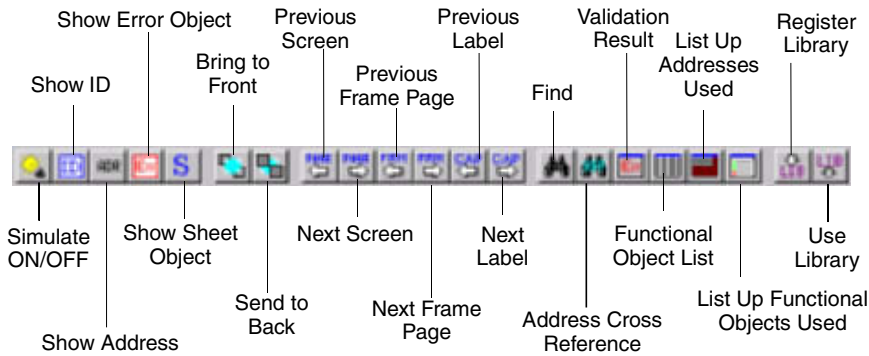

Colors Toolbar

Displays the color settings for functional objects and fixed objects as icons.

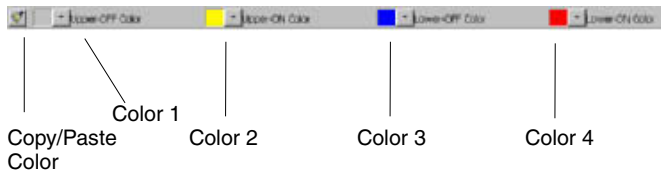

The Copy/Paste Color Button can be used to copy the display color of a functional object or fixed object and paste it into another functional object or fixed object. Therefore, settings can be pasted in a batch without having to open a separate properties dialog box for every setting.

1. Select the functional object or fixed object with the color to be copied.
2. Click the **Copy/Paste Color** Button to copy the color and change the appearance of the cursor to the following.



3. Click over the functional object or fixed object where the color is to be pasted. The Paste Color/Frame Setting Dialog Box will be displayed.



To paste colors to multiple functional objects or fixed objects, select the functional objects or fixed objects that are going to be edited by enclosing them with the cursor.

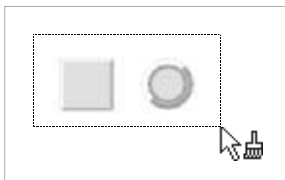

4. Select the items to be pasted and click the **Paste** Button.

Reference

- ◆ The names of the items displayed as Color 1, Color 2, Color 3, and Color 4 in the Color Toolbar vary with the selected functional object and object settings.
Examples: Selecting rectangle, 2-light as the button type for ON/OFF Buttons.

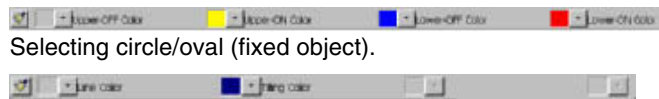

Selecting circle/oval (fixed object).

Font Properties Toolbar

This toolbar displays the font properties setting functions for text in functional objects as icons.

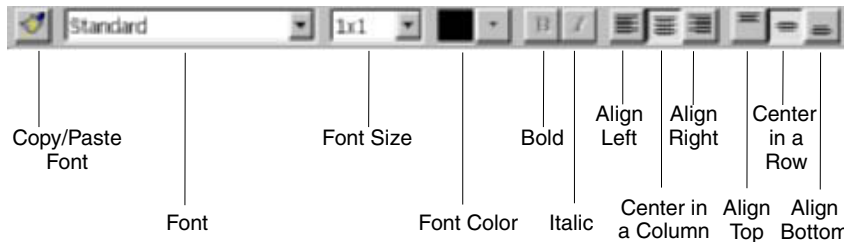

The Copy/Paste Font Properties Button can be used to copy the text properties set for a functional object and paste them into another functional object. Therefore, settings can be pasted in a batch without having to open a separate properties dialog box for every setting.

1. Select the functional object with the text properties to be copied.
2. Select the **Copy/Paste Font Properties** Button to change the appearance of the cursor to the following.



3. Click over the functional object where the text attributes are to be pasted. The Paste Text Attribute Dialog Box will be displayed.

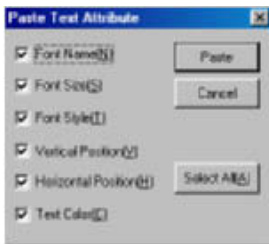

To paste text attributes to multiple functional objects, select the functional objects that are going to be edited by enclosing them with the cursor, as shown below.

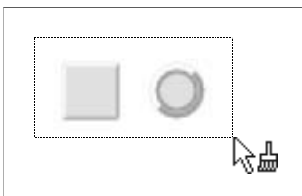

4. Select the items to be pasted and click the **Paste** Button.

Reference

- ◆ When raster fonts (font names: fine, standard, and rough) are selected, the bold and italic styles in the toolbar cannot be used. Refer to *Text Attributes* under 2-8 Common Functional Object Functions in the NS Series Programming Manual for details.

NS-Designer Operation Manual

Address Toolbar

Displays the setting functions for the addresses of the functional objects in a toolbar. Select the functional object for which the address is to be set and set the address.

Using this toolbar, address settings can be edited and changed without having to open a properties dialog box for the settings.

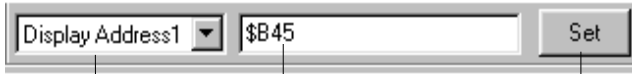

Displays the set address.

Displays the address type. When a functional object has multiple address settings, select the address type from the combo box and then set each address.

Clicking this button displays the Address Setting Dialog Box from which the address can be set.

Selections for ON/OFF Buttons

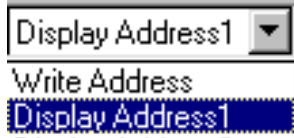

Reference

- ◆ Another method for setting addresses apart from directly inputting from the keyboard, is to input the address from the Address Settings Dialog Box that is displayed by clicking the Settings Button. Refer to 5-7 Address Settings for details.



Screen Creation Screens

These screens are used to create the screens displayed on the PT.

Status Bar

The status bar displays an explanation of the function or object where the cursor is positioned or which is selected.



Displays information on the function of the toolbar icon or menu item selected.

Displays the frame page number currently selected.

Displays the current coordinates of the cursor.

Displays the upper left coordinates of the object.

Displays the object name currently selected.

Displays the switch label name currently selected.

Displays the current zoom status.

Displays the selected NS-Designer system

Displays the PT model currently selected

Reference

- ◆ The toolbars and status bar can be set to be shown or hidden.
 Toolbar: Select **View - Toolbars** and then **Standard, Functional Object, Fixed Object, Operation, Formatting, Color, or Address**.
 Status Bar: 1. Select **View - Status Bar**.
 A check symbol before an item indicates that the item is displayed.
- ◆ The toolbars can be moved to any position on the screen.

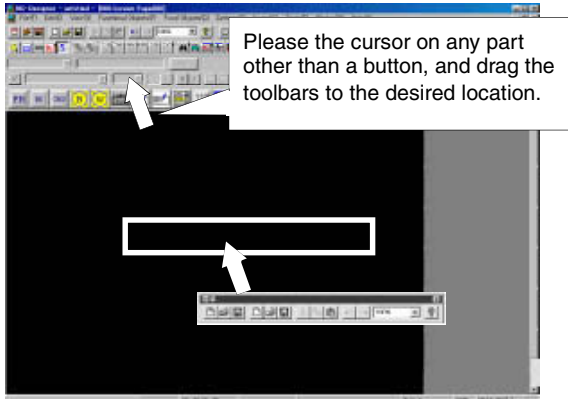



2-5-2 Dialog Box Main Functions

Dialog boxes are used to set detailed settings for executing PT functions.

Edit Box



Enter the character string. If there is a spin button  click the Up Arrow  Button or Down Arrow  Button to increase or decrease numerical values.

Option Buttons

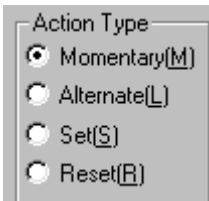

Item names with a circle to their left are optional items. From the multiple optional items, only one item can be selected. The selected item will be indicated by a black dot.

Combo Box

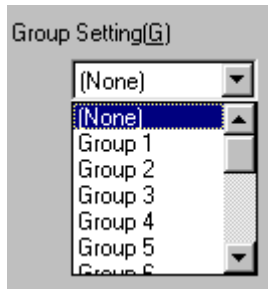

A list of multiple optional items will be displayed in a drop-down menu. Select the items to be set from the list.

List View

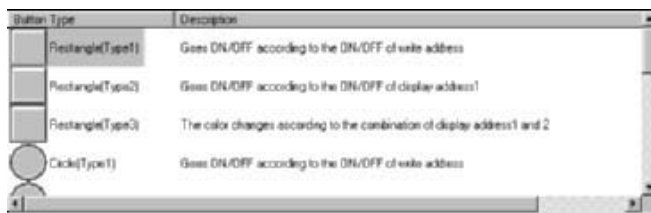

Select the item from the list.

Check Boxes

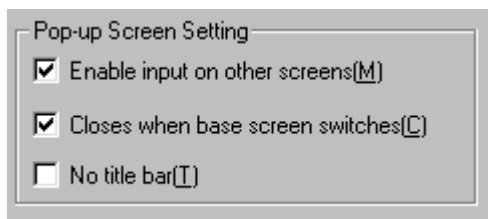

Item names with a square on their left side are the optional items. Select whether or not to enable the item. The selected items are indicated with a check mark.

Section 3 Manipulating Project Files

This section describes the basic operations for manipulating projects where data created for screens is stored.

3-1	Projects	3-1
3-2	Creating New Projects	3-2
3-3	Opening Existing Projects.....	3-3
3-4	Saving Projects	3-5
3-5	Saving a Project Under a Different Name.....	3-7
3-6	Opening Recent Projects.....	3-8
3-7	Opening Template Projects.....	3-9
3-8	Project Maintenance.....	3-12
3-9	Project Properties.....	3-17
3-10	Changing the PT Model	3-21

3-1 Projects

The NS-Designer designates and handles PT screen data as one project. A project consists of data that can be broadly divided into project folders where files such as bitmap files and project files (extension.ipp) are stored.

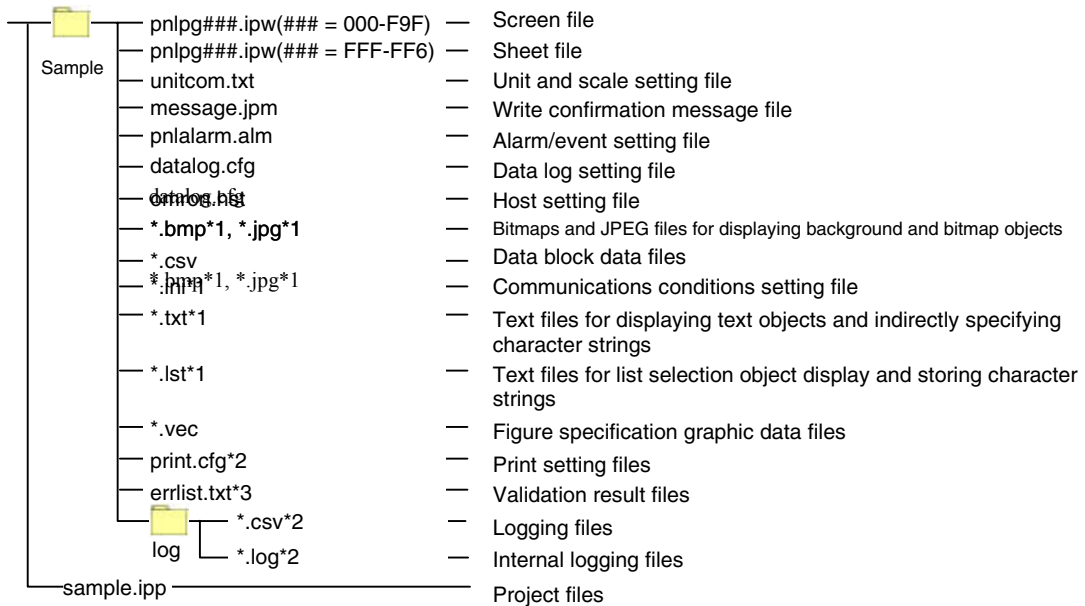

- Note
1. The user can edit these files with a text editor. The other files are created by NS-Designer and must not be edited using a text editor or other means.
 2. These files are created when printing or executing a test and are not transferred when transferring data to the PT.
 3. These files are created when validating and are not transferred when transferring data to the PT.

When files are saved under the name Sample, a file named Sample.IPP will be created in a folder called Sample under \Temp\ in the NS-Designer install directory. To open an existing project, select the file with the IPP extension.

Reference

- ◆ To move or copy the project data to a floppy disk or other storage area, select both the folder and project file, and execute the operation. The project consists of these two data types and cannot be opened if only one of them is selected.

3-2 Creating New Projects

The procedures for operations from creating new projects to opening screens are described here.

1. Select **File - New Project** or click the **New Project** Button in the toolbar.



Reference

- ◆ Projects that were created with NS-Designer Ver. 2.0 or later cannot be run on PTs using system Ver. 1.X. Install NS-Designer Ver. 1.X to create projects. Projects for system Ver. 1.X can be created or edited, however, when using NS-Designer Ver. 5.0 or later.

2. The New Project Dialog Box will be displayed. Select the NS-series PT model and System Version and click the **OK** Button.

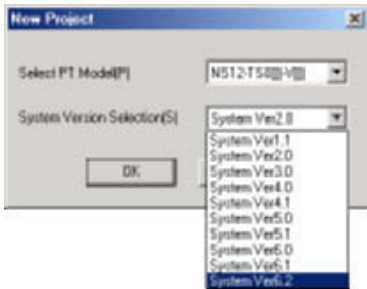

Reference

- ◆ The project system versions that can be run depend on the system program version installed in the PT. Refer to *Appendix 9 Converting Data between Different Versions of NS-series Products* for details.
- ◆ The NS-Designer can also be started by right-clicking the NS-series PT in the Network Configuration Window of the CX-Integrator and selecting *Start Special Application - Start with Settings Inherited*.

3. The New Screen Dialog Box will be displayed. Select **New Screen** or **Reuse Existing Screen** and click the **OK** Button. Refer to *Creating New Screens* under *4-2 Creating and Saving Screens* for details.

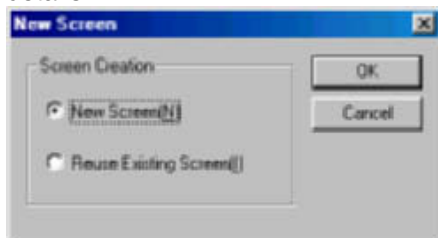

4. Screen creation starts after new screen is opened.

3-3 Opening Existing Projects

Opening From the File Menu

1. Select **File - Open Project** or click the **Open Project** Button in the toolbar.



2. The Select Project Dialog Box will be displayed.
Select the project file (IPP extension) and click the **Open** Button.



Opening by Double-clicking an IPP File

1. Double-click on an IPP file from Windows Explorer to display the Open Screen Dialog Box.

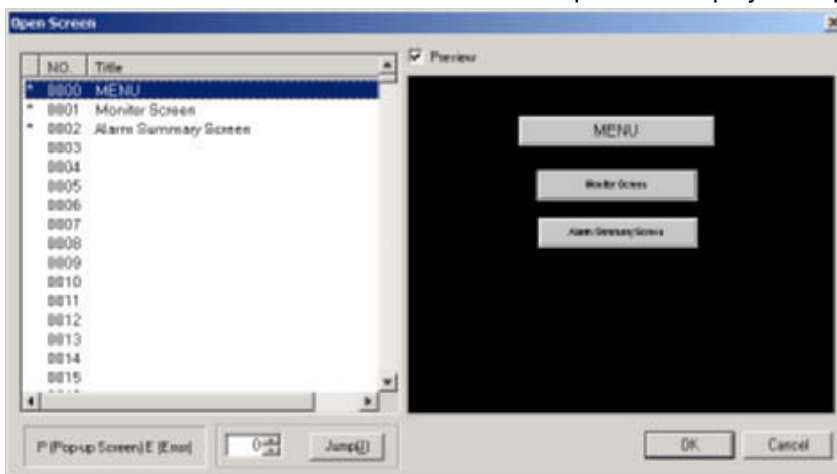

2. Click the **OK** Button.

Reference

- ◆ Screen data that was edited or saved with NS-Designer Ver. 2.X can be converted using the NS-Designer's Settings Menu. The procedure for converting to NS-Designer Ver. 6.X screen data is given below.
 1. Open the NS-Designer Ver. 2.X data in NS-Designer Ver. 6.X.
 2. Select **Settings – Conversion – Project – To Ver6.2**. This will convert the data to NS-Designer Ver. 6.2 data.
 - * Converting screen data for the NS7 to NS-Designer Ver. 6 or higher data will convert it as data for the NS8-TV1□-V1.
 - * Depending on the combination of system program, NS-Designer version, and data version, it may not be possible to use converted data. Refer to *Appendix 9 Converting Data between Different Versions of NS-series Products*.
 - * NS-Designer Ver. 5.0 or later can also convert screen data created with NS-Designer Ver. 1.X.

Reference

- ◆ Project data created with NS-Designer from Ver. 1.X to Ver. 5.X can be edited and saved on NS-Designer Ver. 6.X.
- If project data that was edited or saved with NS-Designer Ver. 1.0 is opened with NS-Designer Ver. 6.X, the following data conversion confirmation message, which indicates making a copy of the data for Ver. 1.1 will be displayed.

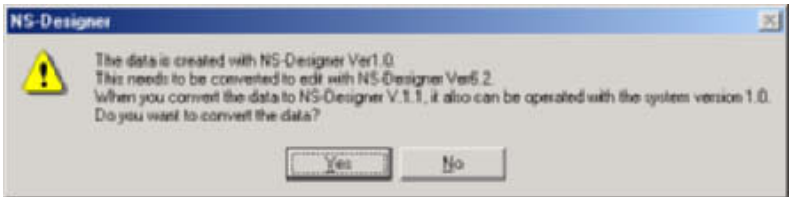

If the **Yes** Button is clicked, the following dialog box will be displayed and the data will be resaved as Ver. 1.1 data under the specified project name.

If the **No** Button is clicked, the project will not be read or converted.

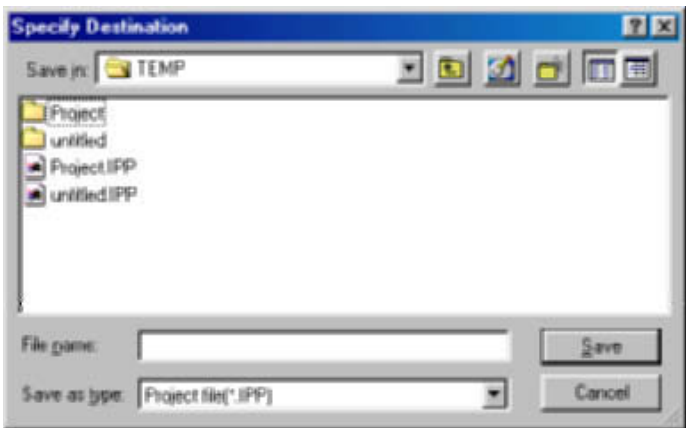

3-4 Saving Projects

The methods for saving project files are described here.

1. Select **File - Save Project** or click the **Save Project** Button in the toolbar.



New Projects

Newly created projects and screens are temporarily created in a temporary directory until saved.

The temporary directory and temporary files are as follows:

(NS-Designer install directory)\TEMP\untitled.ipp

When a project or screen is saved for the first time, the following dialog box will be displayed and the project will be saved (copied from the TEMP directory). Specify the folder and file name where the project will be saved, and click the Save Button.

Always observe the following precautions when specifying the project name.

- The project name must be no more than 42 characters including the IPP extension.
- Select a name using alphanumerics, underscore (_), dollar symbols (\$), and periods (.).

If the project name is specified using other characters, symbols, or marks, an error will occur when the Save Button is clicked.

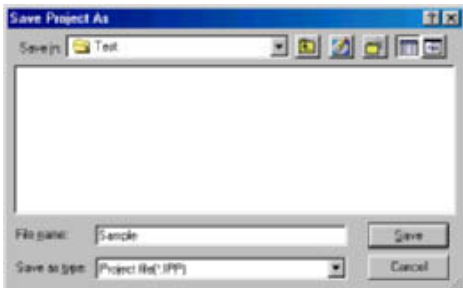

Reference

- ◆ If a project is changed but has not yet been saved, a dialog box confirming whether or not to save the changes will be displayed when the project is closed.

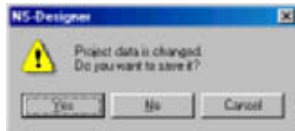

- ◆ When saving new projects, if the specified saving location contains an existing project, the existing project's data will be deleted and overwritten with the new project data.
- ◆ The setting for whether or not the screen is a pop-up screen is saved in the project file (*.IPP). Therefore, even if the screen properties are set to pop-up screen, the screen will operate as a base screen when the PT is operating if the project has not been saved. After changing the setting from base screen to pop-up screen, the relationship between whether the project or screen is saved and the operations at the PT is as follows:

Save project	Save screen	Operations at the PT
Yes	Yes	Operates as a pop-up screen.
Yes	No	Operates as a pop-up screen. (The screen size used is that set for the most recently saved screen.)
No	Yes	Operates as a base screen.

Yes: Saves; No: Does not save

3-5 Saving a Project Under a Different Name

1. Select **File - Save Project As**.
2. The Save Project As Dialog Box will be displayed.
Specify the directory and file name where the project will be saved, and click the **Save** Button.
Always observe the following precautions when specifying the project name.
 - The project name must be no more than 42 characters including the IPP extension.
 - Select a name using alphanumerics, underscore (_), dollar symbols (\$), and periods (.).If the project name is specified using other characters, symbols, or marks, an error will occur when data is transferred to the PT.

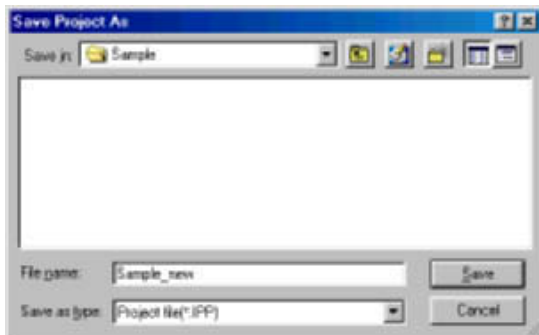

Reference

- ◆ When the project name is changed and saved, all the original project data will also be copied to the new project directory.
- ◆ When specifying the project name, if the specified save destination has an existing project, the existing project's data will be deleted and overwritten with the currently open project data.

3-6 Opening Recent Projects

Up to the four most recently used projects can be opened directly from a menu.

1. Select **File - Recent Projects**.
2. The recently used project names are displayed with the directory path. Select any project from the list.

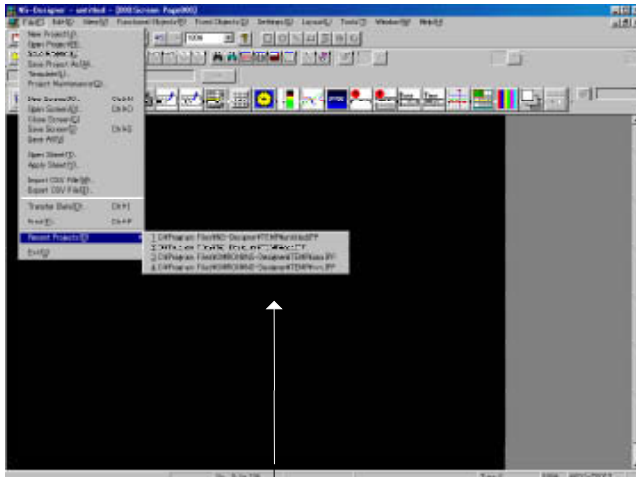

The four most recent projects are displayed beginning with the most recent

Note

- ◆ If a project edited or saved with NS-Designer Ver. 1.0 is opened with NS-Designer Ver. 6.2, the following message, confirming data conversion, will be displayed.



Refer to 3-3 *Opening Existing Projects* for details.

3-7 Opening Template Projects

By specifying a template project, screens that are saved in specific projects can always be reused when creating new screens. This is a useful, for example, for reusing screens from a particular project many times, or for collecting frequently used screens in a specific project and using them as a group screen format when creating projects. The workflow when specifying a template project is given in the following flowchart.

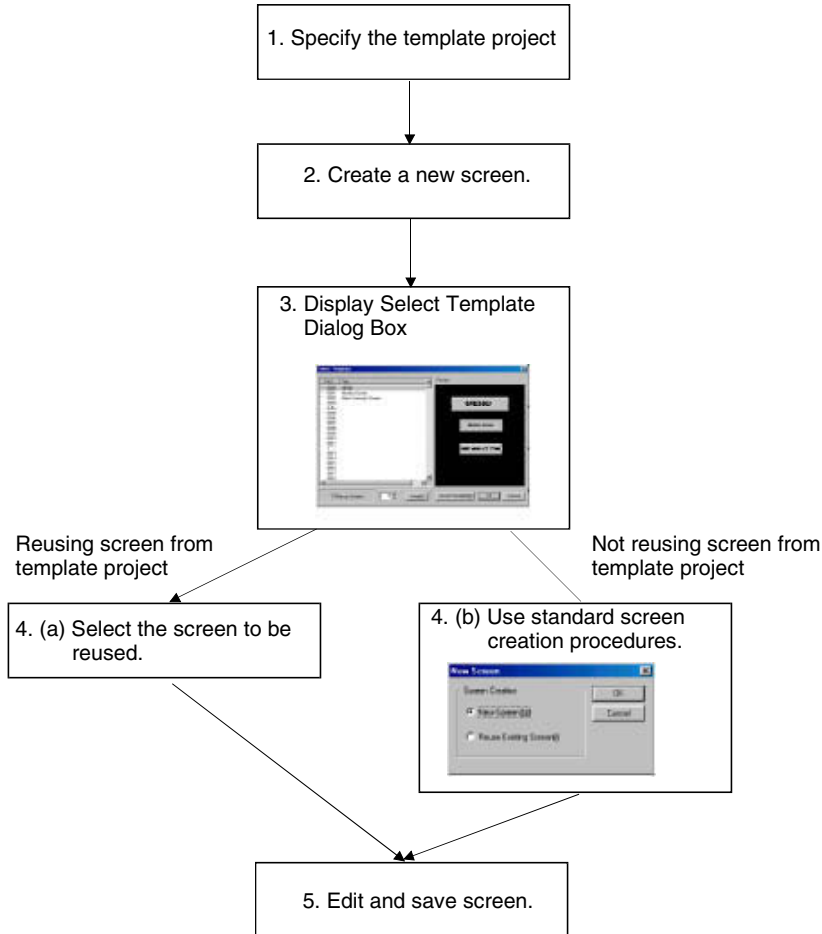

3-7-1 Specifying Template Projects (Flowchart Step 1)

1. Select **File – Select Template Project**.
2. The Select Project Dialog Box will be displayed. Select the project to be specified as a template project and click the **Open** Button.

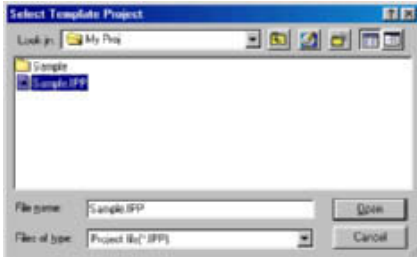

Reference

- ◆ When changing template projects, specify the project again by selecting **File – Select Template Project**.

3-7-2 Reusing Screens (Flowchart Steps 2 to 4)

1. The Select Template Dialog Box will be displayed each time a new screen is created. (Flowchart steps 2 and 3)
Select the screen to be reused. (Flowchart step 4 (a))
When not reusing the screen, click the **Cancel** Button to return to the standard procedure for creating a new screen. (Flowchart step 4 (b))

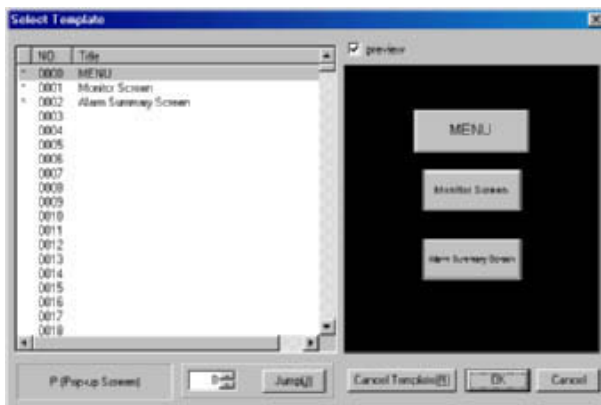

2. Click the **OK** Button.
3. The selected screen will be reused as the new screen.

3-7-3 Canceling Template Projects

When a template project is cancelled, the Select Template Dialog Box is not displayed for creating a new screen, and the standard procedure is resumed.

(Procedure follows flowchart steps 2, 4(b), and 5.)

Click the **Cancel Template** Button in the Select Template Dialog Box.

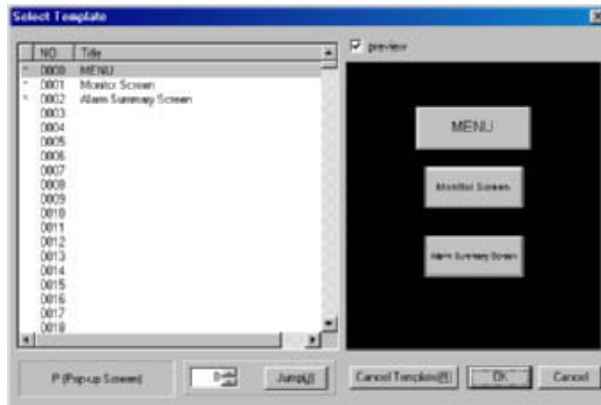

3-8 Project Maintenance

Project maintenance includes functions to copy, delete, back up, and restore projects. The following maintenance functions can be performed.

Item	Details
Duplicate	Copies the specified project.
Delete	Deletes the specified project.
Backup	Backs up the specified project (specify floppy disk or folder).
Restore	Restores the backed up project data.

3-8-1 Procedures

The operating methods common for each setting item are explained below.

1. Select **File – Project Maintenance**.
2. A dialog box will be displayed confirming whether to close the screen being edited. Click the **Yes** Button.

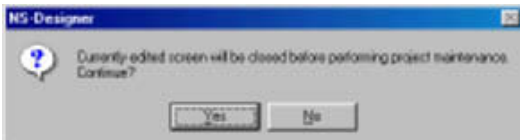

3. The Project Maintenance Dialog Box will be displayed. Select the desired tab.

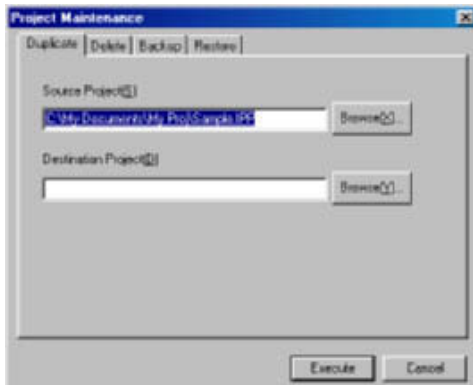

4. Make the settings and then click the **Execute** Button.

Copy

1. Select the **Duplicate** Tab.
2. Set the source project and destination project.

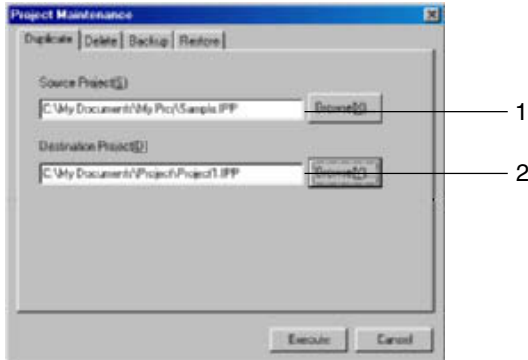

No.	Item	Details
1	Source Project	Set the source project file name to be copied as a full path name. When the NS-Designer is used to open the project, the project file will be displayed automatically.
2	Destination Project	Set the destination project file name to be copied as a full path name.

3. Click the **Execute** Button to display the Confirmation Dialog Box. Click the **Yes** Button to copy the project.

Reference

- ◆ An existing project file can be specified as the project destination, but all the data in the previous existing project file will be deleted. (The following confirmation dialog box will be displayed.)

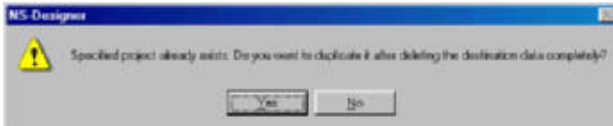

If the same project is specified as the source project and destination project, the data will be deleted before it is copied, so the data will be lost. Do NOT set the same project for the copy source and destination.

Delete

1. Select the **Delete** Tab.
2. Sets the project to be deleted.

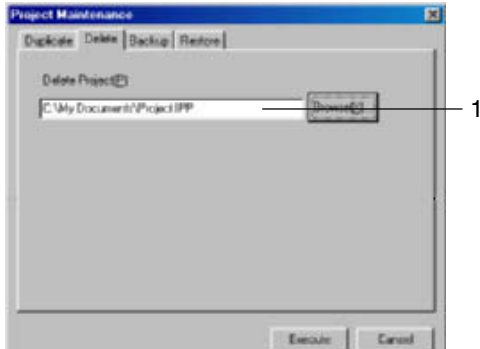

No.	Item	Details
1	Delete Project	Set the name of the project file to be deleted as a full path name.

3. Click the **Execute** Button to display the Confirmation Dialog Box. Click the **Yes** Button to delete the project.

Reference

- ◆ Projects being edited cannot be deleted. Close the project first, and then retry the operation.
- ◆ Projects that have been deleted cannot be restored. Check the project carefully before deleting it.

Backup

1. Select the **Backup** Tab.
2. Set the project to be backed up.

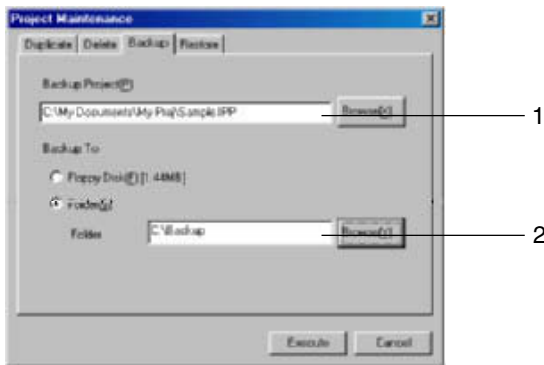

No.	Item	Details
1	Backup Project	Sets the name of the project file to be backed up as a full path name. When the NS-Designer is used to open the project, the project file is displayed automatically.
2	Backup To	When a floppy disk is selected, the backup file will be saved on the floppy disk. Prepare the specified number of 1.44-Mbyte floppy disks. When a folder is selected, the backup file will be saved in the folder. A file is created at the backup destination under the name [project name].XXX (XXX = 000, 001, ...).

3. Click the **Execute** Button to display the Confirmation Dialog Box. Click the **Yes** Button to back up the project.
4. When the backup destination is the floppy disk, the number of floppy disks required will be displayed. When more than one floppy disk is required, switch the floppy disks according to the messages displayed.

Reference

- ◆ If the same backup file of the project already exists in the backup destination, the previously existing backup file will be deleted and a new backup file will be created.

Restore

1. Select the **Restore** Tab.
2. Set the project to be restored.

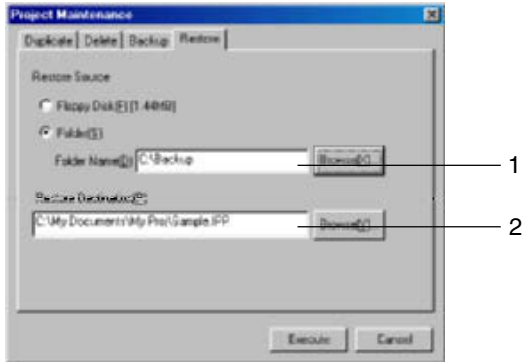

No.	Item	Details
1	Restore Source	When floppy disk is selected, the backup file stored in the floppy disk will be restored. When folder is selected, the backup file stored on the hard disk will be restored.
2	Restore Destination	Sets the name of the project file to be restored as a full path name. Specify the name of the project file with the same name as that of the backup file. Example: If the backup file is TEST.000 , then specify the project name as TEST.IPP (any path can be specified).

3. Click the **Execute** Button to display the confirmation dialog box. Click the **Yes** Button to restore the project.
4. When floppy disk is set as the restore source, switch the floppy disks according to the messages displayed.

Reference

- ◆ An existing project file can be specified as the restore destination, but the data in the existing project file will be deleted. The alarm/event data, however, will not be deleted. The following confirmation dialog box will be displayed.



- ◆ An error will occur if no project with the same name as the backup file exists in the restore destination. If this error occurs, create a project file with the same name as the backup file, and then restore the project.

3-9 Project Properties

Properties can be set for projects. The following items can be set.

Item	Details
Title	Set the project title (up to 64 characters).
Switch Label	Set the number of labels (1 to 16) and the label names (up to 15 characters).
Macro	Register the macros to be used for the project.
Select Language	Select the system language to be used for the PT display.
Pop-up Menu	Set pop-up menus using word buttons, command buttons, and String Display & Input.
Macro Option	Set whether “\n” that is included in the character string when using message box macros (MSGBOX) is to be handled as a line-feed code.
Numeral Input Option	Set either to display present values or delete the current string and input a new string in the display column when performing numerical input for Numerical Display & Input objects.
Input Status Color	Set the display color for text and background in the input field when inputting Numerical Display & Input objects, String Display & Input objects, and Temporary Input objects.
Data Format	Set the data format for specifying line numbers in indirectly specified files.

3-9-1 Procedure

The operating methods common for each project property setting item are explained below.

1. Select **Settings - Project properties**.
2. The Project Properties Dialog Box will be displayed.
3. Make the settings and then click the **OK** Button.

The settings method for each setting item is explained next.

Title

Select the **Title** Tab.

Set a title of up to 64 characters.

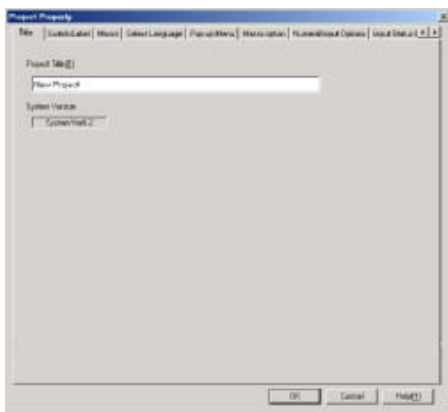

Switch Label

1. Select the **Switch Label** Tab.
2. Make the switch label settings.

NS-Designer Operation Manual

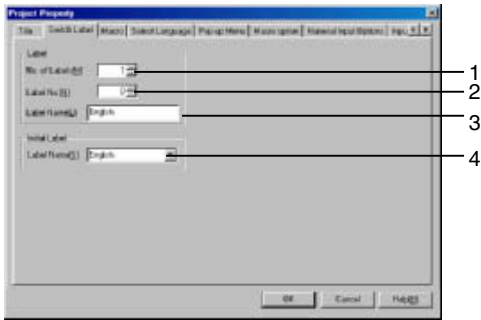

No.	Item	Details
1	No. of Labels	Set how many labels can be switched (1 to 16).
2	Switch No.	Set the label number to be switched.
3	Label Name	Set a label name of up to 15 characters.
4	Initial Label	Set the label number shown on the screen after the power to the PT is turned ON. The default setting is 0.

Macro

1. Select the **Macro** Tab.
2. Register the macros to be used for the project. Refer to *6-1 Registering Macros* for details on how to set macros.

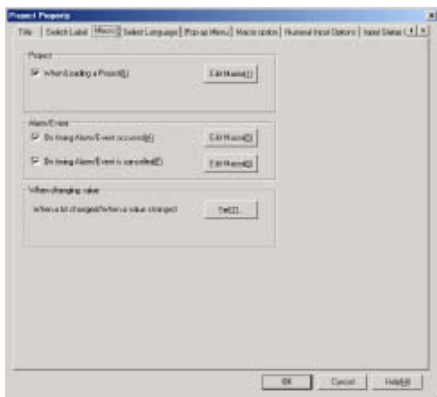

Select Language

1. Select the **Select Language** Tab.
2. Select the system language to be used for the PT display. “System language” is the language used for PT display characters, such as in system menus, keypads, and dialog boxes.

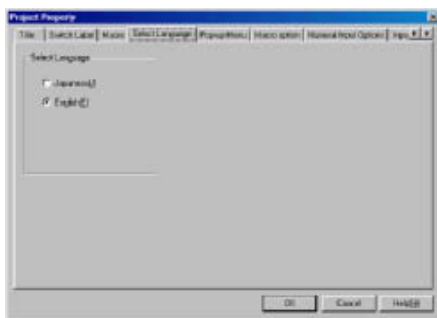

Reference

- ◆ If the character display format is set to ASCII code for string display and input, restore display, and data block tables (character string fields), the characters used for PT display are determined by the following character codes, according to the system language.

System language	Character display	Example (character code: B5)
Japanese	Shift JIS code	†
English	Latin 1 code	μ

If the character strings for label objects are indirectly specified, these characters will also be determined in the way shown in the table.

Pop-up Menu

1. Click the **Pop-up Menu** Tab.
2. Make the settings for the pop-up menu used for setting Word Button, Command Button, and String Display & Input objects.

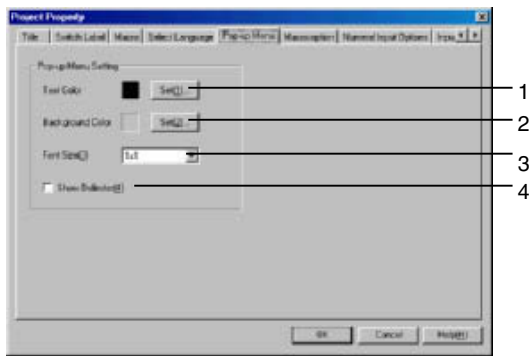

No.	Item	Details
1	Text Color	Set the text color used in the pop-up menu.
2	Background Color	Set the background color of the pop-up menu.
3	Font Size	Set the font size used in the pop-up menu.
4	Show Delimiter	Select to display lines separating items in the pop-up menu.

Reference

- ◆ The settings made on the Pop-up Menu Tab Page are not applied by the Test Tool in the NS-Designer. To check the results of settings made on the Pop-up Menu Tab Page, transfer the project to the PT and check operation on the PT.

Macro Option

1. Click the **Macro Option** Tab.
2. Select to display messages over multiple lines by handling the “\n” in the character string as a line-feed code when using the message box macro (MSGBOX).

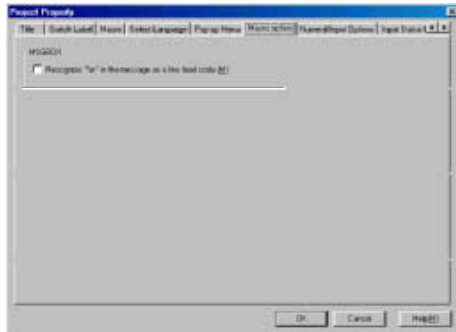

Numeral Input

1. Click the **Numeral Input Options** Tab.
2. Set either to display or delete present values when inputting numerical values in Numerical Display & Input objects.

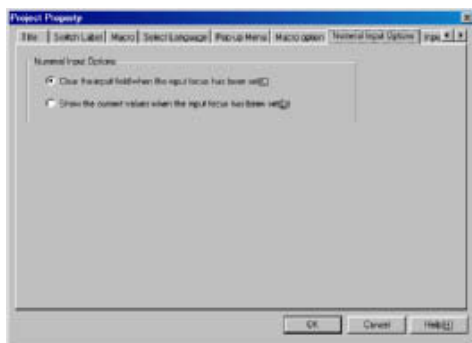

Input Status Color

1. Click the **Input Status Color** Tab.
2. Set the Text and background colors used in the input field when inputting numerical values or character strings for Numerical Display & Input objects, String Display & Input objects, and Temporary Input objects.

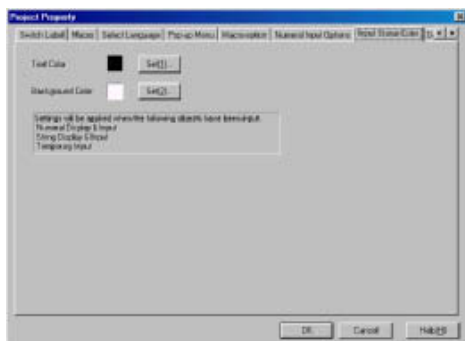

Data Format

1. Click the **Data Format** Tab.
2. Set the data format to BCD or binary for specifying the line numbers in indirectly specified files.

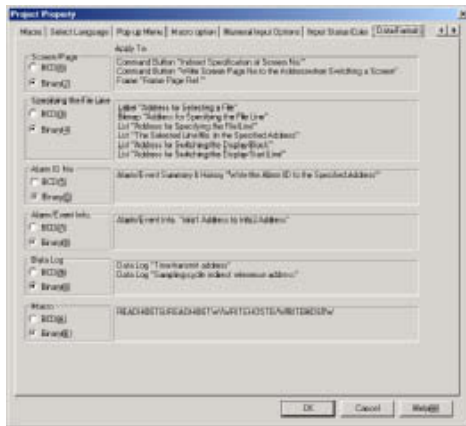

3-10 Changing the PT Model

This function changes the model of the NS-series PT that supports the project.

1. Select **Settings – Conversion - Change PT Model**.
The PT Model Dialog Box will be displayed.

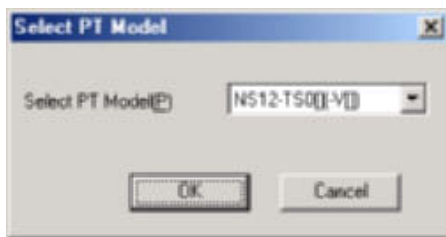

2. Select the PT model to be changed, and then click the **OK** Button.
3. A message to confirm the model change will be displayed. Click the **Yes** Button to change the model.

When the PT model is changed, the screen size will change as follows:

Model before changing	Model after changing	Screen size conversion
NS12	NS10	Converts the basic screen size to 640 × 480 dots.
	NS8	Pop-up screens that are larger than 640 × 480 dots are converted to 640 × 480 dots.
	NS5-SQ/TQ	Converts the basic screen size to 320 × 240 dots.
	NS5-MQ	Pop-up screens that are larger than 320 × 240 dots are converted to 320 × 240 dots.
NS10	NS12	Converts the basic screen size to 800 × 600 dots.
	NS8	No conversion.
	NS5-SQ/TQ	Converts the basic screen size to 320 × 240 dots.
	NS5-MQ	Pop-up screens that are larger than 320 × 240 dots are converted to 320 × 240 dots.
NS8	NS12	Converts the basic screen size to 800 × 600 dots.
	NS10	No conversion.
	NS5-SQ/TQ	Converts the basic screen size to 320 × 240 dots.
	NS5-MQ	Pop-up screens that are larger than 320 × 240 dots are converted to 320 × 240 dots.
NS5-SQ/TQ	NS12	Converts the basic screen size to 800 × 600 dots.
	NS10	Converts the basic screen size to 640 × 480 dots.
	NS8	
NS5-MQ	NS12	Converts the basic screen size to 800 × 600 dots.
	NS10	Converts the basic screen size to 640 × 480 dots.
	NS8	

Reference

- ◆ When the model has been changed from the NS12, NS10, or NS5 to the NS8 (or, conversely, from the NS8 to the NS12, NS10, or NS5), the size of the intervals in the touch-sensitive mesh are different, so it may not be possible to press some of the functional objects. After conversion, always check that the functional objects are above the touch-sensitive mesh size by running validation from the Tools Menu. Refer to *Section 9 Validation* for details on the validation function.
- ◆ Although screen data for the NS5-MQ0□-V2 is displayed in monochrome/16 grayscale levels on the NS-Designer displays and the NS5-MQ0□-V2 screen, the data will be displayed in color if it is converted to data for a PT model with color displays on the NS-Designer or transferred to a PT with a color display screen. The color codes that are used when creating the screen data for the NS5-MQ0□-V2 will be displayed for screen data and the image colors will be used for BMP and JPEG data.
- ◆ All screen data created for PTs with color displays will be displayed in monochrome/16 grayscale levels if the screen data is converted for the NS5-MQ0□-V2 on the NS-Designer or it is transferred to the NS5-MQ0□-V2.

Section 4 Screen Types and Operations

This section describes the basic operations for the screens that can be displayed on the PT.

4-1	Basic Operations	4-1
4-2	Creating and Saving Screens.....	4-18
4-3	Sheets	4-24
4-4	Frames.....	4-28

4-1 Basic Operations

The operating methods common to each screen are explained here.

4-1-1 Setting Screen Properties

Set the properties for the screen currently being edited. The following items can be set using this function.

Item	Details
Title	Set the title of the edited screen (up to 64 characters).
Size/Pop-up	Set the types of edit screen (base screen or pop-up screen) and screen size.
Background/Others	Set the screen background and data file compression settings.
Macro	Register the macros to be set for the screen.
Detail setting	Set the macro execution timing for the SAP (Smart Active Parts) library. For details, refer to <i>How to use Smart Active Parts</i> (PDF) included with the NS-Designer.

Procedure

The operating methods common for each setting item are explained here.

1. Select **Settings - Screen Properties**.
2. The Screen Properties Dialog Box will be displayed.
3. Make the settings and then click the **OK** Button.

The settings method for each setting item is explained here.

Screen Title

1. Select the **Title** Tab.
2. Set a title of up to 64 characters.

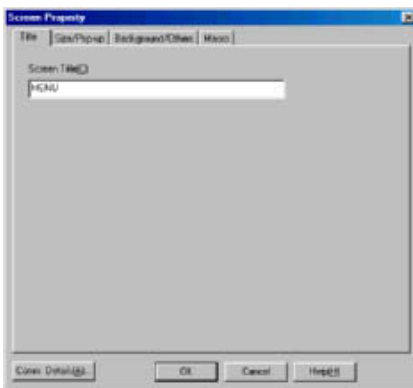

Size/Pop-up

1. Select the **Size/Pop-up** Tab.
2. Set the screen size and pop-up screen setting.

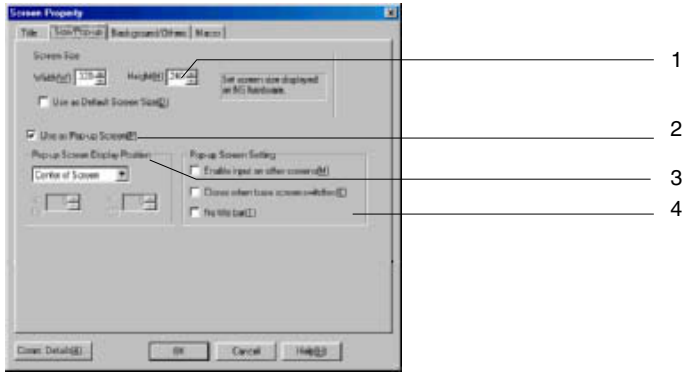

No.	Item	Details
1	Screen Size	Set the PT screen display size. The maximum screen size that can be set depends on the PT model selected. NS12: Up to 796 dots horizontal × 566 dots vertical with title bar. Up to 796 dots horizontal × 596 dots vertical without title bar. NS10, NS8: Up to 636 dots horizontal × 446 dots vertical with title bar. Up to 636 dots horizontal × 476 dots vertical without title bar. NS5: Up to 316 dots horizontal × 206 dots vertical with title bar. Up to 316 dots horizontal × 236 dots vertical without title bar.
	Use as Default Screen Size	Select this item to set the size as the default the next time a new screen is created.
2	Use as Pop-up Screen	Select this item to use the screen as a pop-up screen when the PT is running. When not selected, the screen is used as a base screen. Screen number 0 cannot be set as a pop-up screen. Settings of other screens can be changed freely.
3	Pop-up Screen Display Position	Set the position where the pop-up screen is displayed while the PT is running. Select the position from one of the following settings. Center of Screen, Top Left of Screen, Bottom Left of Screen, Top Right of Screen, Bottom Right of Screen, or Any Position. When Any Position is selected, specify the X and Y coordinates for the top left of the pop-up screen.
4	Pop-up Screen Setting	Set the settings related to the pop-up screen. Each of the setting items is as follows: Select each item to enable the setting. Enable input on other screens Closes when base screen switches No title bar

Reference

- ◆ If *No title bar* is selected under *Pop-up Screen Setting*, the screen’s frame will not be displayed when the screen is displayed on the PT.

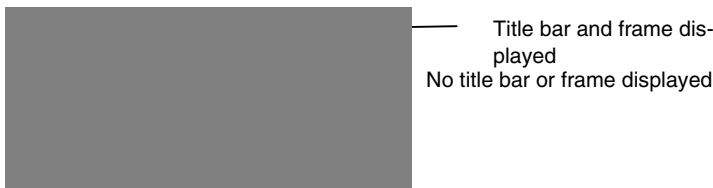

- ◆ If *Any Position* is selected under *Pop-up Screen Display Position* and the values input for the screen coordinates are out of range, the pop-up screen will be displayed as a full screen.

Background/Others

1. Select the **Background/Others** Tab.
2. Set the screen background and data file compression settings.

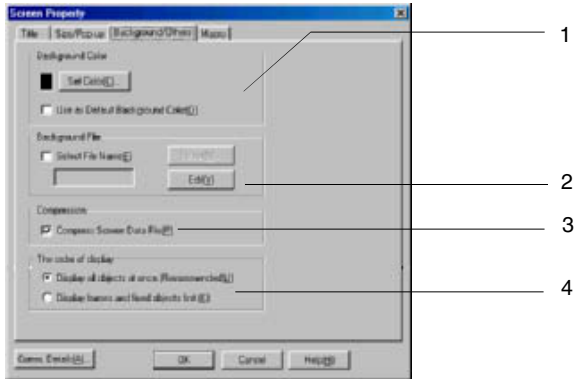

No.	Item	Details
1	Background Color	Select the screen's background color from 256 options.
	Set Color	Click the Set Color Button to display the Color Setting Dialog Box. Select the background color from the dialog box.
	Use as Default Background Color	Select this item to set the background color as the default next time a new screen is created.
2	Background File	Specify the background file.
	Select File Name	Select to specify an image file as the screen background. The following files can be specified. Specify a file name as a character string of up to 12 characters (up to 8 characters for the file name and 3 characters for the extension). The following characters can be used for file names: Alphanumerics, underscore (_), dollar sign (\$), and period (.) BMP and JPEG file formats are supported.
	Select	Click the Select Button to open the File Dialog Box. Select the file from the dialog box.
	Edit	Click the Edit Button to start the image editor and allow the background to be edited. Specify the image editor to be started up in the Editor Tab Page of the Options Dialog Box (Tools - Options).
3	Compress Screen Data File	Select this item to save the screen data file in compressed format.
4	The order of display	
	Display all objects at once. (Recommended)	Select this item to display all objects at once after getting information that is necessary to display the objects.
	Display frames and fixed objects first.	Select this item to display frames and fixed objects first and then display all of the other objects after getting the necessary information.

Reference

- ◆ Bitmap files (BMP or JPEG) that conform to Microsoft Windows standards can be set for the background.
- ◆ Specify which application to start up as the image editor under **Tools - Options**.

Macro

1. Select the **Macro** Tab.
2. Register the macros to be used for the screen. Refer to *6-1 Registering Macros* for details on how to register macros.

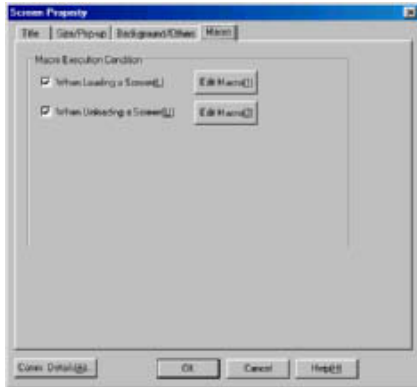

4-1-2 Grid Setting

The formation of squares set at equal intervals on the screen is called the grid. This function sets whether to show or hide the grid and the size of the grid interval.

1. Select **Layout - Grid** to display the Set Grid Dialog Box.

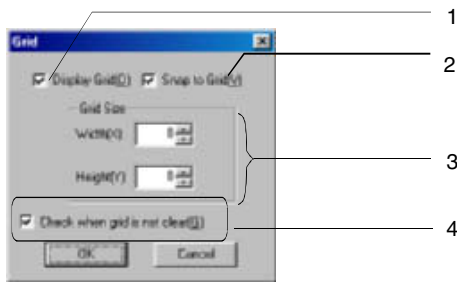

No.	Item	Details
1	Display Grid	Select this item to display the grid lines. The grid serves as a guide for arranging the functional objects.
2	Snap to Grid	Select this item to enable the grid. Enabling the grid allows functional objects to be snapped to the grid when moving them.
3	Grid Size	Specify the width and height of the grid intervals in dot units.
4	Check when grid is not clear	Select this item to reverse the color of the grid line. Use this setting if the grid lines are not clear because they are a similar color to the background.

4-1-3 Switching Items Displayed for Objects

The methods for switching the display type on the screen and confirming object settings are described here.

Simulate ON/OFF

This function can be used to display the form of a functional object on the current screen when the status of the address is ON. (The default is OFF.)

OFF Status

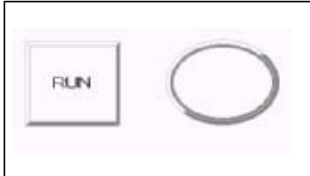

ON Status

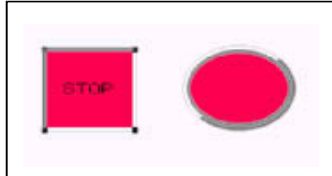

Select **View - Simulate ON/OFF** or click the **Simulate ON/OFF** Button in the toolbar.

Toolbar

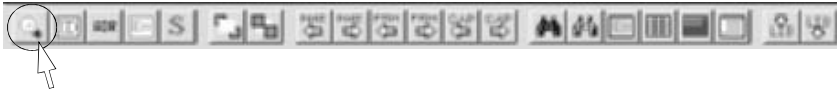

Reference

- ◆ The ▼ symbol before the *Simulate ON/OFF* Menu item indicates that simulate ON status is currently displayed.
- ◆ To return to simulate OFF status, select **View - Simulate ON/OFF** or click the **Simulate ON/OFF** Button in the toolbar again.

Show ID

This function displays the ID numbers assigned to objects, except those assigned to tables. ID numbers are assigned to objects automatically in the order that the objects are created.

Show ID

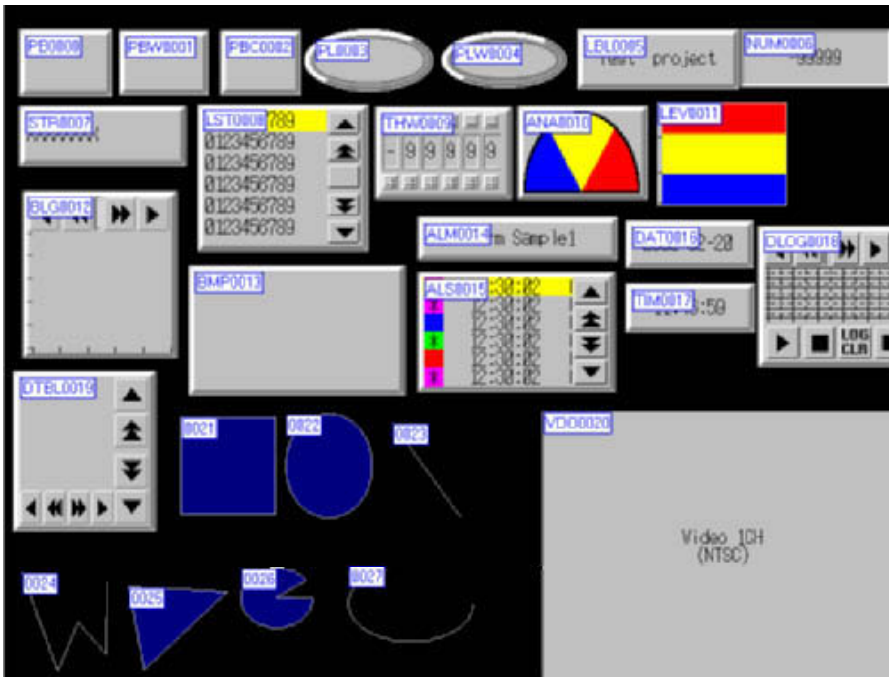

Select **View - Show ID** or click the **Show ID** Button in the toolbar.

Toolbar

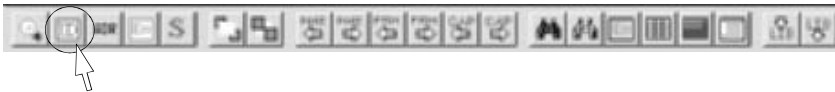

Reference

- ◆ The symbol before the *Show ID* Menu item indicates that the ID numbers are currently displayed.
- ◆ To return to the normal display, select **View - Show ID** or click the **Show ID** Button in the toolbar again.
- ◆ The ID numbers can be displayed in a small font. The procedure is as follows:
 1. Select **Tools - Options**.
 2. Select the **Edit/Disp.** Tab.
 3. Select **Use small font for ID display**.
- ◆ When an object is deleted causing a break in the sequence of ID numbers, the missed ID number will be allocated to the object that is created next.
- ◆ When a table is created, ID numbers are assigned to the table itself as well as to the functional objects contained in it. When the ID numbers are displayed, however, the ID numbers of the functional objects in the table will be displayed without showing the table ID number.

Functional Object IDs

A functional object ID consists of the object type and four-digit numerals.

Type	Functional object	ID
Buttons	ON/OFF Buttons	PB0000 to PB1023
	Word Buttons	PBW0000 to PBW1023
	Command Buttons	PBC0000 to PBC1023
Lamps	Bit Lamps	PL0000 to PL1023
	Word Lamps	PLW0000 to PLW1023
Displays & Inputs	Numeral Displays & Inputs	NUM0000 to NUM1023
	String Displays & Inputs	STR0000 to STR1023
	Thumbwheel Switches	THW0000 to THW1023
	Temporary Inputs	TMP0000 to TMP1023
Displays	Text	LBL0000 to LBL1023
	List Selection	LST0000 to LST1023
	Level Meter	LEV0000 to LEV1023
	Bitmap	BMP0000 to BMP1023
	Analogue Meter	ANA0000 to ANA1023
	Broken-line Graph	BLG0000 to BLG1023
	Video Display	VDO0000 to VDO1023
Alarm	Alarm Display	ALM0000 to ALM1023
	Alarm/Event Summary History	ALS0000 to ALS1023
System Clock	Date	DAT0000 to DAT1023
	Time	TIM0000 to TIM1023
Data Log	Data Log Graph	DLOG0000 to DLOG1023
Data Block	Data Block Table	DTBL0000 to DTBL1023
Others	Frame	FRM0000 to FRM1023
	Table	TBL0000 to TBL1023

Fixed Object IDs

Fixed object IDs are displayed as 4-digit numerals.

0000 to 1023

Show Address

This function displays the address set for each functional object.

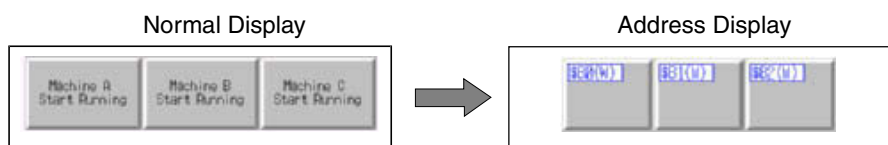

Select **View - Show Address** or click the **Show Address** Button in the toolbar.

Toolbar

**Reference**

- ◆ The symbol before the *Show Address* Menu item indicates that the addresses are currently being displayed.
- ◆ To return to the normal display, select **View - Show Address** or click the **Show Address** Button in the toolbar again.
- ◆ The addresses displayed with this function contain the data set in the General Tab Page of the Object Properties Dialog Box for the functional objects.
- ◆ Addresses are not displayed for data block tables.

NS-Designer Operation Manual

The following information is displayed in each functional object when Show Address is selected.

Type	Functional object	Display information
Button	ON/OFF Button	The write address, display address 1, and display address 2 are displayed in the following format. <div style="border: 1px solid black; padding: 5px; width: fit-content; margin: 5px auto;"> \$B100(W) \$B101(R1) \$B102(R2) </div> (W: Write address; R1: Display address 1; R2: Display address 2)
	Word Button	The write address is displayed in the following format. <div style="border: 1px solid black; padding: 5px; width: fit-content; margin: 5px auto;"> \$W100 </div>
	Command Button	The set values are displayed in the following format.
	Switch Screen	<ul style="list-style-type: none"> Specified screen <div style="border: 1px solid black; padding: 5px; width: fit-content; margin: 5px auto;"> 50(P) \$W100(W) </div> (P: Page number; W: Page write address) Indirectly specified screen <div style="border: 1px solid black; padding: 5px; width: fit-content; margin: 5px auto;"> \$W10(P) \$W100(W) </div> (P: Indirect reference address; W: Page write address) Selection by Pop-up Menu <div style="border: 1px solid black; padding: 5px; width: fit-content; margin: 5px auto;"> POPUP </div> (POPUP is the fixed display.)
Button	Command Button	<ul style="list-style-type: none"> Forward <div style="border: 1px solid black; padding: 5px; width: fit-content; margin: 5px auto;"> PAGE+ \$W100(W) </div> (PAGE+ is the fixed display; W: Page write address) Backward <div style="border: 1px solid black; padding: 5px; width: fit-content; margin: 5px auto;"> PAGE- \$W100(W) </div> (PAGE- is the fixed display; W: Page write address)
	Switch Screen	
	Key Button	<div style="border: 1px solid black; padding: 5px; width: fit-content; margin: 5px auto;"> KEYBUTTON </div> (KEYBUTTON is the fixed display.)
	Control Pop-up Screen	<div style="border: 1px solid black; padding: 5px; width: fit-content; margin: 5px auto;"> PCTRL </div> (PCTRL is the fixed display.)
	Display System Menu	<div style="border: 1px solid black; padding: 5px; width: fit-content; margin: 5px auto;"> SYSMENU </div> (SYSMENU is the fixed display.)

NS-Designer Operation Manual

Type	Functional object	Display information
Button	Command Button	
	Stop Buzzer	<div style="border: 1px solid black; width: 100px; height: 40px; margin: 0 auto; text-align: center; line-height: 40px;">BUZZER</div> <p>(BUZZER is the fixed display.)</p>
	None	<div style="border: 1px solid black; width: 100px; height: 40px; margin: 0 auto; text-align: center; line-height: 40px;">NOP</div> <p>(NOP is the fixed display.)</p>
	Video Capture	<div style="border: 1px solid black; width: 100px; height: 40px; margin: 0 auto; text-align: center; line-height: 40px;">Capture</div> <p>(Capture is the fixed display.)</p>
	Contrast Adjustment	<div style="border: 1px solid black; width: 100px; height: 40px; margin: 0 auto; text-align: center; line-height: 40px;">Contrast + 10</div> <p>(The following function names and set values are displayed.)</p> <ul style="list-style-type: none"> - Contrast - Brightness - Depth - Tone
	Vision Sensor Console Output	<div style="border: 1px solid black; width: 100px; height: 40px; margin: 0 auto; text-align: center; line-height: 40px;">ESC</div> <p>(The signal name is displayed.)</p>
	Data Block Control -FILE--PLC	<div style="border: 1px solid black; width: 100px; height: 40px; margin: 0 auto; text-align: center; line-height: 40px;">File -> PLC</div> <p>(The following control information is displayed.)</p> <ul style="list-style-type: none"> - File -> PLC - PLC -> File - Record Delete
Data Block Control -FILE--NS, NS--PLC	<div style="border: 1px solid black; width: 100px; height: 40px; margin: 0 auto; text-align: center; line-height: 40px;">File -> NS</div> <p>(The following control information is displayed.)</p> <ul style="list-style-type: none"> - File -> NS - NS -> File - NS -> PLC - PLC -> NS 	

NS-Designer Operation Manual

Type	Functional object	Display information
Button	Command Button	<div style="border: 1px solid black; width: 100px; height: 40px; margin: 0 auto; text-align: center; padding: 5px;">Record Label</div> <p>(Record Label is the fixed display)</p>
	Data Block Control -Read Record Label	
Lamp	Bit Lamp	<p>The address is displayed in the following format.</p> <div style="border: 1px solid black; width: 100px; height: 40px; margin: 0 auto; text-align: center; padding: 5px;">\$B100</div>
	Word Lamp	<p>The address is displayed in the following format.</p> <div style="border: 1px solid black; width: 100px; height: 40px; margin: 0 auto; text-align: center; padding: 5px;">\$W100</div>
Display & Input	Numeral Display & Input	<p>The address is displayed in the following format.</p> <div style="border: 1px solid black; width: 100px; height: 40px; margin: 0 auto; text-align: center; padding: 5px;">\$W100</div>
	String Display & Input	<p>The address is displayed in the following format.</p> <div style="border: 1px solid black; width: 100px; height: 40px; margin: 0 auto; text-align: center; padding: 5px;">\$W100</div>

Type	Functional object	Display information
Display & Input	Thumbwheel Switch	The address is displayed in the following format. <div style="border: 1px solid black; padding: 5px; width: fit-content; margin: 10px auto;">\$W100</div>
	Temporary Input	The product name is displayed in the following format. <div style="border: 1px solid black; padding: 5px; width: fit-content; margin: 10px auto;">TEMPORARY</div>
Display	List Selection	The set value is displayed in the following format. <ul style="list-style-type: none"> • Internal Memory (\$W) <div style="border: 1px solid black; padding: 5px; width: fit-content; margin: 10px auto;">\$W100</div> • File <div style="border: 1px solid black; padding: 5px; width: fit-content; margin: 10px auto;">LIST.lst</div>
	Level Meter Analogue Meter	The border information is displayed in the following format. <div style="border: 1px solid black; padding: 5px; width: fit-content; margin: 10px auto;"> \$W120(M) 1000(X) \$W100(OA) \$W101(1A) 0(N) </div> <p>(M: Monitor address) (X: Max. fixed value) (O: Border 1-2 fixed value) (1: Border 2-3 fixed value) (N: Min. fixed value) (XA: Max. indirect address) (OA: Border 1-2 indirect address) (1A: Border 2-3 indirect address) (NA: Min. indirect address)</p>
	Bitmap	The file is displayed in the following format. <div style="border: 1px solid black; padding: 5px; width: fit-content; margin: 10px auto;">ERR.bmp</div>

Show Error Object

Objects for which errors were detected in validation are displayed with red borders. Refer to *Section 9 Validation* for details on the validation function.

- Example:** Validation items
- Overlapping of functional objects
 - Functional objects created inside screen/frame area

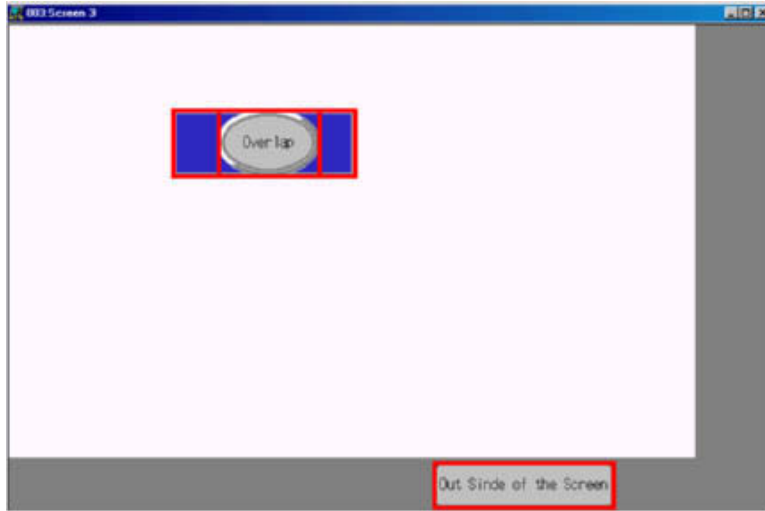

Select **View - Show Error Object** or click the **Show Error Object** Button in the toolbar.

Toolbar



Reference

- ◆ The symbol before the *Show Error Object* Menu item indicates that the error objects are currently displayed.
- ◆ To return to the normal display, select **View - Show Error Object** or click the **Show Error Object** Button in the toolbar again.

Show Sheet Object

This function is used to display the applicable sheet object. The sheet object is displayed by default.

Sheet Objects Not Displayed

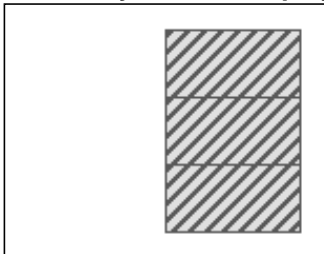

Sheet Objects Displayed



Select **View - Show Sheet Object** or click the **Show Sheet Object** Button in the toolbar.

Toolbar



Reference

- ◆ The symbol before the *Show Sheet Object* Menu item indicates that the sheet objects are currently displayed.
- ◆ To hide the sheet object, select **View - Show Sheet Object** or click the **Show Sheet Object** Button in the toolbar again.
- ◆ Refer to *4-3 Sheets* for details on basic sheet operations.

4-1-4 Changing the Display

The methods for changing the display on the screen are explained here.

Displaying Screens

The methods for switching the display of screen windows are as follows:

Cascade (*Window - Cascade*)

Cascades the open windows on the screen with the active window on top.

Tile (*Window - Tile*)

Tiles the open windows.

Arrange Icons (*Window - Arrange Icons*)

Arranges minimized windows.

The minimized windows are arranged from left to right at the bottom of the application window. (This command cannot be used if there are no minimized windows.)

Previous Screen

Displays the screen of the previous screen page number.

Select **View - Previous Screen** or click the **Previous Screen** Button in the toolbar.

Toolbar



Next Screen

Displays the screen of the next screen page number.

Select **View - Next Screen** or click the **Next Screen** Button in the toolbar.

Toolbar

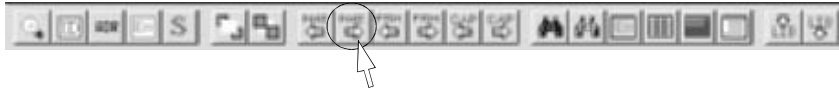

4-1-5 Switch Label

This function is used to switch labels when multiple labels are registered.

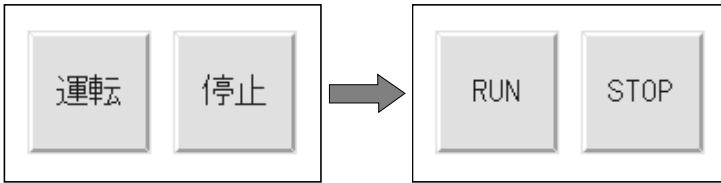

Switching Labels Backward and Forward

Switch labels by selecting *Previous Label* or *Next Label* from the toolbar.

Toolbar

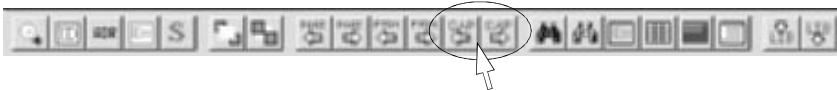

Switching to Any Label

1. Select *View - Switch Label*.

The Switch Label Dialog Box will be displayed.



2. Select the label to be displayed and then click the **OK** Button.

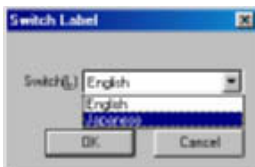

Reference

- ◆ Refer to 3-9 *Project Properties* for details on setting multiple labels.

4-1-6 Show Touch Points

This function is used to display the points where the PT touch points are positioned in the screen. Use this function to check that the functional objects are arranged above touch points.

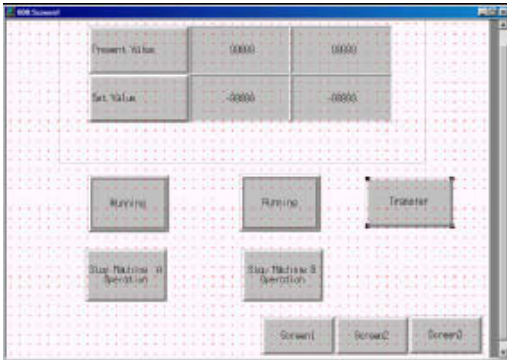

Select **View - Show Touch Points**.

Note Touch input will not be recognized if the functional objects are not created above the touch points. Therefore, always arrange the functional objects above the touch points. Refer to *Arranging Functional Objects* under *5-1 Creating Functional Objects* for details.

Reference

- ◆ The symbol before the *Show Touch Points* Menu item indicates that the touch points are currently displayed.
- ◆ To return to the normal display, select **View - Show Touch Points** again.

4-1-7 Zoom

Zooms the screen display up and down.

Use the Zoom Dialog Box to specify the magnification between 25% and 800%. Select **Fit** to zoom the display up or down to fit the current window size.

1. Select **View - Zoom**.

The Zoom Dialog Box will be displayed.

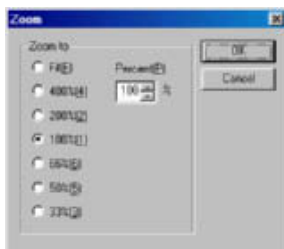

2. Select the magnification and then click the **OK** Button.

Using *Fit*

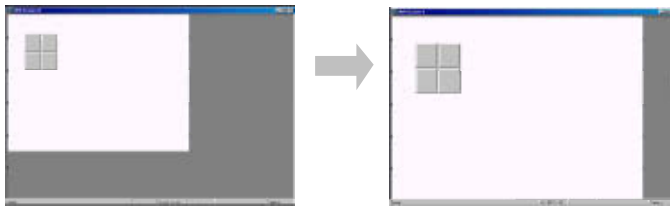

The same horizontal and vertical magnification are used full screen.

4-1-8 Refreshing

Refresh the screen to delete garbage on the screen and correct distortion in the display.

Select **View - Refresh**.

4-2 Creating and Saving Screens

The basic screen operations are explained here.

4-2-1 Creating New Screens

Select **File - New Screen** or click the **New Screen** Button in the toolbar.



The New Screen Dialog Box will be displayed.

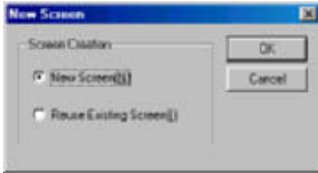

Reference

- ◆ When a new project is created, the New Screen Dialog Box is displayed after the PT model has been selected.

New Screens

Select **New Screen** and then click the **OK** Button.

The new screen will be displayed.

Reference

- ◆ The new screen will be automatically created in the screen with the lowest page number from the screens not being used.

Reusing Existing Screens

1. Select **Reuse Existing Screen** and then click the **OK** Button. Proceed as described below for new screens or for reusing screens.

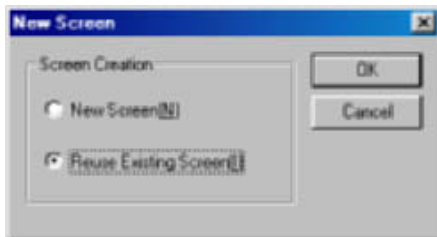

NS-Designer Operation Manual

- The Reuse Existing Screen Dialog Box will be displayed. Select the projects with the screen to be reused.

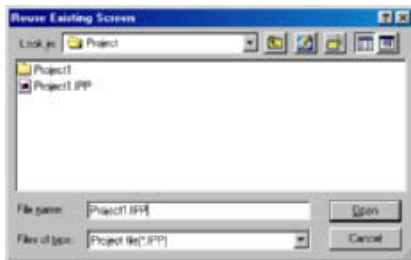

- The Select Page Dialog Box will be displayed. Select the screen to be reused and then click the **OK** Button.

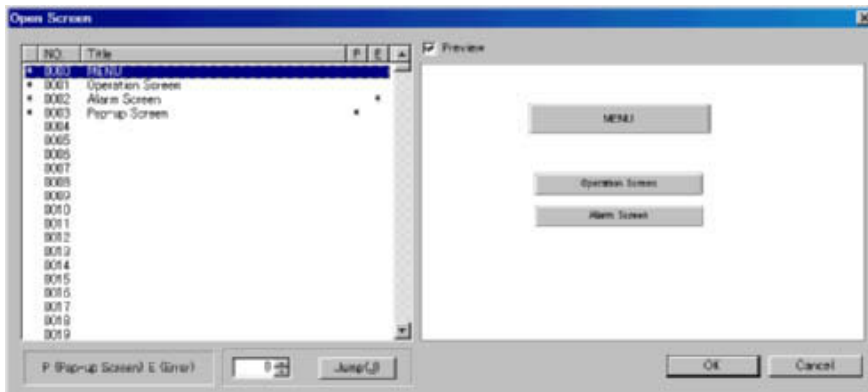

- When the screen with the applicable sheet settings is selected, the following dialog box will be displayed. To cancel the sheet settings, click the **No** Button and proceed to step 5.

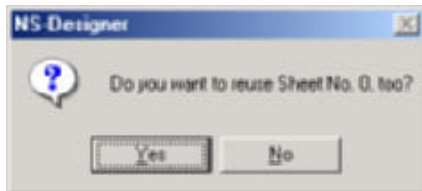

The sheet will be copied with the same sheet number as that of the original sheet. If a sheet with the same sheet number as the copied sheet already exists, a message will be displayed confirming whether to overwrite the sheet. Click the **Yes** Button to overwrite the existing sheet with the sheet being reused. Click the **No** Button to use the existing sheet.

The selected screen will be used to create a new screen.

Reference

- ◆ When using a screen created for a PT with color displays in creating a project for the NS5-MQ0□-V2, the screen will be displayed in monochrome/16 grayscale levels in the preview. When using a screen created for the NS5-MQ0□-V2 in creating a project for a PT with color displays, the screen will be displayed in color in the preview.

Opening Existing Screens

1. Select **File - Open Screen** or click the **Open Screen** Button in the toolbar.

Toolbar



2. The Open Screen Dialog Box will be displayed. Select the screen to be opened and then click the **OK** Button.

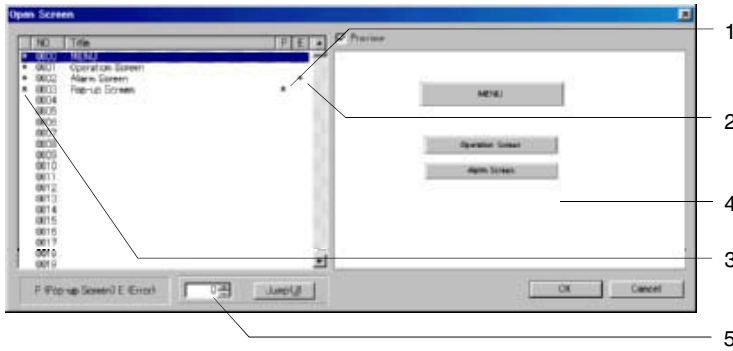

No.	Details
1	An asterisk (*) will be displayed in the pop-up screen.
2	An asterisk (*) will be displayed in pages where the error check detected an error.
3	An asterisk (*) will be displayed in the screen page being used.
4	Previews the selected screen. The screen will not be previewed if the check is removed from the <i>Preview</i> check box.
5	Display a specified screen by specifying the screen page number and clicking the Jump Button.

3. The selected screen will be displayed.

Reference

- ◆ The shortcut keys for opening screens are the **Ctrl + O** Keys.
- ◆ When an unused screen page number is opened, a new screen will be created.

Saving Screens

Select **File - Save Screen** or click the **Save Screen** Button in the toolbar.

Toolbar



Reference

- ◆ The shortcut keys for saving screens are the **Ctrl + S** Keys.
- ◆ If a screen has been changed but not saved yet, a dialog box confirming whether to save the changes will be displayed when the screen is closed. Click the **Yes** Button to save the changes.

- ◆ The setting for whether the screen is a pop-up screen is saved in the project file (*.IPP). Therefore, even if pop-up screen is set in the screen properties, the screen will operate as a base screen when running the PT if the project has not been saved. After changing the setting from a base screen to a pop-up screen, the relationship between whether the project or screen is saved and operations at the PT is as follows:

Save project	Save screen	Operations at the PT
Yes	Yes	Operates as a pop-up screen.
Yes	No	Operates as a pop-up screen. (Uses the screen size that was set when the screen was last saved.)
No	Yes	Operates as a base screen.

Yes: Saves; No: Does not save

Close Screen

1. Select **File - Close Screen** or click the **Close Button**  at the top right of the screen.

Screen Zoomed Out

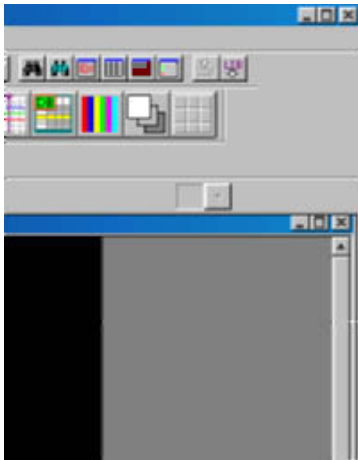

Screen Zoomed In

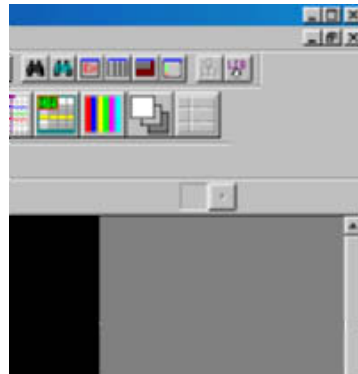

Save All

This function saves the whole project as well as the open screen.

1. Select **File - Save All**.
2. The following dialog box will be displayed when saving has been completed. Click the **OK** Button.



4-2-2 Screen Maintenance

Screen data maintenance, such as copying and deleting screens, switching screen page numbers, and changing screen titles can be performed for the following items.

Item	Details
Change Title	Changes the screen title.
Duplicate	Copies the specified screen.
Delete	Deletes the specified screen.
Switch Screen Page Number	Switches the screen's page number.

4-2-3 Procedure

The screen maintenance procedure is as follows:

1. Select **Tools - Screen Maintenance**.
The Screen Maintenance Dialog Box will be displayed.

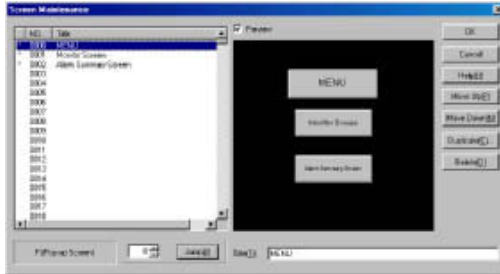

2. Select the screen on which maintenance will be performed.
3. Perform maintenance as follows:

Switching Screen Page Numbers

Click the **Move Up** and **Move Down** Buttons to switch to higher or lower page numbers.

Copying

Click the **Duplicate** Button to display the following dialog box, and then set the destination screen page number and the new screen title.



Deleting

Click the **Delete** Button.

Changing Titles

Enter the new title in the title column.

4. Click the **OK** Button.

Reference

- ◆ If the screen page number to be copied is already being used, the following dialog box will be displayed. Click the **Cancel** Button and specify a different screen page number to stop the screen being overwritten.

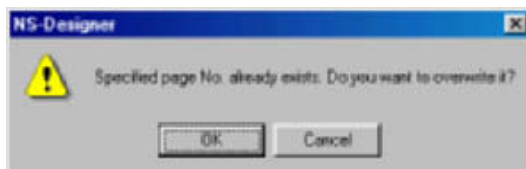

- ◆ Screens that have been deleted cannot be restored. Therefore, check the screen page number carefully before deleting it.

4-3 Sheets

The basic sheet operations are explained here.

Sheets are screens that can be displayed in layers on multiple user screens. If, for example, objects common to each screen such as the date, time, and screen switching objects are created as a sheet, they can be used in more than one screen by performing some simple settings.

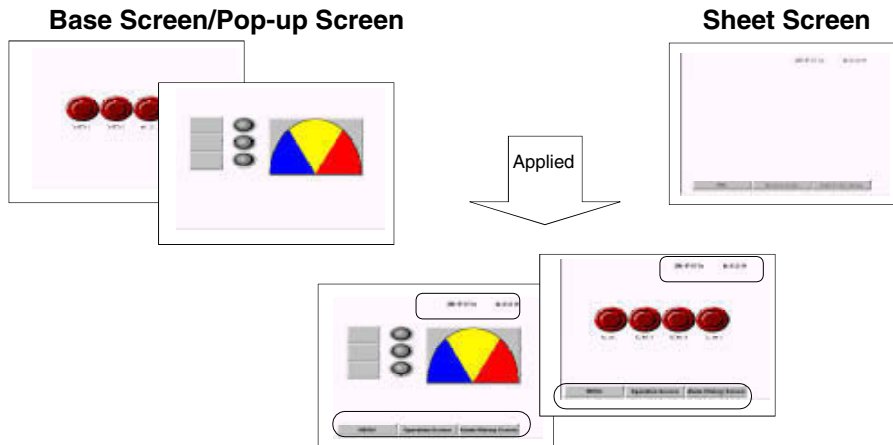

Reference

- ◆ Video Displays and Data Block Tables cannot be created on sheets.

4-3-1 Creating New Sheets

1. Open the project that will be used to create the sheet.
2. Select **File - Open Sheet**.
3. The Open Sheet Dialog Box will be displayed.
Select the sheet page number to be created and then click the **OK** Button.

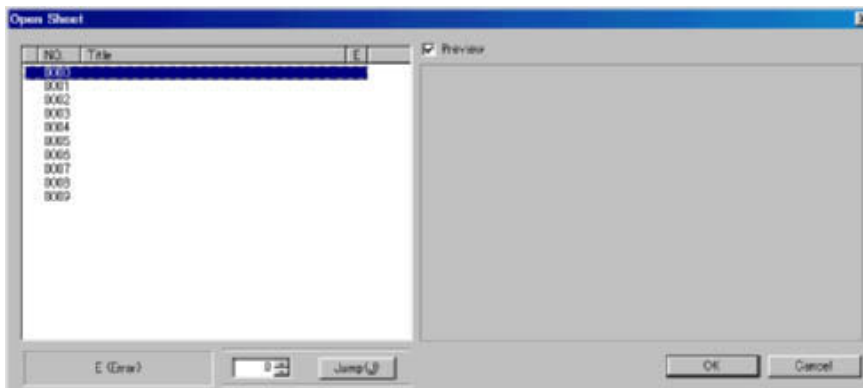

4. The following dialog box will be displayed.
Click the **Yes** Button.



The new sheet will be displayed.

Reference

- ◆ Sheets cannot be used to specify pop-up screens or background files, or to add macro functions. The background color in the sheet is not applied to the destination application screen.

4-3-2 Opening Existing Sheets

1. Select **File - Open Sheet**.
2. The Open Sheet Dialog Box will be displayed. Select the sheet and then click the **OK** Button.

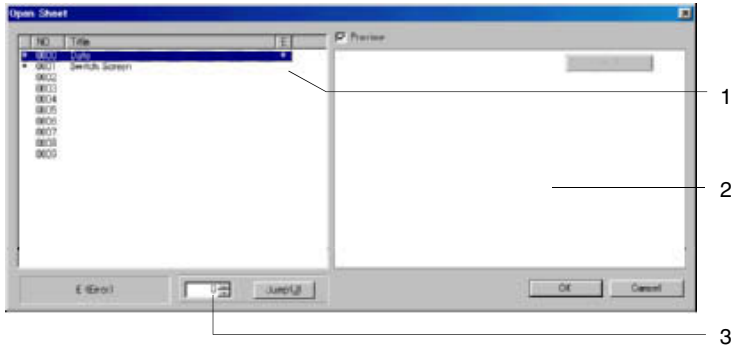

No.	Details
1	An asterisk (*) will be displayed for sheets where the error check detected an error.
2	Displays a preview of the selected sheet. The screen will not be previewed if the check is removed from the <i>Preview</i> check box.
3	Display a specified sheet by specifying the sheet page number and clicking the Jump Button.

4-3-3 Closing Sheets

Select **File - Close Screen** or click the **Close** Button at the top right of the screen window.

Screen Zoomed Out

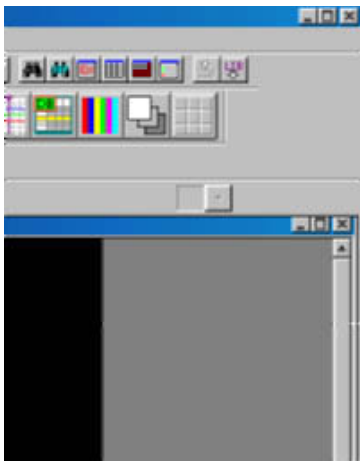

Screen Zoomed In

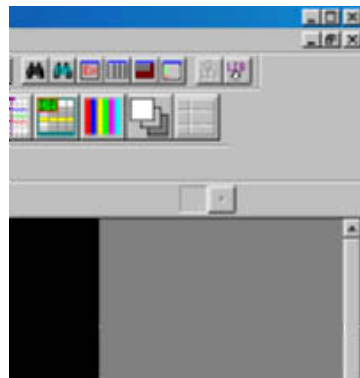

4-3-4 Saving Sheets

Select **File - Save Screen** or click the **Save Screen** Button in the toolbar.

Toolbar



Reference

- ◆ The shortcut keys for saving are the **Ctrl + S** Keys.
- ◆ If a sheet has been changed but not saved yet, a dialog box confirming whether to save the changes will be displayed when the sheet is closed. Click the **Yes** Button to save the changes.

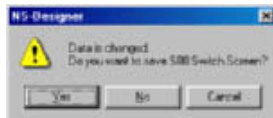

4-3-5 Applying Sheets

The methods for applying sheets to screens are described here.

1. Open the project where the sheet will be applied.
2. Select **File - Apply Sheet**.
The Apply Sheet Dialog Box will be displayed.

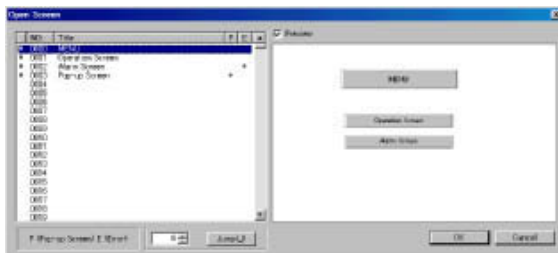

3. Apply the sheet to the screen.
 - a. Select the screen.
 - b. Select the sheet page number to be applied.
 - c. Click the **Apply** Button.

A preview will be displayed of the screen to which the sheet was applied.

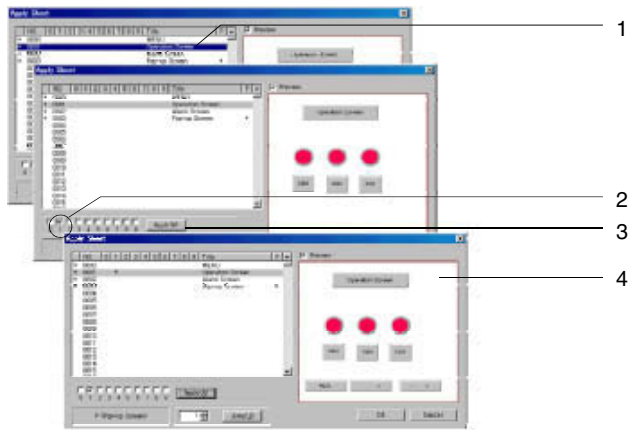

5. Apply the settings and then click the **OK** Button.

Reference

- ◆ If the sheet has not been saved, it will not be reflected in the preview display even when the **Apply** Button is pressed.

4-3-6 Sheet Maintenance

This function is used to display the list of sheets, copy and delete sheets, switch sheet page numbers, and change sheet titles.

Procedure

The sheet maintenance procedure is as follows:

1. Select **Tools - Sheet Maintenance**.
2. The procedure is the same as for Screen Maintenance. Refer to *Screen Maintenance* under 4-2 *Creating and Saving Screens* for details.

4-4 Frames

Frames are used to switch a part of the display contents in screens.

Frames consist of more than one page. The display contents can be switched by switching the pages according to their address value.

The following objects can be arranged in the frames.

- Fixed objects
- Functional objects (Except Video Displays and Data Block Tables)
- Tables

1. Select **Functional Objects - Frame** or click the **Frame** Button in the toolbar.

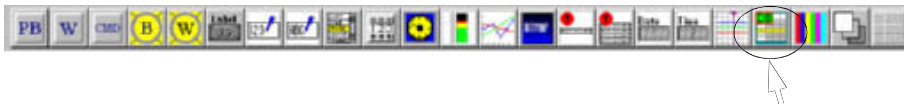

Toolbar

2. The cursor display will change to the following shape.



3. Move the cursor to the position of the frame's first point.
4. Drag the cursor (by clicking the left mouse button and keeping it pressed while moving the mouse) until it is positioned at the end point of the frame display area.

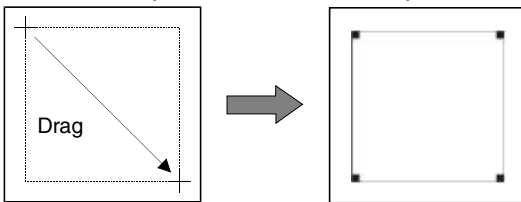

5. Select the frame, and then select **Settings - Object Properties** or click the right mouse button to display the pop-up menu and select **Frame Properties**.

The Frame Setting Dialog Box will be displayed.

General Tab Page

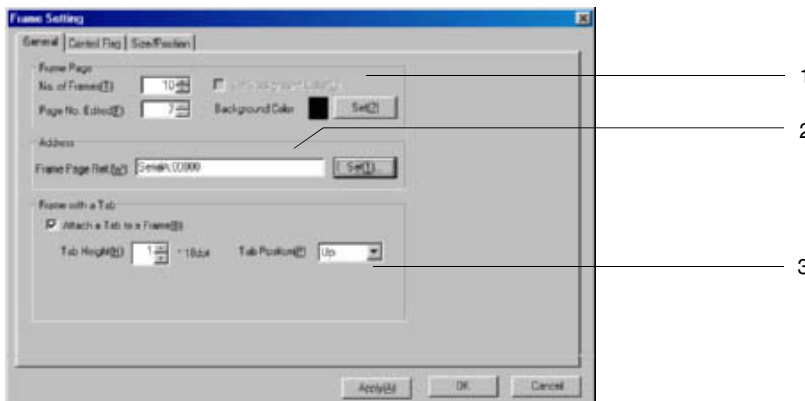

NS-Designer Operation Manual

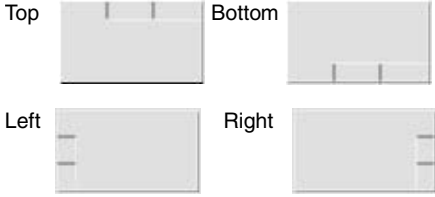
No.	Item	Details
1	Frame Page	Set the number of frame pages and the number of the frame page to be edited.
	No. of Frames	Set the number of frames for which the display contents are changed.
	Page No. Edited	Specify the frame page number of the screen being created.
	Set Background Color	Select this item to enable setting the color of the frame's background.
2	Address	Set the address that specifies the frame page number to be displayed. Examples: Displays frame page number 0 when \$W0 is 0. Displays frame page number 1 when \$W0 is 1. Displays frame page number 2 when \$W0 is 2.
3	Frame with a Tab	Set tabs in the frame. When the PT is running, click the tabs to switch frame pages.
	Attach a Tab to a Frame	Select this item to create frames with tabs for each page.
	Tab Color	Specify the tab color.
	Tab Position	Select the position of the tabs from top, bottom, left, and right. 
	Tab Height	Specify the tab height in 18-dot units. Examples: 18 dots when the tab height is set to 1 36 dots when the tab height is set to 2

Control Flag Tab Page

This tab page is used to control whether all objects in the frame page have input enabled or prohibited, and are displayed or not displayed.

Item	Details
Enable Input	Select to enable or disable input for all objects in the frame or specify indirectly using addresses.
Display/No Display	Select whether to display all objects in the frame or specify indirectly using addresses.

Reference

- ◆ If the frame is set to No Display, input will not be accepted, regardless of whether the functional objects in the frame are set to *Enable Input*.
- ◆ When indirect specification is selected, the indirect input display can be controlled according to the specified address values, as follows:
 - Enable/Disable Input
 - Enable Input when address is ON
(Input is enabled when the specified bit is ON, and disabled when the bit is OFF.)
 - Enable Input when address is OFF
(Input is disabled when the specified bit is ON, and enabled when the bit is OFF.)
 - Display/No Display
 - Display when address is ON
(Display is enabled when the specified bit is ON, and disabled when the bit is OFF.)
 - Display when address is OFF
(Display is disabled when the specified bit is ON, and enabled when the bit is OFF.)
- ◆ Always create screens so that objects are contained within the frames.
- ◆ To set the communications address data format (BCD/binary) select **Settings - Project Properties** and then set the format in the Data Format Tab.

Size/Position Tab Page

This tab page is used to set the frame size and position details.

Item	Details
Size	Set the size of the frame in dot units.
Height	Set the height of the frame.
Width	Set the width of the frame.
Top Left of Screen	Specify the distance from the top left of the screen to the top left of the frame in dot units, and set the position of the frame.
X	Set the horizontal distance from the top left of the screen to the top left of the frame.
Y	Set the vertical distance from the top left of the screen to the top left of the frame.

6. Make the settings and then click the **OK** Button.

The method for creating screens for each frame page is as follows:

1. Double-click the frame area.
2. The functional objects and fixed objects outside the frame area will be hidden, and edit mode will be enabled within the frame.
3. Screens are created using the same procedure as for normal screens.
4. Return to normal screen creation mode by clicking outside the frame area in the screen.

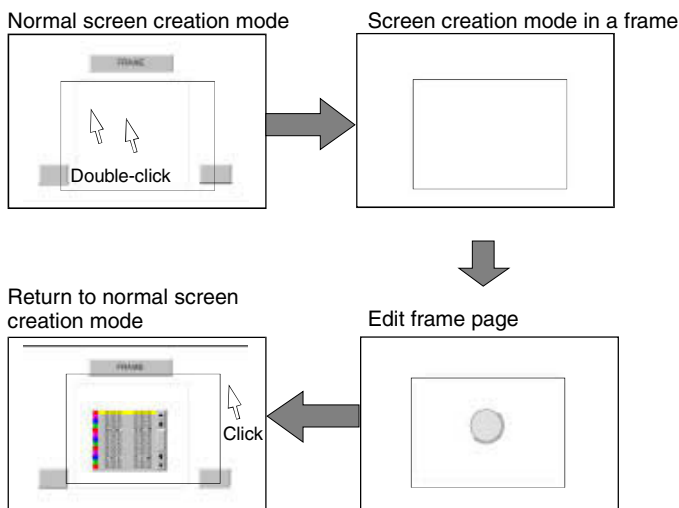

Reference

- ◆ Video Displays and Data Block Tables cannot be created on frames.

4-4-1 Creating Frame Tab Names

The frame tab title is created using text objects. By creating text within frames, the tab titles that are not active will be hidden when the PT is running. Therefore, create tab titles when operating in normal screen editing mode.

Click the **Text** Button in the toolbar and paste the text. Position the text so that it overlaps the tab position.



Reference

- ◆ If a message that overlapping objects is prohibited is displayed, select **Tools - Options**, and then select the **Edit/Disp.** Tab and deselect **Prohibit functional objects from overlapping**.

4-4-2 Switching Frame Pages

The methods used to switch frame pages when working in NS-Designer are explained here.

Switching Frame Pages Backward and Forward

This function is used to switch to the previous or next frame page.

Select **View - Previous/Next Frame Page** or click the **Previous/Next Frame Page** Button in the toolbar.

Toolbar

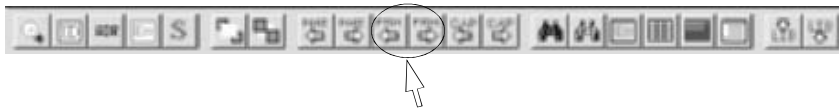

Switching to Any Frame Page

This function is used to display a user-specified frame page.

1. Display the Frame Setting Dialog Box.
2. Specify the page number to be edited.
3. Click the **OK** Button.

Section 5 Object Operations

This section describes common object operations.

5-1	Creating Functional Objects.....	5-1
5-2	Creating Fixed Objects.....	5-8
5-3	Pop-up Menus	5-12
5-4	Editing.....	5-13
5-5	Layout Functions	5-25
5-6	Colors.....	5-35
5-7	Address Settings.....	5-36
5-8	Displaying and Searching Functional Object Lists	5-42
5-9	Listing Functional Objects Used.....	5-46
5-10	Batch Settings	5-49
5-11	Listing Addresses Used.....	5-55
5-12	Cross-referencing Addresses.....	5-59
5-13	Library Registration and Sharing Objects.....	5-63
5-14	Object Defaults	5-68
5-15	Editing Background Bitmaps	5-70
5-16	Options.....	5-71

5-1 Creating Functional Objects

This section describes the process from placing a functional object on a screen through to starting to set the properties.

5-1-1 Creating One Object at a Time

Functional Objects

1. To create a new functional object, select either items under the Functional Object Menu or an icon on the functional object toolbar.

Toolbar

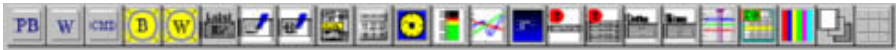

The cursor will change to the following shape.



2. Move the cursor to the position that will be the starting point for the functional object.
3. Drag the cursor to the end point for the functional object.

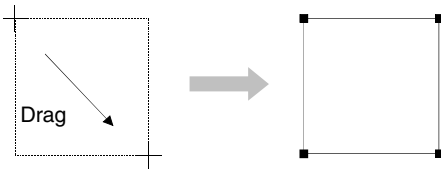

Reference

- ◆ Hold down the **Shift** Key and drag the mouse to change the size of the object while preserving the original vertical/horizontal ratio.
- ◆ Hold down the **Ctrl** Key and drag the cursor in the vertical or horizontal direction to stretch the object uniformly in that direction.
- ◆ Deselect (turn OFF) *Prohibit functional objects from overlapping* on the **Edit/Disp** Tab Page in the Options Dialog Box (*Tools - Options*) to overlap functional objects with other objects.

Note

- ◆ Functional objects must be placed on touch points otherwise they will not be processed as events when they are pressed during PT operation. (See example 1.)
- ◆ In addition, inputs are processed as events for the functional object located on the touch point for the touch switch that received the input. This means that if a point is pressed where no functional object exists but there is a functional object on the touch point in the same touch switch, the same processing will be performed as if the functional object itself was pressed. (See example 2.)
- ◆ The position of touch points can be checked under *View - Show Touch Points*. Refer to *Show Touch Points* under 4-1 Basic Operations for details.

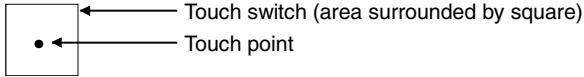

Example 1

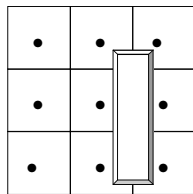

Not processed as an event even when button pressed.

Example 2

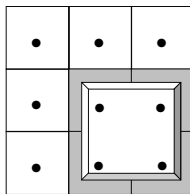

Processed as a button event even if the gray area is pressed.

Example 3

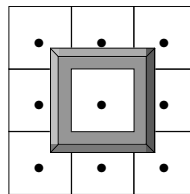

White section (center of button) is processed as an event. The gray area is not processed as an event.

5-1-2 Property Settings

Functional object properties are set in the Property Settings Dialog Box for each functional object.

1. Perform one of the following operations.

- Move the cursor to the functional object for which properties are to be set and double-click the object.

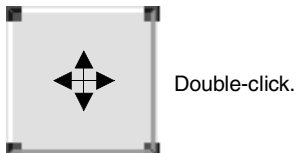

- Select the functional object and select **Settings - Object properties**.
- Select the functional object and click the right mouse button. Select the object properties menu from the pop-up menu that is displayed. (The menu names differ for each functional object.)
- Select the functional object and press the **Enter** Key.

NS-Designer Operation Manual

- The dialog box for setting the functional object properties will be displayed. Make the settings on each tab page.

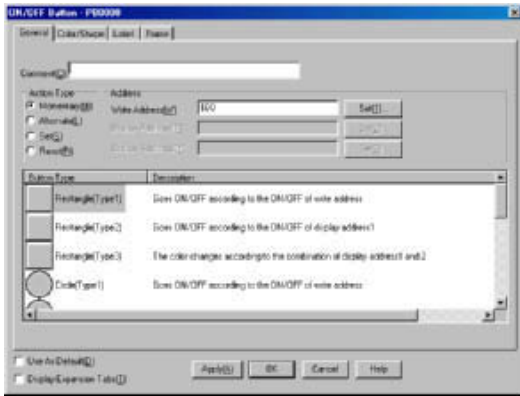

- Make the settings and then click the **OK** Button.

Reference

- Click the **Apply** Button to check the property settings on the screen while continuing to make the settings in the dialog box.
- Perform the following procedure to display the Property Settings Dialog Box for the functional object as soon as the functional object has been created.
 - Select **Tools - Options**.
 - Select the **Edit/Disp** Tab and select (turn ON) *Open property dialog automatically after pasting an object*.

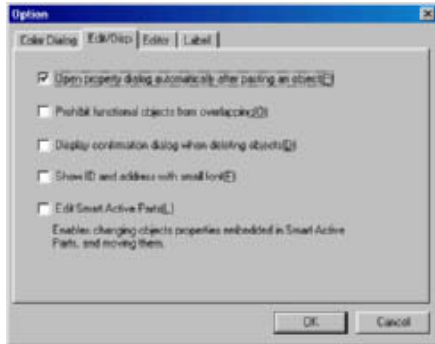

5-1-3 Creating Functional Objects Using Tables

Multiple functional objects of the same kind can be created at the same time by using tables.

The following functional objects can be created using tables.

- ON/OFF Buttons
- Word Buttons
- Command Buttons
- Bit lamps
- Word lamps
- Text objects
- Numeral display and input objects
- String display and input objects

NS-Designer Operation Manual

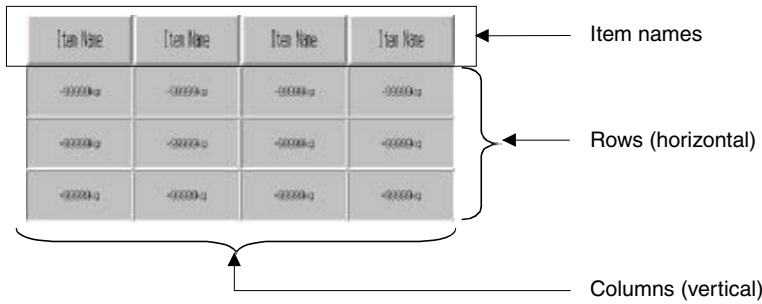

Placing Tables on Screens

1. Either select **Functional objects - Table** or click the **Table** Button on the toolbar.

Toolbar



The cursor will change to the following shape:



2. Move the cursor to the position that will be the starting point for the functional object.
3. Drag the cursor to the end point for the table display region.

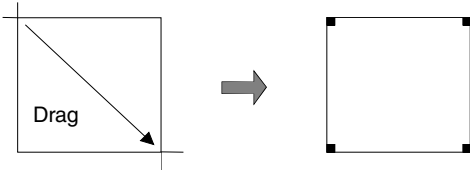



Setting Table Properties

Settings, such as the number of lines and columns in a table and the functional objects to be created, are made in the Property Settings Dialog Box for the table.

To display the Property Settings Dialog Box, select the table and select **Settings – Object Properties**, or right-click and select the **Table** properties from the pop-up menu.

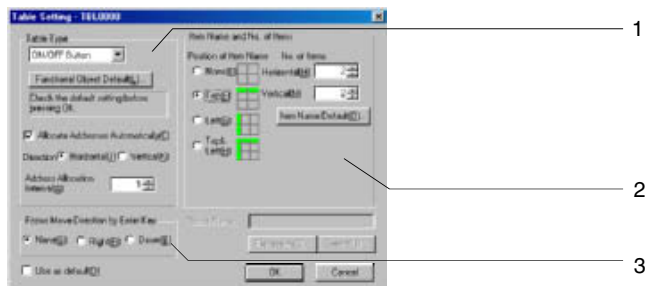
The Table Setting Dialog Box will be displayed.



No.	Item	Details
1	Table type	Sets the type of functional object to be created in the table and the properties.
	Combo Box	Select the type of functional object to be created in the table.
	Functional Object Default Button	Click the Functional Object Default Button to display the Property Settings Dialog Box for the functional object selected from the combo box and set the properties for all functional objects created in the table. If the address is to be automatically allocated, the start address must be specified beforehand.
	Allocate address automatically	Select <i>Allocate address automatically</i> to specify the direction and interval for functional objects in the table and automatically allocate the address. The direction can be selected as either horizontal or vertical. Example: Start address for address allocation: \$B100 Direction: Horizontal; Interval: 2 
2	Item name and No. of items	Sets the item name position and number of items for tables.
	Position of item name	Item names can be set automatically using text objects. The item name position can be selected from top line, left column, or top line and left column. Select <i>None</i> if item names are not required.
	No. of items	Set the number of functional objects to be set in the vertical and horizontal directions.
	Item Name Default Button	Click the Item Name Default Button to display the Property Setting Dialog Box for text objects and set the properties for all item names.
3	Focus move direction by Enter Key	Right or left can be selected as the direction for input focus to move when the Enter Key is pressed after functional object input has been completed. This option is enabled for numeral display and input objects and string display and input objects. Select <i>None</i> if focus travel is not required.

3. Make the settings and then click the **OK** Button.

Batch Table Settings

Batch property settings can be made for lines or columns of functional objects in tables.

1. Select one functional object in the line or column for which the properties are to be edited.

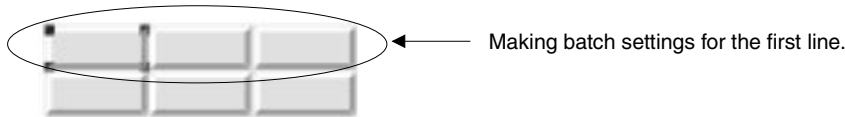

2. Click the right mouse button and select **Batch setting of table - Unit setting of column** or **Batch setting of table - Unit setting of row** from the pop-up menu that is displayed.

NS-Designer Operation Manual

3. The Table Setting Dialog Box will be displayed. Click the **Functional Object Default** Button to display the Batch Setting Dialog Box.

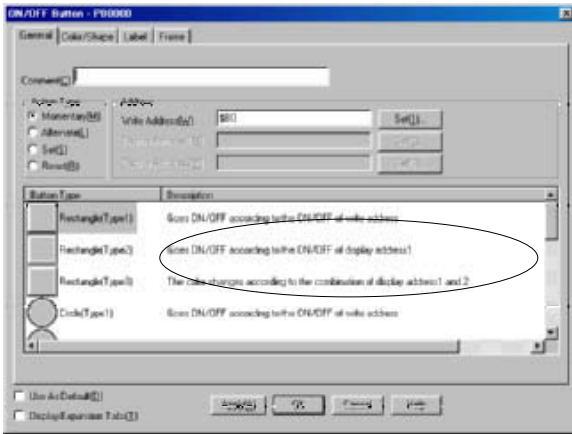

4. The rest of the procedure is the same as for normal settings.

Changing Table Size, Line Height, and Column Widths

The width and height of functional objects in tables can be freely changed in line or column units.

Changing Individual Line Heights or Column Widths

This section describes how to change the line height or column width without changing the size of the table.

The cursor shape changes as shown in the following diagram when the cursor is moved close to the horizontal or vertical edges of the functional object.

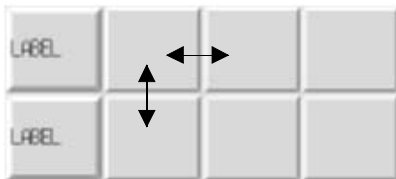

Drag the cursor in the arrow directions until the line or column has reached the desired size.

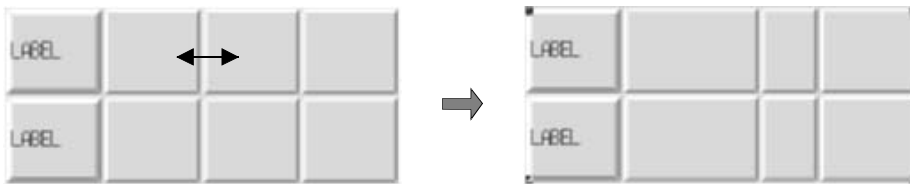

Changing Table Size

This section describes how to change the size of tables without changing the ratio of the line height to the column width.

1. The cursor shape changes as shown in the following diagram when the cursor is moved close to the table.



2. Drag the cursor in the arrow directions until the table has reached the desired size.

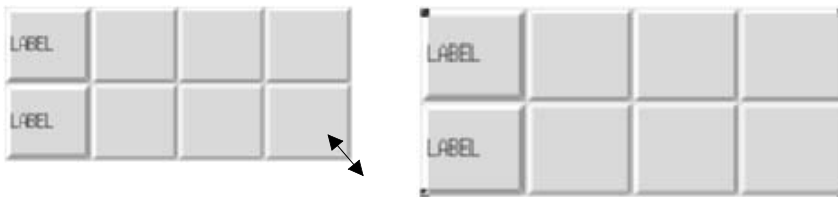

Reference

- ◆ The table width or height can be changed independently.
With the cursor changed to the  shape, drag the cursor in the horizontal or vertical direction.

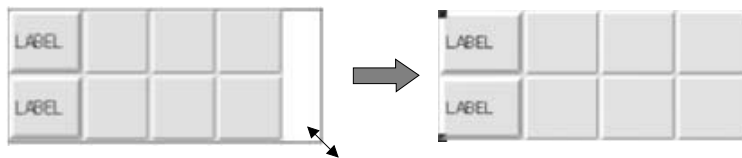

5-2 Creating Fixed Objects

This section describes the process from placing a fixed object on a screen through to starting to set the properties.

5-2-1 Drawing New Fixed Objects

Either select items under the Fixed Object Menu or select an icon on the fixed object toolbar to create a new fixed object.

Rectangles, Circles, Ovals, and Straight Lines

1. Move the cursor to the starting point for the rectangle, circle, oval, or straight line.
2. The cursor will change to the following shape:



3. Drag the cursor to the end point for the rectangle, circle, oval, or straight line.

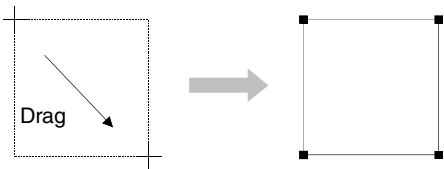

Polygons and Polylines

1. Move the cursor to the starting point for the polygon or polyline and click the left mouse button.
2. Move the cursor to the next point and click the left mouse button. Repeat this operation until all the points for the polygon or polyline are drawn.

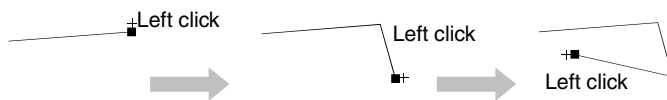

3. Click the right mouse button at the last point to close the drawing mode for polygon and polyline.

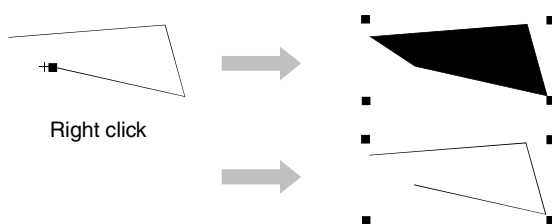

Sectors and Arcs

1. Move the cursor to the starting point for the sector or arc and click the left mouse button.
2. Drag the cursor to draw a circle or oval.

A square mark (■) will appear at the 3-o'clock point on the circumference of the circle or ellipse.

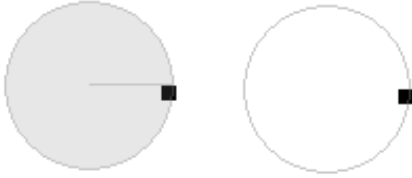

3. Place the cursor on the square box. When the cursor has changed to a plus sign (+), drag the cursor to any position.

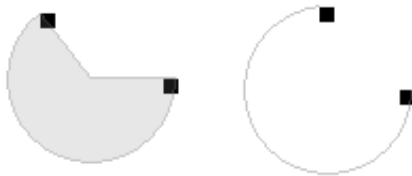

4. Click the right mouse button to close the drawing mode for sectors and arcs.

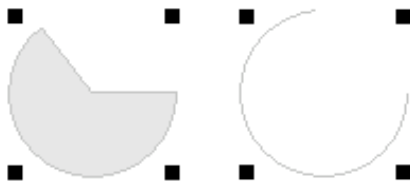

Reference

- ◆ Hold down the **Shift** Key and drag the mouse to change the size of the object while preserving the original vertical/horizontal ratio.
- ◆ Hold down the **Ctrl** Key and drag the cursor in the vertical or horizontal direction to stretch the object uniformly in that direction.
- ◆ Deselect (turn OFF) *Prohibit functional objects from overlapping* on the **Edit/Disp** Tab Page in the Options Dialog Box (*Tools - Options*) to overlap fixed objects with other objects.

Property Settings

Fixed object properties are set in the Property Setting Dialog Box for each fixed object.

1. Select the fixed objects for which the properties are to be set.
2. Perform one of the following operations.

Move the cursor to the fixed object for which properties are to be set and double-click the object.

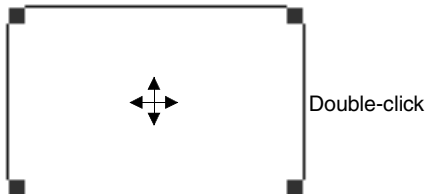

After selecting the fixed object, select **Settings - Object properties**.

After selecting the fixed object, click the right mouse button and select the object properties menu from the pop-up menu that is displayed. (The menu names differ for each fixed object.)

After selecting the fixed object, press the **Enter** Key.

3. The dialog box for setting the fixed object properties will be displayed. Make the settings on each tab page.

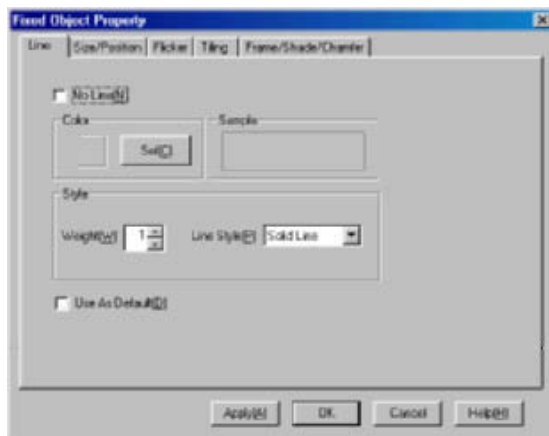

4. Make the settings and then click the **OK** Button.

Reference

- ◆ Use the following procedure to display the Property Setting Dialog Box as soon as a new fixed object has been created.
 1. Select **Tools - Options**.
 2. Select the **Edit/Disp.** Tab and select (turn ON) *Open property dialog automatically after pasting an object*.

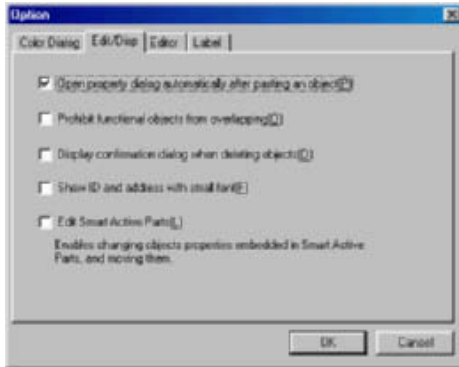

5-3 Pop-up Menu

Edit and layout functions can be displayed on a pop-up menu.
To display this pop-up edit menu, select the object and click the right mouse button.
The items on the pop-up edit menu are the same for all objects.

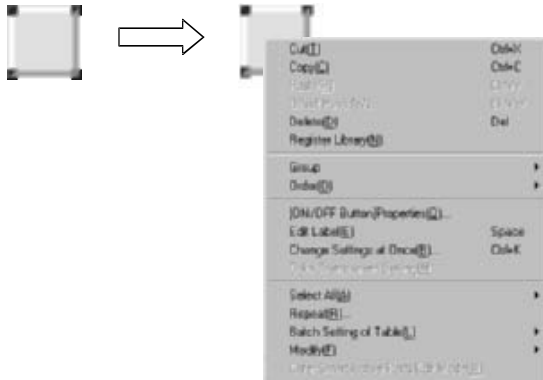

5-4 Editing

This section describes how to edit the types of object that are positioned on a screen.

5-4-1 Undo

Discards changes and restores the previous status. The undo operation can restore up to 10 previous operations. There are two methods for undoing operations.

Select **Edit - Undo** or press the **Undo** Button on the toolbar.

Toolbar

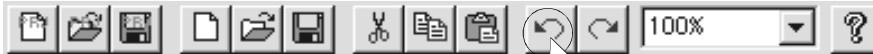

Reference

- ◆ The shortcut keys for undoing operations are the **Ctrl + Z** Keys.

5-4-2 Redo

Redoes operations that were undone using the *Undo* function.

Up to 10 previous operations can be redone. (The number of redo operations is restricted to the number of operations that have been undone.)

Select **Edit - Redo** or press the **Redo** Button on the toolbar.

Toolbar

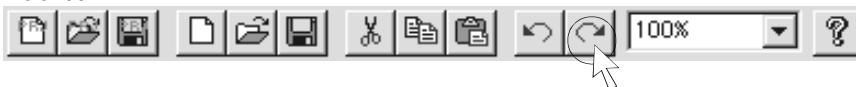

Perform the above operation again to go back one more status.

Reference

- ◆ The shortcut keys for redoing operations are the **Ctrl + Y** Keys.

5-4-3 Cut

Cuts the selected object.

Objects that have been cut can be pasted to other positions or screens using the *Paste* or *Offset Paste* functions. *Offset Paste* can be used for functional objects only.

1. Select the object.
If multiple objects are to be cut at the same time, select all those objects at the same time.
2. Select **Edit - Cut** or press the **Cut** Button on the toolbar.

Toolbar



3. A dialog box to confirm the cut operation will be displayed. Click the **Yes** Button to cut the object or objects.

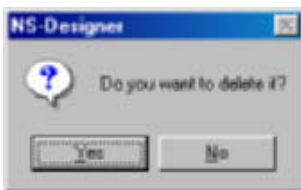

Reference

- ◆ The shortcut keys for cutting objects are the **Ctrl + X** Keys.

Methods for Selecting Multiple Objects

1. Hold the **Shift** Key and click the object.

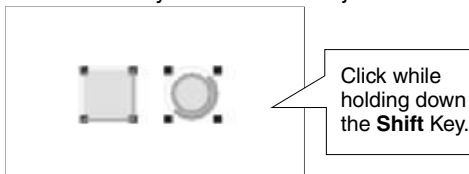

2. Surround the objects using the cursor.

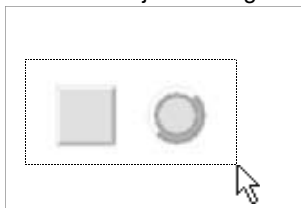

- ◆ Make the following settings if the confirmation dialog box does not have to be displayed before executing the cut operation.
 1. Select **Tools - Options**.
 2. The Options Dialog Box will be displayed. Select the **Edit/Disp.** Tab and deselect (turn OFF) *Display confirmation dialog when deleting objects*.

5-4-4 Copy

Copies the selected objects.

Objects that have been copied can be pasted to other positions or screens using the *Paste* or *Offset Paste* functions. *Offset Paste* can only be used for functional objects.

1. Select the object.

If multiple objects are to be copied at the same time, select all those objects at the same time.

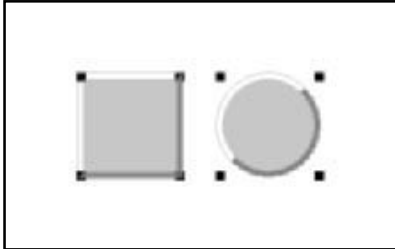

2. Either select **Edit - Copy** or click the **Copy** Button on the toolbar.

Toolbar



Reference

- ◆ The shortcut keys for copying are the **Ctrl + C** Keys.

5-4-5 Paste

Pastes objects that have been copied or cut to other positions or screens.

Standard Paste

Pastes the object with the same settings as the original.

1. Display the paste destination screen.
2. Select **Edit - Paste** or press the **Paste** Button on the toolbar.

Toolbar



Reference

- ◆ The shortcut keys for standard pasting are the **Ctrl + V** Keys.

Offset Paste

Offset paste is supported only for functional objects. The functional object is pasted and allocated an address determined by a specified offset.

1. Display the paste destination screen.
2. Select **Edit - Offset Paste**.
3. The Offset Paste Dialog Box will be displayed. Specify the offset value.



4. Click the **OK** Button.

Reference

- ◆ The shortcut keys for offset pasting are the **Ctrl + W** Keys.

5-4-6 Delete

Deletes the selected objects.

1. Select the object to be deleted.
If multiple objects are to be deleted at the same time, select all those objects at the same time.
2. Select **Edit - Delete**.
3. A dialog box to confirm the delete operation will be displayed. Click the **Yes** Button to delete the object or objects.

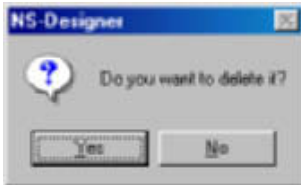

Reference

- ◆ The shortcut key for deleting objects is the **Delete** Key.
- ◆ Select **Edit - Select all** to delete all functional and fixed objects on the screen.
- ◆ Make the following settings if the confirmation dialog box is not required to be displayed before the delete operation is executed.
 1. Select **Tools - Options**.
 2. The Options Dialog Box will be displayed. Select the **Edit/Disp.** Tab and deselect (turn OFF) *Display confirmation dialog* when deleting objects.
- ◆ In contrast to the cut operation, deleted functional or fixed objects cannot be pasted elsewhere.

5-4-7 Find

Finds functional object addresses, comments, or labels.

1. Either select **Edit - Find** or click the **Find** Button on the toolbar.

Toolbar



The Find Dialog Box will be displayed.

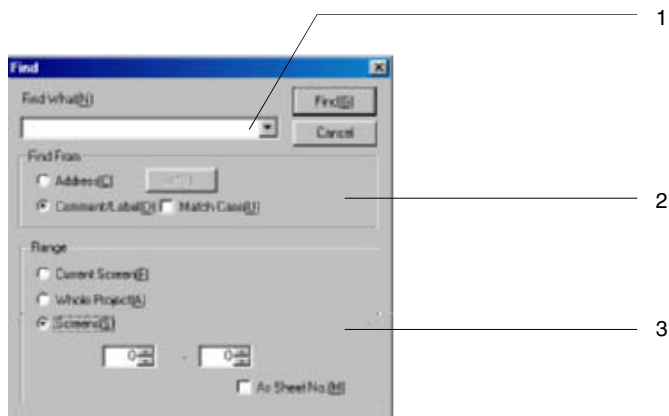

NS-Designer Operation Manual

No.	Setting	Details
1	Find What	Specifies the address, comment, or label to be found.
2	Find From	Selects address, comment, or label as the data to be found. For addresses, click the Set Button to display the Address Setting Dialog Box. Use this dialog box and enter the address to be found in the <i>Find What</i> column. For comments and labels, enter the comment or label name to be found in the <i>Find What</i> column. Select (turn ON) <i>Match Case</i> to distinguish between upper or lower case in the search.
3	Range	Select the search range from the following options.
	Current Screen	Searches the screen displayed on top.
	Whole Project	Searches the whole project.
	Screens	Searches a specified range of screens. If <i>As Sheet No</i> is selected (turned ON), the search will target sheets.

2. Click the **Find** Button to start the search.

When the search has been completed, the Search Result Dialog Box will be displayed.

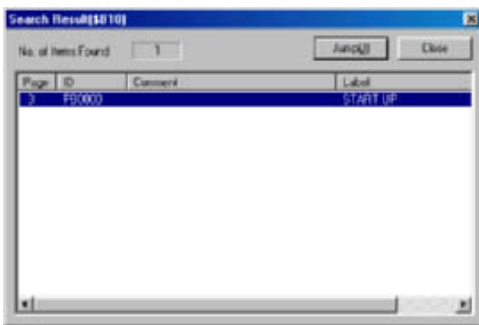

3. Select the desired functional object from the list of search results and click the **Jump** Button or double-click on the line to be selected.

The screen where the selected functional object is found is displayed and the functional object flashes because it is selected.

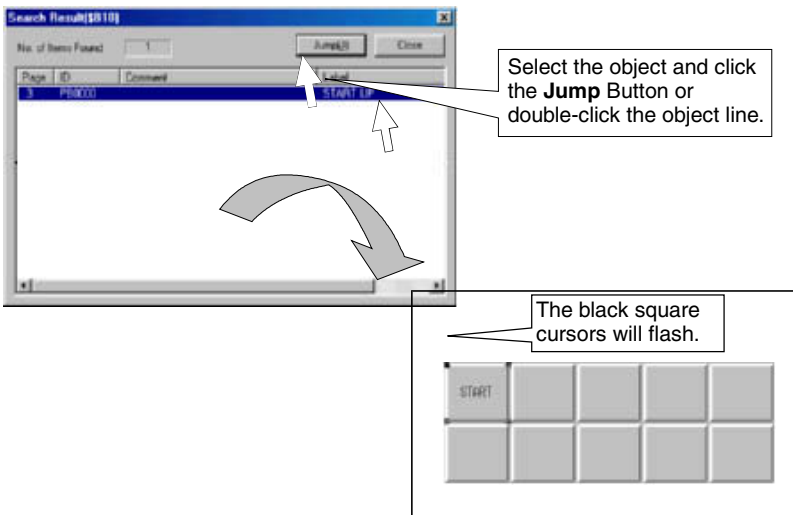

Reference

- ◆ The shortcut keys for finding objects are the **Ctrl + F** Keys.

If *Current Screen* or *Screens* is selected for the search range, addresses set using the following menu items cannot be displayed. Also, if *Whole Project* is selected for the search range, *Jump* cannot be performed from the search results to the addresses set using the following menu items.

Settings - Flicker Setting

Settings - Alarm/Event Setting

Settings - Data Log Setting

Settings - Data Block Setting

Settings - System Setting

Settings - Project Properties - Macro

Settings - Screen Properties - Macro

5-4-8 Replace

Replaces an address set for a functional object with another address or replaces a host set in a project with another host.

Replacing Communications Addresses

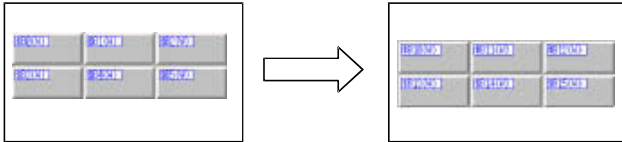

1. Select **Edit - Replace**.

The Replace Dialog Box will be displayed.

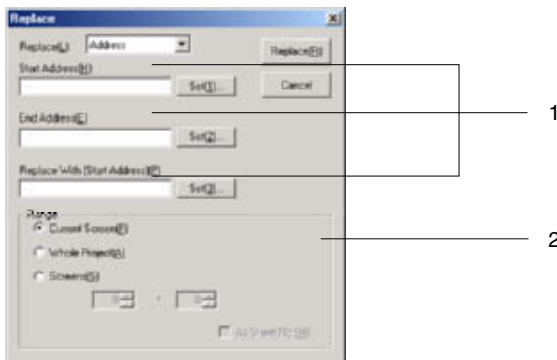

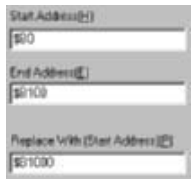
No.	Setting	Details
1	Address Range	<p>Specifies the address range to be replaced. Replaces corresponding addresses in the range <i>Start Address</i> to <i>End Address</i>, starting with <i>Replace With (Start Address)</i>. For the settings shown in the following dialog box, \$B0 to \$B100 will be replaced with \$B1000 to \$B1100.</p>  <p>To replace bits, specify the bit address, e.g., HOST:00000.00.</p>
2	Range	<p>Select the replacement range from <i>Current Screen</i>, <i>Whole Project</i>, or <i>Screens</i>. If <i>As Sheet No</i> is selected (turned ON), the search will target sheets.</p>

2. Click the **Replace** Button. A message confirming the replacement will be displayed.
3. Click the **Yes** Button.



A dialog box to notify that the replace operation has been completed will be displayed.

NS-Designer Operation Manual

- Click the **OK** Button.

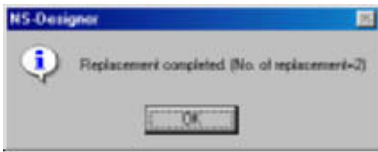

Replacing Hosts

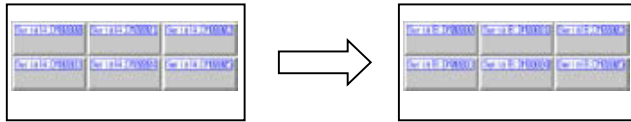

- Select **Edit - Replace**.
The Replace Dialog Box will be displayed.
- Select a host to be replaced.



No.	Setting	Details
1	Replace	Select to replace one of the following: Address Host
2	Search host and Replace host	Specify the name of the host to replace. In the following dialog box, "Serial A" is being replaced with "Serial B." 

NS-Designer Operation Manual

No.	Setting	Details
3	Range	Set the unit number range when the search host is a Temperature Controller. The unit number ranges that can be set are as follows: E5AN/E5AR: 0 to 31 E5ZN: 0 to 15

3. Click the **Replace** Button. A replacement confirmation dialog box will be displayed. Click the **Yes Button**.

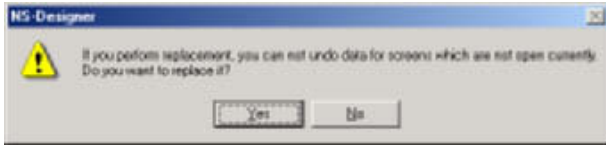

4. A dialog box will be displayed when the replacement has been completed. Click the **OK** Button.



Reference

- ◆ The shortcut keys for replacing addresses are the **Ctrl + H** Keys.
- ◆ If *Current Screen* or *Screens* is selected for the range for address replacement, addresses set using the following menu items cannot be replaced.
 - Settings - Flicker Setting**
 - Settings - Alarm - Event Setting**
 - Settings - Data Log Setting**
 - Settings - Data Block Setting**
 - Settings - System Setting**
 - Settings - Project Properties - Macro**
 - Settings - Screen Properties - Macro**
- ◆ The addresses set in Internal Memory (Bit Memory and Word Memory) cannot be replaced.

5-4-9 Select All

Useful for selecting all objects or the same type of objects on a screen.

All Functional Objects/Fixed Objects

Selects all objects on the screen.

Select **Edit - Select All - All Functional Objects - Fixed Objects**.

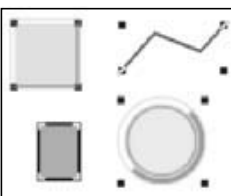

Reference

- ◆ The shortcut keys for selecting all functional and fixed objects are the **Ctrl + A** Keys.

Same Functional Object Type

Selects only the same type of functional or fixed object as one that has already been selected.

Select **Edit - Select All - Same Functional Object Type**.

Functional objects of
the same type

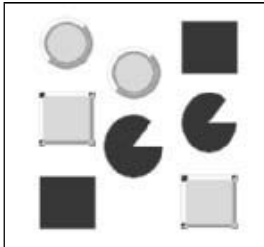

Fixed objects of
the same type

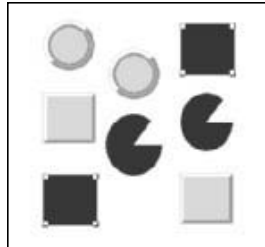

Reference

- ◆ The shortcut keys for selecting all functional or fixed objects of the same type are the **Ctrl + D** Keys.

5-4-10 Repeat

Copies the specified object the specified number of times horizontally or vertically. Functional objects (including those inside tables or frames) can be repeated with an offset value set for the address.

1. Select the object to be repeated.
If multiple objects are to be repeated at the same time, select all those objects at the same time.
2. Select **Edit - Repeat**.
The Repeat Dialog Box will be displayed.

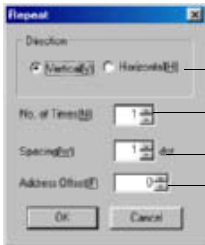

- Select the repeat direction.
- Specify the number of repeats.
- Specify the interval for the repeats.
- Specify the offset value to be added to the address for repeats.

3. Make the settings and then click the **OK** Button.

Example: To set 3 repeats in the horizontal direction at an interval of 8 dots with an offset of 2.

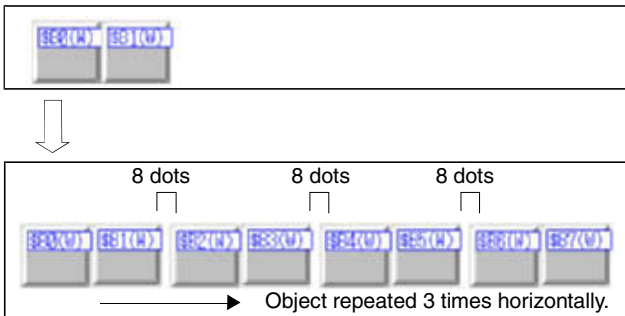

Reference

- ◆ The repeat function cannot be used for Video Displays and Data Block Tables.

5-5 Layout Functions

This section describes the layout functions used to change the size and position of objects on the screen.

5-5-1 Changing Size

1. Select the object for which the size is to be changed.

The cursor shape will change as shown in the following diagram when the cursor is moved close to the ■ marks at the corners of the object.

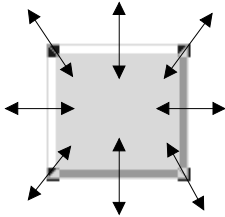

2. Drag the cursor in the arrow directions until the object has reached the target size.

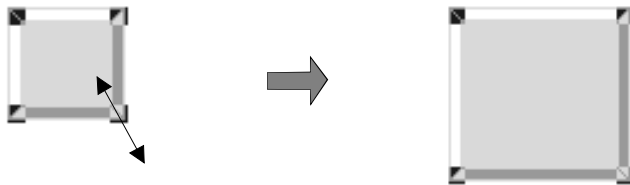

Reference

- ◆ Hold down the **Shift** Key and drag the mouse to change the size of the object while preserving the original vertical/horizontal ratio.
- ◆ Hold down the **Ctrl** Key and drag the cursor in the vertical or horizontal direction to stretch the object uniformly in that direction.
- ◆ The size of a Video Display cannot be changed by using a mouse. To change the size of a Video Display, use the setting in the General Tab Page of the Property Setting Dialog Box.

5-5-2 Moving Objects

1. Place the cursor on the object to be moved.
If multiple objects are to be moved at the same time, select all those objects.
2. Once the cursor has changed as shown below, drag the object to the desired position.

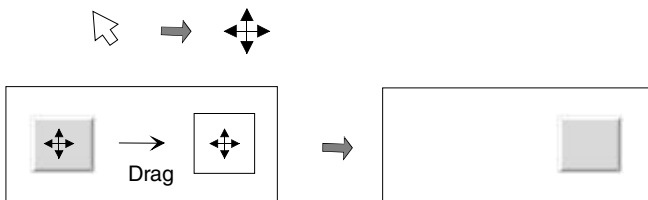

Reference

- ◆ Once the object has been selected, it can be moved by selecting *Layout – Nudge* or by using the Up, Down, Left, or Right Keys. Refer to 5-5-6 *Nudging Objects* for details.
- ◆ A Video Display cannot be moved to the outside of the screen.

5-5-3 Aligning and Distributing Objects

Distributes multiple objects with top, bottom, left, or right alignment or at equal intervals vertically or horizontally.

Example: Placing Objects at the Top of the Screen

1. Select all objects to be top-aligned.
2. Select **Layout – Align/Distribution – Align Top**.
The selected objects will be top-aligned, in line with the upper coordinates of the object(s) at the top of the screen.

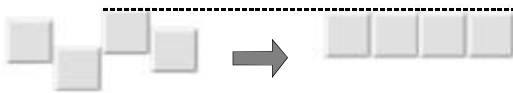

The following table describes the various position alignment functions.

Function	Details
Align Left	Aligns objects to the left.
Center in a Column	Aligns objects to the center of a column.
Align Right	Aligns objects to the right.
Align Top	Aligns objects to the top.
Center in a Row	Aligns objects to the center of row.

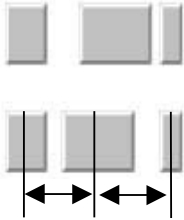
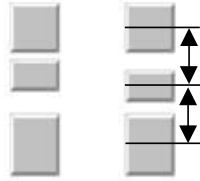
Function	Details
Align Bottom	 <p data-bbox="863 297 1134 322">Aligns objects to the bottom.</p>
Distribute Horizontally	 <p data-bbox="802 580 1193 604">Distributes objects equidistant horizontally.</p>
Distribute Vertically	 <p data-bbox="831 819 1198 844">Distributes objects equidistant vertically.</p>

5-5-4 Make Same Size

Aligns the width and height of selected multiple objects.

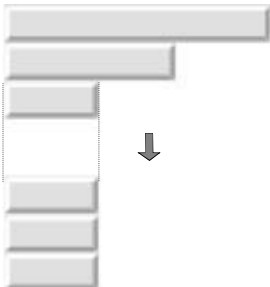

Example: Aligning Size of Objects with Narrowest Object

1. Select all objects to be aligned by width.
2. Select **Layout – Make Same Size – Smallest Width.**

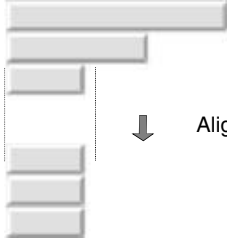
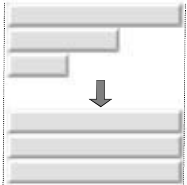

NS-Designer Operation Manual

The following table describes the various size alignment functions.

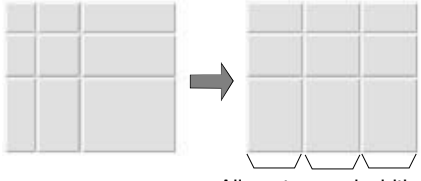
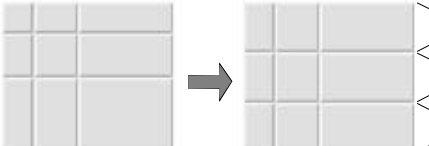
Function	Details
Smallest Width	 <p>Aligns to smallest width.</p>
Largest Width	 <p>Aligns to largest width.</p>
Smallest Height	 <p>Aligns to smallest height.</p>
Largest Height	 <p>Aligns to largest height.</p>
Table Column Width	 <p>Aligns to equal widths.</p>
Table Row Height	 <p>Aligns to equal heights.</p>

5-5-5 Ordering Objects

Changes the display order of overlapped objects.

Moving Objects to the Front

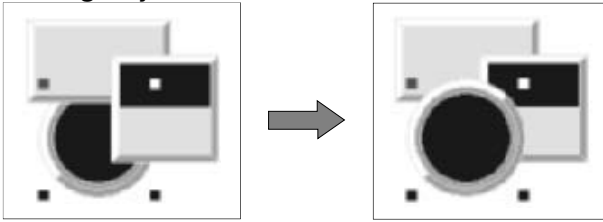

Moving Objects to the Back

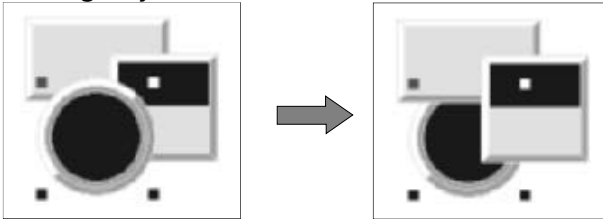

1. Select the objects for which the display order is to be changed.
2. Select **Layout – Order – Bring to Front/Send to Back** or **Bring to Front** or **Send to Back** on the toolbar.



5-5-6 Nudging Objects

Moves selected objects vertically or horizontally in 1-dot units.
When grids are enabled, the object is moved in the set grid units.

1. Select the object to be nudged.
2. Select **Layout – Nudge** and then select the direction to move the object.

Reference

- ◆ Press the Up, Down, Left, or Right Keys to perform the same operation.

5-5-7 Rotating and Flipping Objects

Rotates objects clockwise or counterclockwise or flips objects. Grouped multiple objects can also be rotated or flipped.

Rotating/Flipping Around Object Rectangle

Rotates or flips the object around the center coordinates of the object rectangle. Any labels set to functional objects will not, however, be rotated or flipped.

1. Select the object to be rotated or flipped.
2. Select **Layout – Rotate/Flip** and then select the direction to rotate or flip the object.

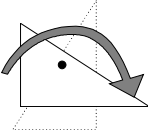
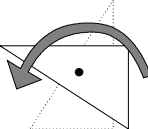
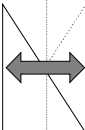
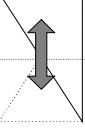
Function	Details
Rotate Right 90 Degrees	
Rotate Left 90 Degrees	
Flip Horizontal	
Flip Vertical	

Reference

- ◆ When rotating or flipping grouped objects, the center of the grouped rectangle will be the center for the rotation or flip.
- ◆ Video Displays cannot be rotated or flipped.

Rotating/Flipping Around Center of Screen/Frame

Rotates or flips the object around the center coordinates of the edit screen or frame.

1. Select the object to be rotated or flipped.
2. Select **Layout – Rotate/Flip** and then select the direction to rotate or flip the object.

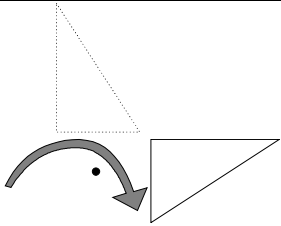
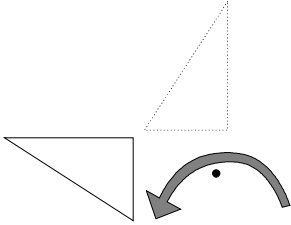
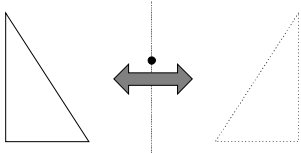
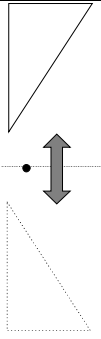
Function	Details
Rotate Right 90 Degrees Around Center of Screen/Frame	
Rotate Left 90 Degrees Around Center of Screen/Frame	
Flip Horizontal Around Center of Screen/Frame	
Flip Vertical Around Center of Screen/Frame	

Reference

- ◆ Video Displays cannot be rotated or flipped.

5-5-8 Modifying Objects

Corner (node) positions and shapes of polylines, polygons, sectors, and arcs can be changed. Nodes of polylines and polygons can also be deleted or added.

Editing Nodes

1. Select the fixed object for which the shape is to be changed.
2. Select **Layout - Edit - Edit Node**.

The fixed object nodes will be displayed.



3. Move the cursor towards the node. When the cursor has changed to a cross (+), drag the cursor to the new position for the node.

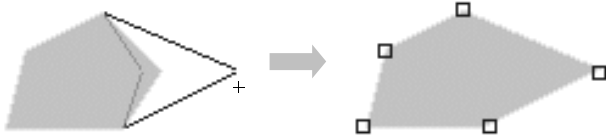

4. Click the right mouse button to close the edit mode for nodes.

Adding Nodes

1. Select the fixed object to which a node is to be added.
2. Select **Layout – Edit – Add Node**.

The fixed object nodes will be displayed.

When the cursor is placed on the border of the fixed object, the cursor will change to the following shape.



3. Click the position on the border where a node is to be added. A node will be added between two existing nodes. Nodes can be added until there are only 4 dots or less between two nodes.

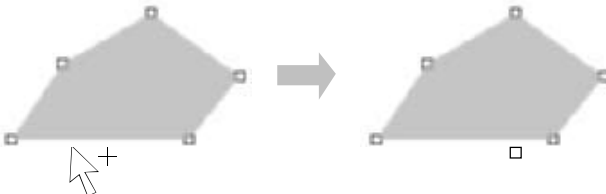

4. Click the right mouse button to close the add mode for nodes.

Removing Nodes

1. Select the fixed object from which a node is to be removed.
2. Select **Layout – Edit – Remove Node**.

The fixed object nodes will be displayed.

The cursor will change to the following shape when brought close to a node.



3. Click the node to be removed.



4. Click the right mouse button to close the remove mode for nodes.

5-5-9 Grouping and Ungrouping Objects

Grouping multiple functional or fixed objects allows them to be handled as one group when editing or adjusting layout. Grouped objects can also be grouped with other functional or fixed objects or placed in other groups.

Grouping Objects

1. Select the functional or fixed objects to be grouped.



2. Select **Layout – Group**.



Reference

- ◆ The shortcut keys for grouping objects are the **Ctrl + G** Keys.
- ◆ Video Displays and tables cannot be grouped.
- ◆ The CSV file import/export function can be used to set functional object properties while the functional objects are still grouped (labels, comments, and addresses only). Refer to *Section 12 Importing/Exporting CSV Files* for information.

Ungrouping Objects

Restores grouped functional or fixed objects to individual objects.

1. Select the group to be ungrouped.
2. Select **Layout – Ungroup**.

Reference

- ◆ The shortcut keys for ungrouping objects are the **Ctrl + U** Keys.
- ◆ Only one group can be ungrouped at a time.

Editing Properties of Grouped Objects

Edit the properties of grouped functional or fixed objects using the following procedure.

1. Move the cursor over the functional or fixed object to be edited, and double-click the left mouse button.

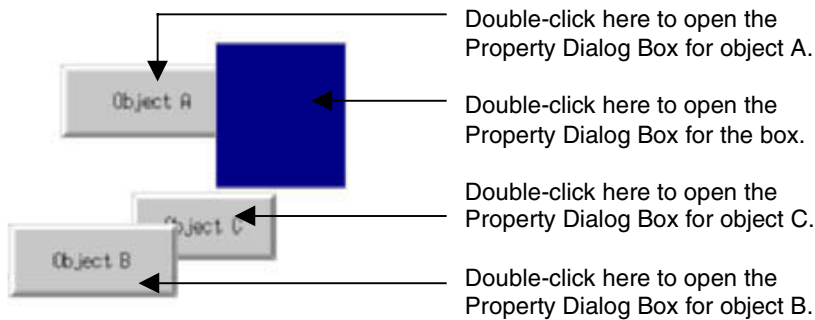

2. The Property Dialog Box for that functional or fixed object will open. Edit the properties as required.

Reference

- ◆ If the mouse button is double-clicked at a position where two or more functional or fixed objects overlap, the Property Dialog Box for the top object will be opened.

To edit grouped functional or fixed objects as a device library object, select *Edit Smart Active Parts* in the **Edit/Disp** Tab Page opened from the Options Dialog Box (*Tools – Options*).

5-6 Colors

Display colors for functional and fixed objects and other colors are selected in the Color Setting Dialog Box. There are two kinds of Color Setting Dialog Boxes. Select the Color Setting Dialog Box that will normally be used from the Color Dialog Tab Page under *Tools – Options*. Refer to *5-16 Options* for details.



The method for displaying the Color Setting Dialog Box is described below. Refer to *Setting Colors* under *2-8 Common Functional Object Functions* in the *NS Series Programming Manual* for details on the dialog box.

Property Setting Dialog Boxes

Click the **Setting** Button next to the color settings column in each Property Setting Dialog Box to display the Color Setting Dialog Box.

Toolbar

Select the object and click the ▼ Button on the color toolbar to display the Color Setting Dialog Box.

5-7 Address Settings

Addresses used for referencing data required for display and for storing entered data can be allocated in any PLC area or PT internal memory area. The display status of objects can be changed and the PT status can be controlled and notified by directly writing to and reading from addresses during PT operation.

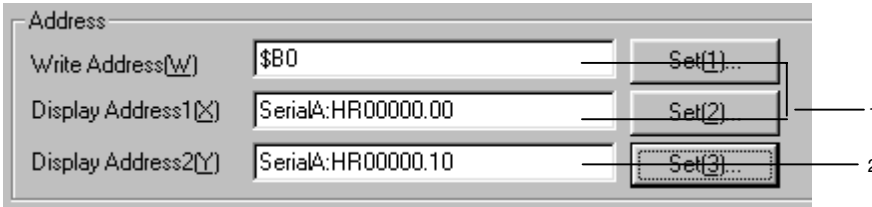

No.	Setting	Details										
1	Address setting	Enter the addresses to be set. The address can be entered directly. Alternatively, click the Setting Button and enter the address in the displayed dialog box. If an invalid address is entered, an error message will be displayed when the OK Button is pressed. Invalid addresses cannot be set.										
2	Index setting	<p>The index setting function is used to allow the addresses allocated to objects to be changed by changing the index attached to a specified area. These variables are called index setting. This enables one object to refer to many addresses. Area types, however, cannot be changed with an index.</p> <p>There are 10 index settings available (I0 to I9).</p> <p>Change the contents of system memory to change index setting. (\$SW27 to \$SW36)</p> <p>Example Using Indexes Specified Address: Serial A: HR00000.00I0 The communications address will automatically change based on the I0 value.</p> <table border="1" style="margin-left: 40px;"> <thead> <tr> <th>I0 (\$SW27) value</th> <th>Address</th> </tr> </thead> <tbody> <tr> <td>0</td> <td>Serial A: HR00000.00</td> </tr> <tr> <td>1</td> <td>Serial A: HR00000.01</td> </tr> <tr> <td>2</td> <td>Serial A: HR00000.02</td> </tr> <tr> <td>⋮</td> <td>⋮</td> </tr> </tbody> </table> <p>Enter index settings directly into the address input column.</p>	I0 (\$SW27) value	Address	0	Serial A: HR00000.00	1	Serial A: HR00000.01	2	Serial A: HR00000.02	⋮	⋮
I0 (\$SW27) value	Address											
0	Serial A: HR00000.00											
1	Serial A: HR00000.01											
2	Serial A: HR00000.02											
⋮	⋮											

Reference

- ◆ If the address exceeds the setting range as a result of an index being specified, the address will be invalid and communications will not be processed.
- ◆ Refer to 2-4 *System Memory* in the *NS Series Programming Manual* for details on system memory.

5-7-1 Setting Addresses

Click the **Setting** Button to the right of the setting column to display the Address Setting Dialog Box. This section describes how to enter addresses using this dialog box.

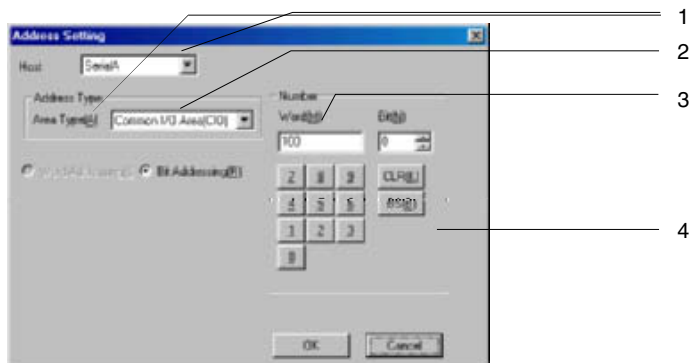

No.	Setting	Details
1	Host name	Select the registered host name under Settings – Register Host or select the host from PT memory.
2	Area Type	Select the communications area. Word or Bit specification are only displayed when those address types can be set. For example, the Word option will not be displayed when making address settings for ON/OFF Buttons.
3	Address	Displays and sets the communications address. The host address is expressed as a 5-digit word address or 5-digit word address and 2-digit bit address. If the address entered here does not have enough digits, the number of digits are automatically adjusted and the address written to the address setting column. Example: If word “1” is entered as the address: “00001” will be entered in the address setting column.
4	Input Button	Click the Input Button to enter the word or bit.

5-7-2 Registering Hosts

Communications with multiple PLCs is possible with NS-series PTs. Specify a host name and addresses for each connected PLC to allow access to any PLC memory area.

Registering New Hosts

This section describes how to register hosts.

1. Select **Settings – Register Host**.

The Register Host Dialog Box will be displayed.

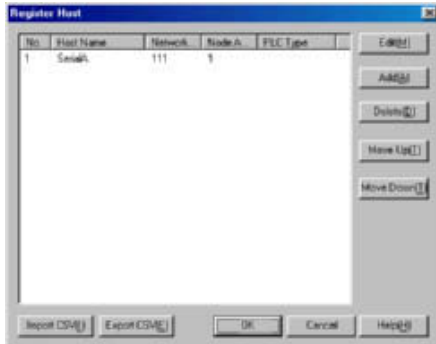

2. Click the **Add** Button.
3. The Edit Host Dialog Box will be displayed. Register all settings in this dialog box.

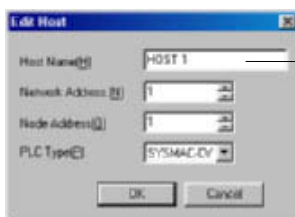

Enter a host name
(up to 16 characters).

4. Click the **OK** Button.

Reference

- ◆ Up to 98 hosts can be registered, not including Serial A and Serial B.

Editing Registered Hosts

1. Select the host to be edited.

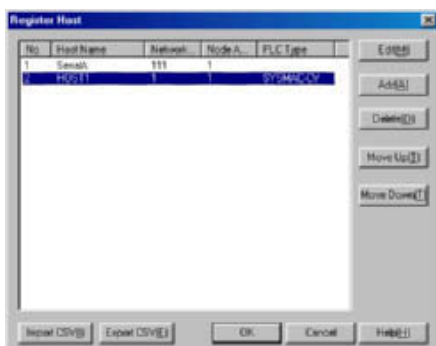

2. Click the **Edit** Button.
3. The Edit Host Dialog Box will be displayed. Edit the settings in this dialog box.

4. Click the **OK** Button.

Reference

- ◆ “Serial A” and “Serial B” are automatically registered as hosts when connecting to PLCs using serial ports A and B. This applies when **PLC** has been set to serial ports A and B under *System Setting*. Only the host name can be changed in these cases.
To delete hosts, set serial ports A and B to **None** under **Settings – System Setting (Comm-All Tab Page)**.

Deleting Registered Hosts

1. Select the host to be deleted.
2. Click the **Delete** Button.
3. A dialog box to confirm the delete operation will be displayed. Click the **Yes** Button.

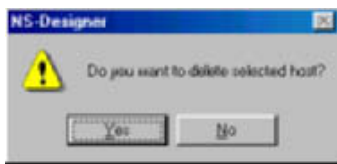

Reference

- ◆ “Serial A” and “Serial B” are automatically registered as hosts when connecting to PLCs using serial ports A and B. This applies when **PLC** has been set to serial ports A and B under *System Setting*. Hosts cannot be deleted using the **Delete** Button in these cases.
- ◆ If a host address is set to a functional object and that host is subsequently deleted, ??? will be applied as the address host name. An error check can be executed to check for illegal addresses. The alarm/event, Data Log, Data Block, and system memory addresses will not, however, be checked for errors.
Projects with ??? applied as the host name will not operate normally on the PT. Be careful with addresses when hosts are deleted.

Moving Registered Hosts

1. Select the host to be moved.
2. Click the **Move Up** or **Move Down** Button to move the host up or down.

Reference

- ◆ “Serial A” and “Serial B” are automatically registered as hosts when connecting to PLCs using serial ports A and B. This applies when **PLC** has been set to serial ports A and B under *System Setting*. Hosts cannot be moved in these cases.
Furthermore, other hosts cannot be moved above these two hosts.

Importing and Exporting CSV Files

Use the CSV file import and export functions to edit settings efficiently.

1. Click the **Export CSV** or **Import CSV** Button.
2. To export files, specify the save directory and the file name and then click the **Save** Button. If importing from a CSV file, select the name of the file to be imported and click the **Open** Button.

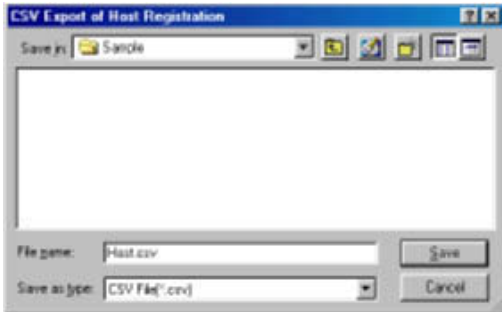

3. An error check is performed when files are imported and any detected errors are displayed in a dialog box, like the one shown below.

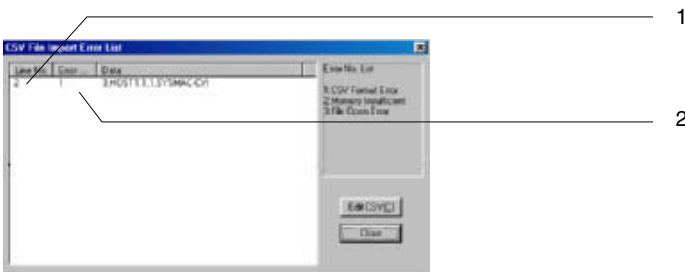

No.	Details		
1	Displays the line number in the CSV file data where the error was found.		
2	Displays the error number. Refer to the following table for details.		
	Error No.	Details	Countermeasure
	1	Format error in imported CSV file.	Check that the imported file is in CSV format. Check that the settings are valid.
	2	Insufficient memory. Settings contained in CSV file cannot be imported.	Close any unnecessary applications and re-execute the import operation.
	3	Could not open the CSV file. CSV file could not be imported.	Check that the file is not being used by another application. If the file is being used by another application, close the file and then re-execute the import operation.

The output CSV file will be displayed in the following format.

(When displayed using Microsoft Excel.)

	A	B	C	D	E	F
1	Host ID	Host Name	Network N	Node Addr	PLC Type	
2		3 HOST1		1	1 SYSMAC-CV	
3						

The host ID is the number automatically allocated to the host when it is registered. The host ID does not change even if it is different from the number in the Register Host Dialog Box or if the host is deleted.

Use 3 onwards when adding new hosts to the imported CSV file. Numbers 1 and 2 are reserved for the following communications settings.

1	Serial port A
2	Serial port B

Note

- ◆ When CSV files are edited using spreadsheet software, a message warning that some changes may be lost if the file is saved in the current format may be displayed when the file is closed. This will not adversely affect PT operation.
- ◆ Serial ports A and B can only be added or deleted under **Settings – System Setting**. Serial ports A and B cannot be added by importing CSV files. Serial port A and B information is not output when CSV files are exported.

5-8 Displaying and Searching Functional Object Lists

Lists of property settings for functional objects in each screen can be displayed and checked and the order of the listed properties (ID No., comment, label, address, font name, text color, text attributes, color, etc.) can be changed. Also, the display can be changed, using the jump function, to the position of a specified functional object.

1. Either select **Tools – Functional Object List** or click the **Functional Object List** Button on the toolbar.

Toolbar



The Functional Object List Dialog Box will be displayed.

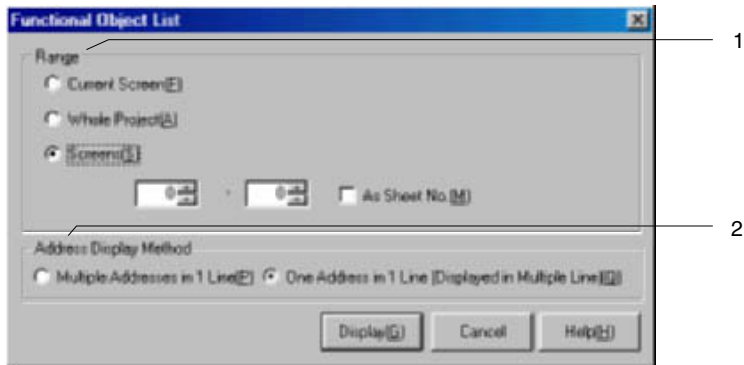

No.	Setting	Details																																			
1	Range	Select the range for the functional object list display from <i>Current Screen</i> , <i>Whole Project</i> , or <i>Screens</i> . If <i>As Sheet No</i> is selected (turned ON), the functional objects in sheets will be the range for the list.																																			
2	Address Display Method	Select the address display method from the following options.																																			
	Multiple Addresses in 1 Line	The addresses set for one functional object are displayed horizontally on one line. <table border="1" style="margin-left: 20px;"> <thead> <tr> <th>Page</th> <th>ID</th> <th>Inside Pr</th> <th>Inside Tab</th> <th>Comment</th> <th>Label</th> <th>Address1</th> <th>Address2</th> <th>Address3</th> </tr> </thead> <tbody> <tr> <td>1</td> <td>FB0000</td> <td></td> <td></td> <td></td> <td></td> <td>\$B10</td> <td>\$B12</td> <td>\$B14</td> </tr> </tbody> </table>	Page	ID	Inside Pr	Inside Tab	Comment	Label	Address1	Address2	Address3	1	FB0000					\$B10	\$B12	\$B14																	
Page	ID	Inside Pr	Inside Tab	Comment	Label	Address1	Address2	Address3																													
1	FB0000					\$B10	\$B12	\$B14																													
	One Address in 1 Line (Displayed in Multiple Line)	The addresses set for one functional object are displayed vertically over multiple lines. <table border="1" style="margin-left: 20px;"> <thead> <tr> <th>Page</th> <th>ID</th> <th>Inside Pr</th> <th>Inside Tab</th> <th>Comment</th> <th>Label</th> <th>Address</th> </tr> </thead> <tbody> <tr> <td>1</td> <td>FB0000</td> <td></td> <td></td> <td></td> <td></td> <td>\$B10</td> </tr> <tr> <td>1</td> <td>FB0000</td> <td></td> <td></td> <td></td> <td></td> <td>\$B22</td> </tr> <tr> <td>1</td> <td>FB0001</td> <td></td> <td></td> <td></td> <td></td> <td>\$B12</td> </tr> <tr> <td>1</td> <td>FB0001</td> <td></td> <td></td> <td></td> <td></td> <td>\$B24</td> </tr> </tbody> </table>	Page	ID	Inside Pr	Inside Tab	Comment	Label	Address	1	FB0000					\$B10	1	FB0000					\$B22	1	FB0001					\$B12	1	FB0001					\$B24
Page	ID	Inside Pr	Inside Tab	Comment	Label	Address																															
1	FB0000					\$B10																															
1	FB0000					\$B22																															
1	FB0001					\$B12																															
1	FB0001					\$B24																															

2. Make the settings and then click the **Display** Button.
3. The Functional Object List Window will be displayed.

NS-Designer Operation Manual

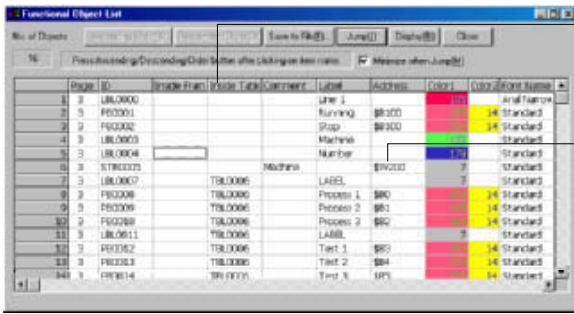

Properties

Displays the property settings for each functional object.

Reference

- ◆ The shortcut keys for displaying functional object lists are the **Ctrl + L** Keys.
- ◆ If the same address is used more than once in the same macro, that address is only counted as being used once.
- ◆ **Macro 1** to **Macro 4** only indicate whether or not macros have been set to that functional object. These display items do not indicate whether or not addresses are used in macros.

Sorting by Settings

Sorts functional object lists in ascending or descending order of properties.

1. Click the titles of the properties to be sorted and select the whole column.

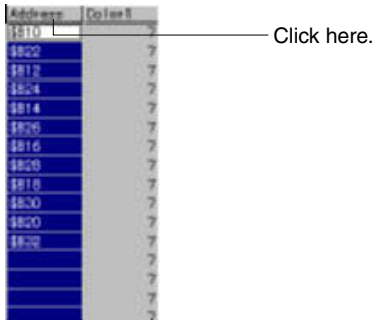

2. Click the **Ascending Order** or **Descending Order** Button.

Sorting Addresses in Ascending Order

Address	Color 1
\$B10	7
\$B12	7
\$B14	7
\$B16	7
\$B18	7
\$B20	7
\$B22	7
\$B24	7
\$B26	7
\$B28	7
\$B30	7
\$B32	7

The addresses are sorted alphabetically, so \$B30 is listed in this position.

Sorting Addresses in Descending Order

Address	Color I
SerialA.0	7
SerialA.0	7
SerialA.0	7
SerialA.0	7
\$B32	7
\$B30	7
\$B28	7
\$B26	7
\$B24	7
\$B22	7
\$B20	7
\$B18	7
\$B16	7
\$B14	7
\$B12	7
\$B10	7

The addresses are sorted alphabetically, so \$B30 is listed in this position.

Jumping to Functional Objects

The display can be changed (using the jump function) from the list to the position on the screen of a specified object.

1. Click the number of the destination functional object to select the whole row.

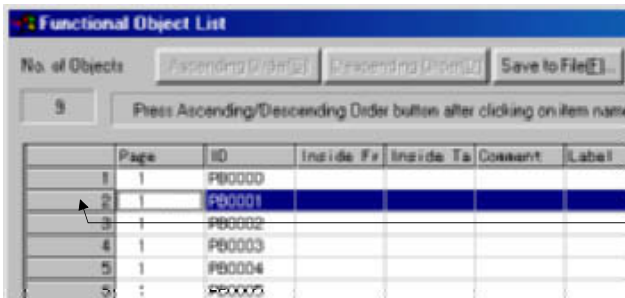

Select the destination functional object.

2. Click the **Jump** Button or double-click the selected row.

The screen where the selected functional object is found will be displayed and the functional object will flash because it is selected.



Note

- ◆ If *Minimize when Jump* is deselected (turned OFF) in the Functional Object List Window, the window will not be minimized when the jump function is used, but the destination functional object will flash because it is selected.

Saving to File

Saves the contents of the Functional Object List Window to a CSV file.

1. Click the **Save to File** Button in the Functional Object List Window.
2. The Save Used Functional Object List Dialog Box will be displayed. Specify the directory and file name for the save operation.

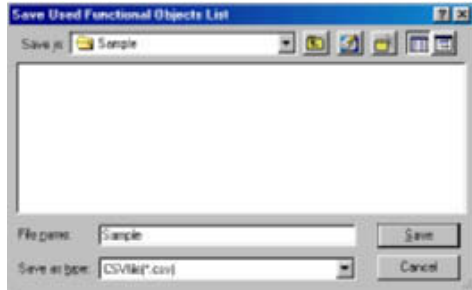

3. Click the **Save** Button.

5-8-1 Redisplaying Lists

Click the **Display** Button in the Functional Object List Dialog Box to redisplay the list to change the display range or refresh the display.

5-9 Listing Functional Objects Used

Lists the number of functional objects in the whole project or in a specified screen.

The display can also be changed (using the jump function) from the list to a specified screen.

5-9-1 Displaying Lists of Used Functional Objects

The method for displaying a list of used functional objects is described below.

1. Either select **Tools – List Up Functional Objects Used** or click the **List Up Functional Objects Used** Button on the toolbar.

Toolbar



The List Up Functional Objects Used Dialog Box will be displayed.

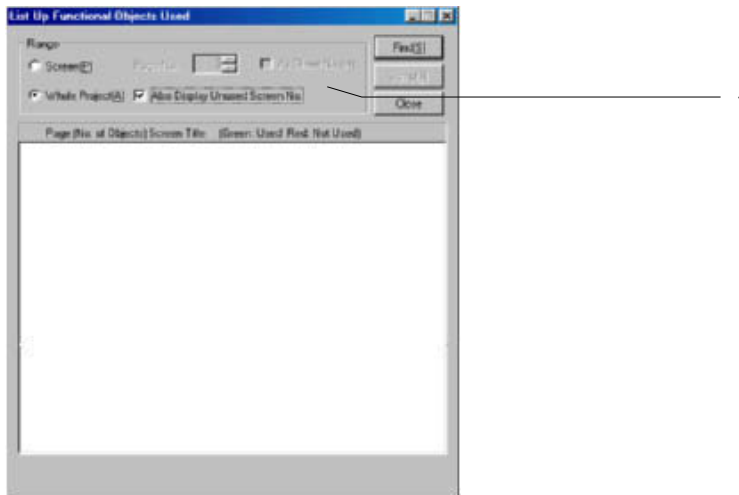

No.	Setting	Details
1	Range	Select either <i>Screen</i> or <i>Whole Project</i> as the search range for the list of functional objects used. If <i>As Sheet No</i> is selected (turned ON), functional objects in sheets will be the range for the search. Select <i>Whole Project</i> and select (turn ON) <i>Also Display Unused Screen No.</i> to included unused screens in the search range.

2. Make the settings and then click the **Find** Button.

NS-Designer Operation Manual

- The number of functional objects used are displayed in a tree structure for each screen, frame, and table.

Click **+** to expand the tree.

Screens with the functional object are displayed in green and those without the functional object are displayed in red.

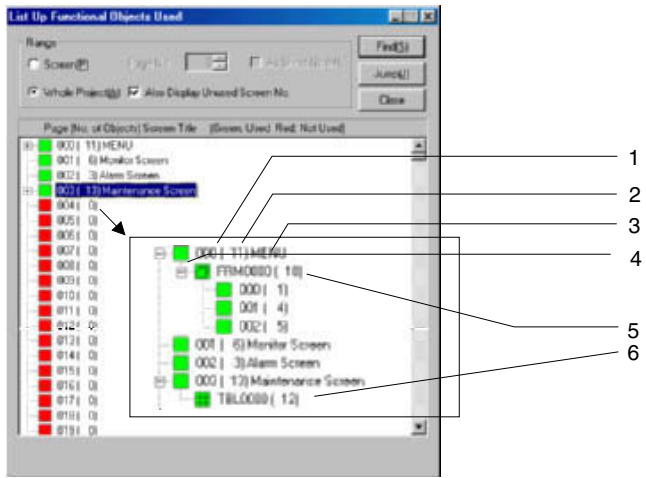

No.	Details
1	Displays the screen page number.
2	Displays the number of functional objects in each screen.
3	Displays the screen title.
4	Click + to expand the tree.
5	The number of functional objects in the frame are displayed for each frame page. <div style="margin-left: 20px;"> <pre> FRM0000 (10) ├── 000 (1) ├── 001 (4) └── 002 (5) </pre> </div>
6	Displays the number of functional objects in tables.

5-9-2 Jumping to Screens, Tables, and Frames

The display can be changed (using the jump function) from the List Up Functional Objects Used Dialog Box to a specified screen or table or frame screen position.

1. Click the destination screen, table, or frame to select it.

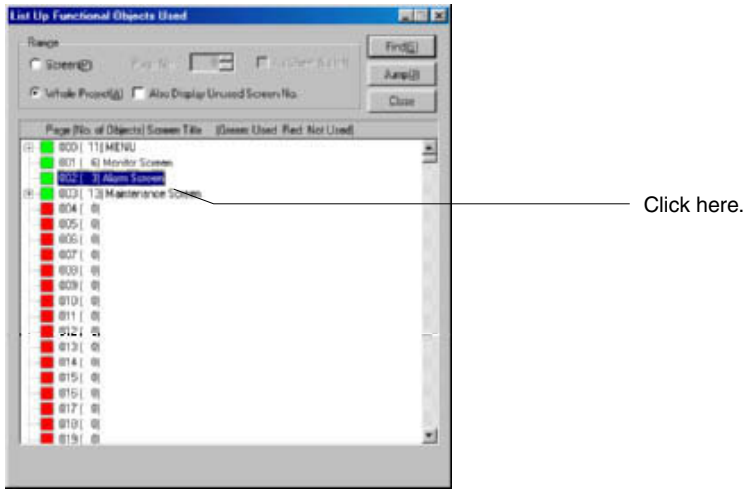

2. Click the **Jump** Button.

The selected screen will be opened. Alternatively, the table or frame will flash to indicate that it has been selected.

When a Screen Is Selected.

When a Table or Frame Is Selected.

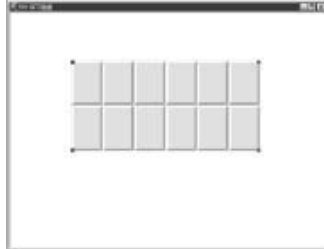
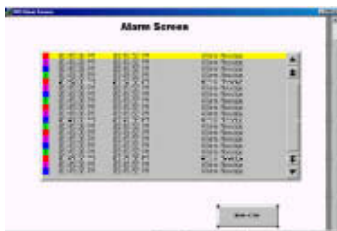

Reference

- ◆ The jump operation can also be performed by double-clicking on the screen or table/frame line.

5-10 Batch Settings

Changes settings for the main properties of multiple functional objects of the same type from the functional object list. Settings for the following properties can be changed as a batch.

- Comments
- Labels
- Addresses

Functional objects can also be added to or deleted from lists.

Functional Object Property Settings

Properties for each functional object can be set as a batch. This section describes how to change settings using ON/OFF Button functional objects as an example.

1. Select the functional objects for which the properties are to be set together.

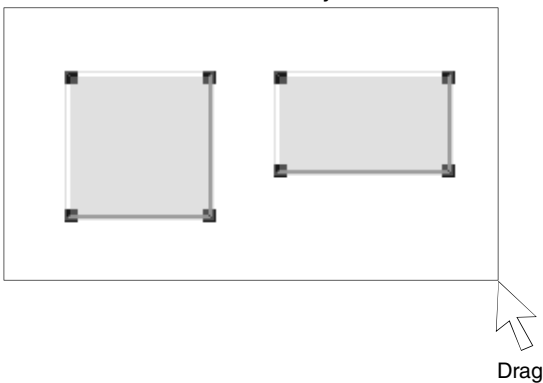

2. Select **Settings – Change Settings at Once**.

Reference

- ◆ The shortcut keys for changing functional object settings as a batch are the **Ctrl + K** Keys.

The Change Settings at Once Window will be displayed. The properties for the selected functional object will be displayed in a list.

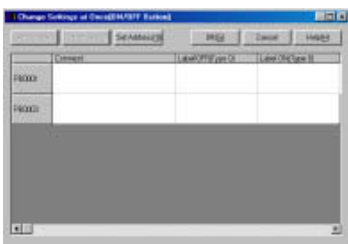

3. Double-click the cell for the property items to be set to enter input mode.

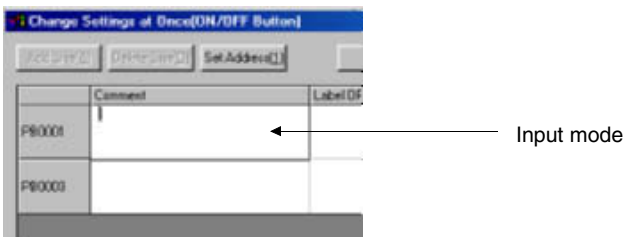

NS-Designer Operation Manual

- 4. Enter the settings data.



- 5. Click the **OK** Button.

Reference

- ◆ Addresses can also be set from the Address Setting Dialog Box. Click the **Set Address** Button to display the Address Setting Dialog Box.
- ◆ The batch-setting function cannot be used if functional objects of different types are selected.
- ◆ The batch-setting function cannot be used if frames or tables are selected.

Adding One Line

New functional objects can be created from the Change Settings at Once Dialog Box by adding a line.

- 1. Click a line to select it.

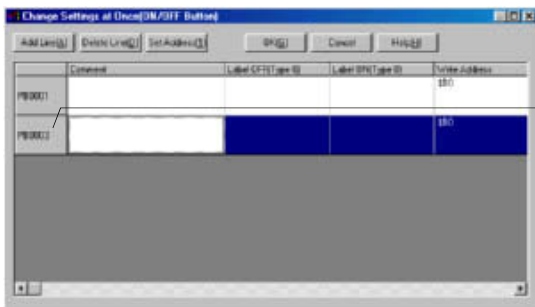

Click here.

- 2. Click the **Add Line** Button.

A new line will be added directly below the selected line. An ID number will be automatically added, using the next lowest free number.

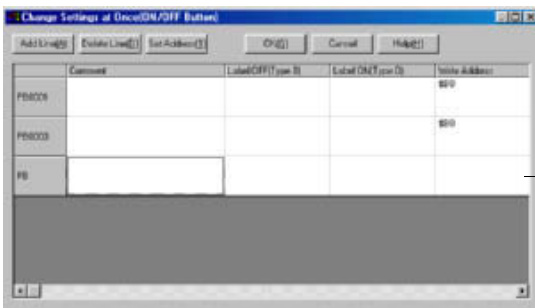

A line is added.

Reference

- ◆ The Add Line function cannot be used for Video Displays and Data Block Tables.

NS-Designer Operation Manual

3. Click the **OK** Button. The newly added functional object will be displayed at the top left of the screen.

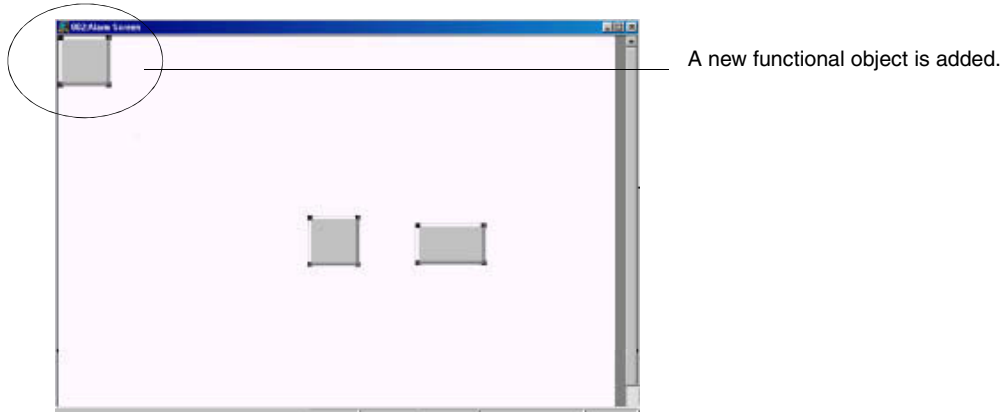

Deleting Lines

Functional objects can be deleted by deleting lines from the Change Settings at Once Dialog Box.

1. Click the line for the functional object to be deleted.

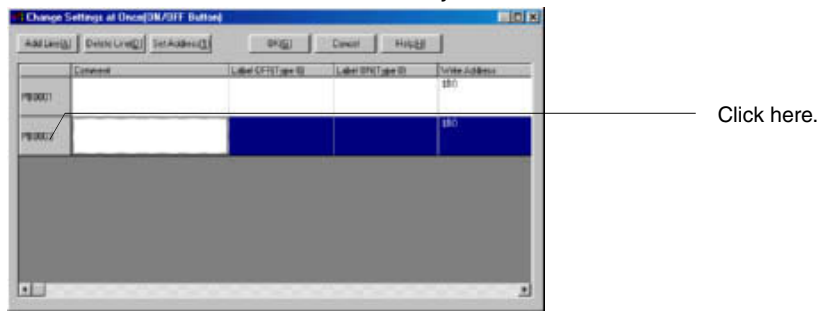

2. Click the **Delete Line** Button.

3. A confirmation dialog box will be displayed. Click the **Yes** Button to delete the line (and the object).



The line will be deleted.

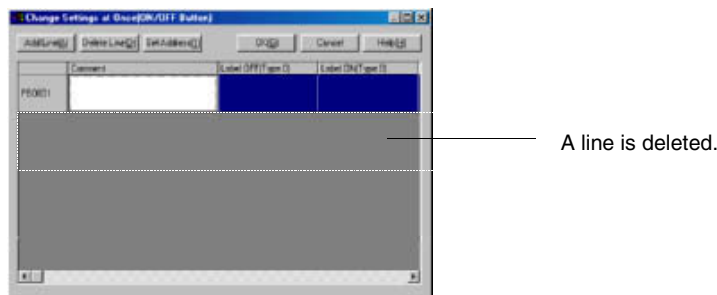

5. Click the **OK** Button. The functional object will be deleted from the screen.

Reference

- ◆ If the operation to delete all lines is performed, all selected lines will be deleted, but a new line will be added and a new functional object of the same type will be created.

NS-Designer Operation Manual

Cutting, Copying, and Pasting Settings

The settings in each cell can be cut, copied, or pasted.

1. Click the cell with the settings to be cut or copied.



Select the settings item to be copied.

2. Click the right mouse button on the selected cell. Select **Cut** or **Copy** from the displayed pop-up menu.

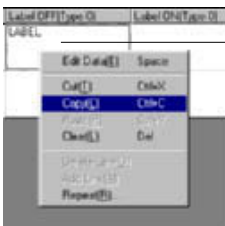

Click the right mouse button.

3. Click the cell where the settings data is to be pasted.

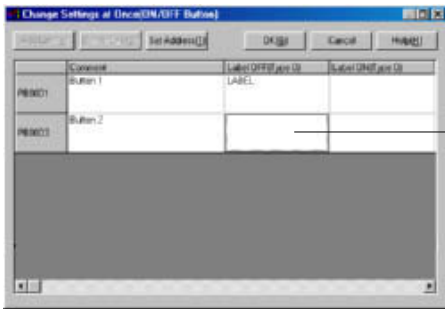

Select the target cell.

4. Click the right mouse button on the selected cell. Select **Paste** from the displayed pop-up menu.



Click the right mouse button.

The cut or copied data will be pasted.

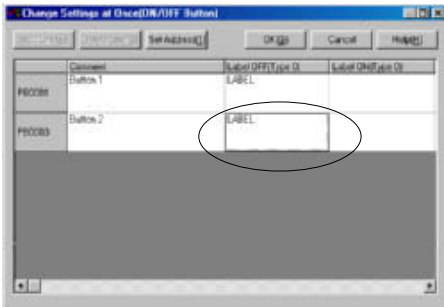

Reference

- ◆ Multiple settings can be selected and copied and pasted. Select all the target cells when performing the paste operation.
- ◆ The shortcut keys for cutting settings are the **Ctrl + X** Keys.
- ◆ The shortcut keys for copying settings are the **Ctrl + C** Keys.
- ◆ The shortcut keys for pasting settings are the **Ctrl + V** Keys.
- ◆ The shortcut key for clearing cells is the **Delete** Key.

Repeating Settings

Duplicates the settings for a selected cell. Addresses or character strings can be copied along with specified offsets for numeric values contained in them.

1. Click the settings item to be repeated.

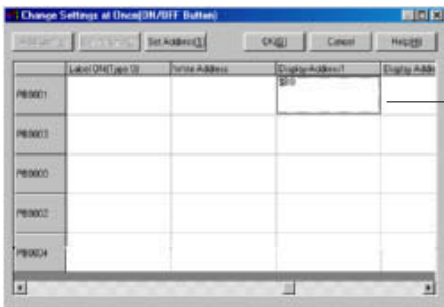

Select the settings item to be repeated.

2. Click the right mouse button on the selected cell. Select **Repeat** from the displayed pop-up menu.

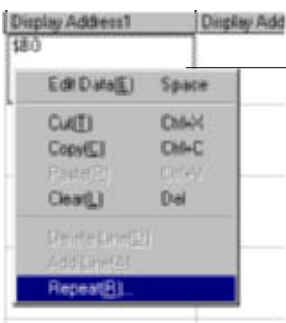

Click the right mouse button.

The Repeat Dialog Box will be displayed.

NS-Designer Operation Manual

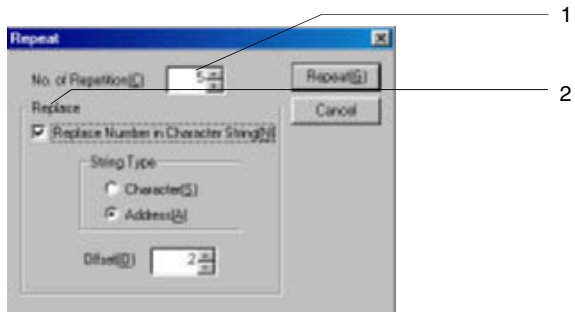

No.	Setting	Details
1	No. of Repetitions	Sets the number of repetitions.
2	Replace	Replaces existing data with the repeat string.
	Replace Number in Character String	If Replace Number in Character String is selected (turned ON), the numeric value in the character string is incremented and the string is copied.
	String Type	Select Character to replace numeric values in comment or label strings. Select Address to replace numbers in addresses. Example: Character – Button 1, Button 2, Button 3,... Address – \$B0, \$B1, \$B2,....
	Offset	Specifies the offset value to be added to the numeric value being replaced.

3. Make the settings and then click the **Repeat** Button.

5-11 Listing Addresses Used

Displays a list of the number of functional objects using each address and a list of functional objects using each address. Can also jump to specified functional object screen positions.

Displaying Lists of Used Addresses

Displays a list of addresses that are used.

1. Either select **Tools – List Up Addresses Used** or click the **List Up Addresses Used** Button on the toolbar.

Toolbar



The List Up Addresses Used Dialog Box will be displayed.

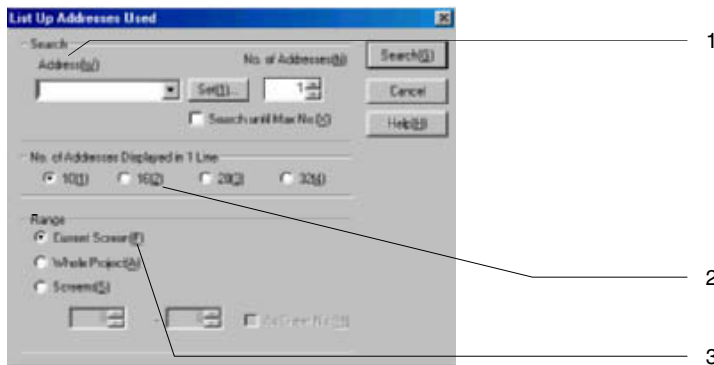

No.	Setting	Details
1	Search	Specifies the conditions for the address search.
	Address	Sets the start address for the search range.
	No. of Addresses	Specifies how many words or bits to search for from the address specified under <i>Address</i> .
	Search until Max No.	Select (turn ON) <i>Search until Max No.</i> to search until the largest bit or word from the address specified under <i>Address</i> .
2	No. of Addresses Displayed in 1 Line	Sets the number of addresses displayed in one line.
3	Range	Select the search range from <i>Current Screen</i> , <i>Whole Project</i> , or <i>Screens</i> . If <i>As Sheet No</i> is selected (turned ON), functional objects in sheets will be the display range.

2. Make the settings and then click the **Search** Button.
3. The used bits and words are displayed for each address.

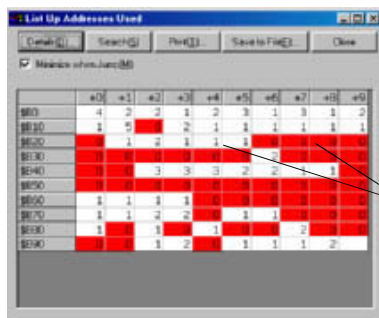

Red: Not used
White: Displays the number of used bits and words.

Saving Search Results to File

Saves the list of search results to a CSV file.

1. Click the **Save to File** Button.
2. The Save List Up Addresses Used Dialog Box will be displayed. Specify the directory and file name for the save operation.

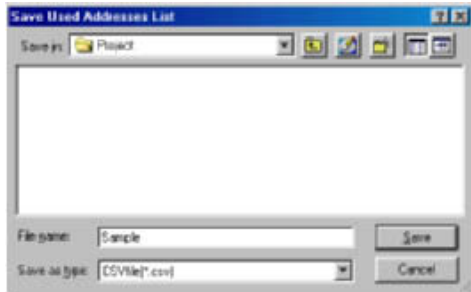

3. Click the **Save** Button.
4. A dialog box to notify that the save operation has been completed will be displayed. Click the **OK** Button.



Reference

- ◆ An example of CSV file output is given below. The search results are given for each address and separated by commas.

```
$B0,2,1,1,0,1,2,0,2,0,1
$B10,0,4,0,2,1,1,1,1,1,1
$B20,0,1,1,1,1,1,0,0,0,0
$B30,0,0,0,0,0,0,2,0,1,1
$B40,0,0,2,2,2,1,4,4,0,0
$B50,2,2,0,0,0,0,0,0,1,0
$B60,1,1,1,1,0,0,0,0,1,1
$B70,1,1,2,2,0,1,1,0,0,0
$B80,1,1,1,0,0,0,0,2,0,0
$B90,0,0,1,1,0,1,1,1,2,1
```

Printing

Prints search results.

1. Click the **Print** Button.
The Print Dialog Box will be displayed.
2. Make the settings and then click the **OK** Button.
3. A dialog box to notify that the print operation has been completed will be displayed. Click the **OK** Button.



Note

- ◆ An example of print output is given below.

List Up Addresses Used										
Addresses										
\$100	:	L	L	L	L	L	L	L	L	L
\$110	:	L	L	L	L	L	L	L	L	L
\$120	:	L	L	L	L	L	L	L	L	L
\$130	:	L	L	L	L	L	L	L	L	L
\$140	:	L	L	L	L	L	L	L	L	L
\$150	:	L	L	L	L	L	L	L	L	L
\$160	:	L	L	L	L	L	L	L	L	L
\$170	:	L	L	L	L	L	L	L	L	L
\$180	:	L	L	L	L	L	L	L	L	L
\$190	:	L	L	L	L	L	L	L	L	L

Searching Again

Click the **Search** Button and make the settings again in the List Up Addresses Used Dialog Box to re-specify the search range or refresh the data.

Displaying Lists of Used Functional Objects

Displays a list of the functional objects that use the selected addresses.

1. Click the cell for the target address. The functional objects using that address will be displayed.
2. Click the **Details** Button or double-click the cell.

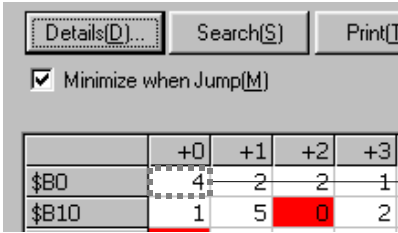

Double-click the cell.

A list of the functional objects using the specified address will be displayed.

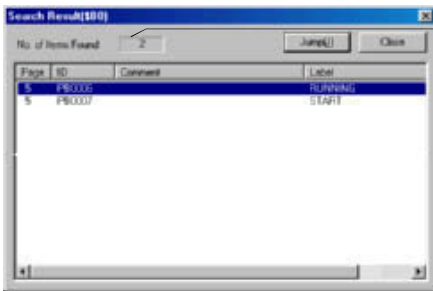

No. of searches

Displays a list of the screen page number where address located, functional object ID number, comment, and label.

Jumping to Functional Objects

The display can be changed (using the jump function) from the list to the position on the screen of a selected functional object.

1. Select the target functional object.
2. Click the **Jump** Button or double-click the selected row.
The screen where the selected functional object is found will be displayed and the functional object will flash because it is selected.

Reference

- ◆ If **Minimize when Jump** is deselected (turned OFF) in the List Up Addresses Used Window, the window will not be minimized when the jump function is used, but the destination functional object will flash because it is selected.

5-12 Cross-referencing Addresses

Searches and displays in a list the status of addresses and functional objects in each screen. Addresses allocated to each functional object can also be replaced and search results can be output to files or printed.

Displaying Address Cross References

Searches and displays in a list the status of addresses and functional objects.

1. Select **Tools – Address Cross Reference**.
2. The Address Cross Reference Window will be displayed. Set the search conditions.

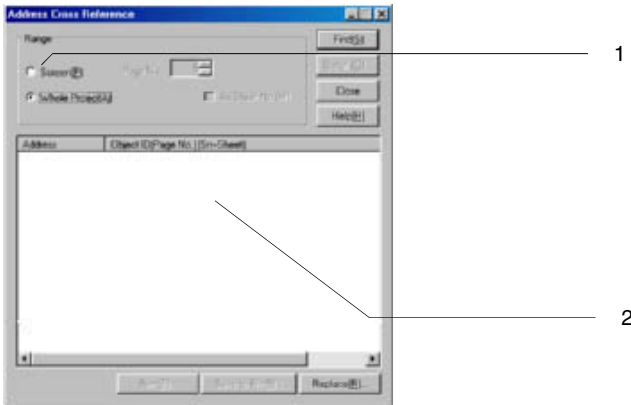

No.	Setting	Details
1	Range	Select either <i>Whole Project</i> or <i>Screen</i> as the search range for the address cross reference display. If <i>As Sheet No</i> is selected (turned ON), address cross references in sheets will be the range for the search.
2	Search Results Display Area	Executes the search and displays a list of search results.

3. Make the settings and then click the **Find** Button.

A list of search results will be displayed.

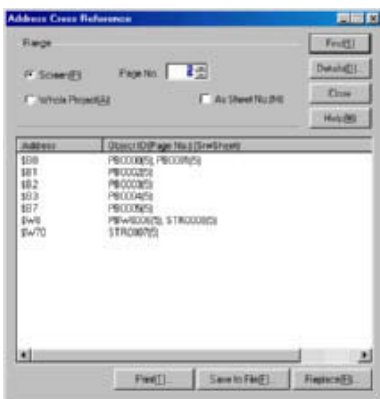

Addresses and Functional Object ID Numbers (Screen Page Numbers)

Note: An “S” will appear before sheet page numbers.

Example: PB0001(S3) is an ON/OFF Button on sheet page 3.

Reference

- ◆ The shortcut keys for displaying address cross references are the **Ctrl + R** Keys.
- ◆ If *Screen* is selected for the range, addresses set using the following menu items cannot be displayed.

Settings - Flicker Setting

Settings - Alarm/Event Setting

Settings - Data Log Setting

Settings - Data Block Setting

Settings - System Setting

Settings - Project Properties - Macro

Settings - Screen Properties - Macro

Replacing Addresses

After searches have been executed, addresses allocated to functional objects can be replaced in one operation.

1. Click the **Replace** Button.
2. The Replace Dialog Box will be displayed. Refer to *Replace* in *5-4 Editing* for detailed settings.

Reference

- ◆ When replacing an address set as a flicker or alarm/event setting, or as a data block interlock address, include the relay number in the specified address. Replacement will not be performed properly if the relay number is not specified.

Saving Search Results to File

Saves the list of search results to a CSV file.

1. Click the **Save to File** Button.
2. The Save Cross Reference Dialog Box will be displayed. Specify the directory and file name for the save operation.

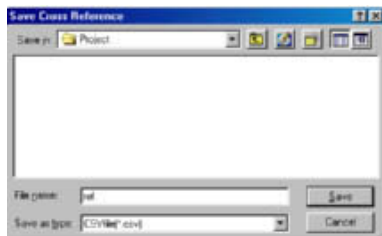

3. Click the **Save** Button.

Reference

- ◆ An example of CSV file output is given below. The search results are given for each address and separated by commas.

```
$B0,PL0001(2), FB0000(2)
$B1,FB0002(2), FL0008(2)
$B2,FB0003(2), FL0007(2)
$B100,FB0004(2)
$B102,FB0005(2)
$B104,FB0006(2)
$B50,PL0009(2)
$B51,PL0010(2)
$W10,NUM0012(2)
$W11,NUM0013(2), NUM0014(2)
$W35,ANAO015(2)
```

Printing Search Results

Prints a list of search results.

1. Click the **Print** Button.
The Print Dialog Box will be displayed.
2. Make the settings and then click the **OK** Button.
3. A dialog box to notify that the print operation has been completed will be displayed. Click the **OK** Button.



Reference

- ◆ An example of print output is given below.

Cross-reference	
Address	Functional object ID (Page) (Sn=sheet)
\$B0	: FL0001(2), FB0000(2)
\$B1	: FB0002(2), FL0008(2)
\$B2	: FB0003(2), FL0007(2)
\$B100	: FB0004(2)
\$B102	: FB0005(2)
\$B104	: FB0006(2)
\$B50	: FL0009(2)
\$B51	: FL0010(2)
\$W10	: NUM0012(2)
\$W11	: NUM0013(2)
\$W35	: ANAO015(2)

Searching Again

Click the **Find** Button to re-specify the search range or refresh the data.

Displaying Detailed Functional Object Information

Displays detailed information for the functional objects that use the specified addresses. The following information is displayed.

- Screen page numbers where the functional object is located.
 - ID number
 - Comment
 - Label
1. Select the addresses for which detailed information is required.
 2. Double-click the selected row or click the **Details** Button.
The Search Result Dialog Box will be displayed.

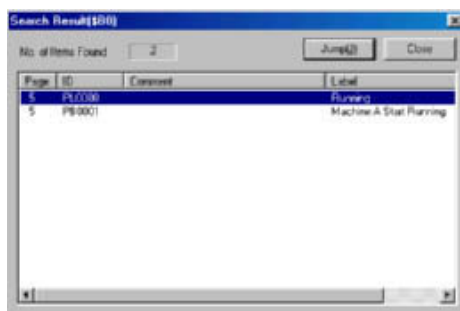

Jumping to Functional Objects

Jumps to specified functional object screen paste positions.

1. Click a functional object to select it.
2. Double-click the selected row or click the **Jump** Button.
The screen where the selected functional object is found will be displayed and the functional object will flash because it is selected.

5-13 Library Registration and Sharing Objects

A library is a collection of objects with set properties. Grouped objects can also be registered in the library.

Library objects can be easily placed and used as a single object on other projects or screens.

5-13-1 Registering Library Objects

An object and all of its properties settings can be registered to a library as one object.

1. Select the object to be registered to a library.



2. Either select **Tools – Register Library** or click the **Register Library** Button on the toolbar.



Reference

- ◆ Video Displays and Data Block Tables cannot be registered in the library.

The Library Dialog Box will be displayed.

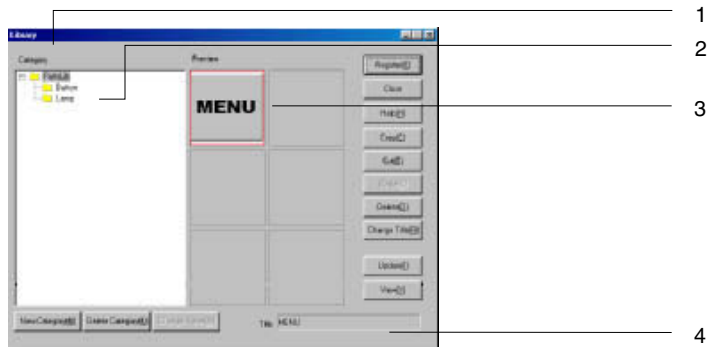

No.	Setting	Details
1	Category	Displays the library configuration on a menu tree. Click <input type="checkbox"/> to expand the display to lower categories.
2	Category	The category corresponds to the folder where the registered library objects are stored for easy management.
3	Preview	Displays a preview of the library object registered to the selected category. Click the <input type="checkbox"/> to select. The border will be displayed in red.
4	Title	Displays the title of the selected library object.

NS-Designer Operation Manual

- 4. Select the storage locations of the category where the library is registered and the preview column.

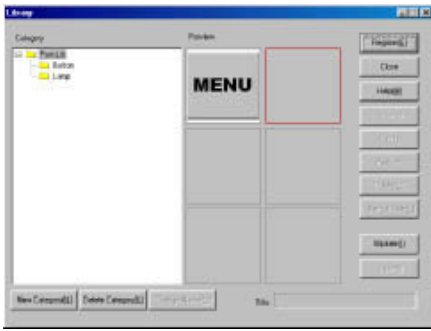

- 5. Click the **Register** Button.
- 6. The Library Title Dialog Box will be displayed. Set the title for the library object to be registered and click the **OK** Button.



- 7. Make the settings and then click the **Close** Button.

Reference

- ◆ If the **Register** Button is clicked while a location where library objects are registered is selected, the existing library objects will be overwritten.

Sharing Objects

This section describes how to share objects registered in the library and place these objects on screens.

- 1. Either select **Tools – Use Library** or click the **Use Library** Button on the toolbar.

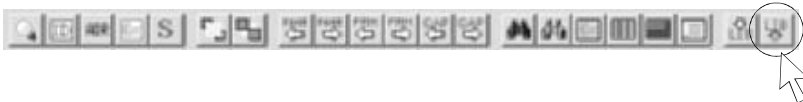

The Library Dialog Box will be displayed.

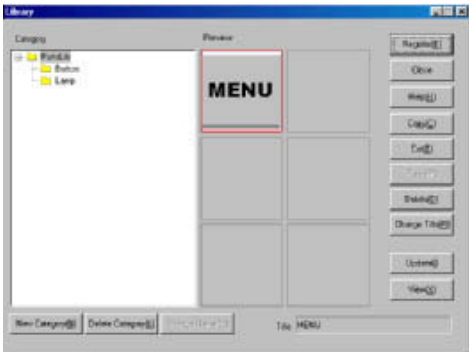

- 2. Specify the category and select the library object to be shared in the preview column.

- Click the **Use** Button.
The Library Dialog Box will be minimized and the library object will be placed on the upper left of the screen.



Managing the Library

Categories and library objects are managed and registration data is changed from the Library Dialog Box.

Either select **Tools – Use Library** or click the **Use Library** Button on the toolbar to display the Library Dialog Box.

Adding Categories

- Select the category above where a new category is to be added.
Example: Adding a “Command Button” below “Buttons”

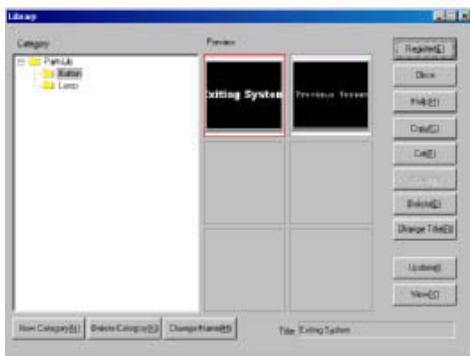

- Click the **New Category** Button to create a new category.

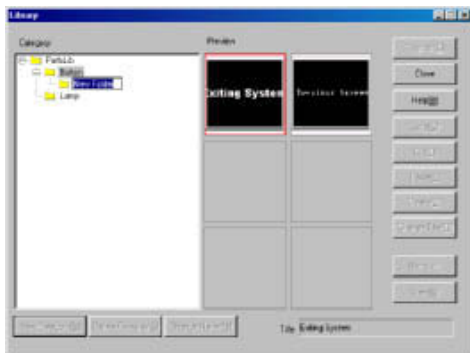

- Enter the category name.



Deleting Categories

1. Select the category to be deleted.
2. Click the **Delete Category** Button.
3. A dialog box to confirm the delete operation will be displayed. Click the **Yes** Button.

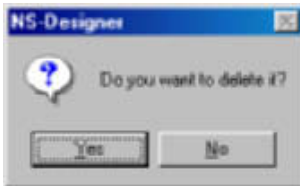

Reference

- ◆ Be careful when deleting categories because all library objects registered in that category will also be deleted.

Changing Categories

1. Select the category for which the name is to be changed.
2. Click the **Change Name** Button.
The category name will be displayed in reverse video and can now be edited.

Cutting, Copying, and Pasting Library Objects

This section describes how to cut or copy objects in the library and paste them to other categories.

1. Select the library object to be cut or copied.
2. Click the **Cut** or **Copy** Button.
3. Select the category where the object is to be pasted from the list of categories.

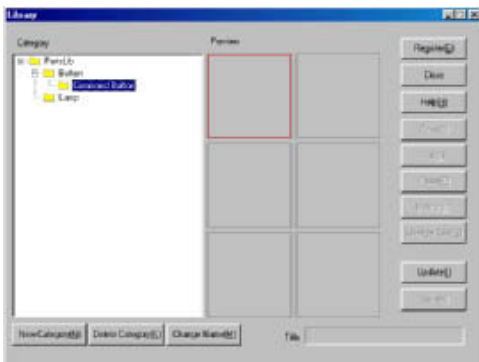

4. Click the **Paste** Button.

Deleting Library Objects

Deletes objects from the library.

1. Select the library object to be deleted.
2. Click the **OK** Button.

Reference

- ◆ In contrast to the cut operation, deleted library objects cannot be pasted elsewhere. Be careful when deleting objects.

Changing Library Object Titles

Changes library object titles.

1. Select the library object for which the title is to be changed.
2. Click the **Change Title** Button.
3. The Library Title Dialog Box will be displayed. Set the new title and click the **OK** Button.

Refreshing Information

Data is refreshed from the Library Dialog Box.

Click the **Update** Button.

Viewing Library Object Previews

The view function opens and displays library object previews in a separate dialog box. If the library object is smaller than the display area in the dialog box, the object will be displayed at full size. If the object is larger than the display area, the size will be adjusted to fit the display area.

Click the **View** Button.

The library object will be displayed in a different dialog box.

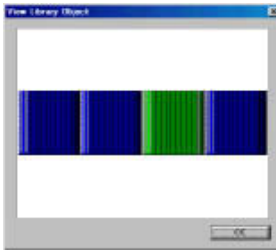

5-14 Object Defaults

Property settings when objects are placed on screens can be specified. Defaults can be set for each functional object type and common fixed object defaults can be set.

5-14-1 Registering Defaults

Specific property values are registered as defaults. Registered properties are used as the defaults for the subsequent functional or fixed objects created.

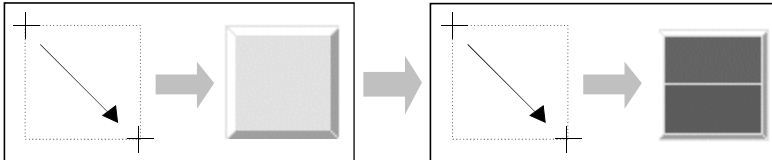

1. Display the Property Dialog Box for the functional or fixed object with the properties to be registered as defaults.
2. Select (turn ON) **Use as default**.

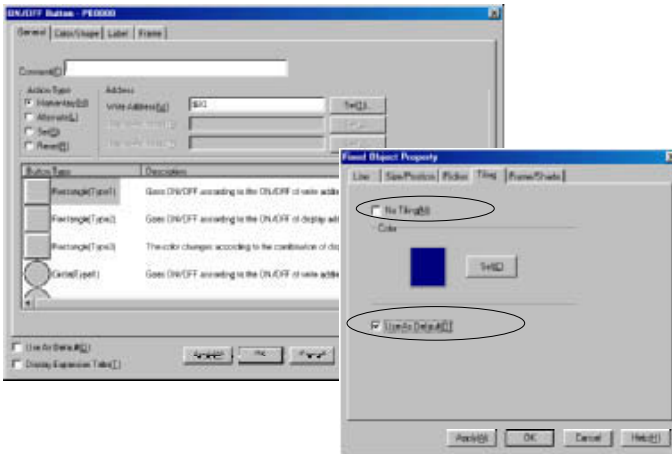

Reference

- ◆ Whether or not *Record Operation Log* in the Write Tab Page is checked cannot be set as a default.

5-14-2 Resetting Defined Defaults

Returns properties registered as defaults to the NS-Designer default settings.

1. Select **Settings – Reset Defined Default** and then select **Functional Object/Fixed Object**.
2. A dialog box to confirm the reset operation will be displayed. Click the **Yes** Button.



3. A dialog box to notify that the reset operation has been completed will be displayed. Click the **OK** Button.



5-15 Editing Background Bitmaps

Image editing software can be started and BMP or JPEG files of background bitmaps can be created and edited.

1. Select **Tools – Edit Background Bitmap**.

The image editor will open.

Reference

- ◆ If a background bitmap has been set already, that data will be read automatically.
- ◆ If new BMP or JPEG files are to be used as background bitmaps, settings must be made in the Screen Properties Dialog Box. Refer to *4-1 Basic Operations* for details.
- ◆ The image editor that will be opened depends on the settings under *Tools – Options*. Refer to *5-16 Options* for details.
This menu cannot be selected if no image editor has been set.

5-16 Options

Makes optional settings for NS-Designer operations.

1. Select **Tools – Options**.
The Option Dialog Box will be displayed.
2. Make the settings and then click the **OK** Button.

Optional settings consist of the 3 types shown below.

5-16-1 Color Dialog

Selects the type of Set Color Dialog Box that will be displayed for setting colors. If *User Palette* is selected, up to 15 colors can be registered on the palette.

Click the **Test** Button to display a sample dialog box.

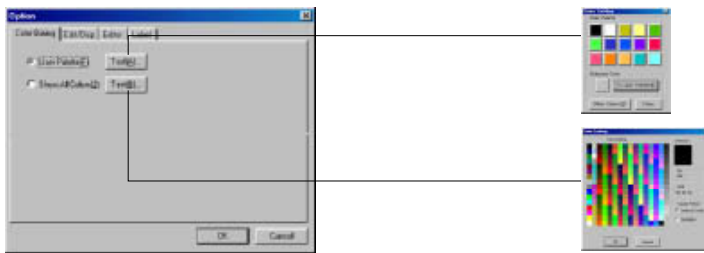

5-16-2 Edit/Disp.

Makes the settings for editing objects.

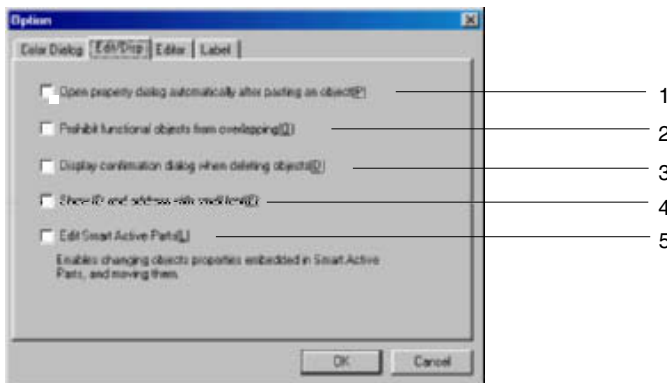

No.	Setting	Details
1	Open property dialog automatically after pasting an object	Select this option to display the Property Setting Dialog Box immediately after pasting an object.
2	Prohibit functional objects from overlapping	Select this option to prohibit functional objects from overlapping.
3	Display confirmation dialog when deleting objects	Select this option to display a confirmation dialog box when cutting or deleting objects.
4	Show ID and address with small font	Select this option to display the ID number in small font when displaying the ID.
5	Edit Smart Active Parts (SAP)	Select this option to open the property dialog of frames and functional objects that compose Smart Active Parts (SAP) without ungrouping the objects/frames. By enabling this option, objects can also be moved and the size of the objects can be changed.

Reference

- ◆ Fixed objects can still be overlapped even if *Prohibit functional objects from overlapping* is selected (turned ON).

5-16-3 Editor

Specifies the editor used when editing text or bitmap files.

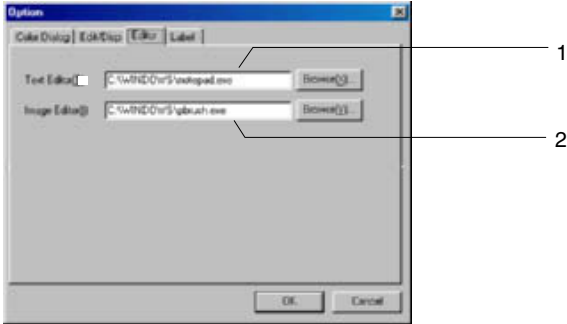

No.	Setting	Details
1	Text Editor	Specifies the editor execution file name used when editing text files.
2	Image Editor	Specifies the editor execution file name used when editing bitmap files.

Reference

- ◆ The executable file path for each editor depends on the operating system. Re-specify the editor execution file if the operating system has been changed.

5-16-4 Labels

The magnification can be specified for automatic adjustment of font sizes set for labels in functional objects.

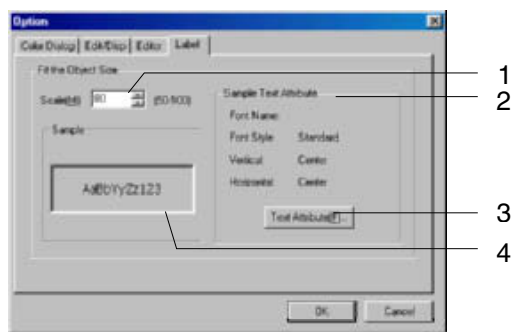

No.	Setting	Details
1	Scale	Set the scale for automatically adjusting the font size. The magnification can be set between 50 and 100 (default: 80).
2	Sample Text Attribute	Display the information on text attributes in the sample display.

NS-Designer Operation Manual

No.	Setting	Details
3	Text Attribute	Display the text attributes dialog box by clicking this button. The information on text attributes set here is displayed as the sample text attributes.
4	Sample	Display as a sample the information after changing automatic adjustment scale or font attributes.

Reference

- 1 The font size and text color cannot be changed in the text attributes dialog box. The scale of raster fonts also cannot be changed. Therefore, font name pull-down menus are not displayed.
- 2 The following message will be displayed if the screen data being edited has not been saved when the Label Tab is selected from *Tools – Options*.

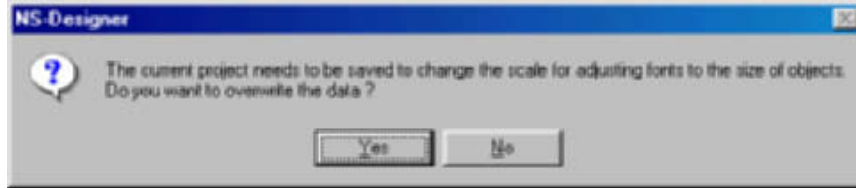

If this screen is displayed for screen data that has already been saved, click the **Yes** Button and save the screen data. Click the **No** Button to return to the Label Tab without saving the screen data.

- 3 Set the scale level and then click the **OK** Button in the option dialog box. The following message will be displayed.

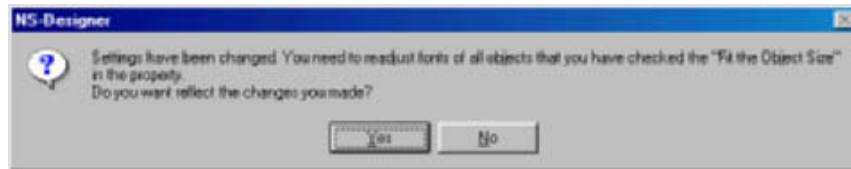

Click the **Yes** Button to select fitting to the Object Size using the set scale. This setting will apply to all the functional object labels for which the option *Fit the object size* is selected.

Section 6 Programming Macros

Macros are functions that execute extra user-specified programs for projects, screens, and functional objects. Arithmetic operations, discrimination between conditions, and other functions that are not normally supported can be added by the user.

6-1 Registering Macros.....	6-1
6-2 List of Error Messages.....	6-8

6-1 Registering Macros

Macros can be registered to projects, screens, and functional objects.

Register the macro by selecting the macro execution conditions and inputting the macro program in the Edit Macro Dialog Box.

Click the OK Button after editing the macro to execute an error check. When an error is detected, an error message will be displayed in the error list. Refer to 6-2 List of Error Messages for details on the messages displayed when errors occur. Macro editing cannot be exited until no errors occur.

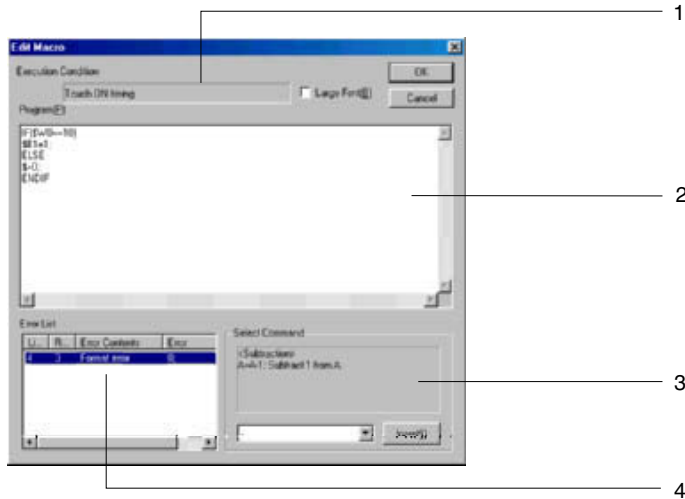

No.	Setting	Details
1	Execution Condition	Displays the execution conditions for the selected macro.
2	Program	The field used to input the macro program. Up to 3,000 characters can be input for one macro.
3	Select Command	When a command is selected from the combo box, an explanation of the selected command will be displayed above the combo box. Click the Insert Button to insert the selected command in the program input field.
4	Error List	Click the OK Button to display the error messages for the errors detected when the error check is executed. When each error in the error list is double-clicked, the cursor will move to the position in the program input field where the error was detected.

Reference

- ◆ Refer to the online manual under *Macro* in the Manual Folder in the NS-Designer Program Folder for information on macro programming methods. To access the manual, however, the online manual option must be selected when installing the NS-Designer.

6-1-1 Registering Macros to Projects

Use the following procedure to register macros to projects.

1. Select **Settings - Project properties**.
2. The Project Properties Dialog Box will be displayed. Click the **Macro** Tab.

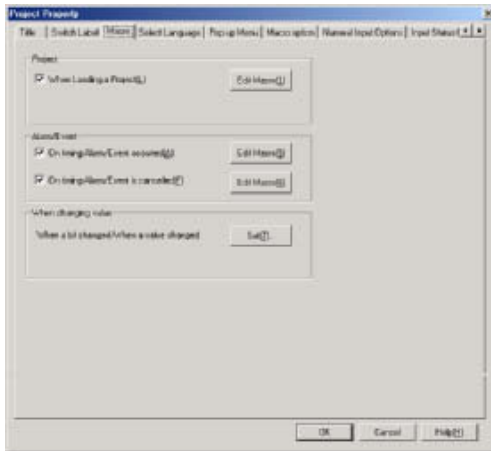

3. Select from the following four execution conditions.

Macro execution condition	Description
When Loading a Project	Executes the macro immediately before loading the first screen after a project is opened.
On timing Alarm/Event occurred	Executes the macro when an alarm occurs.
On timing Alarm/Event is cancelled	Executes the macro when the alarm is cleared.
When a bit changed/When a value changed	Executes the macro when the bit of the specified address turns ON or OFF or when the value of the word of the specified address changes.

4. Click the **Edit Macro** Button to display the Edit Macro Dialog Box.
5. Input the program and then click the **OK** Button.

When a Bit Changes

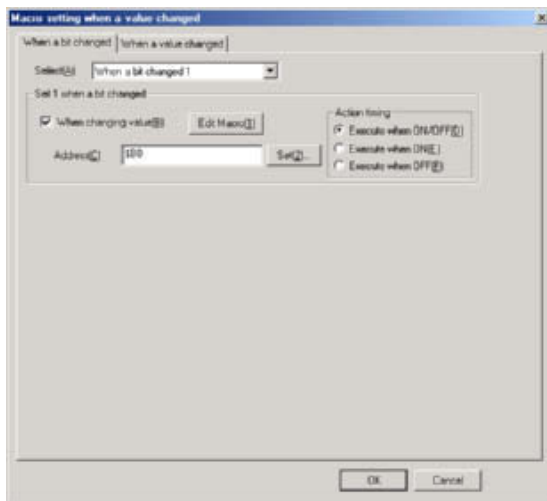

NS-Designer Operation Manual

No.	Setting	Details
1	Select	Selects the bit change macro to set from <i>When a bit changed 1</i> to <i>When a bit changed 10</i> .
2	When changing value	Causes the bit change macro specified in 1, above, to be executed.
3	Action timing	Sets the timing for executing the macro.
	Execute when ON/OFF	Executes the macro when the specified bit turns ON or OFF.
	Execute when ON	Executes the macro when the specified bit turns ON.
	Execute when OFF	Executes the macro when the specified bit turns OFF.

When a Word Value Changes

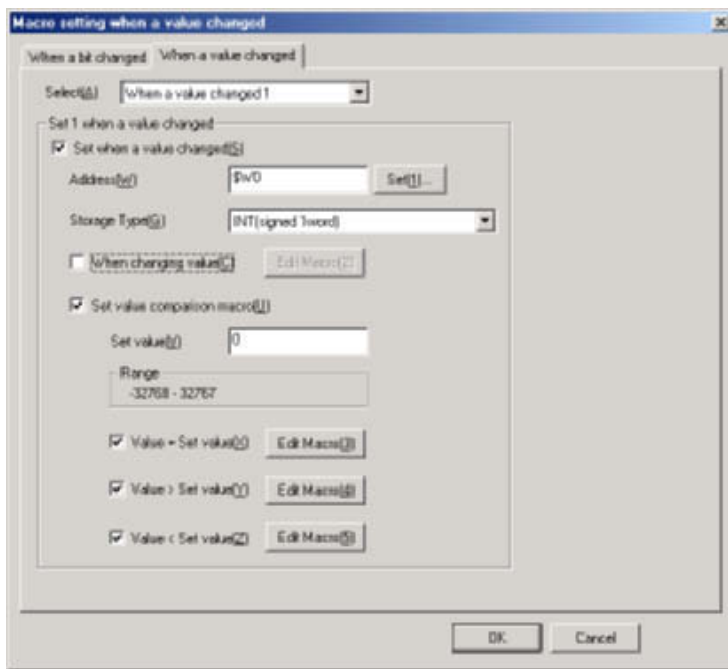

No.	Setting	Details
1	Select	Selects the bit change macro to set from <i>When a value changed 1</i> to <i>When a value changed 10</i> .
2	Set x when a value changed	Causes the value change macro specified in 1, above, to be executed.
3	Address	Specify the communications address to be monitored.
4	Storage type	Sets the storage type of the communications address to one of the following 10 types: INT (signed 1 word) UINT (unsigned 1 word) DINT (signed 2 words) UDINT (unsigned 2 words) BCD2 (unsigned 1 word) BCD2 (unsigned 2 words) BCD1 (signed [leftmost digit: F] 1 word) BCD1 (signed [leftmost digit: F] 2 words) BCD2 (signed [leftmost bit: 1] 1 word) BCD2 (signed [leftmost bit: 1] 2 words)

No.	Setting	Details
5	When changing value	Executes when the value at the communications address changes.
6	Set value comparison macro	Executes the macro as given below based on comparing the value stored at the specified address and the set value.
	Value = Set value	Executes the macro when the value at the specified address equals the set value.
	Value > Set value	Executes the macro when the value at the specified address is greater than the set value.
	Value < Set value	Executes the macro when the value at the specified address is less than the set value.

Reference

- ◆ If the bits/values at specified addresses changed at the same time, macros are executed in the following order.

Case	Macro execution order
Specified addresses for macros turn ON/OFF at the same time.	Executed in order from <i>When a bit changed 1</i> to <i>When a bit changed 10</i> .
The same address is specified for multiple bit change macros.	Executed in order from <i>When a bit changed 1</i> to <i>When a bit changed 10</i> .
The values for specified addresses for macros change at the same time.	Executed in order from <i>When a value changed 1</i> to <i>When a value changed 10</i> .
The same address is specified for multiple value change macros.	Executed in order from <i>When a value changed 1</i> to <i>When a value changed 10</i> .
The address set for an alarm/event macro turns ON at the same time as an address for a bit/value change macro changes.	Executed in order from the trigger macro and then the alarm/event macro.

Registering Macros to Screens

Use the following procedure to register macros to screens.

1. Select **Settings - Screen properties**.
2. The Screen Properties Dialog Box will be displayed. Click the **Macro** Tab.

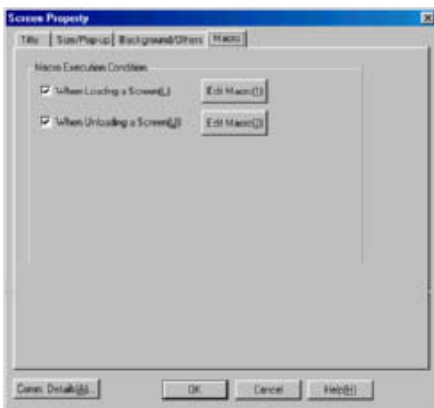

3. Select from the following execution conditions.

Macro execution condition	Description
When Loading a Screen	Executes the macro immediately before displaying the screen after it is opened.
When Unloading a Screen	Executes the macro immediately before the page is switched after closing the screen.

4. Click the **Edit Macro** Button to display the Edit Macro Dialog Box.
5. Input the program and then click the **OK** Button.

6-1-2 Registering Macros to Functional Objects

Use the following procedure to register macros to functional objects.

1. Display the Properties Dialog Box for the functional object where the macro is to be registered.
2. Select *Display Expansion Tab* at the bottom left of the dialog box, and then select the **Macro** Tab that is displayed.

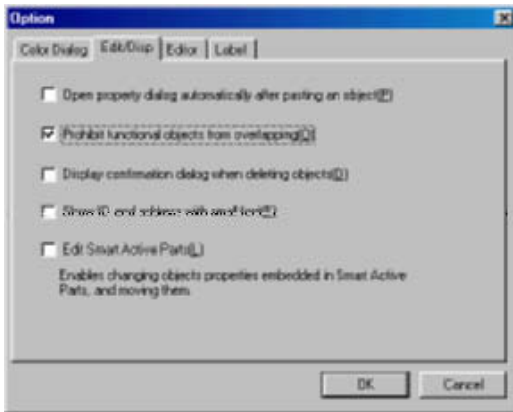

3. Select from the following execution conditions. The execution condition depends on the functional object used.

Macro execution condition	Description
Touch ON Timing	Executes macro the instant the functional object is pressed.
Touch OFF Timing	Executes macro the instant the functional object is released after being pressed.
Before Inputting Numeral/String	Executes the macro immediately before the tenkey and virtual keyboard for inputting numerals and character strings are displayed.
Before Writing Numeral/String	Executes the macro immediately before the host is notified of the numeral or character string that was input.
When Changing Numeral/String	Executes the macro when the value in the address changes.
When Pressing a Display Area	Executes the macro the instant the alarm display area is pressed.
When Selecting an Alarm/Event	Executes the macro immediately after selecting each alarm/event that is displayed in the Alarm/Event Summary History field.
When Selecting a List	Executes the macro immediately after selecting a line from the list selection objects.

4. Click the **Edit Macro** Button to display the Edit Macro Dialog Box.
5. Input the program and then click the **OK** Button.

The execution conditions that can be selected for each functional object are shown in the following table.

Functional object	Touch ON Timing	Touch OFF Timing	When Changing Numeral/String	Before Inputting Numeral/String	Before Writing Numeral/String	When Selecting a List
ON/OFF Buttons	Yes	Yes	No	No	No	No
Word Buttons	Yes	Yes	No	No	No	No
Command Buttons	Yes	Yes	No	No	No	No
Bit Lamp	No	No	Yes	No	No	No
Word Lamp	No	No	Yes	No	No	No
Numeral Displays & Inputs	No	No	Yes	Yes	Yes	No
String Displays & Inputs	No	No	Yes	Yes	Yes	No
Thumbwheel switches	No	No	Yes	No	Yes	No
Text	No	No	No	No	No	No
List Selection	No	No	No	No	No	Yes
Level Meter	No	No	No	No	No	No
Broken-line Graph	No	No	No	No	No	No
Bitmap	No	No	No	No	No	No
Analogue Meter	No	No	No	No	No	No
Video Display	No	No	No	No	No	No
Date	No	No	No	No	No	No
Time	No	No	No	No	No	No
Data Log Graph	No	No	No	No	No	No
Data Block Table	No	No	No	Yes	Yes	No
Temporary Input	No	No	No	No	No	No

Alarm/Event Objects

Functional object	When Pressing a Display Area	When Selecting an Alarm/Event
Alarm/Event Display	Yes	No
Alarm/Event Summary & History	No	Yes

6-2 List of Error Messages

The following table shows the details of error messages that are displayed in the Error List field after executing an error check.

Error message	Details
Format error	The program contains elements other than variable name, function name, or programming that cannot be interpreted.
Variable name error	A variable name is incorrect.
(is missing	The ((left parentheses symbol) is missing from a function or sentence.
No. of () does not agree	The number of () (parentheses) in the program do not agree.
Position of , is incorrect	The position of the , (comma) in the program is incorrect.
Function argument error	The program contains an incorrect function argument, such as word memory being set in a position that permits bit memory only. Check the arguments that can be set by referring to <i>2-1 Function Argument Table</i> in the <i>NS12 Macro Reference</i> included on the NS-Designer CD-ROM.
= command error	The program contains an incorrect substitution statement, such as 3=10 or \$B0=3.
End of program is incomplete	The program that was input is incomplete.
If sentence error	The program contains an incorrect IF, ELSE, or ENDIF statement.
, or ; is missing	The , (comma) after the function argument is missing or the program is not divided using a ; (semicolon).
FOR sentence error	A value outside the range 0 to 32767 is set for n in a FOR (n) statement, or FOR is nested to more than 1 level.

Section 7 System Settings

This section describes how to set the PT's operating parameters and address allocations.

7-1 Settings	7-1
--------------------	-----

7-1 Settings

7-1-1 Common Procedure

Select **Settings - System Setting**. The System Setting Dialog Box will be displayed.

7-1-2 PT Operations

Click the **PT** Tab.

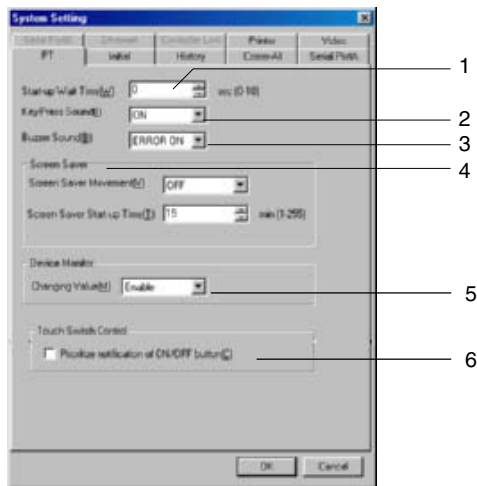

No.	Setting	Details
1	Startup Wait Time	Set the time required before the PT starts communicating with external devices after turning ON the power or resetting the PT. The startup waiting time can be set to between 0 and 10 (unit: s).
2	Key Press Sound	Select whether an input sound will be heard when an object is pressed. ON: Input sound enabled OFF: Input sound disabled
3	Buzzer Sound	Select whether a buzzer will be heard. ON: The buzzer is enabled at the following times: <ul style="list-style-type: none"> When system memory bits \$SB12 to \$SB14 are ON When an error occurs in the PT When a message is displayed for the “x” and “!” icons OFF: The buzzer is disabled ERROR ON: The buzzer is enabled at the following times: <ul style="list-style-type: none"> When an error occurs in the PT When a message is displayed for the “x” and “!” icons
4	Screen Saver	Set the various screen saver settings.
	Screen Saver Movement	Select one of the following screen saver operations. Display Erased: Erases the screen when it is idle for a specified time. OFF: Disables the screen saver.
	Screen Saver Startup Time	Set the amount of time after which the screen saver will start up. The time can be set to between 1 and 255 (unit: s).
5	Device Monitor Changing Value	Set whether to enable or disable changing monitor values for addresses displayed on the device monitor screen on the PT. Enable: Monitor value can be changed. Disable: Monitor value cannot be changed.

NS-Designer Operation Manual

No.	Setting	Details
6	Prioritize notification of ON/OFF Button	Select to prioritize notification of ON/OFF Button notification.

7-1-3 Initial

Click the **Initial** Tab.

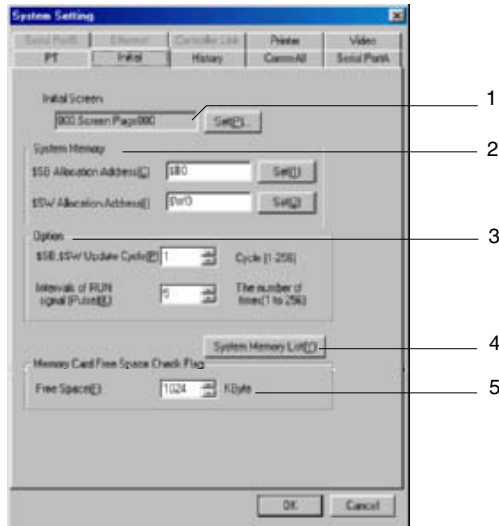

Setting	Details
1 Initial Screen	Select the initial screen to be displayed when the PT starts operation.
2 System Memory	Set the addresses where system memory is allocated.
\$SB Allocation Address	System bit memory can be allocated in the PLC (host) memory area or in \$B. Set the address to a multiple of 16. When \$SB is allocated as host memory, the bit number is not set. A total of 53 bits of bit memory starting from the specified address will be used as system memory. Example: If Serial A is set to DM 00000, the correspondence with \$SB is as follows: \$SB0 Serial A: DM 00000.00 \$SB1 Serial A: DM 00000.01 to \$SB52 Serial A: DM 00003.04
\$SW Allocation Address	System word memory can be allocated in the PLC (host) memory area or in \$W. A total of 39 words of word memory starting from the specified address are used as system memory.
3 Options	Set the system memory update cycle and RUN signal (pulse) interval.
\$SB, \$SW Update Cycle	Set the update cycle for \$SB and \$SW. The cycle can be set to between 1 and 256.
Intervals of RUN Signal (Pulse)	Set the communications interval for writing RUN signals. The interval can be set to between 1 and 256.
4 System Memory List Button	Click the System Memory List Button to display the System Memory List.
5 Memory Card Free Space Check Flag	Set the amount of free space on the Memory Card for which to issue an alarm. If the free space on the Memory Card inserted in the PT is at or below the amount of free space set here, \$SB48 will turn ON.

Reference

- ◆ Set internal memory for both \$SB and \$SW allocation addresses or set the same host address for both for them.
 Example \$SB: Serial A: 00000
 \$SW: Serial A: DM 00000
 Set the same host name (Serial A) for both \$SB and \$SW.
- ◆ TIM, CNT, TK, TU, and CU cannot be allocated for \$SB.
- ◆ TK, TU, and CU cannot be allocated for \$SW.
- ◆ Refer to 2-4 System Memory in the NS Series Programming Manual for details on the system memory.
- ◆ When changing the settings on the Comm-All Tab Page for whether the communications port, the Ethernet, and Controller Link are used, close the System Setting Dialog Box before setting the host address in \$SB or \$SW.

\$SB, \$SW Update Cycle

Data is updated between \$SB/\$SW and the allocated addresses each time the number of communications cycles specified in the \$SB, \$SW Update Cycle field is processed.

Example: When the \$SB, \$SW Update Cycle is set to three cycles.

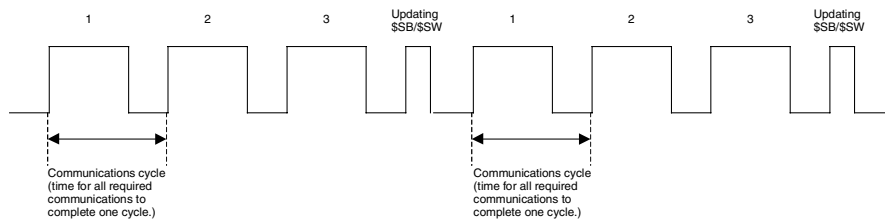

Reference

- ◆ The \$SB and \$SW are also updated when a project starts loading, switching base screens, opening or closing pop-up screens, and switching frames. After updating during these operations, updating is performed according to the setting in the \$SB, \$SW Update Cycle field.

RUN Signal Pulse Interval

The RUN signal (\$SB0, \$SB1) is output after \$SB and \$SW are refreshed the number of times set for the RUN Signal Pulse Interval.

Example: The following illustration is for when the RUN Signal Pulse Interval is set to 3.

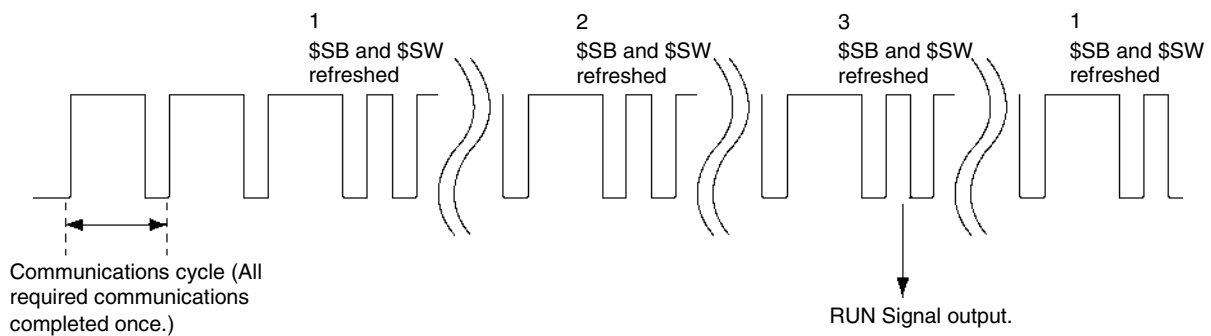

NS-Designer Operation Manual

Initial Value for System Memory

Click the **System Memory List** Button on the Initial Tab Page to display the Initial Value for System Memory Dialog Box.



The \$SB and \$SW can be set to communicate with the PLC allocation addresses set in the Initial Tab Page.

\$SB and \$SW addresses are divided into functional groups, and the user can select the groups for which to perform communications. By selecting items, communications will be performed between the selected area and the PLC address.

The default setting is for only Screen (communications with \$SW0). Change the settings as required.

The above setting example is set for communications as follows:

- \$SW0 Serial A: DM 01000
- \$SW10 to \$SW13 Serial A: DM 01010 to DM 01013

Reference

- ◆ The \$SB bits and \$SW words that are not selected in the Initial Value for the System Memory Dialog Box are set to not communicate with the PLC, and can be used. (When bits and words are not selected, it does not indicate that their use is prohibited.)

7-1-4 History

Click the **History** Tab.

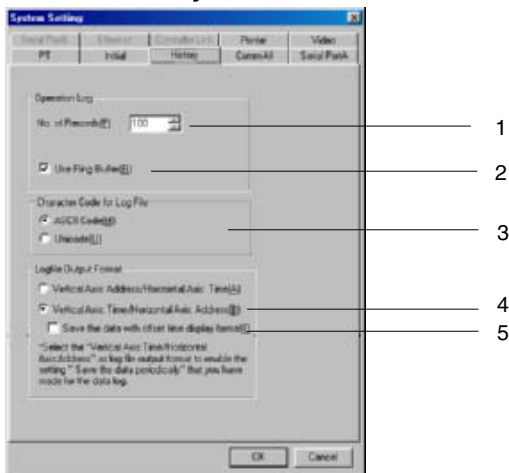

No.	Setting	Details
1	Number of Operation Log Records	Set the number of logging records to be saved in a single file. The number of records can be set to between 0 and 1,024. Set to 0 if it is not necessary to save records.
2	Use Ring Buffer	Select to record data in a ring buffer. When this setting is selected, if the maximum number of items is exceeded, the oldest data is deleted and the new data is recorded. When this setting is not selected, no more data will be recorded once the set maximum is reached.
3	Character Code for Log File	Select the character code (ASCII or Unicode) for alarm/event histories, data logs, operation logs, and error logs.
4	Logfile Output Format	Set the format for outputting the data log to a CSV file.
5	Save the data with offset time display format	Select to display the time as an offset when outputting log data from the data log to a CSV file.

7-1-5 Comm-All

This tab page is used to set the communications destination. Click the **Comm-All** Tab.

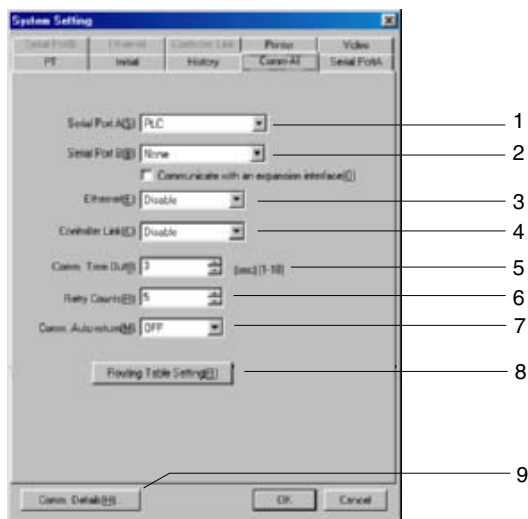

No.	Setting	Details
1	Serial Port A	Select <i>None</i> , <i>PLC</i> , <i>Bar-Code Reader</i> , <i>Temperature Controller</i> , <i>Memory Link</i> , or <i>Modem for Data Transfer</i> for the communications destination. One bar code can be set for each project.
2	Serial Port B	Select <i>None</i> , <i>PLC</i> , <i>Bar-Code Reader</i> , <i>Temperature Controller</i> , <i>Memory Link</i> , or <i>Modem for Data Transfer</i> for the communications destination. One bar code can be set for each project.
	Communicate with an expansion interface	Select this option when using an Expansion Interface for serial communications (NS5 only). This option is for future expansion only. Do not normally select it.
3	Ethernet	Select whether Ethernet will be used. Disabled: Ethernet communications not used. Enabled: Ethernet communications used.
4	Controller Link	Select whether Controller Link will be used. Disabled: Controller Link communications not used. Enabled: Controller Link communications used.
5	Comm. Time Out	Sets the time for the timeout error when a response is not received from the host. The timeout monitor time can be set to between 1 and 10 (unit: s).
6	Retry Counts	Set the number of communications retries before an error screen will be displayed when a communications error occurs while communicating with the host. If communications are unsuccessful after the number of communications retries specified in this setting have been executed, processing set for communications auto-recovery under <i>Comm. Auto-return</i> will be executed. The number of retries can be set to between 0 and 255 times.
7	Routing Table Setting	Click the Routing Table Setting Button to display the Routing Table Setting Dialog Box.
8	Comm. Auto-return	Select whether or not to use communications auto-recovery. Yes: Retries communications when a communications error occurs, without displaying the Error Message Dialog Box. No: Displays the Error Message Dialog Box when a communications error occurs. Click the OK Button in the Error Message Dialog Box to retry communications.
9	Comm. Details Button	Click this button to display a dialog box for making advanced communications settings.

Reference

- ◆ To change the communications port setting, the screen data must be changed.

Example: Changing from using serial port A only to serial port B.

1. Click the **Comm-All** Tab in the System Setting Dialog Box, and change *None* to *PLC* for serial port B (leave the serial port A set to *PLC*).

The host is registered automatically under these conditions. (The default host name is Serial B.)

2. When creating functional objects that will communicate with the PLC connected to serial port B, set the host name to *Serial B* and set the address.

When changing the communications destination of the existing functional objects to the PLC connected to serial port B, change the host name from *Serial A* (default host name when using serial port A) to *Serial B*.

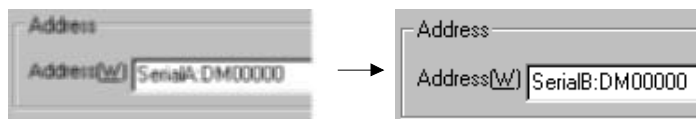

Functions such as *Replace* (refer to 5-4 Editing) and *Change Settings at Once* (refer to 5-10 Batch Settings) are useful here. Settings can be changed efficiently by using the *Import CSV File* and *Export CSV File* functions (refer to Section 12 Importing/Exporting CSV Files).

When the *Import/Export CSV File* functions are used, the whole file is exported to a CSV file, after which the exported file can be opened and functions such as *Replace* can be used to change *Serial A* to *Serial B*. (Indirect addresses and other data are not included in the CSV file. The allocations for these data must be changed separately using the NS-Designer.)

3. When serial port A is not used, click the **Comm-All** Tab in the System Setting Dialog Box, and change the serial port A setting from *PLC* to *None*.

NS-Designer Operation Manual

- ◆ When the settings for whether the communications ports are used have been changed, close the System Setting Dialog Box before setting the host address in \$SB or \$SW. Until the System Setting Dialog Box is closed, the settings that existed prior to the changes are still enabled, and the new host setting cannot be specified in the system memory allocation addresses.

Setting Routing Tables

Click the **Routing Table** Button on the Comm. All Tab Page to display the Routing Table Setting Dialog Box.

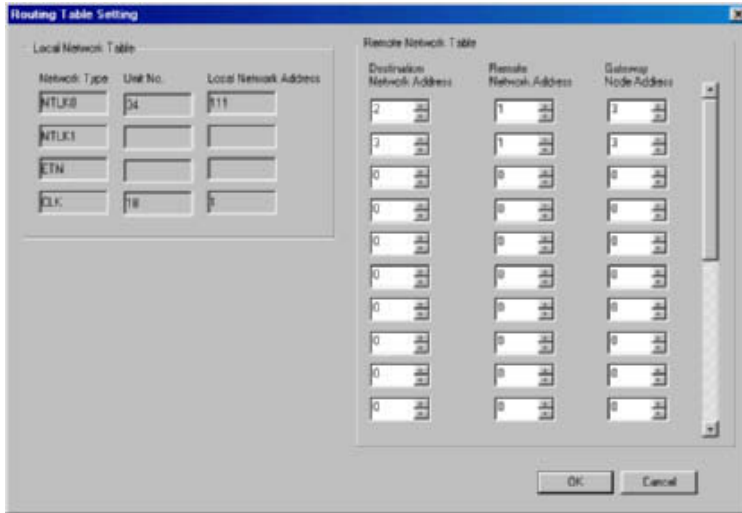

The routing tables consist of a local network table and remote network table. Routing tables are required to use messages on a Controller Link Network.

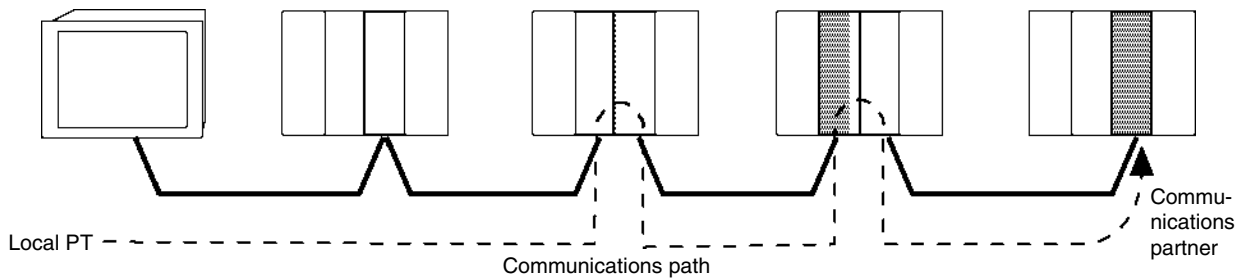

Local Network Table

The local network table is shown on the left side of the Routing Table Setting Dialog Box. The setting for Serial Port A, Serial Port B, Ethernet, and Controller Link Tabs are shown.

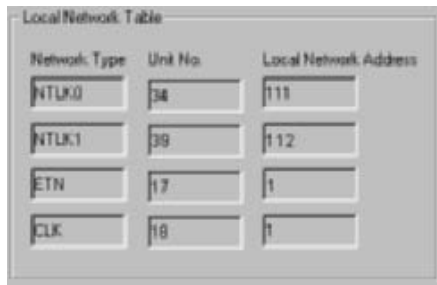

Number	Setting	Details
1	NTLK0	Information for serial port A is shown. The unit number and local network address are fixed. <ul style="list-style-type: none"> • Unit number: 34 • Local network address: 111
2	NTLK1	Information for serial port B is shown. The unit number and local network address are fixed. <ul style="list-style-type: none"> • Unit number: 39 • Local network address: 112
3	ETN	Information for Ethernet is shown. The unit number is fixed. <ul style="list-style-type: none"> • Unit number: 17 • Local network address: The number set on the Ethernet Tab Page is shown.
4	CLK	Information for Controller link is shown. The unit number is fixed. <ul style="list-style-type: none"> • Unit number: 18 • Local network address: The number set on the Controller Link Tab Page is shown.

Reference

- ◆ Close the System Setting Dialog Box after changing the settings on the Comm-All Tab Page for whether communications ports are used, or after changing settings on the Ethernet or Controller Link Tab Pages. The previous setting will remain until the dialog box has been closed.

NS-Designer Operation Manual

Remote Network Table

The remote network table provides the node and network address corresponding to the initial relay point (first point the data must pass) en route to a target network (end network) not directly connected to the local PLC. The table specifies the route from the relay point to the end network.

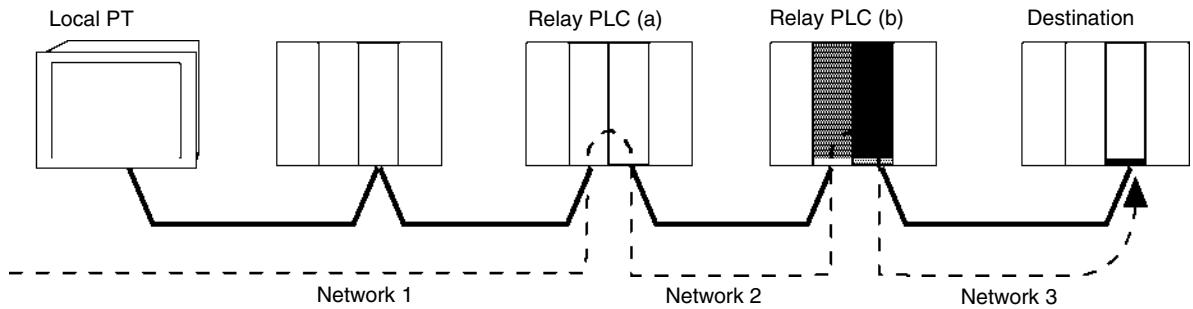

Remote Network Table		
Destination Network Address	Remote Network Address	Gateway Node Address
2	1	3
3	1	3

Number	Setting	Details
1	Destination Network Address	Set the target network address. When the target is on the local network, this setting is not required.
2	Remote Network Address	Set the network address of the first point on the way to the target network. When the target is on the local network, this setting is not required.
3	Gateway Node Address	Set the node address of the first relay point on the way to the target network. When the target is on the local network, this setting is not required.

The following diagram shows an example of a system connection and its routing tables.

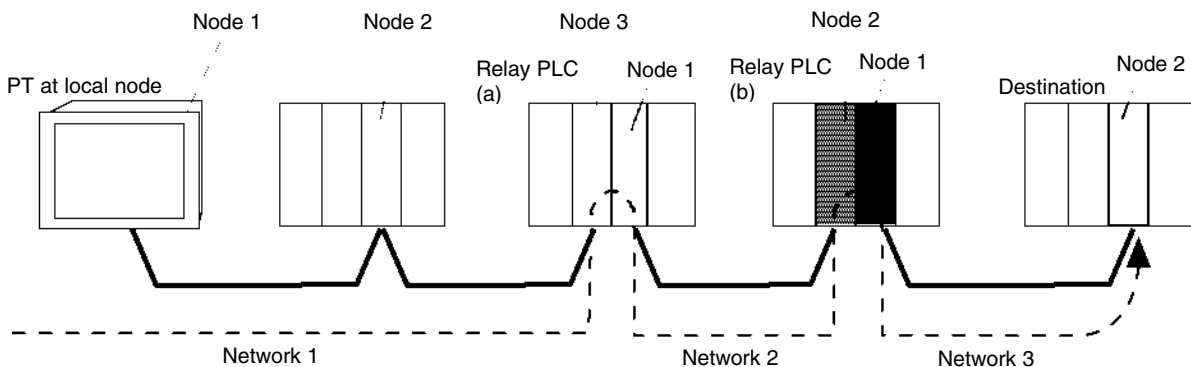

Relay Network Table for Local PT

Destination network address	Relay network address	Gateway node address
3	1	3

Meaning: To go to network 3, first go to node 3 of network 1.

Relay Network Table for PLC (a)

Destination network address	Relay network address	Gateway node address
3	2	2

Meaning: To go to network 3, first go to node 2 of network 2.

Relay Network Table for PLC (b)

Destination network address	Relay network address	Gateway node address
1	2	1

Meaning: To go to network 1, first go to node 1 of network 2.

Relay Network Table for Destination Node

Destination network address	Relay network address	Gateway node address
1	3	1

Meaning: To go to network 1, first go to node 1 of network 3.

Comm. Details

The Comm. Details Dialog Box will be displayed if the **Comm. Details** Button is clicked on the Comm-All Tab page.

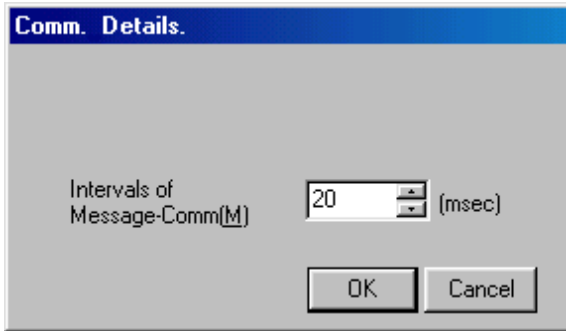

Set the interval of message communications, i.e., the time from starting all communications required on the screen until the next communications are started. The interval can be set to between 2 and 200 ms.

The following examples illustrate operation when the interval set here differs from the time required for actual communications.

Example: Actual Communications Longer than Set Interval

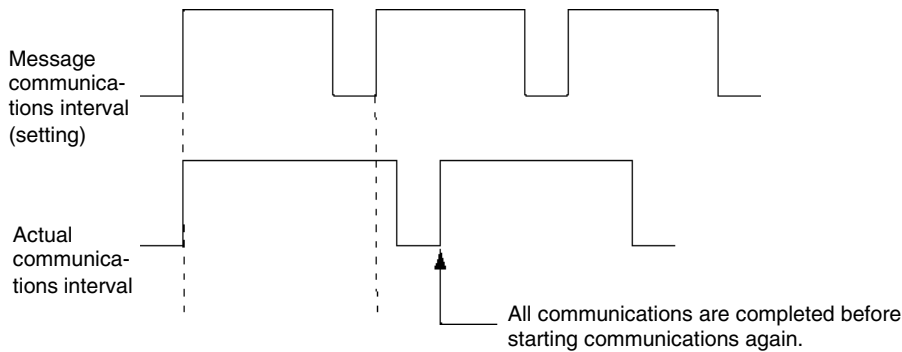

Example: Actual Communications Shorter than Set Interval

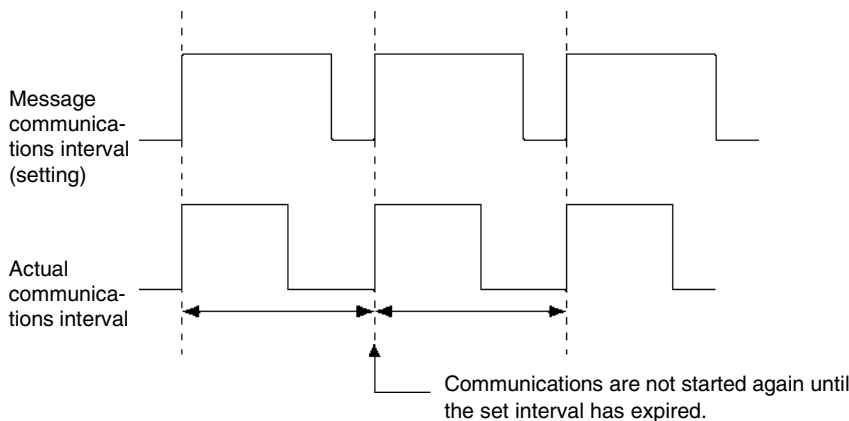

7-1-6 Detailed

The advanced settings are used to set the details of the communications method selected from the Comm-All Tab Page.

Serial Port A and Serial Port B

Select *PLC* or *Bar-Code Reader* under *Serial Port A* or *Serial Port B* in the Comm-All Tab Page to enable the Serial Port A Tab Page or Serial Port B Tab Page.

When Communications Destination Is Set to *PLC*:

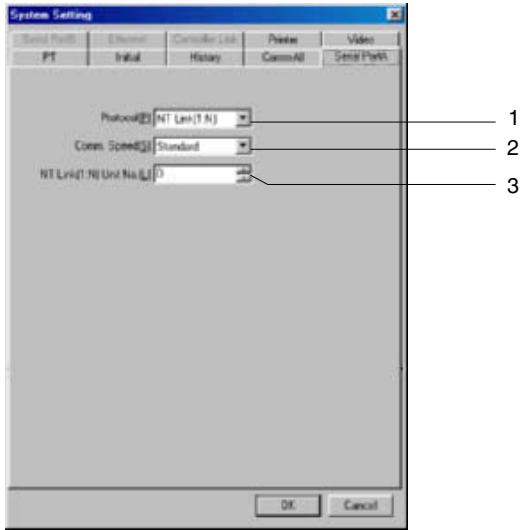

No.	Setting	Details								
1	Protocol	<p>Select the protocol from 1: 1 NT Link, 1: N NT Link, or Host Link.</p> <table border="1"> <thead> <tr> <th>Using both serial ports A and B</th> <th>Supported/not supported</th> </tr> </thead> <tbody> <tr> <td>1: 1 NT Link + 1: 1 NT Links</td> <td>Supported</td> </tr> <tr> <td>1: 1 NT Link + 1: N NT Links</td> <td>Supported</td> </tr> <tr> <td>1: N NT Links + 1: N NT Links</td> <td>Supported</td> </tr> </tbody> </table>	Using both serial ports A and B	Supported/not supported	1: 1 NT Link + 1: 1 NT Links	Supported	1: 1 NT Link + 1: N NT Links	Supported	1: N NT Links + 1: N NT Links	Supported
Using both serial ports A and B	Supported/not supported									
1: 1 NT Link + 1: 1 NT Links	Supported									
1: 1 NT Link + 1: N NT Links	Supported									
1: N NT Links + 1: N NT Links	Supported									
2	Comm. Speed	<p>Select the communications speed. The communications speed range depends on the protocol setting. Refer to the following table for applicable ranges.</p> <table border="1"> <thead> <tr> <th>Protocol</th> <th>Transfer speed selection range</th> </tr> </thead> <tbody> <tr> <td>1: N NT Links</td> <td>Normal or high-speed</td> </tr> <tr> <td>1: 1 NT Link</td> <td>No settings</td> </tr> <tr> <td>Host Link</td> <td>9,600 or 19,200 bps</td> </tr> </tbody> </table>	Protocol	Transfer speed selection range	1: N NT Links	Normal or high-speed	1: 1 NT Link	No settings	Host Link	9,600 or 19,200 bps
Protocol	Transfer speed selection range									
1: N NT Links	Normal or high-speed									
1: 1 NT Link	No settings									
Host Link	9,600 or 19,200 bps									
3	NT Link (1: N) Unit No.	<p>Select the unit number for the 1: N NT Link from 0 to 7. When a 1: 1 NT Link is selected as the protocol, this setting is not required.</p>								

NS-Designer Operation Manual

When Communications Destination Is Set to *Bar-Code Reader*:

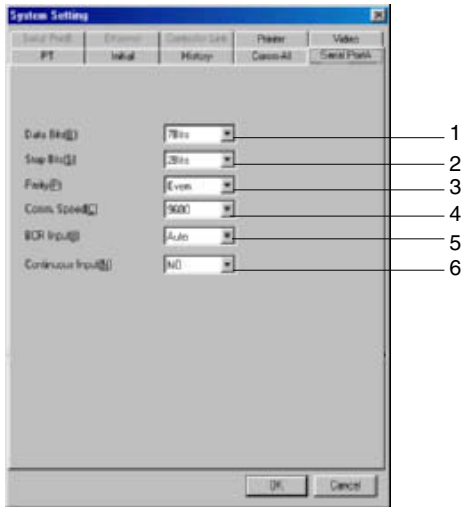

No.	Setting	Details
1	Data Bits	Select the data bit length for the bar code reader from 7 or 8 bits.
2	Stop Bits	Select the data stop bit length for the bar code reader from 1 or 2 bits.
3	Parity	Select the data parity bits for the bar code reader from none, even, or odd.
4	Baud Rate	Select the baud rate for communications with the bar code reader from 4,800, 9,600, or 19,200 bps.
5	BCR Input	Select the confirmation method used after inputting data in the input column from the following options. Auto: Automatically confirms data when it is read from the bar code reader. Manual: Confirms data when the Enter Key is pressed. Data and character strings can be added.
6	Continuous Input	Set whether to move focus to the next object when confirming bar code inputs. This setting can be enabled when <i>BCR Input</i> is set to <i>Auto</i> .

Ethernet

Click the **Ethernet** Tab.

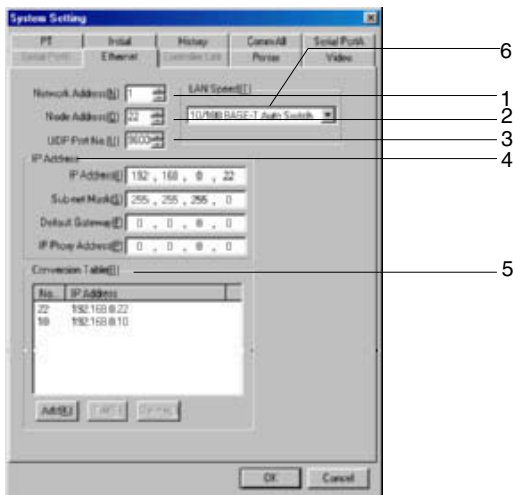

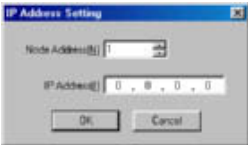
No.	Setting	Details
1	Network Address.	Set the network number of the Ethernet network to which the PT is connected. The number can be set between 1 and 127.
2	Node Address	Set the node address of the PT in the Ethernet network. The address can be set between 1 and 254.
3	UDP Port No.	Set the UDP port number to be used. The number can be set between 1024 and 65535.
4	IP Address	
	IP Address	Set the IP address of the Ethernet to which the PT is connected. The IP address can be set between 0.0.0.0 and 255.255.255.255.
	Sub-net Mask	Set the subnet mask of the Ethernet to which the PT is connected. The subnet mask can be set between 0.0.0.0 and 255.255.255.255.
	Default Gateway	Set the IP router for communications with other networks. The default gateway can be set between 0.0.0.0 and 255.255.255.255.
	IP Proxy Address	Set the IP address or IP proxy address of the transmission destination for Ethernet communications. Set the address between 0.0.0.0 and 255.255.255.255.
5	Conversion Table	<p>Create the conversion table converting FINS node addresses to IP addresses for Ethernet communications. Up to 32 address combinations can be registered.</p> <p>Procedure</p> <ul style="list-style-type: none"> • Adding Settings <ol style="list-style-type: none"> 1. Click the Add Button to display the following dialog box.  <ol style="list-style-type: none"> 2. Set the node address and the IP address to be converted to, and then click the OK Button. The setting range is as follows: <ul style="list-style-type: none"> Node address: 1 to 253 IP address: 0.0.0.0 to 255.255.255.255 <ul style="list-style-type: none"> • Editing or Deleting Settings <p>Select the setting to be edited or deleted.</p> <p>Click the Edit Button or the Delete Button.</p>
6	LAN Speed	Select the method for setting the Ethernet speed from <i>10/100BASE-T Auto Switch</i> or <i>10BASE-T Fixed</i> .

Controller Link

Click the **Controller Link** Tab.

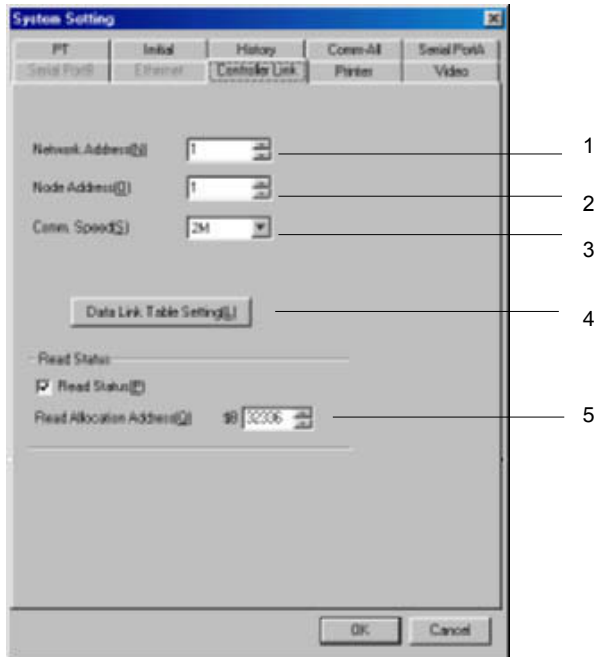

No.	Setting	Details
1	Network Address	Set the network number of the Controller Link Network to which the PT is connected. The number can be set between 1 and 127.
2	Node Address	Set the node number of the PT on the Controller Link Network. The number can be set between 1 and 32.
3	Comm. Speed	Select the baud rate from 500 Kbps, 1 Mbps, or 2 Mbps.
4	Data Link Table Setting	Click the Data Link Table Setting Button to display the Data Link Table Setting Dialog Box. .Refer to page 7-14 for details.
5	Read Status	Set whether the Controller Link Status is read and set the address to which status is read. The address can be set to between \$B0 and \$B 32336.

Setting Data Link Tables

Data Link tables show the way that data is linked. Data link tables can be set using Controller Link Support Software or the CX-Net (Network Setting Tool). The data link tables can only be specified on the NS-Designer.

Click the **Data Link Table Setting** Button to display the Data Link Table Setting Dialog Box.

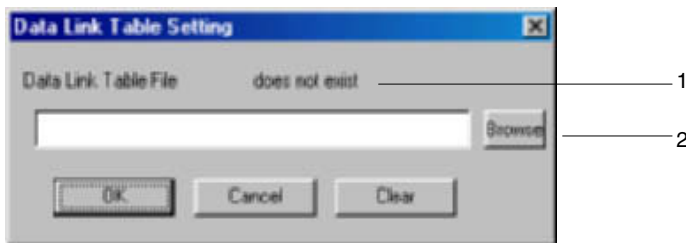

Number	Details				
1	Display whether the Data Link Tables exist in the folder storing the project file. Examples: No Data Link Tables: <table border="1"> <tr> <td>Data Link Table File</td> <td>does not exist</td> </tr> </table> Data Link Table exists: <table border="1"> <tr> <td>Data Link Table File</td> <td>exist</td> </tr> </table>	Data Link Table File	does not exist	Data Link Table File	exist
Data Link Table File	does not exist				
Data Link Table File	exist				
2	Used to select the Data Link Table file. A file name with extension .cl3 must be set. Click the Browse Button and select the Data Link Table file. The specified Data Link Table will be resaved as ClkDLink.cl3 in the project folder.				

Note

- ◆ Delete the data link tables from any node that is not participating in the data links.

Reference

- Any file name can be set when creating data link tables using Controller Link Support Software or CX-Net. Specifying Data Link Tables in the Data Link Table Setting Dialog Box on NS-Designer. The file will be saved as ClkDLink.cl3 in the project folder.
- Data link tables can be set via a network. Set data link tables in the Controller Link I/F Unit using CX-Net or Controller Link Support Software. Data Link Tables are not set in NS-Designer. Setting data link tables via a network can be used to change data link tables.
- When setting data link tables on the NS-Designer, the data link tables cannot be changed via network. If the user attempt to change the settings of data link tables using Controller Link Support Software or CX-Net, the settings in NS-Designer will remain. For this reason, projects and setting files must be re-transferred to the PT when changing data link tables.

Read Status

Status indicates the operating status (network status), such as error information in the Controller Link network and node participation status, and operating status (data link status). Reading the status makes it possible to check whether an error has occurred and whether the machine is operating correctly.



When any \$B address within the range is set in the *Status Allocation Address*, the address will be the start address of 27 consecutive addresses to which status will be read. Refer to *the Operation Manual Appendix 8 Details of CLK Status* for details on the allocation addresses.

7-1-7 Printer

Select the Printer Tab Page.

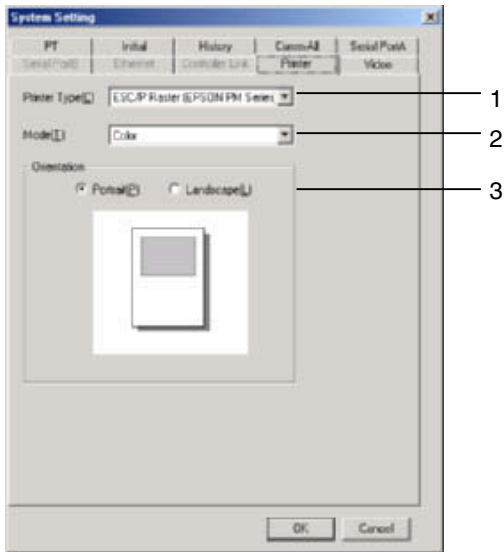

Number	Setting	Details
1	Printer Type	Select either ESC/P Raster or BJ Raster as the printer's control method.
2	Mode	Select from the following: <ul style="list-style-type: none"> • Color • Monochrome • Monochrome (inverse)
3	Orientation	Select to change the orientation of the paper. <ul style="list-style-type: none"> • Portrait • Landscape

7-1-8 Video

Select the Video Tab Page.

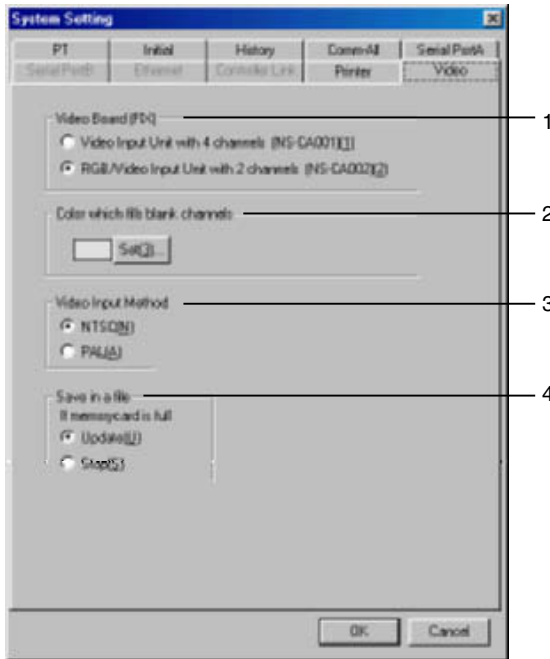

Number	Setting	Details
1	Video Board	Select the type of Video board to be installed in the PT. If this setting is changed, conversion processing will be executed for projects currently being edited.
2	Color which fills blank channels	<p>Set when using an NS-CA002 RGB/Video Input Unit. If the same color set in the video display color is set for graphics such as functional objects, the part overlapping the video display objects will be displayed as a video image and other parts will be displayed in black.</p> <p>Color to fill the rectangle is set to the same color as the video display.</p> <p>Graphic (rectangle)</p> <p>Video display object</p> <p>The section that overlaps the video image is displayed as a transparent image. The section outside the boundary of the video image is displayed in black.</p> <p>Graphic (rectangle)</p>
3	Video Input Method	Select the input method for video signals. This setting is used for all video input from the video card.
4	Save in a file if memory card is full	<p>Set the action to perform if the Memory Card is full when capturing video images using system memory.</p> <p>Update: If the same file name exists, delete the oldest file and save the newer file.</p> <p>Stop: The file will not be saved.</p>

Section 8 Testing

This section describes the test execution methods and test tool.

8-1 Test Function.....	8-1
8-2 Test Tool.....	8-6

8-1 Test Function

The test function is used to manipulate data created on screen in the NS-Designer to check screen data operation without transferring data to the PT.

Pressing buttons, changing addresses, and operating and displaying functional objects can be tested without the PT being used.

Executing Tests

1. Save projects and screens before executing a test.
2. Select **Tools - Test**.
The Test Dialog Box will be displayed.
3. Set the options for executing the test.

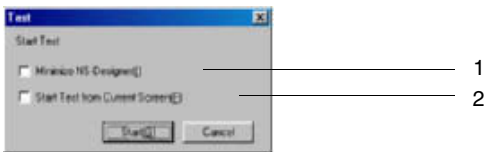

No.	Setting	Details
1	Minimize NS-Designer	Select to minimize the NS-Designer during test execution.
2	Start Test from Current Screen	Select to start the test from the screen currently at the front of the NS-Designer. When this setting is not selected, the test will start from the Initial Screen setting in the Initial Tab Page located under Settings - System Setting.

4. Click the **Start** Button to start up the test function and start the test.

Reference

- ◆ If projects and screens are not saved before a test is executed, a dialog box will be displayed confirming whether to save data when *Tools - Test* is selected. Save data before executing a test.

Test Screen

The test screen and test tool is started up when a test is executed. The test screen is first displayed with the set screen size.

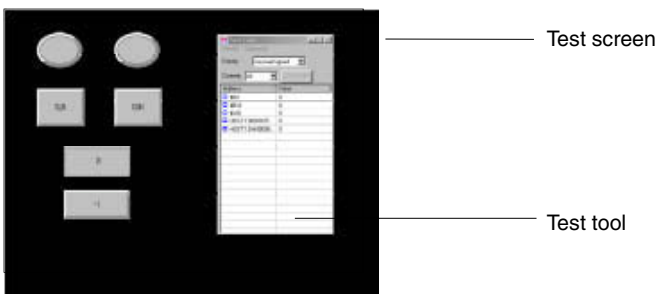

NS-Designer Operation Manual

Switching Screen Display and Style

By double-clicking a position on the test screen where no function is located, the screen display and style can be switched using the following procedure. The settings can also be switched from the View Menu.

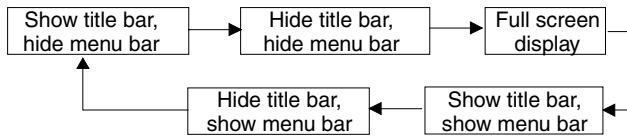

Selecting a Screen

Select **File - Select page**, and display the required screen by selecting it from the Select Page Dialog Box.

Function List

The functions in each menu of the test screen are as follows:

File Menu

Menu item	Function
Select Project	Select the project to be tested.
Select Screen	Select the screen to be displayed.
Exit	Exit the test.

View Menu

Menu item	Function
Title	Select whether to display or hide the test screen title bar.
Menu	Select whether to display or hide the test screen menu bar.
Full Screen	Switch the test screen to full screen display mode.

Option Menu

Menu item	Function
Input mode	Select the input mode for Numeral Display & Input and String Display & Input from keypad or external device (such as keyboard). While external device is selected, the menu item is displayed with a check mark.
Caption mode	Select whether to display labels or show addresses. (This function is the same as that selected under the NS-Designer <i>View - Show Address</i> .) While <i>Show Address</i> is selected, the menu item is displayed with a check mark.
About product information	Displays information on the product.

Reference

- ◆ Addresses are not displayed for data block tables.

Exiting Tests

Ends the test screen and test tool.

1. Use one of the following operations to end the test.
 - Select **File - Exit**.
 - Click the Button at the top right of the window.
 - Double-click the test mode icon at the top left of the window.

NS-Designer Operation Manual

- Click the test mode icon at the top left of the window, and select **Close** from the Control Menu Box that is displayed.
 - Press the Alt + F4 Keys.
2. A dialog box confirming whether to exit the test will be displayed. Click the **Yes** Button to exit the test.

Reference

- ◆ When the menu bar is not displayed in the test screen, double-click on the test screen until the menu bar is displayed.

Test Restrictions

The following restrictions apply to testing. The tests operate differently from PT operations.

1 Changing Date and Time

Date and time settings cannot be changed when using the test function, even if a new date or time is input using the date and time functional objects.



2. Flicker Display Color

When flicker is performed in test mode, the inverse display color may differ from the color displayed at the PT.

3. \$SB and \$SW Operations

In test mode, operations can be checked for the following system memory bits and words only. When checking operations, change the \$SB and \$SW values directly. Changes to other system memory values will not be processed.

\$SB		\$SW	
Offset	Details	Offset	Details
+19	Prohibit Input	+0	Current Screen No.
+33	Save Alarm/Event History	+1	Current Pop-up Screen 1 No.
+36	Save Data Log	+2	Position of Pop-up Screen 1 (X)
+38	Save Operation Log	+3	Position of Pop-up Screen 1 (Y)
+39	Log Functional Object Operation	+4	Current Pop-up Screen 2 No.
+40	Log Switch Screen Operation	+5	Position of Pop-up Screen 2 (X)
+41	Log Macro Operation	+6	Position of Pop-up Screen 2 (Y)
+45	Macro Error Dialog Control	+7	Current Pop-up Screen 3 No.
+46	Notification of Macro Error	+8	Position of Pop-up Screen 3 (X)
+47	Logging Process Error Flag	+9	Position of Pop-up Screen 3 (Y)
+52	Data Block Operation Complete Flag	+10	Current Label No.
\	\	+13	Password No. for Canceling Input Prohibition
		+18	No. of Alarms/Events Occurred
		+19	Occurred Alarm/Event ID
		+20	Cancelled Alarm/Event ID
		+21	Alarm/Event ID of Alarm/Event Object Macro
		+23	Macro Error No.
		+24	Screen Number Having Macro Error
+25	Object ID Having Macro Error		
		+26	Macro Timing Having Error

\$SB		\$SW	
Offset	Details	Offset	Details
		+27	Offset Value for Index 10
		+28	Offset Value for Index 11
		+29	Offset Value for Index 12
		+30	Offset Value for Index 13
		+31	Offset Value for Index 14
		+32	Offset Value for Index 15
		+33	Offset Value for Index 16
		+34	Offset Value for Index 17
		+35	Offset Value for Index 18
		+36	Offset Value for Index 19
		+37	Data Log Group Number
		+38	Data Block Error Number

4. \$SB and \$SW Address Allocations

Communications are not performed between allocated addresses and \$SB or \$SW. For example, when communications are set between \$SW0 and DM 00000:

- Even if the value of \$SW0 is changed, DM 00000 will not change.
- Even if the value of DM 00000 is changed, \$SW0 will not change.

5. Input Dialog

The format of the following input dialogs is different from that used by the PT.

- Each type of keypad displayed when inputting Numeral Display & Input.
- Each type of keypad displayed when inputting String Display & Input.
- Date Setting Dialog Boxes displayed when inputting date settings.
- Time Setting Dialog Boxes displayed when inputting time settings.
- Password Input Dialog Boxes and virtual keyboards that are displayed when inputting passwords.

Also, the PT can display two types of keypads (with and without a temporary input), but in test mode only the keypads without a temporary input can be displayed.

6. Video Display Object

Video images are not displayed in test mode. The display area for a video display will be gray-out instead. The display will also be different if other objects overlap the video display object or a dialog box is displayed.

- PT: The video display object will be displayed on top and any objects overlapping it will not be displayed. The video display object will disappear temporarily if an error dialog box, write confirmation box, etc., is displayed. The video image will return when the dialog box is closed.
- Test mode: Function objects are display on top of the video display object.

7. Command Buttons

The following command button functions will not work in test mode.

- Video controls - Video capture
- Video controls - Contrast adjustment
- Video controls - Vision Sensor Console output

8. Pop-up Menus

Pop-up menus for word buttons, command buttons, and text display and input objects will be different from those on the PT.

- PT: A scroll bar will appear on the right of the menu when there are more than 10 items on the menu.
- Test mode: All menu items will be displayed at the same time even if there are more than 10 items.

9. Log Data File for Data Log

In test mode, only one log data file will be saved for each group. On the PT, up to 999 log data files will be saved for each group. If, however, the output file name that is set is 6 characters or longer, only up to 99 log data files will be saved. The log data file names are as shown in the following table.

PT/Test mode	Log data file names	Details
PT	Trd#*.CSV (default)	# : 00 to 99, indicating data log groups 1 to 100. * : 001 to 999. The largest current number will be incremented by 1 to when the data is saved.
Test mode	Trd#.CSV (default)	# : 0 to 99, indicating data log groups 1 to 100.

10. Reading/Writing Data Block Data Files

Reading and writing data block files is different.

- PT: The read/write location for data files can be set to either the PT or the Memory Card (only when display a confirmation dialog box is set).
- Test mode: The read/write location for data files cannot be set and the operation is performed directly on the CSV data file set for the *Register Data Block*. To test writing a data file, make a CSV data file backup in advance to transfer to the PT.

Refer to 2-16 *Data Blocks* in the *Programming Manual* for details.

11. Displaying Data Block Table Data

Operation is different when editing data block tables.

- PT: Even if values are edited in the data block table, the previous values will be displayed after the screen is switched unless the data file is written.
- Test mode: Values edited in the data block table will be displayed after the screen is switched even if the data file is not written. The data file must be read to return to the previous values.

Refer to 2-16 *Data Blocks* in the *Programming Manual* for details.

12. System Language

The system language cannot be changed in test mode. The language set for the OS of the computer will be displayed.

8-2-2 Setting Values

Use the following procedure with the test tool to change address values set in functional objects. Select the address to be changed and double-click on it or click the **Set Value** Button.



Double-click the selected item or click the **Set Value** Button.

The Set Value Dialog Box will be displayed.

Bit Addresses

Click the **SET** Button to write 1 to the address.

Click the **RESET** Button to write 0 to the address.



Word Addresses

Input the value to be written and then click the **OK** Button.



The symbol will change to for the address that has had a value changed.

Reference

- ◆ Set *Display* to *Hexadecimal* to input BCD formats.
Example:
To input -12 as BCD1 (1-word, signed (most significant digit: F)), input F012.
If *Display* is not set to *Hexadecimal*, input the value converted to the required display format.
Example:
To input -12 as BCD1 (1-word, signed (most significant digit: F)), input the converted value -4,078 in INT.
Refer to 2-8 *Common Functional Object Functions* in the *NS Series Programming Manual* for details on storage formats.
- ◆ The values can also be set from the pop-up menu that is displayed by clicking the right mouse button in the address list field.

Always on Top

The setting for whether to display the test tool on top can be switched under *Options - Always on Top*. While the setting for displaying the test tool on top is selected, the menu item will be displayed with a check mark.

Reference

- ◆ The default setting is for the test tool to be always displayed on top.

Section 9 **Validation**

This section explains the functions used for checking that screen data is correct and displaying a list of errors, based on the validation settings.

9-1 Validation Settings	9-1
9-2 Validation Results.....	9-2
9-3 List of Validation Items	9-4

9-1 Validation Settings

1. Select **Tools - Validation**.
2. The Validation Dialog Box will be displayed. Set each item and then click the **OK** Button.

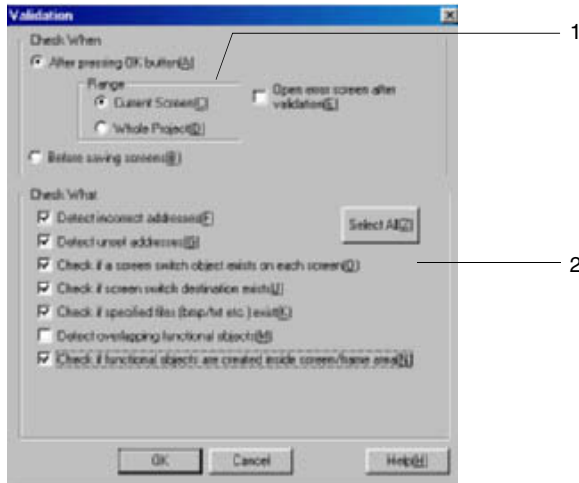

No.	Setting	Details
1	Check When	Set the range and timing for executing validation.
	After pressing OK button	Click the OK Button in the Validation Dialog Box to execute the validation. Select the range for executing the validation from either the front screen page only or the whole project.
	Before saving screens	When saving a screen, validation is executed before the screen is saved. Validation is executed for the front screen only.
	Open error screen after validation	Select this setting to display detected errors after the validation has been completed.
2	Check What	Select the items to be checked for errors. Refer to 9-3 List of Validation Items for details.

Reference

- ◆ Even if the *Detect incorrect address* item is selected and *Current Screen* is selected for the range, addresses for the following items will not be checked. If *Whole Project* is selected for the range and the *Detect Incorrect Address* item is executed, *Jump* cannot be performed from the validation result to the following addresses.

Flicker settings; Data log settings; System settings; Alarm/event settings; Data block settings; Project Properties - Macro; Screen Properties - Macro

9-2 Validation Results

9-2-1 No Error Detected

- **When Validation Is Performed with *After pressing OK button Selected:***
The following dialog box will be displayed after executing validation.

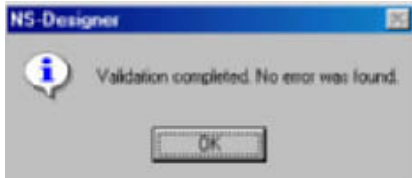

- **When Validation Is Performed with *Before saving screens Selected:***
The screen will be saved after executing validation. A dialog box is not displayed when this method is used.

9-2-2 Error Detected

The Validation Result Dialog Box is displayed after executing validation.

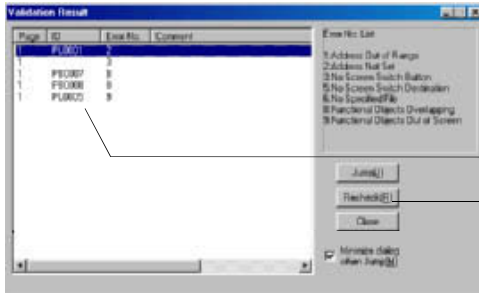

Displays information for objects that were detected with errors.
Executes validation again and displays the most recent data.

Select the error from the validation results and click the **Jump** Button, or double-click on the selected line. The corresponding object or screen will be displayed. When the error occurred in an object, boxes (■) will flash.

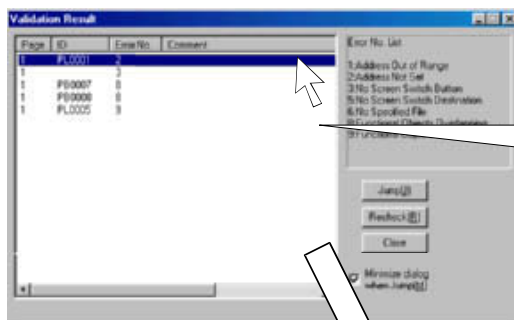

Select and click the **Jump** Button or double-click on the selected line.

The black squares will flash.



Reference

- ◆ The Validation Result Dialog Box will remain open until the **Close** Button or the Close Button (X) at the top right of the dialog box is clicked.

The Validation Result Dialog Box can be reopened after closing by selecting **Tools - Validation Result** or clicking the **Validation Result** Button.

Toolbar



9-3 List of Validation Items

Error No.	Item	Details
1	Detect incorrect addresses	Checks whether the address formats are incorrect or whether the addresses are set outside the specified range. Alarm/event, data log, data block, and system memory allocation addresses, however, are not checked.
2	Detect unset addresses	Searches for functional objects and frames that have not been allocated addresses.
3	Check if a screen switch object exists on each screen	Checks whether screen switch objects operated by Command Buttons exist on each screen.
5	Check if screen switch destination exists	Checks whether the screen switch destination specified by the screen switch command button exists.
6	Check if specified files (bmp/txt etc.) exist	Checks whether files (BMP files, JPEG files, TXT files, or LST files) set in functional objects exist in the screen folder. The screen folder is a folder located one level below the project file. The folder is automatically created with the same name as the project.
8	Detect overlapping functional objects	Checks whether the positions of functional objects are overlapping.
9	Check if functional objects are created inside screen/frame area	Checks whether objects are positioned in areas that are not displayed when the PT is running, or whether the objects in frames are positioned outside the frame area.
10	Check if touch points are included in functional objects	Checks whether the functional objects are positioned above the touch points. When used to check pop-up screens, this setting is used to detect functional objects that have a width or height that is smaller than the mesh size of the touch panel. The touch panel mesh size is 16 × 16 dots for NS12, NS10, and NS5, and 20 × 20 dots for NS8.

Section 10 Transferring Data

This section explains how to transfer screen data that has been created or edited to and from the PT, and how to retrieve registered data from the PT.

10-1	Transferring Data to the PT	10-1
10-2	Transferring Data to and from a Memory Card	10-29
10-3	Data Transfer Using SPMA.....	10-33

Note: Do not perform the following operations while downloading or uploading project data or the system program. The data may be damaged.

Turn OFF the power to the PT.

Press the PT reset switch.

If project data or the system program is damaged by turning OFF the power when writing files, it may not be possible to replace the system program using a normal data transfer. If project data is damaged, format the screen data areas using the system menu of the PT. Refer to *6-2-1 Screen Data Area Format* in the *NS Series Setup Manual* for details on formatting screen data areas. Refer to *3-6-3 Transferring Data with Memory Cards – Errors* in the *NS Series Setup Manual* to replace the System Program.

Do not download a system program earlier than version 6.2 to an NS5-V2 PT. Refer to *3-6-3 Transferring Data with Memory Cards – Errors* in the *NS Series Setup Manual* for information on updating and recovering the system program.

10-1 Transferring Data to the PT

There are two methods for transferring data between a PT and the NS-Designer (personal computer):

- Transferring data to the PT
- Transferring data to a Memory Card inserted into the PT.

These methods can be used in the following cases.

Transferring data to the PT	<ul style="list-style-type: none"> • Installing the System in the PT. • Transferring a project, screen data, and setting file to the PT. • Transferring the project data stored in the PT to the personal computer.
Transferring data to a Memory Card inserted into the PT.	<ul style="list-style-type: none"> • Transferring data to a Memory Card. • Transferring the data stored in the memory card (data logs, alarm histories, data blocks, etc.) to the personal computer. • Deleting files stored on the Memory Card. • Creating/Deleting folders.

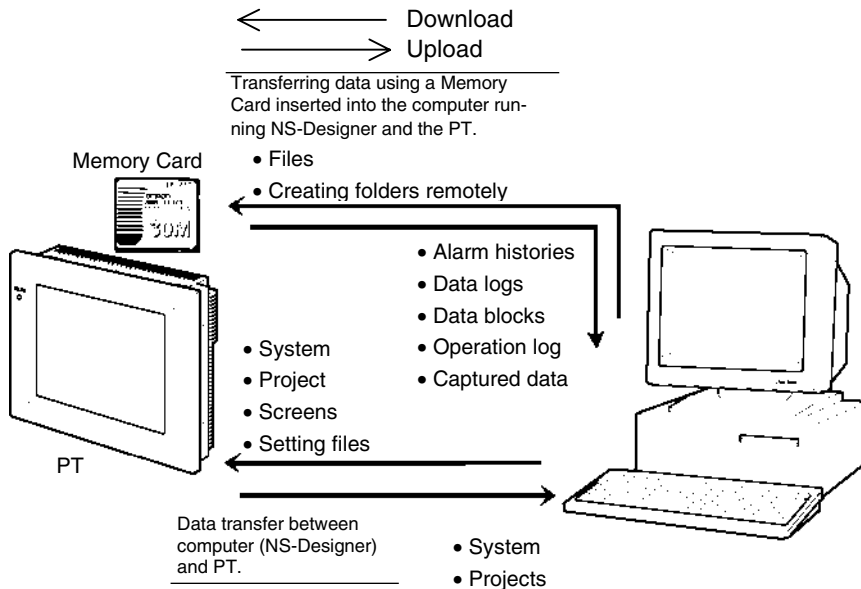

This section describes transferring data to the PT. Refer to *10-2 Transferring Data to and from a Memory Card* to transfer data to a Memory Card.

10-1-1 Preparations and Procedures before Connecting

The preparations and procedures for downloading data created on the NS-Designer to the PT, and uploading data from the PT to the NS-Designer are described below. To transfer the data between the PT and NS-Designer (personal computer), select the method of transfer and make settings to transfer the data beforehand.

■ Transfer Methods

Six communications methods can be used to transfer data between the PT and NS-Designer, as shown in the following table. Select the appropriate method depending on the distance between the PT and NS-Designer, or the features of each transfer method.

Communi- cations method	PT model	Required de- vices	Features
Serial cable	All models	Exclusive ca- ble	Transfers screen data by connecting cable between the PT and personal computer. The length of the cable is 2 m, so the distance between personal computer and PT is limited.
Ethernet	NS12-TS01-V1 NS10-TV01-V1 NS8-TV01-V1 NS8-TV11-V1 NS5-SQ01-V1 NS5-SQ01-V2 NS5-TQ01-V2 NS5-MQ01-V2	Twisted-pair cable	Ethernet is faster than using serial cable and can cover greater distances. In addition, screen data can be transferred via a network.
Modem	All models	Special cable for analog modem	Remote data transfers are possible via phone lines using a modem.
Controller Link	NS12-TS00-V1 NS12-TS01-V1 NS10-TV00-V1 NS10-TV01-V1	Controller Link Support Board, Con- troller Link Interface Unit, twisted-pair cable	Data transfers can be performed to PT connected to a Controller Link network via a Controller Link Support Board mounted in a computer.
USB	All models (See note.)	USB cable	Connecting the personal computer and PT with a USB cable enables faster screen transfer than serial connections.
Memory Card	All models	Memory Card interface on the personal computer	First, store the data from the NS-Designer in a Memory Card. Then, transfer the data from the Memory Card to the PT. Refer to 3-6 <i>Using Memory Cards</i> in the <i>NS Series Setup Manual</i> for details on transferring data using a Memory Card.

Note: Support varies for the NS-V1 Series PTs and the PT system program version. Refer to 3-3-2 *Connecting via USB* in the *Setup Manual*.

NS-Designer Operation Manual

■ Preparations Required for Data Transfer

Connecting via Serial Cable

To transfer data, connect the personal computer and PT with a cable. Connect the RS-232C port on the computer to the tool connector on the PT using a cable. Refer to *2-2 Part Names and Functions* in the *NS Series Setup Manual* for the location of PT connectors. Refer to *Appendix 6 Preparing Cables for Computer Connection* in the *NS Series Setup Manual* for details on preparing the cable.

Transfer method	Recommended cable
Serial Cable Connection	Model: XW2Z-S002 (2 m long) manufactured by OMRON (D-Sub 9-pin Male ↔ D-Sub 9-pin Female)

Reference

- ◆ Log in as the administrator when transferring data via a serial connection using NS-Designer Ver. 5.X or earlier installed on Windows NT, 2000, or XP.

Connecting via Ethernet

To transfer data, connect the personal computer and PT with a cable. Connect an Ethernet port on the computer to the Ethernet connector on the PT using a cable. Refer to *2-2 Part Names and Functions* in the *NS Series Setup Manual* for the location of PT connectors. Refer to *Appendix 6 Preparing Cables for Computer Connection* in the *NS Series Setup Manual* for details on preparing the cable.

Transfer method	Recommended cable
Ethernet Connection	Twisted-pair straight or crossed cable (10/100Base-T)

Reference

- ◆ Log in as the administrator when transferring data via an Ethernet connection using NS-Designer Ver. 5.X or earlier installed on Windows NT, 2000, or XP.

PT Settings before Transferring Data via Ethernet

The first time data is transferred to the PT via Ethernet, it is necessary to set the network address, node address, and IP address beforehand. Make the following settings on the *System Menu – Comm. Tab Page*.

Item	Setting
Network Address	Set the Ethernet network address.
Node Address	Ensure that the PC and PT settings are not the same.
IP Address	Set the same network ID (the underlined parts in the example below) and set the node address as the host ID (the last part of the IP address).

Setting Example

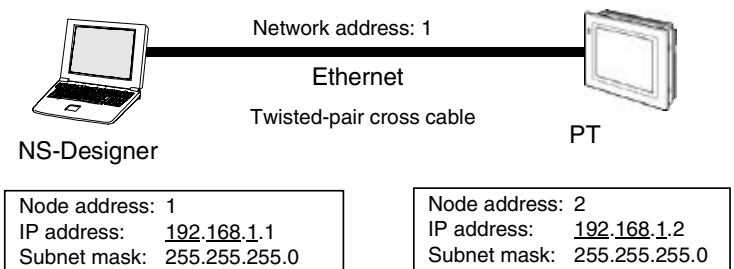

Refer to *6-6-4 Setting Ethernet* in the *NS Series Setup Manual* for details on making settings, such as the IP Address, at the PT.

Reference

- ◆ With NS-Designer Ver. 2.X and earlier versions, data must be transferred via serial cable or Memory Card before transferring data via Ethernet. This is not necessary with Ver. 3.X or later versions.

NS-Designer Operation Manual

Preparations for Transferring Data via Modems

To transfer data, connect the PT and the computer running NS-Designer via cables and modems. Refer to the operation manual for the modem for modem settings.

Settings before Transferring Data via Modems

Make the following settings when connecting the computer to a modem and transferring data over telephone lines to a PT connected via a modem.

PT Settings

The baud rate must be set before transferring screen data to a PT connected via modems. Set the serial port to be used to a modem connection on the *System Menu – Comm. Tab Page*, click the **Details** Button and set the following items.

Item	Setting
Baud rate	Set the baud rate between the modem and PT to 9600, 19200, 38400, 57600, or 115200.
Data bits	The number of data bits (length) is always 8 bits.
Stop bits	The number of stop bits (length) is always 1 bit.
Parity	The parity bit setting is always <i>None</i> .

System Configuration Example

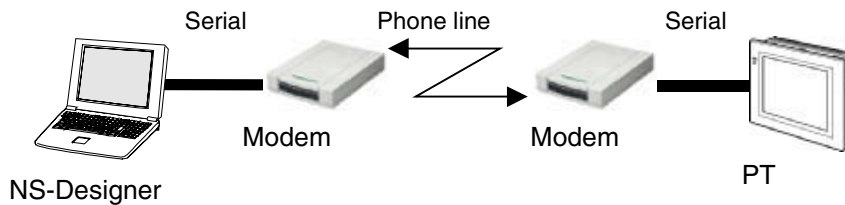

Reference

- ◆ When using a project created with system version 5.X or lower, select **Settings - Conversion - Project -to Ver. 6.0** from the NS-Designer and convert to system project version 6 before making the settings.

NS-Designer Operation Manual

Connecting the PT to a Modem

After completing the modem settings, connect the PT to the modem. Use the following connection diagram as reference and connect the PT to the modem.

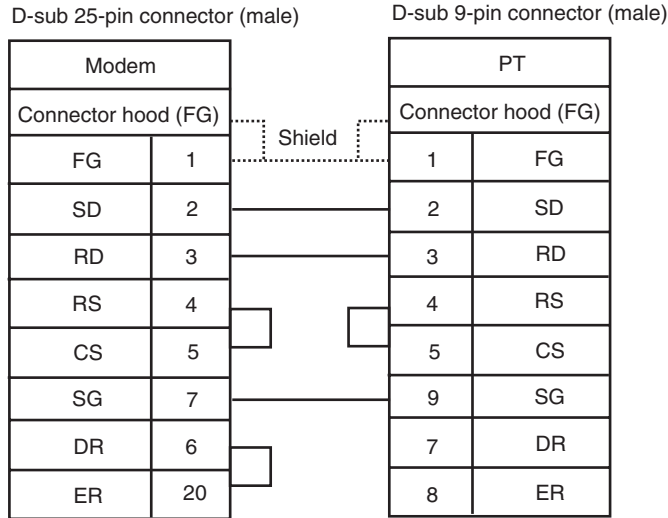

Preparations for Transferring Data via Controller Link

The following hardware is required to transfer data via Controller Link.

Name		Model
PT	Computer Link Interface Unit (See note 1.)	NS-CLK21
Computer	Controller Link Support Board for ISA Bus (See note 2.)	3G8F5-CLK21
	Controller Link Support Board (See note 3.)	3G8F7-CLK21
Twisted-pair Cable		ESVC0.5X2C

- Note 1. Refer to 3-8 *Installing the Controller Link Interface Unit* in the *NS Series Setup Manual* (Cat. No. V083) for information on mounting and wiring the NS-CLK21 Controller Link Interface Unit.
2. Refer to the *Controller Link Support Boards Operation Manual* (Cat. No. W307) for information on mounting and setting the NS-CLK21 Controller Link Support Board for ISA Bus.
3. Refer to the *Controller Link Support Boards for PCI Bus Operation Manual* (Cat. No. W383) for information on mounting and setting the NS-CLK21 Controller Link Support Board for PCI Bus.

Settings before Transferring Data via Controller Link

PT Settings

The following settings must be made from the NS-Designer before transferring screen data to a PT connected via Controller Link. After the settings have been made, they are transferred to the PT along with any screen data without using the Controller Link.

1. Select **Settings – System Settings – Comm – All** from the NS-Designer.
2. Set **Controller Link** to *Use*.
3. Click the **Controller Link** Tab and make the following settings. Set the network address of the Controller Link to which the PT is connected. The setting range is from 1 to 127.
4. Set the node address to the node address of the PT in the Controller Link network. The setting range is from 1 to 32.
5. Set the baud rate to 500 Kbps, 1 Mbps, or 2 Mbps.
6. Click the **OK** Button.

NS-Designer Operation Manual

7. Transfer the settings along with any screen data from the personal computer to the PT without going through the Controller Link network.

Preparations for Transferring Data via USB

Data can be transferred by connecting the PT and the computer running the NS-Designer with a USB cable. The USB port on the computer is connected to the USB slave connector on the PT. Refer to 2-2 *Part Names and Functions* in the *NS Series Setup Manual* for the location of the connector on the PT.

Reference

- ◆ To transfer via USB, the USB driver for data transfer to the PT must be installed in the computer. Refer to 2-2 *Installing the NS-Designer* for the installation procedure.
- ◆ For an NS-V1 Series PT, confirm that the lot number of the PT supports USB transfer and that the system software version installed in the PT supports USB transfer. Refer to 3-3-2 *Connecting via USB* in the *Setup Manual* for details.

Preparations for Transferring Data Using a Memory Card

Data can be saved on a Memory Card from the NS-Designer on the computer and then transferred to the PT from the Memory Card. The Memory Card is inserted into the memory card connector on the PT. Refer to 3-6 *Using Memory Cards* in the *NS Series Setup Manual* for details on transferring data using a Memory Card. Refer to *Appendix 9 List of Optional Products* in the *NS Series Setup Manual* for information on the Memory Cards and Memory Card Adapters that can be used.

■ Data Transfer Types

The following data can be transferred.

Data		Contents	Send	Receive
Projects	Project data	All project data, consisting of screen data and setting file.	OK	OK
	Screen data	Screen data only. Does not contain setting file.	OK	NO
System program		A system program is necessary to operate the PT using communications or to change font sizes. It is only used for special occasions, such as replacing the current system program or recovering system operation.	OK	OK

Reference

- ◆ If the version of system program in the PT older than the version of the screen data, project data, screen data, and setting files cannot be transferred. Refer to *Appendix 9 Converting Data between Different Versions of NS-series Products*.
- ◆ Perform PT system recovery if the system in the PT becomes corrupted or needs to be updated. Refer to 3-6-3 *Transferring Data with Memory Cards – Errors* in the *NS Series Setup Manual* for system recovery and update procedures.

■ Data Transfer Flow

To transfer data to PT, follow the steps given below.

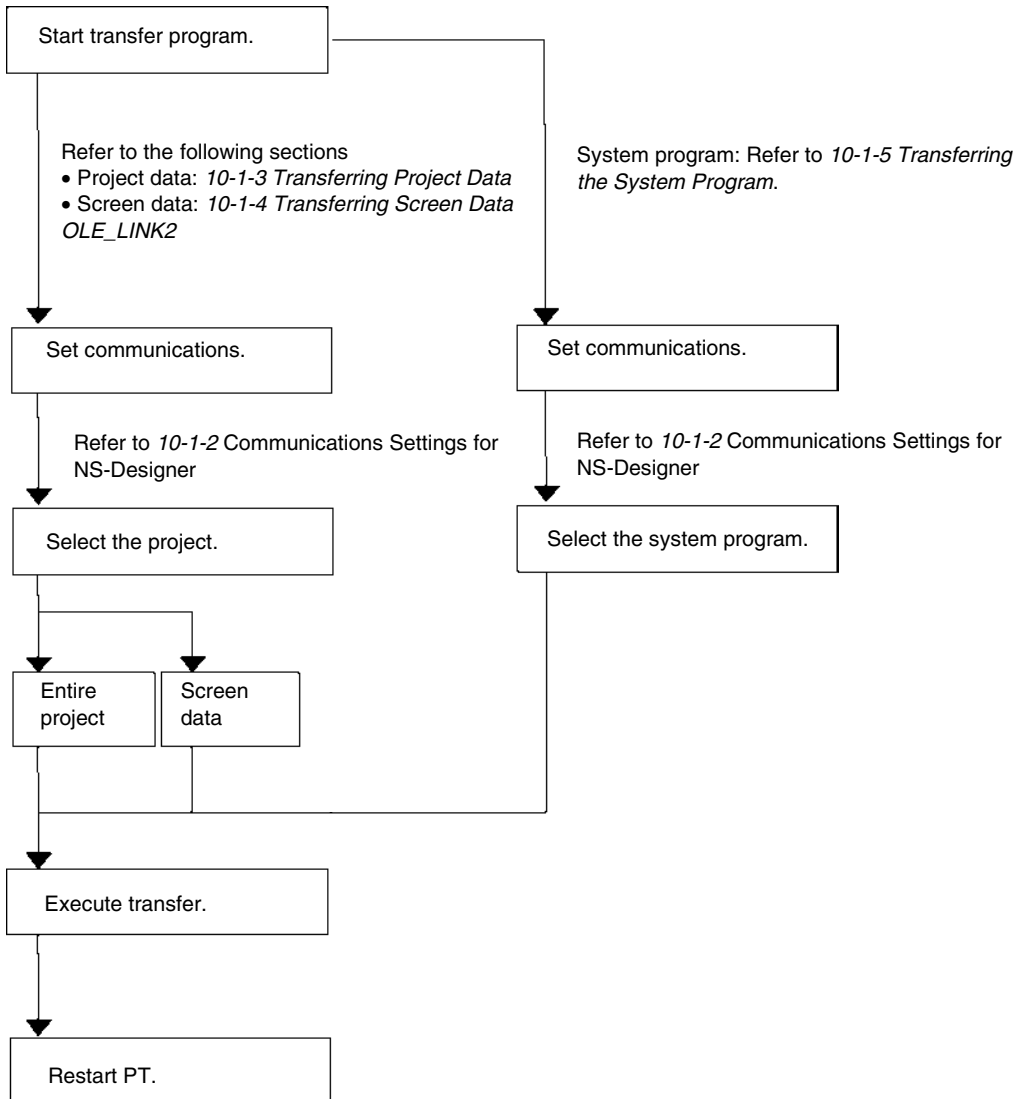

NS-Designer Operation Manual

■ Procedure for Transferring Data

Use the following procedure to transfer data to the PT. In this section, only an outline of the procedure is provided. The actual step may differ depending on the type of data being transferred. For details, refer to 10-1-3 *Transferring Project Data*, 10-1-4 *Transferring Screen Data*, and 10-1-5 *Transferring the System Program*.

1. Click *File* and select *Transfer Data*, or click the Windows Start Button and select *Programs -OMRON - NS-Designer - Screen Data Transfer*.

The Screen Data Transfer Dialog Box will appear.

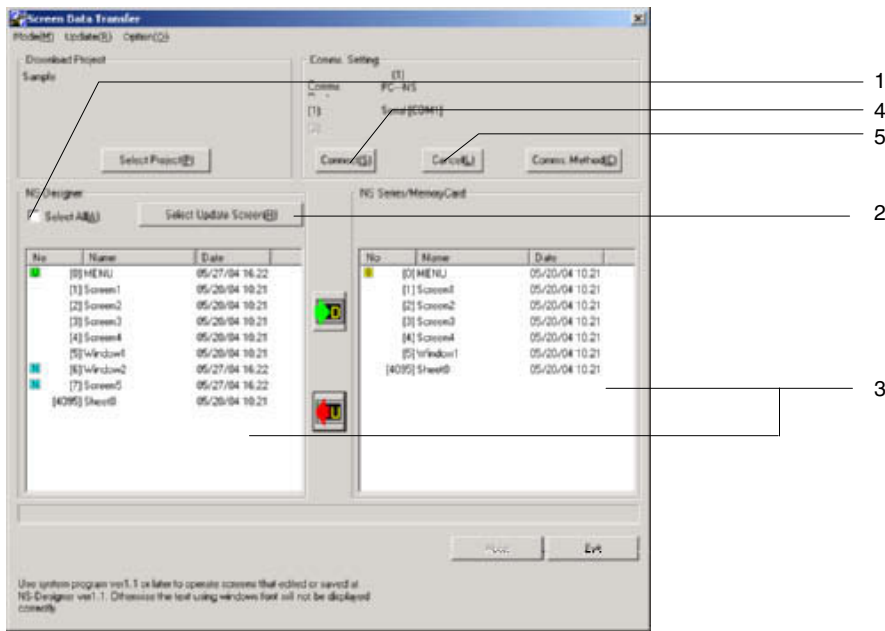

No.	Item	Contents										
1.	Select All	Specifies all screen data and the setting file stored in a project.										
2.	Select Update Screen	Clicking this button will automatically select the screen data with different modification dates between the computer and PT or Memory Card. It is convenient to repeatedly edit and transfer screen data. If this button is not pressed, the updated screen will not be selected.										
3.	List Boxes for NS-Designer and NS-Series/ Memory Card	The screen numbers, screen names, and modification dates are displayed. The icons displayed on the left have the following meanings.										
		<table border="1" style="width: 100%;"> <thead> <tr> <th>Icon</th> <th>Meaning</th> </tr> </thead> <tbody> <tr> <td style="text-align: center;">N</td> <td>Indicates new screen data.</td> </tr> <tr> <td style="text-align: center;">U</td> <td>Indicates modified screen data.</td> </tr> <tr> <td style="text-align: center;">D</td> <td>Indicates old screen data.</td> </tr> <tr> <td style="text-align: center;">None</td> <td>Indicates data that is the same between the computer and PT.</td> </tr> </tbody> </table>	Icon	Meaning	N	Indicates new screen data.	U	Indicates modified screen data.	D	Indicates old screen data.	None	Indicates data that is the same between the computer and PT.
		Icon	Meaning									
		N	Indicates new screen data.									
U	Indicates modified screen data.											
D	Indicates old screen data.											
None	Indicates data that is the same between the computer and PT.											
4	Connect	Click this button to connect the computer and PT.										
5	Cancel	Click this button to disconnect the computer and PT.										

NS-Designer Operation Manual

1. Select **Select Project** from the **Mode** Menu on the Screen Data Transfer Dialog Box.
2. Click the **Select Project** Button, and then select a project. (This step is necessary only to send a specific project. The default selection is the project that is currently being created. Usually it is not necessary to select a project.)
3. Select the communications method. For details, refer to *10-1-2 Communications Settings for NS-Designer*.
4. Click the **Connect** Button. The computer and PT will be connected.

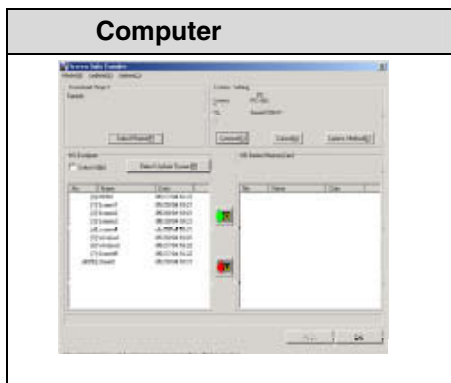

5. The screen data stored in selected project is displayed in both list boxes. Select the items (whole project/screen/setting file) that you want to transfer to the PT.

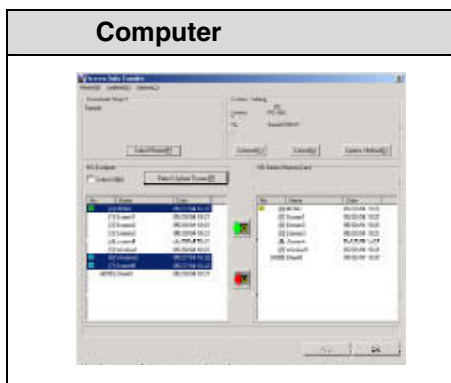

6. Click the  Button to transfer data from the computer to the PT or a Memory Card.

Click the  Button to transfer data from the PT or Memory Card to the computer.

NS-Designer Operation Manual

When uploading, a dialog box will be displayed to specify where the project should be saved. For details, refer to *10-1-3 Transferring Project Data*.

7. A confirmation dialog box will be displayed. Click the **Start** Button to start the transfer.
8. If any of the following items differ between the source and destination, a warning message will be displayed.
 - PT Model
 - System Version
 - Language

Messages will show information about the source and destination.

Click the **Yes** Button to continue with the transfer.

9. When transferring data to a Memory Card is finished, a message that the upload/download has been completed will be displayed. Refer to *3-6 Using Memory Cards* in the *NS Series Setup Manual* for the procedure to transfer data from a Memory Card to the PT. If data transfer is performed via a serial cable, modems, Ethernet, or Controller Link, the following screen will be displayed on the PT while transferring the data.

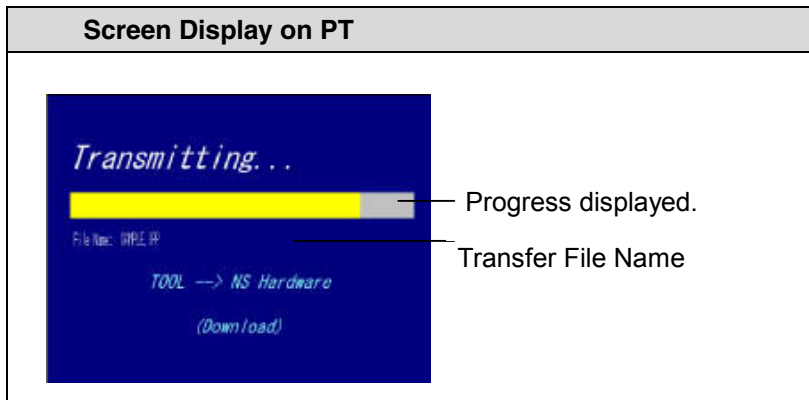

Reference

- ◆ The maximum file size for transferring is 1.44 Mbytes.

If you attempt to transfer data exceeded 1.44 Mbytes, the following message will be displayed and data transfer will be aborted.



Check the size of files such as BMP files, and after changing or deleting data, execute the transfer again.

- When the data transfer has been completed, a screen indicating so will be displayed on the PT and a confirmation dialog box for restarting the PT will be displayed on the computer. If *Auto-reset after the transmission* is selected in the Comms Method Dialog Box, the PT will be automatically reset without displaying the confirmation dialog box.

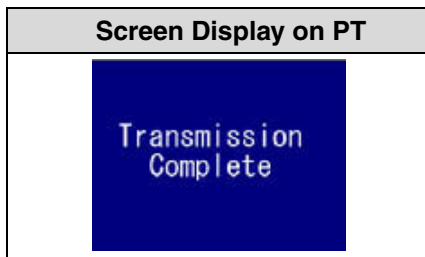

- Click the **Yes** Button to restart the PT.

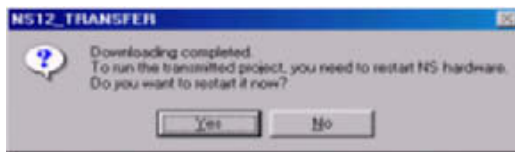

If you click the **No** Button, the screen will return to Screen Data Transfer Dialog Box, and data can be transferred again.

Even if you click the **No** Button, a confirmation dialog box to restart the PT will be displayed again when you exit the Screen Data Transfer Dialog Box. If the **Yes** Button is clicked, the PT will be restarted. If the **No** Button is clicked, it will become necessary to restart the PT directly. If the **Cancel** Button is clicked, the window will return to the Screen Data Transfer Dialog Box.

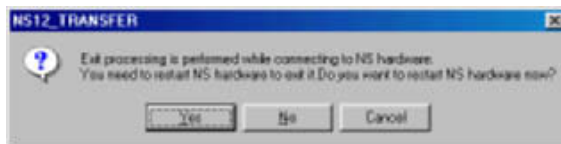

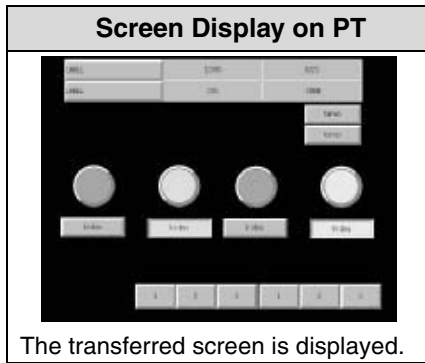

Reference

- ◆ If a communications error occurs or the PT cannot read the transferred data normally and an error occurs, perform data transfer again from the beginning.

NS-Designer Operation Manual

10-1-2 Communications Settings for NS-Designer

Use the following procedure to set the communication methods between the NS-Designer and PT.

Procedure

1. Display the Screen Data Transfer Dialog Box.



2. Click the **Comms. Method** Button.

The Comms. Method Dialog Box will be displayed.

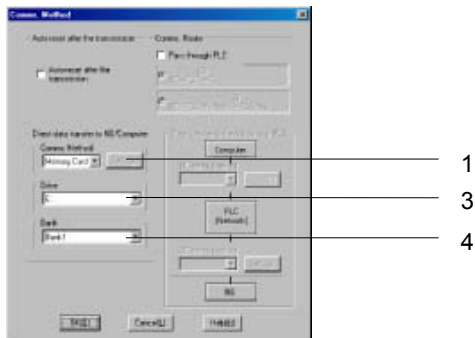

No.	Setting	Details
1	Comms. Method	Select the method of communications with the PT: Ethernet, Serial, Memory Card, Serial (Modem), USB, or CLK (Controller Link).
2	Set	Make settings for the communications method selected in 1, above. Refer to the setting procedure given for each method later in this section.
3	Drive	When a Memory Card is selected as the communications method, specify the drive where the Memory Card is inserted.
4	Bank	When a Memory Card is selected as the communications method, select the bank to be used. A bank refers to a collection of system files and screen data. Banks 1 to 4 can be stored in a Memory Card.
5	Auto-reset after the transmission	Set whether the PT is to be automatically reset when a transfer is completed for Ethernet, Serial, Modem, Controller Link, or USB communications.

3. Click the **OK** Button. The dialog box will be closed and the Screen Data Transfer Dialog Box will return.
4. Click the **Connect** Button in the Screen Data Transfer Dialog Box. After the connection is established, the PT will automatically switch to the following window and go into transfer-wait state.



Reference

- ◆ Check the following items if the connection is not established.
 - Are the cables connected properly?
 - Is the PT turned ON? Is the startup message that is displayed directly after turning ON the power displayed?

Note

- ◆ When transferring data using Ethernet or Controller Link, data can be sent to other nodes on the network unintentionally, so always select the node carefully.

■ Detailed Communications Settings

Serial Communications

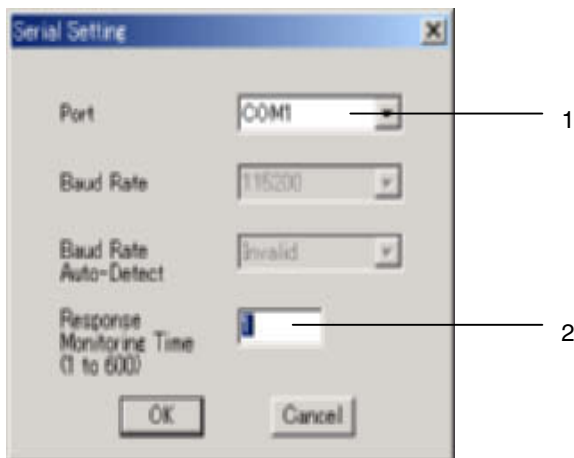

No.	Setting	Details
1	Port	Select the COM port on the computer to use to communicate with the PT.
2	Response Monitoring Time	Set the response monitoring time. Increase the time only when there are frequent communications errors.

NS-Designer Operation Manual

Ethernet Communications

1. Make the following settings on the *Network Tab Page*.

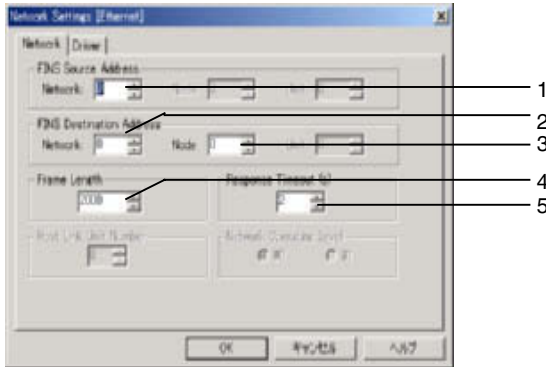

No.	Field	Setting	Details
1	FINS Source Address	Network	Set the network address of the Ethernet network to which the computer is connected.
2	FINS Destination Address	Network	Set the network address of the Ethernet network to which the PT is connected.
3		Node	Set the node address of the PT.
4	Frame Length	-	Set the maximum frame length. Use the default setting.
5	Response Time-out	-	Set the response timeout time. Increase the time only when there are frequent communications errors.

2. Make the following settings on the *Driver Tab Page*.

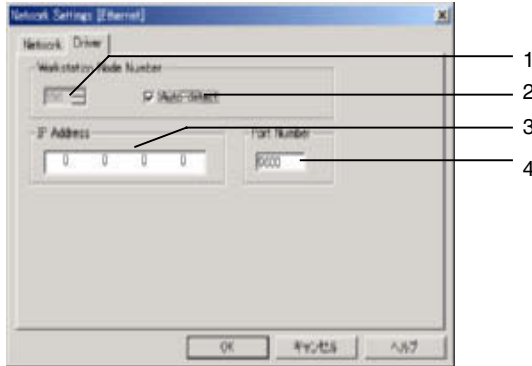

No.	Field	Item	Details
1	Workstation Node Number	-	The workstation node number can be input if the <i>Auto-detect</i> option is not selected. If automatic detection is not used, the node and IP address must be input on the conversion table on the Ethernet Tab Page in the <i>System Settings</i> .
2		Auto-detect	Select this option to automatically generate the node address of the computer from the IP address. If automatic detection is used, the node and IP address do not need to be input on the conversion table on the Ethernet Tab Page in the <i>System Settings</i> . Example: If the IP address of the computer is 192.168.0.10, the node address of the computer will be automatically set to 10.
3	IP Address	-	Set the IP address of the PT to be connected.
4	Port Number	-	Set the UDP port number. Normally 9600 can be used.

Controller Link Communications

1. Make the following settings on the *Network* Tab Page.

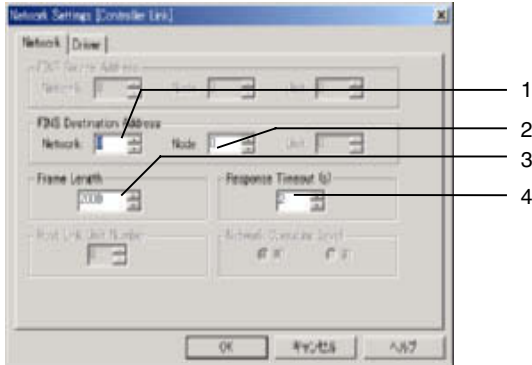

No.	Field	Item	Details
1	FINS Destination Address	Network	Set the network address of the Controller Link network to which the PT is connected.
2		Node	Set the node address of the PT.
3	Frame length	-	Set the maximum frame length. Use the default setting.
4	Response Timeout	-	Set the response timeout time. Increase the time only when there are frequent communications errors.

2. Make the following settings on the *Driver* Tab Page.

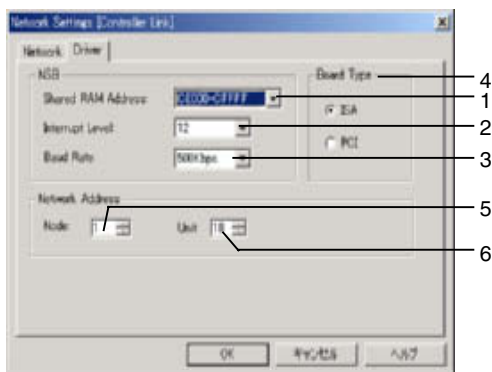

No.	Field	Item	Details
1	NSB	Shared RAM Address	Set to the same value as the DIP switch on the Controller Link Support Board.
2		Interrupt Level	Set to the same value as the jumper pins on the Controller Link Support Board.
3		Baud Rate	Set the baud rate to 500 Kbps, 1 Mbps, or 2 Mbps.
4	Board Type	-	Set the Controller Link Support Board type to <i>ISA</i> for an ISA Board or to <i>PCI</i> for a PCI Board.
5	Network Address	Node	Set the local node address of the Controller Link Support Board.
6		Unit	Set the unit number of the Controller Link Support Board between 16 and 31.

NS-Designer Operation Manual

Modem Communications

1. Make the following settings on the *Network* Tab Page.

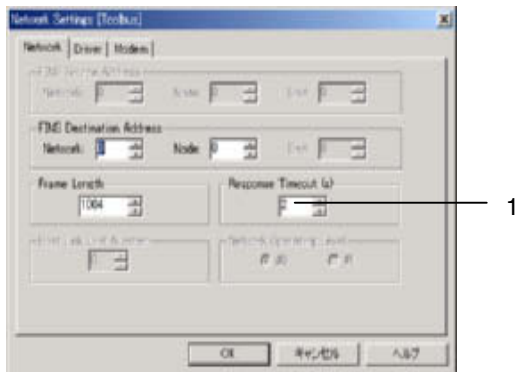

No.	Field	Item	Details
1	Response timeout	-	Set the response timeout time. Increase the time only when there are frequent communications errors.

2. Make the following settings on the *Modem* Tab Page.

The settings on the Driver Tab Page do not need to be made if the following settings are made on the Modem Tab Page.

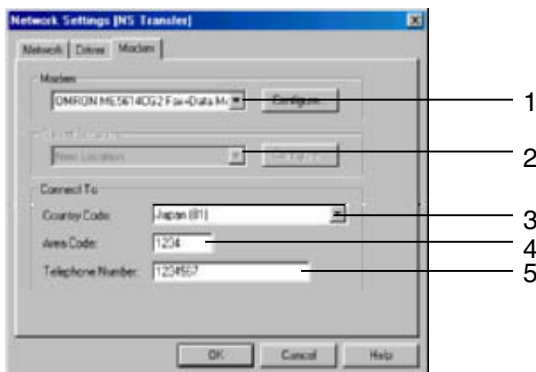

No.	Field	Item	Details
1	Modem	-	Select the modem driver. Click the Configure Button to display the Modem Property Dialog Box.
2	Current Location	-	Set the location of the local modem.
3	Connect To	Country Code	Set the country code of the destination modem, even when communicating within the same country.
4		Area Code	Set the area code of the destination modem, even when communicating within the same area.
5		Telephone Number	Set the phone number of the modem to which to connect.

NS-Designer Operation Manual

3. Click the **Configure** Button on the **Modem Tab** Page and set the modem properties.

Setting Example

Set the following items on the **General** Tab Page.

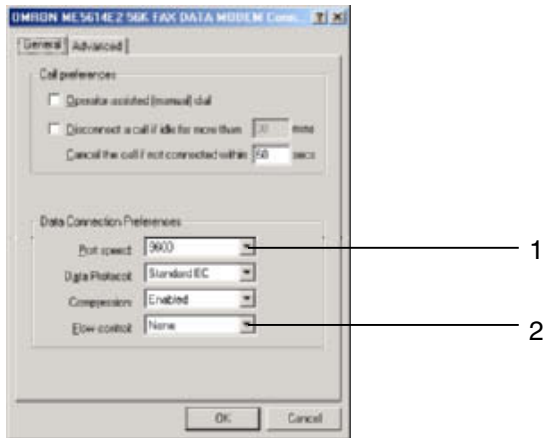

No.	Field on General Tab Page	Item	Details
1	Data connection options	Port speed	Set the baud rate of the modem.
2		Flow control	This item enables or disables flow control. Disable flow control.

Make the following settings on the **Advanced** Tab Page.

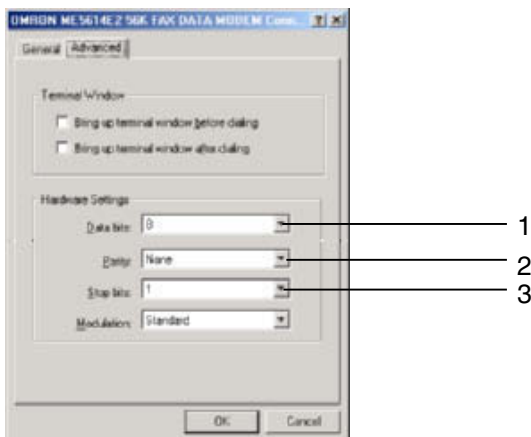

No.	Field on Details Tab Page	Item	Details
1	Hardware settings	Data bits	Set the data length to 8 bits.
2		Parity	Set the parity to "none."
3		Stop bits	Set 1 stop bit.

Reference

- ◆ If the option to Auto-reset after the transmission is selected, the PT will be automatically reset and the phone line will be disconnected after transfer has been completed.

NS-Designer Operation Manual

USB Communications

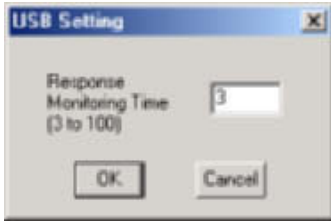

No.	Setting	Details
1	Response monitoring time	The monitoring time for receiving a response. Increase this time only if there are excessive communications errors.

10-1-3 Transferring Project Data

Use the following procedure to transfer all data for a selected project to the PT or a Memory Card.

Procedure: Downloading Project Data

1. Display the Screen Data Transfer Dialog Box.
2. Select **Select Project** from the **Mode** Menu or right-click on the Transfer Data Dialog Box and select **Select Project** from the pull-down menu.
3. Click the **Select Project** Button and select the project. (The default selection is the project data currently being edited by the NS-Designer. Normally, selecting the project is not required.)

Reference

- ◆ When transferring screen data that is being edited, save the screen data before transferring. If the data is not saved before transferring, the most recently saved data will be transferred and unsaved editing will be lost from the transfer data.

4. Click the **Comms. Method** Button and set the communications method. Refer to *10-1-2 Communications Settings for NS-Designer* for details.
5. Click the **Connect** Button. The computer will be connected to the PT.
6. Click **Select All** at the top of the **NS-Designer** Box. All the screens stored in the project will be selected.

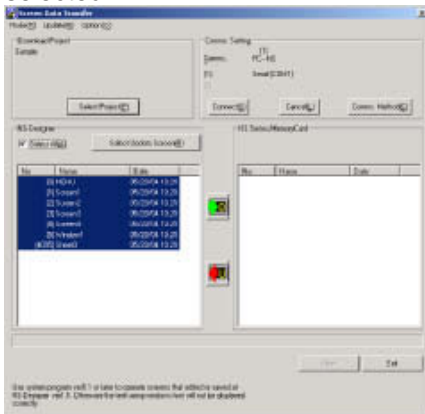

NS-Designer Operation Manual

- Click the **Button** to display the confirmation dialog box and then click the **Start** Button to start downloading the data. When using a Memory Card to transfer data, this will complete the transfer process. Steps 8 and 9 are not required.

The transfer progress will be displayed at the PT and in the Screen Data Transfer Dialog Box.

- When an automatic reset after transfer has not been set, the following dialog box will be displayed at the computer when the data transfer is finished. The PT must be restarted to run the project that has been transferred. Click the **Yes** Button to restart the PT.

If the wrong project data has been transferred, the procedure can be executed again from step 2 without restarting the PT by clicking the **No** Button.

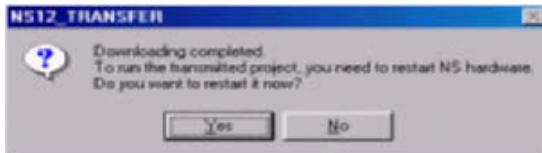

Even if the **No** Button is clicked, the following confirmation dialog box to restart the PT will appear after Screen Data Transfer Dialog Box is closed. If the **Yes** Button is clicked, the PT will be restarted. If the **No** Button is clicked, you will have to restart the PT manually. If the **Cancel** Button is clicked, the Screen Data Transfer Dialog Box will return.



Reference

- ◆ When data is transferred, any of the following history data that was previously recorded in the PT will be deleted.
 - Alarm History
 - Data Log
 - Operation Log
 - Error Log
 - Internal holding areas (\$HB and \$HW), only portions used by the Smart Active Parts.
- ◆ Sheet numbers are displayed as follows on the Screen Data Transfer Dialog Box:

Sheet 0	4095	Sheet 5	4090
Sheet 1	4094	Sheet 6	4089
Sheet 2	4093	Sheet 7	4088
Sheet 3	4092	Sheet 8	4087
Sheet 4	4091	Sheet 9	4086

Procedure: Uploading a Project

Use the following procedure to transfer data stored in the PT or on a Memory Card to the NS-Designer.

- Display the Screen Data Transfer Dialog Box.
- Select **Select Project** from the **Mode** Menu or right-click on the Screen Data Transfer Dialog Box and select **Select Project** from the pop-up menu.

NS-Designer Operation Manual

3. Click the **Comms. Method** Button and set the communications method. For details, refer to *10-1-2 Communications Settings for NS-Designer*.
4. Click the **Connect** Button. The computer will be connected to the PT.

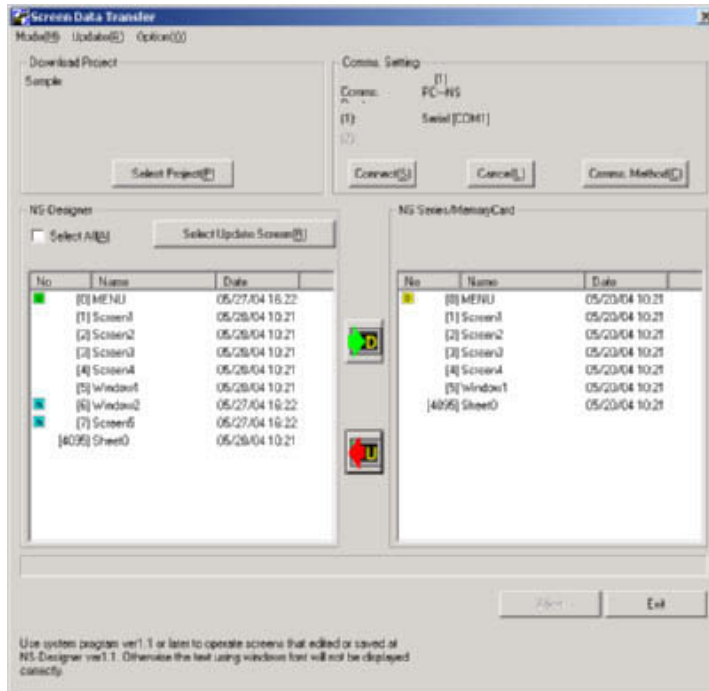

5. Click the  Button. The Save as Dialog Box will be displayed. Specify the project name under which to save the uploading data, and click the **Save** Button.
6. A confirmation dialog box will be displayed. Click the **OK** Button. Uploading will start. The transfer progress will be displayed at the PT and in the Screen Data Transfer Dialog Box.
7. When an automatic reset after transfer has not been set, the following dialog box will be displayed at the computer when the data transfer is finished. The PT must be restarted to operate the screens that have been transferred. Click the **Yes** Button to restart the PT. Click the **No** Button to continue downloading data.

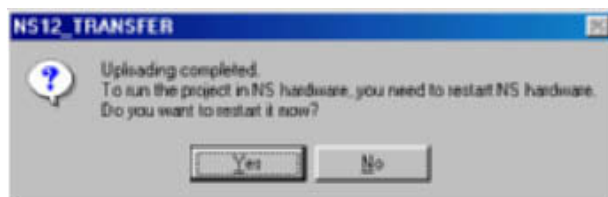

Even if the **No** Button is clicked, the following confirmation dialog box to restart the PT will appear after Screen Data Transfer Dialog Box is closed. If the **Yes** Button is clicked, the PT will be restarted. If the **No** Button is clicked, you will have to restart the PT manually. If the **Cancel** Button is clicked, the Screen Data Transfer Dialog Box will return.

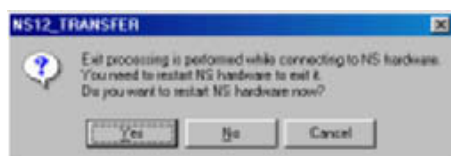

Reference

When uploading data, only the whole project can be transferred. Transferring separate screens is not possible.

The contents of system setting on the NS-Designer cannot be uploaded.

10-1-4 Transferring Screen Data

Individual screen data stored in the selected project can be transferred to PT or Memory Card.

Procedure

1. Display the Screen Data Transfer Dialog Box
2. Select **Select Project** from the **Mode** Menu or right-click on the Screen Data Transfer Dialog Box and select **Select Project** from the pop-up menu.
3. Click the **Select Project** Button and select the project. (The default selection is the project currently being edited by the NS-Designer. Normally, selecting the project is not required.)

Reference

- ◆ When transferring screen data that is being edited, save the screen data before transferring. If the data is not saved before transferring, the most recently saved data will be transferred and any unsaved changes will be lost in the transfer data.

4. Click the **Comms. Method** Button and set the communications method. For details, refer to *10-1-2 Communications Settings for NS-Designer*.
5. Click the **Connect** Button. The computer will be connected to the PT.
6. Select the screen data to transfer from the list box for the NS-Designer. Click the **Select Update Screen** Button to automatically select only screen data with different modification dates between the computer and PT or Memory Card.

NS-Designer Operation Manual

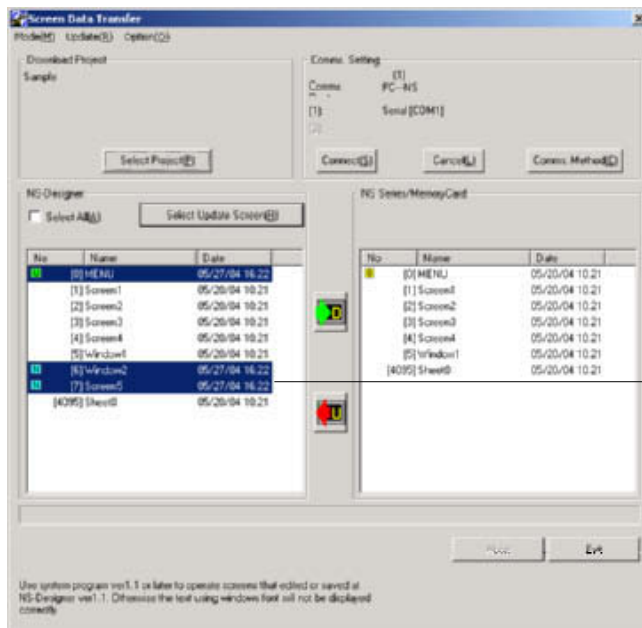

Display screens with different dates.

7. Click the  Button. A confirmation dialog box will be displayed.
8. Click the **Start** Button. The download will be started.

Reference

- ◆ When you select **File - Save All** on the NS-Designer, the modification dates for all screens will be changed. Therefore, if the **Select Updated Screen** Button is clicked, all screens will be selected, not just updated screens.
- ◆ When choosing multiple screens at the same time, select screens while pressing the Ctrl Key. To select a range of screens, select the screens while pressing The Shift Key. To cancel selection, click the screens again while pressing the Ctrl Key.
- ◆ When transferring the data, the following data will be deleted.
 - Alarm History
 - Data Log
 - Operation Log
 - Error Log
 - Internal holding areas (\$HB and \$HW), only portions used by the Smart Active Parts.
- ◆ If the project name read by the data transfer program and the project name stored in the PT are the same, only screen data will be transferred even if the contents of the two projects are different. Always confirm data contents when transferring only screen data.

The transfer progress will be displayed at the PT and in the Screen Data Transfer Dialog Box.

9. When an automatic reset after transfer has not been set, the following dialog box will be displayed at the computer when the data transfer is finished. The PT must be restarted to run the project that has been transferred. Click the **Yes** Button to restart the PT.

Click the **No** Button to return to the Screen Data Transfer Dialog Box, and downloading can be performed again.

NS-Designer Operation Manual

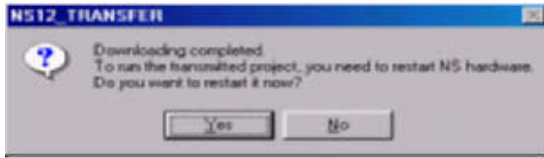

Even if the **No** Button is selected, the confirmation message shown below will be displayed when exiting the Screen Data Transfer Dialog Box. If the **Yes** Button is clicked, the PT will be restarted. If the **No** Button is clicked, it will become necessary to restart the PT directly. To return to the Screen Data Transfer Dialog Box, click the **Cancel** Button.

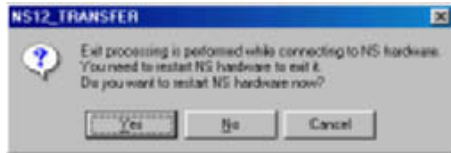

Note

- ◆ If a communications error occurs or the PT cannot read the transferred data normally and an error occurs, perform data transfer again from the beginning.

Reference

- ◆ Sheet numbers are displayed as follows on the Screen Data Transfer Dialog Box:

Sheet 0	4095	Sheet 5	4090
Sheet 1	4094	Sheet 6	4089
Sheet 2	4093	Sheet 7	4088
Sheet 3	4092	Sheet 8	4087
Sheet 4	4091	Sheet 9	4086

10-1-5 Transferring the System Program

A system program is necessary to operate PT for communications or to change font sizes. It is only used for special occasion, such as replacing the system program or recovering system operation.

Procedure: Downloading the System Program

1. Display the Screen Data Transfer Dialog Box.
2. Select **Select System** from the **Mode** Menu or right-click on the Screen Data Transfer Dialog Box and select **Select System** from the pop-up menu.
3. Click the **Select System** Button and select the folder named *bank1*. The folder named *bank1* is in the *System Backup – NS12_V1/NS10_V1/NS8_V1/NS5_V1_V2 – V6_2* folder under the NS-Designer installation folder. Refer to *2-2 Installing the NS-Designer* for details on directories.
4. Click the **Comms. Method** Button and set the communications method. For details, refer to *10-1-2 Communications Settings for NS-Designer*.
5. Click the **Connect** Button. The computer will be connected to the PT.

NS-Designer Operation Manual

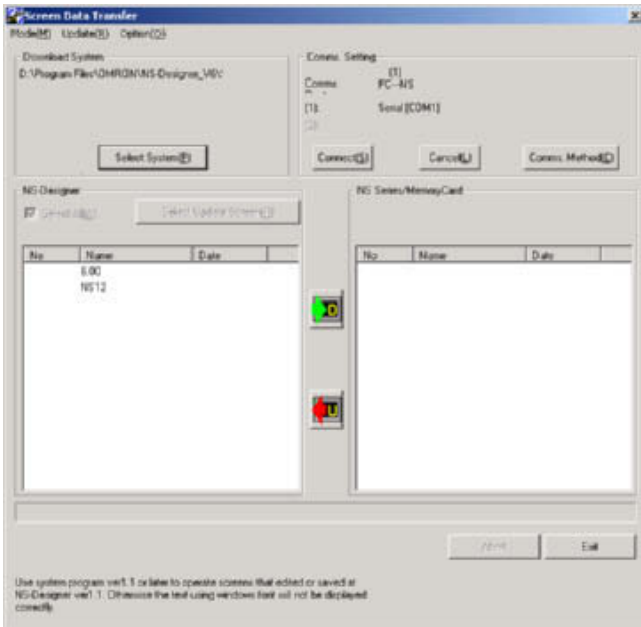

6. Click the  Button. A confirmation dialog box will be displayed.
7. Click the **Start** Button. The download will be started.

The transfer progress will be displayed at the PT and in the Screen Data Transfer Dialog Box.

8. The following dialog box will be displayed at the computer when the data transfer is finished. The PT must be restarted to run the project that has been transferred. Click the **Yes** Button to restart the PT.

Click the **No** Button to return to the Screen Data Transfer Dialog Box, and downloading can be performed again.

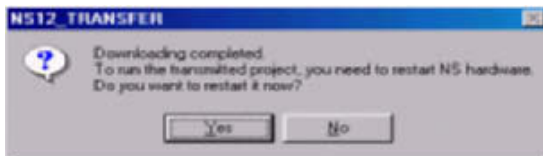

Even if the **No** Button is clicked, the confirmation message shown below will be displayed when exiting the Screen Data Transfer Dialog Box. If the **Yes** Button is clicked, the PT will be restarted. If the **No** Button is clicked, it will become necessary to restart the PT directly. To return to the Screen Data Transfer Dialog Box, click the **Cancel** Button.



Note

- ◆ If a communications error occurs or the PT cannot read the transferred data normally and an error occurs, perform data transfer again from the beginning.

If the system program is transferred to the PT, the screen data in the PT will not be deleted. When transferring the system program, match the version of system program and project data before operating the PT.

If the PT system is destroyed or requires updating, perform the PT system recovery operation. Refer to *3-6-3 Transferring Data with Memory Cards* in the *NS Series Setup Manual* for the procedures to recovery and updating.

Procedure: Uploading the System Program

Use the following procedure to transfer the data stored in the PT or Memory Card to the NS-Designer.

1. Display the Screen Data Transfer Dialog Box.
2. Select **Select System** from the **Mode** Menu or right-click on the Screen Data Transfer Dialog Box and select **Select System** from the pop-up menu.
3. Click the **Comms. Method** Button and set the communications method. For details, refer to *10-1-2 Communications Settings for NS-Designer*.
4. Click the **Connect** Button. The computer will be connected to the PT.

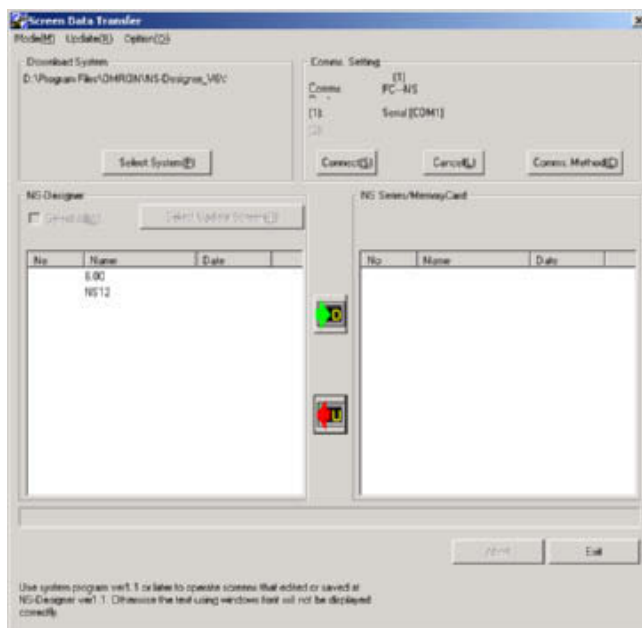

5. Click the  Button. The Save as Dialog Box will be displayed.
6. Specify the project name under which to save the data, and click the **Save** Button.
7. A confirmation dialog box will be displayed. Click the **OK** Button. The upload will be started. The transfer progress will be displayed at the PT and in the Screen Data Transfer Dialog Box.
8. The following dialog box will be displayed at the computer when the data transfer is finished. The PT must be restarted to run the project that has been transferred. Click the **Yes** Button to restart the PT. Click the **No** Button to return to the Screen Data Transfer Dialog Box, and downloading can be performed again.

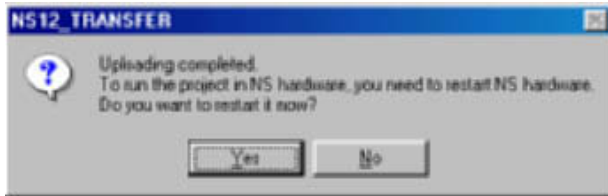

Even if the **No** Button is selected, the confirmation message shown below will be displayed when exiting the Screen Data Transfer Dialog Box. If the **Yes** Button is clicked, the PT will be restarted. If the **No** Button is clicked, it will become necessary to restart the PT directly. To return to the Screen Data Transfer Dialog Box, click the **CANCEL** Button.



Note

- ◆ If a communications error occurs or the PT cannot read the transferred data normally and an error occurs, perform data transfer again from the beginning.

10-2 Transferring Data to and from a Memory Card

This section explains preparations and procedures to transfer data between a Memory Card inserted into PT and the NS-Designer (personal computer).

10-2-1 Preparations for Transferring to a Memory Card in PT

To transfer data between a Memory Card inserted in the PT and the NS-Designer, select the transfer method, and make the settings beforehand.

Transfer Methods

There are five methods to transfer data between a Memory Card inserted in PT and the NS-Designer:

- Serial cable
- Ethernet
- Modems
- Controller Link
- USB

Connect the PT and NS-Designer (personal computer) using either of these methods and transfer the data. Refer to *10-1-1 Preparations and Procedures before Connecting* for the features of these methods and the required cables.

Before Connecting

To transfer data between a Memory Card and the NS-Designer (personal computer) using serial, modem, Ethernet, Controller Link, or USB communications, settings on the PT are required. Refer to *10-1-1 Preparations and Procedures before Connecting* and make settings for FinsGateway.

Transfer Methods

The following operations can be performed between a Memory Card and the NS-Designer.

Memory Card → NS-Designer	Transferring files stored in a Memory Card.
NS-Designer → Memory Card	Transferring files stored in the computer. Deleting files stored in a Memory Card Creating folders in a Memory Card Deleting folders in a Memory Card

Data Transfer Flow

Use the following steps to transfer the data between a Memory Card and the NS-Designer.

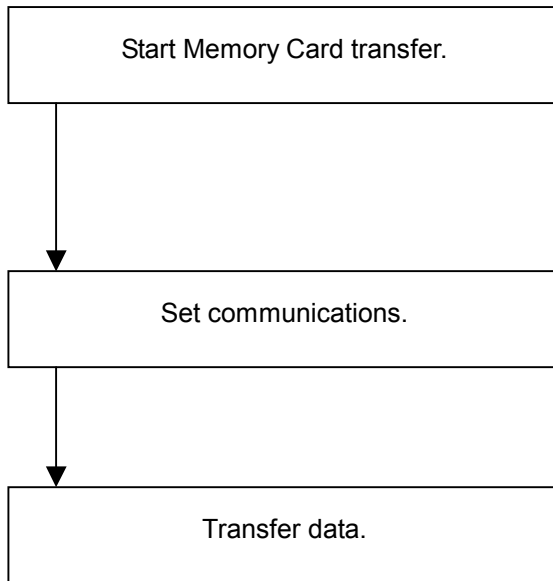

NS-Designer →Memory Card in the PT
Memory Card in the PT→ NS-Designer (Computer)





NS-Designer Operation Manual

10-2-2 Procedure for Transferring Data to a Memory Card in the PT

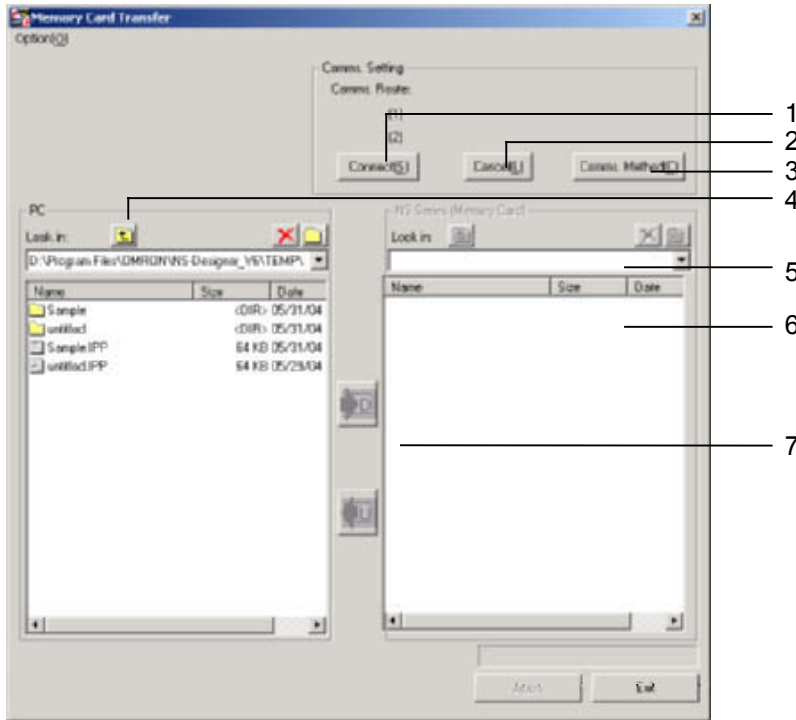
Use the following procedure to transfer data between a Memory Card inserted in the PT and the NS-Designer (personal computer).

1. Click the Windows **Start** Button and select **Programs - OMRON - CX-One - NS-Designer - Memory Card Transfer**.
2. The Memory Card Transfer Dialog Box will be displayed.



Number	Item	Contents
1	Connect Button	Connects the computer to the PT.
2	Cancel Button	Disconnects the computer from the PT.
3	Comms.Method Button	Displays the Comms Method Dialog Box.
4		Displays the next-higher folder.
		Deletes the files selected in the File List. If the selected folder is empty, the folder will be deleted. If the selected folder is not empty, an error message will appear and the folder will not be deleted.
		Creates a new folder.
5	Look in:	Displays where the file is placed. "/" indicates the root folder in the Memory Card.
6	File List	Displays the files and folders that are in the folder as a list. Selecting, transferring, and deleting the files or folders can be performed.
7		Downloads the selected files or folders from the file list of NS-Designer to the Memory Card inserted in PT.
		Uploads the selected files or folders from the file list of the Memory Card to the computer.

NS-Designer Operation Manual

Reference

- ◆ The following action on the PT may be delayed while transferring the data using the Memory card.
 - Key press actions
 - Updating number values and character strings
 - Time for displaying a screen

3. Click the **Comm. Method** Button to select communications method.

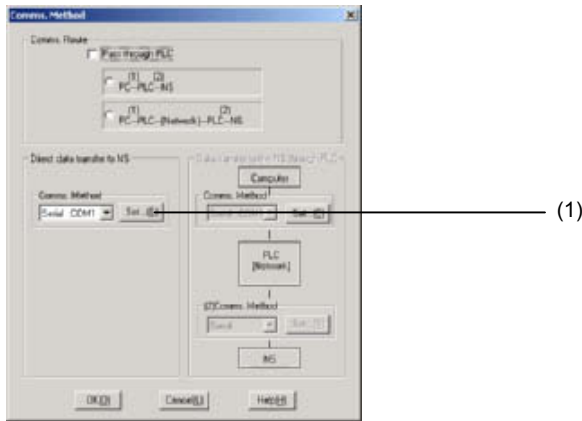

Number	Item	Contents
1	Comms. Method	Selects the communications method to Ethernet, Serial, Modem, Controller Link, or USB.

4. Set the communications method and then click the **OK** Button.
5. Click the **Connect** Button on the Memory Card Transfer Dialog Box. When the connection has been made, the file list will be displayed for the Memory Card.

Reference

- ◆ If the connection is not completed, an error message will be displayed. Click the **Connect** Button again after checking the following items.
 - Communications Method
 - Node Address
 - Cable Connection

6. Select the files or folders from the file list in the Memory Card Transfer Dialog Box to execute the transfer, deletion, and creation of new folders.

10-3 Data Transfer Using SPMA

10-3-1 Overview of SPMA

Data from other devices can be accessed from an application on a computer by going through the networks. This is referred to as SPMA (Single Port Multi Access). When transferring screen data from the NS-Designer, users can send it to the PT through a PLC connected with the PT by a Serial, Ethernet, or Controller Link network.

When transferring/monitoring data, such as a ladder program, from the CX-Programmer, users can also send it to the PLC through the PT connected with the PLC by a Serial, Ethernet, or Controller Link network.

Note

- ◆ Be sure to confirm safety at the destination PT before transferring screen data. In particular, before transferring data using SPMA, be sure to confirm the network address, node address, and unit number.

10-3-2 SPMA Features

Transferring Data from the Computer to the PT through a PLC or a Memory Card in the PT

Screen data can be uploaded/downloaded from the NS-Designer to/from a PT connected by serial, Ethernet, or Controller Link communications through the PLC (CS/CJ-series PLCs only) connected with the PT by a Serial, Ethernet, or Controller Link network. In addition, the data can be downloaded/uploaded to a Memory Card placed in the PT.

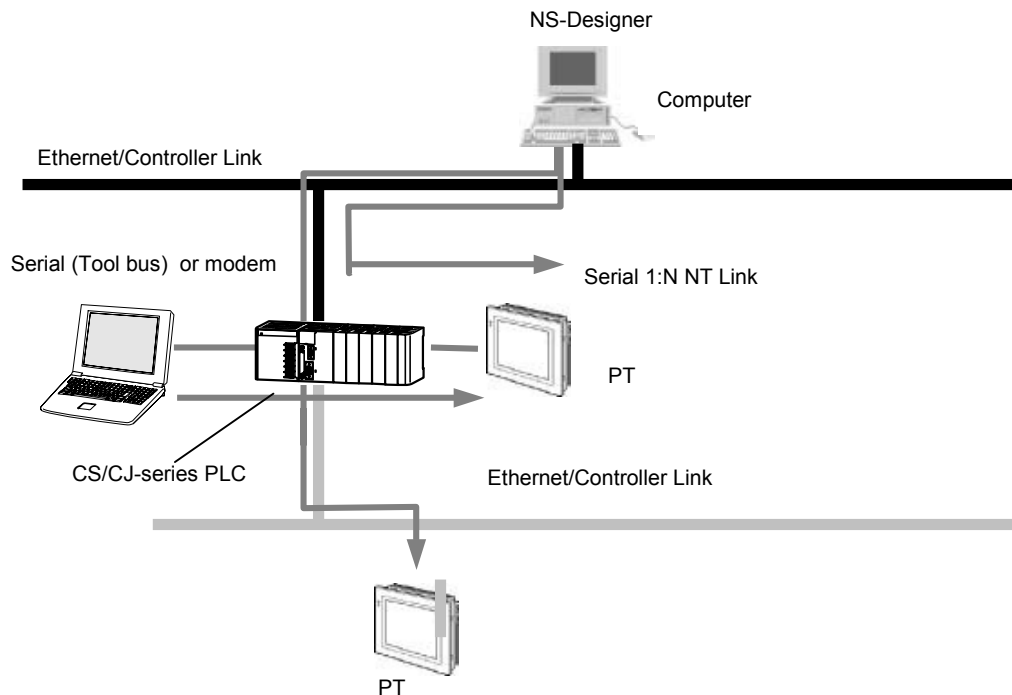

NS-Designer Operation Manual

Transferring/Monitoring Ladder Programs via a PT

Data, such as a ladder program, can be uploaded/downloaded from the CX-Programmer to a PLC connected by a Serial or Controller Link network through a PT connected with the PLC by an Ethernet network.

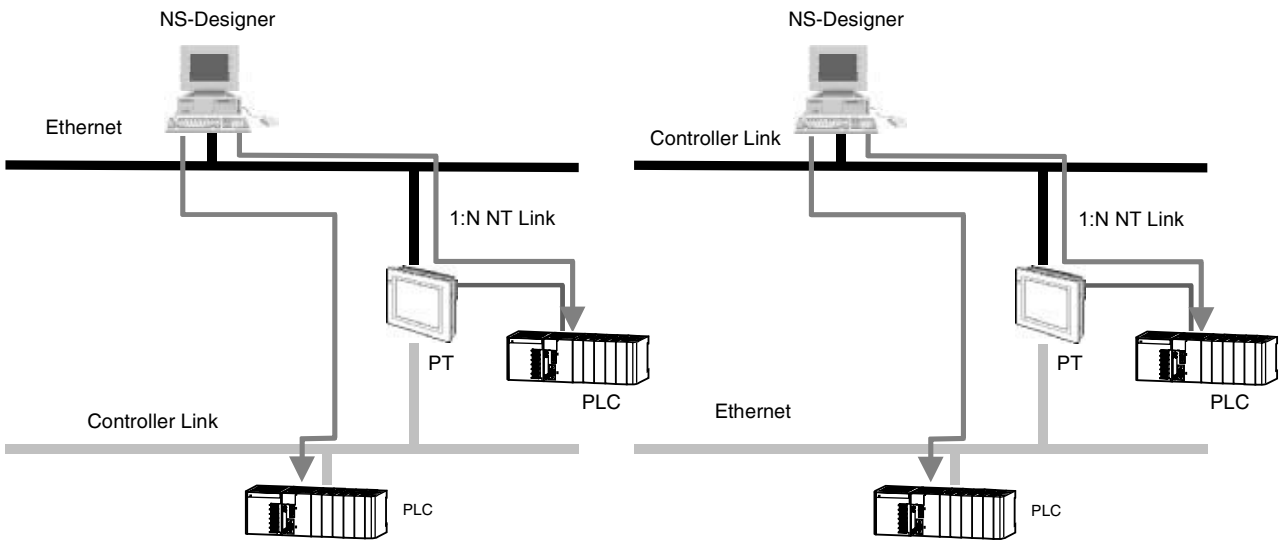

Reference

- ◆ The CX-Net cannot be used when using the CX-Programmer through the PT.
- ◆ Updating screen display and responses of touch input actions may slow down when using the CX-Programmer through the PT.
- ◆ Correct operation is possible only for the configurations described in this manual.

10-3-3 System Configuration

Transferring Screen Data from the NS-Designer to a PT through a PLC

Screen data can be transferred from the NS-Designer to the PT as shown below. Procedures are different depending on the configuration.

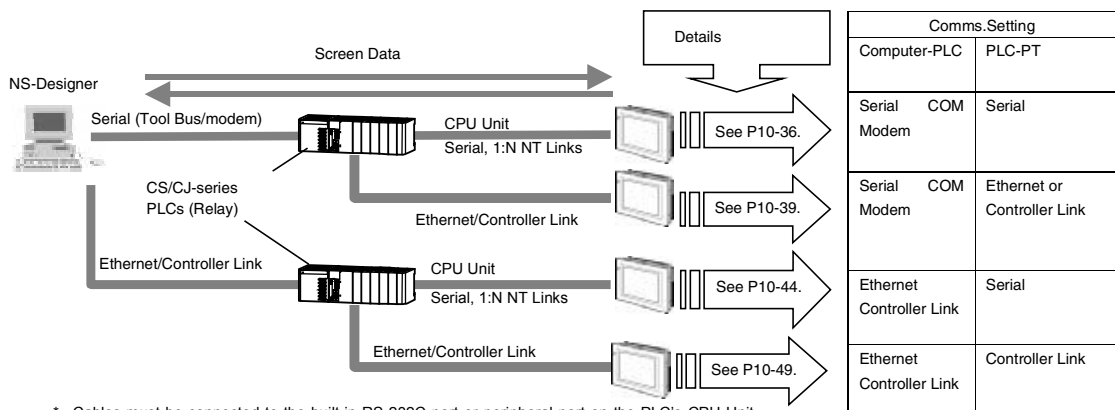

* Cables must be connected to the built-in RS-232C port or peripheral port on the PLC's CPU Unit by a serial 1:N NT Link. To make settings for the expansion routing tables (routing tables that treat serial communications as Network communications), CX-Programmer Ver. 3.1 or later is required.

To transfer screen data to a PT through a PLC, one of the following CPU Units (Lot No. 030201 and later) is required. CPU Units and lot numbers not listed in the following table do not support this function.

PLC series	CPU Unit	Lot number
CJ Series	CJ1H-CPU65H	030201 and later
	CJ1H-CPU66 H	
	CJ1G-CPU42 H	
	CJ1G-CPU43 H	
	CJ1G-CPU44 H	
	CJ1G-CPU45 H	
	CJ1M-CPU11	
	CJ1M-CPU12	
	CJ1M-CPU13	
	CJ1M-CPU21	
	CJ1M-CPU22	
	CJ1M-CPU23	
	CS Series	
CS1H-CPU64 H		
CS1H-CPU65 H		
CS1H-CPU66 H		
CS1H-CPU67 H		
CS1G-CPU42 H		
CS1G-CPU43 H		
CS1G-CPU44 H		
CS1G-CPU45 H		
CS1D-CPU42S		
CS1D-CPU44S		
CS1D-CPU65S		
CS1D-CPU67S		

Reference

- ◆ To send screen data to a PT through a PLC that is connected with a PT by a Serial network, the PT must be connected to the built-in RS-232C port or peripheral port on the PLC's CPU Unit. The screen data cannot be transferred to a PT connected with the RS-232C port on a Serial Communications Board or a RS-422A/485 port of the PLC.
- ◆ When connecting the PLC and PT by a Serial network (1:N NT Links), set *NT Link Max* on the *Settings – Host Link Port* Tab Page in the CX-Programmer to a value greater than 1.
- ◆ Before transferring screen data from the NS-Designer to a PT that is connected by a Serial network (1:N NT Links) through the PLC, confirm that *High Speed* is **ON** under *Option – Pass Through PLC Settings* of the *Screen Data Transfer* tool.

NS-Designer Operation Manual

Transferring/Monitoring Data, such as a Ladder Program, from the CX-Programmer to a PLC through a PT

The following configuration allows transferring and monitoring a PLC from the CX-Programmer.

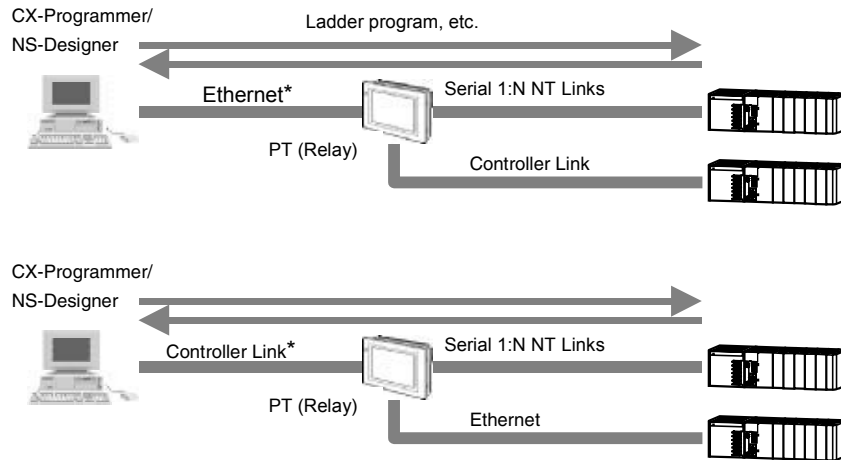

* Cannot transfer/monitor data, such as a ladder program, passing through the PT when the computer (CX-Programmer) is connected to the PT using serial communications, a modem, or a USB cable.

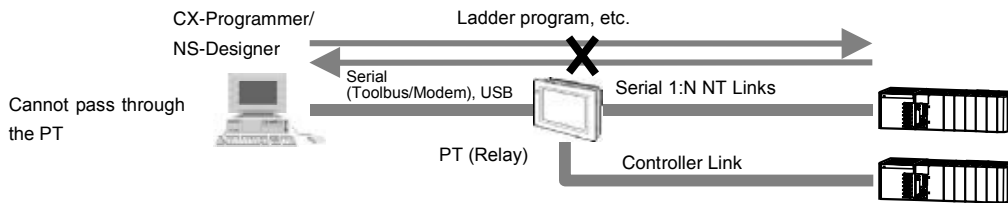

10-3-4 Procedural Example

To explain details of settings simply, procedures are described as tutorial with examples depending on the configuration. The values such as IP Addresses, Network Addresses described below are the examples so please set those in accordance with the actual environment.

Serial Connection between Computer and PLC and Serial 1:N NT Link between PLC and PT Set for Transferring Screen Data to a PT through a PLC.

This section describes data transfer from the NS-Designer to a PT connected either an RS-232C port or a peripheral port on the PLC's CPU Unit by a Serial (1:N NT Link) connection through a PLC connected with the computer by serial (Peripheral bus) connection. In this example, the cable between the computer and the PLC is connected to the peripheral port on the PLC and the cable between the PLC and the PT is connected to the RS-232C port on the PLC.

NS-Designer Operation Manual

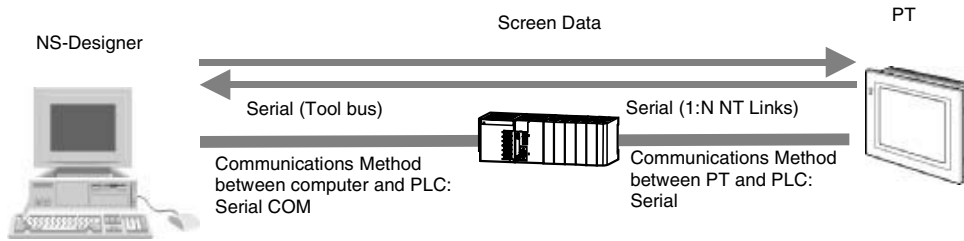

Settings on the PLC

It is not necessary to make settings when connecting using the above system configuration.

Settings on the PT

It is not necessary to make settings when connecting a PLC with a PT by serial 1:N NT Link communications. For information on connection methods for 1:N NT Links, refer to *Section 4 Connecting the Host to Serial Port* in the *NS series Setup Manual*.

Setting the Communications Method

1. Open the desired project on NS-Designer and select *File - Screen Data Transfer*. The Screen data Transfer Dialog Box will appear.
2. Click the **Comms. Method** Button on the top right of the dialog box. The Comms.Setting Dialog Box will appear.
3. Select Pass Through PLC option.
4. Select the communications method between computer and PLC. Here, **Serial (Toolbus)** is set as an example.
5. Select the communications method between PLC and PT. Here, **NT Link** is set as an example.

Select when transferring data via a PLC.

Select communications method between the computer and PLC. (Serial (Toolbus) is selected as an example.)

Select the communications method between the PLC and PT. (Here, NT Link is selected as an example.)

6. Click the **Set...** Button to the right of the communications method setting. The following *Serial Setting* Dialog Box will appear.

NS-Designer Operation Manual

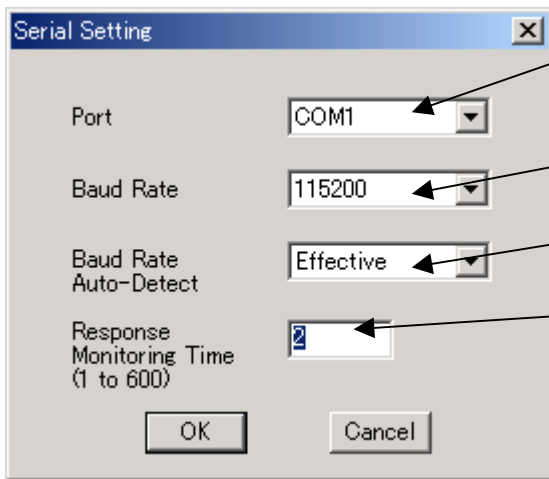

- (1) Set the COM port to use to connect the computer and PLC.
- (2) Set the baud rate between the computer and PLC.
- (3) Set whether to detect the baud rate between the computer and PLC.
- (4) Input the response monitor time. Increase the time only when there are frequent communications error.

1	Port	Set the COM port to use to connect the computer and PLC.
2	Baud rate	Set the baud rate between the computer and PLC to 9600, 19200, 37400, 57600, or 115200.
3	Detect baud rate	Set whether to detect the baud rate set for the peripheral port on the PLC. The default is to detect the baud rate. If detection is disabled (pin 4 on the PLC's DIP switch is turned ON), set the baud rate in 2, above, to the same speed as set for the peripheral port on the PLC.
4	Response monitor time	Input the response monitor time. Increase the time only when there are frequent communications error.

7. Set the *Port* to the COM port to use to connect the computer to the PLC. Here **COM1** is set as an example.
8. Click the **OK** Button in the Serial Setting Dialog Box.
9. Click the **Set...** Button on the right of the *NS* and *PLC* Field.

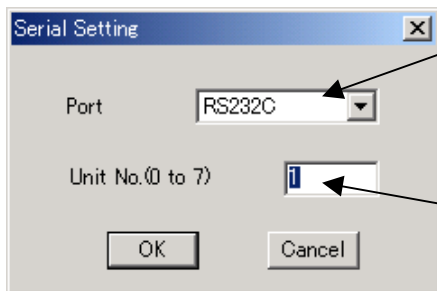

- Enter the port to use to connect the PT and PLC.
- Enter the unit number of the destination PT set for the NT Link (1:N).

10. Set the port to use to connect PLC and the unit number of the PT that will be the destination. Here, the unit number is set to 0 because the cable is connected to the RS-232C port with a 1:1 connection.
11. Click the **OK** Button in the Serial Setting Dialog Box.
12. Click the **OK** Button in the Comms Method Dialog Box.

Transferring Screen Data

1. Click the **Connect** Button in the Screen Data Transfer Dialog Box. After completing the connection, the screen on the PT switches to the following screen and the PT will wait for the data to be transferred. Here, the entire project will be transferred as an example.



2. Check **Select All**, and click the  button to display the Transfer Confirmation Dialog Box.
3. Click the **Start** Button. The download will be started.
4. The following dialog box will be displayed at the computer when the data transfer is finished. The PT must be restarted to operate the screens that have been transferred. Click the **YES** Button to restart the PT. Click the **NO** Button to continue downloading data.

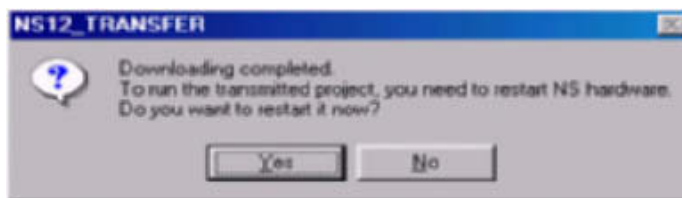

Even if the **NO** Button is selected, the confirmation message shown below will be displayed when exiting the Screen Data Transfer Dialog Box.



If the **YES** Button is clicked, the PT will be restarted. If the **NO** Button is clicked, it will become necessary to restart the PT directly. To return to the Screen Data Transfer Dialog Box, click the **Cancel** Button.

■ Serial Connection between a Computer and a PLC and Ethernet between a PLC and a PT Set for Transferring Data to the PT through the PLC

This section describes an example of the settings used when transferring screen data from the NS-Designer to a PT connected by Ethernet through a PLC connected with the computer by a serial (toolbus) connection.

NS-Designer Operation Manual

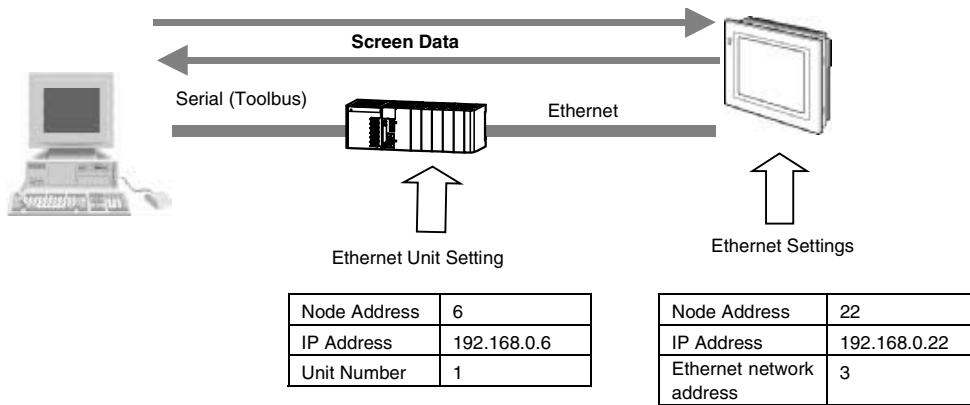

Settings on the PLC

Create the following routing table entry using CX-Net of CX-Programmer Ver. 3.1 or later and transfer the routing tables to the PLC.

1. Input the unit number of the Ethernet Unit. Here, **1** is input.
2. Input the network address of the Ethernet Unit. Here, **3** is input.

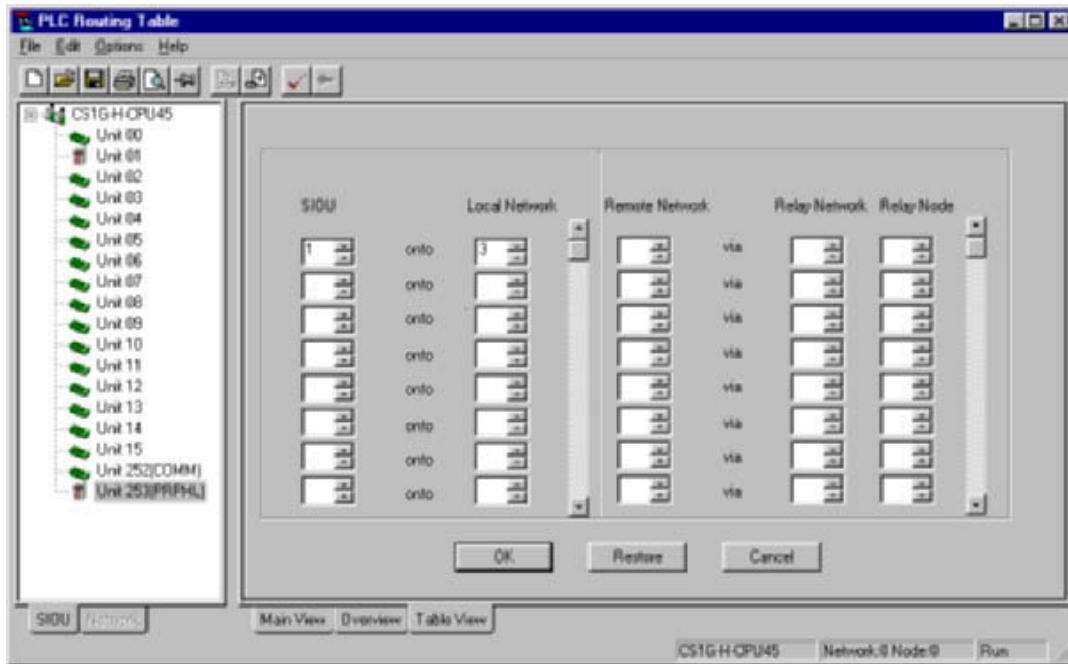

Reference

- ◆ Turn OFF pin 5 on the DIP switch on the PLC's CPU Unit when connecting a device other than a computer running the CX-Programmer (such as a PT or host computer).
- ◆ Turn ON pin 5 when connecting a computer running the CX-Programmer.

Settings on the PT

Make the settings on the NS-Designer shown below. After completing these settings, transfer them to the PT along with the screen data.

1. Select **Settings - System Setting – Comm - All** on the NS-Designer.
2. Set **Ethernet** to **Enable**.
3. Click the **Ethernet** Tab and make the following settings.
Set the same IP address as that of the PT. Here, **192.168.0.22** is set as an example.
4. Set the subnet mask of the PT. Here, **255.255.255.0** is set as an example.
5. Click the **Add** Button to display the IP Address Setting Dialog Box.
Set the same Node Address and IP Address as those set in the Ethernet Unit. Here, **6** is set for Node Address and **192.168.0.6** is set for the IP Address as examples.
6. Click the **OK** Button.



7. Transfer the settings with the screen data to the PT. To do this, connect the PT with the computer directly and perform standard data transfer. Do NOT transfer the data through the PLC.

Setting the Communications Method

1. Open the desired project on the NS-Designer and select **File - Screen Data Transfer**. The Screen Data Transfer Dialog Box will appear.
2. Click the **Comms.Method** Button on the top right of the dialog box. The **Comms.Setting** Dialog Box will appear.
3. Select **Pass Through PLC**.
4. Select the communications method between the computer and PLC. Set **Serial (Toolbus)**.
5. Select the communications method between PLC and PT. Set **Ethernet**.

NS-Designer Operation Manual

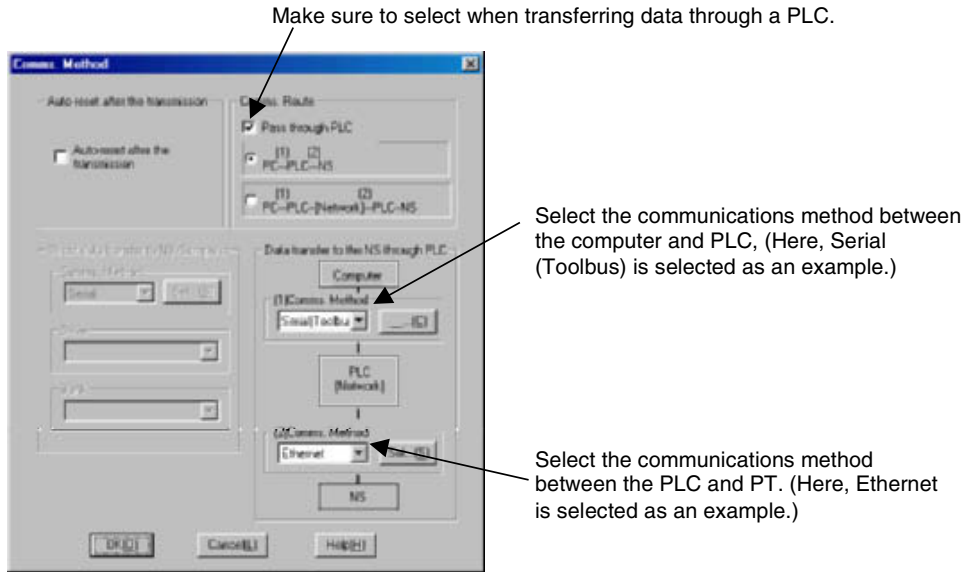

6. Click the **Set...** Button on the right of the communications method setting. The following Serial Setting Dialog Box will appear.

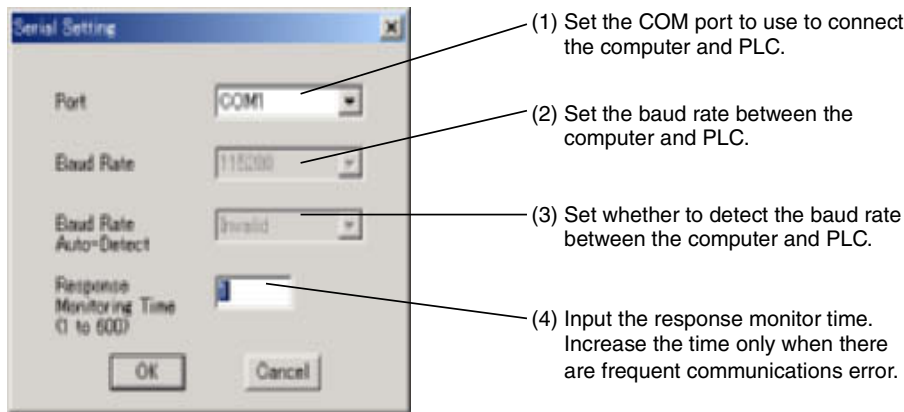

1	Port	Set the COM port on the computer to use to connect the computer and PLC.
2	Baud Rate	Set the baud rate between the computer and PLC to 9600, 19200, 34700, 57600, or 115200.
3	Baud Rate Auto-Detect	Set whether to detect the baud rate set for the peripheral port on the PLC. The default is to detect the baud rate. If detection is disabled (pin 4 on the PLC's DIP switch is turned ON), set the baud rate in 2, above, to the same speed as set for the peripheral port on the PLC.
4	Response Monitoring Time	Input the response monitor time. Increase the time only when there are frequent communications error.

7. Set the Port to the COM port to use to connect the computer to the PLC. Here **COM1** is set as an example.
8. Click the **OK** Button in the Serial Setting Dialog Box.
9. Click the **Set...** Button on the right of the *NS and PLC* Field. The Ethernet Setting Dialog Box shown below will be displayed.

NS-Designer Operation Manual

- 10. Set the Network Address between the PT and PLC (the value set in the local network table using CX-Net). Here, 3 is set as the Network Address for Ethernet communications.
- 11. Set the Node Address of the destination PT for the *Node Address*. Here, the node address of the PT is input. Here, 22 is set as an example.

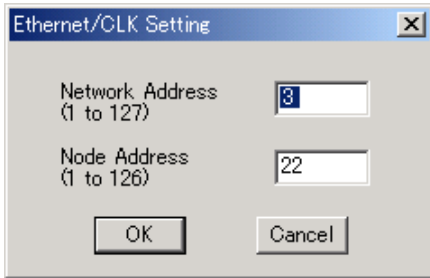

- 12. Click the **OK** Button in the Ethernet Setting Dialog Box.
- 13. Click the **OK** Button in the Comms Method Dialog Box.

Transferring Screen Data

- 1. Click the **Connect** button in the Screen Data Transfer Dialog Box. After completing the connection, the window will switch to the following window. Here, the entire project will be transferred as an example.



- 2. Select **Select All**, and click the  button to display the Transfer Confirmation Dialog Box.
- 3. Click the **Start** Button. The download will be started.
- 4. The following dialog box will be displayed at the computer when the data transfer is finished. The PT must be restarted to operate the screens that have been transferred. Click the **YES** Button to restart the PT. Click the **NO** Button to continue downloading data.

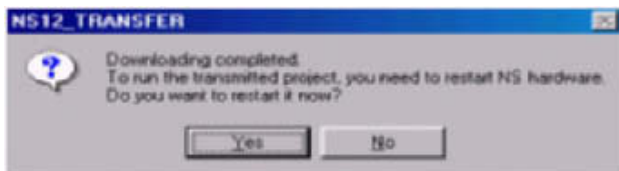

Even if the **NO** Button is selected, the confirmation message shown below will be displayed when

NS-Designer Operation Manual

exiting the Screen Data Transfer Dialog Box.



If the **YES** Button is clicked, the PT will be restarted. If the **NO** Button is clicked, it will become necessary to restart the PT directly. To return to the Screen Data Transfer Dialog Box, click the **Cancel** Button.

■ Ethernet between a Computer and a PLC and Serial 1:N NT Link between the PLC and a PT Set for Transferring Screen Data to the PT through the PLC

This section describes data transfer from the NS-Designer to a PT connected with either the RS-232C port or peripheral port in the PLC by a Serial connection through a PLC connected by Ethernet.

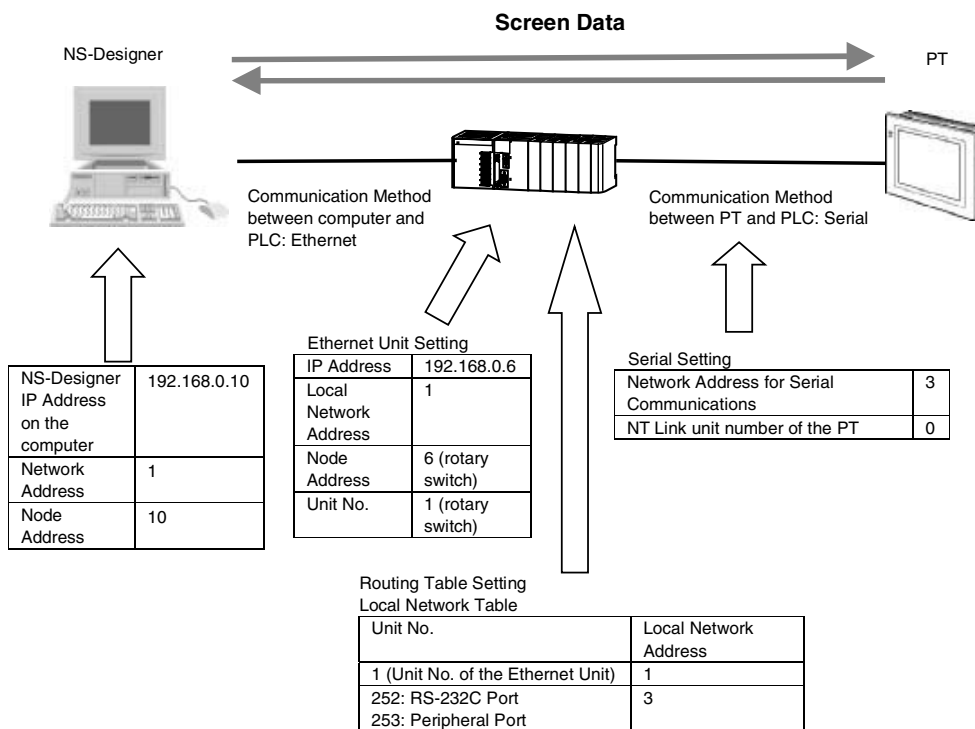

Settings on the PLC

Set the IP Address of the PLC Ethernet Unit (hardware or software setting) and Node Address (rotary switch setting).

For instance, set values as follows:

IP Address: 192.168.0.6

Network Address: 1

Node Address: 6

Refer to the *Chapter 9 Ethernet Connection- Setting an Ethernet Unit* in the *Tutorial Manual* for details on settings.

1. Create the routing tables using CX-Net in CX-Programmer Ver. 3.1 or later and transfer them to the

PLC. Create the local network table treating either the RS232-C port or peripheral port as the Communications Unit by setting the items shown below.

Connecting the PT with the PLC Using the RS-232C Port

Treat the RS-232C port as the Communications Unit. Set 252 for the SIOU, and set 3 for the Local Network of the serial communications that pass through this unit number.

Unit Number	Local Network Address
252 (serial port)	3

Connecting the PT with the PLC by the Peripheral Port

Treat the peripheral port as the Communications Unit. Set 253 for the SIOU, and set 3 for the Local Network of the serial communications that pass through this unit number.

Unit Number	Local Network Address
253 (peripheral port)	3

2. Add the Local Network Table for PLC Ethernet Unit in the same manner. Set 1 for the SIOU and 1 for Local Network.

Unit Number	Local Network Address
1	1

Settings on the PT

There is no need to make settings when connecting a PLC with a PT by Serial (1:N NT Link) connection.

Setting the Communications Method

1. Open the desired project on the NS-Designer and select **File - Screen Data Transfer**. The Screen Data Transfer Dialog Box will appear.
2. Click the **Comms.Setting** Button at the top right of the dialog box. The **Comms.Setting** Dialog Box will appear.
3. Select **Pass Through PLC**.
4. Select the communications method under **Computer**. Here, **Ethernet** is set.
5. Select the communications method between the PLC and PT. Set **NT Link** under **NS and PLC**.

NS-Designer Operation Manual

Select this option to transfer through the PLC.

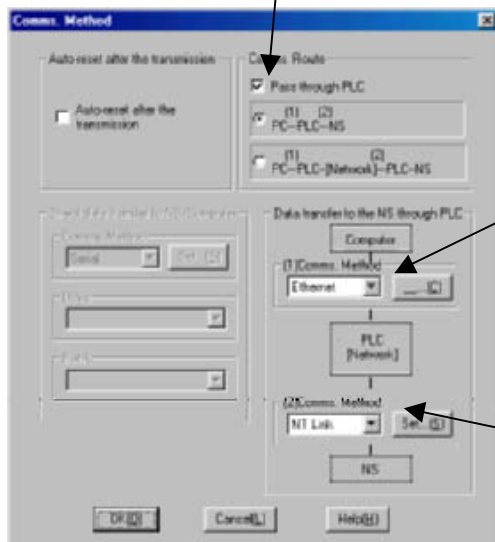

Set the communications method between the computer and PLC.

Select the communications method between the PLC and PT.

6. Click the **Set...** Button to the right of the communications method setting. The following Network Setting Dialog Box will appear.

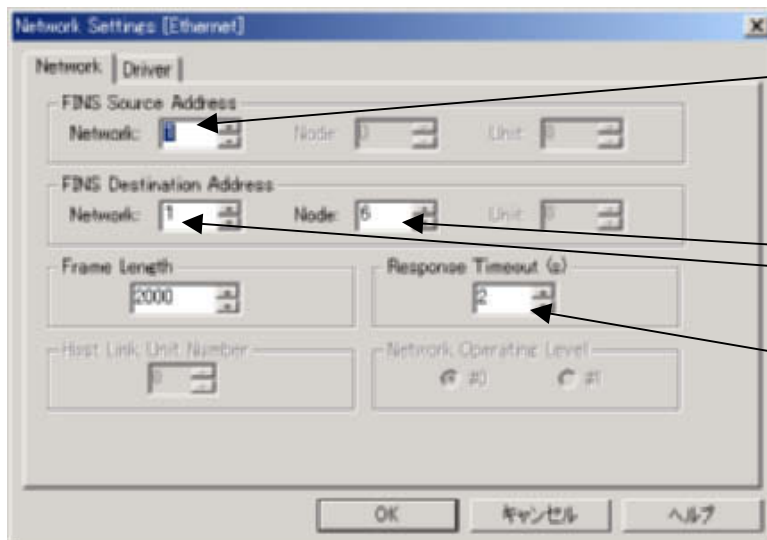

Set the Ethernet network address.

Set the network address and node number of the PLC's Ethernet Unit.

Input the response monitor time. Increase the time only when there are frequent communications error.

7. Input the Ethernet network address for the *Network* of the FINS source address. Here, **1** is set as an example.
8. Input network address and node number of the PLC's Ethernet Unit for the *Network* and *Node* of the FINS destination address. Here, **1** is set for the *Network* and **6** is set for the *Node* as an example.
9. Click the **Driver** Tab and make the following settings.

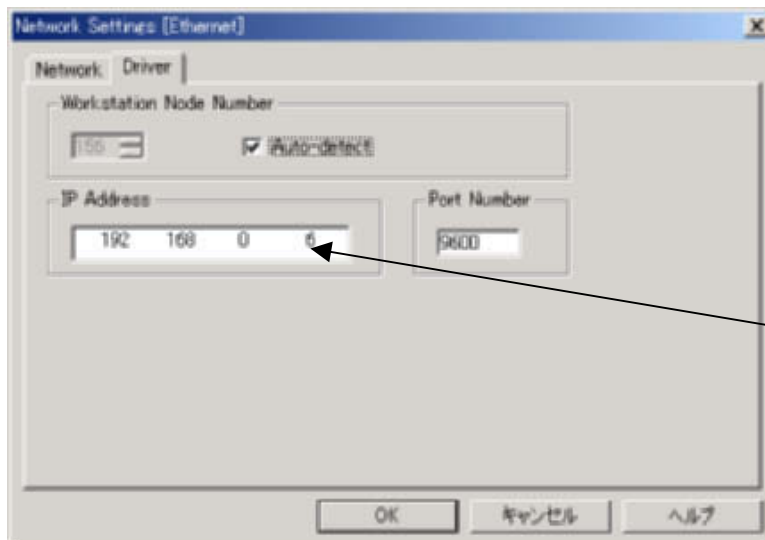

Set the IP address of the PLC's Ethernet Unit.

10. Input the IP address of the PLC's Ethernet Unit. Here, **192.168.0.6** is set for the *IP Address* as an example.
11. Click the **OK** Button in the Network Settings Dialog Box.
12. Click the **Set...** Button on the right of the *NS and PLC* Field. The Serial Setting Dialog Box shown below will be displayed.

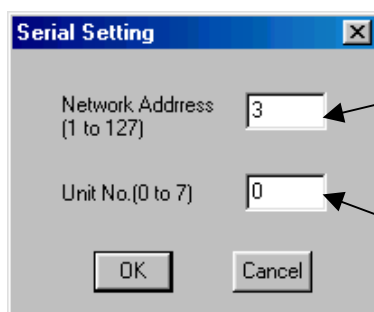

Set the serial communications network address (the value set for the local network table in the CX-Net) between the PT and PLC.

Input the unit number of the PT that is the target of the 1:N NT Link.

13. Set the serial communications network address (the value set for the local network table in the CX-Net) between the PT and PLC. Set 3 as the Serial communications network address.
14. Set the unit number of the destination PT. Here, 0 is set because the RS-232C port is connected 1:1.
15. Click the **OK** Button in the Serial Setting Dialog Box.
16. Click the **OK** Button in the Comms Method Dialog Box.

Transferring Screen Data

1. Click the **Connect** Button in the Screen Data Transfer Dialog Box. After completing the connection, the screen on the PT switches to the following screen and the PT will wait for the data to be transferred. Here, the entire project will be transferred as an example.



2. Select **Select All**, and click the  Button to display the Transfer Confirmation Dialog Box.
3. Click the **Start** Button. The download will be started.
4. The following dialog box will be displayed at the computer when the data transfer is finished. The PT must be restarted to operate the screens that have been transferred. Click the **YES** Button to restart the PT. Click the **NO** Button to continue downloading data.

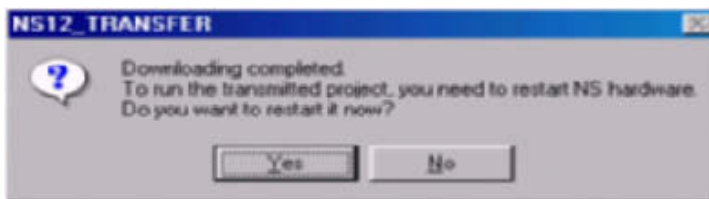

Even if the **NO** Button is selected, the confirmation message shown below will be displayed when exiting the Screen Data Transfer Dialog Box.



If the **YES** Button is clicked, the PT will be restarted. If the **NO** Button is clicked, it will become necessary to restart the PT directly. To return to the Screen Data Transfer Dialog Box, click the **Cancel** Button.

NS-Designer Operation Manual

■ Ethernet between a Computer and a PLC and Controller Link between a PLC and a PT Set for Transferring Data to the PT through the PLC

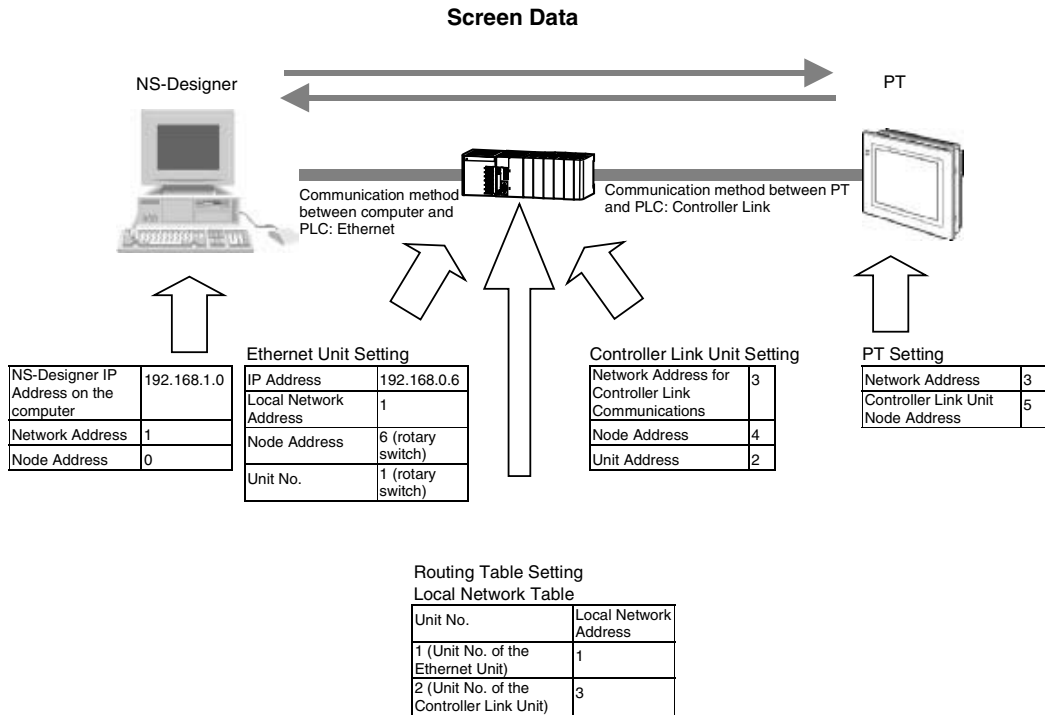

Settings on the PLC

1. Set the IP Address of the PLC Ethernet Unit (hardware or software setting) and Node Address (rotary switch setting).

For instance, set values as follows:

IP Address: 192.168.0.6
 Network Address: 1
 Node Address: 6

Note: Refer to the *Chapter 9 Ethernet Connection- Setting an Ethernet Unit* in the Tutorial Manual for details on settings.

2. Set the Node Address and Network Address of the PLC Controller Link Unit.

For instance, set values as follows:

Node Address: 4
 Network Address: 3

Note: Refer to *Controller Link Units Operation Manual (W309)* for details on settings.

3. Create the following routing table using CX-Net in CX-Programmer Ver. 3.1 or later and transfer it to the PLC.

	Unit Number	Local Network Address
Ethernet Unit	1	1
Controller Link Unit	2	3

NS-Designer Operation Manual

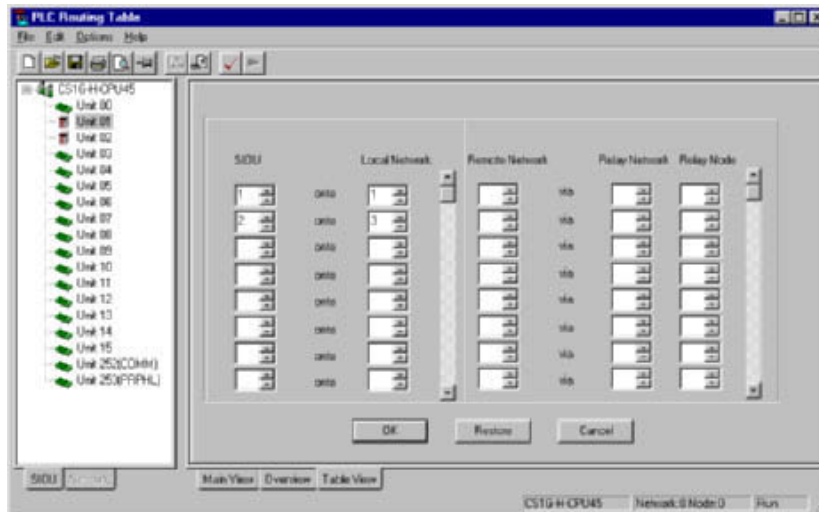

Settings on the PT

Make the settings on the NS-Designer shown below. After completing these settings, transfer them to the PT along with the screen data.

1. Select **Settings – System Setting – Comm-All** in NS-Designer.
2. Set **Controller Link** to **Enable** and click the **Routing Table Setting** Button. The Routing Table Setting Dialog Box will be displayed.

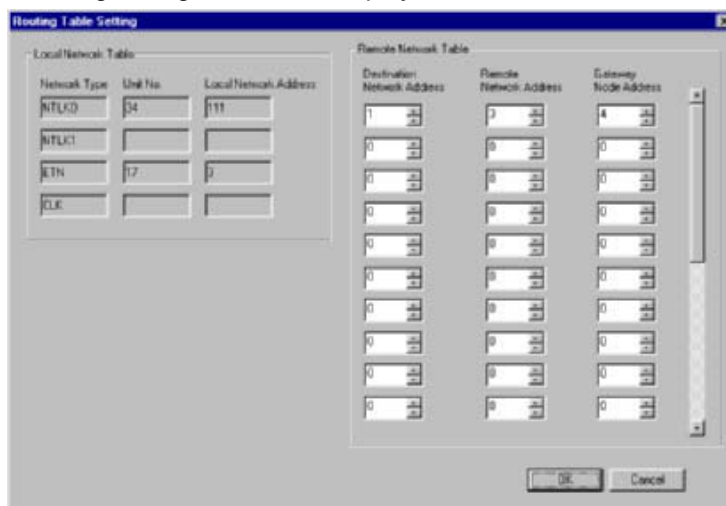

3. Input 1 as the *Destination Network Address*, 3 as the *Remote Network Address*, and 4 as the *Gateway Node Address* (Controller Link Unit's node address). Click the **OK** Button to return to the System Setting Dialog Box.
4. Transfer the above settings along with any desired screen data to the PT. At this time, connect the PT directly to the computer. Perform normal screen transfer without selecting **Pass Through PLC**.

Setting the Communications Method

1. Open the desired project on the NS-Designer and select **File - Screen Data Transfer**. The Screen Data Transfer Dialog Box will appear.

NS-Designer Operation Manual

2. Click the **Comms.Method** Button at the top right of the dialog box. The **Comms.Method** Dialog Box will appear.
3. Select **Pass Through PLC**.
4. Select the communications method under **Computer**. Here, **Ethernet** is set.
5. Select the communications method between the PLC and PT. Here, **CLK** (Controller Link) is set.
Select this option to transfer through the PLC.

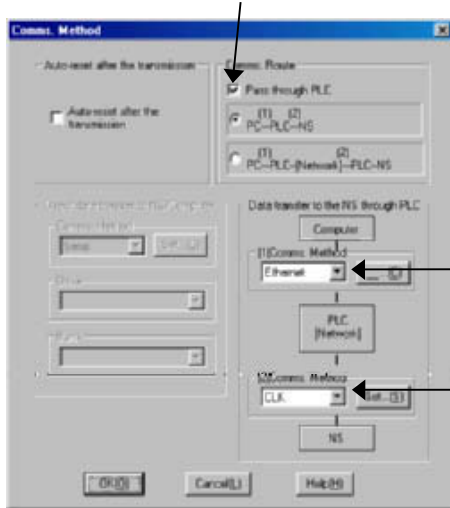

Select the communications method between the computer and PLC.

Select the communications method between the PLC and PT.

6. Click the **Set...** Button to the right of the communications method setting. The following Network Setting Dialog Box will appear.

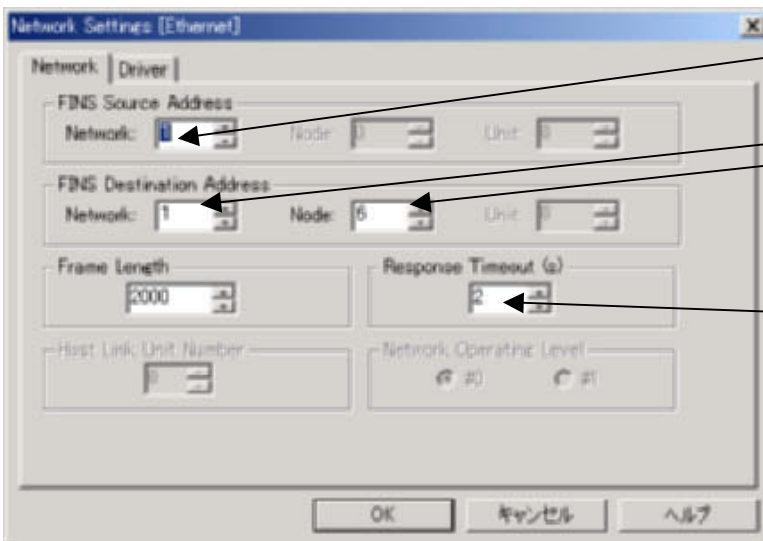

Set the Ethernet network address

Set the network address and node number of the PLC's Ethernet Unit.

Input the response monitor time. Increase the time only when there are frequent communications error.

7. Input the Ethernet network address for the **Network** of the FINS source address. Here, **1** is set as an example.
8. Input network address and node number of the PLC's Ethernet Unit for the **Network** and **Node** of the FINS destination address. Here the network address is set to **1** and the node number is set to **6** as examples.
9. Click the **Driver** Tab and make the following settings.

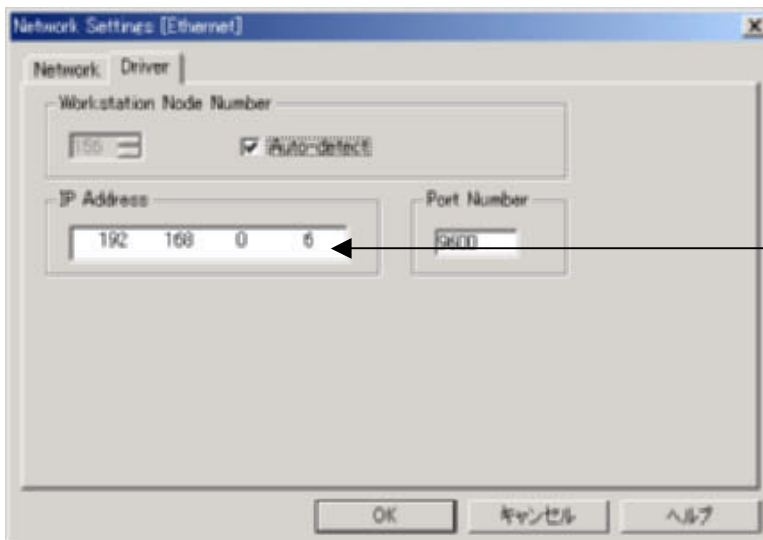

Set the IP address of the PLC's Ethernet Unit.

10. Input the IP address of the PLC's Ethernet Unit. Here, **192.168.0.6** is input as an example.
11. Click the **OK** Button in the Network Setting Dialog Box.
12. Set the Network Address between the PT and PLC (the value set in the local network table using CX-Net). In this example, 3 was set as the Network Address for Controller Link communications and so set 3.
13. Set the Node Address of the destination PT. In this example, set the Node Address of the PT's Controller Link Unit, i.e., set 5.

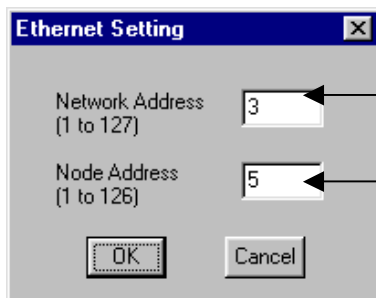

Set the Controller Link communications network address (the value set for the local network table in the CX-Net) between the PT and PLC.

Set the unit number of the PT that will be the destination.

14. Click the **OK** Button.

NS-Designer Operation Manual

■ Transferring Data, such as a Ladder Program, from CX-Programmer to a PLC through a PT

Transferring Data, such as a Ladder Program, from a Computer to a PLC through a PT Connected to the Computer via Ethernet and Connected to the PLC via Serial 1:N NT Link

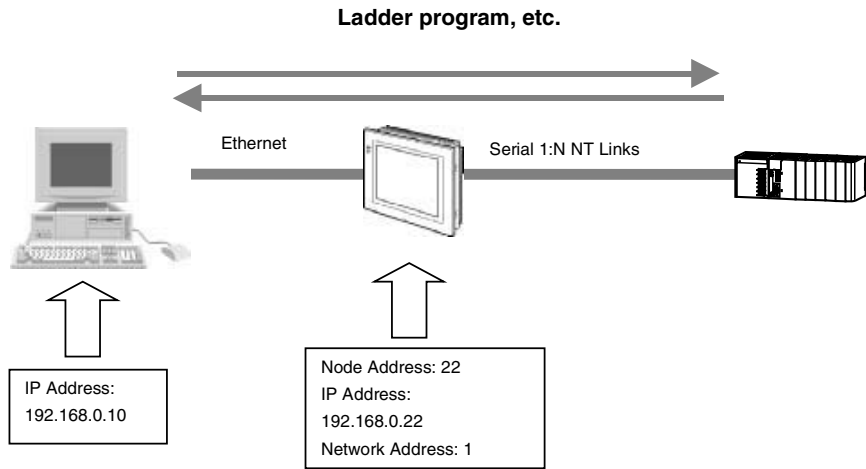

Settings on the PT

Go to the *System Menu - Comm Tab Page*. Press the **Enable** Button under *Ethernet* to display settings on the right side of the screen. Set these items in the way shown in the following table.

It is also possible to make the following settings in the NS-Designer's system settings, and transfer them together with any desired screen data beforehand.

Item	Setting
Network address	1 (network address between the computer and PT)
Node address	22 (PT's node address)
IP address	192.168.0.22 (PT's IP address)
Subnet mask	255.255.255.0
IP address (of computer)	192.168.0.10

Settings on the PLC

It is not necessary to make settings when connecting a PLC with a PT by serial communications (1:N NT Link).

Settings on the Computer

1. Start up CX-Programmer. Then, set the IP address of the PT in the *IP Address* on the *Network Settings - Driver Tab Page*.
2. Click the **Network** Tab and set the items in the table below.

Item	Setting
FINS Source Address	Set the local network address of the PT.
FINS Destination Address	Connection via serial port A: 111 Connection via serial port B: 112
Node	Here, 10 is set as an example.
Frame Length	Here, 1000 is set as an example.
Response Timeout	Default value is 2.

NS-Designer Operation Manual

Reference

- ◆ The node set from the *Network* Tab Page is fixed at 1. Transfer will not be performed correctly if another number is set. Be sure to set 1.

3. After completing the settings, establish online connection and transfer the data (e.g., ladder program).

The following example shows how to perform settings for transferring data, such as a ladder program, from CX-Programmer, via a PT connected via Ethernet, to a PLC connected via Controller Link.

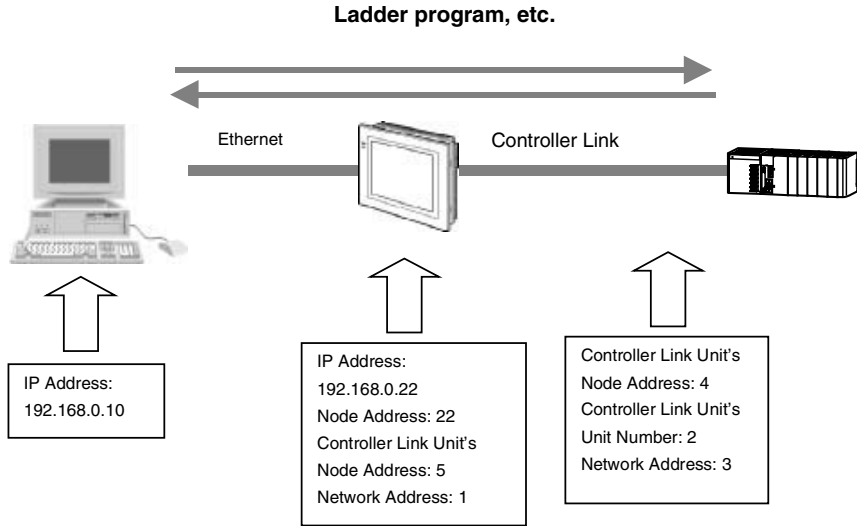

Settings on the PT

Perform the following settings with NS-Designer.

1. Select **Settings - System Setting - Comm - All** on the NS-Designer.
2. Set **Controller Link** and **Ethernet** to **Enable**, click the **Controller Link** Tab, and make the following settings.

Set the network address for Controller Link communications between the PT and PLC.

Set the unit number for the PT's Controller Link Unit.

NS-Designer Operation Manual

- Click the **Ethernet** Tab and make the following settings.



- Set the network address between the computer and NS-Designer as the network address. In this example, **1** is set.
- Set the PT's node address as the node address. In this example, **22** is set.
- Set the IP address set for the PT as the IP address. In this example, **192.168.0.22** is set.
- Next set the subnet mask. In this example, **255.255.255.0** is set.
- Next, click the **Add** Button at the bottom left of the dialog box to display the IP Address Setting Dialog Box. In this example, the node address and IP address set for the PT and computer are set.
- Click the **OK** Button.
- Transfer the above settings together with any desired screen data to the PT.

Settings on the PLC

Start up CX-Programmer. Connect the computer directly to the PLC. Create the following routing table and transfer it to the PLC.

Item	Setting
SIOU (unit number of the PLC's Controller Link Unit)	2
Local Network	3
Remote Network	1
Relay Network	3
Relay Node	5

NS-Designer Operation Manual

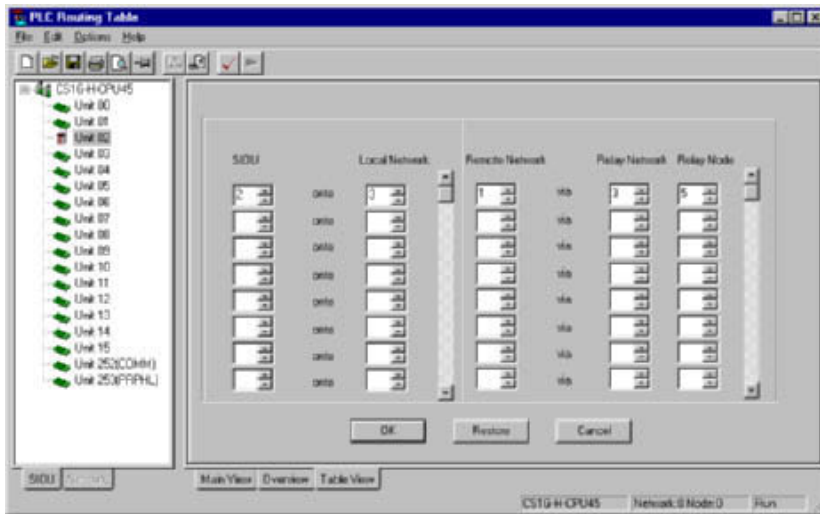

Settings on the Computer

Start up CX-Programmer.

1. Set the IP address of the PT in the *IP Address* on the *Network Settings - Driver* Tab Page.

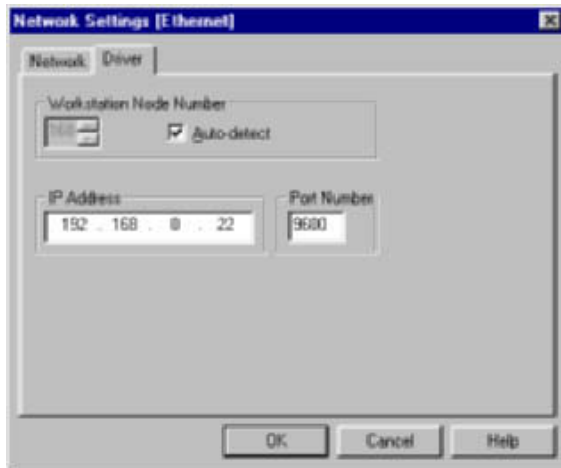

2. Click the **Network** Tab and make the following settings.

Item	Setting
FINS Source Address – Network (between computer and PT)	1
FINS Destination Address – Network (between PT and PLC)	3
Node	4



3. After completing the settings, establish online connection and transfer the data (e.g., ladder program).

Transferring Ladder Programs

Refer to the manual for the CX-Programmer for details on transferring ladder programs.

Section 11 Printing

This section describes functions provided for printing.

11-1	Printing Project Information	11-1
11-2	Printing Page Information.....	11-4
11-3	Previews.....	11-8
11-4	Outputting to an RTF File.....	11-9
11-5	Headers and Footers.....	11-10
11-6	Margins.....	11-12

11-1 Printing Project Information

Project information can be printed. The information that can be printed is given below.

Information	Details
Screen Title List	Prints a list of screen titles.
Sheet Title List	Prints a list of sheet screen titles.
Alarm Setting List	Prints a list of registered alarms and events.
Unit & Scale List	Prints a list of registered numeric units and scales. To print only registered items turn ON <i>Print Set Item Only</i> .
Password Setting	Prints a list of registered passwords.
System Data (Labels, System Setting)	Prints a list of label switch names and system settings.

1. Select **File - Print**.
2. The Print Dialog Box will be displayed. Select the **Project Information** Tab.
3. Select the information to be printed.

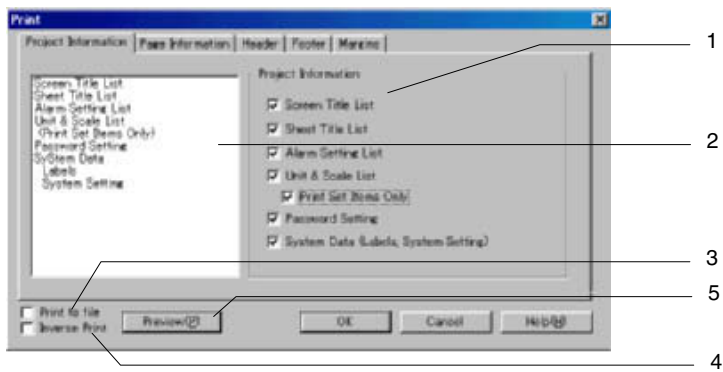

No.	Item	Details
1	Include	Select the information to be printed.
2	Printing Items List	Lists the items selected in No. 1, above.
3	Print to File	Outputs the selected items to an RTF (rich text format) file instead of a printer.
4	Inverse Print	Reverses black and white when printing.
5	Preview Button	Click this button to see a preview of the printed image.

Reference

- ◆ Project information will be printed normally even if *Reverse black and white* is selected.
4. Click the **OK** Button.
The Print Dialog Box will be displayed.
 5. Click the **OK** Button to start printing.

11-1-1 Printing Samples

Some samples of printer output are shown below.

Project Information, Top of Each Page

The project file name and project title are printed.

Project name: Operation Screen Title: New Project

Screen/Sheet Title Lists

Only the titles of screen pages that have been created are printed.

Page Title List

Page 0: MENU
 Page 1: Operation
 Page 2: Switch label

Sheet Title List

Sheet 0: Switch screen
 Sheet 1: Date & time display
 Sheet 2:
 Sheet 3:
 Sheet 4:
 Sheet 5:
 Sheet 6:
 Sheet 7:
 Sheet 8:
 Sheet 9:

Alarm Setting List

Alarm Setting List

No.	Address	Priority	Display Type	Group	Auto Screen Switch	Switch Screen No.	Auto Deletion	Save History	Text Color
1	SB100	1	High	0	ON	0	OFF	OFF	217
	Message								
	(Japanese) Alarm 1								
	(English) Alarm 1								
2	SB101	2	Middle	0	OFF	0	OFF	OFF	
	(Japanese) Alarm 2								
	(English) Alarm 2								

Unit and Scale Settings

Unit & Scale Setting List

No.	Unit name	Scale	Offset
1	mm	10	0
2	cm	10	10
3	m	1	0
4	km	1	0
5	inch	1	0
6	g	1	0
7	kg	1	0
8	cc	1	0
9	ml	1	0
10	l	1	0
11	C	1	0

Password Settings

<u>Password Setting</u>	
<u>Level</u>	<u>Password</u>
Level 1	Password 1
Level 2	Password 2
Level 3	Password 3
Level 4	
Level 5	

System Data

<u>System Data</u>	
PT	
	<Start Up Wait Time> = 10 sec
	<Key Press Sound> = ON
	<Buzzar Sound> = ERR ON
	<Screen Saver>
	<Screen Saver Movement> = OFF
	<Screen Saver Start-up Time> = 15 min









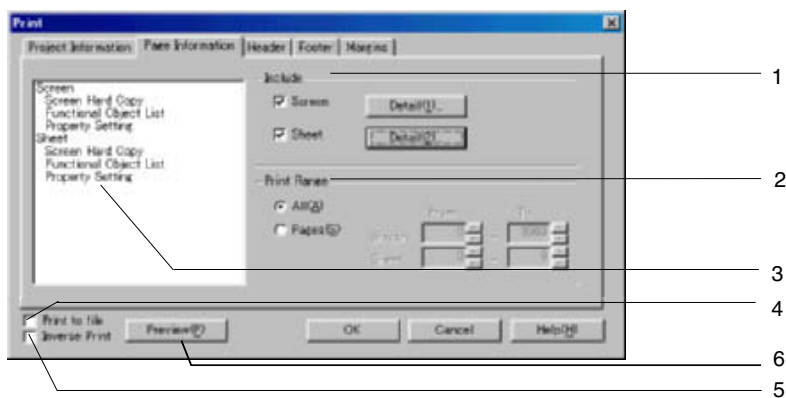

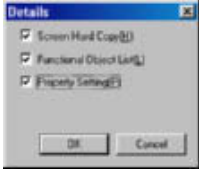
11-2 Printing Page Information

User screen information can be printed. The following information can be printed.

Item	Details
Screen Hard Copy	Prints a hardcopy of the screen.
Functional Object List	Prints a list of the functional objects in each screen.
Property Setting	Prints a list of the properties of the functional objects in each screen.

1. Select **File - Print**.
2. The Print Dialog Box will be displayed. Select the **Page Information** Tab and select the range to be printed.
3. Select the information and ranges to be printed. (Click the **Details** Button to set the information to be printed.)



No.	Item	Details				
1	Include	Select the information to be printed. Click the Details Button to display the following dialog box and select the information to be printed. 				
2	Print	Select the range of screens to be printed from the following options. <table border="1" data-bbox="331 555 518 622"> <tr> <td>All</td> <td>Prints information on all screens that are used.</td> </tr> <tr> <td>Pages</td> <td>Prints information on the specified screens.</td> </tr> </table>	All	Prints information on all screens that are used.	Pages	Prints information on the specified screens.
All	Prints information on all screens that are used.					
Pages	Prints information on the specified screens.					
3	Printing Items List	Lists the items selected in No. 1, above.				
4	Print to File	Outputs the selected items to an RTF (rich text format) file instead of a printer.				
5	Inverse Print	Reverses black and white when printing. Example: <table border="0" data-bbox="531 763 927 936"> <tr> <td style="text-align: center;">  Normal display </td> <td style="text-align: center; vertical-align: middle;">  </td> <td style="text-align: center;">  Reverse black and white display </td> </tr> </table>	 Normal display		 Reverse black and white display	
 Normal display		 Reverse black and white display				
6	Preview Button	Click this button to see a preview of the printed image.				

4. Click the **OK** Button.
The Print Dialog Box will be displayed.
5. Click the **OK** Button to start printing.

Reference

- ◆ Project information will be printed normally even if *Inverse Print* is selected.

11-2-1 Printing Samples

Some samples of printer output are shown below.

Project Information, Top of Each Page

The screen page number and screen title are printed.

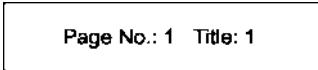

Screen Hard Copy

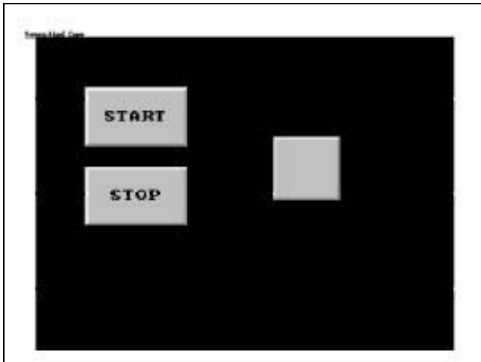

Functional Object List

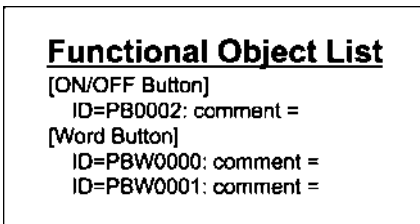

Property Settings

The property settings on each tab page are printed.



Reference

- ◆ All property information for objects will be printed for property settings. This may result in a large number of pages being printed.

It is recommended that the Functional Object List is used to more efficiently check object settings. The Functional Object List can be saved to a CSV file, which can also be printed.

Select **Tools - Functional Object List**, select the desired range, and click the **Save** Button to save the Functional Object List to a CSV file. Refer to *5-9 Listing Functional Objects Used* for details on operating procedures.

- ◆ With data block tables, only the settings for each tab page in the Property Settings Dialog Box are printed. Settings for each data block field (e.g., communications addresses, data formats, keypads) are not printed.

11-3 Previews

Previews can be displayed of the printer output for project information or page information.

1. Select the items to be printed in the Print Dialog Box.
2. Click the **Preview** Button.

A preview window will be displayed. Operating procedures for the preview window are the same as those for the standard Windows® preview window.

Example for Printing Page Information

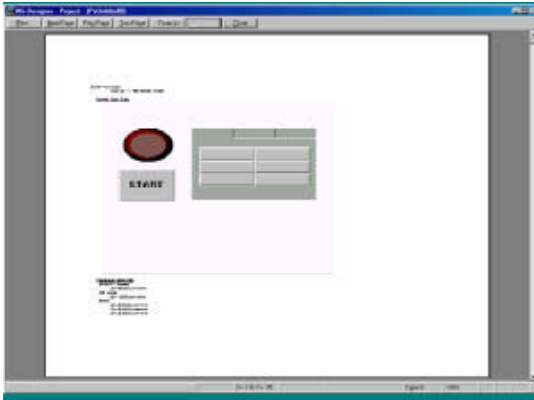

3. To return to the Print Dialog Box from the Preview Window, click the **Print** Button in the Preview Window.

Reference

- ◆ The header and footer information can also be checked on the preview. Refer to *11-5 Headers and Footers* for information on headers and footers.
- ◆ To close the Preview Window and Editing Window, click the **Close** Button in the Preview Window.

11-4 Outputting to an RTF File

The selected project or page information can be printed to an RTF (rich text format) file. RTF files can be edited with MS Word and other word processing software. The procedure for outputting to an RTF file is as follows:

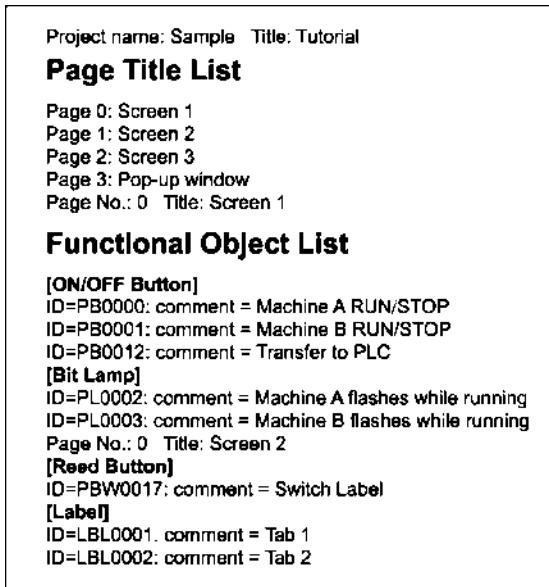

1. Select the items to be output to the RTF file in the Print Dialog Box.
2. Select *Print to File*.

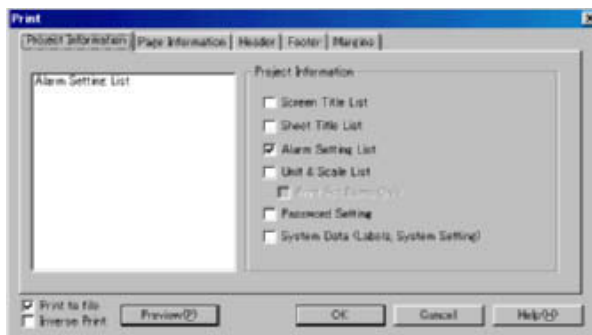

3. Click the **OK** Button.
4. The dialog box shown below will be displayed. Specify the directory and file name where the RTF file will be saved, and click the **Save** Button.

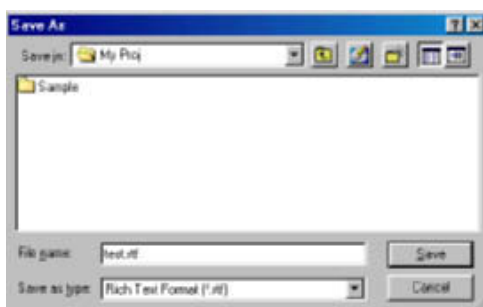

11-5 Headers and Footers

Headers and footers can be added to the documents to be printed.

The header is the margin at the top of the page and the footer is the space at the page where the page number, date, time, and text strings can be printed.

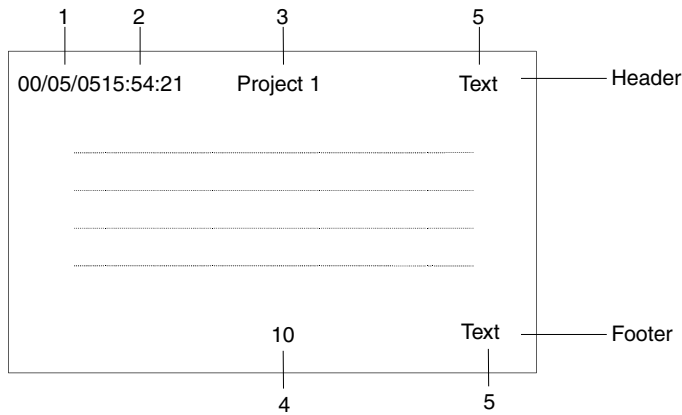

A sample of a printed header and footer is shown below.

(1) Date (2) Time (3) Project name (4) Page number (5) Text string

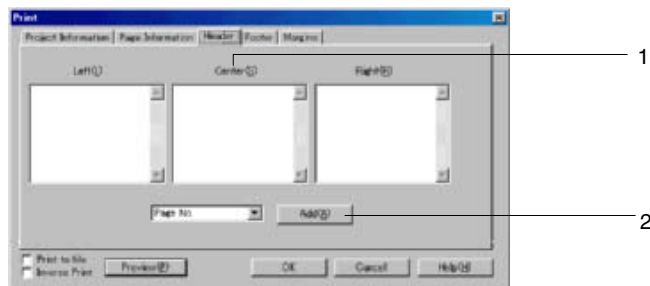

1. Select the **Header** Tab or the **Footer** Tab in the Print Dialog Box.
2. Select the items to insert into the header/footer and the locations for the items.



No.	Item	Details
1	Position	The insertion position for text strings in headers and footers can be set to left, center, or right.
2	Items	<p>Use the following procedure to set the items to insert.</p> <ol style="list-style-type: none"> 1. Place the cursor at the insertion position. 2. Select the item to insert from the combo box and click the Add Button. <p>"&" followed by the printing item name will appear in the input field. "&" does not have to be added when inputting character strings.</p> <p>Example: The following settings will produce the header and footer shown in the previous sample.</p> <p>Header</p>  <p>Footer</p> 

11-6 Margins

Set the distances from the edge of the paper to the printed characters. The project or page information will be printed inside the area bounded by the margins. The header and footer will be printed in the margins.

1. Select the **Margins** Tab of the Print Dialog Box.
2. Set the width of the top, bottom, left, and right margins.

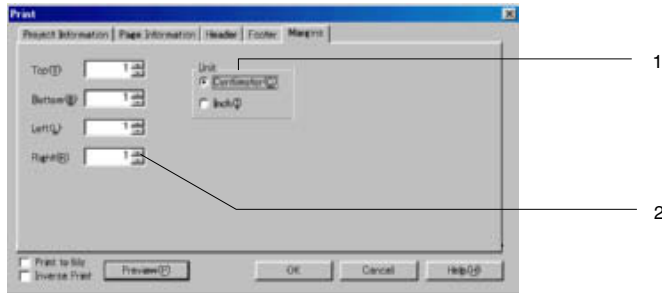

No.	Item	Details
1	Units	Select centimeters or inches for the margins set in item 2, below.
2	Margins	Set the width of the top, bottom, left, and right margins. Each margin can be set to between 0 and 10 centimeters (0 and 4 inches).

Section 12 Importing/Exporting CSV Files

This section describes the methods used to import and export property information for functional objects as CSV files.

The CSV files that are exported can be edited using spreadsheet software or a text editor and then reimported to set functional object properties in a "batch" operation.

The following items can be edited in the CSV files.

- Address settings
- Comment settings
- Label settings

Functional objects cannot be added or deleted.

12-1	Exporting CSV Files	12-1
12-2	Editing CSV Files	12-2
12-3	Importing CSV Files	12-3

12-1 Exporting CSV Files

The property information for functional objects in the entire project or for selected screens can be exported to a CSV file.

1. Select **File - Export CSV File**.
2. The Export CSV File Dialog Box will be displayed.
Select the range to be exported and then click the **OK** Button.

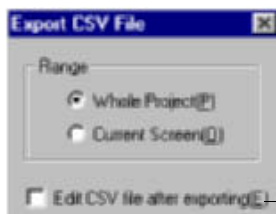

Add a checkmark to start the spreadsheet software automatically and open the CSV file when it is exported.

A dialog box to specify the location in which to save the CSV file will be displayed.

Reference

- ◆ When exporting CSV files on Windows 2000 or XP, Unicode or ASCII can be selected as the output code. To translate a label, for example from Japanese into Chinese, using Excel, select Unicode. Unicode, however, is not supported for Windows 95, 98, and NT, i.e., the output code is always ASCII (multibyte). Windows 2000 or XP is required to specify Unicode.

For details, refer to *13-2-3 Creating Multi-language Display Screens Using the CSV Import/Export Function*.

Reference

- ◆ *Edit CSV file after exporting* can be turned ON when exporting to the CSV file to automatically start the application associated with the CSV extension. If the executable file for the associated application cannot be found, the following error message will be displayed.

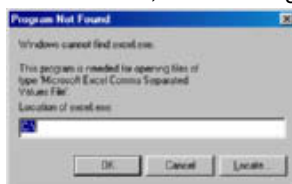

Specify the executable file to start the application and open the exported CSV file.

12-2 Editing CSV Files

CSV files can be edited with spreadsheet software or a text editor.

In the CSV file, the labels, comments, and addresses set for the functional objects can be edited.

1. Open the CSV file that was exported to the spreadsheet software or text editor.
If *Edit CSV file after exporting* was turned ON when exporting to the CSV file, the spreadsheet software or text editor associated with the CSV extension will be started and the file will be opened automatically.

1	****VER3																			
2	****Project_T																			
3	PAGED	*PNLPG000	IPW																	
4	PAGED	*ON/OFF	Bt	Comment	Label OFF(Eng)	Label ON(Eng)	Label OFF(Japanese)	Label ON(Japanese)	Write Address	Display Address1	Display Address2									
5	PAGED	PB0000		STOP					\$B100	\$B200	\$B300									
6	PAGED	*Word Bt	Comment	Label(English)			Label(Japanese)		Address											
7	PAGED	PB00001							\$W100											
8	PAGED	*Command	Comment	Label(English)			Label(Japanese)													
9	PAGED	PB00002		Switch Screen																
10	PAGED	*Bt Lamp	Comment	Label(English)			Label(Japanese)		Display Address											
11	PAGED	PL0003							\$B0											
12	PAGED	PL0004							\$B0											

Example 1: Changing the write address for an ON/OFF button from \$B0 to \$B10.

61	5	PAGE3-T	*ON/OFF Bt	Comment	Label OFF(Type 0)	Label ON(T	Write Address	Display A	Display Address2
62	6	PAGE3-T	PB0007				\$B0		\$B100
63	7	PAGE3-T	PB0008				\$B1		

Example 2: Setting the label for a command button to "Screen 1."

61	5	PAGE3-T	*ON/OFF Bt	Comment	Label OFF(Type 0)	Label ON(T			
62	6	PAGE3-T	PB0007						
63	7	PAGE3-T	PB0008						
64	8	PAGE3-T	PB0009		STOP		RUN		

2. After editing, confirm that the extension of the filename is CSV and save the file.

Reference

- ◆ Objects and screens cannot be added or deleted from the CSV file.
- ◆ When the file is closed, a message warning that some changes may be lost if the file is saved in the current format may be displayed. This will not adversely affect PT operation.
- ◆ The file contains internal information required by the NS-Designer when the file is imported (****VER3). Do not edit this information.

12-3 Importing CSV Files

CSV files that have been edited externally can be reimported into the NS-Designer to change the property information of the entire project or selected screens. An error check will be performed on the CSV file when importing.

1. Select **File - Import CSV File**.
2. The Import CSV File Dialog Box will be displayed.
Select the range to be imported and then click the **OK** Button.

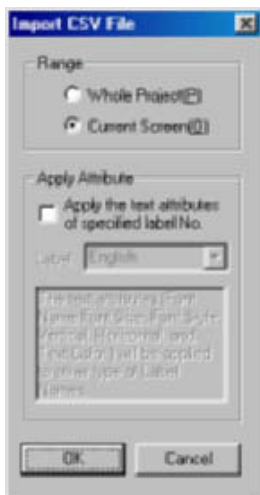

3. A dialog box will be displayed to select the CSV file to import.
Specify the file and click the **Open** Button.



4. A dialog box to notify that the import operation has been completed will be displayed. Click the **OK** Button.

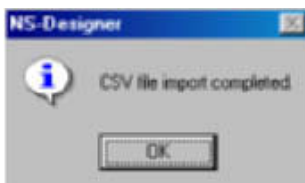

No.	Details																																																																			
1	Displays the line number in the CSV file data where the error was found.																																																																			
2	Displays the error number. Refer to the following table for details.																																																																			
	<table border="1"> <thead> <tr> <th data-bbox="347 349 430 405">Error No.</th> <th data-bbox="459 349 699 405">Details</th> <th data-bbox="699 349 1436 405">Countermeasure</th> </tr> </thead> <tbody> <tr> <td data-bbox="347 405 430 533">1</td> <td data-bbox="459 405 699 533">Address or label setting is not correct.</td> <td data-bbox="699 405 1436 533"> 1. Confirm that addresses are set within the range of the number of addresses set in the System Settings. 2. Confirm that the format of address settings is correct. 3. Confirm that none of the labels are too long. </td> </tr> <tr> <td data-bbox="347 533 430 595">2</td> <td data-bbox="459 533 699 595">Format error in imported CSV file.</td> <td data-bbox="699 533 1436 595">Check that the imported file is in CSV format.</td> </tr> <tr> <td data-bbox="347 595 430 712">3</td> <td data-bbox="459 595 699 712">Insufficient memory. Settings contained in CSV file cannot be imported.</td> <td data-bbox="699 595 1436 712">Close any unnecessary applications and re-execute the import operation.</td> </tr> <tr> <td data-bbox="347 712 430 853">4</td> <td data-bbox="459 712 699 853">Could not open the CSV file. CSV file could not be imported.</td> <td data-bbox="699 712 1436 853">Check that the file is not being used by another application. If the file is being used by another application, close the file and then re-execute the import operation.</td> </tr> </tbody> </table>	Error No.	Details	Countermeasure	1	Address or label setting is not correct.	1. Confirm that addresses are set within the range of the number of addresses set in the System Settings. 2. Confirm that the format of address settings is correct. 3. Confirm that none of the labels are too long.	2	Format error in imported CSV file.	Check that the imported file is in CSV format.	3	Insufficient memory. Settings contained in CSV file cannot be imported.	Close any unnecessary applications and re-execute the import operation.	4	Could not open the CSV file. CSV file could not be imported.	Check that the file is not being used by another application. If the file is being used by another application, close the file and then re-execute the import operation.																																																				
Error No.	Details	Countermeasure																																																																		
1	Address or label setting is not correct.	1. Confirm that addresses are set within the range of the number of addresses set in the System Settings. 2. Confirm that the format of address settings is correct. 3. Confirm that none of the labels are too long.																																																																		
2	Format error in imported CSV file.	Check that the imported file is in CSV format.																																																																		
3	Insufficient memory. Settings contained in CSV file cannot be imported.	Close any unnecessary applications and re-execute the import operation.																																																																		
4	Could not open the CSV file. CSV file could not be imported.	Check that the file is not being used by another application. If the file is being used by another application, close the file and then re-execute the import operation.																																																																		
	5	A project file name or screen file name specified in the CSV file does not exist.	<p>Refer to the following and insert the project file names or screen file names.</p> <table border="1"> <thead> <tr> <th></th> <th>Column A</th> <th>Column B</th> <th>Column C</th> <th></th> </tr> </thead> <tbody> <tr> <td>Row 1</td> <td>1</td> <td>***VERG</td> <td></td> <td></td> </tr> <tr> <td></td> <td>2</td> <td>***Project_T</td> <td></td> <td>1</td> </tr> <tr> <td></td> <td>3</td> <td>PAGE0</td> <td>**PNLPG000.IPW</td> <td></td> </tr> <tr> <td>Row 2</td> <td>4</td> <td>PAGE0</td> <td>*ON/OFF (Comment)</td> <td></td> </tr> <tr> <td></td> <td>5</td> <td>PAGE0</td> <td>PB0000</td> <td>2</td> </tr> <tr> <td></td> <td>6</td> <td>PAGE0</td> <td>*Word Bit Comment</td> <td></td> </tr> <tr> <td></td> <td>7</td> <td>PAGE0</td> <td>PBW0001</td> <td></td> </tr> <tr> <td></td> <td>8</td> <td>PAGE0</td> <td>*Comment Comment</td> <td></td> </tr> <tr> <td></td> <td>9</td> <td>PAGE0</td> <td>PB0002</td> <td></td> </tr> <tr> <td></td> <td>10</td> <td>PAGE0</td> <td>*Bit Lamp Comment</td> <td></td> </tr> <tr> <td></td> <td>11</td> <td>PAGE0</td> <td>PL0003</td> <td></td> </tr> <tr> <td></td> <td>12</td> <td>PAGE0</td> <td>PL0004</td> <td></td> </tr> </tbody> </table> <p>Columns are A, B, and C in order from the left. Rows are 1, 2, and 3 in order from the top.</p> <ol style="list-style-type: none"> The project file name is specified in the B column in the rows with a "1" in the A column. (The version is specified in row 1 of the B column, however, so the project file name is specified in row 2.) Format: ***project name Example: If the project name is "Test": ***Test The screen file name is specified in the C column in the rows with a "2" in the A column. (The project file name is specified in row 1 of the B column, however, so the screen file name is specified in row 3.) Format: **PNLPG screen page number/sheet page number.IPW Screen page numbers are 3-digit hexadecimal numbers starting from 000. Sheet page numbers are 3-digit hexadecimal numbers in the range FFF (page number 0) to FF6 (page number 9). Example: If the screen page number is 16: **PNLPG010.IPW Example: If the sheet page number is 3: **PNLPGFFC.IPW 		Column A	Column B	Column C		Row 1	1	***VERG				2	***Project_T		1		3	PAGE0	**PNLPG000.IPW		Row 2	4	PAGE0	*ON/OFF (Comment)			5	PAGE0	PB0000	2		6	PAGE0	*Word Bit Comment			7	PAGE0	PBW0001			8	PAGE0	*Comment Comment			9	PAGE0	PB0002			10	PAGE0	*Bit Lamp Comment			11	PAGE0	PL0003			12	PAGE0	PL0004	
	Column A	Column B	Column C																																																																	
Row 1	1	***VERG																																																																		
	2	***Project_T		1																																																																
	3	PAGE0	**PNLPG000.IPW																																																																	
Row 2	4	PAGE0	*ON/OFF (Comment)																																																																	
	5	PAGE0	PB0000	2																																																																
	6	PAGE0	*Word Bit Comment																																																																	
	7	PAGE0	PBW0001																																																																	
	8	PAGE0	*Comment Comment																																																																	
	9	PAGE0	PB0002																																																																	
	10	PAGE0	*Bit Lamp Comment																																																																	
	11	PAGE0	PL0003																																																																	
	12	PAGE0	PL0004																																																																	
3	<p>Details on the error that was detected will be displayed. The format is as follows: Row number, screen page number, ID number, and error detection identifier For the previous dialog box, there is a mistake in the CSV format of the Numeral Display Object with ID number NUM0003 located on screen page number 0 on line 9.</p>																																																																			

Applying Attributes

When importing a CSV file of screen data that has been set using multiple label settings, the specified label attributes can be applied to all the labels.

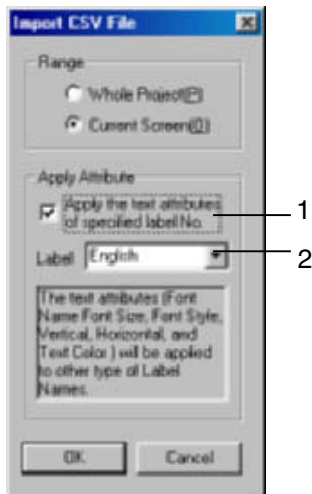

No.	Item	Details
1	Apply the text attributes of specified label No.	Select to apply attributes. If the number of set labels is 1, this option is disabled.
2	Label	Select the name of the label to which the attributes are to be applied.

Reference

- ◆ The following items are affected when label properties are applied.
 - Font name
 - Font size
 - Font style
 - Vertical position
 - Horizontal position
 - Text color
- ◆ If label attributes are applied to a CSV file that has been reedited, such as by adding screen data, and then imported after label attributes were applied, the label attributes will also be applied to the previous data for the selected label name.

Section 13 Multi-language Display

This section describes the settings required for multi-language display on the PT screen using the label switching function or the indirect specification function, or by importing/exporting CSV files.

13-1	Overview.....	13-1
13-2	Creating Multi-language Display Screens	13-2

13-1 Overview

Multi-language displays use Unicode for the character information displayed in a screen. This enables switching the screen between different languages, such as Japanese, English, and Chinese.

NS-series PTs use the label switching function, the object character string indirect reference function (e.g., for list selection or text), and the CSV file import/export function to implement multi-language displays.

A computer environment (Windows 2000 or Window XP) that supports creating Unicode data is required for multi-language displays.

This section describes the settings required for multi-language display on the PT screen.

13-2 Creating Multi-language Display Screens

The following methods can be used to create screens that allow multi-language display.

1. Input multi-language characters in NS-Designer property settings.
2. Display multi-language characters using indirect object specification.
3. Create multi-language display screens using the CSV import/export function.

13-2-1 Inputting Multi-language Characters in NS-Designer Property Settings

Settings on the PC

In order to create screen data with NS-Designer using the multi-language function, it is necessary to perform Windows settings beforehand. The settings are made from the Windows Control Panel. The actual settings required depend on the input language. Perform settings in the way indicated in the following table.

Language used	Input method	PC setting
Japanese	IME (MS-IME, ATOK, etc.)	Not required (Use standard setting.)
Western European languages (German, Spanish, etc.)	Character Map	Not required (Use standard setting.)
	On-screen Keyboard	Additional setting for input locale
Simplified Chinese, Traditional Chinese, Hangul	IME (MS-PinYin98, etc.)	Additional setting for input locale (input system setting)

Note: The PC settings are used by other functions as well and so be sure to make these settings before creating a multi-language display screen.

Reference

- ◆ Use Windows 2000 or XP when creating multi-language screen data with NS-Designer. The creation of multi-language screen data is not possible with Windows 95, 98, ME, or NT.

Setting the Input Locale for Western European Languages

The windows shown in the following explanations are for Windows 2000.

1. Open **Control Panel – Regional Options** and select the Input Locales Tab Page. Click the **Add** Button.
 - In Windows XP, open **Control Panel – Regional Options** and select the Languages Tab Page. Click the **Details** Button under *Text services and input languages*.

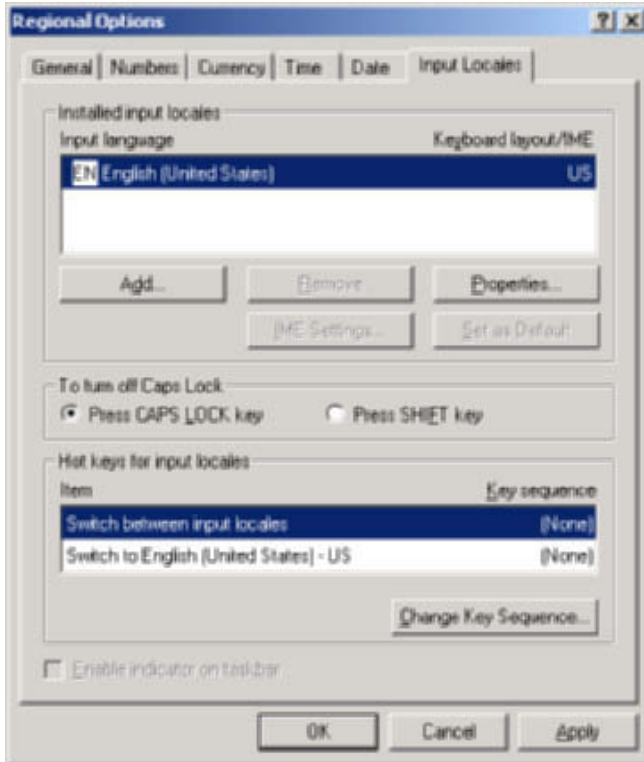

2. The following window will be displayed. Select the language to be input under *Input locale* (*Input language* in Windows XP) and click the **OK** Button.

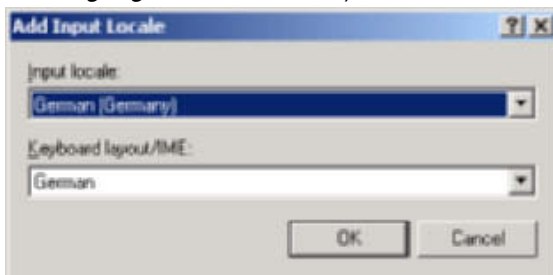

3. *Switch between input locales* is automatically set under *Hot keys for input locales*. Also the *Enable indicator on taskbar* option at the bottom of the window is automatically selected. If the setting is *None*, change the setting with the **Change Key Sequence** Button (**Key Settings** Button in Windows XP).

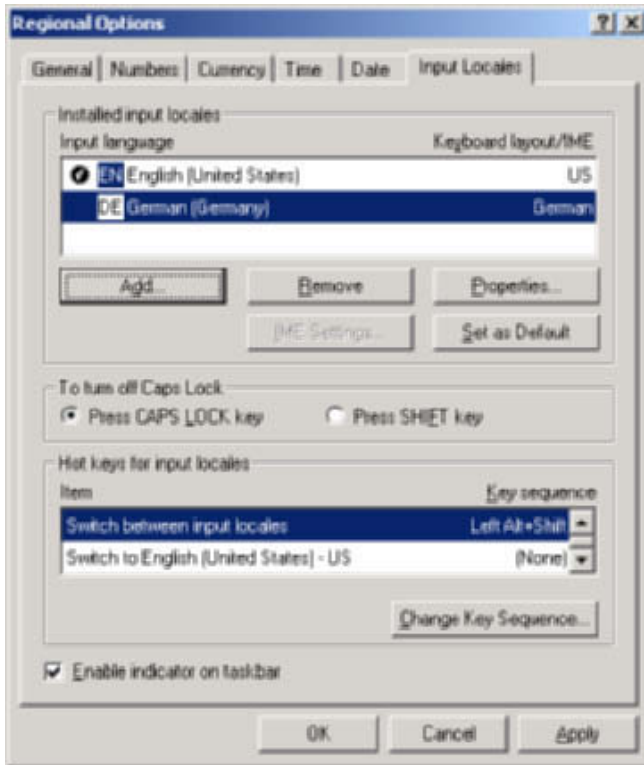

4. Click the **OK** Button to complete the settings.
5. After completing the settings, confirm that the indicator in the bottom right-hand corner changes when the left Alt Key and Shift Key are pressed.
 - When inputting Japanese using MS-IME:



- When inputting German using On-screen Keyboard:

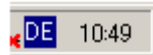

In this example, German was added. Use the same procedure to add Spanish or any other western European language. Set as many languages as required.

Setting the Input Locale for Simplified Chinese, Traditional Chinese, and Hangul

In order to input Asian languages, such as Chinese, the appropriate input system and fonts must be installed. As an example, the setting procedure required for inputting Chinese using MS-PinYin98 is explained below.

1. Setting the System Language

Add Chinese to the system language settings.

1. Open **Control Panel – Regional Options**.
2. Under **Language settings for the system (Code page conversion tables** in Windows XP), select the **Simplified Chinese** option and click the **OK** Button. The Windows CD-ROM may be required at this point.
3. After the **OK** Button is pressed, a prompt asking whether or not to restart Windows will be dis-

played. Restart Windows.

The fonts required to display Chinese characters will be displayed.

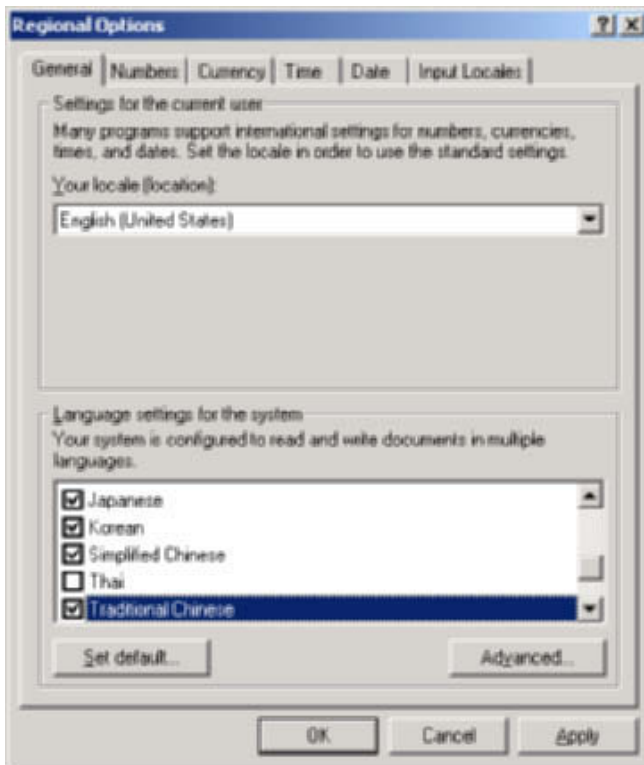

In this example, Simplified Chinese was added. Use the same procedure to add Traditional Chinese or Hangul. Select Traditional Chinese and Korean in the list box.

2. Adding the Input Locale

1. Open **Control Panel – Regional Options**, select the Input Locales Tab Page, click the **Add** Button, and add Chinese under *Input locale*.
 - In Windows XP, open **Control Panel – Regional Options**, and select the Languages Tab Page. Click the **Details** Button under *Text services and input languages* and add Chinese. There are several types of Chinese input system (IME). In this example, the input system MS-PinYin98 is selected. Click the **OK** Button.

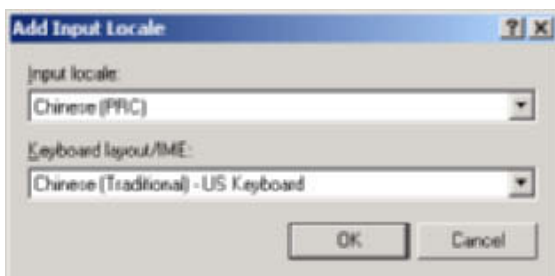

2. *Switch between input locales* is automatically set under *Hot keys for input locales*. Also the *Enable indicator on taskbar* option at the bottom of the window is automatically selected. If the setting is *None*, change the setting with the **Change Key Sequence** Button (**Key Settings** Button in Windows XP).

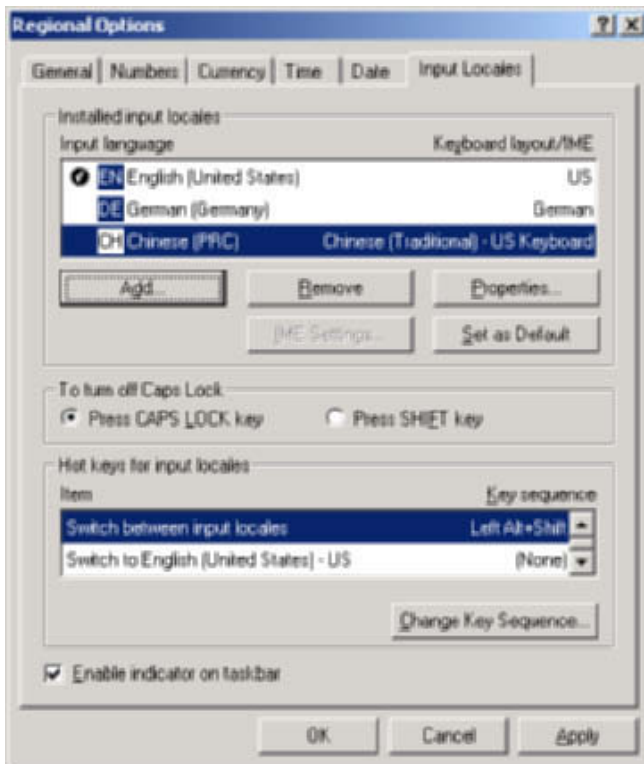

3. Click the **OK** Button to complete the settings.
4. After completing the settings, confirm that the indicator in the bottom right-hand corner changes when the left ALT Key and SHIFT Key are pressed.
 - When inputting Japanese using MS-IME:



- When inputting German using On-screen Keyboard:

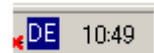

- When inputting Chinese using MS-PinYin98:



Inputting Multi-language Characters in NS-Designer Property Settings

The method for inputting multi-language characters in NS-Designer property settings is explained below.

1) Inputting Multi-language Characters in Property Settings Using IME

1. Select the language to be input either after clicking the indicator on the Windows taskbar or by using the Alt and Shift Keys.

NS-Designer Operation Manual



2. Input the required characters in the *Label* input box in the Property Settings Dialog Box for the required objects.

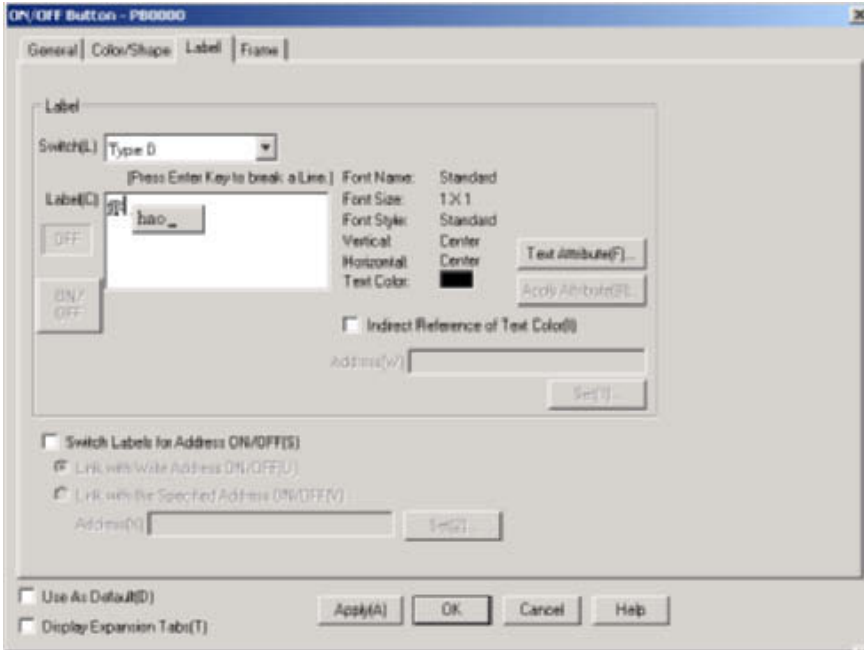

Reference

- ◆ "IME" stands for "Input Method Editor" and is an input system for inputting special language characters from the keyboard. It can, for example, be used to convert characters to and from those used in Japanese. There are IME systems for different languages; for example, MS-IME2000 or ATOK can be used for Japanese and MS-PinYin98 can be used for Chinese. There are systems that come with Windows and systems that can be purchased separately. Refer to the software manual or help file for details.

2) Inputting Using the On-screen Keyboard

"On-screen Keyboard" is a standard Windows program that allows a keyboard to be displayed on the screen and characters to be input using this keyboard. It is started by selecting **Programs – Accessories – Accessibility – On-screen Keyboard**. Depending on the Windows setup, it may not be installed. In this case, install it from **Control Panel – Add/Remove Programs – Add/Remove Windows Components**.

The following image is for input in English. If the input locale is switched to another language in the way mentioned later, the keyboard display will change accordingly.



3) Character Map

”Character Map” is a standard Windows program that allows characters to be selected from a list and then input into the application as desired. It is started by selecting **Programs – Accessories – System Tools – Character Map**. Depending on the Windows setup, it may not be installed. In this case, install it from **Control Panel – Add/Delete Programs – Add/Delete Windows Components**.

The characters outlined in the following image are the western European characters that can be input with the NS Series. Regardless of the input locale setting mentioned later, these characters can always be input with NS-Designer.

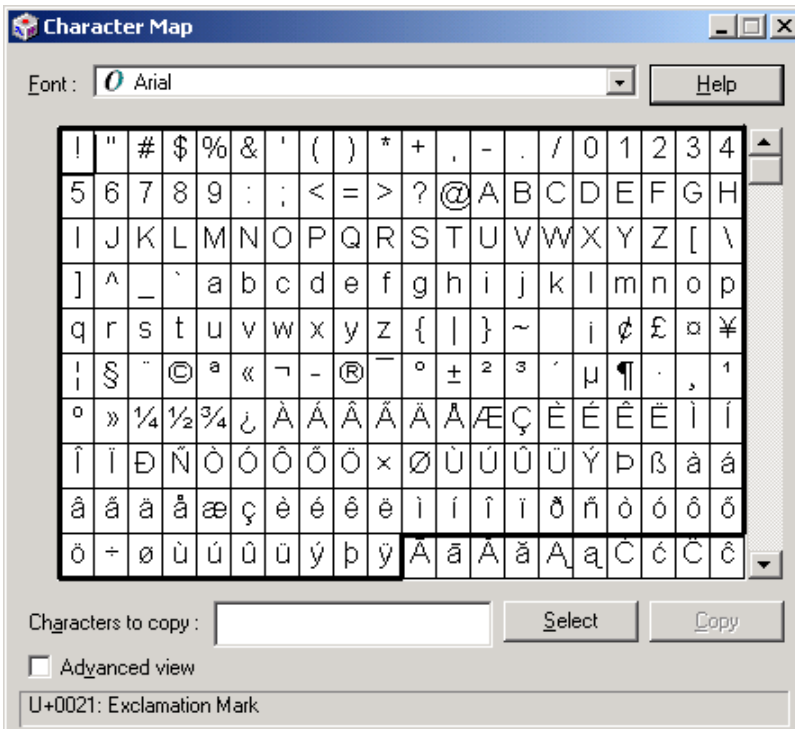

Note: In some circumstances, the characters outside the outlined section may not be displayed on NS-Designer or the PT.

Character strings are input using the Character Map in the following way.

1. Insert the desired characters in *Characters to copy* by double-clicking them in order.
2. Once all the desired characters have been inserted, click the **Copy** Button.
3. Input the character string in the desired place in NS-Designer using Ctrl-V (i.e., press the Ctrl and V Keys at the same time to copy the character string).

Reference

◆ Unicode

Characters are input and displayed on a computer (not just with the NS Series), using a character code. Each character is assigned a number based on this code.

For example, the number 41 hex is assigned to the letter "A". Sentences can be constructed, words can be arranged, and characters can be displayed on the screen using this code.

ISO has established a character code for alphanumeric characters (i.e., numbers and letters of the alphabet). Windows and the NS Series use the ISO8859/1 character code to represent characters for English, French, Italian, German, and other western European languages.

Asian languages, such as Japanese, Simplified Chinese, and Traditional Chinese use a large number of characters and there are character codes for these languages that have been defined by standards organizations (e.g., JIS in Japan and GB in China).

"Unicode" is a character code that was established with the purpose of unifying the various western European and Asian languages. Windows NT, 2000, and XP as well the NS Series use Unicode to achieve multi-language display with ease.

13-2-2 Displaying Multi-language Characters Using Indirect Object Specification

With the NS Series, multi-language display is created when Unicode-format text files for text objects and list objects with multi-language input are read. Also, with data block tables, reading/writing of data files is possible in Unicode format. Unicode format also allows multi-language display to be used for the log output of alarm/event history and the import/export of CSV files.

The objects for which data can be read or displayed using Unicode are given in the following table.

Object name	Operation
List objects	Files storing character strings in Unicode format are read and displayed as lists.
Text objects	Files storing character strings in Unicode format are read and displayed.
Data block settings	Data files are read and written.
Log output	CSV files edited in Unicode format can be imported and exported. Log output to CF is also possible.

In order to display multiple languages using indirect specification of object properties, the following settings are required.

1. Create the indirectly specified Unicode text.
2. In the Property Settings Dialog Box for the objects, set the character code to Unicode.
3. Specify the indirectly specified file name in the Property Settings Dialog Box.

Text Objects

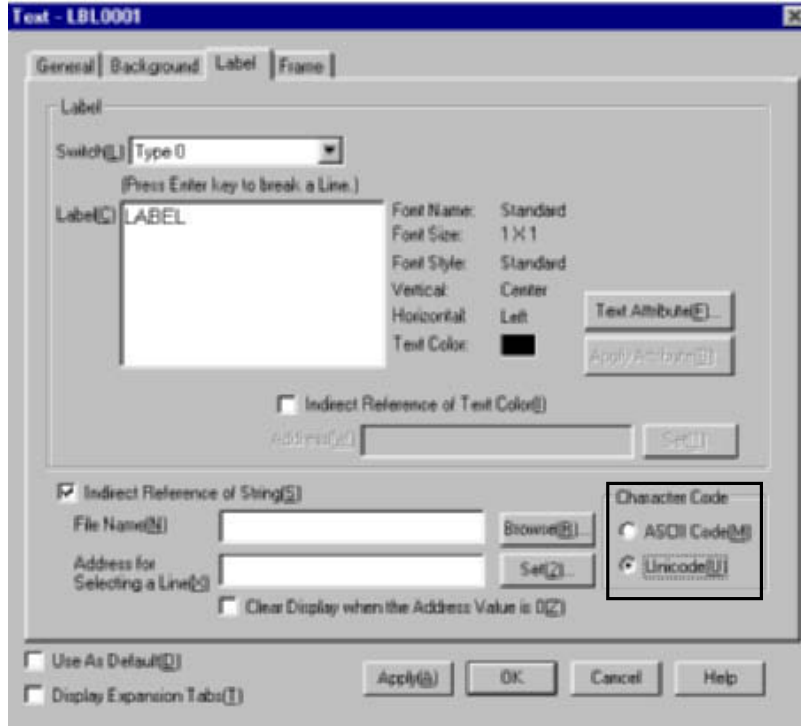

Data Block Objects

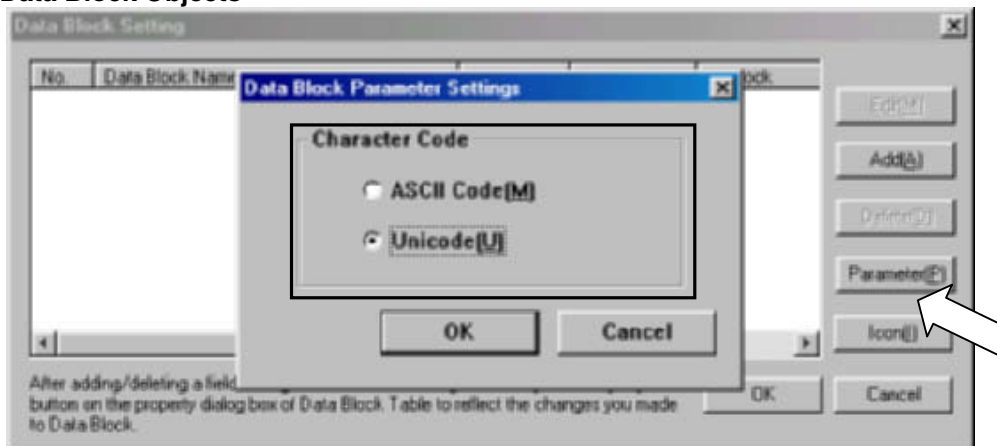

Alarm/Event History

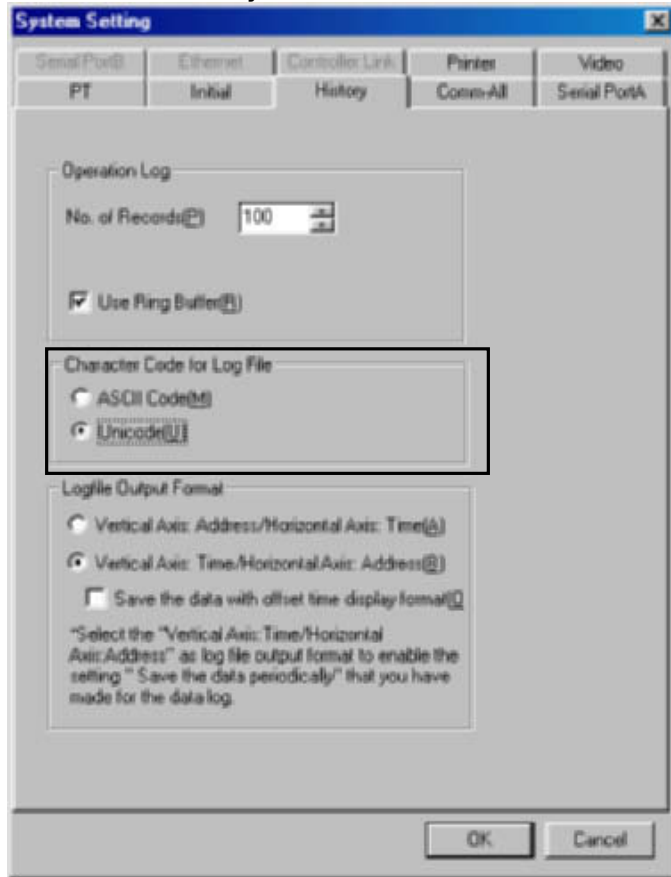

13-2-3 Creating Multi-language Display Screens Using the CSV Import/Export Function

This section describes the procedure for creating multi-language display screens using the CSV import/export function. The following diagram outlines the screen creation procedure.

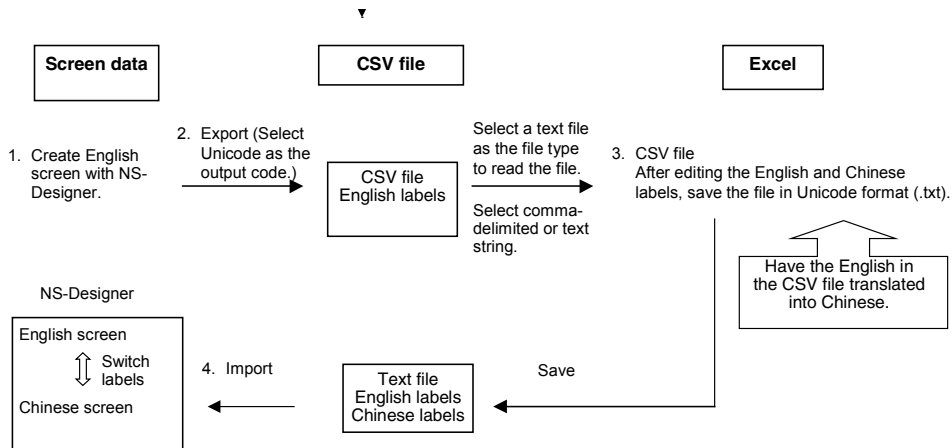

1. Setting the Number of Labels and Creating a Screen (Preparation)

Before creating a screen, set more than one for *No. of Labels* on the Project Property Dialog Box to switch languages during machine operation. Then, create a screen in English in the usual way.

(The number of labels can be changed after creating a screen.)

2. Exporting Screen Data

Export the created screen data to a CSV file using NS-Designer. When doing this, select Unicode as the output code.

3. Editing and Saving the File

Edit the CSV file with a version of Excel that supports Unicode (Excel 2000 or 2002). Make sure that the CSV file is loaded from the Open Dialog Box opened from the File Menu on Excel and opened by starting the Text File Wizard. If the CSV file is opened without starting the Text File Wizard (opened by drag-and-drop or by associating the file type with the program), according to Excel specifications, Unicode data may not be loaded correctly and garbled characters and improper line-feed may appear.

Save the data as Unicode text (extension .txt).

4. Importing the Text File

Importing the converted file using NS-Designer completes creation of the multi-language display screen. Transfer it to the PT and confirm whether the input labels can be displayed correctly in each language by switching labels.

Procedure for Creating Screens

1. Create the screen data in English beforehand.



Open the Settings Menu and set the *No. of Labels* field in the Project Property Dialog Box to 2 min.

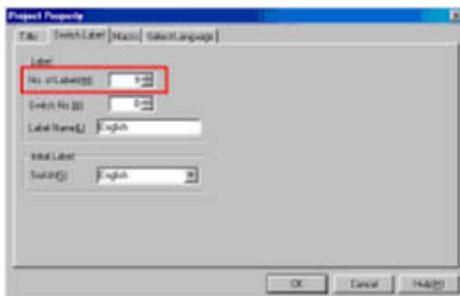

2. After creating the screen data, export the project data to a CSV file.
 - Select **Export CSV File** from the File Menu.

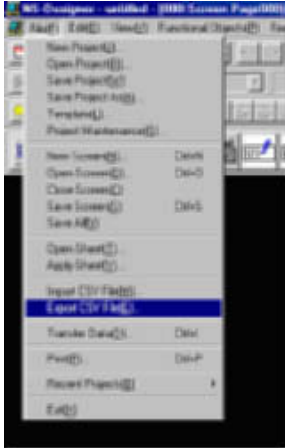

The following screen will be displayed. Select **Unicode** for the output code.

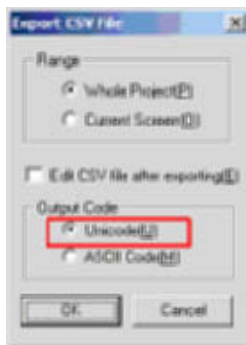

Click the **OK** Button and specify the name of the file to be exported. Finally, click the **Save** Button to complete exporting the data to the CSV file.

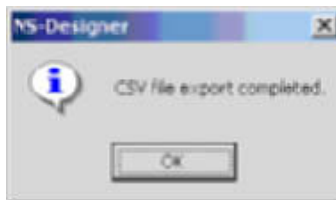

- Exported CSV files are read using Excel. Select **Open** from the File Menu in Excel and then select the CSV file to be edited in the dialog box. Specify **Text Files** in the *Files of type* field, and then open the selected file.

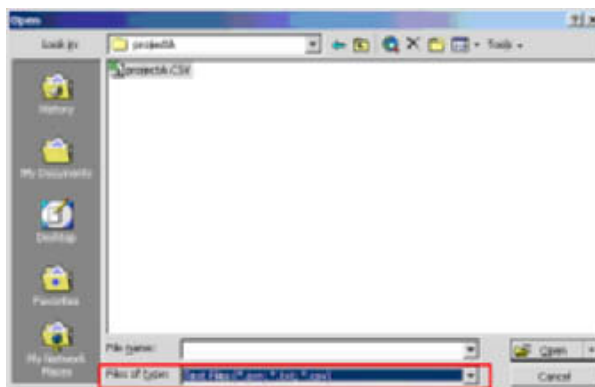

NS-Designer Operation Manual

The *Text Import Wizard* will open. Select the format of the original data in the *Original data type* field and click the **Next >** Button to proceed to the next step.

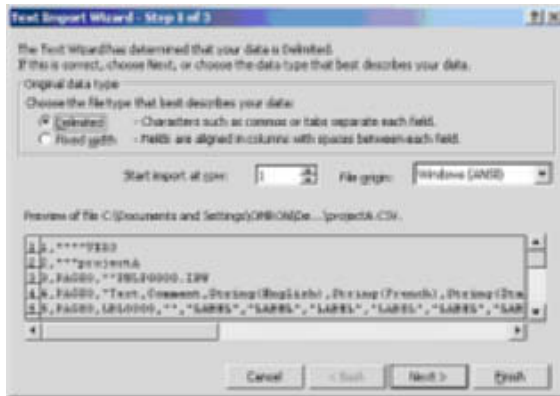

Deselect **Tab** in the *Delimiters* field, and select **Comma**. Click the **Next >** Button to proceed to the next step.

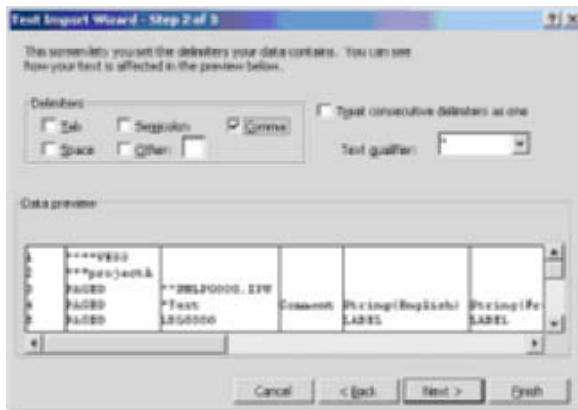

Select all the rows in the *Data preview* field, and select **Text** in the *Column data format* field.

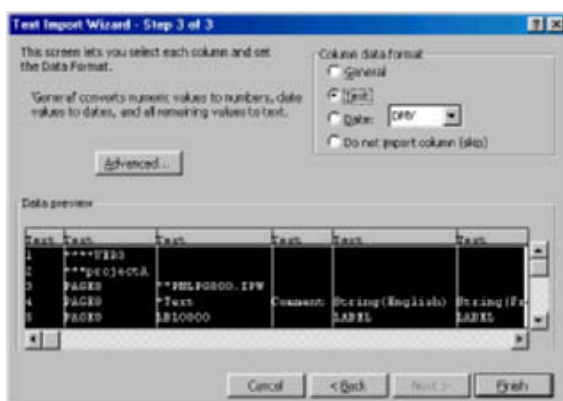

NS-Designer Operation Manual

Input the translation details below the cell of the label name corresponding to the language to be used in the display.

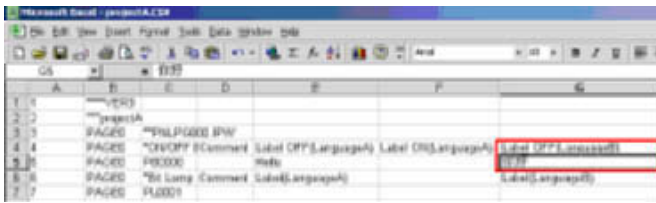

After editing is completed, save the file. Specify **Unicode Text** in the *Files of type* field.

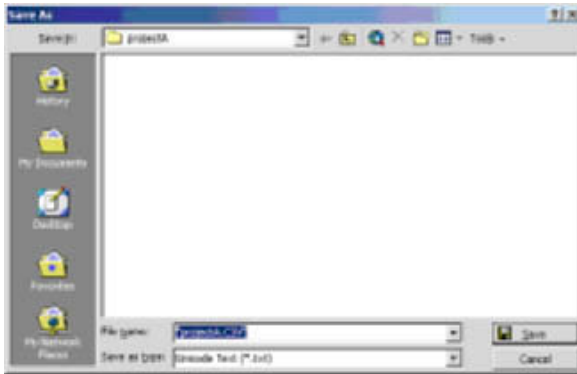

- 4. Import text files using NS-Designer. Always check whether the project is the pre-edited version before importing the file. When the dialog box for completing the import operation is displayed, screen creation allowing multiple display languages will be completed.

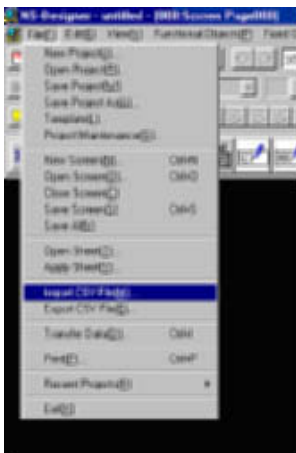

Open the project again with NS-Designer. When the label is switched, the translated version of the label will be displayed.

Original language

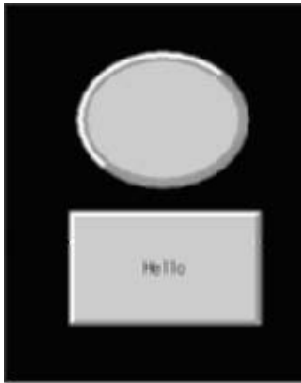

Translated language

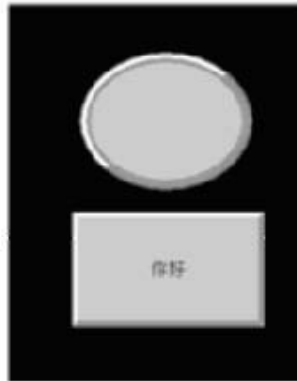

Appendices

These appendices provide reference information for using the NS-Designer. Refer to them as required.

Appendix 1	Quick Reference	A-1
Appendix 2	Objects	A-12
Appendix 3	Shortcut Keys	A-16
Appendix 4	Version Information	A-17
Appendix 5	Resource Report	A-18
Appendix 6	Error Messages	A-19
Appendix 7	Connecting Cable Specifications	A-26
Appendix 8	Details of CLK Status	A-28
Appendix 9	Converting Data between Different Versions of NS-series Products	A-31

Appendix 1 Quick Reference

This appendix lists where to look for information on the various functions of the NS-Designer.

"Programming Manual" refers to the *NS Series Programming Manual* (Cat. No. V073-E1-□) and "Cross Reference" refers to the *NS Series Cross-Reference* provided on the NS-Designer CD.

	Item	Procedure	Reference	
Fixed objects	Displaying lines, arrows, and polylines	Fixed Object - Line or Polyline	Section 5-2	
	Displaying rectangles	Fixed Object - Rectangle	Section 5-2	
	Displaying triangles, trapezoids, diamonds, and other polygons	Fixed Object - Polygon	Section 5-2	
	Displaying circles and ovals	Fixed Object - Circle/Oval	Section 5-2	
	Displaying an arc	Fixed Object - Arc	Section 5-2	
	Displaying a sector	Fixed Object - Sector	Section 5-2	
	Filling fixed objects	Tiling Tab Page on the Fixed Object Properties Dialog Box (Settings - Object Properties)	<i>Programming Manual Section 2-6</i>	
	Displaying bitmap data	Display a bitmap object (Functional Object - Bitmap). JPEG files can also be displayed.	<i>Programming Manual Section 2-12</i>	
	Using the same fixed object in more than one application	1. Select a registered object and then register it as an object in the library using Tools - Register Library . 2. Display the library object using Tools - Use Library .	Section 5-13	
	Displaying special symbols and characters	1. Create image data using a BMP or JPEG file. 2. Display a bitmap object (Functional Object - Bitmap).	<i>Programming Manual Section 2-12</i>	
	Displaying the same graphic in many locations or on many screens	1. Select a registered object and then register it as an object in the library using Tools - Register Library . 2. Display the library object using Tools - Use Library .	Section 5-13	
	Changing displayed objects according to specified conditions		1. Create bitmap objects (Functional Object - Bitmap). 2. Indirectly specify the display files to change the bitmap that is displayed based on PLC or PT status.	<i>Programming Manual Section 2-12</i>
			1. Display a word button object (Functional Object - Word Button). 2. Set <i>Select shape</i> for the button shape on the General Tab Page. 3. Set the shapes to be displayed when the button is pressed, when it is not pressed, and when the set value matches on the Color/Shape Tab Page.	<i>Programming Manual Section 2-9</i>
Video display	Displaying video images	Display the images using a video display object (Functional Object - Video Display).	<i>Programming Manual Section 2-12</i>	
Text display	Displaying text that does not change	Display the text with a text object (Functional Object - Text).	<i>Programming Manual Section 2-12</i>	
	Changing displayed text based on PLC status	Use a String Display and Input object (Functional Object - String Display & Input).	<i>Programming Manual Section 2-11</i>	

NS-Designer Operation Manual

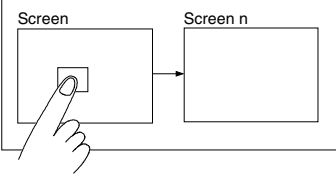
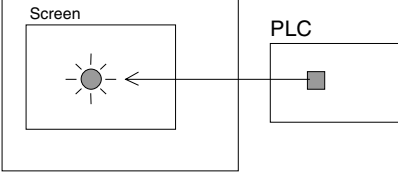
Item		Procedure	Reference
Text display	Changing displayed text based on PLC status	<ol style="list-style-type: none"> 1. Create a text object (Functional Object - Text). 2. Select <i>Indirect Reference of String</i> on the Label Tab Page. The displayed text will change according to PLC or PT status. 	<i>Programming Manual Section 2-12</i>
Screen display	Changing the displayed screen using a button	Create a command button object set to change the screen (Functional Object - Command Button). 	<i>Programming Manual Section 2-9</i>
	Changing the displayed screen when a specified bit turns ON	Switch to a specific screen when a specified bit turns ON using the automatic screen change function in the alarm/event settings (Settings - Alarm/Event Setting).	<i>Programming Manual Section 2-13</i>
	Changing to a different screen based on PLC or PT status when the screen is changed	Change the screen by writing the screen page number to \$SW0 in system memory. (\$SW0 in system memory contains the current screen page number.)	<i>Programming Manual Section 2-4</i>
		Create a command button object set to change the screen (Functional Object - Command Button) and use indirect screen page number specification from the PLC or NT to control the screen page number according to PLC or PT status.	<i>Programming Manual Section 2-9</i>
	Creating screens with other screens overlaid on them	Turn ON the <i>Use as Pop-up Screen</i> setting on the Size/Pop-up Tab Page of the screen properties (Settings - Screen Properties).	<i>Section 4-1</i>
	Creating a common screen to be used with many other screens	<ol style="list-style-type: none"> 1. Create the common portion of the display as a sheet (File - Open Sheet). 2. Apply the sheet (File - Apply Sheet) to display it on the required screens. 	<i>Section 4-3</i>
	Changing only a portion of the display based on PLC or PT status	Create the portion to be switched as a frame object (Functional Object - Frame).	<i>Section 4-4</i>
PLC bit status display	Controlling a lamp based on PLC bit ON/OFF status	Create a bit lamp object (Functional Object - Bit Lamp). 	<i>Programming Manual Section 2-10</i>
	Controlling a displayed object based on PLC bit ON/OFF status	Create bitmap objects (Functional Objects - Bitmap) and then indirectly specify the display files to change the bitmap that is displayed based on PLC status.	<i>Programming Manual Section 2-12</i>
		<ol style="list-style-type: none"> 1. Create an ON/OFF button object (Functional Object - ON/OFF Button). 2. Select <i>Select shape</i> for the button type and then specify the shapes to change to on the Color/Shape Tab Page. 	<i>Programming Manual Section 2-9</i>
Changing PLC bit status by pressing a button and displaying the status by lighting a lamp	<ol style="list-style-type: none"> 1. Create an ON/OFF button object (Functional Object - ON/OFF Button) and set the PLC bit as a write address. 2. Create a bit lamp object (Functional Object - Bit Lamp) and set the display address to the same PLC bit. 	<i>Programming Manual Section 2-9</i>	

NS-Designer Operation Manual

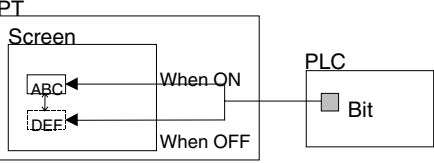
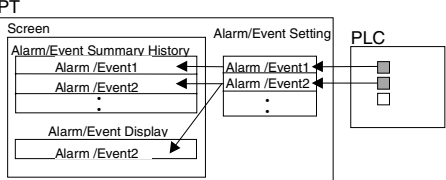
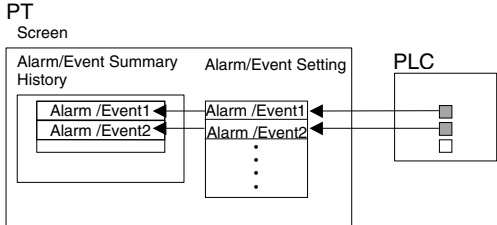
Item	Procedure	Reference
<p>PLC bit status display</p>	<p>Controlling displayed text based on PLC bit ON/OFF status</p>	<p>1. Create an ON/OFF button object (Functional Object - ON/OFF Button).</p> <p>2. Turn ON the <i>Switch Labels for Address ON/OFF</i> setting on the Text Tab Page of the Properties Setting Dialog Box. Then select <i>Link with the Specified Address ON/OFF</i> and set the PLC bit.</p> 
<p>Controlling displayed text based on PLC bit ON/OFF status</p>	<p>Create a text object and select <i>Indirect Reference of String</i> on the Label Tab Page. The displayed text will change according to ON/OFF status of the PLC bit.</p>	<p><i>Programming Manual Section 2-12</i></p>
<p>Displaying an alarm or event message based on PLC bit ON/OFF status</p>	<p>1. Set the display message and the PLC bit in the alarm/event settings (Settings - Alarm/Event Setting).</p> <p>2. To display one line, create an alarm/event display object (Functional Objects - Alarm/Event Display) and to display a list, create an alarm/event summary history object (Functional Objects - Alarm/Event Summary History).</p> 	<p><i>Programming Manual Section 2-13</i></p>
<p>Recording a history of PLC bit ON/OFF status, saving it in the PT, and displaying it for confirmation</p>	<p>1. Set the display message and the PLC bit in the alarm/event settings (Settings - Alarm/Event Setting).</p> <p>2. Create an alarm/event summary history object (Functional Objects - Alarm/Event Summary History).</p> <p>3. Select <i>Alarm history</i> for the display data on the General Tab Page in the Property Setting Dialog Box.</p> 	<p><i>Programming Manual Section 2-13</i></p>
<p>PLC word status display</p>	<p>Displaying numeric data</p> <p>Use a numeral display and input object (Functional Object - Numeral Display & Input). To prevent input, turn ON <i>Display Expansion Tab</i> on the Control Flag Tab Page of the Property Setting Dialog Box and disable input.</p>	<p><i>Programming Manual Section 2-11</i></p>
<p>Displaying a level meter</p>	<p>Create a level meter object (Functional Object - Level Meter).</p>	<p><i>Programming Manual Section 2-12</i></p>
<p>Displaying an analogue meter</p>	<p>Create an analogue meter object (Functional Object - Analogue Meter).</p>	<p><i>Programming Manual Section 2-12</i></p>

NS-Designer Operation Manual

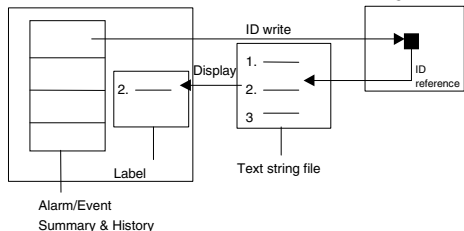
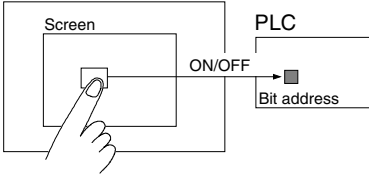
Item		Procedure	Reference
PLC word status display	Displaying a broken-line graph	Create a broken-line graph object (Functional Object - Broken-line Graph).	Programming Manual Section 2-15
	Displaying text string data	Create a String Display and Input object (Functional Object - String Display & Input). To prevent input, turn ON <i>Display Expansion Tab</i> on the Control Flag Tab Page of the Property Setting Dialog Box and disable input.	Programming Manual Section 2-11
	Displaying a data log graph	Create a data log graph object (Functional Object - Data Log Graph).	Programming Manual Section 2-14
	Changing the color of a lamp based on PLC word status	Create a word lamp object (Functional Object - Word Lamp). The lamp can be switched among 10 colors.	Programming Manual Section 2-10
	Displaying detailed information and countermeasures by pressing an alarm/event summary history object	<p>1. Turn ON the <i>Write Alarm ID to the Specified Address</i> setting on the General Tab Page of the Property Setting Dialog Box for an alarm/event summary history object (Functional Objects - Alarm/Event Summary History) and set a write address for the PLC word.</p> <p>2. Create text objects (Functional Object - Text).</p> <p>3. Select indirect specification of the text string on the Text Tab Page and set the same PLC word as set in step 1. When an alarm or event occurs, an ID number will be written to the specified address and the text will be changed according to the value of the number.</p> <p>NS</p>  <p>The diagram illustrates the data flow for displaying alarm/event summary history. It shows a PLC box with an 'ID reference' output. An arrow labeled 'ID write' points from the PLC to an 'Alarm/Event Summary & History' object. From this object, an arrow labeled 'Display' points to a 'Text string file' box containing three numbered lines (1. ____, 2. ____, 3. ____). Another arrow labeled 'Display' points from the 'Text string file' to a 'Label' box, which is part of the 'Alarm/Event Summary & History' object's interface.</p>	Programming Manual Section 2-13
Displaying recipe data	<p>1. Create a data block table object (Functional Object - Data Block Table).</p> <p>2. Set the data block to be displayed on the General Tab Page of the Property Settings Dialog Box.</p>	Programming Manual Section 2-16	
Writing data to the PLC	Turning ON/OFF a PLC from the PT	<p>Create a button that will turn ON/OFF the specified bit using an ON/OFF button object (Functional Object - ON/OFF Button).</p> <p>PT</p>  <p>The diagram shows a hand pressing a button on a 'Screen'. An arrow labeled 'ON/OFF' points from the button to a 'PLC' box, which has a 'Bit address' input.</p>	Programming Manual Section 2-9

NS-Designer Operation Manual

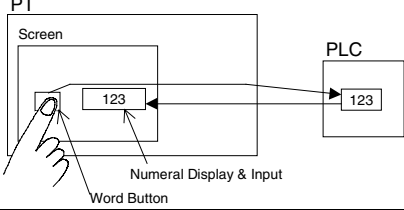
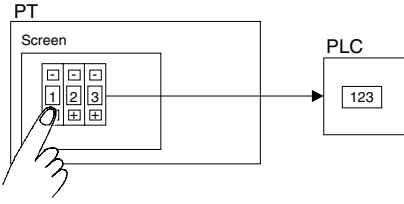
Item		Procedure	Reference	
Writing data to the PLC	Writing numeric values	Inputting numbers from a tenkey	<ol style="list-style-type: none"> 1. Create a numeral display and input object (Functional Object - Numeral Display & Input). 2. On the Keypad Tab Page of the numeral display and input property settings, set either <i>Standard system keypad</i> or <i>Large standard system keypad</i> as the input method. 	<i>Programming Manual Section 2-11</i>
		Writing a constant with one button	<ol style="list-style-type: none"> 1. Create a word button object (Functional Object - Word Button). 2. Select <i>Set Value</i> for the button operation on the General Tab Page in the Property Setting Dialog Box. 	<i>Programming Manual Section 2-9</i>
		Incrementing or decrementing a value with buttons	<ol style="list-style-type: none"> 1. Create a word button object (Functional Object - Word Button). 2. Select <i>Increment/Decrement</i> for the button operation on the General Tab Page in the Property Setting Dialog Box. Set a negative value to decrement. 	<i>Programming Manual Section 2-9</i>
		Inputting a value from a pop-up window	<ol style="list-style-type: none"> 1. Create a numeral display and input object (Functional Object - Numeral Display & Input). 2. On the Keypad Tab Page of the Property Setting Dialog Box, select <i>Input from Pop-up Screen</i>. 	<i>Programming Manual Section 2-11</i>
		Inputting a value from a pop-up window	Create a command button object on the specified pop-up window (Functional Object - Command Button). Set <i>Key button</i> on the General Tab Page of the Property Setting Dialog Box.	<i>Programming Manual Section 2-9</i>
		Inputting from thumbwheel switches	Create thumbwheel switch object (Functional Object - Thumbwheel Switch). 	<i>Programming Manual Section 2-11</i>
Writing text strings	Inputting from a virtual keyboard	<ol style="list-style-type: none"> 1. Create a String Display and Input object (Functional Object - String Display & Input). 2. On the Keyboard Tab Page of the Property Setting Dialog Box, set either <i>Standard system keypad</i> or <i>Large standard system keypad</i>. 	<i>Programming Manual Section 2-11</i>	
	Transferring a text string to a specific object when a button is pressed	<ol style="list-style-type: none"> 1. Create a command button object (Functional Object - Command Button). 2. Select <i>Keyboard</i> for the function selection on the General Tab Page in the Property Setting Dialog Box. 3. To send a set string, select <i>Specified string</i> and to send a string that depends on the value of an address, select <i>Indirect Specification of String</i>. 	<i>Programming Manual Section 2-9</i>	
	Writing recipe data to PLCs	<ol style="list-style-type: none"> 1. Create a data block table object (Functional Object - Data Block Table). 2. Set the data block to be written on the General Tab Page of the Property Settings Dialog Box. 	<i>Programming Manual Section 2-16</i>	

NS-Designer Operation Manual

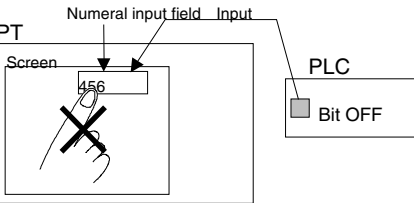
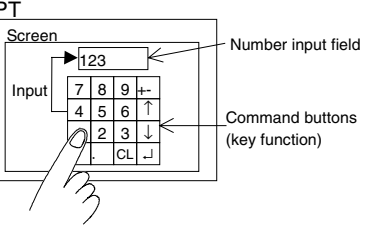
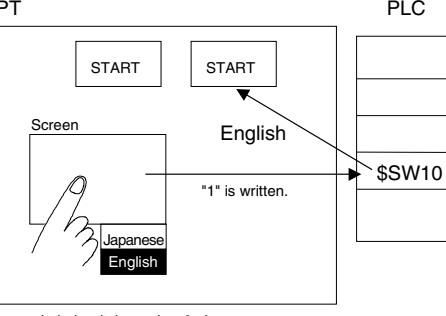
Item	Procedure	Reference
<p>Writing data to the PLC</p> <p>Disabling writing numeral or text strings from PLC operations</p>	<ol style="list-style-type: none"> 1. Create a numeral display and input object (Functional Object - Numeral Display & Input) or create a string display and input object (Functional Object - String Display & Input). 2. Turn ON <i>Display Expansion Tab</i> on the Control Flag Tab Page of the Property Setting Dialog Box and set <i>Enable input on other screens</i> to <i>Indirect</i>. The specific bit can be used to enable and disable writing from the numeral display and input object or the string display and input object. 	<p><i>Programming Manual Section 2-8</i></p>
<p>Functional objects with buttons</p> <p>Creating an original tenkey and registering it as a library object</p>	<ol style="list-style-type: none"> 1. Create a command button object (Functional Object - Command Button). 2. Set <i>Key button</i> on the General Tab Page of the Property Setting Dialog Box and create a button to send the specified text string or command code to the input field for the specified functional object. 3. Select the entire tenkey and select Tools - Register Library. 	<p><i>Section 5-13 Programming Manual Section 2-9</i></p>
<p>Changing a label using a button</p> <p>Changing a label using a button</p>	<ol style="list-style-type: none"> 1. Create a word button object (Functional Object - Word Button). 2. Select <i>Load Keyboard Screen</i> for the button operation on the General Tab Page in the Property Setting Dialog Box. Set the set value to the label switch number. 3. Set the \$SW10 as the write address. (\$SW0 in system memory contains the current label switch number.)  <p>Label switch number 0: Japanese Label switch number 1: English</p>	<p><i>Programming Manual Sections 2-4 and 2-9</i></p>

NS-Designer Operation Manual

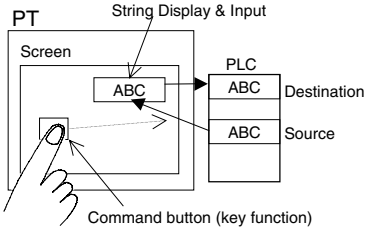
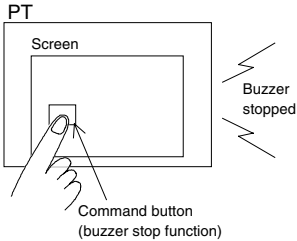
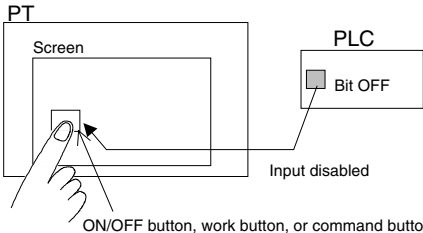
Item	Procedure	Reference
<p>Functional objects with buttons</p> <p>Transferring data between PLC words with a button</p>	<ol style="list-style-type: none"> 1. Create a command button object (Functional Object - Command Button). 2. Select <i>Keyboard</i> for the function selection on the General Tab Page in the Property Setting Dialog Box. 3. Select indirect specification of the text string and set the PLC source address. 4. Create a String Display and Input object (Functional Object - String Display & Input). 5. Set the PLC destination address for the address on the General Tab Page in the Property Setting Dialog Box. 6. Set the input method to <i>Other Input Method (command button etc)</i> on the Keyboard Screen Tab Page in the Property Setting Dialog Box.  <p>The diagram shows a PT (Panel Terminal) with a 'Screen' containing a 'String Display & Input' object labeled 'ABC'. A 'Command button (key function)' is shown with a hand icon pointing to it. The button is connected to a PLC with 'ABC' as the 'Source' and 'ABC' as the 'Destination'.</p>	<p><i>Programming Manual Sections 2-9 and 2-11</i></p>
<p>Stopping the PT's buzzer with a button</p>	<ol style="list-style-type: none"> 1. Create a command button object (Functional Object - Command Button). 2. Select <i>Stop buzzer</i> for the function selection on the General Tab Page in the Property Setting Dialog Box and create a button to stop the buzzer when pressed.  <p>The diagram shows a PT with a 'Screen' containing a 'Command button (buzzer stop function)'. A hand icon points to the button. A lightning bolt symbol labeled 'Buzzer stopped' is shown next to the button.</p>	<p><i>Programming Manual Section 2-9</i></p>
<p>Using a button to close or move a pop-up screen</p>	<ol style="list-style-type: none"> 1. Create a command button object (Functional Object - Command Button). 2. Select <i>Pop-up Screen Control</i> for the function selection on the General Tab Page in the Property Setting Dialog Box and create a button to control the pop-up screen. 	<p><i>Programming Manual Section 2-9</i></p>
<p>Disabling a button from a PLC operation</p>	<ol style="list-style-type: none"> 1. Create a button. 2. Turn ON <i>Display Expansion Tab</i> on the Control Flag Tab Page of the Property Setting Dialog Box and set <i>Enable input on other screens to Indirect</i>. The specific address can be used to enable and disable writing the specified address from the button.  <p>The diagram shows a PT with a 'Screen' containing an 'ON/OFF button, work button, or command button'. A hand icon points to the button. The button is connected to a PLC with a 'Bit OFF' indicator and the label 'Input disabled'.</p>	<p><i>Programming Manual Section 2-8</i></p>

NS-Designer Operation Manual

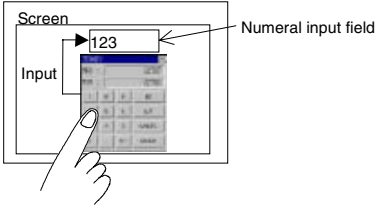
Item	Procedure	Reference
Numeral display and input and thumb-wheel switches	1. Create a numeral display and input object (Functional Object - Numeral Display & Input). 2. On the Keypad Tab Page of the numeral display and input property settings, set either <i>Standard system keypad</i> or <i>Large standard system keypad</i> as the input method. PT 	<i>Programming Manual Section 2-11</i>
Placing more than one numeral display and input object on the same screen and moving the focus between them by pressing the Enter Key	1. Create a table object (Functional Object - Table). 2. Set the movement direction for the <i>Focus Move Direction by Enter Key</i> setting on the Property Setting Dialog Box for the table.	<i>Section 5-1</i>
Restricting the range of numbers that can be input	1. Create a numeral display and input object (Functional Object - Numeral Display & Input) or create a thumbwheel switch object (Functional Object - Thumbwheel Switch). 2. Turn ON <i>Display Expansion Tab</i> on the Max/Min Tab Page of the Property Setting Dialog Box and set the range of numbers that can be input.	<i>Programming Manual Section 2-11</i>
Numeral display and input	1. Create a numeral display and input object (Functional Object - Numeral Display & Input). 2. Select <i>Unit</i> or <i>Scale</i> on the General Tab Page in the Property Setting Dialog Box.	<i>Programming Manual Section 2-11</i>
Operations	Layout - Grid	<i>Section 4-1</i>
Copying objects that have been created	1. Select the object to be copied. 2. Select Edit - Copy . 3. Select Edit - Paste .	<i>Section 5-4</i>
Automatically setting different addresses when copying and pasting functional objects	Use Edit - Offset Paste to specify the offset value when pasting.	<i>Section 5-4</i>
Reusing screen data	1. Create a new screen (File - New Screen). 2. In the New Screen Dialog Box, select <i>Reuse Exiting Screen</i> . 3. Select the project containing the screen to be reused in the Reuse Exiting Screen Dialog Box. 4. Select the screen to reuse from the screen list.	<i>Section 4-2</i>
Reusing screen data	To reuse a screen from the same project when creating a new screen, use File - Select Template Project .	<i>Section 3-7</i>
Operations	1. Select the screen to be copied. 2. Select Edit - Select All - All Functional Objects/Fixed Objects . 3. Select Edit - Copy . 4. Open the destination screen. 5. Select Edit - Paste .	<i>Section 5-4</i>

NS-Designer Operation Manual

	Item	Procedure	Reference
Operations	Grouping multiple objects as one object	1. Select all of the objects to group. 2. Select Layout - Group . Note: To return grouped objects to individual objects, select Layout - Ungroup .	Section 5-5
	Specifying an object behind another object	Try clicking in a different position to select the object behind.	Section 5-4
	Accurately aligning the positions of objects	1. Select the object in front. 2. Select Layout - Order - Bring to Back . 3. Select the object that was previously behind.	Section 5-5
	Changing a range of PLC bits or words set for functional objects	Use the replacement function (Edit - Replace) to change a range of bits or words set for functional objects.	Section 5-4
	Setting a range or comments, labels, or PLC bits/words for functional objects	1. Select the functional objects to be set. They must all be of the same type. 2. Use Settings - Change Settings at Once .	Section 5-10
		1. Export the functional object property settings to a CSV file using File - Export CSV File . 2. Use spreadsheet software to set the properties. 3. Import the modified CSV file to NS-Designer using File - Import CSV File .	Section 12
	Pasting colors set for existing functional objects or fixed objects to other functional objects or fixed objects	1. Select the functional or fixed object from which to copy the color format. 2. Click the Color Copy/Paste Button on the Color Toolbar. 3. Click on the destination object.	Section 2-5
	Pasting the label font formats from an existing functional object to another functional object	1. Select the functional or fixed object from which to copy the label font format. 2. Click the Copy/Paste Font Button on the Font Toolbar. 3. Click on the destination object.	Section 2-5
	Using an object that has been created in another screen or project	1. Select the object and register it in the library (Tool - Register Library). 2. Use Tool - Use Library to position the object on the screen.	Section 5-13
	Creating multiple functional objects of the same type	1. Create the objects in a table object (Functional Object - Table). 2. Select the type of object to be created in the table as the <i>Table type</i> in the Property Setting Dialog Box.	Section 5-1
	Confirming PLC bit and word status	Used Tool - List Up Addresses Used .	Section 5-11
	Checking the number of objects used on each screen	Use Tools - List Up Functional Objects Used .	Section 5-9
	Finding addresses, comments, labels, or PLC bits/words set for functional object.	Use Edit - Find .	Section 5-4
	Reordering screens	Use the Move Up and Move Down Buttons under Tools - Screen Maintenance .	Section 4-2



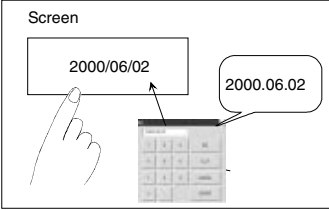







NS-Designer Operation Manual

Item		Procedure	Reference
Operations	Copying screens	Select the screen to copy and click the Duplicate Button under Tools - Screen Maintenance .	Section 4-2
	Deleting screens	Select the screen to delete and click the Delete Button under Tools - Screen Maintenance .	Section 4-2
Checking the ON/OFF status of objects on screens created on the NS-Designer		Use View - Simulate ON/OFF .	Section 4-1
Checking addresses set for functional objects on screens created on the NS-Designer		Use View - Show Address .	Section 4-1
Switching labels set for functional objects on screens created on the NS-Designer		Select the label to display under View - Switch Label .	Section 4-1
		Switch between labels by selecting Previous Label or Next Label from the object creation toolbar.	Section 4-1
Checking the settings of functional objects on a list		Use Tools - Functional Object List .	Section 5-9
Finding duplicated settings of PLC bits and words		Used Tool - Address Cross Reference .	Section 5-12
Finding setting errors		Use Tools - Validation .	Section 9
Displaying objects for which errors were detected in validation so that they can be easily found		Use View - Show Error Object .	Section 4-1
Displaying the time and date		Use Functional Object - Date/Time .	Programming Manual Section 2-17
Selecting the language used for the PT's system menus and dialog boxes		Select the language on the Select Language Tab Page of the Project Property Dialog Box (Settings - Project properties).	Section 3-9
Setting the time and date to display		<ol style="list-style-type: none"> 1. Create a time/data object (Functional Object - Date/Time). 2. Click the object during PT operation. A dialog box will appear to set the time and date. 3. Input a new time and date into the dialog box to change the time and date. 	Programming Manual Section 2-17
Requiring passwords to input data for functional objects		<ol style="list-style-type: none"> 1. Set the passwords under Settings - Password Setting. 2. Turn ON Display Expansion Tab on the Password Tab Page of the Property Setting Dialog Box and set the level of password to request. 	Programming Manual Section 2-8
Displaying a message dialog box when data is input for functional objects		<ol style="list-style-type: none"> 1. Turn ON Display Expansion Tab on the Write Setting Tab Page of the Property Setting Dialog Box for the functional object and turn ON Display confirmation dialog when writing. 2. Select User Specified Message. 3. Click the Edit Message Button and set the desired message in the Message Setting Dialog Box. 	Programming Manual Section 2-8
Making functional objects flash		<ol style="list-style-type: none"> 1. Make the settings for each flicker number under Settings - Flicker Setting. 2. Turn ON Display Expansion Tab on the Flicker Tab Page of the Property Setting Dialog Box for the functional object and set the flicker number. 	Programming Manual Section 2-8

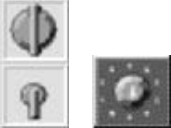











NS-Designer Operation Manual

Item	Procedure	Reference
Making fixed objects flash	Use the Flicker Tab Page of the Property Setting Dialog Box for each object.	<i>Programming Manual Section 2-6</i>
Testing project data offline	Use Tool - Test .	<i>Section 8</i>
Copying project data	Use the Duplicate Tab Page of the Project Maintenance Dialog Box (File - Project Maintenance).	<i>Section 3-8</i>
Deleting project data	Use the Delete Tab Page of the Project Maintenance Dialog Box (File - Project Maintenance).	<i>Section 3-8</i>
Backing up project data	Use the Backup Tab Page of the Project Maintenance Dialog Box (File - Project Maintenance).	<i>Section 3-8</i>
Restoring a project from backup data	Use the Restore Tab Page of the Project Maintenance Dialog Box (File - Project Maintenance).	<i>Section 3-8</i>
Copying project data to a floppy disk	Use the Backup Tab Page of the Project Maintenance Dialog Box (File - Project Maintenance) and specify a floppy disk as the backup location.	<i>Section 3-8</i>
Performing calculations on the PT	Use the macro function.	<i>Section 6-1</i>
Changing the model of the NS-series PT	Use Settings - Change PT Model .	<i>Section 3-10</i>







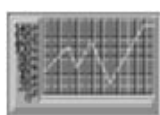

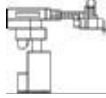

Appendix 2 Objects

Object type	Object name	Shape
Switches	DIP switch, horizontal	
	DIP switch, vertical	
	Seesaw 1	
	Seesaw 2	
	Seesaw 3	
	Selector	
	Micro switch 1	
	Micro switch 2	
	Lever	
	Pushbutton, round Shape changes with status of address	<p>ON</p>  <p>OFF</p> 

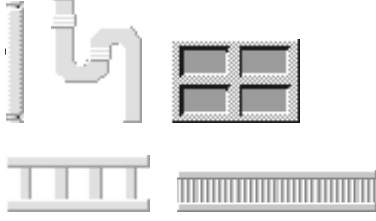



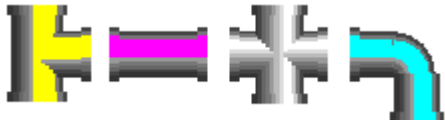



NS-Designer Operation Manual

Object type	Object name	Shape
Switches	Pushbutton, square Shape changes with status of address	ON 
		OFF 
Lamps	Round Shape changes with status of address	ON 
		OFF 
	Octagon Shape changes with status of address	ON 
		OFF 
	Square Shape changes with status of address	ON 
		OFF 
Meters	7-segment LED	
	Level meter	
Others	Frame 1	
	Frame 2	
	Actuator	
	Graph	

NS-Designer Operation Manual

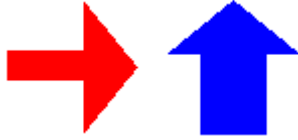
Object type	Object name	Shape
Others	Conveyor	
	Dialog box	
	Robot 1	
	Robot 2	
	Others	
Pipes and Valves	Audio Switch	
	Tank	
	Valve (Handle)	
	Valve (Relief)	
	Pipe	
	Blower	

NS-Designer Operation Manual

Object type	Object name	Shape
Pipes and Valves	Hopper	
	Pump	
Symbols	Basic	
	Check Box	
	Arrow	
	Valve	
	Pipe	
	Pump	

Appendix 3 Shortcut Keys

The following shortcut keys can be used with the NS-Designer.

Menu	Function	Shortcut keys
File	New Screen	Ctrl + N
	Open Screen	Ctrl + O
	Save Screen	Ctrl + S
	Transfer Data	Ctrl + I
	Print	Ctrl + P
Edit	Undo	Ctrl + Z
	Redo	Ctrl + Y
	Cut	Ctrl + X
	Copy	Ctrl + C
	Paste	Ctrl + V
	Offset Paste	Ctrl + W
	Delete	Delete
	Find	Ctrl + F
	Replace	Ctrl + H
	All Functional Objects/Fixed Objects	Ctrl + A
	Same Functional Objects	Ctrl + D (when object is selected)
Display	Previous Screen	Shift + PageUp
	Next Screen	Shift + PageDown
	Previous Frame Page	PageUp (when frame is selected)
	Next Frame Page	PageDown (when frame is selected)
	Refresh	F9
Settings	Object Properties	Enter (when functional object is selected)
	Edit Label	Space (when functional object with label setting is selected)
	Change Settings as a Batch	Ctrl + K (when functional object is selected)
Layout	Move Up	Up cursor key (when object is selected)
	Move Down	Down cursor key (when object is selected)
	Move Left	Left cursor key (when object is selected)
	Move Right	Right cursor key (when object is selected)
	Group	Ctrl + G (when more than one object is selected)
	Ungroup	Ctrl + U (when grouped objects are selected)
	One dot shift	Ctrl + ↑, →, ↓, or ← (when Snap to Grid is selected)
Tools	Validation	Ctrl + E
	Validation Result	Ctrl + Q
	Functional Object List	Ctrl + L
	Address Cross Reference	Ctrl + R
	Test	Ctrl + T

Appendix 4 Version Information

Information on the version of NS-Designer can be displayed.

Select **Help - About NS-Designer**.

The NS-Designer Dialog Box will be displayed. The corresponding NS-Designer version number will be shown in place of x.xx.

Click the **OK** Button to close the dialog box.



Appendix 5 Resource Report

A resource report can be generated to display the file size of screen and sheet files (extension IPW).

Select **Tools – Resource Report**.

The Resource Report Dialog Box will be displayed.

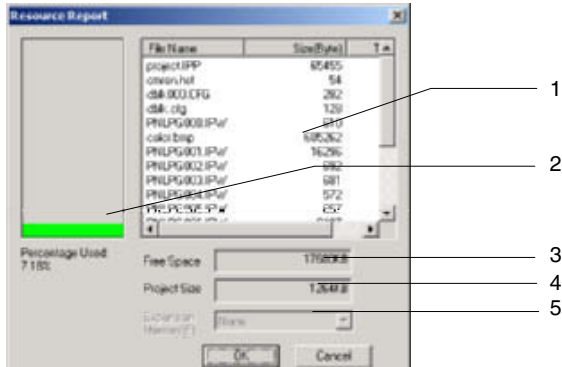

No.	Item	Details
1	Transfer file information	All file names in the project are displayed along with the file byte sizes and whether or not the file can be transferred. All files that can be transferred are displayed, including project files, screen files, bitmap files used on the screens, text files, etc. If the PT system version is 1.X, the maximum size of file that can be transferred is 1 Mbyte. Files that can be transferred to version-1.X PTs will be indicated as "OK." Files that cannot be transferred to version-1.X PTs will be indicated as "NG." If the system version is 2.0, there is no restriction on the size of files that can be transferred. Any files that are corrupted will be indicated as "ERR."
2	Percentage used	The percentage of the allowable project size is displayed. If the percentage used is larger than 100%, file transfer will not be possible. Delete unnecessary files and data to maintain file sizes at less than 100%.
3	Free space	The available space in the PT with no project data transferred is displayed.
4	Project size	The total size of all files in the project is displayed.

Appendix 6 Error Messages

The error messages displayed on the NS-Designer are listed in the following table along with probable countermeasures (in alphabetical order).

Message	Countermeasure
Address after replacement is not set.	Correctly designate the <i>start address after replacement</i> for replacement in the Replace Dialog Box.
Address input format is not correct. Input address again using correct format and applicable type (bit, word, etc).	Set the address using the correct format. The correct address can be set by using the Address Set Dialog Box.
Address is not set.	Set an address in the Address Dialog Box.
Address is not set.	Sets the communications address.
Address setting after replacement is not correct.	Set the <i>start address after replacement</i> to a value within the proper address range.
Address type of start address and end address is not the same.	Set the same type of address for the start address and the end address.
Address will exceed limit. Pasting aborted.	Check the range of addresses that can be set and repeat the operation so that the address range is not exceeded.
Background file error.	Check to see if the background file (BMP or JPEG) is corrupted.
BMP file of the compressed format is not supported.	Use a BMP file that is not compressed.
Cannot be set because there are already more than 160,000 Always log points. NS5: Cannot be set because there are already more than 120,000 Always log points.	A maximum of 160,000 points can be set to be always logged (120,000 points for the NS5). Change the log timing in the Data Log Group Setting Dialog Box, reduce the number log points, or delete addresses until there are 160,000 or fewer points.
Cannot be set because the logging holding capacity has been exceeded for the number of always logging points.	A maximum of 50,000 points can be set to be always logged. Reduce the number of points to be always logged, i.e., change the logging periods or reduce the number of logs in the Data Log Group Setting Dialog Box.
Cannot create a frame inside a frame.	Position the frame outside any other frames.
Cannot create any more frames.	Do not use more than 10 frames on one screen.
Cannot create any more new screens.	Create no more than 4,000 user screens in any one project.
Cannot create any more screens.	Create no more than 4,000 user screens in any one project.
Cannot create any more.	Create no more than 500 fields in any one data block.
Cannot Delete the screen file stored in NS hardware.	The project in the PT may be set to read-only. Initialize data using <i>Screen data region format</i> on the Data Initialization Tab Page under System Menu and transfer the whole project.
Cannot establish connection with specified communications method.	Check the following items. PT power supply. Cable connection. Is the PT started? (If it is not started, end the transfer program and start the PT.)
	Make correct settings for unset items and connect again.
Cannot find any project files in NS hardware.	Resend the whole project.

NS-Designer Operation Manual

Message	Countermeasure
Cannot find Project file at NS hardware. Transmit the whole project again.	Resend the whole project.
Cannot open anymore screens. Close xxx to open new screen. Do you want to save the changes you made to xxx?	A maximum of 16 screens can be opened for simultaneous editing. Specify whether or not to save the applicable screen.
Cannot open COM port.	Close the other application and try the connection again.
Cannot perform transmission because the memory for transmission is insufficient. Reset NS hardware and transmit the whole project again.	Reset the PT and transmit the whole project again.
Cannot register data to 1 folder anymore. (Max:4096). Register it to other folder.	Click the New Category Button in the Library Dialog Box and create a new category to place the objects in.
Cannot restore to the currently edited project.	Open another project or restart the NS-Designer and repeat the operation.
Cannot reuse the library object. It contains the function which is not supported in the current system version.	Confirm the version of the screen currently being edited and system versions for which the library object is supported.
Cannot reuse the screen because the system project of source project is newer than current editing project.	Match the version of the source project and the project you are editing, and repeat the operation. The version can be checked on the <i>Title</i> Tab Page of the <i>Project Properties</i> under the <i>Settings</i> in the NS-Designer.
Cannot set screen No. 0 as a pop-up screen.	Always set screen number 0 as a base screen.
Cannot set this address. Please set other address.	Set a correct address.
Cannot specify this project as a template because system version is newer than current editing project.	Match the version of the template project with the project you are editing, and repeat the operation. The version can be checked on the <i>Title</i> Tab Page of the <i>Project Properties</i> under the <i>Settings</i> in the NS-Designer.
Cannot start up editor. Check the setting at [Tools]-[Options]-[Editor].	Specify the editor on the Editor Tab Page under Tools - Options or check the specific executable file to be sure that it is correct.
Character string is not set.	Set the character string to search for in the Find Dialog Box.
CSV file xx is not correct.(Line:xx Row:xx)	Correct the specified line and row in the specified CSV file and then try and import it again.
Currently edited project cannot be deleted.	Open another project or restart the NS-Designer and repeat the operation.
Data block table cannot be created on the frame.	Create data block table objects on normal screens.
Data block table cannot be created on the pop-up screen.	
Data block table cannot be created on the sheet.	
Data cannot be loaded. Check whether the IPP file and project folder name are the same.	Use explorer or other search method to check whether a folder exists with the same name as the IPP file name.

NS-Designer Operation Manual

Message	Countermeasure
Downloading aborted. This Project includes the file which name contains invalid character. The characters that can be used are alphanumeric characters (0 to 9, A to Z, a to z), dollar sign (\$), underscore (_), and. Check and adjust project file.	There are limits on transferable file names. Check the error message and use NS-Designer to adjust the file name accordingly. There are similar limits on notation for text files indirectly accessed.
End address is not set.	Correctly designate the end address for replacement in the Replace Dialog Box.
End page No. is out of range. Set a number from 0 to 3999.	The end page number is 3,999. Set the end page number to a number between 0 and 3,999.
End page No. is smaller than the start page No.	Set the start page number so that it is smaller than the end page number.
End sheet number is out of range. Set a number from 0 to 9.	Sheet screen page numbers must be set in the range 0 to 9. Set the sheet screen page number to a number between 0 and 9.
Error detected at NS hardware. (0x03a7)	Contact your OMRON service representative.
Error occurred while writing to a flash memory. Transmission failed.	Initialize data using <i>Screen data region format</i> on the Data Initialization Tab Page under System Menu and transfer the project.
Exceeding maximum/minimum limit.	Set a number within the upper and lower limits.
Failed to create new folder.	The folder could not be created because of insufficient space on the hard disk. Increase the available space on the hard disk and repeat the operation.
Failed to delete.	Check to see if the specified category or file has been opened by another application and repeat the operation. It is also possible that data has been corrupted.
Failed to export CSV file.	The file could not be saved because of insufficient space on the hard disk. Increase the available space on the hard disk and repeat the operation.
Failed to get configuration information from the printer for NS-Designer. Settings cannot be performed for the printer.	This message is displayed when files containing information for printer settings cannot be obtained. Reinstall NS-Designer.
Failed to import CSV file.	Check to be sure that the file to be imported is in CSV format and repeat the operation.
Failed to open communications with the PLC. CX-Server reported an unknown error.	Exit Screen Data Transfer of NS-Designer if this message appears on the CX-Server when connecting to the PLC to send the settings for the Path Through PLC .
Failed to read file. (Data Block (X) CSV File)	The specified CSV data file does not exist. Create a CSV data file in the project folder.
Failed to read project file.	The project file may be corrupted. If there is a backup file, restore the project file using the backup file under Project Maintenance - File - Project Maintenance .
Failed to register.	Check to see if the specified category in the library has been opened by another application and repeat the operation. It is also possible that data has been corrupted.
Failed to restore the project.	Not have any free space left. Change the Restore Destination or increase the free space, and repeat the operation.
Failed to save file.	The file could not be created because of insufficient space on the hard disk. Increase the available space on the hard disk and repeat the operation.

Message	Countermeasure
Failed to start the CX-Server.	CX-Server may not be installed correctly. Refer to <i>Section 2 Setup, Starting, and Exiting</i> and uninstall CX-Server and then reinstall NS-Designer and CX-Server.
Failed to process the CX-Server.	CX-Server may not be installed correctly. Refer to <i>Section 2 Setup, Starting, and Exiting</i> and uninstall CX-Server and then reinstall NS-Designer and CX-Server.
Failed to use.	Check to see if the specified category or file has been opened by another application and repeat the operation. It is also possible that data has been corrupted.
Failed to write a file. (Data Block (X) CSV File)	The specified CSV data file does not exist. Create a CSV data file in the project folder.
Failed to write to a file. Check the free space and perform writing again.	The file could not be created because of insufficient space on the hard disk. Increase the available space on the hard disk and repeat the operation.
File check sum error.	The file is corrupted. Redo the file using backup data.
The specified filename has already been reserved in the System. Change the filename.	Set the output file name for the data log group to a name other than <i>Trend</i> .
File not found. Please verify the correct file name was given.	Correctly input an existing project name in the Open Project Dialog Box.
File size exceeded the maximum. Please check the project data. (03a9)	The maximum size file that can be transferred is 1.44 MB. Re-execute the transfer with a file smaller than 1.44 MB.
File writing error occurred.	Increase the available space in the computer.
Frame size is not set. Please be sure to set this item.	Set the frame size on the Frame Tab Page in the Object Properties Dialog Box.
Frame size is out of range. Please set the value from 0 to 16.	Set the frame size on the Frame Tab Page in the Object Properties Dialog Box to a number between 0 and 16.
Functional objects overlap. To permit overlapping, change the setting from [Tools]-[Options].	As a rule, set functional objects so that they do not overlap. To permit overlapping, change the setting on the Edit/Display Tab Page under Tools - Options .
Import data of screen page No. xx is not found in CSV file xx.	The number of screens defined in the import data is different from the number in the project into which the data is being imported. If there are fewer screens in the import data, temporarily move the extra screen files to a separate folder and repeat the operation.
Incorrect project is specified. Select correct project.	Correctly input an existing project name for project maintenance.
Incorrect value is set for node address. Set the value from 1 to 254.	Set an integer within the specified range for the node address in the Edit Host Dialog Box.
Initialization of transmission library failed.	Reinstall the NS-Designer.
Memory for undoing /redoing operation is insufficient. Increase the free memory by closing other screens or exiting other applications etc.	Increase the free memory by closing other screens or exiting other applications and then repeating the operation.
More than 5,000 items have been set.	The maximum number of alarm/events that can be registered is 5,000. Reduce the number of alarms and events to 5,000 or less by deleting unneeded ones from the Alarm/Event Setting Dialog Box.
Network No. is out of range. Set the number from 1 to 127.	Set an integer within the specified range for the network number in the Edit Host Dialog Box.
No items are selected.	Select an item and repeat the operation.

NS-Designer Operation Manual

Message	Countermeasure
No. of Address to find is out of range.	Reset the address to search for within the allowable range of addresses.
No. of functional objects inside a table exceeds the maximum limit (256).	Reduce the number of items horizontally or vertically in the Table Setting Dialog Box so that the total number of functional objects is 256 or less.
NS hardware error.	Contact your OMRON service representative.
NS hardware is already connected. Restart the NS hardware to change the communication method.	Restart the PT and make the new connection.
Operation failed.	Check to see if the specified category or file has been opened by another application and repeat the operation. It is also possible that data has been corrupted.
Other project exists in this directory. Cannot create new one.	Specify another folder or create a new folder in which to save the project file.
Please ensure that the maximum limit is not smaller than minimum limit.	The lower limit is higher than the upper limit. Make the correct limit settings.
Please enter an integer between oo and oo.	Input an integer within the specified range.
Project cannot be specified as project name because it is being edited with NS-Designer, which has been started up already	Specify another project name, or stop editing the project with NS-Designer and save the project.
Project file differs between transmission source and destination. Select the whole project and perform transmission again.	Individual screen data cannot be transferred for a different project when a project already exists in the PT (or in the specified Memory Card bank). To transfer the screen data, transfer the entire project.
Project file name contains invalid character. Usable characters are alphanumeric (0-9, A-Z, a-z), dollar mark (\$), underscore (_) and.	There are limits on transferable file names. Check the error message and use NS-Designer to adjust the file name accordingly. There are similar limits on notation for text files indirectly accessed.
Project file name is too long. It should be within 42 characters.	There are limits on transferable file names. Check the error message and use NS-Designer to adjust the file name accordingly. There are similar limits on notation for text files indirectly accessed.
Project name is not set.	Specify the name of the project file to be processed. Correctly input an existing project name for project maintenance.
Restore source data does not exist. Check the data.	Check to see if the specification for the restore source is correct.
Screen is not open.	Either select the entire project for the <i>Check When</i> setting on the Error Check Dialog Box or open the screens to be checked and repeat the operation.
Screen page No. is out of range. Set a number from 0 to 3999.	Set the screen number to a number between 0 and 3,999.
Screen size of download project is incorrect.	Mount Expansion Memory to the PT or take other steps to increase the available memory in the PT. Alternately, reduce the size of the screen data being transferred. The screen data size can be confirmed using Tools - Resource Report .
Set PT Memory (\$B/\$W) both for \$SB/\$SW Allocation Address or set host memory (DM etc.) both for them.	Set the addresses for both \$SB and \$SW to PT memory addresses (\$B and \$W) or set them both to host memory addresses for the same host.
Setting is not completed. Please be sure to set this item.	Specify a data block.

Message	Countermeasure
Sheet page No. is out of range. Set a number from 0 to 9.	Set the sheet page number to a number between 0 and 9.
Specified file name contains invalid characters: Alphanumeric (A-Z,a-z,0-9), underscore (_), dollar mark (\$), and period (.).	The specified file name contains illegal characters. Change the file name to one that uses only the following characters. Alphanumerics (A-Z, a-z, 0-9), underscores (_), dollar signs (\$), and periods (.).
Specify the file name within 12 characters (8+3 format).	Specify a file name of 12 characters or less (8+3 format) when specifying file names in dialog boxes used to set properties, e.g., when making list selections.
Start address is larger than the end address.	Set the start address so that it is smaller than the end address.
Start address is not set.	Correctly designate the start address for replacement in the Replace Dialog Box.
Start address setting is not correct.	Set a correct address.
Start page No. is out of range. Set a number from 0 to 3999.	Screen page numbers must be set in the range 0 to 3,999. Set the screen page number to a number between 0 and 3,999.
Test Tool is already started up. Cannot start Test.	Stop the test tool and then restart it.
The address is out of range.	Set an address that is within range in the Address Dialog Box.
The capacity of NS hardware is insufficient. Transmission failed.	Reduce the amount of screen data and transfer the project again.
The data is created with NS-Designer Ver. 1.0. This needs to be converted to edit with NS-Designer Ver. 6.2. When you convert the data to NS-Designer V1.1, it also can be operated with the system version 1.0. Do you want to convert the data?	You are attempting to use NS-Designer Ver. 6.2 to edit a project that was saved using NS-Designer Ver. 1.0. To convert the data from Ver. 1.0 to Ver. 1.1, which can be edited using NS-Designer Ver. 6.2, click the Yes Button. To leave the data unconverted, click the No Button and edit the project using NS-Designer Ver. 1.0.
The file name is incorrect. Input correct file name.	Input a file name in the correct format.
The number of characters exceed the limit. Set characters no more than X characters.	Set no more than the specified number of characters.
The object that cannot be arranged on the pop-up screen is contained.	Screens with video display objects or data block tables cannot be converted to pop-up screens. Either delete the video display objects and data block tables or do not perform the pop-up screen setting.
The selected PT model and System Version do NOT match.	Select a PT model and System Version that match. Refer to <i>Appendix 9 Converting Data between Different Versions of NS-series Products</i> for details on supported combinations.
The setting data format is different.	Check the data block field storage format and the setting data format.
The start sheet number is out of range. Set a number from 0 to 9.	Sheet screen page numbers must be set in the range 0 to 9. Set the sheet screen page number to a number between 0 and 9.
The value is out of range.	Input a value within the correct range.
The version of CSV file is newer than the project you are editing. Import CSV file cannot be performed.	Check the NS-Designer version being used, upgrade to match the version of the CSV file, as required, and then import the CSV file again.

NS-Designer Operation Manual

Message	Countermeasure
This object can be created only one for each screen.	Only one video display object or data block table can be created per screen.
This program is already started up.	Multiple copies of the transfer program cannot be started. Use the transfer program that is already started.
Time-out error occurred. Check the cable. Perform transmission again after restarting NS hardware.	Check the following items. PT power supply. Cable connection. Is the PT started? (If it is not started, end the transfer program and start the PT.)
	When transferring via serial communications, check the communications cable and the COM port that is being used. When using Ethernet, make sure that a PT with the node address specified for the transfer actually exists.
To reference a string indirectly, set both File Name and Address for Selecting a Line.	Specify both a file name for storing the text string and an address for specifying the file line on the Label Tab Page in the Text Property Setting Dialog Box.
Total No. of Always log addresses exceeds the maximum limit of 50.	A maximum of 50 addresses can be set for standing logging. Either change the log timing in the Data Log Group Setting Dialog Box or delete addresses that have been registered until there are 50 or fewer Always log addresses.
Total number of functional object will exceed the limit. Cannot continue operation.	Do not use more than 1,024 functional objects on one screen. Finding Out the Number of Functional Objects The number of functional objects that is being used can be found using Tools – List Up Functional Objects Used.
Transfer already in progress.	Check the destination node.
Video display cannot be created on the frame object.	Create video display objects on normal screens.
Video display cannot be created on the pop-up screen.	
Video display cannot be created on the sheet.	

Appendix 7 Connecting Cable Specifications

There are three methods that can be used for data communications between the NS-Designer (computer) and the NS-series PT.

- Serial communications
- Ethernet
- Memory Cards

Refer to the following information when preparing a connecting cable for the NS-Designer. A cable is not required if Memory Cards are going to be used.

A-7-1 Serial Cable

The cable is wired as described next depending on the type of RS-232C connector on the computer being connected.

- **Computers with a 25-pin Connector**

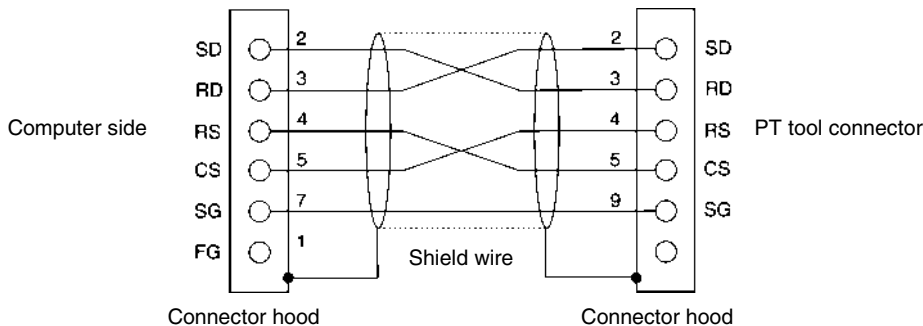

Use the following products to assemble the connecting cable.

Name	Model	Remarks
Connector	XM2D-2501	25-pin connector by OMRON (for computer end)
	XM2A-0901	9-pin connector by OMRON (for PT end)
Connector hood	XM2S-2511	25-pin connector by OMRON (for computer end)
	XM2S-0911	9-pin connector by OMRON (for PT end)
Cable	AWG28 x 5PIFVV-SB	Multi-core shielded cable (Fujikura Ltd.)
	CO-MA-VV-SB 5P x 28AWG	Multi-core shielded cable (Hitachi Cable Ltd.)

NS-Designer Operation Manual

• **Computers with a 9-pin Connector**

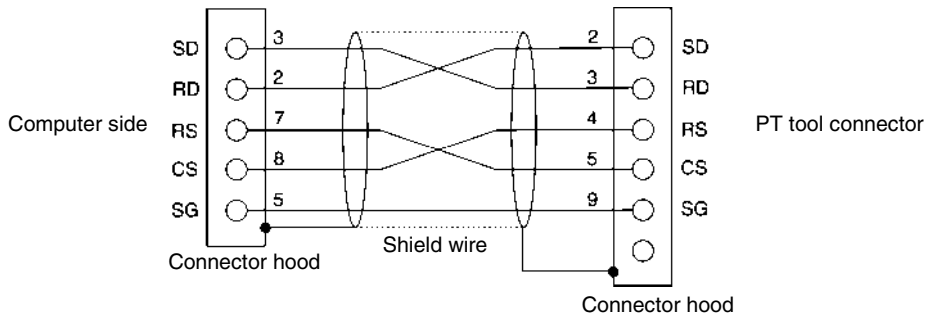

Use the following products to assemble the connecting cable.

Name	Model	Remarks
Connector	XM2D-0901	9-pin connector by OMRON (for computer end)
	XM2A-0901	9-pin connector by OMRON (for PT end)
Connector hood	XM2S-0911	9-pin mm-pitch screw by OMRON
	XM2S-0913	9-pin inch-pitch screw by OMRON
Cable	AWG28 x 5PIFVV-SB	Multi-core shielded cable (Fujikura Ltd.)
	CO-MA-VV-SB 5P x 28AWG	Multi-core shielded cable (Hitachi Cable Ltd.)

Note: Use a connector hood on the computer-end connector with screws that match the specifications of the connector on the computer.

A-7-2 Ethernet

• **Ethernet Connector Pin Arrangement**

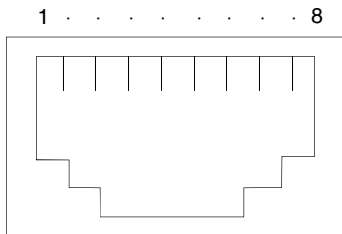

Pin number	Signal name	Name
1	TD+	Twisted-pair output (differential output)
2	TD-	Twisted-pair output (differential output)
3	RD+	Twisted-pair input (differential input)
4	NC	
5	NC	
6	RD-	Twisted-pair input (differential input)
7	NC	
8	NC	

Appendix 8 Details of CLK Status

Address (start address = n)	Bit	Status	Contents
n	0 to 7	Error Information	Not used
	8		1: Node address setting range error
	9		1: Duplicate node address
	10		1: Inconsistent network parameters
	11		1: Hardware error
	12		1: Communications controller send error
	13		Not used
	14		Not used
	15		1: Error log exists
	n + 1		0 to 7
8 to 15		1: Startup node address	
n + 2	0	Network Participation Status	Node 1
	1		Node 2
	2		Node 3
	3		Node 4
	4		Node 5
	5		Node 6
	6		Node 7
	7		Node 8
	8		Node 9
	9		Node 10
	10		Node 11
	11		Node 12
	12		Node 13
	13		Node 14
	14		Node 15
	n + 3		0
1		Node 17	
2		Node 18	
3		Node 19	
4		Node 20	
5		Node 21	
6		Node 22	
7		Node 23	
8		Node 24	
9		Node 25	
10		Node 26	
11		Node 27	
12		Node 28	
13		Node 29	
14		Node 30	
n + 4			
n + 6	0 to 14	Local Data Link Participation Status	Not used
	15		0: Local node data link not participating or data link inactive 1: Local node data link participating

NS-Designer Operation Manual

Address (start address = n)	Bit	Status	Contents
n + 7	0 to 7	Data Link Status	Node 1
	8 to 15		Node 2
n + 8	0 to 7		Node 3
	8 to 15		Node 4
n + 9	0 to 7		Node 5
	8 to 15		Node 6
n + 10	0 to 7		Node 7
	8 to 15		Node 8
n + 11	0 to 7		Node 9
	8 to 15		Node 10
n + 12	0 to 7		Node 11
	8 to 15		Node 12
n + 13	0 to 7		Node 13
	8 to 15		Node 14
n + 14	0 to 7		Node 15
	8 to 15		Node 16
n + 15	0 to 7		Node 17
	8 to 15		Node 18
n + 16	0 to 7		Node 19
	8 to 15		Node 20
n + 17	0 to 7		Node 21
	8 to 15		Node 22
n + 18	0 to 7		Node 23
	8 to 15		Node 24
n + 19	0 to 7		Node 25
	8 to 15		Node 26
n + 20	0 to 7		Node 27
	8 to 15		Node 28
n + 21	0 to 7		Node 29
	8 to 15		Node 30
n + 22	0 to 7		Node 31
	8 to 15		Node 32
n + 23	0	Data Link Normal Operation Status	Node 1
	1		Node 2
	2		Node 3
	3		Node 4
	4		Node 5
	5		Node 6
	6		Node 7
	7		Node 8
	8		Node 9
	9		Node 10
	10		Node 11
	11		Node 12
	12		Node 13
	13		Node 14
	14		Node 15
	15		Node 16

NS-Designer Operation Manual

Address (start address = n)	Bit	Status	Contents
n + 24	0	Data Link Normal Operation Status	Node 17
	1		Node 18
	2		Node 19
	3		Node 20
	4		Node 21
	5		Node 22
	6		Node 23
	7		Node 24
	8		Node 25
	9		Node 26
	10		Node 27
	11		Node 28
	12		Node 29
	13		Node 30
	14		Node 31
	15		Node 32
n + 25	0	Data Link Error Detection Status	Node 1
	1		Node 2
	2		Node 3
	3		Node 4
	4		Node 5
	5		Node 6
	6		Node 7
	7		Node 8
	8		Node 9
	9		Node 10
	10		Node 11
	11		Node 12
	12		Node 13
	13		Node 14
	14		Node 15
	15		Node 16
n + 26	0	Data Link Error Detection Status	Node 17
	1		Node 18
	2		Node 19
	3		Node 20
	4		Node 21
	5		Node 22
	6		Node 23
	7		Node 24
	8		Node 25
	9		Node 26
	10		Node 27
	11		Node 28
	12		Node 29
	13		Node 30
	14		Node 31
	15		Node 32

Appendix 9 Converting Data between Different Versions of NS-series Products

The following tables show the data compatibility between different versions of NS-series products.

Hardware and System Program

The versions of the system program that can be installed in the PT vary with the model. The possible combinations are shown in the following table. Use a system program that can be installed for the hardware used.

Item	NS12/NS10/NS7	NS12-V1/NS10-V1/NS8-V1/NS5-V1	NS5-V2
System Program Ver. 1.X	Supported	Not supported	Not supported
System Program Ver. 2.X	Supported	Not supported	Not supported
System Program Ver. 3.X	Supported	Not supported	Not supported
System Program Ver. 4.X	Not supported	Supported (except for the NS5-V1)	Not supported
System Program Ver. 5.X	Not supported	Supported	Not supported
System Program Ver. 6.0	Not supported	Supported	Not supported
System Program Ver. 6.2	Not supported	Supported	Supported

System Program and Screen Data Version

The versions of screen data that can be used on the PT depend on the version of the system program installed there. The “screen data version” is the version of the program selected when screen data is created on NS-Designer. The combinations that can be used on the PT are shown in the following table. Screen data versions are upwardly compatible.

Item	System Program Ver. 1.X	System Program Ver. 2.X	System Program Ver. 3.X	System Program Ver. 4.X	System Program Ver. 5.X	System Program Ver. 6.0	System Program Ver. 6.2
Screen data version: Ver. 1.X	Supported	Supported	Supported	Supported	Supported	Supported	Supported
Screen data version: Ver. 2.X	Not supported	Supported	Supported	Supported	Supported	Supported	Supported
Screen data version: Ver. 3.X	Not supported	Not supported	Supported	Supported	Supported	Supported	Supported
Screen data version: Ver. 4.X	Not supported	Not supported	Not supported	Supported	Supported	Supported	Supported
Screen data version: Ver. 5.X	Not supported	Not supported	Not supported	Not supported	Supported	Supported	Supported
Screen data version: Ver. 6.0	Not supported	Not supported	Not supported	Not supported	Not supported	Supported	Supported
Screen data version: Ver. 6.2	Not supported	Not supported	Not supported	Not supported	Not supported	Not supported	Supported

NS-Designer and Screen Data Version

The versions of screen data that can be read and created depend on the NS-Designer version. Convert the data as required with NS-Designer before reading it.

Item	NS-Designer Ver. 1.X	NS-Designer Ver. 2.X	NS-Designer Ver. 3.X	NS-Designer Ver. 4.X	NS-Designer Ver. 5.X	NS-Designer Ver. 6.0	NS-Designer Ver. 6.2
Screen data version: Ver. 1.X	Reading supported	Conversion to screen data version 2.X required	Conversion to screen data version 2.X required	Conversion to screen data version 2.X required	Reading supported	Reading supported	Reading supported
Screen data version: Ver. 2.X	Reading not supported	Reading supported	Reading supported	Reading supported	Reading supported	Reading supported	Reading supported
Screen data version: Ver. 3.X	Reading not supported	Reading not supported	Reading supported	Reading supported	Reading supported	Reading supported	Reading supported
Screen data version: Ver. 4.X	Reading not supported	Reading not supported	Reading not supported	Reading supported	Reading supported	Reading supported	Reading supported
Screen data version: Ver. 5.X	Reading not supported	Reading not supported	Reading not supported	Reading not supported	Reading supported	Reading supported	Reading supported
Screen data version: Ver. 6.0	Reading not supported	Reading not supported	Reading not supported	Reading not supported	Reading not supported	Reading supported	Reading supported
Screen data version: Ver. 6.2	Reading not supported	Reading not supported	Reading not supported	Reading not supported	Reading not supported	Reading not supported	Reading supported

Revision History

A manual revision code appears as a suffix to the catalog number on the cover of the manual.

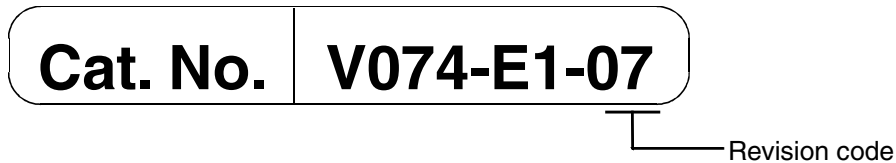

The following table outlines the changes made to the manual during each revision. Page numbers refer to the previous version.

Revision code	Date	Revised content
01	May 2002	Original production
02	January 2003	Addition of data transfer passing through the networks Addition of Switch Box function Contents revised to reflect the upgrade from version 2.0 to version 3.0
03	April 2003	Addition of information related to the printing function Addition of information related to "V1" models Addition of information related to other version upgrades
04	October 2003	Addition of information related to NS-Designer Ver. 5.0 upgrade. Addition of information related to NS5 PTs.
05	July 2004	Addition of information related to NS-Designer Ver. 6.0 upgrade.
06	February 2005	Addition of information related to the NS5-V2 Series. Addition of information related to other version upgrades.
07	October 2005	Notice: Information on general precautions notation and copyright added before page P-1. Read and Understand this Manual: Information on liability and warranty added after P-3.

OMRON Corporation

Control Devices Division H.Q.

Shiokoji Horikawa, Shimogyo-ku,
Kyoto, 600-8530 Japan

Tel: (81)75-344-7109/Fax: (81)75-344-7149

Regional Headquarters

OMRON EUROPE B.V.

Wegalaan 67-69, NL-2132 JD Hoofddorp
The Netherlands

Tel: (31)2356-81-300/Fax: (31)2356-81-388

OMRON ELECTRONICS LLC

1 East Commerce Drive, Schaumburg, IL 60173
U.S.A.

Tel: (1)847-843-7900/Fax: (1)847-843-8568

OMRON ASIA PACIFIC PTE. LTD.

83 Clemenceau Avenue,
#11-01, UE Square,
Singapore 239920

Tel: (65)6835-3011/Fax: (65)6835-2711

OMRON (CHINA) CO., LTD.

Room 2211, Bank of China Tower,
200 Yin Cheng Zhong Road,
PuDong New Area, Shanghai, 200120 China
Tel: (86)21-5037-2222/Fax: (86)21-5037-2200

OMRON

Authorized Distributor: