

CX-Process Tool

INTRODUCTION GUIDE

OMRON

CX-Process Tool

The *CX-Process Tool Operation Manual* is included as a PDF file on the CX-One CD-ROM under OMRON/CX-One/CX-Process Tool. Be sure to read the *Precautions* and other information at the beginning of the manual before using the CX-Process Tool.

This *CX-Process Tool Introduction Guide* describes basic operating procedures for the CX-Process Tool. For application precautions and detailed descriptions, refer to the Help or the PDF *Operation Manual*.

Note: Acrobat Reader 4.0 or higher is required to display the PDF file.

CX-Process Tool

The CX-Process Tool

A Loop Controller is a Controller that has the functionality of multiple high-performance Controllers. Combining function blocks that form functional components enables programming control without restrictions for analog values, such as temperatures, pressures, and flowrates.

Programming with the CX-Process Tool enables graphical engineering to paste function blocks and connect lines with the mouse. The system also has the following features compared with single-loop controllers and dedicated temperature controllers.

1. The system is based on PLCs, so a wide variety of PLC Units, such as Process I/O Units, Analog I/O Units, and Communications Units, can be used.
2. Data can be exchanged with the ladder-programmed CPU Unit at a high speed without any programming, so loop control programming can be coordinated with sequence control.
3. Changes, such as increasing or decreasing the number of loops and changing the control methods, can also be flexibly performed by combining function blocks.

A simple example of programming for one-loop temperature control will be presented as a sample in this *Introduction Guide*. Function blocks can also be combined for multi-loop control, cascade control, heating/cooling control, and program control.

CONTENTS

Overview	Example System	
	System Configuration	
	Creating Function Block Data	
SECTION 1	Creating Simple Function Block Data for the Loop Controller	1-1
	1 Starting the CX-Process Tool	1-2
	2 Making a New Project	1-2
	3 Registering the Loop Controller	1-4
	4 Creating Function Block Data	1-5
	5 Connecting Function Blocks	1-8
	6 Set ITEMS for Function Blocks	1-9
	7 Communications Settings between Computer and PLC	1-12
	8 Transferring Function Block Data to the Loop Controller	1-14
	9 Starting Operation	1-15
	10 PID Tuning	1-16
	11 Uploading and Saving Function Block Data	1-19
SECTION 2	Making the NS-series PT Screen for the Loop Controller	2-1
	1 Setting the CSV Tags in Advance	2-2
	2 Automatically Creating the NS-series PT Screen for the Loop Controller	2-2
	3 Displaying the NS-series PT Screen for the Loop Controller	2-6
Appendix	Useful Functions	

Overview

Example System

This section provides an explanation of basic CX-Process Tool operation using the following simple system as an example.

System Configuration

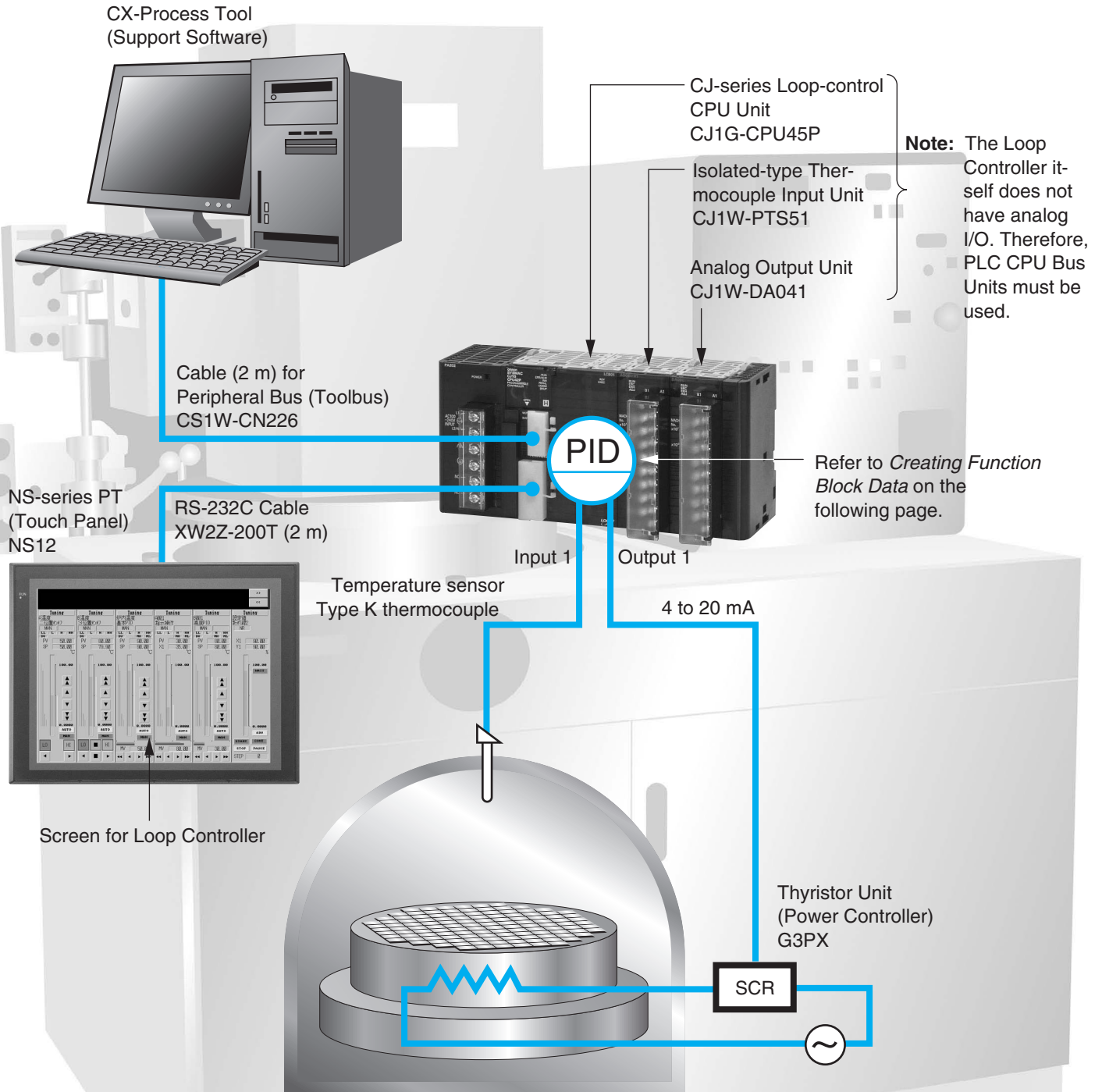

- This system controls one loop.

- A type K thermocouple is used for the temperature sensor input.
- The temperature range is 0.0 to 500.0°C.
- The output is 4 to 20 mA and heater control is performed using a Thyristor Unit (Power Controller).
- Continuous proportional PID is set.

Note: The default operation cycle (1 s) is used.

- The screen for the Loop Controller is displayed by connecting a NS-series PT (Touch Panel).

Creating Function Block Data

Thermocouple Input Unit
CJ1W-PTS51

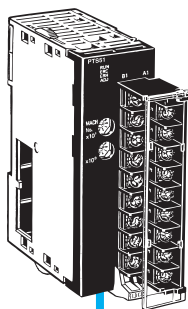

Type K thermocouple

Function Block Data

Cycle: System common operation cycle

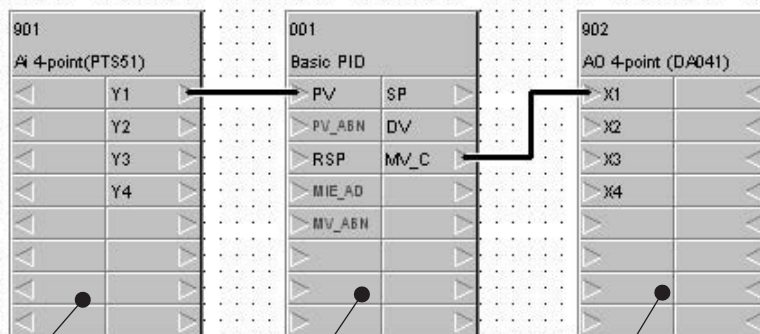

Field Terminal Block for Analog Input (Isolated Ai 4-point Terminal (PTS51)) (Block Model 566)
Inputs the analog signal from the CJ1W-PTS51.

Control Block for PID Control (Basic PID) (Block Model 011) Performs PID calculations.

Field Terminal Block for Analog Output (Ao 4-point Terminal (DA041)) (Block Model 587) Outputs the analog signal from the CJ1W-DA041.

Analog Output Unit
CJ1W-DA041

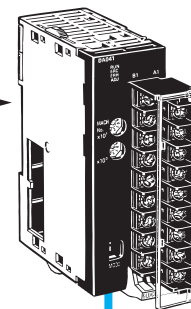

4 to 20 mA

Loop Controller

(in CJ-series CJ1G-CPU45P Loop-control CPU Unit)

To simplify descriptions, operations for startup settings at the PLC (such as creating I/O tables (see note) and setting DM Area words allocated to Analog I/O Units) is not included in the following description of operations for the CX-Process Tool. Be sure to separately make the settings using the CX-Programmer.

Note: With CJ-series Loop-control CPU Units, I/O tables can be automatically generated based on the mounted Units when the power supply is turned ON without performing the operation to create I/O tables. (With CS-series CPU Units, an operation must be performed to create the I/O tables.)

SECTION

Creating Simple Function Block Data for the Loop Controller



This section presents the flow of operations for starting the CX-Process Tool (Support Software), inputting the thermocouple, creating function block data for one PID loop with an output of 4 to 20 mA, downloading the data to the Loop Controller, tuning PID control, and saving files.

1

1 Starting the CX-Process Tool

2

Starting the CX-Process Tool/Making a New Project

From the Start Menu, select **All Programs - OMRON - CX-One - CX-Process Tool - CX-Process Tool** to start the CX-Process Tool.

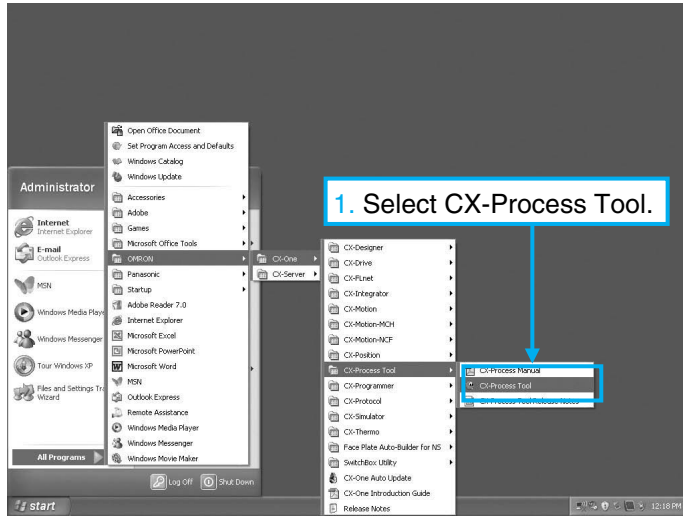

2 Making a New Project

The window at the right will open when the CX-Process Tool starts.

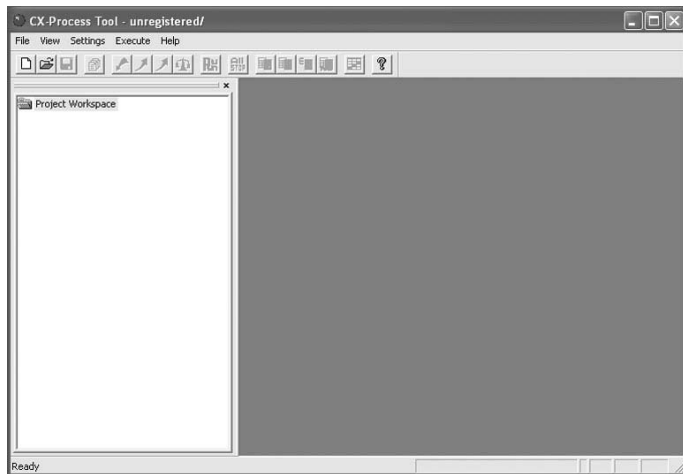

First, make a project.

Click the **Make a New Function Block File Button**  to make a new project.

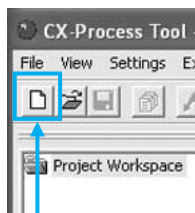

2-1. Make a new project.

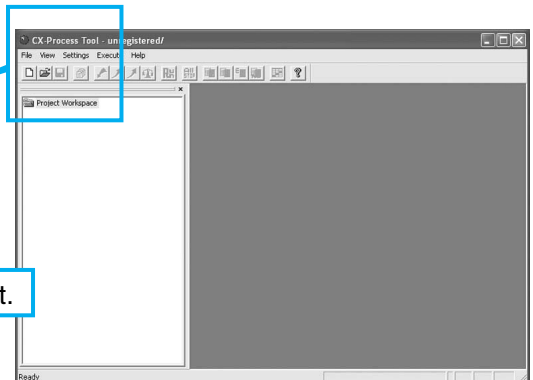

Select a folder in which to save the data, and then click the **OK** Button.

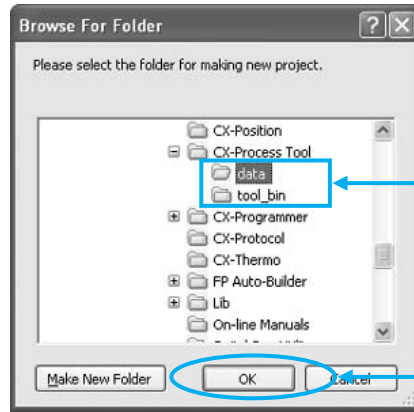

2-2. Select the folder in which to save the data.

Click the **OK** Button.

The window at the right will open when the **OK** Button is pressed. Enter the project name.

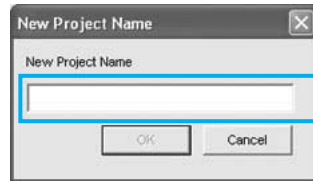

2-3. Enter the project name.

- For example, enter "Temperature Control."

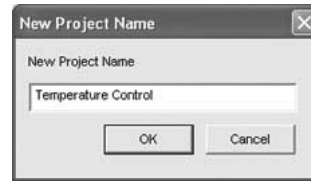

The folder in which the project name was entered (called the project folder) will be created in the window on the left (called the project workspace).

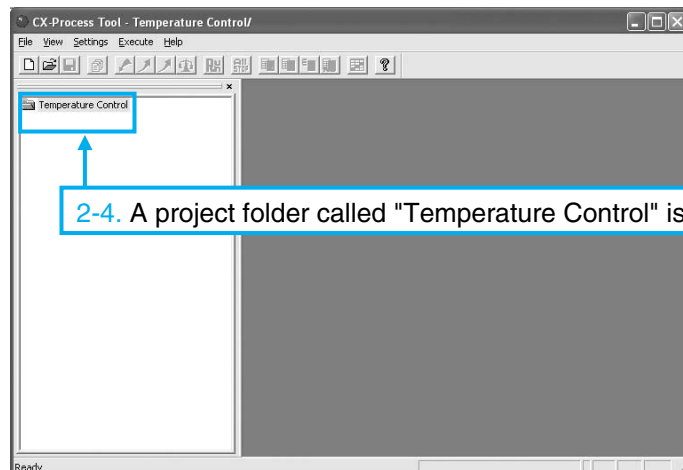

2-4. A project folder called "Temperature Control" is created.

3 Registering the Loop Controller

Next, register the Loop Controller to be used.

Right-click the Project Folder **Temperature Control** and select **Insert**.

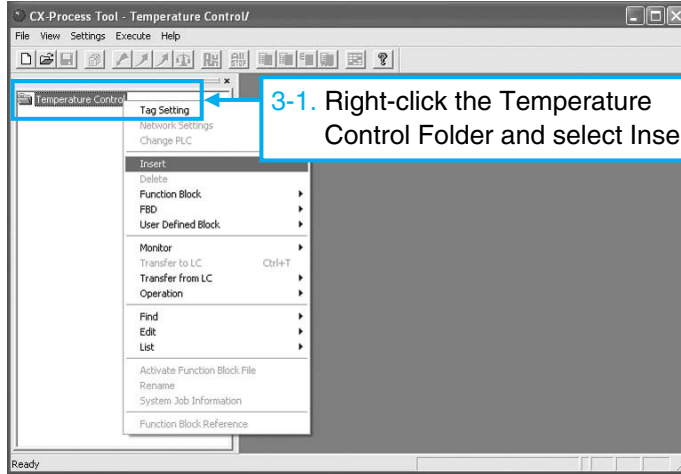

3

Registering the Loop Controller

A dialog box for selecting the Loop Controller will open. The Loop Controller to be used is a CJ-series Loop-control CPU Unit. Therefore, first select *Loop CPU Unit/Process CPU* for the LC type.

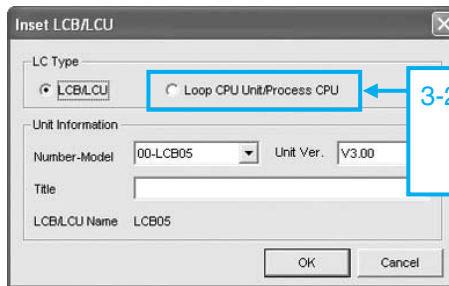

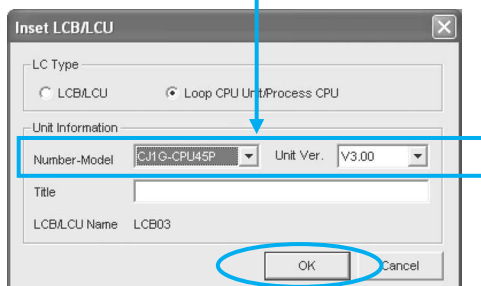

Next, select the model number and LCB Unit version. The model number is the CJ1G-CPU45P and the version is 3.0.

3-3. Select the model number and the LCB Unit version in the *Unit Information* Field. Select CJ1G-CPU45P for the model number and 3.0 for the version.



Click the **OK** Button.

A node function block file labeled  Node00 [CJ1G-H CPU45] will be added under the Temperature Control Project Folder  Node00 [CJ1G-H CPU45] .

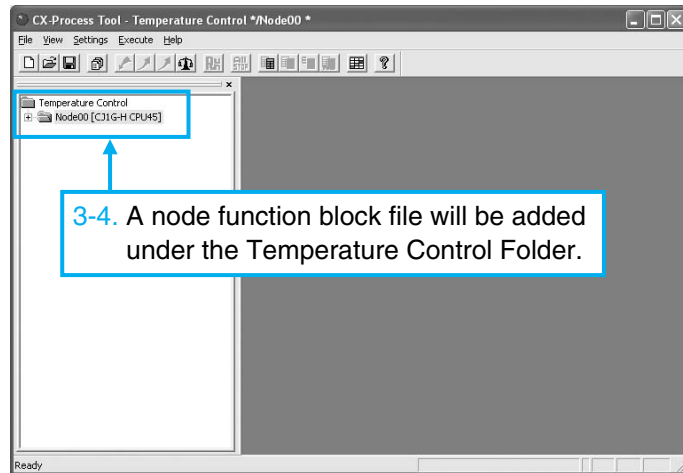

4 Creating Function Block Data

Next, actually create simple function block data.

Click the plus sign (+) to the left of the  Node00 [CJ1G-H CPU45] node function block file, and then click the plus sign on the LCU/LCB element folder underneath it. The tree structure will be opened.

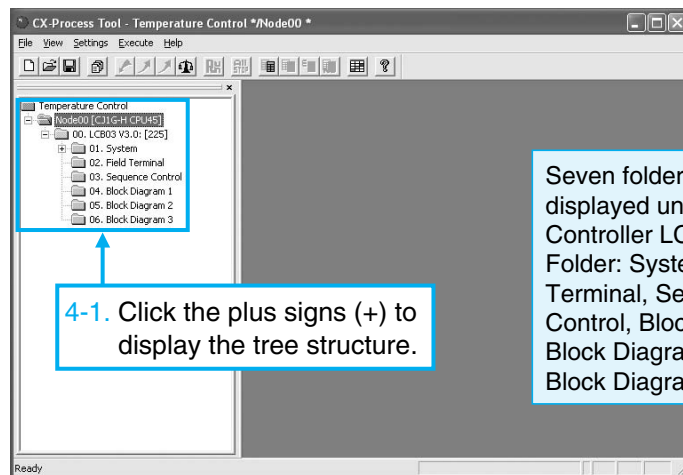

Seven folders will be displayed under the Loop Controller LCB03 V3.0 Folder: System, Field Terminal, Sequence Control, Block Diagram 1, Block Diagram 2, and Block Diagram 3.

The window shown on the right will open when the 04. Block Diagram 1 Folder in the tree is double-clicked. Paste the following three items into the Function Block Diagram Window at the right.

- Function block for analog input:
Isolated Ai 4-point Terminal (PTS51)
- Function block for PID: Basic PID
- Function block for analog output:
Isolated Ao 4-point Terminal (DA041)

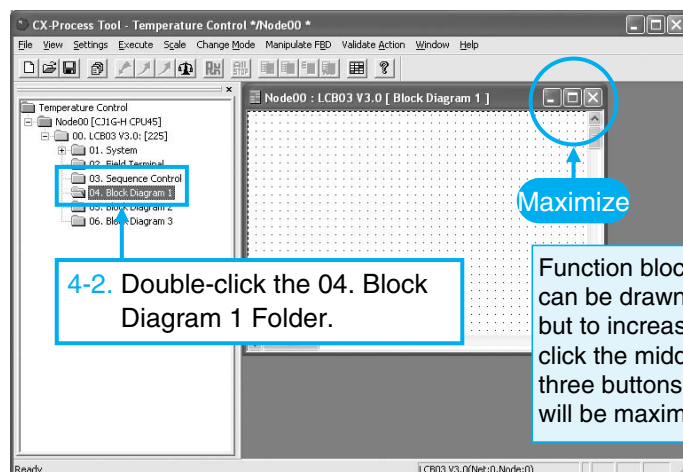

Maximize

Function block diagrams can be drawn at this point, but to increase the area, click the middle of the three buttons. The window will be maximized.

First, paste the function block Isolated Ai 4-point Terminal (PTS51) for analog input. Right-click in the window at the right. The pop-up menu shown in the figure at the right will be displayed. Select **Register - Field Terminal** from the menu.

4-3. Paste the function blocks. First, register the Isolated Ai 4-point Terminal.

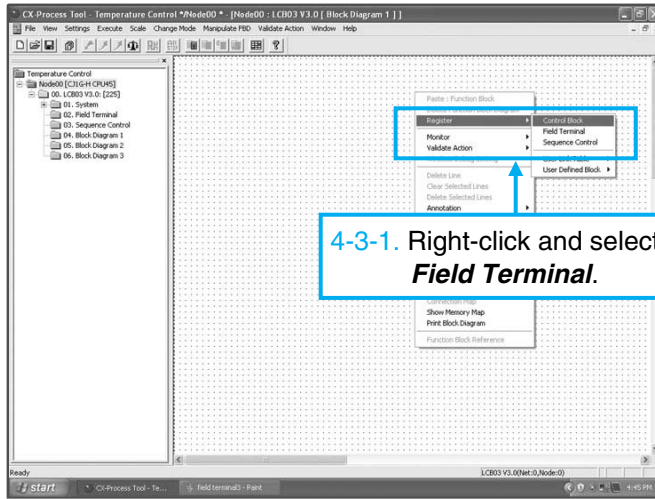

4-3-1. Right-click and selected **Register - Field Terminal**.

The dialog box shown at the right will be displayed. Press the **Insert** Button.

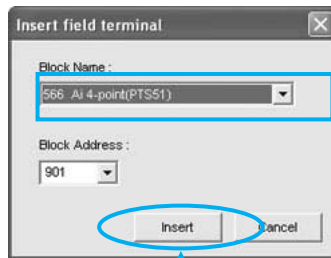

4-3-2. Select **566 Ai 4-point (PTS51)**.

Click the **Insert** Button.

A window for the Isolated Ai 4-point Terminal (PTS51) Block will appear.

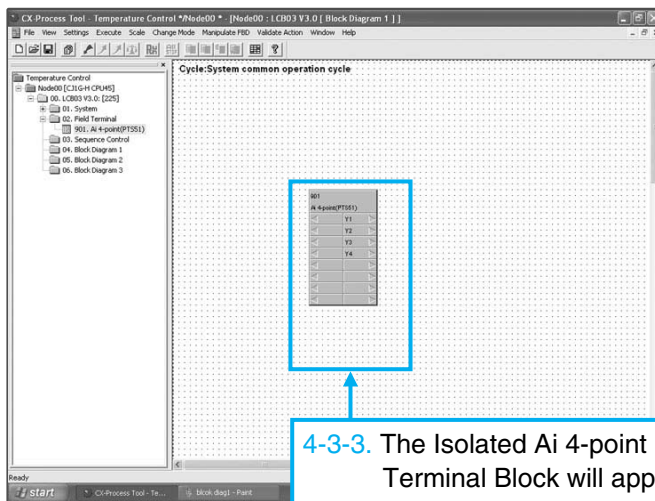

4-3-3. The Isolated Ai 4-point Terminal Block will appear.

The function block can be moved without restriction by dragging it with the mouse.

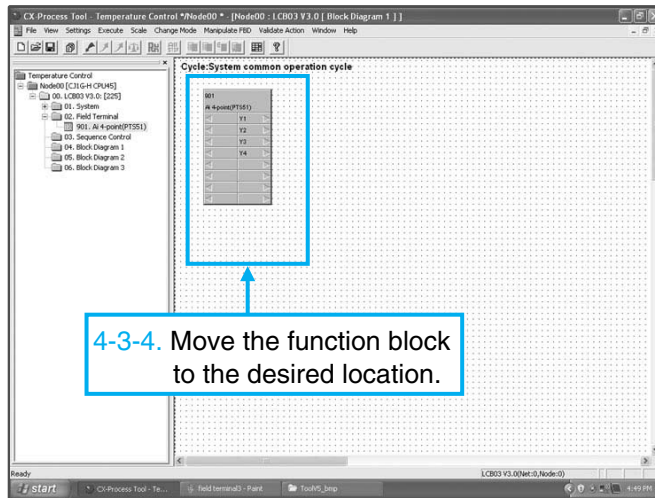

4-3-4. Move the function block to the desired location.

Next, paste the Basic PID Block. Just as in the previous procedure, right-click and select **Register - Control Block**.

4-4. Register the Basic PID Block.

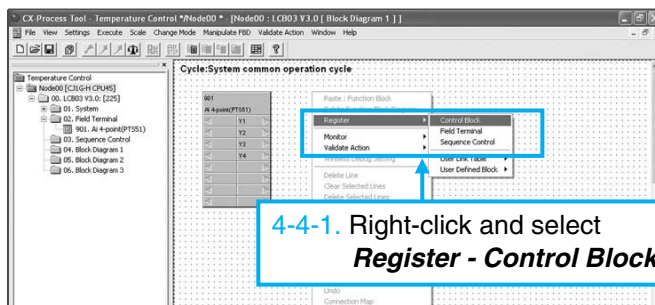

4-4-1. Right-click and select **Register - Control Block**.

A window for selecting the function block will open. Click the **Down-Arrow** ▾.

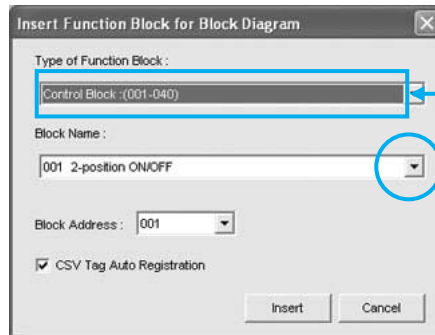

4-4-2. Select the control block.

Click.

Select **Basic PID** from the function block names and click the **Insert** Button.

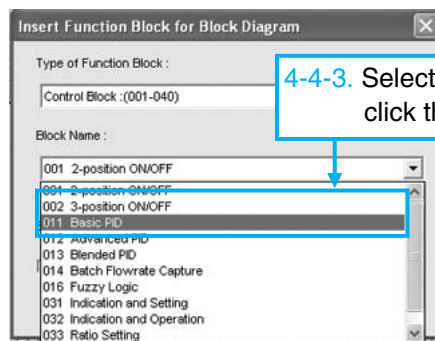

4-4-3. Select **Basic PID** and click the **Insert** Button.

4

5

Connecting Function Blocks

Paste the function block Isolated Ao 4-point Terminal (DA041) for analog output in the same way. Right-click in the window on the right and select **Register - Field Terminal**. Set the Field Terminal to *Ao 4-point (DA041)*.

4-5. Register the Ao 4-point Terminal (DA041).

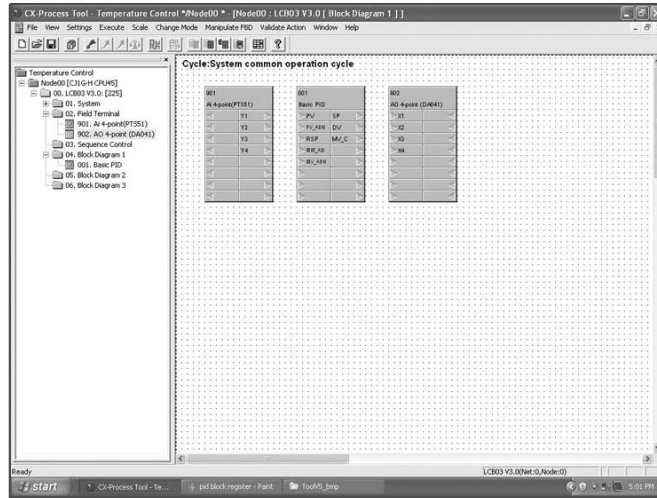



This completes pasting the function blocks.

5 Connecting Function Blocks

Next, connect the function blocks that were pasted.

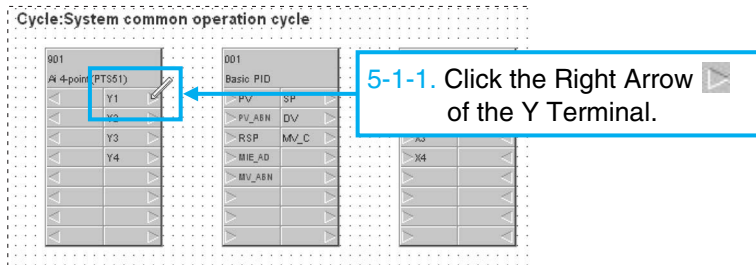
First, click the Right Arrow  of the Y1 Terminal of the Ai 4-point (PTS51) block.



Drag the mouse to the PV Terminal  of the Basic PID Block and double-click.

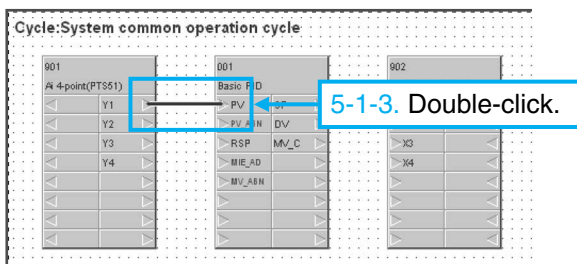
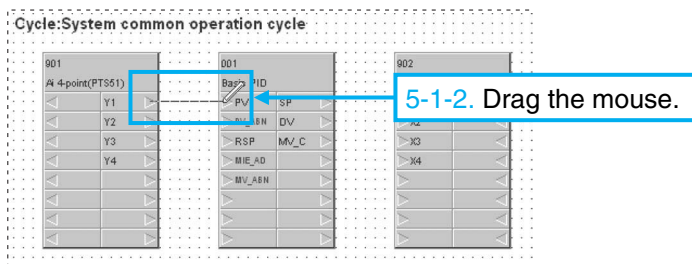

In the same way, connect the Right Arrow of the MV_C Terminal for Basic PID with the Right Arrow for the X1 Terminal of Ao 4-point (DA041).

5-2. Connect the Basic PID block to the Ao 4-point Terminal (DA041).

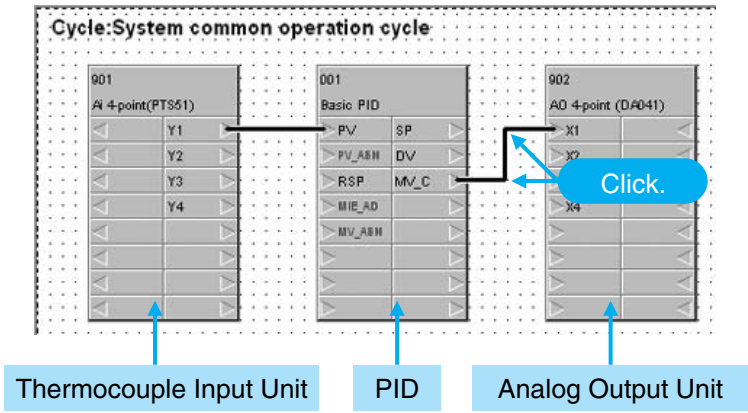

6 Set ITEMS for Function Blocks

Next, make settings so that the pasted function blocks can be used.

Double-click 901. Ai 4-point (PTS51) in the tree in the window on the left. The details of the function block will be displayed in the window on the right.



6-1. Setting the Function Block for Analog Input

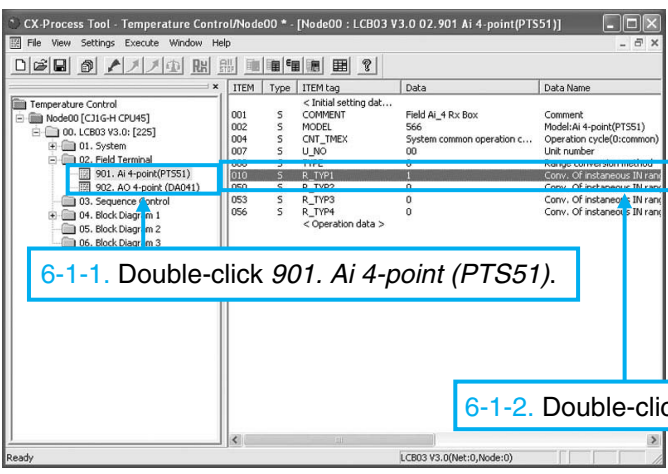

6-1-1. Double-click 901. Ai 4-point (PTS51).

6-1-2. Double-click ITEM 007.

First, change the unit number. Double-click ITEM 007 in the window on the right. The window shown at the right will be displayed. The unit number is currently set to "95." Set the unit number to be used (00) and press the OK Button.

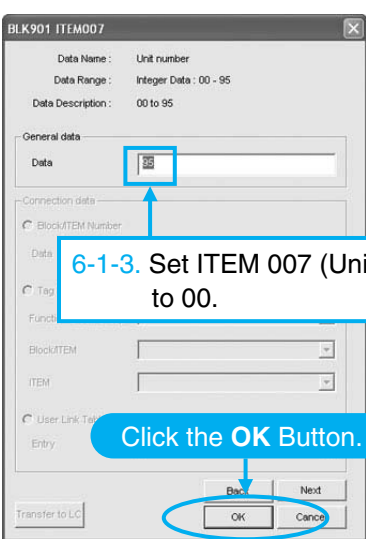

6-1-3. Set ITEM 007 (Unit Number) to 00.

Double-click *ITEM 010* to use Input 1. Next, because a type K thermocouple is being used and the input range is 0.0 to 500.0°C, change *Data* to 1 and click the **OK** Button.

Note: The input type setting (i.e., parameter) for the CJ1W-PTS51 Isolated-type Thermocouple Input Unit must be set to a type K thermocouple (decimal point) = 0001 hex as given below:

DM Area Word Allocated in the CPU Unit
D20019 = 0001 hex
(When the unit number is 0.)

(It is not necessary to know the address if the setting is made by editing parameters by double-clicking CJ1W-PTS51 in the I/O tables in the CX-Programmer.)

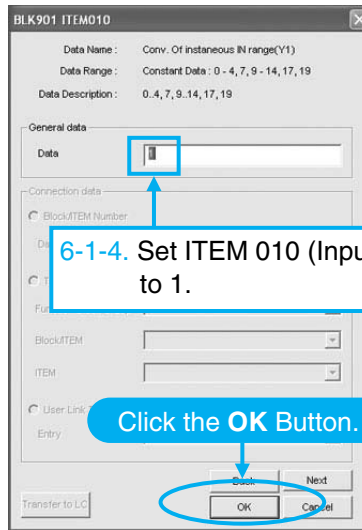

The ITEM Setting Window will close. Confirm that the settings have changed.

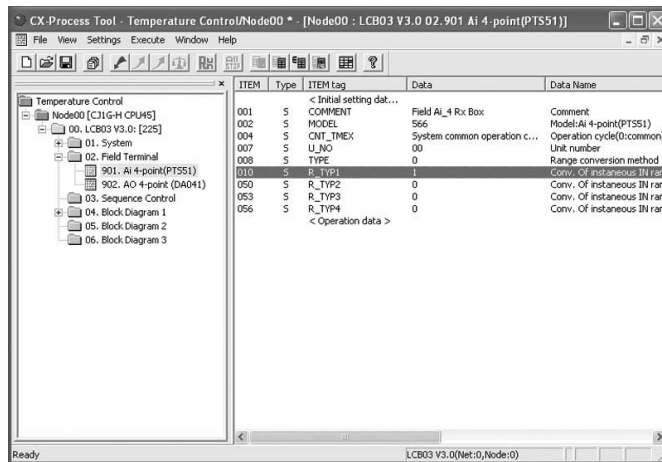

Next, double-click 902. Ao 4-point (DA041) in the tree in the window on the left. Change the unit number in the same way as above. Double-click *ITEM 007* in the window on the right.

6-2. Setting the Function Block for Analog Output

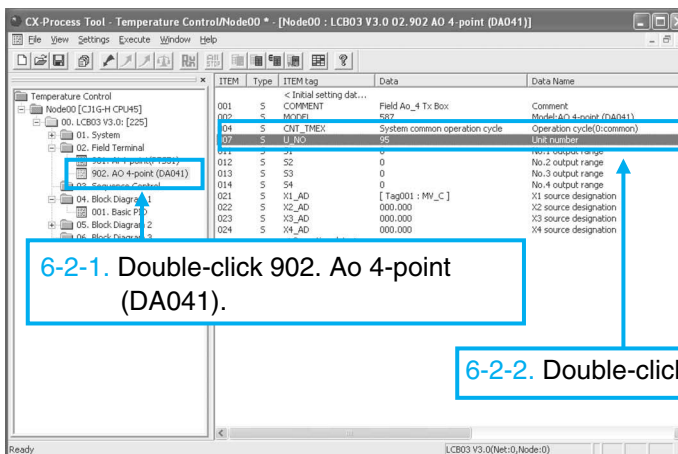

The unit number is currently set to "95." Set the unit number to be used (01) and press the **Next** Button.

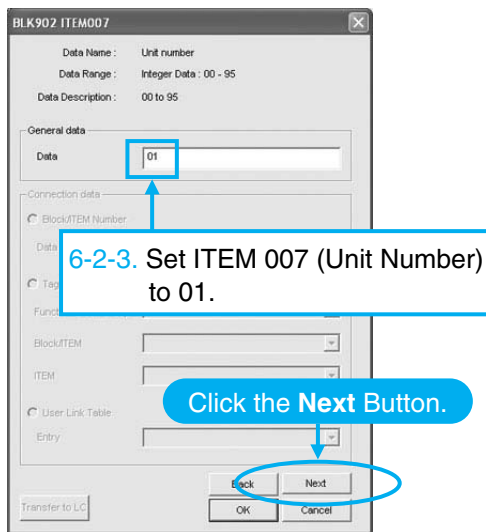

An output of 4 to 20 mA is used for the system. To keep Output 1 the same as the default setting of 0, simply press the **OK** Button. The window will close.

Note: Analog Output Unit

The output range setting (parameter) for the CJ1W-DA041 must be set to 1 to 5 V/4 to 20 mA = 0002 hex as listed below:
 DM Area Word Allocated in the CPU Unit D20101 = 0002 Hex
 (When the unit number is 1 and Output 1 is used)

(It is not necessary to know the address if the setting is made by editing parameters by double-clicking *CJ1W-DA041* in the I/O tables in the CX-Programmer.)

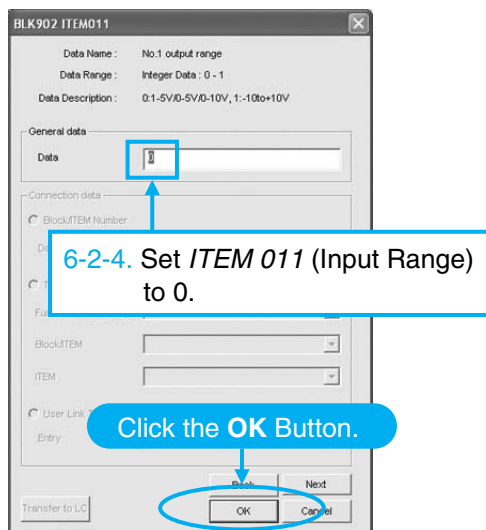

This completes pasting function blocks, connecting function blocks, and setting ITEMS.

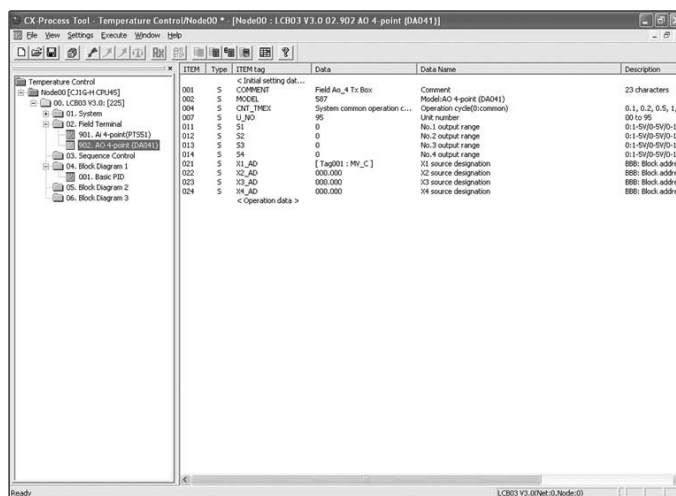
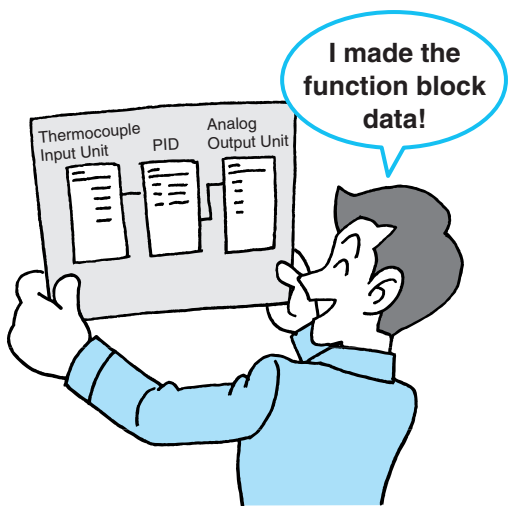

In this example, the operation cycle is set to 1 s for the entire system and the start mode is set to a hot start (i.e., operation starts with the auto/manual status held immediately before the power supply was turned OFF.) Therefore, System Common block is used at its default values.

7 Communications Settings between Computer and PLC

Next, connect the computer and the PLC with a cable and make the communications settings to enable sending the function blocks to the Loop Controller.

Connect the computer to the PLC at the peripheral port using a Peripheral Port Connecting Cable.

7-1. Connect the cable.

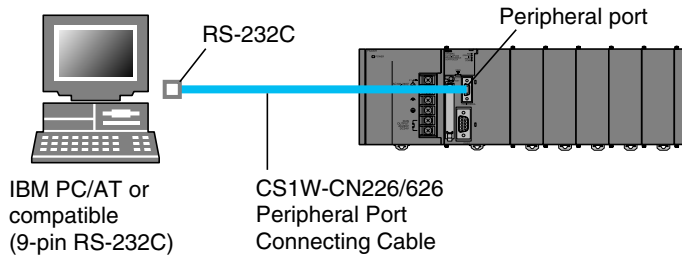

IBM PC/AT or compatible (9-pin RS-232C)

CS1W-CN226/626 Peripheral Port Connecting Cable

7-2. Setting Communications Conditions

Right-click *Node00[CJ1G-H CPU45]* *Node00 [CJ1G-H CPU45]* in the tree in the window on the left to set the communications port and select **Change PLC** from the pop-up menu.

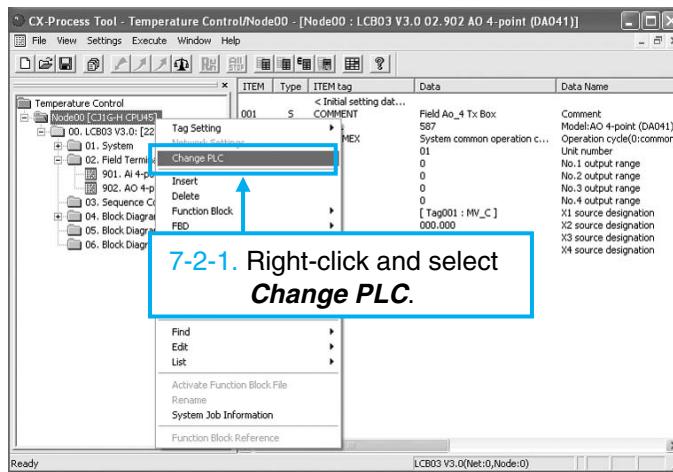

7-2-1. Right-click and select **Change PLC**.

A dialog box will open. Click the **OK** Button.

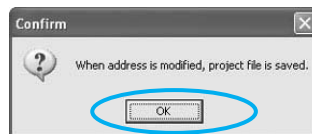

Click the **OK** Button.

The Change PLC Window will open. Click the **Settings** Button.

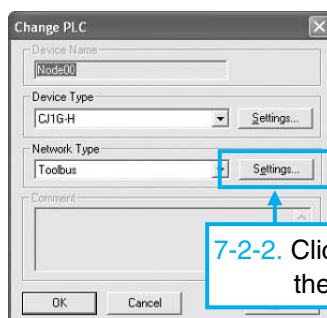

7-2-2. Click the Settings Button in the Change PLC Window.

The Network Settings [Toolbus] Window will open. Click the **Driver** Tab.

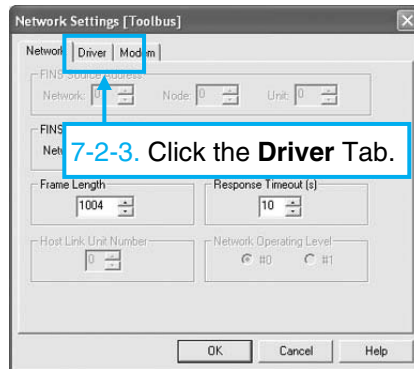

Set the *Port Name* to the actual port to be used, and then click the **OK** Button to close the window.

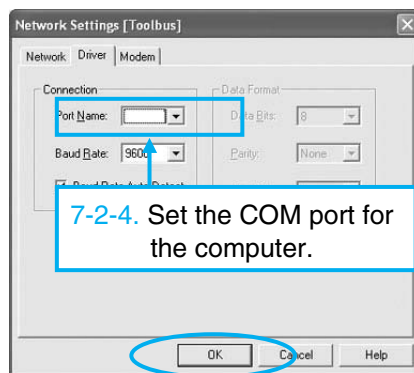

Click the **OK** Button.

The communications setting will be completed once the **OK** Button is clicked once again.

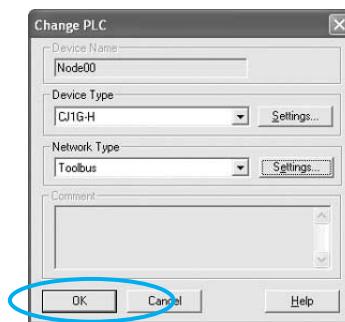

Click the **OK** Button.

With the CX-Process Tool, an online connection will be made automatically when online operations, such as downloading, are performed after making the communications settings described above.

8 Transferring Function Block Data to the Loop Controller

Now that communications settings have been completed, transfer the function block data to the Loop Controller.

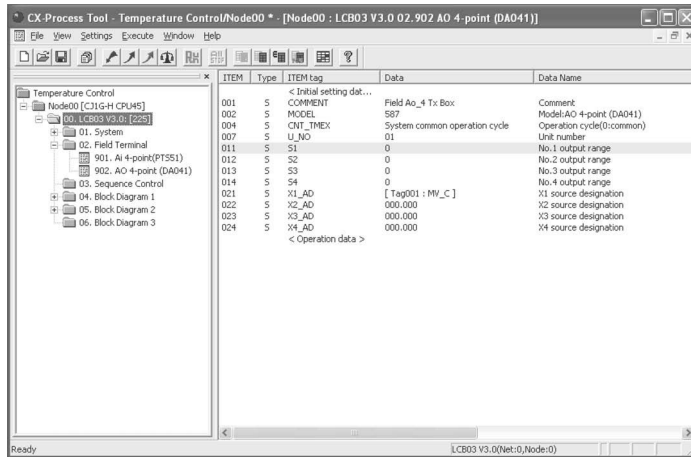

Right-click

on the tree in the window at the left and select **Transfer to LC** from the pop-up menu.

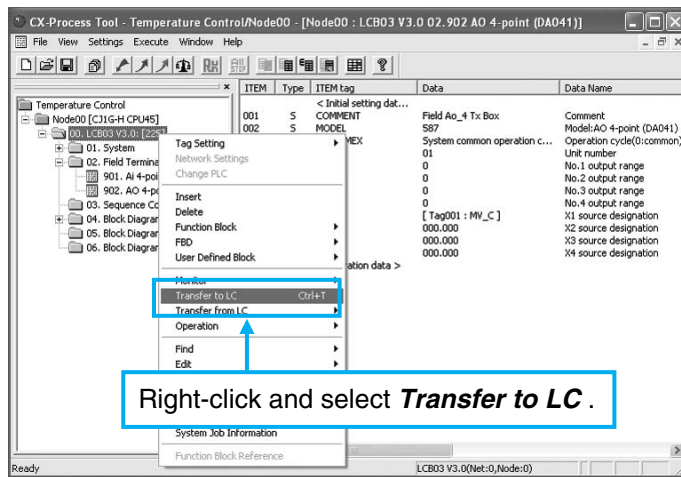

Click the **OK** Button.



Click the **OK** Button.

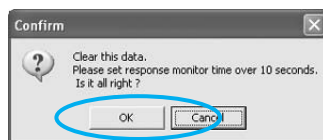

Click the **OK** Button.

Click the **Start** Button. The window will automatically close when the download has been completed.

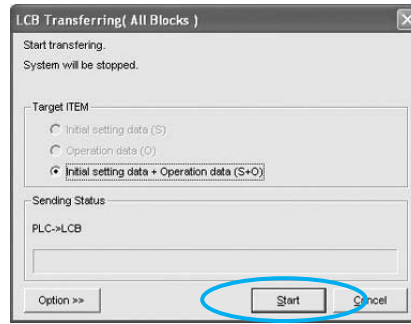
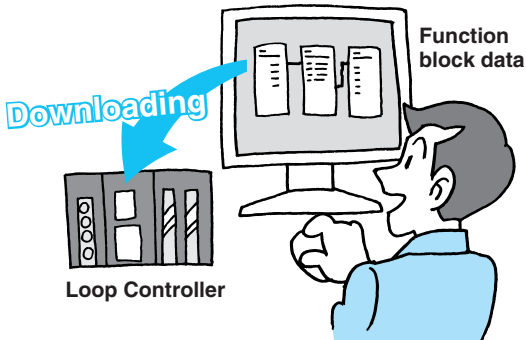

Click the **Start** Button.

9 Starting Operation

The window to start transferring will be displayed continuing with the transfer operation. Click the **OK** Button.

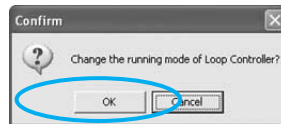

Click the **OK** Button.

Select *Cold Start* and click the **Execute** Button.

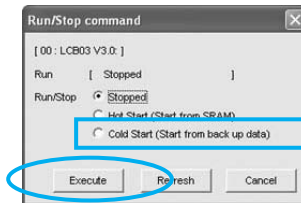

Select *Cold Start* for the Run/Stop Command.

Click the **Execute** Button.

The operation status display will change to *Cold Start* when operation has been started.



In this example, the operation is started right after downloading, but operation can also be started by using an operation command from the menu, or operation automatically when the power is turned ON (but a hot start will be used by default).

Use *Hot Start* to hold the manipulated variable (MV) and other settings from immediately before a momentary stop. Otherwise, normally use *Cold Start*.

10 PID Tuning

Tune PID constants for the Basic PID Block.

Right-click the Basic PID Block and select **Monitor - Tuning Screen** from the pop-up menu.

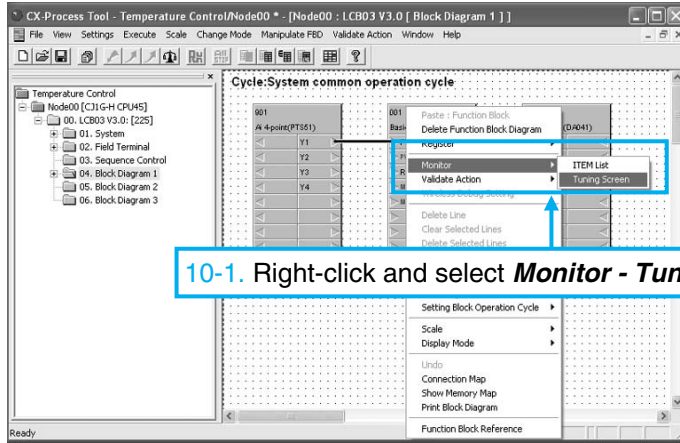

10-1. Right-click and select **Monitor - Tuning Screen**.

The Tuning Screen Configuration Window will open. At this point, set the tuning screen.

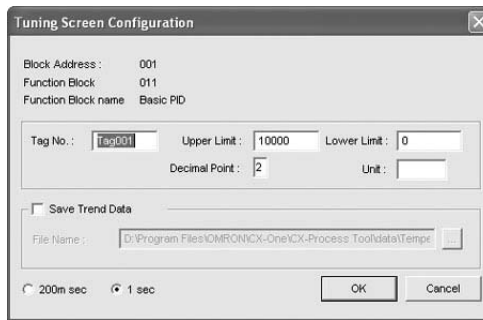

For the system configuration specified at the beginning of this guide, the temperature range is to be set to 0.0 to 500.0°C. Therefore, input **5000** for the *Upper Limit*, **1** for the *Decimal Point*, and **deg C** for the *Unit*. When finished, click the **OK** Button.

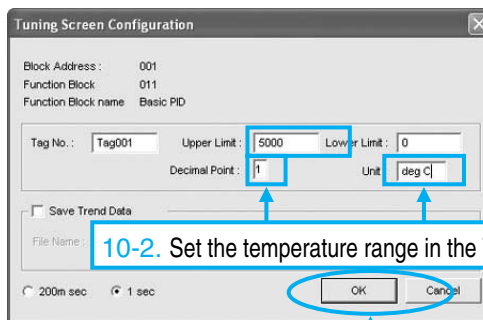

10-2. Set the temperature range in the Tuning Screen Configuration Window.

Click the **OK** Button.

The window shown at the right will not be displayed if the PLC is not actually connected. The window, however, is included here as reference.

Clicking on a setting name will display a dialog box to change the setting. Change the setting with the 10-key pad dialog box (using the mouse) or by using the keyboard.

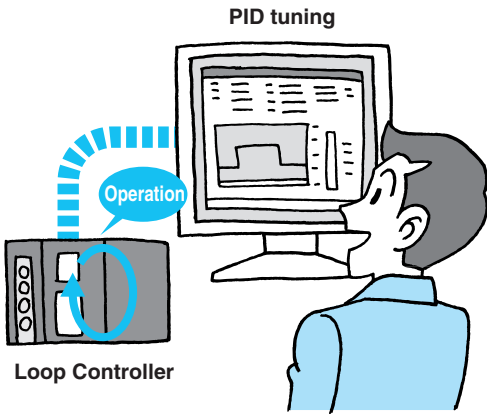

The window will be displayed and then trend data will be displayed.

PV
 SP
 Upper limit
 Lower limit

Reference Information

● Autotuning (AT)

Autotuning is provided as a convenient means for tuning PID control. To perform autotuning, click the **AT** Button. The PID constants will be tuned when autotuning is started.

The following figure shows an example of AT execution and the response of the subsequent temperature control loop. Compared with the response example on the previous page, temperature settings are changed faster.

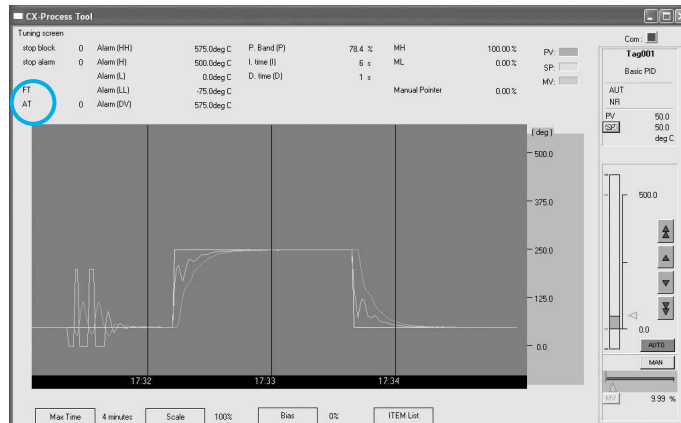

● Fine Tuning (FT)

Execute fine tuning (FT) when the control performance produced by autotuning is not acceptable, when autotuning produces instability in the PV, or when interruption of control cannot be allowed.

Fine tuning improves control by automatically setting PID constants using three user settings listed below along with fuzzy logic applied to the previous control conditions.

- Hunting
- Overshooting
- Responsiveness

Either one or two of the user settings can be set to any of five adjustment levels. For example, to improve control responsiveness and overshooting, the *Responsiveness* and *Hunting* parameters can be set to the desired levels.

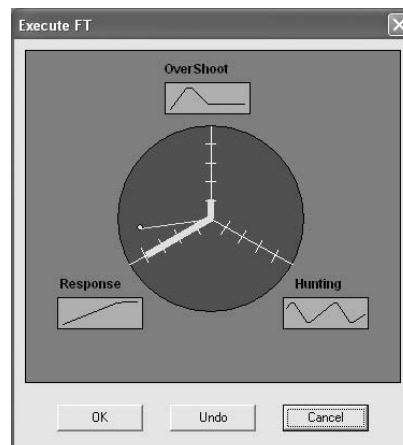

11 Uploading and Saving Function Block Data

Upload the data from the actual Loop Controller and save the data in a file.

Upload the parameters (e.g., PID constants) tuned in the actual Loop Controller to the computer. Right-click **00.LCB03 V3.0: [225]** in the tree in the window on the left and select **Transfer from LC - Previous**.

11-1. Upload the data from the actual Loop Controller.

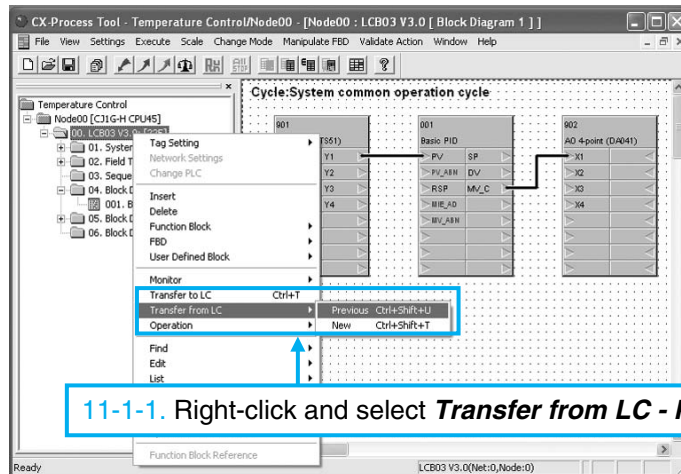

11-1-1. Right-click and select **Transfer from LC - Previous**.

Click the **OK** Button.

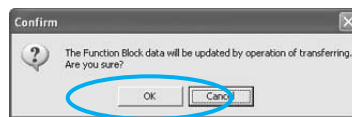

Click the **OK** Button.

Click the **Start** Button. Transferring the setting parameters from the Loop Controller to the computer will begin. The window will close when the transfer has been completed.

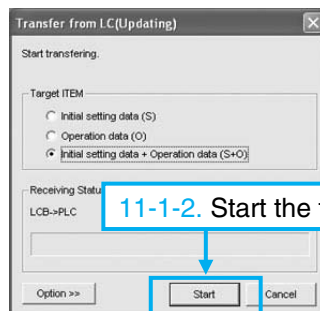

11-1-2. Start the transfer.

Click the **Save** Button  on the toolbar to save the function block data.

11-2. Save the function block data.

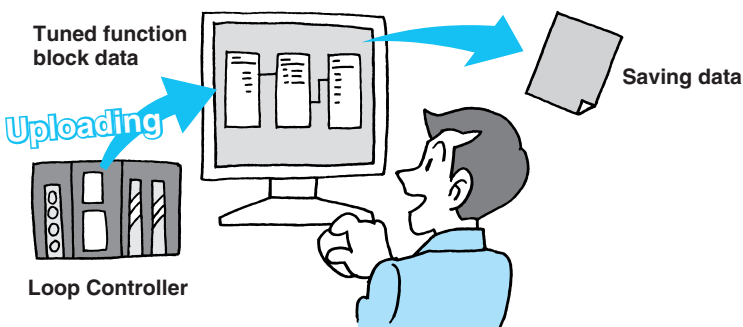

SECTION



Making the NS-series PT Screen for the Loop Controller

This section describes the operational flow from using the Face Plate Auto-Builder for NS to automatically generate the NS-series PT screen for the Loop Controller based on the function block data that was created, up to displaying the screen on the CX-Designer (Screen Creation Support Software for NS-series PTs).

1 Setting the CSV Tags in Advance

CSV tags must be set in advance (i.e., before creating the NS-series PT screen for the Loop Controller). Right-click *001.Basic PID* in the tree in the window on the left and select **Tab Setting - CSV Tag** from the pop-up menu.

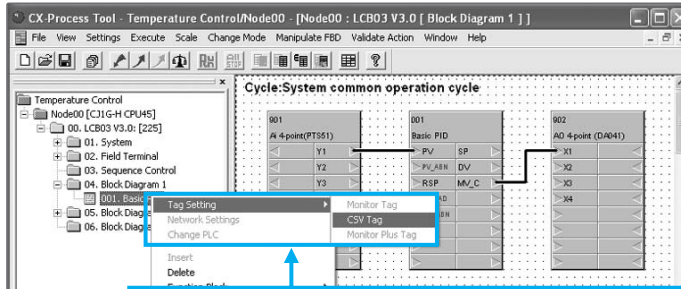

1-1. Right-click *001.Basic PID* and select **Tab Setting - CSV Tag**.

Input the *Scaling Upper Limit*, *Scaling Lower Limit*, *DP* (i.e., decimal point position), and *Unit*. Click the **OK** Button.

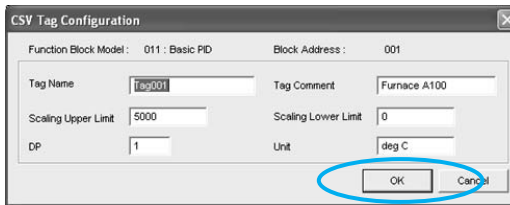

Click the **OK** Button.

2 Automatically Creating the NS-series PT Screen for the Loop Controller

Automatically create the NS-series PT screen for the Loop Controller. Start the Face Plate Auto-Builder for NS (NSFP) and the project for the CX-Designer will be generated automatically. Select **Execute - Create Tag File - Start NSFP** from the menu.

2-1. Start the Face Plate Auto-Builder for NS (NSFP) at the same time as creating tag files.

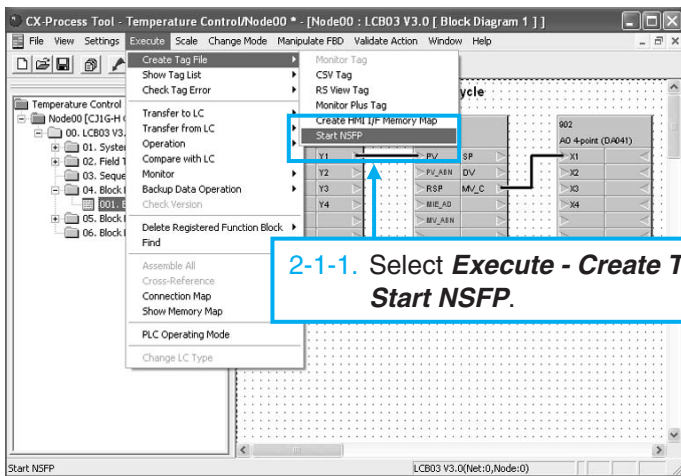

2-1-1. Select **Execute - Create Tag File - Start NSFP**.

2 Setting the CSV Tags in Advance/Automatically Creating the NS-series PT Screen for the Loop Controller

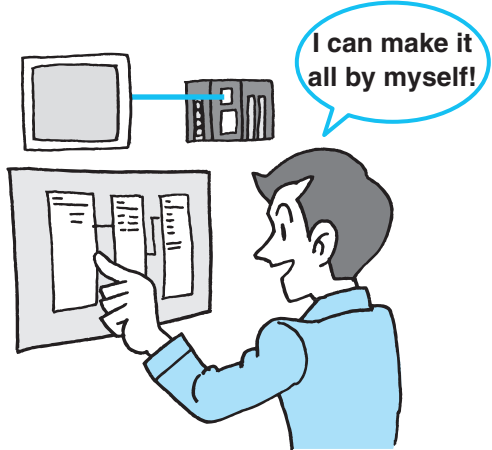

Click the **OK** Button.

2-2. Compile the tags.

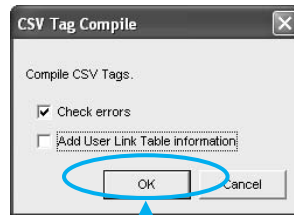

Click the **OK** Button.

Click the **OK** Button. The following window will be displayed.

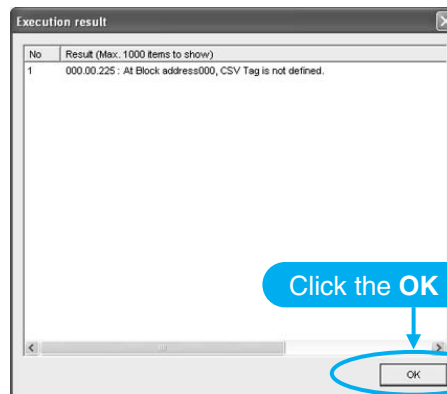

Click the **OK** Button.

Click the **OK** Button.

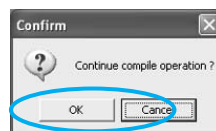

Click the **OK** Button.

Give the file a name (in this case, TagList) and click the **Save** Button.

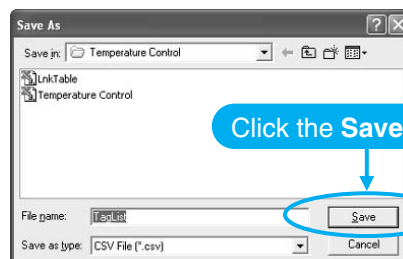

Click the **Save** Button.

Click the **OK** Button.

The Face Plate Auto-Builder for NS will start.

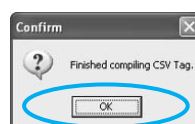

Click the **OK** Button.

Name the project and click the **Browse (2)** Button. Set the output folder, set *NS 12* for the *PT Model*, and click the **Build** Button.

2-3. The project for the CX-Designer will be automatically generated when the **Build** Button is clicked.

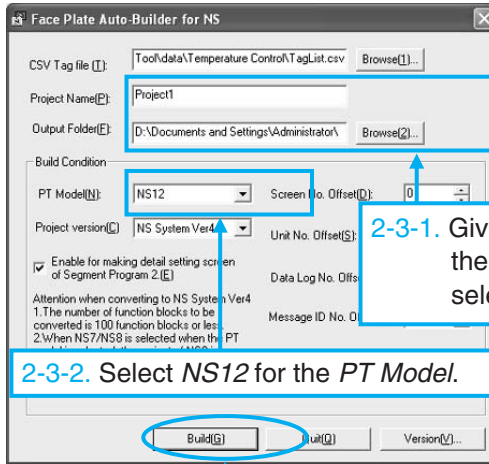

2-3-1. Give the project a name. Click the **Browse (2)** Button and select the folder to save in.

2-3-2. Select *NS12* for the *PT Model*.

Click the **Build** Button.

Register the host (i.e., host registration in CX-Designer project) so that the NS-series PT and the PLC can communicate. When the window is displayed, click the **Settings** Button.

2-4. Registering the host in the CX-Designer project.

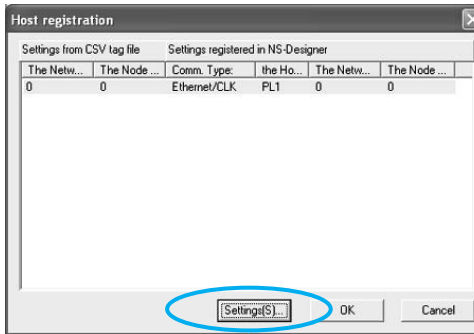

Click the **Settings** Button.

Select *Serial Port A* for *Comm. Type*.

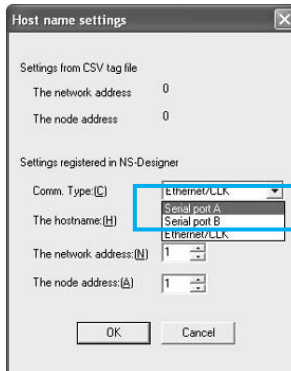

2-4-1. Select *Serial Port A*.

Click the **OK** Button.

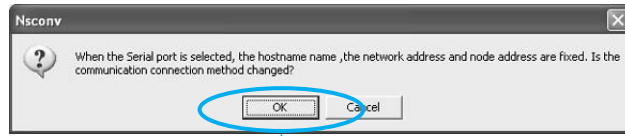

Click the **OK** Button.

Click the **OK** Button.

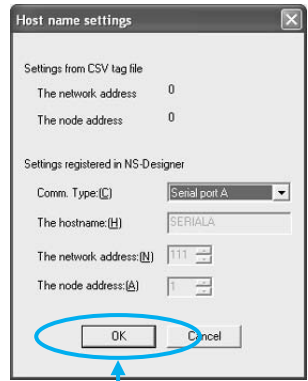

Click the **OK** Button.

Click the **OK** Button.

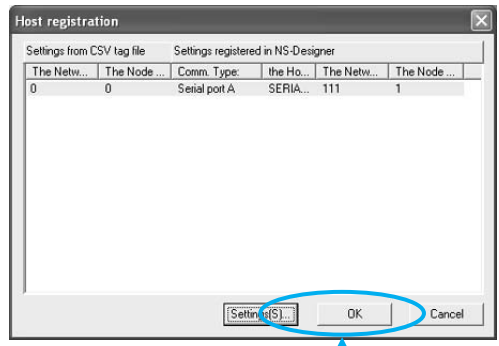

Click the **OK** Button.

A progress dialog box will be displayed.

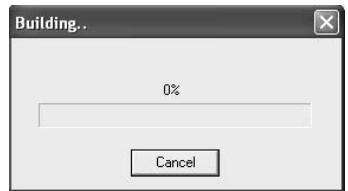

A message saying that building has been completed will be displayed. Click the **OK** Button.

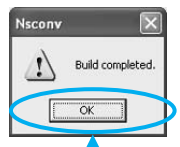

Click the **OK** Button.

3 Displaying the NS-series PT Screen for the Loop Controller

Display the NS-series PT screen for the Loop Controller.

Double-click the automatically created project file (with the name given above) for the CX-Designer. The CX-Designer will start.



3-1. Double-click the CX-Designer project file.

The generated faceplate can be checked by selecting items on the screen.

3-2. The screen for the Loop Controller is generated automatically.

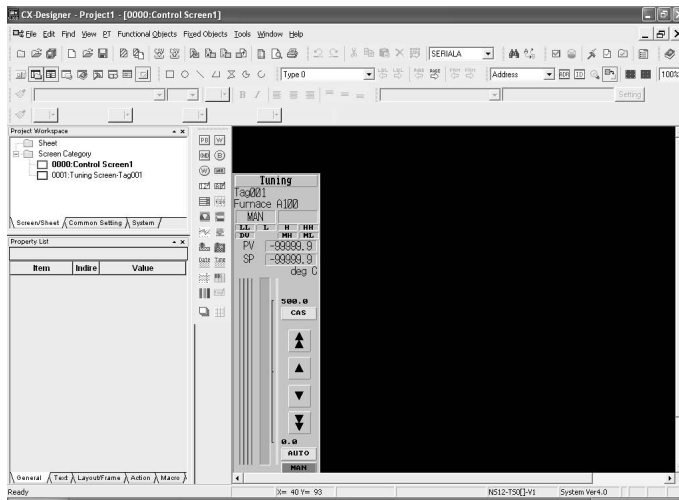

Reference Information

The trend screen that is created can be checked by selecting items on the screen.

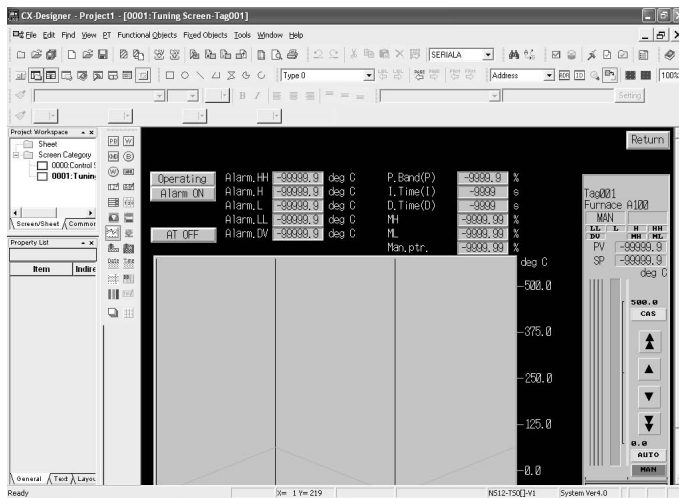



Useful Functions

Useful Functions

1 Viewing the Online Manual

The online manual is useful to find proper settings, such as for setting ITEMS in function blocks.

To view the online manual, double-click *04. Block Diagram 1* in the tree in the window on the left. A block diagram will be displayed. Next, right-click the function block you want to find information about (in this case, Isolated Ai 4-point Terminal). A menu will be displayed. Click **Function Block reference** at the bottom of the menu.

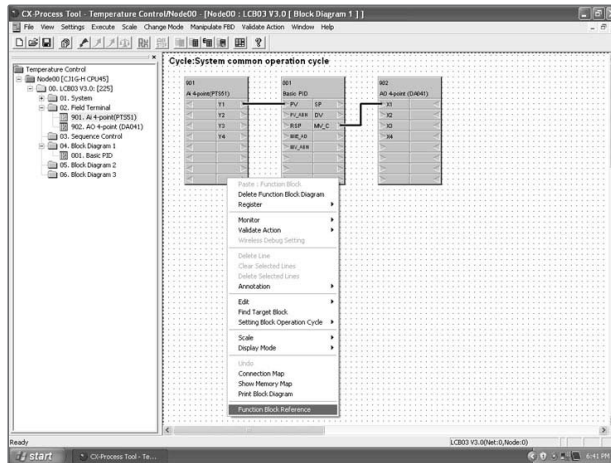

The online manual will open and the function block will be explained. This explanation may be useful for reference.

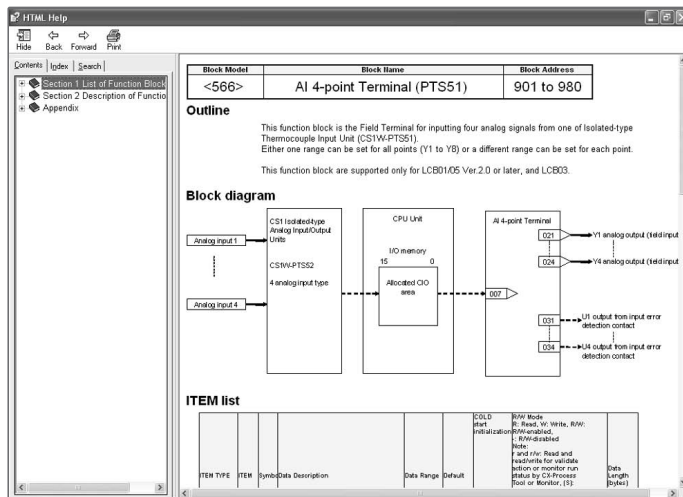

To close the window, click the **Close Button**  at the upper right of the window.

2 HMI Function

This function automatically assigns function block data (e.g., PV, SP, and MV) in order of function block address to addresses in the specified bank in the EM Area of the CPU Unit as a constant data conversion area.

The HMI function is set in the System Common Block (Block Model 000). By default, the refresh cycle in EM0 is set to 1 s. The blocks that are allocated are determined according to the block addresses given to the registered function blocks. For example, the block address will be 001 if the Basic PID Block is pasted first. A total of 40 words (fixed) are allocated for each block address: 20 words for send data from the Loop Controller to the CPU Unit memory (E00000 + block address x 20, i.e., E00020 to E00039 if the block number is 001) and 20 words for receive data from the CPU Unit memory to the Loop Controller (E15000 + block address x 20, i.e., E15020 to E15039 if the block number is 001).

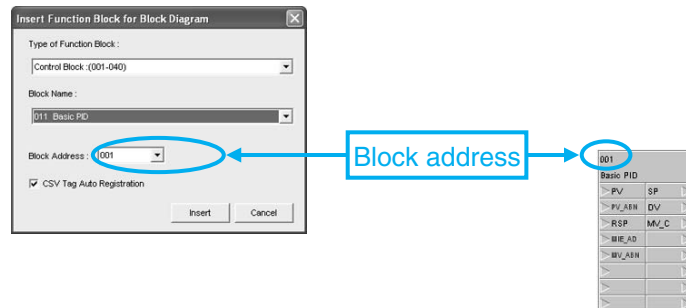

The ITEMS for which memory is allocated depends on the function block, but with the Basic PID Block, for example, ITEMS will be transferred as shown in the following figure.

Example: Basic PID (Block Model 011) (Offset from Beginning Word)

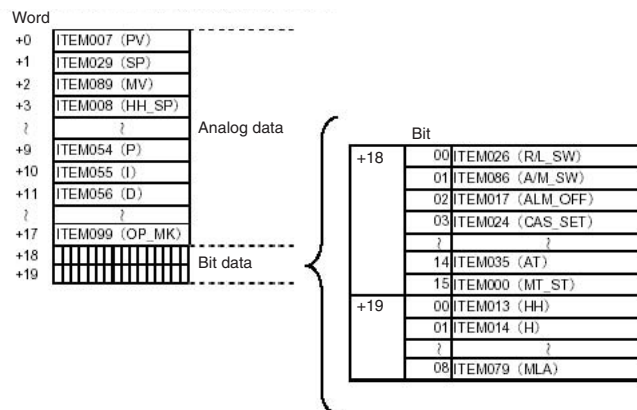

Allocated addresses can be output as a list in a CSV file by selecting **Execute - Create Tag File - Create HMI I/F Memory Map**.

3 User Link Tables

User link tables are used to exchange data between user-set I/O memory in the CPU Unit and function blocks in the Loop Controller.

Normally, Field Terminals are used for data exchange with I/O Units and the HMI function is used for data exchange with I/O memory for CPU Units. With these functions, however, the I/O memory addresses for the CPU Unit are automatically allocated. User link tables are useful for reading and writing data in the Loop Controller to user-set memory area addresses in the CPU Unit. For example, to read the remote set point (RSP) data from the DM Area in the CPU Unit's I/O memory, allocate addresses in the DM Area to a user link table and connect the table to the RSP of the PID Block. In the following figure, D100 is allocated to a user link table, and the table is connected to the RSP of the Basic PID Block.

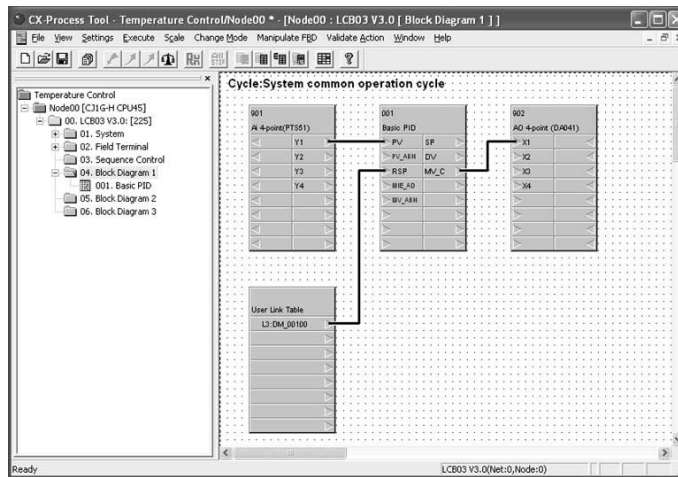

4 Connection Maps

Analog and contact information is connected to function blocks. To check the relationship of all I/O for a function block, use a connection map to display a relational diagram for input source ITEMS and output source ITEMS as a list.

To use connection maps, right-click the Basic PID Block on the function block diagram. The connection map can be used by selecting it from the menu.

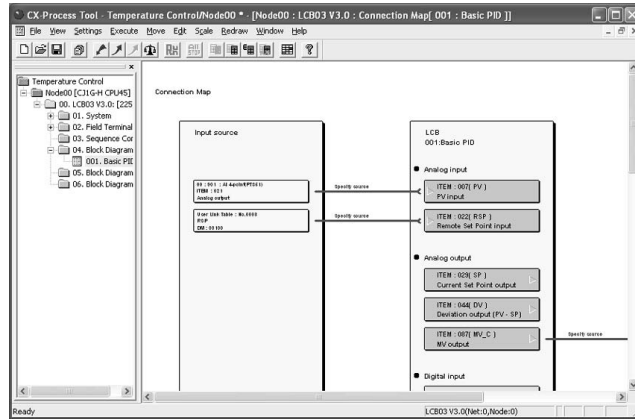

Warranty and Limitations of Liability

WARRANTY

OMRON's exclusive warranty is that the products are free from defects in materials and workmanship for a period of one year (or other period if specified) from date of sale by OMRON. OMRON MAKES NO WARRANTY OR REPRESENTATION, EXPRESS OR IMPLIED, REGARDING NON-INFRINGEMENT, MERCHANTABILITY, OR FITNESS FOR PARTICULAR PURPOSE OF THE PRODUCTS. ANY BUYER OR USER ACKNOWLEDGES THAT THE BUYER OR USER ALONE HAS DETERMINED THAT THE PRODUCTS WILL SUITABLY MEET THE REQUIREMENTS OF THEIR INTENDED USE. OMRON DISCLAIMS ALL OTHER WARRANTIES, EXPRESS OR IMPLIED.

LIMITATIONS OF LIABILITY

OMRON SHALL NOT BE RESPONSIBLE FOR SPECIAL, INDIRECT, OR CONSEQUENTIAL DAMAGES, LOSS OF PROFITS, OR COMMERCIAL LOSS IN ANY WAY CONNECTED WITH THE PRODUCTS, WHETHER SUCH CLAIM IS BASED ON CONTRACT, WARRANTY, NEGLIGENCE, OR STRICT LIABILITY.

In no event shall the responsibility of OMRON for any act exceed the individual price of the product on which liability is asserted.

IN NO EVENT SHALL OMRON BE RESPONSIBLE FOR WARRANTY, REPAIR, OR OTHER CLAIMS REGARDING THE PRODUCTS UNLESS OMRON'S ANALYSIS CONFIRMS THAT THE PRODUCTS WERE PROPERLY HANDLED, STORED, INSTALLED, AND MAINTAINED AND NOT SUBJECT TO CONTAMINATION, ABUSE, MISUSE, OR INAPPROPRIATE MODIFICATION OR REPAIR.

This catalog mainly provides information that is necessary for selecting suitable models, and does not contain precautions for correct use. Always read the precautions and other required information provided in product operation manuals before using the product.

- The application examples provided in this catalog are for reference only. Check functions and safety of the equipment before use.
- Never use the products for any application requiring special safety requirements, such as nuclear energy control systems, railroad systems, aviation systems, medical equipment, amusement machines, vehicles, safety equipment, or other application involving serious risk to life or property, without ensuring that the system as a whole has been designed to address the risks, and that the OMRON products are properly rated and installed for the intended use within the overall equipment or system.

Note: Do not use this document to operate the Unit.

Printed on 100%
Recycled Paper



OMRON Corporation Industrial Automation Company Control Devices Division H.Q.

Shiokoji Horikawa, Shimogyo-ku,
Kyoto, 600-8530 Japan
Tel: (81)75-344-7109
Fax: (81)75-344-7149

Regional Headquarters

OMRON EUROPE B.V.

Wegalaan 67-69, NL-2132 JD Hoofddorp
The Netherlands
Tel: (31)2356-81-300/
Fax: (31)2356-81-388

OMRON ELECTRONICS LLC

1 East Commerce Drive, Schaumburg,
IL 60173 U.S.A.
Tel: (1)847-843-7900/Fax: (1)847-843-8568

OMRON ASIA PACIFIC PTE. LTD.

83 Clemenceau Avenue,
#11-01, UE Square,
Singapore 239920
Tel: (65)6835-3011/Fax: (65)6835-2711

OMRON (CHINA) CO., LTD.

Room 2211, Bank of China Tower,
200 Yin Cheng Zhong Road,
PuDong New Area, Shanghai, 200120 China
Tel: (86)21-5037-2222/Fax: (86)21-5037-2200

Authorized Distributor:

Note: Specifications subject to change without notice.

Cat. No. R143-E1-01
Printed in Japan
0606-1M