

QX-870 Industrial Raster Scanner User Manual



Copyright and Disclaimer

Copyright ©2018
Omron Microscan Systems, Inc.
Tel: +1.425.226.5700 / 800.762.1149
Fax: +1.425.226.8250

All rights reserved. The information contained herein is proprietary and is provided solely for the purpose of allowing customers to operate and/or service Omron Microscan-manufactured equipment and is not to be released, reproduced, or used for any other purpose without written permission of Omron Microscan.

Throughout this manual, trademarked names might be used. We state herein that we are using the names to the benefit of the trademark owner, with no intention of infringement.

Disclaimer

The information and specifications described in this manual are subject to change without notice.

Latest Manual Version

For the latest version of this manual, see the Download Center on our web site at:
www.microscan.com.

Technical Support

For technical support, e-mail: helpdesk@microscan.com.

Warranty

For current warranty information, see: www.microscan.com/warranty.

Omron Microscan Systems, Inc.

United States Corporate Headquarters

+1.425.226.5700 / 800.762.1149

United States Northeast Technology Center

+1.603.598.8400 / 800.468.9503

European Headquarters

+31.172.423360

Asia Pacific Headquarters

+65.6846.1214

Table of Contents

Chapter 1	Quick Start	
	Step 1 Check Hardware	1-2
	Step 2 Connect the System	1-3
	Step 3 Position Scanner and Symbol	1-4
	Step 4 Install ESP	1-5
	Step 5 Select Model	1-6
	Step 6 Connect	1-7
	Step 7 Test Read Rate	1-10
	Step 8 Configure the Scanner	1-11
	Step 9 Save Changes in ESP	1-12
Chapter 2	Using ESP	
	EZ Mode	2-2
	App Mode	2-3
	Menu Toolbar	2-4
	Navigating in ESP	2-15
	Send/Receive Options	2-16
Chapter 3	Hardware Integration	
	Cordsets	3-2
	QX-870 and QX-1 Connectors and Pinouts	3-3
	Power and Trigger Switching	3-8
	Port Routing	3-9
	Application Examples	3-10
Chapter 4	Scanner Setup	
	Calibration	4-2
	Configuration Database	4-4
	Ordered Output	4-6
	Output Format	4-10
Chapter 5	Scanner Parameters	
	Communication	5-2
	Read Cycle	5-43
	Symbologies	5-70
	I/O Parameters	5-107
	Matchcode	5-168
	Diagnostics	5-177
Chapter 6	Terminal	
	Terminal Window	6-2
	Find	6-3
	Send	6-4
	Macros	6-5
	Terminal Window Menus	6-6

Table of Contents

Chapter 7	Utilities	
	Serial Utility Commands	7-2
	Read Rate	7-4
	Counters	7-6
	Device Control	7-8
	Differences from Default	7-9
	Master Database	7-10
	Digital Bar Code	7-16
	Firmware	7-17
	Default/Reset/Save	7-20
	Scanner Status Requests	7-22
	Other Serial Utility Commands	7-23
	Embedded Menus	7-28
Appendices		
	Appendix A General Specifications	A-2
	Appendix B Electrical Specifications	A-6
	Appendix C Ground and Shield Considerations	A-15
	Appendix D Flying Lead Cordset Pinouts	A-17
	Appendix E Updated Pin Assignment of QX Connector T	A-18
	Appendix F Serial Commands	A-20
	Appendix G Protocol Commands	A-85
	Appendix H ASCII Table	A-94
	Appendix I Configuring Ethernet TCP/IP	A-95
	Appendix J Using EtherNet/IP	A-98
	Appendix K Operating EtherNet/IP Serial Gateway Data Fields	A-107
	Appendix L Allen-Bradley Version 16 PLC Setup	A-109
	Appendix M Allen-Bradley Version 20 PLC Setup	A-123
	Appendix N EIPScan Setup	A-130
	Appendix L Interface Standards	A-136
	Appendix M Glossary of Terms	A-137

About the QX-870 Industrial Raster Scanner

The key features of the QX-870 Industrial Raster Scanner are:

- X-Mode™ symbol reconstruction and aggressive decode algorithm
- Ethernet TCP/IP and EtherNet/IP™
- Ultra-high-performance processing
- Real-time decoding
- Green Flash performance indicator
- LED array for performance, communication, and I/O user feedback
- EZ Button for setup and testing
- Compact size for easy integration into a wide variety of applications

Scanner Communication

There are three ways to configure and test the QX-870:

- Omron Microscan's Windows-based **ESP Software** (Easy Setup Program), which offers point-and-click ease of use and visual responses to user adjustments.
- Serial commands, such as **<K100,1>**, that can be sent from **ESP's Terminal** or another terminal program.
- The **EZ Button** on the side of the scanner.

"EtherNet/IP" is a trademark of the Open DeviceNet Vendors Association.

Warning and Caution Summary

This equipment has been tested and found to comply with the limits for a Class A digital device, pursuant to part 15 of the FCC Rules. These limits are designed to provide reasonable protection against harmful interference in a residential installation. This equipment generates, uses, and can radiate radio frequency energy, and, if not installed and used in accordance with the instructions, may cause harmful interference to radio communication. However, there is no guarantee that interference will not occur in a particular installation. If this equipment does cause harmful interference to radio or television reception, which can be determined by turning the equipment off and on, the user is encouraged to try to correct the interference by one or more of the following measures:

- Reorient or relocate the receiving antenna;
- Increase the separation between the equipment and receiver;
- Connect the equipment into an outlet on a circuit different from that to which the receiver is connected;
- Consult the dealer or an experienced radio/TV technician for help.

For connection to a UL-listed direct plug-in power unit marked Class II and rated 10 to 28 VDC at 5 watts or greater.

European models must use a similarly rated Class I or Class II power supply that is certified to comply with standard for safety EN 60950.

CAUTION: Use of controls or adjustments or performance of procedures other than those specified herein may result in hazardous radiation exposure.

There are no user-serviceable parts in the scanner. Opening the scanner voids the Omron Microscan Systems, Inc. warranty and could expose the user to laser diode power of up to 7mW.

The laser beam can be harmful to eyesight. Avoid eye contact with the laser beam. Never point the beam at other people, or in a direction where people may be passing.

CAUTION: LASER RADIATION - DO NOT STARE INTO BEAM - CLASS 2 LASER PRODUCT; 655nm, 1.75mW, 40~186 μ S.

DANGER: (Invisible) Laser Radiation when open (and interlock defeated). AVOID DIRECT EXPOSURE TO BEAM.

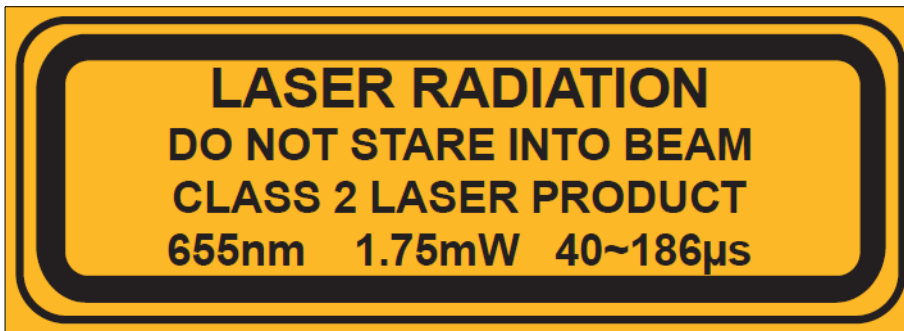

Warning and Caution Summary (cont.)

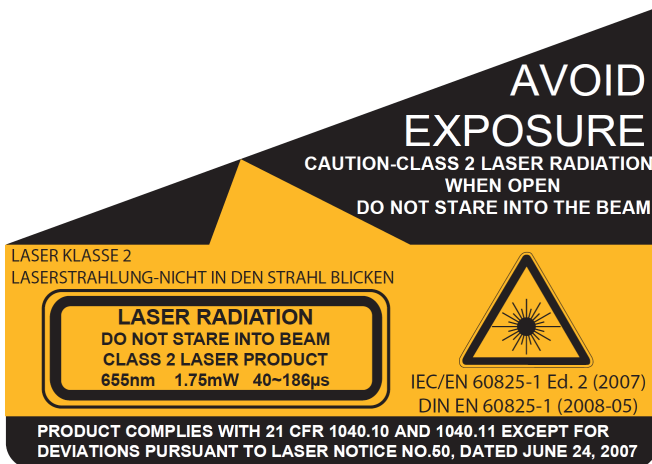

- Wavelength: 655 nm
- Beam Divergence: 0.4mrad (typ.)
- Pulse Duration: 40~186µs
- Maximum Power: 1.75mW
- Location of the QX-870's laser aperture:



Laser Aperture

AVOID EXPOSURE –
Laser Radiation is emitted
from this aperture.

CAUTION: Use of controls or adjustments or performance of procedures other than those specified herein may result in hazardous radiation exposure.

IMPORTANT: The QX-870 is intended for connection to a UL-listed direct plug-in power unit marked Class 2 and rated 5 VDC at 3.5 Watts, or greater if using electrical accessories.

European models must use a similarly rated Class 1 or Class 2 power supply that is certified to comply with standard for safety EN 60950.

Warning and Caution Summary (cont.)

Warning Label Placement

These labels are located on the QX-870 Industrial Raster Scanner:

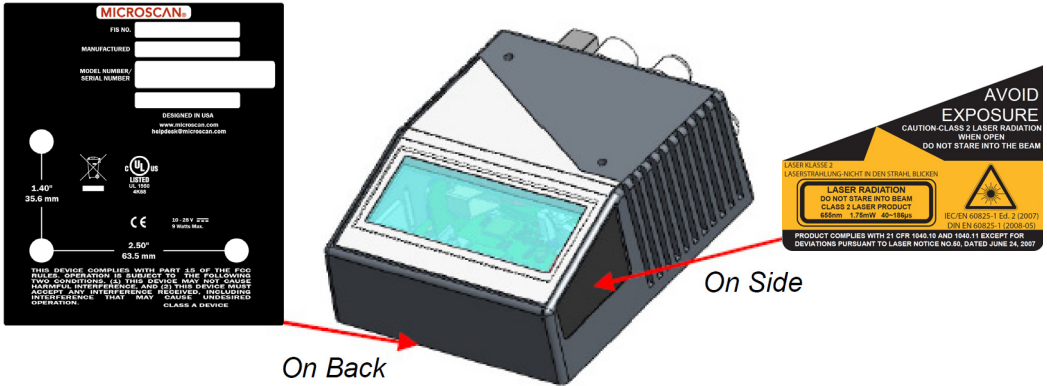

Statements of Compliance



The QX-870 has been tested for compliance with FCC (Federal Communications Commission) regulations and has been found to conform to all applicable FCC Rules and Regulations.

To comply with FCC RF exposure compliance requirements, this device must not be co-located or operate in conjunction with any other antenna or transmitter.

Changes or modifications not expressly approved by the party responsible for compliance could void the user's authority to operate the equipment.



The QX-870 has been tested for compliance with CE (Conformité Européenne) standards and guidelines, and has been found to conform to applicable CE standards, specifically the following requirements:

Heavy Industrial: EN 61000-6-2:2005

Radiated Emissions: EN 55022:2006 Class A 30-1000 MHz

Conducted Emissions: EN 55022:2006 Class A .15-30 MHz

The QX-870 has been tested by an independent electromagnetic compatibility laboratory in accordance with the applicable specifications and instructions.



Manufacturer: Omron Microscan Systems, Inc., 700 SW 39th St., Renton, WA 98057, USA

Производитель: «Омрон Майкроскан Системс Инк., США, Рентон, штат Вашингтон 98057, 700 SW 39th Street

Representative: Omron Electronics Limited Liability Company, 125040, Russian, Moscow, Ulitsa Pravdy, 26. OGRN 10677746976582

Представитель: Общество с ограниченной ответственностью "Омрон Электроникс", 125040, Российская Федерация, город Москва, улица Правды, дом 26, ОГРН 10677746976582

Date of Manufacture: The first two digits of the serial number are the two-digit year of manufacture, or the year of manufacture +20 for serial numbers starting with 3.

Дата изготовления: первые две цифры серийного номера являются двумя последними цифрами года изготовления + 20 для серийных номеров, начинающихся с 3.

Statement of RoHS Compliance

All Omron Microscan readers with a 'G' suffix in the FIS number are RoHS-Compliant. All compliant readers were converted prior to March 1, 2007. All standard accessories in the Omron Microscan Product Pricing Catalog are RoHS-Compliant except 20-500013-01 and 98-000039-02. These products meet all the requirements of "Directive 2002/95/EC" European Parliament and the Council of the European Union for RoHS compliance. In accordance with the latest requirements, our RoHS-Compliant products and packaging do not contain intentionally added Deca-BDE, Perfluorooctanes (PFOS) or Perfluorooctanic Acid (PFOA) compounds above the maximum trace levels. To view the document stating these requirements, please visit:

<http://eur-lex.europa.eu/LexUriServ/LexUriServ.do?uri=CELEX:32002L0095:EN:HTML>

and

<http://eur-lex.europa.eu/LexUriServ/LexUriServ.do?uri=OJ:L:2006:372:0032:0034:EN:PDF>

Please contact your sales manager for a complete list of Omron Microscan's RoHS-Compliant products.

This declaration is based upon information obtained from sources which Omron Microscan believes to be reliable, and from random sample testing; however, the information is provided without any representation of warranty, expressed or implied, regarding accuracy or correctness. Omron Microscan does not specifically run any analysis on our raw materials or end product to measure for these substances.

The information provided in this certification notice is correct to the best of Omron Microscan's knowledge at the date of publication. This notice is not to be considered a warranty or quality specification. Users are responsible for determining the applicability of any RoHS legislation or regulations based on their individual use of the product.

In regards to "RoHS Directive 2011_65_EU" Omron Microscan produces Monitoring and Control Instruments as well as Industrial Monitoring & Control Instruments as defined within the directive. Omron Microscan has developed and is implementing a RoHS2 compliance plan with the intention of bringing all active products listed in our current marketing literature within full compliance as per the directive deadlines.

Key milestones for the transition plan are as follows:

- Complete internal product audit by July 2014.
- Initial "Monitoring and Control Instruments" RoHS2 compliant products available by December 2014
- Initial "Industrial Monitoring & Control Instruments" RoHS2 compliant products available by July 2015
- All new products introduced in 2015 are expected to be WEEE & RoHS2 compliant.

Omron Microscan will mark the products with the 'CE' marking that complies with the RoHS2 process to acquire 'CE' certification per the example given: Example >> Machinery directive + EMC directive + RoHS2 = Declaration of Conformity.

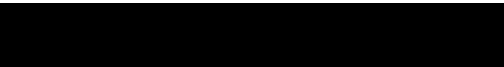

1 Quick Start

Contents

Step 1 Check Hardware.....	1-2
Step 2 Connect the System	1-3
Step 3 Position Scanner and Symbol	1-4
Step 4 Install ESP	1-5
Step 5 Select Model.....	1-6
Step 6 Connect.....	1-7
Step 7 Test Read Rate	1-10
Step 8 Configure the Scanner.....	1-11
Step 9 Save Changes in ESP	1-12

This section explains how to set up and test the QX-870 quickly using **ESP** (Easy Setup Program). Detailed setup information for installing the scanner into an application can be found in subsequent sections.

Step 1 — Check Hardware

Item	Description	Part Number
1	QX-870 Industrial Raster Scanner	FIS-0870-XXXXG
2	QX-1 Interface Device	98-000103-02
3	QX Cordset, Common, M12 12-pin Socket to M12 12-pin Plug, 1 m	61-000162-02
4	QX Cordset, Host, Serial, M12 12-pin Plug to DB9 Socket, 1 m	61-000152-02
5	QX Cordset, Host, Serial, M12 12-pin Socket to DB9 Socket, 1 m	61-000153-02
6	QX Power Supply, 100-240VAC, +24VDC, M12 12-pin Socket	97-000012-01
7	QX Cordset, Host, Ethernet, M12 8-pin Plug to RJ45, 1 m	61-000160-02
8	QX Photo Sensor, M12 4-pin Plug, NPN, Dark On, 2 m	99-000020-02

Important: This product is intended to be supplied by a Listed power supply marked “Class 2” or “LPS” and rated from 10 to 28 VDC, 9.0 Watts.

Note: The QX-870 does not require an Ethernet crossover cordset, because the scanner itself performs automatic internal crossover (transmit-to-receive switching). Omron Microscan offers a standard straight-through (un-crossed) Ethernet cordset (61-000160-02).

Important: Do not attempt to power more than four scanners with a single power supply in a daisy chain configuration. Add a QX-1 and one power supply for every four additional scanners in the daisy chain.

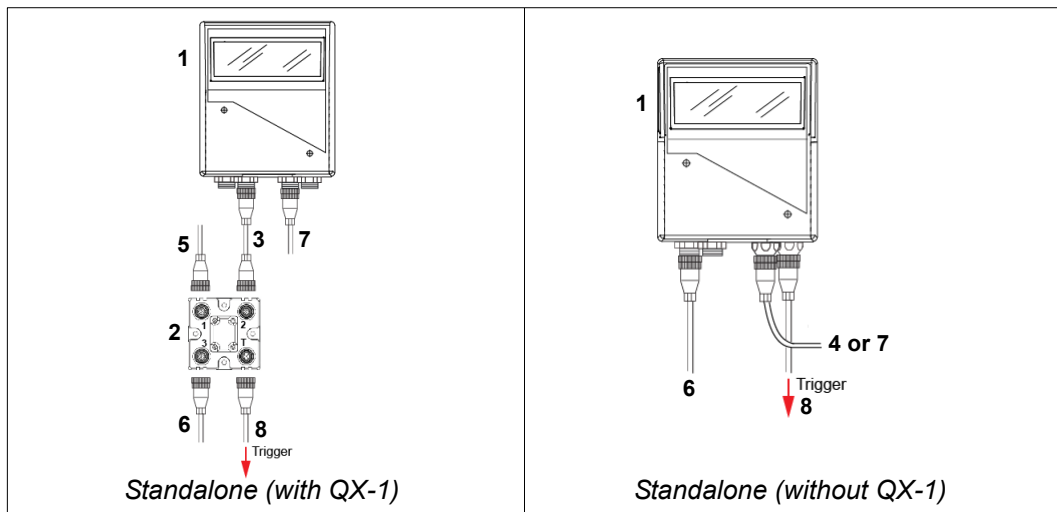

Hardware Required

Caution: Be sure that all connections are secure **BEFORE** applying power to the system. Always power down **BEFORE** disconnecting any cables.

Step 2 — Connect the System

Important: If you are connecting Ultra-Lock cordsets to the QX-870 and QX-1, align the pins first and then push the connector into place. Do not twist the connectors, as this will bend the pins.

Important: Do not attempt to power more than four scanners with a single power supply in a daisy chain configuration. Add a QX-1 and one power supply for every four additional scanner in the daisy chain.

Note: The configuration instructions below are for simple, direct connections to an RS-232 or Ethernet host. The QX-1 can be added to RS-232 or Ethernet configurations in which greater flexibility and complexity are required. The first diagram in Step 1 shows a standalone configuration that includes the QX-1.

RS-232 Standalone (without QX-1)

- Connect the Serial Communication Cable from “B” on the QX-870 to the host.
- Connect the photo sensor (if required) to “T” on the QX-870.
- Connect the power supply to “P/M” on the QX-870.
- Plug in the power supply.

Ethernet Standalone (without QX-1)

Important: Configure Ethernet-enabled readers off-line and then connect to network when ready for dynamic use.

Note: The QX-870 does not require an Ethernet crossover cordset, because the scanner itself performs automatic internal crossover (transmit-to-receive switching). Omron Microscan offers a standard straight-through (un-crossed) Ethernet cordset (61-000160-02).

- Connect the Ethernet Communication Cable from “B” on the QX-870 to the host network.
- Connect the power supply to “P/M” on the QX-870.
- Plug in the power supply.

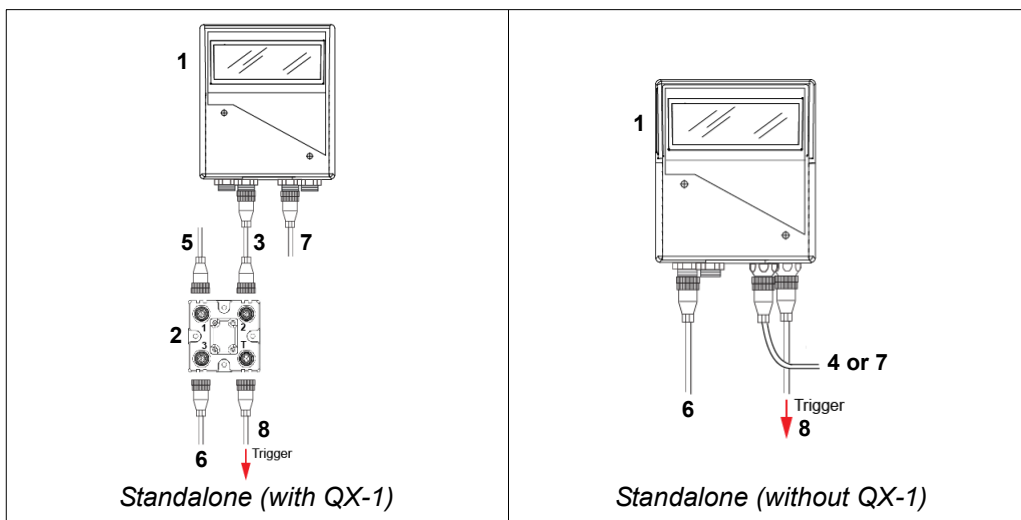

Step 3 — Position Scanner and Symbol

- Place a test symbol in a location with as little ambient light as possible.
- Position the scanner at the focal distance used in the application.
- Align the test symbol with the scanner's field of view.
- Tip the scanner relative to the test symbol to avoid glare from specular reflection.

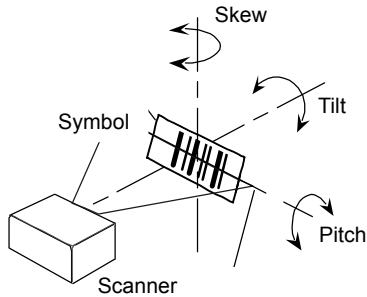

**Maximum
skew, tilt,
and pitch:
 $\pm 30^\circ$**

Step 4 — Install ESP

ESP Software can be found on the Omron Microscan Tools Drive that is packaged with the QX-870.

1. Follow the prompts to install ESP from the Tools Drive.
2. Click on the ESP icon to run the program.



Note: ESP can also be installed from the **Download Center** at www.microscan.com.

Minimum System Requirements

- 233 MHz Pentium PC
- Windows 8, 7, Vista, or XP operating system (32-bit or 64-bit)
- Internet Explorer 6.0 or higher
- 128 MB RAM or greater
- 160 MB free disk space
- 800 x 600 256 color display (1024 x 768 32-bit color recommended)

Step 5 — Select Model

When **ESP** is opened, the following menu will appear:

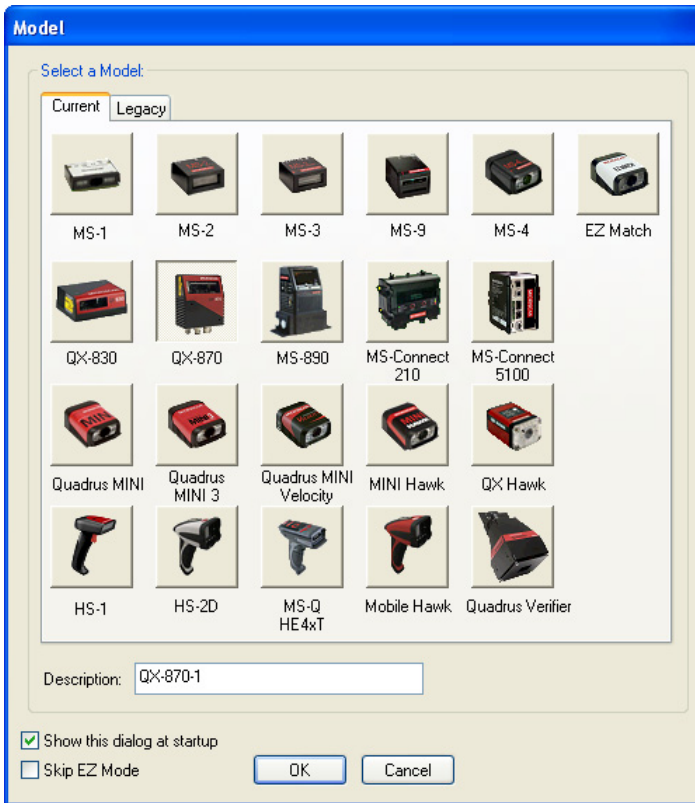

1. Click the button showing the QX-870.
2. Click **OK**.
Note: The QX-870 can also be selected by double-clicking the button showing the QX-870.
3. Click **Yes** when this dialog appears:

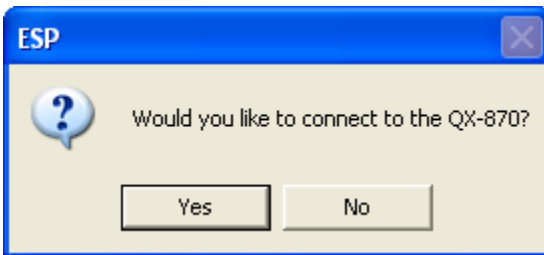

Note: To select another model later, click the **Switch Model** button near the top of the screen or use **Model > New Model** in the menu toolbar.

Step 6 — Connect

Connection Wizard

To connect using the Connection Wizard:

- Click **Connect** on the menu toolbar, and then select **Connection Wizard**.
- Select **RS-232** or **Ethernet** to activate the appropriate display.
- Configure RS-232 or Ethernet settings as required by the application, and click **Connect**.

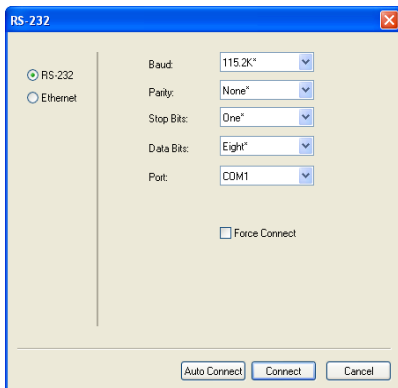

RS-232 Connection Wizard

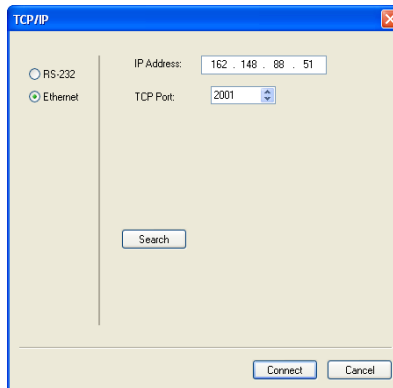

Ethernet Connection Wizard

- When a connection is established, the green indicator in the status bar at the bottom right of the screen will be visible:

QX-870-1 QX-870 **CONNECTED** Point-to-Point COM1 115.2K : N : 8 : 1

Important: The scanner is in **Continuous Read Mode** by default. For best connection results, be sure that no decodable symbols are within the scanner's field of view while attempting to connect.

Connect (cont.)

Step 6 — Connect (cont.)

Ethernet TCP/IP

Once the QX-870 is connected, incoming symbol data can be displayed in the **Terminal**, as shown below.

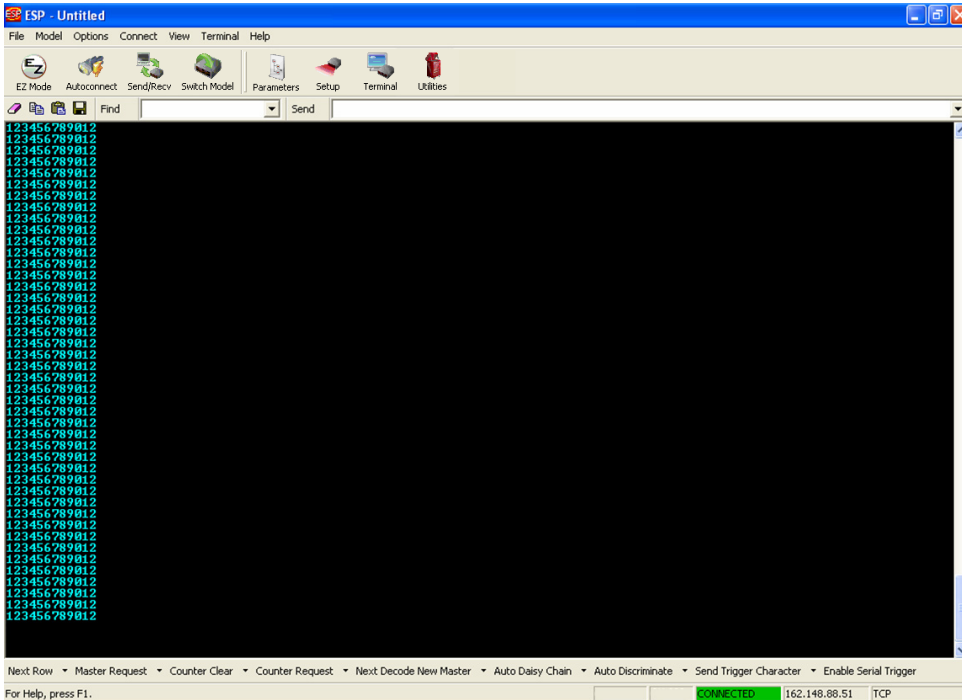

Step 7 — Test Read Rate

Read Rate indicates the number or percentage of successful decodes per second achieved by the scanner.

1. Click the **Test** button in ESP's **EZ Mode** to start the Read Rate test.

Symbol data and read rate percentage information should appear in the **Symbol Information** table in the bottom portion of the view. The Read Rate LEDs on the side of the QX-870 will indicate the percentage of successful decodes per second.

2. Click **Stop** to end the Read Rate test.

Note: Read Rate can also be tested using the **Read Rate** interface in **Utilities**.

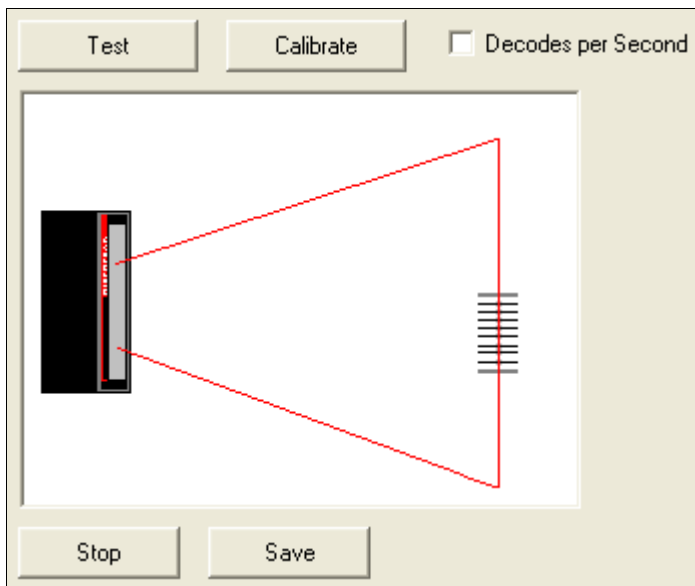

Step 8 — Configure the Scanner

Click the **App Mode** button to make configuration changes to the scanner.

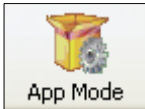

The following modes are accessible by clicking the buttons at the top of the screen:



- Click the **EZ Mode** button to return to EZ Mode.
- Click the **Autoconnect** button to establish communication.
- Click the **Send/Recv** button to send or receive commands.
- Click the **Switch Model** button to open the model menu, or to return to a previous model.
- Click the **Parameters** button to show the tabbed tree control views.
- Click the **Setup** button to show the tabbed interface views.
- Click the **Terminal** button to display decoded symbol data and to send serial commands.
- Click the **Utilities** button to access Read Rate, Counters, Device Control, Differences from Default, Master Database, Digital Bar Code, and Firmware.

For further details, see **Omron Microscan ESP Help** in the dropdown Help menu.

Step 9 — Save Changes in ESP

To make changes to a configuration setting:

Parameters	ESP Values
[-] Communications	
[+] RS232 A	
[+] RS232 B	Enabled
[+] RS422	Disabled
[+] Ethernet	Enabled
[+] Protocol Selection	Point-to-Point
[+] External Data Routing	Disabled
[+] Array Communication Modes	Disabled
[-] Preamble	Disabled*
... Preamble Characters	Disabled*
[+] Postamble	Enabled

1. Left-click on the + to expand the desired tree.

2. Double-click on the desired parameter and click once in the selection box to view options.

3. Place the cursor in the selection box, scroll down to the setting to be changed, and click once on the setting.

4. Left-click again on the open screen to complete the selection.

5. Right-click on the open screen and select **Save to Reader** to implement the command in the scanner.

Saving Options

- **Send, No Save.** Changes will be lost when power is re-applied to the scanner.
- **Send and Save.** This activates all changes in current memory *and* saves to the scanner for power-on.

Save Changes in ESP

2 Using ESP

Contents

EZ Mode.....	2-2
App Mode.....	2-3
Menu Toolbar.....	2-4
Navigating in ESP.....	2-15
Send/Receive Options.....	2-16

This section explains the basic structure and elements of **ESP** (Easy Setup Program).

When **ESP** is opened, unless otherwise specified in **ESP Preferences**, the **EZ Mode** view will appear. **App Mode** contains several configuration menus (**Communication**, **Read Cycle**, **Symbologies**, **I/O Parameters**, **Matchcode**, and **Diagnostics**), a **Setup** interface, a **Terminal** interface, and a **Utilities** interface.

ESP can be used to configure the QX-870 in three different ways:

- **Graphic User Interfaces:** Scanner settings can be configured using such point-and-click tools as buttons, spin boxes, check boxes, and drag-and-drop functions.
- **Tree Controls:** Each configuration menu contains a list of all option settings that pertain to that specific area of scanner operation. For example, the **Read Cycle** menu shows a **Laser Setup** command, and then a list of the parameters **Laser On/Off**, **Laser Framing Status**, **Laser On Position**, **Laser Off Position**, and **Laser Power**. Each parameter can be configured using dropdown menus or fields where characters can be entered.
- **Terminal:** **ESP's Terminal** allows the user to send serial configuration and utility commands directly to the scanner by typing them in the provided field.

Information about using specific commands in **ESP** is provided in subsequent sections.

For **ESP** system requirements, see [Minimum System Requirements](#) in Chapter 1, [Quick Start](#).

EZ Mode

EZ Mode allows the user to test read rate and calibrate the scanner. After connecting to the scanner, the **EZ Mode** view will appear. On-screen instructions assist the user with positioning, testing, and calibration.

Test

Click the **Test** button to start the read rate test for a quick indication of the scanner's read capabilities and the limits of the application. When **Decodes per Second** is unchecked, the test will count the percentage of decodes relative to the number of actual scans. Click **Stop** to end the test.

Calibrate

The calibration routine that will optimize the scanner by comparing Read Rates at various camera and image processing settings.

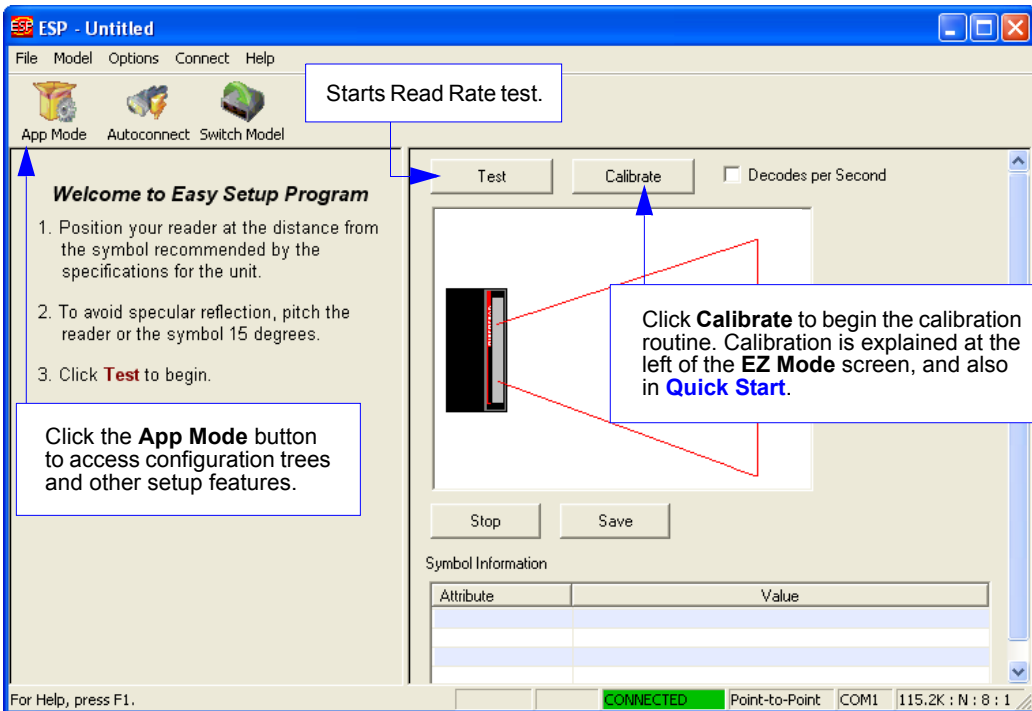

App Mode

From **EZ Mode**, click on the **App Mode** button to access the tabbed tree controls in **Parameters**, the intuitive user interfaces in **Setup**, the **Terminal** interface, and the **Utilities** interface.

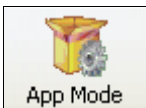

Note: The **App Mode** and **EZ Mode** buttons appear in the same position to allow easy switching between these primary modes.

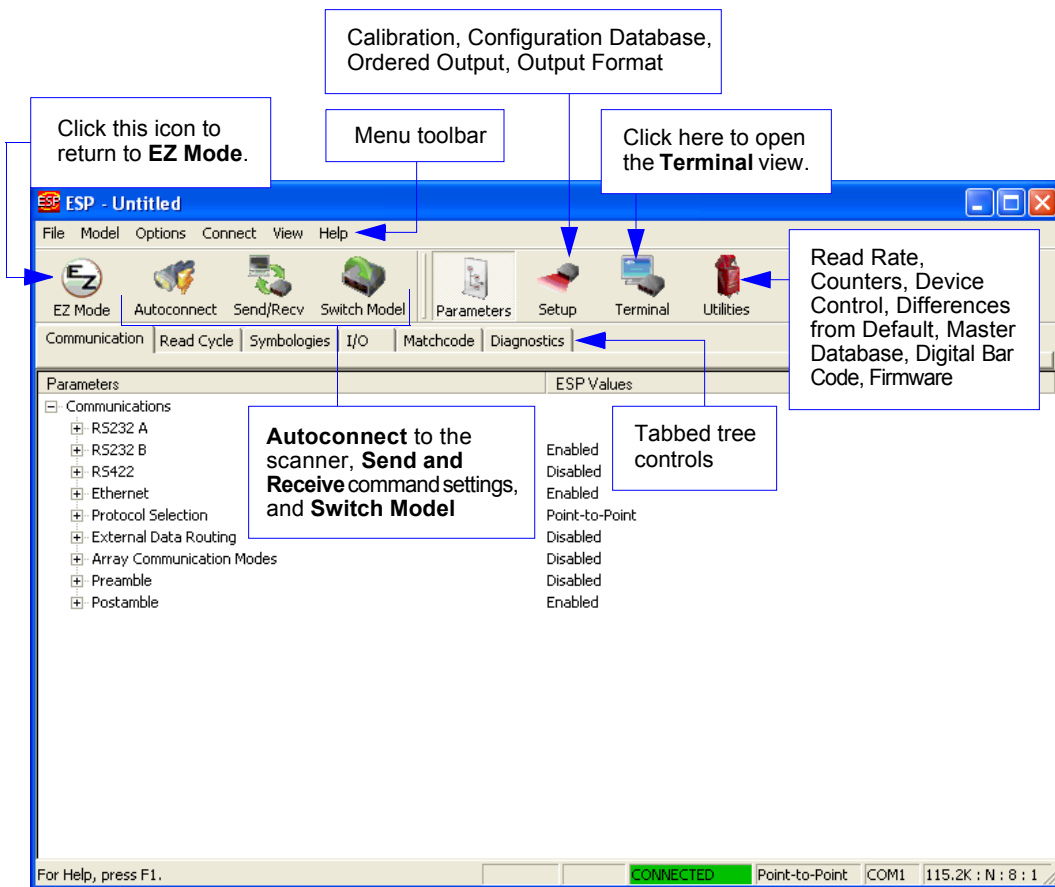

Menu Toolbar

File

New

Whenever **New** is selected, the default configuration of **ESP** is loaded.

Open/Save

When **Save** or **Save As** is selected, the **ESP** configuration is saved to the host computer's hard drive and available whenever the same file is selected under **Open**.

Important: When configuration changes are saved to the hard drive, these changes are not automatically saved to the scanner. The illustration below shows how settings can be saved and received between **ESP** and the scanner, and **ESP** and the host hard drive.

File	
New	Ctrl+N
Open...	Ctrl+O
Save	Ctrl+S
Save As...	
Print...	Ctrl+P
Import...	
Export...	
Recent File	
Exit	

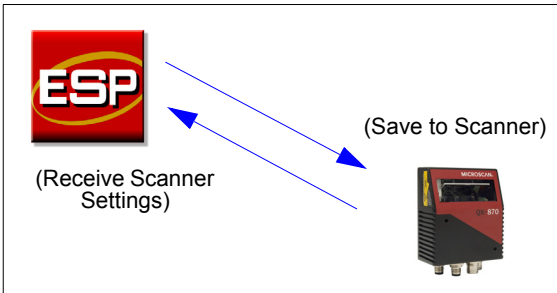

Import/Export

Import converts the ASCII settings from a text file to **ESP** configuration settings.

Export converts the active **ESP** configuration settings to an ASCII text file.

Model

The **Model** dropdown menu shows a list of recent scanners that have been used with ESP. When a different model is chosen, the connection to the present model is terminated.

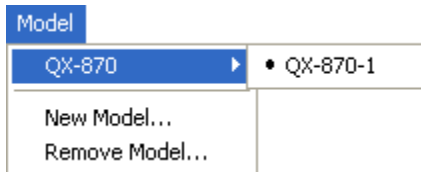

To connect to another model, select **New Model**, choose a new model from the **pop-up menu** that appears, and click **OK**.

Note: When an **ESP** file is saved, the settings of all the models defined in that file are saved.

Options

The **Options** menu allows the user to save memos and set up **ESP Preferences**.

Note: Preferences will be saved and loaded into **ESP** whenever **ESP** is opened next, whether or not the **ESP** file is saved.

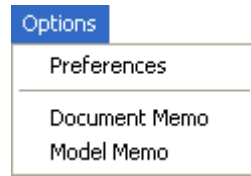

Preferences > General Tab

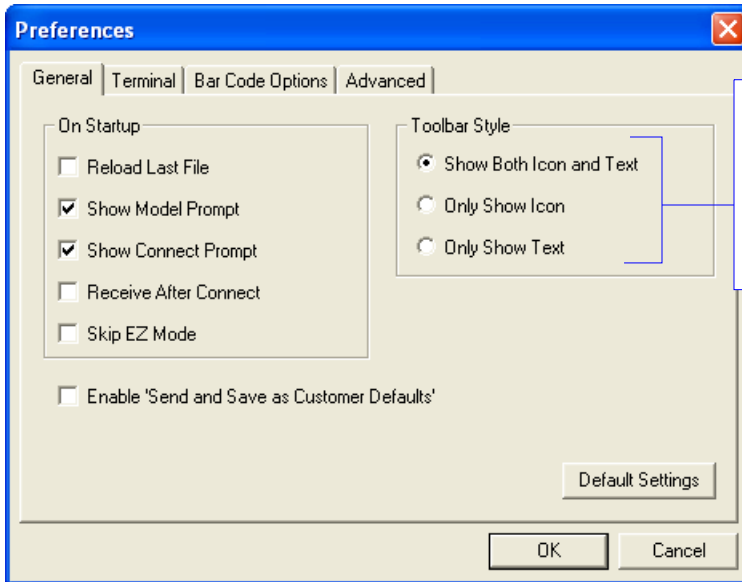

The **Toolbar Style** options allow the user to determine how **ESP** will display the mode options in the two rows at the top of the screen.

Reload Last File

At startup, reloads the last file saved to the host computer's hard drive.

Show Model Prompt

At startup, shows the model menu displaying all supported scanners.

Show Connect Prompt

At startup, displays the **Would you like to connect to the QX-870?** prompt.

Receive After Connect

At startup, loads the scanner's settings into **ESP**. (This is not recommended if **ESP** settings are needed for future use.)

Skip EZ Mode

At startup, skips **EZ Mode** and opens directly in **App Mode**.

Enable 'Send and Save as Customer Defaults'

At startup, enables the **Send and Save as Customer Defaults** option in the **Send/Recv** command.

Preferences > Terminal Tab

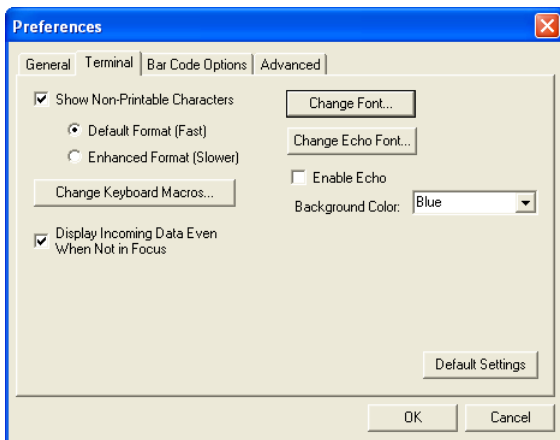

Show Non-Printable Characters

When **Show Non-Printable Characters** is enabled, characters such as “CRLF” will be displayed in the Terminal window. When **Enhanced Format** is checked, the characters are displayed with more detailed formatting.

Change Keyboard Macros

Clicking the **Change Keyboard Macros** button brings up the **Function Keys** dialog. In this dialog, select the desired function key and then enter the macro keystrokes in the associated key map. For example, to make **Ctrl-F2** the keystroke to send a trigger character, select **F2**, then in the **Ctrl** row, enter **<trigger character>** and click **OK**. Then whenever the **Ctrl-F2** keystroke is pressed, the trigger character will start the read cycle.

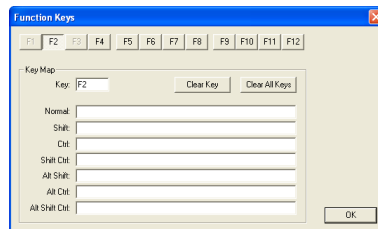

Note: The **F1** key is reserved for opening **ESP Help** and the **F3** key is reserved for the **Find Next** function.

Change Font

Allows the user to modify the font used for decode data received from the scanner on the Terminal.

Change Echo Font

Allows the user to modify the font used for command characters typed into the Terminal.

Enable Echo

Allows the user to enter command characters in Terminal.

Display Incoming Data Even When Not in Focus

When **Display Incoming Data Even When Not in Focus** is enabled, data from the scanner will continue to appear in the Terminal even when **ESP** is not the top window.

Preferences > Bar Code Options Tab

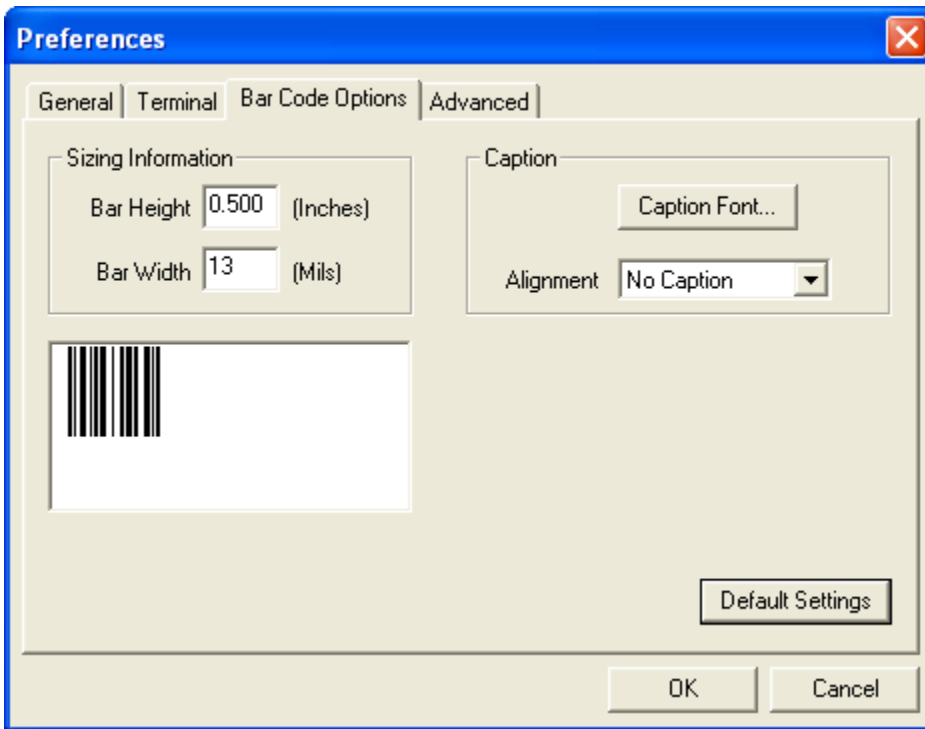

Sizing Information

Sets the bar height (in inches) and bar width (in **mils**, or thousandths of an inch) of user-created symbols.

Example: A bar width of 13 mils is 0.013 inches.

Caption

Allows the user to define a caption for the symbol, and to determine the alignment of the caption in relation to the symbol.

Preferences > Advanced Tab

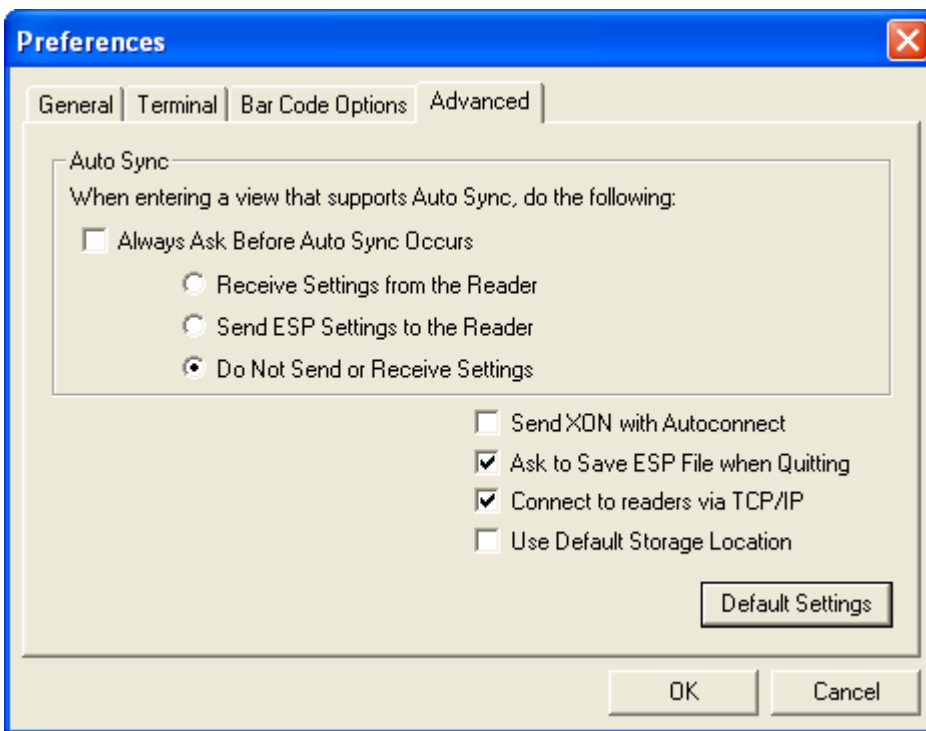

The **Auto Sync** options at the top of the **Advanced** tab allow the user to determine whether Auto Sync will be enabled automatically in sections of **ESP** where it is used, or if it will ask before it enables Auto Sync functions.

Always Ask Before Auto Sync Occurs

If this option box is checked, specific Auto Sync functions can be enabled. **Receive Settings from the Reader** will automatically send the scanner's settings to **ESP** when Auto Sync is enabled. **Send ESP Settings to the Reader** will automatically send all scanner configuration settings chosen in **ESP** to the scanner. **Do Not Send or Receive Settings** creates a condition in which Auto Sync will not automatically send scanner settings to **ESP**, or send **ESP** settings to the scanner.

Send XON with Autoconnect

Sends an **XON (Begin Transmission)** command to the scanner before starting the **Autoconnect** routine.

Preferences > Advanced Tab (cont.)

Ask to Save ESP File when Quitting

When enabled, prompts the user to save a **.esp** file when ending a session.

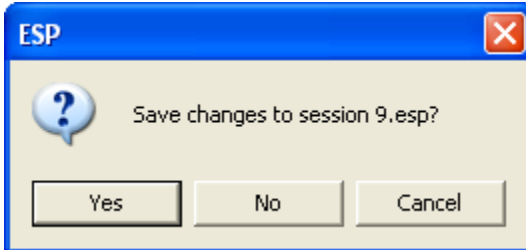

The **.esp** file will be saved in the location specified by the user.

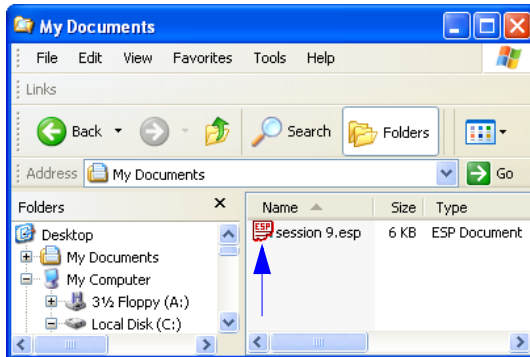

Connect to Readers via TCP/IP

When enabled, shows the **TCP/IP Connection Wizard** by default.

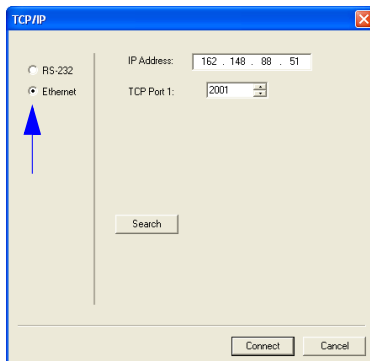

Use Default Storage Location

When enabled, automatically stores data in **ESP's** Application Data folder.

Document Memo

The information entered in the **Document Memo** field will appear in a context-sensitive text box whenever the cursor hovers over the **Document Memo** item on the **Options** menu.

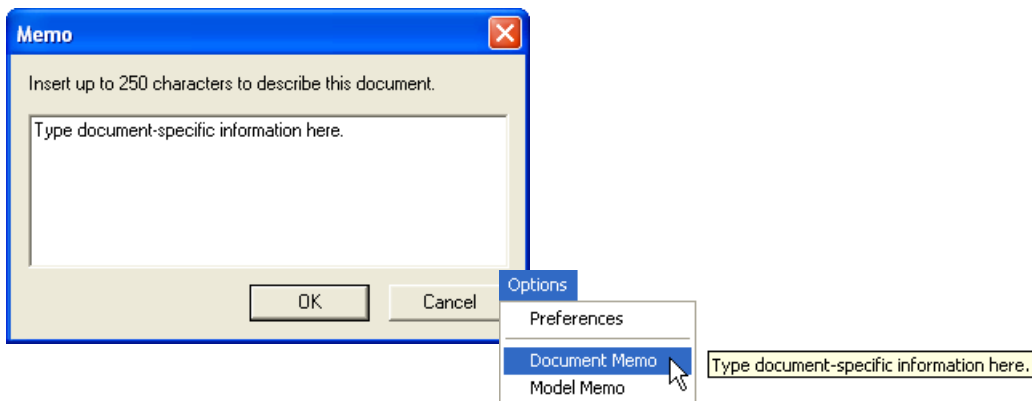

Model Memo

Similar to **Document Memo**, the information entered in the **Model Memo** field will appear in a context-sensitive text box whenever the cursor hovers over the **Model Memo** item on the **Options** menu. Memos created in **Model Memo** are specific to the model enabled when the message was created.

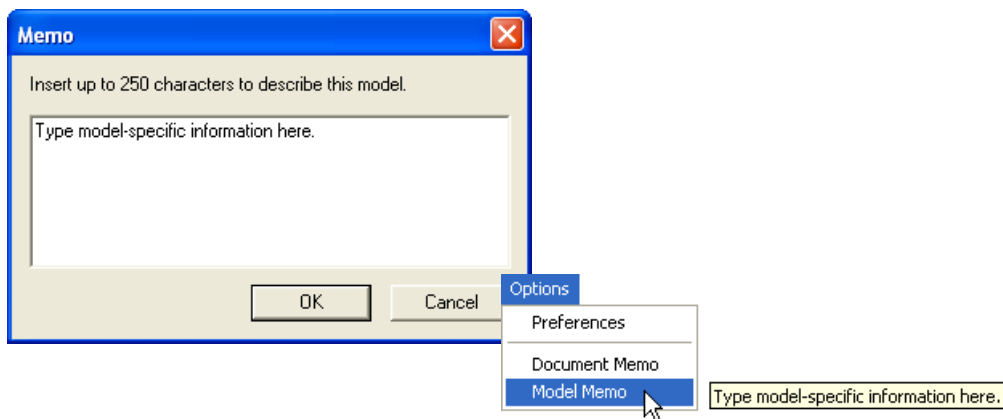

Note: Memos must be saved in a **.esp** file to make them available in the next session. If the current session is not saved, any memos that have been entered during the session will be discarded, and will be unavailable in the next session.

Connect

The **Connect** dropdown menu allows the user to access the **Connection Wizard**, as well as the **Autoconnect** and **Configure Multidrop** dialogs. **Connect** and **Disconnect** can also be performed directly from the dropdown menu without opening a dialog.

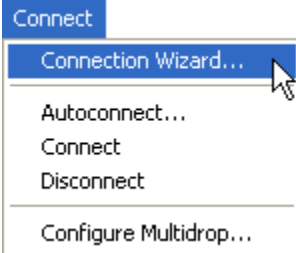

Connection Wizard

To connect using the **Connection Wizard**:

- Click **Connect** on **ESP**'s menu toolbar, and then select **Connection Wizard**.
- Select **RS-232** or **Ethernet** to activate the appropriate display.
- Configure RS-232 or Ethernet settings as required by the application, and click **Connect**.

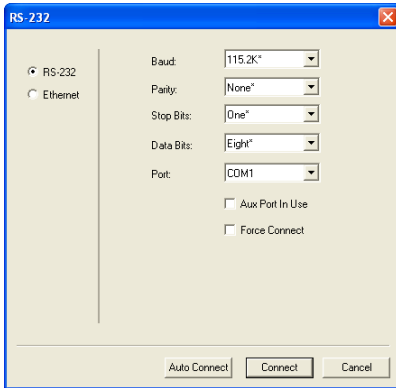

RS-232 Connection Wizard

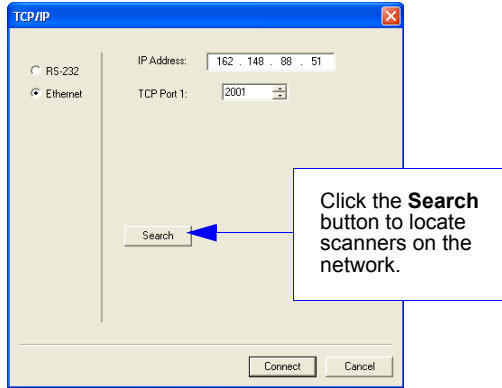

Ethernet Connection Wizard

- When a connection is established, the green indicator in the status bar at the bottom right of the screen will be visible:

Autoconnect

- If the RS-232 connection attempt fails, use **Autoconnect** to establish a connection between the scanner and the host.

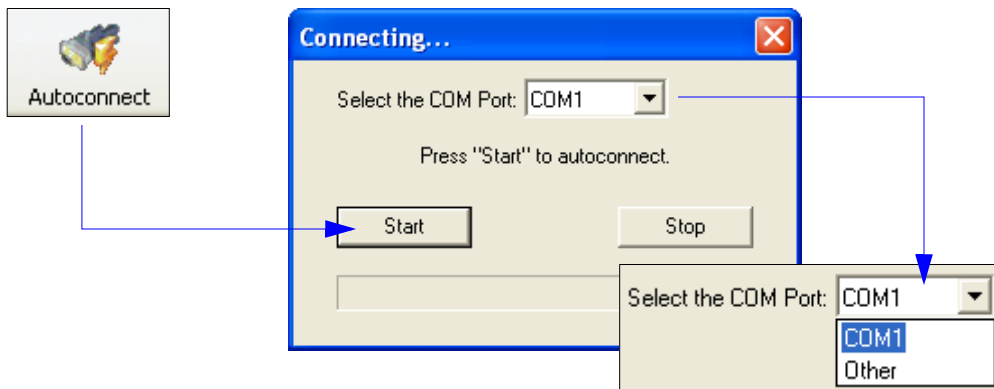

- If the communication port is not the default **COM1**, use the dropdown menu to change the port.

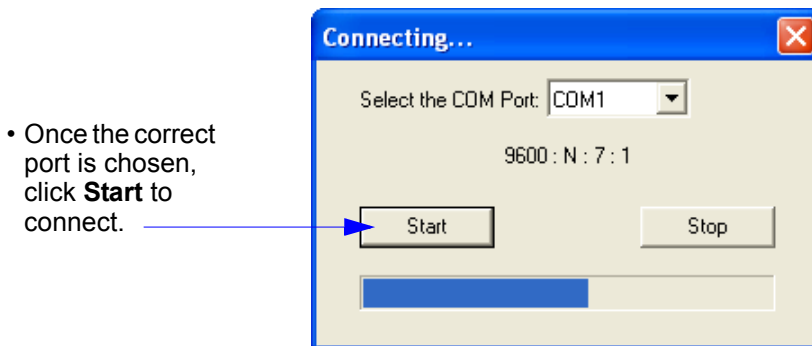

- Once the correct port is chosen, click **Start** to connect.
- When a connection is established, the green indicator in the status bar at the bottom right of the screen will be visible.

View

The **View** menu allows the user to move quickly between the **Setup**, **Terminal**, and **Utilities** interfaces without using the icon buttons on the **App Mode** toolbar. It also allows the user to access the **Bar Code Dialog**, shown below.

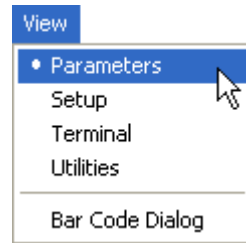

Bar Code Dialog

Symbols can be created in the **Bar Code Dialog** by typing the text to be encoded. This is a useful tool for creating configuration symbols, allowing the user to configure the scanner by reading the user-created symbols.

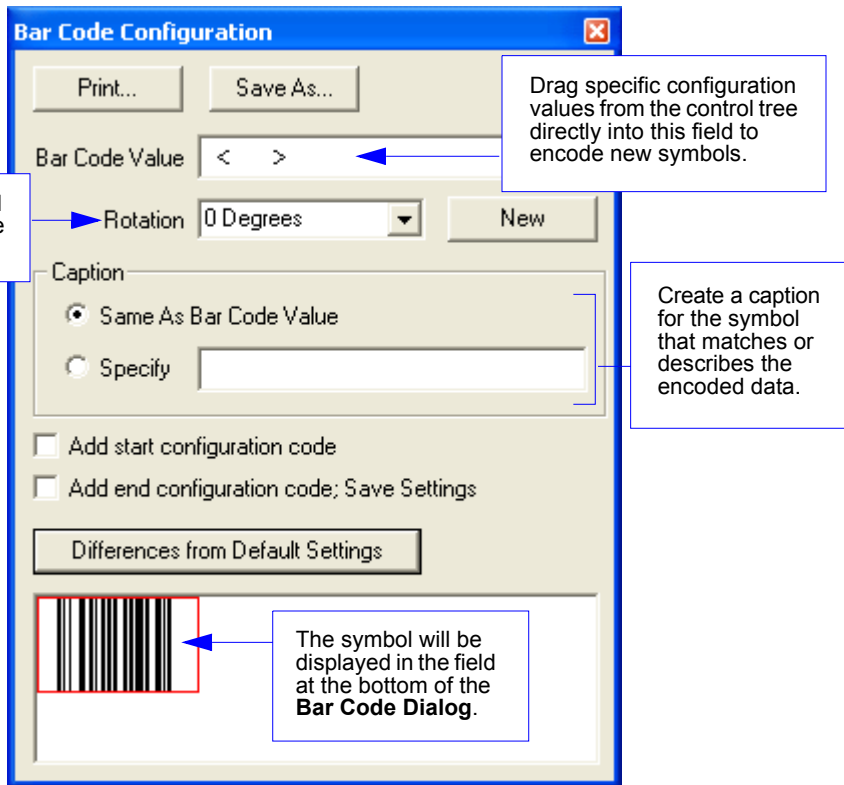

The screenshot shows the "Bar Code Configuration" dialog box. It has a blue title bar with a close button. The main area is light gray and contains several controls:

- Buttons for "Print..." and "Save As..." at the top left.
- A "Bar Code Value" field containing "< >" with a blue arrow pointing to it from a callout box that says: "Drag specific configuration values from the control tree directly into this field to encode new symbols."
- A "Rotation" dropdown menu set to "0 Degrees" with a blue arrow pointing to it from a callout box that says: "Choose a spatial orientation for the new symbol."
- A "Caption" section with two radio buttons: "Same As Bar Code Value" (selected) and "Specify" (with an empty text field next to it). A blue arrow points to the "Specify" field from a callout box that says: "Create a caption for the symbol that matches or describes the encoded data."
- Two checkboxes: "Add start configuration code" and "Add end configuration code; Save Settings", both of which are unchecked.
- A button labeled "Differences from Default Settings".
- A barcode preview area at the bottom left, outlined in red, with a blue arrow pointing to it from a callout box that says: "The symbol will be displayed in the field at the bottom of the Bar Code Dialog."
- A "New" button on the right side.

Navigating in ESP

To change scanner settings, or to access the **Setup**, **Terminal**, or **Utilities** views, click the **App Mode** button.

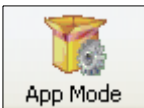

To return to **EZ Mode**, click the **EZ Mode** button.

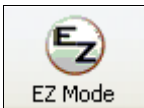

To make changes to configuration settings in the tree controls:

1. **Left-click** on the + to expand menu items.
2. **Double-click** the desired parameter and **single-click** in the selection box to view options.
3. Place the cursor in the selection box, scroll down to the desired setting, and **single-click** the setting.

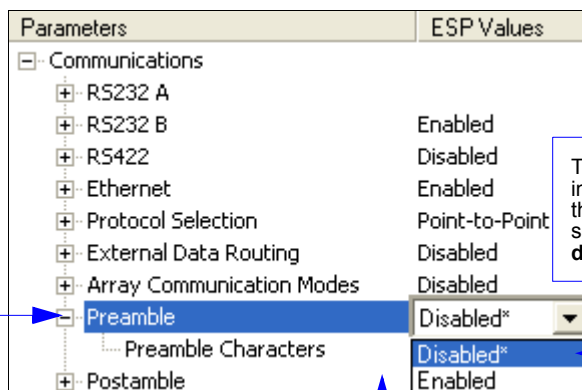

The **X** indicates that the setting is **default**.

4. **Left-click** again on the open screen to complete the selection.
5. **Right-click** on the open screen and select **Save to Reader** to implement the command in the scanner. The command can be sent without saving, or sent and saved simultaneously.

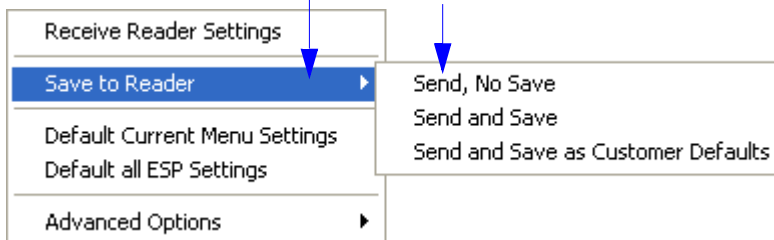

Send/Receive Options

To access **Receive**, **Save**, and **Default** options, click the **Send/Recv** button. These options can also be reached by right-clicking in any of the configuration views.



Receiving

From the **Send/Recv** menu, select **Receive Reader Settings**.

Caution: Selecting this option will upload the scanner's settings. If the **ESP** file has a number of custom settings that must be maintained and downloaded into the scanner, these settings will be lost.

This function is useful for receiving (uploading) the scanner's settings and saving them as a file for future use. For example, if the scanner has settings that must not change, **Receive Reader Settings** would load those settings to **ESP** and save them in an **ESP** file for later retrieval.

Receiving the scanner's settings will also assure that any unwanted subsequent changes in **ESP** will not be saved.

Saving

Send, No Save (<A>)

Saves **ESP** settings to current memory.

Send and Save (<Z>)

Activates all changes in current memory *and* saves to the scanner for power-on.

Send and Save as Customer Defaults (<Zc>)

Saves default settings for quick retrieval.

This option will be visible only if **Enable 'Send and Save as Customer Defaults'** is checked in **ESP Preferences**.

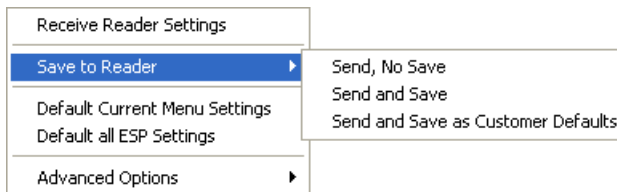

Defaulting

When **Default Current Menu Settings** or **Default all ESP Settings** are selected, only the **ESP** settings are defaulted.

Advanced Options

Send Current View

This is the same as **Save to Reader** > **Send No Save** except that only the commands in the current configuration tree are sent.

Send Current Command

This is the same as **Send Current View**, except that it saves only the command that is currently selected.

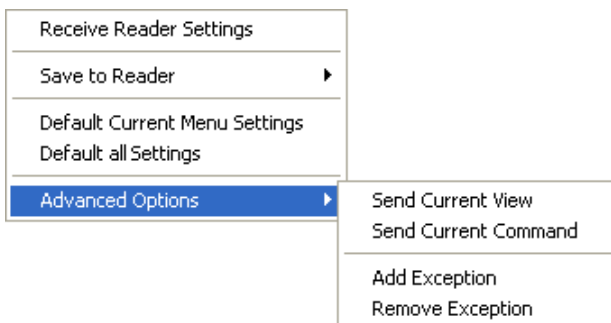

Add/Remove Exception

After a **Receive Reader Settings** command is performed¹ and the **Add Exception** option is selected, a list of serial commands may appear. These are commands that may be in the scanner's firmware, but are not included in, or are different from, the current version of **ESP**.

These commands can be edited by double-clicking them and changing them as needed.

It is important to note that these commands will be saved to the scanner whenever a **Save to Reader** command is sent, or when an **<A>** or a **<Z>** command is sent.

Also, if there is a corresponding **ESP** menu item, the **ESP Value** column for that item will be blank following a **Receive Reader Settings** command.

1. From the **Send/Recv** button or by right-clicking in any blank section of a tree control view.

■ 3 *Hardware Integration*

Contents

Cordsets	3-2
QX-870 and QX-1 Connectors and Pinouts.....	3-3
Power and Trigger Switching.....	3-8
Port Routing.....	3-9
Application Examples	3-10

This section introduces the details of QX-870 hardware, and explains how that hardware can be integrated in an application.

Cordsets

The terms “cordset” and “cable” are both applicable to industrial connectivity, but they are not synonymous. Cordsets enable communications and power between scanners and interface devices. Cordsets have an M12 connector at one or both ends. Examples of cordsets are shown below.

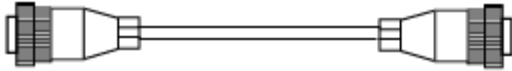

M12 to M12 Cordset



M12 to RJ45 (Ethernet) Cordset

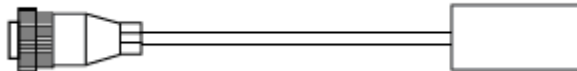

M12 to Photo Sensor Cordset

Cables do not have M12 connectors at either end. An example of a cable is shown below.

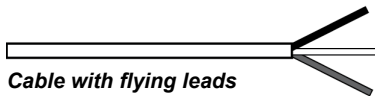

Cable with flying leads

QX-870 and QX-1 Connectors and Pinouts

When deploying a network of scanners and interface devices in an industrial setting, it is important to use components whose pin assignments are arranged in a way that avoids communication errors and equipment damage. This can be achieved with components that are designed in a logical, consistent, and easy-to-implement way.

The QX-870 has a very simple pin assignment methodology. The clearly identified connectors at the back of the unit can be used to receive and bus power, and also to send and receive data and commands.

QX-870 (Base View)



A is a serial M12 12-pin plug on both Serial and Ethernet models.

B is a serial M12 12-pin socket on serial models, and an 8-pin socket on Ethernet models.

P/M is a serial M12 12-pin plug on both Serial and Ethernet models.

T is a 4-pin Micro-Change socket on both Serial and Ethernet models (identical to the QX-1 trigger connector).

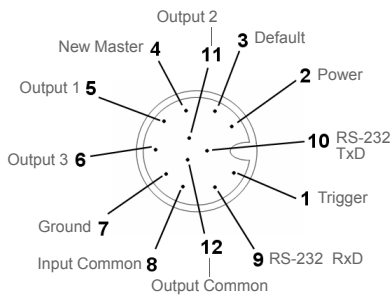

A (All Models) M12 12-pin Plug

Pin	Function	Wire Color
1	Trigger	White
2	Power	Brown
3	Default	Green
4	New Master	Yellow
5	Output 1	Gray
6	Output 3	Pink
7	Ground	Blue
8	Input Common	Red
9	RS-232 (Host) RxD	Black
10	RS-232 (Host) TxD	Violet
11	Output 2	Gray/Pink
12	Output Common	Red/Blue

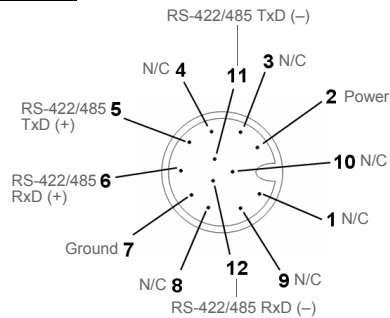

P/M (All Models) M12 12-pin Plug

Pin	Function	Wire Color
1	N/C	White
2	Power	Brown
3	N/C	Green
4	N/C	Yellow
5	422/485 TxD (+)	Gray
6	422/485 RxD (+)	Pink
7	Ground	Blue
8	N/C	Red
9	N/C	Black
10	N/C	Violet
11	422/485 TxD (-)	Gray/Pink
12	422/485 RxD (-)	Red/Blue

Continued next page

QX-870 and QX-1 Connectors and Pinouts (continued)

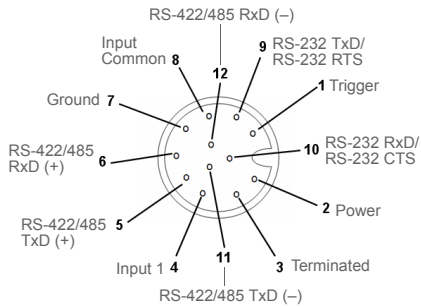

B (Serial Models) M12 12-pin Socket

Pin	Function	Wire Color
1	Trigger	White
2	Power	Brown
3	Terminated	Green
4	Input 1	Yellow
5	Port 3 422/485 TxD (+)	Gray
6	Port 3 422/485 RxD (+)	Pink
7	Ground	Blue
8	Input Common	Red
9	Port 2 TxD/Port 1 RTS	Black
10	Port 2 RxD/Port 1 CTS	Violet
11	Port 3 422/485 TxD (-)	Gray/Pink
12	Port 3 422/485 RxD (-)	Red/Blue

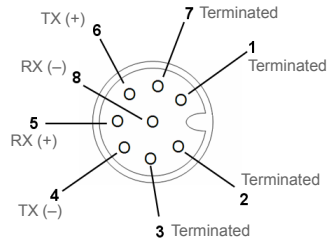

B (Ethernet Models) M12 8-pin Socket

Pin	Function
1	Terminated
2	Terminated
3	Terminated
4	Port 4 TX (-)
5	Port 4 RX (+)
6	Port 4 TX (+)
7	Terminated
8	Port 4 RX (-)

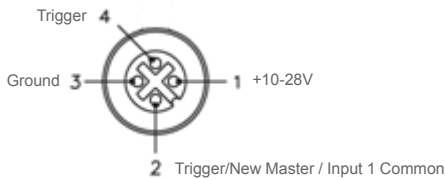

Connector T (Trigger) 4-pin Socket

Pin	Function
1	+ 10-28V
2	Trig/NM/Input 1 Common
3	Ground
4	Trigger

QX-1 Interface Device

The QX-1 Interface Device's receptacles are physically the same as those on the QX-870, but they do not have explicit pin assignments. The QX-1 allows users to bus power and communications as required by the application.

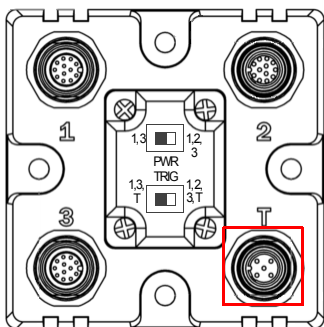

QX-1 Interface Device

Connectors 1 and 3 are 12-pin plugs, and **Connector 2** is a 12-pin socket. All three connectors can be assigned to bus power and data as required by the application.

The two switches at the center of the device allow the user to route signals as needed.

Pin	Function
1	+ 10-28V
2	Trig/NM/Input 1 Common
3	Ground
4	Trigger

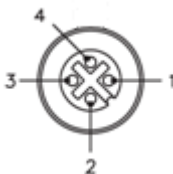

QX-1 Trigger Connector 4-pin Socket

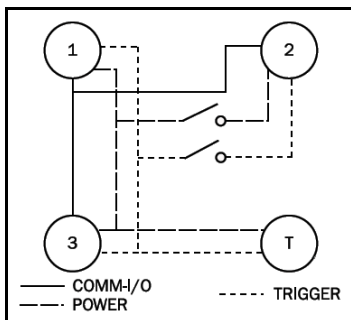

QX-1 Communications - I/O - Power - Trigger

This simple diagram (shown on the base of the QX-1) illustrates how power, communications, I/O, and trigger signal can be routed through the QX-1 device depending on the needs of the application. The switches greatly increase signal routing flexibility.

Grounding the QX-870

Proper grounding is necessary for operator safety, noise reduction, and the protection of equipment from voltage transients. Buildings, including any steelwork, all circuits, and all junction boxes must be grounded directly to an earth ground in compliance with local and national electrical codes.

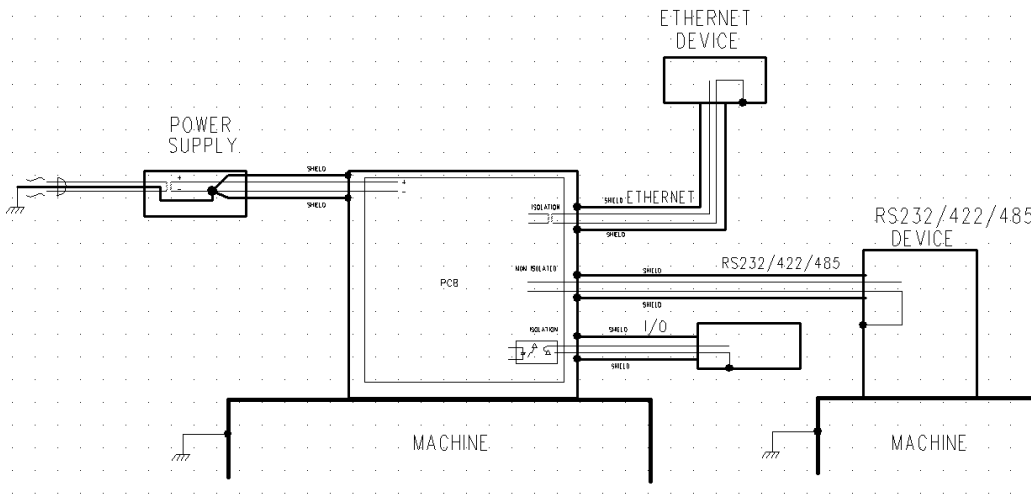

An earth ground is provided through the cable shields and chassis of the scanner.

Ground Loops

Ground loops (signal degradation due to different ground potentials in communicating devices) can be eliminated or minimized by ensuring that both the host, scanner, and their power supplies are connected to a common earth ground.

Expected Power and Ground Connections for Proper Operation

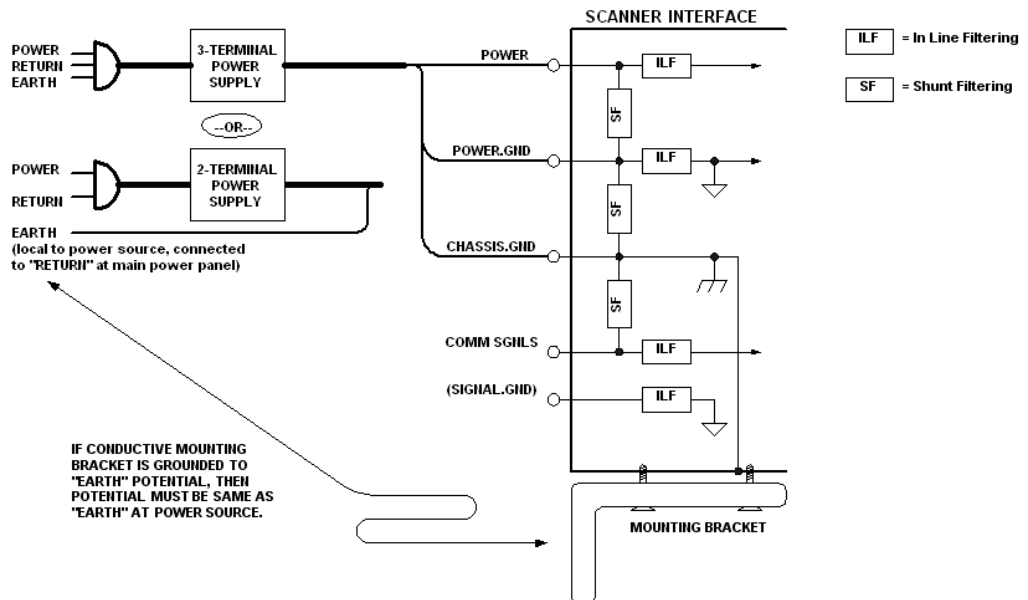

Notes:

- Ensure that mounting bracket "Earth" is at the same potential as power source "Earth".
- Supply "Return" and "Earth" ground must be stable, low-impedance reference points.
- "2-Terminal Power Supply" must still provide an "Earth" connection to the scanner.
- "Signal Ground" can be used for communications and/or discrete signal ground reference. It must **not** be used as Power Ground or Earth Ground.

Power and Trigger Switching

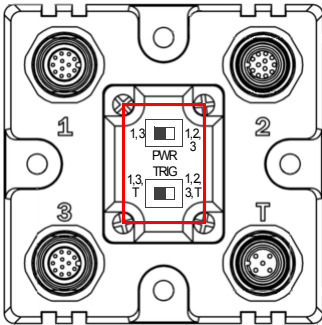

Power can be bussed between scanners and interface devices. At each location on a network where a new power supply is added, the Power switch on the QX-1 can be used to break power between Connector 2 and Connectors 1, 3, and T.

The **Trigger** signal between Connector 2 and Connectors 1, 3, and T can be broken using the Trigger switch. This isolates trigger signals as required by the application.

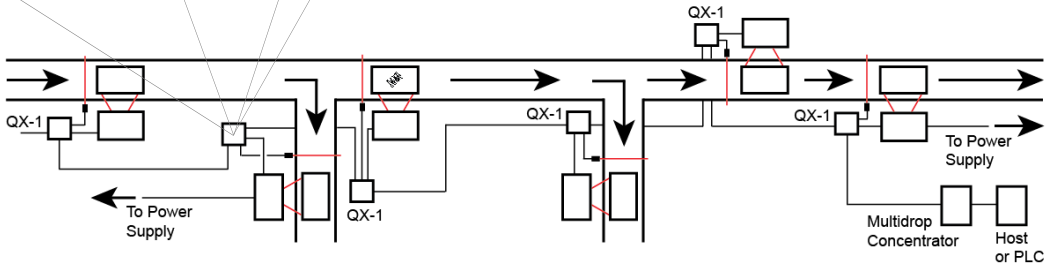

Port Routing

The physical advantages created by flexible signal routing and switching are enhanced further by **Port Routing**, which can be configured in **ESP**. Port Routing eliminates the need for dedicated “Host” and “Aux” ports in a traditional sense. With Port Routing, any port can be defined as a Host or Aux port. Port Routing also allows users to define the data types that are accessible from specific ports.

The primary benefit of Port Routing is that any type of data can be routed to any port, and can be sent through multiple ports simultaneously. Multiple types of data can also be appended to the symbol data that is output from the scanner to the host. Command data, symbol data, extra symbol information, and diagnostic data are enabled by default in the QX-870.

The table below lists different types of data, with examples for each data type.

Data Type	Example
Command Data	Serial commands; scanner responses to serial commands.
Symbol Data	Any string of data encoded in a symbol.
Extra Symbol Information	Decodes per trigger, decode direction, configuration database index number.
Diagnostic Data	Laser status, temperature, service message.

The screen capture below (from ESP) shows the QX-870's four communications ports and the parameters for each.

Parameters	ESP Values
<ul style="list-style-type: none"> [-] Communications <ul style="list-style-type: none"> [-] RS232 A <ul style="list-style-type: none"> Baud Rate 115.2K Parity None Stop Bits One Data Bits Eight Symbol Data Output Enabled Extra Symbol Information Enabled Diagnostics Output Enabled External Source Processing Mode Command [-] RS232 B <ul style="list-style-type: none"> Baud Rate 115.2K Parity None Stop Bits One Data Bits Eight Symbol Data Output Enabled Extra Symbol Information Enabled Diagnostics Output Enabled External Source Processing Mode Command [-] RS422 <ul style="list-style-type: none"> Baud Rate 115.2K Parity None Stop Bits One Data Bits Eight Symbol Data Output Disabled Extra Symbol Information Disabled Diagnostics Output Disabled External Source Processing Mode Command [-] Ethernet <ul style="list-style-type: none"> IP Address 192.168.0.100 Subnet 255.255.0.0 Gateway 0.0.0.0 IP Address Mode DHCP [-] TCP Port 1 <ul style="list-style-type: none"> Symbol Data Output Enabled Extra Symbol Information Enabled Diagnostics Output Enabled External Source Processing Mode Command [-] TCP Port 2 <ul style="list-style-type: none"> Symbol Data Output Enabled Extra Symbol Information Enabled Diagnostics Output Enabled External Source Processing Mode Command [-] Ethernet/Net/IP <ul style="list-style-type: none"> Enabled [-] Protocol Selection <ul style="list-style-type: none"> Point-to-Point [-] External Data Routing <ul style="list-style-type: none"> Disabled [-] Array Communication Modes <ul style="list-style-type: none"> Disabled [-] Preamble <ul style="list-style-type: none"> Disabled [-] Postamble <ul style="list-style-type: none"> Enabled 	

RS-232 A, RS-232 B, and RS-422 are serial. RS-232 A is always enabled. RS-232 B and RS-422 can be enabled or disabled to match the physical requirements of the application. **Ethernet** can also be enabled or disabled as required.

RS-232 A, RS-232 B, and RS-422 can be configured for Baud Rate, Parity, Stop Bits, Data Bits, Symbol Data Output, Extra Symbol Information (Decodes Before Output, Symbol Position Output, etc.), Diagnostics Output, and External Source Processing Mode (Command or Data).

Ethernet can be configured for IP Address, Subnet Mask, Gateway, IP Address Mode (Primary or Secondary TCP Port), Symbol Data Output, Extra Symbol Information, Diagnostics Output, and External Source Processing Mode.

Application Examples

The following examples demonstrate how the components described in previous pages can be deployed in industrial applications.

Daisy Chain

Daisy chain configurations are used in applications such as product packaging, where single items have multiple symbols. For example, a box with one symbol on the top and symbols on either side requires at least three scanners to ensure that all symbols will be decoded.

The highlighted areas below demonstrate how a daisy chain can be arranged. One scanner is placed above the conveyor line and one scanner is placed on each side of the line. The three scanners essentially function as a single scanner, and data is sent from the primary scanner to the host or PLC.

Important: Do not attempt to power more than four scanners with a single power supply in a daisy chain configuration. Add a QX-1 and one power supply for every four additional scanners in the daisy chain.

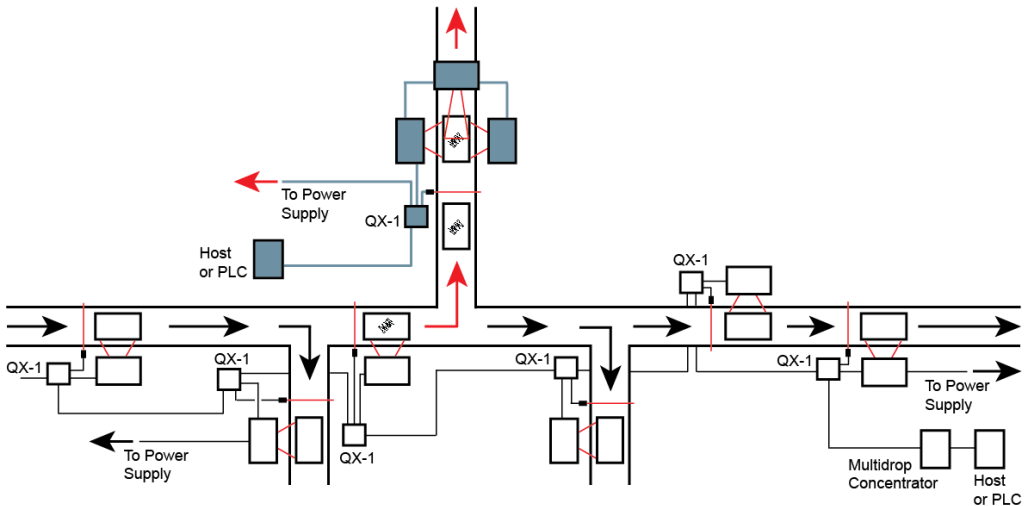

Multidrop

Multidrop networks are used in applications where it is necessary to decode symbols at multiple locations within an industrial process. Scanners are placed at stations located between manufacturing steps, and data from those scanners is directed to a multidrop concentrator before being sent to a host. An example of this type of application is food packaging, in which part number data is collected and tracked throughout the packaging process.

The highlighted areas below demonstrate how a multidrop network can be arranged.

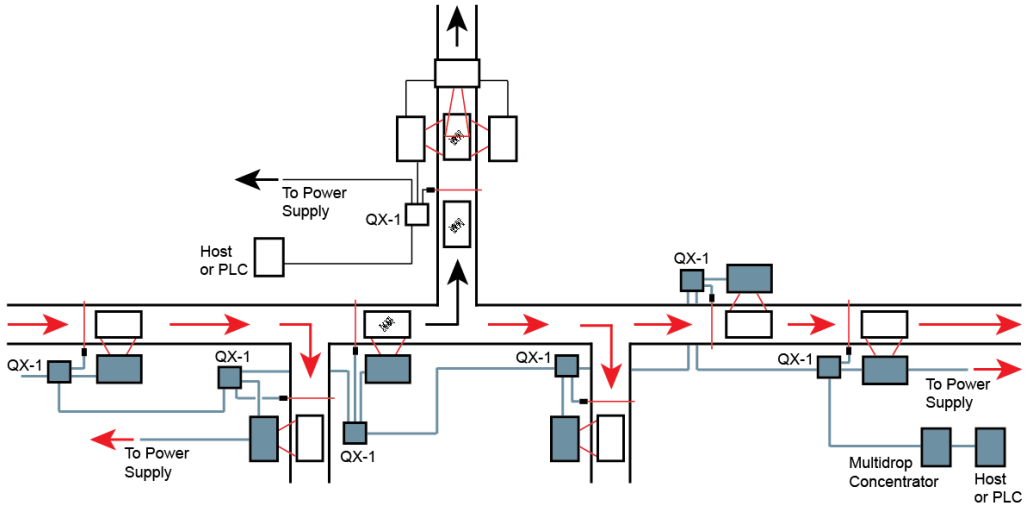

Ethernet TCP/IP and EtherNet/IP

Ethernet TCP/IP is the standard Ethernet interface used to connect multiple locations in a network, such as computers in an office network. It can also be used to network other communications devices, such as scanners and PLCs on a factory floor.

EtherNet/IP™ is a protocol developed and governed by **ODVA** (Open DeviceNet Vendors Association). It is based on the Common Industrial Protocol (CIP™). The CIP layer is an additional layer within the standard Ethernet interface (Ethernet TCP/IP). EtherNet/IP is common in control systems and PLCs, especially in the United States.

The highlighted areas below demonstrate how an Ethernet daisy chain can be arranged. Ethernet-enabled scanners can also be set up in standalone configurations, or multiple Ethernet-enabled scanners along a production or packaging line can be connected to Ethernet.

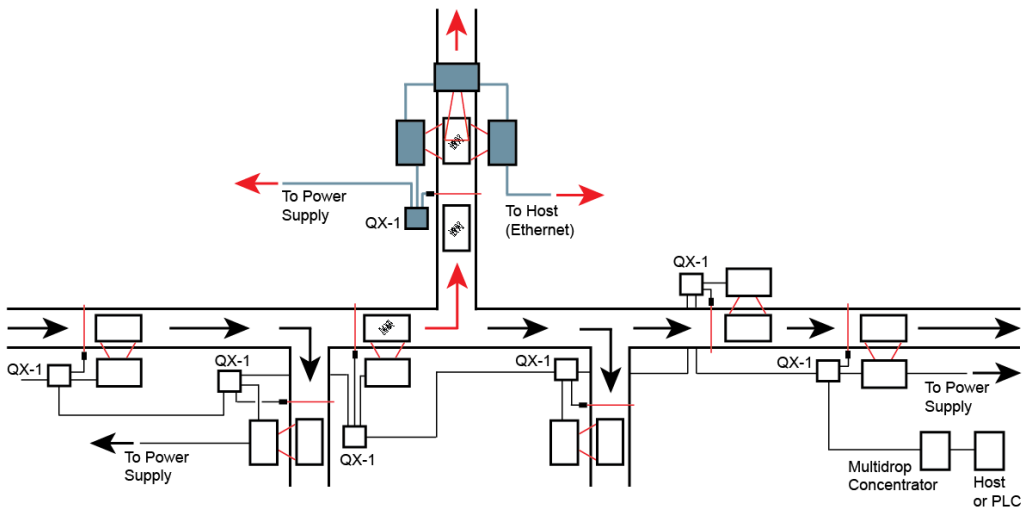

“EtherNet/IP” and “CIP” are trademarks of the Open DeviceNet Vendors Association.

4 *Scanner Setup*

Contents

Calibration..... 4-2
Configuration Database 4-4
Ordered Output..... 4-6
Output Format..... 4-10

This section describes ESP's four **Setup** interfaces: **Calibration**, **Configuration Database**, **Ordered Output**, and **Output Format**. Each interface allows the user to make changes to scanner configuration quickly and easily.

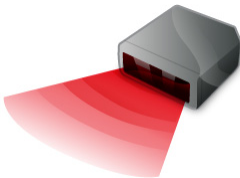

Calibration

The settings in the **Calibration** interface can also be configured using the **<@>** and **<@CAL>** serial commands, and the **Calibration Options** command.

The **Test** and **Calibrate** features are also available in **EZ Mode**.

Top Offset, Bottom Offset, Sweep and other raster functions can be set using the fields below, and top and bottom offset can also be set by clicking and dragging the edges of the laser arc in the picture.

The screenshot shows the Calibration interface with the following elements:

- Buttons:** Test, Calibrate, Save, Stop, Raster Frame, Reset.
- Checkboxes:** Decodes per Second, Laser Frame, Symbology Detect.
- Fields:** Framing Select (Raster Framing), Gain (20), Tracking (40), Laser Power (Medium), Top Offset (127), Bottom Offset (127), Sweep (10).
- Diagram:** A scanner with a red laser line and a curved arc. The arc is labeled with '0' at the top and '255' at the bottom.
- Fixed Parameter Calibration Panel:** Scan Speed (500, Fixed), Gain (20), Tracking (40, Fixed), Laser Power (Medium, Fixed), Raster Options (Search), Laser Frame (unchecked), Symbology Detect (checked).

Click **Save** to save calibration settings, or **Stop** to cancel the calibration process.

Scan Speed, Gain, Tracking, Laser Power, and Raster Options can also be configured in the **Reader Setup** command.

Laser Off Position

Percentage of the full scan arc that the scan beam moves through before the laser turns off. The combined values of **Laser On Position** and **Laser Off Position** cannot exceed 100 percent, the total arc of one scan.

Laser Off Position must always exceed the value of **Laser On Position** for a scan to take place.

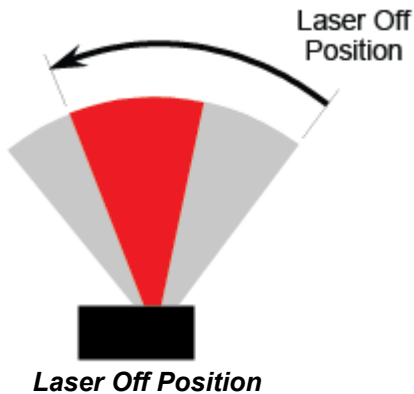

Laser On Position

Percentage of the full scan arc that the scan beam moves through before the laser turns on. For example, if set to 30, the laser will be off during the first 30 percent of the scan.

When **Laser Framing** is disabled, the laser is **on** for 100 percent of the full scan.

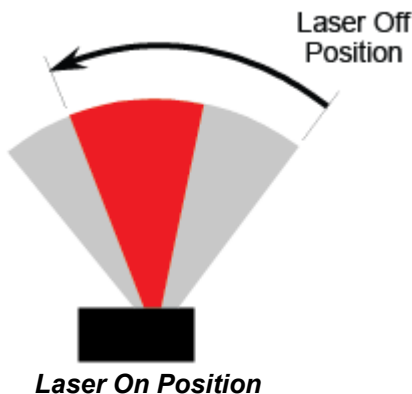

Configuration Database

Configuration Database settings can also be configured by using the **Configuration Database** serial commands.

Calibration | Configuration Database | Ordered Output | Output Format

Index	Gain	AGC Mode	Tracking	Raster Top	Raster Bottom	Raster Speed	Framing Status	Laser On Position	Laser Off Position	Laser Power	Background Color
Current	20	Continuous	40	127	127	10	Disabled	10	95	Medium	White
1	60	Continuous	80	127	127	10	Disabled	10	95	Low	White
2	60	Continuous	80	127	127	10	Disabled	10	95	Low	White
3	60	Continuous	80	127	127	10	Disabled	10	95	Low	White
4	60	Continuous	80	127	127	10	Disabled	10	95	Low	White
5	60	Continuous	80	127	127	10	Disabled	10	95	Low	White
6	60	Continuous	80	127	127	10	Disabled	10	95	Low	White
7	60	Continuous	80	127	127	10	Disabled	10	95	Low	White
8	60	Continuous	80	127	127	10	Disabled	10	95	Low	White
9	60	Continuous	80	127	127	10	Disabled	10	95	Low	White
10	60	Continuous	80	127	127	10	Disabled	10	95	Low	White

5 Number of Active Indexes

5 Number of Database Cycles

Time Switch Mode

10 Time (x10 ms)

Double-clicking on an Index will bring up the **Configuration Database Settings** dialog.

Use the **Number of Active Indexes** field to determine how many database indexes will be used.

Use the **Number of Database Cycles** to determine how many times the active indexes will be repeated.

Use the **Switch Timing** field to determine the amount of time between active indexes.

Configuration Database Settings

Double-clicking an Index will bring up the **Configuration Database Settings** dialog for that database index.

Database #1

Gain 60 (0 - 255)	AGC Mode Continuous*	Tracking 80 (5 - 127)
Raster Top 127 (0 - 255)	Raster Bottom 127 (0 - 255)	Raster Speed 10 (0 - 200)
Framing Status Disabled*	Laser On Position 10 (10 - 90)	Laser Off Position 95 (15 - 95)
Laser Power Low*	Background Color White*	

OK Cancel

The settings shown above can be configured differently for every active index. Once all active database indexes are configured, the index can be concatenated and cycled for the number of times specified in **Number of Database Cycles**.

Ordered Output

Output filtering is a method of providing a set of good read qualifiers and also providing ordered output. There is a filter for up to the first 10 positions in a multisymbol output. The first filter corresponds to the first symbol output at the end of the read cycle. Each filter has settings for the following six parameters: **Filter Number**, **Symbology Type**, **Length**, **Wildcard**, **Placeholder**, **Matching Data**, **Decode Direction**, and **Database Number**.

Calibration | Configuration Database | **Ordered Output** | Output Format

Filter Number, Symbology Type, Length, Wildcard, Placeholder, and Matching Data are all displayed in the table below. Double-clicking on any row of the table will display the **Ordered Output Filter Settings** dialog, where settings can be changed.

Filter Number	Symbology Type	Length	Wildcard	Placeholder	Matching Data	Decode Direction	Database Number
1	Any Type	0	*	?		Either	Any
2	Any Type	0	*	?		Either	Any
3	Any Type	0	*	?		Either	Any
4	Any Type	0	*	?		Either	Any
5	Any Type	0	*	?		Either	Any

Receive settings from the scanner, **Send** settings to the scanner, or **Send and Save** settings.

Number of Filters: ▼

Receive
Send
Send and Save

Note: These buttons only affect this view.

Number of Filters refers to the number of active output filters. **0** disables all output filters. Any non-zero numeral will enable output filtering to be performed using the filter indexes covered by this value.

For example, if the number of filters is **5**, then filter indexes 1, 2, 3, 4, and 5 will be applied.

Filter Number

This is the filter index number that represents the position of the symbol in the data output at the end of the read cycle. This index number should be entered along with the following filter settings for the predetermined symbol position.

Symbology Type

Specifies the symbology type allowed to occupy this location in multisymbol output.

Note: To filter or order a symbol, the symbol must meet all the requirements of the selected filter index.

Length

Specifies the length of the decoded symbol allowed to occupy this location in multisymbol output.

Note: To filter or order a symbol, the symbol must meet all requirements of the selected filter index.

Wildcard

This is the character to be used in the data output field when performing a data filter comparison. The wildcard character represents the end of matching, and allows for variable lengths of symbol output.

Placeholder

The placeholder character requires a character to be present, but does not compare the data value.

Matching Data

This is the data string to be used when comparing symbol data for output filtering and ordering. This data string may also contain wildcard and placeholder characters to facilitate matching. Remember that in order to filter or order symbol data, it must meet all the requirements of the selected filter index.

Examples:

- Filter data = "123*". This will match data strings of "123", "123456", and "123ABC", but not "12".
- Filter data = "123*AB?C". This will be interpreted as "123*".
- Filter data = "123?". This will match "1234" and "123A", but not "123", "12345", or "1234C".
- Filter data = "123?A". This will match "1234A" and "123BA", but not "123", "1234C", or "1234ABCD".
- Filter data = "123?A?". This will match "1234AB" and "123BAT", but not "1234A" or "123BATS".
- Filter data = "12???*". This will match "1234", "123456", and "123ABC", but not "12" or "123".
- Filter data = "123?A*". This will match "1234A", "123BA", and "123BATS", but not "1234" or "1234C".

Ordered Output Filter Settings

Ordered Output Filter Settings

Filter # 1 Criteria

Symbology Type: Any Type

Length: 0

Enter Match String

Matching String: *

ASCII Lookup: CR Add to Match String

Match String Definables

Wildcard Character: *

Placeholder Character: ?

Database Number: Any

Decode Direction: Either

Apply Cancel

Double-clicking on a row in the Ordered Output table brings up the **Ordered Output Filter Settings** dialog.

Use these settings to determine **Symbology Type**, **Length** of the symbol, a user-defined **Matching String**, **ASCII Lookup**, **Wildcard Character**, **Placeholder Character**, **Database Number**, and **Decode Direction**. Click **Apply** to save the settings to the corresponding filter.

Rules for Output Filter Configuration

Output Filter Configuration Rule # 1

Each symbol that is decoded must match one of the filters before it can be saved to a read cycle record. There is an exception to this rule, however, when the number of symbols required for a read cycle exceeds the number of active filters. In such a case, unfiltered symbols can be placed into unfiltered output positions.

For example, if the number of symbols required is 6 but there are only 5 active filters, the last position can be filled by any (unfiltered) qualified symbol.

Output Filter Configuration Rule # 2

The same filter setup can be used multiple times.

For example, filters 1, 2, and 3 can be set up to filter Code 39 symbols, and the output will occur in the order the symbols are decoded.

Output Filter Configuration Rule # 3

All qualified symbols will be sorted and output in the matching filter position. If a symbol matches filter 3, it will be output as the third symbol. If a filter does not have a matching qualified symbol, a No Read message will be output in place of the symbol (assuming the No Read message is enabled).

For example, if there is not a symbol that meets filter 3's requirements, then a No Read message will be output in the third output position.

Output Format

Enable Output Format

This is a global enable/disable parameter. Use **Set Number of Symbols** and **Output Phrase** to assign symbols for formatting, and **Symbol Parse** to determine the specific output content for the assigned symbols.

On the **Output Format** tab, check the **Enable Output Format** box.

Calibration | Configuration Database | Ordered Output | **Output Format**

Enable Output Format Auto Sync with Reader

Set Number of Symbols: 1

Output Phrase

Preamble: Symbol #1  Postamble:

Enable Parse Enable

Show Parse Table

Set Number of Symbols

Number of Symbols determines the number of symbols to which output formatting will apply.

Output Phrase

Output Phrase refers to the user-defined Preamble, selected symbols, and Postamble sequence in the read cycle result.

Enable Output Format
 Set Number of Symbols: 5

Use the **Set Number of Symbols** spin box to determine the number of symbols to be included in the output phrase.

Output Phrase

Preamble: CR

Symbol #1: Parse

Symbol Separator: /

Symbol #2: Parse

Symbol #3: Parse

Symbol #4: Parse

Symbol #5: Parse

Postamble: CR LF

Enable Parse Parse Parse Parse Parse Enable

Enter **Postamble** characters by double-clicking in the text field and then using the Postamble calculator.

Check the **Parse** boxes beneath the symbols to be formatted.

Enter **Postamble** characters by double-clicking in the text field and then using the Postamble calculator.

Preamble

CR

SOH	STX	ETX	EOT	ENQ
ACK	BEL	BS	HT	LF
VT	FF	CR	SO	SI
SI	DC1	DC2	DC3	DC4
NAK	SYN	ETB	CAN	EM
SUB	ESC	FS	GS	RS
US	SP			

Click 'Delete' to remove characters.

OK Cancel

Postamble

CR LF

SOH	STX	ETX	EOT	ENQ
ACK	BEL	BS	HT	LF
VT	FF	CR	SO	SI
SI	DC1	DC2	DC3	DC4
NAK	SYN	ETB	CAN	EM
SUB	ESC	FS	GS	RS
US	SP			

Click 'Delete' to remove characters.

OK Cancel

Symbol Parse

Extract

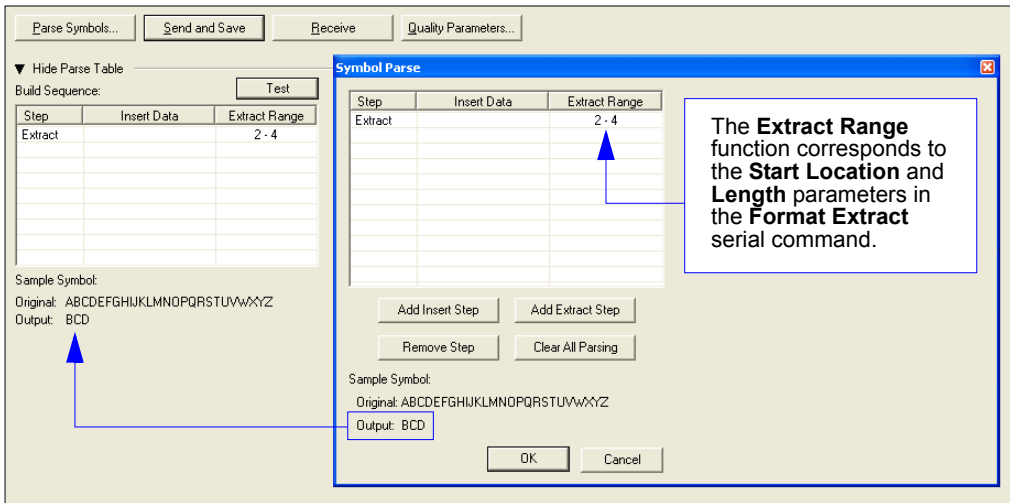

Multiple character sequences can be extracted and inserted using **Symbol Parse**. In this example, the selected extraction range is characters 2-4. The “Sample Symbol” example on the **Symbol Parse** dialog shows the selected character positions extracted and output as desired. Simultaneously, the data string from the selected symbol is displayed at the bottom left of the **Parse Table**, followed by the user-defined extracted output.

Output Index

Output Index refers to the database entry to be modified with this command. A formatted output is built by *extracting data from a symbol's original data output* and/or inserting user-defined characters.

It may be helpful to think of individual indexes as positions in the final formatted output. Starting with index # 1, enter either an extract or insert command to begin building the desired output string. Then, with the next index number, enter either an extract or insert command to continue building the output string. Continue this process until the string is built.

Start Location

Defines the location within the symbol data where the character extraction will begin. The first character extracted will also be the first character in the sequence displayed in user-defined output.

Length

Defines the length (in consecutive characters) that will be extracted and placed in user-defined output.

Insert

Symbol Parse

Step	Insert Data	Extract Range
Insert		

Buttons: Add Step, Remove Step, Clear All Parsing

Sample Symbol Parse:
 Original: ABCDEFGHIJKLMNOPQRSTUVWXYZ0123456789
 Output:

Insert

SP SP

SOH	STX	ETX	EOT	ENQ
ACK	BEL	BS	HT	LF
VT	FF	CR	SO	SI
SI	DC1	DC2	DC3	DC4
NAK	SYN	ETB	CAN	EM
SUB	ESC	FS	GS	RS
US	SP			

Click 'Delete' to remove characters.

Buttons: OK, Cancel

The **Insert** process is very similar to the **Extract** process, except that **Insert** allows the user to enter characters using the **Insert** calculator (shown above).

Buttons: Parse Symbols, Send and Save

▼ Hide Parse Table

Build Sequence: Test

Step	Insert Data	Extract Range
Insert	SP SP	
Extract		3 - 5

Buttons: Add Step, Remove Step, Clear All Parsing

Sample Symbol Parse:
 Original: ABCDEFGHIJKLMNOPQRSTUVWXYZ0123456789
 Output: CDE

Notice that **Extract** and **Insert** share the same **Parse Table**.

5 Scanner Parameters

Contents

Communication	5-2
Read Cycle	5-43
Symbologies	5-70
I/O Parameters.....	5-107
Matchcode	5-168
Diagnostics	5-177

This section explains the function and purpose of the **Parameters** commands in ESP's tabbed tree controls.

Important: Unless otherwise specified, command settings shown in this section are the default settings.

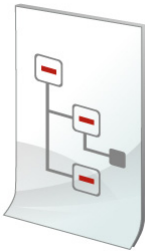

Communication

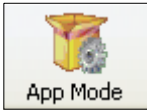

Click the **App Mode** button and then the **Parameters** button to display the tree control tabs.

Then click the **Communication** tab to display the Communication tree control.

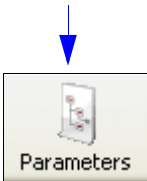

Parameters	ESP Values
[-] Communications	
[+] RS232 A	
[+] RS232 B	Enabled
[+] RS422	Disabled
[+] Ethernet	Enabled
[+] Protocol Selection	Point-to-Point
[+] External Data Routing	Disabled
[+] Array Communication Modes	Disabled
[+] Preamble	Disabled
[+] Postamble	Enabled*

The * indicates that the setting is the default.

To open nested options, **single-click** the +.

To change a setting, **double-click** the setting and use the cursor to scroll through the options.

Note: Communication settings can also be sent to the scanner from ESP's Terminal using Omron Microscan's K command format. Refer to the **Communication** section of **Appendix E**.

Port Routing

The QX-870 features a communication system based on **Port Routing** instead of traditional, dedicated serial ports. Decisions can be made about the direction and content of communication between ports based on different **Data Types**. Any available port can be used in any combination.

The fundamental concept of Port Routing is that communication design can be based upon Data Types rather than ports. The advantage of this is the ability to map different data types to different ports—the user is no longer limited to a “Host Port” and “Aux Port” for specific types of input and output. Since each port is independent instead of fixed for a particular purpose, the scanner behaves more like a data switch.

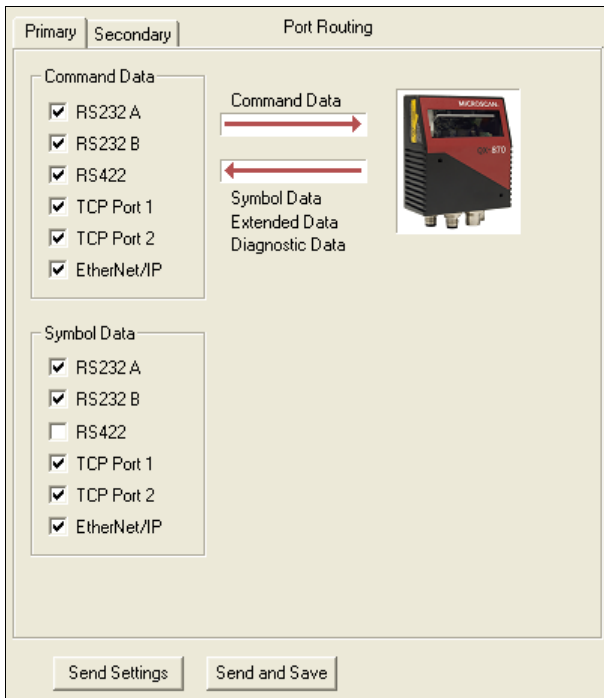

Port Routing Advantages

- Data can be routed in on one port and out on the same port or a different port like a switch or router. **Transparent Mode**, **Half Duplex Mode**, **Full Duplex Mode**, and **Custom Mode**.
- External Data Routing still follows the “To/From Host/Aux” paradigm. The new capability allows the customer to define the data direction—which port behaves as the “Host Port” and which port behaves as the “Aux Port”.
- Only one daisy chain setup required per system.
- Minimal configuration required for each port, with similar items grouped together.

RS-232 A

The following settings define the basic transmission speeds and digital standards that ensure common RS-232 formatting.

[-] RS232 A	
Baud Rate	115.2K
Parity	None
Stop Bits	One
Data Bits	Eight
Symbol Data Output	Enabled
Extra Symbol Information	Enabled
Diagnostics Output	Enabled
External Source Processing Mode	Command

Baud Rate

Can be used to transfer data faster or to match host port settings.
The rate at which the scanner and host transfer data back and forth.

Baud Rate	115.2K*
	600
	1200
	2400
	4800
	9600
	19.2K
	38.4K
	57.6K
	115.2K*

Parity

Only changed if necessary to match host setting.
An error detection routine in which one data bit per character is set to **1** or **0** so that the total number of bits in the data field is either even or odd.

Parity	None*
	None*
	Even
	Odd

Stop Bits

Only changed if necessary to match host setting.
One or two bits added to the end of each character to indicate the end of the character.

Stop Bits	One*
	One*
	Two

Data Bits

Only changed if necessary to match host setting.
One or two bits added to the end of each character to indicate the end of the character.

Data Bits	Eight*
	Seven
	Eight*

Symbol Data Output

Enables or disables decoded symbol data output from the scanner.

Symbol Data Output	Enabled*
	Disabled
	Enabled*

Extra Symbol Information

Enables or disables extra symbol information output from the scanner.

Extra Symbol Information	Enabled*
	Disabled
	Enabled*

Diagnostics Output

Enables or disables diagnostics output from the scanner.

Diagnostics Output	Enabled*
	Disabled
	Enabled*

External Source Processing Mode

Enables or disables processing of commands or data from sources external to the scanner.

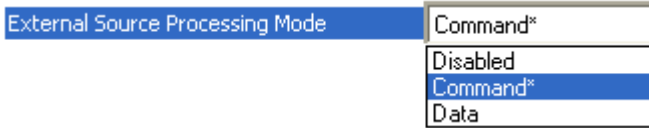

Command

Command enables command processing in the scanner.

Note: Command processing is always enabled for **RS-232 A**.

Data

Data enables RS-232 A as a data source port.

Note: The data path between **in** the source port and **out** the source port is always two-way. Data is copied from source data ports and all those source ports' data is transmitted to the destination port, and from the destination port to the source port.

RS-232 B

The following settings define the basic transmission speeds and digital standards that ensure common RS-232 formatting.

RS232 B	Enabled
Baud Rate	115.2K
Parity	None
Stop Bits	One
Data Bits	Eight
Symbol Data Output	Enabled
Extra Symbol Information	Enabled
Diagnostics Output	Enabled
External Source Processing Mode	Command

Baud Rate

Can be used to transfer data faster or to match host port settings.
The rate at which the scanner and host transfer data back and forth.

Baud Rate	115.2K*
	600
	1200
	2400
	4800
	9600
	19.2K
	38.4K
	57.6K
	115.2K*

Parity

Only changed if necessary to match host setting.
An error detection routine in which one data bit per character is set to **1** or **0** so that the total number of bits in the data field is either even or odd.

Parity	None*
	None*
	Even
	Odd

Stop Bits

Only changed if necessary to match host setting.
One or two bits added to the end of each character to indicate the end of the character.

Stop Bits	One*
	One*
	Two

Data Bits

Only changed if necessary to match host setting.

One or two bits added to the end of each character to indicate the end of the character.

Data Bits	Eight*
	Seven
	Eight*

Symbol Data Output

Enables or disables decoded symbol data output from the scanner.

Symbol Data Output	Enabled*
	Disabled
	Enabled*

Extra Symbol Information

Enables or disables extra symbol information output from the scanner.

Extra Symbol Information	Enabled*
	Disabled
	Enabled*

Diagnostics Output

Enables or disables diagnostics output from the scanner.

Diagnostics Output	Enabled*
	Disabled
	Enabled*

External Source Processing Mode

Enables or disables processing of commands or data from sources external to the scanner.

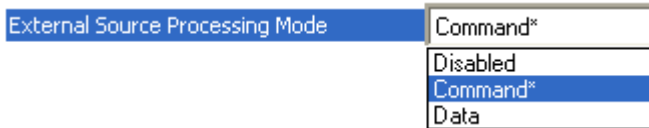

Command

Command enables command processing in the scanner.

Data

Data enables RS-232 B as a data source port.

Note: The data path between **in** the source port and **out** the source port is always two-way. Data is copied from source data ports and all those source ports' data is transmitted to the destination port, and from the destination port to the source port.

RS-422

The following settings define the basic transmission speeds and digital standards that ensure common RS-422 formatting.

RS422	Disabled
Baud Rate	115.2K
Parity	None
Stop Bits	One
Data Bits	Eight
Symbol Data Output	Disabled
Extra Symbol Information	Disabled
Diagnostics Output	Disabled
External Source Processing Mode	Command

Baud Rate

Can be used to transfer data faster or to match host port settings.
The rate at which the scanner and host transfer data back and forth.

Baud Rate	115.2K*
	600
	1200
	2400
	4800
	9600
	19.2K
	38.4K
	57.6K
	115.2K*

Parity

Only changed if necessary to match host setting.
An error detection routine in which one data bit per character is set to **1** or **0** so that the total number of bits in the data field is either even or odd.

Parity	None*
	None*
	Even
	Odd

Stop Bits

Only changed if necessary to match host setting.
One or two bits added to the end of each character to indicate the end of the character.

Stop Bits	One*
	One*
	Two

Data Bits

Only changed if necessary to match host setting.
One or two bits added to the end of each character to indicate the end of the character.

Data Bits	Eight*
	Seven
	Eight*

Symbol Data Output

Enables or disables decoded symbol data output from the scanner.

Symbol Data Output	Enabled*
	Disabled
	Enabled*

Extra Symbol Information

Enables or disables extra symbol information output from the scanner.

Extra Symbol Information	Enabled*
	Disabled
	Enabled*

Diagnostics Output

Enables or disables diagnostics output from the scanner.

Diagnostics Output	Enabled*
	Disabled
	Enabled*

External Source Processing Mode

Enables or disables processing of commands or data from sources external to the scanner.

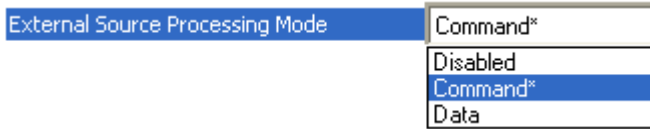

Command

Command enables command processing in the scanner.

Data

Data enables RS-422 as a data source port.

Note: The data path between **in** the source port and **out** the source port is always two-way. Data is copied from source data ports and all those source ports' data is transmitted to the destination port, and from the destination port to the source port.

Ethernet Status

Enables or disables Ethernet connectivity in the scanner.

Important: For further information about setting up TCP/IP with a PC, see Appendix G – [Configuring Ethernet TCP/IP](#).

[-] Ethernet	Enabled
IP Address	192.168.0.100
Subnet	255.255.0.0
Gateway	0.0.0.0
IP Address Mode	DHCP
[-] TCP Port 1	2001
Symbol Data Output	Enabled
Extra Symbol Information	Enabled
Diagnostics Output	Enabled
External Source Processing Mode	Command
[-] TCP Port 2	2003
Symbol Data Output	Enabled
Extra Symbol Information	Enabled
Diagnostics Output	Enabled
External Source Processing Mode	Command

IP Address

Enter the IP address of the scanner in this field.

[-] Ethernet	Enabled
IP Address	192.168.0.100
Subnet	255.255.0.0
Gateway	0.0.0.0
IP Address Mode	DHCP
[-] TCP Port 1	2001
Symbol Data Output	Enabled
Extra Symbol Information	Enabled
Diagnostics Output	Enabled
External Source Processing Mode	Command
[-] TCP Port 2	2003
Symbol Data Output	Enabled
Extra Symbol Information	Enabled
Diagnostics Output	Enabled
External Source Processing Mode	Command

Subnet

Enter the Subnet address of the scanner in this field.

[-] Ethernet	Enabled
IP Address	192.168.0.100
Subnet	255.255.0.0
Gateway	U.U.U.U
IP Address Mode	DHCP
[-] TCP Port 1	2001
Symbol Data Output	Enabled
Extra Symbol Information	Enabled
Diagnostics Output	Enabled
External Source Processing Mode	Command
[-] TCP Port 2	2003
Symbol Data Output	Enabled
Extra Symbol Information	Enabled
Diagnostics Output	Enabled
External Source Processing Mode	Command

Gateway

Enter the Gateway address of the scanner in this field.

[-] Ethernet	Enabled
IP Address	192.168.0.100
Subnet	255.255.0.0
Gateway	0 . 0 . 0 . 0
IP Address Mode	DHCP
[-] TCP Port 1	2001
Symbol Data Output	Enabled
Extra Symbol Information	Enabled
Diagnostics Output	Enabled
External Source Processing Mode	Command
[-] TCP Port 2	2003
Symbol Data Output	Enabled
Extra Symbol Information	Enabled
Diagnostics Output	Enabled
External Source Processing Mode	Command

IP Address Mode

Determines how the scanner's IP address will be defined.

[-] Ethernet	Enabled
IP Address	192.168.0.100
Subnet	255.255.0.0
Gateway	0.0.0.0
IP Address Mode	DHCP*
[-] TCP Port 1	Static
Symbol Data Output	DHCP*
Extra Symbol Information	Enabled
Diagnostics Output	Enabled
External Source Processing Mode	Command
[-] TCP Port 2	2003
Symbol Data Output	Enabled
Extra Symbol Information	Enabled
Diagnostics Output	Enabled
External Source Processing Mode	Command

Static

In **Static Mode**, the scanner uses the user-defined IP address entered in ESP.

DHCP

In **DHCP Mode**, the scanner automatically acquires the IP address, Subnet, and Gateway addresses from a DHCP or BOOTP server.

TCP Port 1

One of two TCP ports for Ethernet communication with the scanner. The default setting is **2001**.

[-] Ethernet	Enabled
IP Address	192.168.0.100
Subnet	255.255.0.0
Gateway	0.0.0.0
IP Address Mode	DHCP
[-] TCP Port 1	2001 1024 - 65535
Symbol Data Output	Enabled
Extra Symbol Information	Enabled
Diagnostics Output	Enabled
External Source Processing Mode	Command
[-] TCP Port 2	2003
Symbol Data Output	Enabled
Extra Symbol Information	Enabled
Diagnostics Output	Enabled
External Source Processing Mode	Command

Symbol Data Output

Enables or disables decoded symbol data output from the scanner.

Extra Symbol Information

Enables or disables extra symbol information output from the scanner.

Diagnostics Output

Enables or disables diagnostics output from the scanner.

External Source Processing Mode

Enables or disables processing of commands or data from sources external to the scanner.

Command

Command enables command processing in the scanner.

Data

Data enables Ethernet TCP Port 1 as a data source port.

Note: The data path between **in** the source port and **out** the source port is always two-way. Data is copied from source data ports and all those source ports' data is transmitted to the destination port, and from the destination port to the source port.

TCP Port 2

One of two TCP ports for Ethernet communication with the scanner. The default setting is **2003**.

[-] Ethernet	Enabled
IP Address	192.168.0.100
Subnet	255.255.0.0
Gateway	0.0.0.0
IP Address Mode	DHCP
[-] TCP Port 1	2001
Symbol Data Output	Enabled
Extra Symbol Information	Enabled
Diagnostics Output	Enabled
External Source Processing Mode	Command
[-] TCP Port 2	2003 1024 - 65535
Symbol Data Output	Enabled
Extra Symbol Information	Enabled
Diagnostics Output	Enabled
External Source Processing Mode	Command

Symbol Data Output

Enables or disables decoded symbol data output from the scanner.

Extra Symbol Information

Enables or disables extra symbol information output from the scanner.

Diagnostics Output

Enables or disables diagnostics output from the scanner.

External Source Processing Mode

Enables or disables processing of commands or data from sources external to the scanner.

Command

Command enables command processing in the scanner.

Data

Data enables Ethernet TCP Port 2 as a data source port.

Note: The data path between **in** the source port and **out** the source port is always two-way. Data is copied from source data ports and all those source ports' data is transmitted to the destination port, and from the destination port to the source port.

EtherNet/IP

Enables or disables EtherNet/IP operation in the scanner.

Important: See Appendix H, [Using EtherNet/IP](#), for detailed information about implementing EtherNet/IP in an application.

[-] Ethernet	Enabled
... IP Address	192.168.0.100
... Subnet	255.255.0.0
... Gateway	0.0.0.0
... IP Address Mode	DHCP
[-] TCP Port 1	2001
... Symbol Data Output	Enabled
... Extra Symbol Information	Enabled
... Diagnostics Output	Enabled
... External Source Processing Mode	Command
[-] TCP Port 2	2003
... Symbol Data Output	Enabled
... Extra Symbol Information	Enabled
... Diagnostics Output	Enabled
... External Source Processing Mode	Command
[-] EtherNet/IP	Enabled*
... Symbol Data Output	Disabled
... Extra Symbol Information	Enabled*
... Diagnostics Output	Enabled
... External Source Processing Mode	Command

Symbol Data Output

Enables or disables decoded symbol data output from the scanner.

Extra Symbol Information

Enables or disables extra symbol information output from the scanner.

Diagnostics Output

Enables or disables diagnostics output from the scanner.

External Source Processing Mode

Enables or disables processing of commands or data from sources external to the scanner.

Command

Command enables command processing in the scanner.

Data

Data enables EtherNet/IP as a data source port.

Note: The data path between **in** the source port and **out** the source port is always two-way. Data is copied from source data ports and all those source ports' data is transmitted to the destination port, and from the destination port to the source port.

Protocol Selection

In general, the point-to-point protocols will work well in most applications. They require no address and must use RS-232 or RS-422 communication standards.

Protocols define the sequence and format in which information is transferred between the scanner and the host, or in the case of **Multidrop**, between the scanners and a concentrator.

Note: In all protocol modes, the **Preamble** and **Postamble** character strings can be used to frame the decoded data, and both are included in calculating the **LRC** (Longitudinal Redundancy Check).

<input type="checkbox"/> Protocol Selection	Point-to-Point
--- Address	1
--- Protocol Port	RS232 A
<input type="checkbox"/> ACK / NAK Options	
--- RES	NUL
--- REQ	NUL
--- STX	NUL
--- ETX	NUL
--- ACK	ACK
--- NAK	NAK
<input type="checkbox"/> Polling Mode Options	
--- RES	EOT
--- REQ	ENQ
--- STX	STX
--- ETX	ETX
--- ACK	ACK
--- NAK	NAK
--- Response Timeout	5
--- LRC Status	Disabled

Protocol Options

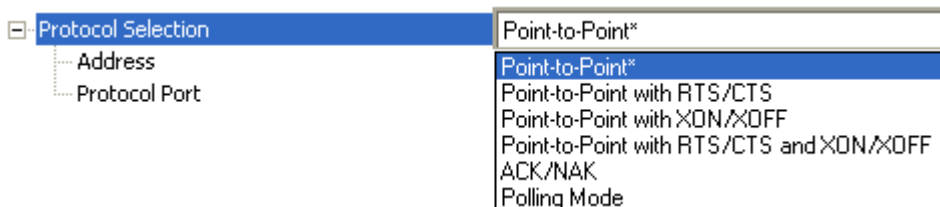

Point-to-Point (Standard)

Used only with RS-232 or RS-422.

Standard **Point-to-Point** requires no address and sends the data to the host whenever it is available, without a request or handshake from the host.

Point-to-Point with RTS/CTS

A scanner initiates a data transfer with an RTS (request-to-send) transmission. The host, when ready, responds with a CTS (clear-to-send) and the data is transmitted. RTS and CTS signals are transmitted over two dedicated wires as defined in the RS-232 standard. Used only with RS-232.

Point-to-Point with RTS/CTS (request-to-send/clear-to-send) is a simple hardware handshake protocol that allows a scanner to initiate data transfers to the host.

Point-to-Point with XON/XOFF

If an XOFF has been received from the host, data will not be sent to the host until the host sends an XON. During the XOFF phase, the host is free to carry on other chores and accept data from other devices. Used only with RS-232.

This option enables the host to send the XON and XOFF command as a single byte transmission command of start (**^Q**) or stop (**^S**).

Point-to-Point with RTS/CTS and XON/XOFF

Used only with RS-232.

This option is a combination of **Point-to-Point with RTS/CTS** and **Point-to-Point with XON/XOFF**.

ACK/NAK

See [ACK / NAK Options](#).

Polling Mode

See [Polling Mode Options](#).

Address

The **Protocol Address** can be any number between **1** and **50**.

<input type="checkbox"/> Protocol Selection	Point-to-Point
Address	1 (1-50)
Protocol Port	RS232 A
<input type="checkbox"/> ACK / NAK Options	
RES	NUL
REQ	NUL
STX	NUL
ETX	NUL
ACK	ACK
NAK	NAK
<input type="checkbox"/> Polling Mode Options	
RES	EOT
REQ	ENQ
STX	STX
ETX	ETX
ACK	ACK
NAK	NAK
Response Timeout	5
LRC Status	Disabled

Protocol Port

RS-232 A or **RS-422** can be used as **Protocol Ports**.

<input type="checkbox"/> Protocol Selection	Point-to-Point
Address	1
Protocol Port	RS232 A*
<input type="checkbox"/> ACK / NAK Options	RS232 A*
RES	RS422
REQ	NUL
STX	NUL
ETX	NUL
ACK	ACK
NAK	NAK
<input type="checkbox"/> Polling Mode Options	
RES	EOT
REQ	ENQ
STX	STX
ETX	ETX
ACK	ACK
NAK	NAK
Response Timeout	5
LRC Status	Disabled

ACK / NAK Options

These parameters take effect for **ACK/NAK** on the main RS-232 or RS-422 ports (not on the Auxiliary Port), and are completely independent of the **Polling Mode Options**.

The scanner always follows the protocol in both directions (to and from the host). There is no option to disable it from either direction.

[-] Protocol Selection	Point-to-Point
Address	1
Protocol Port	RS232 A
[-] ACK / NAK Options	
RES	NUL
REQ	NUL
STX	NUL
ETX	NUL
ACK	ACK
NAK	NAK
[-] Polling Mode Options	
RES	EOT
REQ	ENQ
STX	STX
ETX	ETX
ACK	ACK
NAK	NAK
Response Timeout	5
LRC Status	Disabled

RES-NAK Defaults

<i>RES: (Reset)</i>	NUL (0x00)
<i>REQ: (Request)</i>	NUL (0x00)
<i>STX: (Start of Text)</i>	NUL (0x00)
<i>ETX: (End of Text)</i>	NUL (0x00)
<i>ACK: (Acknowledge)</i>	ACK (0x06)
<i>NAK: (Negative Acknowledge)</i>	NAK (0x15)

ACK/NAK Protocol

The following are general outlines of the **ACK/NAK** protocol. Items that are framed by brackets ([]) can either be disabled or enabled. LRC does not include STX, but it does include preamble, postamble, and ETX.

Symbol Data Output

TX to host: [STX] [preamble] SYMBOL DATA [postamble] [ETX] [LRC]

Response from host: ACK/NAK. Sent when LRC, ETX, postamble, or timeout (waiting for more data) are detected (if REQ is disabled) depending on what is enabled.

Commands from Host to Scanner

TX to Scanner: [STX] <command> [ETX] [LRC]

Response from Scanner: ACK/NAK. Sent when LRC, ETX, or command-ending angle bracket '>' are received, depending on what is enabled.

Command Response from Scanner to Host

TX to host: [STX] [preamble] COMMAND RESPONSE DATA [postamble] [ETX] [LRC]

Response from host: ACK/NAK. Sent when LRC, ETX, postamble, command-ending angle bracket '>', or timeout (waiting for more data) are detected, depending on what is enabled.

As with **Polling Mode <K140,5>**, the scanner can optionally perform the REQ and RES event sequences in ACK/NAK mode. If the sender does not receive an ACK or NAK, it will send REQ to request such a response (if enabled). When the sender receives an ACK, too many NAKs, or times out (if already enabled), it will send a RES (if enabled) to terminate the transaction.

Note: See [ACK/NAK Data Flow Examples](#) in Appendix E for sample ACK/NAK communication scenarios.

Polling Mode Options

These parameters only take effect for **Polling Mode <K140,5>** on the main RS-232 or RS-422 ports (not on the Auxiliary Port), and are completely independent of the **ACK/NAK Options <K147>**.

The values of protocol characters can be changed, but the protocol events cannot be disabled. The polling mode address is configured in the **<K140>** command.

To enable true multidrop protocol, the RS422/485 port must be enabled, **<K102,1>**, in order to turn the transmitter on and off. If RS-232 is enabled instead of RS422/485, **<K102,0>**, then **Polling Mode** will operate as a **Point-to-Point** polling protocol. This is because the RS-232 transmitter is always left on when enabled.

Note: See **ACK/NAK Data Flow Examples** in Appendix E for sample **Polling Mode** communication scenarios.

[-] Protocol Selection	Point-to-Point
-- Address	1
-- Protocol Port	RS232 A
[-] ACK / NAK Options	
-- RES	NUL
-- REQ	NUL
-- STX	NUL
-- ETX	NUL
-- ACK	ACK
-- NAK	NAK
[-] Polling Mode Options	
-- RES	EOT
-- REQ	ENQ
-- STX	STX
-- ETX	ETX
-- ACK	ACK
-- NAK	NAK
-- Response Timeout	5
-- LRC Status	Disabled

RES-NAK Defaults

RES: (Reset)	EOT (0x04)
REQ: (Request)	ENQ (0x05)
STX: (Start of Text)	STX (0x02)
ETX: (End of Text)	ETX (0x03)
ACK: (Acknowledge)	ACK (0x06)
NAK: (Negative Acknowledge)	NAK (0x15)

Response Timeout

Only used when a response is required from the host. While in **Multidrop**, if the scanner does not receive an **ACK** or **NAK** from the host after sending polled data, it will act on a fault. The scanner can be set to wait indefinitely by setting **Response Timeout** to zero.

The time that the scanner will wait before timing out if **ACK**, **NAK**, and **ETX** are enabled, and a host response is expected.

[-] Protocol Selection	Point-to-Point
Address	1
Protocol Port	RS232 A
[-] ACK / NAK Options	
RES	NUL
REQ	NUL
STX	NUL
ETX	NUL
ACK	ACK
NAK	NAK
[-] Polling Mode Options	
RES	EOT
REQ	ENQ
STX	STX
ETX	ETX
ACK	ACK
NAK	NAK
Response Timeout	0.005 <input type="button" value="▲"/> <input type="button" value="▼"/> Seconds
LRC Status	Disabled

LRC Status

Used when extra data integrity is required.

An error-checking routine that verifies the accuracy of transmissions. It is the exclusive OR of all characters following the **STX** (start of text) up to and including the **ETX** (end of text). What this means is that the binary representation of all the characters in a transmission are cumulatively added in a column and each resulting odd integer is assigned a 1 and each even integer a 0 (two 1s = 0, two 0s = 0, a 1 and a 0 = 1). The extra LRC character is then appended to the transmission, and the receiver (usually the host) performs the same addition and compares the results.

<input type="checkbox"/> Protocol Selection	Point-to-Point
Address	1
Protocol Port	RS232 A
<input type="checkbox"/> ACK / NAK Options	
RES	NUL
REQ	NUL
STX	NUL
ETX	NUL
ACK	ACK
NAK	NAK
<input type="checkbox"/> Polling Mode Options	
RES	EOT
REQ	ENQ
STX	STX
ETX	ETX
ACK	ACK
NAK	NAK
Response Timeout	5
LRC Status	Disabled*
	Disabled*
	Enabled

External Data Routing

External Data Routing settings configure the global operation of all external data port settings.

External Data Routing	Disabled
Destination Port	RS232 A
Ambles to Source	Disabled
Echo to Source	Disabled
Output at End of Read Cycle	Disabled
Output at ETX	CR
Output at Timeout	200

External Data Routing Options

External Data Routing	Disabled*
Destination Port	Disabled*
Ambles to Source	Transparent
Echo to Source	Half Duplex
Output at End of Read Cycle	Full Duplex
Output at ETX	Custom
Output at Timeout	CR
	200

Transparent Mode

When **Transparent Mode** is enabled, the following conditions apply:

Symbol Data to Source = Fixed to **Enabled**

Ambles to Source = Fixed to **Disabled**

Echo to Source = Fixed to **Enabled**

Output at End of Read Cycle = Fixed to **Enabled**

Output at ETX = Fixed to **Enabled** with user-defined characters. Default character will be used if this setting is set to Disabled.

Output at Timeout = Fixed to **Enabled** with user-defined timeout. Default time will be used if this setting is set to Disabled.

Mode of Operation

- Source Port data will echo back to itself.
- Source Port data will always pass through even when the Destination Port is in Polling Mode with the host.
- Whenever ETX is received on the Source Port or symbol data is generated, the data will be sent to the Destination Port with its data appearing between the Preamble and symbol data.
- Source Port data will always be sent to the Destination Port with a Preamble and Postamble.
- Symbol data will be sent to the Source Port on a good read without Preamble or Postamble in Point-to-Point protocol even if the Destination Port is in Polling Mode with the host.
- Destination Port data always echoes to the Source Port even if the Destination Port is in Polling Mode.

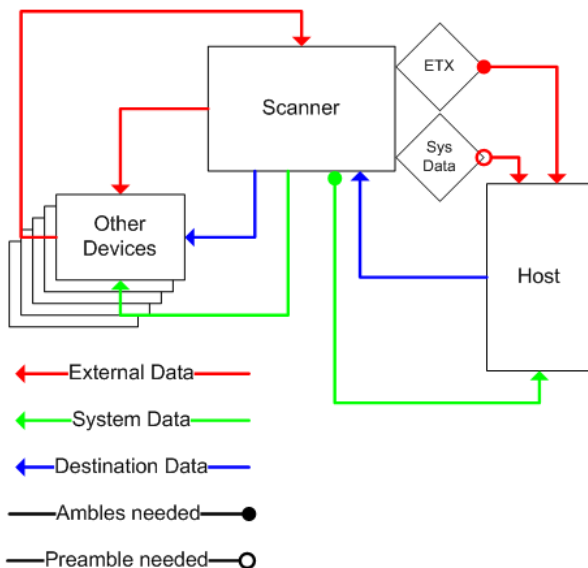

Half Duplex Mode

When **Half Duplex Mode** is enabled, the following conditions apply:

Symbol Data to Source = Fixed to **Enabled**

Ambles to Source = Fixed to **Enabled**

Echo to Source = Fixed to **Disabled**

Output at End of Read Cycle = Fixed to **Disabled**

Output at ETX = Fixed to **Disabled** with user-defined characters. Default character will be used if this setting is set to Disabled.

Output at Timeout = Fixed to **Disabled** with user-defined timeout. Default time will be used if this setting is set to Disabled.

Mode of Operation

- Source Port data is not echoed back to itself.
- Source Port data is ignored when the Destination Port is in Polling Mode.
- Source Port data or symbol data is sent to the Destination Port whenever it is received.
- Source Port data is sent to the Destination Port without a Preamble or Postamble.
- Symbol data is sent to the Source Port and the Destination Port at the same time, and conforms to the communication parameters.
- Destination Port data is echoed to the Source Port in an un-pollled mode.

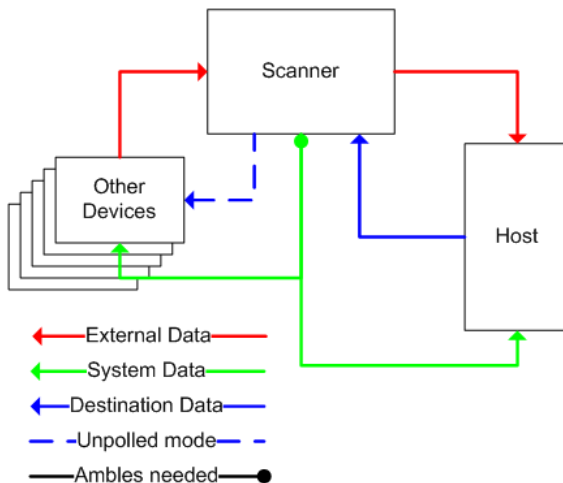

Full Duplex Mode

When **Full Duplex Mode** is enabled, the following conditions apply:

Symbol Data to Source = Fixed to **Disabled**

Ambles to Source = Fixed to **Disabled**

Echo to Source = Fixed to **Disabled**

Output at End of Read Cycle = Fixed to **Disabled**

Output at ETX = Fixed to **Disabled** with user-defined characters. Default character will be used if this setting is set to Disabled.

Output at Timeout = Fixed to **Disabled** with user-defined timeout. Default time will be used if this setting is set to Disabled.

Mode of Operation

- Source Port data is not echoed back to itself.
- Source Port data is ignored when the Destination Port is in Polling Mode.
- Source Port data or symbol data is sent to the Destination Port whenever it is received.
- Source Port data is always sent to the Destination Port without a Preamble or Postamble.
- Symbol data is not sent to the Source Port.
- Destination port data is echoed to the source port in an un-pollled mode.

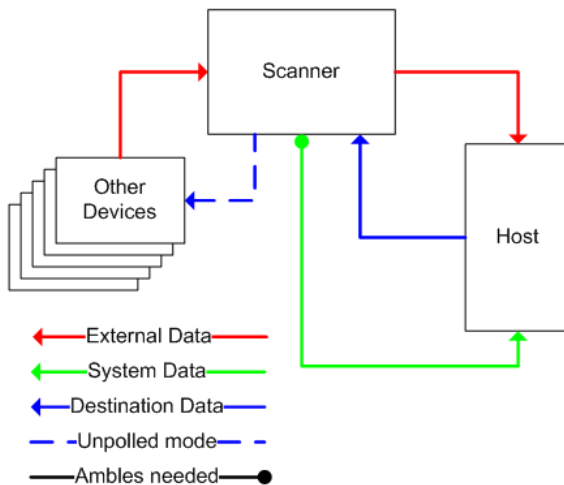

Custom Mode

Custom allows for user-defined communication (Ambles to Source, Echo to Source, Output at End of Read Cycle, Output at ETX, Output at Timeout).

Destination Port

Determines the port to which data will be sent.

External Data Routing	Disabled
Destination Port	RS232 A*
Ambles to Source	RS232 A*
Echo to Source	RS232 B
Output at End of Read Cycle	RS422
Output at ETX	TCP Port 1
Output at Timeout	TCP Port 2
	EtherNet/IP

Ambles to Source

Enables or Disables the ability to send Preambles and Postambles to the Source port.

External Data Routing	Disabled
Destination Port	RS232 A
Ambles to Source	Disabled*
Echo to Source	Disabled*
Output at End of Read Cycle	Enabled
Output at ETX	CR
Output at Timeout	200

Echo to Source

Enables or Disables the ability to send an Echo to the Source port.

External Data Routing	Disabled
Destination Port	RS232 A
Ambles to Source	Disabled
Echo to Source	Disabled*
Output at End of Read Cycle	Disabled*
Output at ETX	Enabled
Output at Timeout	200

Output at End of Read Cycle

Enables or Disables the ability to output data at the end of read cycle.

External Data Routing	Disabled
Destination Port	RS232 A
Ambles to Source	Disabled
Echo to Source	Disabled
Output at End of Read Cycle	Disabled*
Output at ETX	Disabled*
Output at Timeout	Enabled

Output at ETX

Determines the output at ETX.

- [-] External Data Routing Disabled
- Destination Port RS232 A
- Ambles to Source Disabled
- Echo to Source Disabled
- Output at End of Read Cycle Disabled
- Output at ETX
- Output at Timeout

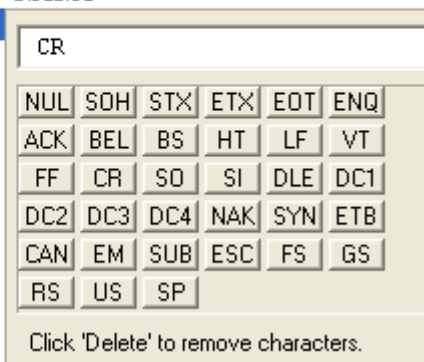

A dialog box for selecting a character. It features a text input field at the top containing 'CR'. Below the input field is a grid of buttons, each labeled with a control character: NUL, SOH, STX, ETX, EOT, ENQ, ACK, BEL, BS, HT, LF, VT, FF, CR, SO, SI, DLE, DC1, DC2, DC3, DC4, NAK, SYN, ETB, CAN, EM, SUB, ESC, FS, GS, RS, US, SP. At the bottom of the dialog, there is a text label: 'Click 'Delete' to remove characters.'

Output at Timeout

Determines the Timeout value for output.

- [-] External Data Routing Disabled
- Destination Port RS232 A
- Ambles to Source Disabled
- Echo to Source Disabled
- Output at End of Read Cycle Disabled
- Output at ETX
- Output at Timeout

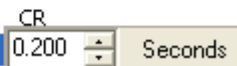

An input field for the timeout value. The text 'CR' is visible above the field. The field contains the value '0.200' followed by a spinner control and the unit 'Seconds'.

Array Communication Modes

[-] Array Communication Modes	Disabled
Source	RS232 B
Daisy Chain ID Status	Disabled
Daisy Chain ID	1 /

Mode

Daisy Chain

When set to **Daisy Chain**, follows Omron Microscan Daisy Chain protocol.

Note: Daisy Chain can also be autoconfigured by sending the **Daisy Chain Autoconfigure** serial command.

[-] Array Communication Modes	Disabled*
Source	Disabled*
Daisy Chain ID Status	Daisy Chain

Source

Defines the communication port.

[-] Array Communication Modes	Disabled
Source	RS232 B*
Daisy Chain ID Status	RS232 A
Daisy Chain ID	RS232 B*
	RS422
	TCP Port 1
	TCP Port 2

Daisy Chain ID Status

When enabled, the scanner will append a two-character prefix to each scanner in the array. This allows the user to identify which scanner sent the data.

Note: Daisy Chain ID will automatically disable Symbol Data Output, Extra Symbol Information, and Diagnostics Output for the Source Port.

Symbol Data Output will be automatically enabled, Extra Symbol Information will be automatically enabled, and Diagnostics Output will be automatically disabled for the Destination Port.

[-] Array Communication Modes	Disabled
Source	RS232 B
Daisy Chain ID Status	Disabled*
Daisy Chain ID	Disabled*
	Enabled

Daisy Chain ID

The **Daisy Chain ID** is a two-character identifier.

- [-] Array Communication Modes Disabled
 - Source RS232 B
 - Daisy Chain ID Status Disabled
 - **Daisy Chain ID**

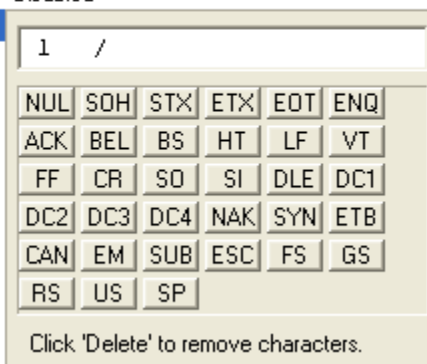

1 /					
NUL	SOH	STX	ETX	EOT	ENQ
ACK	BEL	BS	HT	LF	VT
FF	CR	SO	SI	DLE	DC1
DC2	DC3	DC4	NAK	SYN	ETB
CAN	EM	SUB	ESC	FS	GS
RS	US	SP			

Click 'Delete' to remove characters.

Daisy Chain Autoconfigure

For quick setup of a daisy chain configuration.

The command to **Autoconfigure** the daisy chain is sent to the primary scanner and the software responds in the following ways:

- Counts the number of secondary scanners in the daisy chain.
- Assigns an internal ID number (1...n) to each secondary scanner, where the first secondary scanner is number **1** (the primary scanner's ID being a **0**).
- Propagates the communication settings and the relevant operating modes of the primary scanner to the ports of each secondary scanner.
- Resets each secondary scanner.
- Confirms that each secondary scanner has acquired the new settings.

When setting up a daisy chain operation, perform the following steps:

1. Set the primary scanner (the one connected to the host) to **Serial Data** Trigger Mode. This sets all the scanners in the chain to **Serial Data** when the command is executed.

Important: All secondary scanners must be set to **Serial Data** Trigger Mode for **Daisy Chain** to function.

Before **Autoconfigure**, the primary scanner must be set to **Serial (S)**:

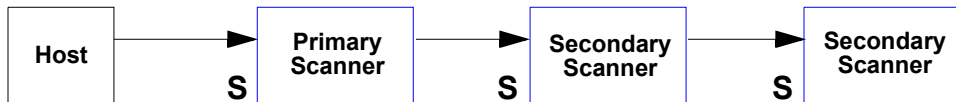

2. Send the **<K150DAISY>** command from ESP's Terminal.
3. If necessary, set the primary scanner to **External Edge**.

After **Autoconfigure**, the primary scanner can be set to **External Edge (E)**, but the other scanners must remain in **Serial (S)**:

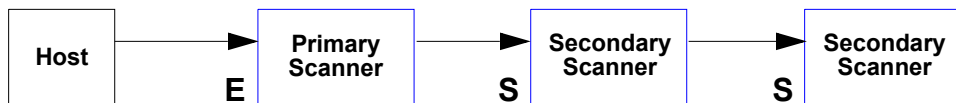

Important: If the scanner is Ethernet-enabled, first check to determine if **RS-232 B** is available. If it is available, set RS-232 B as the **Source** port in **Array Communication Modes**. Otherwise, set RS-232 A as the Source port. Port Routing for Symbol Data Output and Extra Symbol Information will be disabled on the Source port.

Preamble

Useful for identifying and controlling incoming data. For example, defining the preamble as a carriage return and a line feed causes each decoded message to be displayed on its own line.

<input type="checkbox"/> Preamble	Disabled
<input type="checkbox"/> Preamble Characters	CR

Preamble Characters

Allows the user to define up to four postamble characters that can be added to the end of the decoded data

<input type="checkbox"/> Preamble	Disabled
<input type="checkbox"/> Preamble Characters	

CR

SOH	STX	ETX	EOT	ENQ	ACK
BEL	BS	HT	LF	VT	FF
CR	SO	SI	DLE	DC1	DC2
DC3	DC4	NAK	SYN	ETB	CAN
EM	SUB	ESC	FS	GS	RS
US	SP				

Click 'Delete' to remove characters.

Postamble

Useful for identifying and controlling incoming data. For example, defining the postamble as a carriage return and a line feed causes each decoded message to be displayed on its own line.

<input type="checkbox"/> Preamble	Disabled
<input type="checkbox"/> Preamble Characters	CR

Postamble Characters

Allows the user to define up to four postamble characters that can be added to the end of the decoded data.

Postamble Enabled

Postamble Characters

CR LF

SOH	STX	ETX	EOT	ENQ	ACK
BEL	BS	HT	LF	VT	FF
CR	SO	SI	DLE	DC1	DC2
DC3	DC4	NAK	SYN	ETB	CAN
EM	SUB	ESC	FS	GS	RS
US	SP				

Click 'Delete' to remove characters.

Read Cycle

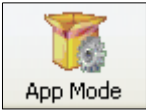

Click the **App Mode** button and then the **Parameters** button to display the tree control tabs.

Then click the **Read Cycle** tab to display the Read Cycle tree control.

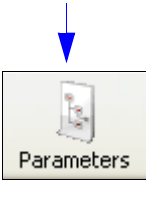

Parameters	ESP Values
[-] Read Cycle	
[+] Multisymbol	
[-] Trigger	
Mode	Continuous Read
[-] Trigger Filter Duration	
Leading Edge	313
Trailing Edge	313
External Trigger State	Active Closed*
[+] Serial Trigger	
[+] Decodes Before Output	
[+] End of Read Cycle	
Processing Timeout	200
[+] Reader Setup	
[+] Laser Setup	

The * indicates that the setting is the default.

To open nested options, **single-click** the +.

To change a setting, **double-click** the setting and use the cursor to scroll through the options.

Note: Read Cycle settings can also be sent to the scanner from ESP's Terminal using Omron Microscan's K command format. Refer to the **Read Cycle** section of **Appendix E**.

Read Cycle Setup

Setting up read cycle and triggering parameters involves a series of decisions based on the particular application, as follows:

1. Select the number of symbols to be read in a single cycle.
2. Decide on the trigger type to be used: if serial, choose a serial character; if external, choose either **External Level** or **External Edge**.
3. Designate how the read cycle should end (**Timeout**, **New Trigger**).

Multisymbol

Multisymbol is commonly used in shipping applications where a shipping symbol contains individual symbols for part number, quantity, etc. This feature allows one trigger to pick up all the symbols.

Multisymbol allows the user to define up to 100 symbols that can be read in a single read cycle.

The following conditions apply:

- The maximum number of characters in a read cycle is 3,000 for all symbols.
- All No Read messages are posted at the end of the data string, unless output filtering is enabled.
- If more than one symbol is within the field of view at the same time, symbol data may not be displayed in the order of appearance.
- If **Matchcode Type** is set to **Sequential** or if **Trigger** is set to **Continuous Read 1 Output**, the scanner will behave as if **Number of Symbols** were set to **1**, regardless of the user-defined configuration.

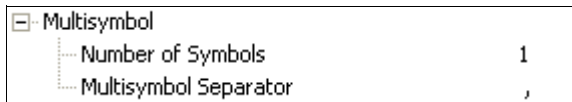

Number of Symbols

Number of Symbols is the number of different symbols that can be read in a single read cycle.



Multisymbol Separator

Multisymbol Separator is used to delimit or separate data fields with a user-defined character.

The Multisymbol Separator can be any valid ASCII character, inserted between each symbol read when Number of Symbols is set to any number greater than 1.

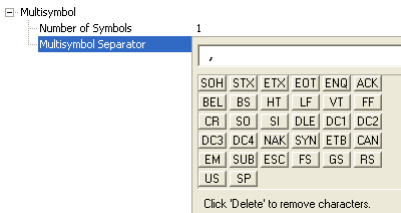

Trigger

The **Trigger** is the event that initiates a read cycle.

Note: When calibrating the scanner or testing read rate, the current trigger setting will be disregarded.

Trigger	
Mode	Continuous Read
Trigger Filter Duration	
Leading Edge	313
Trailing Edge	313
External Trigger State	Active Closed

Trigger Mode

Continuous Read

Continuous Read is useful in testing symbol readability or scanner functions. It is not recommended for normal operations.

In Continuous Read, trigger input options are disabled, the scanner is always in the read cycle, and it will attempt to decode and transmit data for every symbol. If a single symbol stays within read range for multiple read cycles, its data will be transmitted repeatedly until it leaves the read range.

The scanner sends replies to serial commands that require responses when symbol data is transmitted, or read cycle timeout is enabled and a timeout occurs. Depending on the combination of enabled symbologies and the Threshold Mode setting, the scanner may take longer than the timeout to process symbol data.

Trigger	
Mode	Continuous Read*
Trigger Filter Duration	
Leading Edge	
Trailing Edge	
External Trigger State	

Note: When to Output and No Read options have no affect on **Continuous Read**.

Continuous Read 1 Output

Continuous Read 1 Output can be useful in applications where it is not feasible to use a trigger and all succeeding symbols contain different information. It is also effective in applications where the objects are presented by hand.

In **Continuous Read 1 Output** the scanner self-triggers whenever it decodes a new symbol or a timeout occurs.

If **End of Read Cycle Mode** is set to **Timeout** and the symbol doesn't change, the output is repeated at the end of each timeout period. For example, if **Timeout** is set to one second, the scanner sends the symbol data immediately and repeats the output at intervals of one second for as long as the symbol remains in the field of view.

If **End of Read Cycle Mode** is set to **New Trigger**, the scanner will send the current symbol data immediately, *but only once*. A new symbol appearing in the scanner's range will be read and sent immediately, provided it is not identical to the previous symbol.

Caution: In automated environments, **Continuous Read 1 Output** is not recommended because there is typically no reliable way to verify that a symbol was missed.

Note: If **Trigger Mode** is set to **Continuous Read 1 Output**, the scanner will behave as if **Number of Symbols** were set to **1**, regardless of the user-defined configuration.

External Level

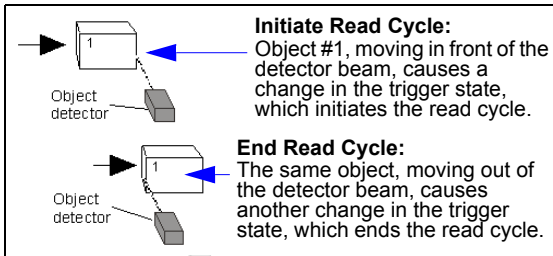

This mode is effective in an application where the speeds of the conveying apparatus are variable and the time the scanner spends reading each object is not predictable. It also allows the user to determine if a No Read has occurred.

External Level allows the read cycle (active state) to begin when a trigger (change of state) from an external sensing device is received. The read cycle persists until the object moves out of the sensor range and the active trigger state changes again.

Important: **Level** and **Edge** apply to the active logic state (**Negative** or **Positive**) that exists while the object is in a read cycle, between the rising edge and the falling edge. *Rising edge* is the trigger signal associated with the appearance of an object. *Falling edge* is the trigger signal associated with the subsequent disappearance of the object. This applies both to **External Level** and **External Edge**.

External Edge

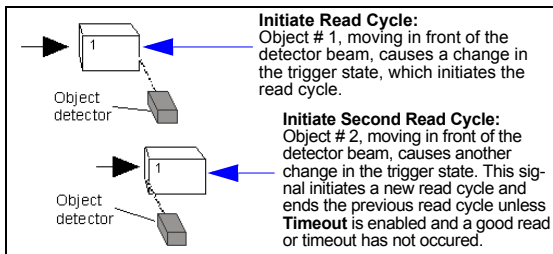

This mode is highly recommended in any application where conveying speed is constant, or if spacing, object size, or read cycle timeouts are consistent.

External Edge, as with **Level**, allows the read cycle (active state) to begin when a trigger (change of state) from an external sensing device is received. However, the passing of an object out of sensor range does not end the read cycle. The read cycle ends with a good read output, or, depending on the **End of Read Cycle Mode** setting, a timeout or new trigger occurs.

Serial Data

Serial Data is effective in a highly controlled environment where the host knows precisely when the object is in the field of view. It is also useful in determining if a No Read has occurred.

In **Serial Data**, the scanner accepts an ASCII character from the host or controlling device as a trigger to start a read cycle. A **Serial Data** trigger behaves the same as an **External Edge** trigger.

Serial commands are entered inside angle brackets, as shown here: **<n>**.

Note: In **Serial Data**, sending a non-delimited start serial character will start a read cycle; however, a non-delimited stop serial character has no effect.

Serial Data and Edge

Serial Data and Edge is seldom used but can be useful in an application that primarily uses an external sensing device but occasionally needs to be triggered manually.

An auxiliary terminal can be connected to the auxiliary port so the user can send the serial trigger character through the scanner to the host.

In this mode the scanner accepts either a serial ASCII character or an external trigger pulse to start the read cycle.

Note: In **Serial Data**, sending a non-delimited start serial character will start a read cycle; however, a non-delimited stop serial character has no effect.

Trigger Filter Duration

Leading Edge

Used to ignore accidental triggers when **Trigger Mode** is set to **External Edge** or **External Level**.

To consider a change in state on the trigger input, the level must be stable for the trigger filter duration. In an edge mode, the scanner will trigger a read cycle if the active state has been uninterrupted for the entire trigger filter duration. In a level mode, the leading edge is filtered such that on an active edge, the state must be held interrupted for the trigger filter duration before a trigger will occur.

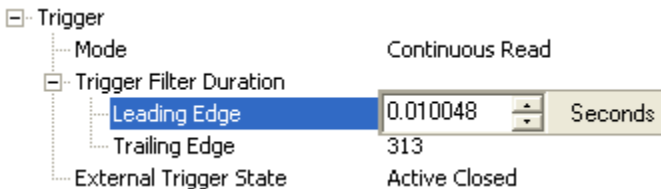

Trailing Edge

Used to ignore accidental triggers when **Trigger Mode** is set to **External Edge** or **External Level**.

To consider a change in state on the trigger input, the level must be stable for the trigger filter duration. In an edge mode, the scanner will trigger a read cycle if the active state has been uninterrupted for the entire trigger filter duration. In a level mode, the trailing edge is filtered such that on the falling edge, the state must be held for the trigger filter duration before the trigger will be deemed inactive.

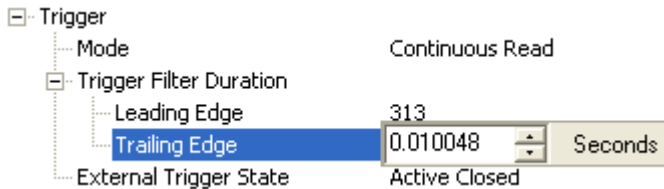

External Trigger State

Allows users to select the trigger polarity that will be used in their application.

Determines the active state of the trigger signal applied to the cable input of the scanner.

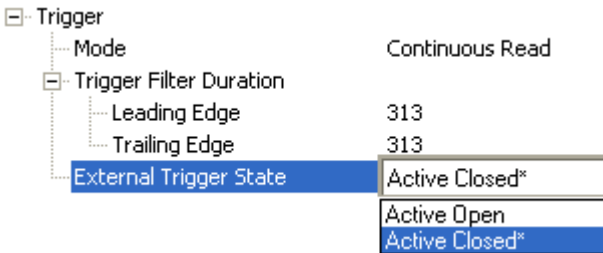

Serial Trigger

Allows the user to define the trigger character and delimiters that start and stop the read cycle. A serial trigger is considered an online host command and requires the same command format as all host commands. It must be entered within angle bracket delimiters < and > or, in the case of non-delimited triggers, it must define individual start and stop characters.

Serial Trigger	
Character (Delimited)	SP
Start Character (Non-Delimited)	0x00 NUL
Stop Character (Non-Delimited)	0x00 NUL

Character (Delimited)

Allows the user to define the trigger character that initiates the read cycle. A single ASCII host serial trigger character that initiates the read cycle. A delimited trigger character is one that either starts or ends the read cycle and is enclosed by delimiters such as < and >.

Serial Trigger

- Character (Delimited) SP
- Start Character (Non-Delimited) 0x00 NUL
- Stop Character (Non-Delimited) 0x00 NUL

SOH	STX	ETX	EDT	ENQ	ACK
BEL	BS	HT	LF	VT	FF
CR	SO	SI	DLE	DC1	DC2
DC3	DC4	NAK	SYN	ETB	CAN
EM	SUB	ESC	FS	GS	RS
US	SP				

Click 'Delete' to remove characters.

Note: **Serial Data** or **Serial Data and Edge** trigger mode must be enabled for **Serial Trigger Character** to function.

Start Character (Non-Delimited)

Useful in applications where different characters are required to start a read cycle.

A single ASCII host serial trigger character that starts the read cycle and is not enclosed by delimiters such as < and >.

Non-delimited **Start** characters can be defined and will function according to the trigger event.

When defining **Start** trigger characters, the following rules apply:

- In **External Edge** the scanner looks only for the **Start** trigger character and ignores any **Stop** trigger character that may be defined.
- In **External Level** the **Start** trigger character begins the read cycle and the **Stop** trigger character ends it. Note that even after a symbol has been decoded and the symbol data transmitted, the scanner remains in **External Level** trigger read cycle until a **Stop** character is received.
- In **Serial Data and Edge** trigger mode, either a **Start** trigger character or a hardware trigger can start an edge trigger read cycle.

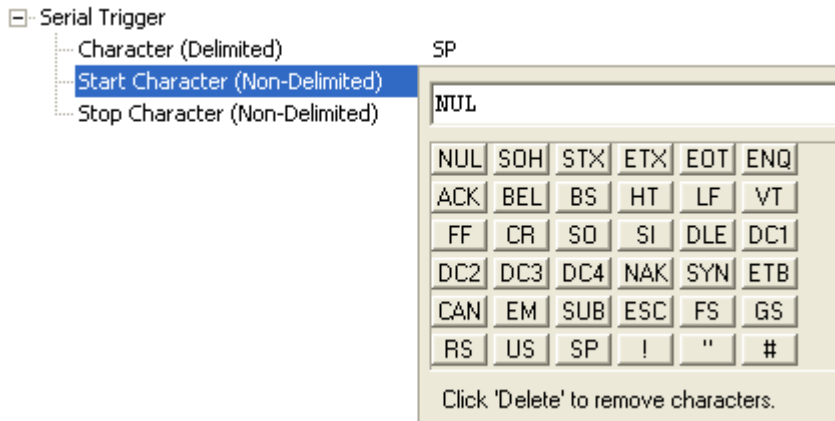

Stop Character (Non-Delimited)

Useful in applications where different characters are required to end a read cycle.

A single ASCII host serial trigger character that ends the read cycle and is not enclosed by delimiters such as < and >.

Non-delimited **Stop** characters can be defined and will function according to the trigger event.

When defining **Stop** trigger characters, the following rules apply:

- In **External Edge** the scanner looks only for the **Start** trigger character and ignores any **Stop** trigger character that may be defined.
- In **External Level** the **Start** trigger character begins the read cycle and the **Stop** trigger character ends it. Note that even after a symbol has been decoded and the symbol data transmitted, the scanner remains in **External Level** trigger read cycle until a **Stop** character is received.
- In **Serial Data and Edge** trigger mode, either a **Start** trigger character or a hardware trigger can start an edge trigger read cycle.

Serial Trigger

- Character (Delimited) SP
- Start Character (Non-Delimited) 0x00 NUL
- Stop Character (Non-Delimited)

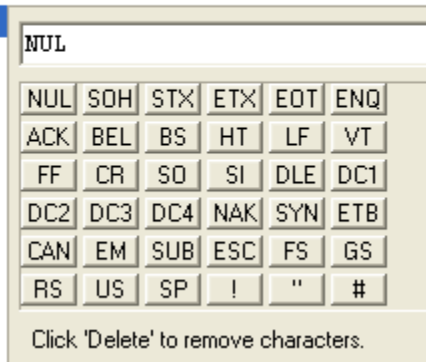

NUL	SOH	STX	ETX	EOT	ENQ
ACK	BEL	BS	HT	LF	VT
FF	CR	SO	SI	DLE	DC1
DC2	DC3	DC4	NAK	SYN	ETB
CAN	EM	SUB	ESC	FS	GS
RS	US	SP	!	"	#

Click 'Delete' to remove characters.

Decodes Before Output

Decodes Before Output specifies the number of times a symbol needs to be decoded to qualify as a good read.



Decodes Before Output Mode



Non-Consecutive

In **Non-Consecutive** mode, decodes will be counted in any order. Multiple symbols can be decoded in any order.

Consecutive

In **Consecutive** mode, all decodes must be identical until the good read count is satisfied. Only one unique symbol can be qualified at a time.

Number Before Output

The number of successful decodes performed by the scanner before symbol data is output.



End of Read Cycle

The read cycle is the time during which the scanner will attempt to decode a symbol. A read cycle can be ended by a timeout or a new trigger, or a combination of the two.

[-] End of Read Cycle	
Mode	Timeout
Read Cycle Timeout	100

End of Read Cycle Mode

Note: When operating in **Continuous Read** or **Continuous Read 1 Output**, the scanner is always in the read cycle.

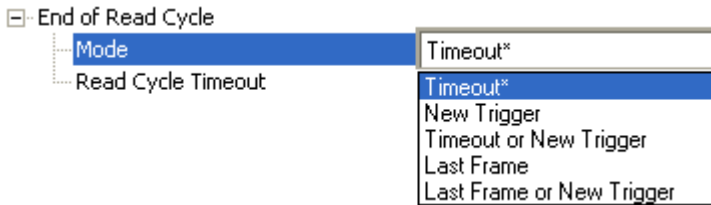

Timeout

Typically used with **Continuous Read 1 Output** and **Serial Data and Edge**.

It is effective in highly controlled applications when the maximum length of time between objects can be predicted. It assures that a read cycle ends before the next symbol appears, giving the system extra time to decode and transmit the data to the host.

Timeout ends the read cycle, causing the scanner to stop reading symbols and send the symbol data or No Read message when the time set in **Timeout** elapses (times out), if **When to Output Symbol Data** is set to **End of Read Cycle**.

If in **Continuous Read 1 Output**, a timeout initiates a new read cycle and allows the same symbol to be read again.

With **External Edge**, **Serial Data**, or **Serial Data and Edge** enabled, a timeout ends the read cycle and symbol data or a No Read message is sent to the host.

With **External Level** enabled, the read cycle does not end until the falling edge trigger occurs or a timeout occurs. The next read cycle does not begin until the next rising edge trigger.

New Trigger

New Trigger is an effective way to end a read cycle when objects move past the scanner at irregular intervals (not timing-dependent).

New Trigger ends the current read cycle and initiates a new one when a new trigger occurs. **New Trigger** refers only to a rising edge trigger.

With **External Edge**, **Serial Data**, or **Serial Data and Edge** enabled, an edge or serial trigger ends a read cycle and initiates the next read cycle.

In the case of **External Level**, a falling edge trigger ends the read cycle but the next read cycle does not begin until the occurrence of the next rising edge trigger.

Timeout or New Trigger

Useful in applications that require an alternative way to end the read cycle. For example, if an assembly line should stop completely or the intervals between objects are highly irregular.

Timeout or New Trigger is identical to **Timeout** except that a timeout or a new trigger (whichever occurs first) ends the read cycle.

Last Frame

Useful in applications in which the timeout duration varies.

Last Frame or New Trigger

Useful in applications in which line speeds are irregular and a new object could appear before the last frame in the sequence.

Last Frame or New Trigger is identical to **New Trigger** except that a new trigger or last frame (whichever occurs first) ends the read cycle.

Read Cycle Timeout

Read Cycle Timeout determines the duration of the read cycle.

End of Read Cycle

Mode	Timeout
Read Cycle Timeout	1.000 <input type="button" value="▲"/> <input type="button" value="▼"/> Seconds

Processing Timeout

Useful in higher speed applications with long processing times.

Processing Timeout	200	10 - 65535 (x1ms)
--------------------	-----	-------------------

Note: If a timeout occurs during processing and no symbols in the field of view have been decoded, the result will be a No Read. For this reason, a longer timeout should be tried to ensure that the symbol is decoded successfully.

Reader Setup

Reader Setup parameters allow the user to configure **Gain Level**, **Tracking**, and **Scan Speed** parameters, as well as various **Automatic Gain Control** parameters.

[-] Reader Setup	
Gain Level	40
Tracking	40
Scan Speed	50
[-] Automatic Gain Control (AGC)	
AGC Sampling Mode	Continuous
AGC Minimum	0
AGC Maximum	255
Symbol Detect Status	Disabled
Transition Counter	14
Maximum Element	400
Scan Width Enhance	Disabled

Gain Level

Gain Level can be used in two different ways, depending on the **AGC Sampling Mode**.

When AGC Sampling Mode is set to Disabled: Gain Level is used as a “Fixed Gain”. The analog signal is amplified by this gain value. For Fixed Gain operation, changes to gain adjustment setting should be performed in **Auto Calibration**.

When AGC Sampling Mode is set to Leading Edge or Continuous: Gain Level defines the “set point” analog signal level. The AGC system will attempt to hold the analog signal at this level by automatically raising and lowering the gain as needed.

[-] Reader Setup	
Gain Level	40 (0 - 255)
Tracking	40
Scan Speed	50
[-] Automatic Gain Control (AGC)	
AGC Sampling Mode	Continuous
AGC Minimum	0
AGC Maximum	255
Symbol Detect Status	Disabled
Transition Counter	14
Maximum Element	400
Scan Width Enhance	Disabled

Tracking

Useful in fine-tuning tracking or when conditions of poor contrast or blurred bar edges exist. Tracks peak signals and selects an amplitude reference point to sample the analog signals for converting to digital.

Note: Tracking is optimized at the factory before shipment; in some cases the default value might not be 40.

[-] Reader Setup	
Gain Level	40
Tracking	40 (5 - 127)
Scan Speed	50
[-] Automatic Gain Control (AGC)	
AGC Sampling Mode	Continuous
AGC Minimum	0
AGC Maximum	255
Symbol Detect Status	Disabled
Transition Counter	14
Maximum Element	400
Scan Width Enhance	Disabled

Scan Speed

Allows the user to set the number of scans per second by controlling the motor speed of the spinning mirror in the scanner.

[-] Reader Setup	
Gain Level	40
Tracking	40
Scan Speed	500 (300 - 1400)
[-] Automatic Gain Control (AGC)	
AGC Sampling Mode	Continuous
AGC Minimum	0
AGC Maximum	255
Symbol Detect Status	Disabled
Transition Counter	14
Maximum Element	400
Scan Width Enhance	Disabled

Automatic Gain Control

AGC Sampling Mode

Disabled (Fixed Gain)

When **AGC Sampling Mode** is **Disabled**, the first parameter in the **Gain Level** command defines the Fixed Gain used to amplify the analog signal. In most applications, when changing the sampling mode to Disabled, the Gain Level will need to be changed. For Fixed Gain operation, changes to gain adjustment settings can be performed in **Auto Calibration**.

Leading Edge

Leading Edge uses only the first signal sample to calculate gain adjustments. The **Transition Counter** value is used to determine which transition triggers the sample.

Important: This option should only be used if recommended by an Omron Microscan Sales or Applications representative, as the other AGC modes cover most application requirements.

Continuous

Continuous will take the highest value among any samples within a scan and use that value to make adjustments.

Reader Setup	
Gain Level	40
Tracking	40
Scan Speed	50
Automatic Gain Control (AGC)	
AGC Sampling Mode	Continuous*
AGC Minimum	Disabled
AGC Maximum	Leading Edge
Symbol Detect Status	Continuous*
Transition Counter	14
Maximum Element	400
Scan Width Enhance	Disabled

AGC Minimum

Sets a gain limit that AGC cannot go below when not in Fixed Gain operation.

[-] Reader Setup	
Gain Level	40
Tracking	40
Scan Speed	50
[-] Automatic Gain Control (AGC)	
AGC Sampling Mode	Continuous
AGC Minimum	0 (0 - 255)
AGC Maximum	255
Symbol Detect Status	Disabled
Transition Counter	14
Maximum Element	400
Scan Width Enhance	Disabled

AGC Maximum

Sets a gain limit that AGC cannot exceed when not in Fixed Gain operation.

[-] Reader Setup	
Gain Level	40
Tracking	40
Scan Speed	50
[-] Automatic Gain Control (AGC)	
AGC Sampling Mode	Continuous
AGC Minimum	0
AGC Maximum	255 (0 - 255)
Symbol Detect Status	Disabled
Transition Counter	14
Maximum Element	400
Scan Width Enhance	Disabled

Symbol Detect Status

When **Symbol Detect Status** is enabled, Bad Symbol/No Symbol is output depending on whether or not there were enough transition counts, rather than based on a simple No Read.

Note: Symbol detection can only be used when **AGC Sampling Mode** is set to **Disabled** (Fixed Gain).

Reader Setup	
Gain Level	40
Tracking	40
Scan Speed	50
Automatic Gain Control (AGC)	
AGC Sampling Mode	Continuous
AGC Minimum	0
AGC Maximum	255
Symbol Detect Status	Disabled*
Transition Counter	Disabled*
Maximum Element	Enabled
Scan Width Enhance	Disabled

Transition Counter

Number of bar/space transitions required for an AGC sample. When multiple samples take place within a scan, the largest value is used.

If symbol detection is enabled, the transition counter defines the minimum number of transitions required for a scan to qualify as a **No Symbol** (number of transitions < transition counter), or **Bad Symbol** (number of transitions > or = transition counter and no decode).

Reader Setup	
Gain Level	40
Tracking	40
Scan Speed	50
Automatic Gain Control (AGC)	
AGC Sampling Mode	Continuous
AGC Minimum	0
AGC Maximum	255
Symbol Detect Status	Disabled
Transition Counter	14 (6 - 255)
Maximum Element	400
Scan Width Enhance	Disabled

Maximum Element

Maximum Element is the maximum bar (element) size before a reset. Value is in increments of 0.01% of the scanner's full scan width, not increments of the framed scan width.

Reader Setup	
Gain Level	40
Tracking	40
Scan Speed	50
Automatic Gain Control (AGC)	
AGC Sampling Mode	Continuous
AGC Minimum	0
AGC Maximum	255
Symbol Detect Status	Disabled
Transition Counter	14
Maximum Element	400
Scan Width Enhance	Disabled

50 - 5000 (x 0.01% of scan)

Scan Width Enhance

The scanner can adjust for Gain differences across the entire scan width. This is a useful feature for long symbols that use most of the scan width available.

Note: This command is intended for applications in which symbols are three inches or more from the scanner.

Reader Setup	
Gain Level	40
Tracking	40
Scan Speed	50
Automatic Gain Control (AGC)	
AGC Sampling Mode	Continuous
AGC Minimum	0
AGC Maximum	255
Symbol Detect Status	Disabled
Transition Counter	14
Maximum Element	400
Scan Width Enhance	Disabled*

Disabled*

Enabled

Disabled

The scanner will not adjust for scan width variation.

Enabled

The scanner will adjust for scan width variation.

Additional Information about Gain, Tracking, and Transition Counter

Gain

The QX-870 Industrial Raster Scanner is an optical device. Optical devices deal with a wide range of brightness, in a way similar to a camera. If the image is too bright, the exposure must be reduced. If the image is too dark, the exposure must be increased. The scanner will only work properly if it is within the range of brightness that can resolve light and dark changes, or “transitions”, in the field of view. If the gain is too low, the entire symbol looks like a dark bar to the scanner. If the gain is too high, the entire symbol looks like a white bar to the scanner. Brightness conditions can be affected by the distance between the symbol and scanner, or by the consistency of the material on which the symbol is printed.

The **AGC Sampling Mode** command has two primary functions: **AGC** (either **Leading Edge** or **Continuous**) and **Disabled (Fixed Gain)**.

AGC (Leading Edge or Continuous)

AGC self-adjusts the optical-electrical gain to hold brightness to one range for all materials and distances. The **Auto Calibration** menu shows what AGC is doing to control brightness, as in the example shown here:

Scan Rate	Motor Set	Gain Set	Track Thrsh	Level	Read Rate
500	500	65	45	-35.0	100% 0089305467640

The value **-35.0** indicates that brightness has been reduced by 35 dB. The symbol used in this example was very close to the scanner, using high laser power. As the laser power is lowered and/or the symbol is moved farther from the scanner, the attenuation (brightness reduction) value becomes lower. The user does nothing to adjust the gain in order to keep the scanner decoding; AGC performs the task of raising gain to accommodate the greater distance.

The actual attenuation factor is determined by the return light from the symbol and the “SETPOINT” value that the control system is attempting to hold. (SETPOINT is an abstracted number range that has to do with the feedback system’s dynamic range.) A very low SETPOINT value of 0-20 would tend to keep the symbol amplitude low. A very high SETPOINT value of 150-255 would tend to keep the symbol amplitude high. The gain will change to hold the feedback value equal to the user SETPOINT setting of amplitude (**Gain Level**) at all times.

Disabled (Fixed Gain)

Fixed Gain is a gain mode in which there are no changes in the gain system. The system takes the total gain range and divides it into 255 steps. Then the value of the **Gain Level** setting is converted directly into the gain value. Nothing will change this value unless the user changes the **Gain Level** setting.

When To Use Fixed Gain vs. AGC

The **AGC** settings (**Leading Edge** or **Continuous**) are preferable for most applications, as they provide the best overall scannable area. However, there are times when AGC will have difficulty locking onto the symbol of interest, especially when extraneous non-symbol objects in the field of view appear to be symbols. AGC can only base its measurements on one object. If that object is not the actual symbol, AGC performance and consistency are adversely affected.

Leading Edge bases its calculations on the first object it detects, even if the first object is not a symbol. This is helpful if the symbol is always at the leading edge of the decode direction.

Continuous is the recommended setting for Omron Microscan scanners. Continuous always samples throughout the entire scan but is most interested in the object with the most sharply-defined bars. This can occasionally mislead the scanner when bar-like objects or specular reflection enter the field of view.

Fixed Gain is preferable if AGC repeatedly fails to choose the correct **Gain Level** setting for the application. In some applications, symbols might be surrounded by a greater number of symbol-like false candidates than actual symbols. The Fixed Gain setting will never change its value, so once it is set, surrounding objects in the field of view will not distract the scanner from decoding actual symbols.

Fixed Gain is also useful in applications using symbols that have very low bar counts, or in applications using **Symbol Reconstruction** on symbols with tilted or skewed placement.

The **AGC Minimum** and **AGC Maximum** parameters are useful in applications with depth of field limitations that are not conducive to Fixed Gain operation.

To determine the appropriate minimum and maximum gain:

- Set **AGC Sampling Mode** to **Disabled (Fixed Gain)** and find the range of gain levels that yields successful decodes in the application (both the lowest and the highest gain levels).
- Enter those values in the **AGC Minimum** and **AGC Maximum** fields. This will leave the scanner room for gain changes to increase depth of field (within the limitations of what works for the application).

Maximum gain may be too high for symbols on white backgrounds, because it may attempt to process false bars. Especially in applications using symbologies that require more processing, setting gain too high can slow decode performance substantially.

Setting a minimum gain can prevent the system from occasionally “under-gaining” because of previous false candidates that appear very bright.

Tracking

Tracking is the frequency detection value that determines the threshold between a white bar and a black bar. This is a range of frequencies that have been divided into **127** steps. For most applications, the default tracking value (**40**) is robust enough to deal with most marginal signals. However, in some instances, symbols are printed on a “noisy” substrate, or symbols are relatively distant from the scanner and the signal-to-noise ratio and optical focus are not ideal. In such cases, using a combination of **Gain Level** and **Tracking** can improve decode performance by rejecting “noise” and correctly recognizing the bars of the candidate symbol.

Transition Counter

Transition Counter is an integral part of the AGC system. Transition Counter determines the number of black bars that will be counted before an AGC sample is taken. Setting a Transition Counter value lower than the default of **14** gives the scanner less integration time for the candidate symbol, and makes the scanner more susceptible to false objects.

A Transition Counter value greater than **14** requires more bars to be present for the symbol even to qualify as an object. When setting the Transition Counter value, it is important to keep in mind what occurs when the symbol is first presented to the scanner—before gain is applied to the symbol. A few bars are usually missed due to distortion at first. Setting Transition Counter to the same value as the number of bars contained in the symbol can cause the scanner not to take an AGC sample at all. The value of **14** is optimal except in the case of low bar count due to:

- Symbols that are tilted so that only 10 bars or fewer are available in a single scan line. (See **Symbol Reconstruction**).
- Symbologies with typically low bar counts, such as **Pharmacode**. Applications using symbols with fewer than 10 bars should use **Fixed Gain** operation.

Laser Setup

Laser Setup allows the user to configure **Laser On/Off**, **Laser Framing Status**, **Laser On Position**, **Laser Off Position**, and **Laser Power**.

[-] Laser Setup	
... Laser On/Off	Disabled
... Laser Framing Status	Disabled
... Laser On Position	10
... Laser Off Position	95
... Laser Power	Medium

Laser On/Off

When Enabled, the laser is **On** only during the read cycle. When Disabled, the laser operates continuously.

Note: A serial trigger or external trigger must be enabled for **Laser On/Off** to take effect.

[-] Laser Setup	
... Laser On/Off	Disabled*
... Laser Framing Status	Disabled*
... Laser On Position	Enabled
... Laser Off Position	95
... Laser Power	Medium

Laser Framing Status

When Enabled, the laser will be **off** for the duration of the **Laser Off** time (beginning from the start of the read cycle), and the laser will then be **on** for the duration of the **Laser On** time.

[-] Laser Setup	
... Laser On/Off	Disabled
... Laser Framing Status	Disabled*
... Laser On Position	Disabled*
... Laser Off Position	Enabled
... Laser Power	Medium

Laser On Position

The duration of **Laser Off** time. **Laser On Position** is a ratio of the total scan width, with increments equal to 1/100th of the total scan width.

[-] Laser Setup	
... Laser On/Off	Disabled
... Laser Framing Status	Disabled
... Laser On Position	10 (10 - 90)
... Laser Off Position	95
... Laser Power	Medium

Laser Off Position

The duration of **Laser On** time. **Laser Off Position** is a ratio of the total scan width, with increments equal to 1/100th of the total scan width.

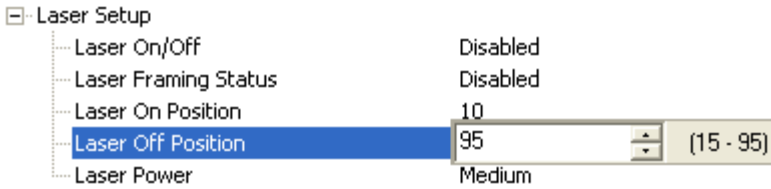

Laser Power

Allows the user to select the **Laser Power** setting as follows:

Low: Laser Power = ~0.6mW. Typically only needed for decoding high density symbols located close to the scanner.

Medium: Laser Power = ~1.0mW.

High: Laser Power = ~1.5mW. Typically used for decoding lower density symbols located far from the scanner.

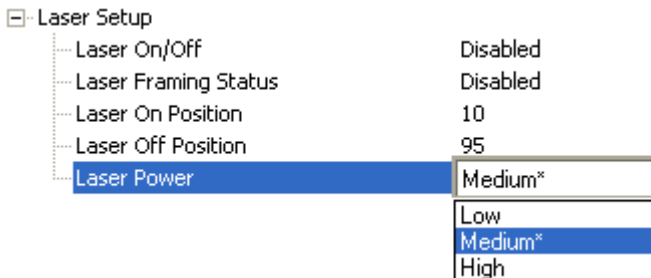

Raster Setup

Raster Setup allows the user to configure **Top Offset**, **Bottom Offset**, **Sweep Rate**, and **Read Cycle On/Off**.

Raster Setup	
Status	Disabled
Top Offset	127
Bottom Offset	127
Sweep Rate	10
Read Cycle On/Off	Disabled

Top Offset

A value of **0** = the side opposite the scanner connectors (the top of the scanner). A value of **255** = the side with the connectors (the bottom of the scanner).

If **Top Offset** is greater than **Bottom Offset**, then Top defines the raster position in a straight line only. If Top is less than Bottom, then the raster will sweep back and forth between the Top and Bottom offsets if the sweep rate is greater than 0.

The Top Offset is considered the “home” position.

Raster Setup	
Status	Disabled
Top Offset	127 (0 - 255)
Bottom Offset	127
Sweep Rate	10
Read Cycle On/Off	Disabled

Bottom Offset

A value of **0** = the side opposite the scanner connectors (the top of the scanner). A value of **255** = the side with the connectors (the bottom of the scanner).

If **Top Offset** is greater than **Bottom Offset**, then Top defines the raster position in a straight line only. If Top is less than Bottom, then the raster will sweep back and forth between the Top and Bottom offsets if the sweep rate is greater than 0.

Raster Setup	
Status	Disabled
Top Offset	127
Bottom Offset	127 (0 - 255)
Sweep Rate	10
Read Cycle On/Off	Disabled

Sweep Rate

Sweep rate defines how many times per second the raster passes between the Top Offset and Bottom Offset.

For example, if sweep rate is set to **3**, and the raster is starting at the Top Offset, it will reach the bottom offset in 1/3 of a second.



Read Cycle On/Off

Always start a read cycle with the raster at the Top Offset, then enable the **Read Cycle On/Off** parameter.

Note: The sweep rate must be significantly faster than the triggering rate in order for this feature to be effective.

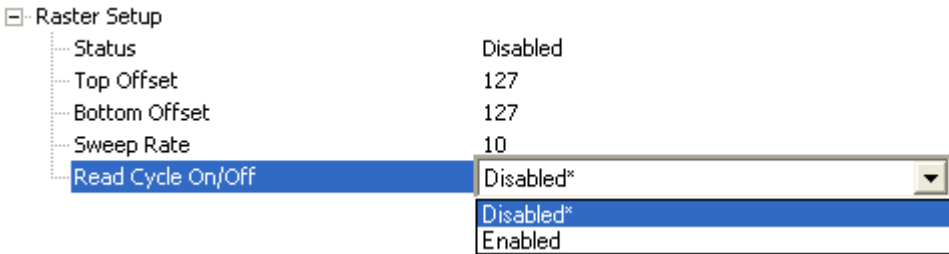

Symbologies

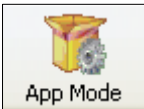

Click the **App Mode** button and then the **Parameters** button to display the tree control tabs.

Then click the **Symbologies** tab to display the Symbologies tree control.

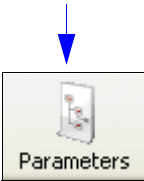

Communication | Read Cycle | **Symbologies** | I/O | Matchcode | Diagnostics

Parameters	ESP Values
[-] Symbologies	
[-] 1D Symbologies	
[-] Code 39	Enabled
[-] Code 128	Both Standard or Edge
[-] Interleaved 2 of 5	Enabled
[-] Codabar	Enabled
[-] UPC/EAN	Both Standard or Edge
[-] Code 93	Both Standard or Edge
[-] Pharmacode	Disabled
[-] DataBar Expanded	Disabled
[-] DataBar Limited	Disabled
[-] DataBar Omnidirectional	Disabled
[-] Stacked Symbologies	
[-] PDF417	Enabled
[-] Micro PDF417	Disabled
[-] Composite	Disabled
[-] AIAG	Disabled
[-] Quiet Zone	Narrow, Enhanced*
[-] Symbology Identifier	Standard
[-] Background Color	Narrow
[-] Depth of Field Enhance	Standard, Enhanced
[-] Symbol Reconstruction	Narrow, Enhanced*
[-] Code Ratio Mode	

To open nested options, **single-click** the **+**.

The * indicates that the setting is the default.

To change a setting, **double-click** the setting and use the cursor to scroll through the options.

Note: Symbologies settings can also be sent to the scanner from ESP's Terminal using Omron Microscan's K command format. Refer to the **Symbologies** section of **Appendix E**.

Code 39

Code 39 is considered the standard for non-retail 1D symbology.

An alphanumeric symbology with unique start/stop code patterns, composed of 9 black and white elements per character, of which 3 are wide.

Code 39	Enabled
Check Character Status	Disabled
Check Character Output Status	Disabled
Large Intercharacter Gap	Disabled
Fixed Symbol Length Status	Disabled
Fixed Symbol Length	10
Full ASCII Set	Disabled

Check Character Status

Enables or Disables the check character.

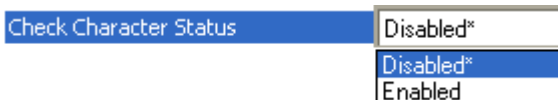

Check Character Output Status

Check Character Output Status, when added to the symbol, provides additional data security.

When enabled, the check character character is read and compared along with the symbol data. When disabled, symbol data is sent without the check character.

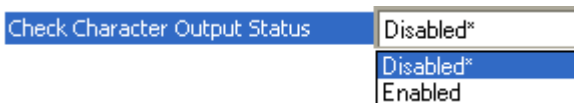

Note: With **Check Character Output Status** enabled and an **External Edge**, **External Level**, or **Serial Data** trigger option enabled, an invalid check character calculation will cause a **No Read Message** to be transmitted at the end of the read cycle.

Large Intercharacter Gap

Large Intercharacter Gap is helpful for reading symbols that are printed out of specification.

When enabled, the scanner can read symbols with gaps between symbol characters that exceed three times (3x) the narrow element width.

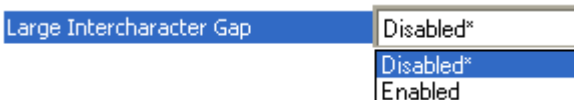

Important: Do not use **Large Intercharacter Gap** with **Narrow** or **Narrow, Enhanced** Quiet Zone enabled, because a large intercharacter gap (over 3x) could cause a narrow quiet zone (5x) to be interpreted as an intercharacter gap.

Fixed Symbol Length Status

When enabled, the scanner will check the symbol length against the symbol length field. If disabled, any length will be considered valid.

Fixed Symbol Length Status	Disabled*
	Disabled*
	Enabled

Fixed Symbol Length

Fixed Symbol Length helps prevent truncations and increases data integrity by ensuring that only one symbol length will be accepted.

Specifies the exact number of characters that the scanner will recognize (this does not include start and stop and check character characters). The scanner ignores any symbology that does not match the specified length.

Fixed Symbol Length	10	(1 - 128)
---------------------	----	-----------

Full ASCII Set

Must be enabled when reading characters outside the standard character set (0-9, A-Z, etc.)

The user must know in advance whether or not to use the **Full ASCII Set** option. Since **Full ASCII Set** requires two code words to encode one character, it is less efficient.

Standard Code 39 encodes 43 characters; zero through nine, capital "A" through capital "Z", minus symbol, plus symbol, forward slash, space, decimal point, dollar sign, and percent symbol. When **Full ASCII Set** is enabled, the scanner can read the full ASCII character set, from 0 to 255.

Full ASCII Set	Disabled*
	Disabled*
	Enabled

Code 128

Code 128 is a smaller symbology useful in applications with limited space and high-security requirements.

A very dense alphanumeric symbology. It encodes all 128 ASCII characters, it is continuous, has variable length, and uses multiple element widths measured edge to edge.

Code 128	Both Standard or Edge
Fixed Symbol Length Status	Disabled
Fixed Symbol Length	10
EAN Status	Enabled
Output Format	Standard
Application Record Separator Status	Disabled
Application Record Separator Chara...	,
Application Record Brackets	Disabled
Application Record Padding	Disabled
Separation Factor	Normal

Fixed Symbol Length Status

When enabled, the scanner will check the symbol length against the symbol length field. If disabled, any length will be considered a valid symbol.

Fixed Symbol Length Status	Disabled*
	Disabled*
	Enabled

Fixed Symbol Length

Fixed Symbol Length helps prevent truncations and increases data integrity by ensuring that only one symbol length will be accepted.

This specifies the exact number of characters that the scanner will recognize (this does not include start, stop, and check character characters). The scanner ignores any symbol not having the specified length.

Fixed Symbol Length	10	(1 - 128)
---------------------	----	-----------

EAN Status

When this field is disabled, the scanner will not check any Code 128 labels for conformance to EAN requirements, or perform any special formatting.

When enabled, the scanner can read symbols with or without a function 1 character in the first position. If a symbol has a function 1 character in the first position, it must conform to EAN format. Symbols that conform to EAN format will also be subject to the special output formatting options available in this command.

If EAN status is required, the scanner will only decode symbols that have a function 1 character in the first position and that conform to EAN format. All symbols read will be subject to the special output formatting options available in this command.



Note: Code 128 status must be enabled for EAN status to be active.

Output Format

In **Standard**, the scanner will not apply special EAN output formatting options.

In **Application**, the scanner will apply the special EAN output formatting options to decoded EAN-conforming symbols.



Application Record Separator Status

When enabled, an EAN separator will be inserted into the output between fields whenever an EAN-conforming symbol is decoded and EAN output formatting applies.

Application Record Separator Status	Disabled*
	Disabled*
	Enabled

Application Record Separator Character

This is an ASCII character that serves as an EAN separator in formatted EAN output.

Application Record Separator Character	/
NUL SOH STX ETX EOT ENQ	
ACK BEL BS HT LF VT	
FF CR SO SI DLE DC1	
DC2 DC3 DC4 NAK SYN ETB	
CAN EM SUB ESC FS GS	
RS US SP	
Click 'Delete' to remove characters.	

Application Record Brackets

If an EAN-conforming symbol is decoded and EAN formatting applies, this feature places bracket characters around the application identifiers in the formatted output.

Application Record Brackets	Disabled*
	Disabled*
	Enabled

Application Record Padding

This feature causes the scanner to pad variable-length application fields with leading zeroes. This is not done for the last field of a symbol.

Application Record Padding	Disabled*
	Disabled*
	Enabled

Separation Factor

Separation Factor	Normal*
	Normal*
	High
	Highest

Normal

No limits are placed on bar ratio accuracy.

High

The scanner will enforce a higher level of accuracy on bar ratios. If the symbol falls outside this limit, it will be rejected.

Highest

The scanner will enforce the highest level of accuracy on bar ratios. If the symbol falls outside this limit, it will be rejected.

Interleaved 2 of 5

Interleaved 2 of 5 has been popular because it is the most dense symbology for printing numeric characters less than 10 characters in length; however, Omron Microscan does not recommend this symbology for any new applications because of inherent problems such as symbol truncation.

A dense, continuous, self-checking, numeric symbology. Characters are paired together so that each character has five elements, two wide and three narrow, representing numbers 0 through 9, with the bars representing the first character and the interleaved spaces representing the second character. (A check character is highly recommended).

<input type="checkbox"/> Interleaved 2 of 5	Disabled
<input type="checkbox"/> Check Character Status	Disabled
<input type="checkbox"/> Check Character Output Status	Disabled
<input type="checkbox"/> Symbol Length 1	10
<input type="checkbox"/> Symbol Length 2	6
<input type="checkbox"/> Guard Bar	Disabled
<input type="checkbox"/> Range Mode Status	Disabled

Check Character Status

This option is not typically used, but it can be enabled for additional security in applications where the host requires redundant check character verification.

An error correcting routine in which the check character character is added.

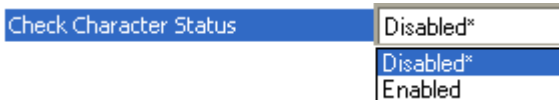

Check Character Output Status

When enabled, a check character character is sent along with the symbol data for added data security.

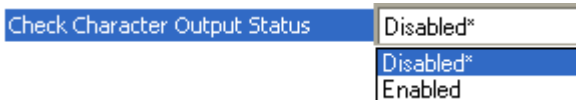

Symbol Length 1

Useful in applications where Interleaved 2 of 5 symbols of a specific length are required.

The **Symbol Length 1** field is one of two fields against which the decoded symbol is compared before accepting it as valid or rejecting it.

Important: If **Range Mode Status** is set to **Disabled**, the length of the symbol must match either **Symbol Length 1** or **Symbol Length 2** to be considered a valid symbol.

If **Range Mode Status** is set to Enabled, **Symbol Length 1** and **Symbol Length 2** form a range into which the length of the symbol must fall to be considered valid.

Symbol Length 1	16	(0 - 128)
-----------------	----	-----------

Symbol Length 2

Useful in applications where Interleaved 2 of 5 symbols of a specific length are required.

The **Symbol Length 2** field is one of two fields against which the decoded symbol is compared before accepting it as valid or rejecting it.

Important: If **Range Mode Status** is set to **Disabled**, the length of the symbol must match either **Symbol Length 2** or **Symbol Length 1** to be considered a valid symbol.

If **Range Mode Status** is set to Enabled, **Symbol Length 2** and **Symbol Length 1** form a range into which the length of the symbol must fall to be considered valid.

Symbol Length 2	6	(0 - 128)
-----------------	---	-----------

Guard Bar

Note: Whenever **Guard Bar** is enabled, the presence of guard bars is required for decoding to take place.

Useful when Interleaved 2 of 5 multisymbols are enabled to prevent false data output. This typically occurs with highly tilted or skewed symbols.

A guard bar is a heavy bar, at least twice the width of the wide bar, surrounding the printed Interleaved 2 of 5 symbol and helping to prevent false reads.

Guard Bar	Disabled*
	Disabled*
	Enabled

Range Mode Status

Important: Unless **Range Mode** is enabled, **Symbol Length** must be set to decode Interleaved 2 of 5 symbols.

Useful in applications where Interleaved 2 of 5 symbols of a specific length are required.

When **Range Mode** is disabled, the scanner checks the value of the symbol length against the values set in **Symbol Length 1** and **Symbol Length 2**. If the symbol length does not match either of the preset values, then it is rejected as invalid.

When **Range Mode** is enabled, **Symbol Length 1** and **Symbol Length 2** are combined to form a range of valid symbol lengths. Any symbol length that does not fall into this range is rejected as an invalid symbol. Either of the preset symbol length values in the **Symbol Length 1** and **Symbol Length 2** fields can form the start or end of the range.



Codabar

Used in photo-finishing and library applications. Previously used in medical applications, but not typically used in newer medical applications.

Codabar is a 16-bit character set (0 through 9, and the characters \$, :, /, ., +, and -) with start/stop codes and at least two distinctly different bar widths.

Codabar	Enabled
Start and Stop Match Status	Enabled
Start and Stop Output Status	Enabled
Large Intercharacter Gap	Disabled
Fixed Symbol Length Status	Disabled
Fixed Symbol Length	10
Check Character Type	Disabled
Check Character Output Status	Disabled

Start and Stop Match Status

When disabled, the scanner will decode Codabar symbols whether or not the start and stop characters are the same.

When enabled, the scanner will not decode Codabar symbols unless the start and stop characters are the same.

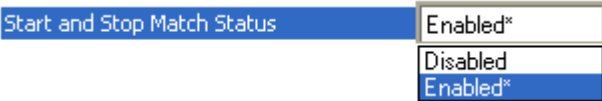

Start and Stop Output Status

When disabled, the start and stop characters will *not* be present in the data output of the decoded symbol.

When enabled, the start and stop characters *will* be present in the data output of the decoded symbol.

Note: Because the start and stop characters are included as part of the data, the characters must be included as part of the length in a fixed length mode of operation.

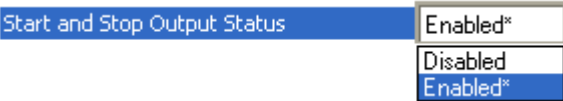

Large Intercharacter Gap

When disabled, the spaces between characters, or the “intercharacter gap”, are ignored during the decode process.

Note: If the intercharacter space is large enough to be considered a margin, the symbol will not decode, regardless of this parameter’s setting.

Large Intercharacter Gap	Disabled*
	Disabled*
	Enabled

Fixed Symbol Length Status

When disabled, the scanner will accept any Codabar symbol provided it doesn’t exceed the system’s maximum capabilities.

When enabled, the scanner will reject any Codabar symbol that doesn’t match the fixed length.

Fixed Symbol Length Status	Disabled*
	Disabled*
	Enabled

Fixed Symbol Length

This is the value against which all Codabar symbol lengths will be compared.

Fixed Symbol Length	10	(1 - 128)
---------------------	----	-----------

Check Character Type

When disabled, the scanner will not perform any character checking calculations on decoded Codabar symbols.

When set to **Mod 16**, the scanner will perform a modulus 16 check character calculation on the symbol. If the symbol does not pass this calculation, it will not be decoded.

When set to **NW 7**, the scanner will perform an NW7 modulus 11 check character calculation on the symbol. If the symbol does not pass this calculation, it will not be decoded.

When set to **Both**, the scanner will perform both the Mod 16 and NW7 modulus 11 check character calculations on the symbol. If the symbol does not pass either calculation, it will not be decoded.

Check Character Type	Disabled*
	Disabled*
	Mod 16
	NW 7
	Both

Check Character Output Status

When this field is disabled and a check character calculation is enabled, the scanner will strip the verified check character from the symbol data output. This condition must be accounted for if a fixed length is also being used.

When enabled, the scanner will output the check character as part of the symbol data. This condition must be accounted for if a fixed length is also being used.

Check Character Output Status	Disabled*
	Disabled*
	Enabled

UPC/EAN

Used primarily in point-of-sale applications in the retail industry. It is commonly used with Omron Microscan scanners in applications in combination with **Matchcode** when there is a need to verify that the right product is being placed in the right packaging.

UPC (Universal Product Code) is a fixed length, numeric, continuous symbology. UPC can have two- or five-digit supplemental data following the normal symbol. The UPC Version A (UPC, A) symbol is used to encode a 12 digit number. The first digit is the number system character, the next five are the manufacturer number, the next five are the product number, and the last digit is the checksum character.

When enabled, the scanner will read UPC Version A and UPC Version E only.

[-] UPC/EAN	Both Standard or Edge
EAN Status	Enabled
Supplementals Status	Disabled
Separator Status	Disabled
Separator Character	,
Supplementals Type	Both
UPC-E as UPC-A	Disabled

EAN Status

EAN is the European version of the UPC symbology and is used in European retail applications.

Note: **UPC** must be enabled for **EAN** to take effect.

EAN is a subset of UPC. When enabled, the scanner will read UPC Version A, UPC Version E, EAN 13, and EAN 8. It also appends a leading zero to UPC Version A symbol information and transmits 13 digits. If transmitting 13 digits when reading UPC Version A symbols is not desired, disable EAN.



Note: The extra character identifies the country of origin.

Supplementals Status

Reads **Supplementals** typically used in publications and documentation.

A supplemental is a 2 to 5 digit symbol appended to the main symbol. When set to **Enabled** or **Required**, the scanner reads supplemental code data that has been appended to the standard UPC or EAN codes.

Supplementals Status	Disabled*
	Disabled*
	Enabled
	Required

Disabled

UPC **Supplementals** will not be decoded.

Enabled

When enabled, the scanner will try to decode a main and a supplemental. However, if a supplemental is not decoded, the main will be sent by itself at the end of the read cycle.

Required

When set to **Required**, both the main and the supplemental symbols must be read or a single No Read condition results.

For example, if **Supplementals** is set to **Required**, **Separator** is enabled, and an asterisk is defined as the UPC separator character. Then the data is displayed as:

MAIN * SUPPLEMENTAL.

Note: Under no circumstances will the supplemental symbol data be sent without a main symbol.

Note: If additional symbols—other than the main or supplemental—will be read in the same read cycle, **Number of Symbols** should be set accordingly.

Separator Status

Allows users to distinguish between the main and **Supplemental** symbols.

A character can be inserted between the standard UPC or EAN symbology and the supplemental symbology when **Supplementals** is set to **Enabled** or **Required**.

Separator Status	Disabled*
	Disabled*
	Enabled

Separator Character

As required by the application.

Allows the user to change the separator character from a comma to a new character.

Note: Whenever **Separator Character** is defined as a comma (,) sending a **<K473,s?>** command from ESP's Terminal will return the current settings, including the separator character comma which appears after the separator status comma.

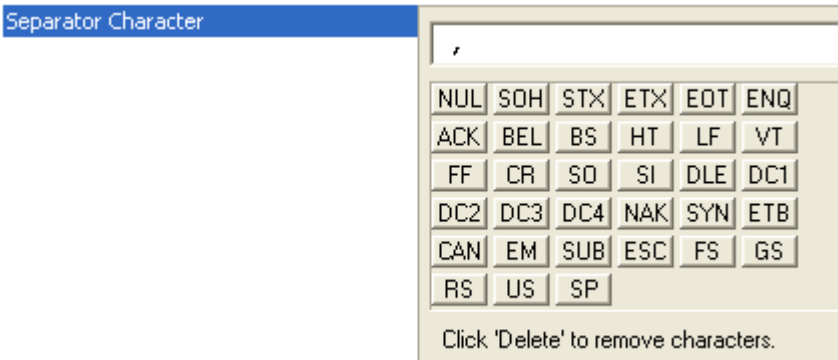

Supplementals Type

As required by symbology used in application.

Allows the user to select 2 character or 5 character supplements, or both.



Both

Either 2 character or 5 character supplementals will be considered valid.

Two Characters Only

Only two character supplementals will be considered valid.

Five Characters Only

Only five character supplementals will be considered valid.

UPC-E as UPC-A

When disabled, the scanner will output the version E symbols in their encoded 6-character format. When enabled, the scanner will format the symbol as either a 12-character UPC-A symbol or an EAN-13 symbol, depending on the state of the EAN status parameter. This formatting reverses the zero suppression that is used to generate the symbol in the UPC specification.



Code 93

Used in some clinical applications.

Code 93 is a variable-length, continuous symbology employing four element widths. Each Code 93 character has nine modules that may be either black or white. Each character contains three bars and three spaces.

<input type="checkbox"/> Code 93	Both Standard or Edge
<input type="checkbox"/> Fixed Symbol Length Status	Disabled
<input type="checkbox"/> Fixed Symbol Length	10

Fixed Symbol Length Status

When disabled, the scanner will accept any Code 93 symbol provided it doesn't exceed the system's maximum capabilities.

When enabled, the scanner will reject any Code 93 symbol that doesn't match the fixed symbol length.

Fixed Symbol Length Status	Disabled*
	Disabled*
	Enabled

Fixed Symbol Length

This is the symbol length value against which all Code 93 symbols will be compared.

Fixed Symbol Length	10	(1 - 128)
---------------------	----	-----------

Pharmacode

Used mostly in pharmaceutical packaging.

Encodes up to five different numbers, each with its own color, which may be entered in decimal or “binary” format with a **1** represented by a thick bar and a **0** represented by a thin bar. Bar width is independent of height.

In decimal format, each part can be up to 999,999.

In binary format, each input can have up to 19 ones and zeros.

☐ Pharmacode	Disabled
Fixed Symbol Length Status	Disabled
Fixed Symbol Length	10
Minimum Bars	4
Bar Width Status	Mixed
Direction	Forward
Fixed Threshold Value	400

Important: When Pharmacode is enabled, other linear symbologies will not decode properly. Disable Pharmacode before reading other linear symbologies.

Fixed Symbol Length Status

When enabled, the scanner will check the symbol length against the symbol length field. If disabled, any length will be considered valid.

Fixed Symbol Length Status	Disabled*
	Disabled*
	Enabled

Fixed Symbol Length

Specifies the exact number of bars that must be present for the scanner to recognize and decode the Pharmacode symbol.

Fixed Symbol Length	10	(1 - 128)
---------------------	----	-----------

Minimum Bars

Sets the minimum number of bars that a Pharmacode symbol must have to be considered valid.

Minimum Bars	4	(4 - 16)
--------------	---	----------

Note: The minimum allowed bar count is **4**.

Bar Width Status

If set to **Mixed**, the scanner will autodiscriminate between narrow bars and wide bars. If set to **All Narrow**, all bars will be considered as narrow bars. If set to **All Wide**, all bars will be considered as wide bars. If set to **Fixed Threshold**, it will use the fixed threshold value to determine whether the bars are narrow or wide. The **Bar Width Status** setting will be ignored when the scanner is able to tell the difference between the narrow and the wide bars.



Direction

Specifies the direction in which a symbol can be read.



Fixed Threshold Value

Used when **Bar Width Status** is set to **Fixed Threshold**. Defines the minimum difference in pixels that will distinguish a narrow bar from a wide bar.



GS1 DataBar

Note: GS1 DataBar symbologies were previously known as “Reduced Space Symbology” or “RSS”.

DataBar Expanded	Disabled
Fixed Symbol Length Status	Disabled
Fixed Symbol Length	14
DataBar Limited	Disabled
DataBar Omnidirectional	Disabled

DataBar Expanded

Note: DataBar Expanded was previously known as “RSS Expanded”.

Used to encode primary and supplementary data in retail point-of-sale and other applications.

DataBar Expanded is a variable length symbology that can encode supplementary information in addition to the 14-digit EAN item identification number and is capable of encoding up to 74 numeric or 41 alphabetic characters.

Where appropriate, use 1 (non-stacked) for better performance over 2 (stacked and non-stacked).

DataBar Expanded	Disabled
Fixed Symbol Length Status	Disabled
Fixed Symbol Length	14

Fixed Symbol Length Status

When enabled, the scanner will check the symbol length against the symbol length field, minus the embedded check character. If disabled, any length would be considered valid.

Fixed Symbol Length Status	Disabled*
	Disabled*
	Enabled

Fixed Symbol Length

Fixed Symbol Length helps prevent truncations and increases data integrity by ensuring that only one symbol length will be accepted.

Specifies the exact number of characters that the scanner will recognize (this does not include start, stop, and check character characters). The scanner ignores any symbol not having the specified length.

Fixed Symbol Length	14	[1 - 74]
---------------------	----	------------

DataBar Limited

Note: DataBar Limited was previously known as “RSS Limited”.

DataBar Limited is designed to be read by laser scanners and CCD imagers. It is not recommended for omnidirectional slot scanners.

Encodes a smaller 14-digit symbol (74 modules wide) that is not omnidirectional.



DataBar Omnidirectional

Note: DataBar Omnidirectional was previously known as “RSS-14”.

Used in the grocery, retail, and prescription drug industries where 14-digit EAN item identification may be needed.

DataBar-14 is a fixed symbol length symbology that encodes 14 digits, including a 1-digit indicator. DataBar-14 is 96 modules wide. It can be stacked in two rows, it can read omnidirectionally if printed in full height, or horizontally if height-truncated for small marking.

Note: Where appropriate, use **1** (non-stacked) for better performance instead of **2** (stacked; decode both stacked and non-stacked).



PDF417

Used in applications where a large amount of information (over 32 characters) needs to be encoded within a symbol, typically where the symbol is transported from one facility to another. For example, an automobile assembly line might use a single symbol with multiple fields of information that will be read at several stations along the way, without reference to a database.

A two-dimensional, multi-row (3 to 90), continuous, variable-length symbology that has high data capacity (up to 2,700 numeric characters, 1,800 printable ASCII characters, or 1,100 binary characters per symbol). Each symbol character consists of 4 bars and 4 spaces in a 17-module structure.

PDF417	Enabled
Scan Count	65535
Fixed Symbol Length Status	Disabled
Fixed Symbol Length	10
Decode at End of Read	Disabled

Note: Sending **<a1>** from ESP's Terminal will cause PDF417 data to be prefaced with information consisting of error correction level (ECC Level *n*), number of rows (*n* Rows), number of columns (*n* Columns), number of informative code words (*n* Info Code Words) and the number of data characters (*n* Data Characters). This feature can be disabled by re-sending **<a1>**.

Scan Count (Raster Sweep Count)

Determines the number of raster sweeps before any in-process stacked symbol decode attempt is abandoned.

Scan Count	65535	(1 - 65535)
------------	-------	-------------

Fixed Symbol Length Status

When Enabled, the scanner will reject any PDF417 symbol that does not match the **Fixed Symbol Length**.

Fixed Symbol Length Status	Disabled*
	Disabled*
	Enabled

Fixed Symbol Length

Used to increase data integrity by ensuring that only one symbol length will be accepted.

When enabled, the PDF symbol must contain the same number of characters as the symbol length setting before it can be considered a good read. The scanner will ignore any symbol not having the specified length.

Fixed Symbol Length	10	(1 - 2710)
---------------------	----	------------

Note: **Fixed Symbol Length Status** must be enabled for **Fixed Symbol Length** to take effect.

Decode at End of Read



Disabled

The scanner will attempt to decode the PDF417 symbol whenever the algorithm determines that there are enough error correction code words.

Enabled

The scanner will not attempt to decode the PDF417 symbol until the end of the read cycle.

MicroPDF417

Used for labelling small items that need large data capacity.

A variant of PDF417, a very efficient and compact stacked symbology that can encode up to 250 alphanumeric characters or 366 numeric characters per symbol.

Micro PDF417	Disabled
Scan Count	65535
Fixed Symbol Length Status	Disabled
Fixed Symbol Length	10

Scan Count (Raster Sweep Count)

Determines the number of raster sweeps before any in-process stacked symbol decode attempt is abandoned.

Scan Count	65535	(1 - 65535)
------------	-------	-------------

Fixed Symbol Length Status

When Enabled, the scanner will reject any MicroPDF417 symbol that does not match the **Fixed Symbol Length**.

Fixed Symbol Length Status	Disabled*
	Disabled*
	Enabled

Fixed Symbol Length

Used to increase data integrity by ensuring that only one symbol length will be accepted.

When enabled, the MicroPDF417 symbol must contain the same number of characters as the symbol length setting before it can be considered a good read. The scanner will ignore any symbol not having the specified length.

Fixed Symbol Length	10	(1 - 366)
---------------------	----	-----------

Note: **Fixed Symbol Length Status** must be enabled for **Fixed Symbol Length** to take effect.

Composite

When set to **Enabled** or **Required**, will decode the 2D composite component of a linear symbol. The linear symbol can be DataBar-14, DataBar Expanded, DataBar Limited, EAN-128, UPC-A, EAN-13, EAN-8, and UPC-E.

<input type="checkbox"/> Composite	Disabled
Separator Status	Disabled
Separator	,

Enabled

If **Composite** is set to **Enabled**, the scanner will decode both the 2D composite and linear components. However, if the 2D composite component is not decoded, the linear data will be sent by itself at the end of the read cycle.

Required

If set to **Required**, the scanner must decode both components, or a No Read will occur.

Separator Status

Allows the user to distinguish between the main and **Supplemental** symbols.

Separates the linear and the composite component.

Separator Status	Disabled*
	Disabled*
	Enabled

Separator

The Separator Character will be the same as the character defined in the **Multisymbol Separator** field.

As required by the application.

Allows the user to change the separator character from a comma to a new character.

Separator	<input type="text" value=","/>																																				
	<table border="1"><tr><td>NUL</td><td>SOH</td><td>STX</td><td>ETX</td><td>EOT</td><td>ENQ</td></tr><tr><td>ACK</td><td>BEL</td><td>BS</td><td>HT</td><td>LF</td><td>VT</td></tr><tr><td>FF</td><td>CR</td><td>SO</td><td>SI</td><td>DLE</td><td>DC1</td></tr><tr><td>DC2</td><td>DC3</td><td>DC4</td><td>NAK</td><td>SYN</td><td>ETB</td></tr><tr><td>CAN</td><td>EM</td><td>SUB</td><td>ESC</td><td>FS</td><td>GS</td></tr><tr><td>RS</td><td>US</td><td>SP</td><td></td><td></td><td></td></tr></table>	NUL	SOH	STX	ETX	EOT	ENQ	ACK	BEL	BS	HT	LF	VT	FF	CR	SO	SI	DLE	DC1	DC2	DC3	DC4	NAK	SYN	ETB	CAN	EM	SUB	ESC	FS	GS	RS	US	SP			
NUL	SOH	STX	ETX	EOT	ENQ																																
ACK	BEL	BS	HT	LF	VT																																
FF	CR	SO	SI	DLE	DC1																																
DC2	DC3	DC4	NAK	SYN	ETB																																
CAN	EM	SUB	ESC	FS	GS																																
RS	US	SP																																			
	Click 'Delete' to remove characters.																																				

AIAG

AIAG is a standard controlled by the Automotive Industry Action Group. AIAG is used in automotive applications.

When AIAG is Enabled, each Status field can be Enabled or Disabled, and an ID can be defined for each status.

[-] AIAG	Disabled
ID1	N
Status1	Enabled
ID2	P
Status2	Disabled
ID3	Q
Status3	Disabled
ID4	V
Status4	Disabled
ID5a	S
ID5b	M
ID5c	G
Status5	Disabled
ID6	H
Status6	Disabled
ID7	E Z
Status7	Disabled
ID8	E B
Status8	Disabled
ID9	E D
Status9	Disabled
ID10	E C
Status10	Disabled
ID11	E L
Status11	Disabled
ID12	E X
Status12	Disabled

Quiet Zone

Used when the leading and trailing edges of the symbols are smaller than the standard margin or other objects encroach into the margins.

Allows the scanner to read 1D symbols with quiet zones less than 8 times the width of the narrow bar element. The Quiet Zone is the space at the leading and trailing ends of a symbol. Each quiet zone can be as narrow as only five times the width of the narrow bar element when Quiet Zone is Enabled and set to **Narrow** or **Narrow, Enhanced**.

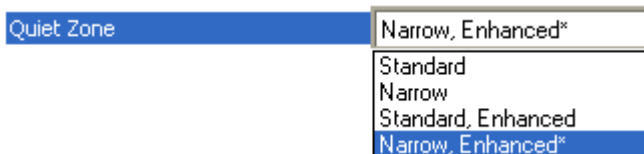

Note: Do not use **Narrow** or **Narrow, Enhanced** when **Large Intercharacter Gap** is enabled for Code 39, unless **Symbol Reconstruction** is also enabled.

Note: Any Quiet Zone setting other than Standard will increase processing requirements.

Standard

The scanner locates symbols using a standard 8x Quiet Zone requirement.

Narrow

The scanner locates symbols using a 5x Quiet Zone requirement.

Standard, Enhanced

The scanner locates symbols using an enhanced algorithm for standard 8x Quiet Zones. The enhanced algorithm has a higher tolerance for leading-edge “noise”, and is particularly useful for high density symbols.

Narrow, Enhanced

The scanner locates symbols using an enhanced algorithm for 5x Quiet Zones. The enhanced algorithm has a higher tolerance for leading-edge “noise”, and is particularly useful for high density symbols.

This setting is the Default because it overcomes many symbol quality issues, such as printing and placement inconsistencies.

Symbology Identifier

Symbology Identifier is a standard prefix set of characters that identifies the symbol type. When enabled, the scanner analyzes and identifies the symbology and adds a three-character identifying prefix to the data:

-] (closed bracket character) indicating the presence of a symbology identifier.
- **A, C, E, F, G, I, L, e, or p**
- (A = Code 39; C = Code 128; E = UPC/EAN; F = Codabar; G = Code 93; I = Interleaved 2 of 5; L = PDF417 and MicroPDF417; e = GS1 DataBar (RSS); p = Pharmacode)
- Modifier

Example: **]C** indicates a Code 128 symbol.



Disabled

When set to Disabled, symbol data output does not contain Symbology Identifier information.

Enabled AIM ID

When set to **Enabled AIM ID**, symbol data output contains a three-character AIM Symbology Identifier sequence.

Enabled Readable ID

When set to Enabled Readable ID, symbol data output contains a human-readable description of the decoded symbology.

Examples:

]CODE39
]CODE128
]UPCA
]UPCEAN13

Explanation of Modifiers for Code 39, Codabar, and Interleaved 2 of 5

- For Code 39, Codabar, and Interleaved 2 of 5, the modifier indicates **Check Character** and **Check Character Output** status.
- For Code 39 only, Full ASCII must be enabled to see modifiers **4**, **5**, and **7**.

<i>Modifier</i>	<i>Check Character</i>	<i>Check Character Output</i>	<i>Full ASCII Conversion (Code 39 Only)</i>
0	Disabled	N/A	No
1	Enabled	Enabled	No
3	Enabled	Disabled	No
4	Disabled	N/A	Yes
5	Enabled	Enabled	Yes
7	Enabled	Disabled	Yes

Example: **JA5** indicates a **Code 39** symbol with **Check Character** and **Check Character Output** enabled and Full ASCII conversion performed.

Explanation of Modifiers for Other Symbologies

- For Code 128, a **1** indicates EAN 128; otherwise the modifier is **0**.
- For all other symbologies, the modifier is **0**.

Background Color

Symbol backgrounds are often **White**, or other very light colors. If the background is darker than the symbol, **Black** background should be enabled.

Allows the user to specify the symbol background used in the application.



White

When **White** background is enabled, the bars of linear symbols and the elements of 2D symbols are recognized as dark on a light background.

Black

When **Black** background is enabled, the bars of linear symbols and the elements of 2D symbols are recognized as light on a dark background.

Depth of Field Enhance

The Default **Depth of Field Enhance** setting of **Medium** will be ideal for 75% of all depth of field issues. **Low** and **High** account for the other 25%.

Note: Any setting other than Disabled will increase processing requirements.

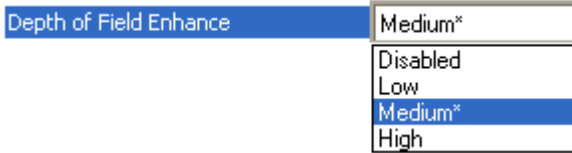

Disabled

No extra processing of elements is performed to extend depth of field.

Low

Minimal additional processing of elements is performed to extend depth of field. The **Low** setting is not recommended for most applications that require **Depth of Field Enhance**. However, some focus and printing issues may make this the optimal setting.

Medium

Some additional processing of elements is performed to extend depth of field. The **Medium** setting is the most likely to be useful in applications that require **Depth of Field Enhance**.

High

Additional processing of elements is performed to extend depth of field. The **High** setting is not recommended for most applications that require **Depth of Field Enhance**. However, some focus and printing issues may make this the optimal setting.

Symbol Reconstruction

Industrial environments present many data capture challenges, some of which are damaged symbols, partially covered symbols, poorly printed symbols, and variation of label placement. Symbol quality, location, and orientation cannot always be controlled. Labels can be torn, partially obscured, overprinted, or underprinted due to variations in print mechanisms. For industrial tracking and traceability to be reliable, symbols must be decoded regardless of damage, label tilt, or any other discontinuities.

The QX-870 features X-Mode™ technology, which allows the scanner to reconstruct data from damaged or poorly positioned symbols by “stepping through” the elements (bars) in multiple stages and then combining the successfully decoded regions into completed symbol data output, as shown in the simplified example below.

Note: Symbol Reconstruction functions with Code 39, Code 128, Interleaved 2 of 5, and UPC/EAN symbols.

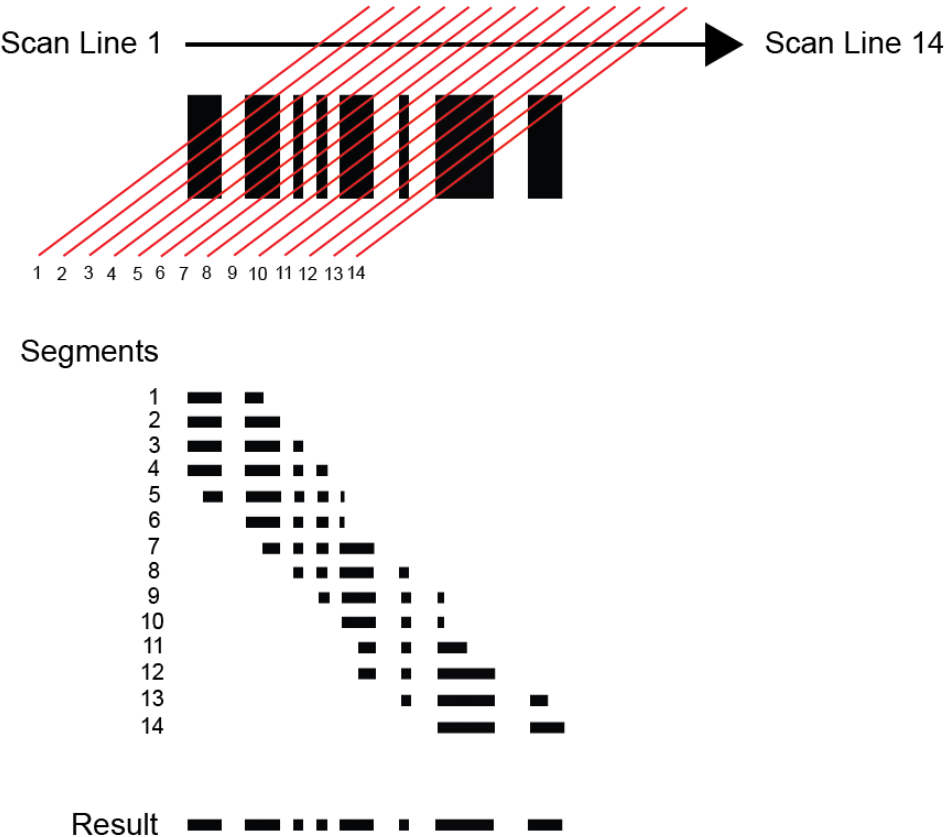

Symbol Reconstruction Redundancy

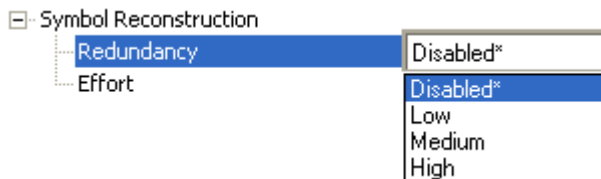

Disabled

When Symbol Reconstruction **Redundancy** is **Disabled**, the scanner will not attempt to reconstruct symbols across multiple scan lines.

Low

When Symbol Reconstruction Redundancy is set to **Low**, the scanner will attempt to reconstruct symbols across multiple scan lines. Only the minimum amount of redundancy checking will be applied to qualify the reconstruction result. This can limit the **Effort** level required to decode. However, this is the lowest level of proof required, so occasionally the symbol's level of data integrity may lead to a misread.

Note: Applications with low area coverage may be forced to use this setting.

Medium

When Symbol Reconstruction Redundancy is set to **Medium**, the scanner will attempt to reconstruct symbols across multiple scan lines. A larger amount of redundancy checking will be applied to qualify the reconstruction result. This may require the decode **Effort** level to be increased. This level of redundancy checking is helpful in avoiding misreads. Occasionally the symbol's level of data integrity may lead to a misread, but this setting requires enough matching data to protect the majority of data.

Note: Applications with average area coverage can use this setting.

High

When Symbol Reconstruction Redundancy is set to **High**, the scanner will attempt to reconstruct symbols across multiple scan lines. A very large amount of redundancy checking will be applied to qualify the reconstruction result. This will require the effort level to rise to achieve a decode. This level of redundancy checking is helpful in avoiding misreads. Occasionally the symbol's level of data integrity may lead to a misread, but this setting requires enough matching data to protect the majority of data.

Note: Applications with a large amount of area coverage can use this setting. However, as aspect ratio decreases and line speed increases, **High** may not provide enough decodes to be useful. The **Effort** level may also require more time in some cases.

Symbol Reconstruction Effort

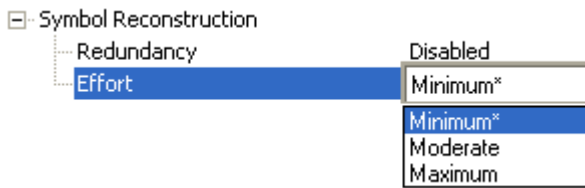

Minimum

When Symbol Reconstruction Effort is set to **Minimum**, the scanner will attempt to reconstruct symbols across multiple scan lines. However, the required processing time will be limited to a minimum level, so candidate symbols that are not valid will be rejected quickly.

Moderate

When Symbol Reconstruction Effort is set to **Moderate**, the scanner will attempt to reconstruct symbols across multiple scan lines. The required processing time will be limited to a level that is expected to work optimally for most applications. Moderate is the appropriate setting for most symbol reconstruction scenarios. Moderate can still reject candidate symbols, but there may be a noticeable pause in throughput. Usually, candidate symbols will either decode or self-eliminate before the effort level is reached.

Maximum

When Symbol Reconstruction Effort is set to **Maximum**, the scanner will attempt to reconstruct symbols across multiple scan lines. However, if a large amount of processing is required, reconstruction is allowed to attempt all decode possibilities. This Effort level may cause the system to stall on the present data as it attempts to decode all possibilities.

Symbol Ratio Mode

Symbol Ratio Mode is useful for determining how much quality and data security validation will be applied when decoding a Code 39, Codabar, or Interleaved 2 of 5 symbol.

Tight ratios will only decode a high-quality symbol.

Standard ratios will decode most symbols.

Aggressive ratios will not validate the entire symbol before decoding. The ratios are “loosened” to read poor-quality symbols. This setting is not recommended unless users understand the potential ramifications: character substitution rate may increase dramatically when Symbol Ratio Mode is set to Aggressive.

[-] Symbol Ratio Mode	
Code 39	Standard
Codabar	Standard
Interleaved 2 of 5	Standard

Code 39

[-] Symbol Ratio Mode	
Code 39	Standard*
Codabar	Tight
Interleaved 2 of 5	Standard*
	Aggressive

Tight

Maximum ratio is set to **3.6:1**. A Validate function, which compares the ratio between the maximum and minimum bars in the symbol, is used for additional security. A Validate Bars function minimizes the acceptance of skewed symbols.

Standard

Maximum ratio is set to **4.0:1**. A Validate function, which compares the ratio between the maximum and minimum bars in the symbol, is used for additional security.

Aggressive

Maximum ratio is set at **5.5:1**. A Validate function is not used in this mode. This method may be useful on long symbols where the spot velocity can change throughout the symbol and effect the minimum and maximum bar values.

Codabar

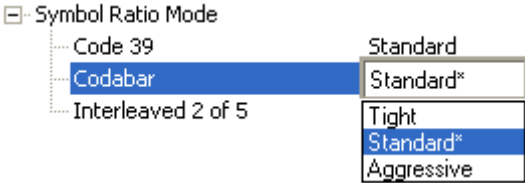

Tight

Maximum ratio is set to **3.6:1**. A Validate function, which compares the ratio between the maximum and minimum bars in the symbol, is used for additional security. A Validate Bars function minimizes the acceptance of skewed symbols.

Standard

Maximum ratio is set to **4.0:1**. A Validate function, which compares the ratio between the maximum and minimum bars in the symbol, is used for additional security.

Aggressive

Maximum ratio is set to **5.8:1**. A Validate function is not used in this mode. This method may be useful on long symbols where the spot velocity can change throughout the symbol and effect the minimum and maximum bar values.

Interleaved 2 of 5

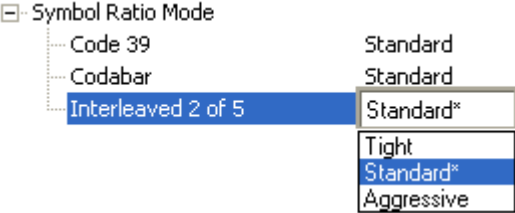

Tight

Maximum ratio is set to **3.6:1**. A Validate function, which compares the ratio between the maximum and minimum bars in the symbol, is used for additional security. A Validate Bars function minimizes the acceptance of skewed symbols.

Standard

Maximum ratio is set to **4.8:1**. A Validate function, which compares the ratio between the maximum and minimum bars in the symbol, is used for additional security.

Aggressive

Maximum ratio is set to **6.1:1**. A Validate function is not used in this mode. This method may be useful on long symbols where the spot velocity can change throughout the symbol and effect the minimum and maximum bar values.

I/O Parameters

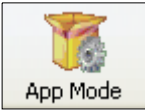

Click the **App Mode** button and then the **Parameters** button to display the tree control tabs.

Then click the **I/O** tab to display the I/O Parameters tree control.

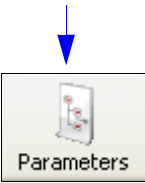

Parameters	ESP Values
[-] I/O Parameters	
+ Symbol Data Output	Good Read
+ No Read Message	Enabled
+ Bad Symbol Message	Disabled
+ No Symbol Message	Disabled
+ Read Duration Output	Disabled
+ Output Indicators	
+ Serial Verification	
+ EZ Button	Enabled
+ Status Indicators	PHY Activity
+ Calibration Options	
+ Database Identifier Output	Disabled
+ Input 1	Disabled*
+ Output 1 Parameters	Disabled*
+ Output 2 Parameters	Reset Counts
+ Output 3 Parameters	Unlatch Output
+ Quality Output	
+ Symbol Position Output	

The * indicates that the setting is the default.

To open nested options, **single-click** the +.

To change a setting, **double-click** the setting and use the cursor to scroll through the options.

Note: I/O Parameters settings can also be sent to the scanner from ESP's Terminal using Omron Microscan's K command format. Refer to the **I/O Parameters** section of **Appendix E**.

Symbol Data Output

Symbol Data Output relates to data and should not be confused with **Outputs 1, 2, and 3** listed in the **Output Parameters** which describe output states and functions.

Useful when the host needs symbol data only under certain conditions.

Defines the conditions under which decoded symbol data is transmitted to the host.

Note: Symbol Data Output Status, if set to **Match** or **Mismatch**, will not take effect unless **Matchcode Type** is enabled and a master symbol is loaded into memory.

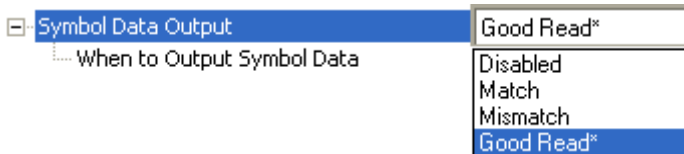

Symbol Data Output Status

Disabled

It is useful when an application only needs to use the discrete outputs and can allow the scanner to do the decision-making. When **Disabled**, the host does not need the symbol data and the communication lines are used only for setup and status checks.

When set to **Disabled**, the scanner will not transmit any data that is generated during a read cycle (symbols, No Reads, etc.)

Match

Match is used in an application that requires specific symbol information and needs to sort, route, or verify based on matching the specific symbol data.

When set to **Match**, the scanner transmits symbol data whenever a symbol matches a master symbol. However, if **Matchcode Type** is **Disabled**, it transmits on any good read.

Note: A No Read can still be transmitted if **Enabled**.

Mismatch

Mismatch is typically used as a flag within the host system to prevent an item from being routed in the wrong container.

With Mismatch enabled, the scanner transmits symbol data whenever the symbol data information does NOT match the master symbol.

Note: A No Read can still be transmitted if **Enabled**.

Good Read

Good Read is used when an application requires all symbol data to be transmitted. It's typically used in tracking applications in which each object is uniquely identified.

With **Good Read** enabled, the scanner transmits symbol data on any good read regardless of **Matchcode Type** setting.

Note: A No Read can still be transmitted if **Enabled**.

When to Output Symbol Data

This command allows the user to choose when symbol data can be sent to the host.

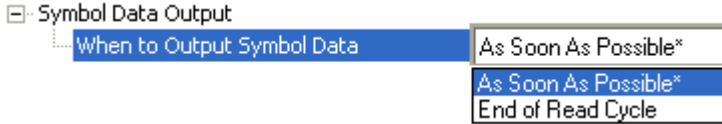

As Soon As Possible

As Soon As Possible is useful in applications in which symbol data needs to be moved quickly to the host, typically when the host is making decisions based on symbol data.

Note: More than one decode might in fact be required to qualify as a good read, depending on how **Decodes Before Output** is set.

Enabling **As Soon As Possible** causes symbol data to be sent to the host immediately after a symbol has been successfully decoded.

End of Read Cycle

End of Read Cycle is useful in timing-based systems in which the host is not ready to accept data at the time that it is decoded.

Enabling **End of Read Cycle** means that symbol data does not get sent to the host until the read cycle ends with a timeout or new trigger.

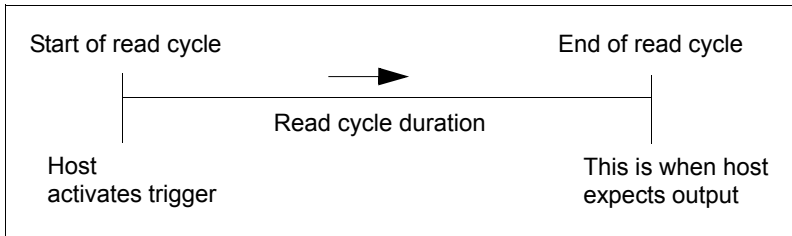

No Read Message

Used in applications where the host needs serial verification that a symbol has not been read and especially useful in new print verification.

When enabled, and if no symbol has been decoded before timeout or the end of the read cycle, the No Read message will be transmitted to the host.

<input type="checkbox"/> No Read Message	Enabled
Message	NOREAD

No Read Message Status

Disabled

Only symbol data is output after a read cycle.

Enabled

When the scanner is in a triggered mode, a No Read message will be appended for each failed read attempt.

Message

Any combination of ASCII characters can be defined as the No Read message.

Note: **No Read Message** will only be transmitted if **Symbol Data Output** is set to **Match**, **Mismatch**, or **Good Read**. **No Read Message** can be set to any ASCII character.

<input type="checkbox"/> No Read Message	Enabled
Message	NOREAD

Bad Symbol Message

Useful in determining if a symbol is present and if user defined requirements for that symbol are met. Can tell the user if a qualified symbol is present but not decodable.

Sets the requirements that will qualify an object or a symbol before outputting a decode or message. When enabled, sends a message to the host whenever an object meets the qualifications setup but is not decoded.

Note: When **Symbology Identifier** is enabled, the **Bad Symbol Message** is preceded by the identifier for the symbology being used.



Message

Any combination of ASCII characters can be defined as the Bad Symbol Message.



No Symbol Message

Useful in determining if a symbol is present and if user defined requirements for that symbol are met. Can tell the user if an object does not qualify as a symbol.

Sets the requirements that will qualify an object or a symbol before outputting a decode or message. When enabled, sends a message to the host whenever an object meets the qualifications setup but is not decoded.

Note: When **Symbology Identifier** is enabled, the **No Symbol Message** is preceded by the identifier for the symbology being used.

<input type="checkbox"/> No Symbol Message	Disabled
Message	NO_SYMBOL

Message

Any combination of ASCII characters can be defined as the No Symbol Message.

<input type="checkbox"/> No Symbol Message	Disabled
Message	N O _ S Y M B O L

Read Duration Output

Useful in evaluating actual read cycle timing results, especially when initially setting up an application to determine maximum line speed (obtainable based on spacing between symbols.)

When enabled the duration of the read cycle (in milliseconds) is appended to the symbol data. The read duration is the time from the beginning of the read cycle until data is output.

Important: To measure the entire read cycle when in **External Level** trigger mode, set **When to Output Symbol Data** to **End of Read Cycle**.

This output can measure over 49 days' worth of duration; if exceeded, the "OVERFLOW" message will be output in place of the duration.

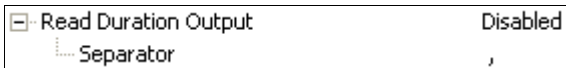

Separator

User-defined character that separates the symbol information from the **Read Duration Output**.

Read Duration Output

Separator

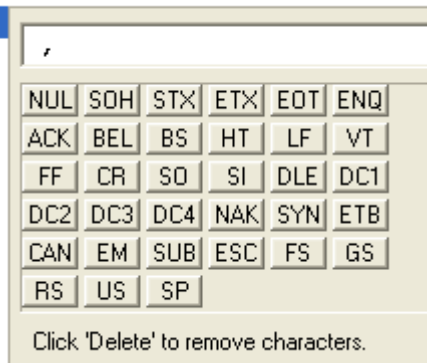

Output Indicators

Output Indicators	
Green Flash Mode	On Good Read
Green Flash Duration	100
Beeper	On Good Read

The QX-870 has a beeper and two LED arrays, as follows:

1. An array of green LEDs projected from the front of the scanner that can be programmed to flash in response to user-defined conditions.
2. An array of status LEDs on the side of the scanner.

Green Flash Mode

Output Indicators	
Green Flash Mode	On Good Read*
Green Flash Duration	Disabled
Beeper	On Good Read*
	Static Presentation
	Match
	Mismatch

Used as a visual verification that a good read has occurred.

An array of green LEDs in the front of the scanner can be programmed to flash in response to user-defined conditions.

Disabled

Green flash LEDs are disabled.

On Good Read

Green flash LEDs will flash when a good read condition is met or when **Matchcode** is enabled and a match occurs.

Static Presentation

Static Presentation Mode is used in conjunction with **Continuous Read** mode.

When operating in **Static Presentation Mode**, the red LEDs will illuminate while the scanner is searching for a symbol in **Continuous Read** mode. When a symbol is placed in the field of view and a good read occurs, the green LEDs will illuminate and stay on for the duration of time set in **Green Flash Duration**. Only one read will occur during that time unless more than one symbol is enabled in **Number of Symbols**.

Note: If **Static Presentation Mode** is selected but the scanner is not in **Continuous Read**, the **Green Flash** will not occur.

To use Static Presentation:

1. Enable **Continuous Read**.
2. Select the number of symbols.
3. Enable **Static Presentation** in **Green Flash Mode**.
4. Select the read time in **Green Flash Duration**.

Match

The green LEDs will flash when a match condition is met. If multisymbol is enabled, then green flash LEDs will illuminate only if all symbols qualify as a match. If matchcode is disabled, then this mode will activate the LEDs on a good read.

Mismatch

Same as **Match**, except that LEDs will illuminate on a mismatch.

Green Flash Duration

Provides visual verification that a good read has occurred.

When a good read occurs, the green LEDs will illuminate and stay on for the time set in the **Green Flash Duration** value.



Beeper

An audible verification that either a good read or a No Read has occurred.

A beep is emitted after each good read or No Read.

Note: The beeper will also sound at any of the following times:

- When the scanner is defaulted.
- When a **Send and Save** command is sent from ESP.
- At the conclusion of an **Auto Calibration** procedure.
- When a **<Z>**, **<Zp>**, **<Zrd>**, or **<K701,,1>** command is sent from ESP's Terminal.



Serial Verification

Allows the user to verify configuration command status.

Serial Verification	
Serial Command Echo Status	Disabled
Serial Command Beep Status	Disabled
Control/Hex Output	Control

Serial Command Echo Status

This command is useful in removing any doubt about the scanner's interpretation of any configuration command.

For example, if the current preamble is "SOM" and **<K701,1,START>** is entered, the scanner will echo back **<K701,SOM>** since the attempted entry "START" exceeds the four character limit for that command. Therefore, it is rejected and the existing "SOM" message is echoed back and remains the preamble message.

When enabled, a configuration command received from the host is echoed back to the host with the resultant settings.

If a command with multiple fields is processed, some of the fields may have been processed properly while others were not. The changes will appear in the string echoed back so that the user will know which fields did or did not change.

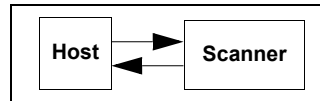

Serial Verification	
Serial Command Echo Status	Disabled*
Serial Command Beep Status	Disabled*
Control/Hex Output	Enabled

Serial Command Beep Status

Used to audibly verify the acceptance and validity of a command.

Causes the scanner to beep once whenever a K command is entered to indicate that the command was accepted and processed.

If an invalid command is entered, the scanner beeps 5 times to indicate an invalid entry. However, this does not necessarily mean that all data fields have been entered incorrectly. Only one bad field needs to be found in order to activate the 5 beep response.

Serial Verification	
Serial Command Echo Status	Disabled
Serial Command Beep Status	Disabled*
Control/Hex Output	Disabled*
	Enabled

Control / Hex Output

Useful for viewing settings with binary characters when using serial commands on a terminal. Determines the response to a **Serial Command Echo** or status request command.

When set to **Control**, two characters are transmitted to represent a non-displayable character. For example, a carriage return will be shown as: **^M**.

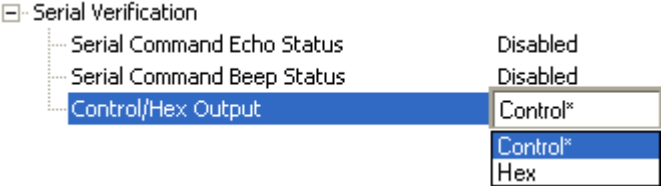

EZ Button



Serves as a master switch to enable/disable the EZ Button status.

<input checked="" type="checkbox"/> EZ Button	Enabled
Default On Power-on	Enabled
Single Beep	Read Rate
Two Beeps	Calibration
Three Beeps	Save for Power-on
Four Beeps	Auto Framing
<input checked="" type="checkbox"/> Auto Framing Options	
Laser Framing	Enabled

The EZ Button has four positions: **Single Beep**, **Two Beeps**, **Three Beeps**, and **Four Beeps**, selectable by the length of time the button is held down, and indicated by one, two, three, and four beeps in succession. Each position can be programmed for any of eight **EZ Button Modes**.

EZ Button Status



Disabled

When set to **Disabled**, the EZ Button does not function.

Enabled

When selected, the EZ Button is enabled and the function of each button position is selected by the **EZ Button Modes** command.

Trigger

When selected, the EZ Button acts as a trigger for the scanner to start and end read cycles. All other button operations are inactive.

In External Level: The read cycle endures for as long as the EZ Button is pressed, unless a timeout occurs and **End of Read Cycle Mode** is set to **Timeout**.

In External Edge: As with **External Level**, **External Edge** allows a read cycle to be initiated by pressing the EZ Button, but unlike **External Level**, the read cycle ends with a good read output, a timeout, or a new trigger.

Unlatch Outputs

In this configuration, the EZ Button will unlatch any logic outputs that have been latched.

Parameter Switch

The parameter switch toggles between custom defaults and power-on settings. The condition is the same as that achieved by sending the **<Arc>** and **<Arp>** commands consecutively.

Default on Power-On

When enabled, if the EZ Button is held down on power-on, the scanner will default to customer defaults and save for power-on. This is the same as sending a **<Zrc>** command from ESP's Terminal.



EZ Button Modes

Useful for performing multiple, repetitive tasks at the work site.

Allows the user to program each of the EZ Button's 4 positions from a selection of 8 modes.

Single Beep

Hold down button until a single beep is heard (and the 20% LED illuminates).

EZ Button	Enabled
Default On Power-on	Enabled
Single Beep	Read Rate*
Two Beeps	Disabled
Three Beeps	Read Rate*
Four Beeps	Calibration
Auto Framing Options	Save for Power-on
Laser Framing	Auto Framing
	Load New Master
	Sleep mode
	Bar Code Configuration

Disabled

When set to **Disabled**, the associated button position will have no function associated with it, and the position will be skipped over.

Read Rate

Read Rate is initiated when the associated button position is selected. Read Rate will perform decodes/second and is the same as sending a **<C>** from ESP's Terminal. To exit Read Rate, quickly press and release the EZ Button.

Calibration

Calibration is initiated when the associated button position is selected. To cancel Calibration, quickly press and release the EZ Button.

Save for Power-On

All scanner settings will be saved to non-volatile memory to be recalled on power-on whenever the associated button position is selected. This is the same as sending a **<Z>** from ESP's Terminal.

Auto Framing

Auto Framing is initiated when this button position is selected. To cancel Auto Framing, quickly press and release the EZ Button.

Load New Master

Functions in the same way as **New Master Pin** input whenever the associated button position is selected.

Sleep Mode

When **Sleep Mode** is selected, the scanner will shut the motor and laser off when this button position is selected. To cancel Sleep Mode, quickly press and release the EZ Button.

Bar Code Configuration

Enables **Bar Code Configuration Mode** whenever the associated button position is selected. When enabled, the scanner can accept configuration commands from symbols. To disable, quickly press and release the EZ Button.

Two Beeps

Hold down button until two quick beeps are heard (and the 20% and 40% LEDs illuminate.)

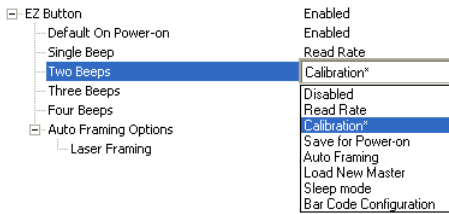

Disabled

When set to **Disabled**, the associated button position will have no function associated with it, and the position will be skipped over.

Read Rate

Read Rate is initiated when the associated button position is selected. Read Rate will perform decodes/second and is the same as sending a **<C>** from ESP's Terminal. To exit Read Rate, quickly press and release the EZ Button.

Calibration

Calibration is initiated when the associated button position is selected. To cancel Calibration, quickly press and release the EZ Button.

Save for Power-On

All scanner settings will be saved to non-volatile memory to be recalled on power-on whenever the associated button position is selected. This is the same as sending a **<Z>** from ESP's Terminal.

Auto Framing

Auto Framing is initiated when this button position is selected. To cancel Auto Framing, quickly press and release the EZ Button.

Load New Master

Functions in the same way as **New Master Pin** input whenever the associated button position is selected.

Sleep Mode

When **Sleep Mode** is selected, the scanner will shut the motor and laser off when this button position is selected. To cancel Sleep Mode, quickly press and release the EZ Button.

Bar Code Configuration

Enables **Bar Code Configuration Mode** whenever the associated button position is selected. When enabled, the scanner can accept configuration commands from symbols. To cancel Bar Code Configuration, quickly press and release the EZ Button.

Three Beeps

Hold down button until three quick beeps are heard (and the 20%, 40%, and 60% LEDs illuminate).

EZ Button	Enabled
Default On Power-on	Enabled
Single Beep	Read Rate
Two Beeps	Calibration
Three Beeps	Save for Power-on*
Four Beeps	Disabled
Auto Framing Options	Read Rate
Laser Framing	Calibration
	Save for Power-on*
	Auto Framing
	Load New Master
	Sleep mode
	Bar Code Configuration

Disabled

When set to **Disabled**, the associated button position will have no function associated with it, and the position will be skipped over.

Read Rate

Read Rate is initiated when the associated button position is selected. Read Rate will perform decodes/second and is the same as sending a **<C>** from ESP's Terminal. To exit Read Rate, quickly press and release the EZ Button.

Calibration

Calibration is initiated when the associated button position is selected. To cancel Calibration, quickly press and release the EZ Button.

Save for Power-On

All scanner settings will be saved to non-volatile memory to be recalled on power-on whenever the associated button position is selected. This is the same as sending a **<Z>** from ESP's Terminal.

Auto Framing

Auto Framing is initiated when this button position is selected. To cancel Auto Framing, quickly press and release the EZ Button.

Load New Master

Functions in the same way as **New Master Pin** input whenever the associated button position is selected.

Sleep Mode

When **Sleep Mode** is selected, the scanner will shut the motor and laser off when this button position is selected. To cancel Sleep Mode, quickly press and release the EZ Button.

Bar Code Configuration

Enables **Bar Code Configuration Mode** whenever the associated button position is selected. When enabled, the scanner can accept configuration commands from symbols. To disable, quickly press and release the EZ Button.

Four Beeps

Hold down button until four quick beeps are heard (and the 20%, 40%, 60%, and 80% LEDs illuminate).

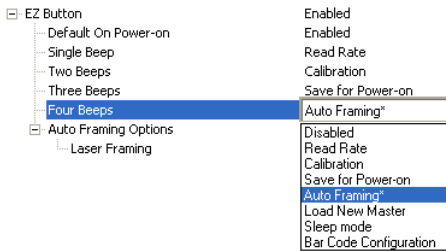

Disabled

When set to **Disabled**, the associated button position will have no function associated with it, and the position will be skipped over.

Read Rate

Read Rate is initiated when the associated button position is selected. Read Rate will perform decodes/second and is the same as sending a **<C>** from ESP's Terminal. To exit Read Rate, quickly press and release the EZ Button.

Calibration

Calibration is initiated when the associated button position is selected. To cancel Calibration, quickly press and release the EZ Button.

Save for Power-On

All scanner settings will be saved to non-volatile memory to be recalled on power-on whenever the associated button position is selected. This is the same as sending a **<Z>** from ESP's Terminal.

Auto Framing

Auto Framing is initiated when this button position is selected. To cancel Auto Framing, quickly press and release the EZ Button.

Load New Master

Functions in the same way as **New Master Pin** input whenever the associated button position is selected.

Sleep Mode

When **Sleep Mode** is selected, the scanner will shut the motor and laser off when this button position is selected. To cancel Sleep Mode, quickly press and release the EZ Button.

Bar Code Configuration

Enables **Bar Code Configuration Mode** whenever the associated button position is selected. When enabled, the scanner can accept configuration commands from symbols. To disable, quickly press and release the EZ Button.

Auto Framing Options

When Enabled, **Laser Framing** is performed when the **Auto Framing** button beep position is selected (**Single Beep**, **Two Beeps**, **Three Beeps**, or **Four Beeps**).

[-] Auto Framing Options

Laser Framing	Enabled*
	Disabled
	Enabled*

Status Indicators

The side of the QX-870 features an array of LEDs that indicate various aspects of scanner activity.



[-] Status Indicators	PHY Activity
Bar Graph	Read Rate / Good Read
I/O 1	Output Active
I/O 2	Input Active

Controls the operation of the MOD/ACT and NET/LNK LEDs.

Note: MOD and ACT function as one combined LED, as do NET and LNK.

[-] Status Indicators	PHY Activity*
Bar Graph	Disabled
I/O 1	PHY Activity*
I/O 2	Protocol Activity

Disabled

When set to **Disabled**, the MOD/ACT and NET/LNK LEDs are always off.

Note: All green and red LEDs will turn on briefly during power-on or reset to confirm that they are functioning.

PHY Activity

If Ethernet is available:

LNK = Solid green when transceiver is linked.

ACT = Blinking green when transceiver detects Tx or Rx activity.

Otherwise, for all RS232 and RS422/485 activity:

LNK = Blinking green with Tx data activity.

ACT = Blinking green with Rx data activity.

Note: Red is never turned on.

Protocol Activity

If EtherNet/IP is enabled:

MOD = Module status, per EtherNet/IP specification

NET = Network status, per EtherNet/IP specification

Otherwise, the MOD and NET LEDs are always off.

Bar Graph

Read Rate, Auto Calibration, Bar Code Configuration, and Read Cycle Result all share the Bar Graph (20% – 100%) LEDs.

Status Indicators	PHY Activity
Bar Graph	Read Rate / Good Read*
I/O 1	Disabled
I/O 2	Read Rate / Good Read*

I/O 1

I/O 1 always shows the combined state of the discrete outputs. If any output is active, the I/O 1 LED will be on.

Status Indicators	PHY Activity
Bar Graph	Read Rate
I/O 1	Output Active*
I/O 2	Disabled
	Output Active*
	Input Active

I/O 2

I/O 2 always shows the state of the hardware input trigger. If the trigger is active, I/O 2 will be on.

Status Indicators	PHY Activity
Bar Graph	Read Rate
I/O 1	Output Active
I/O 2	Input Active*
	Disabled
	Output Active
	Input Active*

Calibration Options

Calibration Options specifies the operation of the calibration feature. The default configuration is set up to perform calibration on **Gain**, **Focus** and **Symbol Type**.

[-] Calibration Options	
Video	Calibrate
Scan Speed	Calibrate
Laser Power	Calibrate
Laser Framing	Don't Calibrate
Symbol Type	Calibrate

Video

When set to **Calibrate**, there will be an attempt to change **Video** settings (**Gain** and **Tracking**). Video settings include Gain and Tracking.

[-] Calibration Options	
Video	Calibrate*
Scan Speed	Don't Calibrate
Laser Power	Calibrate*
Laser Framing	Don't Calibrate
Symbol Type	Calibrate

Scan Speed

When set to **Calibrate**, there will be an attempt to change **Scan Speed**. If a better read rate at a different speed is found, the new speed will be the calibration result for Scan Speed.

[-] Calibration Options	
Video	Calibrate
Scan Speed	Calibrate*
Laser Power	Don't Calibrate
Laser Framing	Calibrate*
Symbol Type	Calibrate

Laser Power

When set to **Calibrate**, there will be an attempt to change **Laser Power**. If a better read rate at a higher power is found, or if the same read rate at a lower power is found, the new power level will be the calibration result for Laser Power.

[-] Calibration Options	
Video	Calibrate
Scan Speed	Calibrate
Laser Power	Calibrate*
Laser Framing	Don't Calibrate
Symbol Type	Calibrate*

Laser Framing

When set to **Calibrate**, there will be an attempt to frame the symbol automatically. Framing is based on symbol readability. The frame line will be decreased until a drop in read performance is detected. Once the line length is found then a small margin is added to account for variation.

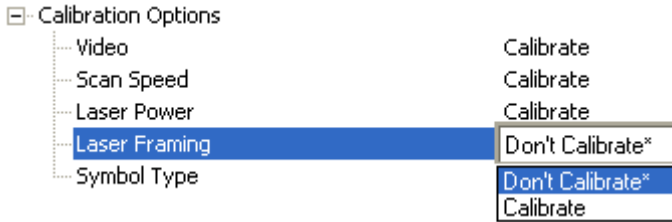

Symbol Type

When set to **Calibrate**, all supported symbologies (except PDF417 and Pharmacode) will be attempted during calibration. Symbol lengths are not detected. Any new symbologies successfully decoded during calibration will remain enabled at the end of the process. All enabled symbologies will remain enabled.

For example, assume that only Code 39 is enabled at the beginning of calibration. If a Code 128 symbol is read during calibration, then Code 128 as well as Code 39 will be enabled at the end of calibration.

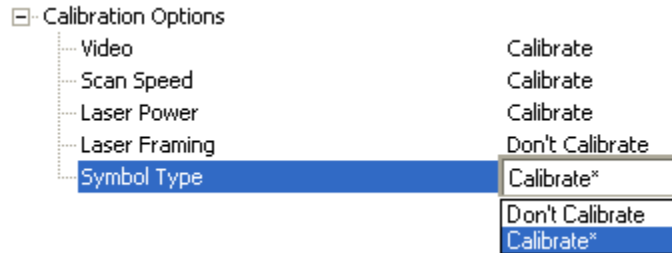

Database Identifier Output

Useful in tracking which database entries read which symbols.

Database Identifier Output Status

<input type="checkbox"/> Database Identifier Output	Disabled
<input type="checkbox"/> Separator Character	SP

Disabled

When this command is disabled, no database identifier information will be output.

Enabled

When this command is enabled, the scanner will append a two-digit number and the characters “DB” to the data output following the separator for each symbol decoded using [Configuration Database](#). For example, if the separator is an underscore character and the second database entry reads a symbol encoded with “data capture” during the read cycle, the symbol data output will be “data capture_DB02”. If the database is not active, no identifiers will be attached to output.

Separator Character

The separator character separates the symbol data from the database identifier.

<input type="checkbox"/> Database Identifier Output	Disabled
<input type="checkbox"/> Separator Character	

SP

NUL	SOH	STX	ETX	EOT	ENQ
ACK	BEL	BS	HT	LF	VT
FF	CR	SO	SI	DLE	DC1
DC2	DC3	DC4	NAK	SYN	ETB
CAN	EM	SUB	ESC	FS	GS
RS	US	SP			

Click 'Delete' to remove characters.

Input 1

[-] Input 1	Disabled
Active State	Active Open

Input Mode

Determines the function of the Input pin.

[-] Input 1	Disabled*
Active State	Disabled*
	Reset Counts
	Unlatch Output

Disabled

When set to **Disabled**, the Input pin has no impact on operation.

Reset Counts

When set to **Reset Counts**, a transition to the active state of the Input will cause the scanner to reset the internal counters.

Unlatch Output

This setting is used in combination with any of the three outputs in **Latch Mode 1 (Unlatch Input # 1 Pin)**. A transition to the active state will clear any of the three outputs that were previously latched.

Active State

[-] Input 1	Disabled
Active State	Active Open*
	Active Open*
	Active Closed

Active Open

Input function is activated when input state is de-energized.

Active Closed

Input function is activated when input state is energized.

Output 1 Parameters

Output On

Output On provides discrete signalling to host software to control external devices such as PLCs and relays. It is useful for routing, sorting, and to prevent mis-packaging and mis-routing.

Sets the discrete output functions for specific user-selected conditions. Allows the user to set the conditions under which an output (or outputs) will be activated.

Note: If **Output On** is set to any mode containing **Match** or **Mismatch**, the transition (switching) will only occur if **Matchcode Type** is enabled and **Master Symbol(s)** are loaded into memory.

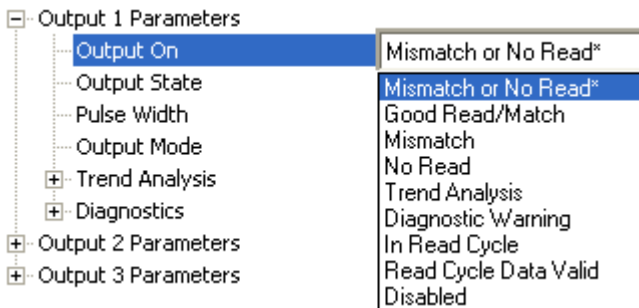

Mismatch or No Read

Activates discrete output when the data does not match that of the master symbol or the symbol has not been decoded before the end of the read cycle.

Good Read / Match

Activates a discrete output when the symbol data matches the master symbol.

Mismatch

Activates a discrete output whenever the symbol data does not match that of the master symbol.

No Read

Activates a discrete output whenever the symbol data is not decoded before the end of the read cycle.

Trend Analysis

Typically used when successful decodes are occurring but a discrete output is needed to flag a trend in quality issues.

Activates discrete output when a trend analysis condition is met, depending on the trend analysis option enabled.

I/O Parameters

Diagnostic Warning

Typically used when a discrete indication of a diagnostic condition is needed.

Activates discrete output when a diagnostic warning condition is met, depending on the diagnostic option enabled.

In Read Cycle

Activates a discrete output when the scanner is in a read cycle.

Read Cycle Data Valid

Activates discrete output when all the data generated in the read cycle has left the scanner.

Output State

Sets the active electrical state of the discrete output.

[-] Output 1 Parameters	
Output On	Mismatch or No Read
Output State	Normally Open*
Pulse Width	Normally Open*
Output Mode	Normally Closed
[-] Trend Analysis	
Trend Analysis Mode	No Read
Number of Triggers	0
Number to Output On	0
Decodes per Trigger	0
[-] Diagnostics	
High Temperature	Disabled
Service Unit	Disabled
Laser Current High	Disabled
Laser Current Low	Disabled
Low Temperature	Disabled

Pulse Width

Sets the time in 10 ms increments that the discrete output remains active.

[-] Output 1 Parameters	
Output On	Mismatch or No Read
Output State	Normally Open
Pulse Width	0.050 <input type="text"/> Seconds
Output Mode	Pulse
[-] Trend Analysis	
Trend Analysis Mode	No Read
Number of Triggers	0
Number to Output On	0
Decodes per Trigger	0
[-] Diagnostics	
High Temperature	Disabled
Service Unit	Disabled
Laser Current High	Disabled
Laser Current Low	Disabled
Low Temperature	Disabled

Output Mode

Sets the condition in which the discrete output is de-activated.

[-] Output 1 Parameters	
Output On	Mismatch or No Read
Output State	Normally Open
Pulse Width	50
Output Mode	Pulse*
[-] Trend Analysis	
Trend Analysis Mode	Pulse*
Number of Triggers	Latch Mode 1 (Unlatch Input #1 Pin)
Number to Output On	Latch Mode 2 (Unlatch Opposite Condition)
Decodes per Trigger	Latch Mode 3 (Unlatch Re-Enter Read Cycle)
0	
[-] Diagnostics	
High Temperature	Disabled
Service Unit	Disabled
Laser Current High	Disabled
Laser Current Low	Disabled
Low Temperature	Disabled

Pulse

This is the default mode of operation in which the programmable output is activated when the **Output On** condition has been met and held active for the duration of the selected pulse width.

Latch Mode 1 (Unlatch Input # 1 Pin)

The programmable output is activated when the **Output On** condition has been met and held active until the **Input # 1 Pin** transitions.

Note: **Input 1** must be set to **Unlatch Output** for Latch Mode 1 to function.

If the Output Condition is set to **Read Cycle Data Valid**, then the read cycle will wait for Input 1 to unlatch the output before continuing on. This is to provide system handshake ability despite communication channel. The read cycle data must leave all channels before **Read Cycle Data Valid** will output.

Latch Mode 2 (Unlatch Opposite Condition)

The programmable output is activated when the **Output On** condition has been met and held active until the opposite condition selected under **Output On** has been met.

For example, if **No Read** is enabled under **Output On**, the programmable output will go active on a No Read and remain active until the opposite condition, a good read, occurs.

If the Output Condition is set to **Read Cycle Data Valid**, then the read cycle will continue but every new **Read Cycle Data Valid** event causes the output to change state to the opposite condition. This provides a toggle event per every read cycle output. The only known output state will be the on a power-on or reset. After reading begins, the state becomes undetermined. Only the state change itself has meaning—not the absolute value.

Latch Mode 3 (Unlatch Re-enter Read Cycle)

The programmable output is activated when the **Output On** condition has been met and held active until a new read cycle begins.

Note: All of the **Output On** modes are inhibited when any **Diagnostic Warning** is active for **Output 1**.

Trend Analysis

Note: **Output On** under **Output 1 Parameters** must be set to **Trend Analysis** for this output to function.

Under **Output 1 Parameters**, expand the **Trend Analysis** tree.

Useful in cases where the user doesn't want to shut down for one condition but wants to monitor quality and read conditions.

Applies **Trend Analysis** settings to **Output 1**.

With **Trend Analysis**, the user can track the occurrences and frequency of mismatches, No Reads, and the number of reads per trigger, and output the results to any of three outputs.

Trend Analysis Mode = No Read

Trigger Evaluation Period = 25 triggers (read cycles)

Number to Output On = 4

In this example, the scanner will activate an output when 4 No Reads occur within a period of 25 triggers (read cycles).

Trend Analysis Mode

Sets the trend condition (**Mismatch**, **No Read**, **Decodes per Trigger**, **Bad Symbol**, or **No Symbol**) that will activate the output.

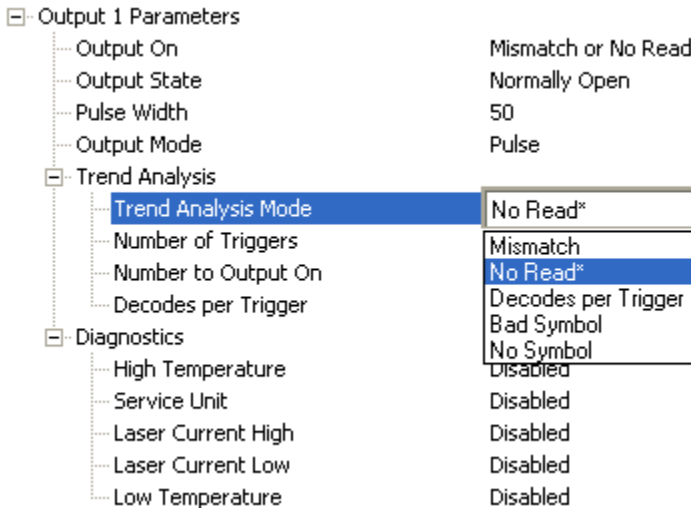

Mismatch

Output will be activated when the number of mismatches equals the value entered for **Number to Output On** within the trigger window selected in **Number of Triggers**.

No Read

Output will be activated when the number of No Reads equals the value entered for **Number to Output On** within the trigger window selected in **Number of Triggers**.

Decodes per Trigger

Output will be activated when the number of decodes equals the value entered for **Number to Output On** within the trigger window selected in **Number of Triggers**.

Bad Symbol

Output will be activated when the number of **Bad Symbol** occurrences equals the value entered for **Number to Output On** within the trigger window selected in **Number of Triggers**.

No Symbol

Output will be activated when the number of **No Symbol** occurrences equals the value entered for **Number to Output On** within the trigger window selected in **Number of Triggers**.

Number of Triggers

The number of triggers to examine for the trend analysis condition.

[-] Output 1 Parameters	
Output On	Mismatch or No Read
Output State	Normally Open
Pulse Width	500
Output Mode	Pulse
[-] Trend Analysis	
Trend Analysis Mode	No Read
Number of Triggers	0 (0 - 255)
Number to Output On	0
Decodes per Trigger	0

Number to Output On

Example: If **Number to Output On** is set to 3 and **Trend Analysis Mode** is set to **No Read**, then the output will not be activated until 3 No Reads have occurred.

Sets the number of **Trend Analysis Mode** events (mismatches, No Reads, or reads/trigger as configured by **Trend Analysis Mode**) to occur within the trigger evaluation period before activating the associated output.

[-] Output 1 Parameters	
Output On	Mismatch or No Read
Output State	Normally Open
Pulse Width	500
Output Mode	Pulse
[-] Trend Analysis	
Trend Analysis Mode	No Read
Number of Triggers	0
Number to Output On	0 (0 - 255)
Decodes per Trigger	0

Decodes per Trigger

When set to this mode, and when the appropriate output is set to output on trend analysis, the scanner will function in a **Decodes per Trigger** mode during the read cycle and the trend analysis operation. Output will be activated based on whether or not the symbol decode count at the end of the read cycle is less than the decodes per trigger threshold.

Note: Although this setup causes the scanner to function in a **Decodes per Trigger** mode, the decode count will only be appended to the symbol data if the status of the **Decodes per Trigger** command is enabled.

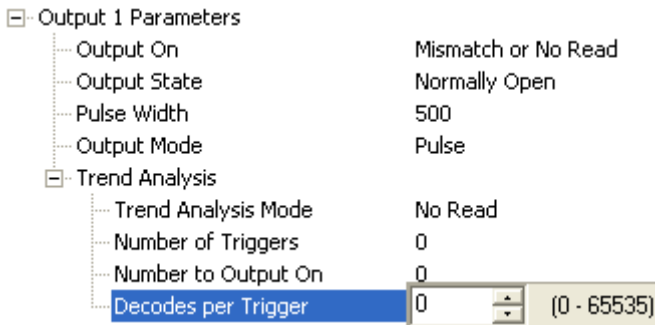

Example:

Decodes per Trigger threshold: 100

100 or more decodes = No output

Fewer than 100 decodes = Output fires

Diagnostics

Note: **Output On** under **Output 1 Parameters** must be set to **Diagnostic Warning** for this output to function.

Under **Output 1 Parameters**, expand the **Diagnostics** tree.

When **Diagnostic Warning** is enabled, the **Output On** configuration has no effect. The output will remain active as long as one of the diagnostic warning conditions is met. The output will become inactive once it detects that there are no diagnostic warning conditions.

High Temperature

Activates output when the temperature exceeds factory-defined upper limits.

[-] Output 1 Parameters	
Output On	Mismatch or No Read
Output State	Normally Open
Pulse Width	50
Output Mode	Pulse
[-] Trend Analysis	
Trend Analysis Mode	No Read
Number of Triggers	0
Number to Output On	0
Decodes per Trigger	0
[-] Diagnostics	
High Temperature	Disabled*
Service Unit	Disabled*
Laser Current High	Enabled
Laser Current Low	Disabled
Low Temperature	Disabled

I/O Parameters

Service Unit

Allows the user to set up the output to toggle to active when the service timer has expired. This condition will only be held for one service timer click.

Note: This feature cannot be used if the scanner is in **Continuous Read**.

When **Service Unit** is enabled, a message of up to 10 ASCII characters is sent whenever the system detects that the service timer's limit has been reached. The service timer is reset at power-on, meaning that the service timer's limit is the amount of time since last reset. Service timer increments can be set in seconds or minutes.

[-] Diagnostics	
Service Unit	Disabled*
	Disabled*
	Enabled

Laser Current High

Activates output when the laser current exceeds factory-defined upper limits.

[-] Output 1 Parameters	
Output On	Mismatch or No Read
Output State	Normally Open
Pulse Width	50
Output Mode	Pulse
[-] Trend Analysis	
Trend Analysis Mode	No Read
Number of Triggers	0
Number to Output On	0
Decodes per Trigger	0
[-] Diagnostics	
High Temperature	Disabled
Service Unit	Disabled
Laser Current High	Disabled*
Laser Current Low	Disabled*
Low Temperature	Enabled

Laser Current Low

Activates output when the laser current drops below factory-defined lower limits.

[-] Output 1 Parameters	
Output On	Mismatch or No Read
Output State	Normally Open
Pulse Width	50
Output Mode	Pulse
[-] Trend Analysis	
Trend Analysis Mode	No Read
Number of Triggers	0
Number to Output On	0
Decodes per Trigger	0
[-] Diagnostics	
High Temperature	Disabled
Service Unit	Disabled
Laser Current High	Disabled
Laser Current Low	Disabled*
Low Temperature	Disabled*

Disabled*	▼
Disabled*	
Enabled	

Low Temperature

Activates output when the temperature drops below factory-defined lower limits.

[-] Output 1 Parameters	
Output On	Mismatch or No Read
Output State	Normally Open
Pulse Width	50
Output Mode	Pulse
[-] Trend Analysis	
Trend Analysis Mode	No Read
Number of Triggers	0
Number to Output On	0
Decodes per Trigger	0
[-] Diagnostics	
High Temperature	Disabled
Service Unit	Disabled
Laser Current High	Disabled
Laser Current Low	Disabled
Low Temperature	Disabled*

Disabled*	▼
Disabled*	
Enabled	

Output 2 Parameters

Output 2 has the same parameters and default settings as Output 1.

[-] Output 2 Parameters	
Output On	Mismatch or No Read
Output State	Normally Open
Pulse Width	50
Output Mode	Pulse
[-] Trend Analysis	
Trend Analysis Mode	No Read
Number of Triggers	0
Number to Output On	0
Decodes per Trigger	0
[-] Diagnostics	
High Temperature	Disabled
Service Unit	Disabled
Laser Current High	Disabled
Laser Current Low	Disabled
Low Temperature	Disabled

Output On

Output On provides discrete signalling to host software to control external devices such as PLCs and relays. It is useful for routing, sorting, and to prevent mis-packaging and mis-routing.

Sets the discrete output functions for specific user-selected conditions. Allows the user to set the conditions under which an output (or outputs) will be activated.

Note: If **Output On** is set to **Match** or **Mismatch**, a transition (switching) will not occur unless **Matchcode Type** is enabled and a master symbol is loaded into memory.

[-] Output 2 Parameters	
Output On	Mismatch or No Read*
Output State	Mismatch or No Read*
Pulse Width	Good Read/Match
Output Mode	Mismatch
Trend Analysis	No Read
Diagnostics	Trend Analysis
Diagnostics	Diagnostic Warning
[-] Output 3 Parameters	In Read Cycle
	Read Cycle Data Valid
	Disabled

Mismatch or No Read

Activates discrete output when the data does not match that of the master symbol or the symbol has not been decoded before the end of the read cycle.

Good Read / Match

Activates a discrete output when the symbol data matches the master symbol.

Note: To output on **Good Read** when **Matchcode** is not enabled, enable any output for **Match**.

Mismatch

Activates a discrete output whenever the symbol data does not match that of the master symbol.

No Read

Activates a discrete output whenever the symbol data is not decoded before the end of the read cycle.

Trend Analysis

Typically used when successful decodes are occurring but a discrete output is needed to flag a trend in quality issues.

Activates discrete output when a trend analysis condition is met, depending on the trend analysis option enabled.

Diagnostic Warning

Typically used when a discrete indication of a diagnostic condition is needed.

Activates discrete output when a diagnostic warning condition is met, depending on the diagnostic option enabled.

In Read Cycle

Activates a discrete output when the scanner is in a read cycle.

Read Cycle Data Valid

Activates discrete output when all the data generated in the read cycle has left the scanner.

Output State

Sets the active electrical state of the discrete output.

[-] Output 2 Parameters

Output On	Mismatch or No Read
Output State	Normally Open*
Pulse Width	Normally Open*
Output Mode	Normally Closed

Pulse Width

Sets the time in 10 ms increments that the discrete output remains active.

[-] Output 2 Parameters

Output On	Mismatch or No Read
Output State	Normally Open
Pulse Width	0.500 <input type="text"/> Seconds
Output Mode	Pulse

Output Mode

Sets the condition in which the discrete output is de-activated.

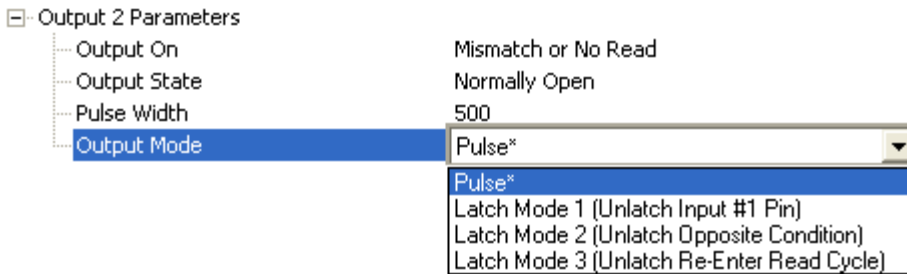

Pulse

This is the default mode of operation in which the programmable output is activated when the **Output On** condition has been met and held active for the duration of the selected pulse width.

Latch Mode 1 (Unlatch Input # 1 Pin)

The programmable output is activated when the **Output On** condition has been met and held active until the **Input # 1 Pin**.

Note: Input 1 must be set to **Unlatch Output** for Latch Mode 1 to function.

If the Output Condition is set to **Read Cycle Data Valid**, then the read cycle will wait for Input 1 to unlatch the output before continuing on. This is to provide system handshake ability despite communication channel. The read cycle data must leave all channels before **Read Cycle Data Valid** will output.

Latch Mode 2 (Unlatch Opposite Condition)

The programmable output is activated when the **Output On** condition has been met and held active until the opposite condition selected under **Output On** has been met.

For example, if **No Read** is enabled under **Output On**, the programmable output will go active on a No Read and remain active until the opposite condition, a good read, occurs.

If the Output Condition is set to **Read Cycle Data Valid**, then the read cycle will continue but every new **Read Cycle Data Valid** event causes the output to change state to the opposite condition. This provides a toggle event per every read cycle output. The only known output state will be the on a power-on or reset. After reading begins, the state becomes undetermined. Only the state change itself has meaning—not the absolute value.

Latch Mode 3 (Unlatch Re-enter Read Cycle)

The programmable output is activated when the **Output On** condition has been met and held active until a new read cycle begins.

Note: All of the **Output On** modes are inhibited when any **Diagnostic Warning** is active for **Output 2**.

Trend Analysis

Note: **Output On** under **Output 2 Parameters** must be set to **Trend Analysis** for this output to function.

Under **Output 2 Parameters**, expand the **Trend Analysis** tree.

Useful in cases where the user doesn't want to shut down for one condition but wants to monitor quality and read conditions.

Applies **Trend Analysis** settings to **Output 2**.

With **Trend Analysis**, the user can track the occurrences and frequency of mismatches, No Reads, and the number of reads per trigger, and output the results to any of three outputs.

Trend Analysis Mode = No Read

Trigger Evaluation Period = 25 triggers (read cycles)

Number to Output On = 4

In this example, the scanner will activate an output when 4 No Reads occur within a period of 25 triggers (read cycles).

Trend Analysis Mode

Sets the trend condition (**Mismatch**, **No Read**, **Decodes per Trigger**, **Bad Symbol**, or **No Symbol**) that will activate the output.

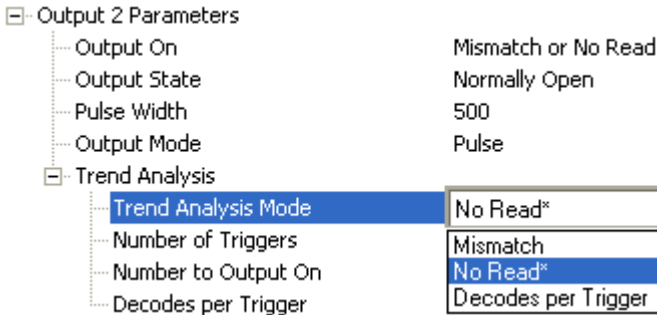

Mismatch

Output will be activated when the number of mismatches equals the value entered for **Number to Output On** within the trigger window selected in **Number of Triggers**.

No Read

Output will be activated when the number of No Reads equals the value entered for **Number to Output On** within the trigger window selected in **Number of Triggers**.

Decodes per Trigger

Output will be activated when the number of decodes equals the value entered for **Number to Output On** within the trigger window selected in **Number of Triggers**.

Bad Symbol

Output will be activated when the number of **Bad Symbol** occurrences equals the value entered for **Number to Output On** within the trigger window selected in **Number of Triggers**.

No Symbol

Output will be activated when the number of **No Symbol** occurrences equals the value entered for **Number to Output On** within the trigger window selected in **Number of Triggers**.

I/O Parameters

Number of Triggers

The number of triggers to examine for the trend analysis condition.

[-] Output 2 Parameters	
Output On	Mismatch or No Read
Output State	Normally Open
Pulse Width	500
Output Mode	Pulse
[-] Trend Analysis	
Trend Analysis Mode	No Read
Number of Triggers	0 (0 - 255)
Number to Output On	0
Decodes per Trigger	0

Number to Output On

Example: If **Number to Output On** is set to 3 and **Trend Analysis Mode** is set to **No Read**, then the output will not be activated until 3 No Reads have occurred.

Sets the number of **Trend Analysis Mode** events (mismatches, No Reads, or reads/trigger as configured by **Trend Analysis Mode**) to occur within the trigger evaluation period before activating the associated output.

[-] Output 2 Parameters	
Output On	Mismatch or No Read
Output State	Normally Open
Pulse Width	500
Output Mode	Pulse
[-] Trend Analysis	
Trend Analysis Mode	No Read
Number of Triggers	0
Number to Output On	0 (0 - 255)
Decodes per Trigger	0

Decodes per Trigger

When set to this mode, and when the appropriate output is set to output on trend analysis, the scanner will function in a **Decodes per Trigger** mode during the read cycle and the trend analysis operation. Output will be activated based on whether or not the symbol decode count at the end of the read cycle is less than the decodes per trigger threshold.

Note: Although this setup causes the scanner to function in a **Decodes per Trigger** mode, the decode count will only be appended to the symbol data if the status of the **Decodes per Trigger** command is enabled.

[-] Output 2 Parameters	
Output On	Mismatch or No Read
Output State	Normally Open
Pulse Width	500
Output Mode	Pulse
[-] Trend Analysis	
Trend Analysis Mode	No Read
Number of Triggers	0
Number to Output On	0
Decodes per Trigger	0 (0 - 65535)

Example:

Decodes per Trigger threshold: 100

100 or more decodes = No output

Fewer than 100 decodes = Output fires

Diagnostics

Note: **Output On** under **Output 2 Parameters** must be set to **Diagnostic Warning** for this output to function.

Under **Output 2 Parameters**, expand the **Diagnostics** tree.

When **Diagnostic Warning** is enabled, the **Output On** configuration has no effect. The output will remain active as long as one of the diagnostic warning conditions is met. The output will become inactive once it detects that there are no diagnostic warning conditions.

High Temperature

Activates output when the temperature exceeds factory-defined upper limits.

[-] Output 2 Parameters	
Output On	Mismatch or No Read
Output State	Normally Open
Pulse Width	50
Output Mode	Pulse
[-] Trend Analysis	
Trend Analysis Mode	No Read
Number of Triggers	0
Number to Output On	0
Decodes per Trigger	0
[-] Diagnostics	
High Temperature	Disabled*
Service Unit	Disabled*
Laser Current High	Enabled
Laser Current Low	Disabled
Low Temperature	Disabled

Service Unit

Allows the user to set up the output to toggle to active when the service timer has expired. This condition will only be held for one service timer click.

Note: This feature cannot be used if the scanner is in **Continuous Read**.

When **Service Unit** is enabled, a message of up to 10 ASCII characters is sent whenever the system detects that the service timer's limit has been reached. The service timer is reset at power-on, meaning that the service timer's limit is the amount of time since last reset. Service timer increments can be set in seconds or minutes.

[-] Output 2 Parameters	
Output On	Mismatch or No Read
Output State	Normally Open
Pulse Width	50
Output Mode	Pulse
[-] Trend Analysis	
Trend Analysis Mode	No Read
Number of Triggers	0
Number to Output On	0
Decodes per Trigger	0
[-] Diagnostics	
High Temperature	Disabled
Service Unit	Disabled*
Laser Current High	Disabled*
Laser Current Low	Enabled
Low Temperature	Disabled

Laser Current High

Activates output when the laser current exceeds factory-defined upper limits.

[-] Output 2 Parameters	
Output On	Mismatch or No Read
Output State	Normally Open
Pulse Width	50
Output Mode	Pulse
[-] Trend Analysis	
Trend Analysis Mode	No Read
Number of Triggers	0
Number to Output On	0
Decodes per Trigger	0
[-] Diagnostics	
High Temperature	Disabled
Service Unit	Disabled
Laser Current High	Disabled*
Laser Current Low	Disabled*
Low Temperature	Enabled

I/O Parameters

Laser Current Low

Activates output when the laser current drops below factory-defined lower limits.

[-] Output 2 Parameters	
Output On	Mismatch or No Read
Output State	Normally Open
Pulse Width	50
Output Mode	Pulse
[-] Trend Analysis	
Trend Analysis Mode	No Read
Number of Triggers	0
Number to Output On	0
Decodes per Trigger	0
[-] Diagnostics	
High Temperature	Disabled
Service Unit	Disabled
Laser Current High	Disabled
Laser Current Low	Disabled*
Low Temperature	Disabled*
	Enabled

Low Temperature

Activates output when the temperature drops below factory-defined lower limits.

[-] Output 2 Parameters	
Output On	Mismatch or No Read
Output State	Normally Open
Pulse Width	50
Output Mode	Pulse
[-] Trend Analysis	
Trend Analysis Mode	No Read
Number of Triggers	0
Number to Output On	0
Decodes per Trigger	0
[-] Diagnostics	
High Temperature	Disabled
Service Unit	Disabled
Laser Current High	Disabled
Laser Current Low	Disabled
Low Temperature	Disabled*
	Disabled*
	Enabled

Output 3 Parameters

Output 3 has the same parameters and default settings as **Output 1** and **Output 2**.

[-] Output 3 Parameters	
Output On	Mismatch
Output State	Normally Open
Pulse Width	50
Output Mode	Pulse
[-] Trend Analysis	
Trend Analysis Mode	No Read
Number of Triggers	0
Number to Output On	0
Decodes per Trigger	0
[-] Diagnostics	
High Temperature	Disabled
Service Unit	Disabled
Laser Current High	Disabled
Laser Current Low	Disabled
Low Temperature	Disabled

Output On

Output On provides discrete signalling to host software to control external devices such as PLCs and relays. It is useful for routing, sorting, and to prevent mis-packaging and mis-routing.

Sets the discrete output functions for specific user-selected conditions. Allows the user to set the conditions under which an output (or outputs) will be activated.

Note: If **Output On** is set to **Match** or **Mismatch**, a transition (switching) will not occur unless **Matchcode Type** is enabled and a master symbol is loaded into memory.

[-] Output 3 Parameters	
Output On	Mismatch or No Read*
Output State	Mismatch or No Read*
Pulse Width	Good Read/Match
Output Mode	Mismatch
Trend Analysis	No Read
Diagnostics	Trend Analysis
Quality Output	Diagnostic Warning
Symbol Position Output	In Read Cycle
	Read Cycle Data Valid
	Disabled

I/O Parameters

Mismatch or No Read

Activates discrete output when the data does not match that of the master symbol or the symbol has not been decoded before the end of the read cycle.

Good Read / Match

Activates a discrete output when the symbol data matches the master symbol.

Note: To output on **Good Read** when **Matchcode** is not enabled, enable any output for **Match**.

Mismatch

Activates a discrete output whenever the symbol data does not match that of the master symbol.

No Read

Activates a discrete output whenever the symbol data is not decoded before the end of the read cycle.

Trend Analysis

Typically used when successful decodes are occurring but a discrete output is needed to flag a trend in quality issues.

Activates discrete output when a trend analysis condition is met, depending on the trend analysis option enabled.

Diagnostic Warning

Typically used when a discrete indication of a diagnostic condition is needed.

Activates discrete output when a diagnostic warning condition is met, depending on the diagnostic option enabled.

In Read Cycle

Activates a discrete output when the scanner is in a read cycle.

Read Cycle Data Valid

Activates discrete output when all the data generated in the read cycle has left the scanner.

Output State

Sets the active electrical state of the discrete output.

[-] Output 3 Parameters

Output On	Mismatch
Output State	Normally Open*
Pulse Width	Normally Open*
Output Mode	Normally Closed

Pulse Width

Sets the time in 10 ms increments that the discrete output remains active.

[-] Output 3 Parameters

Output On	Mismatch
Output State	Normally Open
Pulse Width	0.500 <input type="text"/> Seconds
Output Mode	Pulse

Output Mode

Sets the condition in which the discrete output is de-activated.

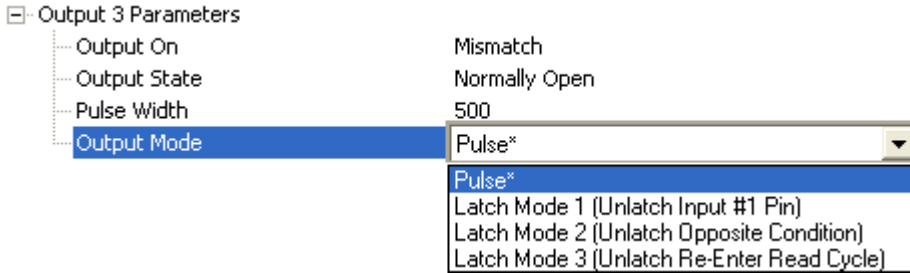

Pulse

This is the default mode of operation in which the programmable output is activated when the **Output On** condition has been met and held active for the duration of the selected pulse width.

Latch Mode 1 (Unlatch Input # 1 Pin)

The programmable output is activated when the **Output On** condition has been met and held active until the **Input # 1 Pin**.

Note: **Input 1** must be set to **Unlatch Output** for Latch Mode 1 to function.

If the Output Condition is set to **Read Cycle Data Valid**, then the read cycle will wait for Input 1 to unlatch the output before continuing on. This is to provide system handshake ability despite communication channel. The read cycle data must leave all channels before **Read Cycle Data Valid** will output.

Latch Mode 2 (Unlatch Opposite Condition)

The programmable output is activated when the **Output On** condition has been met and held active until the opposite condition selected under **Output On** has been met.

For example, if **No Read** is enabled under **Output On**, the programmable output will go active on a No Read and remain active until the opposite condition, a good read, occurs.

If the Output Condition is set to **Read Cycle Data Valid**, then the read cycle will continue but every new **Read Cycle Data Valid** event causes the output to change state to the opposite condition. This provides a toggle event per every read cycle output. The only known output state will be the on a power-on or reset. After reading begins, the state becomes undetermined. Only the state change itself has meaning—not the absolute value.

Latch Mode 3 (Unlatch Re-enter Read Cycle)

The programmable output is activated when the **Output On** condition has been met and held active until a new read cycle begins.

Note: All of the **Output On** modes are inhibited when any **Diagnostic Warning** is active for **Output 3**.

Trend Analysis

Note: **Output On** under **Output 3 Parameters** must be set to **Trend Analysis** for this output to function.

Under **Output 3 Parameters**, expand the **Trend Analysis** tree.

Useful in cases where the user doesn't want to shut down for one condition but wants to monitor quality and read conditions.

Applies **Trend Analysis** settings to **Output 3**.

With **Trend Analysis**, the user can track the occurrences and frequency of mismatches, No Reads, and the number of reads per trigger, and output the results to any of three outputs.

Trend Analysis Mode = No Read

Trigger Evaluation Period = 25 triggers (read cycles)

Number to Output On = 4

In this example, the scanner will activate an output when 4 No Reads occur within a period of 25 triggers (read cycles).

Trend Analysis Mode

Sets the trend condition (**Mismatch**, **No Read**, **Decodes per Trigger**, **Bad Symbol**, or **No Symbol**) that will activate the output.

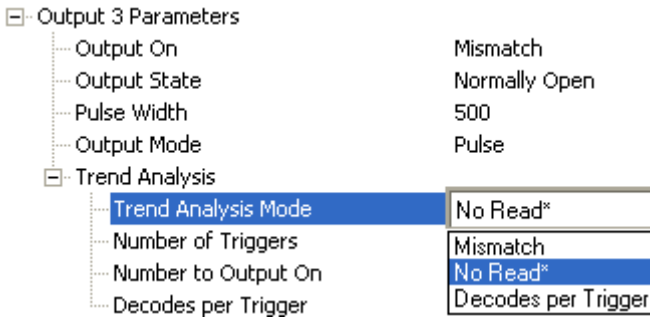

Mismatch

Output will be activated when the number of mismatches equals the value entered for **Number to Output On** within the trigger window selected in **Number of Triggers**.

No Read

Output will be activated when the number of No Reads equals the value entered for **Number to Output On** within the trigger window selected in **Number of Triggers**.

Decodes per Trigger

Output will be activated when the number of decodes equals the value entered for **Number to Output On** within the trigger window selected in **Number of Triggers**.

Bad Symbol

Output will be activated when the number of **Bad Symbol** occurrences equals the value entered for **Number to Output On** within the trigger window selected in **Number of Triggers**.

No Symbol

Output will be activated when the number of **No Symbol** occurrences equals the value entered for **Number to Output On** within the trigger window selected in **Number of Triggers**.

Number of Triggers

The number of triggers to examine for the trend analysis condition.

[-] Output 3 Parameters	
Output On	Mismatch
Output State	Normally Open
Pulse Width	500
Output Mode	Pulse
[-] Trend Analysis	
Trend Analysis Mode	No Read
Number of Triggers	0 (0 - 255)
Number to Output On	0
Decodes per Trigger	0

Number to Output On

Example: If **Number to Output On** is set to 3 and **Trend Analysis Mode** is set to **No Read**, then the output will not be activated until 3 No Reads have occurred.

Sets the number of **Trend Analysis Mode** events (mismatches, No Reads, or reads/trigger as configured by **Trend Analysis Mode**) to occur within the trigger evaluation period before activating the associated output.

[-] Output 3 Parameters	
Output On	Mismatch
Output State	Normally Open
Pulse Width	500
Output Mode	Pulse
[-] Trend Analysis	
Trend Analysis Mode	No Read
Number of Triggers	0
Number to Output On	0 (0 - 255)
Decodes per Trigger	0

Decodes per Trigger

When set to this mode, and when the appropriate output is set to output on trend analysis, the scanner will function in a **Decodes per Trigger** mode during the read cycle and the trend analysis operation. Output will be activated based on whether or not the symbol decode count at the end of the read cycle is less than the decodes per trigger threshold.

Note: Although this setup causes the scanner to function in a **Decodes per Trigger** mode, the decode count will only be appended to the symbol data if the status of the **Decodes per Trigger** command is enabled.

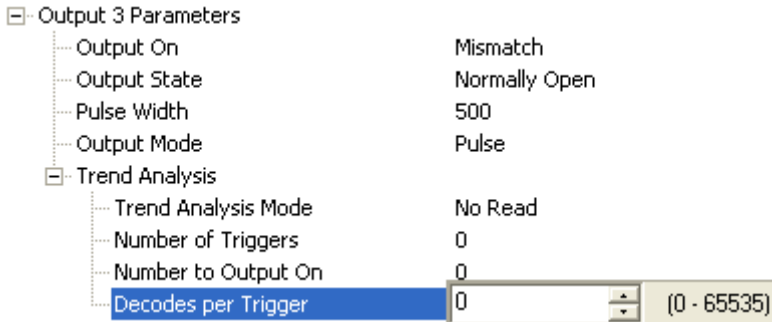

Example:

Decodes per Trigger threshold: 100

100 or more decodes = No output

Fewer than 100 decodes = Output fires

Diagnostics

Note: **Output On** under **Output 3 Parameters** must be set to **Diagnostic Warning** for this output to function.

Under **Output 3 Parameters**, expand the **Diagnostics** tree.

When **Diagnostic Warning** is enabled, the **Output On** configuration has no effect. The output will remain active as long as one of the diagnostic warning conditions is met. The output will become inactive once it detects that there are no diagnostic warning conditions.

High Temperature

Activates output when the temperature exceeds factory-defined upper limits.

[-] Output 3 Parameters	
Output On	Mismatch
Output State	Normally Open
Pulse Width	50
Output Mode	Pulse
[-] Trend Analysis	
Trend Analysis Mode	No Read
Number of Triggers	0
Number to Output On	0
Decodes per Trigger	0
[-] Diagnostics	
High Temperature	Disabled*
Service Unit	Disabled*
Laser Current High	Enabled
Laser Current Low	Disabled
Low Temperature	Disabled

I/O Parameters

Service Unit

Allows the user to set up the output to toggle to active when the service timer has expired. This condition will only be held for one service timer click.

Note: This feature cannot be used if the scanner is in **Continuous Read**.

When **Service Unit** is enabled, a message of up to 10 ASCII characters is sent whenever the system detects that the service timer's limit has been reached. The service timer is reset at power-on, meaning that the service timer's limit is the amount of time since last reset. Service timer increments can be set in seconds or minutes.

[-] Output 3 Parameters	
Output On	Mismatch
Output State	Normally Open
Pulse Width	50
Output Mode	Pulse
[-] Trend Analysis	
Trend Analysis Mode	No Read
Number of Triggers	0
Number to Output On	0
Decodes per Trigger	0
[-] Diagnostics	
High Temperature	Disabled
Service Unit	Disabled*
Laser Current High	Disabled*
Laser Current Low	Enabled
Low Temperature	Disabled

Laser Current High

Activates output when the laser current exceeds factory-defined upper limits.

[-] Output 3 Parameters	
Output On	Mismatch
Output State	Normally Open
Pulse Width	50
Output Mode	Pulse
[-] Trend Analysis	
Trend Analysis Mode	No Read
Number of Triggers	0
Number to Output On	0
Decodes per Trigger	0
[-] Diagnostics	
High Temperature	Disabled
Service Unit	Disabled
Laser Current High	Disabled*
Laser Current Low	Disabled*
Low Temperature	Enabled

Laser Current Low

Activates output when the laser current drops below factory-defined lower limits.

[-] Output 3 Parameters	
Output On	Mismatch
Output State	Normally Open
Pulse Width	50
Output Mode	Pulse
[-] Trend Analysis	
Trend Analysis Mode	No Read
Number of Triggers	0
Number to Output On	0
Decodes per Trigger	0
[-] Diagnostics	
High Temperature	Disabled
Service Unit	Disabled
Laser Current High	Disabled
Laser Current Low	Disabled*
Low Temperature	Disabled*
	Enabled

I/O Parameters

Low Temperature

Activates output when the temperature drops below factory-defined lower limits.

[-] Output 3 Parameters	
Output On	Mismatch
Output State	Normally Open
Pulse Width	50
Output Mode	Pulse
[-] Trend Analysis	
Trend Analysis Mode	No Read
Number of Triggers	0
Number to Output On	0
Decodes per Trigger	0
[-] Diagnostics	
High Temperature	Disabled
Service Unit	Disabled
Laser Current High	Disabled
Laser Current Low	Disabled
Low Temperature	Disabled*
	Disabled*
	Enabled

Quality Output

Quality Output	
Quality Output Separator	,
Decodes/Trigger Status	Disabled
Decode Direction Output	Disabled

Quality Output Separator

The separator character separates quality output data from symbol data.

Quality Output	
Quality Output Separator	
Decodes/Trigger Status	
Decode Direction Output	

NUL	SOH	STX	ETX	EOT	ENQ
ACK	BEL	BS	HT	LF	VT
FF	CR	SO	SI	DLE	DC1
DC2	DC3	DC4	NAK	SYN	ETB
CAN	EM	SUB	ESC	FS	GS
RS	US	SP			

Click 'Delete' to remove characters.

Decodes per Trigger Status

When Enabled, the scanner enters a state where it processes frames as configured until the end of a read cycle, with or without a successful symbol decode. When the read cycle ends, the scanner outputs any decoded symbol data along with the decodes per trigger count.

Quality Output	
Quality Output Separator	
Decodes/Trigger Status	Disabled*
Decode Direction Output	Disabled*
	Enabled

Decode Direction Output

When Enabled, compares the symbol decode direction to the direction specified in **Output Filter Configuration**.

Quality Output	
Quality Output Separator	,
Decodes/Trigger Status	Disabled
Decode Direction Output	Disabled*
	Disabled*
	Enabled

Symbol Position Output

[-] Symbol Position Output	
Raster Status	Disabled
Scan Status	Disabled
Separator	SP

Raster Status

Scan Status

When Enabled, the location of the symbol within the scan line is appended to the symbol data output. The scan position is formatted with a leading identifier of “SP” plus two zero-padded three digit numbers (corresponding to the first and last bar of the symbol for most symbologies), separated by a colon. The scan position values correspond to the configurable **Laser On/Off** position values in the **Laser Setup** command.

Example: Assume a symbol with the data “HELLO” is read when its first bar is at 25% of the scan width and its last bar is at 85% of the scan width. The data output would be **HELLO SP025:085**, assuming that no other outputs or formatting were enabled.

Separator

This character separates all other symbol information from the **Scan Status** data field.

[-] Symbol Position Output	
Raster Status	Disabled
Scan Status	Disabled
Separator	

NUL	SOH	STX	ETX	EOT	ENQ
ACK	BEL	BS	HT	LF	VT
FF	CR	SO	SI	DLE	DC1
DC2	DC3	DC4	NAK	SYN	ETB
CAN	EM	SUB	ESC	FS	GS
RS	US	SP			

Click 'Delete' to remove characters.

Matchcode

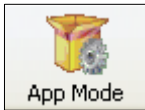

App Mode

Click the **App Mode** button and then the **Parameters** button to display the tree control tabs.

Then click the **Matchcode** tab to display the Matchcode tree control.

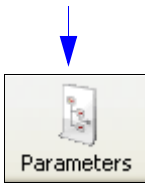

Parameters

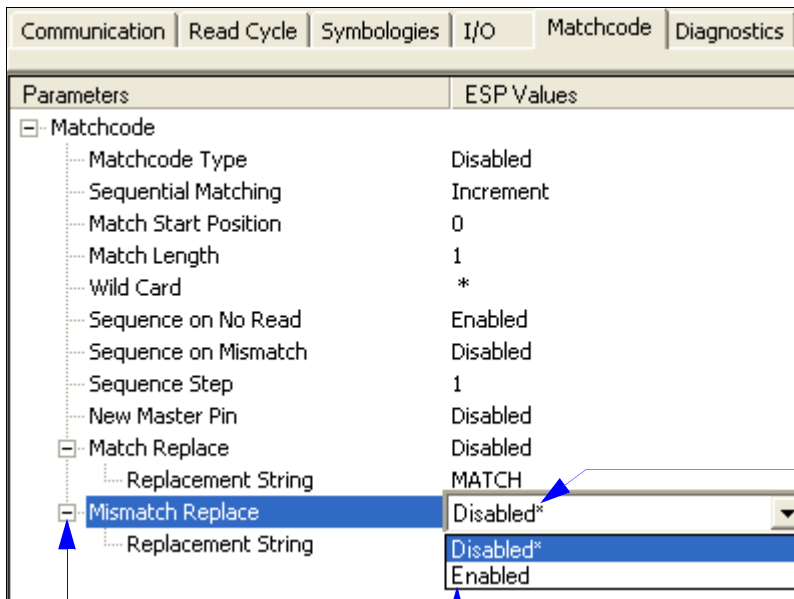

The * indicates that the setting is the default.

To open nested options, **single-click** the +.

To change a setting, **double-click** the setting and use the cursor to scroll through the options.

Note: Matchcode settings can also be sent to the scanner from ESP's Terminal using Omron Microscan's K command format. Refer to the **Matchcode** section of **Appendix E**.

Overview of Matchcode

Matchcode allows the user to store master symbol data in the scanner's memory, compare that data against other symbol data, and define how symbol data and/or discrete signal output will be directed.

A master symbol database can be set up for up to 10 master symbols.

Note: **Matchcode** will function with multiple symbols; however, if **Matchcode Type** is set to **Sequential** or if **Trigger Mode** is set to **Continuous Read 1 Output**, the scanner will behave as if **Number of Symbols** were set to **1**, regardless of the user-defined configuration.

Matchcode is used in applications to sort, route, or verify data based on matching the specific symbol in a variety of ways as defined in this section. For example, a manufacturer might sort a product based on dates that are embedded in the symbol.

Steps for Entering and Using Master Symbols

1. Set **Trigger Mode** to **External Level**, **External Edge**, or **Serial Data**.
2. Choose the method of symbol comparison that fits the application.
3. Define the type of output required with Matchcode setup:
 - a. Symbol data output
 - b. Discrete output
4. Select the number of master symbols required.
5. Decide how the master symbol(s) will be entered:
 - a. Use ESP to type master symbol data directly.
 - b. Send a serial command with symbol data in the form of **<K231, master symbol#, data>**.
 - c. Send a **<G>** (Read Next Symbol as Master Symbol) command.
 - d. Enable the **New Master Pin** command and activate the discrete input to store the next symbol read as the master symbol.

Matchcode Type

Allows the user to choose the way that master symbols will be compared with subsequently read symbols.

Note: First set **Trigger Mode** to **External Level**, **External Edge**, or **Serial Data**.

[-] Matchcode	
Matchcode Type	Disabled*
Sequential Matching	Disabled*
Match Start Position	Enabled
Match Length	Sequential
Wild Card	Wild Card
Sequence on No Read	Enabled
Sequence on Mismatch	Disabled
Sequence Step	1
New Master Pin	Disabled

Sequential

Instructs the scanner to compare symbols or portions of symbols with the master symbol. Instructs the scanner to sequence after each match (numeric only) and compare symbols or portions of symbols for sequential numbers.

Wild Card

Allows the user to enter user-defined wild card characters in the master symbol.

Note: If **Matchcode Type** is set to **Sequential**, the scanner will behave as if **Number of Symbols** were set to **1**, regardless of the user-defined configuration.

Sequential Matching

Useful in tracking product serial numbers that increment or decrement sequentially. With Sequential enabled, Sequential Matching determines if a count is in ascending (incremental) or descending (decremental) order.

[-] Matchcode	
Matchcode Type	Disabled
Sequential Matching	Increment*
Match Start Position	Increment*
Match Length	Decrement
Wild Card	*
Sequence on No Read	Enabled
Sequence on Mismatch	Disabled
Sequence Step	1
New Master Pin	Disabled

Match Start Position

Match Start Position is useful in defining specific portions of a symbol for comparison. For example, if a symbol contains a part number, manufacturing date, and lot code info, but only the part number information is needed, set the scanner to sort only the part number and to ignore the other characters.

Match Start Position determines the portions of symbols that will be matched by defining the first character in the symbol (from left to right) that will be compared with those of the master symbol, when **Matchcode Type** is set to **Enabled** or **Sequential**.

For example, if **Match Start Position** is set to **3**, the first 2 characters read in the symbol will be ignored and only the 3rd and subsequent characters to the right will be compared, up to the number of characters specified by **Match Length**.

Note: Match Start Position must be set to **1** or greater to enable this feature. A **0** setting will disable this feature.

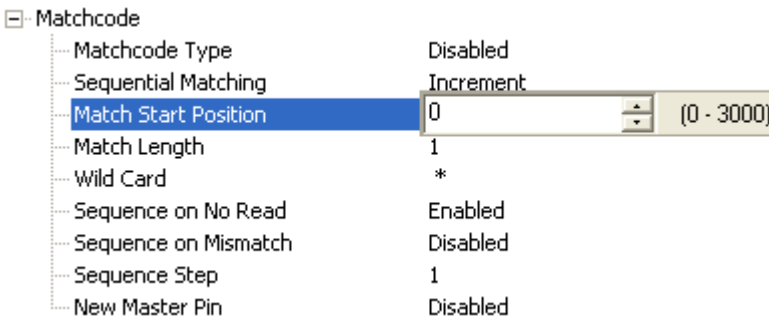

Match Length

Example: If **Match Length** is set to **6** in a 10-character symbol, and **Match Start Position** is set to **2**, only the 2nd through 7th characters (from left to right) will be compared.

Defines the length of the character string that will be compared with that of the master symbol when **Match Start Position** is set to **1** or greater. When **Match Start Position** is set to **0**, no comparison will occur.

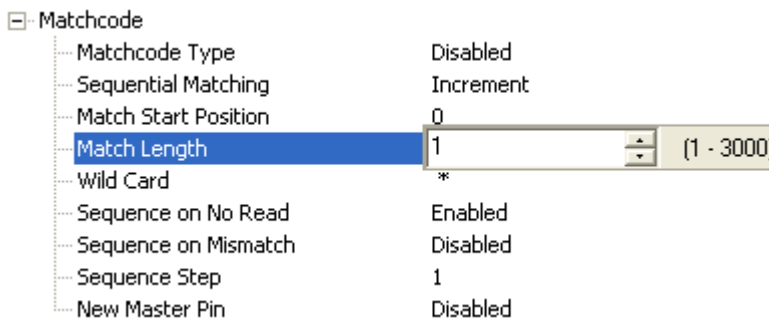

Wild Card

Wild Card allows you to define a wild card character as part of the master symbol.

Entering a wild card sequence at the end of the master symbol, as in **CR******, will result in matches for symbol lengths such as CR1, CR12, or CR123, but not for CR1234. **The number of wild card characters entered must be at least one more than the total number of symbol data characters present.** You can use as many wild card characters as required, even if the number of wild card characters exceeds the total number of symbol data characters.

Wild cards can also be used as placeholders. For example, if you want to match the **3** in CR358, you must enter ****3*****.

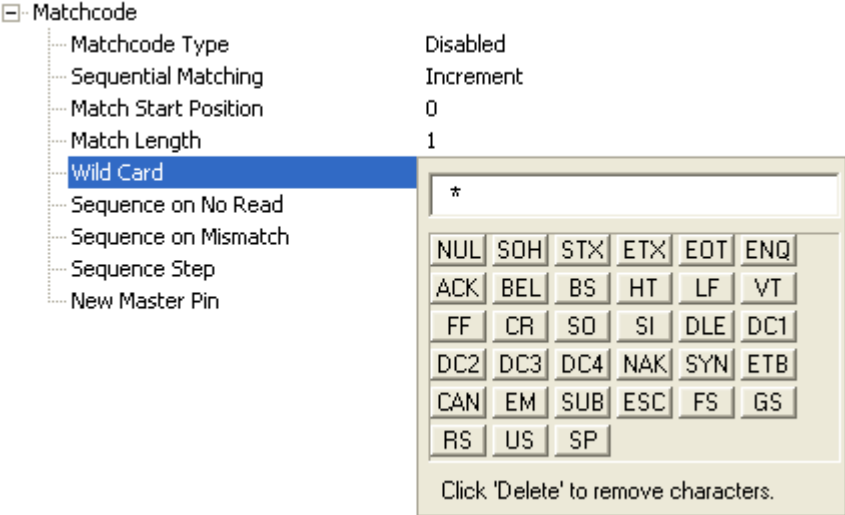

Sequence on No Read

Sequence on No Read is useful when the scanner needs to stay in sequence even if no decode occurs.

When **Sequence on No Read** is **Enabled** and **Matchcode Type** is set to **Sequential**, the scanner sequences the master symbol on every match or No Read. When disabled, it does not sequence on a No Read.

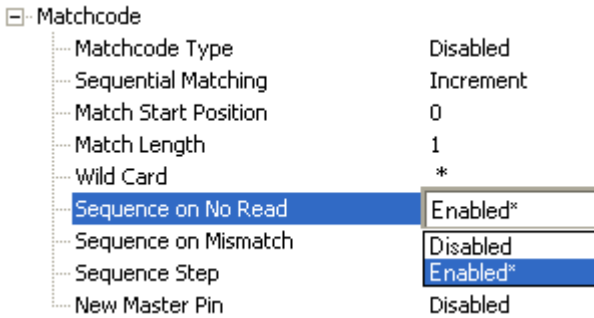

Consider the following decodes as an example of **Sequence on No Read Enabled**:

<i>Master Symbol</i>	<i>Decoded Symbol</i>	<i>Master Symbol after Decode</i>
001	001	002
002	002	003
003	No Read	004 (sequence on No Read)
004	004	005
005	No Read	006 (sequence on No Read)
006	No Read	007 (sequence on No Read)
007	007	008

Consider the following decodes as an example of **Sequence on No Read Disabled**:

<i>Master Symbol</i>	<i>Decoded Symbol</i>	<i>Master Symbol after Decode</i>
001	001	002
002	002	003
003	No Read	003 (not sequenced)
003	003	004
004	No Read	004 (not sequenced)
004	No Read	004 (not sequenced)
004	004	005

Sequence on Mismatch

Note: **Matchcode Type** must be set to **Sequential** for this command to function.

Enable this parameter if every trigger event should have a decode *and* more than one consecutive mismatch may occur. When set to Enabled, the master symbol sequences on every decode, match, or mismatch.

Disable this parameter if every trigger event should have a decode but no more than one consecutive mismatch may occur. When set to Disabled, the master symbol will not sequence whenever consecutive mismatches occur.

The scanner will sequence the master to one more or one less than the decoded symbol.

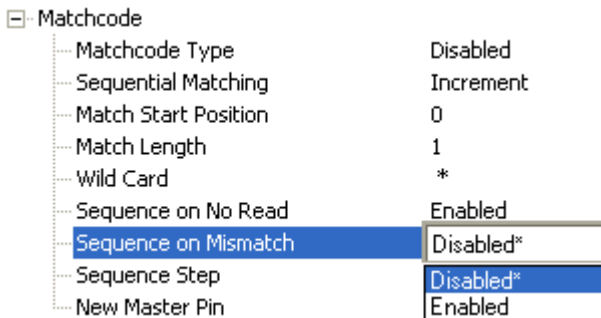

Consider the following decodes as an example of **Sequence on Mismatch Enabled**:

<i>Master Symbol</i>	<i>Decoded Symbol</i>	<i>Master Symbol after Decode</i>
001	001	002
002	002	003
003	abc	004 (sequence on mismatch)
004	004	005
005	def	006 (sequence on mismatch)
006	ghi	007 (sequence on mismatch)
007	007	008

Consider the following decodes as an example of **Sequence on Mismatch Disabled**:

<i>Master Symbol</i>	<i>Decoded Symbol</i>	<i>Master Symbol after Decode</i>
001	001	002
002	002	003
003	abc	004 (sequenced because of previous match)
004	004	005
005	def	006 (sequenced because of previous match)
006	ghi	006 (not sequenced)
006	006	007

Sequence Step

When the master symbol is sequenced (incremented/decremented), **Sequence Step** defines the magnitude of change.

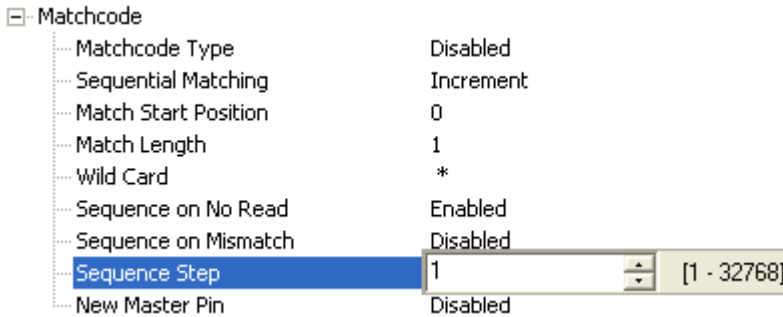

New Master Pin

If **Matchcode** and **New Master Pin** are enabled and the new master pin is momentarily connected to ground (must be held low for a minimum of 10 ms), master symbol information will be loaded into the database based on the next read cycle that achieves a Good Read, starting with **Index 1**. The **Master Database** will be loaded with all symbols decoded in the read cycle as long as it does not exceed the **Master Symbol Database Size** parameter.

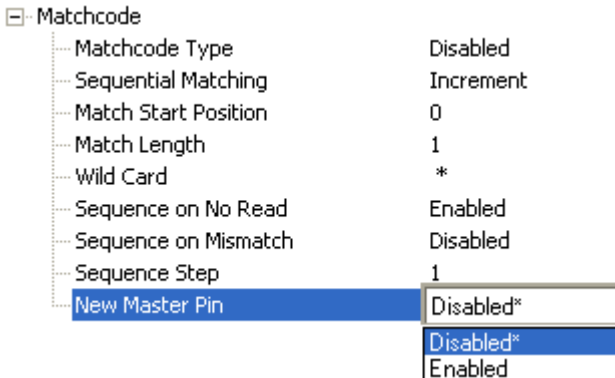

New Master Load Status

The new master status responds with the number of the next master position to be loaded, where 0 represents “idle” or “no master to be loaded.”

Example: If the user has the **Master Symbol Database Size** set to **1**, and then either sends a **<G>** or toggles an active **New Master Pin**, the state will be **1**, and prior to reading and effectively loading position **1**, the response to **<NEWM>** would be **<NEWM/1>**. Once a symbol has been read and loaded, the status will be cleared: **<NEWM/0>**.

Match Replace

Provides a convenient shortcut for applications that need to output a predefined text string whenever a symbol matches a master symbol.

Outputs a user-defined data string whenever a match occurs and **Matchcode** is enabled.

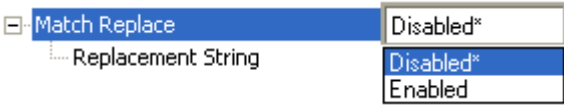

Replacement String

User-defined data string that, when enabled, replaces symbol data whenever a match occurs.

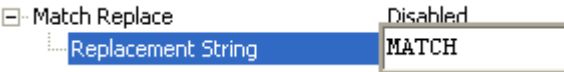

Mismatch Replace

Provides a convenient shortcut for applications that need to output a predefined text string whenever a symbol does not match a master symbol.

Outputs a user-defined data string whenever a mismatch occurs and **Matchcode** is enabled.

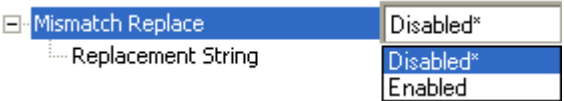

Replacement String

User-defined data string that, when enabled, replaces symbol data whenever a mismatch occurs.

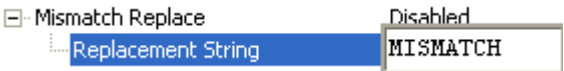

Diagnostics

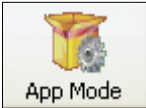

Click the **App Mode** button and then the **Parameters** button to display the tree control tabs.

Then click the **Diagnostics** tab to display the Diagnostics tree control.

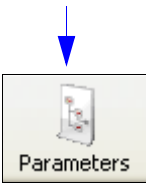

Parameters	ESP Values
[-] Diagnostics	
+ Counts (Read-only)	
+ Hours Since Reset (Read-only)	
+ Laser High	
+ Laser Low	
+ High Temperature Threshold	
+ Low Temperature Threshold	
[-] Service Message	
Status	Disabled*
Service Message	Disabled*
Threshold	Enabled
Resolution	Seconds
User-Defined Name	QX-830

The * indicates that the setting is the default.

To open nested options, **single-click** the +.

To change a setting, **double-click** the setting and use the cursor to scroll through the options.

Note: Matchcode settings can also be sent to the scanner from ESP's Terminal using Omron Microscan's K command format. Refer to the **Diagnostics** section of **Appendix E**.

Counts (Read-only)

[-] Counts (Read-only)	
Power-on	0
Resets	0
Power-on Saves	0
Custom Default Saves	0

Power-On

16-bit counter that increments on scanner power-on.

Used for detecting unwanted resets caused by power supply problems or ESD transients.

Returns the number of times the scanner has been re-powered or a watchdog reset occurs.

0 to **65,535** power-ons.

Resets

16-bit counter that increments every time the scanner is reset. Value is reset on power-on.

Used for detecting unwanted resets caused by power supply problems or ESD transients.

Resets include watchdog reset, **<A>**, **<Z>**, **<Zd>**, and hardware defaults. A watchdog reset is a reset that is forced whenever the software locks up.

0 to **65,535** resets.

Power-On Saves

16-bit counter that increments every time a scanner setting is saved for power-on.

Custom Default Saves

16-bit counter that increments every time a scanner setting is saved to the customer parameter section of flash memory.

Hours Since Reset (Read-only)

Used as a troubleshooting tool that can help pinpoint the cause of a reset.

Records the number of hours and minutes of operation since the last system reset.

Hours Since Reset (Read-only)	
Hours	0
Minutes	0

Hours

16-bit counter that increments every 60 minutes.

Range: 0 to 23 hours.

Minutes

16-bit counter that increments every 60 seconds.

Range: 0 to 59 minutes.

Laser High

When Enabled, a **Laser High** message is transmitted whenever the laser current exceeds a factory-calibrated reference value which cannot be altered. The message repeats once every 30 minutes until the condition is corrected.

Alerts the user to impending laser failure. (Contact Omron Microscan Service.)

Status

Allows the user to Enable or Disable the Laser High message.

[-] Laser High

Status	Disabled*
Message	Disabled*
	Enabled

Message

Defines the **Laser High** message.

[-] Laser High

Status	Disabled
Message	H I G H _ L A S E R

Laser Low

When Enabled, a **Laser Low** message is transmitted whenever the laser current falls below a factory-calibrated reference value which cannot be altered. The message repeats once every 30 minutes until the condition is corrected.

Alerts the user to impending laser failure. (Contact Omron Microscan Service.)

Status

Allows the user to Enable or Disable the Laser Low message.



Message

Defines the **Laser Low** message.

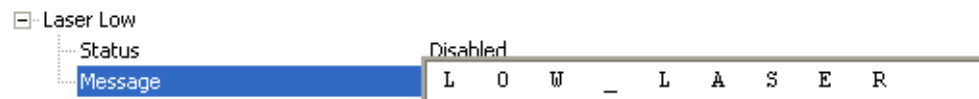

High Temperature Threshold

A message can be defined that will display when a user-defined **High Temperature Threshold** has been reached. The message repeats once every 30 minutes until the condition is corrected. This value is a reference to the external ambient temperature in the environment around the scanner.

Helps ensure that the scanner is being used within its temperature specification. Also, since hotter environments tend to shorten the life of electronics components, a user may want to set the temperature threshold closer to the nominal temperature of 25° F.

A user can set a temperature value that when exceeded will cause a high temperature message to be displayed. If **High Temperature Threshold** is set to zero, the warning message is disabled.

Status

Allows the user to Enable or Disable the High Temperature Threshold.



Message

The user can enter a message of up to 10-characters that will be displayed whenever **High Temperature Threshold** is exceeded.

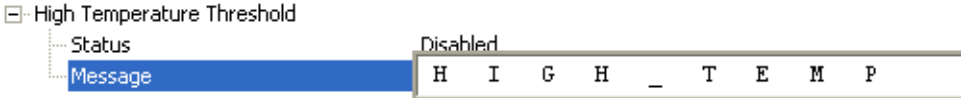

Low Temperature Threshold

A message can be defined that will display when a user-set **Low Temperature Threshold** has been reached. The message repeats once every 30 minutes until the condition is corrected. This value is a reference to the external ambient temperature in the environment around the scanner.

Helps ensure that the scanner is being used within its temperature specification.

The user can set a low temperature value that, whenever the ambient temperature falls below it, causes a low temperature message to be displayed. If **Low Temperature Threshold** is set to zero, the warning message will be disabled.

Status

Allows the user to Enable or Disable the Low Temperature Threshold.

Low Temperature Threshold

Status	Disabled*
Message	Disabled*
	Enabled

Message

The user can enter a message of up to 10-characters that will be displayed whenever the ambient temperature falls below the **Low Temperature Threshold**.

Low Temperature Threshold

Status	Disabled
Message	L O W _ T E M P

Service Message

Status

When Enabled, a **Service Message** of up to 128 characters is sent whenever the system detects that the service time has expired.

Service Message	
Status	Disabled*
Service Message	Disabled*
Threshold	Enabled
Resolution	Seconds

Service Message

Allows the user to define a service message of up to 128 characters.

Service Message	
Status	Disabled
Service Message	SERVICE
Threshold	300
Resolution	Seconds

Threshold

Allows the user to determine the length of time until the service message will be sent.

Service Message	
Status	Disabled
Service Message	SERVICE
Threshold	300 (1 - 65535)
Resolution	Seconds

Resolution

The service timer has a resolution field for setting up the timer increment. Options are increments of seconds or minutes.

Service Message	
Status	Disabled
Service Message	SERVICE
Threshold	300
Resolution	Seconds*
	Seconds*
	Minutes

User-Defined Name

User-Defined Name allows the user to enter any combination of ASCII characters to identify the scanner.

User-Defined Name

Q X - 8 7 0

6 Terminal

Contents

- Terminal Window..... 6-2
- Find 6-3
- Send 6-4
- Macros..... 6-5
- Terminal Window Menus..... 6-6

This section describes the multiple functions of ESP's **Terminal** interface.



Terminal Window

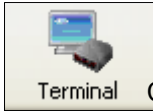

Click this button to display the **Terminal** view.

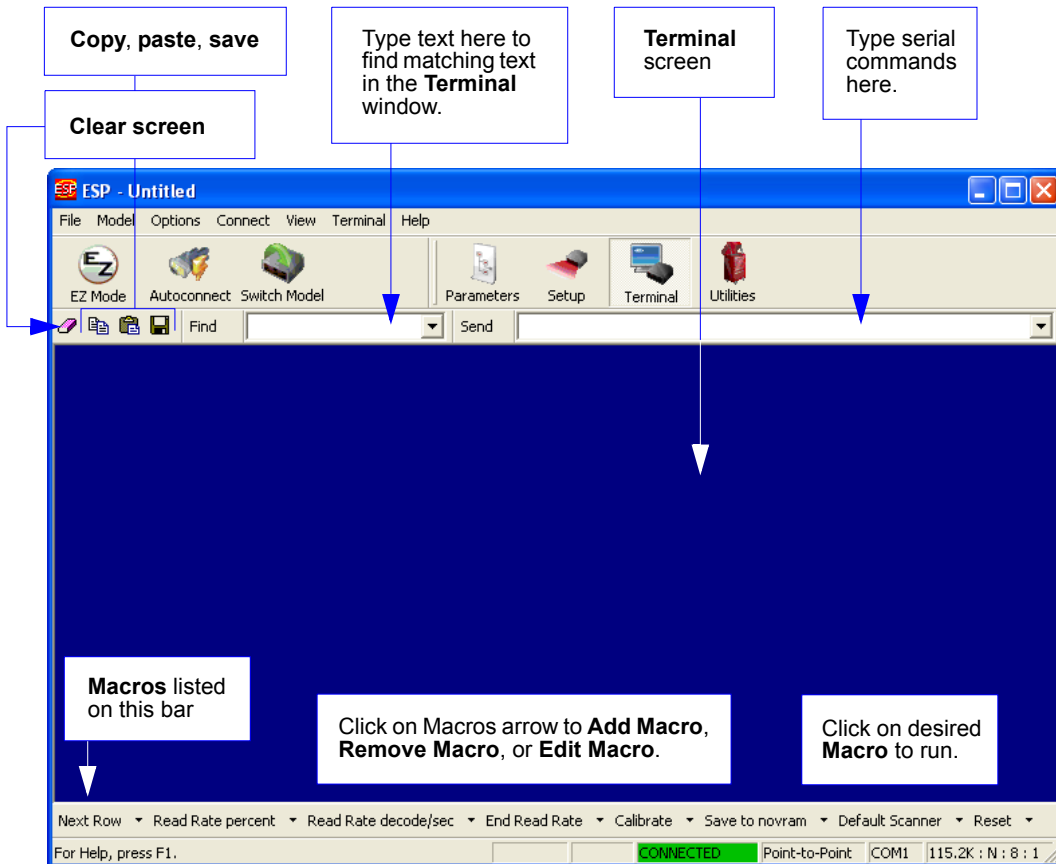

The screenshot shows the Terminal window interface with several callouts:

- Copy, paste, save**: Callout pointing to the top toolbar icons.
- Clear screen**: Callout pointing to the 'Find' button in the toolbar.
- Type text here to find matching text in the Terminal window.**: Callout pointing to the 'Find' text input field.
- Terminal screen**: Callout pointing to the large blue terminal area.
- Type serial commands here.**: Callout pointing to the 'Send' text input field.
- Macros listed on this bar**: Callout pointing to the 'Macros' button in the bottom toolbar.
- Click on Macros arrow to Add Macro, Remove Macro, or Edit Macro.**: Callout pointing to the dropdown arrow next to the 'Macros' button.
- Click on desired Macro to run.**: Callout pointing to the 'Macros' button.

The interface includes a menu bar (File, Model, Options, Connect, View, Terminal, Help), a toolbar with icons for EZ Mode, Autoconnect, Switch Model, Parameters, Setup, Terminal, and Utilities, and a status bar at the bottom showing connection details like 'CONNECTED', 'Point-to-Point', 'COM1', and '115.2K : N : 8 : 1'.

The **Terminal** interface allows the user to send serial commands to the scanner by using macros, by copying and pasting, or by typing commands in the **Send** text field.

The Terminal also displays symbol data or information from the scanner.

Right-clicking on the Terminal screen displays a menu of additional options.

Find

The **Find** function allows the user to enter text strings to be searched for in the Terminal.

For example:

1. Type “ABC” into the **Find** box.

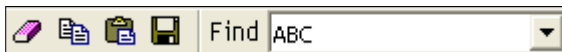

2. Press **Enter**.
The first instance of “ABC” will be highlighted in the Terminal window.
3. Click the **Find** button to the left of the text field to locate additional instances of “ABC”.

Send

The **Send** function allows the user to enter serial commands and then send them to the scanner.

1. Type the command into the **Send** box.

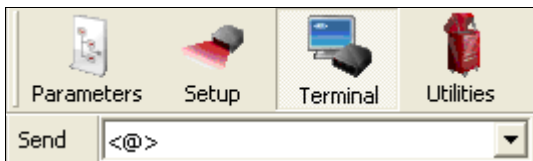

2. Press **Enter**.
3. Click the **Send** button to the left of the text field to send the command additional times.

Macros

Macros can be stored in a macro selection bar, edited in a separate window, and executed by clicking on the macro name.

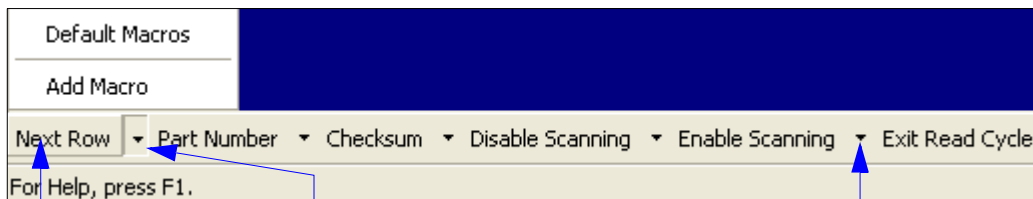

Click on **Next Row** to see the next row of macros

Click on the first arrow here to see **Add Macro** or **Default Macros**. When macros are defaulted, the entire macro set is restored to the original macro commands.

Click on subsequent arrows to edit macros.

Click a macro button to execute it in the Terminal.

If the macro is a command, it is sent to the scanner at the same time that it is displayed.

Editing a Macro

Click the arrow next to any macro and select **Edit** to display the following dialog:

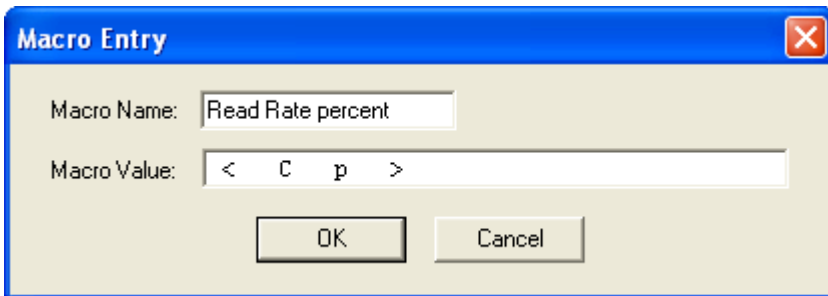

Edit the macro value or type a new **Macro Name** in the text field provided and define it in the **Macro Value** field. Click **OK** to save the entry.

Terminal Window Menus

Right-click on the **Terminal** window to display the following menu:



- **Copy** selected text to clipboard.
- **Paste** from Terminal or other text.
- **Clear** all text in Terminal window.
- **Select All** text in the Terminal window.
- **Save...** brings up a **Save As** dialog.
- **Change Font...** of text in Terminal; brings up a **Font** dialog.
- **Change Echo Font...** to change typed text; brings up a **Font** dialog.
- **Enable Echo** enables Echo text (typed by user).
- **Change Background Color** of Terminal window.
- **Non-Printable Characters** allows the user to hide non-printable characters, or to show them in **Standard** or **Enhanced** format.
- **Default Settings** returns all the above settings to default.
- **Keyboard Macros** allows the user to create new keyboard macro commands that can be sent from function keys (F2, F4, F5, etc.)

Terminal Dropdown Menu

The dropdown **Terminal** menu has **Capture Text**, **Save Current Text**, **Send File**, **Find Next**, and **Find Previous** functions, as well as the same functions defined above.

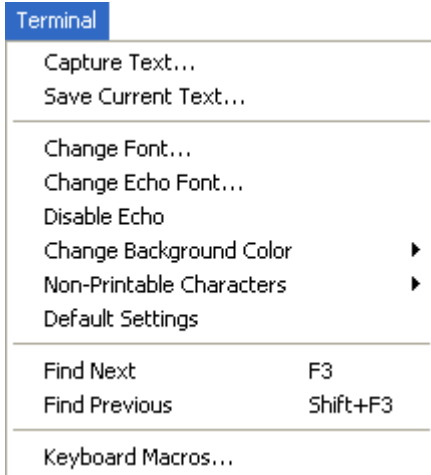

- **Capture Text...** allows the user to append data in real time to a text file. While in operation, the text file cannot be opened. Pause interrupts the capture flow and Stop ends the flow and opens the file.
- **Save Current Text...** saves all text in the Terminal window to a text file.
- **Find Next** searches for a user-defined section of text in the Terminal.
- **Find Previous** operates in the same way as Find Next, but searches backward through Terminal text.



7 Utilities

Contents

- Serial Utility Commands 7-2
- Read Rate 7-4
- Counters 7-6
- Device Control 7-8
- Differences from Default 7-9
- Master Database 7-10
- Digital Bar Code 7-16
- Firmware 7-17
- Default/Reset/Save 7-20
- Scanner Status Requests 7-22
- Other Serial Utility Commands 7-23
- Embedded Menus 7-28

This section explains the function and purpose of serial utility commands, which are generally performed during scanner operation.



Serial Utility Commands

Note: For a list of all K commands, see [Serial Commands](#).

Type	Command	Name
Read Rate	<C>	Enter Decodes/Second Test
	<Cp>	Enter Decode Percent Test
	<J>	Exit Decodes/Second and Decode Percent Tests
Counters	<a1>	PDF417 Information
	<N>	No Read Counter
	<O>	No Read Counter Reset
	<T>	Trigger Counter
	<U>	Trigger Counter Reset
	<V>	Good Read/Match Counter
	<W>	Good Read/Match Counter Reset
	<X>	Mismatch Counter
Device Control	<Y>	Mismatch Counter Reset
	<L1>	Programmable Output 1
	<L2>	Programmable Output 2
	<L3>	Programmable Output 3
	<I>	Disable Scanner
Master Database	<H>	Enable Scanner
	<G>	Store Next Symbol Read to Database Index 1
	<Gn>	Store Next Symbol Read to Database Index <i>n</i>
Part Number / Checksum	<NEWM>	New Master Load Status
	<#>	Display All Firmware Part Numbers
	<#a>	Display Application Code Part Number
	<#b>	Display Boot Code Part Number
	<#f>	Display FPGA Code Part Number
	<I>	Display All Available Firmware Checksums
	<Ia>	Display Application Code Code Checksum
	<Ib>	Display Boot Code Checksum
Default/Reset/Save	<If>	Display FPGA Code Checksum
	<Z>	Save Current Settings for Power-On
	<Zc>	Save Current Settings as Customer Default Parameters for Power-On
	<Zrc>	Recall Customer Default Settings and Save for Power-On
	<Zrd>	Recall Omron Microscan Default Settings and Save for Power-On (Will not default "sticky settings")

Default/Reset/Save	<Zrdall>	Recall Omron Microscan Default Settings and Save for Power-On (Will also default "sticky settings")
	<A>	Reset (Will not save for power-on)
	<Arp>	Reset and Recall Power-On Parameters
	<Arc>	Reset and Recall Customer Default Parameters
	<Ard>	Reset and Recall Omron Microscan Default Parameters
Scanner Status Request Commands	<K?>	All Status Request
	<K??>	All Descriptor Status Request
	<K?#>	All Range Status Request
	<Knnn?>	Single Status Request
	<Knnn??>	Single Descriptor Status Request
	<Knnn?#>	Single Range Status Request
	<Knnnd>	Default Customer Parameter
Embedded Menus	<D>	Enter Embedded Menus
Other Serial Utility Commands	<@CAL>	Calibrate without Menu
	<@>	Calibrate with Menu
	<BCCFG>	Enter Bar Code Configuration

Read Rate



Click the **Utilities** button and then the **Read Rate** tab to display the Read Rate view.

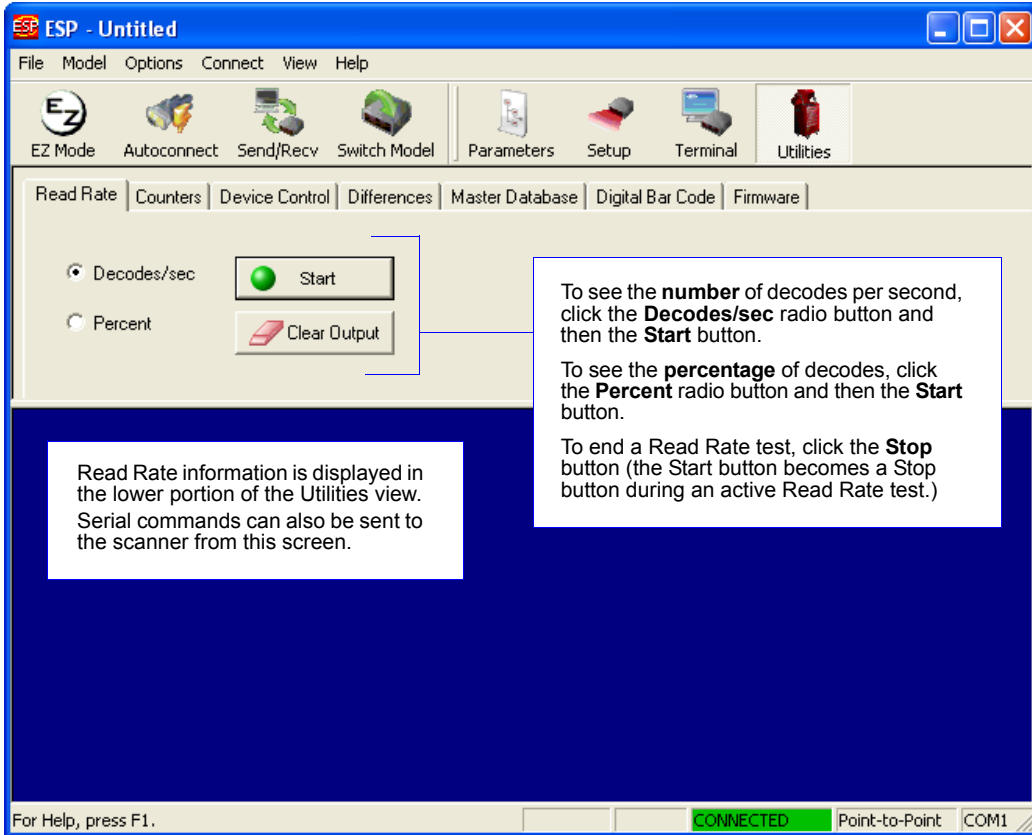

Important: When Read Rate is enabled, the **Configuration Database** is not active, regardless of how the scanner is configured.

Read Rate Serial Utility Commands

Enter Decodes / Second Test

Sending **<C>** instructs the scanner to transmit the decodes per second and symbol data (if any). The decode rate can vary dramatically due to the angle and location of the symbol in relation to the field of view. This test is very useful in aligning and positioning the scanner during setup.

Enter Decode Percent Test

Sending **<Cp>** instructs the scanner to transmit the percentage of decodes and any decoded symbol data.

End Decodes / Second and Decode Percent Tests

Sending **<J>** ends both the Percent test and the Decodes/Second test.

PDF417 Information

Sending **<a1>** causes PDF417 data that is decoded in a triggered read cycle to be prefaced with information about the symbol's level of error correction (error correction level n), number of rows (n rows), number of columns (n columns), number of informative code words (n code words), and number of data bits (n data bits). This feature can be disabled by sending **<a1>** again.

Counters

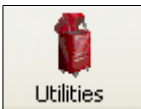

Click the **Utilities** button and then the **Counters** tab to display the Counters view.

Counter commands can be a numeric value from **00000** to **65535**. After reaching the maximum numeric limit of 65535, an error message will be displayed and the counter will automatically roll over and start counting again at 00000. To obtain the cumulative total of counts after the rollover has occurred, add 65536 per each rollover (the scanner does not keep track of the number of rollovers) to the current count.

Note: All counter values will be lost if power is recycled to the scanner, or if the scanner receives a **Reset** or **Save** command.

Click the **Request** button to display the appropriate count or **Clear** to set the counter to zero.

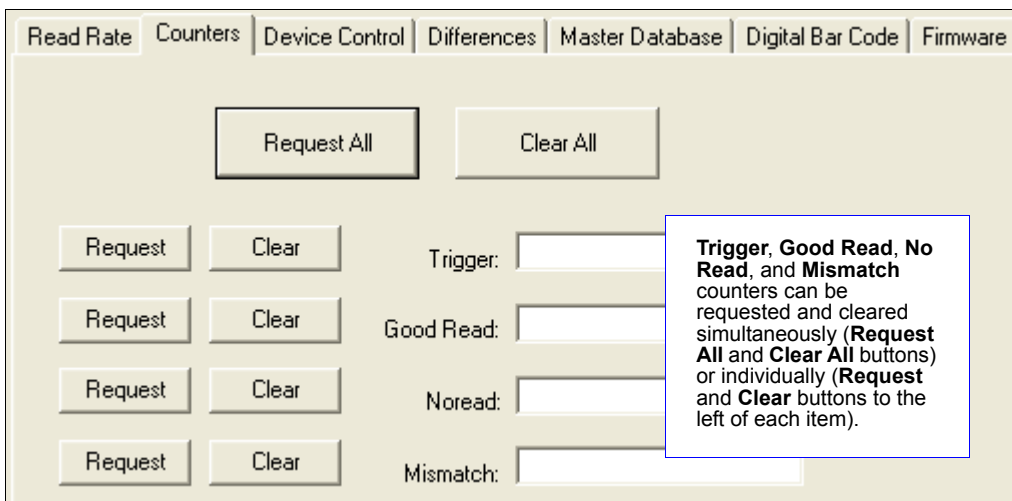

The screenshot shows a software interface with a menu bar at the top containing: Read Rate, Counters, Device Control, Differences, Master Database, Digital Bar Code, and Firmware. The 'Counters' tab is selected. Below the menu bar are two large buttons: 'Request All' and 'Clear All'. Underneath these are four rows of controls. Each row has a 'Request' button on the left and a 'Clear' button on the right. To the right of each pair of buttons is a label and a text input field: 'Trigger:', 'Good Read:', 'Noread:', and 'Mismatch:'. A blue-bordered callout box on the right side of the interface contains the following text: 'Trigger, Good Read, No Read, and Mismatch counters can be requested and cleared simultaneously (Request All and Clear All buttons) or individually (Request and Clear buttons to the left of each item).'

Counters Serial Utility Commands

No Read Counter

Sending **<N>** displays the total number of No Reads that have occurred since the last reset.

No Read Counter Reset

Sending **<O>** sets the No Read Counter to 00000.

Trigger Counter

Sending **<T>** displays the total number of triggers since the last reset.

Trigger Counter Reset

Sending **<U>** sets the trigger counter to 00000.

Good Read / Match Counter (or Good Read Counter)

Sending **<V>** displays the total number of good reads matching the master symbol, or, if **Master Symbol** is not enabled, the number of good reads since the last reset. This counter is always enabled, but will only work as a match count when **Master Symbol** is enabled. If **Master Symbol** is not enabled, this counter records the number of good reads. This count can be requested at any time.

Good Read / Match Counter Reset

Sending **<W>** sets the Match Counter to 00000.

Mismatch Counter

Sending **<X>** displays the number of decoded symbols since the last reset that do not match the master symbol.

Mismatch Counter Reset

Sending **<Y>** sets the Mismatch Counter to zero.

Device Control

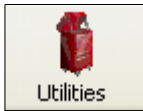

Click the **Utilities** button and then the **Device Control** tab to display the Device Control view.

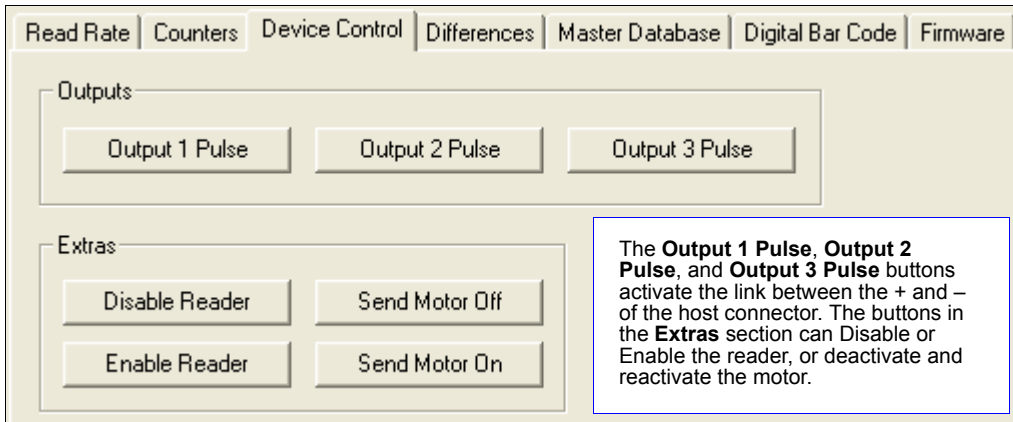

Device Control Serial Utility Commands

Output 1 Pulse

Sending **<L1>** activates the link between Output 1 (+) and Output 1 (-) of the host connector (regardless of Master Symbol or Output 1 status).

Output 2 Pulse

Sending **<L2>** activates the link between Output 2 (+) and Output 2 (-) of the host connector (regardless of Master Symbol or Output 2 status).

Output 3 Pulse

Sending **<L3>** activates the link between Output 3 (+) and Output 3 (-) of the host connector (regardless of Master Symbol or Output 3 status).

Disable Reader

Sending **<I>** will turn the scanner OFF, end the current read cycle, and will not allow the scanner to enter another read cycle until turned ON. This feature is useful during extended periods of time when no symbols are being decoded, or the scanner is being configured. Disabling the scanner will not affect any commands that have already been downloaded.

Enable Reader

Sending **<H>** will turn the scanner ON and allow it to enter read cycles.

Differences from Default



Click the **Utilities** button and then the **Differences** tab to display the Differences from Default view.

Clicking the **Differences from Default** button will cause **ESP** to check all stored configuration settings and compare them to default settings. All settings that are different than default will appear in the left column (shown below), and descriptions of those settings will appear in the right column.

Read Rate
Counters
Device Control
Differences
Master Database
Digital Bar Code
Firmware

Click this button for a list of **ESP** configuration settings that are different than default settings.

Click **Generate Barcode** to display the **Bar Code Dialog**. Then create configuration symbols containing the required configuration commands.

Differences from Default	Generate Bar Code
<K200,3>	Mode (External Edge)
<K220,,50>	Read Cycle Timeout (50)
<K474h,2>	Code 128 (Edge to Edge)
<K810,3>	Output On (No Read)
<K811,1>	Output On (Good Read/Match)
<K812,2>	Output On (Mismatch)

Click **Save As** to save the report as plain text or a tab-delimited text file.

Send configuration settings to the scanner and save in ESP by clicking **Send and Save**.

Send configuration settings to the scanner without saving by clicking **Send to Reader**.

- To create a symbol containing any of the command settings in the table, click **Generate Barcode**.
- To save the **Differences from Default** report, either as plain text or as a tab-delimited text file, click **Save As**.
- Click **Send and Save** to send the settings to the scanner and save them, or **Send to Reader** to send the settings without saving them.

Important: To use **Differences from Default**, connect to the scanner and **Receive Reader Settings** via the **Send/Recv** button on the toolbar.

Master Database



Click the **Utilities** button and then the **Master Database** tab to display the Master Database view.

Important: The **Master Database** is used for all **Matchcode** modes except **Sequential** and **Wild Card**, both of which use **Master Database Index # 1**.

Master Database Overview

Used where more than one master symbol is required, as in a **Multisymbol** setup, for matching and other **Matchcode** operations.

Allows the user to define up to 10 master symbols as the master symbol database, which can be entered by keyboard, scanned in, displayed, or deleted by serial or **ESP** commands.

1. Click the **Master Database** tab.
2. Enable **Matchcode Type**.
3. Set the **Master Symbol Database Size**.
4. Select the database index in which the master symbol will be entered.
5. Do one of the following to enter master symbol data:
 - a. Double-click the index row to type data directly into the index.
 - b. Click the **Read Symbol into Selected Index** to enter the next decoded symbol.

Set **Master Symbol Database Size** here.

Loads the next symbol decoded into the selected index.

Saves the database to the scanner.

Loads the scanner's saved master symbols into **ESP**.

Double-click a row to enter data into popup text box.

Caution: Since the total number of characters available for the master symbol database is limited, changes to the Master Symbol Database Size will re-allocate the number of characters available for each master symbol and could cause existing master symbols to be deleted. See manual for details.

Index	Master Symbol Data
1	Master Symbol 1
2	Master Symbol 2
3	Master Symbol 3
4	Master Symbol 4
5	Master Symbol 5

Master Symbol Database Size

Master Symbol Database Size allows the user to select 1 to 10 master symbols for the master symbol database.

Set **Master Symbol Database Size** here.

Important: Since the total number of characters available for the master symbol database is **3000**, changes to the **Master Symbol Database Size** will re-allocate the number of characters available for each master symbol and could cause existing master symbols to be deleted (except master symbol #1, unless it also exceeds the size limitation).

The table below specifies the maximum number of characters available to each symbol according the number of master symbols defined, from 1 to 10.

Master Symbol Number	Maximum Characters
# 1	3000
# 2	1500
# 3	1000
# 4	750
# 5	600
# 6	500
# 7	428
# 8	375
# 9	333
# 10	300

Enter Master Symbol Data

Allows the user to enter master symbol data for any enabled master symbol index number (1 to 10), provided the total number of characters does not exceed the maximum allowed.

Enter data for **1 to 10** master symbols.

Caution: If no data is entered, the existing data will be deleted.

1. Open the **Utilities** menu.
2. Set the number of master symbols to be created in **Master Symbol Database Size**.
3. Double-click on each master symbol number in the table, type master symbol data in the popup dialog that appears, and click **OK**.
4. When all master symbol data has been entered, click the **Send Database to the Reader** button.

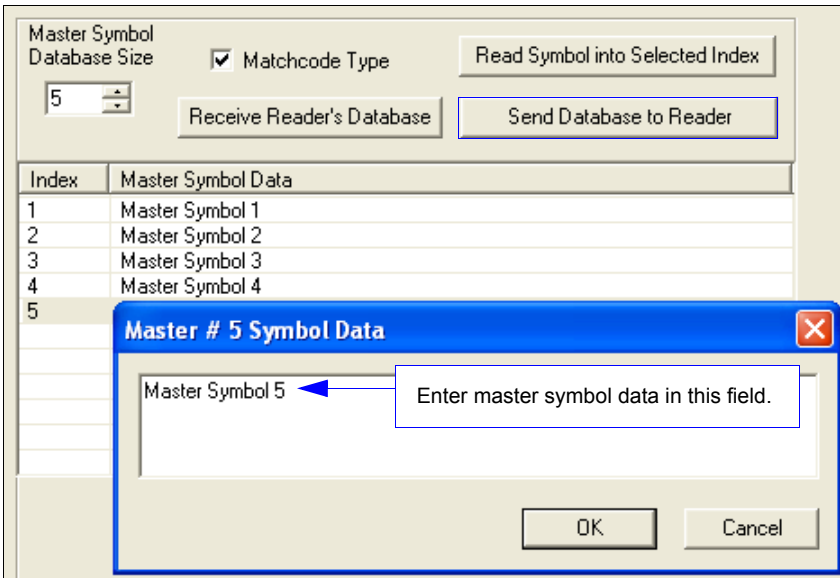

Request Master Symbol Data

Returns master symbol data for any enabled master symbols from **1** to **10**.

1. Click the **Utilities** button and the **Master Database** tab.
2. Click the **Receive Reader's Database** button.

Master Symbol Database Size: 5

Matchcode Type

Read Symbol into Selected Index

Receive Reader's Database

Send Database to Reader

Read Next Symbol as Master Symbol

After the size of the database is set, the scanner can read the next symbol as the master symbol for any given master symbol number.

<Gmaster symbol number>

To store the next symbol decoded as master symbol # 1, send:

<G> or **<G1>**.

To store the next symbol decoded as the master symbol for any other master symbol database number, send:

<Gmaster symbol number [1-10]>.

For example, **<G5>** will cause the next symbol read to be entered as master symbol # 5.

In the **Master Database** tab,

1. Select the master symbol index number in which new symbol data will be stored.
2. Click the **Read Symbol into Selected Index** button.

Master Symbol Database Size: 5

Matchcode Type

Read Symbol into Selected Index

Receive Reader's Database

Send Database to Reader

Caution: If an index with existing data is selected, that data will be overwritten by the new decoded data when this command is used.

Request New Master Status

Informs the user when a new master symbol is pending and which position it is in.

Returns the position in the master symbol database that will be loaded on the next read.

Send the **<NEWM>** command from ESP's Terminal.

The scanner returns: **<NEWM/next master to load>**

Once a symbol has been read and loaded, the status will be cleared and the response will be **<NEWM/0>**.

Delete Master Symbol Data

Master symbol data can be deleted using **ESP**.

1. Click the **Utilities** button to access the master symbol.
2. Click the **Master Database** tab and double-click the symbol number to be deleted.
3. Delete text and click **OK**.

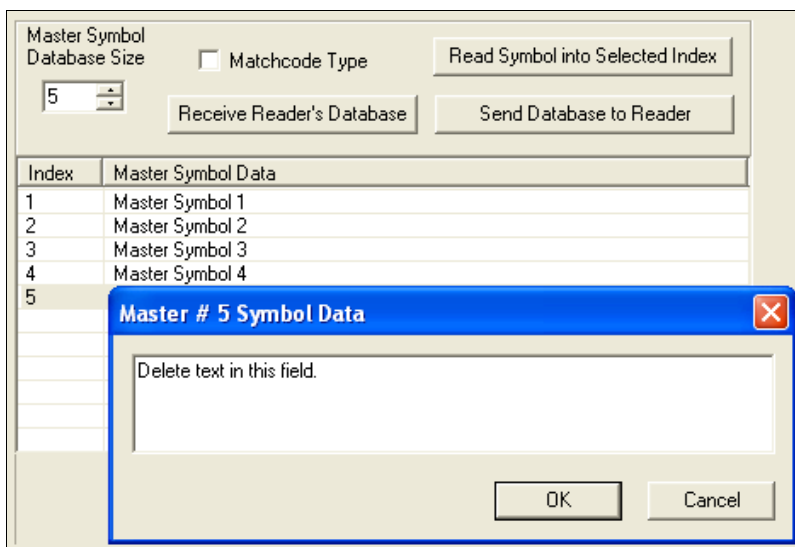

Digital Bar Code

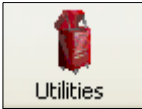

Click the **Utilities** button and then the **Digital Bar Code** tab to display the Digital Bar Code view.

Click the **Digital Bar Code** tab and the **Start** button to view a digitized representation of the symbol in front of the scanner.



This routine is useful for conveying a sense of the symbol's readability and graphically indicating bad or unreadable portions of symbols or extraneous "noise". A green waveform indicates a decoded symbol; a red waveform indicates an undecoded symbol or other object. The red triangles represent the width of the scan beam relative to the symbol. The upward pointing arrows indicate the symbol's quiet zone.

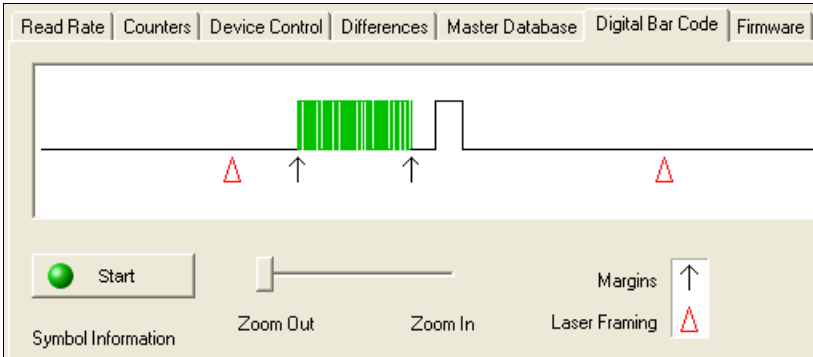

Zoom In / Zoom Out

Increase the zoom level by sliding the **Zoom** lever to the right. It may be necessary to scroll right or left to view the symbol's waveform in its entirety.

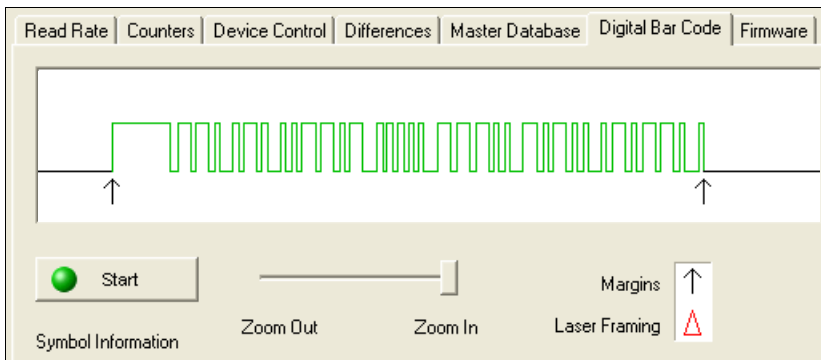

Firmware



Click the **Utilities** button and then the **Firmware** tab to display the Firmware view.

The screenshot shows the 'Firmware' tab selected in a window with tabs for Read Rate, Counters, Device Control, Differences, Master Database, Digital Bar Code, and Firmware. The Firmware section contains two main areas:

- Firmware Update:** A dropdown menu labeled 'App Code' and a 'Start...' button.
- Firmware Verification:** Two rows of controls. The first row has a dropdown menu labeled 'App Code', a 'Request Part No.' button, and an empty text input field. The second row has a dropdown menu labeled 'App Code', a 'Request Checksum' button, and an empty text input field.

Firmware Update

Firmware Update is used to download application code to the scanner. Application code versions are specific to the scanner. Consult with a sales representative before downloading application code. If needed, application/boot code in the form of a ***.mot** file can be requested.

To download application code:

1. First, be sure that the scanner is connected to the host computer.
2. Apply power to the scanner.
3. In the **Firmware Update** dropdown menu, select **App Code**. This will open a dialog that allows the user to browse for the application code file.
4. Navigate to where the application code file (a ***.mot** file) is located on the host computer.
5. Allow approximately a minute for firmware to download.

As the application code begins to download, the scanner will be silent, the LEDs will flash intermittently, and a progress indicator at the bottom of the ESP window will show when the download is complete.

Caution: Do not interrupt power or disconnect the host cable while download is in progress.

Firmware Verification

Request Part Number

Send a request to the scanner for application code, boot code, or FPGA code part numbers.

1. Click the **Firmware** tab.
2. Select App Code, Boot Code, or FPGA Code from the dropdown menu to the left of the **Request Part No.** button.
3. Click the **Request Part No.** button to see the part number displayed in the text field to the right.

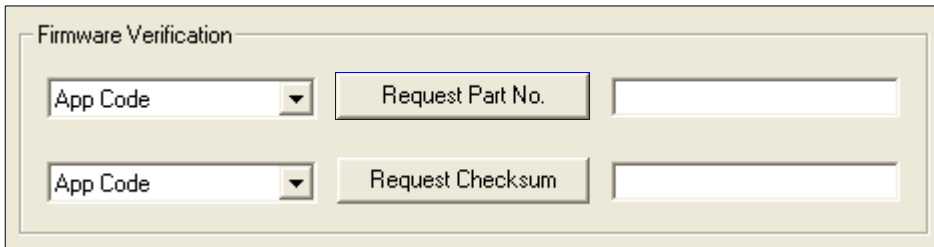

The screenshot shows a window titled "Firmware Verification". It contains two rows of controls. The top row features a dropdown menu with "App Code" selected, a button labeled "Request Part No.", and an empty text input field. The bottom row features a dropdown menu with "App Code" selected, a button labeled "Request Checksum", and an empty text input field.

Request Part Number by Serial Command

- When **<#>** (a request for all product part numbers) is sent, the scanner returns:
<#b/BOOT_P/N><#a/APP_P/N><#p/PROFILE_P/N>.
- When **<#a>** (a request for the application code part number) is sent, the scanner returns:
<#a/APP_P/N>.
- When **<#b>** (a request for the boot code part number) is sent, the scanner returns:
<#b/BOOT_P/N>.
- When **<#f>** (a request for the FPGA code part number) is sent, the scanner returns:
<#f/FPGA_P/N>.

Request Checksum

Send a request to the scanner for application code, boot code, or FPGA code checksums.

1. Click the **Firmware** tab.
2. Select App Code, Boot Code, or FPGA Code from the dropdown menu to the left of the **Request Checksum** button.
3. Click the **Request Checksum** button to see the part number displayed in the text field to the right.

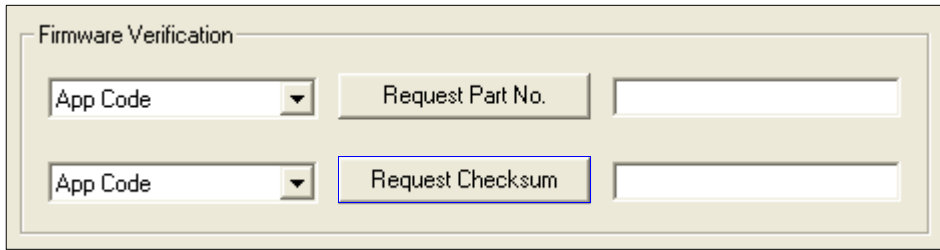

The screenshot shows a 'Firmware Verification' window with two rows of controls. The top row contains a dropdown menu with 'App Code', a 'Request Part No.' button, and an empty text field. The bottom row contains a dropdown menu with 'App Code', a 'Request Checksum' button (highlighted with a blue border), and an empty text field.

Request Checksum by Serial Command

- When **<!>** (a request for all available firmware checksums) is sent, the scanner returns: **<!b/BOOT_CHECKSUM><!a/APP_CHECKSUM><!p/PROFILE_CHECKSUM>**
- When **<!a>** (a request for the application code checksum) is sent, the scanner returns: **<!a/APP_CHECKSUM>**
- When **<!b>** (a request for the boot code checksum) is sent, the scanner returns: **<!b/BOOT_CHECKSUM>**
- When **<!f>** (a request for the FPGA code checksum) is sent, the scanner returns: **<!f/FPGA_CHECKSUM>**

Default / Reset / Save

Understanding and controlling the scanner’s active, saved, and default settings is critical to its successful operation.

	<i>Function</i>	<i>Serial Cmd</i>	<i>ESP^a</i>	<i>EZ Button</i>
Resets (not saved for power-on)	Reset (Will not save for power-on)	<A>	Save to Reader, Send No Save	No
	Reset and Recall Power-On Parameters	<Arp>	Send <Arp> from Terminal	No
	Reset and Recall Customer Default Parameters	<Arc>	Send <Arc> from Terminal	No
	Reset and Recall Omron Microscan Default Parameters	<Ard>	Send <Ard> from Terminal	No
Saved for Power-on	Save Current Settings for Power-On	<Z>	Save to Reader, Send and Save	No
	Save Current Settings as Customer Default Parameters for Power-On	<Zc>	Save to Reader, Send and Save Customer Defaults for Power-On ^b	No
	Recall Customer Default Settings and Save for Power-On	<Zrc>	Send <Zrc> from Terminal	Press and hold while powering on scanner
	Recall Omron Microscan Default Settings and Save for Power-On (Will not default “sticky settings”)	<Zrd>	Send <Zrd> from Terminal	No
	Recall Omron Microscan Default Settings and Save for Power-On (Will also default “sticky settings”)	<Zrdall>	Send <Zrdall> from Terminal	No

a. When right-clicking in a tree control to select **Default Current Menu Settings** or **Default All ESP Settings**, it is important to note that only **ESP** settings are defaulted. To save these defaults to the scanner itself, follow up with a **Save to Reader, Send and Save** command.

b. Only available in ESP if enabled in **Preferences (General tab)**, accessible from the Options dropdown menu.

Resets

Resets (“A” commands) affect only the current settings (active memory) and are not saved for power-on.

Saved for Power-on

Power-on parameters (“Z” commands) are saved to NOVRAM and recalled and loaded into current parameters when power is cycled to the scanner or the <Arp> command is issued.

Defaults

Defaults are Omron Microscan firmware settings or saved customer settings that can be recalled, either by software or hardware reset.

Customer Default Parameters

Customer default parameters (saved by **<Zc>**) are the same set of parameters as power-on parameters but are saved in a different, isolated section of NOVRAM. This allows a user essentially to create a back-up set of parameters that can be recalled in the event that the current parameters or power-on parameters have been accidentally changed or are no longer desired.

It is important to note that a hardware default does not affect customer default parameters. For example, a user that has inadvertently changed communication settings and saved them with a **<Z>** command, may not know the correct settings or have the capability to communicate within those settings. By first doing an EZ Button default to restore the known Omron Microscan defaults, the user can then recall the previous customer-saved settings with an **<Arc>** or **<Zrc>** command.

Restore Customer Defaults

Use the EZ Button to default the scanner by holding it down while applying power to the scanner (if this feature is enabled).

Omron Microscan Default Parameters

Omron Microscan default parameters are contained in the firmware and cannot be changed.

Software Defaults

Omron Microscan default parameters can be recalled (loaded into current settings) with the **<Ard>** command or recalled and saved for power-on with the **<Zrd>** command.

Restore Omron Microscan Defaults

If a software default and reset is not possible, it may be necessary to reset the scanner by shorting (connecting) specific pins. This procedure has the same effect as the **<Zrd>** software command.

Important: For this reset to occur, this command must be executed within 60 seconds of a power-on or a reset.

- Apply power to the scanner.
- Locate default pin and ground.
- Momentarily connect these wires (or pins) and listen for a series of short beeps.
- Within 3 seconds, connect them again. A longer beep should be heard. If not, repeat the process.

Default on Power-On

Use the EZ Button to default the scanner by holding it down while applying power to the scanner (if this feature is enabled).

Scanner Status Requests

<K?> All Status Request

This is the fastest way to learn the scanner's current configuration. Sending this request will return the current settings of all commands, starting with the lowest K command value and ending with the highest K command value.

<K??> All Descriptor Status Request

This request will return all current descriptors for every K command, starting with the lowest K command value and ending with the highest K command value.

<K?#> All Range Status Request

This request will return the current settings of all commands within the user-defined range, starting with the lowest user-defined K command value and ending with the highest user-defined K command value.

<Knnn?> Single Status Request

This request will return the value of the variables associated with the requested K command. The request of a single entry of a database command cannot exceed the number of database slots for the specific command.

<Knnn??> Single Descriptor Status Request

This request returns the basic functional description of all fields in the requested K command.

<Knnn?#> Single Range Status Request

This request will return the value range and storage type description of all fields in the requested K command.

<Knnnd> Default Customer Parameter

This request will default a single K command if the command has customer-defined parameters rather than factory-defined parameters.

Calibration Progress Indicators

The calibration process occurs in five phases: Quick Focus, Search Pass, Focus Pass, Medium Pass, and Fine-Tune Pass. The scanner quickly locates the configuration setup, defines a calibration range for the parameters, and then tunes the parameters for optimal performance.

During the calibration process, the scanner has a number of ways to communicate its progress to the user. The following three types of feedback are the primary ways that the scanner communicates calibration progress.

LEDs	Calibration Progress
20%	Search Pass in progress
20%, 40%	Locate Center Focus in progress
20%, 40%, 60%	Medium Pass in progress
20%, 40%, 60%, 80%	Fine-Tune Pass in progress
20%, 40%, 60%, 80%, 100%	Calibrated Successfully (holds for green flash duration)

Beeper/Green Flash

The beeper and green LED flash are used to indicate calibration status as shown in the table below:

Indicator	Status
2 quick beeps	Calibration has started
5 quick beeps	Calibration has failed
1 long beep	Calibration has been completed successfully
1 sec. Green Flash	Calibration has been completed successfully

Outline of Full Auto Calibration Process

Auto Calibration runs a calibration cycle for the scanner to optimize basic symbol decoding parameters. **Focus**, **Gain**, **Shutter Speed**, and **Symbol Type** are all configured during Auto Calibration. To configure the operation of Auto Calibration see **Calibration Options**. The calibration cycle can be entered either through ESP, serial command, or the EZ Button.

1. If laser framing is enabled, set scan line to full.
2. If laser power calibration is enabled, set laser power to factory default.
3. If motor speed calibration is enabled, set motor speed to factory default.
4. If video calibration is enabled, set gain and tracking to default.
5. If symbology detection is enabled: initialize symbology detection array with current symbology status configuration; enable all symbologies (except PDF417 and Pharmacode); symbology detection continues to operate concurrently with all remaining calibration processes.
6. Set LEDs to display 20% LED on, all others off.
7. Pre-position the raster: As-Is: no change; Straight: set raster straight out; Search or Frame: sweep the raster through full sweep angle. If a symbol is found, place raster in the middle of the symbol. If no symbol is found, set raster straight out.
8. Set LEDs to display 40% LED on, all others off.
9. Perform one pass of symbology detection (100 scans are decoded).
10. Perform motor and laser calibration (if enabled).
11. If motor speed calibration is enabled, motor speed starts at 300 sps, and is increased by 50 sps until 500 sps. After 500 sps, motor speed is increased by 100 sps until 1,000 sps. Motor speed calibration is limited to a maximum of 1000 sps, or motor speed is not changed.
12. If laser power calibration is enabled, at each motor speed increment, laser power is cycled between low, medium, and high power settings, or laser power is not changed.
13. If video calibration is enabled, and AGC is enabled (not in Fixed Gain operation), several gain and tracking pairs are used at each motor speed and laser power combination, or video settings are unchanged.
14. A “best-ever” read rate value is initialized to **0** to start the calibration process.
15. At each motor speed/laser power/video combination, a new read rate is acquired. The settings used to acquire the new read rate are recorded as the new “best” if:
 - The new read rate is better than 95%. Go to the next motor speed.
 - The new read rate is greater than the best read rate. Go to the next laser power.
 - The new read rate is equal to the best read rate, and the motor speed is greater. Go to the next laser power.
 - The new read rate is equal to the best read rate, and the laser power is less. Go to the next laser power.
16. Set LEDs to display 60% LED on, all others off.
17. Restore user-configured video (gain and tracking) settings.

Other Serial Utility Commands

18. Perform video calibration, (if enabled): take initial read rate at current settings; calibrate video, select new gain and tracking; take final read rate with new gain and tracking; if final read rate is < 2%, video calibration fails; if final read rate is > or = initial read rate, video calibration passes and new settings take effect; if final read rate is < initial read rate, video settings revert to pre-calibration values (this is not considered a “failure”; all other settings calibrated by other calibration processes like motor speed and laser power).
19. Perform raster framing if the raster parameter of the calibration command is set to “Frame”.
20. Perform laser framing, if enabled.
21. If symbology detection is enabled, update user NOVRAM with any new symbologies detected during calibration.

Notes:

If any step in the calibration process fails, or if the user cancels calibration, the remainder of calibration is canceled and all settings are restored to their previous state. This does not apply to symbology status when symbology detection is enabled. Any symbols that are decoded during calibration will be enabled, even if any other calibration processes fail or are canceled.

Bar Code Configuration Mode

Bar Code Configuration Mode is a way of programming the scanner by using symbols.

Bar Code Configuration Mode can be entered two different ways:

1. By forcing the scanner into **Bar Code Configuration Mode** by serial command **<BCCFG>**.
2. By configuring one of the four EZ Button positions (**Single Beep, Two Beeps, Three Beeps, Four Beeps**) to **Bar Code Configuration Mode**.

Once **Bar Code Configuration Mode** has been entered, symbols can be thought of as serial data. Configure the scanner by printing symbols in Omron Microscan's serial command format. Commands are processed as if the data were streamed in through the serial port. The scanner will acknowledge the symbol with a beep, green flash, and echo the serial data to the host. If the command causes the scanner to produce more serial output, such as serial verification or counter requests, the data will be routed to the host.

Bar Code Configuration Mode can be exited by any reset **<A>** or **<Z>** command as well as a **<J>** or a quick press and release of the EZ Button.

The command to exit **Bar Code Configuration Mode** can be included as part of the symbol. For example, try encoding **<K200,4><K220,1><J>** into a symbol. This configures the scanner to enable **Serial Trigger Mode**, to program a new trigger to end the read cycle, and to exit **Bar Code Configuration Mode** with **<J>**.

To end all EZ Button functions, press the EZ Button once and quickly release.

Embedded Menus

The QX-870 contains Embedded Menus to provide easy configuration in situations where a ESP Software may not be available or applicable.

The Embedded Menus consist of a Main Menu and a sub-menu for every group of commands.

The following example shows how a user can operate the QX-870's Embedded Menus.

Upon connection, send a **<D>** command to the reader to bring up the main menu.

Main Menu

For the purpose of this example, assume the user wants to navigate to the **Symbologies** menu. The user would select **C** from the list.

```
===== [MAIN MENU] =====
A) COMMUNICATION
B) SCANNER SETUP
C) SYBBOLOGIES
D) SCANNER I/O SETUP
E) DIAGNOSTICS SETUP
F) CONFIG IP DATABASE
G) OUTPUT ORDER FILTER
H) MATCHCODE
-- PLEASE PRESS A-H TO EDIT, ESC TO EXIT |
```

Command Menu

The user then selects **B** to navigate to the **Code 128** menu.

```
===== [SYBBOLOGIES] =====
---- Code Type ----- Status -----
A) CODE 39                ENABLE
B) CODE 128              DISABLE
C) CODE I 2 OF 5         DISABLE
D) CODABAR                DISABLE
E) UPC                    DISABLE
F) CODE 93                DISABLE
G) PHARMA CODE           DISABLE
H) PDF417                 DISABLE
----- Global Parameters -----
I) Quiet Zone Status      = DISABLE
J) Symbology Identifier Status = DISABLE
K) Background Color       = White
-- PLEASE PRESS A-K TO EDIT, 1=MAIN MENU, 2=PREVIOUS MENU, ESC TO EXIT |
```

Parameter Menu

The user then selects **B** to configure the **Fixed Symbol Length Status** parameter.

```
===== [CODE 128] =====
A) Code 128 Status = DISABLE
B) Fixed Symbol Length Status = DISABLE
C) Symbol Length = 10
D) EAN-128 Status = DISABLE
E) Output Format = Standard
F) Application Record Separator Status = DISABLE
G) Application Record Separator Character = ,
H) Application Record Brackets = DISABLE
I) Application Record Padding = DISABLE
-- PLEASE PRESS A-I TO EDIT, 1=MAIN MENU, 2=PREVIOUS MENU, ESC TO EXIT |
```

Parameter Options Menu

At this level, the current setting and system default are both shown. The user can select the desired option and go back to the previous menu, or press **Enter** or **ESC** to return to the previous menu without any change to the parameter.

```
===== [Fixed Symbol Length Status] =====
A) DISABLE [CURRENT] [DEFAULT]
B) ENABLE
-- PLEASE PRESS A-B TO CHANGE THE PARAMENTER, ESC TO CANCEL |
```

Another example of a **Parameter Options**-level menu is the **Symbol Length**, shown below. In this menu, the user is prompted to enter a desired value in a range from **1** to **128**, and the menu shows a system default of **10**. After a desired value has been entered, the user must press **Enter** to confirm that the value is valid and return to the previous menu, or press **ESC** to return to the previous menu without any change to the parameter. The user could also return to the previous menu by pressing **Enter** when no value has been entered.

```
===== [Symbol Length] =====
A) Symbol Length = 10
   Rang: 1 - 128
   System Default: 10
-- PLEASE TYPE THE NEW VALUE, THEN ENTER, ESC TO CANCEL
-- NEW VALUE = |
```

Appendices

Contents

Appendix A General Specifications	A-2
Appendix B Electrical Specifications	A-6
Appendix C Ground and Shield Considerations	A-15
Appendix D Flying Lead Cordset Pinouts.....	A-17
Appendix E Updated Pin Assignment of QX Connector T	A-18
Appendix F Serial Commands.....	A-20
Appendix G Protocol Commands	A-85
Appendix H ASCII Table	A-94
Appendix I Configuring Ethernet TCP/IP.....	A-95
Appendix J Using EtherNet/IP.....	A-98
Appendix K Operating EtherNet/IP Serial Gateway Data Fields	A-107
Appendix L Allen-Bradley Version 16 PLC Setup	A-109
Appendix M Allen-Bradley Version 20 PLC Setup	A-123
Appendix N EIPScan Setup	A-130
Appendix O Interface Standards	A-136
Appendix P Glossary of Terms.....	A-137

Appendix A — General Specifications

Mechanical

Height: 4.59" (109 mm)

Width: 3.74" (95 mm)

Depth: 1.76" (45 mm)

Weight: 16 oz. (453 g)

Environmental

Enclosure: Die-cast aluminum, IP65

Operating Temperature: 0° to 50° C (32° to 122° F)

Storage Temperature: -40° to 75° C (-40° to 167° F)

Humidity: up to 90% (non-condensing)

Emissions

Heavy Industrial: EN 61000-6-2:2005

Radiated Emissions: EN

55022:2006 Class A 30-1000 MHz

Conducted Emissions: EN

55022:2006 Class A .15-30 MHz

Communication Interface

Standard Interfaces: RS-232, RS-422, RS-485, Ethernet

Symbologies

Standard Offering: Code 39, Codabar, Code 93, Interleaved 2 of 5, Code 128, PDF417, MicroPDF417, Pharmacode, UPC, GS1 DataBar

Applications Standards: EAN-128, AIAG

Laser Light

Type: Laser diode

Output Wavelength: 655 nm

Beam Divergence: 0.4mrad (typ.)

Pulse Duration: 40~186µs

Maximum Power: 1.75mW

Operating Life: 50,000 hours @ 25° C

Safety Class: Visible laser: Class 2, 655 nm



Scanning Parameters

Mirror Type: Rotating, 10-faceted

Scan Rate: Adjustable from 300 to 1,400 scans per second; Default = 500

Scan Width Angle: Typically 60°

Pitch: ±50° max.

Skew: ±40° max.

Symbol Contrast: 25% min. absolute dark-to-light differential at 655 nm wavelength

Raster Mirror Performance: 1° - 10°: 80 sweeps per second; 11° - 20°: 60 sweeps per second; 21° - 34° (max.): 40 sweeps per second; 35° - 36° (max.): 20 sweeps per second

Protocols

Point-to-Point, Point-to-Point with RTS/CTS, Point-to-Point with XON/XOFF, Point-to-Point with RTS/CTS and XON/XOFF, Multidrop, Daisy Chain, User-Defined Multidrop, Ethernet TCP/IP, EtherNet/IP

Discrete I/O

Input 1 (Trigger / New Master): Bi-directional optoisolated 4.5–28V rated (13 mA at 24VDC); New Master is (-) to signal ground

Outputs (1, 2, 3): Optoisolated, 1–28V rated ($I_{CE} < 100$ mA at 24VDC, current limited by user)

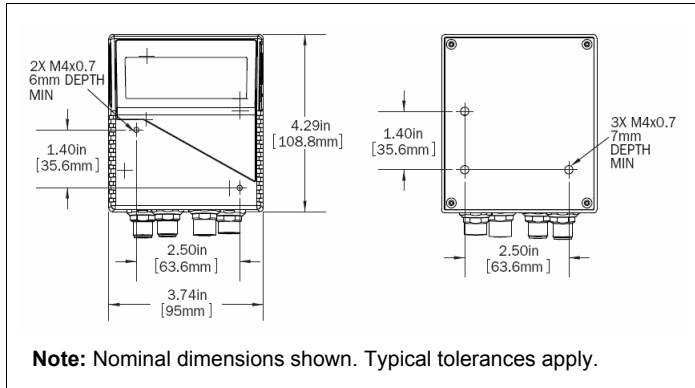

QX-870 Dimensions

QX-1 Interface Device

Mechanical

Height: .75" (19.1 mm)

Width: 2.50" (83.5 mm)

Depth: 3.15" (80 mm)

Weight: 7 oz. (200 g)

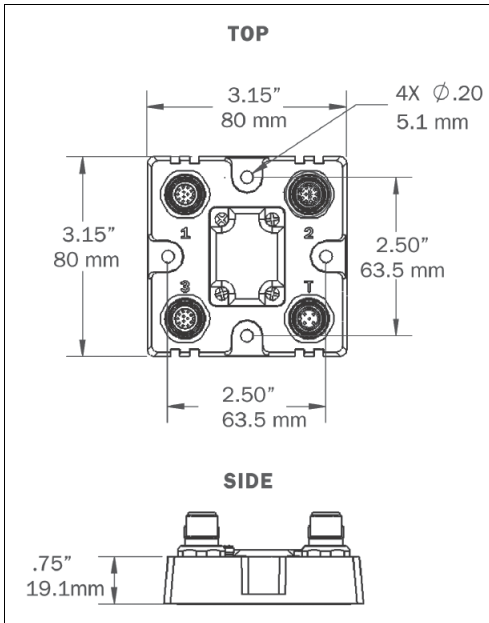

QX-1 Dimensions

General Specifications

Read Ranges

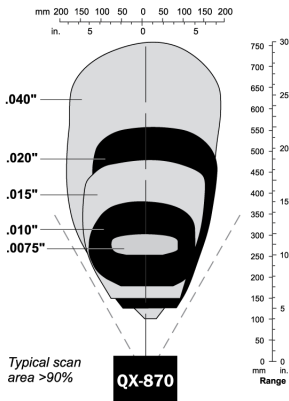

Low Density

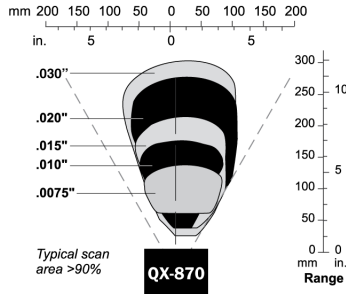

Medium Density

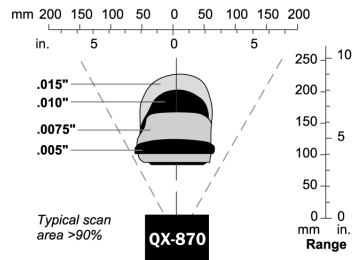

High Density

	Narrow Bar Width	Read Range
Low Density	.0075" (.191 mm)	10" to 12" (254 mm to 305 mm)
	.010" (.254 mm)	7" to 15" (178 mm to 381 mm)
	.015" (.381 mm)	6" to 19" (152 mm to 483 mm)
	.020" (.508 mm)	5" to 22" (127 mm to 558 mm)
	.040" (1.02 mm)	4" to 30" (102 mm to 762 mm)
Medium Density	.0075" (.191 mm)	2.5" to 5.5" (64 mm to 140 mm)
	.010" (.254 mm)	1.5" to 7" (38 mm to 178 mm)
	.015" (.381 mm)	1.5" to 8.5" (38 mm to 216 mm)
	.020" (.508 mm)	1.5" to 11" (38 mm to 280 mm)
	.030" (.762 mm)	1" to 12" (25 mm to 304 mm)
High Density	.0033" (.084 mm)	Call Omron Microscan.
	.005" (.127 mm)	4" to 5" (102 mm to 127 mm)
	.0075" (.191 mm)	3.5" to 6.75" (89 mm to 171 mm)
	.010" (.254 mm)	3.25" to 8" (82 mm to 203 mm)
	.015" (.381 mm)	3.25" to 9" (82 mm to 228 mm)

Read Ranges based on a Grade A Code 39 label running at 500 scans per second.

FIS Options

QX-870	
FIS-0870-0004G	Industrial Raster Scanner, Low Density, Sweeping Raster, Serial
FIS-0870-0005G	Industrial Raster Scanner, Medium Density, Sweeping Raster, Serial
FIS-0870-0006G	Industrial Raster Scanner, High Density, Sweeping Raster, Serial
FIS-0870-1004G	Industrial Raster Scanner, Low Density, Sweeping Raster, Serial + Ethernet
FIS-0870-1005G	Industrial Raster Scanner, Medium Density, Sweeping Raster, Serial + Ethernet
FIS-0870-1006G	Industrial Raster Scanner, High Density, Sweeping Raster, Serial + Ethernet

Safety Certifications

CDRH, FCC, UL/cUL, CE, CB, BSMI, RoHS/WEEE



RoHS/WEEE Compliant

©2018 Omron Microscan Systems, Inc.
All rights reserved. Specifications subject to change.

Product specifications are given for typical performance at 25°C (77°F) using grade A labels. Performance characteristics may vary at high temperatures or other environmental extremes. Warranty—One year limited warranty on parts and labor. Extended warranty available.

Appendix B — Electrical Specifications

Power Requirement	9 Watts (max.), 10-28VDC, 200 mV p-p max. ripple, 270mA at 24VDC (typ.)
Default	Internally tied PWR+. Use PWR- to activate.

QX-870 Connectors

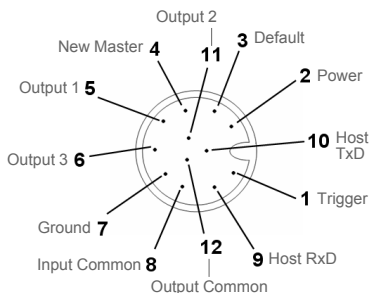

Connector A (All Models)
M12 12-pin Plug

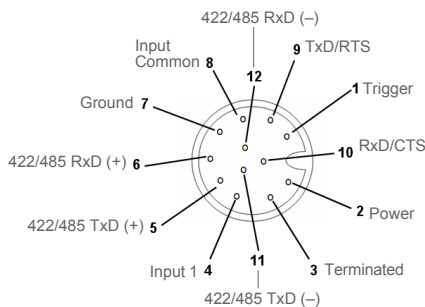

Connector B (Serial Models)
M12 12-pin Socket

Pin	Function	Wire Color
1	Trigger	White
2	Power	Brown
3	Default	Green
4	New Master	Yellow
5	Output 1	Gray
6	Output 3	Pink
7	Ground	Blue
8	Input Common	Red
9	Host RxD	Black
10	Host TxD	Violet
11	Output 2	Gray/Pink
12	Output Common	Red/Blue

Pin	Function	Wire Color
1	Trigger	White
2	Power	Brown
3	Terminated	Green
4	Input 1	Yellow
5	422/485 TxD (+)	Gray
6	422/485 RxD (+)	Pink
7	Ground	Blue
8	Input Common	Red
9	TxD/RTS	Black
10	RxD/CTS	Violet
11	422/485 TxD (-)	Gray/Pink
12	422/485 RxD (-)	Red/Blue

Continued next page

QX-870 Connectors (continued)

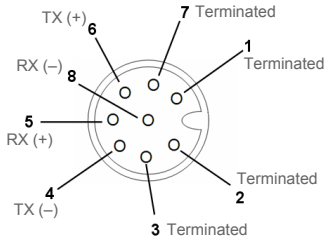

**Connector B (Ethernet Models)
M12 8-pin Socket**

Pin	Function
1	Terminated
2	Terminated
3	Terminated
4	TX (-)
5	RX (+)
6	TX (+)
7	Terminated
8	RX (-)

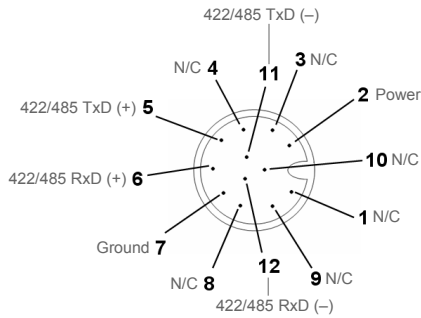

**Connector P/M (All Models)
M12 12-pin Plug**

Pin	Function	Wire Color
1	N/C	White
2	Power	Brown
3	N/C	Green
4	N/C	Yellow
5	422/485 TxD (+)	Gray
6	422/485 RxD (+)	Pink
7	Ground	Blue
8	N/C	Red
9	N/C	Black
10	N/C	Violet
11	422/485 TxD (-)	Gray/Pink
12	422/485 RxD (-)	Red/Blue

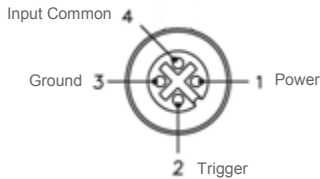

**Connector T (Trigger)
M12 4-pin Socket**

Pin	Function
1	Power
2	Trigger
3	Ground
4	Input Common

QX-1 Connectors

Connector T on the QX-1 Interface Device is the Trigger connector.

Connectors 1, 2, and 3 can be used to bus power and data as required by the application.

The connectors on the QX-1 interface device physically mirror those on the QX-870 scanner, but they do not have explicit pin assignments. The QX-1 connectors take on the communications and power roles that are assigned to them.

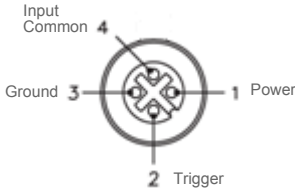

1	Power
2	Trigger
3	Ground
4	Input Common

**QX-1 Trigger Connector
4-pin Socket**

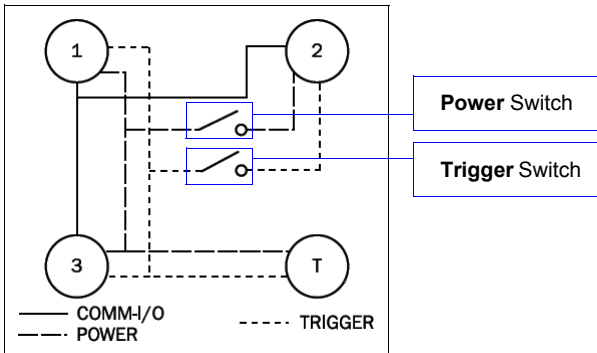

QX-1 Wiring Diagram

Connectors 1 and 3 are 12-pin plugs, and **Connector 2** is a 12-pin socket. All three connectors can be assigned to bus power and data.

The two switches at the center of the device allow the user to route signals as needed.

The simple diagram above (also shown on the base of the QX-1) illustrates how power, communications, I/O, and trigger signal can be routed through the QX-1 device.

Power can be bussed between scanners and interface devices. At each location on a network where a new power supply is added, the Power switch on the QX-1 can be used to break power between Connector 2 and Connectors 1, 3, and T.

The **Trigger** signal between Connector 2 and Connectors 1, 3, and T can be broken using the Trigger switch. This isolates trigger signals as required.

Optoisolated Outputs

The reader has optoisolated outputs that can transfer signals from the reader to peripherals. Outputs can be configured as either NPN or PNP, but NPN and PNP cannot be mixed in a system, because the output common is shared by all outputs.

NPN Output for Host Input

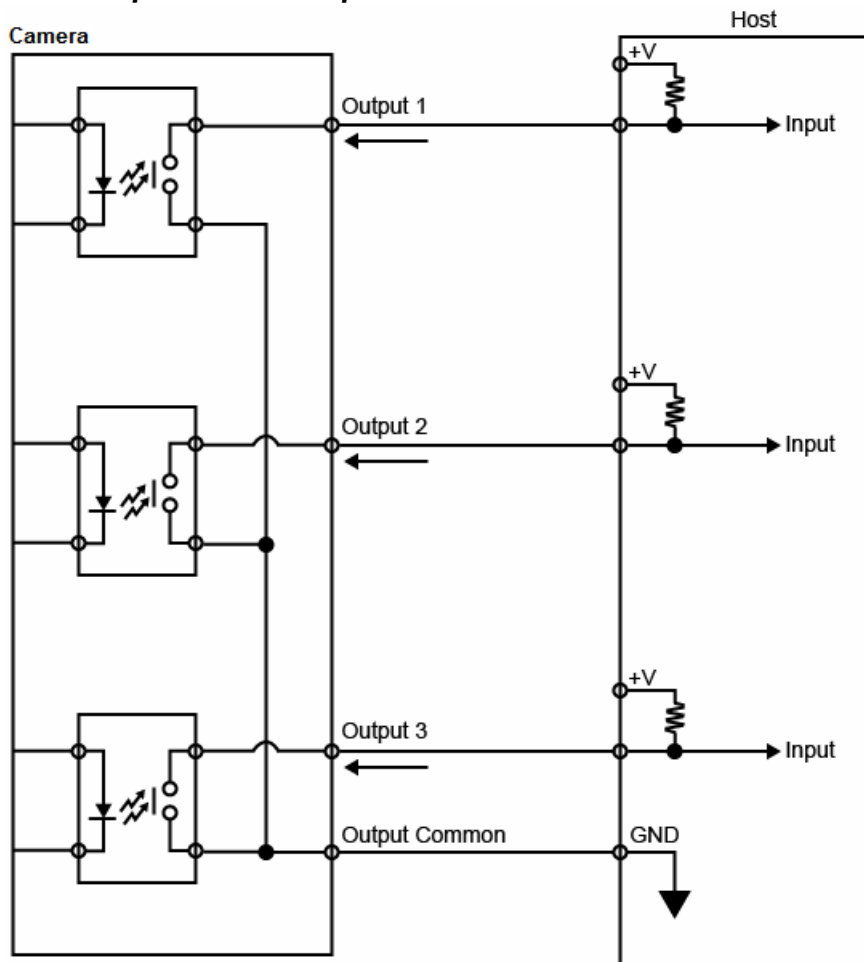

NPN Output for External Load

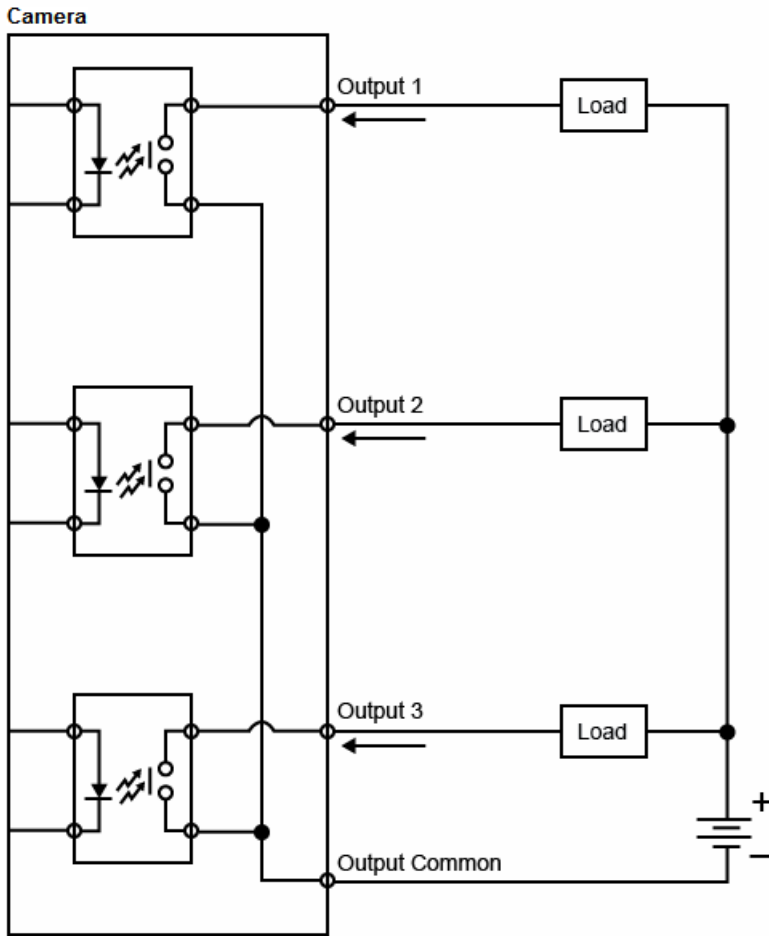

PNP Output for Host Input

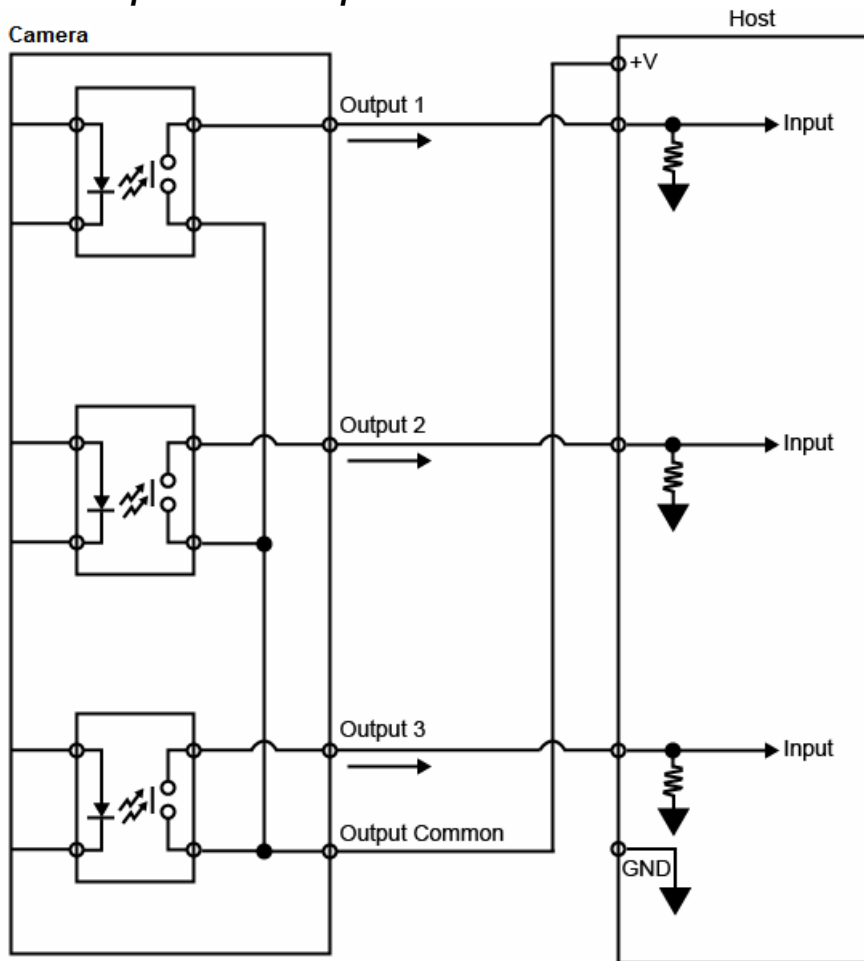

PNP Output for External Load

Camera

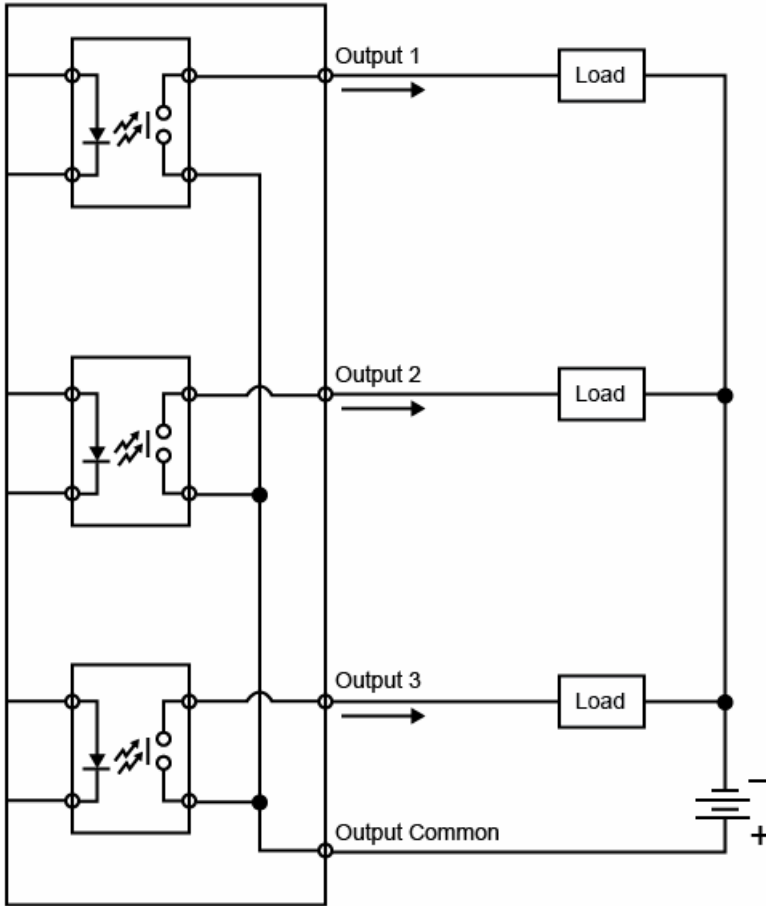

Optoisolated Inputs

All discrete inputs are optoisolated. Inputs can be configured as either NPN or PNP, but NPN and PNP cannot be mixed in a system, because the input common is shared by all inputs.

NPN

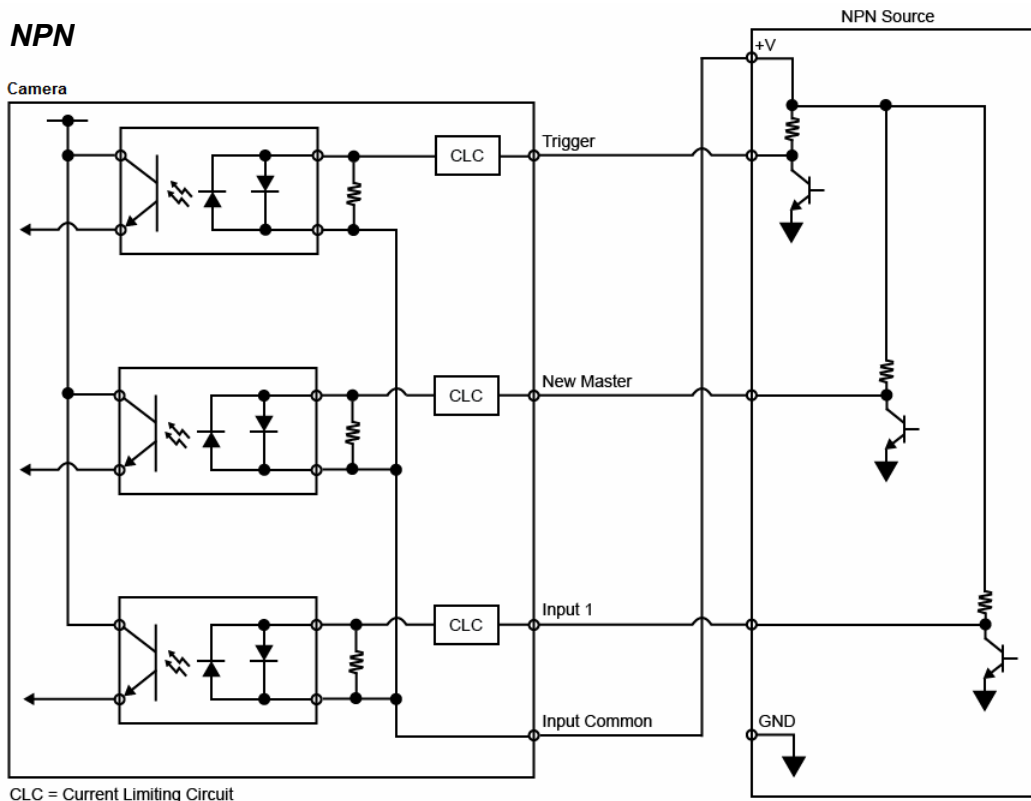

PNP

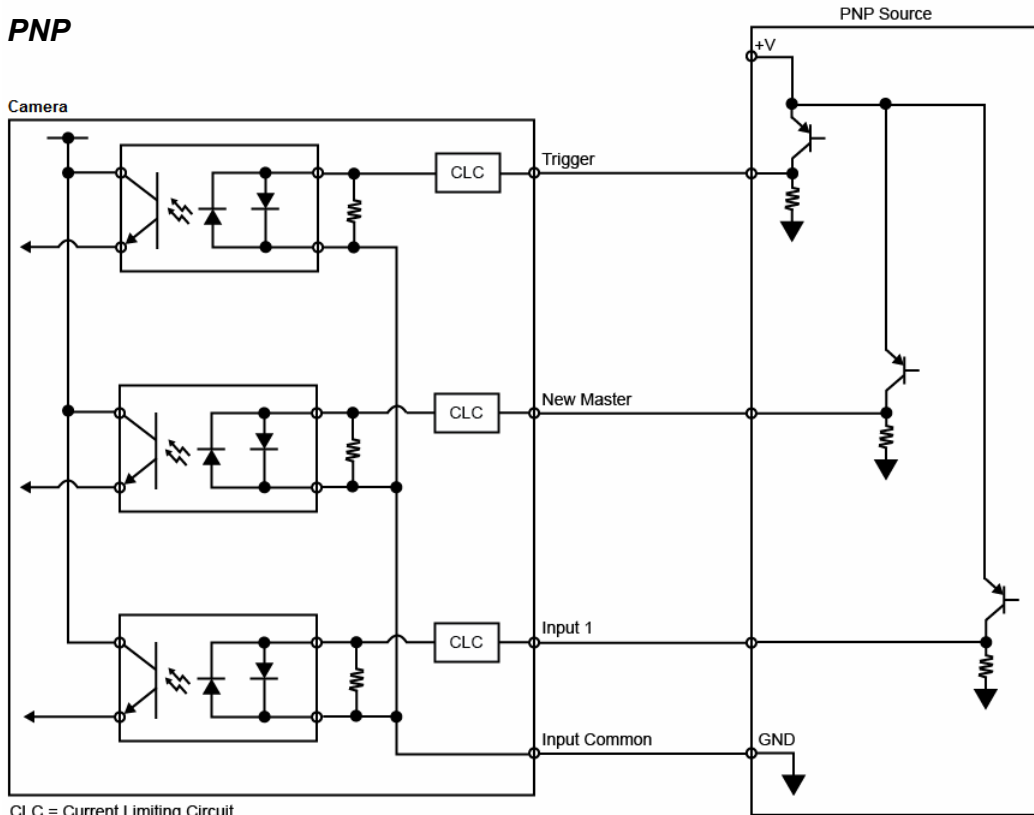

CLC = Current Limiting Circuit

Appendix C — Ground and Shield Considerations

Proper grounding is necessary for operator safety, noise reduction, and the protection of equipment from voltage transients. Buildings, including any steelwork, all circuits, and all junction boxes must be grounded directly to an earth ground in compliance with local and national electrical codes.

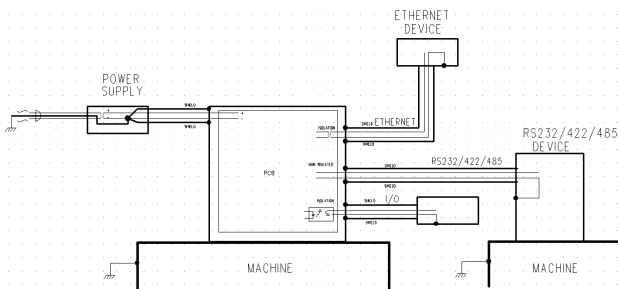

An earth ground is provided through the cable shields and chassis of the scanner.

Ground Loops

Ground loops (signal degradation due to different ground potentials in communicating devices) can be eliminated or minimized by ensuring that both the host, scanner, and their power supplies are connected to a common earth ground.

Grounding and Isolation

Important: Mounting a QX-870 to grounded conductive material may cause communication problems or unreliable operation. If you need to mount the reader to a bracket or plate, be sure that a proper ground connection is available. If not, electrical isolation of the reader should be performed. Using Omron Microscan's Isolation Mounting Kit, P/N 98-9000038-01, will ensure that no ground loop or other external electrical noise can occur through the reader.

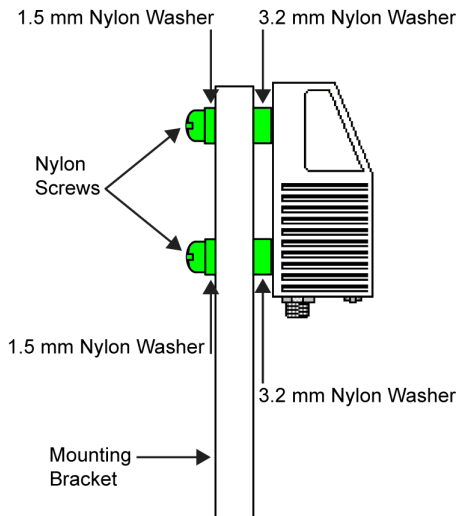

Expected Power and Ground Connections for Proper Operation

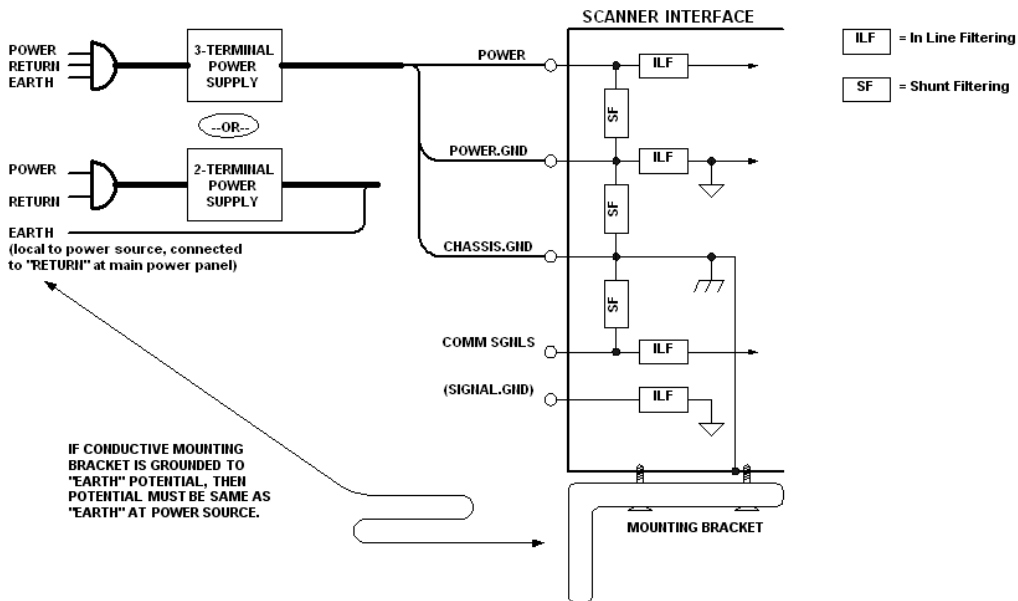

Notes:

- Ensure that mounting bracket "Earth" is at the same potential as power source "Earth".
- Supply "Return" and "Earth" ground must be stable, low-impedance reference points.
- "2-Terminal Power Supply" must still provide an "Earth" connection to the scanner.

Appendix D — Flying Lead Cordset Pinouts

Omron Microscan offers two flying leads cordsets—61-000166-02 and 61-000167-02—for use in QX hardware configurations. The diagrams below show the correspondence of wire colors to pins.

61-000166-02 — QX Cordset, M12 12-Pin Plug, Flying Leads

The 61-000166-02 cordset connects to QX-870 Connector B (serial) and QX-1 Connector 2.

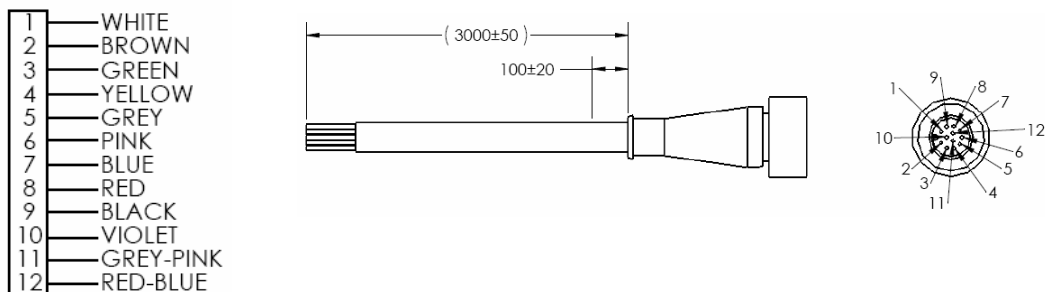

61-000167-02 — QX Cordset, M12 12-Pin Socket, Flying Leads

The 61-000167-02 cordset connects to QX-870 Connectors A and P/M, and QX-1 Connectors 1 and 3.

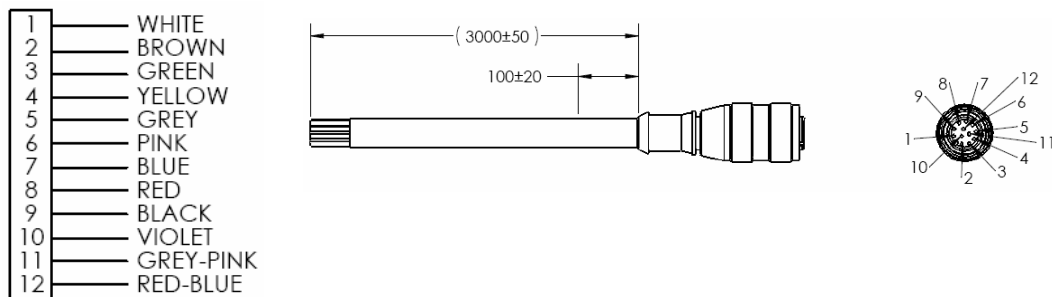

Appendix E — Updated Pin Assignment of QX Connector T

Problem

The trigger signal from Connector T interferes with the operation of Trigger, New Master, and Input 1 on Connectors A and B, or across multiple scanners, if interconnected.

Cause

The Trigger and Common pins from Connector T are not connected to the correct signal within the circuit. The standard photo sensor will signal the input common pin instead of the trigger pin. The photo sensor signal that is switching the common line will interfere with any inputs wired into Connectors A or B.

Original pin assignments:

Connector T / Pin Name		Photo Sensor
1	Power	Power
2	Input Common	NPN
3	Ground	Ground
4	Trigger	Jumper to Power

Note: This will only cause an issue if using Trigger, New Master, or Input 1 on Connectors A or B.

Solution

The pin assignment of Connector T has been modified by swapping the input common and trigger pins. The pin assignments on all other connectors remain the same.

Pin assignment modifications are highlighted:

Connector T / Pin Name		Photo Sensor
1	Power	Power
2	Trigger	NPN
3	Ground	Ground
4	Input Common	Jumper to Power

Note: Use a PNP photo sensor when the QX-870 is connected to the MS-Connect 210.

The proper configuration is shown here:

Photo Sensor	
1	Power
2	PNP
3	Ground
4	Jumper to Pin 3

Part Number Transition

The following table shows the new part numbers of the affected QX-870s and QX-1s.

Original Part Number	New Part Number	Description
FIS-0870-0001G	FIS-0870-0004G	QX-870, Low Density, Serial
FIS-0870-0002G	FIS-0870-0005G	QX-870, Medium Density, Serial
FIS-0870-0003G	FIS-0870-0006G	QX-870, High Density, Serial
FIS-0870-1001G	FIS-0870-1004G	QX-870, Low Density, Serial + Ethernet
FIS-0870-1002G	FIS-0870-1005G	QX-870, Medium Density, Serial + Ethernet
FIS-0870-1003G	FIS-0870-1006G	QX-870, High Density, Serial + Ethernet
98-000103-01	98-000103-02	QX-1 Interface Accessory

Appendix F — Serial Commands

Note: For a list of utility commands such as defaults, read rate requests, device control options, and scanner status requests, see [Serial Utility Commands](#) .

Communication	
RS-232 A	<K100,baud rate,parity,stop bits,data bits>
RS-232 B	<K101,status,baud rate,parity,stop bits,data bits>
RS-422	<K102,status,baud rate,parity,stop bits,data bits>
Ethernet	<K126,status,IP address,subnet,gateway,IP address mode>
Ethernet TCP Ports	<K127,TCP Port 1,TCP Port 2>
EtherNet/IP	<K129,status>
RS-232 A Data Type	<K130,symbol data output,extra symbol information,diagnostic output,external source processing mode>
RS-232 B Data Type	<K131,symbol data output,extra symbol information,diagnostic output,external source processing mode>
RS-422 Data Type	<K132,symbol data output,extra symbol information,diagnostic output,external source processing mode>
Ethernet TCP Port 1 Data Type	<K133,symbol data output,extra symbol information,diagnostic output,external source processing mode>
Ethernet TCP Port 2 Data Type	<K134,symbol data output,extra symbol information,diagnostic output,external source processing mode>
EtherNet/IP Data Type	<K136,symbol data output,extra symbol information,diagnostic output,external source processing mode>
Preamble	<K141,status,preamble>
Postamble	<K142,status,postamble>
Response Timeout	<K143,response timeout>
LRC Status	<K145,status>
ACK/NAK Options	<K147,RES,REQ,STX,ETX,ACK,NAK>
Polling Mode Options	<K148,RES,REQ,STX,ETX,ACK,NAK>
Autoconfiguration Daisy Chain	<K150DAISY>
Protocol Selection	<K160,protocol,address,protocol port>
External Data Routing	<K161,mode,destination port,ambles to source,echo to source,output at end of read cycle,output at ETX,output at timeout>
Array Communication Modes	<K162,mode,source,daisy chain i.d. status,daisy chain i.d.>
Read Cycle	
Trigger Mode / Trigger Filter Duration	<K200,trigger mode,leading edge trigger filter duration,trailing edge trigger filter duration>
Serial Trigger Character	<K201,serial trigger character>
External Trigger State	<K202,external trigger state>
End of Read Cycle	<K220,mode,read cycle timeout>
Decodes Before Output	<K221,mode,number before output>
Multisymbol	<K222,number of symbols,multisymbol separator>
Serial Trigger Start Character	<K229,start character>

Serial Trigger Stop Character	<K230,stop character>
Processing Timeout	<K245,processing timeout>
Motor On/Scan Speed	<K500,scan speed>
Motor Off	<K501,motor off>
Maximum Element	<K502,maximum element>
Automatic Gain Control	<K504,gain level,AGC sampling mode,AGC minimum,AGC maximum>
Symbol Detect Status / Transition Counter	<K505,symbol detect status,transition counter>
Raster Framing	<K506,status,top offset,bottom offset,sweep rate,read cycle on/off>
Scan Width Enhance	<K511,status>
AGC Tracking	<K520,tracking>
Laser Setup	<K700,laser on/off,laser framing status,laser on position,laser off position,laser power>

Configuration Database

Number of Active Indexes	<K252,number of active indexes,number of database cycles>
Configuration Database	<K253,index,gain,AGC mode,tracking,raster top,raster bottom,raster speed,framing status,laser on position,laser off position,laser power,background color>
Switch Timing	<K254,switch mode,frame count/time>

Symbologies

Quiet Zone	<K450,quiet zone status>
Background Color	<K451,background color>
Symbol Ratios	<K452,Code 39,Codabar,Interleaved 2 of 5>
Composite	<K453,symbology status,separator status,separator>
AIAG	<K454,status,ID1,status1,ID2,status2,ID3,status3,ID4,status4,ID5a,ID5b,ID5c,status5,ID6,status6,ID7,status7,ID8,status8,ID9,status9,ID10,status10,ID11,status11,ID12,status12>
Depth of Field Enhance	<K456,DOF Enhance mode>
Code 39	<K470,status,check character status,check character output status,large intercharacter gap,fixed symbol length status,fixed symbol length,full ASCII set>
Codabar	<K471,status,start/stop match status,start/stop output status,large intercharacter gap,fixed symbol length status,fixed symbol length,check character type,check character output status>
Interleaved 2 of 5	<K472,status,check character status,check character output status,symbol length 1,symbol length 2,guard bar,range mode status>
UPC/EAN	<K473,mode,EAN status,supplementals status,separator status,separator character,supplementals type,UPC-E as UPC-A>
Code 128 / EAN 128	<K474,status,fixed symbol length status,fixed symbol length,EAN status,output format,application record separator status,application record separator character,application record brackets,application record padding,separation factor>
Code 93	<K475,mode,fixed symbol length status,symbol length>
PDF417	<K476,status,raster sweep count,fixed symbol length status,fixed symbol length,unused,codeword collection>

Serial Commands

Pharmacode	<K477,status,fixed bar count status,fixed bar count,minimum bar count,bar width mode,direction,fixed threshold value>
DataBar Omnidirectional (RSS-14)	<K482,status>
DataBar Limited (RSS Limited)	<K483,status>
DataBar Expanded (RSS Expanded)	<K484,status,fixed symbol length status,fixed symbol length>
MicroPDF417	<K485,status,raster sweep count,fixed symbol length status, fixed symbol length>
Symbol Reconstruction	<K496,symbol reconstruction redundancy,symbol reconstruction effort>

I/O Parameters

Calibration Options	<K521,raster framing,video,scan speed,laser power,laser framing, symbology>
Serial Verification	<K701,serial command echo status, serial command beep status, control/hex output>
Beeper	<K702,status>
Quality Output	<K704,quality output separator, decodes per trigger status, decode direction output>
Symbol Data Output	<K705,symbol data output status, when to output symbol data, symbology identifier status>
Read Duration Output	<K706,status,separator>
No Read Message	<K714,status,message>
Bad Symbol Message	<K715,status,message>
No Symbol Message	<K716,status,message>
Input 1	<K730,input mode,active state>
Green Flash LED	<K750,green flash mode,unused,green flash duration>
Status Indicators	<K751,status,bar graph,I/O 1,I/O 2>
Symbol Position Output	<K758,raster position output status,scan position output status, separator>
Database Identifier Output	<K759,status,separator character>
EZ Button	<K770,status,default on power-on>
EZ Button Modes	<K771,single beep,two beeps,three beeps,four beeps>
Auto Framing Options	<K773,laser framing>
Trend Analysis Output 1	<K780,trend analysis mode,number of triggers,number to output on,decodes per trigger>
Trend Analysis Output 2	<K781,trend analysis mode,number of triggers,number to output on,decodes per trigger>
Trend Analysis Output 3	<K782,trend analysis mode,number of triggers,number to output on,decodes per trigger>
Diagnostics Output 1	<K790,high temperature,service unit,unused,laser current high, laser current low,low temperature>
Diagnostics Output 2	<K791,high temperature,service unit,unused,laser current high, laser current low,low temperature>
Diagnostics Output 3	<K792,high temperature,service unit,unused,laser current high, laser current low,low temperature>
Output 1 Parameters	<K810,output on,output state,pulse width,output mode>

Output 2 Parameters	<K811,output on,output state,pulse width,output mode>
Output 3 Parameters	<K812,output on,output state,pulse width,output mode>
Matchcode	
Matchcode	<K223,matchcode type,sequential matching,match start position,match length,wild card,sequence on no read,sequence on mismatch>
Master Symbol Database Size	<K224,number of master symbols>
New Master Pin	<K225,status>
Sequence Step	<K228,sequence step>
Master Symbol	<K231,index,master symbol data>
Match Replace	<K735,status,replacement string>
Mismatch Replace	<K736,status,replacement string>
Diagnostics	
High Temperature Threshold	<K402,status,message>
Low Temperature Threshold	<K403,status,message>
Counts (Read-only)	<K406> (returns: power-on,resets, power-on saves,custom default saves)
Hours Since Reset (Read-only)	<K407> (returns: hours,minutes)
Service Message	<K409,status,service message, threshold,resolution>
Laser Current Warning Message	<K411,laser high status,laser high message,laser low status,laser low message>
User-Defined Name	<K412,user-defined name>
Output Format	
Format Extract	<K740,output index,start location,length>
Format Insert	<K741,output index,length,hex string>
Format Assign	<K742,symbol number,status>
Output Format Status	<K743,output format status>
Output Filter Configuration	<K744,filter number,symbology,length,wildcard,placeholder,data,decode direction,database index>
Output Filter Enable	<K745,number of filters>

Serial Command Format

Omron Microscan readers are controlled by two types of serial commands: configuration commands and utility commands.

Rules that apply to both configuration and utility commands

- Less than '**<**' and greater than '**>**' angle bracket characters enclose the commands.
- Commands and data are case sensitive. Characters must be entered as upper or lower case, as specified.

Serial Utility Commands

Serial Utility Commands are sent during operations and are not followed by **<A>** or **<Z>**.

Serial Configuration Commands (K Commands)

Omron Microscan's serial configuration commands begin with a single "K" character followed by a 3-digit numeric character, comma-separated command fields, and an initializing command, as follows:

<Knumeric character,data,data,...etc.><initializing command>

An initializing command **<Z>** or **<A>** may follow the command.

- **<Z>** initializes the scanner's memory and saves for power-on.
- **<A>** initializes the scanner's memory but does not save for power-on.

For example, to enable **UPC** and save the change for power-on, send **<K473,1><Z>**.

To change **Baud Rate** and reset without saving changes for power-on, send **<K100,3><A>**.

Serial Configuration Command Conventions

- All command fields (except the last) must be followed by a comma (without a space).
- NULL cannot be used. The characters **<**, **>**, and **,** can be used, but only if entered as hex pairs (see [ASCII Character Entry Modifier](#)).
- All fields preceding a modified field must be included.
- If there is no change in preceding fields, then commas alone can be entered in these fields. For example, if only the last field in the following command is changing, **<K100,4,1,0,0>** can be entered as **<K100,,,,0>**.
- All fields *following* a modified field can be omitted. For example, to change Baud Rate only, send **<K100,3>**.

Concatenating Configuration Commands

Commands can be concatenated (added together) in a single string. For example, **<K145,1><K220,1><K450,1><A>** enables **LRC**, sets **End of Read Cycle** mode to **New Trigger**, enables **Narrow Quiet Zone**, and resets the data buffers without saving the changes for power-on.

Serial Command Status Request

To ensure that any command was received and accepted, send the **Show Reader Status** command: **<?>**.

The status of a specific serial command can be requested by entering the command followed by a question mark. For example, send **<K142?>** to request the status of **Postamble**.

Entering Control Characters in Serial Commands

To enter control characters within a serial command, hold down the **Ctrl** key while typing the desired character.

Example: To enter a carriage return and line feed (**^M^J**), enter **<K141,1,CNTL-m CNTL-j>**

Serial Configuration Commands

The following serial commands can be entered through ESP's Terminal to control QX-870 functions. Detailed descriptions of command parameters are available in Chapter 5, [Scanner Parameters](#).

Communication

RS-232 A	<K100,baud rate,parity,stop bits,data bits>
RS-232 B	<K101,status,baud rate,parity,stop bits,data bits>
RS-422	<K102,status,baud rate,parity,stop bits,data bits>
Ethernet	<K126,status,IP address,subnet,gateway,IP address mode>
Ethernet TCP Ports	<K127,TCP Port 1,TCP Port 2>
EtherNet/IP	<K129,status>
RS-232 A Data Type	<K130,symbol data output,extra symbol information,diagnostic output,external source processing mode>
RS-232 B Data Type	<K131,symbol data output,extra symbol information,diagnostic output,external source processing mode>
RS-422 Data Type	<K132,symbol data output,extra symbol information,diagnostic output,external source processing mode>
Ethernet TCP Port 1 Data Type	<K133,symbol data output,extra symbol information,diagnostic output,external source processing mode>
Ethernet TCP Port 2 Data Type	<K134,symbol data output,extra symbol information,diagnostic output,external source processing mode>
EtherNet/IP Data Type	<K136,symbol data output,extra symbol information,diagnostic output,external source processing mode>
Preamble	<K141,status,preamble>
Postamble	<K142,status,postamble>
Response Timeout	<K143,response timeout>
LRC Status	<K145,status>
ACK/NAK Options	<K147,RES,REQ,STX,ETX,ACK,NAK>
Polling Mode Options	<K148,RES,REQ,STX,ETX,ACK,NAK>
Autoconfiguration Daisy Chain	<K150DAISY>
Protocol Selection	<K160,protocol,address,protocol port>
External Data Routing	<K161,mode,destination port,ambles to source,echo to source,output at end of read cycle,output at ETX,output at timeout>
Array Communication Modes	<K162,mode,source,daisy chain i.d. status,daisy chain i.d.>

RS-232 A

Baud Rate, RS-232 A

Serial Cmd: <K100,baud rate,parity,stop bits,data bits>

Default: **8 = 115.2K**

Options:	0 = 600	1 = 1200	2 = 2400
	3 = 4800	4 = 9600	5 = 19.2K
	6 = 38.4K	7 = 57.6K	8 = 115.2K
	9 = 230K		

Parity, RS-232 A

Serial Cmd: <**K100**,baud rate,**parity**,stop bits,data bits>

Default: **0 = None**

Options: **0 = None** 1 = Even 2 = Odd

Stop Bits, RS-232 A

Serial Cmd: <**K100**,baud rate,parity,**stop bits**,data bits>

Default: **0 = One**

Options: **0 = One** 1 = Two

Data Bits, RS-232 A

Serial Cmd: <**K100**,baud rate,parity,stop bits,**data bits**>

Default: **1 = Eight**

Options: 0 = Seven **1 = Eight**

RS-232 B

Status, RS-232 B

Serial Cmd: <**K101**,**status**,baud rate,parity,stop bits,data bits>

Default: **1 = Enabled**

Options: 0 = Disabled **1 = Enabled**

Baud Rate, RS-232 B

Serial Cmd: <**K101**,**status**,**baud rate**,parity,stop bits,data bits>

Default: **8 = 115.2K**

Options: 0 = 600 1 = 1200 2 = 2400
 3 = 4800 4 = 9600 5 = 19.2K
 6 = 38.4K 7 = 57.6K **8 = 115.2K**
 9 = 230K

Parity, RS-232 B

Serial Cmd: <**K101**,**status**,baud rate,**parity**,stop bits,data bits>

Default: **0 = None**

Options: **0 = None** 1 = Even 2 = Odd

Stop Bits, RS-232 B

Serial Cmd: <**K101**,**status**,baud rate,parity,**stop bits**,data bits>

Default: **0 = One**

Options: **0 = One** 1 = Two

Serial Commands

Data Bits, RS-232 B

Serial Cmd: <**K101**,status,baud rate,parity,stop bits,**data bits**>

Default: **1 = Eight**

Options: 0 = Seven **1 = Eight**

RS-422

Status, RS-422

Serial Cmd: <**K102**,status,baud rate,parity,stop bits,data bits>

Default: **0 = Disabled**

Options: **0 = Disabled** 1 = Enabled

Baud Rate, RS-422

Serial Cmd: <**K102**,status,**baud rate**,parity,stop bits,data bits>

Default: **8 = 115.2K**

Options: 0 = 600 1 = 1200 2 = 2400
3 = 4800 4 = 9600 5 = 19.2K
6 = 38.4K 7 = 57.6K **8 = 115.2K**
9 = 230K

Parity, RS-422

Serial Cmd: <**K102**,status,baud rate,**parity**,stop bits,data bits>

Default: **0 = None**

Options: **0 = None** 1 = Even 2 = Odd

Stop Bits, RS-422

Serial Cmd: <**K102**,status,baud rate,parity,**stop bits**,data bits>

Default: **0 = One**

Options: **0 = One** 1 = Two

Data Bits, RS-422

Serial Cmd: <**K102**,status,baud rate,parity,stop bits,**data bits**>

Default: **1 = Eight**

Options: 0 = Seven **1 = Eight**

Ethernet

Serial Cmd: <**K126**,status,IP address,subnet,gateway,IP address mode>

Default: **1 = Enabled**

Options: 0 = Disabled **1 = Enabled**

IP Address

Serial Cmd: <**K126**,status,**IP address**,subnet,gateway,IP address mode>

Default: **192.168.0.100**

Options: 0.0.0.0 – 255.255.255.255

Subnet

Serial Cmd: <**K126**,status,IP address,**subnet**,gateway,IP address mode>

Default: **255.255.0.0**

Options: 0.0.0.0 – 255.255.255.255

Gateway

Serial Cmd: <**K126**,status,IP address,subnet,**gateway**,IP address mode>

Default: **0.0.0.0**

Options: 0.0.0.0 – 255.255.255.255

IP Address Mode

Serial Cmd: <**K126**,status,IP address,subnet,gateway,**IP address mode**>

Default: **1 = DHCP**

Options: 0 = Static **1 = DHCP**

Ethernet TCP Ports**TCP Port 1**

Serial Cmd: <**K127**,**TCP Port 1**,TCP Port 2>

Default: **2001**

Options: 1024 – 65535

TCP Port 1

Serial Cmd: <**K127**,TCP Port 1,**TCP Port 2**>

Default: **2003**

Options: 1024 – 65535

EtherNet/IP

Serial Cmd: <**K129**,status>

Default: **1 = Enabled**

Options: 0 = Disabled **1 = Enabled**

RS-232 A Data Type**Symbol Data Output, RS-232 A**

Serial Cmd: <**K130**,**symbol data output**,extra symbol information,diagnostic output,external source processing mode>

Default: **1 = Enabled**

Options: 0 = Disabled **1 = Enabled**

Serial Commands

Extra Symbol Information, RS-232 A

Serial Cmd: <**K130**,symbol data output,**extra symbol information**,diagnostic output,external source processing mode>

Default: **1 = Enabled**

Options: 0 = Disabled **1 = Enabled**

Diagnostic Output, RS-232 A

Serial Cmd: <**K130**,symbol data output,extra symbol information,**diagnostic output**,external source processing mode>

Default: **1 = Enabled**

Options: 0 = Disabled **1 = Enabled**

External Source Processing Mode, RS-232 A

Serial Cmd: <**K130**,symbol data output,extra symbol information,diagnostic output,**external source processing mode**>

Default: **1 = Command**

Options: 0 = Disabled **1 = Command** 2 = Data

RS-232 B Data Type

Symbol Data Output, RS-232 B

Serial Cmd: <**K131**,**symbol data output**,extra symbol information,diagnostic output,external source processing mode>

Default: **1 = Enabled**

Options: 0 = Disabled **1 = Enabled**

Extra Symbol Information, RS-232 B

Serial Cmd: <**K131**,symbol data output,**extra symbol information**,diagnostic output,external source processing mode>

Default: **1 = Enabled**

Options: 0 = Disabled **1 = Enabled**

Diagnostic Output, RS-232 B

Serial Cmd: <**K131**,symbol data output,extra symbol information,**diagnostic output**,external source processing mode>

Default: **1 = Enabled**

Options: 0 = Disabled **1 = Enabled**

External Source Processing Mode, RS-232 B

Serial Cmd: <**K131**,symbol data output,extra symbol information,diagnostic output,**external source processing mode**>

Default: **1 = Command**

Options: 0 = Disabled **1 = Command** 2 = Data

RS-422 Data Type

Symbol Data Output, RS-422

Serial Cmd: <**K132**,*symbol data output*,extra symbol information,diagnostic output,
external source processing mode>

Default: **1 = Enabled**

Options: 0 = Disabled **1 = Enabled**

Extra Symbol Information, RS-422

Serial Cmd: <**K132**,symbol data output,**extra symbol information**,diagnostic output,
external source processing mode>

Default: **1 = Enabled**

Options: 0 = Disabled **1 = Enabled**

Diagnostic Output, RS-422

Serial Cmd: <**K132**,symbol data output,extra symbol information,**diagnostic output**,
external source processing mode>

Default: **1 = Enabled**

Options: 0 = Disabled **1 = Enabled**

External Source Processing Mode, RS-422

Serial Cmd: <**K132**,symbol data output,extra symbol information,diagnostic output,
external source processing mode>

Default: **1 = Command**

Options: 0 = Disabled **1 = Command** 2 = Data

Ethernet TCP Port 1 Data Type

Symbol Data Output, Ethernet TCP Port 1

Serial Cmd: <**K133**,*symbol data output*,*extra symbol information*,*diagnostic output*,*external source processing mode*>

Default: **1 = Enabled**

Options: 0 = Disabled **1 = Enabled**

Extra Symbol Information, Ethernet TCP Port 1

Serial Cmd: <**K133**,*symbol data output*,***extra symbol information***,*diagnostic output*,*external source processing mode*>

Default: **1 = Enabled**

Options: 0 = Disabled **1 = Enabled**

Diagnostic Output, Ethernet TCP Port 1

Serial Cmd: <**K133**,*symbol data output*,*extra symbol information*,***diagnostic output***,*external source processing mode*>

Default: **1 = Enabled**

Options: 0 = Disabled **1 = Enabled**

External Source Processing Mode, Ethernet TCP Port 1

Serial Cmd: <**K133**,*symbol data output*,*extra symbol information*,*diagnostic output*,***external source processing mode***>

Default: **1 = Command**

Options: 0 = Disabled **1 = Command** 2 = Data

Ethernet TCP Port 2 Data Type

Symbol Data Output, Ethernet TCP Port 2

Serial Cmd: <**K134**,*symbol data output*,*extra symbol information*,*diagnostic output*,*external source processing mode*>

Default: **1 = Enabled**

Options: 0 = Disabled **1 = Enabled**

Extra Symbol Information, Ethernet TCP Port 2

Serial Cmd: <**K134**,*symbol data output*,***extra symbol information***,*diagnostic output*,*external source processing mode*>

Default: **1 = Enabled**

Options: 0 = Disabled **1 = Enabled**

Diagnostic Output, Ethernet TCP Port 2

Serial Cmd: <**K134**,symbol data output,extra symbol information,**diagnostic output**,external source processing mode>

Default: **1 = Enabled**

Options: 0 = Disabled **1 = Enabled**

External Source Processing Mode, Ethernet TCP Port 2

Serial Cmd: <**K134**,symbol data output,extra symbol information,diagnostic output,**external source processing mode**>

Default: **1 = Command**

Options: 0 = Disabled **1 = Command** 2 = Data

EtherNet/IP Data Type**Symbol Data Output, EtherNet/IP**

Serial Cmd: <**K136**,symbol data output,extra symbol information,diagnostic output,external source processing mode>

Default: **1 = Enabled**

Options: 0 = Disabled **1 = Enabled**

Extra Symbol Information, EtherNet/IP

Serial Cmd: <**K136**,symbol data output,**extra symbol information**,diagnostic output,external source processing mode>

Default: **1 = Enabled**

Options: 0 = Disabled **1 = Enabled**

Diagnostic Output, EtherNet/IP

Serial Cmd: <**K136**,symbol data output,extra symbol information,**diagnostic output**,external source processing mode>

Default: **1 = Enabled**

Options: 0 = Disabled **1 = Enabled**

External Source Processing Mode, EtherNet/IP

Serial Cmd: <**K136**,symbol data output,extra symbol information,diagnostic output,**external source processing mode**>

Default: **1 = Command**

Options: 0 = Disabled **1 = Command** 2 = Data

Preamble**Preamble Status**

Serial Cmd: <**K141**,**status**,preamble character(s)>

Default: **0 = Disabled**

Options: **0 = Disabled** 1 = Enabled

Serial Commands

Preamble Characters

Serial Cmd: <K141,status,preamble character(s)>

Default: **CR (0x0D)**

Options: 1 – 4 ASCII characters

Postamble

Postamble Status

Serial Cmd: <K142,status,postamble character(s)>

Default: **1 = Enabled**

Options: 0 = Disabled **1 = Enabled**

Postamble Characters

Serial Cmd: <K142,status,postamble character(s)>

Default: **CR LF (0x0D 0x0A)**

Options: 1 – 4 ASCII characters

Response Timeout

Serial Cmd: <K143,response timeout>

Default: **5 (x10 ms = 50)**

Options: 0 to 255 (x10 ms)

LRC Status

Serial Cmd: <K145,status>

Default: **0 = Disabled**

Options: **0 = Disabled** 1 = Enabled

ACK/NAK Options

Serial Cmd: <K147,RES,REQ,STX,ETX,ACK,NAK>

RES-NAK Defaults

RES: (Reset) 00 (disabled)

REQ: (Request) 00 (disabled)

STX: (Start of Text) 00 (disabled)

ETX: (End of Text) 00 (disabled)

ACK: (Acknowledge) 06

NAK: (Negative Acknowledge) 15

Polling Mode Options

Serial Cmd: **<K148,RES,REQ,STX,ETX,ACK,NAK>**

RES-NAK Defaults

RES: (Reset)	04
REQ: (Request)	05
STX: (Start of Text)	02
ETX: (End of Text)	03
ACK: (Acknowledge)	06
NAK: (Negative Acknowledge)	15

Autoconfiguration Daisy Chain

Serial Cmd: **<K150DAISY>**

ASCII Character Entry Modifier

Commands that require ASCII text fields, such as **Preamble** and **Postamble** commands, can be sent to the scanner as hex pairs (see Appendix E, **ASCII Table**, for conversions).

Serial Cmd Format: **<Knnnh,00-FF>**

To enter ASCII fields as hex values (00 to FF), add a lower-case **h** directly after the command's **K** number, and then enter the hex value that corresponds with the desired ASCII character.

Example:

Serial Cmd: **<K142,status,postamble character(s)>**

The ASCII characters **<**, **>**, and **,** can only be entered as hex pairs. So, to make **>** the postamble in the symbol decode output, enter the **Postamble** command as follows:

<K142h,,3E>

Note that the "status" field contains only a **,**. This is because the only field that is being changed is the "postamble character(s)" field. (See **Serial Configuration Command Conventions** for a more detailed explanation of this command shortcut.)

Protocol Selection

Protocol

Serial Cmd: **<K160,protocol,address,protocol port>**

Options:

0	= Point-to-Point
1	= Point-to-Point with RTS/CTS
2	= Point-to-Point with XON/XOFF
3	= Point-to-Point with RTS/CTS and XON/XOFF
4	= ACK/NAK
5	= Polling Mode

Serial Commands

Address

Serial Cmd: <**K160**,*protocol*,**address**,*protocol port*>

Default: **1**

Options: 1 – 50

1 = Poll address 0x1C, select address 0x1D

2 = Poll address 0x1E, select address 0x1F

...

50 = Poll address 0x7E, select address 0x7F

Protocol Port

Serial Cmd: <**K160**,*protocol*,*address*,**protocol port**>

Default: **0**

Options: 0 – 1

0 = Main RS-232 on QX-870 Connector A

1 = RS-422/485 on QX-870 Connector B

External Data Routing

Mode

Serial Cmd: <**K161**,**mode**,*destination port*,*ambles to source*,*echo to source*,*output at end of read cycle*,*output at ETX*,*output at timeout*>

Default: **0 = Disabled**

Options: **0 = Disabled**

1 = Transparent

2 = Half Duplex

3 = Full Duplex

4 = Customized

Destination Port

Serial Cmd: <**K161**,*mode*,**destination port**,*ambles to source*,*echo to source*,*output at end of read cycle*,*output at ETX*,*output at timeout*>

Default: **0 = RS-232 on QX-870 Connector A**

Options: **0 = RS-232 on QX-870 Connector A**

1 = RS-232 on QX-870 Connector B

2 = RS-422 on QX-870 Connector B

4 = Ethernet TCP Port 1

5 = Ethernet TCP Port 2

6 = EtherNet/IP

Ambles to Source

Serial Cmd: <**K161**,mode,destination port,**ambles to source**,echo to source,output at end of read cycle,output at ETX,output at timeout>

Default: **0 = Disabled**

Options: **0 = Disabled** 1 = Enabled

Echo to Source

Serial Cmd: <**K161**,mode,destination port,ambles to source,**echo to source**,output at end of read cycle,output at ETX,output at timeout>

Default: **0 = Disabled**

Options: **0 = Disabled** 1 = Enabled

Output at End of Read Cycle

Serial Cmd: <**K161**,mode,destination port,ambles to source,echo to source,**output at end of read cycle**,output at ETX,output at timeout>

Default: **0 = Disabled**

Options: **0 = Disabled** 1 = Enabled

Output at ETX

Serial Cmd: <**K161**,mode,destination port,ambles to source,echo to source,output at end of read cycle,**output at ETX**,output at timeout>

Default: **CR (0x0D)**

Options: Any 7-bit ASCII character

Output at Timeout

Serial Cmd: <**K161**,mode,destination port,ambles to source,echo to source,output at end of read cycle,output at ETX,**output at timeout**>

Default: **200 (x10 ms = 2 seconds)**

Options: 0 – 65535

Array Communication Modes**Mode**

Serial Cmd: <**K162**,mode,source,daisy chain i.d. status,daisy chain i.d.>

Default: **0 = Disabled**

Options: **0 = Disabled** 1 = Daisy Chain

Serial Commands

Source

Serial Cmd: <K162,mode,source,daisy chain i.d. status,daisy chain i.d.>

Default: **1 = RS-232 on QX-870 Connector B**

Options: 0 = RS-232 on QX-870 Connector A

1 = RS-232 on QX-870 Connector B

2 = RS-422 on QX-870 Connector B

4 = Ethernet TCP Port 1

5 = Ethernet TCP Port 2

Daisy Chain ID Status

Serial Cmd: <K162,mode,source,daisy chain i.d. status,daisy chain i.d.>

Default: **0 = Disabled**

Options: **0 = Disabled** 1 = Enabled

Daisy Chain ID

Serial Cmd: <K162,mode,source,daisy chain i.d. status,daisy chain i.d.>

Default: **1/**

Options: One or two ASCII characters.

Read Cycle

Trigger Mode / Trigger Filter Duration	< K200 ,trigger mode,leading edge trigger filter duration,trailing edge trigger filter duration>
Serial Trigger Character	< K201 ,serial trigger character>
External Trigger State	< K202 ,external trigger state>
End of Read Cycle	< K220 ,mode,read cycle timeout>
Decodes Before Output	< K221 ,mode,number before output>
Multisymbol	< K222 ,number of symbols,multisymbol separator>
Serial Trigger Start Character	< K229 ,start character>
Serial Trigger Stop Character	< K230 ,stop character>
Processing Timeout	< K245 ,processing timeout>
Scan Speed	< K500 ,scan speed>
Maximum Element	< K502 ,maximum element>
Automatic Gain Control	< K504 ,gain level,AGC sampling mode,AGC minimum,AGC maximum>
Symbol Detect Status / Transition Counter	< K505 ,symbol detect status,transition counter>
Raster Framing	< K506 ,status,top offset,bottom offset,sweep rate,read cycle on/off>
Scan Width Enhance	< K511 ,status>
AGC Tracking	< K520 ,tracking>
Laser Setup	< K700 ,laser on/off,laser framing status,laser on position,laser off position,laser power>

Trigger Mode / Filter Duration

Trigger Mode

Serial Cmd: <**K200**,trigger mode,leading edge trigger filter,trailing edge trigger filter>

Default: **0** = Continuous Read

Options: **0** = Continuous Read

1 = Continuous Read 1 Output

2 = External Level

3 = External Edge

4 = Serial Data

5 = Serial Data and Edge

Leading Edge Trigger Filter

Serial Cmd: <**K200**,trigger mode,leading edge trigger filter,trailing edge trigger filter>

Default: **313** (~10 ms)

Options: 1 to 65535 (x 32.0 μ s)

Trailing Edge Trigger Filter

Serial Cmd: <**K200**,trigger mode,leading edge trigger filter,trailing edge trigger filter>

Default: **313** (~10 ms)

Options: 1 to 65535 (x 32.0 μ s)

Serial Trigger Character (Delimited)

Serial Cmd: <K201,serial trigger character>

Default: **Space (0x20)**

Options: Any 7-bit ASCII character

External Trigger State

Serial Cmd: <K202,active state>

Default: **1 = Positive**

Options: 0 = Negative **1 = Positive**

End of Read Cycle

End of Read Cycle Mode

Serial Cmd: <K220,end of read cycle,read cycle timeout>

Default: **0 = Timeout**

Options: **0 = Timeout**

1 = New Trigger

2 = Timeout or New Trigger

3 = Last Frame

4 = Last Frame or New Trigger

Read Cycle Timeout

Serial Cmd: <K220,end of read cycle,read cycle timeout>

Default: **100 (x10 ms = 1 second)**

Options: 1 to 65535

Decodes Before Output

Decodes Before Output

Serial Cmd: <K221,decodes before output,mode>

Default: **1**

Options: 1 to 255

Mode

Serial Cmd: <K221,decodes before output,mode>

Default: **0 = Non-Consecutive**

Options: **0 = Non-Consecutive** 1 = Consecutive

Multisymbol

Number of Symbols

Serial Cmd: <K222,number of symbols,multisymbol separator>

Default: **1**

Options: 1 to 100

Multisymbol Separator

Serial Cmd: <**K222**,number of symbols,**multisymbol separator**>

Default: **, (comma)**

Options: Any 7-bit ASCII character

Start Trigger Start Character (Non-Delimited)

Serial Cmd: <**K229**,**start character**>

Default: **NULL (0x00)**

Options: Two hex digits representing any ASCII character except <, >, **XON**, and **XOFF**.

Stop Trigger Stop Character (Non-Delimited)

Serial Cmd: <**K230**,**stop character**>

Default: **NULL (0x00)**

Options: Two hex digits representing any ASCII character except <, >, **XON**, and **XOFF**.

Processing Timeout

Serial Cmd: <**K245**,**processing timeout**>

Default: **200 (0.2 seconds)**

Options: 1 to 65535

Scan Speed

Serial Cmd: <**K500**,**scan speed**>

Default: **30 (300 scans per second)**

Options: 30 to 140 (x10 scans per second)

Maximum Element

Serial Cmd: <**K502**,**maximum element**>

Default: **400 (x 0.01% of scan)**

Options: 50 to 5000

Automatic Gain Control**AGC Level**

Serial Cmd: <**K504**,**AGC level**,AGC mode,**minimum gain**,**maximum gain**>

Default: **40 (QX-870 model-dependent – see Omron Microscan Product Pricing**

Options: **Catalog)** 0 to 255

AGC Mode

Serial Cmd: <**K504**,AGC level,**AGC mode**,**minimum gain**,**maximum gain**>

Default: **2 = Continuous**

Options: 0 = Disabled 1 = Leading Edge **2 = Continuous**

Serial Commands

Minimum Gain

Serial Cmd: <**K504**,AGC level,AGC mode,**minimum gain**,maximum gain>

Default: **0** (QX-870 model-dependent – see Omron Microscan Product Pricing Catalog)

Options: 0 to 255

Maximum Gain

Serial Cmd: <**K504**,AGC level,AGC mode,**minimum gain**,**maximum gain**>

Default: **255** (QX-870 model-dependent – see Omron Microscan Product Pricing Catalog)

Options: 0 to 255

Symbol Detect Status / Transition Counter

Symbol Detect Status

Serial Cmd: <**K505**,**symbol detect status**,transition counter>

Default: **0 = Disabled**

Options: **0 = Disabled** 1 = Enabled

Transition Counter

Serial Cmd: <**K505**,**symbol detect status**,**transition counter**>

Default: **14**

Options: 1 to 255

Raster Framing

Raster Framing Status

Serial Cmd: <**K506**,**status**,top offset,bottom offset,sweep rate,read cycle on/off>

Default: **1 = Enabled**

Options: 0 = Disabled **1 = Enabled**

Top Offset

Serial Cmd: <**K506**,**status**,**top offset**,bottom offset,sweep rate,read cycle on/off>

Default: **88**

Options: 0 - 255

Bottom Offset

Serial Cmd: <**K506**,**status**,top offset,**bottom offset**,sweep rate,read cycle on/off>

Default: **167**

Options: 0 - 255

Sweep Rate

Serial Cmd: <**K506**,**status**,top offset,bottom offset,**sweep rate**,read cycle on/off>

Default: **10**

Options: 0 - 80

Read Cycle On/Off

Serial Cmd: <**K506**,status,top offset,bottom offset,sweep rate,**read cycle on/off**>

Default: **0 = Disabled**

Options: **0 = Disabled** 1 = Enabled

Scan Width Enhance

Serial Cmd: <**K511**,status>

Default: **0 = Disabled**

Options: **0 = Disabled** 1 = Enabled

AGC Tracking

Serial Cmd: <**K520**,tracking value>

Default: **40 (QX-870 model-dependent – see Omron Microscan Product Pricing**

Options: **Catalog) 5 to 127**

Laser Setup**Laser On/Off Status**

Serial Cmd: <**K700**,laser on/off status,laser framing status,laser on position,laser off position,laser power>

Default: **0 = Disabled**

Options: **0 = Disabled** 1 = Enabled

Laser Framing Status

Serial Cmd: <**K700**,laser on/off status,**laser framing status**,laser on position,laser off position,laser power>

Default: **0 = Disabled**

Options: **0 = Disabled** 1 = Enabled

Laser On Position

Serial Cmd: <**K700**,laser on/off status,laser framing status,**laser on position**,laser off position,laser power>

Default: **10**

Options: 10 to 90

Laser Off Position

Serial Cmd: <**K700**,laser on/off status,laser framing status,laser on position,**laser off position**,laser power>

Default: **95**

Options: 15 to 95

Serial Commands

Laser Power

Serial Cmd: <**K700**,laser on/off status,laser framing status,laser on position,laser off position,**laser power**>

Default: **1 = Medium**

Options: 0 = Low **1 = Medium** 2 = High

Configuration Database

Number of Active Indexes	< K252 , <i>number of active indexes,number of database cycles</i> >
Configuration Database	< K253 , <i>index,gain,AGC mode,tracking,raster top,raster bottom,raster speed,framing status,laser on position,laser off position,laser power,background color</i> >
Switch Timing	< K254 , <i>switch mode,frame count/time</i> >

Number of Active Indexes

Number of Active Indexes

Serial Cmd: <**K252**,*number of active indexes,number of database cycles*>

Default: **0 (Disabled)**

Options: 0 to 10

Number of Database Cycles

Serial Cmd: <**K252**,*number of active indexes,number of database cycles*>

Default: **0 (Disabled)**

Options: 0 to 255

Configuration Database

Index

Serial Cmd: <**K253**,*index,gain,AGC mode,tracking,raster top,raster bottom,raster speed,framing status,laser on position,laser off position,laser power,background color*>

Options: 1 to 10 (database index number)

Gain

Serial Cmd: <**K253**,*index,gain,AGC mode,tracking,raster top,raster bottom,raster speed,framing status,laser on position,laser off position,laser power,background color*>

Default: **40**

Options: 0 to 255

AGC Mode

Serial Cmd: <**K253**,*index,gain,AGC mode,tracking,raster top,raster bottom,raster speed,framing status,laser on position,laser off position,laser power,background color*>

Default: **2 = Continuous**

Options: 0 = Disabled 1 = Leading Edge **2 = Continuous**

Serial Commands

Tracking

Serial Cmd: <**K253**,index,gain,AGC mode,**tracking**,raster top,raster bottom,raster speed,framing status, laser on position,laser off position,laser power, background color>

Default: **40**

Options: 5 to 127

Raster Top

Serial Cmd: <**K253**,index,gain,AGC mode,tracking,**raster top**,raster bottom,raster speed,framing status, laser on position,laser off position,laser power, background color>

Default: **88**

Options: 0 to 255

Raster Bottom

Serial Cmd: <**K253**,index,gain,AGC mode,tracking,raster top,**raster bottom**,raster speed,framing status, laser on position,laser off position,laser power, background color>

Default: **167**

Options: 0 to 255

Raster Speed

Serial Cmd: <**K253**,index,gain,AGC mode,tracking,raster top,raster bottom,**raster speed**,framing status, laser on position,laser off position,laser power, background color>

Default: **10**

Options: 0 to 80

Framing Status

Serial Cmd: <**K253**,index,gain,AGC mode,tracking,raster top,raster bottom,raster speed,**framing status**, laser on position,laser off position,laser power,background color>

Default: **0 = Disabled**

Options: **0 = Disabled** 1 = Enabled

Laser On Position

Serial Cmd: <**K253**,index,gain,AGC mode,tracking,raster top,raster bottom,raster speed,framing status, **laser on position**,laser off position,laser power, background color>

Default: **10**

Options: 10 to 90

Laser Off Position

Serial Cmd: <**K253**,index,gain,AGC mode,tracking,raster top,raster bottom,raster speed,framing status, laser on position,**laser off position**,laser power,background color>

Default: **95**

Options: 15 to 95

Laser Power

Serial Cmd: <**K253**,index,gain,AGC mode,tracking,raster top,raster bottom,raster speed,,framing status, laser on position,laser off position,**laser power**,background color>

Default: **1 = Medium**

Options: 0 = Low **1 = Medium** 2 = High

Background Color

Serial Cmd: <**K253**,index,gain,AGC mode,tracking,raster top,raster bottom,raster speed,framing status, laser on position,laser off position,laser power,**background color**>

Default: **0 = White**

Options: **0 = White** 1 = Black

Switch Timing**Switch Mode**

Serial Cmd: <**K254**,**switch mode**,frame count/time>

Default: **0 = Time**

Options: **0 = Time**
1 = Number of raster sweeps

Frame Count/Time

Serial Cmd: <**K254**,switch mode,**frame count/time**>

Default: **10 (100 ms)**

Options: 1 to 65535 (in 10 ms increments)

Serial Commands

Symbologies

Quiet Zone	< K450 ,quiet zone status>
Background Color	< K451 ,background color>
Symbol Ratios	< K452 ,Code 39,Codabar,Interleaved 2 of 5>
Composite	< K453 ,symbology status,separator status,separator>
AIAG	< K454 ,status,ID1,status1,ID2,status2,ID3,status3,ID4,status4,ID5a,ID5b,ID5c,status5,ID6,status6,ID7,status7,ID8,status8,ID9,status9,ID10,status10,ID11,status11,ID12,status12>
Depth of Field Enhance	< K456 ,DOF Enhance mode>
Code 39	< K470 ,status,check character status,check character output status,large intercharacter gap,fixed symbol length status,fixed symbol length,full ASCII set>
Codabar	< K471 ,status,start/stop match status,start/stop output status,large intercharacter gap,fixed symbol length status,fixed symbol length,check character type,check character output status>
Interleaved 2 of 5	< K472 ,status,check character status,check character output status,symbol length 1,symbol length 2,guard bar,range mode status>
UPC/EAN	< K473 ,mode,EAN status,supplementals status,separator status,separator character,supplementals type,UPC-E as UPC-A>
Code 128 / EAN 128	< K474 ,status,fixed symbol length status,fixed symbol length,EAN status,output format,application record separator status,application record separator character,application record brackets,application record padding,separation factor>
Code 93	< K475 ,mode,fixed symbol length status,symbol length>
PDF417	< K476 ,status,raster sweep count,fixed symbol length status,fixed symbol length,unused,codeword collection>
Pharmacode	< K477 ,status,fixed bar count status,fixed bar count,minimum bar count,bar width mode,direction,fixed threshold value>
DataBar Omnidirectional (RSS-14)	< K482 ,status>
DataBar Limited (RSS Limited)	< K483 ,status>
DataBar Expanded (RSS Expanded)	< K484 ,status,fixed symbol length status,fixed symbol length>
MicroPDF417	< K485 ,status,raster sweep count,fixed symbol length status,fixed symbol length>
Symbol Reconstruction	< K496 ,symbol reconstruction redundancy,symbol reconstruction effort>

Quiet Zone

Serial Cmd: <**K450**,quiet zone status>

Default: **3 = Narrow, Enhanced**

Options: 0 = Standard

1 = Narrow

2 = Standard, Enhanced

3 = Narrow, Enhanced

Background Color

Serial Cmd: <**K451,background color**>

Default: **0 = White**

Options: 1 = Black

Symbol Ratios

Code 39

Serial Cmd: <**K452,Code 39,Codabar,Interleaved 2 of 5**>

Default: **1 = Standard**

Options: 0 = Tight

1 = Standard

2 = Aggressive

Codabar

Serial Cmd: <**K452,Code 39,Codabar,Interleaved 2 of 5**>

Default: **1 = Standard**

Options: 0 = Tight

1 = Standard

2 = Aggressive

Interleaved 2 of 5

Serial Cmd: <**K452,Code 39,Codabar,Interleaved 2 of 5**>

Default: **1 = Standard**

Options: 0 = Tight

1 = Standard

2 = Aggressive

Composite

Symbology Status (Composite)

Serial Cmd: <**K453,symbology status,separator status,separator**>

Default: **0 = Disabled**

Options: **0 = Disabled** 1 = Enabled 2 = Required

Separator Status (Composite)

Serial Cmd: <**K453,symbology status,separator status,separator**>

Default: **0 = Disabled**

Options: **0 = Disabled** 1 = Enabled

Serial Commands

Separator (Composite)

Serial Cmd: <**K453**,*symbology status,separator status,separator*>

Default: **, (comma)**

Options: Any 7-bit ASCII character

AIAG

Serial Cmd: <**K454**,*status,ID1,status1,ID2,status2,ID3,status3,ID4,status4,ID5a,ID5b,ID5c,status5,ID6,status6,ID7,status7,ID8,status8,ID9,status9,ID10,status10,ID11,status11,ID12,status12*>

Default: **0 = Disabled**

Options: **0 = Disabled** 1 = Enabled

Depth of Field Enhance

Serial Cmd: <**K456**,*mode*>

Default: **2 = Medium**

Options: 0 = Disabled

1 = Low

2 = Medium

3 = High

Code 39

Serial Cmd: <**K470**,*status,check character status,check character output status,large intercharacter gap,fixed symbol length status,fixed symbol length,full ASCII set*>

Default: **1 = Enabled**

Options: 0 = Disabled **1 = Enabled**

Check Character Status (Code 39)

Serial Cmd: <**K470**,*status,check character status,check character output status,large intercharacter gap,fixed symbol length status,fixed symbol length,full ASCII set*>

Default: **0 = Disabled**

Options: **0 = Disabled** 1 = Enabled

Check Character Output Status (Code 39)

Serial Cmd: <**K470**,*status,check character status,check character output status,large intercharacter gap,fixed symbol length status,fixed symbol length,full ASCII set*>

Default: **0 = Disabled**

Options: **0 = Disabled** 1 = Enabled

Large Intercharacter Gap (Code 39)

Serial Cmd: <**K470**,status,check character status,check character output status,**large intercharacter gap**,fixed symbol length status,fixed symbol length,full ASCII set>

Default: **0 = Disabled**

Options: **0 = Disabled** 1 = Enabled

Fixed Symbol Length Status (Code 39)

Serial Cmd: <**K470**,status,check character status,check character output status,large intercharacter gap,**fixed symbol length status**,fixed symbol length,full ASCII set>

Default: **0 = Disabled**

Options: **0 = Disabled** 1 = Enabled

Fixed Symbol Length (Code 39)

Serial Cmd: <**K470**,status,check character status,check character output status,large intercharacter gap,fixed symbol length status,**fixed symbol length**,full ASCII set>

Default: **10**

Options: 1 to 128

Full ASCII Set (Code 39)

Serial Cmd: <**K470**,status,check character status,check character output status,large intercharacter gap,fixed symbol length status,fixed symbol length,**full ASCII set**>

Default: **0 = Disabled**

Options: **0 = Disabled** 1 = Enabled

Codabar

Serial Cmd: <**K471**,status,start/stop match,start/stop output,large intercharacter gap,fixed symbol length status,symbol length,check character type,check character output>

Default: **0 = Disabled**

Options: **0 = Disabled** 1 = Enabled

Start/Stop Match (Codabar)

Serial Cmd: <**K471**,status,**start/stop match**,start/stop output,large intercharacter gap,fixed symbol length status,symbol length,check character type,check character output>

Default: **1 = Enabled**

Options: 0 = Disabled **1 = Enabled**

Serial Commands

Start/Stop Output (Codabar)

Serial Cmd: <**K471**,status,start/stop match,**start/stop output**,large intercharacter gap,fixed symbol length status,symbol length,check character type,check character output>

Default: **1 = Enabled**

Options: 0 = Disabled **1 = Enabled**

Large Intercharacter Gap (Codabar)

Serial Cmd: <**K471**,status,start/stop match,start/stop output,**large intercharacter gap**,fixed symbol length status,symbol length,check character type,check character output>

Default: **0 = Disabled**

Options: **0 = Disabled** 1 = Enabled

Fixed Symbol Length Status (Codabar)

Serial Cmd: <**K471**,status,start/stop match,start/stop output,large intercharacter gap,**fixed symbol length status**,symbol length,check character type,check character output>

Default: **0 = Disabled**

Options: **0 = Disabled** 1 = Enabled

Symbol Length (Codabar)

Serial Cmd: <**K471**,status,start/stop match,start/stop output,large intercharacter gap,fixed symbol length status,**symbol length**,check character type,check character output>

Default: **10**

Options: 1 to 128

Check Character Type (Codabar)

Serial Cmd: <**K471**,status,start/stop match,start/stop output,large intercharacter gap,fixed symbol length status,symbol length,**check character type**,check character output>

Default: **0 = Disabled**

Options: **0 = Disabled**

1 = Mod 16

2 = NW7 (Mod 11)

3 = Both Mod 16 and NW7 (Mod 11)

Check Character Output (Codabar)

Serial Cmd: <**K471**,status,start/stop match,start/stop output,large intercharacter gap,fixed symbol length status,symbol length,check character type,**check character output**>

Default: **0 = Disabled**

Options: **0 = Disabled** 1 = Enabled

Interleaved 2 of 5

Serial Cmd: <**K472**,status,check character status,check character output status,symbol length #1,symbol length #2,guard bar status,range mode status>

Default: **1 = Enabled**

Options: 0 = Disabled **1 = Enabled**

Check Character Status (Interleaved 2 of 5)

Serial Cmd: <**K472**,status,**check character status**,check character output status,symbol length #1,symbol length #2,guard bar status,range mode status>

Default: **0 = Disabled**

Options: **0 = Disabled** 1 = Enabled

Check Character Output Status (Interleaved 2 of 5)

Serial Cmd: <**K472**,status,check character status,**check character output status**,symbol length #1,symbol length #2,guard bar status,range mode status>

Default: **0 = Disabled**

Options: **0 = Disabled** 1 = Enabled

Symbol Length #1 (Interleaved 2 of 5)

Serial Cmd: <**K472**,status,check character status,check character output,**symbol length #1**,symbol length #2,guard bar status,range mode status>

Default: **16**

Options: 0 to 128

Symbol Length #2 (Interleaved 2 of 5)

Serial Cmd: <**K472**,status,check character status,check character output,symbol length #1,**symbol length #2**,guard bar status,range mode status>

Default: **6**

Options: 0 to 128

Serial Commands

Guard Bar Status (Interleaved 2 of 5)

Serial Cmd: <K472,status,check character status,check character output,symbol length #1,symbol length #2,**guard bar status**,range mode status>

Default: **0 = Disabled**

Options: **0 = Disabled** 1 = Enabled

Range Mode Status (Interleaved 2 of 5)

Serial Cmd: <K472,status,check character status,check character output,symbol length #1,symbol length #2,guard bar status,**range mode status**>

Default: **1 = Enabled**

Options: 0 = Disabled **1 = Enabled**

UPC/EAN

Serial Cmd: <K473,**UPC status**,EAN status,supplementals status,separator status,separator character,supplemental type,format UPC-E as UPC-A>

Default: **3 = Both Standard and Edge-to-Edge**

Options: 0 = Disabled

1 = Standard

2 = Edge-to-Edge

3 = Both Standard and Edge-to-Edge

EAN Status

Serial Cmd: <K473,UPC status,**EAN status**,supplementals status,separator status,separator character,supplemental type,format UPC-E as UPC-A>

Default: **1 = Enabled**

Options: 0 = Disabled **1 = Enabled**

Supplementals Status (UPC/EAN)

Serial Cmd: <K473,UPC status,EAN status,**supplementals status**,separator status,separator character,supplemental type,format UPC-E as UPC-A>

Default: **0 = Disabled**

Options: **0 = Disabled** 1 = Enabled 2 = Required

Separator Status (UPC/EAN)

Serial Cmd: <K473,UPC status,EAN status,supplementals status,**separator status**,separator character,supplemental type,format UPC-E as UPC-A>

Default: **0 = Disabled**

Options: **0 = Disabled** 1 = Enabled

Separator Character (UPC/EAN)

Serial Cmd: <**K473**,UPC status,EAN status,supplementals status,separator status,
separator character,supplemental type,format UPC-E as UPC-A>

Default: , (comma)

Options: Any 7-bit ASCII character

Supplemental Type (UPC/EAN)

Serial Cmd: <**K473**,UPC status,EAN status,supplementals status,separator status,
separator character,**supplemental type**,format UPC-E as UPC-A>

Default: **0 = Both**

Options: **0 = Both** 1 = 2 characters only 2 = 5 characters only

Format UPC-E as UPC-A (UPC/EAN)

Serial Cmd: <**K473**,UPC status,EAN status,supplementals status,separator status,
separator character,supplemental type,**format UPC-E as UPC-A**>

Default: **0 = Disabled**

Options: **0 = Disabled** 1 = Enabled

Code 128/EAN 128

Serial Cmd: <**K474,status**,fixed symbol length status,fixed symbol length,EAN 128 status,
output format,application record separator status,application record separator
character,application record brackets,application record padding,separation
factor>

Default: **3 = Both Standard and Edge-to-Edge**

Options: 0 = Disabled

1 = Standard

2 = Edge-to-Edge

3 = Both Standard and Edge-to-Edge

Fixed Symbol Length Status (Code 128/EAN 128)

Serial Cmd: <**K474,status**,**fixed symbol length status**,fixed symbol length,EAN 128 status,
output format,application record separator status,application record separator
character,application record brackets,application record padding,separation
factor>

Default: **0 = Disabled**

Options: **0 = Disabled** 1 = Enabled

Fixed Symbol Length (Code 128/EAN 128)

Serial Cmd: <**K474,status**,fixed symbol length status,**fixed symbol length**,EAN 128
status,output format,application record separator status,application record
separator character,application record brackets,application record padding,
separation factor>

Default: **10**

Options: 1 to 128

Serial Commands

EAN 128 Status (Code 128/EAN 128)

Serial Cmd: <**K474**,status,fixed symbol length status,fixed symbol length,**EAN 128 status**,output format,application record separator status,application record separator character,application record brackets,application record padding,separation factor>

Default: **1 = Enabled**

Options: 0 = Disabled **1 = Enabled** 2 = Required

Output Format (Code 128/EAN 128)

Serial Cmd: <**K474**,status,fixed symbol length status,fixed symbol length,EAN 128 status,**output format**,application record separator status,application record separator character,application record brackets,application record padding,separation factor>

Default: **0 = Standard**

Options: **0 = Standard** 1 = Application

Application Record Separator Status (Code 128/EAN 128)

Serial Cmd: <**K474**,status,fixed symbol length status,fixed symbol length,EAN 128 status,output format,**application record separator status**,application record separator character,application record brackets,application record padding,separation factor>

Default: **0 = Disabled**

Options: **0 = Disabled** 1 = Enabled

Application Record Separator Character (Code 128/EAN 128)

Serial Cmd: <**K474**,status,fixed symbol length status,fixed symbol length,EAN 128 status,output format,application record separator status,**application record separator character**,application record brackets,application record padding,separation factor>

Default: **, (comma)**

Options: Any 7-bit ASCII character

Application Record Brackets (Code 128/EAN 128)

Serial Cmd: <**K474**,status,fixed symbol length status,fixed symbol length,EAN 128 status,output format,application record separator status,application record separator character,**application record brackets**,application record padding,separation factor>

Default: **0 = Disabled**

Options: **0 = Disabled** 1 = Enabled

Application Record Padding (Code 128/EAN 128)

Serial Cmd: <**K474**,*status, fixed symbol length status, fixed symbol length, EAN 128 status, output format, application record separator status, application record separator character, application record brackets,***application record padding**,*separation factor*>

Default: **0 = Disabled**

Options: **0 = Disabled** 1 = Enabled

Separation Factor

Serial Cmd: <**K474**,*status, fixed symbol length status, fixed symbol length, EAN 128 status, output format, application record separator status, application record separator character, application record brackets, application record padding, separation factor*>

Default: **0 = Normal**

Options: **0 = Normal**

1 = High

2 = Highest

Code 93

Serial Cmd: <**K475**,*status, fixed symbol length status, symbol length*>

Default: **3 = Both Standard and Edge-to-Edge**

Options: 0 = Disabled

1 = Standard

2 = Edge-to-Edge

3 = Both Standard and Edge-to-Edge

Fixed Symbol Length Status (Code 93)

Serial Cmd: <**K475**,*status, fixed symbol length status, symbol length*>

Default: **0 = Disabled**

Options: **0 = Disabled** 1 = Enabled

Symbol Length (Code 93)

Serial Cmd: <**K475**,*status, fixed symbol length status, symbol length*>

Default: **10**

Options: 1 to 128

PDF417

Serial Cmd: <**K476**,*status, raster sweep count, fixed symbol length status, fixed symbol length, unused, decode at end of read cycle*>

Default: **0 = Disabled**

Options: **0 = Disabled** 1 = Enabled

Serial Commands

Raster Sweep Count

Serial Cmd: <**K476**,status,**raster sweep count**,fixed symbol length status,fixed symbol length,unused,decode at end of read cycle>

Default: **65535**

Options: 1 to 65535

Fixed Symbol Length Status (PDF417)

Serial Cmd: <**K476**,status,raster sweep count,**fixed symbol length status**,fixed symbol length,unused,decode at end of read cycle>

Default: **0 = Disabled**

Options: **0 = Disabled** 1 = Enabled

Fixed Symbol Length (PDF417)

Serial Cmd: <**K476**,status,raster sweep count,fixed symbol length status,**fixed symbol length**,unused,decode at end of read cycle>

Default: **10**

Options: 1 to 2710

Decode at End of Read Cycle (PDF417)

Serial Cmd: <**K476**,status,raster sweep count,fixed symbol length status,fixed symbol length,unused,**decode at end of read cycle**>

Default: **0 = Disabled**

Options: **0 = Disabled** 1 = Enabled

Pharmacode

Serial Cmd: <**K477**,status,fixed symbol length status,fixed symbol length,minimum bars,bar width status,direction,fixed threshold value>

Default: **0 = Disabled**

Options: **0 = Disabled** 1 = Enabled

Fixed Symbol Length Status (Pharmacode)

Serial Cmd: <**K477**,status,**fixed symbol length status**,fixed symbol length,minimum bars,bar width status,direction,fixed threshold value>

Default: **0 = Disabled**

Options: **0 = Disabled** 1 = Enabled

Fixed Symbol Length (Pharmacode)

Serial Cmd: <**K477**,status,fixed symbol length status,**fixed symbol length**,minimum bars,bar width status,direction,fixed threshold value>

Default: **10**

Options: 1 to 16

Minimum Bars (Pharmacode)

Serial Cmd: <**K477**,*status, fixed symbol length status, fixed symbol length,* **minimum bars**,*bar width status, direction, fixed threshold value*>

Default: **4**

Options: 1 to 16

Bar Width Status (Pharmacode)

Serial Cmd: <**K477**,*status, fixed symbol length status, fixed symbol length,* minimum bars,**bar width status**,*direction, fixed threshold value*>

Default: **0 = Mixed**

Options: **0 = Mixed**

1 = All Narrow

2 = All Wide

3 = Fixed Threshold

Direction (Pharmacode)

Serial Cmd: <**K477**,*status, fixed symbol length status, fixed symbol length,* minimum bars,*bar width status,* **direction**,*fixed threshold value*>

Default: **0 = Forward**

Options: **0 = Forward** 1 = Reverse

Fixed Threshold Value (Pharmacode)

Serial Cmd: <**K477**,*status, fixed symbol length status, fixed symbol length,* minimum bars,*bar width status, direction,* **fixed threshold value**>

Default: **400**

Options: 1 to 65535

GS1 DataBar (RSS)

DataBar Omnidirectional (RSS-14)

Serial Cmd: <**K482,status**>

Default: **0 = Disabled**

Options: **0 = Disabled** 1 = Enabled

DataBar Limited (RSS Limited)

Serial Cmd: <**K483,status**>

Default: **0 = Disabled**

Options: **0 = Disabled** 1 = Enabled

DataBar Expanded (RSS Expanded)

Serial Cmd: <**K484,status,fixed symbol length status,fixed symbol length**>

Default: **0 = Disabled**

Options: **0 = Disabled** 1 = Enabled

Fixed Symbol Length Status (DataBar Expanded)

Serial Cmd: <**K484,status,fixed symbol length status,fixed symbol length**>

Default: **0 = Disabled**

Options: **0 = Disabled** 1 = Enabled

Fixed Symbol Length (DataBar Expanded)

Serial Cmd: <**K484,status,fixed symbol length status,fixed symbol length**>

Default: **14**

Options: 1 to 74

MicroPDF417

Serial Cmd: <**K485,status,raster sweep count,fixed symbol length status,fixed symbol length**>

Default: **0 = Disabled**

Options: **0 = Disabled** 1 = Enabled

Raster Sweep Count (MicroPDF417)

Serial Cmd: <**K485,status,raster sweep count,fixed symbol length status,fixed symbol length**>

Default: **65535**

Options: 1 to 65535

Fixed Symbol Length Status (MicroPDF417)

Serial Cmd: <**K485,status,raster sweep count,fixed symbol length status,fixed symbol length**>

Default: **0 = Disabled**

Options: **0 = Disabled** 1 = Enabled

Fixed Symbol Length (MicroPDF417)

Serial Cmd: <**K485,status,raster sweep count,fixed symbol length status,fixed symbol length**>

Default: **10**

Options: 1 to 366

Symbol Reconstruction

Symbol Reconstruction Redundancy

Serial Cmd: <**K496**,*symbol reconstruction redundancy*,*symbol reconstruction effort*>

Default: **0 = Disabled**

Options: **0 = Disabled**

1 = Low

2 = Medium

3 = High

Symbol Reconstruction Effort

Serial Cmd: <**K496**,*symbol reconstruction redundancy*,***symbol reconstruction effort***>

Default: **0 = Minimum**

Options: **0 = Minimum**

1 = Moderate

2 = Maximum

I/O Parameters

Calibration Options	<K521,raster framing,video,scan speed,laser power,laser framing,symbology>
Serial Verification	<K701,serial command echo status, serial command beep status, control/hex output>
Beeper	<K702,status>
Quality Output	<K704,quality output separator, decodes per trigger status, decode direction output>
Symbol Data Output	<K705,symbol data output status, when to output symbol data, symbology i.d. output status>
Read Duration Output	<K706,status,separator>
No Read Message	<K714,status,message>
Bad Symbol Message	<K715,status,message>
No Symbol Message	<K716,status,message>
Input 1	<K730,input mode,active state>
Green Flash LED	<K750,green flash mode,unused,green flash duration>
Status Indicators	<K751,status,bar graph,I/O 1,I/O 2>
Symbol Position Output	<K758,raster position output status,scan position output status, separator>
Database Identifier Output	<K759,status,separator character>
EZ Button	<K770,status,default on power-on>
EZ Button Modes	<K771,single beep,two beeps,three beeps,four beeps>
Auto Framing Options	<K773,laser framing>
Trend Analysis Output 1	<K780,trend analysis mode,number of triggers,number to output on,decodes per trigger>
Trend Analysis Output 2	<K781,trend analysis mode,number of triggers,number to output on,decodes per trigger>
Trend Analysis Output 3	<K782,trend analysis mode,number of triggers,number to output on,decodes per trigger>
Diagnostics Output 1	<K790,high temperature,service unit,unused,laser current high, laser current low,low temperature>
Diagnostics Output 2	<K791,high temperature,service unit,unused,laser current high, laser current low,low temperature>
Diagnostics Output 3	<K792,high temperature,service unit,unused,laser current high, laser current low,low temperature>
Output 1 Parameters	<K810,output on,output state,pulse width,output mode>
Output 2 Parameters	<K811,output on,output state,pulse width,output mode>
Output 3 Parameters	<K812,output on,output state,pulse width,output mode>

Calibration Options

Raster Framing

Serial Cmd: <K521,raster framing,video,scan speed,laser power,laser framing,symbology>

Default: **1 = Raster Frame**

Options: 0 = As-Is **1 = Raster Frame** 2 = Raster Search
 2 = Raster Straight Line

Serial Commands

Video

Serial Cmd: <**K521**,*raster framing*,**video**,*scan speed*,*laser power*,*laser framing*,*symbology*>

Default: **1 = Calibrate**

Options: 0 = Don't Calibrate **1 = Calibrate**

Scan Speed

Serial Cmd: <**K521**,*raster framing*,*video*,**scan speed**,*laser power*,*laser framing*,*symbology*>

Default: **1 = Calibrate**

Options: 0 = Don't Calibrate **1 = Calibrate**

Laser Power

Serial Cmd: <**K521**,*raster framing*,*video*,*scan speed*,**laser power**,*laser framing*,*symbology*>

Default: **1 = Calibrate**

Options: 0 = Don't Calibrate **1 = Calibrate**

Laser Framing

Serial Cmd: <**K521**,*raster framing*,*video*,*scan speed*,*laser power*,**laser framing**,*symbology*>

Default: **0 = Don't Calibrate**

Options: **0 = Don't Calibrate** 1 = Calibrate

Symbology

Serial Cmd: <**K521**,*raster framing*,*video*,*scan speed*,*laser power*,*laser framing*,**symbology**>

Default: **1 = Calibrate**

Options: 0 = Don't Calibrate **1 = Calibrate**

Serial Verification

Serial Command Echo Status

Serial Cmd: <**K701**,**serial command echo status**,*serial command beep status*,*control/hex output*>

Default: **0 = Disabled**

Options: **0 = Disabled** 1 = Enabled

Serial Command Beep Status

Serial Cmd: <**K701**,*serial command echo status*,**serial command beep status**,*control/hex output*>

Default: **0 = Disabled**

Options: **0 = Disabled** 1 = Enabled

Control/Hex Output

Serial Cmd: <**K701**,*serial command echo status,serial command beep status,control/hex output*>

Default: **0 = Control**

Options: **0 = Control** 1 = Hex

Beeper

Serial Cmd: <**K702**,*beeper status*>

Default: **1 = Good Read**

Options: 0 = Disabled **1 = Good Read** 2 = No Read

Quality Output**Separator**

Serial Cmd: <**K704**,*separator,decodes per trigger status*>

Default: **, (comma)**

Options: Any 7-bit ASCII character

Decodes per Trigger Status

Serial Cmd: <**K704**,*separator,decodes per trigger status*>

Default: **0 = Disabled**

Options: **0 = Disabled** 1 = Enabled

Symbol Data Output**Symbol Data Output Status**

Serial Cmd: <**K705**,*symbol data output status,when to output,symbology i.d. output status*>

Default: **3 = Good Read**

Options: 0 = Disabled 1 = Match 2 = Mismatch
3 = Good Read

When to Output Symbol Data

Serial Cmd: <**K705**,*symbol data output status,when to output,symbology i.d. output status*>

Default: **0 = As Soon As Possible**

Options: **0 = ASAP** 1 = End of Read Cycle

Symbology ID Output Status

Serial Cmd: <**K705**,*symbol data output status,when to output,symbology i.d. output status*>

Default: **0 = Disabled**

Options: **0 = Disabled** 1 = Enabled (AIM-Defined ID) 2 = Readable ID

Read Duration Output

Read Duration Output Mode

Serial Cmd: <**K706,status,separator**>

Default: **0 = Disabled**

Options: **0 = Disabled** 1 = Enabled

Read Duration Output Separator

Serial Cmd: <**K706,status,separator**>

Default: **Space (0x20)**

Options: Any 7-bit ASCII character

No Read Message

No Read Message Status

Serial Cmd: <**K714,No Read message status,No Read message**>

Default: **1 = Enabled**

Options: 0 = Disabled **1 = Enabled**

No Read Message

Serial Cmd: <**K714,no read message status,No Read message**>

Default: **NOREAD**

Options: Any valid ASCII string up to 128 characters

Bad Symbol Message

Bad Symbol Message Status

Serial Cmd: <**K715,bad symbol message status,message**>

Default: **0 = Disabled**

Options: **0 = Disabled** 1 = Enabled

Bad Symbol Message

Serial Cmd: <**K715,bad symbol message status,message**>

Default: **BAD_SYMBOL**

Options: Any valid ASCII string up to 128 characters

No Symbol Message

No Symbol Message Status

Serial Cmd: <**K716,no symbol message status,message**>

Default: **0 = Disabled**

Options: **0 = Disabled** 1 = Enabled

No Symbol Message

Serial Cmd: <**K716**,no symbol message status,**message**>

Default: **NO_SYMBOL**

Options: Any valid ASCII string up to 128 characters

Input 1

Serial Cmd: <**K730**,**status**,active state>

Default: **0 = Disabled**

Options: **0 = Disabled**
 1 = Reset Counts
 2 = Unlatch Output

Active State

Serial Cmd: <**K730**,**status**,active state>

Default: **0 = Active Open**

Options: **0 = Active Open** 1 = Active Closed

Green Flash LED**Green Flash Mode**

Serial Cmd: <**K750**,green flash mode,unused,green flash duration>

Default: **1 = Good Read**

Options: 0 = Disabled
1 = Good Read
 2 = Static Presentation
 3 = Match
 4 = Mismatch
 5 = Strobe

Green Flash Duration

Serial Cmd: <**K750**,green flash mode,unused,green flash duration>

Default: **100 (1 second)**

Options: 0 to 65535 (in 10 ms increments)

Status Indicators

Serial Cmd: <**K751**,**status**,bar graph,I/O 1,I/O 2>

Default: **1 = PHY Activity**

Options: 0 = Disabled
1 = PHY Activity
 2 = Protocol Activity

Serial Commands

Bar Graph

Serial Cmd: <**K751**,*status,bar graph*,I/O 1,I/O 2>

Default: **1 = Read Rate / Good Read**

Options: 0 = Disabled

1 = Read Rate / Good Read

I/O 1

Serial Cmd: <**K751**,*status,bar graph,I/O 1,I/O 2*>

Default: **1 = Output Active**

Options: 0 = Disabled

1 = Output Active

2 = Input Active

I/O 2

Serial Cmd: <**K751**,*status,bar graph,I/O 1,I/O 2*>

Default: **2 = Input Active**

Options: 0 = Disabled

1 = Output Active

2 = Input Active

Symbol Position Output

Raster Position Output Status

Serial Cmd: <**K758**,*raster position output status,scan position output status,separator*>

Default: **0 = Disabled**

Options: **0 = Disabled** 1 = Enabled

Scan Position Output Status

Serial Cmd: <**K758**,*raster position output status,scan position output status,separator*>

Default: **0 = Disabled**

Options: **0 = Disabled** 1 = Enabled

Separator

Serial Cmd: <**K758**,*raster position output status,scan position output status,separator*>

Default: **Space (0x20)**

Options: Any 7-bit ASCII character

Database Identifier Output

Serial Cmd: <**K759**,*status*,separator>

Default: **0 = Disabled**

Options: **0 = Disabled** 1 = Enabled

Separator

Serial Cmd: <**K759**,*status*,*separator*>

Default: **Space (0x20)**

Options: Any 7-bit ASCII character

EZ Button

Global Status

Serial Cmd: <**K770**,*global status*,*default on power-on*>

Default: **1 = Enabled**

Options: 0 = Disabled
1 = Enabled
 2 = Trigger
 3 = Unlatch Outputs
 4 = Parameter Switch

Default on Power-On

Serial Cmd: <**K770**,*global status*,*default on power-on*>

Default: **1 = Enabled**

Options: 0 = Disabled **1 = Enabled**

EZ Button Modes

Serial Cmd: <**K771**,*single beep*,*two beeps*,*three beeps*,*four beeps*>

Options: 0 = Disabled 1 = Enabled

Single Beep	Two Beeps	Three Beeps	Four Beeps
0 = Disabled	0 = Disabled	0 = Disabled	0 = Disabled
1 = Read Rate	1 = Read Rate	1 = Read Rate	1 = Read Rate
2 = Auto Calibration	2 = Auto Calibration	2 = Auto Calibration	2 = Auto Calibration
3 = Save for Power-On	3 = Save for Power-On	3 = Save for Power-On	3 = Save for Power-On
4 = Auto Framing	4 = Auto Framing	4 = Auto Framing	4 = Auto Framing
5 = Load New Master	5 = Load New Master	5 = Load New Master	5 = Load New Master
6 = Sleep Mode	6 = Sleep Mode	6 = Sleep Mode	6 = Sleep Mode
7 = Unused	7 = Unused	7 = Unused	7 = Unused
8 = Unused	8 = Unused	8 = Unused	8 = Unused
9 = Bar Code Config.	9 = Bar Code Config.	9 = Bar Code Config.	9 = Bar Code Config.

Auto Framing Options

Laser Status

Serial Cmd: <K773,unused,laser status>

Default: 1 = Enabled

Options: 0 = Disabled 1 = Enabled

Trend Analysis Output 1

Trend Analysis Mode

Serial Cmd: <K780,trend analysis mode,trigger evaluation period,number to output on,decodes per trigger threshold>

Default: 1 = No Read

Options: 0 = Mismatch
1 = No Read
2 = Decodes per Trigger
3 = Bad Symbol
4 = No Symbol

Trigger Evaluation Period

Serial Cmd: <K780,trend analysis mode,trigger evaluation period,number to output on,decodes per trigger threshold>

Default: 0

Options: 0 to 255

Number to Output On

Serial Cmd: <K780,trend analysis mode,trigger evaluation period,number to output on,decodes per trigger threshold>

Default: 0

Options: 0 to 255

Decodes per Trigger Threshold

Serial Cmd: <K780,trend analysis mode,trigger evaluation period,number to output on,decodes per trigger threshold>

Default: 0

Options: 0 to 65535

Trend Analysis Output 2

Serial Cmd: <K781,trend analysis mode,trigger evaluation period,number to output on>

Trend Analysis Output 3

Serial Cmd: <K782,trend analysis mode,trigger evaluation period,number to output on>

Diagnostics Output 1

High Temperature

Serial Cmd: <K790,high temperature,service unit,unused,laser current high,laser current low,low temperature>

Default: 0 = Disabled

Options: 0 = Disabled 1 = Enabled

Service Unit

Serial Cmd: <K790,high temperature,service unit,unused,laser current high,laser current low,low temperature>

Default: 0 = Disabled

Options: 0 = Disabled 1 = Enabled

Laser Current High

Serial Cmd: <K790,high temperature,service unit,unused,laser current high,laser current low,low temperature>

Default: 0 = Disabled

Options: 0 = Disabled 1 = Enabled

Laser Current Low

Serial Cmd: <K790,high temperature,service unit,unused,laser current high,laser current low,low temperature>

Default: 0 = Disabled

Options: 0 = Disabled 1 = Enabled

Low Temperature

Serial Cmd: <K790,high temperature,service unit,unused,laser current high,laser current low,low temperature>

Default: 0 = Disabled

Options: 0 = Disabled 1 = Enabled

Diagnostics Output 2

Serial Cmd: <K791,high temperature,service unit,unused,laser current high,laser current low,low temperature>

Diagnostics Output 3

Serial Cmd: <K792,high temperature,service unit,unused,laser current high,laser current low,low temperature>

Output 1 Parameters

Output On

Serial Cmd: <**K810,output on,output state,pulse width,output mode**>

Default: **Mismatch or No Read**

Options: **0 = Mismatch or No Read**

1 = Match or Good Read

2 = Mismatch

3 = No Read

4 = Trend Analysis

5 = Validation

6 = Diagnostic Warning

7 = In Read Cycle

8 = Read Cycle Data Valid

Output State

Serial Cmd: <**K810,output on,output state,pulse width,output mode**>

Default: **0 = Normally Open**

Options: **0 = Normally Open** 1 = Normally Closed

Pulse Width

Serial Cmd: <**K810,output on,output state,pulse width,output mode**>

Default: **50 (50 ms)**

Options: 1 to 65535 (in 1 ms increments)

Output Mode

Serial Cmd: <**K810,output on,output state,pulse width,output mode**>

Default: **0 = Pulse**

Options: **0 = Pulse**

1 = Latch Mode 1 (Unlatch Input 1 Pin)

2 = Latch Mode 2 (Unlatch Opposite Condition)

3 = Latch Mode 3 (Unlatch Re-Enter Read Cycle)

Output 2 Parameters

Serial Cmd: <**K811,output on,output state,pulse width,output mode**>

Configurable Output 3

Serial Cmd: <**K812,output on,output state,pulse width,output mode**>

Matchcode

Matchcode	< K223 ,matchcode type,sequential matching,match start position,match length,wild card,sequence on no read,sequence on mismatch>
Master Symbol Database Size	< K224 ,number of master symbols>
New Master Pin	< K225 ,status>
Sequence Step	< K228 ,sequence step>
Master Symbol	< K231 ,index,master symbol data>
Match Replace	< K735 ,status,replacement string>
Mismatch Replace	< K736 ,status,replacement string>

Matchcode

Matchcode Type

Serial Cmd: <**K223**,**matchcode type**,sequential matching,match start position,match length,wild card character,sequence on No Read,sequence on mismatch>

Default: **0 = Disabled**

Options: **0 = Disabled**
 1 = Enabled
 2 = Wild Card
 3 = Sequential

Sequential Matching

Serial Cmd: <**K223**,matchcode type,**sequential matching**,match start position,match length,wild card character,sequence on No Read,sequence on mismatch>

Default: **0 = Increment**

Options: **0 = Increment** 1 = Decrement

Match Start Position

Serial Cmd: <**K223**,matchcode type,sequential matching,**match start position**,match length,wild card character,sequence on No Read,sequence on mismatch>

Default: **0**

Options: 0 to 3000

Match Length

Serial Cmd: <**K223**,matchcode type,sequential matching,match start position,**match length**,wild card character,sequence on No Read,sequence on mismatch>

Default: **1**

Options: 1 to 3000

Serial Commands

Wild Card Character

Serial Cmd: <**K223**,*matchcode type,sequential matching,match start position,match length,wild card character,sequence on No Read,sequence on mismatch*>

Default: * (asterisk)

Options: Any 7-bit ASCII character

Sequence on No Read

Serial Cmd: <**K223**,*matchcode type,sequential matching,match start position,match length,wild card character,sequence on No Read,sequence on mismatch*>

Default: **1 = Enabled**

Options: 0 = Disabled **1 = Enabled**

Sequence on Mismatch

Serial Cmd: <**K223**,*matchcode type,sequential matching,match start position,match length,wild card character,sequence on No Read,sequence on mismatch*>

Default: **0 = Disabled**

Options: **0 = Disabled** 1 = Enabled

Master Symbol Database Size

Serial Cmd: <**K224**,*number of master symbols*>

Default: **1**

Options: 1 to 10

New Master Pin

Serial Cmd: <**K225**,*status*>

Default: **0 = Disabled**

Options: **0 = Disabled** 1 = Enabled

Sequence Step

Serial Cmd: <**K228**,*sequence step*>

Default: **1**

Options: 1 to 32768

Master Symbol

Index

Serial Cmd: <**K231**,*index,master symbol data*>

Options: 1 to 32768

Master Symbol Data

Serial Cmd: <**K231**,*index,master symbol data*>

Options: Any valid ASCII string

Match Replace

Serial Cmd: <**K735**,*status*,*replacement string*>

Default: **0 = Disabled**

Options: **0 = Disabled** 1 = Enabled

Replacement String

Serial Cmd: <**K735**,*status*,***replacement string***>

Default: **MATCH**

Options: Any valid ASCII string up to 128 characters

Mismatch Replace

Serial Cmd: <**K736**,*status*,*replacement string*>

Default: **0 = Disabled**

Options: **0 = Disabled** 1 = Enabled

Replacement String

Serial Cmd: <**K736**,*status*,***replacement string***>

Default: **MISMATCH**

Options: Any valid ASCII string up to 128 characters

Diagnostics

High Temperature Threshold	< K402 , <i>status,message</i> >
Low Temperature Threshold	< K403 , <i>status,message</i> >
Counts (Read-only)	< K406 > (returns: <i>power-on,resets, power-on saves,custom default saves</i>)
Hours Since Reset (Read-only)	< K407 > (returns: <i>hours,minutes</i>)
Service Message	< K409 , <i>status,service message, threshold,resolution</i> >
Laser Current Warning Message	< K411 , <i>laser high status,laser high message,laser low status, laser low message</i> >
User-Defined Name	< K412 , <i>user-defined name</i> >

High Temperature Threshold

Serial Cmd: <**K402**,*status,message*>

Default: **0 = Disabled**

Options: **0 = Disabled** 1 = Enabled

Message

Serial Cmd: <**K402**,*status,message*>

Default: **HIGH_TEMP**

Options: Any valid ASCII string up to 128 characters

Low Temperature Threshold

Serial Cmd: <**K403**,*status,message*>

Default: **0 = Disabled**

Options: **0 = Disabled** 1 = Enabled

Message

Serial Cmd: <**K403**,*status,message*>

Default: **LOW_TEMP**

Options: Any valid ASCII string up to 128 characters

Counts (Read-only)

Power-On

Serial Cmd: <**K406**,*power-on,resets,power-on saves,power-on flash saves*>
16-bit counter that increments on scanner power-on.

Resets

Serial Cmd: <**K406**,*power-on,resets,power-on saves,power-on flash saves*>
16-bit counter that increments on scanner reset. Value is reset on power-on.

Power-On Saves

Serial Cmd: <**K406**,power-on,resets,**power-on saves**,power-on flash saves>

16-bit counter that increments when a scanner setting is saved for power-on (<**Z**> command).

Custom Default Saves

Serial Cmd: <**K406**,power-on,resets,power-on saves,**power-on flash saves**>

16-bit counter that increments when a scanner setting is saved to the customer parameter section of flash memory (<**Zc**> command).

Hours Since Reset (Read-only)**Hours**

Serial Cmd: <**K407**,hours,minutes>

16-bit counter (0 to 65535)

Minutes

Serial Cmd: <**K407**,hours,minutes>

16-bit counter (0 to 60)

Service Message

Serial Cmd: <**K409**,status,service message,threshold,resolution>

Default: **0 = Disabled**

Options: **0 = Disabled** 1 = Enabled

Service Message

Serial Cmd: <**K409**,status,**service message**,threshold,resolution>

Default: **SERVICE**

Options: Any valid ASCII string up to 128 characters

Threshold

Serial Cmd: <**K409**,status,service message,**threshold**,resolution>

Default: **300 (5 minutes)**

Options: 1 to 65535

Resolution

Serial Cmd: <**K409**,status,service message,threshold,**resolution**>

Default: **0 = Seconds**

Options: **0 = Seconds** 1 = Minutes

Laser Current Warning Message

High Current Status

Serial Cmd: <**K411**,*high current status*,*high current message*,*low current status*,*low current message*>

Default: **0 = Disabled**

Options: **0 = Disabled** 1 = Message

High Current Message

Serial Cmd: <**K411**,*high current status*,**high current message**,*low current status*,*low current message*>

Default: **HIGH_LASER**

Options: Any valid ASCII string up to 128 characters

Low Current Status

Serial Cmd: <**K411**,*high current status*,*high current message*,**low current status**,*low current message*>

Default: **0 = Disabled**

Options: **0 = Disabled** 1 = Message

Low Current Message

Serial Cmd: <**K411**,*high current status*,*high current message*,*low current status*,**low current message**>

Default: **LOW_LASER**

Options: Any valid ASCII string up to 128 characters

User-Defined Name

Serial Cmd: <**K412**,*user-defined name*>

Default: **QX-870**

Options: Any valid ASCII string up to 50 characters

Output Format

Format Extract	< K740 ,output index,start location,length>
Format Insert	< K741 ,output index,length,hex string>
Format Assign	< K742 ,symbol number,status>
Output Format Status	< K743 ,output format status>
Output Filter Configuration	< K744 ,filter number,symbology,length,wildcard,placeholder,data,decode direction,database index>
Output Filter Enable	< K745 ,number of filters>

Format Extract

Output Index

Serial Cmd: <**K740**,output index,start location,length>

Options: 1 to 100

Start Location

Serial Cmd: <**K740**,output index,**start location**,length>

Default: **0**

Options: 1 to *n* (maximum number of characters in the symbol data).

Length

Serial Cmd: <**K740**,output index,start location,**length**>

Default: **0 (Disabled; end of format cell array)**

Options: 1 to *n* (maximum number of characters in the symbol data).

Format Insert

Output Index

Output Index refers to the database entry to be modified with this command. A formatted output is built by extracting data from a symbol's original data output and/or inserting user-defined characters.

It may be helpful to think of individual indexes as positions in the final formatted output. Starting with index # 1, enter either an extract or insert command to begin building the required output string. Then, with the next index number, enter either an extract or insert command to continue building the output string. Continue this process until the string is complete.

Serial Cmd: <**K741**,output index,length,hex string>

Options: 1 to 100

Serial Commands

Length

Specifies the length of the user-defined character string that will be inserted. This function is limited to 4 characters per output index, so multiple indexes must be entered in order to insert longer character sequences.

For example, to insert a 10-character sequence in user-defined output, three commands with consecutive index numbers would be required, where the first two character sequence lengths were 4 and the third was 2.

Serial Cmd: <**K741**,output index,**length**,hex string>

Default: **0 (Disabled; end of format cell array)**

Options: 1 to 4

Hex String

Specifies a character string that represents ASCII characters to be inserted in the database entry. Two hex characters are required for every ASCII character to be inserted in the user-defined output string. These two characters comprise the hex (base 16) value of the ASCII character.

For example, to enter the three-character sequence "Hi!", **3** would indicate the length of the string, and a hex sequence of **486921** would be the ASCII sequence to be inserted. (48 = H; 69 = i; 21 = !)

Important: Each pair of hex characters represents one ASCII character. Hex character pairs range from 00 to FF. Since there is a limit of 4 ASCII characters per insertion per database entry, there is a limit of 8 hex characters per insertion per database entry.

Serial Cmd: <**K741**,output index,**length**,**hex string**>

Default: **NULL (0x00)**

Options: 00 to FF (As many as 4 bytes, or hex pairs.)

Format Assign

Symbol Number

Serial Cmd: <**K742**,**symbol number**,**status**>

Options: 1 to 10

1 = Formatted output status for symbol # 1.

2 = Formatted output status for symbol # 2.

...

...

10 = Formatted output status for symbol # 10.

Status

Serial Cmd: <**K742**,**symbol number**,**status**>

Default: **0 = Disabled**

Options: **0 = Disabled**

1 = Enabled (Assign parameters to specified symbol.)

Output Format Status

Serial Cmd: <**K743**, **output format status**>

Default: **0 = Disabled**

Options: **0 = Disabled**

1 = Enabled

Output Filter Configuration

Filter Number

Serial Cmd: <**K744**, **filter number**, *symbology type*, *length*, *wildcard*, *placeholder*, *data*, *decode direction*, *database index*>

Options: 1 to 10

Symbology Type

Serial Cmd: <**K744**, *filter number*, **symbology type**, *length*, *wildcard*, *placeholder*, *data*, *decode direction*, *database index*>

Default: **0**

Options: 0 = Any type

1 = Interleaved 2 of 5

2 = Code 39

3 = Code 128

4 = Codabar

5 = UPC

6 = PDF417

7 = EAN 128

8 = Code 93

9 = Pharmacode

10 = GS1 DataBar (RSS)

11 = MicroPDF417

12 = Composite

Length

Serial Cmd: <**K744**, *filter number*, *symbology type*, **length**, *wildcard*, *placeholder*, *data*, *decode direction*, *database index*>

Default: **0**

Options: 0 to 128

Wildcard

Serial Cmd: <**K744**, *filter number*, *symbology type*, *length*, **wildcard**, *placeholder*, *data*, *decode direction*, *database index*>

Default: *** = (0x2A)**

Options: Any ASCII input in the form of a pair of hex characters

Serial Commands

Placeholder

Serial Cmd: <**K744**, filter number, symbology type, length, wildcard, **placeholder**, data, decode direction, database index>

Default: **? = (0x3F)**

Options: Any ASCII input in the form of a pair of hex characters

Data

Serial Cmd: <**K744**, filter number, symbology type, length, wildcard, placeholder, **data**, decode direction, database index>

Default: **NULL (0x00)**

Options: Any ASCII input in the form of a pair of hex characters

Decode Direction

Serial Cmd: <**K744**, filter number, symbology type, length, wildcard, placeholder, data, **decode direction**, database index>

Default: **0 = Any Direction**

Options: **0 = Any Direction**

1 = Forward

2 = Reverse

Database Index

Serial Cmd: <**K744**, filter number, symbology type, length, wildcard, placeholder, data, decode direction, **database index**>

Default: **0** (any index)

Options: 0 to 10

Output Filter Enable

Serial Cmd: <**K745**, number of filters>

Default: **0**

Options: 0 to 10

Serial Utility Commands

Type	Command	Name
Read Rate	<C>	Enter Decodes/Second Test
	<Cp>	Enter Decode Percent Test
	<J>	Exit Decodes/Second and Decode Percent Tests
Counters	<a1>	PDF417 Information
	<N>	No Read Counter
	<O>	No Read Counter Reset
	<T>	Trigger Counter
	<U>	Trigger Counter Reset
	<V>	Good Read/Match Counter
	<W>	Good Read/Match Counter Reset
	<X>	Mismatch Counter
Device Control	<Y>	Mismatch Counter Reset
	<L1>	Programmable Output 1
	<L2>	Programmable Output 2
	<L3>	Programmable Output 3
	<I>	Disable Scanner
Master Database	<H>	Enable Scanner
	<G>	Store Next Symbol Read to Database Index 1
	<Gn>	Store Next Symbol Read to Database Index <i>n</i>
Part Number / Checksum	<NEWM>	New Master Load Status
	<#>	Display All Firmware Part Numbers
	<#a>	Display Application Code Part Number
	<#b>	Display Boot Code Part Number
	<#f>	Display FPGA Code Part Number
	<!>	Display All Available Firmware Checksums
	<!a>	Display Application Code Code Checksum
	<!b>	Display Boot Code Checksum
Default/Reset/Save	<!f>	Display FPGA Code Checksum
	<Z>	Save Current Settings for Power-On
	<Zc>	Save Current Settings as Customer Default Parameters for Power-On
	<Zrc>	Recall Customer Default Settings and Save for Power-On
	<Zrd>	Recall Omron Microscan Default Settings and Save for Power-On (Will not default "sticky settings")
	<Zrdall>	Recall Omron Microscan Default Settings and Save for Power-On (Will also default "sticky settings")
	<A>	Reset (Will not save for power-on)
<Arp>	Reset and Recall Power-On Parameters	

Serial Commands

Default/Reset/Save	<Arc>	Reset and Recall Customer Default Parameters
	<Ard>	Reset and Recall Omron Microscan Default Parameters
Scanner Status Request Commands	<K?>	All Status Request
	<K??>	All Descriptor Status Request
	<K?#>	All Range Status Request
	<Knnn?>	Single Status Request
	<Knnn??>	Single Descriptor Status Request
	<Knnn?#>	Single Range Status Request
	<Knnnd>	Default Customer Parameter
Other Serial Utility Commands	<@CAL>	Calibrate without Menu
	<@>	Calibrate with Menu
	<BCCFG>	Enter Bar Code Configuration

Appendix G — Protocol Commands

Communication Protocol Command Table

Protocol Command (Mnemonic displayed on menu)	Control Characters (Entered in menu or serial command)	Hex Value	Effect of Command
RES	^D	04	Reset
REQ	^E	05	Request
EOT	^D	04	Reset
STX	^B	02	Start of Text
ETX	^C	03	End of Text
ACK	^F	06	Acknowledge
NAK	^U	15	Negative Acknowledge
XON	^Q	11	Begin Transmission
XOFF	^S	13	Stop Transmission

ACK/NAK Data Flow Examples

Setup 1

RES	0x00 (disabled)
REQ	0x00 (disabled)
STX	0x00 (disabled)
ETX	0x00 (disabled)
ACK	0x06
NAK	0x15
LRC	disabled

Transfer 1

HOST_TX	<K141,0>
SCANNER_TX	'ACK'

Transfer 2

HOST_TX	<K141?>
SCANNER_TX	'ACK'
SCANNER_TX	<K141,0>
HOST_TX	'ACK'

Error Condition

Transfer 1

SCANNER_TX	symbol data
HOST_TX	'NAK' (host rejects)
SCANNER_TX	symbol data (resend data)
HOST_TX	'ACK' (transaction complete)

Transfer 2

HOST_TX	<K141?>
SCANNER_TX	'ACK'
SCANNER_TX	<K141,0>
	timeout reached...
	timeout reached...
	timeout reached...
Timeout Reached	transaction aborted, data is flushed

Setup 2

RES	0x00 (disabled)
REQ	0x00 (disabled)
STX	0x00 (disabled)
ETX	0x00 (disabled)
ACK	0x06
NAK	0x15
LRC	enabled

Transfer 1

HOST_TX	<K141,0>a
SCANNER_TX	'ACK'

Transfer 2

HOST_TX	<K141?>B
SCANNER_TX	'ACK'
SCANNER_TX	<K141,0>a
HOST_TX	'ACK'

Error Condition

Transfer 1

HOST_TX	<k141,0>x (BAD LRC)
SCANNER_TX	'NAK'
HOST_TX	<K141,0>a (GOOD LRC)
SCANNER_TX	'ACK'

Protocol Commands

Setup 3

RES	0x00 (disabled)
REQ	0x00 (disabled)
STX	0x28 '('
ETX	0x29 ')'
ACK	0x06
NAK	0x15
LRC	enabled

Transfer 1

HOST_TX	(<K141,0>)H
SCANNER_TX	'ACK'

Transfer 2

HOST_TX	(<K141?>)k
SCANNER_TX	'ACK'
SCANNER_TX	(<K141,^M>)w
HOST_TX	'ACK'

Setup 4

RES 0x21 '!'
REQ 0x3D '='
STX 0x28 '('
ETX 0x29 ')'
ACK 0x06
NAK 0x15
LRC enabled

Transfer 1

HOST_TX (<K141,0>)H
 SCANNER_TX 'ACK'

Transfer 2

HOST_TX (<K100?>)n
 SCANNER_TX 'ACK'
 HOST_TX '!'
 SCANNER_TX (<K100,8,0,0,1>)X
 HOST_TX 'ACK'
 SCANNER_TX '!'

Error Condition

Transfer 1

HOST_TX (<K141,0>)H
 SCANNER_TX 'ACK'
 HOST_TX (<K100?>)n
 SCANNER_TX 'ACK'
 HOST_TX '!'
 SCANNER_TX (<K100,8,0,0,1>)X
 timeout reached...
 SCANNER_TX '='
 timeout reached...
 SCANNER_TX '='
 timeout reached...
 SCANNER_TX '='
 timeout reached...
 SCANNER_TX '!'

Polling Mode Data Flow Examples

Setup 1

Address	0x01 (translates to) Poll Req @ '0x1C', Unit Select @ '0x1D'
RES	0x04
REQ	0x05
STX	0x02
ETX	0x03
ACK	0x06
NAK	0x15
LRC	disabled

Transfer 1

HOST_TX	'RES' '0x1D' 'REQ' (Select Unit 1 to receive data)
SCANNER_TX	'0x1D' 'ACK' (Unit responds with its address)
HOST_TX	'STX' <T> 'ETX'
SCANNER_TX	'0x1D' 'ACK' (Unit responds with its address)
HOST_TX	'RES' (Terminate Transfer 2)

Transfer 2

HOST_TX	'RES' '0x1C' 'REQ' (Poll Unit 1 for data)
SCANNER_TX	'0x1C' 'STX' <T/00000> 'ETX'
HOST_TX	'ACK'
SCANNER_TX	'RES' (Terminate Transfer 1)

Starting with a 'RES' ensures a clean transaction, without "leftovers" from the previous transaction.

Error Condition 1

HOST_TX	'RES' '0x1C' 'REQ' (Poll Unit 1 for data)
SCANNER_TX	'0x1C' 'STX' <T/00000> 'ETX'
HOST_TX	' <i>Nothing</i> ' (Host should 'ACK' here)
	timeout reached...
SCANNER_TX	'REQ' (Unit requests an 'ACK' again)
	timeout reached...
SCANNER_TX	'REQ' (Unit requests an 'ACK' again)
	timeout reached...
SCANNER_TX	'REQ' (Unit requests an 'ACK' again)
	timeout reached...
SCANNER_TX	'RES' (Terminate Transfer 1, data is flushed)

Error Condition 2

HOST_TX 'RES' '0x1C' 'REQ' (Poll Unit 1 for data)
SCANNER_TX '0x1C' 'STX' <T/00000> 'ETX'
HOST_TX '*Nothing*' (Host should 'ACK' here)
 timeout reached...
SCANNER_TX 'REQ' (Unit requests an 'ACK' again)
HOST_TX '*NAK*' (Host rejects data frame)
 (Retry Event)
SCANNER_TX '0x1C' 'STX' <T/00000> 'ETX' (Unit sends again)
HOST_TX 'ACK' (Host receives data)
SCANNER_TX 'RES' (Terminate Transfer 1)

The protocol makes 3 retry attempts before data is flushed and transfer is aborted.

Setup 2

Address	0x01 (translates to) Poll Req @ '0x1C', Unit Select @ '0x1D'
RES	0x04
REQ	0x05
STX	0x02
ETX	0x03
ACK	0x06
NAK	0x15
LRC	enabled

Transfer 1

HOST_TX	'RES' '0x1D' 'REQ' (Select Unit 1 to receive data)
SCANNER_TX	'0x1D' 'ACK' (Unit responds with its address)
HOST_TX	'STX' <T> 'ETX' 'LRC'
SCANNER_TX	'0x1D' 'ACK' (Unit responds with its address)
HOST_TX	'RES' (Terminate Transfer 2)

Transfer 2

HOST_TX	'RES' '0x1C' 'REQ' (Poll Unit 1 for data)
SCANNER_TX	'0x1C' 'STX' <T/00000> 'ETX' 'LRC'
SCANNER_TX	'ACK'
HOST_TX	'RES' (Terminate Transfer 1)

Starting with a 'RES' ensures a clean transaction, without "leftovers" from the previous transaction.

Error Condition 1

HOST_TX	'RES' '0x1C' 'REQ' (Poll Unit 1 for data)
SCANNER_TX	'0x1C' 'STX' <T/00000> 'ETX' 'LRC'
HOST_TX	'Nothing' (Host should 'ACK' here)
	timeout reached...
SCANNER_TX	'REQ' (Unit requests an 'ACK' again)
	timeout reached...
SCANNER_TX	'REQ' (Unit requests an 'ACK' again)
	timeout reached...
SCANNER_TX	'REQ' (Unit requests an 'ACK' again)
	timeout reached...
SCANNER_TX	'RES' (Terminate Transfer 1, data is flushed)

Error Condition 2

HOST_TX 'RES' '0x1C' 'REQ' (Poll Unit 1 for data)
 SCANNER_TX '0x1C' 'STX' <T/00000> 'ETX' 'LRC'
 HOST_TX 'Nothing' (Host should 'ACK' here)
 timeout reached...
 SCANNER_TX 'REQ' (Unit requests an 'ACK' again)
 HOST_TX 'NAK' (Host rejects data frame)
 (Retry Event)
 SCANNER_TX '0x1C' 'STX' <T/00000> 'ETX' 'LRC' (Unit sends again)
 HOST_TX 'ACK' (Host receives data)
 SCANNER_TX 'RES' (Terminate Transfer 1)

Error Condition 3

HOST_TX 'RES' '0x1C' 'REQ' (Poll Unit 1 for data)
 SCANNER_TX '0x1C' 'STX' <T/00000> 'ETX' 'BAD LRC'
 HOST_TX 'NAK' (Host rejects bad LRC data)
 (Retry Event)
 SCANNER_TX '0x1C' 'STX' <T/00000> 'ETX' 'GOOD LRC' (Unit sends again)
 HOST_TX 'ACK' (Host receives data)
 SCANNER_TX 'RES' Terminate Transfer 1)

The protocol makes 3 retry attempts before data is flushed and transfer is aborted.

Appendix H — ASCII Table

Dec	Hex	Mne	Ctrl	Dec	Hex	Ch	Dec	Hex	Ch	Dec	Hex	Ch
00	00	NUL	^@	32	20	SP	64	40	@	96	60	`
01	01	SOH	^A	33	21	!	65	41	A	97	61	a
02	02	STX	^B	34	22	"	66	42	B	98	62	b
03	03	ETX	^C	35	23	#	67	43	C	99	63	c
04	04	EOT	^D	36	24	\$	68	44	D	100	64	d
05	05	ENQ	^E	37	25	%	69	45	E	101	65	e
06	06	ACK	^F	38	26	&	70	46	F	102	66	f
07	07	BEL	^G	39	27	'	71	47	G	103	67	g
08	08	BS	^H	40	28	(72	48	H	104	68	h
09	09	HT	^I	41	29)	73	49	I	105	69	i
10	0A	LF	^J	42	2A	*	74	4A	J	106	6A	j
11	0B	VT	^K	43	2B	+	75	4B	K	107	6B	k
12	0C	FF	^L	44	2C	,	76	4C	L	108	6C	l
13	0D	CR	^M	45	2D	-	77	4D	M	109	6D	m
14	0E	SO	^N	46	2E	.	78	4E	N	110	6E	n
15	0F	SI	^O	47	2F	/	79	4F	O	111	6F	o
16	10	DLE	^P	48	30	0	80	50	P	112	70	p
17	11	DC1	^Q	49	31	1	81	51	Q	113	71	q
18	12	DC2	^R	50	32	2	82	52	R	114	72	r
19	13	DC3	^S	51	33	3	83	53	S	115	73	s
20	14	DC4	^T	52	34	4	84	54	T	116	74	t
21	15	NAK	^U	53	35	5	85	55	U	117	75	u
22	16	SYN	^V	54	36	6	86	56	V	118	76	v
23	17	ETB	^W	55	37	7	87	57	W	119	77	w
24	18	CAN	^X	56	38	8	88	58	X	120	78	x
25	19	EM	^Y	57	39	9	89	59	Y	121	79	y
26	1A	SUB	^Z	58	3A	:	90	5A	Z	122	7A	z
27	1B	ESC	^[59	3B	;	91	5B	[123	7B	{
28	1C	FS	^\	60	3C	<	92	5C	\	124	7C	
29	1D	GS	^]	61	3D	=	93	5D]	125	7D	}
30	1E	RS	^^	62	3E	>	94	5E	^	126	7E	~
31	1F	US	^_	63	3F	?	95	5F	_	127	7F	D

Appendix I — Configuring Ethernet TCP/IP

When using Ethernet to deploy QX-870s in an application, the host computer must be in the same IP range as the devices. Network settings are accessible in Windows from the Control Panel. The steps below show how TCP/IP settings can be configured.

1. From the **Windows Start Menu**, open **Control Panel** and double-click **Network Connections**.

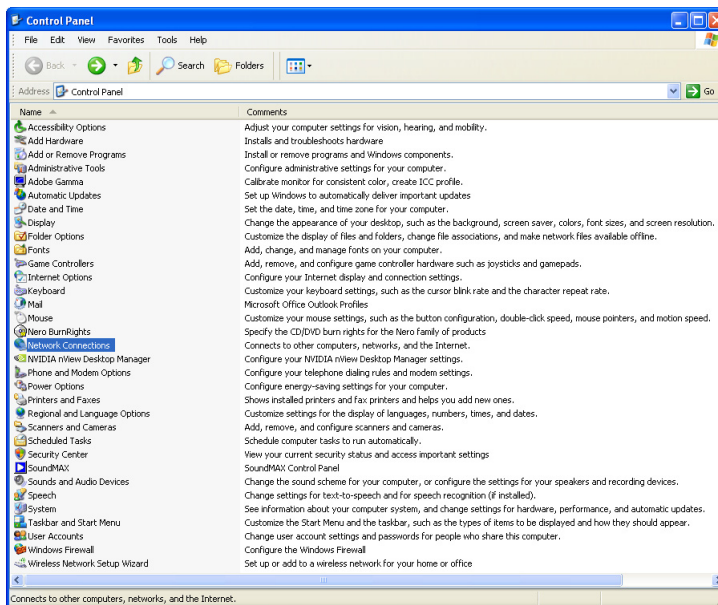

2. The **Network Connections** dialog will appear. Double-click the icon for the Local Area Connection being used in the application.

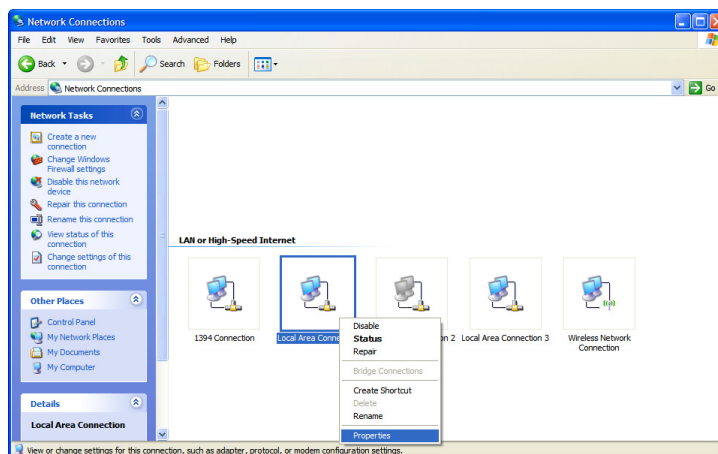

Configuring Ethernet TCP/IP (cont.)

- The **Local Area Connection Status** dialog will appear. To check the host computer's connection settings, click **Details** on the **Support** tab.

To verify connection status:

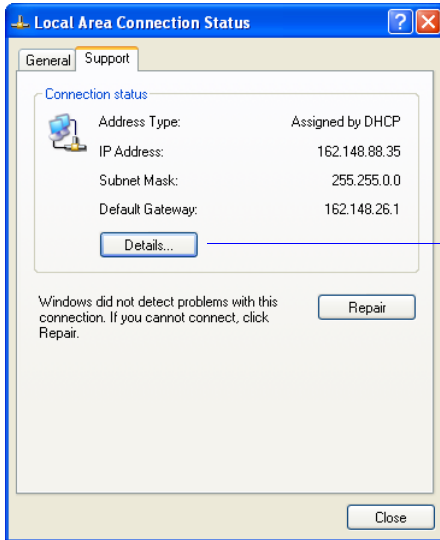

On the **Support** tab, click the **Details** button to bring up a list of **Network Connection Details**.

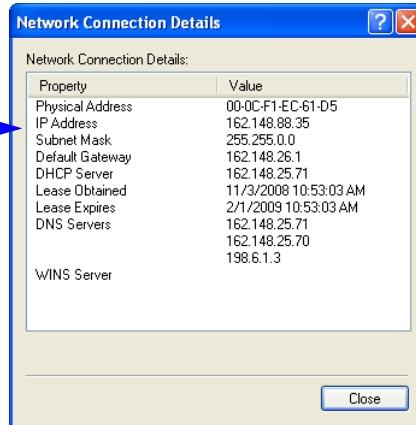

- A connected QX-870's default address information can be verified in ESP by clicking the **Search** button in the **Connection Wizard**. Compare the imager's IP address to the host's IP address to determine whether or not they are in the same subnet range (this can be determined by your I.T. department if you are unsure).

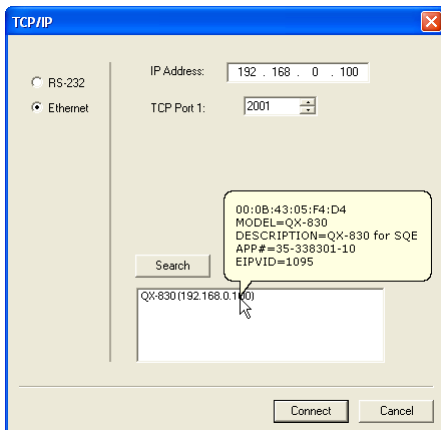

Configuring Ethernet TCP/IP (cont.)

5. To change the host computer's connection settings, click **Properties** on the **General** tab.

To change TCP/IP settings:

On the **General** tab, click the **Properties** button to bring up a list of items being used by the current connection. On the **Local Area Connection Properties** dialog, double-click **Internet Protocol (TCP-IP)**.

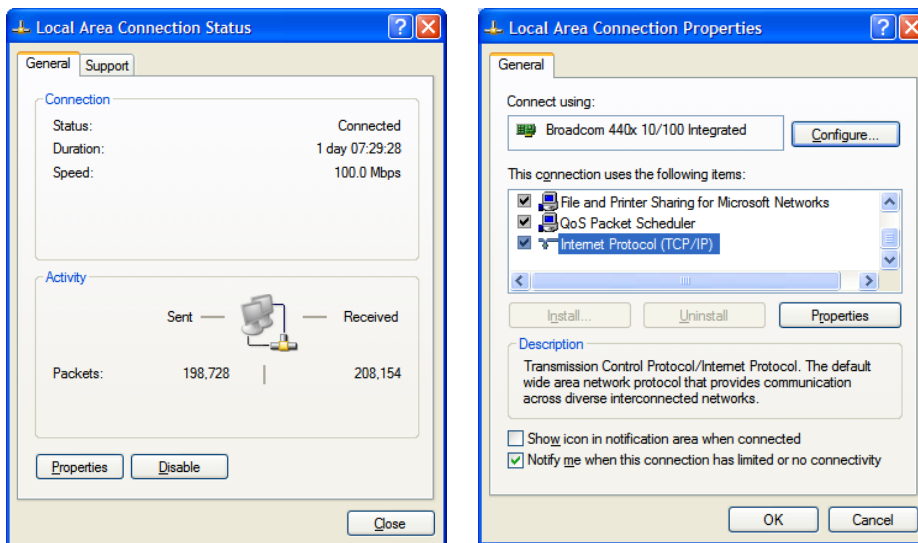

6. The **Internet Protocol (TCP/IP) Properties** dialog will appear.

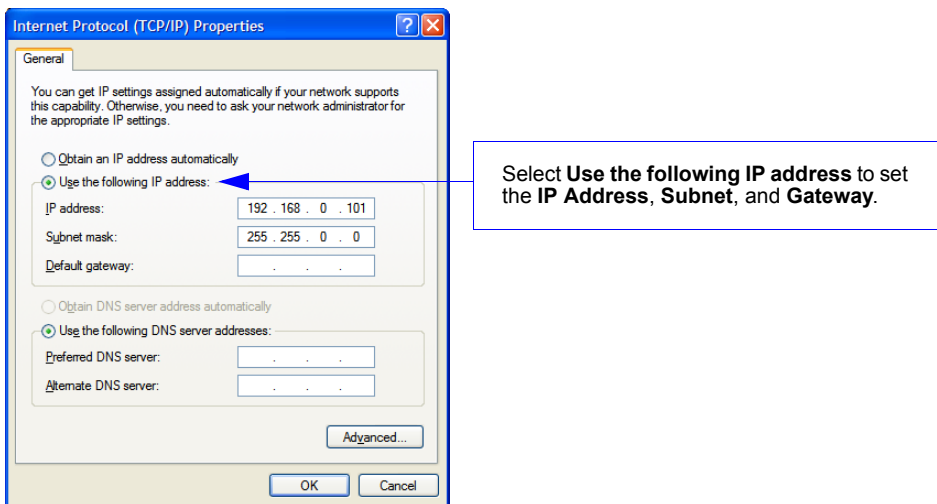

Appendix J — Using EtherNet/IP

Overview

The EIP interface will be identified as a Generic Device (0x00). The interface is designed to support remote serial transmit and receive using explicit unconnected messaging.

Necessary Tools

The following tools are helpful for configuring the EIP:

- EtherNet/IP Messaging Tool – can be a PLC or Software Tool, must be capable of sending explicit messages and establishing Class 1 connections. [EIPScan](#) is an example of such a tool.
- Terminal emulation or serial communication tool that can connect to a TCP socket, such as HyperTerminal.
- ESP – Omron Microscan's Easy Setup Program. This tool has the ability to find Omron Microscan products on the network, configure their ip address, then configure all application parameters.

EtherNet/IP Terms of Use

EtherNet/IP Technology is governed by the Open DeviceNet Vendor Association, Inc (ODVA). Any person or entity that makes and sells products that implement EtherNet/IP Technology must agree to the Terms of Usage Agreement issued by ODVA. See www.odva.org for details.

Device Type

The EtherNet/IP device type is 0x00, Generic Device.

Vendor ID

Omron Microscan's Vendor ID is **1095**.

Product Code

The Product Code is **870**.

QX-870 EtherNet/IP Object Model

The QX-870 uses Class 1 connected messaging to communicate most data in three different io assemblies. The user chooses one of two input assemblies, plus the output assembly, to create a Class 1 connection.

Connection properties supported:

Class: 1

Trigger Mode: Cyclic and Change of State

Cyclic Rate: Greater than 20 ms recommended. 10 ms minimum.

Size: Fixed

Type: Point-to-Point (PLC OUT, O->T), Point-to-Point and Multicast (PLC IN, T->O)

Priority: Low, High, and Scheduled

Data Types

Data Type	AB PLC	ODVA CIP EDS	Description
U8	SINT	USINT	Unsigned, 8 bit
U32	DINT	UDINT	Unsigned, 32 bit
STRING32	STRING	UDINT and BYTE[]	A 32 bit length field, followed by 8 bit ASCII characters

QX-870 Small IN Assembly 0x64, 100 decimal (IN = QX-870 -> PLC)

Field #	Data Type	Size (# of Data Type Elements)	Field Name
0	U32	1	User-Defined Tag Echo Echo from asm OUT 0xC6
1	U32 (32 bit flags)	1	Command Echo Echo from asm OUT 0xC6
2	U32 (32 bit flags)	1	Output Control Echo Echo from asm OUT 0xC6
3	U32	1	Read Cycle Sequence Counter: When this value changes, it indicates the following read cycle report fields have changed. 0 = Read cycle report has been "reset" to "empty". Read cycle report data is only valid when Sequence is not 0.
4	STRING 32	U32 + U8[64]	Read Cycle Report: Decoded Data Up to 64, 8-bit chars The first U32 is the length of the bar code data in the U8[64] field.
		Total= 84 U8, or 21 U32	

This is a small, lightweight input assembly. It is a subset of the "Big IN Assembly 0x65". It provides feedback of the output assembly, and the text of any bar codes decoded by the reader.

See **Big IN Assembly 0x65** for a description of the data fields.

QX-870 Big IN Assembly 0x65, 101 decimal (IN = QX-870 -> PLC)

Field #	Data Type	Size (# of Data Type Elements)	Field Name
0	U32	1	User-Defined Tag Echo Echo from asm OUT 0xC6
1	U32 (32 bit flags)	1	Command Echo Echo from asm OUT 0xC6
2	U32 (32 bit flags)	1	Output Control Echo Echo from asm OUT 0xC6
3	U32 (32 bit flags)	1	External Input Status (Physical Pin State)
4	U32 (32 bit flags)	1	External Output Status (Physical Pin State)
5	U32 (32 bit flags)	1	Device Status
6	U32	1	Read Cycle Sequence Counter: When this value changes, it indicates the following read cycle report fields have changed. 0 = Read cycle report has been “reset” to “empty”. Read cycle report data is only valid when Sequence is not 0.
7	U32	1	Read cycle report: Trigger count <T>
8	U32	1	Read cycle report: Decode/Match count <V>
9	U32	1	Read cycle report: Mismatch count <X>
10	U32	1	Read cycle report: Noread count <N>
11	STRING 32	U32 + U8[128]	Read cycle report: Decoded Data Up to 128, 8-bit chars The first U32 is the length of the bar code data in the U8[128] field.
		Total= 176 U8, or 44 U32	

This contains more status information, and a longer bar code string, than the “Small IN Assembly 0x64”. This gives the PLC visibility of the device’s discrete io, current operational status, and read cycle counters.

User Defined Tag Echo, Command Echo, Output Control Echo

These are a direct echo of the equivalent fields in the OUT assembly. They provide the PLC programmer with a method of verifying that the OUT data has been received by QX-870.

External Input Status (Physical Pin State)

Bit #	Pin Name
0	Trigger
1	New Master
2-31	Reserved

0 = no current sensed on input

1 = current sensed on input

External Output Status (Physical Pin State)

Bit #	Pin Name
0	Out1
1	Out2
2	Out3
3-31	Reserved

0 = output contact is open

1 = output contact is closed

Device Status

Field #	Bit Name	State
0	Reserved	
1	New Master Requested	1 = New Master Requested
2-7	Reserved	
8	Scanning Disabled	1 = Scanning Disabled
9-15	Reserved	
16	In Read Cycle	1 = In Read Cycle
17	Actively Scanning	1 = Active Scanning

Note the following details with “In Read Cycle” and “Actively Scanning” signals:

1. They may be very short-lived. It is possible for the reader to begin and end a read cycle without these signals being seen in active state.
2. They are only valid for normal read cycle operation: continuous, serial, and triggered. They do not reflect operation during bar code configuration, read rate, auto-calibration, or ESP “Setup” mode.

Read Cycle Sequence Counter

When this value changes, it indicates a new read cycle report is present.

Read cycle report data is only valid when Sequence is not 0.

Read cycle reports are only output during normal read cycles: continuous, serial, and triggered. Read cycle reports are not output during bar code configuration, read rate, auto-calibration, or ESP “Setup” mode.

Read Cycle Report: Trigger, Decode/Match, Mismatch, No Read Count

These are the historical read cycle result counters. By comparing the values to a previous report, the number of decodes, mismatches and noreads in the current read cycle can be determined.

Read Cycle Report: Decode Data

This string has the same format that would be output a serial port or tcp connection, with one difference: preamble and postamble are not added.

QX-870 OUT Assembly 0xC6, 198 decimal: Command (OUT= PLC -> QX-870)

Field #	Data Type	Size (# of Data Type Elements)	Field Name
0	U32	1	User-Defined Tag
1	U32 (32 bit flags)	1	Command
2	U32 (32 bit flags)	1	External Output Control

User Defined Tag

This provides the PLC programmer a method of uniquely identifying multiple readers in the system. This field serves no functional purpose in the QX-870. The value sent by the PLC for this field is echoed back to the input assemblies.

Command

Bit #	Action
0	Trigger
1	New Master
2-7	
8	Disable Scanning
9-15	Reserved
16	Clear Read Cycle Report and Counters
17	Unlatch Outputs
18-31	Reserved

The PLC programmer should verify that a Command has been received by QX-870 by observing the equivalent “echo” field in the IN assemblies.

Trigger (0)

Edge event-driven. Takes effect when read mode is Serial, Edge, or Level. A transition from 0 to 1 is a rising edge trigger event. A transition from 1 to 0 is a falling edge trigger event. The following sources all induce trigger events in the reader, including:

- A serial command from a serial com port
- EZ button
- External Trigger input signal on connector A
- Command:Trigger bit in the OUT assembly

If the reader is to be exclusively triggered by the PLC, then all other trigger sources must be kept idle.

New Master (1)

Edge-event driven. A transition from 0 to 1 is a command to the unit similar to sending the <G> serial command, or activating the New Master input on connector A. When activated, the New Master function instructs the reader to store the next decode in the master symbol database.

Disable Scanning (8)

Operates the same as the <H> and <I> commands. A transition from 0 to 1 is the same as sending an <I> command, which issues a “disable” event. A transition from 1 to 0 is the same thing as sending an <H> command, which issues an “enable” event. Note that the most recent command, either <H> or <I> serial commands or the Camera Action:DisableScanning command will always override the previous “scanning disable” state. To verify scanning status, observe the DeviceStatus field in asm 0x65.

Clear Read Cycle Report and Counters (16)

Trigger, Decode/Match, Mismatch, Noread, Decoded Data string, and Sequence. A transition from 0 to 1 is similar to sending the commands <U><W><Y><O>, which clear the historical read cycle counters. Also, the Sequence counter and Decoded Data string will go to 0. Note that if this command is received while a read cycle is active, execution of the command will be delayed until the read cycle has ended, and the read cycle's information will probably be lost.

Unlatch Outputs (17)

If any outputs are configured for “Unlatch on Input1”, a transition from 0 to 1 will unlatch the output. See configuration commands K810-812. It is not necessary for Input 1 to be enabled.

External Output Control

Bit #	Pin Name
0	Out1
1	Out2
2	Out3
3-31	Reserved

0 = open the output contact

1 = close the output contact

Note: Not operational at this time.

QX-870 OUT Assembly 0xC7, 199 decimal: Serial Command (OUT: PLC -> QX-870)

Field #	Data Type	Size (# of Data Type Elements)	Field Name
0	U32	1	Length of Command String (Field 1)
1	U8	256	Command String

Accessible only by unconnected explicit message.

This assembly enables the PLC to send serial commands to the device, similar to a serial port.

Known Issues and Limitations

1. External Output Control has not been implemented yet.
2. There is currently no way to receive serial command responses back from the QX-870.

Programming Flow Charts

Triggered by PLC, symbol data required, timeout or decode ends read cycle.

Setup:

Read Cycle Trigger Mode = External Edge or External Level.

Symbol Data Output = Enabled globally and for EtherNet/IP.

When to Output = As Soon As Possible.

End of Read Cycle = Timeout.

No Read message = Enabled.

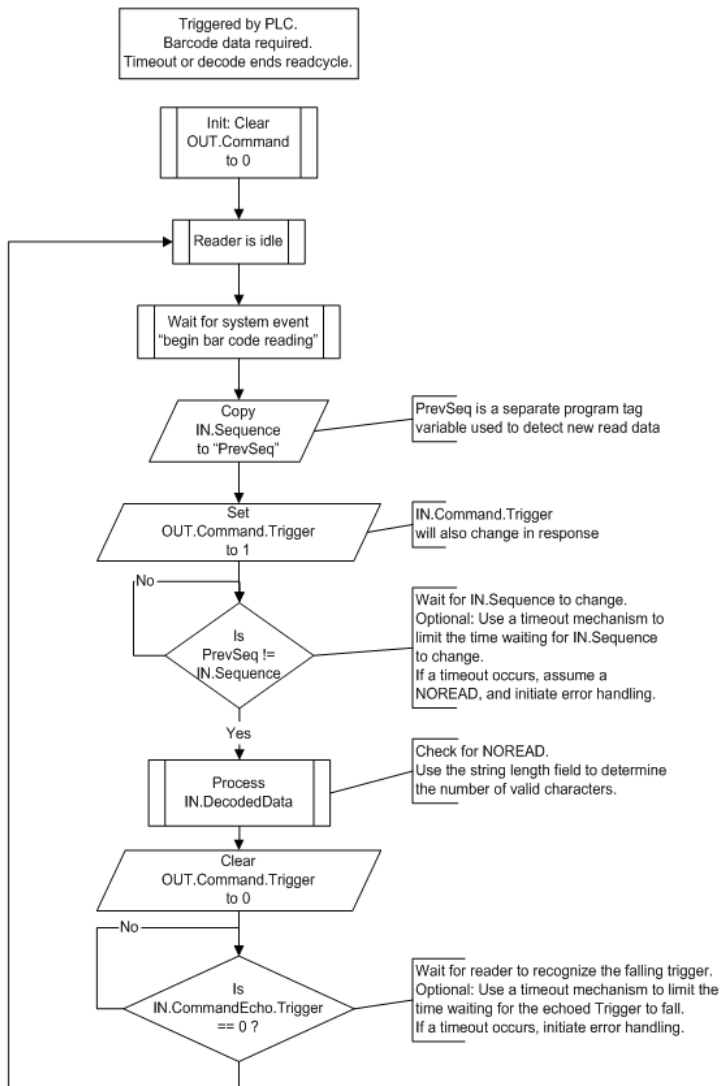

NET and MOD LED Indicators

MOD (Module)

Indicator State	Summary	Requirement	Implementation
Steady OFF	No power	If no power is supplied to the device, the module status indicator will be steady OFF .	Per requirement
Steady GREEN	Device operational	If the device is operating correctly, the module status indicator will be steady GREEN .	Per requirement
Steady RED	Major fault	If the device has detected a non-recoverable minor fault, the module status indicator will be steady RED .	Safe Mode: Basic comm. only. Scanning system non-functional.
Flashing GREEN / RED	Self-test	While the device is performing its power-up testing, the module status indicator will be flashing GREEN / RED .	Per requirement.

NET (Network)

Indicator State	Summary	Requirement	Implementation
Steady OFF	No power, no IP address	If the device does not have an IP address (or is powered off), the network status indicator will be steady OFF .	Per requirement. Before device has acquired an IP address via DHCP.
Flashing GREEN	No connections	If the device has no established connections, but has obtained an IP address, the network status indicator will be flashing GREEN .	Per requirement. After device has acquired an IP address (static or DHCP).
Steady GREEN	Connected	If the device has at least one established connection (even to the Message Router), the network status indicator will be steady GREEN .	Per requirement.
Flashing RED	Connection timeout	If one or more of the connections in which the device is the target has timed out, the network status indicator will be flashing RED .	Per requirement.
Steady RED	Duplicate IP	If the device has detected that its IP address is already in use, the network status indicator will be steady RED .	Not implemented.
Flashing GREEN / RED	Self-test	While the device is performing its power-up testing, the module status indicator will be flashing GREEN / RED .	Per requirement.

Appendix K — Operating the Serial Gateway Data Fields in the QX-870 EtherNet/IP (CIP) Interface Object

This appendix outlines a rough pseudo-code description of how to operate the serial gateway data fields in the QX-870 EtherNet/IP (CIP) interface object.

Service Code

All EtherNet/IP (CIP) data com transactions with the QX-870, both send and receive, are performed with Service Code=0x45, Class ID=0x68, Instance=1, Attribute ID=0x6A. Each transaction can send data, receive data, or both. Attribute 0x6A has a variable size, with a minimum of 16 bytes, and the maximum 486 bytes. The first 16 bytes are a header with several fields that enable serial gateway-style functionality. The remainder of the data packet can be 0 to 470 bytes, and contains the serial data. The usage of these fields, and the serial data, is described below.

To send a command to the QX-870:

1. Populate the Serial Data field with a serial command.
2. Populate the Send Length field with the string length of the serial command.
3. If only sending a command, and not waiting for a response in the same transaction:
 - Populate the Receive Timeout field with 0.
 - Populate the Receive Length field with 0.

If sending a command and waiting for a response in the same transaction:

- If sending a serial trigger, and expecting symbol data output:
Populate the Receive Timeout with a value equal to the device's read cycle timeout <K220,,timeout>, plus 20 (milliseconds).
 - If sending a command that requests data, like a read of the counters <T><V><X><N>:
Populate the Receive Timeout with a value of 10 (milliseconds) or greater.
Populate the Receive Length field with a value set to the maximum length of data the PLC can handle in one transaction, up to 470. If set too small, the device will fragment the response over multiple transactions.
4. Populate the Receive Request Flags with 0x1, if needed, to delete all pending data from the device before it sends a response to the command.
 5. Initiate the transaction.
 6. When the transaction is complete, check the Receive Length field:
 - If Receive Length is 0, no data has been received.

- If Receive Length is non-zero, then new data has been received.
Process the Serial Data field up to the value of Receive Length, and manage any fragmentation per standard programming technique. Check the Receive Response Flags. If the value is not 3, then the string sitting in the Serial Data field is not a complete message. It is a fragment of a larger message.

To receive data from the QX-870:

1. Populate the Send Length field with 0.
2. Populate the Receive Length field with a value set to the maximum length of data the PLC can handle in one transaction, up to 470. If set too small, the device will fragment the response over multiple transactions.
3. Populate the Receive Timeout field with a value that the PLC is willing to wait for the transaction to complete. When receiving bar code data, this would typically be set to the read cycle timeout <K220,,timeout>, plus 20 milliseconds or so. When checking for a command response, set this to at least 10 milliseconds.
4. Populate the Receive Request Flags with 0x1, if needed, to delete all pending data from the device, and only respond with data generated by the device after this request is received.
5. Initiate the transaction.
6. When the transaction is complete, check the Receive Length field:
 - If Receive Length is 0, no data has been received.
 - If Receive Length is non-zero, then new data has been received:
Process the Serial Data field up to the value of Receive Length, and manage any fragmentation per standard programming technique. Check the Receive Response Flags. If the value is not 3, then the string sitting in the Serial Data field is not a complete message. It is a fragment of a larger message.

Appendix L — Allen-Bradley Version 16 PLC Setup

This section was created and run on the following Allen Bradley/Rockwell components:

- RSLogix 5000 Version 16
- ControlLogix 5561 processor
- 756-ENBT/A EtherNet/IP interface card, firmware version 4.003 or newer.

This setup procedure was also followed in RSLogix with a CompactLogix 5332E as the processor, though the final program was not tested with a CompactLogix processor.

1. Create the I/O Configuration for the base system, including the system's Ethernet interface:

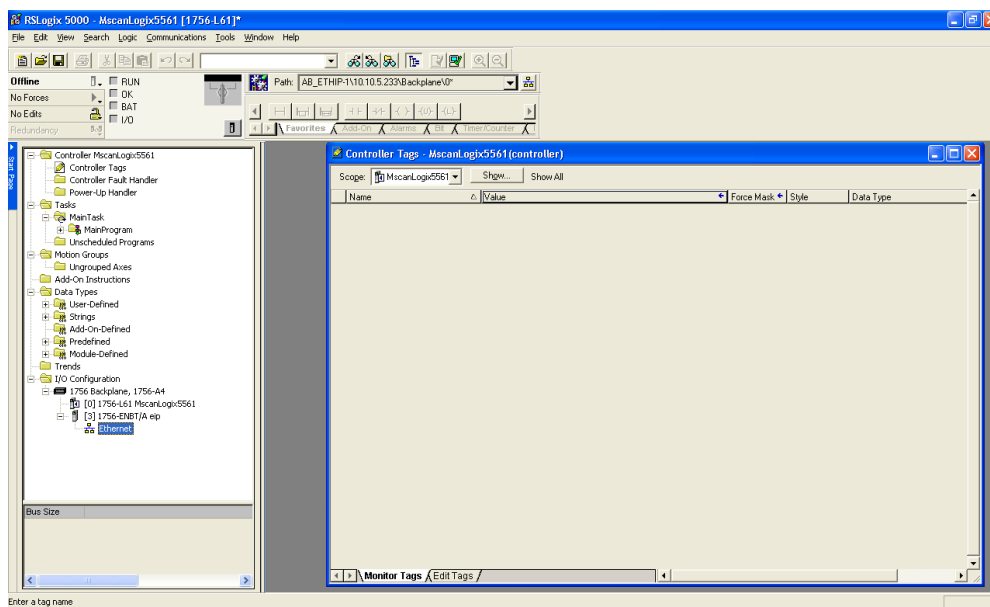

2. Add QX-870 by right-clicking on the Ethernet interface, and select “New Module”:

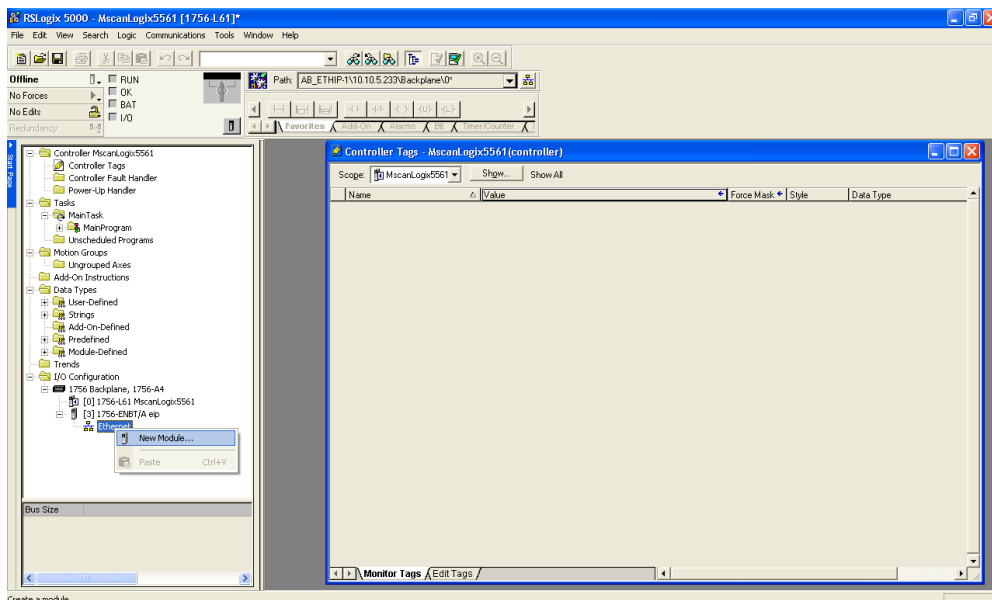

3. Select “ETHERNET-MODULE Generic Ethernet Module”, and click OK:

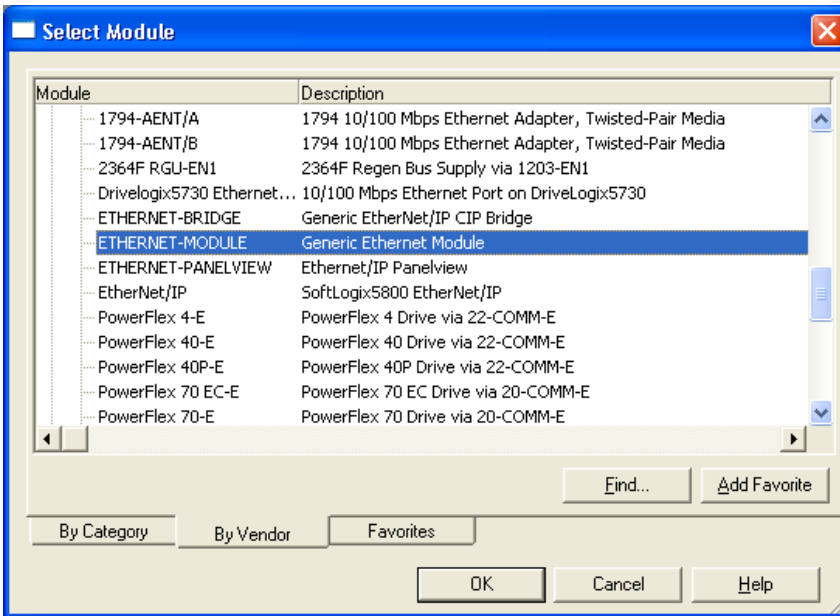

4. Configure the following fields:

“Name” = A useful name to remember the unit

“IP Address” = The IP Address of QX-870

“Comm Format” = “Data – DINT”

“Input” “Assembly Instance” = Choose either 100 (Small) or 101 (Big)

“Input” “Size” = 21 (Small), or 44 (Big)

“Output” “Assembly Instance” = 198

“Output” “Size” = 3

“Configuration” “Assembly Instance” = 1

“Configuration” “Size” = 0 (none)

5. Click OK when done.

Example: For Small IN (Instance 100, Size 21):

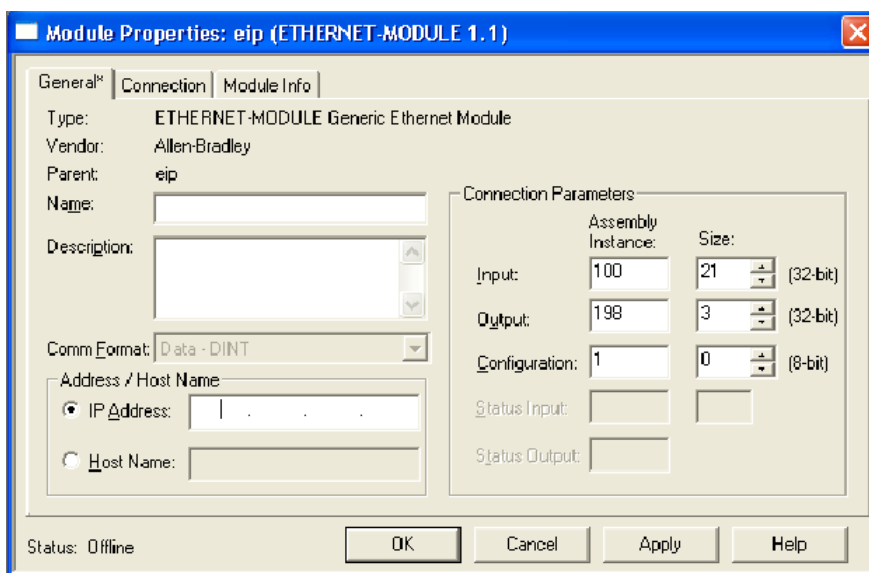

Allen-Bradley Version 16 PLC Setup

Example: For Big IN (Instance 101, Size 44):

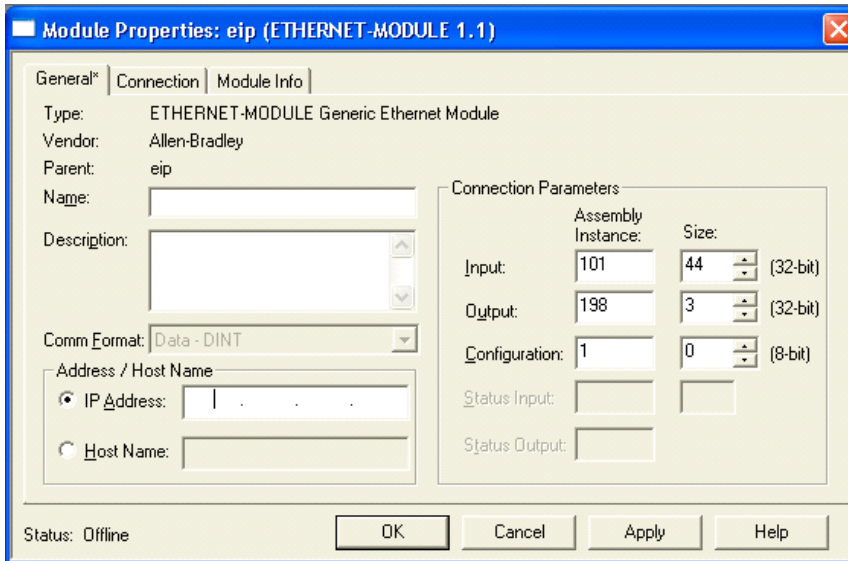

6. Configure the “Required Packet Interval (RPI)” and click OK. 20 ms or slower is strongly recommended. 10 ms is the minimum allowed by QX-870:

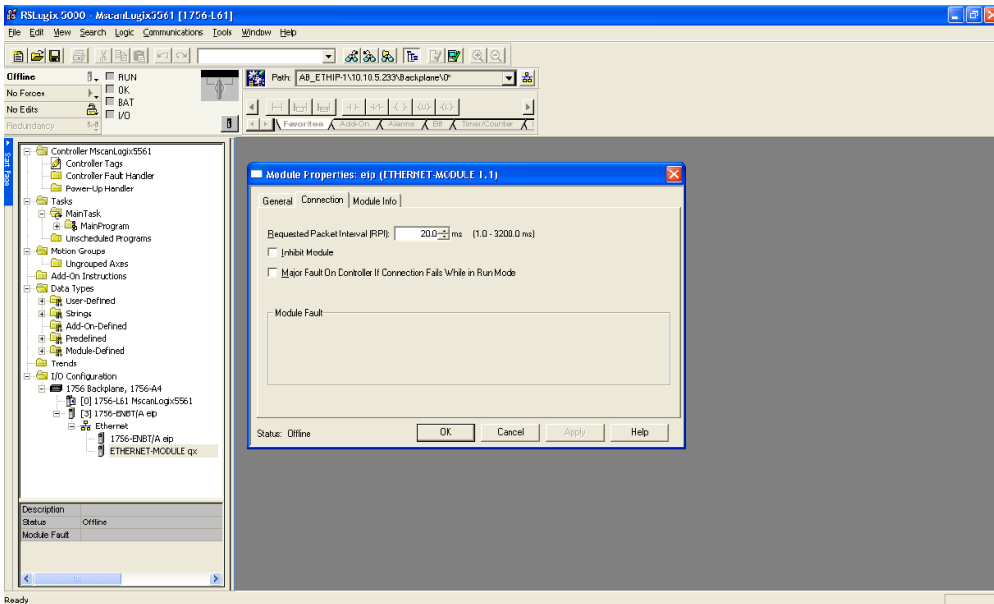

- Double-click on the “Controller Tags” item, and verify QX-870’s :I and :O tags appear in the Controller Tags window:

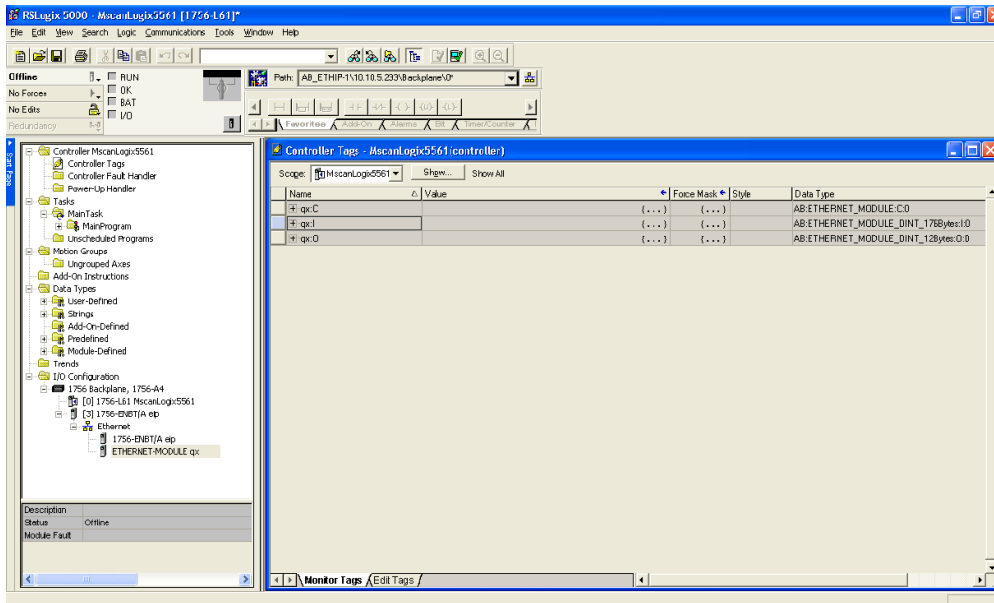

- Open the “Main Routine”:

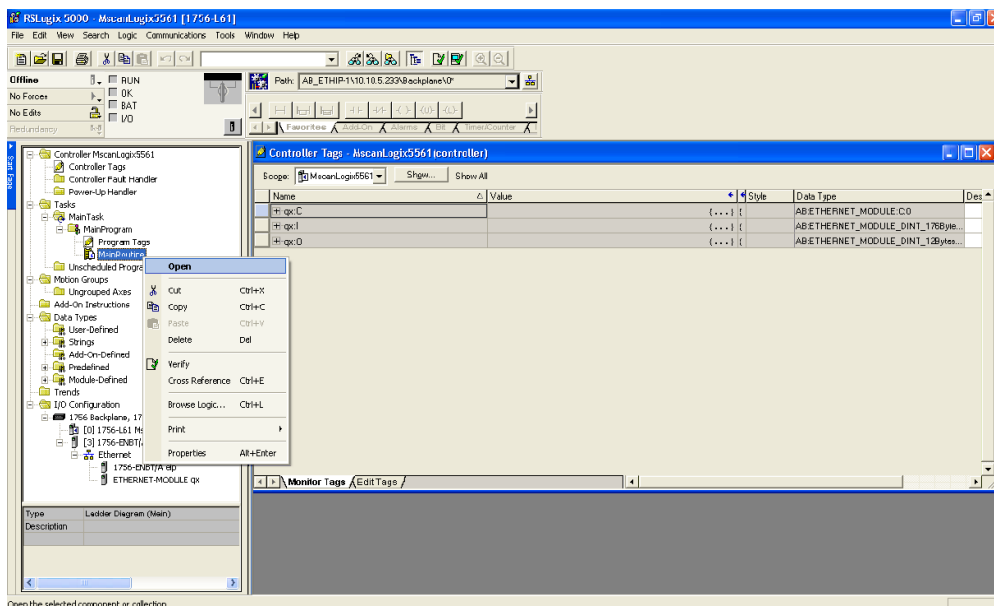

9. Right-click on the top rung and select “Import Rung”:

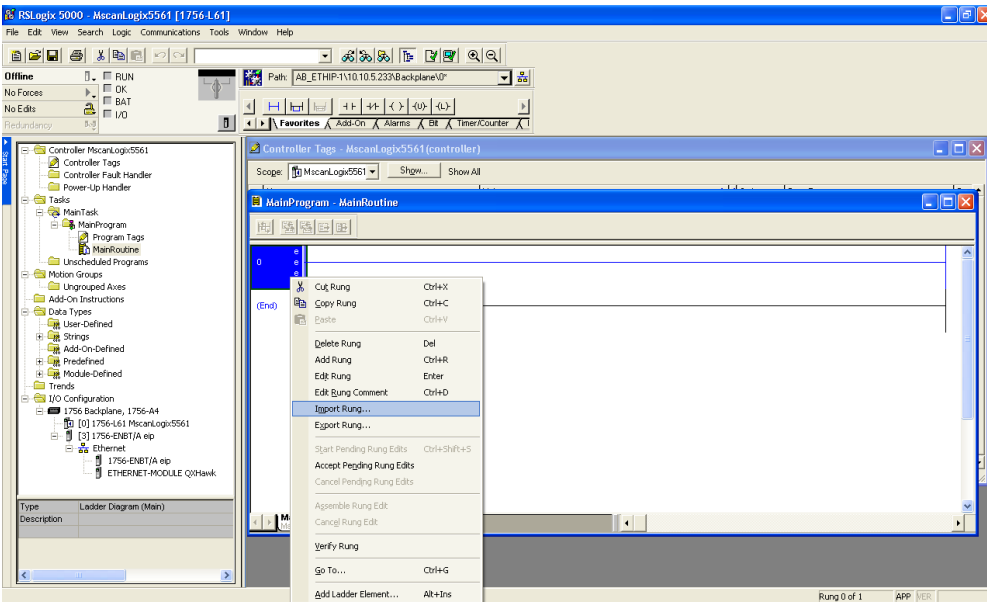

10. Click the **Attachments** icon in this PDF to show the **32-000001-xx.L5X** file. Save the file to the location of your choice. Navigate to the file and click **Import**.

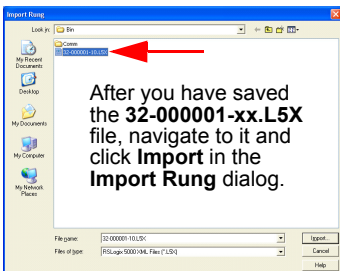
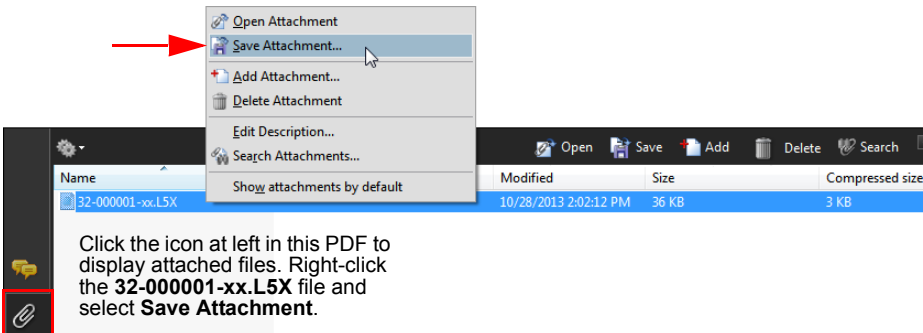

- At the “Import Configuration” window, link the first two items to the module name assigned earlier:

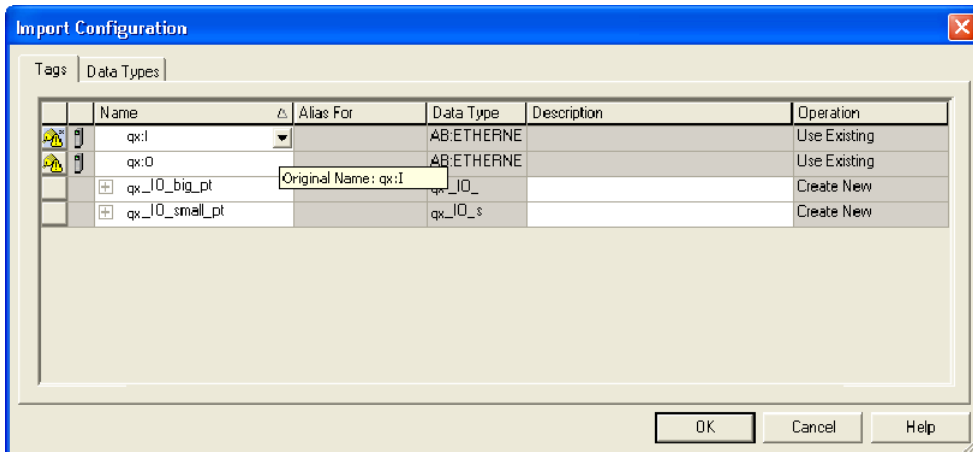

- Link “:I” to the input assembly:

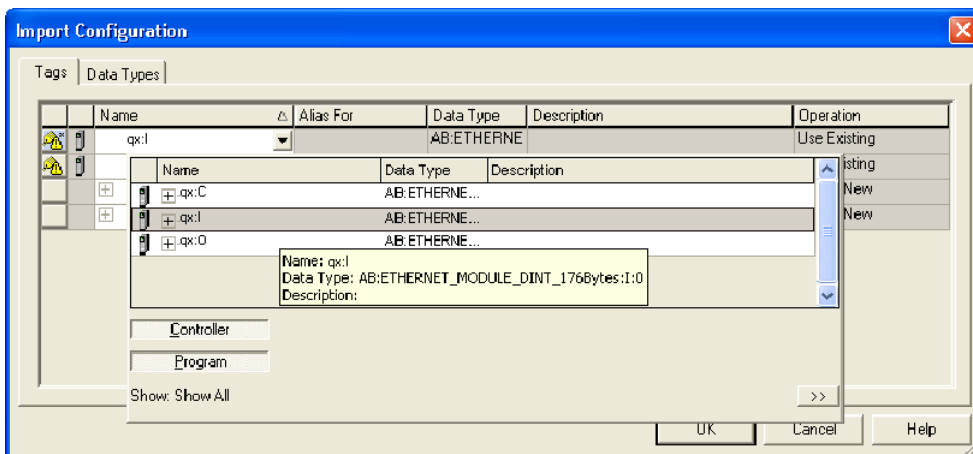

13. Link “:O” to the output assembly:

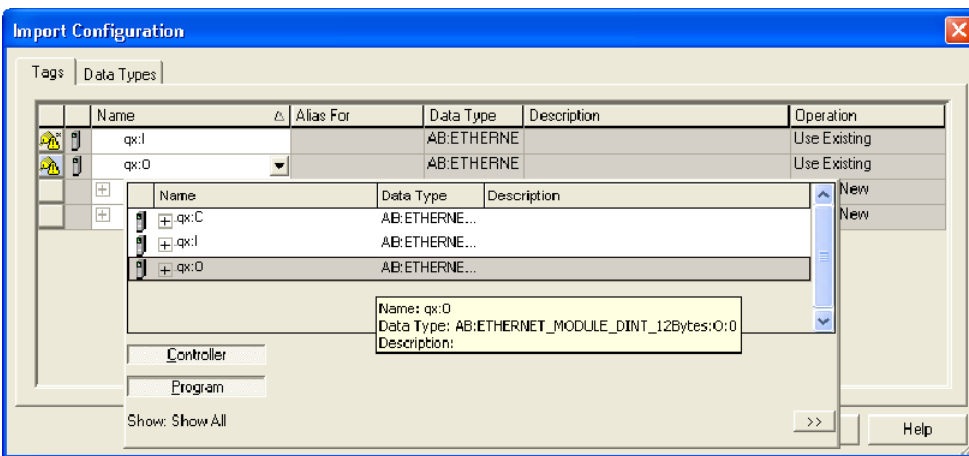

14. Delete any empty rungs:

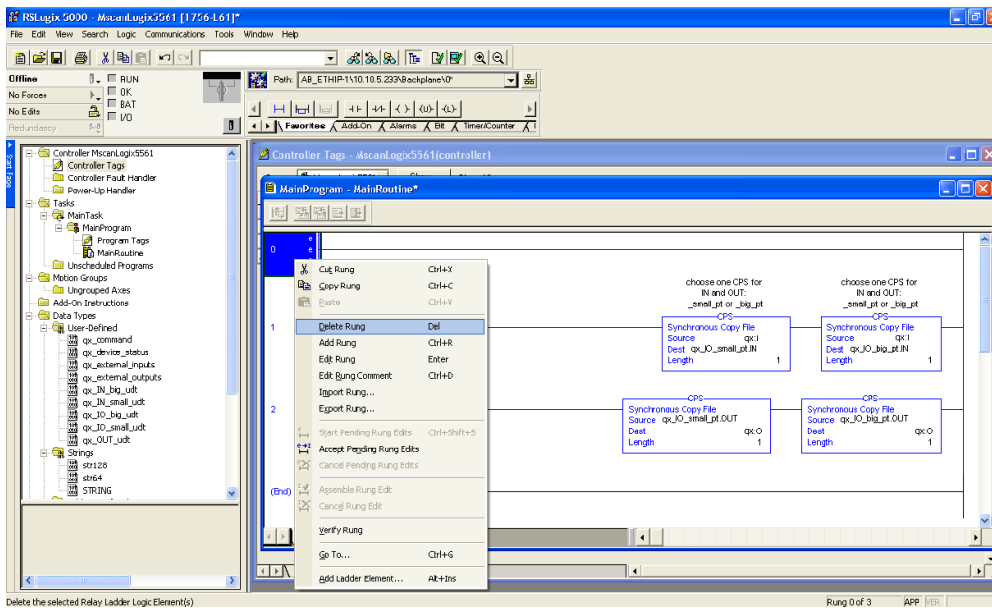

15. Select one CPS instruction per rung, the “_small_pt” on the left, or the “_big_pt” on the right. Keep the one that corresponds to the assembly sizes configured for the module, and delete the other:

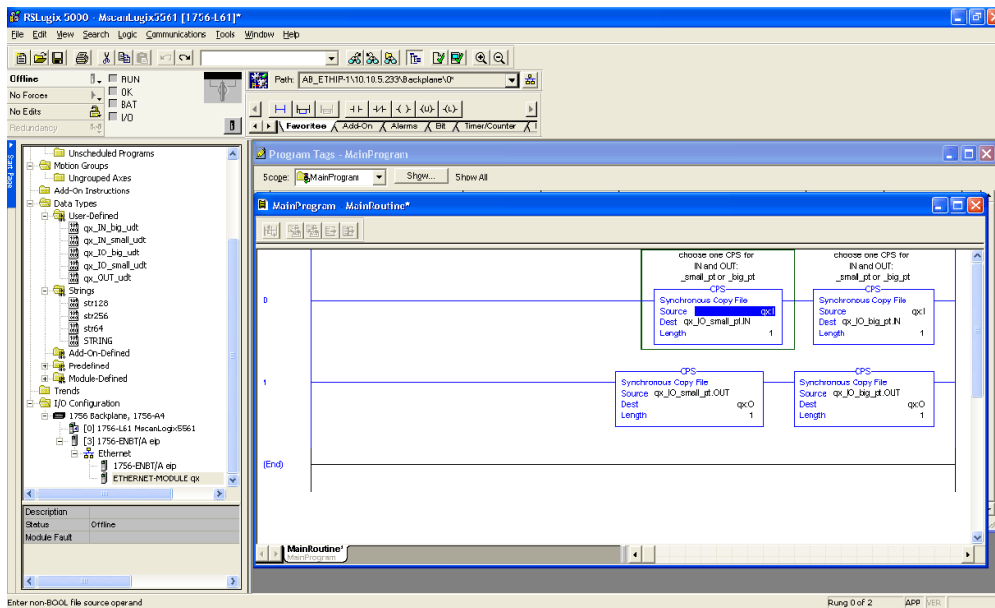

Allen-Bradley Version 16 PLC Setup

16. In this example, the small assembly set has been kept:

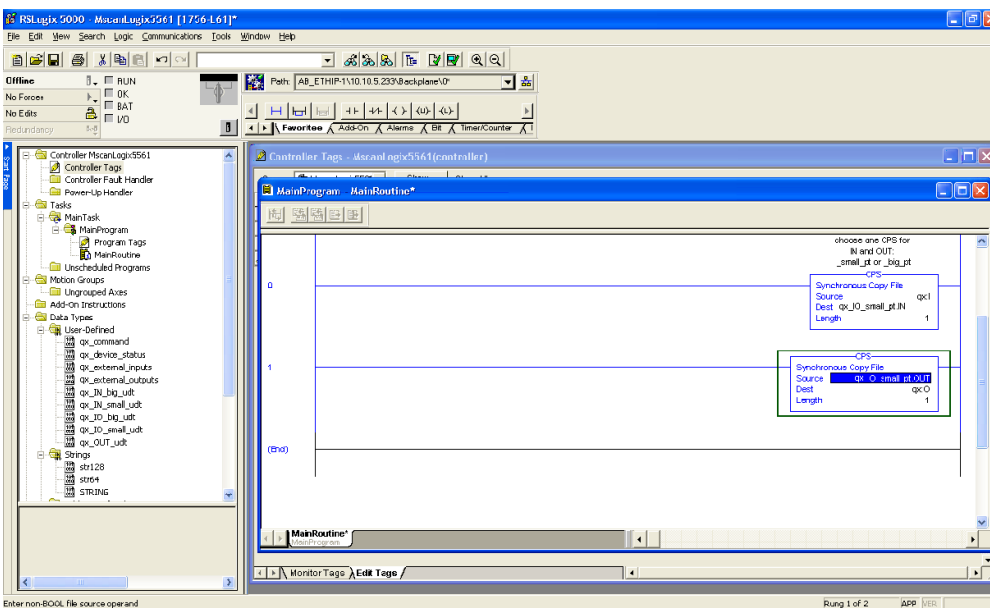

In this example, the big assembly set has been kept:

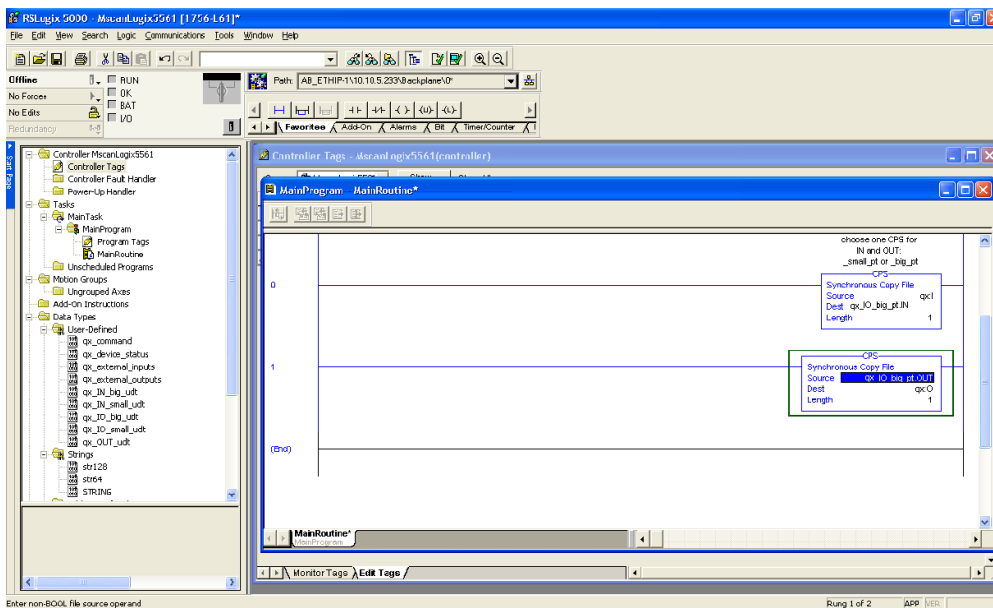

For the remainder of this document, the big assembly set is demonstrated.

The system is now configured to test communication with the QX-870.

17. Select the control button next to “Offline”, and select “Download”:

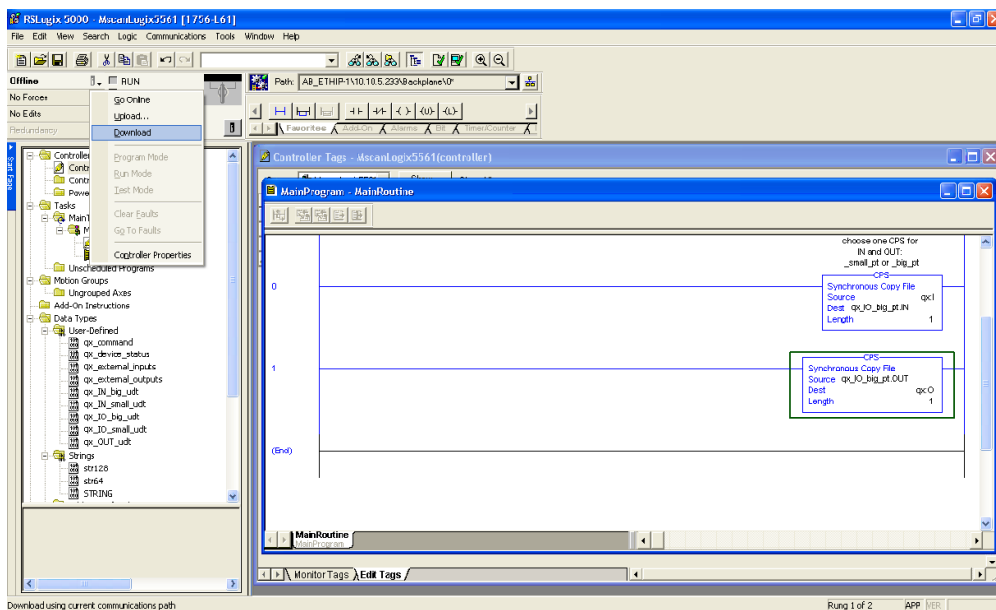

18. Once the program has downloaded, make sure the PLC is in Run Mode:

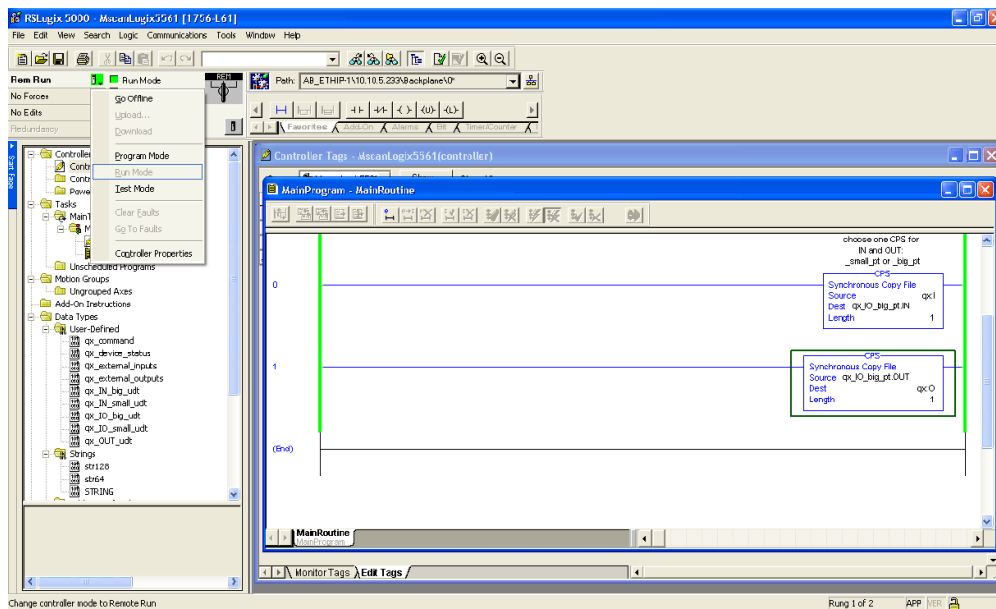

19. To open the Program Tags, right-click on “Program Tags” and select “Monitor Tags”:

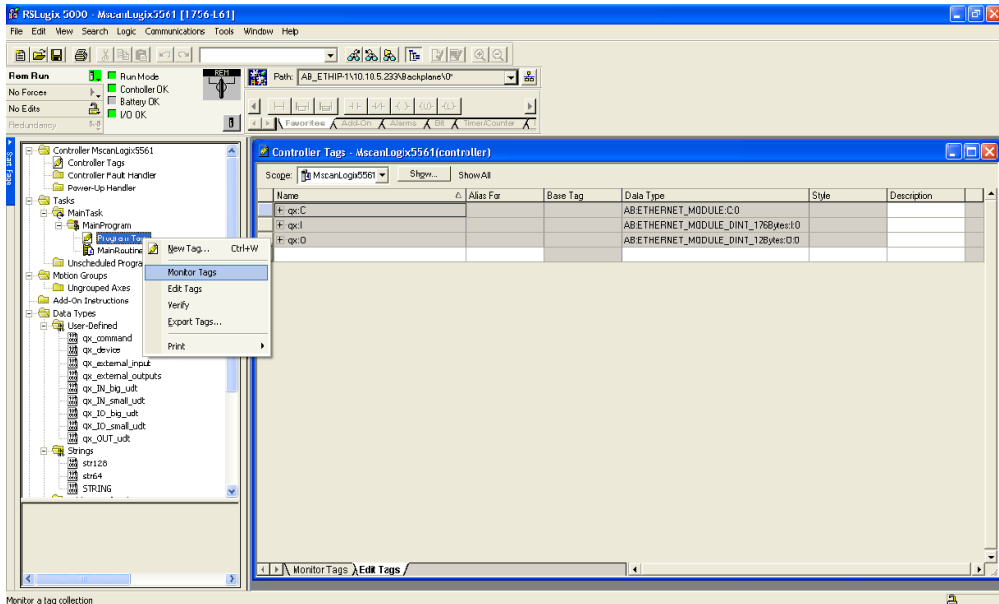

20. Expand the “QXHawk_IO_big_pt” so that the .IN and .OUT structures and values are visible:

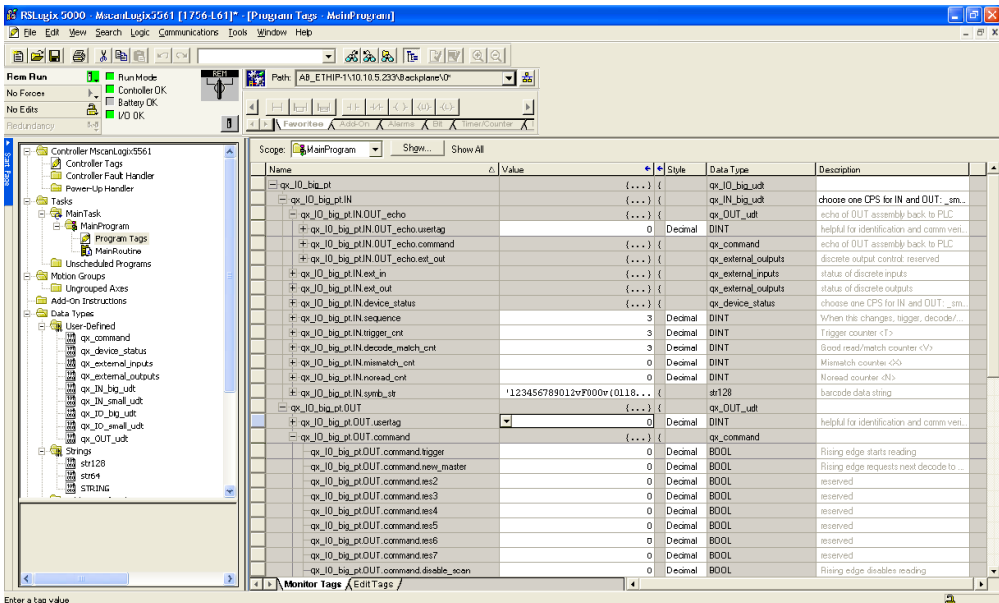

21. Change the “.OUT.usertag” to non-zero:

The screenshot shows the RSLogix 5000 software interface. The main window displays a table of variable declarations for the 'MainProgram'. The table has columns for Name, Value, Style, Data Type, and Description. The variable 'qx_io_big_pt.OUT.usertag' is selected, and its value is being changed from 0 to 10.

Name	Value	Style	Data Type	Description
- qx_io_big_pt	(...)	{	qx_io_big_udt	
- qx_io_big_pt.IN	(...)	{	qx_io_big_udt	choose one CPS for IN and OUT...
- qx_io_big_pt.IN.OUT_echo	(...)	{	qx_OUT_udt	echo of OUT assembly back to PLC
+ qx_io_big_pt.IN.OUT_echo.usertag	0	Decimal	DINT	helpful for identification and comm ven...
+ qx_io_big_pt.IN.OUT_echo.command	(...)	{	qx_command	echo of OUT assembly back to PLC
+ qx_io_big_pt.IN.OUT_echo.est_out	(...)	{	qx_external_outputs	discrete output control; reserved
+ qx_io_big_pt.IN.est_in	(...)	{	qx_external_inputs	status of discrete inputs
+ qx_io_big_pt.IN.est_out	(...)	{	qx_external_outputs	status of discrete outputs
+ qx_io_big_pt.IN.device_status	(...)	{	qx_device_status	choose one CPS for IN and OUT...
+ qx_io_big_pt.IN.sequence		Decimal	DINT	When this changes, triggers decode/...
+ qx_io_big_pt.IN.trigger_cnt	3	Decimal	DINT	Triggers counter <T3>
+ qx_io_big_pt.IN.decode_match_cnt	3	Decimal	DINT	Good read/match counter <V>
+ qx_io_big_pt.IN.mismatch_cnt	0	Decimal	DINT	Mismatch counter <O>
+ qx_io_big_pt.IN.nonrad_cnt	0	Decimal	DINT	Nonrad counter <N>
+ qx_io_big_pt.IN.symbt_str	'123456789012vF000v'(0118...	(...)	{	str128
+ qx_io_big_pt.OUT	(...)	{	qx_OUT_udt	
+ qx_io_big_pt.OUT.usertag	10	Decimal	DINT	helpful for identification and comm ven...
+ qx_io_big_pt.OUT.command	(...)	{	qx_command	
- qx_io_big_pt.OUT.trigger	0	Decimal	BOOL	Rising edge starts reading
- qx_io_big_pt.OUT.command.new_master	0	Decimal	BOOL	Rising edge requests next decode to ...
- qx_io_big_pt.OUT.command.test2	0	Decimal	BOOL	reserved
- qx_io_big_pt.OUT.command.test3	0	Decimal	BOOL	reserved
- qx_io_big_pt.OUT.command.test4	0	Decimal	BOOL	reserved
- qx_io_big_pt.OUT.command.test5	0	Decimal	BOOL	reserved
- qx_io_big_pt.OUT.command.test6	0	Decimal	BOOL	reserved
- qx_io_big_pt.OUT.command.test7	0	Decimal	BOOL	reserved
- qx_io_big_pt.OUT.command.disable_scan	0	Decimal	BOOL	Rising edge disables reading

Appendix M — Allen-Bradley Version 20 PLC Setup

- To add a new EDS file to RSLogix 5000 Version 20 select the **EDS Hardware Installation Tool** from the menu item under **Tools**.

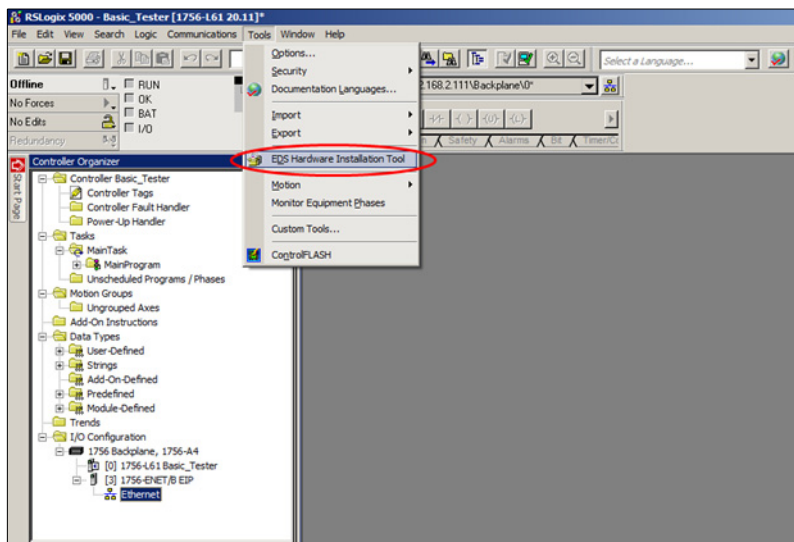

- Click the **Next** button.

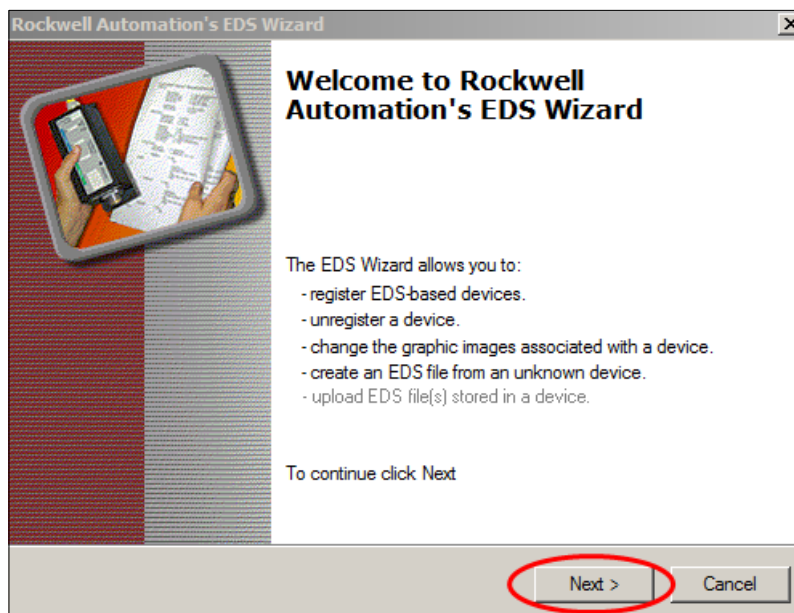

- Make sure the **Register an EDS file(s)** radio button is selected, then click **Next**.

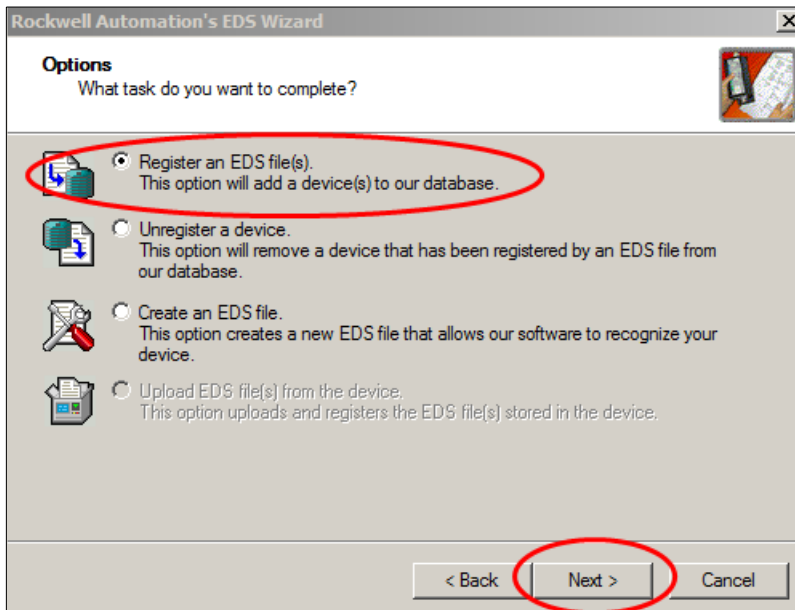

- Click the **Browse** button to locate the new EDS file on your PC. Then click **Next**.

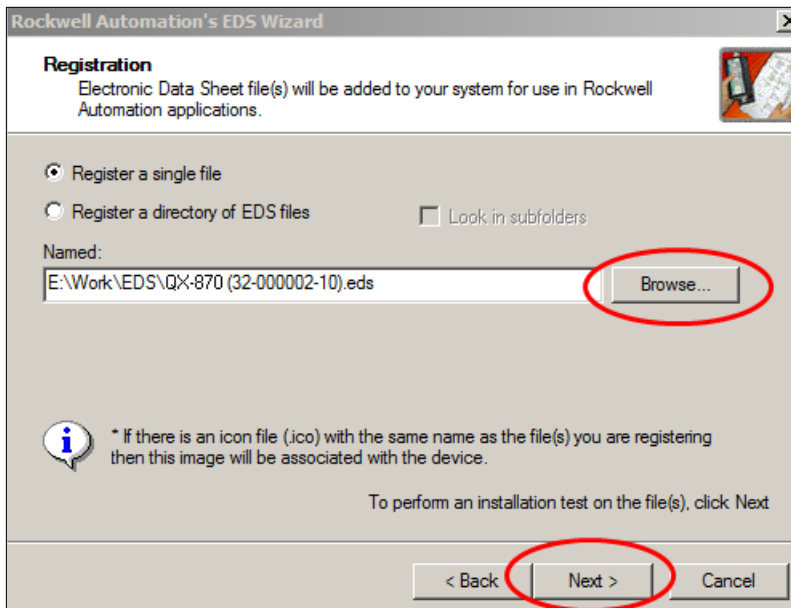

- Click the **Next** button.

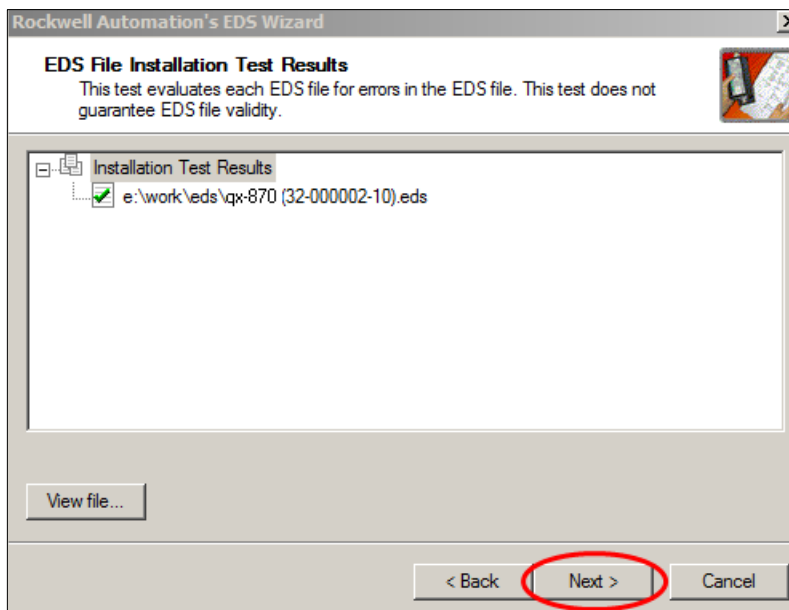

- Click the **Next** button.

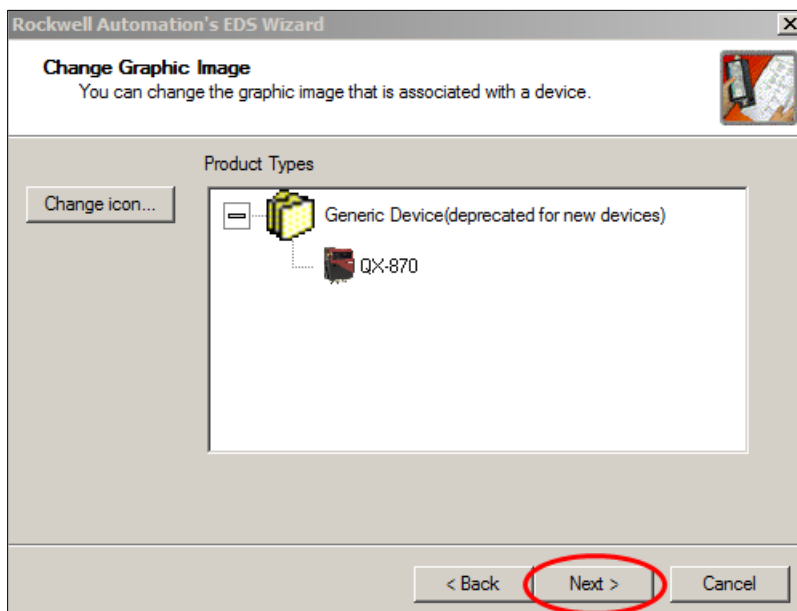

Allen-Bradley Version 20 PLC Setup

- Click the **Next** button.

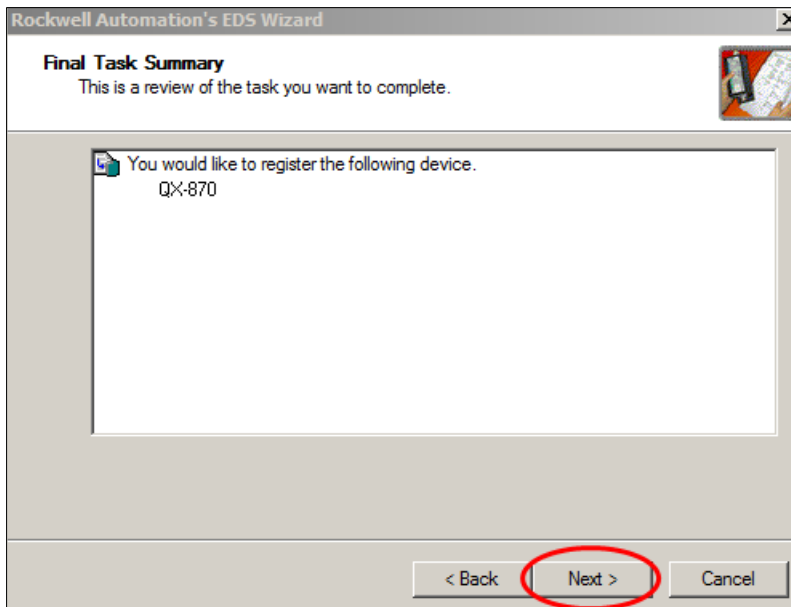

- Click the **Finish** button.

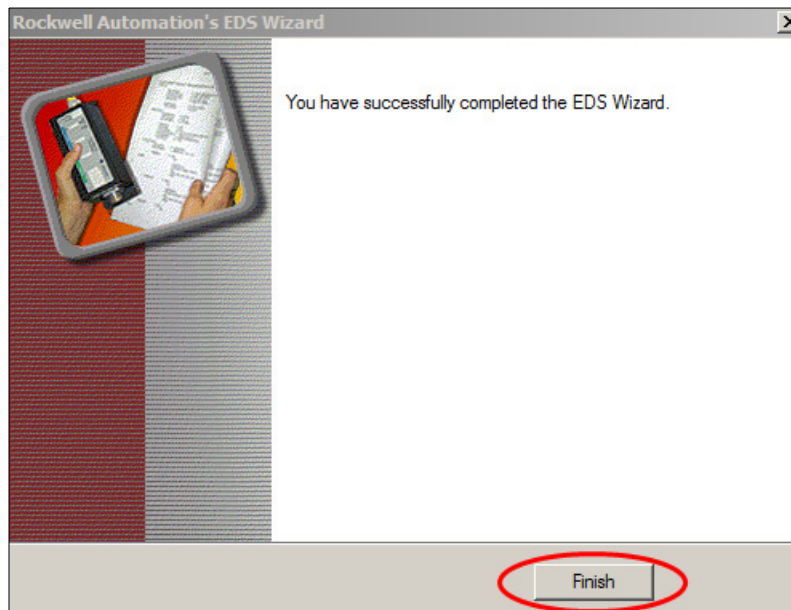

- Now the EDS file has been loaded into RSLogix's database. Right-click the **Ethernet** menu item and select **New Module**.

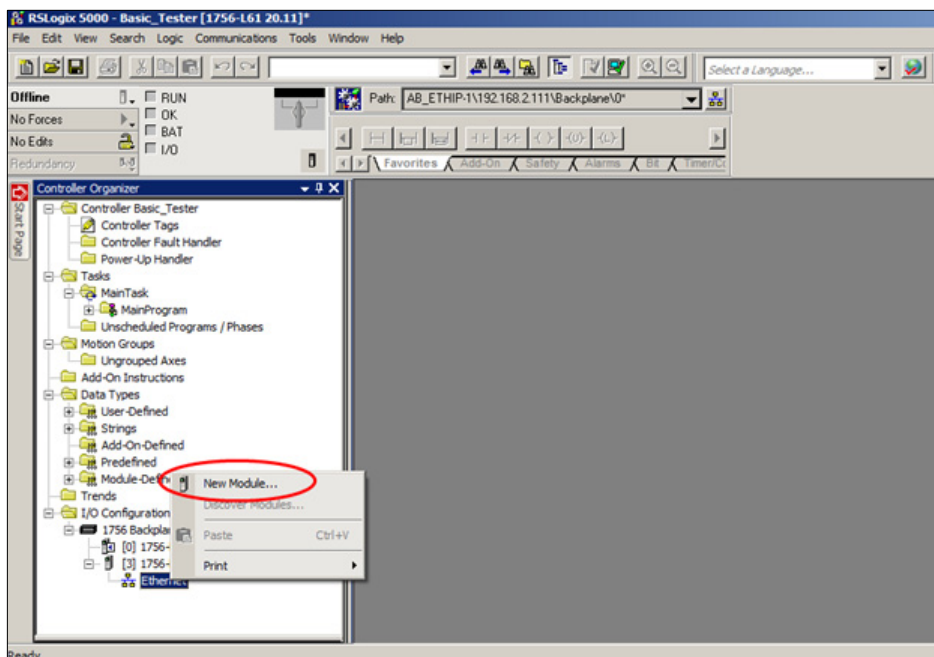

- To find your camera in the list, type **fis** and the dialog will show only devices with the letters “fis” in the name. Either double-click the camera you want or highlight it and click the **Create** button.

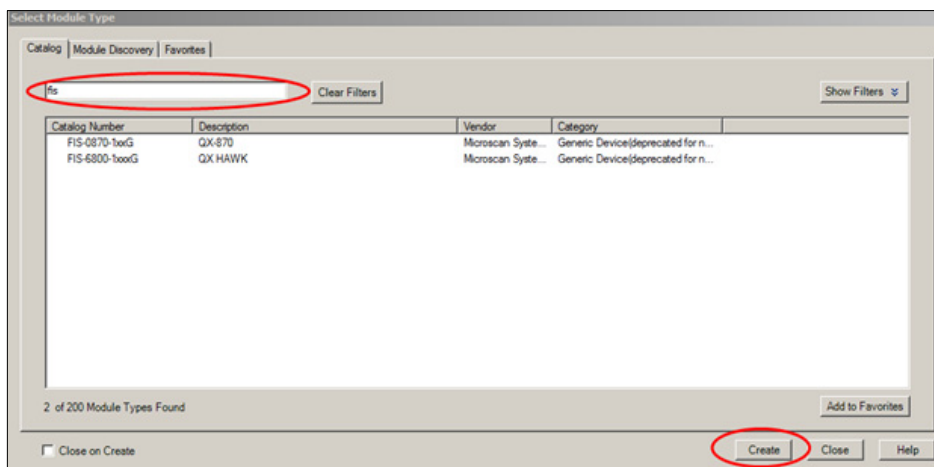

Allen-Bradley Version 20 PLC Setup

- Enter the name of the device used in the PLC program and the IP address of the camera.

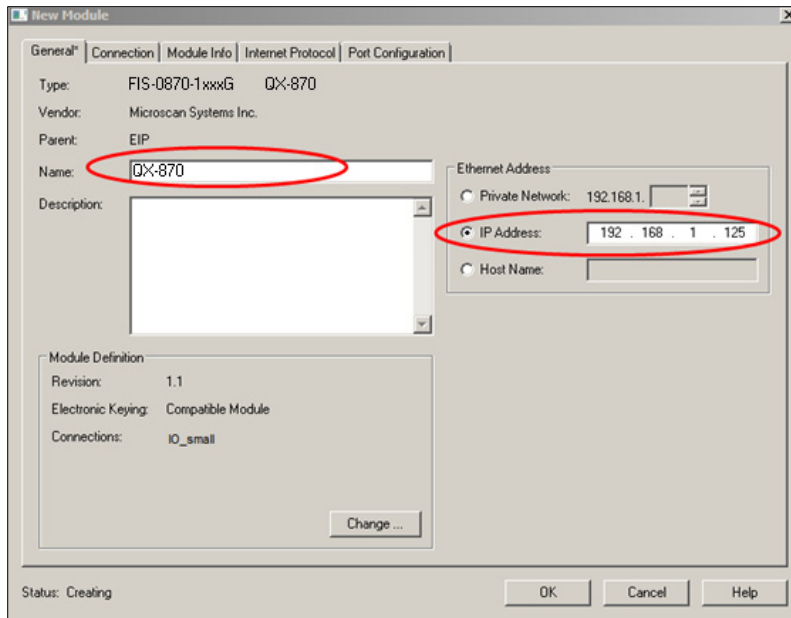

- After the new device has been added to the project, the default assembly data will be the **small** size. You can change it to large by double-clicking the camera menu item in the tree control and clicking the **Change** button on the dialog.

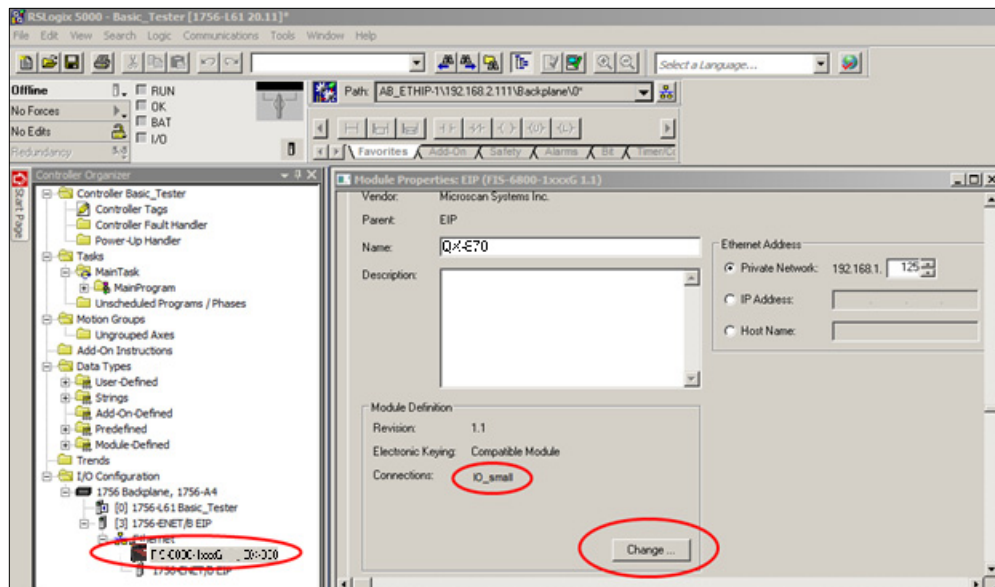

- Select the large assembly size and click the **OK** button when done.

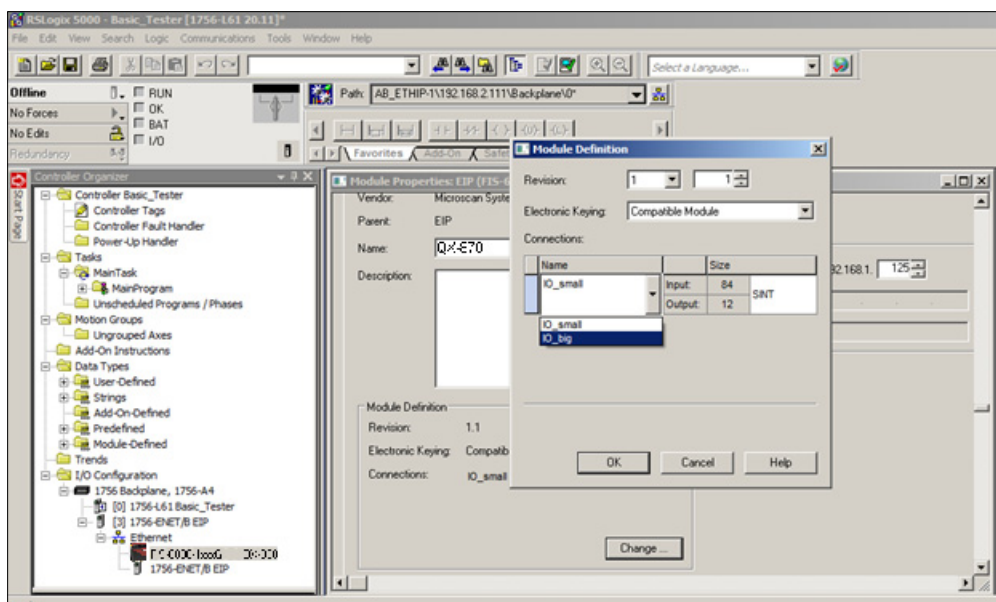

Appendix N — EIPScan Setup

This procedure is for the EIPScan simulation tool published by Pyramid Solutions.

1. Right-click on **EIPScan Test Tool** and select **Add Device**.

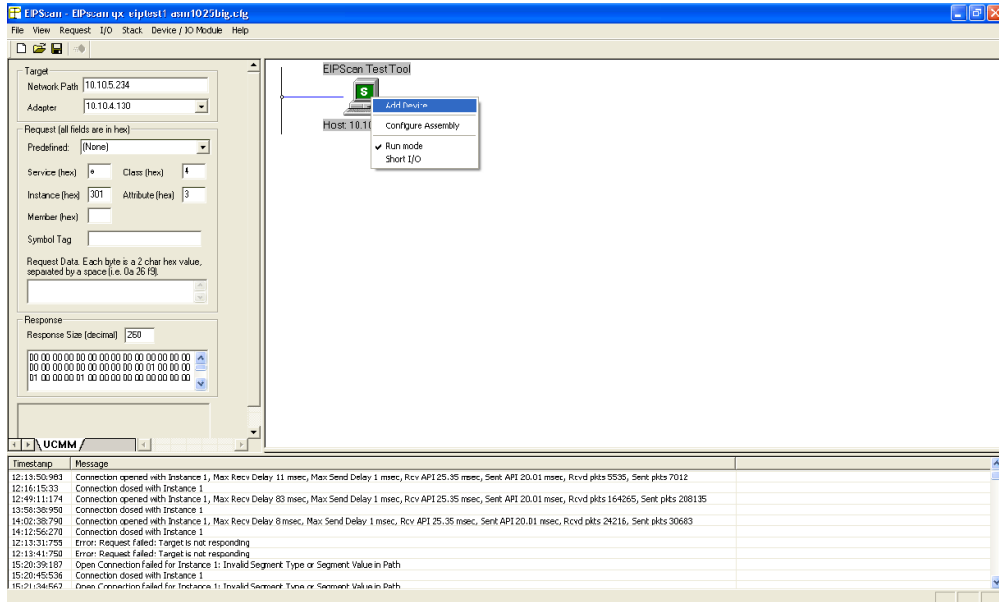

2. Set the **IP Address** to match the QX-870.

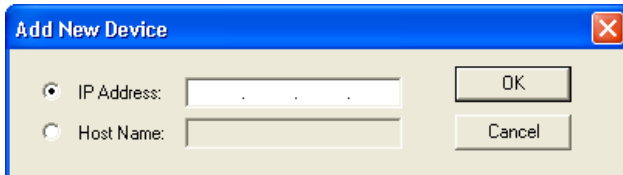

The QX-870 will appear in the main window.

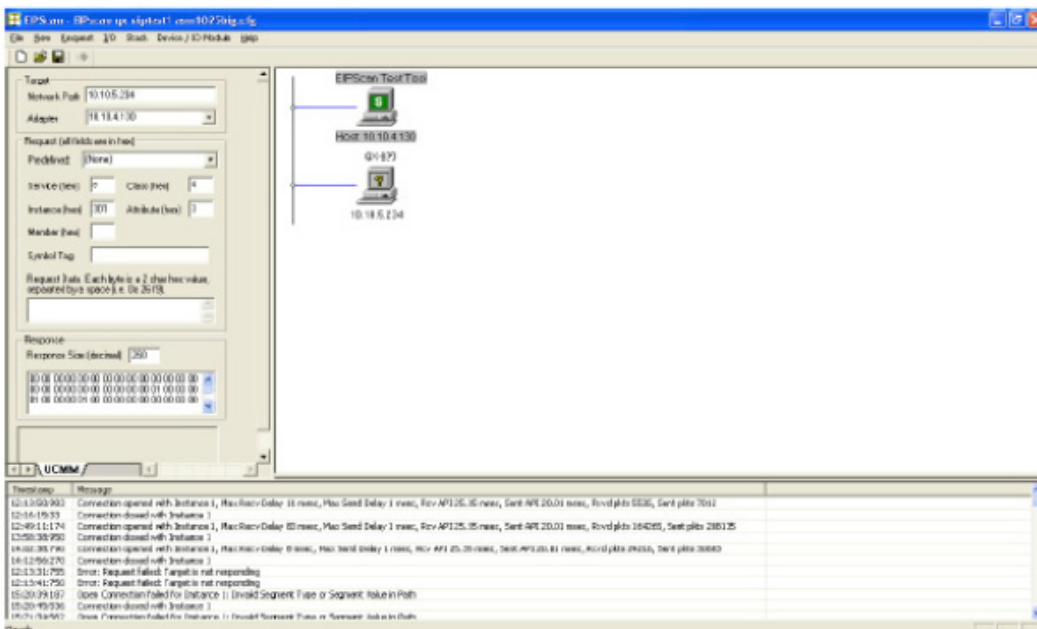

3. Right-click on QX-870 and select Add Class1 Connection.

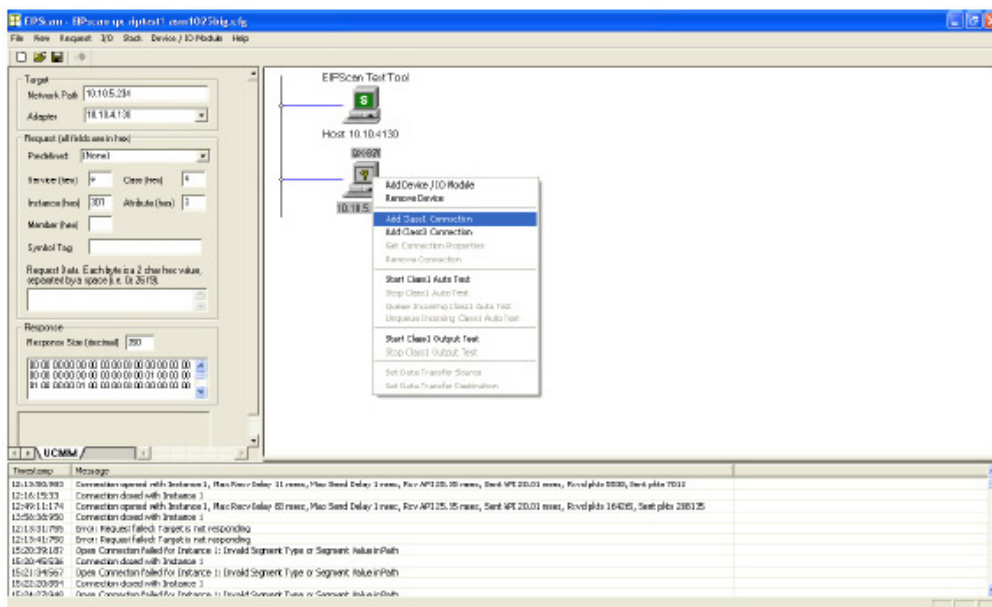

- When the **Add Class1 Connection** dialog appears, select **Data Size**.
- Populate **Originator->Target (OUT)** with **12**, and **Target->Originator (Big IN)** with **176**.

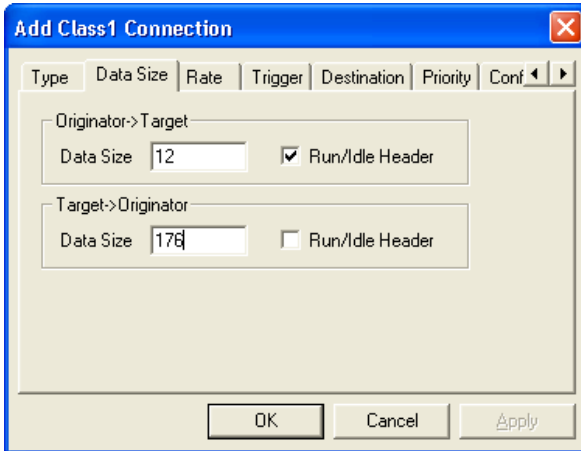

Alternately, **Target->Originator** could be set to **84** for the Small IN assembly.

- Select **Rate** and set packet rate to **20** milliseconds in both directions.

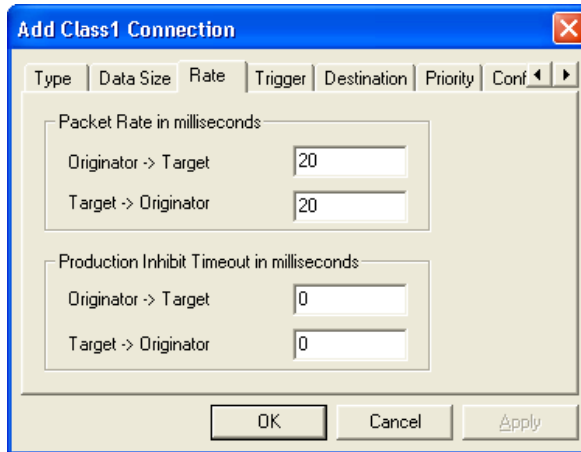

7. Select **Destination**.
8. Populate **Originator->Target (OUT)** with **198**, and **Target->Originator (Big IN)** with **101**.

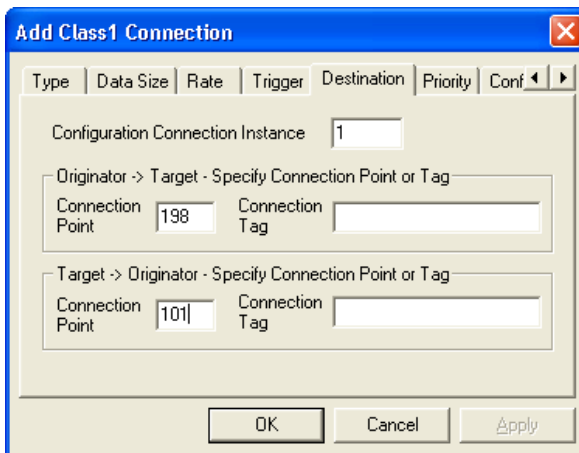

Alternately, **Target->Originator** could be set to **100** for the Small IN assembly.

9. Click **OK** and the IO data windows will appear in the main area.
10. In the **I/O** menu, select **Run mode** so that there is a check mark next to it.

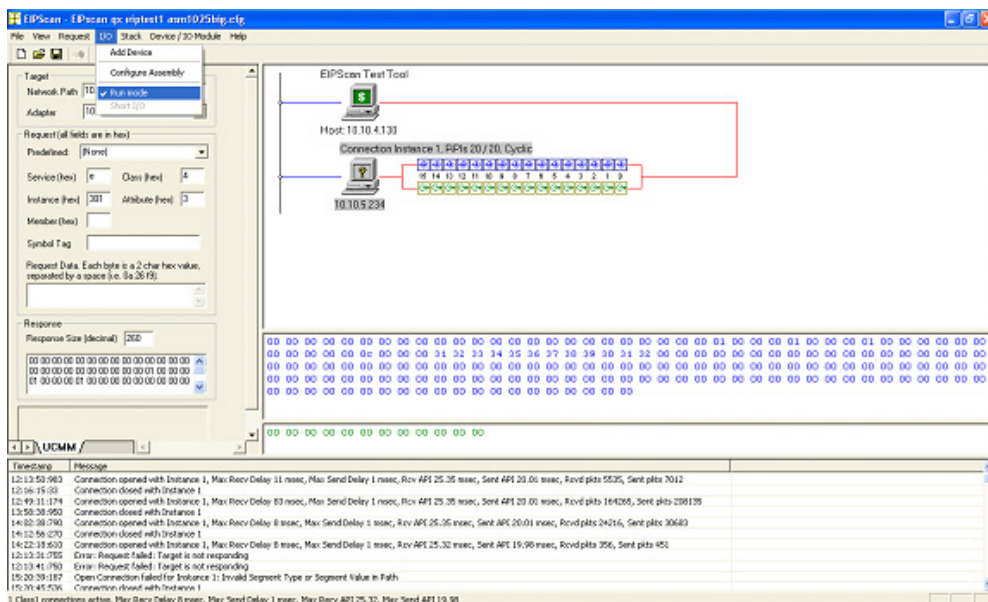

EIPScan Setup

EIPScan begins polling the unit, and displays the content of the **IN** (blue) and **OUT** (green) assemblies.

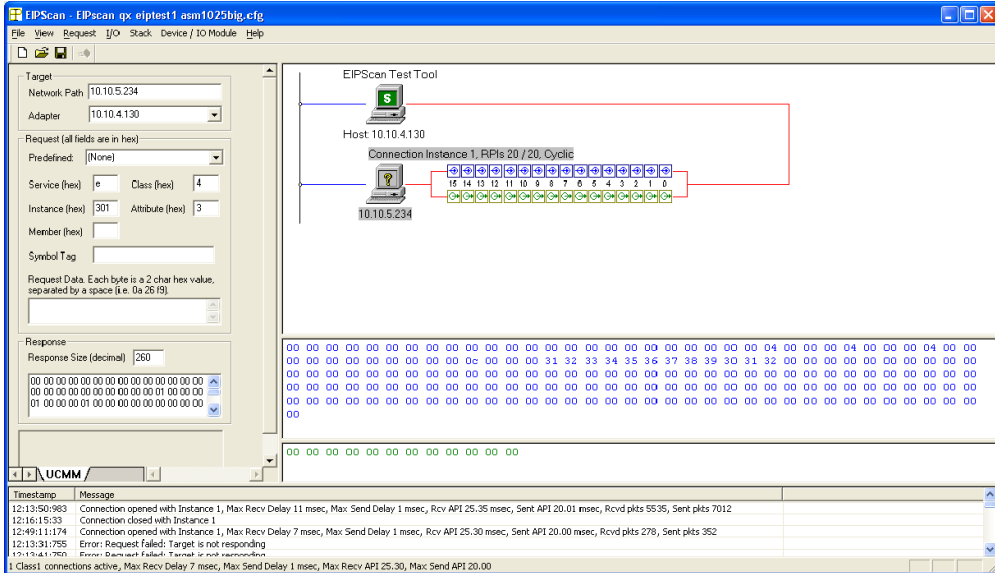

The order of data displayed in each assembly block corresponds to the object model documentation. For a quick test, we can simulate the PLC setting the **User Tag**, with the QX-870 echoing it back.

11. Click on the first byte (User Tag) in the green area (OUT).

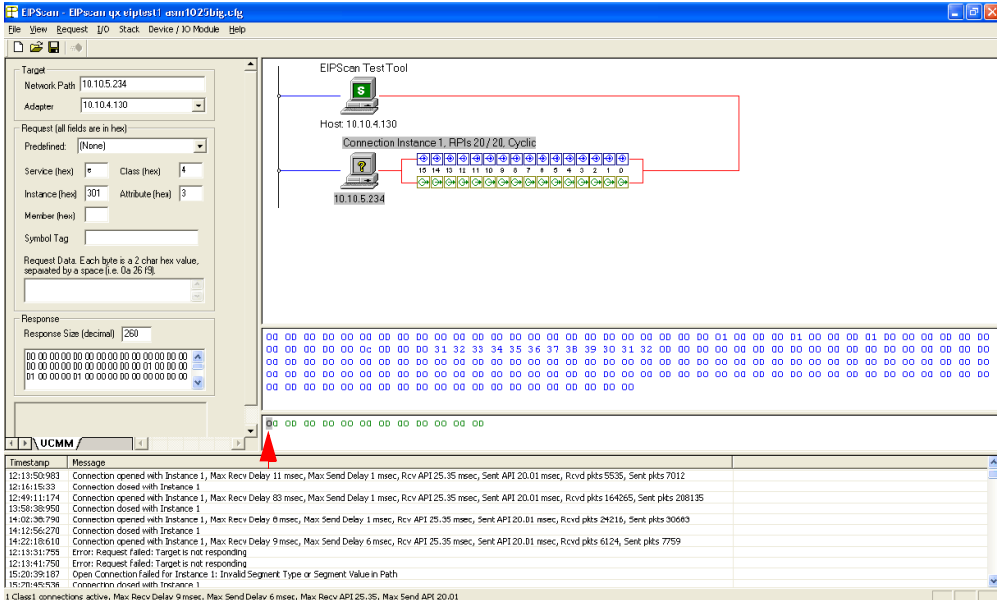

12. Change the first byte to non-zero. The first byte (User Tag echo) in the blue area (IN) will change to the same value.

The screenshot shows the EIPScan Test Tool interface. On the left, the configuration panel shows: Target Network Path 10.10.5.234, Adaptor 10.10.4.130, Service (hex) 4, Instance (hex) 301, Attribute (hex) 3, Member (hex), and Symbol Tag. The Request Data field is empty. The Response Size (decimal) is set to 260. The main window displays a network diagram with Host 10.10.4.130 and Host 10.10.5.234 connected via 'Connection Instance 1, RPIs 20/20, Cyclic'. Below the diagram, a hex data stream is shown. The first line (IN) starts with 'a5' followed by 255 zeros. The second line (OUT) starts with 'a5' followed by 255 zeros. A red arrow points to the first byte 'a5' in the IN section.

All bytes in the green OUT area will be echoed back in the blue IN area, at the same location relative to the beginning of the assemblies. Each byte, and bit, has a unique purpose. Please consult the object model for a description. Note that all data is displayed in little-endian order.

This screenshot is identical to the previous one but includes red callout boxes with labels pointing to specific bytes in the hex data stream. The labels are: 'User Tag echo' (pointing to the first 'a5'), 'Command echo', 'Output control echo', 'Ext In', 'Ext Out', 'Device status', 'Sequence', 'Trigger count', 'Good-Match count', 'Mismatch count', 'Noread count', 'Symbol length', 'Symbol data', and 'User Tag', 'Command', 'Output control' (pointing to the first three bytes of the OUT section).

Appendix O — Interface Standards

Interface Standards, established by the Electronic Industries Association (EIA), specify such things as the signaling voltage levels, maximum cable lengths, and number of drivers. In the QX-870, selection of interface is made by pin assignment and, in the case of host communication, by software switching between RS-232 and RS-422/RS-485.

RS-232

RS-232 defines an interface between two devices such as, for example, the scanner and host. It differs from the other interfaces by dedicating individual pins to specific functions and by requiring both devices to share a common ground line. Since both device chassis are connected to a common ground, a ground loop potential and the possibility of noise interference exists. Therefore cable lengths are limited to a maximum of 50 feet (19.7m). Despite being the most limited, this interface is used frequently because of the large installed base of RS-232 equipment.

RS-422/RS-485

RS-422, unlike RS-232, measures signals differentially; that is, the receiver looks at the potentials between the two receive (or transmit) wires rather than the potential between signal and ground. As a result, cables, if shielded, can be up to 4000 feet (1219m) in length. Like RS-232, RS-422 communication is designed for only two devices on a single line and must have a common ground. It can be used wherever RS-232 is used.

Ethernet TCP/IP and EtherNet/IP

TCP/IP and EtherNet/IP protocols are supported over Ethernet. A 6-byte hardware address is used, which is divided into a 3-byte vendor ID and a 3-byte vendor-defined field. Ethernet-enabled device manufacturers are assigned a unique vendor ID, and are then responsible for insuring that all of their devices have unique addresses in the last 3 bytes.

Appendix P — Glossary of Terms

AGC — See **Automatic Gain Control**.

Analog — A smooth, continuous voltage or current signal or function whose magnitude (value) is the information.

Automatic Gain Control (AGC) — Adjustment to signal strength that seeks to maintain a constant level regardless of the distance between a scanner and symbol.

Baud Rate — The number of discrete signal events per second; bits per second.

Check Character — A Modulus 43 or Modulus 10 character that is added to encoded symbol data for additional data integrity.

Connector — A plug or socket on a device or cable providing in/out connectivity for various circuits and pins.

Concentrator — Intermediary device that relays data from scanners to a host and commands from the host to the scanners or other devices.

Counter — Memory space allocated to keep track of scanner events.

Daisy Chain — Linkage of primary and secondary scanners allowing data to be sent to the host.

Decode — A good read. The successful interpretation and output of the information encoded in a symbol.

Default — Restores non-volatile or flash memory settings, initializes serial commands, and resets all counters.

Delimited — A delimited command or field is bracketed by predefined characters.

Decode Rate — The number of good reads per second achieved by a scanner.

Discrete I/O — Inputs and outputs characterized by discrete signal transitions from one voltage level to another so that digital switching can occur.

End of Read Cycle — The time or condition at which the scanner stops expecting symbol information to decode.

External Edge — Allows a read cycle to be initiated by a trigger signal from an object detector when it detects the appearance of an object. The read cycle ends with a good read, a timeout, or a new trigger.

External Level — Allows a read cycle to be initiated by a trigger signal from a photo sensor. The read cycle ends when the object moves out of the detector's range.

Firmware — Software hard-coded in non-volatile memory and closely tied to specific pieces of hardware.

Fixed Symbol Length — Increases data integrity by ensuring that only one symbol length will be accepted.

Full Duplex — A communication system in which signals can travel simultaneously between devices.

Gain — Optimal signal strength.

Good Read — A decode. The successful scanning and decoding of the information encoded in a symbol.

Glossary of Terms

Half Duplex — A communication system in which signals can travel between devices in both directions, but not simultaneously.

Host — A computer, PLC, or other device that is used to execute commands and process data and discrete signals.

Initialize — Implement serial configuration commands into the scanner's active memory.

Input — A channel or communication line. Decoded data or a discrete signal that is received by a device.

Ladder Orientation — A linear symbol orientation in which the bars are parallel to the symbol's direction of travel.

LED — See **Light-Emitting Diode**.

Light-Emitting Diode (LED) — A semiconductor device that emits light when conducting current.

Multidrop — A communication protocol for networking two or more scanners or other devices with a concentrator (or controller) and characterized by the use of individual device addresses and the RS-485 standard.

Noise — The same as static in a phone line or "snow" in a television picture, noise is any unwanted electrical signal that interferes with the symbol data being decoded and transmitted by the scanner.

Normally Closed — A discrete output state that is only active when open.

Normally Open — A discrete output state that is only active when closed.

Output — A channel or communication line. Data or discrete signals that are transmitted or displayed by a device.

Parity — An error detection routine in which one data bit in each character is set to 1 or 0 so that the total number of 1 bits in the data field is even or odd.

Picket Fence Orientation — A linear symbol orientation in which the bars are perpendicular to the symbol's direction of travel.

Pitch — Rotation of a symbol around an axis parallel to the symbol length on the substrate.

PLC — See **Programmable Logic Controller**.

Port — Logical circuit for data entry and exit. (One or more ports may be included within a single connector.)

Programmable Logic Controller (PLC) — An electronic device used in industrial automation environments such as factory assembly lines and automotive manufacturing facilities.

Protocol — The rules for communication between devices, providing a means to control the orderly flow of information between linked devices.

Read Cycle — A programmed period of time or condition during which a scanner will accept symbol input.

Skew — Rotation of a symbol around an axis parallel to the symbol height on the substrate.

Substrate — The surface upon which a symbol is printed, stamped, or etched.

Symbol Transitions — The transition of bars and spaces on a symbol, used to detect the presence of a symbol on an object.

Symbology — A symbol type, such as Code 39 or Code 128, with special rules to define the widths and positions of bars and spaces to represent specific numeric or alphanumeric information.

Tilt — Rotation of a symbol around an axis perpendicular to the substrate.

Trigger — A signal, transition, or character string that initiates a read cycle.

Very Large-Scale Integration (VLSI) — The creation of integrated circuits by combining thousands of transistor-based circuits on a single chip.

