



50.00

REV

PACK

Q2V

Driving Quality

Installation & Operation Instructions

Item code: Q2V-Axxxx-xxx

200 V Class, Three-Phase: 0.1 to 22 kW

200 V Class, Single-Phase: 0.1 to 4.0 kW

400 V Class, Three-Phase: 0.37 to 30 kW



WARNING

Risk of electric shock.



• Read manual before installing • Wait 5 minutes for capacitor removing power and opening the manual switch between the drive and motor.



AVERTISSEMENT

Risque de choc électrique



• Lire le manuel avant l'installation. Attendre 5 minutes après avoir coupé l'alimentation et déconnecte la protection entre le driver et le moteur, pour permettre la décharge des condensateurs

1 English

◆ General Information

Do not use this manual as a replacement for the Technical Manual. The products and specifications given in this manual and the manual contents can change without notice to make the product and manual better. Be sure to always use the most recent version of this manual. Use the manual for the correct installation, wiring, adjustment, and operation of this product. This manual is available for download on our documentation website. Refer to the back page of this manual.

◆ Qualifications for the Intended User

This manual is created for electrical specialists and engineers who have experience with AC drive installation, adjustment, repair, inspection, and parts replacement. Persons without technical training, minors, persons with disabilities or mental problems, persons with perception problems, and persons with pacemakers must not use or operate this product.

◆ Safety

Read the safety guidelines carefully before installing, wiring, or operating this product.

■ Explanation of Signal Words

⚠ DANGER

Identifies a hazardous situation, which, if not avoided, will cause death or serious injury.

⚠ WARNING

Identifies a hazardous situation, which, if not avoided, can cause death or serious injury.

⚠ CAUTION

Identifies a hazardous situation, which, if not avoided, can cause minor or moderate injury.

NOTICE

Identifies a property damage message.

■ General Safety Instructions

The manufacturer manufactures and supplies electronic components for a variety of industrial applications. The selection and application of products is the responsibility of the designer of the equipment or the customer that assembles the final product. The manufacturer is not responsible for how our products are incorporated into the final system design. In all cases, our products should not be incorporated into a product or design as the exclusive or sole safety control function. All control functions are designed to dynamically detect failures and operate safely without exception. All products that are designed to incorporate parts manufactured by us must be provided to the end user and include proper warnings and instructions regarding their safe use and operation. All warnings from the manufacturer must be promptly issued to the end user. The manufacturer offers warranties only for the quality of our products, in compliance with standards and specifications that are described in the manual. The manufacturer does not offer other warranties, either explicit or implied. Injuries, property damage, and lost business opportunities caused by improper storage or handling and negligence oversight on the part of your company or your customers will void our warranty for the product.

Note:

Failure to obey the safety messages in the manual can cause serious injury or death. The manufacturer is not responsible for injuries or damage to equipment caused by ignoring the safety messages.

- Read this manual carefully when mounting, operating, and repairing AC drives.
- Obey all warnings, cautions, and notices.
- Approved personnel must perform all work.
- Install the drive in an area with these conditions.

⚠ DANGER *Electrical Shock Hazard. Electrical Shock Hazard. Do not examine, connect, or disconnect wiring on an energized drive. Before servicing, disconnect all power to the equipment and wait for the time specified on the warning label at a minimum. The internal capacitor stays charged after the drive is de-energized. The charge indicator LED extinguishes when the DC bus voltage decreases below 50 Vdc. When all indicators are OFF, measure for dangerous voltages to make sure that the drive is safe. If you do work on the drive when it is energized, it will cause serious injury or death from electrical shock.*

⚠ WARNING *Fire Hazard. Do not connect power supply wiring to drive output terminals U/T1, V/T2, and W/T3. Connect power supply wiring to main circuit input terminals R/L1, S/L2, and T/L3. Failure to obey can cause death or serious injury.*

⚠ WARNING *Crush Hazard. Only approved personnel can operate a crane or hoist to move the drive. Failure to obey can cause death or serious injury from falling equipment.*

⚠ WARNING *Electrical Shock Hazard. Do not make changes to the drive body or drive circuitry. Failure to obey can cause death or serious injury and will void warranty. The manufacturer is not responsible for changes to the product made by the user.*

⚠ WARNING *Electrical Shock Hazard. Only let authorized persons install, wire, maintain, examine, replace parts, and repair the drive. Failure to obey can cause death or serious injury.*

⚠ WARNING *Electrical Shock Hazard. Always ground the motor-side grounding terminal. Contacting the motor case can cause death or serious injury from incorrect equipment grounding.*

⚠ WARNING *Electrical Shock Hazard. Do not work on the drive or around the drive while wearing loose clothing or jewelry. Tighten loose clothing and remove all metal objects such as watches or rings. Failure to obey can cause death or serious injury.*

⚠ WARNING *Electrical Shock Hazard. The leakage current of the drive will be more than 3.5 mA. The IEC/EN 61800-5-1: 2007 standard specifies that users must wire the power supply to automatically turn off when the protective ground wire disconnects. Users can also connect a protective ground wire that has a minimum cross-sectional area of 10 mm² (copper wire) or 16 mm² (aluminum wire). Failure to obey these standards can cause death or serious injury.*

⚠ WARNING *Sudden Movement Hazard. Remove all persons and objects from the area around the drive, motor, and load before starting Auto-Tuning. The drive and motor can start suddenly during Auto-Tuning and cause death or serious injury.*

⚠ WARNING *Sudden Movement Hazard. Remove all persons and objects from the area around the drive, motor, and machine area and attach covers, couplings, shaft keys, and machine loads before energizing the drive. Failure to obey can cause death or serious injury.*

⚠ WARNING *Fire Hazard. Do not use the main circuit power supply (Overcurrent Category III) at incorrect voltages. Make sure that the drive rated voltage aligns with the power supply voltage before energizing the drive. Failure to obey can cause death or serious injury.*

⚠ WARNING *Fire Hazard. Do not put flammable or combustible materials on top of the drive and do not install the drive near flammable or combustible materials. Attach the drive to metal or other noncombustible material. Failure to obey can cause death or serious injury.*

⚠ WARNING *Fire Hazard. Tighten all terminal screws to the correct tightening torque. Connections that are too loose or too tight can cause incorrect operation and damage to the drive. Incorrect connections can also cause death or serious injury from fire.*

⚠ WARNING *Fire Hazard. Tighten screws against the bit at an angle in the specified range described in this manual. Tightening screws at an angle outside of the specified range can cause damage the terminal block or start a fire if the connection is loose.*

⚠ WARNING *Electrical Shock Hazard. Do not cause a short circuit on the drive output circuit. Failure to obey can cause death or serious injury.*

⚠ WARNING *Electrical Shock Hazard. Always use a type B Residual Current Monitor/Residual Current Device (RCM/RCD) where a residual current operated protective or monitoring device protects against direct or indirect contact as specified by IEC/EN 60755 The drive can cause a residual current with a DC component in the protective earthing conductor. Failure to obey can cause death or serious injury.*

⚠ WARNING *Electrical Shock Hazard. Ground the neutral point on the power supply to comply with the EMC Directive before turning on the EMC filter or if there is high resistance grounding. If the EMC filter is switched ON without the neutral point being grounded or if there is high resistance grounding, it can cause death or serious injury.*

⚠ WARNING *Electrical Shock Hazard. Do not immediately energize the drive or operate peripheral devices after the drive blows a fuse or trips an RCM/RCD. Wait for the time specified on the warning label at a minimum and make sure that all indicators are OFF. Then check the wiring and peripheral device ratings to find the cause of the problem. Contact the manufacturer before energizing the drive or peripheral devices if the cause is not known. Failure to obey can cause death or serious injury and damage to the drive.*

⚠ WARNING *Crush Hazard. Test the system to make sure that the drive operates safely after you wire the drive and set parameters. If you do not test the system, it can cause damage to equipment or serious injury or death*

⚠ WARNING *Fire Hazard. Install sufficient branch circuit short circuit protection as specified by applicable codes and this manual. The drive is suited for circuits that supply not more than 31,000 RMS symmetrical amperes, 240 Vac maximum (200 V Class), 480 Vac maximum (400 V Class). Failure to obey can cause death or serious injury.*

⚠ CAUTION *Crush Hazard. Do not hold the drive by the front cover or terminal cover. Tighten the screws correctly before moving the drive. Failure to obey can cause minor to moderate injury.*

⚠ CAUTION *Burn Hazard. Do not touch a hot drive heatsink. De-energize the drive, wait 15 minutes minimum, and make sure that the heatsink is cool to replace the cooling fans. Failure to obey can cause minor to moderate injury.*

NOTICE *Observe correct electrostatic discharge (ESD) procedures when touching the drive and circuit boards. Failure to obey can cause ESD damage to the drive circuitry.*

NOTICE *Do not connect or disconnect the motor from the drive while the drive is supplying voltage. Incorrect equipment sequencing can cause damage to the drive.*

NOTICE *Do not do a withstand voltage test or Megger test on the drive. Failure to obey can cause damage to the drive.*

NOTICE *Do not connect or operate damaged equipment or equipment with missing parts. Failure to obey can cause damage to the drive and connected equipment.*

NOTICE *Install fuses and an RCM/RCD. Failure to obey can cause damage to the drive.*

NOTICE *Do not use unshielded wire for control wiring. Use shielded, twisted-pair wires and ground the shield to the ground terminal of the drive. Failure to obey can cause electrical interference and unsatisfactory system performance.*

NOTICE *Do not allow unqualified personnel to use the product. Before you connect a dynamic braking option to the drive, make sure that you review "Braking Unit, Braking Resistor Unit Instruction Manual (TOBPC72060001)". Failure to obey can cause damage to the drive and braking circuit.*

NOTICE *Make sure that all connections are correct after you install the drive and connecting peripheral devices. Failure to obey can cause damage to the drive.*

NOTICE *Do not connect phase-advancing capacitors, LC/RC noise filters, or leakage breakers (RCM/RCD) to the motor circuit. If you connect these devices to the output circuits, it can cause damage to the drive and connected equipment.*

NOTICE *Use an inverter-duty motor or vector-duty motor with reinforced insulation and windings applicable for use with an AC drive. If the motor does not have the correct insulation, it can cause a short circuit or ground fault from insulation deterioration.*

NOTICE *Do not put devices that radiate strong electromagnetic waves, for example radio transmitters, near the drive. If you use these devices near the drive, the drive can operate incorrectly.*

■ Intended Use

This AC drive is electrical equipment that controls the speed and rotational direction of a motor in a commercial application. Do not use this product for other functions.

1. Read and understand all safety precautions.
2. Wire and ground the drive as specified by all applicable standards and safety precautions.
3. Tightly attach all parts and protective covers.
4. Always use the product in the correct environmental conditions as specified in this manual.

Note:



This product is not designed and manufactured for use in life-support machines or systems.





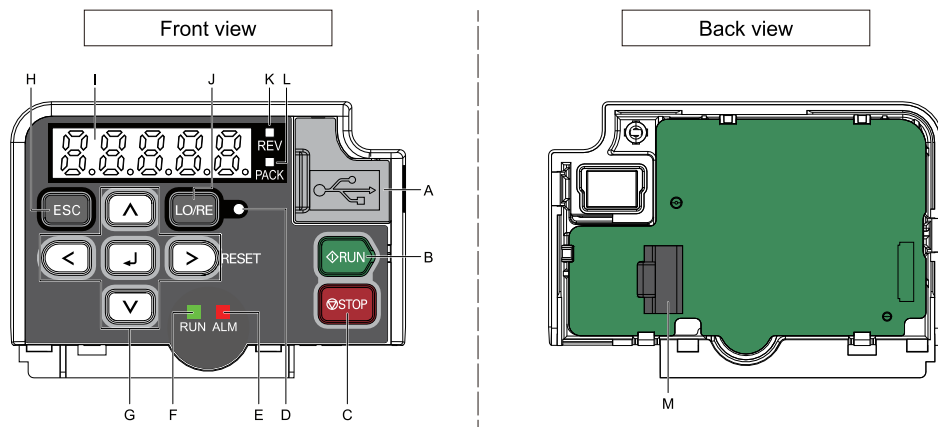

▲ WARNING *Injury to Personnel. This product is manufactured with strict quality-control guidelines. Install applicable safety devices to minimize the risk of accidents when installing the product where its failure could cause a life-or-death situation, loss of human life, or a serious accident or physical injury.*











■ Exclusion of Liability

The manufacturer cannot be held responsible for any damages to the product, equipment or persons if this product is used in any other way than specified in *Intended Use on page 4*.

◆ Keypad: Names and Functions**Figure 1.1 Keypad****Table 1.1 Keypad: Names and Functions**

Symbol	Name	Function
A	USB Terminal	Insertion point for a USB cable. Use a USB cable (USB standard 2.0, type A - mini-B) to connect the drive to a PC.
B	RUN Key 	Starts the drive in LOCAL Mode. Starts the motor tuning procedure in Auto-Tuning Mode. Note: Before you use the keypad to operate the motor, push  on the keypad to set the drive to LOCAL Mode.

Symbol	Name	Function
C	STOP Key 	Stops drive operation. Note: Uses a stop-priority circuit. Push  to stop the motor. This will also stop the motor when a Run command is active at an external Run command source (REMOTE Mode). To disable  priority, set $o2-02 = 0$ [STOP Key Selection of Function = Disabled].
D	LO/RE LED 	<ul style="list-style-type: none"> • Illuminated: The keypad controls the Run command (LOCAL Mode). • OFF: The control circuit terminal or serial transmission device controls the Run command (REMOTE Mode). Note: <ul style="list-style-type: none"> • LOCAL: Operated using the keypad. Use the keypad to enter Run/Stop commands and the frequency reference command. • REMOTE: Operated from the control circuit terminal or serial transmission. Use the frequency reference source entered in $b1-01$ and the Run command source selected in $b1-02$.
E	ALM/ERR LED 	<ul style="list-style-type: none"> • Illuminated: The drive detects a fault. • OFF: There are no drive faults or alarms. • Flashing: <ul style="list-style-type: none"> – An alarm – An oPE parameter setting error – An Auto-Tuning error Note: The LED will illuminate to identify a fault if the drive detects a fault and an alarm at the same time.
F	RUN LED 	Illuminated: The drive is in regular operation. OFF: The drive is stopped. Flashing: <ul style="list-style-type: none"> • The drive is decelerating to stop. • The drive received a Run command, but the frequency reference is 0 Hz. Flashing quickly: <ul style="list-style-type: none"> • The drive received a Run command from the MFDI terminals and is switching to REMOTE Mode while the drive is in LOCAL Mode. • The drive received a Run command from the MFDI terminals when the drive is not in Drive Mode. • The drive received a Fast Stop command. • The safety function shuts off the drive output. <ul style="list-style-type: none"> • The user pushed  on the keypad while the drive is operating in REMOTE Mode. • The drive is energized with an active Run command and $b1-17 = 1$ [RUN@PowerUp Selection = Disregard RUN].

Sym bol	Name	Function
G	Left Arrow Key 	Moves the cursor to the left.
	Up Arrow Key/ Down Arrow Key  / 	<ul style="list-style-type: none"> Moves to a different screen. Selects parameter numbers and increments or decrements setting values.
	Right Arrow Key (RESET) 	<ul style="list-style-type: none"> Moves the cursor to the right. Restarts the drive to clear a fault.
	ENTER Key 	<ul style="list-style-type: none"> Enters parameter values and settings. Selects each mode, parameter, and set value.
H	ESC Key 	<ul style="list-style-type: none"> Goes back to the previous screen. Push and hold to go back to the frequency reference screen (the initial screen).
I	LED Display	Shows parameters, errors, and other data.
J	LO/RE Selection Key 	<p>Switches drive control for the Run command and frequency reference between the keypad (LOCAL) and an external source (REMOTE).</p> <p>Note:</p> <ul style="list-style-type: none"> The LOCAL/REMOTE Selection Key continuously stays enabled after the drive stops in Drive Mode. If the application must not switch from REMOTE to LOCAL because it will have a negative effect on system performance, set $o2-01 = 0$ [<i>LO/RE Key Selection of Function = Disabled</i>] to disable . If the drive is receiving a Run command from an external source, it will not switch between LOCAL and REMOTE.
K	REV LED 	Illuminated: The drive received a Reverse run command.
L	PACK LED 	Illuminated: The drive is In Q2Pack operation.
M	RJ-45 Connector	Connects to the drive using an RJ-45 8-pin straight through UTP CAT5e extension cable or keypad connector.

▲ WARNING *Sudden Movement Hazard. The drive may start unexpectedly if switching control sources when setting $b1-07 = 2$ [LO/RE Run Selection = Accept RUN]. Clear all personnel from rotating machinery and electrical connections prior to switching control sources. Failure to comply may cause death or serious injury.*

◆ Mechanical Installation

▲ WARNING *Fire Hazard. Do not put flammable or combustible materials on top of the drive and do not install the drive near flammable or combustible materials. Attach the drive to metal or other noncombustible material. Failure to obey can cause death or serious injury.*

▲ CAUTION *Crush Hazard. Do not hold the drive by the front cover or terminal cover. Tighten the screws correctly before moving the drive. Failure to obey can cause minor to moderate injury.*

NOTICE *Do not put drive peripheral devices, transformers, or other electronics near the drive. Shield the drive from electrical interference if components must be near the drive. Failure to obey can cause incorrect operation.*

NOTICE Do not let unwanted objects, for example metal shavings or wire clippings, fall into the drive during drive installation and project construction. Put a temporary cover over the top of the drive during installation. Remove the temporary cover before start-up or the drive will overheat. Failure to obey can cause damage to the drive.

NOTICE Install the drive as specified by EMC Guidelines. Failure to obey can cause incorrect operation and damage to electrical devices.

NOTICE Obey correct electrostatic discharge (ESD) procedures when you touch the drive. Incorrect ESD procedures can cause damage to the drive circuitry.

■ Installation Environment

The installation environment is important for the lifespan of the product and to make sure that the drive performance is correct. Make sure that the installation environment agrees with these specifications.

Environment	Conditions
Area of Use	Indoors
Power Supply	Overvoltage Category III
Ambient Temperature Setting	IP20 enclosure: -10 °C to +50 °C (14 °F to 122 °F). UL Type 1 enclosure: -10 °C to +40 °C (14 °F to 104 °F). <ul style="list-style-type: none"> • Drive reliability is better in environments that do not have wide temperature fluctuations. • When installing the drive in an enclosure, use a cooling fan or air conditioner to keep the internal air temperature in the permitted range. • Do not let the drive freeze.
Humidity	95% RH or less, non-condensing
Storage Temperature	-20 °C to +70 °C (-4 °F to +158 °F)
Surrounding Area	Pollution degree 2 or less Install the drive in an area without: <ul style="list-style-type: none"> • Oil mist, corrosive or flammable gas, or dust • Metal powder, oil, water, or other unwanted materials • Radioactive materials or flammable materials • Harmful gas or fluids • Salt • Direct sunlight Keep wood and other flammable materials away from the drive.
Altitude	1000 m (3281 ft.) maximum Note: Derate the output current by 1% for each 100 m (328 ft.) to install the drive in altitudes between 1000 m to 4000 m (3281 ft. to 13123 ft.). It is not necessary to derate the rated voltage in these conditions: <ul style="list-style-type: none"> • When installing the drive at 2000 m (6562 ft.) or lower • When installing the drive between 2000 m to 4000 m (6562 ft. to 13123 ft.) and grounding the neutral point on the power supply. Contact the manufacturer or your nearest sales representative when not grounding the neutral point.
Vibration	<ul style="list-style-type: none"> • 10 Hz to 20 Hz: 1 G (9.8 m/s², 32.15 ft/s²) • 20 Hz to 55 Hz: 0.6 G (5.9 m/s², 19.36 ft/s²)
Installation Position	Install the drive vertically for sufficient cooling airflow.

■ Removing the Covers

▲ DANGER *Electrical shock Hazard. Disconnect the power to the drive and wait for the charge indicator LED to go off, then remove the covers. Failure to obey could cause death or serious injury.*

◆ Electrical Installation

▲ DANGER *Electrical Shock Hazard. Electrical Shock Hazard. Do not examine, connect, or disconnect wiring on an energized drive. Before servicing, disconnect all power to the equipment and wait for the time specified on the warning label at a minimum. The internal capacitor stays charged after the drive is de-energized. The charge indicator LED extinguishes when the DC bus voltage decreases below 50 Vdc. When all indicators are OFF, measure for dangerous voltages to make sure that the drive is safe. If you do work on the drive when it is energized, it will cause serious injury or death from electrical shock.*

▲ WARNING *Electrical Shock Hazard. Make sure that all electrical connections are correct and install all drive covers before energizing the drive. Use terminals for their intended function only. Incorrect wiring or ground connections, and incorrect repair of protective covers can cause death or serious injury.*

▲ WARNING *Electrical Shock Hazard. Correctly ground the drive before turning on the EMC filter switch. Failure to obey can cause death or serious injury.*

▲ WARNING *Electrical Shock Hazard. Use the terminals for the drive only for their intended purpose. Refer to the technical manual for more information about the I/O terminals. Wiring and grounding incorrectly or modifying the cover may damage the equipment or cause injury.*

■ Standard Connection Diagram

Wire the drive as specified by [Figure 1.2](#). Refer to [Main Circuit Wire Gauges and Tightening Torques on page 44](#) for wire gauges and tightening torques as specified by European standards and UL standards.

▲ WARNING *Sudden Movement Hazard. Set the MFDI terminal parameters before you close the control circuit wiring. Incorrect Run/Stop circuit sequence settings can cause death or serious injury from moving equipment.*

▲ WARNING *Sudden Movement Hazard. Correctly wire the start/stop and safety circuits before energizing the drive. Momentarily closing a digital input terminal can start a drive that is programmed for 3-Wire control. Failure to obey can cause death or serious injury from moving equipment.*

▲ WARNING *Sudden Movement Hazard. When you use a 3-Wire sequence, set A1-03 = 3330 [Init Parameters = 3-Wire Initialization] and make sure that b1-17 = 1 [RUN@PowerUp Selection = Disregard RUN] (default). If you do not correctly set the drive parameters for 3-Wire operation before you energize the drive, the motor can suddenly rotate in reverse when you energize the drive. This can cause serious injury or death.*

▲ WARNING *Fire Hazard. Install sufficient branch circuit short circuit protection as specified by applicable codes and this manual. The drive is suited for circuits that supply not more than 31,000 RMS symmetrical amperes, 240 Vac maximum (200 V Class), 480 Vac maximum (400 V Class). Failure to obey can cause death or serious injury.*

NOTICE *When the input voltage is 440 V or higher or if the wiring distance is longer than 100 m (328 ft.), be sure to use a drive duty motor or carefully monitor the motor insulation voltage. Failure to obey can cause damage to the motor insulation.*

NOTICE *Do not connect the AC control circuit ground to the drive enclosure. Failure to obey can cause incorrect control circuit operation.*

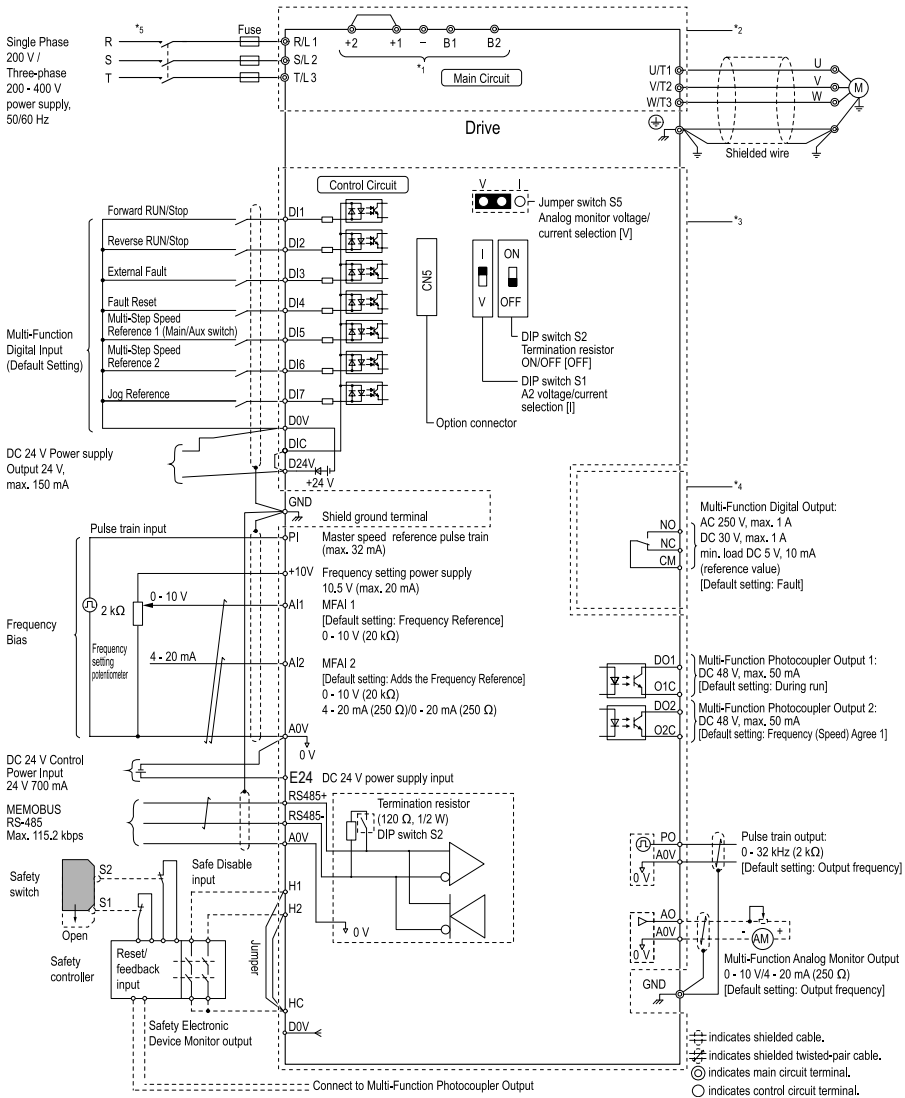

Figure 1.2 Standard Connection Diagram

*1 For three-phase 200 V class and 400 V class drives, use terminals -, +1, +2, B1, and B2 to connect options to the drive. For single-phase 200 V class drives, use terminals -, +1, B1, and B2 to connect options to the drive.

▲ WARNING *Fire Hazard. Only connect factory-recommended devices or circuits to drive terminals B1, B2, -, +1, +2, and +3 terminals. Do not connect AC power to these terminals. Incorrect wiring can cause damage to the drive and serious injury or death from fire.*

*2 For circuit protection, the main circuit is separated from the surface case that can touch the main circuit.

*3 The control circuit is a Safety Extra-Low Voltage circuit. Separate this circuit from other circuits with reinforced insulation. Make sure that the Safety Extra-Low Voltage circuit is connected as specified.

- *4 Reinforced insulation separates the output terminals from other circuits. Users can also connect circuits that are not Safety Extra-Low Voltage circuits if the drive output is 250 Vac 1 A max. or 30 Vdc 1 A maximum.
- *5 Set $L8-05 = 1$ [In PhaseLoss Selection = Enabled] or set the wiring sequence to prevent input phase loss.

■ Control Circuit Wire Gauges and Tightening Torques

Use shielded wire for control circuit terminal wiring. Use crimp ferrules on the wire ends for more reliable wiring.

Table 1.2 Wire Gauges

Terminal	Bare Wire		Crimp Ferrule	
	Recommended Gauge mm ² (AWG)	Applicable Gauge mm ² (AWG)	Recommended Gauge mm ² (AWG)	Applicable Gauge mm ² (AWG)
E24V, DI1-DI7, D0V, DIC, D24V AO, A0V, AI1, AI2, +10V, H1, H2, HC PO, PI, RS485+, RS485-, DO1, O1C, DO2, O2C	0.75 (18)	<ul style="list-style-type: none"> Stranded wire 0.25 - 1.0 (24 - 17) Solid wire 0.25 - 1.5 (24 - 16) 	0.5 (20)	0.25 to 0.5 (24 to 20)
NO, NC, CM	0.75 (18)	<ul style="list-style-type: none"> Stranded wire 0.25 - 1.5 (24 - 16) Solid wire 0.25 - 1.5 (24 - 16) 	0.5 (20)	0.25 to 1.0 (24 to 17)

Crimp Ferrules

Attach an insulated sleeve to the wire when you use crimp ferrules. We recommend the CRIMPFOX 6 crimping tool from PHOENIX CONTACT.

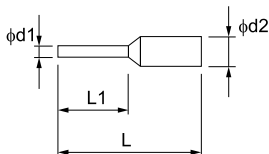

Figure 1.3 Crimp Ferrule Dimensions

Table 1.3 Crimp Ferrule Models and Dimensions

Wire Gauge mm ² (AWG)	Model	L (mm)	L1 (mm)	d1 (mm)	d2 (mm)
0.25 (24)	AI 0.25-8YE	12.5	8	0.8	2.0
0.34 (22)	AI 0.34-8TQ	12.5	8	0.8	2.0
0.5 (20)	AI 0.5-8WH, AI 0.5-8OG	14	8	1.1	2.5

◆ Drive Start-Up

Refer to the motor nameplate and record the information in this table before you start the drive.

Item	Value
Motor Rated Power	kW
Motor Rated Voltage	V
Motor Rated Current	A
Motor Rated Frequency	Hz

Item	Value
Motor Maximum Frequency	Hz
Number of Motor Poles	
Motor Base Rotation Speed	min ⁻¹ (r/min)
Number of Motor Encoder Pulses	ppr

Note:

- When you change A1-02 [Control Method], the settings of some parameters automatically change.
- This manual also shows parameters that are not in Setup Mode. Use the  to set the parameters not shown in the Setup Mode.

◆ Drive Parameters

Refer to the following table when setting the most important parameters.

Note:

You can change parameters with "RUN" in the "No." column during Run.

No. (Hex.)	Name	Description
A1-02 (0102)	Control Method	Sets the control method for the drive application and the motor. 0: V/f Control, 1: PG V/f Control, 2: OLVector, 3: CLVector, 4: Adv OLVector, 5: PM OLVector, 6: PM AOLVector, 7: PM CLVector, 8: EZ Vector
A1-03 (0103)	Init Parameters	Sets parameters to default values. 0: No Initialization, 1110: User / Solution Initialization, 2220: 2-Wire Initialization, 3330: 3-Wire Initialization, 4440: Q2pack Init
b1-01 (0180)	Freq. Ref. Sel. 1	Sets the input method for the frequency reference. 0: Keypad, 1: Analog Input, 2: Modbus, 3: Option PCB, 4: Pulse Train Input
b1-02 (0181)	Run Comm. Sel 1	Sets the input method for the Run command. 0: Keypad, 1: Analog Input, 2: Modbus, 3: Option PCB
b1-03 (0182)	Stopping Method Selection	Sets the method to stop the motor after removing a Run command or entering a Stop command. 0: Ramp->Stop, 1: Coast->Stop, 2: DC Inj->Stop, 3: Timed Coast->Stop, 9: Distance Stop
b1-04 (0183)	Reverse Operation Selection	Sets the reverse operation function. Disable reverse operation in fan or pump applications where reverse rotation is dangerous. 0: Enabled, 1: Disabled
C1-01 (0200) RUN	Accel Time 1	Sets the length of time to accelerate from zero to maximum output frequency.
C1-02 (0201) RUN	Decel Time 1	Sets the length of time to decelerate from maximum output frequency to zero.
C2-01 (020B)	Jerk@Start of Accel	Sets the jerk acceleration time at start.

No. (Hex.)	Name	Description
C2-02 (020C)	Jerk@End of Accel	Sets the jerk acceleration time at completion.
C2-03 (020D)	Jerk@Start of Decel	Sets the jerk deceleration time at start.
C2-04 (020E)	Jerk@End of Decel	Sets the jerk deceleration time at completion.
C6-01 (0223)	ND/HD Duty Selection	Sets the drive duty rating. 0: HD Rating, 1: ND Rating
C6-02 (0224)	Carrier Frequency Selection	Sets the carrier frequency for the transistors in the drive. 1: 2.0 kHz, 2: 5.0 kHz (4.0 kHz for AOLV/PM), 3: 8.0 kHz (6.0 kHz for AOLV/PM), 4: 10.0 kHz (8.0 kHz for AOLV/PM), 5: 12.5 kHz (10.0 kHz for AOLV/PM), 6: 15.0 kHz (12.0 kHz AOLV/PM), 7: Swing PWM 1 (Audible Sound 1), 8: Swing PWM 2 (Audible Sound 2), 9: Swing PWM 3 (Audible Sound 3), A: Swing PWM 4 (Audible Sound 4), B: Leakage Current Rejection PWM, F: User (C6-03 to C6-05)
d1-01 to d1-16 (0280 - 0291) RUN	Reference 1 to Reference 16	Sets the frequency reference in the units from <i>o1-03 [FrqDisplay Unit Selection]</i> .
d1-17 (0292) RUN	Jog Reference	Sets the JOG frequency reference in the units from <i>o1-03 [FrqDisplay Unit Selection]</i> . Set <i>H1-xx: MFDI Function Select = 6 [Jog Reference]</i> to use the Jog frequency reference.
d2-01 (0289)	FRef Upper Limit	Sets maximum limit for all frequency references. This value is a percentage of <i>E1-04 [Max Output Frequency]</i> .
d2-02 (028A)	FRef Lower Limit	Sets minimum limit for all frequency references. This value is a percentage of <i>E1-04 [Max Output Frequency]</i> .
E1-01 (0300)	Input AC Supply Voltage	Sets the drive input voltage.
E1-04 (0303)	Max Output Frequency	Sets the maximum output frequency for the V/f pattern.
E1-05 (0304)	Max Output Voltage	Sets the maximum output voltage for the V/f pattern.
E1-06 (0305)	Base Frequency	Sets the base frequency for the V/f pattern.
E1-09 (0308)	Min Output Frequency	Sets the minimum output frequency for the V/f pattern.
E2-01 (030E)	Mot Rated Current (FLA)	Sets the motor rated current in amps.
E2-11 (0318)	Motor Rated Power (kW)	Sets the motor rated output in 0.01 kW increments.

No. (Hex.)	Name	Description
H1-01 - H1-07 (0438, 0439, 0400 - 0404)	DI1 Function Selection to DI7 Function Selection	Sets the functions for MFDI terminals DI1 to DI7.
H2-01 (040B)	NO,NC,CM FuncSelection	Sets the function for MFDO terminal NO-CM, or NC-CM.
H2-02 (040C)	DO1-O1C FuncSelection	Sets the function for MFDO terminal DO1-O1C.
H2-03 (040D)	DO2-O2C Funct Selection	Sets the function for MFDO terminal DO2-O2C.
H3-01 (0410)	AI1 Signal Level Select	Sets the input signal level for MFAI terminal AI1. 0: 0 to 10V (Lower Limit at 0), 1: 0 to +10V (Without Lower Limit)
H3-02 (0434)	AI1 Function Selection	Sets a function for MFAI terminal AI1.
H3-03 (0411) RUN	AI1 Gain Setting	Sets the gain of the analog signal input to MFAI terminal AI1.
H3-04 (0412) RUN	AI1 Bias Setting	Sets the bias of the analog signal input to MFAI terminal AI1.
H3-09 (0417)	AI2 Signal Level Select	Sets the input signal level for MFAI terminal AI2. 0: 0 to 10V (Lower Limit at 0), 1: 0 to +10V (Without Lower Limit)
H3-10 (0418)	AI2 Function Selection	Sets a function for MFAI terminal AI2.
H3-11 (0419) RUN	AI2 Gain Setting	Sets the gain of the analog signal input to MFAI terminal AI2.
H3-12 (041A) RUN	AI2 Bias Setting	Sets the bias of the analog signal input to MFAI terminal AI2.
H3-13 (041B)	An.In FilterTime Constant	Sets the time constant to apply a primary delay filter to the MFAI terminal.
H3-14 (041C)	An.In Term.Enable Sel	Sets the enabled terminal or terminals when <i>H1-xx: MFDI Function Select = 12 [AI Input Sel]</i> is ON. 1: AI1 only, 2: AI2 only, 3: AI1 and AI2
H4-01 (041D)	AO An.Out Select	Sets the monitor number to send from MFAO terminal AO.
H4-02 (041E) RUN	AO An.Out Gain	Sets the gain of the monitor signal that is sent from MFAO terminal AO.

No. (Hex.)	Name	Description
H4-03 (041F) RUN	AO An.Out Bias	Sets the bias of the monitor signal that is sent from MFAO terminal AO.
H4-07 (0423)	AO Signal Level Select	Sets the MFAO terminal AO output signal level. 1: 0 to 10 Vdc, 2: -10 to +10 Vdc, 3: 4 to 20 mA
L1-01 (0480)	Motor Cool Type for OL1 Calc	Sets the motor overload protection with electronic thermal protectors. 0: Disabled, 1: VTorque, 2: CT 10:1 Speed Range, 3: CT 100:1 SpeedRange, 4: PM VTorque, 5: PM CTorque, 6: VT (50Hz)
L1-02 (0481)	OL1 Protect Time	Sets the operation time for the electronic thermal protector of the drive to prevent damage to the motor. Usually it is not necessary to change this setting.
L3-04 (0492)	StallP@Decel Enable	Enables Stall Prevention during deceleration. 0: Disabled, 1: Enabled
L3-50 (0458)	StallP@Decel Mode	Sets the method that the drive will use to prevent overvoltage faults when decelerating. 0: General Purpose, 1: Automatic Decel Reduction, 2: Gen Purpose w/ DB Resistor, 3: HiFlux Overexcitation, 4: HiFlux2 Overexcitation, 6: HiFlux3 Overexcitation

◆ Troubleshooting

If the drive or motor do not operate correctly, look at the drive keypad for fault and alarm information.

- For drive faults:
 - The keypad shows the fault code.
 - The ALM LED illuminates continuously.
 - The drive shuts off output, and the output terminal set for *Fault [H2-01 to H2-03 = 3]* activates. The motor coasts to stop.
- For drive alarms:
 - The keypad shows the alarm code.
 - The ALM LED flashes.
 - The drive will continue to operate the motor. Some alarms let you select a motor stopping method.

■ Fault Reset

1. Remove the cause of the fault or alarm.
2. While the keypad is showing the fault or alarm code, push  on the keypad.

This table lists the most frequent faults and alarms with possible causes and solutions. Refer to the Technical Manual for a full list of faults and alarms.

Code	Name	Causes	Possible Solutions
bb	Baseblock	An external baseblock command was entered through MFDI terminal DI1 to DI7, and the drive output stopped as shown by an external baseblock command.	Examine the external sequence and timing of the baseblock command input.
CrST	Cannot Reset	The drive received a fault reset command when a Run command was active.	Turn off the Run command then de-energize and re-energize the drive.
EF	FWD/REV Run Command Input Error	A forward command and a reverse command were input at the same time for longer than 500 ms.	Make sure that the sequence is correct. Do not set the forward and reverse inputs at the same time.
EF1 to EF7	External Fault (Terminal DIx)	One of the digital inputs caused an external fault through an external device. The digital input settings are incorrect.	<ul style="list-style-type: none"> Find the device that caused the external faults. Remove the cause and reset the fault. Make sure that the digital input terminal functions are correct.
GF	Ground Fault	Overheating caused damage to the motor or the motor insulation is not satisfactory.	Measure the motor insulation resistance, and replace the motor if there is electrical conduction or unserviceable insulation.
		The motor main circuit cable is contacting ground to make a short circuit.	<ul style="list-style-type: none"> Examine the motor main circuit cable for damage, and repair short circuits. Measure the resistance between the motor main circuit cable and the ground terminal. If there is electrical conduction, replace the cable.
		An increase in the stray capacitance of the cable and the ground terminal caused an increase in the leakage current.	<ul style="list-style-type: none"> If the wiring length of the cable is more than 100 m, decrease the carrier frequency. Decrease the stray capacitance.
		There was a problem with the drive hardware.	Replace the control board or the drive. For information about replacing the control board, contact the manufacturer or your nearest sales representative.
oC	Overcurrent	The load is too heavy.	<ul style="list-style-type: none"> Measure the current flowing into the motor. Replace the drive with a larger capacity model if the current value is more than the drive rated current. Decrease the load or replace with a larger drive to prevent sudden changes in the current level.
		Overheating caused damage to the motor or the motor insulation is not satisfactory.	Measure the motor insulation resistance, and replace the motor if there is electrical conduction or unserviceable insulation.
		The motor main circuit cable is contacting ground to make a short circuit.	<ul style="list-style-type: none"> Examine the motor main circuit cable for damage, and repair short circuits. Measure the resistance between the motor main circuit cable and the ground terminal. If there is electrical conduction, replace the cable.

		<p>A short circuit or ground fault on the drive output side caused damage to the output transistor of the drive.</p>	<ul style="list-style-type: none"> • Make sure that there is not a short circuit in terminal B1 and terminals U/T1, V/T2, and W/T3. Make sure that there is not a short circuit in terminals - and terminals U/T1, V/T2, and W/T3. • If there is a short circuit, contact the manufacturer or your nearest sales representative.
		<p>The acceleration time is too short.</p>	<ul style="list-style-type: none"> • Calculate the torque necessary during acceleration related to the load inertia and the specified acceleration time. • Increase the values set in <i>C1-01 [Accel Time 1]</i>, <i>C1-03 [Accel Time 2]</i>, <i>C1-05 [Accel Time 3]</i>, or <i>C1-07 [Accel Time 4]</i> until you get the necessary torque. • Increase the values set in <i>C2-01 [Jerk@Start of Accel]</i>, <i>C2-02 [Jerk@End of Accel]</i>, <i>C2-03 [Jerk@Start of Decel]</i>, and <i>C2-04 [Jerk@End of Decel]</i> until you get the necessary torque. • Replace the drive with a larger capacity model.
		<p>The drive is trying to operate a specialized motor or a motor that is larger than the maximum applicable motor output of the drive.</p>	<ul style="list-style-type: none"> • Examine the motor nameplate, the motor, and the drive to make sure that the drive rated current is larger than the motor rated current. • Replace the drive with a larger capacity model.
		<p>A magnetic contactor was switched at the output.</p>	<p>Set the operation sequence to not turn ON or OFF the magnetic contactor while the drive is outputting voltage.</p>
		<p>The V/f pattern settings are incorrect.</p>	<ul style="list-style-type: none"> • Examine the ratios between the V/f pattern frequency and voltage. Decrease the voltage if it is too high compared to the frequency. • Adjust V/f Pattern Parameters <i>E1-04 to E1-10</i>. For motor 2, adjust <i>E3-04 to E3-10</i>.
		<p>The torque compensation gain is too large.</p>	<p>Decrease the value set in <i>C4-01 [Trq Comp Gain]</i> to make sure that the motor does not stall.</p>
		<p>Electrical interference caused a problem.</p>	<p>Examine the control circuit lines, main circuit lines, and ground wiring, and decrease the effects of electrical interference.</p>
		<p>The gain during overexcitation operation is too large.</p>	<ul style="list-style-type: none"> • Find the time when the fault occurs. • If the fault occurs at the same time as overexcitation operation, decrease the value set in <i>n3-13 [OverExcBr Gain]</i> and consider the motor flux saturation.
		<p>The drive received a Run command while the motor was coasting.</p>	<ul style="list-style-type: none"> • Examine the sequence and input the Run command after the motor fully stops. • Set <i>b3-01 = 1 [SpSrch@Start Selection = Enabled]</i> or set <i>H1-xx = 67, 68 [Speed Srch 1 or 2]</i> to input speed search commands from the MFDI terminals.

		The motor code is set incorrectly for PM Control Methods.	<ul style="list-style-type: none"> Enter the correct motor code to <i>E5-01 [PM Mot Code Selection]</i> as specified by the PM motor. For specialized motors, refer to the motor test report and set <i>E5: PM MOTOR SETTINGS</i> correctly.
		If the drive detects the fault at start or in the low speed range (10% or less) and $n8-57 = 1$ [<i>High-Freq Injection = Enabled</i>] for PM Control methods, the high frequency injection gain is too high.	<ul style="list-style-type: none"> Set <i>E5: PM MOTOR SETTINGS</i> correctly or do Rotational Auto-Tuning. Decrease the value of $n8-41$ [<i>HFI PoleDet Pgain</i>] in 0.5 unit increments. <p>Note: Set $n8-41 > 0.0$ for IPM motors.</p>
		The current flowing in the motor is more than the value set in <i>L8-27 [OverCurr Det Gain]</i> for PM Control.	Correct the value set in <i>L8-27</i> .
		The control method is set incorrectly for the motor.	Set <i>A1-02 [Control Method]</i> correctly.
		The motor main circuit cable is too long.	Replace the drive with a larger capacity model.
		Speed search does not complete at start when you use an induction motor in EZOLV control.	When $E9-01 = 0$ [<i>Motor Type Selection = IM</i>], set $b3-24 = 2$ [<i>SpSrch Method Selection = Current Det2</i>].
oL1	Motor Overload	The load is too heavy.	Decrease the load. Note: Reset <i>oL1</i> when $U4-16$ [<i>MotorOLEstimate (oL1)</i>] < 100.
		The acceleration/deceleration times or cycle times are too short.	<ul style="list-style-type: none"> Examine the acceleration/deceleration times and the motor start/stop frequencies (cycle times). Increase the value set in Acceleration/Deceleration Times <i>CI-01 to CI-08</i>.
		Overload occurred while running at low speed.	<ul style="list-style-type: none"> Lower the load when running at low speed. Increase the motor speed. If the motor is run frequently at low speeds, replace the motor with a larger motor or use a drive-dedicated motor. <p>Note: For general-purpose motors, overload can occur while running at low speed when operating at below the rated current.</p>
		<i>L1-01 [Motor Cool Type for OLI Calc]</i> is set incorrectly.	Set <i>L1-01</i> in as specified by the motor qualities for a drive-dedicated motor.

		The V/f pattern does not fit the motor qualities.	<ul style="list-style-type: none"> Examine the ratios between the V/f pattern frequency and voltage. Decrease the voltage if it is too high compared to the frequency. Adjust V/f Pattern Parameters <i>E1-04 to E1-10</i>. For motor 2, adjust <i>E3-04 to E3-10</i>. Decrease the values set in <i>E1-08 [Mid A Voltage]</i> and <i>E1-10 [Min Output Voltage]</i>. <p>Note: If <i>E1-08</i> and <i>E1-10</i> are set too low, the overload tolerance will decrease at low speeds.</p>
		<i>E1-06 [Base Frequency]</i> is set incorrectly.	Set <i>E1-06</i> to the rated frequency shown on the motor nameplate.
		One drive is operating more than one motor.	Set <i>L1-01 = 0 [Motor Cool Type for OLI Calc = Disabled]</i> , connect thermal overload relay to each motor to prevent damage to the motor.
		The electronic thermal protector qualities and the motor overload properties do not match.	<ul style="list-style-type: none"> Examine the motor qualities and set <i>L1-01 [Motor Cool Type for OLI Calc]</i> correctly. Connect a thermal overload relay to the motor.
		The electronic thermal protector is operating at an incorrect level.	Set <i>E2-01 [Mot Rated Current (FLA)]</i> to the value shown on the motor nameplate.
		There is increased motor loss from overexcitation operation.	<ul style="list-style-type: none"> Lower the value set in <i>n3-13 [OverExcBr Gain]</i>. Set <i>L3-50 \neq 3 or 4 [StallP@Decel Mode \neq HiFlux Overexcitation or HiFlux2 Overexcitation]</i>. Set <i>L3-04 = 0 [StallP@Decel Enable = Disabled]</i>.
		The speed search-related parameters are set incorrectly.	<ul style="list-style-type: none"> Examine the settings for all speed search related parameters. Adjust <i>b3-03 [SpSrch Deceleration Time]</i>. Set <i>b3-24 = 1 [SpSrch Method Selection = Speed Estimation]</i> after Auto-Tuning.
		Phase loss in the input power supply is causing the output current to change.	Make sure that there is no phase loss, and repair problems.
oL2	Drive Overload	The load is too heavy.	Decrease the load.
		The acceleration/deceleration times or cycle times are too short.	<ul style="list-style-type: none"> Examine the acceleration/deceleration times and the motor start/stop frequencies (cycle times). Increase the value set in Acceleration/Deceleration Times <i>C1-01 to C1-08</i>.

		The V/f pattern does not fit the motor qualities.	<ul style="list-style-type: none"> Examine the ratios between the V/f pattern frequency and voltage. Lower the voltage if it is too high compared to the frequency. Adjust V/f Pattern Parameters <i>E1-04 to E1-10</i>. Lower the values set in <i>E1-08 [Mid A Voltage]</i> and <i>E1-10 [Min Output Voltage]</i> For motor 2, adjust <i>E3-04 to E3-10</i>. <p>Note: If <i>E1-08</i> and <i>E1-10</i> are set too low, the overload tolerance is will decrease at low speeds.</p>
		The drive capacity is too small.	Replace the drive with a larger capacity model.
		Overload occurred while running at low speed.	<ul style="list-style-type: none"> Decrease the load when running at low speed. Replace the drive with a larger capacity model. Decrease the value set in <i>C6-02 [Carrier Frequency Selection]</i>.
		The torque compensation gain is too large.	Decrease the value set in <i>C4-01 [Trq Comp Gain]</i> to make sure that the motor does not stall.
		The speed search-related parameters are set incorrectly.	<ul style="list-style-type: none"> Examine the settings for all speed search related parameters. Adjust <i>b3-03 [SpSrch Deceleration Time]</i>. Set <i>b3-24 = 1 [SpSrch Method Selection = Speed Estimation]</i> after Auto-Tuning.
		Phase loss in the input power supply is causing the output current to change.	<ul style="list-style-type: none"> Correct any wiring errors in the main circuit drive input power. Make sure that there is no phase loss, and repair problems.
ov	Overvoltage	Deceleration time is too short and regenerative energy is flowing from the motor into the drive.	<ul style="list-style-type: none"> Set <i>L3-04 = 1 [StallP@Decel Enable = Enabled]</i> and <i>L3-50 = 0 [StallP@Decel Mode = General Purpose]</i>. Increase the values set in <i>C1-02 [Decel Time 1]</i>, <i>C1-04 [Decel Time 2]</i>, <i>C1-06 [Decel Time 3]</i>, or <i>C1-08 [Decel Time 4]</i>. Connect a dynamic braking option to the drive. Perform Deceleration Rate Auto-Tuning.
		The acceleration time is too short.	<ul style="list-style-type: none"> Make sure that sudden drive acceleration does not cause the fault. Increase the values set in <i>C1-01 [Accel Time 1]</i>, <i>C1-03 [Accel Time 2]</i>, <i>C1-05 [Accel Time 3]</i>, or <i>C1-07 [Accel Time 4]</i>. Increase the value set in <i>C2-02 [Jerk@End of Accel]</i>. Set <i>L3-11 = 1 [Overvolt Supression Select = Enabled]</i>.
		The braking load is too large.	Connect a dynamic braking option to the drive.

	There are surge voltages in the input power supply.	Connect a DC reactor to the drive. Note: If you turn the phase advancing capacitors ON and OFF and use thyristor converters in the same power supply system, there can be surge voltages that irregularly increase the input voltage.
	The drive output cable or motor is shorted to ground (the current short to ground is charging the main circuit capacitor of the drive through the power supply).	<ol style="list-style-type: none"> 1. Examine the motor main circuit cable, terminals, and motor terminal box, and then remove ground faults. 2. Re-energize the drive.
	<p>If the drive detects ov in these conditions, the speed search-related parameters are incorrect:</p> <ul style="list-style-type: none"> • During speed search • During momentary power loss recovery • When the drive starts again automatically 	<ul style="list-style-type: none"> • Examine the settings for all speed search related parameters. • Set <i>b3-19</i> $\neq 0$ [<i>Speed Retry Times</i> $\neq 0$ times]. • Adjust <i>b3-03</i> [<i>SpSrCh Deceleration Time</i>] settings. • Do Stationary Auto-Tuning for Line-to-Line Resistance and then set <i>b3-24</i> = 1 [<i>SpSrCh Method Selection = Speed Estimation</i>].
	The power supply voltage is too high.	Decrease the power supply voltage to match the drive rated voltage.
	The braking resistor or braking resistor unit wiring is incorrect.	Correct wiring errors in the connection to the braking resistor or braking resistor unit.
	The encoder cable is disconnected or wired incorrectly.	Examine for wiring errors or disconnected wires in the encoder cable, and repair problems.
	Noise interference along the encoder cable.	Isolate the encoder cable from the drive output line or a different source of electrical interference.
	Electrical interference caused a drive malfunction.	<ul style="list-style-type: none"> • Examine the control circuit lines, main circuit lines, and ground wiring, and decrease the effects of electrical interference. • Make sure that a magnetic contactor is not the source of the electrical interference, then use a Surge Protective Device if necessary.
	The load inertia is set incorrectly.	<ul style="list-style-type: none"> • Examine the load inertia settings with KEB, overvoltage suppression, or stall prevention during deceleration. • Adjust <i>L3-25</i> [<i>Load Inertia Ratio</i>] to match the qualities of the machine.
	The Short Circuit Braking function used in OLV/PM control method.	Connect a braking resistor to the drive.

		There is motor hunting.	<ul style="list-style-type: none"> Adjust <i>n1-02 [HuntPrev Gain Setting]</i> settings. Adjust <i>n2-02 [AFR Time 1]</i> and <i>n2-03 [AFR Time 2]</i> settings. Adjust <i>n8-45 [SpdFbck Det.Gain]</i> and <i>n8-47 [Pull-In Comp.Time Constant]</i> settings.
		Speed search does not complete at start when you use an induction motor in EZOLV control.	When <i>E9-01 = 0 [Motor Type Selection = IM]</i> , set <i>b3-24 = 2 [SpSrch Method Selection = Current Det2]</i> .
PF	Input Phase Loss	There is a phase loss in the drive input power.	Correct errors with the wiring for main circuit drive input power.
		Loose wiring in the input power terminals.	Tighten the terminal screws to the correct tightening torque.
		The drive input power voltage is changing too much.	<ul style="list-style-type: none"> Examine the input power for problems. Make the drive input power stable.
		Unsatisfactory balance between voltage phases.	<ul style="list-style-type: none"> Examine the input power for problems. Make the drive input power stable. If the input power supply is good, examine the magnetic contactor on the main circuit side for problems.
		The main circuit capacitors have become unserviceable.	<ul style="list-style-type: none"> Examine the capacitor maintenance time in monitor <i>U4-05 [Capacitor Maintenance]</i>. If <i>U4-05</i> is more than 90%, replace the capacitor. Contact the manufacturer or your nearest sales representative for more information.
			<ul style="list-style-type: none"> Examine the input power for problems. Re-energize the drive. If the alarm stays, replace the circuit board or the drive. Contact the manufacturer or your nearest sales representative for more information.
STo	Safe Torque OFF	Safe Disable inputs H1-HC and H2-HC are open.	<ul style="list-style-type: none"> Make sure that the Safe Disable signal is input from an external source to terminal H1-HC and H2-HC. When the Safe Disable function is not in use, connect terminals H1-HC and H2-HC.
		There is internal damage to the two Safe Disable channels.	Replace the board or the drive. For information about replacing the control board, contact the manufacturer or your nearest sales representative.
SToF	Safe Torque OFF Hardware	One of the two terminals H1-HC or H2-HC received the Safe Disable input signal.	<ul style="list-style-type: none"> Make sure that the Safe Disable signal is input from an external source to terminal H1-HC and H2-HC.
		The Safe Disable input signal is wired incorrectly.	<ul style="list-style-type: none"> When the Safe Disable function is not in use, connect terminals H1-HC and H2-HC.
		There is internal damage to one Safe Disable channel.	Replace the control board or the drive. For information about replacing the control board, contact the manufacturer or your nearest sales representative.

◆ Disposal

■ Disposal Instructions

Correctly dispose the drive and packing material as specified by applicable regional, local, and municipal laws and regulations.

■ WEEE Directive



The wheeled bin symbol on this product, its manual, or its packaging identifies that you must recycle it at the end of its product life.

You must discard the product at an applicable collection point for electrical and electronic equipment (EEE). Do not discard the product with usual waste.

◆ European Standards



Figure 1.4 CE Mark

The CE Mark identifies that the product meets environmental and safety standards in the European Union. Products manufactured, sold, or imported in the European Union must display the CE Mark.

European Union standards include standards for electrical appliances (Low Voltage Directive), standards for electrical noise (EMC Directive), and standards for machinery (Machinery Directive).

This product displays the CE Mark in accordance with the Low Voltage Directive, the EMC Directive, and the Machinery Directive.

Table 1.4 Harmonized Standard

European Directive	Harmonized Standard
CE Low Voltage Directive Compliance 2014/35/EU	IEC/EN 61800-5-1:2007
EMC Directive 2014/30/EU	EN 61800-3 2004+A1:2012
Machinery Directive 2006/42/EC	<ul style="list-style-type: none"> • EN ISO 13849-1:2015 (Cat. 3, PL e) • IEC 62061:2005/A2:2015 (SILCL3) • EN 62061:2005/A2:2015 (SILCL3) • IEC/EN 61800-5-2:2007 (SIL3)

■ CE Low Voltage Directive Compliance

This product is tested according to IEC/EN 61800-5-1:2007 and complies with the CE Low Voltage Directive. The following conditions must be satisfied for machines and devices incorporating this product to comply with the CE Low Voltage Directive.

■ Area of Use

Install this product in a location with overvoltage category III and pollution degree 2 or less. These standards are defined by IEC/EN 60664.

■ Connect a Fuse to the Input Side (Primary Side)

The drive circuit protection must comply with IEC/EN 61800-5-1:2007 for protection against a short circuit in the internal circuitry. Connect a semiconductor protection fuse on the input side for branch circuit protection.

Refer to *Factory Recommended Branch Circuit Protection on page 42*.

⚠ WARNING *Electrical Shock Hazard. Do not immediately energize the drive or operate peripheral devices after the drive blows a fuse or trips an RCM/RCD. Wait for the time specified on the warning label at a minimum and make sure that all indicators are OFF. Then check the wiring and peripheral device ratings to find the cause of the problem. Contact the manufacturer before energizing the drive or peripheral devices if the cause is not known. Failure to obey can cause death or serious injury and damage to the drive.*

■ EMC Directive

All drives were tested in accordance with European standard IEC/EN 61800-3:2004/A1:2012, and comply with the EMC Directive.

Use drives with built-in EMC filters or install external EMC filters to the drive input side to comply with the EMC Directive.

■ Install a Drive to Conform to the EMC Directive

Install drives with this procedure to comply with the EMC Directive when the drive is a single unit or installed in a larger device.

1. Install the drive on a grounded metal plate.
2. Wire the drive and motor.
3. Move the EMC switch screw or screws to the OFF position for networks that are not symmetrically grounded, ungrounded or grounded with high resistance.

4. Ground the wire shielding on the drive side and motor side.

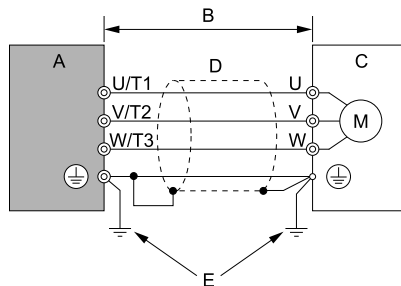

- A - Drive
 B - Maximum wiring length
 2xxx, 4xxx: 20 m (65.6 ft.)
 maximum
 Bxxx: 10 m (32.8 ft.)
 maximum
 C - Motor
 D - Metal conduit
 E - Grounding wire

Figure 1.5 Wiring the Drive and Motor

5. Use a cable clamp to ground the motor cable to the metal plate.

Note:

Make sure that the protective ground wire complies with technical specifications and local safety standards.

6. Connect an AC or DC reactor to decrease harmonic distortion.

Note:

To maintain compliance with IEC/EN 61000-3-2 on drive models 2004, 2006, 4002, and 4004, install a DC reactor.

■ Enable/Disable the Internal EMC Filter

Move the screw or screws to turn ON and OFF (enable and disable) the EMC filter.

⚠ WARNING *Electrical Shock Hazard. Make sure that the power to the drive is OFF and the CHARGE LED light is OFF before you move the EMC filter screw or screws. Failure to obey could cause death or serious injury.*

⚠ WARNING *Electrical Shock Hazard. Do not remove covers or touch circuit boards while the drive is energized. Failure to obey can cause death or serious injury.*

⚠ WARNING *Electrical Shock Hazard. Ground the neutral point on the power supply to comply with the EMC Directive before turning on the EMC filter or if there is high resistance grounding. If the EMC filter is switched ON without the neutral point being grounded or if there is high resistance grounding, it can cause death or serious injury.*

⚠ WARNING *Electrical Shock Hazard. Connect the ground cable correctly. Failure to obey can cause death or serious injury.*

Make sure that the symmetric grounding network is applied, and install the screw or screws in the ON position to enable the built-in EMC filter in compliance with the EMC Directive.

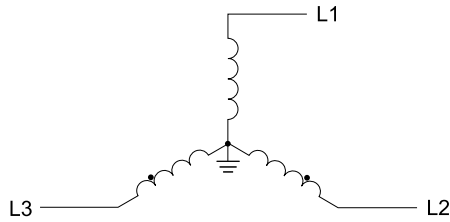

Figure 1.6 Symmetric Grounding

NOTICE When operating the drive with a non-grounding network, high resistance grounding, asymmetric grounding network, install the screw or screws in the OFF position to disable the built-in EMC filter. Failure to obey the instructions can damage the drive.

NOTICE When disabling the internal EMC filter, move the screws from ON to OFF and then tighten to the specified torque. Completely removing the screws or tightening the screws to an incorrect torque may cause drive failure.

If you lose an EMC filter switch screw, install the correct size screw with the correct tightening torque.

NOTICE Only use the screws specified in this manual. Failure to obey could damage the drive.

Table 1.5 Screw Sizes and Tightening Torques

Model	Screw Size	Tightening Torque N·m (in·lb)
B001 - B004, 2001 - 2006	M3 × 16	0.5 - 0.6 (4.4 - 5.3)
B006 - B012, 2010 - 2021, 4001 - 4012	M3 × 20	0.5 - 0.6 (4.4 - 5.3)
2030 - 2082, 4018 - 4060	M4 × 20	1.2 - 1.5 (10.6 - 13.3)

◆ **Safe Disable Input**

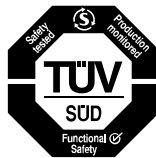

Figure 1.7 TUV Mark

The TUV mark identifies that the product complies with the safety standards.

This section gives precautions to support the Safe Disable input. Contact the manufacturer for more information.

Table 1.6 Applied Safety Standards and Unified Standards

Safety Standards	Unified Standards
Functional Safety	IEC/EN 61508:2010 (SIL3)
	IEC/EN 62061/A2:2015 (SILCL3)
	IEC/EN 61800-5-2:2007 (SIL3)
Machine Safety	ISO/EN ISO 13849-1:2015 (Cat.3, PL e)
EMC	IEC/EN 61000-6-7:2015
	IEC/EN 61326-3-1:2017
Low Voltage Directive	IEC/EN 61800-5-1:2007

SIL = Safety Integrity Level.

■ Safe Disable Specifications

The Safe Disable input provides the stop function that complies with “Safe Torque Off” as specified by IEC/EN 61800-5-2:2007. The Safe Disable input meets the requirements of EN ISO 13849-1 and IEC/EN 61508. It also has a safety status monitor to detect safety circuit errors.

When you install the drive as a component in a system, you must make sure that the system complies with the applicable safety standards.

Table 1.7 Specifications for the Safety Function

Item	Description
Input/output	<ul style="list-style-type: none"> Input: 2 Safe Disable input (H1, H2) Signal ON level: 18 Vdc to 28 Vdc Signal OFF level: -4 Vdc to +4 Vdc Output: 1 MFDO safety monitor output for external device monitor (EDM)
Response time from opening the input to stopping the drive output	3 ms or less
Response time from opening H1 and H2 terminal inputs to operating the EDM signal	30 ms or less
Failure probability	Less frequent operation request mode
	Frequent operation request mode or continuous mode
	PFD = 1.38E-5
	PFH = 3.35E-9
Performance level	The Safe Disable input complies with the performance level requirements of EN ISO 13849-1.
HFT (hardware fault tolerance)	N = 1
Type of subsystem	Type B
MTTF _D	High
DC _{avg}	Medium
Mission time	10 years

EDM = External Device Monitoring

PFD = Probability of Failure on Demand

PFH = Probability of Dangerous Failure per Hour

■ Safe Disable Circuit

The Safe Disable circuit has two isolated channels (terminals H1 and H2) that stop the output transistors. The input can use the internal power supply of the drive.

Set the EDM function to one of the MFDO terminals [H2-xx = E or 10E] to monitor the status of the Safe Disable function. This is the "Safe Disable monitor output function".

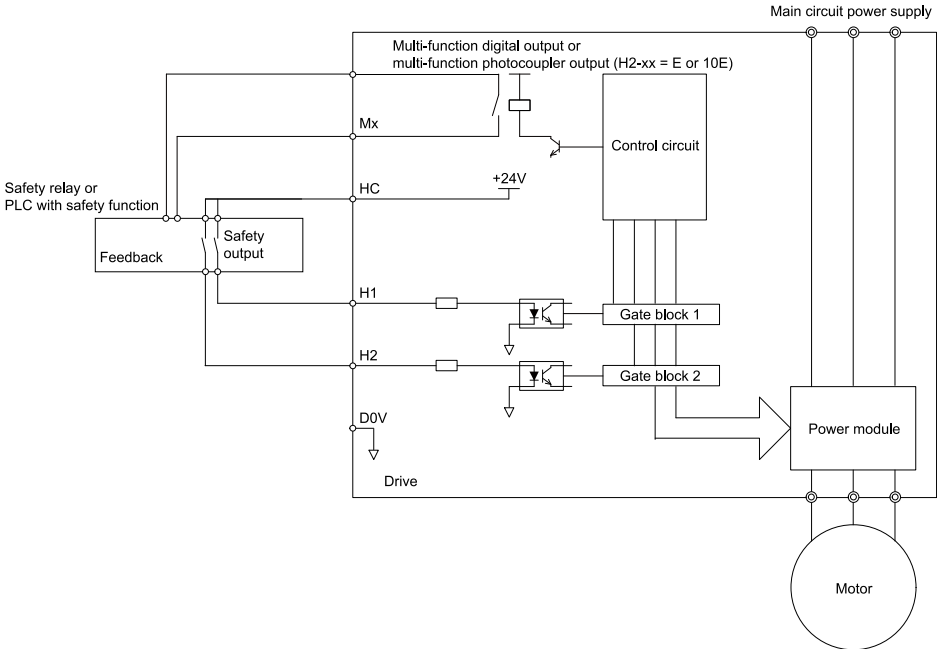

Figure 1.8 Safe Disable Function Wiring Example

■ Enabling and Disabling the Drive Output ("Safe Torque Off")

Example of drive operation when as the drive changes from the "Safe Torque Off" status to usual operation.

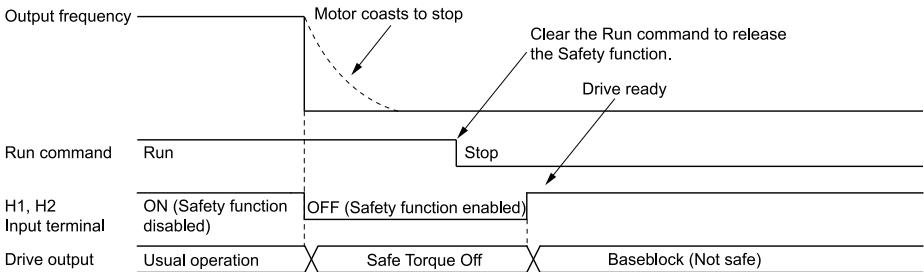

Figure 1.9 Safe Disable Operation

Switching from Usual Operation to “Safe Torque Off”

Turn OFF (open) safety input terminal H1 or H2 to enable the Safe Disable function. When the Safe Disable function is enabled while the motor is operating, the drive output and motor torque turn off and the motor always coasts to stop. The *b1-03 [Stopping Method Selection]* setting does not have an effect on the stopping method.

The “Safe Torque Off” status is only possible with the Safe Disable function. Clear the Run command to stop the drive. Turning off drive output (a baseblock condition) \neq “Safe Torque Off”.

Note:

A maximum of 3 ms will elapse from when terminals H1 or H2 shut off until the drive switches to the “Safe Torque Off” status. Set the OFF status for terminals H1 and H2 to hold for at least 3 ms. The drive may not be able to switch to the “Safe Torque Off” status if terminals H1 and H2 are only open for less than 3 ms.

Turn OFF terminals H1 and H2 after the motor fully stops. This will prevent the motor from coasting to stop during usual operation.

Going from “Safe Torque Off” to Usual Operation

The safety input will only release when there is no Run command.

- **During Stop:**
When the Safe Disable function is triggered during stop, close the circuit between terminals H1-HC and H2-HC to disable “Safe Torque Off”. Enter the Run command after the drive stops correctly.
- **During Run:**
When the Safe Disable function is triggered during run, close the circuit between terminals H1-HC and H2-HC to disable “Safe Torque Off” after clearing the Run command. Enter the Stop command, then enter the Run command when terminals H1 and H2 are ON or OFF.

■ Safe Disable Monitor Output Function and Keypad Display

Information about the relation between the input channel status, Safety monitor output status, and drive output status.

Table 1.8 Safe Disable Input and External Device Monitor (EDM) Terminal Status

Input Channel Status		Safety Monitor Output Status		Drive Output Status	Keypad Display	LED Status	MEMOBUS Register 0020H	
Input 1 (H1-HC)	Input 2 (H2-HC)	MFDO Terminal (H2-xx = E)	MFDO Terminal (H2-xx = 10E)				bit C	bit D
ON (Close the circuit)	ON (Close the circuit)	OFF	ON	Baseblock (Drive ready)	Normally displayed	-	0	0
OFF (Open)	ON (Close the circuit)	OFF	ON	Safety status (STo)	SToF (Flashing)	ALM: Flashing RUN: Flashing	1	0
ON (Close the circuit)	OFF (Open)	OFF	ON	Safety status (STo)	SToF (Flashing)	ALM: Flashing RUN: Flashing	1	0
OFF (Open)	OFF (Open)	ON	OFF	Safety status (STo)	STo (Flashing)	RUN: Flashing	0	1

Safety Function Status Monitor

The drive Safety monitor output sends a feedback signal about the status of the Safety function. The Safety monitor output is one of the possible settings available for the MFDO terminals. If there is damage to the Safe Disable circuit, a controller (PLC or safety relay) must read this signal as an input signal to hold the “Safe Torque Off” status. This will help verify the condition of the safety circuit. Refer to the manual for the safety device for more information about the Safety function.

It is possible to switch polarity of the Safety monitor output signal with the MFDO function settings.

Keypad Display

If the two input channels are OFF (Open), the keypad will flash *STo* [*Safe Torque OFF*].

If there is damage to the Safe disable circuit or the drive, the keypad will flash *SToF* [*Safe Torque OFF Hardware*] when one input channel is OFF (Open), and the other is ON (Short circuit). When you use the Safe disable circuit correctly, the keypad will not show *SToF*.

If there is damage to the drive, the keypad will show *SCF* [*Safety Circuit Fault*] when the drive detects a fault in the Safe disable circuit. Refer to the chapter on Troubleshooting for more information.

■ Validating the Safe Disable Function

After you replace parts or do maintenance on the drive, first complete all necessary wiring to start the drive, then test the Safe Disable input with these steps. Keep a record of the test results.

- When the two input channels are OFF (Open), make sure that the keypad flashes *STo* [*Safe Torque OFF*], and make sure that the motor is not running.
- Monitor the ON/OFF status of the input channels and make sure that MFDO set to the EDM function operates correctly.

If one or more of the these items are true, the ON/OFF status of the MFDO may not display correctly on the keypad:

- Incorrect parameter settings.
- A problem with an external device.
- The external wiring has a short circuit or is disconnected.
- There is damage to the device.

Find the cause and repair the problem to correctly display the status.

- Make sure that the EDM signal operates during usual operation.

2 Attachments

◆ UL Standards



Figure 2.1 UL/cUL Mark

The UL/cUL Mark indicates that this product satisfies stringent safety standards. This mark appears on products in the United States and Canada. It shows UL approval, indicating that it has been determined that the product complies with safety standards after undergoing strict inspection and assessment. UL-approved parts must be used for all major components that are built into electrical appliances that obtain UL approval.

This product has been tested in accordance with UL standard UL61800-5-1, and has been verified to be in compliance with UL standards.

Machines and devices integrated with this product must satisfy the following conditions for compliance with UL standards.

■ Area of Use

Installation Environment	Overtoltage category III and pollution degree 2 or less (according to UL61800-5-1)
Ambient Temperature	UL Type 1 enclosure: -10 °C to +40 °C (14 °F to 104 °F). IP20 enclosure: -10 °C to +50 °C (14 °F to 122 °F).

■ Wire the Main Circuit Terminal Block

Wire the main circuit terminal block correctly as specified by the instructions in the manual.

Comply with local standards for correct wire gauges in the region where the drive is used.

To select the correct wire gauge, refer to [Main Circuit Wire Gauges and Tightening Torques on page 44](#).

▲ WARNING *Electrical Shock Hazard. The leakage current of the drive will be more than 3.5 mA. The IEC/EN 61800-5-1: 2007 standard specifies that users must wire the power supply to automatically turn off when the protective ground wire disconnects. Users can also connect a protective ground wire that has a minimum cross-sectional area of 10 mm² (copper wire) or 16 mm² (aluminum wire). Failure to obey these standards can cause death or serious injury.*

▲ WARNING *Electrical Shock Hazard. Only connect peripheral options, for example a DC reactor or braking resistor, to terminals +1, +2, -, B1, and B2. Failure to obey can cause serious injury or death.*

Notes on Wiring the Main Circuit Terminal Block

- Use UL-Listed, vinyl-coated insulated copper wires for operation with a continuous maximum permitted temperature of 75 °C at 600 V
- Remove all unwanted objects that are near the terminal block connections.
- Remove the insulation from the connection wires to the wire stripping lengths shown in the manual.
- Do not use bent or crushed wires. Remove the damaged end of the wire before you use it. Incorrect connections can cause death or serious injury from fire.
- Do not solder stranded wire. Soldered wire connections can become loose over time and cause unsatisfactory drive performance.
- If you use stranded wire, make sure that all of the wire strands are in the connection. Also, do not twist the stranded wire too much. Incorrect connections can cause death or serious injury from fire.
- Put the wire all the way into the terminal block. Remove the insulation from the wire to the recommended wire stripping length to fit the wire with insulation in the plastic housing.
- Use a torque driver, torque ratchet, or torque wrench for the screws. A slotted driver or a hex tool will be necessary to wire the screw clamp terminal. Use applicable tools as specified by the recommended conditions in the product manual.
- If you use power tools to tighten the terminal screws, use a low speed setting (300 to 400 r/min). Failure to obey can cause damage to the terminal screws.

- Wire gauges on existing drive models to be replaced may not match wire gauge ranges on new drives. Refer to the Technical Manual for correct wire gauges.
- Do not tighten the terminal screws at an angle of 5 degrees or more. Failure to obey can cause damage to the terminal screws.

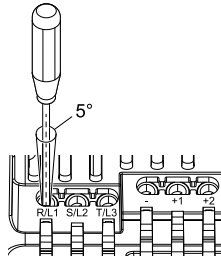

Figure 2.2 Permitted Angle

- Put the bit all the way into the hex socket to tighten the hex socket cap screw.
- When tightening slotted screws, hold the straight-edge screwdriver perpendicularly to the screw. Do not allow the tip of the screwdriver to shift or protrude from the groove of the screw.

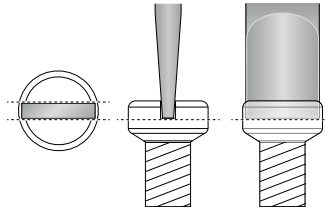
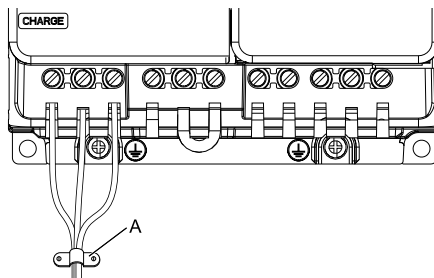

Figure 2.3 Tightening Slotted Screws





- After connecting the wires to the terminal block, lightly pull on the wires to make sure that they do not come out of the terminals.
- Remove the correct section of the wiring cover to make wiring easier.
- Do not let strain on the wiring cause damage. Use a strain relief near the wiring to release the tension.



A - Strain relief

Figure 2.4 Strain Relief Example

Table 2.1 Recommended Wiring Tools

Screw	Bit		Torque Driver Model (Tightening Torque)	Torque Wrench
	Model	Manufacturer		
 M3	SF-BIT-SL 0,5X3,0-70	PHOENIX CONTACT	TSD-M 1,2NM (0.3 - 1.2 N·m)	-
 M4	SF-BIT-SL 1,0X4,0-70	PHOENIX CONTACT	TSD-M 3NM (1.2 - 3 N·m)	-
 M5 *1	SF-BIT-SL 1,2X6,5-70	PHOENIX CONTACT	Wire Gauge ≤ 25 mm ² (AWG 10): TSD-M 3NM (1.2 - 3 N·m)	Wire Gauge ≤ 25 mm ² (AWG 10): -
			Wire Gauge ≥ 30 mm ² (AWG 8): -	Wire Gauge ≥ 30 mm ² (AWG 8): 4.1 - 4.5 N·m *2 *3
 M6	SF-BIT-HEX 5-50	PHOENIX CONTACT	-	5 - 9 N·m *2 *3

*1 When wiring drive models 2042, 2056, 4031, 4038, 4044, and 4060, select the correct tools for the wire gauge.

*2 Use 6.35 mm (0.25 in) bit socket holder.

*3 Use a torque wrench that can apply this torque measurement range.

■ Factory-Recommended Branch Circuit Protection for UL Listing

Use branch circuit protection to protect against short circuits and to maintain compliance with UL61800-5-1. We recommend connecting semiconductor protection fuses on the input side for branch circuit protection. Refer to [Factory Recommended Branch Circuit Protection on page 42](#) for the recommended fuses.

⚠ WARNING *Electrical Shock Hazard. Do not immediately energize the drive or operate peripheral devices after the drive blows a fuse or trips an RCM/RCD. Wait for the time specified on the warning label at a minimum and make sure that all indicators are OFF. Then check the wiring and peripheral device ratings to find the cause of the problem. Contact the manufacturer before energizing the drive or peripheral devices if the cause is not known. Failure to obey can cause death or serious injury and damage to the drive.*

- 200 V class
Use the fuses specified in this document to prepare the drive for use on a circuit that supplies not more than 31,000 RMS symmetrical amperes and 240 Vac when there is a short circuit in the power supply.
- 400 V class
Use the fuses specified in this document to prepare the drive for use on a circuit that supplies not more than 31,000 RMS symmetrical amperes and 480 Vac when there is a short circuit in the power supply.

The built-in short circuit protection of the drive does not provide branch circuit protection. The user must provide branch circuit protection as specified by the National Electric Code (NEC), the Canadian Electric Code, Part I (CEC), and local codes.

■ Low Voltage Wiring for Control Circuit Terminals

You must provide low voltage wiring as specified by the National Electric Code (NEC), the Canadian Electric Code, Part I (CEC), and local codes. The NEC class 1 circuit conductor is recommended. Use the UL approved class 2 power supply for external power supply.

Table 2.2 Control Circuit Terminal Power Supplies

Input/Output	Terminals	Power Supply Specifications
Digital input	DI1-DI7, DIC, D0V, D24V	Uses the LVLC power supply in the drive. Use the UL Listed class 2 power supply for external power supply.
Analog input	+10V, AI1, AI2, A0V	Uses the LVLC power supply in the drive. Use the UL Listed class 2 power supply for external power supply.
Analog output	AO, A0V	Uses the LVLC power supply in the drive.
Pulse train output	PO, A0V	Uses the LVLC power supply in the drive. Use the UL Listed class 2 power supply for external power supply.
Pulse train input	PI, A0V	Uses the LVLC power supply in the drive. Use the UL Listed class 2 power supply for external power supply.
Safe disable input	H1, H2, HC	Uses the LVLC power supply in the drive. Use the UL Listed class 2 power supply for external power supply.
Serial communication input/output	RS485+, RS485-, A0V	Uses the LVLC power supply in the drive. Use the UL Listed class 2 power supply for external power supply.
24 V external power supply	E24V, A0V	Use the UL Listed class 2 power supply.

■ Drive Motor Overload and Overheat Protection

The drive motor overload and overheat protection function complies with the National Electric Code (NEC) and the Canadian Electric Code, Part I (CEC).

Set the Motor Rated Current and *L1-01 through L1-04 [Motor Cool Type for OL1 Calc through Motor oH FLT Reaction Select]* correctly to enable motor overload and overheat protection.

Refer to the control method and set the motor rated current with *E2-01 [Mot Rated Current (FLA)]*, *E5-03 [PM Mot Rated Current (FLA)]*, or *E9-06 [Motor Rated Current]*.

E2-01 Mot Rated Current (FLA)

No. (Hex.)	Name	Description	Default (Range)
E2-01 (030E)	Mot Rated Current (FLA)	Sets the motor rated current in amps.	Determined by o2-04 and C6-01 (10% to 200% of the drive rated current)

Note:

- If $E2-01 < E2-03$ [Mot No-Load Current] the drive will detect $oPE02$ [Parameter Range Setting Error].
- The default settings and setting ranges are in these units:
 - 0.01 A: 2001 to 2042, B001 to B018, 4001 to 4023
 - 0.1 A: 2056 to 2082, 4031 to 4060

The value set for $E2-01$ becomes the reference value for motor protection, the torque limit, and torque control. Enter the motor rated current as written on the motor nameplate. Auto-Tuning the drive will automatically set $E2-01$ to the value input for $T1-04$ [Motor Rated Current].

E5-03 PM Mot Rated Current (FLA)

No. (Hex.)	Name	Description	Default (Range)
E5-03 (032B)	PM Mot Rated Current (FLA)	Sets the PM motor rated current (FLA).	Determined by E5-01 (10% to 200% of the drive rated current)

Note:

When the drive model changes, the display units for this parameter also change.

- 0.01 A: 2001 to 2042, B001 to B018, 4001 to 4023
- 0.1 A: 2056 to 2082, 4031 to 4060

The drive automatically sets $E5-03$ to the value input for $T2-06$ [PMMot Rated Current] after you do these types of Auto-Tuning:

- PM Motor Parameter Settings
- PM Stationary Auto-Tuning
- PM StaTun for Stator Resistance
- PM Rotational Auto-Tuning

E9-06 Motor Rated Current

No. (Hex.)	Name	Description	Default (Range)
E9-06 (11E9)	Motor Rated Current	Sets the motor rated current in amps.	Determined by E9-01 and o2-04 (10% to 200% of the drive rated current)

Note:

When the drive model changes, the display units for this parameter also change.

- 0.01 A: 2001 to 2042, B001 to B018, 4001 to 4023
- 0.1 A: 2056 to 2082, 4031 to 4060

The setting value of $E9-06$ is the reference value for motor protection. Enter the motor rated current shown on the motor nameplate. Auto-Tuning the drive will automatically set $E9-06$ to the value input for $T4-07$ [Motor Rated Current].

L1-01 Motor Cool Type for OL1 Calc

No. (Hex.)	Name	Description	Default (Range)
L1-01 (0480)	Motor Cool Type for OL1 Calc	Sets the motor overload protection with electronic thermal protectors.	Determined by A1-02 (0 - 6)

This parameter enables and disables the motor overload protection with electronic thermal protectors.

The cooling capability of the motor changes when the speed control range of the motor changes. Use an electronic thermal protector that aligns with the permitted load characteristics of the motor to select motor protection.

The electronic thermal protector of the drive uses these items to calculate motor overload tolerance and supply overload protection for the motor:

- Output current
- Output frequency
- Motor thermal characteristics
- Time characteristics

If the drive detects motor overload, the drive will trigger an *oL1 [Motor Overload]* and stop the drive output.

Set $H2-01 = 4D$ [$NO, NC, CM FuncSelection = Motor OL1$] to set a motor overload alarm. If the motor overload level is more than 90% of the *oL1* detection level, the output terminal turns ON and triggers an overload alarm.

0 : Disabled

Disable motor protection when motor overload protection is not necessary or when the drive is operating more than one motor.

Refer to [Figure 2.5](#) for an example of the circuit configuration to connect more than one motor to one drive.

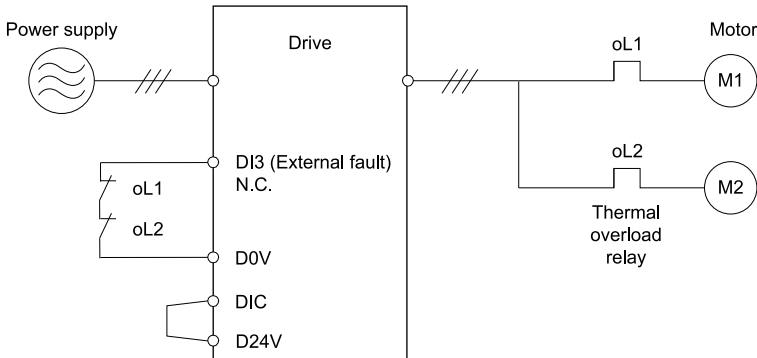

Figure 2.5 Protection Circuit Configuration to Connect More than One Motor to One Drive

NOTICE When one drive is operating more than one motor at the same time or when the rated current of the motor is much larger than rated current of a standard motor, you cannot protect the motor with electronic thermal protection. To protect each motor, set L1-01 = 1 [Motor Cool Type for OL1 Calc = VTorque], configure the circuits, then add thermal relays to each motor. The magnetic contactor installed for motor protection cannot be switched ON/OFF during run. Failure to obey can cause motor failure.

1 : VTorque

Use this setting for general-purpose motors with a 60 Hz base frequency.

The overload tolerance decreases as motor speed decreases because the cooling fan speed decreases and the ability of the motor to cool decreases in the low speed range.

The overload tolerance characteristics of the motor change the trigger point for the electronic thermal protector. This provides motor overheat protection from low speed to high speed across the full speed range.

Load Tolerance	Cooling Capability	Overload Characteristics (at 100% motor load)
	<p>This motor is designed to operate with commercial line power. Operate at a 60 Hz base frequency to maximize the motor cooling ability.</p>	<p>If the motor operates at frequencies less than 60 Hz, the drive will detect <i>oLL</i>. The drive triggers a fault relay output and the motor coasts to stop.</p>

2 : CT 10:1 Speed Range

Use this setting for drive-dedicated motors with a speed range for constant torque of 1:10.

The speed control for this motor is 10% to 100% when at 100% load. Operating slower than 10% speed at 100% load will cause motor overload.

Load Tolerance	Cooling Capability	Overload Characteristics (at 100% motor load)
	<p>This motor is designed to withstand increased temperatures during continuous operation in the low speed range (10% base frequency).</p>	<p>The motor operates continuously at 10% to 100% base frequency. Operating slower than 10% speed at 100% load will cause motor overload.</p>

3 : CT 100:1 SpeedRange

Use this setting for vector motors with a speed range for constant torque of 1:100.

The speed control for this motor is 1% to 100% when at 100% load. Operating slower than 1% speed at 100% load will cause motor overload.

Load Tolerance	Cooling Capability	Overload Characteristics (at 100% motor load)
	<p>This motor is designed to withstand increased temperatures during continuous operation in the low speed range (1% base frequency).</p>	<p>The motor operates continuously at 1% to 100% base frequency. Operating slower than 1% speed at 100% load will cause motor overload.</p>

4 : PM V Torque

Use this setting for PM motors with derated torque characteristics.

The overload tolerance decreases as motor speed decreases because the cooling fan speed decreases and the ability of the motor to cool decreases in the low speed range.

The overload tolerance characteristics of the motor change the trigger point for the electronic thermal protector. This provides motor overheat protection from low speed to high speed across the full speed range.

Load Tolerance	Cooling Capability	Overload Characteristics (at 100% motor load)
	<p>This motor is designed to withstand increased temperatures during continuous operation at rated speed and rated torque.</p>	<p>If the motor operates continuously at lower speed than rated rotation speed at more than 100% torque, the drive will detect <i>o.L.</i> The drive triggers a fault relay output and the motor coasts to stop.</p>

5 : PM C Torque

Use this setting with a PM motor for constant torque that has a speed range for constant torque of 1:500.

The speed control for this motor is 0.2% to 100% when at 100% load. Operating slower than 0.2% speed at 100% load will cause motor overload.

Load Tolerance	Cooling Capability	Overload Characteristics (at 100% motor load)
	<p>This motor is designed to withstand increased temperatures during continuous operation in the low speed range (0.2% base frequency).</p>	<p>The motor operates continuously at 0.2% to 100% rated speed. Operating slower than 0.2% speed at 100% load will cause motor overload.</p>

6 : VT (50Hz)

Use this setting for general-purpose motors with a 50 Hz base frequency.

The overload tolerance decreases as motor speed decreases because the cooling fan speed decreases and the ability of the motor to cool decreases in the low speed range.

The overload tolerance characteristics of the motor change the trigger point for the electronic thermal protector. This provides motor overheat protection from low speed to high speed across the full speed range.

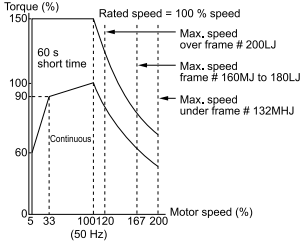
Load Tolerance	Cooling Capability	Overload Characteristics (at 100% motor load)
	<p>This motor is designed to operate with commercial line power. Operate at a 50 Hz base frequency to maximize the motor cooling ability.</p>	<p>If the motor operates at frequencies less than commercial line power, the drive will detect <i>oLL</i>. The drive triggers a fault relay output and the motor coasts to stop.</p>

L1-02 OL1 Protect Time

No. (Hex.)	Name	Description	Default (Range)
L1-02 (0481)	OL1 Protect Time	Sets the operation time for the electronic thermal protector of the drive to prevent damage to the motor. Usually it is not necessary to change this setting.	1.0 min (0.1 - 5.0 min)

Set the overload tolerance time to the length of time that the motor can operate at 150% load from continuous operation at 100% load.

When the motor operates at 150% load continuously for 1 minute after continuous operation at 100% load (hot start), the default setting triggers the electronic thermal protector.

Figure 2.6 shows an example of the electronic thermal protector operation time. Motor overload protection operates in the range between a cold start and a hot start.

This example shows a general-purpose motor operating at the base frequency with *L1-02* set to 1.0 min.

- Cold start
Shows the motor protection operation time characteristics when the overload occurs immediately after starting operation from a complete stop.
- Hot start
Shows the motor protection operation time characteristics when overload occurs from continuous operation below the motor rated current.

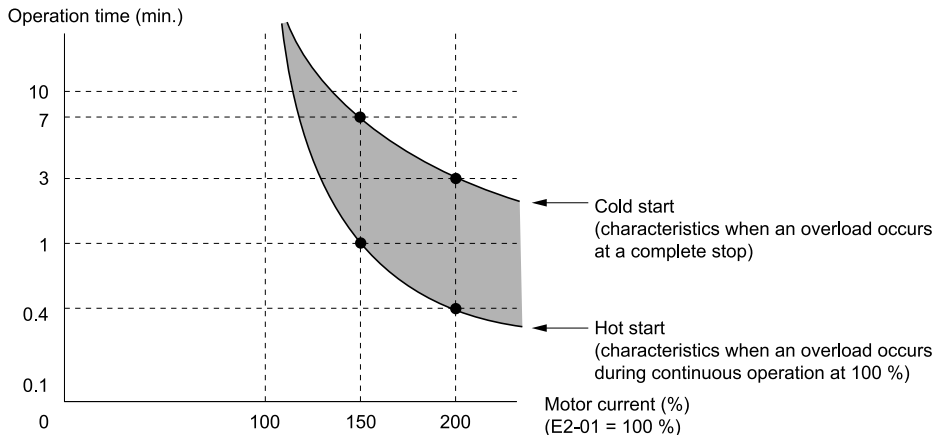

Figure 2.6 Protection Operation Time for a General-purpose Motor at Rated Output Frequency

L1-03 Motor oH AL Reaction Select

No. (Hex.)	Name	Description	Default (Range)
L1-03 (0482)	Motor oH AL Reaction Select	Sets drive operation when the PTC input signal entered into the drive is at the oH3 [Motor Overheat Alarm] detection level.	3 (0 - 3)

0 : Ramp->Stop

The drive ramps the motor to stop in the deceleration time. Fault relay output terminal 1NO-1CM turns ON and 1NC-1CM turns OFF.

1 : Coast->Stop

The output turns OFF and the motor coasts to stop. Fault relay output terminal 1NO-1CM turns ON, and 1NC-1CM turns OFF.

2 : Fast Stop (C1-09)

The drive stops the motor in the deceleration time set in C1-09 [Fast Stop Time]. Fault relay output terminal 1NO-1CM turns ON, and 1NC-1CM turns OFF.

3 : Alarm Only

The keypad shows oH3, and operation continues. The output terminal set for Alarm [H2-01 to H2-03 = 4] turns ON.

L1-04 Motor oH FLT Reaction Select

No. (Hex.)	Name	Description	Default (Range)
L1-04 (0483)	Motor oH FLT Reaction Select	Sets the drive operation when the PTC input signal to the drive is at the oH4 [Motor Overheat Fault (PTC Input)] detection level.	1 (0 - 2)

0 : Ramp->Stop

The drive ramps the motor to stop in the deceleration time. The output terminal set for Fault [H2-01 to H2-03 = 3] activates.

1 : Coast->Stop

The output turns OFF and the motor coasts to stop. The output terminal set for *Fault [H2-01 to H2-03 = 3]* activates.

2 : Fast Stop (C1-09)

The drive stops the motor in the deceleration time set in *C1-09 [Fast Stop Time]*. The output terminal set for *Fault [H2-01 to H2-03 = 3]* activates.

◆ China RoHS Compliance



Figure 2.7 China RoHS Mark

The China RoHS mark is displayed on products containing six specified hazardous substances that are in excess of regulatory limits, based on the “Administrative Measures for the Restriction of the Use of Hazardous Substances in Electrical and Electronic Products” and “Marking for the Restricted Use of Hazardous Substances in Electronic and Electrical Products” (SJ/T 11364-2014), which were promulgated on January 26, 2016. The number displayed in the center of the mark indicates the environment-friendly use period (number of years) in which electrical and electronic products that are being produced, sold, or imported to China can be used. The date of manufacture of the electrical and electronic product is the starting date of the environment-friendly use period for the product. The six specified hazardous substances contained in the product will not leak outside of the product during normal use within this period and will have no serious impact on the environment, the human body, or property.

The environment-friendly use period for this product is 15 years. This period is not the product warranty period.

Table 2.3 Contents of Hazardous Substances in This Product

Parts Name	Hazardous Substances					
	Lead (Pb)	Mercury (Hg)	Cadmium (Cd)	Hexavalent Chromium (Cr(VI))	Polybrominated Biphenyls (PBB)	Polybrominated Diphenyl Ethers (PBDE)
Circuit Board	×	○	○	○	○	○
Electronic Parts	×	○	○	○	○	○
Brass Screw	×	○	○	○	○	○
Aluminum Die Casting	×	○	○	○	○	○

This table has been prepared in accordance with the provisions outlined in SJ/T 11364.

○: Indicates that said hazardous substance contained in all of the homogeneous materials for this part is below or equal to the limit requirement of GB/T 26572.

×: Indicates that said hazardous substance contained in at least one of the homogeneous materials used for this part is above the limit requirement of GB/T 26572.

Note:

This product complies with EU RoHS directives. In this table, "×" indicates that hazardous substances that are exempt from EU RoHS directives are contained.

◆ 对应中国RoHS指令



图 2.8 中国RoHS标志

中国RoHS标志依据2016年1月26日公布的《电器电子产品有害物质限制使用管理办法》，以及《电子电气产品有害物质限制使用标识要求》（SJ/T 11364-2014）作成。电子电气产品中特定6种有害物质的含量超过规定值时，应标识此标志。中间的数字为在中国生产销售以及进口的电子电气产品的环保使用期限（年限）。电子电气产品的环保使用期限从生产日期算起。在期限内，正常使用产品的过程中，不会有特定的6种有害物质外泄进而对环境、人和财产造成深刻影响。

本产品的环保使用期限为15年。但需要注意的是环保使用期限并非产品的质量保证期限。

表 2.4 本产品中有害物质的名称及含量

部件名称	有害物质					
	铅(Pb)	汞(Hg)	镉(Cd)	六价铬(Cr(VI))	多溴联苯(PBB)	多溴二苯醚(PBDE)
实装基板	×	○	○	○	○	○
电子元件	×	○	○	○	○	○
黄铜螺钉	×	○	○	○	○	○
铝压铸	×	○	○	○	○	○

本表格依据SJ/T 11364的规定编制。
 ○：表示该有害物质在该部件所有均质材料中的含量均在GB/T 26572规定的限量要求以下。
 ×：表示该有害物质至少在该部件的某一均质材料中的含量超出GB/T 26572规定的限量要求。
 （注） 本产品符合欧盟RoHS指令。上表中的“×”表示含有欧盟RoHS指令豁免的有害物质。

◆ Factory Recommended Branch Circuit Protection

■ Three-Phase 200 V Class

Table 2.5 Factory-Recommended Branch Circuit Protection: Three-Phase 200 V Class

Drive Model	Time Delay Fuse	Semiconductor Protection Fuse Rated Current Manufacturer: EATON/Bussmann	
	Class J, T, and CC Fuse Rated Current A	Model	Input Rated Current A
2001	3	FWH-25A14F	25
2002	6	FWH-25A14F	25
2004	6	FWH-25A14F	25
2006	10	FWH-25A14F	25
2010	20	FWH-70B	70

Drive Model	Time Delay Fuse	Semiconductor Protection Fuse Rated Current Manufacturer: EATON/Bussmann	
	Class J, T, and CC Fuse Rated Current A	Model	Input Rated Current A
2012	25	FWH-70B	70
2021	40	FWH-90B	90
2030	-	FWH-100B	100
2042	-	FWH-150B	150
2056	-	FWH-200B	200
2070	-	FWH-200B	200
2082	-	FWH-225A	225

■ Single-Phase 200 V Class

Table 2.6 Factory-Recommended Branch Circuit Protection: Single-Phase 200 V Class

Drive Model	Time Delay Fuse	Semiconductor Protection Fuse Rated Current Manufacturer: EATON/Bussmann	
	Class J, T, and CC Fuse Rated Current A	Model	Input Rated Current A
B001	3	FWH-25A14F	25
B002	6	FWH-25A14F	25
B004	10	FWH-60B	60
B006	15	FWH-80B	80
B010	25	FWH-100B	100
B012	30	FWH-125B	125
B018	-	FWH-150B	150



■ Three-Phase 400 V Class



Table 2.7 Factory-Recommended Branch Circuit Protection: Three-Phase 400 V Class

Drive Model	Time Delay Fuse	Semiconductor Protection Fuse Rated Current Manufacturer: EATON/Bussmann	
	Class J, T, and CC Fuse Rated Current A	Model	Input Rated Current A
4001	3	FWH-40B	40
4002	6	FWH-40B	40
4004	10	FWH-50B	50





















Drive Model	Time Delay Fuse	Semiconductor Protection Fuse Rated Current Manufacturer: EATON/Bussmann	
	Class J, T, and CC Fuse Rated Current A	Model	Input Rated Current A
4005	10	FWH-70B	70
4007	15	FWH-70B	70
4009	20	FWH-90B	90
4012	25	FWH-90B	90
4018	-	FWH-80B	80
4023	-	FWH-100B	100
4031	-	FWH-125B	125
4038	-	FWH-175B	175
4044	-	FWH-200B	200
4060	-	FWH-200B	200

◆ Main Circuit Wire Gauges and Tightening Torques



















Symbol	Screw
	Hex bolt, cross-slotted
	Hex bolt, slotted
	Hex self locking nut

Symbol	Screw
	Hex socket cap
	Philips/slot combo
	Slot

■ Three-Phase 200 V Class

Model	Terminals	Recommended Gauge mm ² (AWG kcmil)	Applicable Gauge mm ² (AWG kcmil)	Wire Stripping Length *7 mm	Terminal Screw	Tightening Torque N·m (lb. ·in.)
2001 2002 2004 2006	R/L1, S/L2, T/L3 U/T1, V/T2, W/T3	2.5 (14)	2.5 (14)	6.5	 M3	0.5 - 0.6 (4.4 - 5.3)
	-, +1, +2	2.5 (14)	2.5 (14)	6.5	 M3	0.5 - 0.6 (4.4 - 5.3)
	B1, B2	2.5 (14)	2.5 (14)	6.5	 M3	0.5 - 0.6 (4.4 - 5.3)
		2.5 *2 (14)	2.5 *2 (14)	-	 M3.5	0.8 - 1.0 (7.1 - 8.9)
2010	R/L1, S/L2, T/L3 U/T1, V/T2, W/T3	2.5 (14)	2.5 - 4 (14 - 12)	8	 M3	0.5 - 0.6 (4.4 - 5.3)
	-, +1, +2	2.5 (12)	2.5 - 4 (14 - 10)	8	 M3	0.5 - 0.6 (4.4 - 5.3)
	B1, B2	2.5 (14)	2.5 - 4 (14 - 12)	8	 M3	0.5 - 0.6 (4.4 - 5.3)
		4 *2 (10)	2.5 - 6 *2 (14 - 10)	-	 M4	1.2 - 1.5 (10.6 - 13.3)
2012	R/L1, S/L2, T/L3 U/T1, V/T2, W/T3	2.5 (12)	2.5 - 4 (14 - 10)	8	 M3	0.5 - 0.6 (4.4 - 5.3)
	-, +1, +2	2.5 (10)	2.5 - 4 (12 - 10)	8	 M3	0.5 - 0.6 (4.4 - 5.3)
	B1, B2	2.5 (14)	2.5 - 4 (14 - 12)	8	 M3	0.5 - 0.6 (4.4 - 5.3)
		4 *2 (10)	2.5 - 6 *2 (14 - 10)	-	 M4	1.2 - 1.5 (10.6 - 13.3)
2021	R/L1, S/L2, T/L3	4 (8)	2.5 - 6 (14 - 8)	10	 M4	1.5 - 1.7 (13.5 - 15)
	U/T1, V/T2, W/T3	2.5 (10)	2.5 - 4 (14 - 8)	10	 M4	1.5 - 1.7 (13.5 - 15)
	-, +1, +2	6 (8)	4 - 10 (14 - 8)	10	 M4	1.5 - 1.7 (13.5 - 15)
	B1, B2	2.5 (14)	2.5 - 4 (14 - 10)	10	 M4	1.5 - 1.7 (13.5 - 15)
		6 (8)	2.5 - 6 (14 - 8)	-	 M4	1.2 - 1.5 (10.6 - 13.3)

2 Attachments

Model	Terminals	Recommended Gauge mm ² (AWG kcmil)	Applicable Gauge mm ² (AWG kcmil)	Wire Stripping Length *7 mm	Terminal Screw	Tightening Torque N·m (lb. ·in.)
2030	R/L1, S/L2, T/L3	6 (8)	4 - 10 (12 - 6)	10	 M4	1.5 - 1.7 (13.5 - 15)
	U/T1, V/T2, W/T3	6 (8)	4 - 10 (12 - 6)	10	 M4	1.5 - 1.7 (13.5 - 15)
	-, +1, +2	10 (6)	2.5 - 16 (12 - 6)	10	 M4	1.5 - 1.7 (13.5 - 15)
	B1, B2	2.5 (12)	2.5 - 4 (12 - 8)	10	 M4	1.5 - 1.7 (13.5 - 15)
	 M4	6 (8)	6 - 16 (10 - 6)	-	 M4	2.0 - 2.5 (17.7 - 22.1)
2042	R/L1, S/L2, T/L3	10 (6)	2.5 - 16 (12 - 6)	10	 M4	1.5 - 1.7 (13.5 - 15)
	U/T1, V/T2, W/T3	10 (6)	2.5 - 16 (12 - 6)	10	 M4	1.5 - 1.7 (13.5 - 15)
	-, +1, +2	16 (4)	4 - 25 (10 - 2)	18	 M5	2.3 - 2.5 (19.8 - 22)
	B1, B2	4 (10)	2.5 - 6 (14 - 6)	10	 M4	1.5 - 1.7 (13.5 - 15)
	 M5	10 (6)	6 - 16 (10 - 6)	-	 M5	2.0 - 2.5 (17.7 - 22.1)
2056	R/L1, S/L2, T/L3	16 (4)	4 - 25 (10 - 2)	18	 M5	2.3 - 2.5 (19.8 - 22)
	U/T1, V/T2, W/T3	16 (4)	4 - 25 (10 - 2)	18	 M5	2.3 - 2.5 (19.8 - 22) AWG 8 ≤ 4.1 - 4.5 (36 - 40)
	-, +1, +2	25 (2)	6 - 35 (8 - 2)	18	 M5	4.1 - 4.5 (36 - 40) ≤ 25 mm² 2.3 - 2.5 (19.8 - 22)
	B1, B2	10 (8)	4 - 16 (12 - 6)	10	 M4	1.5 - 1.7 (13.5 - 15)
	 M6	10 (6)	10 - 25 (8 - 4)	-	 M6	5.4 - 6.0 (47.8 - 53.1)

















Model	Terminals	Recommended Gauge mm ² (AWG kcmil)	Applicable Gauge mm ² (AWG kcmil)	Wire Stripping Length *1 mm	Terminal Screw	Tightening Torque N·m (lb. ·in.)
2070	R/L1, S/L2, T/L3	25 (2)	6 - 35 (6 - 1)	20	Ⓜ M6	5 - 5.5 (45 - 49)
	U/T1, V/T2, W/T3	16 (2)	6 - 25 (8 - 1)	20	Ⓜ M6	5 - 5.5 (45 - 49)
	-, +1, +2	35 (1)	10 - 50 (6 - 1/0)	20	Ⓜ M6	5 - 5.5 (45 - 49)
	B1, B2	10 (8)	4 - 16 (12 - 6)	10	⊖ M4	1.5 - 1.7 (13.5 - 15)
	⊕	16 (4)	10 - 25 (6 - 4)	-	⊕ M6	5.4 - 6.0 (47.8 - 53.1)
2082	R/L1, S/L2, T/L3	35 (1)	10 - 50 (6 - 1/0)	20	Ⓜ M6	5 - 5.5 (45 - 49)
	U/T1, V/T2, W/T3	25 (2)	10 - 35 (6 - 1)	20	Ⓜ M6	5 - 5.5 (45 - 49)
	-, +1, +2	50 (2/0)	16 - 70 (2 - 2/0)	20	Ⓜ M6	5 - 5.5 (45 - 49)
	B1, B2	16 (6)	4 - 16 (10 - 6)	10	⊖ M4	1.5 - 1.7 (13.5 - 15)
	⊕	16 (4)	10 - 25 (6 - 4)	-	⊕ M6	5.4 - 6.0 (47.8 - 53.1)













*1 Remove insulation from the ends of wires to expose the length of wire shown.

*2 If you turn on the internal EMC filter, the leakage current of the drive will be more than 3.5 mA. Use these closed-loop crimp terminals or equivalent to connect a protective ground wire that has a minimum cross-sectional area of 10 mm² (copper wire).

- 8-4NS from JST Mfg. Co., Ltd.
- R8-4S from NICHIFU Co., Ltd.

■ Single-Phase 200 V Class

Model	Terminals	Recommended Gauge mm ² (AWG kcmil)	Applicable Gauge mm ² (AWG kcmil)	Wire Stripping Length *7 mm	Terminal Screw	Tightening Torque N·m (lb. ·in.)
B001 B002 B004	L/L1, N/L2 U/T1, V/T2, W/T3	2.5 (14)	2.5 (14)	6.5	 M3	0.5 - 0.6 (4.4 - 5.3)
	-, +1	2.5 (14)	2.5 (14)	6.5	 M3	0.5 - 0.6 (4.4 - 5.3)
	B1, B2	2.5 (14)	2.5 (14)	6.5	 M3	0.5 - 0.6 (4.4 - 5.3)
		2.5 *2 (14)	2.5 *2 (14)	-	 M3.5	0.8 - 1.0 (7.1 - 8.9)
B006	L/L1, N/L2	2.5 (12)	2.5 - 4 (14 - 10)	8	 M3	0.5 - 0.6 (4.4 - 5.3)
	U/T1, V/T2, W/T3	2.5 (14)	2.5 - 4 (14 - 12)	8	 M3	0.5 - 0.6 (4.4 - 5.3)
	-, +1, +2	2.5 (12)	2.5 - 4 (14 - 10)	8	 M3	0.5 - 0.6 (4.4 - 5.3)
	B1, B2	2.5 (14)	2.5 - 6 (14 - 12)	8	 M3	0.5 - 0.6 (4.4 - 5.3)
		2.5 *2 (10)	2.5 - 4 *2 (14 - 10)	-	 M4	1.2 - 1.5 (10.6 - 13.3)
B010	L/L1, N/L2	2.5 (10)	2.5 - 4 (12 - 10)	8	 M3	0.5 - 0.6 (4.4 - 5.3)
	U/T1, V/T2, W/T3	2.5 (14)	2.5 - 4 (14 - 12)	8	 M3	0.5 - 0.6 (4.4 - 5.3)
	-, +1, +2	2.5 (10)	2.5 - 4 (12 - 10)	8	 M3	0.5 - 0.6 (4.4 - 5.3)
	B1, B2	2.5 (14)	2.5 - 6 (14 - 12)	8	 M3	0.5 - 0.6 (4.4 - 5.3)
		2.5 *2 (10)	2.5 - 4 *2 (14 - 10)	-	 M4	1.2 - 1.5 (10.6 - 13.3)

















Model	Terminals	Recommended Gauge mm ² (AWG kcmil)	Applicable Gauge mm ² (AWG kcmil)	Wire Stripping Length *1 mm	Terminal Screw	Tightening Torque N·m (lb. ·in.)
B012	L/L1, N/L2	4 (8)	2.5 - 6 (14 - 8)	10	 M4	1.5 - 1.7 (13.5 - 15)
	U/T1, V/T2, W/T3	2.5 (12)	2.5 - 4 (14 - 10)	10	 M4	1.5 - 1.7 (13.5 - 15)
	-, +1, +2	4 (8)	2.5 - 6 (14 - 8)	10	 M5	1.5 - 1.7 (13.5 - 15)
	B1, B2	2.5 (14)	2.5 - 4 (14 - 12)	10	 M4	1.5 - 1.7 (13.5 - 15)
		4 *2 (10)	2.5 - 6 *2 (14 - 10)	-	 M4	1.2 - 1.5 (10.6 - 13.3)
B018	L/L1, N/L2	6 (8)	2.5 - 10 (12 - 6)	10	 M4	1.5 - 1.7 (13.5 - 15)
	U/T1, V/T2, W/T3	2.5 (10)	2.5 - 4 (14 - 8)	10	 M4	1.5 - 1.7 (13.5 - 15)
	-, +1	6 (8)	2.5 - 10 (12 - 6)	10	 M5	1.5 - 1.7 (13.5 - 15)
	B1, B2	2.5 (14)	2.5 - 4 (14 - 12)	10	 M4	1.5 - 1.7 (13.5 - 15)
		6 *2 (8)	4 - 10 *2 (12 - 8)	-	 M5	2.0 - 2.5 (17.7 - 22.1)



















*1 Remove insulation from the ends of wires to expose the length of wire shown.

*2 If you turn on the internal EMC filter, the leakage current of the drive will be more than 3.5 mA. Use these closed-loop crimp terminals or equivalent to connect a protective ground wire that has a minimum cross-sectional area of 10 mm² (copper wire).













- 8-4NS from JST Mfg. Co., Ltd.
- R8-4S from NICHIFU Co.,Ltd.







■ Three-Phase 400 V Class

Model	Terminals	Recommended Gauge mm ² (AWG kcmil)	Applicable Gauge mm ² (AWG kcmil)	Wire Stripping Length *7 mm	Terminal Screw	Tightening Torque N·m (lb. ·in.)
4001 4002	R/L1, S/L2, T/L3 U/T1, V/T2, W/T3	2.5 (14)	2.5 - 4 (14 - 12)	8	 M3	0.5 - 0.6 (4.4 - 5.3)
	-, +1, +2	2.5 (14)	2.5 - 4 (14 - 12)	8	 M3	0.5 - 0.6 (4.4 - 5.3)
	B1, B2	2.5 (14)	2.5 - 4 (14 - 12)	8	 M3	0.5 - 0.6 (4.4 - 5.3)
		2.5 *2 (14)	2.5 - 6 *2 (14 - 10)	-	 M4	1.2 - 1.5 (10.6 - 13.3)
4004 4005 4007 4009	R/L1, S/L2, T/L3 U/T1, V/T2, W/T3	2.5 (14)	2.5 - 4 (14 - 12)	8	 M3	0.5 - 0.6 (4.4 - 5.3)
	-, +1, +2	2.5 (14)	2.5 - 4 (14 - 12)	8	 M3	0.5 - 0.6 (4.4 - 5.3)
	B1, B2	2.5 (14)	2.5 - 4 (14 - 12)	8	 M3	0.5 - 0.6 (4.4 - 5.3)
		2.5 *2 (10)	2.5 - 6 *2 (14 - 10)	-	 M4	1.2 - 1.5 (10.6 - 13.3)
4012	R/L1, S/L2, T/L3	2.5 (12)	2.5 - 4 (14 - 10)	10	 M4	1.5 - 1.7 (13.5 - 15)
	U/T1, V/T2, W/T3	2.5 (14)	2.5 - 4 (14 - 12)	10	 M4	1.5 - 1.7 (13.5 - 15)
	-, +1, +2	2.5 (10)	2.5 - 4 (14 - 8)	10	 M4	1.5 - 1.7 (13.5 - 15)
	B1, B2	2.5 (14)	2.5 - 4 (14 - 12)	10	 M4	1.5 - 1.7 (13.5 - 15)
		4 *2 (10)	2.5 - 6 *2 (14 - 10)	-	 M4	1.2 - 1.5 (10.6 - 13.3)

Model	Terminals	Recommended Gauge mm ² (AWG kcmil)	Applicable Gauge mm ² (AWG kcmil)	Wire Stripping Length *7 mm	Terminal Screw	Tightening Torque N·m (lb. ·in.)
4018	R/L1, S/L2, T/L3	2.5 (10)	2.5 - 4 (12 - 8)	10	 M4	1.5 - 1.7 (13.5 - 15)
	U/T1, V/T2, W/T3	2.5 (10)	2.5 - 4 (12 - 8)	10	 M4	1.5 - 1.7 (13.5 - 15)
	-, +1, +2	4 (10)	2.5 - 6 (14 - 8)	10	 M4	1.5 - 1.7 (13.5 - 15)
	B1, B2	2.5 (14)	2.5 - 4 (14 - 12)	10	 M4	1.5 - 1.7 (13.5 - 15)
		4 *2 (10)	2.5 - 16 *2 (14 - 6)	-	 M5	2.0 - 2.5 (17.7 - 22.1)
4023	R/L1, S/L2, T/L3	4 (8)	2.5 - 6 (14 - 6)	10	 M4	1.5 - 1.7 (13.5 - 15)
	U/T1, V/T2, W/T3	4 (10)	2.5 - 6 (14 - 8)	10	 M4	1.5 - 1.7 (13.5 - 15)
	-, +1, +2	4 (8)	4 - 6 (12 - 6)	10	 M4	1.5 - 1.7 (13.5 - 15)
	B1, B2	2.5 (12)	2.5 - 4 (14 - 10)	10	 M4	1.5 - 1.7 (13.5 - 15)
		4 *2 (10)	4 - 16 *2 (10 - 6)	-	 M5	2.0 - 2.5 (17.7 - 22.1)
4031	R/L1, S/L2, T/L3	6 (8)	4 - 10 (12 - 6)	10	 M4	1.5 - 1.7 (13.5 - 15)
	U/T1, V/T2, W/T3	6 (8)	4 - 10 (12 - 6)	10	 M4	1.5 - 1.7 (13.5 - 15)
	-, +1, +2	10 (6)	2.5 - 16 (12 - 4)	18	 M5	2.3 - 2.5 (19.8 - 22) AWG 8 ≤ 4.1 - 4.5 (36 - 40)
	B1, B2	2.5 (10)	2.5 - 4 (12 - 8)	10	 M4	1.5 - 1.7 (13.5 - 15)
		6 (8)	6 - 16 (10 - 6)	-	 M6	5.4 - 6.0 (47.8 - 53.1)

2 Attachments

Model	Terminals	Recommended Gauge mm ² (AWG kcmil)	Applicable Gauge mm ² (AWG kcmil)	Wire Stripping Length *7 mm	Terminal Screw	Tightening Torque N·m (lb. in.)
4038	R/L1, S/L2, T/L3	10 (6)	4 - 16 (12 - 6)	10	 M4	1.5 - 1.7 (13.5 - 15)
	U/T1, V/T2, W/T3	6 (8)	2.5 - 10 (12 - 6)	10	 M4	1.5 - 1.7 (13.5 - 15)
	-, +1, +2	16 (4)	4 - 25 (10 - 2)	18	 M5	2.3 - 2.5 (19.8 - 22) AWG 8 ≤ 4.1 - 4.5 (36 - 40)
	B1, B2	4 (10)	2.5 - 6 (14 - 6)	10	 M4	1.5 - 1.7 (13.5 - 15)
		10 (6)	6 - 16 (10 - 6)	-	 M6	5.4 - 6.0 (47.8 - 53.1)
4044	R/L1, S/L2, T/L3	16 (4)	4 - 25 (10 - 2)	18	 M5	2.3 - 2.5 (19.8 - 22) AWG 8 ≤ 4.1 - 4.5 (36 - 40)
	U/T1, V/T2, W/T3	10 (6)	4 - 16 (12 - 4)	18	 M5	2.3 - 2.5 (19.8 - 22) AWG 8 ≤ 4.1 - 4.5 (36 - 40)
	-, +1, +2	16 (2)	6 - 25 (8 - 2)	18	 M5	2.3 - 2.5 (19.8 - 22)
	B1, B2	6 (8)	4 - 10 (12 - 6)	10	 M4	1.5 - 1.7 (13.5 - 15)
		10 (6)	6 - 16 (10 - 6)	-	 M6	5.4 - 6.0 (47.8 - 53.1)

Model	Terminals	Recommended Gauge mm ² (AWG kcmil)	Applicable Gauge mm ² (AWG kcmil)	Wire Stripping Length *1 mm	Terminal Screw	Tightening Torque N·m (lb. ·in.)
4060	R/L1, S/L2, T/L3	25 (2)	6 - 35 (10 - 2)	18	 M5	4.1 - 4.5 (36 - 40) ≤ 25 mm ² 2.3 - 2.5 (19.8 - 22)
	U/T1, V/T2, W/T3	16 (4)	4 - 25 (6 - 2)	18	 M5	2.3 - 2.5 (19.8 - 22) AWG 8 ≤ 4.1 - 4.5 (36 - 40)
	-, +1, +2	25 (2)	6 - 35 (6 - 2)	18	 M5	4.1 - 4.5 (36 - 40) ≤ 25 mm ² 2.3 - 2.5 (19.8 - 22)
	B1, B2	10 (8)	2.5 - 16 (12 - 6)	10	 M4	1.5 - 1.7 (13.5 - 15)
		10 (6)	6 - 16 (10 - 6)	-	 M6	5.4 - 6.0 (47.8 - 53.1)

*1 Remove insulation from the ends of wires to expose the length of wire shown.

*2 If you turn on the internal EMC filter, the leakage current of the drive will be more than 3.5 mA. Use these closed-loop crimp terminals or equivalent to connect a protective ground wire that has a minimum cross-sectional area of 10 mm² (copper wire).

- 8-4NS from JST Mfg. Co., Ltd.
- R8-4S from NICHIFU Co., Ltd.

Q2V

Driving Quality

Installation & Operation Instructions

Omron Office Addresses

OMRON EUROPE B.V.

Tel: +31 (0) 23 568 13 00
industrial.omron.eu

France

Tel: +33 (0) 1 56 63 70 00
industrial.omron.fr

Poland

Tel: +48 22 458 66 66
industrial.omron.pl

Switzerland

Tel: +41 (0) 41 748 13 13
industrial.omron.ch

Austria

Tel: +43 (0) 2236 377 800
industrial.omron.at

Germany

Tel: +49 (0) 2173 680 00
industrial.omron.de

Portugal

Tel: +351 21 942 94 00
industrial.omron.pt

Turkey

Tel: +90 212 467 30 00
industrial.omron.com.tr

Belgium

Tel: +32 (0) 2 466 24 80
industrial.omron.be

Hungary

Tel: +36 1 399 30 50
industrial.omron.hu

Russia

Tel: +7 495 648 94 50
industrial.omron.ru

United Kingdom

Tel: +44 (0) 1908 258 258
industrial.omron.co.uk

Czech Republic

Tel: +420 234 602 602
industrial.omron.cz

Italy

Tel: +39 02 326 81
industrial.omron.it

South Africa

Tel: +27 (0)11 579 2600
industrial.omron.co.za

More Omron representatives

industrial.omron.eu

Denmark

Tel: +45 43 44 00 11
industrial.omron.dk

Netherlands

Tel: +31 (0) 23 568 11 00
industrial.omron.nl

Spain

Tel: +34 902 100 221
industrial.omron.es

Finland

Tel: +358 (0) 207 464 200
industrial.omron.fi

Norway

Tel: +47 (0) 22 65 75 00
industrial.omron.no

Sweden

Tel: +46 (0) 8 632 35 00
industrial.omron.se

In the event that the end user of this product is to be the military and said product is to be employed in any weapons systems or the manufacture thereof, the export will fall under the relevant regulations as stipulated in the Foreign Exchange and Foreign Trade Regulations. Therefore, be sure to follow all procedures and submit all relevant documentation according to any and all rules, regulations and laws that may apply. Specifications are subject to change without notice for ongoing product modifications and improvements.

Original Instructions

© 2019 YASKAWA Europe GmbH

MANUAL NO. TOEP YE0UQ2V 03A
Revision A <0>-1
May 2020 (E24 correction)
Published in Germany

