

OMRON

Easy to Read and
Easy to Understand

Code Reader

Technical Guide



Table of Contents

Barcodes and 2D Codes	3
Code Types	13
Code Reading Methods	39

▶ What Are Barcodes and 2D Codes?

Linear (1D) barcodes have been in commercial use since the 1970s and are the most common symbologies used for automatic identification. Increasing numbers of manufacturers are using two-dimensional (2D) symbols, such as Data Matrix, that offer greater placement flexibility and increased data capacity.

Machine-readable symbols generally fall into the categories of linear barcodes, stacked symbols, 2D symbols and Optical Character Recognition (OCR) fonts. OMRON Microscan provides fast, reliable reading solutions for 1D and 2D Symbology Standards in the right and OCR. Our products read any linear barcodes or 2D symbols printed or marked by any means, and verify them to industry standards.

LINEAR BARCODES



Code 128



Code 39



Pharmacode



Code 93



Interleaved 2 of 5



UPC

STACKED SYMBOLOGIES



PDF417



GS1 DataBar (Stacked)



GS1 DataBar (Composite)



Micro PDF417

1D and 2D Symbology Standards

- **ISO/IEC 15416**
1D Print Quality Standard
- **ISO/IEC 15415**
2D Print Quality Standard
- **Automotive Industry Action Group: AIAG B-4**
Parts Identification and Tracking
- **U.S. Department of Defense: IUID MIL-STD-130**
Permanent and Unique Item Identification
- **Electronic Industries Alliance: EIA 706**
Component Marking
- **Clinical and Laboratory Standards Institute: AUTO2-A2**
Bar Codes for Specimen Container Identification
- **ISO/IEC 16022**
International Symbology Specification
- **ISO/IEC 15434**
Symbol Data Format Syntax
- **Society of Aerospace Engineers: AS9132**
Data Matrix Quality Requirements For Part Marking
- **AIM DPM / ISO 29158**
Direct Part Mark Quality Guideline

Note: Symbologies on this page are not shown to scale and are not intended for testing purposes.

2D SYMBOLOGIES



Data Matrix



QR Code



Aztec Code



DotCode

DIRECT PART MARKS

Direct part marks (DPM) are typically 2D Data Matrix symbols permanently marked by such methods as dot peen or laser / chemical etch onto substrates including metal, plastic, rubber or glass. OMRON Microscan offers a comprehensive family of readers and verifiers with illumination and decode algorithms specifically designed for difficult direct part marks.



Thermal printing on foil



Dot peen on metal

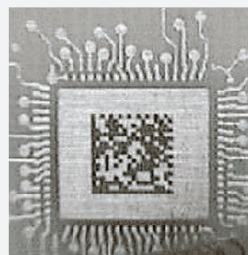

Laser etch on metal



Inkjet on ABS plastic

► Construction of Barcodes

Basic Barcode Structure

Basically, a barcode is composed of a combination of the following elements.

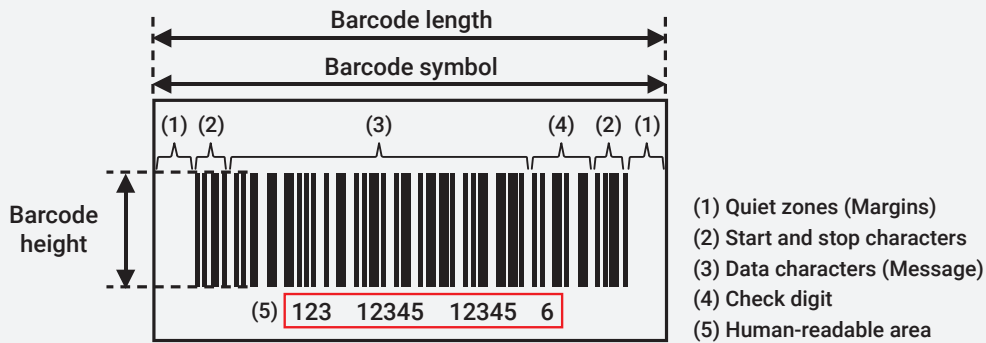

(1) Quiet Zones (Margins)

Empty spaces placed before and after a barcode, which are required for the barcode to be read. For a barcode to be read, it must have a sufficient empty spaces. If the spaces are insufficient or contain other patterns, etc., reading of the barcode becomes unstable. To enable stable reading, this quiet zone at the ends of the barcode symbol must be at least 10 times the narrow bar width (module).

(2) Start and Stop Characters

Characters that represent the beginning and end of the data. The start and stop characters vary depending on the barcode type.

(3) Data Characters (Message)

Part of a barcode in which information such as alphanumeric characters and symbols are encoded. The encoded information is expressed by combining bars and spaces of different widths.

(4) Check Digit

A character used for checking if information read by a code reader has no errors. A check digit is normally added to the end of the data. The barcode reader reads and calculates the value of the data up to the check digit based on a prescribed formula and compares the result with the printed check digit value to check if they match.

(5) Human-readable Area

An area that provides information that humans can read. The numbers and letters in this area are the ones encoded and shown as the barcode.

Optimal Size of Barcodes

To stably read barcodes, their height and length must be set to an optimal size.

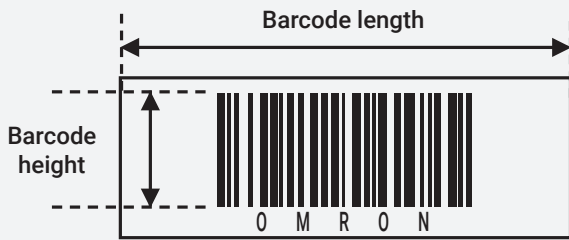

Barcode length

Must be such that a quiet zone **at least 10 times** wider than the narrow bar width is secured to the left and right of the barcode symbol.

Barcode height

Ensure the maximum printable height possible.
(**At least 15%** of the barcode length as a guide.)

Examples of Bad Codes

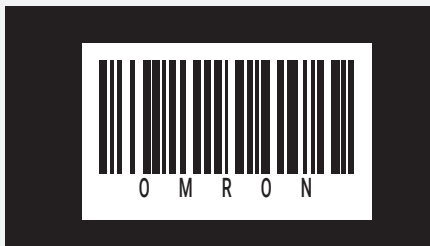

Insufficient quiet zone



Insufficient barcode height

Barcode Types and Structures

Barcodes have different structures depending on their type, and some do not conform to the basic structure.

Example 1: Pharmacode



Without start character/
stop character

Example 2: Code 39



12345F
With check digit



12345
Without check digit

Selectable between with or without check digit

Bars and Spaces

“Black bars” and “white spaces” are the smallest units that make up a barcode.

A barcode is composed of a combination of bars and spaces of different widths, each of which is called as follows.

WB: wide bar
NB: narrow bar
WS: wide space
NS: narrow space

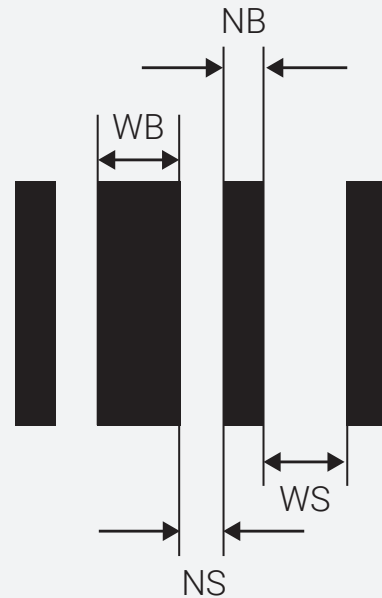

The ratio of the width of Thick (Wide) to Thin (Narrow) bar/space is defined as follows.

NB:WB = NS:WS = 1:2 to 1:3 (Recommended value is 1:2.5.)

If this ratio falls in a specified range, reading of the barcode becomes unstable.

The narrow bar width, called the “module”, is a factor to consider when selecting a code reader.

	Thin module	Thick module
Barcode size	Small	Large
Number of barcode digits that can be printed in a specified space	Large number of digits can be printed	Small number of digits can be printed
Reading distance range (Scan depth)	Narrow	Wide
Print accuracy of barcode printer	High accuracy is required Example: Laser printer Thermal transfer printer	Low accuracy is OK Example: Dot printer Inkjet printer for FA use

Binary-level and Multi-level

Barcodes such as that described on the previous page, made up of bars and spaces of two different widths, are called **binary-level** barcodes.

Major examples of binary-level barcodes are Interleaved Two of Five (ITF) and Code 39.

On the other hand, barcodes whose bar and space sizes have four levels are called **multi-level** barcodes.

Major examples of multi-level barcodes are Japanese Article Number (JAN) and Code 128.

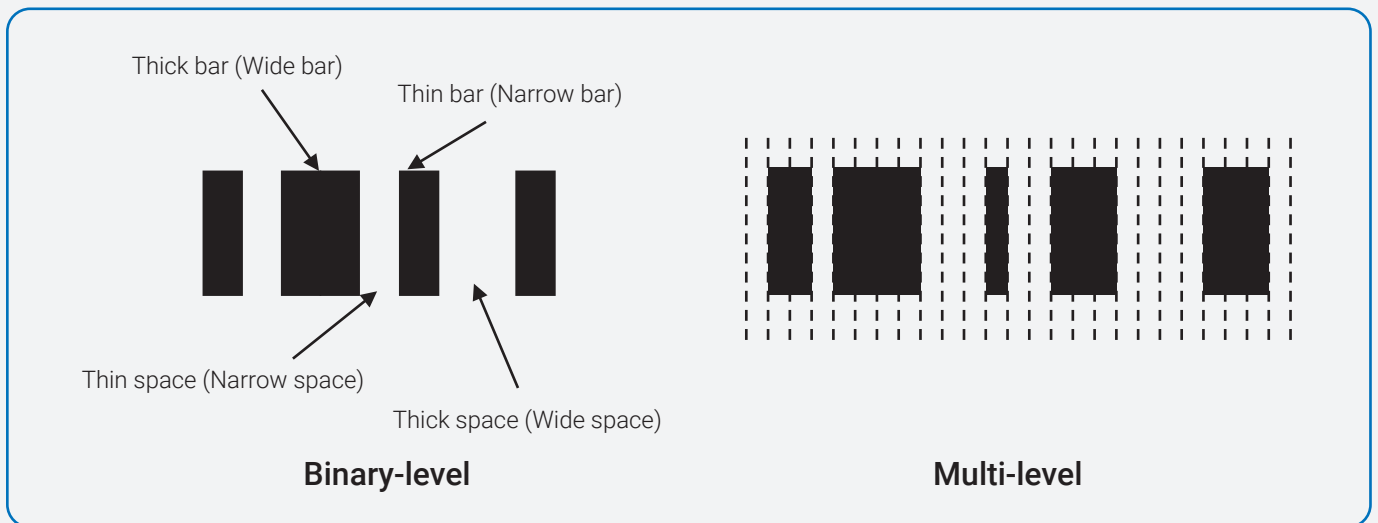

The size ratio between bars and spaces is "1:2:3:4" for multi-level barcodes, leaving almost no room for tolerance.

Due to the above, the possibility of scan errors increases if the barcode printing is not good, and recognizing the sizes of bars and spaces becomes difficult. When printing multi-level barcodes, use a printer with high printing accuracy such as a laser printer.

If the printing accuracy is low ...

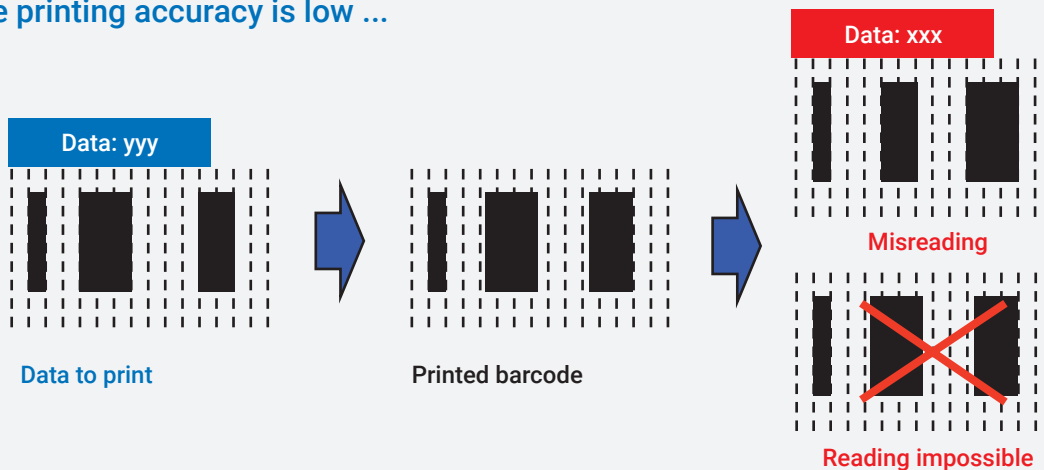

Check Digit

The check digit is a numerical value calculated to check whether or not the barcode has been correctly read, and mainly added at the end of the code. Misreading is avoided by checking that the check digit added at the end of the code matches the check digit calculated from the read barcode.

Check Flow



Read value:
0001234567895

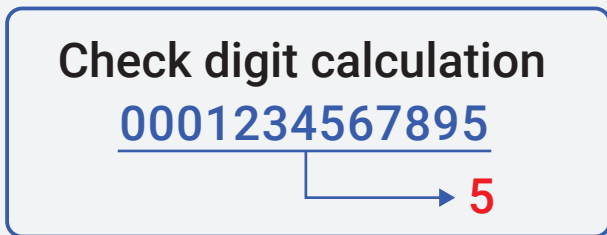

1. The barcode reader scans a barcode that consists of data "000123456789" and a check digit "5".
2. It calculates the check digit from the data of the read barcode.
3. It compares the calculated check digit with the check digit added to the barcode.
The reading is judged "Reading OK" if the check digits match, or "Reading NG" if they don't.

Example of Check Digit Calculation

The following describes an example of calculating the check digit using "modulus 10 and weight 3," which is employed in JAN and ITF codes.

Number of digits	1	2	3	4	5	6	7	8	9	10	11	12
No.	12	11	10	9	8	7	6	5	4	3	2	1
Code character	0	0	0	1	2	3	4	5	6	7	8	9
Weight	×1	×3	×1	×3	×1	×3	×1	×3	×1	×3	×1	×3
Subtotal	0	0	0	3	2	9	4	15	6	21	8	27
Calculation result	0+0+0+3+2+9+4+15+6+21+8+27 = 95											
Check digit	10 - 5 (last digit of 95) = 5											

Method for Calculating the Check Digit of "000123456789 (12 Digits)"

1. Multiply the value of each odd number digit by "3" and the value of each even number digit by "1."
2. Add the numbers obtained in step 1 and subtract its last digit from "10". The obtained value is the check digit.

► Construction of 2D Codes

QR Code Structure

The Quick Response (QR) code is a 2D matrix barcode developed in 1994 by DENSO WAVE INCORPORATED.

The QR code was registered to the AIM International Standards in 1997, to the JEIDA Standards in 1998, to the JIS Standards in 1999, and to the ISO/IEC Standards in 2000.

QR code® is a registered trademark of DENSO WAVE Inc.

QR Code Specifications

The smallest black or white square that makes up a QR code is called a cell.

A QR code is represented by a combination of cells that make up the finder pattern, timing pattern, alignment pattern, format information, error correction code (Reed-Solomon code), etc.

QR Code Outline Specifications

Symbol size	Version 1: 21 cells × 21 cells (Smallest) Version 2: 25 cells × 25 cells to Version 40: 177 cells × 177 cells (Largest) * Defined in increments of four cells.	
Maximum data capacity	Numeric	7,089 characters
	Alphanumeric (US-ASCII)	4,296 characters
	Binary (8 bits)	2,953 bytes
	Kanji/Kana (Shift JIS)	1,817 characters

Finder Pattern (Position Detection Pattern)

A pattern used to detect the QR code position. It is located at three corners in a QR code, and at one corner in a Micro QR code. As shown in the figure below, the size ratio between the black cells and the white cell is 1:1:3:1:1 to enable high-speed reading from any direction.

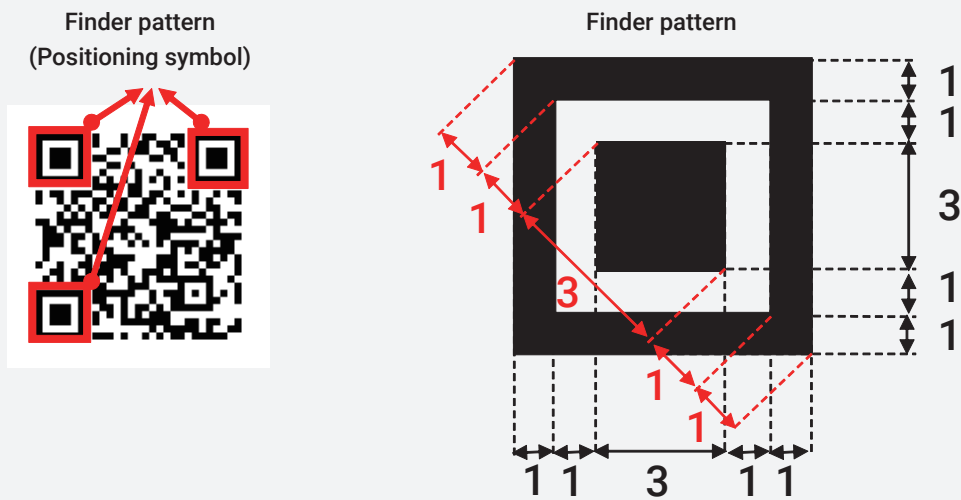

Alignment Pattern

Compensates for the position of each cell due to distortion.

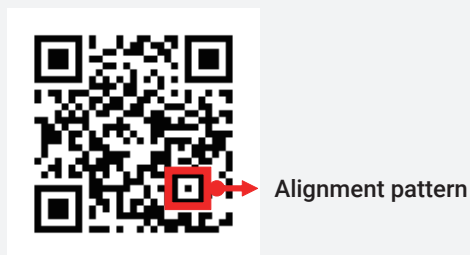

Quiet Zone

The blank portion around the 2D code symbol. It requires the equivalent of four cells in a QR code, and the equivalent of two cells in a micro QR code.

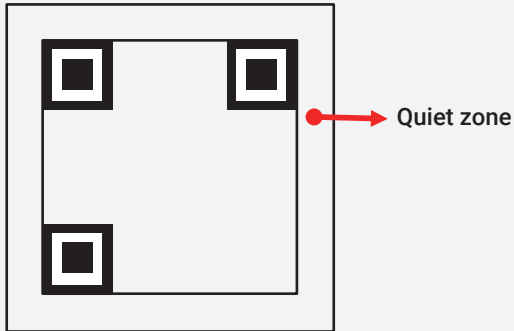

Timing Pattern

Consists of white cells and black cells placed alternately. It is used to determine the module coordinates within the symbol.

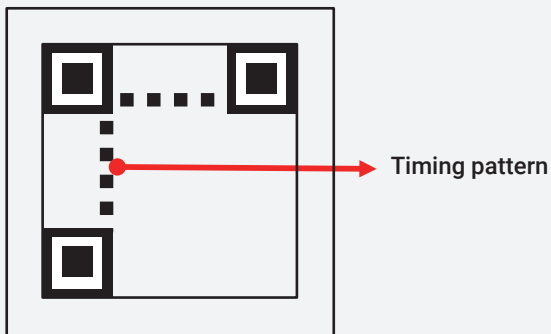

Format Information

Includes the error correction level and mask processing pattern used in the symbol. There are two copies as a backup measure: one located on the upper left, and another, which is split in two, located on the bottom left and upper right.

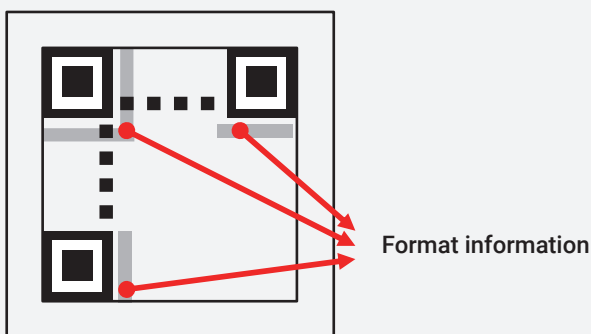

Error Correction Code (Reed-Solomon Code)

A code generated using the Reed-Solomon algorithm to recover data when a portion of the QR code is lost due to dirt, stain, damage, etc. There are four levels of error correction capability from which the user can select. Increasing the level improves the correction capability, but it makes the symbol size larger as the volume of information increases.

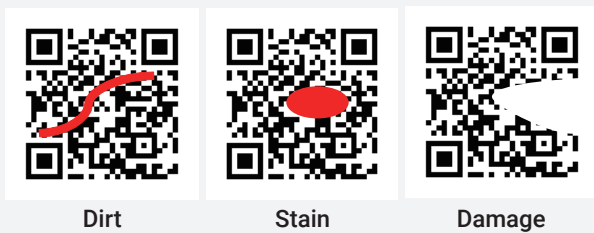

Error correction capability	
Error correction level	Lost symbol area
L	7%
M	15%
Q	25%
H	30%

Data Code and Error Correction Code Locations

The data code and error correction code have fixed positions as shown in the figure below. The QR code is formed with masking so that no marks appear with the same shape as the finder pattern.

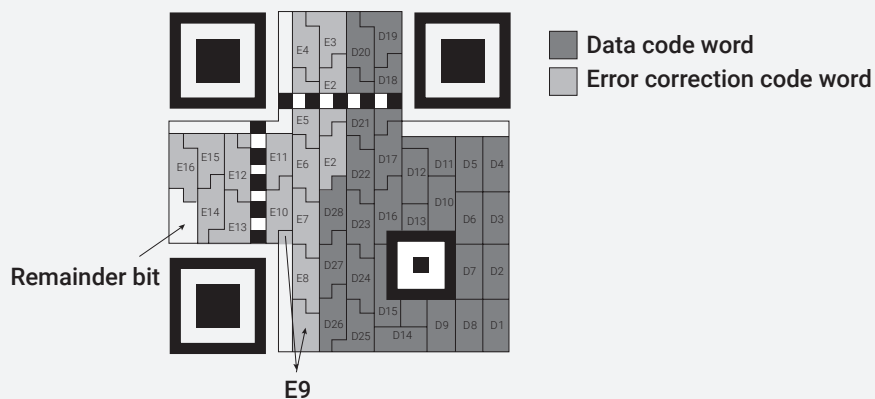

Example of symbol character array (Version 2-M)

Excerpt from the JIS standards

2 Code Types

▶ JAN and POS Systems

The most familiar barcode in daily life in Japan is the barcode named **J**apan **A**rticle **N**umber (**JAN**), standardized by JIS (JIS-X-0501). It is defined in the international standard ISO/IEC 15420. JAN consists of 13 digits (standard version) or 8 digits (short version). It is printed on most commercially distributed products, and is utilized by POS systems that are widely used in retailing, including convenience stores.

Compatible with **U**niversal **P**roduct **C**ode (**UPC**) of the U.S. and Canada and **E**uropean **A**rticle **N**umber (**EAN**) of Europe, JAN is a universal code that can be used all over the world.



What is a POS system?

A system that reads JAN codes on products that have been purchased at supermarkets, convenience stores, and so on to record and aggregate their sales information for the purpose of using it as marketing data.

Besides of allowing for sales management and precise inventory and sales order management, another advantage of POS systems is that they make it easier to analyze and use other linked data to compare the sales trend at multiple stores, understand the trend by combining weather or events with sales, and so on. This is the reason why they are attracting attention as systems to collect marketing data, especially at franchise chains.

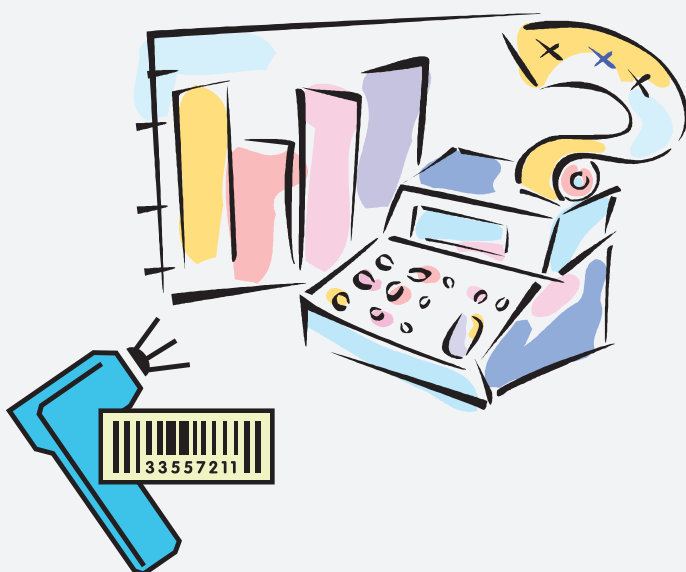

Today, we sold n packages of xx, making a total of 123,456 yen.

→ **Sales management**

Let's procure 100 packages of xx. We only have 10 packages left.

→ **Precise inventory and sales order management**

Festivals are coming up from next week. Let's procure more drinks than usual.

→ **Analysis using linked data**

JAN consists of 13 digits (standard version) or 8 digits (short version) and includes the following information:

- “Country code” Indicates the country of origin of the product. “49” or “45” for Japan.
- “Manufacturer code” Indicates the manufacturer of the product.
- “Product item code” Indicates the name of the product.
- “Check digit” Checks whether or not the barcode has been read correctly.

Originally, the manufacturer code is 5 digits long. However, as the number of applications for manufacturer code rose steeply, all new manufacturer codes registered after January 2001 are 7 digits long.

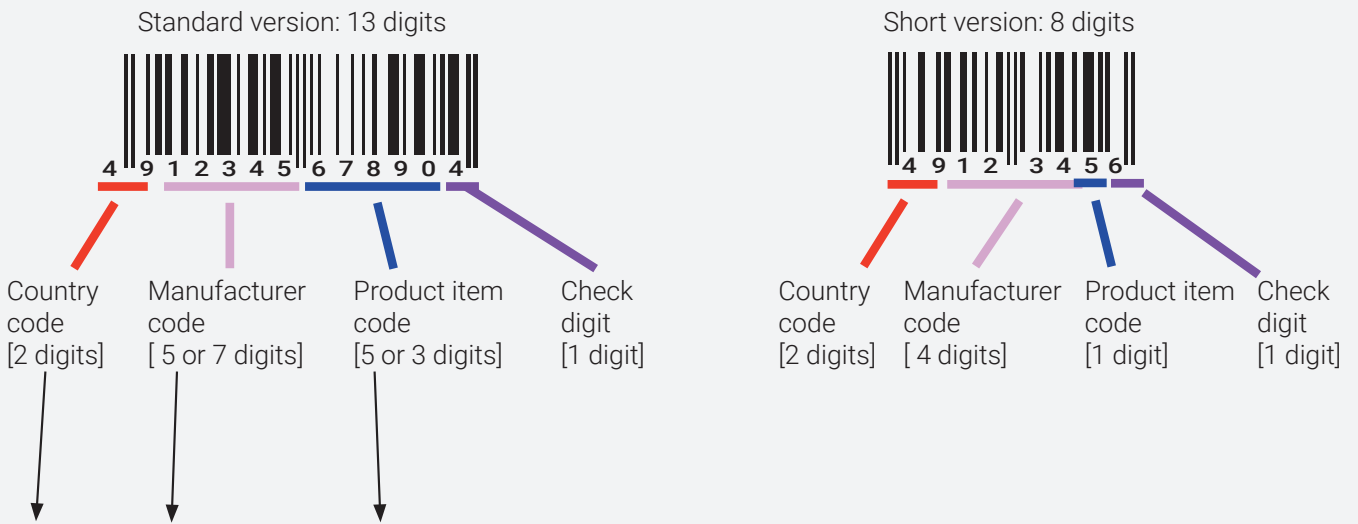

This code is unique and indicates that it is a product called yyy made by the Japanese company xxx.

JAN dimensions are defined in the JIS Standards, and are as follows.

- The basic dimension of the narrow bar width is 0.33 mm.
- JAN dimensions can be reduced or enlarged from 0.8 to 2.0 times the basic dimension.

As described above, the size can be changed to some extent, allowing for creating barcodes in accordance with the printable area or the code reader performance, such as reduced printing for small areas or enlarged printing to match the reading range of the code reader.

The following table shows the standard JAN code dimensions for each enlargement factor.

Enlargement factor	0.8x	1.0x	1.2x	2.0x
Narrow bar width	0.26 mm	0.33 mm	0.396 mm	0.66 mm
Barcode length	29.83 mm	37.29 mm	44.75 mm	74.58 mm
Barcode height	18.29 mm	22.86 mm	27.43 mm	45.72 mm
Height of symbol including human-readable text	21.25 mm	26.57 mm	31.88 mm	53.14 mm

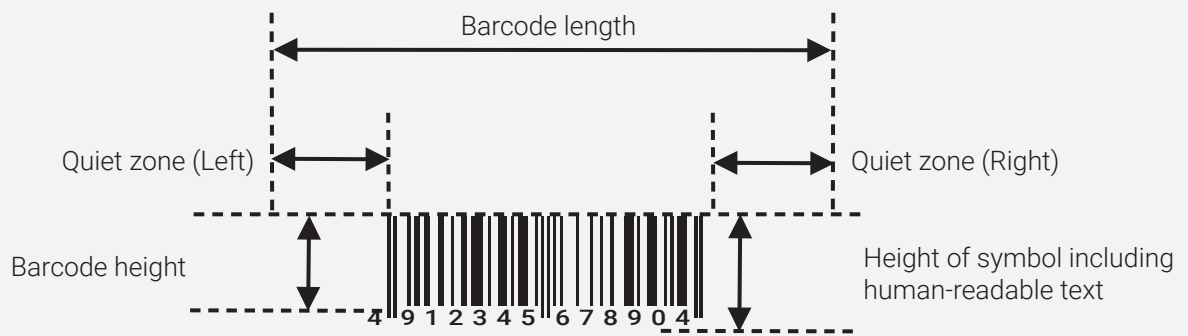

The quiet zone (margin) requires a space of approximately 10 modules or more.

Universal Product Code (UPC) is a barcode used in the U.S. and Canada. The barcode is printed on the product package along with its numerical representation, and read by a POS terminal at the time of the product's sale to use information for product distribution management. While JAN codes consist of 13 or 8 digits, UPC codes consist of 12 or 8 digits. Therefore, to export products to the U.S. or Canada, the UPC codes must also be printed. UPC was consolidated into the EAN (JAN) system, enabling the reading of EAN (JAN) also in the U.S. and Canada from 2005.

There are two mainly used versions of UPC: UPC-A which consists of 12 digits and UPC-E which consists of 8 digits. UPC-A **does not include a country code** since it is used in the U.S. and Canada. Instead, the content of the information changes depending on the value of the first digit called **Number System character (NS)**. For example, NS = 0, 6, 7 are used for marking the source of general foods and sundries, and consists of the following information:

- Number System character** 1 digit
- Manufacturer code** 5 digits (or 7 digits)
- Item code** 5 digits (or 3 digits)
- Check digit** 1 digit

UPC-E is a zero-suppressed version, where the code is shortened by suppressing zeros. It is created by abbreviating the manufacturer code and item code in UPC-A.

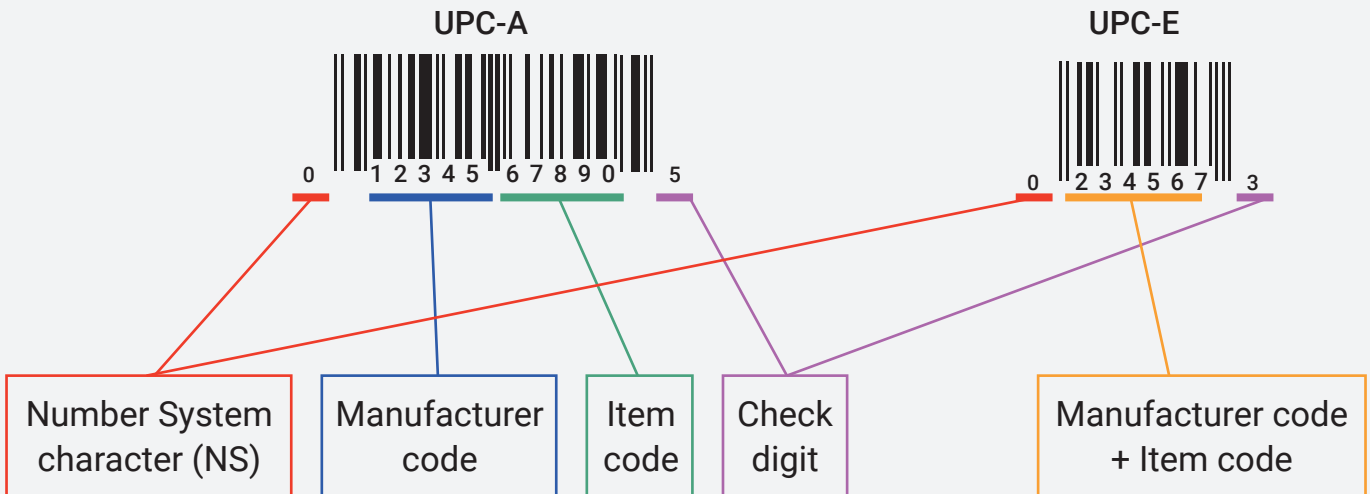

Interleaved Two of Five (ITF) is a barcode developed by Intermec, Inc. in 1972. It is mainly used as the standard distribution code printed on corrugated packaging.

The information must be made up of **even number of digits from 0 to 9** only. It may comprise **any** number of digits. As its name Inter-leaved (inserted) Two of Five (two out of the five bars are wide) suggests, ITF is made up of two wide bars and three spaces.



ITF is a barcode with an **extremely high information density**, and it has the following characteristics:

- Compared with another code of the same number of digits, **its size can be smaller**.
- Compared with another code of the same size, **it can contain more digits (information)**.

Therefore, **ITF is effective when in need of placing a barcode in a small space**.

In spite of its many benefits, ITF has also issues as a result of a misreading called **skipped reading**.

Skipped reading is a phenomenon in which a barcode that represents "1280" is misread as "12" with some digits skipped.

Skipped reading can occur if a laser from the barcode reader scans the barcode diagonally to cause an output of a misread value. By setting the barcode reader to scan a specified number of digits to read, you can determine the occurrence of skipped reading.

[From] Number of digits to read not specified

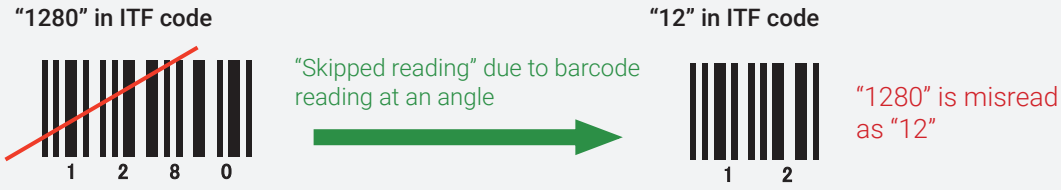

[To] Number of digits to read specified (4 digits)



Why does skipped reading occur?

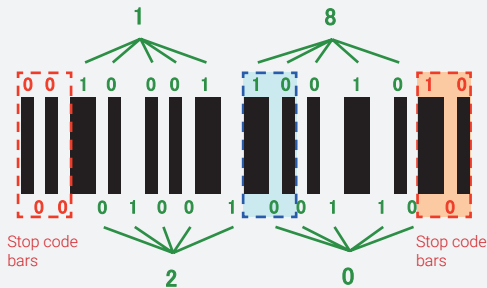

In the barcode described on the left, the first bar and space pattern representing "80" has the same pattern as the stop code bar. Therefore, if the barcode reader reads up to that portion, it reads the pattern as the stop code bar.

Characteristics of ITF codes

- One character is represented by five bars (spaces).
- The start and stop of a barcode is represented by bar patterns.

▶ Standard Distribution Code

A representative example of ITF code is “ITF-14”.

“ITF-14”, also called **Standard Distribution Code**, is a barcode mainly printed on packing boxes made of corrugated cardboard or other material, and is specified as a barcode for logistics in the JIS Standards (JIS-X-0502).

The barcode consists of a total of **14 digits**, generated by adding a 1-digit packaging indicator at the beginning and a 1-digit check digit at the end of the JAN code system (digits 1 to 12), and has been standardized for use on packing boxes used in distribution logistics.

The black frame around the Standard Distribution Code is called **bearer bar**.

Printing on corrugated cardboards is done using flexography (printing method that uses resin or rubber letterpress).

However, blurred or thicker bars may appear in the printed barcode because the not completely flat corrugated cardboard surface causes the flexographic printing pressure to vary.

The bearer bar is provided to hold the printing pressure constant and **prevent blurred or thicker bars** by avoiding direct printing pressure on the barcode bars.

There is also “ITF-16” in the same category of logistics codes.

It is an extended version of “ITF-14”, with two more information digits. However, **consolidation with “ITF-14” is necessary since it has already been abolished**.

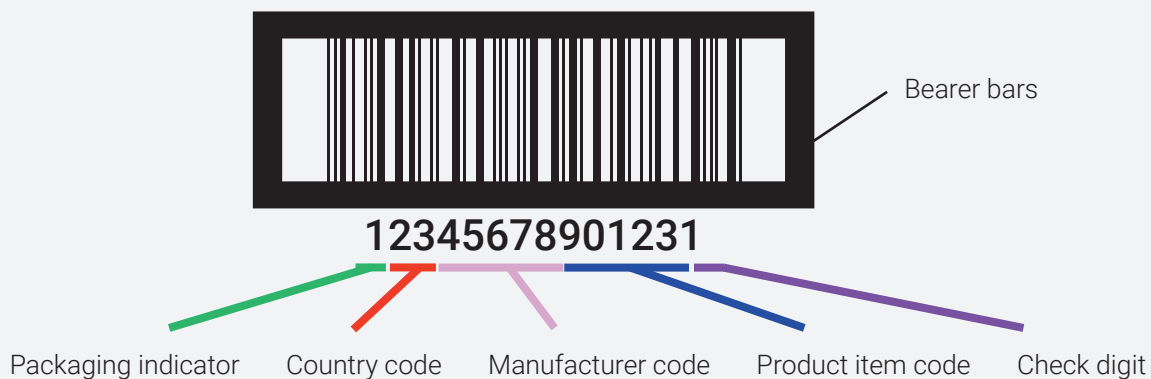

The dimensions of the Standard Distribution Code can be reduced or enlarged from 0.25 to 1.2 times the reference 1-mm narrow bar width (magnification 1x). However, when printing on corrugated cardboard, a magnification of 0.6 or higher is considered desirable. (0.625 to 1.2 for exportation.)

The following shows the barcode length for each enlargement factor and the barcode printing position.



Enlargement factor	ITF-14 length
1.2x	171 mm
1.0x	143 mm
0.8x	114 mm
0.625x	89 mm
0.4x	57 mm
0.25x	36 mm

Regulation for printing position

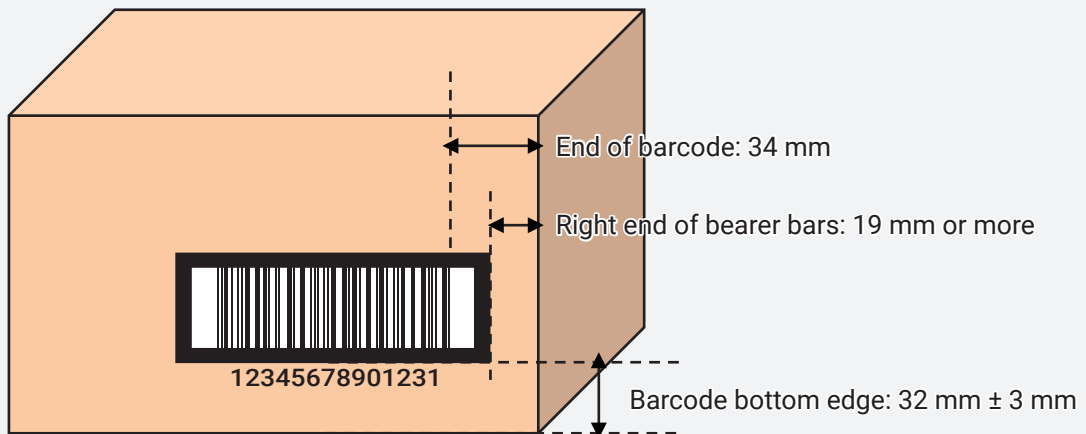

▶ Code 39 and NW-7

What Is Code 39?

Code 39 is a barcode developed by Intermec, Inc. in 1975.

It is widely used in the industrial field because it not only allows numbers, but also letters and symbols, which enables the indication of product identification numbers, and has low misreading rate.

Character Set

Code 39 consists of the following characters:

Numbers (0 to 9), letters (A to Z), symbols (-, space, \$, /, +, %)
Start and Stop codes (*)

Example of Code 39

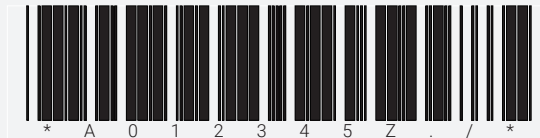

What Is NW-7?

NW-7 (CODABAR) is a barcode developed by Monarch Marking Systems, Inc. in 1972.

It is used since quite early on because its structure is rather simple and does not require high printing accuracy. It is especially used in blood banks, door-to-door delivery (shipping label) management, loan management at libraries, membership cards, etc.

Due to its simple structure, skipped reading can occur relatively easily depending on the printing conditions. Therefore, preventive measures such as setting the number of digits to read in the reader must be taken.

Character Set

NW-7 consists of the following characters:

Numbers (0 to 9), symbols (-, \$, :, /, ., +)
Start and Stop codes (A to D)

Example of NW-7



▶ Code 128 and GS1-128

What Is Code 128?

Code 128 is a barcode developed by Computer Identics Corporation in 1981.

Code 128 can represent all 128 ASCII code characters used by computers.

Due to its high information density and reliability, it is used for logistics all over the world, along with EAN and UCC.

A point to note is that one character is made up of 11 modules, and each bar or space is 1 to 4 modules wide.

Printing this complex pattern requires a high-precision printer.

Character Set

All ASCII characters: numbers (0 to 9), upper and lower case letters (A to Z, a to z), symbols

Example of Code 128



What Is GS1-128?

GS1-128 is a barcode developed by GS1 (EAN.UCC) in 1988.

The background for the development of GS1-128 from Code 128 was the need for a more advanced product management, logistics management, and business management as a result of the advancement of distribution management systems such as Point-of-Sale (POS) systems, Electronic Ordering Systems (EOS), and Electronic Data Interchange (EDI) systems.

Specifically, with GS1-128, it is possible to make up a label by combining the necessary information, such as lot number, manufacturing date, packing date, warranty period, sell-by date, serial number, quantity, unit of measure, etc.

It is widely used in the food industry, healthcare industry, transport and logistics industry and so on due to its high information density and reliability, as explained above.

Example of GS1-128

The barcode includes multiple pieces of information, such as lot number and manufacturing date.

These pieces of information are separated using a classification code called Application Identifier (AI).

When creating a barcode, the creator selects the information to manage from the more than 100 types of available AIs.



What Is GS1 DataBar (RSS)?

GS1 DataBar is one of the standard barcode symbols established by GS1 (international organization that plans and formulates international standards to increase supply chain efficiency and transparency). Although it is a 1D symbol, it can represent more information in less space as a result of applying 2D symbol encoding techniques.

What Is GTIN?

GTIN is the abbreviation for Global Trade Item Number, and is a 14-digit international product identification code standardized by GS1.

The first digit is the “Package Indicator” and indicates the package type or quantity in the package.

The next 2 digits are the Country code, the next 5 or 7 digits are the Manufacturer code, the next 5 or 3 digits are the Item code, and the last digit, the check digit.

GS1 DataBar Versions

GS1 DataBar comprises seven variations in three types: GS1 DataBar Omnidirectional (Basic), GS1 DataBar Limited, and GS1 DataBar Expanded.

The following provides an overview of each symbol.

Type 1: GS1 DataBar Omnidirectional

GS1 DataBar Omnidirectional

- Basic GS1 DataBar symbol.
- Supports the 14-digit GTIN and can encode numbers 0 to 9.
- Can be also read with an omnidirectional scanner.
- The smallest symbol size is 5.6 mm (height) × 16.3 mm (length).
- Given a module width of X, the minimum bar height is “33X”.



GS1 DataBar Truncated

- A space-saving barcode generated by limiting the bar height of GS1 DataBar Omnidirectional.
- Supports the 14-digit GTIN and can encode numbers 0 to 9.
- Requires a CCD, laser, or imager scanner because it cannot be read with an omnidirectional scanner.
- The smallest symbol size is 2.2 mm (height) × 16.3 mm (length).
- Given a module width of X, the minimum bar height is “13X”.



GS1 DataBar Stacked

- A standard GS1 DataBar code split between the second and fourth data character and piled up in two rows in order to reduce the symbol width and enable printing on products with extremely small printing space. However, it requires a 1 to 3-line separator pattern between rows.
- Supports the 14-digit GTIN and can encode numbers 0 to 9.
- Requires a CCD, laser, or imager scanner because it cannot be read with an omnidirectional scanner.
- The smallest symbol size is 2.2 mm (height) × 8.5 mm (length).
- Given a module width of X, the minimum bar height is “13X”. (Upper row: 5X, lower row: 7X, separator: 1X.)



GS1 DataBar Stacked Omnidirectional

- GS1 DataBar Stacked that is designed to be read by omnidirectional scanners.
- Supports the 14-digit GTIN and can encode numbers 0 to 9.
- The smallest symbol size is 11.7 mm (height) × 8.5 mm (length).
- Given a module width of X, the minimum bar height is “69X”. (Upper and lower rows: 33X, separator: 3X.)



Type 2: GS1 DataBar Limited

GS1 DataBar Limited

- The smallest in size, it is a limited version of GS1 DataBar symbol.
- Supports the 14-digit GTIN but the Package Indicator is limited to "0" or "1".
- Requires a CCD, laser, or imager scanner because it cannot be read with an omnidirectional scanner.
- The smallest symbol size is 1.7 mm (height) × 12.6 mm (length).
- Given a module width of X, the minimum bar height is "10X".
- Requires a space of "5X" on the right side since a revision to the Standards in 2011.



Type 3: GS1 DataBar Expanded

GS1 DataBar Expanded

- A barcode that allows to not only encode the standard product code, but also supplementary information such as weight, lot number, expiration date, etc.
- Similarly to GS1-128, allows for concatenation of information by forming a set with an Application Identifier, and can encode up to "74 digits" of numbers or "41 digits" of letters.
- Given a module width of X, the minimum bar height is "34X".



GS1 DataBar Expanded Stacked

- A GS1 DataBar Expanded barcode symbol split in multiple rows to deal with limited printing width.
- Supports from 2 to 20 symbol characters per row and up to 11 rows. (Requires a 3-line separator pattern between rows.)
- Given a module width of X, the minimum bar height of a level is "34X".



What Is Composite Symbology?



Composite Symbology consists of composite symbols that are useful to represent a large volume of information. It is used in the distribution of small products such as cosmetics, pharmaceuticals and medical supplies, and is set to become standard for pharmaceuticals.

Composite Symbol Structure

Composite symbols consists of two stacked components, a 1D symbol (JAN/EAN/UPC, GS1-128, GS1 DataBar) in the lower row and a 2D symbol (PDF417, Micro PDF417) in the upper row.

Composite Symbol Types

There are three composite symbol types: "CC-A", "CC-B", and "CC-C", which are classified as follows. (CC is the abbreviation for "Composite Component".)

Type	Capacity (in digits)	Upper row 2D symbol	Lower row 1D symbol	Example of symbol
CC-A	56	Micro PDF417	GS1 DataBar JAN/EAN/UPC GS1-128	
CC-B	338	Micro PDF417	GS1 DataBar JAN/EAN/UPC GS1-128	
CC-C	2361	PDF417	GS1-128	

QR Code Types, Sizes and Data Capacities

There are three types of QR codes: Model 1 with no alignment pattern, Model 2 with an alignment pattern, and Micro QR with one Positioning symbol. Each one has different characteristics and data capacity.

The following explains each QR code.

Model 1

Original code from which Model 2 and Micro QR codes were developed.

Versions 1 to 14 are defined in the AIM International Standards.



Symbol size	Version 1: 21 cells × 21 cells (Smallest) Version 2: 25 cells × 25 cells to Version 14: 73 cells × 73 cells (Largest) * Each increment in version adds four cells each in the horizontal and vertical directions.	
Maximum data capacity	Numeric	1,167 characters
	Alphanumeric (US-ASCII)	707 characters
	Binary (8 bits)	468 bytes
	Kanji/Kana (Shift JIS)	299 characters

Model 2

This QR code model adds to Model 1 an alignment pattern for the position correction function to support a larger volume of data. They are available in symbol sizes version 1 to 40, with version 40 able to encode up to 7,089 characters if they were only numbers.



Alignment pattern

Symbol size	Version 1: 21 cells × 21 cells (Smallest) Version 2: 25 cells × 25 cells to Version 40: 177 cells × 177 cells (Largest) * Each increment in version adds four cells each in the horizontal and vertical directions.	
Maximum data capacity	Numeric	7,089 characters
	Alphanumeric (US-ASCII)	4,296 characters
	Binary (8 bits)	2,953 bytes
	Kanji/Kana (Shift JIS)	1,817 characters

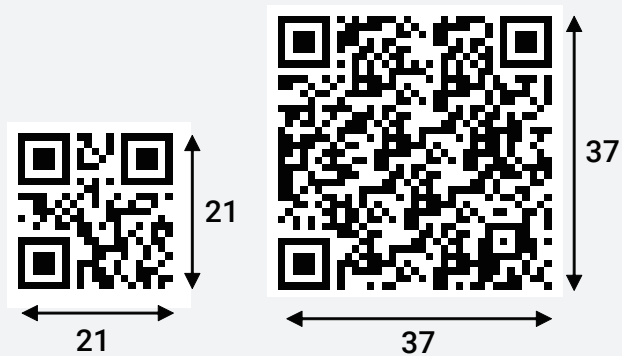

Micro QR

A major characteristic of the Micro QR code is that it has one Positioning symbol.

QR codes need a certain size because they need to locate Positioning symbols at three corners; however, Micro QR codes can be printed onto a smaller space since they have only one Positioning symbol.

Micro QR codes, which requires less printing space as just described, are used on circuit boards and so on mainly for the purpose of FA.

Furthermore, they are available in four versions, from M1 to M4, with the smallest cell structure being 11 × 11.

Symbol size	Version M1: 11 cells × 11 cells (Smallest) Version M2: 13 cells × 13 cells to Version M4: 17 cells × 17 cells (Largest) * Each increment in version adds two cells each in the horizontal and vertical directions.	
Maximum data capacity	Numeric	35 characters
	Alphanumeric (US-ASCII)	21 characters
	Binary (8 bits)	15 bytes
	Kanji/Kana (Shift JIS)	9 characters

Size Calculation

The following procedure describes how to determine the QR code size.

1. Decide the version.

Decide the volume of data, type of character, error correction level to select a candidate.

2. Decide the cell size.

Decide the size of the cell to print based on the printer resolution and scanner performance.

3. Decide the QR code size.

The QR code size and required space can be calculated by the below-described formula by multiplying the number of cells of the version decided in step 1 by the cell size decided in step 2.

Given a cell size of x [mm] and a version y ,
the formula for calculating the side of the QR code is as follows.
 $x(21 + 4y)$ [mm]

The formula for calculating the side of the required space is as follows.
(Including the Quiet zone.)
 $x(29 + 4y)$ [mm]

For example, if the cell size is 0.25 [mm], and the version is 10:
The side of the QR code is, $0.25 \text{ [mm]} \times (21 + 4 \times 10) = 15.25 \text{ [mm]}$.
The side of the required space is, $0.25 \text{ [mm]} \times (29 + 4 \times 10) = 17.25 \text{ [mm]}$.

Capacity per Version in Number of Characters

Model 2

Version	No. of cells	Numeric				Alphanumeric				Binary				Kanji			
		L	M	Q	H	L	M	Q	H	L	M	Q	H	L	M	Q	H
1	21 × 21	41	34	27	17	25	20	16	10	17	14	11	7	10	8	7	4
2	25 × 25	77	63	48	34	47	38	29	20	32	26	20	14	20	16	12	8
3	29 × 29	127	101	77	58	77	61	47	35	53	42	32	24	32	26	20	15
4	33 × 33	187	149	111	82	114	90	67	50	78	62	46	34	48	38	28	21
5	37 × 37	255	202	144	106	154	122	87	64	106	84	60	44	65	52	37	27
6	41 × 41	322	255	178	139	195	154	108	84	134	106	74	58	82	65	45	36
7	45 × 45	370	293	207	154	224	178	125	93	154	122	86	64	95	75	53	39
8	49 × 49	461	365	259	202	279	221	157	122	192	152	108	84	118	93	66	52
9	53 × 53	552	432	312	235	335	262	189	143	230	180	130	98	141	111	80	60
10	57 × 57	652	513	364	288	395	311	221	174	271	213	151	119	167	131	93	74
11	61 × 61	772	604	427	331	468	366	259	200	321	251	177	137	198	155	109	85
12	65 × 65	883	691	489	374	535	419	296	227	367	287	203	155	226	177	125	96
13	69 × 69	1022	796	580	427	619	483	352	259	425	331	241	177	262	204	149	109
14	73 × 73	1101	871	621	468	667	528	376	283	458	362	258	194	282	223	159	120
15	77 × 77	1250	991	703	530	758	600	426	321	520	412	292	220	320	254	180	136
16	81 × 81	1408	1082	775	602	854	656	470	365	586	450	332	250	361	277	198	154
17	85 × 85	1548	1212	876	674	938	734	531	408	644	504	364	280	397	310	224	173
18	89 × 89	1725	1346	948	746	1046	816	574	452	718	460	394	310	442	345	243	191
19	93 × 93	1903	1500	1063	813	1153	909	644	493	792	624	442	338	488	384	272	208
20	97 × 97	2061	1600	1159	919	1249	970	702	557	858	666	482	362	528	410	297	235
21	101 × 101	2232	1708	1224	969	1352	1035	742	587	929	711	509	403	572	438	314	248
22	105 × 105	2409	1872	1358	1056	1460	1134	823	640	1003	779	565	439	618	480	348	270
.
.
.
40	177 × 177	7089	5596	3993	3057	4296	3391	2420	1852	2953	2331	1663	1273	1817	1435	1024	784

Micro QR

Version	No. of cells	Error correction level	Numeric	Alphanumeric	Binary	Kanji
M1	11 × 11	Error detection only	5	-	-	-
M2	13 × 13	L	10	6	-	-
		M	8	5	-	-
M3	15 × 15	L	23	14	9	6
		M	18	11	7	4
M4	17 × 17	L	35	21	15	9
		M	30	18	13	8
		Q	21	13	9	5

Data Matrix Structure

Data Matrix is a 2D code developed by International Data Matrix, Inc. (ID Matrix) of the U.S. in 1987. It was registered to AIM International Standards in 1996, and to ISO/IEC Standards in 2000. Data Matrix includes old, earlier versions ECC000, ECC050, ECC080, ECC100 and ECC140, and a newer version ECC200, introduced in 1995, that has the error correction method changed to the Reed-Solomon code and a distortion correction function added.

Data Matrix Outline Specifications

Symbol size	ECC000 to ECC140 9 cells × 9 cells (Smallest) to 49 cells × 49 cells (Largest) ECC200 10 cells × 10 cells (Smallest) to 144 cells × 144 cells (Largest)	
Maximum data capacity	Numeric	3,116 characters
	Alphanumeric (US-ASCII)	2,335 characters

ECC000, ECC050, ECC080, ECC100 and ECC140

They are symbols always composed of an odd number of cells, from a cell size of 9 × 9 to 49 × 49. They use convolution correction for error correction, and are almost never used since a slight distortion greatly affects the reading accuracy when the data size is large.

ECC200

This version improves the error correction function for distortion that was problematic in the above-described, earlier versions of Data Matrix codes. It is a symbol always composed of an even number of cells, with cell sizes from 10×10 to 144×144 .

It uses Reed-Solomon code for error correction, which enables data recovery even when a portion of the code is damaged, is resistant to distortion, and can be made compact. When using Data Matrix, ECC200 is normally used since it is the one standardized internationally.

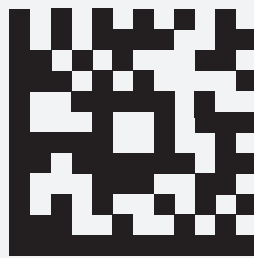

ECC200

Data Matrix (ECC200) Structure

Alignment Pattern and Timing Pattern

The Data Matrix structure is such that the actual data area is surrounded by an L-shaped alignment pattern and a dotted-line timing pattern. The L-shaped alignment pattern enables the code reader to determine the orientation of the symbol, while the timing pattern makes it easier to recognize the data cells. In this way, the symbol can be read from any direction by using the image-processed alignment and timing patterns to detect its position.

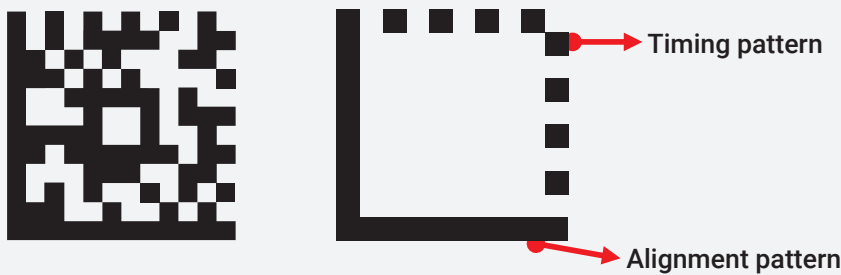

Furthermore, Data Matrix can be made extremely resistant to symbol distortion by splitting symbols with 24×24 or more data cells into blocks of 24×24 cells or less.

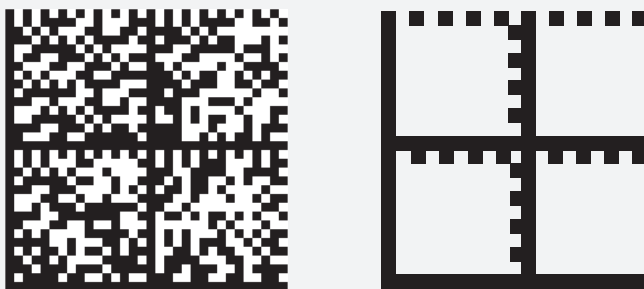

Quiet Zone

The blank portion around the 2D symbol.
It must be at least 1-cell wide.

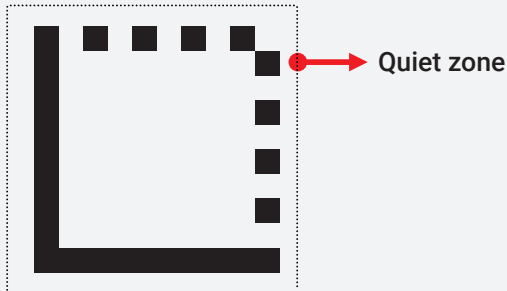

Error Correction Code (Reed-Solomon Code)

In Data Matrix, symbols have a Reed-Solomon code added as error correction code in order to recover data even when a portion is damaged.

Data and Error Correction Code Locations

The following figure shows the order in which the data and error correction code are arranged.

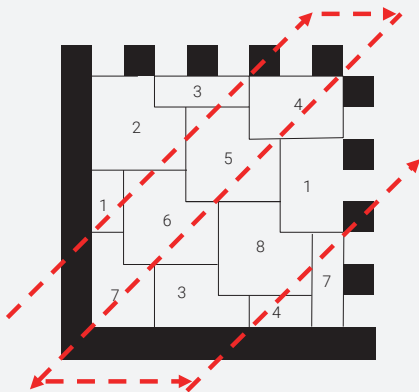

For example, when creating a Data Matrix for the data OMRON, the Data Matrix is created by concatenating the error correction code calculated by using Reed-Solomon algorithm to the data part.

Data (OMRON) + Error correction code ⇒

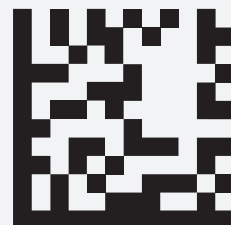

Data Matrix Size and Data Capacity

The table below shows the relationship between the symbol size (number of cells) and the volume of information (for ECC200).

The symbol size of the example code on the right is 12 × 12.

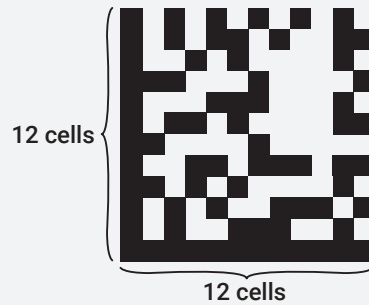

Symbol size	Capacity *1				
	Numeric	Alphanumeric	Alphanumeric symbol	JIS 8-bit character	Kanji (Shift JIS)
10 × 10	6	3	3	1	—
12 × 12	10	6	5	3	1
14 × 14	16	10	9	6	3
16 × 16	24	16	14	10	5
18 × 18	36	25	22	16	8
20 × 20	44	31	28	20	10
22 × 22	60	43	38	28	14
24 × 24	72	52	46	34	17
26 × 26	88	64	57	42	21
32 × 32	124	91	81	60	30
36 × 36	172	127	113	84	42
40 × 40	228	169	150	112	56
44 × 44	288	214	190	142	71
48 × 48	348	259	230	172	86
52 × 52	408	304	270	202	101
64 × 64	560	418	372	278	139
8 × 18	10	6	5	3	1
8 × 32	20	13	12	8	4
12 × 26	32	22	20	14	7
12 × 26	44	31	28	20	10
16 × 36	64	46	41	30	15
16 × 48	98	72	64	47	23

*1: Regarding capacity (maximum volume of information that can be carried)

The same 2D code may carry different volumes of information depending on their symbol size.

In other words, the larger the volume of necessary information, the larger needs to be the symbol size.

Furthermore, the maximum volume of information that a code can carry varies depending on the used character type. With QR code and Data Matrix, the maximum number of characters for the same symbol size increases in the order of "numeric" > "alphanumeric" > "kanji". Moreover, the maximum number of characters that can be carried also varies depending on the order in which the character types are lined up or combined.

GS1 DataMatrix

GS1 DataMatrix is a 2D symbol based on the ECC200, and standardized for distribution by Global Standard 1 (GS1). In recent years, GS1 DataMatrix has been attracting attention also outside of industrial applications because it allows large volumes of information to be described in a small area.

GS1 DataMatrix is used in pharmaceuticals (Europe) and in surgical implements such as scalpels and scissors (Japan), and is set to become standard in the healthcare and medical industries. GS1 DataMatrix has the same structure as GS1-128.

Data Structure of GS1 DataMatrix

The encoded data (all information described in DataMatrix) of GS1 DataMatrix consists of a start character, Application Identifiers, data, and separator characters. A single encoded data may include multiple pieces of data.

- **Start Character**

In GS1 DataMatrix, FNC1 (Function 1 symbol) is placed at the beginning of the encoded data.

- **Application Identifier (AI)**

An Application Identifier defines what type of information is in the data that is paired with the Application Identifier. It consists of two to four numeric digits, and its data attributes such as numeric or alphanumeric, and number of digits are defined by GS1.

Applicaation Identifier	Data definition	Attribute	Number of digits
01	GTIN	Numeric	14
10	Batch No./Lot No.	Alphanumeric	Variable (up to 20)
11	Date of manufacture	Numeric	6
15	Best before date	Numeric	6
17	Expiration date	Numeric	6
21	Serial No.	Alphanumeric	Variable (up to 20)

- **Separator Character**

In GS1 DataMatrix, the carried data may be a fixed length data such as the manufacturing date, or a variable length data such as the serial number. When carrying a variable length data, FNC1 must be inserted as a separator character at the end of the data.

However, a separator character is unnecessary if the variable length data is at the end of the encoded data.

Example of GS1 DataMatrix

- Example of Code

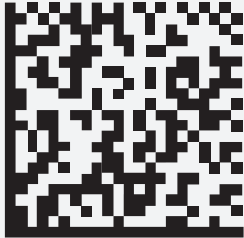

Example of GS1 DataMatrix code

- Data Composition

Applicaation Identifier	Data definition	Data
01	GTIN	03453120000011
17	Expiration date	080508
10	Batch No./Lot No.	ABCD1234
410	Ship to - deliver to global location No.	9501101020917

- Structure of Encoded Data

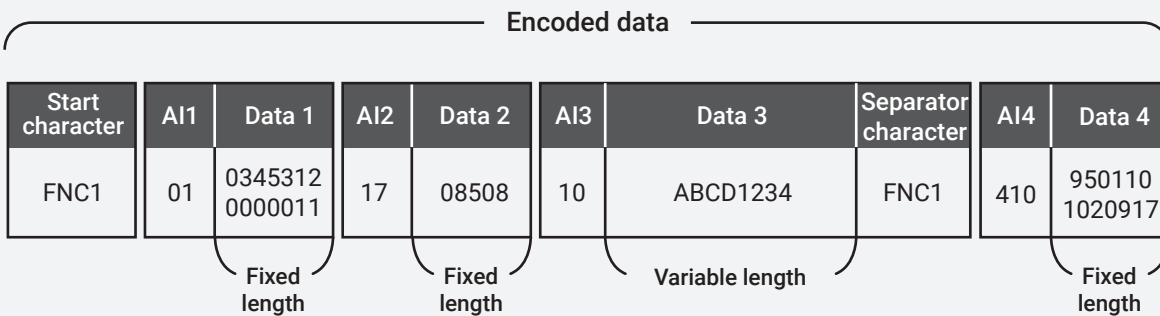

Structure of example code data

- Human-readable Interpretation

(01)03453120000011(17)080508(10)ABCD1234(410)9501101020917

Aztec Code

- **Versions and Shapes**

This code got its name from the finder pattern at its center, which resembles an Aztec pyramid.

- **Characteristics**

Does not require a quiet zone.

Allows for high speed reading since it can be read from any angle. It also boasts an error correction function with high error correction rate.

- **International Standards**

ISO/IEC 24778

- **Error Correction Rate/(Error) Recovery Rate**

Can be specified from 1% to 99%.



Dot Code

- **Versions and Shapes**

The symbol is made up of dots that are not adjacent to each other.

The dots can be of any shape: round, square, hexagonal, etc. because they are not defined in particular.

- **Characteristics**

1. Has a robust structure, suited for high speed printers.

Can be decoded also when a column is missing due to printer head clogging.

2. Convenient for the user because the number of vertical by horizontal dots can be freely changed in order to design the code to fit within the printing space.

- **International Standards**

None

- **Other Standards**

AIM Standards

- **Error Correction Rate/(Error) Recovery Rate**

Approx. 15%



3 Code Reading Methods

► Laser Fixed-Mount Barcode Reader

Reading Barcodes with a Laser Fixed-mount Barcode Reader

A laser fixed-mount barcode reader is a barcode reader mainly made up of a laser diode, a polygonal mirror, a motor, and photodetector.

The following explains the principles and features of a laser fixed-mount barcode reader.

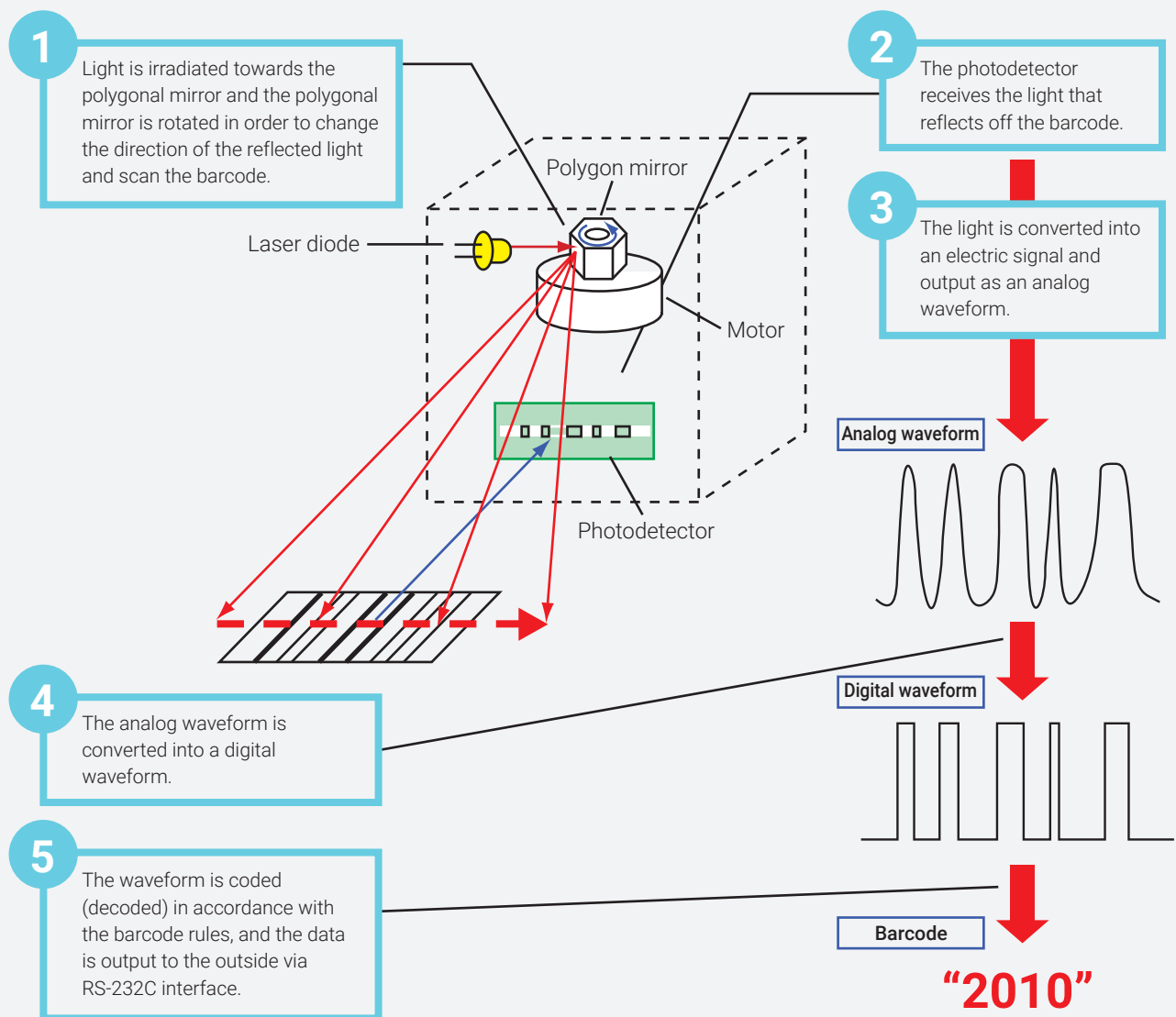

Using Laser Barcode Readers Correctly

Setting the Mounting Angle

With a laser barcode reader, reading is done by irradiating laser diode light at an angle to the barcode and receiving its diffuse reflection.

Mount the barcode reader slightly skewed with respect to the pitch axis, as shown in Figure 1.

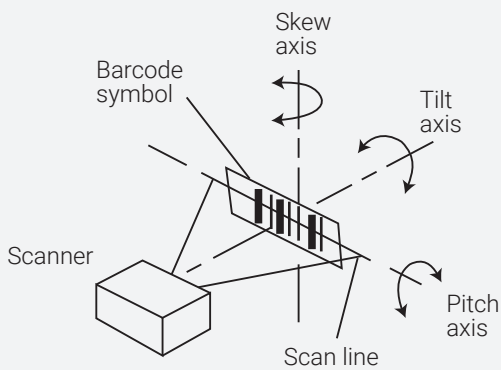
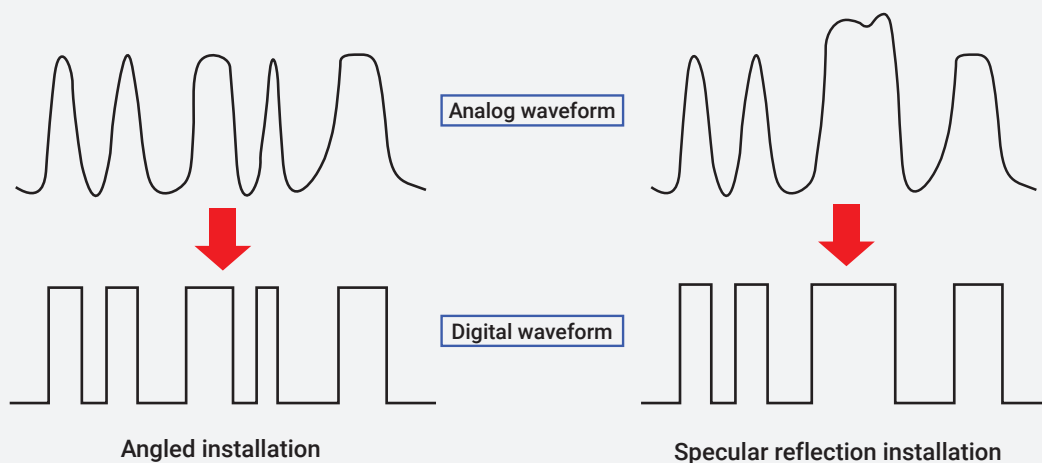

Figure 1. Symbol/Scanner Positioning

The reason to mount the barcode reader skewed is because mounting it (specular reflection mounting) leads to misreading as a result of strong reflections (specular reflection or direct reflection) from the barcode surface around the angle of incidence of 0° . This can be expressed as the following waveforms.



Limitations

Glossy Barcodes

Glossy barcodes (laminated barcodes, barcodes printed on metallic surfaces) cause specular reflection of the laser light. This causes a small amount of light to return to the sensor head due to less amount of the diffuse reflection light component, making the barcodes difficult to read.

If your workpiece causes this, pay enough attention to the installation angle of the barcode reader.

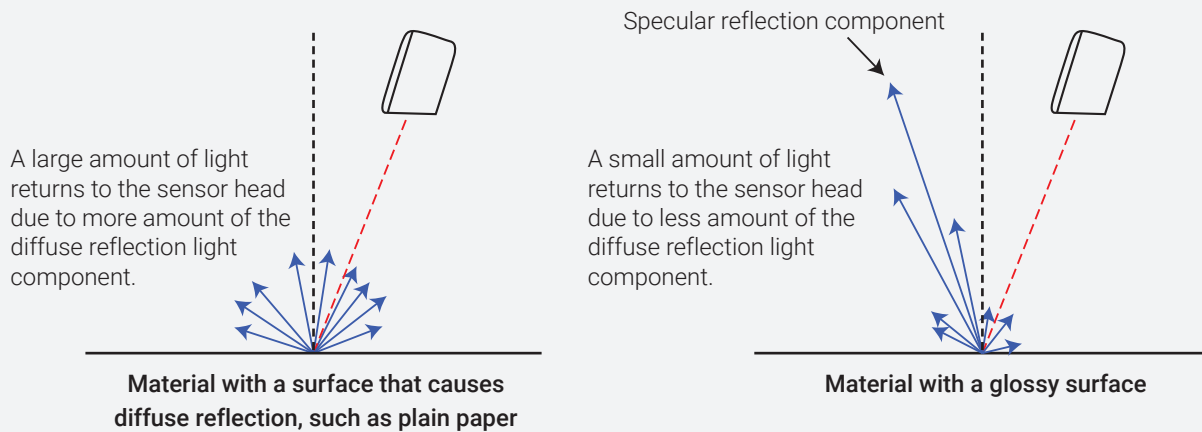

When Laser Light Illuminates a Metallic Surface

When laser light is incident on an exposed metal surface, it is subjected to specular reflection. This allows the specular reflection from the metal surface, in addition to the reflection from the barcode, to enter the photodetector of the barcode reader, resulting in unstable reading.

To prevent this, cover the metal surface, or coat it with matte black paint, etc.

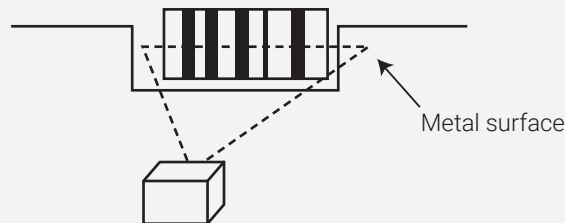

Setting the Reading Distance (Mounting Distance)

The reading distance depends on the width of the barcode narrow bar (width of the narrowest bar in the barcode). The following figure shows the reading range characteristics of OMRON's MS-3 Series laser barcode scanner.

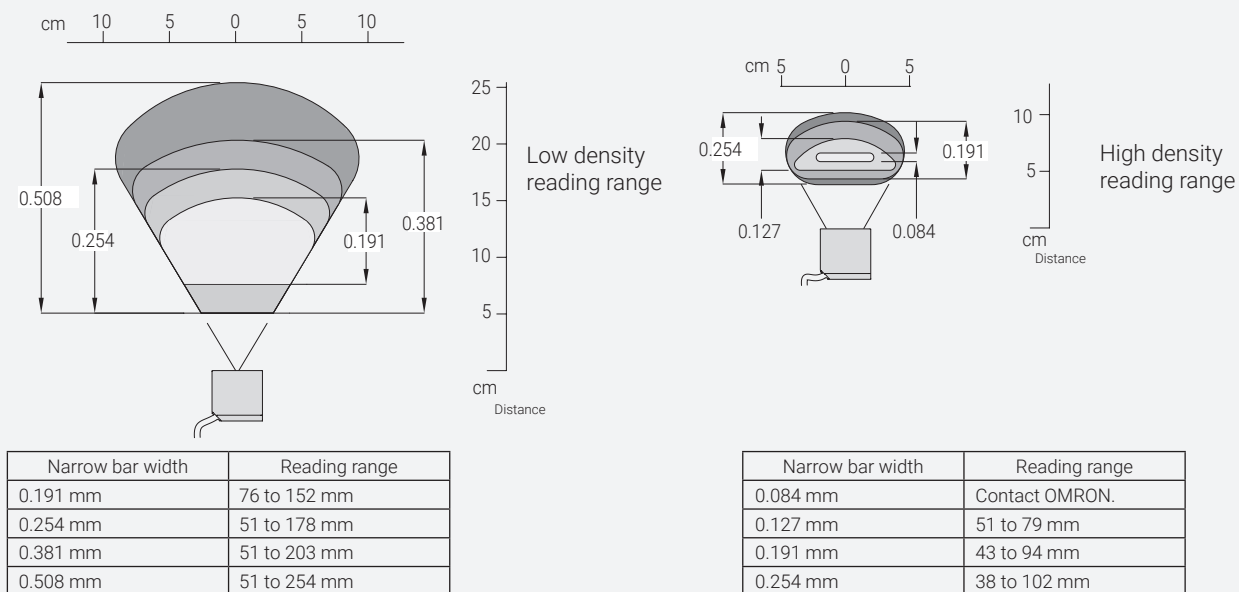

Note: In the case of a right angle type, subtract 15 mm from the reading range. The reading range is based on the optimal scan speed for a specific symbol density.

Contrast between Bars and Spaces (PCS)

When reading a barcode, the difference in intensities of the reflected light is important.

In other words, the more the difference in the intensity of reflection, the more easily the barcode can be read.

Conversely, when the intensity difference is not obvious, the barcode may not be read.

Print Contrast Signal (PCS) is a value that indicates the contrast between bars and spaces of a barcode symbol and is calculated by the following formula:

$$\text{PCS} = \frac{\text{Reflectance of spaces} - \text{Reflectance of bars}}{\text{Reflectance of spaces}}$$

The closer PCS is to 1, the easier will be to read the barcode.

To make PCS closer to 1, it is necessary to: 1. Raise the reflectance of the white space portion, or 2. Lower the reflectance of the black bar portion.

Therefore, to create an easy-to-read barcode, it is necessary to: 1. Print the bar dark, or 2. Use a base surface as white as possible for the space portion.

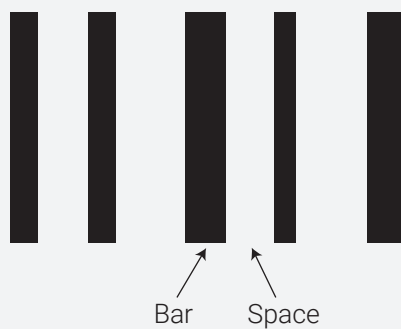

Relationship between Narrow Bar Width and Reading Distance

The reading distance varies depending on the narrow bar width.

Under the conditions on the previous page, the reading distance is from 80 to 150 mm when the narrow bar width is 0.2 mm, and from 60 to 70 mm when the narrow bar width is 1.0 mm.

This is because the size of the laser beam that illuminates the barcode, that is, the laser light width varies depending on the reading distance.

In order to read a barcode with thin narrow bars, a laser barcode reader is adjusted in such a way that the laser light width becomes the smallest at a certain distance.

The distance at which the laser light width becomes the smallest is called the focal length.

Thin, barcode narrow bars can be read if the laser light width is small; however, they cannot be read anymore farther beyond the focal length since the laser light width becomes large.

The reading distance is determined by the laser light width.

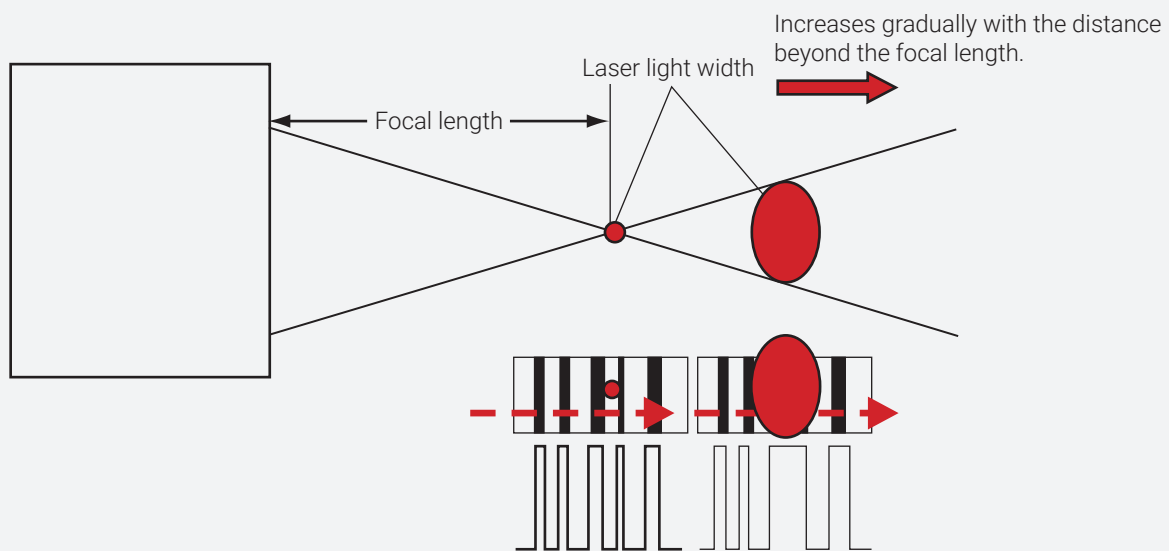

Relationship between Laser Light Position from the Focal Length and Laser Light Width

► Single Scan and Raster Scan

Difference between Single Line Scan and Raster Line Scan

The difference between single line scan and raster line scan is that the laser beam of the laser barcode reader scans differently.

In single line scan, reading is done by scanning one line of the barcode label at a time. If the scanned line is damaged, the laser barcode reader cannot read accurately.

In raster line scan, reading is done by scanning multiple lines of the barcode at a time. As a feature, with raster line scan, reading is possible also when the label is partially damaged, as long as any one of the multiple lines scanned is good.

Single scan



Raster scan

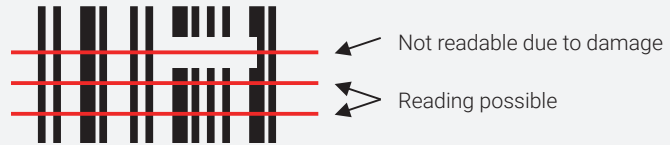

Reading from other lines is possible although the label is partially damaged.

Selecting between Single Line Scan and Raster Line Scan

Whether to select single line scan or raster line scan depends on whether the barcode will be read while the product is static or traveling, and, if it is travelling, also on its travel direction.

Raster line scan is recommended for reading a static label because of its high reading probability. Raster line scan is also recommended for reading a traveling label because of its high reading probability. However, depending on conditions such as the cycle time, the single line scan may be recommended instead because of its high response performance.

When reading vertically (ladder scanning), even single scan allows results similar to raster scan since the barcode is read multiple times as the product travels. In this case, the conveyor belt speed can be increased by expanding the reading range by, for example, increasing the barcode height.

When reading horizontally (picket fence scanning), select raster scan and expand the reading range because reading will become impossible if the barcode position fluctuates.

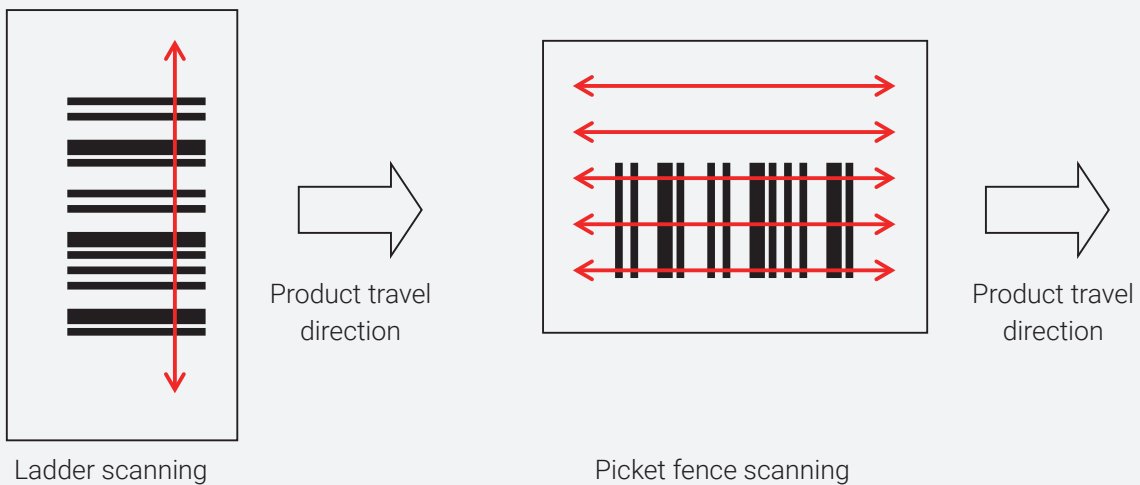

► CCD Fixed-Mount Barcode Reader

Reading Barcodes with a CCD Fixed-Mount Barcode Reader

A CCD fixed-mount barcode reader is a barcode reader with LEDs as the light source and CCD as the photodetector. The following explains the principles and features of a CCD fixed-mount barcode reader.

A CCD barcode reader is made up of a lens, CCD (photodetector) and LEDs (light source), and reads a barcode based on the principles described in the figure below.

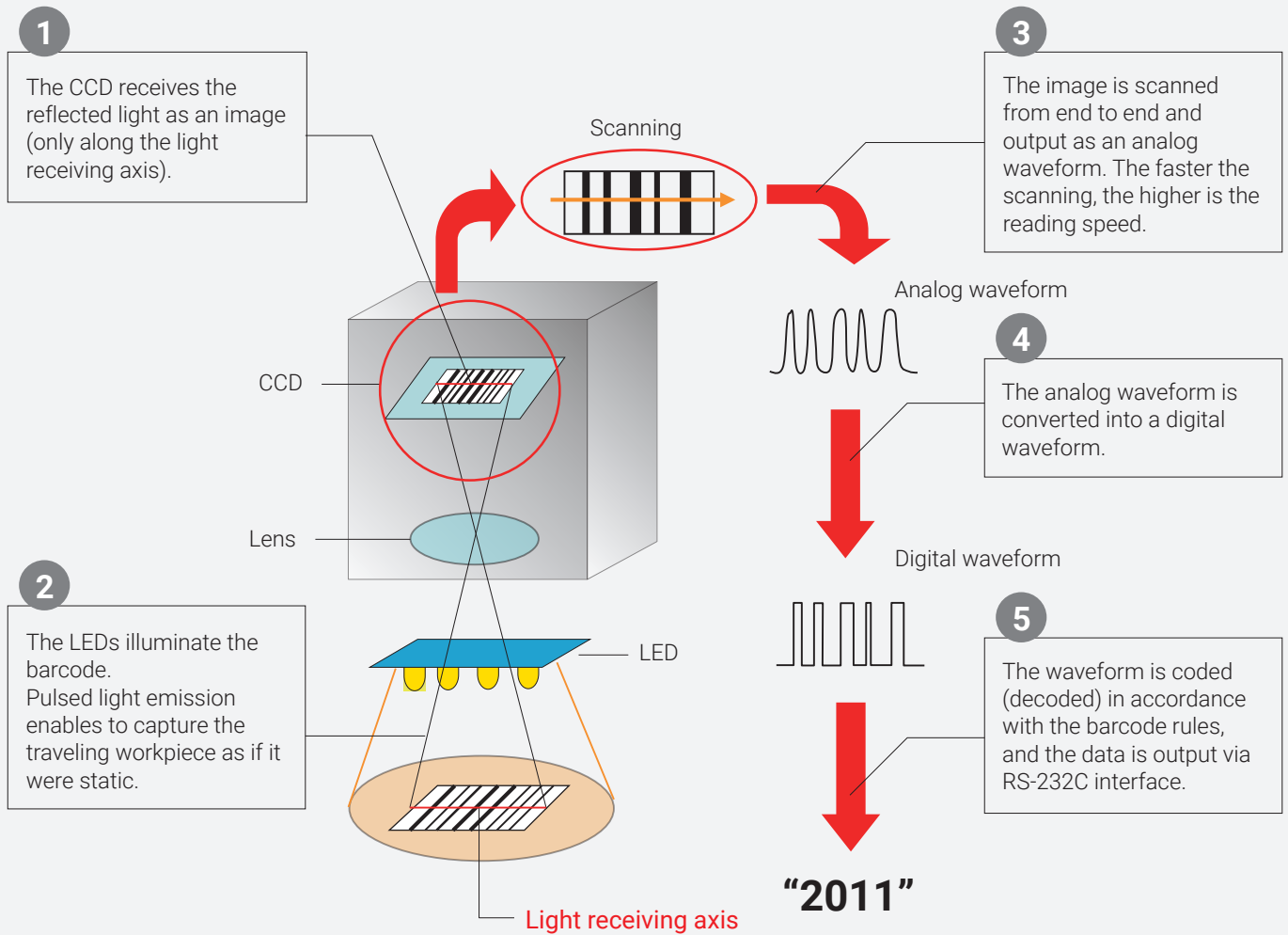

Notes on Mounting

When mounting a CCD fixed-mount barcode reader, the following points must be noted in general.

1. Notes on the Mounting Angle

CCD barcode readers have a linear axis, called "light receiving axis", along which the reflected light can be received. The barcode cannot be read if it is not on this light receiving axis.

Mount in such a way that the barcode is on the light receiving axis.

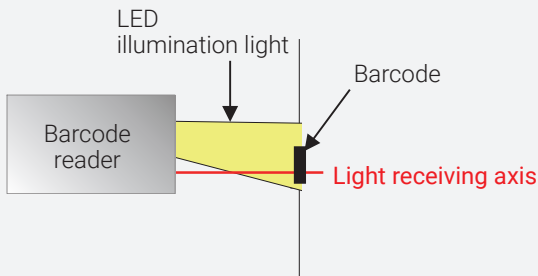

Reading is possible if the barcode is on the light receiving axis.

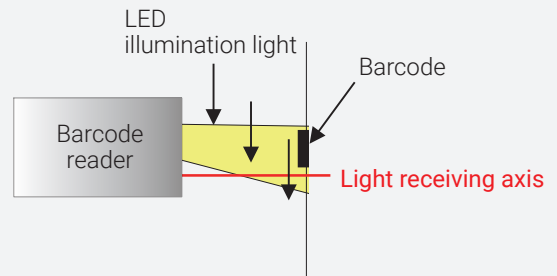

Even within the illumination range, reading is impossible if the barcode is not on the light receiving axis.

Mounting the CCD fixed-mount barcode reader perpendicular to the barcode makes reading impossible due to specular reflection.

Mount in such a way that the light receiving axis is at an angle of approximately 10° with respect to the barcode.

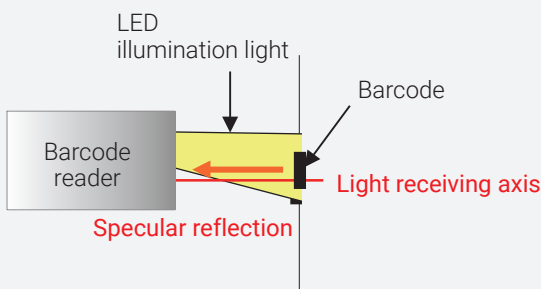

If mounted perpendicular to the barcode, reading is impossible due to the specularly reflected light.

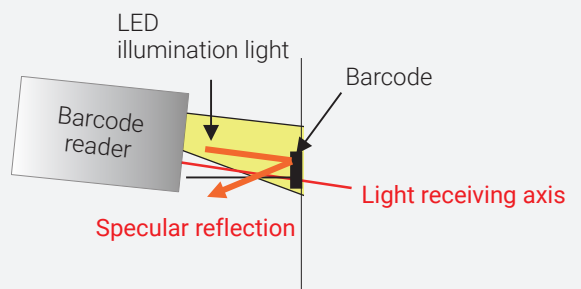

By mounting at an angle of 10°, reading becomes possible because the barcode reader is not affected by the specularly reflected light.

2. Notes on Mounting Distance

Mount the CCD barcode reader at a location where the barcode is in focus.

In CCD barcode readers, the image is formed on the CCD by using a lens; therefore, if the barcode is out of focus, the image becomes blurred. If the image is blurred, the barcode cannot be read accurately.

For this reason, mount the barcode reader at a location where the barcode is in focus to enable stable reading.

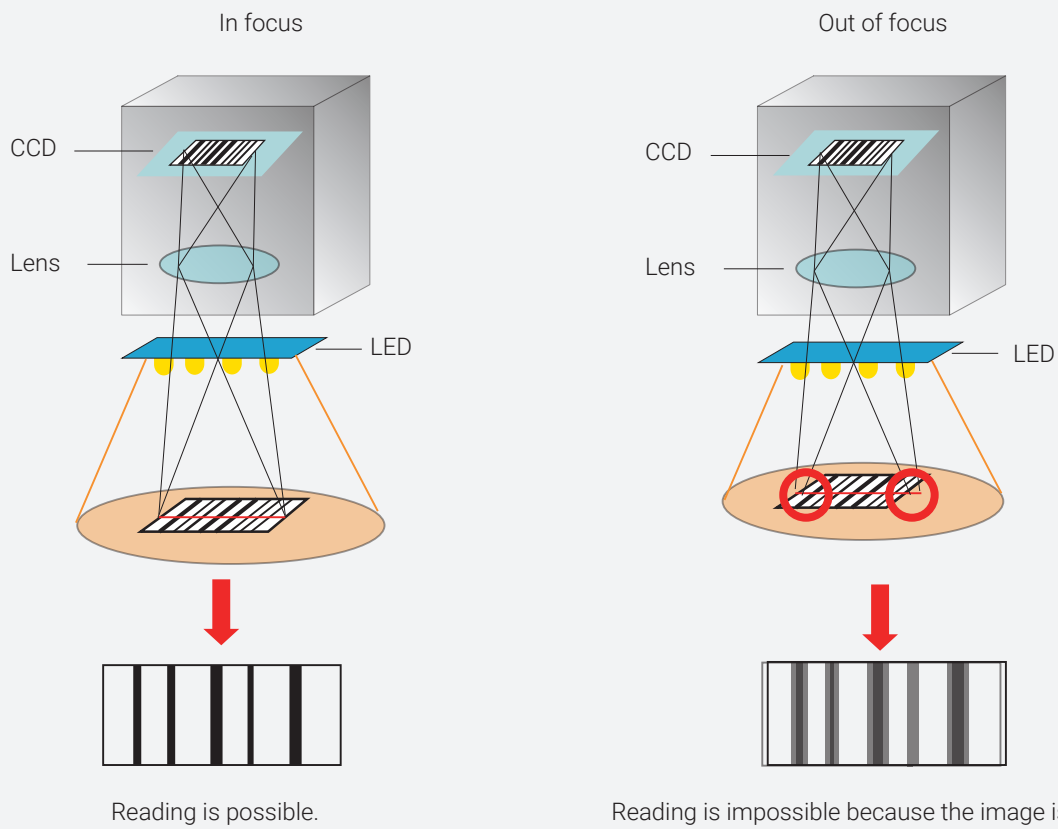

3. Notes on the Barcode Travel Direction

As shown below, there are two directions in which barcodes can travel: A and B.

If reading a traveling barcode, use travel direction A for the barcode in order to read stably because this direction affects less the narrow bar width that will be captured as an image.

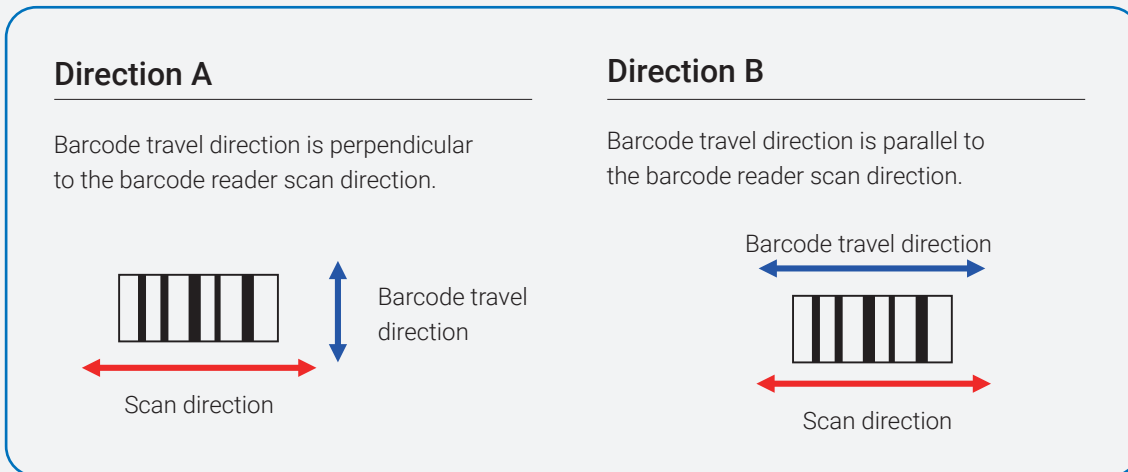

When reading a traveling barcode, the position of the barcode being read changes while the LEDs are emitting light. If the barcode is read in direction B, the barcode may not be read accurately since the narrow bar width captured on the CCD will vary.

Reading in Direction B

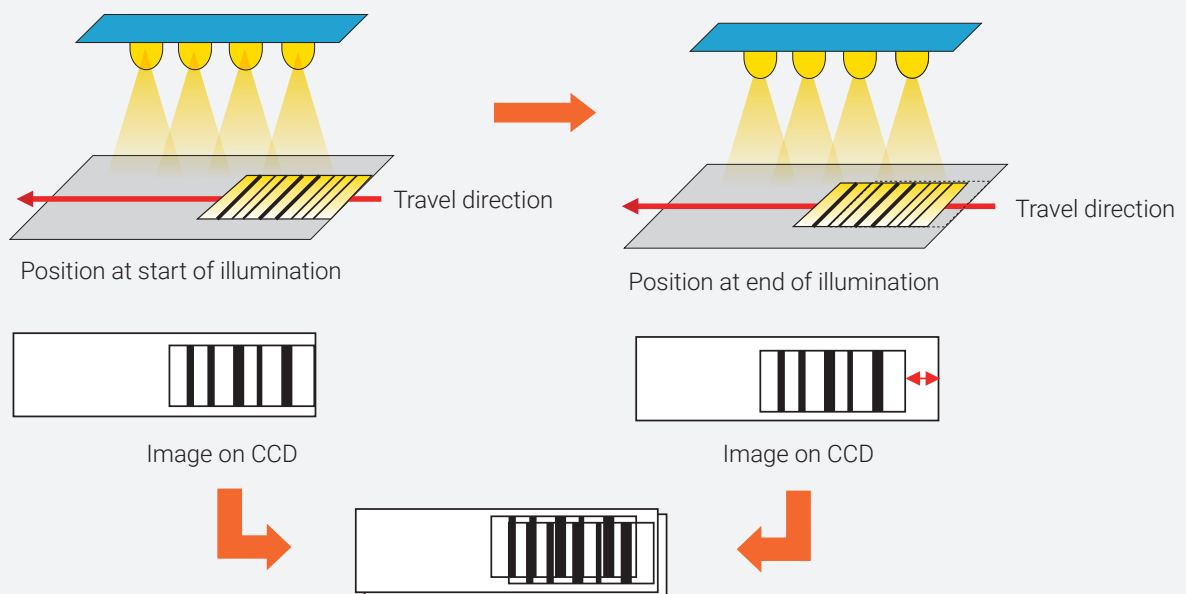

Reading in Direction A

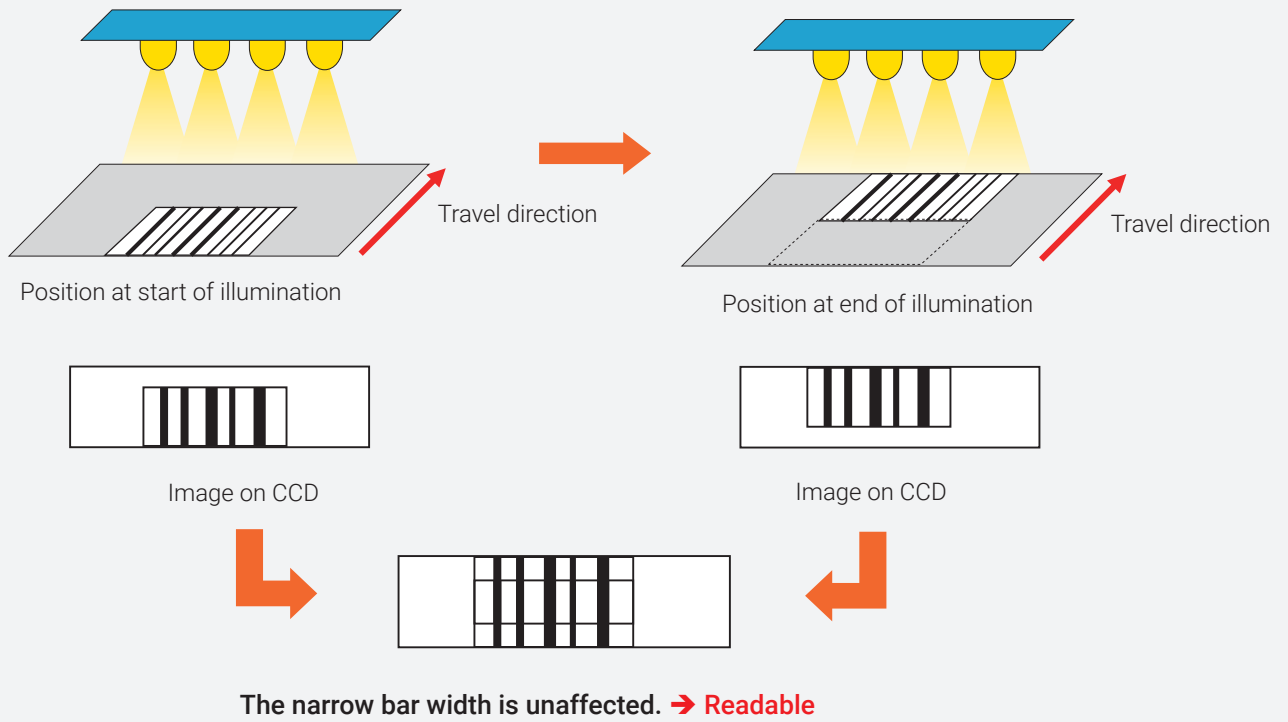

4. Notes on Dirty and Damaged Barcodes

If there is a big dirty or damaged part on the light receiving axis, the reading accuracy may decrease. However, the barcode may be readable with a small dirty or damaged part.

In CCD barcode readers, the thickness of the light receiving axis is close to 1 mm, and reading is possible if the dirty or damaged part is smaller than the light receiving axis since it can be canceled.

If the dirty or damaged part is larger than the light receiving axis, the reading accuracy may decrease.

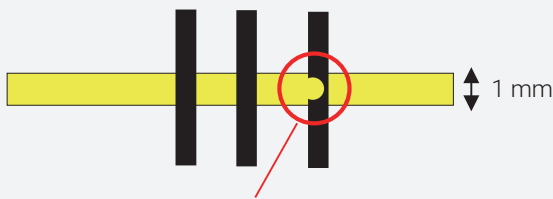

A small damage can be canceled to allow reading.

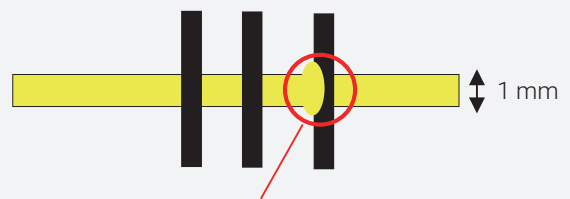

A large damage changes the narrow bar width being read, and hampers accurate reading.

The thickness of the light receiving axis in CCD barcode readers is close to 1 mm, making them more resistant to dirt than single-scan laser barcode readers (spot diameter of 0.2 mm).

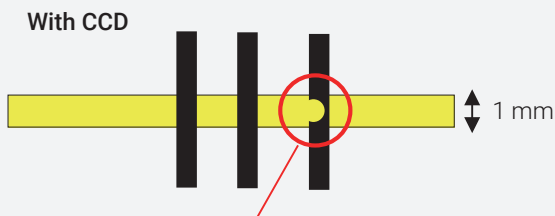

Damage of 0.2 mm to 1 mm can be canceled to allow reading.

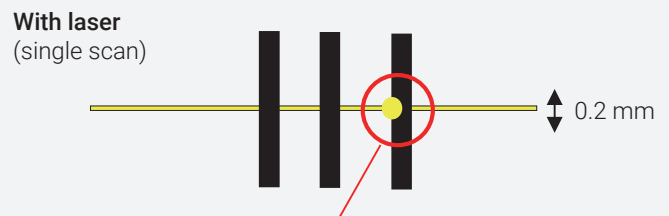

Even a small damage results in inability to read.

* Laser barcode readers supporting raster scan can read with high accuracy also when there is dirt.

5. Notes on Reading Range

Unlike laser light, the illumination range of a LED is small. For this reason, the readable range depends on the size of the barcode reader itself.

Due to the above, its reading range is smaller compared with that of a laser barcode reader.

CCD Barcode Reader Characteristics

Strong points of CCD barcode readers are that they are compact and inexpensive. They can be implemented in accordance with the environment of use, and with modest investment. Furthermore, since their light source is LEDs, they are not only safer than laser barcode readers, but they also have long service life and high reliability.

The following is a summary of CCD and laser barcode reader characteristics. It is important to select the type of barcode reader to use in accordance with the environment of use and required performance.

Scanning method	Strong point	Weak point
CCD	<ul style="list-style-type: none"> • Compact • Inexpensive • LED has long service life 	<ul style="list-style-type: none"> • Limited readable distance • Cannot raster scan • Small reading range (field of view)
Laser	<ul style="list-style-type: none"> • Long readable distance • Wide reading range • Can raster scan 	<ul style="list-style-type: none"> • Big

Barcode Inclination

The inclination of the barcode with respect to the reader can be thought in terms of the rotation of the three axes described below. The allowable rotation angle of these axes must be carefully considered.

Pitch

A rotation around an axis in the barcode height direction. It is equivalent to the rotation of a product when reading a barcode attached horizontally to the product.

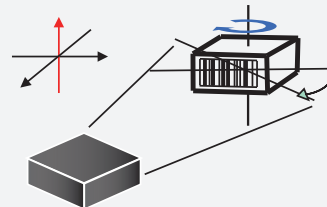

Tilt

A rotation around an axis perpendicular to the barcode surface. It is equivalent to the rotation of a product when reading a barcode attached to the upper surface of the product.

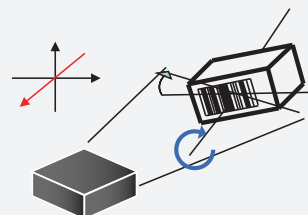

Skew

A rotation around an axis in the barcode length direction. It is equivalent to the rotation of a product when reading a barcode attached vertically to the product.

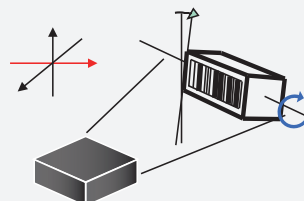

*** Important Note**

Laser barcode readers cannot read correctly if the laser light is almost perpendicular (specular reflection range) to the barcode. Since the barcode reader reads by receiving the diffuse reflection of the laser light, receiving the specularly reflected light makes the barcode reader unable to recognize the barcode because the light is too strong.

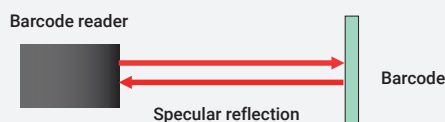

CCD Handheld Code Reader Reading Principles

A CCD handheld code reader is a barcode reader that requires the scanner head to get close or slightly touch the barcode to read it. The light source is arranged at equal intervals at the front of the scanner head to illuminate the barcode symbol uniformly. The light reflected by the barcode symbol is converted into an electrical signal (image) by the CCD sensor located at the back of the scanner head. The image is encoded in accordance with the barcode standard.

2. The reflected light is converted into an electrical signal (image) by the CCD sensor.
The barcode is read from the image by using image processing, and encoded.

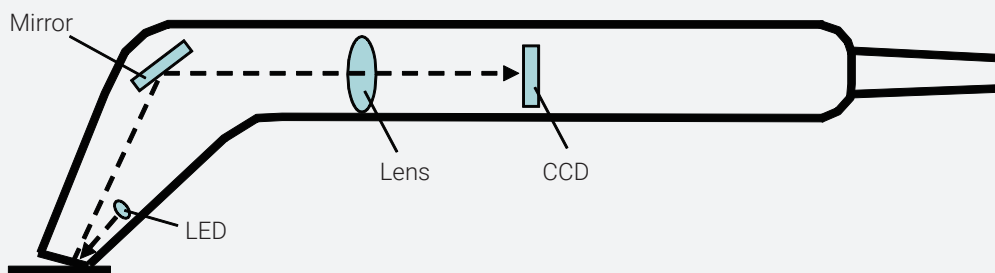

1. The light source (LED) illuminates the barcode symbol.

Operating Principles

The code reader converts the captured image into a grayscale image to decode using a process compliant with the 2D code specifications, and read the information.

For this reason, reading may fail although the barcode printing is optimal if the image that will become the input information is bad.

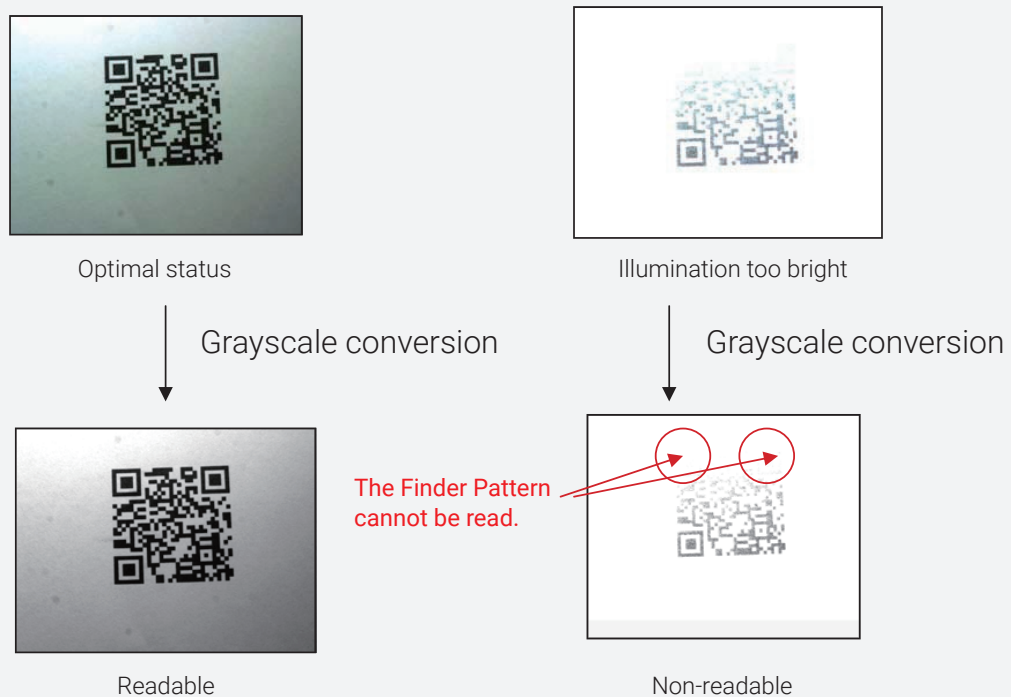

Mechanism to Produce Contrast

The brightness measured by the camera varies depending on the workpiece reflectance. Most images are bright where the reflectance is high, and dark where the reflectance is low.

The contrast appears due to the difference in reflectance between the background and the portion where the code is printed.

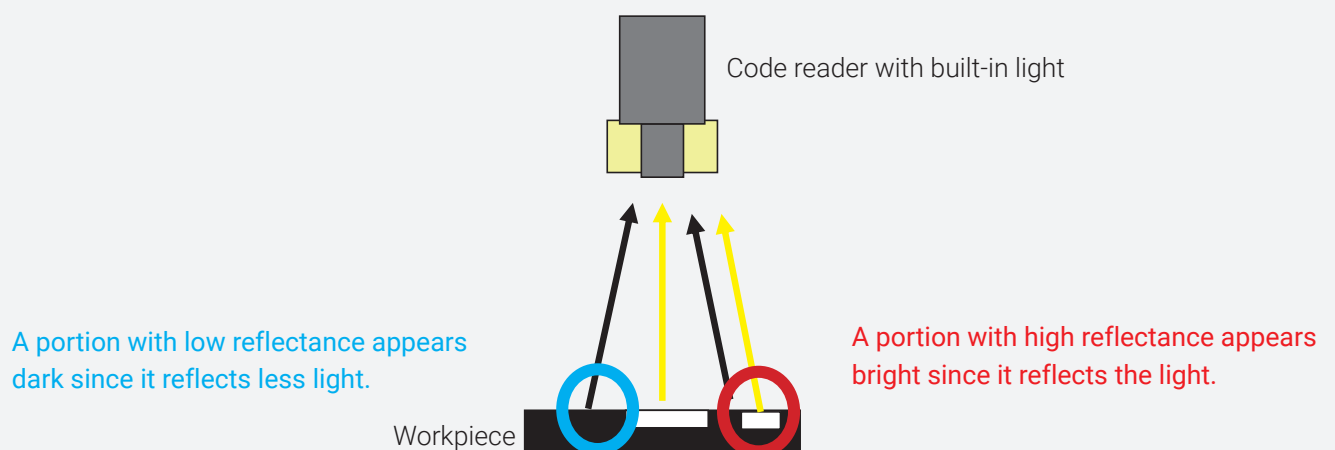

Note: Do not use this document to operate the Unit.

OMRON Corporation Industrial Automation Company
Kyoto, JAPAN

Contact: www.ia.omron.com

Regional Headquarters

OMRON EUROPE B.V.

Wegalaan 67-69, 2132 JD Hoofddorp
The Netherlands
Tel: (31)2356-81-300/Fax: (31)2356-81-388

OMRON ELECTRONICS LLC

2895 Greenspoint Parkway, Suite 200
Hoffman Estates, IL 60169 U.S.A.
Tel: (1) 847-843-7900/Fax: (1) 847-843-7787

OMRON ASIA PACIFIC PTE. LTD.

No. 438A Alexandra Road # 05-05/08 (Lobby 2),
Alexandra Technopark,
Singapore 119967
Tel: (65) 6835-3011/Fax: (65) 6835-2711

OMRON (CHINA) CO., LTD.

Room 2211, Bank of China Tower,
200 Yin Cheng Zhong Road,
PuDong New Area, Shanghai, 200120, China
Tel: (86) 21-5037-2222/Fax: (86) 21-5037-2200

Authorized Distributor:

© OMRON Corporation 2020 All Rights Reserved.
In the interest of product improvement,
specifications are subject to change without notice.

Cat. No. Q284-E1-01

0320 (0320)