

Power Line Data Generator

User's Manual K7DD

1
Overview

2
Procedures

3
Installation and
Wiring

4
K7DD Function

5
Support Tool
Function

6
Using K7DD
Parameters

7
Communications

8
Troubleshooting

A
Appendices

I
INDEX



NOTE

All rights reserved. No part of this publication may be reproduced, stored in a retrieval system, or transmitted, in any form, or by any means, mechanical, electronic, photocopying, recording, or otherwise, without the prior written permission of OMRON.

No patent liability is assumed with respect to the use of the information contained herein. Moreover, because OMRON is constantly striving to improve its high-quality products, the information contained in this manual is subject to change without notice. Every precaution has been taken in the preparation of this manual. Nevertheless, OMRON assumes no responsibility for errors or omissions. Neither is any liability assumed for damages resulting from the use of the information contained in this publication.

Trademarks

- Microsoft, Windows Excel, and Visual Basic are either registered trademarks or trademarks of Microsoft Corporation in the United States and other countries.
- Modbus is a registered trademark or trademark of Schneider Electric USA, Inc. in Japan, the United States or other countries.

Other company names and product names in this document are the trademarks or registered trademarks of their respective companies.

Copyrights

Microsoft product screen shots reprinted with permission from Microsoft Corporation.

Preface

Thank you for purchasing a K7DD Power Line Data Generator. This manual describes how to use the K7DD.

Read this manual thoroughly and be sure you understand it before attempting to use the K7DD correctly according to the information provided. Keep this manual in a safe place for easy reference.

A PDF version of this manual can be downloaded from the OMRON website.

(<https://www.omron.com>)

Terms and Conditions Agreement

Warranty, Limitations of Liability

Warranties

- **Exclusive Warranty**

Omron's exclusive warranty is that the Products will be free from defects in materials and workmanship for a period of twelve months from the date of sale by Omron (or such other period expressed in writing by Omron). Omron disclaims all other warranties, express or implied.

- **Limitations**

OMRON MAKES NO WARRANTY OR REPRESENTATION, EXPRESS OR IMPLIED, ABOUT NON-INFRINGEMENT, MERCHANTABILITY OR FITNESS FOR A PARTICULAR PURPOSE OF THE PRODUCTS. BUYER ACKNOWLEDGES THAT IT ALONE HAS DETERMINED THAT THE PRODUCTS WILL SUITABLY MEET THE REQUIREMENTS OF THEIR INTENDED USE.

Omron further disclaims all warranties and responsibility of any type for claims or expenses based on infringement by the Products or otherwise of any intellectual property right.

- **Buyer Remedy**

Omron's sole obligation hereunder shall be, at Omron's election, to (i) replace (in the form originally shipped with Buyer responsible for labor charges for removal or replacement thereof) the non-complying Product, (ii) repair the non-complying Product, or (iii) repay or credit Buyer an amount equal to the purchase price of the non-complying Product; provided that in no event shall Omron be responsible for warranty, repair, indemnity or any other claims or expenses regarding the Products unless Omron's analysis confirms that the Products were properly handled, stored, installed and maintained and not subject to contamination, abuse, misuse or inappropriate modification. Return of any Products by Buyer must be approved in writing by Omron before shipment. Omron Companies shall not be liable for the suitability or unsuitability or the results from the use of Products in combination with any electrical or electronic components, circuits, system assemblies or any other materials or substances or environments. Any advice, recommendations or information given orally or in writing, are not to be construed as an amendment or addition to the above warranty.

See <http://www.omron.com/global/> or contact your Omron representative for published information.

Limitation on Liability; Etc

OMRON COMPANIES SHALL NOT BE LIABLE FOR SPECIAL, INDIRECT, INCIDENTAL, OR CONSEQUENTIAL DAMAGES, LOSS OF PROFITS OR PRODUCTION OR COMMERCIAL LOSS IN ANY WAY CONNECTED WITH THE PRODUCTS, WHETHER SUCH CLAIM IS BASED IN CONTRACT, WARRANTY, NEGLIGENCE OR STRICT LIABILITY.

Further, in no event shall liability of Omron Companies exceed the individual price of the Product on which liability is asserted.

Application Considerations

Suitability of Use

Omron Companies shall not be responsible for conformity with any standards, codes or regulations which apply to the combination of the Product in the Buyer's application or use of the Product. At Buyer's request, Omron will provide applicable third party certification documents identifying ratings and limitations of use which apply to the Product. This information by itself is not sufficient for a complete determination of the suitability of the Product in combination with the end product, machine, system, or other application or use. Buyer shall be solely responsible for determining appropriateness of the particular Product with respect to Buyer's application, product or system. Buyer shall take application responsibility in all cases.

NEVER USE THE PRODUCT FOR AN APPLICATION INVOLVING SERIOUS RISK TO LIFE OR PROPERTY OR IN LARGE QUANTITIES WITHOUT ENSURING THAT THE SYSTEM AS A WHOLE HAS BEEN DESIGNED TO ADDRESS THE RISKS, AND THAT THE OMRON PRODUCT(S) IS PROPERLY RATED AND INSTALLED FOR THE INTENDED USE WITHIN THE OVERALL EQUIPMENT OR SYSTEM.

Programmable Products

Omron Companies shall not be responsible for the user's programming of a programmable Product, or any consequence thereof.

Disclaimers

Performance Data

Data presented in Omron Company websites, catalogs and other materials is provided as a guide for the user in determining suitability and does not constitute a warranty. It may represent the result of Omron's test conditions, and the user must correlate it to actual application requirements. Actual performance is subject to the Omron's Warranty and Limitations of Liability.

Change in Specifications

Product specifications and accessories may be changed at any time based on improvements and other reasons. It is our practice to change part numbers when published ratings or features are changed, or when significant construction changes are made. However, some specifications of the Product may be changed without any notice. When in doubt, special part numbers may be assigned to fix or establish key specifications for your application. Please consult with your Omron's representative at any time to confirm actual specifications of purchased Product.

Errors and Omissions

Information presented by Omron Companies has been checked and is believed to be accurate; however, no responsibility is assumed for clerical, typographical or proofreading errors or omissions.

Safety Precautions





Definition of Precautionary Information

The following notation is used in this manual to provide precautions required to ensure safe usage of the K7DD Power Line Data Generator.









The safety precautions that are provided are extremely important to safety. Always read and heed the information provided in all safety precautions. The following notation is used.

 CAUTION	Indicates a potentially hazardous situation which, if not avoided, may result in minor or moderate injury, or property damage.
Precautions for Safe Use	Precautions on what to do and what not to do to ensure safe usage of the Product.
Precautions for Correct Use	Precautions on what to do and what not to do to ensure proper operation and performance.

Symbols

Symbol		Meaning
Caution		<ul style="list-style-type: none"> General Caution Indicates unspecified general cautions, warnings, and dangers.
		<ul style="list-style-type: none"> Electrical Shock Caution Indicates possibility of electric shock under specific conditions.
Prohibition		<ul style="list-style-type: none"> General Prohibition Indicates unspecified general prohibitions.
		<ul style="list-style-type: none"> Disassembly Prohibition Indicates prohibitions the disassembly of a device because of the possibility of injuries due to electric shock.
Mandatory Caution		<ul style="list-style-type: none"> General instructions Indicates instructions on unspecified general action.



⚠ CAUTION

Minor injury due to electric shock may occasionally occur. Do not touch the Product except for any buttons (keys) while power is being supplied.	
Electric shock may occasionally occur. Always turn OFF the power supplies to the measured object and the Product before wiring the special CT and voltage input.	
Minor electric shock, fire, or malfunction may occasionally occur. Do not allow metal objects, conductors, or cuttings from installation work to enter the Product.	
Minor electric shock, fire, or Product failure may occasionally occur. For the wire passing through the primary side of the special CT, be sure to use an insulated wire with basic insulation or higher degree of insulation. When clamping a busbar or other conductive material, ensure basic insulation or higher level of insulation, e.g., by covering it with an insulating material.	
Minor injury due to explosion may occasionally occur. Do not use the Product where subject to flammable or explosive gas.	
Minor electric shock, fire, or malfunction may occasionally occur. Do not disassemble, modify, or repair the Product or touch the interior of the Product.	
Property damage may occasionally occur due to ignition. Always make sure that the wires are connected properly before turning ON the power supply.	
Property damage may occasionally occur due to ignition. When wiring, make sure that the wiring material is properly inserted all the way into each terminal hole of the Product.	
Property damage may occasionally occur. Take appropriate measures such as performing periodic inspection of the Product and installing a monitoring device on a separate line.	





Take adequate security measures against DDoS attacks (Distributed Denial of Service attacks), computer viruses and other technologically harmful programs, unauthorized access and other possible attacks before using this product.

Security Measures

<p>Anti-virus protection Install the latest commercial-quality antivirus software on the computer connected to the control/monitor system and maintain to keep the software up-to-date.</p>	
--	---

<p>Security measures to prevent unauthorized access Take the following measures to prevent unauthorized access to our products.</p> <ul style="list-style-type: none"> • Install physical controls so that only authorized personnel can access control/monitor systems and equipment. • Reduce connections to control/monitor systems and equipment via networks to prevent access from untrusted devices. • Install firewalls to shut down unused communications ports and limit communications hosts and isolate control/monitor systems and equipment from the IT network. • Use a virtual private network (VPN) for remote access to control/monitor systems and equipment. • Scan virus to ensure safety of SD cards or other external storages before connecting them to control/monitor systems and equipment. 	
<p>Data input and output protection Validate backups and ranges to cope with unintentional modification of input/output data to control/monitor systems and equipment.</p> <ul style="list-style-type: none"> • Checking the scope of data • Checking validity of backups and preparing data for restore in case of falsification and abnormalities • Safety design, such as emergency shutdown, in case of data tampering and abnormalities 	
<p>Data recovery Backup data and keep the data up-to-date periodically to prepare for data loss.</p>	

Security Measures of K7DD Support Tool

<p>To prevent computer viruses, install antivirus software on a computer where you use this software. Make sure to keep the antivirus software updated.</p>	
<p>Keep your computer's OS updated to avoid security risks caused by a vulnerability in the OS. Manage usernames and passwords in the OS or this software carefully to protect them from unauthorized uses.</p>	
<p>Always use the highest version of this software to add new features, increase operability, and enhance security.</p>	
<p>Set up a firewall (E.g., disabling unused communication ports, limiting communication hosts, etc.) on a network for a control/monitor system and devices to separate them from other IT networks. Make sure to connect to the control/monitor system inside the firewall.</p>	
<p>Use a virtual private network (VPN) for remote access to a control/monitor system and devices from this software.</p>	

Precautions for Safe Use

- (1) Do not store, install, or use the Product in the following locations:
 - Outdoor or locations subject to direct sunlight
 - Locations subject to rain and wind damage
 - Locations subject to excessive vibration or shock
 - Locations subject to rapid temperature changes
 - Locations prone to icing and dew condensation
 - Locations subject to water or oil
 - Locations subject to dust or corrosive gases (particularly sulfurizing gases, ammonia, etc.)
 - Locations subject to influence of static electricity and noise
 - Locations subject to bugs and small animals
 - Locations subject to electromagnetic fields
 - Locations subject to a load
- (2) A switch or circuit breaker should be provided close to the Product. The switch or circuit breaker should be within easy reach of the operator, and must be marked as a means to cut off the power to the Product.
- (3) Mount the Product in the correct direction for installation.
- (4) Use and store the Product in a location where the ambient temperature and humidity are within the specified ranges. If applicable, provide forced cooling.
- (5) Be sure to use terminals of operation power supply carefully, because they have hazardous voltage.
- (6) Use the wire given in this manual.
- (7) When wiring, use a wire of sufficient length.
- (8) Make sure that the operation power supply voltage and the load voltage and current are within the specifications of the Product.
- (9) Check terminal polarity when wiring and wire all connections correctly. Do not wire the input and output terminals incorrectly.
- (10) Make sure the crimp terminals for wiring are of the specified size.
- (11) Do not wire anything to the release holes.
- (12) Confirm that the input and output terminals are correctly wired before power is supplied.
- (13) The terminal block may be damaged if you insert a flat-blade screwdriver in the release hole with excessive force. When inserting a flat-blade screwdriver into the release holes, operate with a force of 15·N or less.
- (14) To prevent inductive noise, wire the lines connected to the Product separately from power lines carrying high voltages or currents. Also, do not wire in parallel with or on the same cables as power lines. Other measures for reducing noise are to separate from ducts including noisy lines.
- (15) The Product may be subject to radio disturbances. Do not install the Product near equipment that generates high frequencies or surges.
- (16) The maximum terminal temperature is 65°C. Use wires with a heat resistance of 65°C minimum to wire the terminals.
- (17) For accurate measurement with the Product, use the range suitable for the measurement voltage and current.
- (18) Periodically check that the LCD display and LED indicators operate correctly. Depending on the operating environment, the display or indicators may fail due to deterioration.
- (19) Do not exceed the communications distance that is given in the specifications and use the specified communications cable. For information on the communication distance and the cable, refer to  *A-1 Specifications (P.A-2)*.

- (20) Do not continue to use the Product if the front surface peels.
- (21) The alarm output function is a function for the output of an alarm when the set threshold value is exceeded. Do not use this function for control, etc.
- (22) Use the Product inside the control panel to prevent external noise.
- (23) When discarding the Product, properly dispose of it as industrial waste.
- (24) Always use the special CT that is specified by OMRON's model number.
- (25) Clamp the wire of the special CT correctly. After clamping, make sure until it clicks into place.
- (26) The measurement accuracy may deteriorate due to the influence of external magnetic fields. Install the special CT as far away as possible from electric wires with large current flows, except for those to be measured.
- (27) Connect the special CT input and the voltage input correctly to the same application.
- (28) Install equipment so that wiring cables do not touch moving parts.
- (29) Do not build a system that judges the open/closed state of the valve based on the measurement value of the Product. A system error may occur.
- (30) If you accidentally drop the Product, the inside of the Product may be damaged, so do not use it.
- (31) Do not bend a wire more than its natural bending radius or pull on it with excessive force. Doing so may cause wire disconnection, or damage to the terminal block.
- (32) Do not wire anything to the release holes.

Precautions for Correct Use

- (1) During periodic inspection, installation of an additional sensor, or adjustment of sensor position, use the Product after ensuring that operations can be performed normally.
- (2) Do not use the Product as a safety apparatus, or for the rescue of human lives.
- (3) Confirm that wire does not stick up after wiring of stranded cable.
- (4) In crossover wiring, connecting more than one K7DD in parallel may allow a large amount of current to flow. Keep the current to 10 A or less per terminal.
- (5) When wiring a ferrule terminal or single wire, push it directly into the terminal hole. When wiring a stranded wire, insert the wire into the terminal hole while pushing straight along the taper of the release hole with the recommended flat-blade screwdriver.

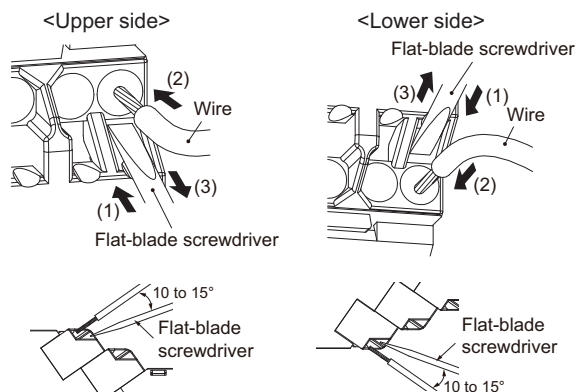

- (6) The terminal block may be damaged if specialized tool is not used. Use a recommended flat-blade screwdriver to insert into a release hole on the terminal block.
- (7) Only a professional with an understanding of electricity and electric devices must handle it. Read this manual carefully before using the Product.
- (8) Use the power supply voltage, input power, and other power supplies and transformers with suitable capacities and rated outputs.

- (9) Do not install the Product close contact with the heating element.
- (10) Use a power supply that will reach the rated voltage within 1 second after the power is turned ON.
- (11) Do not install the Product near equipment that generates high frequencies or surges.
- (12) Make sure that the setting values registered in the Product match the specifications of the load and special CT that are actually used.
- (13) Do not ground the terminal on the output side of the special CT. Failure to do so may result in unstable measurement.
- (14) Do not directly clamp the special CT to the lines exceeding 600 VAC.
- (15) If an error occurs during the operation of the Product, stop the operation immediately and make suitable corrections such as replacement.
- (16) Do not use any liquids such as paint thinner, similar solvents or alcohol to clean the Product. Clean it with a soft, dry cloth.

Regulations and Standards

Conformance to Safety Standards

- The protection provided by the device may be impaired if the device is used in a manner that is not specified by the manufacturer.
- To use the Product, install it as an embedded device within a control panel.
- To use the special CT, install it in the same control panel as the Product with a sufficient clearance from other devices.
- For the special CT, use one with –C suffixed to the model.
- For the operation power supply and voltage inputs, use recommended fuses that are externally installed.
- Use the voltage and CT inputs under conditions specified for the measurement category.
- The maximum temperature of the terminal block is 65°C. Therefore, use wires with a rated temperature of 65°C or higher.
- Select wires in accordance with Table 2 so that the case temperature of the special CT will be 65°C or less.
- For the wire passing through the primary side of the special CT, use an insulated wire with basic insulation or higher degree of insulation that conforms to the rated voltage and size of the AWM (Appliance Wiring Material) wire in Table 1.
- Table 1 below shows the nominal voltage and measurement circuit connections available for each measurement category in the Main Power Supply System Configurations. Do not use the device under conditions that exceed this category and conditions.

Table 1

Measuring Voltage System Configurations		
3-phase, 4-wire type (neutral point grounding)	3-phase, 3-wire type	Single-phase, 2-wire type
Phase voltage ≤ 150 V	Line voltage ≤ 150 V	
Rated voltage and size of AWM wires: 150 V min. No size limit		
Phase voltage $> 150 \leq 300$ V	Line voltage $> 150 \leq 300$ V	
Rated voltage and size of AWM wires: 600 V min. 1 AWG min.		
Phase voltage ≤ 150 V	Line voltage ≤ 150 V	
Rated voltage and size of AWM wires: 150 V min. No size limit		
Phase voltage $> 150 \leq 300$ V	Line voltage $> 150 \leq 300$ V	
Rated voltage and size of AWM wires: 300 V min. No size limit		
Phase voltage $> 300 \leq 347$ V	Line voltage $> 300 \leq 480$ V	
Rated voltage and size of AWM wires: 600 V min. 1 AWG min.		

Table 2

Special CT model	Wire size	Ambient operating temperature of K7DD and special CT
K6CM-CICB005-C	24 AWG min. (0.25 mm ² min.)	55°C max.
K6CM-CICB025-C	12 AWG min. (3.5 mm ² min.)	55°C max.
K6CM-CICB100-C	4 AWG (22 mm ²)	45°C max.
	2 AWG (35 mm ²)	50°C max.
	1 AWG min. (50 mm ² min.)	55°C max.
K6CM-CICB200-C	2/0 AWG (70 mm ²)	45°C max.
	3/0 AWG min. (95 mm ² min.)	50°C max.
K6CM-CICB400-C	3/0 AWG min. x2 (95 mm ² min. x2)	40°C max.

● **Connection diagrams**

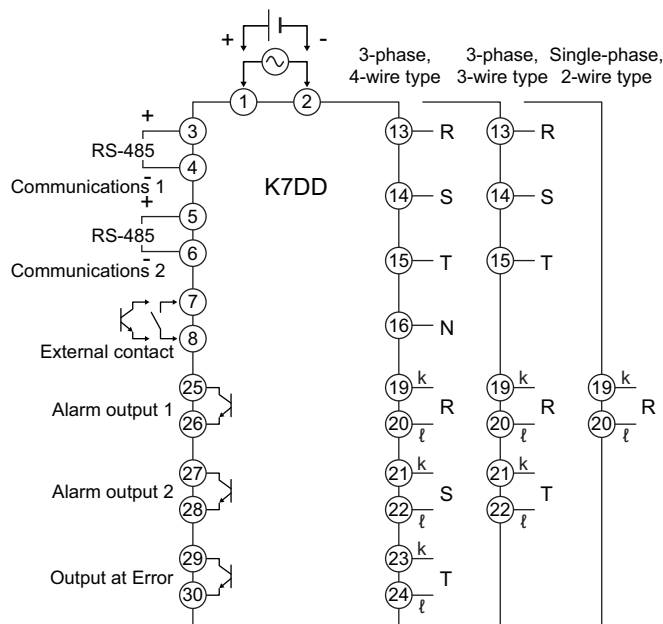

● **Measurement Category**

The measurement category classifies the places and equipment which you can connect to the measurement terminals, as prescribed in EN/IEC 61010-2-030.

Each category is as follows.

CAT II: Energy-consuming equipment with an energy supply from fixed wiring equipment (such as a power outlet)

CAT III: Equipment in fixed wiring equipment that particularly demands equipment reliability and effectiveness

CAT IV: Equipment to use at the electrical service entry

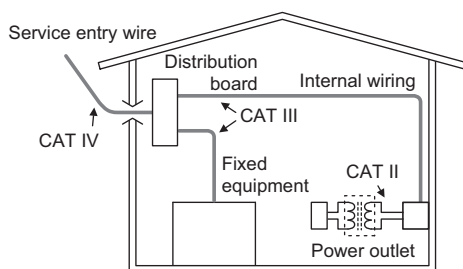

Conformance to EN/IEC Standards

This is a Class A product. In residential areas it may cause radio interference, in which case the user may be required to take adequate measures to reduce interference. The product must be installed within a control panel.

Terminology

Term	Abbreviation	Description
% FS	-	This shows a percentage to the input range (at full scale).
alarm latch	-	Once an alarm turns ON, this function keeps it ON until the alarm latch is released.
channel	CH	In the Power Line Data Generator K7DD, CH indicates the unit of voltage and current measurement loop for each phase of the power line.
CT	-	An acronym for Current Transformer. This is a current sensor that can measure alternating current on a non-contact basis. When you run the power cable through the ring-shaped core, the sensor measures the induced voltage to the secondary winding around the core to detect an alternating current value.
flashing	-	This means that the display flashes at 1-s intervals (lit for 0.5 s and out for 0.5 s).
flashing at high speed	-	This means that the display flashes at 0.5-s intervals (lit for 0.25 s and out for 0.25 s).
Modbus RTU	-	This is a standard communications control method that conforms to Modicon Inc.'s RTU-mode Modbus Protocol (PI-MBUS-300 Rev. J).
Operation Command	-	A generic term for the signals that command operation of devices. In the K7DD, Operation Command signals are given and executed via communications or key operations.
parameter	-	There are two types of parameters: the parameter that the user can set, and the parameter that accesses a monitored value. The parameter that can be set is called a "setting parameter." In addition, the parameter that can be accessed only via communications is called a "parameter exclusive to communications."
power ON reset	-	The power ON reset is a reset process inside the K7DD. It can be executed in any of the following ways. <ul style="list-style-type: none"> • Cycling the power supply • Executing the Software Reset Command via communications • Moving to the Operation Level with key operation (by pressing the Level Key for 1 second or more in the operation stopped state)
special CT	-	A CT (Current Transformer) recommended for the Power Line Data Generator K7DD. Use the CT with a rated current and voltage, according to the target power line.

Manual Structure

Page Structure and Symbols

Level 2 heading

Special information

Icons indicate precautions, additional information, or reference information.



Procedures

Indicates a procedure.

Manual name

2 Procedures

Common Settings

This section describes common settings for configurations using the K7DD unit only and using K7DD Support Tool.

(1) Identify Voltage and Current of Actuator and Select Special CT

Check the electrical wiring of the actuator to be monitored.

Check it beforehand since the information is necessary for the parameter settings on the K7DD. The K7DD can monitor the following three types of electrical wiring states.

- 3P3W2M: 3-Phase, 3-Wire, 2-Watt Meter Method
- 3P4W: 3-phase 4-wire
- Single phase current

Refer to [3-5 Wiring to the Power Lines \(P.3-13\)](#) for details.

Precautions for Correct Use

Be aware that the K7DD cannot measure the following wiring states:

- 1P2W: Single-phase, 2-wire type
- 3P3W3M: 3-phase, 3-wire 3-watt meter method

Note that the Unit does not support applications where wiring is switched during the course of operation.

Check the ratings (voltage and current) of the actuator to be monitored.

Since the following items are necessary in the K7DD parameter settings, check them in advance.

- Current Input Range
- Voltage Input Range

Prepare a special CT suitable for the power line to monitor.

1. Check the rated voltage and current of the monitored actuator on its nameplate, etc.
2. Select the smallest special CT of which the rated current is within the range. Refer to [A-1-2 Special CTs \(P.A-6\)](#) for the types of special CTs.

2-7

2-2 Configuration with the K7DD Unit Only

2

Level 1 heading

Level 2 heading

Gives the current heading.

Page tab

Indicates the current section number.

Icons

Special information in this user's manual is classified as follows:



Precautions for Correct Use

Precautions on what to do and what not to do to ensure proper operation and performance.



Setting-related page

In *Section 6 Using K7DD Parameters*, this indicates the page related to the setting level.



Additional information to read as required.

This information is provided to increase understanding or make operation easier.



References are provided to more detailed or related information.



Tool Operating Procedure

In *Section 2 Procedures*, this indicates the procedure to perform with the K7DD Support Tool.



Configuration with Key Operations

In *Section 2 Procedures*, this indicates the procedure to perform with key operations on the K7DD.

Notation on Main Display and LVL Display

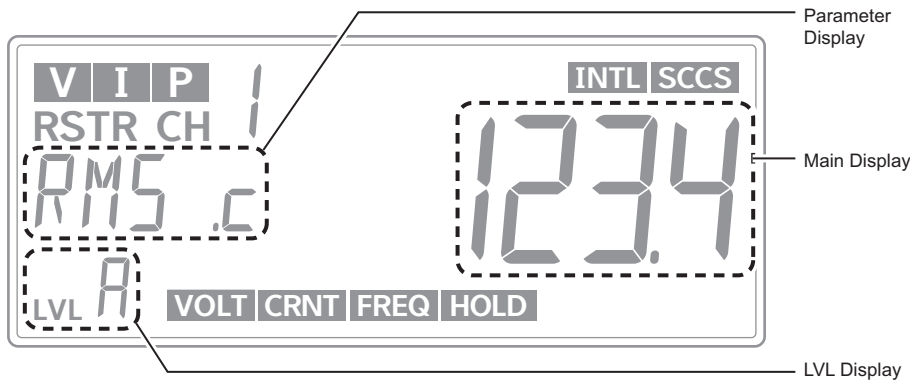

Main Display/Parameter Display

The following tables show the correspondence between the symbols displayed on the main display/parameter display and alphabet characters.

<i>R</i>	<i>b</i>	<i>E</i> or <i>c</i>	<i>d</i>	<i>E</i>	<i>F</i>	<i>G</i>	<i>H</i>	<i>z</i>	<i>J</i>	<i>K</i>	<i>L</i>	<i>M</i>
A	B	C	D	E	F	G	H	I	J	K	L	M

<i>N</i>	<i>o</i>	<i>P</i>	<i>Q</i>	<i>R</i>	<i>S</i>	<i>t</i>	<i>U</i>	<i>V</i>	<i>W</i> or <i>w</i>	<i>x</i>	<i>Y</i>	<i>Z</i>
N	O	P	Q	R	S	T	U	V	W	X	Y	Z

LVL Display

The following table shows the characters displayed on the LVL.

● LVL Display

Character	Meaning	
Blank		Shows that the Unit is on the Monitoring Level.
<i>Q</i>	Initial Setting Level	Shows that the Unit is on the Initial Setting Level.
<i>I</i>	Communications Level	Shows that the Unit is on the Communications Level.
<i>R</i>	Adjustment Level	Shows that the Unit is on the Adjustment Level.

Revision History

A manual revision code appears as a suffix to the catalog number on the back cover of the manual.

Cat. No.	N233-E1-01
-----------------	-------------------

↑ Revision code

Revision code	Date	Revised content
01	February 2023	Original production

Sections in this Manual

1	Overview	1
2	Procedures	2
3	Installation and Wiring	3
4	K7DD Function	4
5	Support Tool Function	5
6	Using K7DD Parameters	6
7	Communications	7
8	Troubleshooting	8
A	Appendices	A
I	INDEX	I

CONTENTS

Terms and Conditions Agreement	2
Warranty, Limitations of Liability	2
Application Considerations	3
Disclaimers	3
Safety Precautions	4
Definition of Precautionary Information.....	4
Symbols	4
Precautions for Safe Use	7
Precautions for Correct Use	8
Regulations and Standards	9
Conformance to Safety Standards.....	9
Conformance to EN/IEC Standards	11
Terminology	12
Manual Structure	13
Page Structure and Symbols	13
Icons	14
Notation on Main Display and LVL Display	15
Revision History	16
Sections in this Manual	17

Section 1 Overview

1-1 Outline	1-2
1-2 Features	1-4
1-3 Model Number Legend	1-5
1-4 Part names and functions	1-6
1-5 Internal Block Diagram	1-11
1-6 Example Configurations for Use	1-12

Section 2 Procedures

2-1 Overview of Operating Procedures	2-2
To Monitor with the K7DD.....	2-2
How to Configure Features and Alarm Thresholds.....	2-2
Accurate Monitoring with Trigger Settings	2-3
2-2 Configuration with the K7DD Unit Only	2-4
Flow of Configuration with the K7DD Unit Only	2-4
Common Settings	2-6
(1) Identify Voltage and Current of Actuator and Select Special CT.....	2-6
(2) Installation and Wiring	2-7
Wiring Example of 3P3W2M Connection (3-phase, 3-wire, 2-watt Meter Method)	2-7
Wiring Example of 3P4W Connection.....	2-8
Wiring Example of Single-phase Current Connection	2-9
Configuration Procedure with the K7DD Unit Only	2-10

(3) K7DD Input Setting	2-10
(4) Operation Settings for Alarm Output.....	2-11
(5) Simplified Threshold Settings (Teaching)	2-12
(6-1) Check the Notification Status of the K7DD	2-13
(6-2) Check the K7DD Operation after Maintenance	2-13
2-3 Configuration with K7DD Support Tool.....	2-14
Flow of Configuration with the K7DD Support Tool.....	2-14
2-3-1 Settings with Application Setting File.....	2-15
2-3-2 To capture sudden errors.....	2-15

Section 3 Installation and Wiring

3-1 Dimensions	3-2
3-2 Installation.....	3-4
3-3 How to Connect to the Push-In Plus Terminal Blocks	3-5
3-4 I/O Wiring.....	3-8
3-5 Wiring to the Power Lines	3-13
3-6 Wiring the Communications Cables	3-14
3-7 Setting the Unit Number	3-16

Section 4 K7DD Function

4-1 K7DD Functions.....	4-2
4-2 Feature Measurement	4-3
4-3 Simplified Threshold Settings.....	4-4
4-3-1 Overview.....	4-4
4-3-2 Conditions to Use	4-5
4-3-3 Description of Operation.....	4-6
4-4 Alarm	4-9
4-4-1 Types of Alarm Notification Methods.....	4-9
4-4-2 Releasing the Alarm Latch.....	4-10
4-4-3 Alarm Types.....	4-10
4-5 Measurement Error.....	4-11
4-5-1 Types of Notification of Measurement Errors.....	4-11
4-6 Self-diagnosis Error	4-13

Section 5 Support Tool Function

5-1 Support Tool Functions	5-2
5-2 All Feature Measurement and Trigger Measurement Simulation.....	5-3
5-2-1 All Feature Measurement	5-3
5-2-2 Trigger Measurement Simulation.....	5-5
5-3 Abnormal Data Registration	5-6
5-4 Feature Selection Support/Alarm Threshold Setting Support	5-7
5-5 Digital Maintenance Log/ Arrival Prediction	5-8

Section 6 Using K7DD Parameters

6-1	Levels	6-2
6-2	Setting Parameters and Setting Values	6-4
6-2-1	Parameter Flow	6-5
6-3	Display of Measurement Value Mark	6-6
6-3-1	Feature Value Range for Monitoring	6-7
6-4	Monitoring Level	6-9
6-4-1	Switching Measurement Values and Displayed Channels	6-9
6-4-2	Parameters on Monitoring Level	6-10
6-5	Adjustment Level (LVL <i>R</i>)	6-13
6-5-1	Moving to Adjustment Level	6-13
6-5-2	Setting Parameters on Adjustment Level	6-14
6-6	Initial Setting Level (LVL <i>I</i>)	6-20
6-6-1	Moving to Initial Setting Level	6-20
6-6-2	Parameters on Initial Setting Level	6-21
6-7	Communications Setting Level (LVL <i>I</i>)	6-23
6-7-1	Moving to Communications Setting Level	6-23
6-7-2	Setting Parameters on Communications Setting Level	6-24
6-8	Operation Command with Key Operation	6-25

Section 7 Communications

7-1	Communications	7-2
7-2	Communications Overview	7-3
7-3	To Monitor All Feature Values Together (Read Variable Area)	7-5
7-3-1	Reading Measurement Values/Statuses	7-5
7-4	Changing Setting Parameters (Write Variable Area)	7-6
7-4-1	Writing Setting Parameters	7-6
7-5	Operation Command	7-7
7-6	Modbus RTU Communications Format	7-9
7-6-1	Frame Configurations	7-9
7-6-2	Read Variable Area Command	7-12
7-6-3	Write Variable Area Command	7-13
7-6-4	Operation Command or Write Variable Area Command (Single)	7-15
7-7	Variable Area Map	7-17
7-7-1	Variable Area Map Descriptions	7-17
7-7-2	Common Variable Area	7-19
7-7-3	Variable Area for Each Channel	7-23
7-7-4	K7DD Information Area	7-24
7-7-5	Details about Status Information	7-25

Section 8 Troubleshooting

8-1	Troubleshooting	8-2
------------	------------------------------	------------

Section A Appendices

A-1	Specifications	A-2
A-1-1	K7DD	A-2
Ratings and Specifications		A-2
Measurement Specifications		A-4
Push-In Plus Terminal Blocks Specifications		A-5
Specifications of K7DD Support Tool		A-5
A-1-2 Special CTs		A-6
Models		A-6
Ratings and Specifications		A-6
A-1-3 Applicable Standards		A-8
A-2	Parameters List.....	A-9
A-3	Parameter Flow.....	A-12
A-4	Feature Calculations	A-13
A-4-1	Feature Values of Voltage System.....	A-13
A-4-2	Feature Values of Current System.....	A-15
A-4-3	Feature Values of Power Consumption, Power Factor and Power Frequency.....	A-17

INDEX



Overview

This section describes the overview, features, model number legend, part names and functions, internal block diagram, and example configurations for use of the K7DD.

1-1	Outline	1-2
1-2	Features	1-4
1-3	Model Number Legend	1-5
1-4	Part names and functions	1-6
1-5	Internal Block Diagram	1-11
1-6	Example Configurations for Use	1-12

1-1 Outline

What is the K7DD?

The K7DD is a condition monitoring device to support condition monitoring and error diagnosis of a rotation mechanism, such as servomotors.

The Unit measures voltage and current from the power lines of the rotation mechanism, converting them to various features such as power and harmonics. It can thus capture mechanical errors that occur on the rotation mechanism.

K7DD Support Tool is also available to assist for more accurate condition monitoring and error diagnosis. This tool enables more detailed setting of measurement timing and automatic calculation of alarm thresholds for feature values by automatically extracting features that correlate with relevant errors from among a variety of features.

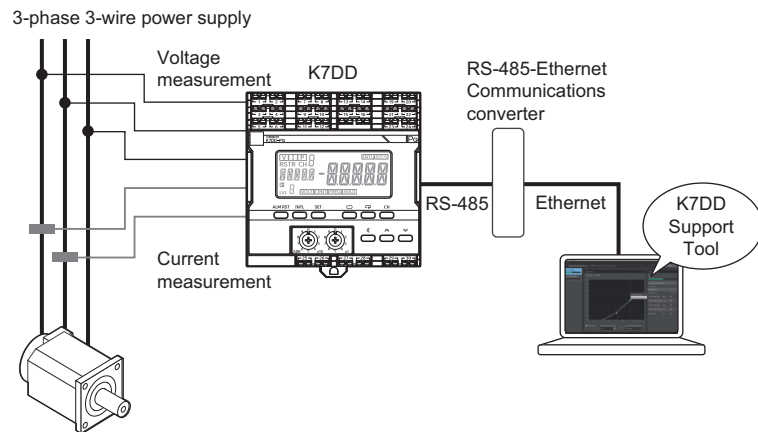

Condition monitoring is possible not only for rotation mechanisms such as servo motors, but also for non-rotating applications such as solenoid valves.

Error Detection Mechanism of the K7DD

When a rotation mechanism operates, such as when cutting with an end mill, a load is applied to the mechanism due to friction. The effect of the load will then appear in the electrical signal of the power lines.

To analyze the effect of the load, it is necessary to observe the fluctuations of electrical signals from various aspects, such as R.M.S. value of power lines, frequencies, and power factors.

The K7DD captures errors in rotation mechanisms by simultaneously processing high-speed sensing and high-speed parameter conversion of fluctuations of electrical signals appearing on the power lines.

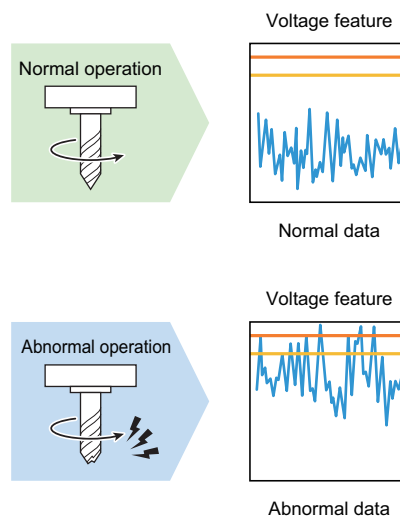

Applications That Can be Monitored by the K7DD

The K7DD can monitor the condition of rotation mechanisms powered by AC motors. Motors driven by inverters or servo drivers are also included.



Servo motor equipment



Induction motor equipment

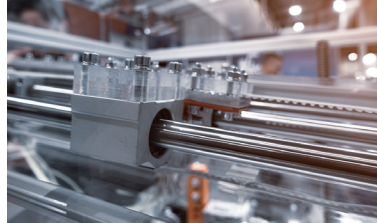

Rotation mechanisms powered by AC motors are used in a variety of facilities, including the spindles of cutting machines, conveyor systems using ball screws, and electric valves that regulate the pressure, flow rate, etc. of various fluids.

Highly Accurate Condition Monitoring with the K7DD Support Tool

If errors in equipment can be easily reproduced, effects can be inspected visually and quantitatively using the dedicated K7DD Support Tool.

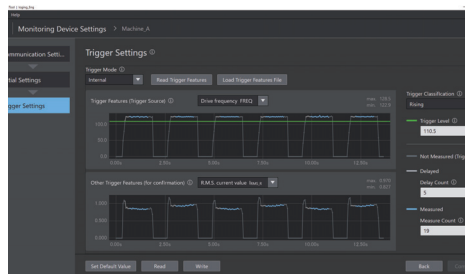

Complex equipment operations can be easily checked with waveforms.

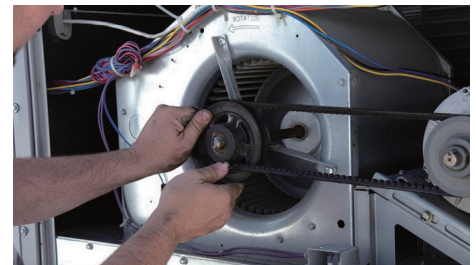

Reproduce errors and collect abnormality data.

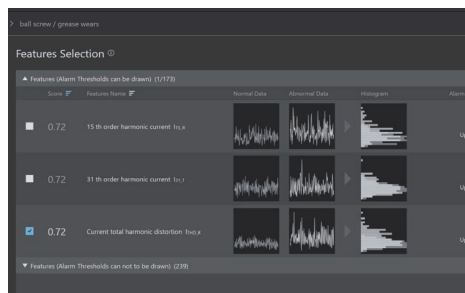

Numerical conversion of extent of effects of more than 400 types of feature values

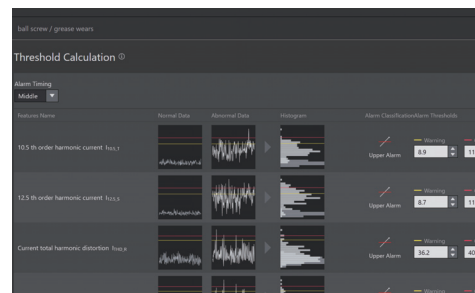

Thresholds are automatically suggested when selecting effective feature values

1-2 Features

The K7DD has three features to accurately detect errors in the rotation mechanism.

High-Speed Sensing

The Unit can accurately capture the condition of the rotation mechanism by sensing the voltage and current at a high sampling rate of 400 kHz.

High-Speed Parameter Conversion

The sensed voltage or current can be converted to various feature parameters at a high speed of 50 ms to track the behavior of the rotation mechanism.

Parallel Processing of High-Speed Sensing and High-Speed Parameter Conversion (Ensuring Sensing Continuity)

Performing high-speed sampling sensing and conversion to feature parameters in parallel realizes continuous monitoring of a large number of features. This ensures the occurrence of monitored errors can be detected without fail.

● Conversion to Feature Parameters According to Wiring Method

The Unit supports 3-phase 3-wire (3P3W2M) and 3-phase 4-wire (3P4W) power connection methods, thus accommodating a variety of applications. It is also possible to measure only current, regardless of the wiring method, although the feature parameters are limited.

The measured voltage and current values can be converted to 17 different feature parameters. Parameters that exist for each power supply phase, such as R.M.S. values, are converted for all phases. Harmonics are also calculated up to 63rd order per phase. All together, more than 400 feature parameters can be converted at high speed.

The voltage and current measurement results can be converted to such large numbers of parameters in 50 ms cycles.

Convertible parameters		3-phase 3-wire	3-phase 4-wire	Only current
Converted from voltage measurement result	R.M.S. value	✓	✓	×
	Fundamental amplitude	✓	✓	×
	Waveform peak+	✓	✓	×
	Waveform peak-	✓	✓	×
	Unbalance	✓	✓	×
	Total harmonic distortion	✓	✓	×
Converted from current measurement result	R.M.S. value	✓	✓	✓
	Fundamental amplitude	✓	✓	✓
	Waveform peak+	✓	✓	✓
	Waveform peak-	✓	✓	✓
	Unbalance	✓	✓	✓
	Harmonic current	✓	✓	✓
	Total harmonic distortion	✓	✓	✓
Converted from measurement results of voltage and current	Frequency	✓	✓	✓
	Enabled	✓	✓	×
	Disabled	✓	✓	×
	Apparent power	✓	✓	×
	Power factor	✓	✓	×

1-3 Model Number Legend

This section shows the model number legend of the K7DD.

K7DD -
 (1) (2) (3) (4)

(1)	(2)	(3)	(4)	Meaning
Base model	models	Product classification	Power supply voltage	
K7DD				Power Line Data Generator
	PQ			Voltage and Current
		M		Main Unit
			A	100 to 240 V AC power supply
			D	24 V DC power supply

Refer to A-1 *Specifications* (P.A-2) for the specifications of each model.

1-4 Part names and functions

Appearance

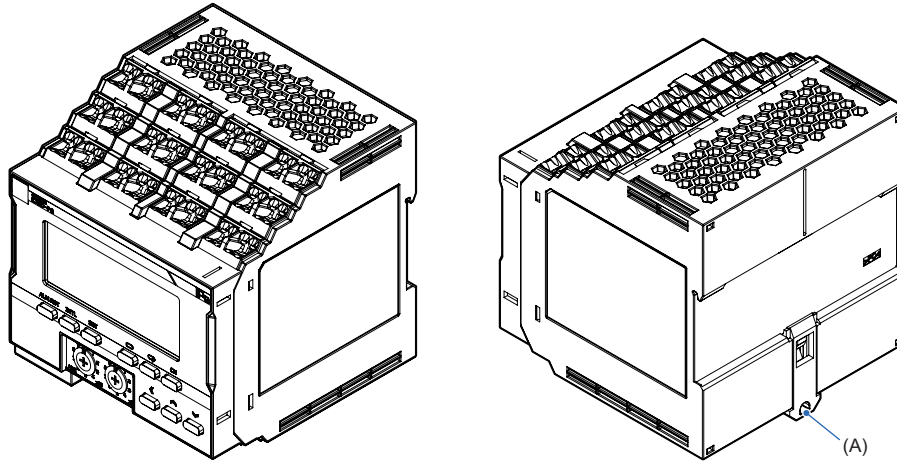

Symbol	Name	Function
(A)	DIN Track mounting hook	Used for mounting to the DIN Track. Only one hook is available on the bottom side.

Front Section

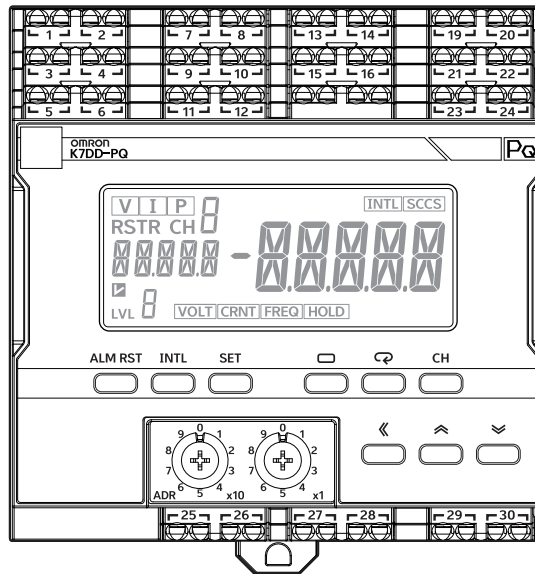

● Indicators

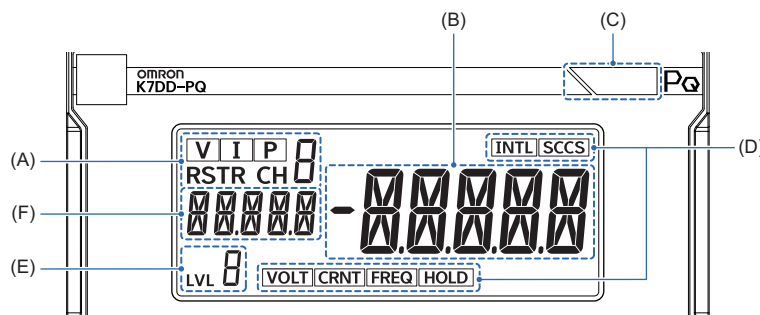

Symbol	Name	Function																															
(A)	Channel display	<ul style="list-style-type: none"> [V] [I] [P]: Lights according to the feature value displayed in the main display. [V]: R.M.S. voltage, voltage fundamental amplitude, and voltage total harmonic distortion [I]: R.M.S. current, current fundamental amplitude, current total harmonic distortion [P]: Active power Not lit: Power factor, Frequency [R] [S] [T] [R] [CH*]: Lights according to the wiring state and the displayed feature value. <table border="1"> <thead> <tr> <th rowspan="2">Wiring state</th> <th rowspan="2">Feature value*1</th> <th colspan="3">Displayed channel</th> </tr> <tr> <th>CH1</th> <th>CH2</th> <th>CH3</th> </tr> </thead> <tbody> <tr> <td rowspan="2">3-phase 3-wire 2-watt meter method (3P3W2M)</td> <td>Feature value of voltage system</td> <td>RS</td> <td>ST</td> <td>TR</td> </tr> <tr> <td>Feature value of current system</td> <td>R</td> <td>S</td> <td>T</td> </tr> <tr> <td rowspan="2">3-phase 4-wire (3P4W)</td> <td>Feature value of voltage system</td> <td>R</td> <td>S</td> <td>T</td> </tr> <tr> <td>Feature value of current system</td> <td>R</td> <td>S</td> <td>T</td> </tr> <tr> <td>Single-phase current</td> <td>Feature value of current system</td> <td>CH1</td> <td>CH2</td> <td>CH3</td> </tr> </tbody> </table> <p>*1. Not lit for any of the features other than voltage and current systems.</p>	Wiring state	Feature value*1	Displayed channel			CH1	CH2	CH3	3-phase 3-wire 2-watt meter method (3P3W2M)	Feature value of voltage system	RS	ST	TR	Feature value of current system	R	S	T	3-phase 4-wire (3P4W)	Feature value of voltage system	R	S	T	Feature value of current system	R	S	T	Single-phase current	Feature value of current system	CH1	CH2	CH3
Wiring state	Feature value*1	Displayed channel																															
		CH1	CH2	CH3																													
3-phase 3-wire 2-watt meter method (3P3W2M)	Feature value of voltage system	RS	ST	TR																													
	Feature value of current system	R	S	T																													
3-phase 4-wire (3P4W)	Feature value of voltage system	R	S	T																													
	Feature value of current system	R	S	T																													
Single-phase current	Feature value of current system	CH1	CH2	CH3																													
(B)	Main display	Indicates a measurement value or a set value.																															

Symbol	Name	Function
(C)	Alarm output indicator	Indicates the alarm judgment results in three colors. Green: Normal Yellow: A warning alarm has occurred. Red: A critical alarm has occurred. It will turn red also if any other fatal failure occurs.
(D)	Status display	[INTL]: Collecting abnormal data (Normal data has been acquired) [SCCS]: Valid feature detected. [VOLT]: Voltage Value Out-of-Range Error has occurred (updated even during hold). [CRNT]: Current Value Out-of-Range Error has occurred (updated even during hold). [FREQ]: Frequency Out-of-Range Error has occurred (updated even during hold). [HOLD]: Measured value is held at the previous value while waiting for trigger.
(E)	Level display	Displays the current level. None: Shows that the Unit is on the Monitoring Level. I: Shows that the Unit is on the Initial Setting Level. C: Shows that the Unit is on the Communications Setting Level. A: Shows that the Unit is on the Adjustment Level.
(F)	Parameter display	Displays parameters (feature values).

● Operation Keys and Switch

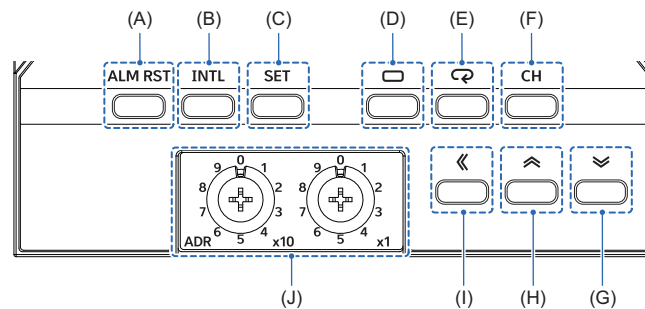

Symbol	Name	Function
(A)	Alarm Latch Cancel Key	Releases the alarm latch.
(B)	Normal Data Acquisition Key	Acquires normal data and then starts the acquisition of error data.
(C)	Abnormal Data Acquisition Key	Completes the acquisition of error data.
(D)	Level Key	Selects the setting level.
(E)	Mode Key	Switches setting parameter displays, on the setting level that allows you to change the parameter. In the Monitoring Level, it switches the displayed measurement values.
(F)	Channel Key	Switches the phase or axis of the displayed feature value.
(G)	Down Key	Decreases the set value for the displayed parameter.
(H)	Up Key	Increases the set value for the displayed parameter.
(I)	Shift Key	Used for digit shift in the set value of the displayed parameter.
(J)	Unit Number Setting Switch	Sets the unit number. The setting range is from 01 to 99. *1

*1. Specifying unit number 00 enables broadcasting.

Terminal Section

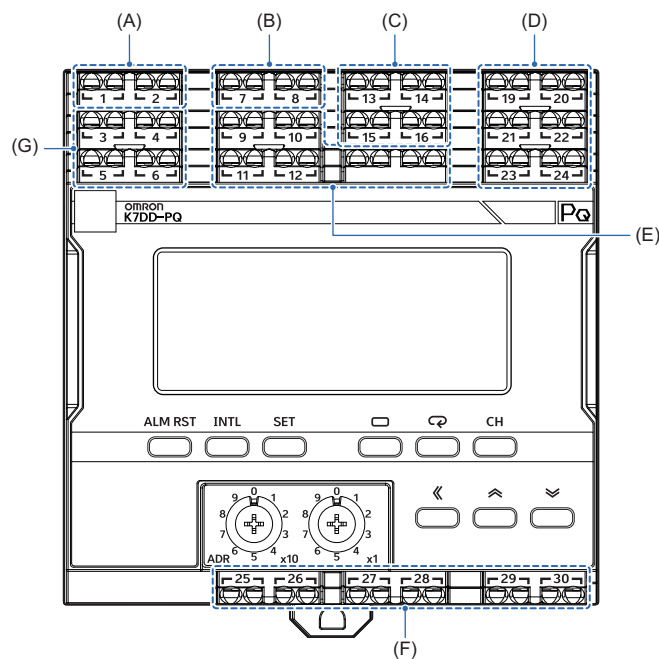

Symbol	Terminal Numbers	Name	Function
(A)	1 and 2	Operation power supply	Connected with the operation power supply to the K7DD.
(B)	7 and 8	Trigger input 1	Used to input the trigger signals of measurement start and end. NPN transistor collector: Number 7 terminal NPN transistor emitter: Number 8 terminal
(C)	13	Voltage Input 1	3-phase 3-wire (3P3W2M) connection: Voltage input 1: Phase-R, voltage input 2: Phase-S, voltage input 3: Phase-T 3-phase 4-wire (3P4W) connection: Voltage input 1: Phase-R, voltage input 2: Phase-S, voltage input 3: Phase-T, voltage input 4: Phase-N
	14	Voltage Input 2	
	15	Voltage Input 3	
	16	Voltage Input 4	
(D)	19 and 20	Current input 1	Single phase current connection: Current input 1: Phase-R 3-phase 3-wire (3P3W2M) connection: Current input 1: Phase-R, Current input 2: Phase-T 3-phase 4-wire (3P4W) connection: Current input 1: Phase-R, current input 2: Phase-S, current input 3: Phase-T Special CT installation orientation K side: Number 19, Number 21, and Number 23 terminals L side: Number 20, Number 22, and Number 24 terminals
	21 and 22	Current input 2	
	23 and 24	Current input 3	
(E)	9 and 10	Not used.	These terminals should not be used. Do not wire anything.
	11 and 12		

Symbol	Terminal Numbers	Name	Function
(F)	25 and 26	Alarm output 1	Compares the measured feature value and the alarm threshold (critical) to produce an alarm output. (Normally close)
	27 and 28	Alarm output 2	Compares the measured feature value and the alarm threshold (warning) to produce an alarm output. (Normally close)
	29 and 30	Output at Error	Produces an output at error, in case of a self-diagnosis error. (Normally close)
(G)	3 and 4	RS-485 communications 1	The communications protocol is Modbus RTU. Number 3 Terminal: +, Number 4 Terminal: -
	5 and 6	RS-485 communications 2	The communications protocol is Modbus RTU. Number 5 Terminal: +, Number 6 Terminal: -



Install wiring according to  *Section 3 Installation and Wiring*.

1-5 Internal Block Diagram

The internal block diagram of the K7DD is shown below.

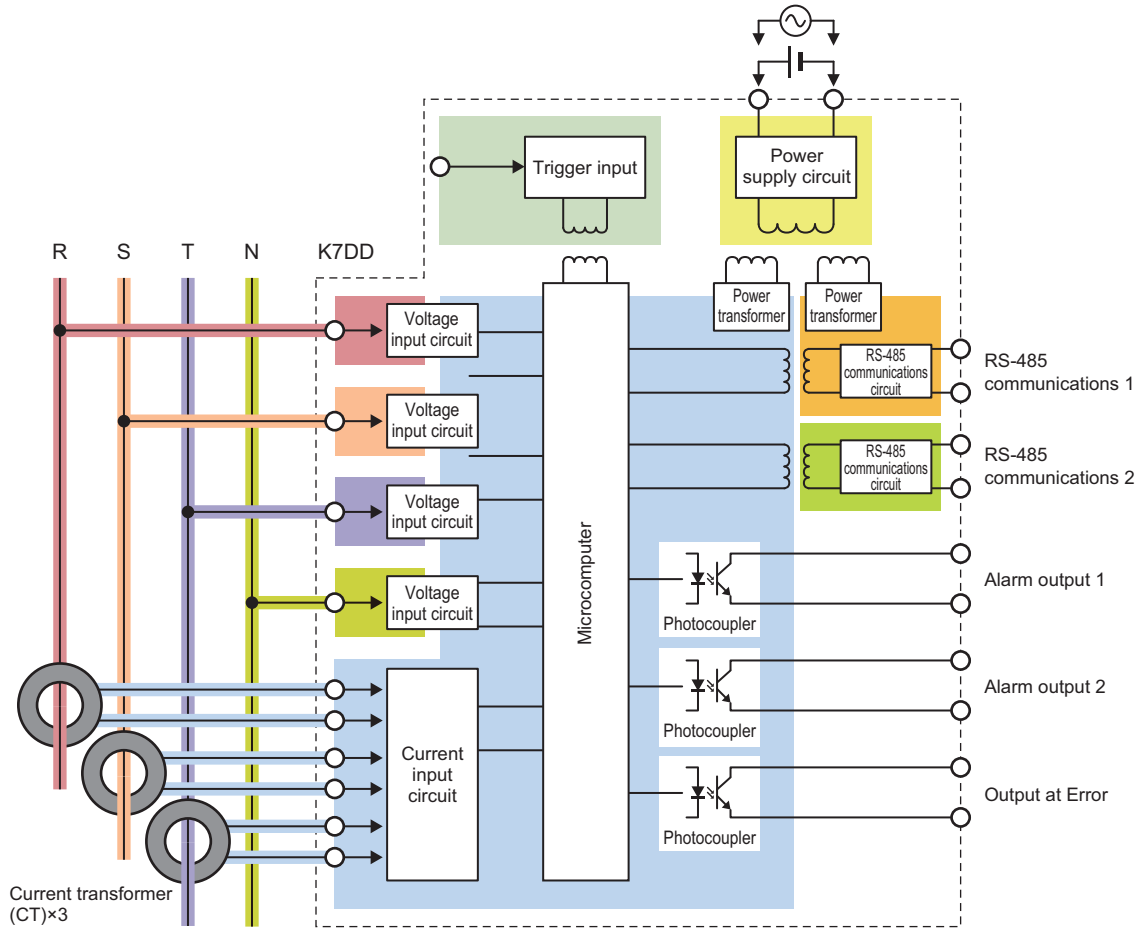

1-6 Example Configurations for Use

Example Configuration (1)

This is a typical configuration for using the K7DD.

The K7DD Support Tool is used for configuring the K7DD.

Use Push-In Plus terminals Number 3 (+) and Number 4 (-) for connection.

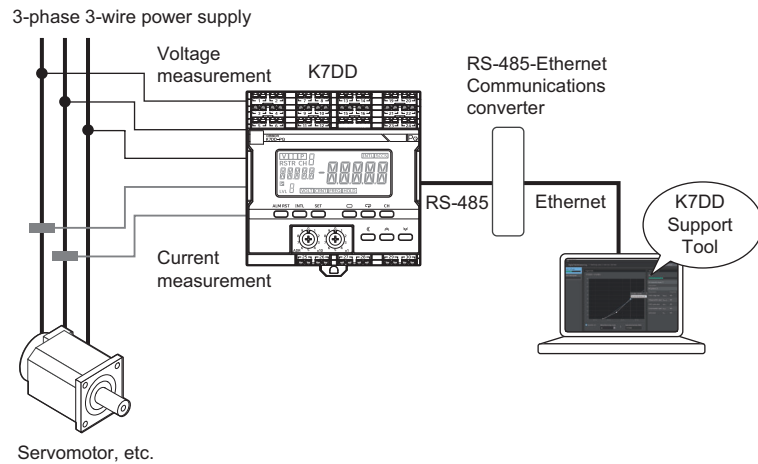

Precautions for Correct Use

The communications protocol for the K7DD is compatible with Modbus RTU. Since the K7DD Support Tool employs Modbus-TCP, the communications protocol must be converted. Use a communications converter for connection to the computer.

Example Configuration (2)

This is a configuration for using the K7DD with a minimum number of devices.

If the measured feature value exceeds the threshold, the warning lamp is lit with the transistor output signal.

The K7DD is configured only from the main unit without using the K7DD Support Tool.

For how to configure the setting on the K7DD unit, refer to [2-2 Configuration with the K7DD Unit Only](#) (P.2-4).

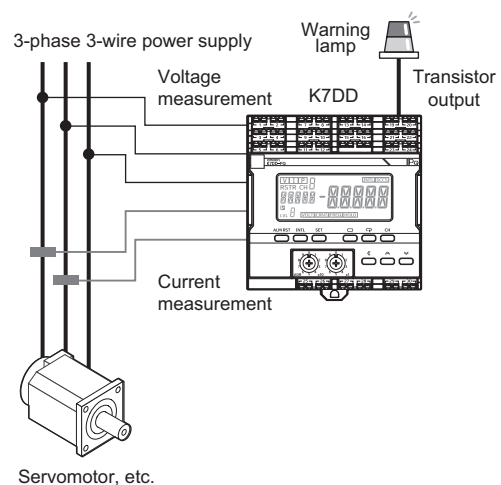

2

Procedures

This section describes the procedures from preparations to startup of the K7DD.

2-1 Overview of Operating Procedures	2-2
Accurate Monitoring with Trigger Settings	2-3
2-2 Configuration with the K7DD Unit Only	2-4
Flow of Configuration with the K7DD Unit Only	2-4
Common Settings	2-6
Configuration Procedure with the K7DD Unit Only	2-10
2-3 Configuration with K7DD Support Tool	2-14
Flow of Configuration with the K7DD Support Tool	2-14
2-3-1 Settings with Application Setting File	2-15
2-3-2 To capture sudden errors	2-15

2-1 Overview of Operating Procedures

To Monitor with the K7DD

The K7DD measures the feature values of the drive power of a device by selecting and setting the following two items, and detects signs of deterioration of the instrument by capturing changes in these feature values.

- Selecting feature values highly relevant to device errors
- Alarm threshold setting

How to Configure Features and Alarm Thresholds

There are two methods for configuring the K7DD: using only the K7DD unit, and using the Support Tool.

Setting method	Function	Example configuration
Configuration with the K7DD unit only*1	<p>Set feature values and thresholds using the "Simplified Threshold Setting Function" by key operation on the unit.</p> <p>[Use this method when...]</p> <ul style="list-style-type: none"> • You want to try condition monitoring with a simple configuration. • You want to detect deterioration errors that frequently appear. 	<p>3-phase 3-wire power supply</p> <p>Voltage measurement</p> <p>K7DD</p> <p>Current measurement</p> <p>Alarm output</p> <p>Error output</p> <p>Servomotor, etc.</p>
Configuration with K7DD unit and Support Tool	<p>The following three types of settings are available when using the Support Tool, depending on user circumstances.</p> <ol style="list-style-type: none"> 1) Configuration with assisting functions of the Support Tool This allows for accurate monitoring with trigger settings. 2) Configuration by loading the Application Setting File without reproducing errors □ 2-3-1 Settings with Application Setting File (P.2-15) 3) Configuration using the maximum feature value updated inside the K7DD □ 2-3-2 To capture sudden errors (P.2-15) 	<p>3-phase 3-wire power supply</p> <p>Voltage measurement</p> <p>K7DD</p> <p>Current measurement</p> <p>Alarm output</p> <p>Error output</p> <p>Servomotor, etc.</p> <p>RS-485-Ethernet Communications converter</p> <p>RS-485</p> <p>Ethernet</p> <p>K7DD Support Tool</p>

*1. The applicable scope of these methods is as follows:

- These methods detect changes that slowly appear in feature values, such as aging and deterioration. Sudden errors cannot be captured.
- If the difference between normal and abnormal data is small, automatic selection and setting will not work.

Accurate Monitoring with Trigger Settings

The K7DD Support Tool allows you to set triggers on the K7DD unit. With trigger settings, you can choose the timing to measure feature values when the rotation mechanism is operating stably, thus enabling more accurate monitoring.

● Trigger Settings for More Accurate Measurement

The K7DD monitors changes in the feature values of power to capture device deterioration.

For example, when measuring a device with a rotation mechanism as the monitoring target, its operation start and end times are not suitable for detecting the deterioration of the device because the voltage and current*1 significantly change at these times. To more accurately capture changes in feature values, it is necessary to capture the sections where the device is running with a stable current and voltage.

If triggers are set on the K7DD, feature values can be measured at such appropriate timing. The measured data will then be the subject of error judgment.

Note that applications that run continuously may not require a trigger setting. In such cases, set the trigger to continuous mode.

*1. The current and voltage are used for calculating feature values.

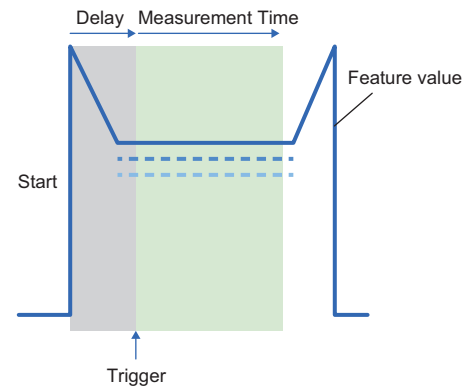

● Trigger Types

There are two types of triggers: the internal trigger and the external trigger. Select the trigger according to your applications.

Internal trigger: The feature value measured by the K7DD is used as the trigger input. This can be used for devices that repeat a certain movement.

It is unnecessary to wire to the trigger input terminal on the K7DD.

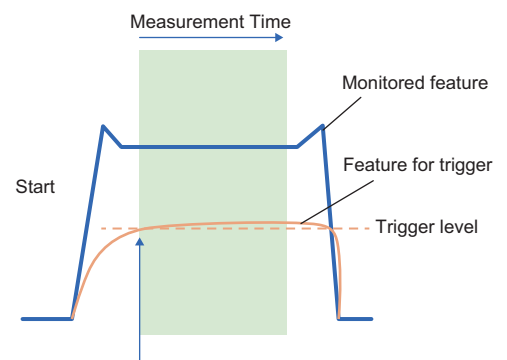

External trigger: ON signals are directly input to the K7DD upon starting of the rotation mechanism. In this way, the measurement timing is ensured.

It is necessary to wire to the trigger input terminal on the K7DD.

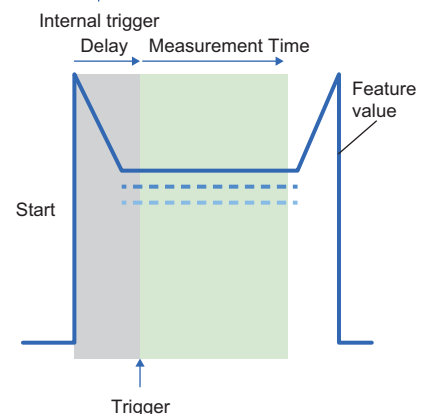

2-2 Configuration with the K7DD Unit Only

Flow of Configuration with the K7DD Unit Only

Steps (1) and (2) are common to [□□ 2-2 Configuration with the K7DD Unit Only](#) and [□□ 2-3 Configuration with K7DD Support Tool](#).

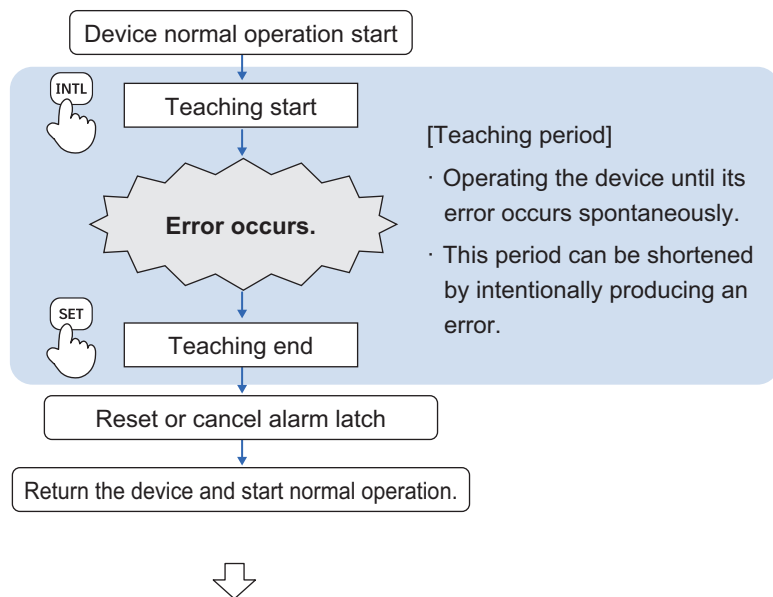
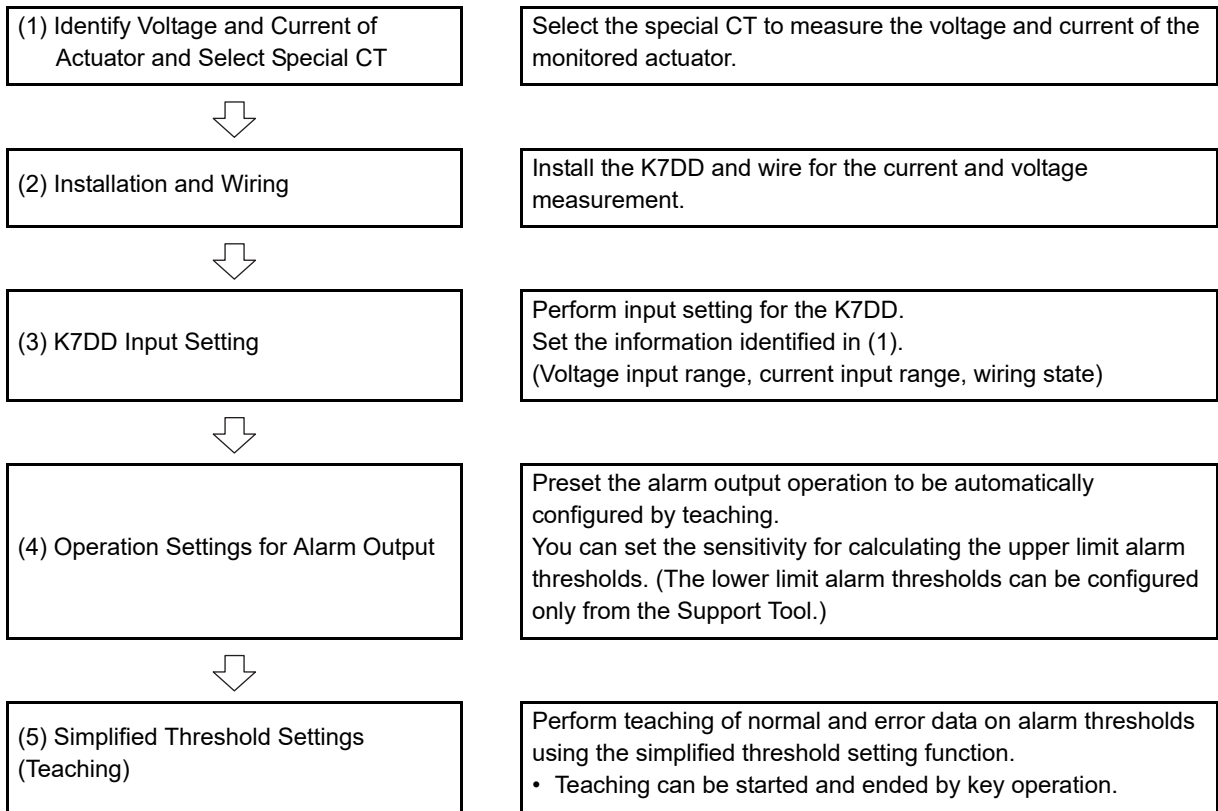



(6) Monitoring Operation

<p>(6-1) Check the Notification Status of the K7DD</p> <p>Check alarm output and alarm output indicator display for normal, warning, and critical statuses. Check the monitored device and perform maintenance as needed.</p> <p>If there was no need for maintenance, review the alarm thresholds by repeating the procedure from step (4).</p>
<p>Maintenance implementation</p>
<p>(6-2) Check the K7DD Operation after Maintenance</p> <p>Confirm that the K7DD status is normal after maintenance.</p> <p>If the feature value does not drop to normal, there is a possibility that there is another abnormal factor.</p>

Common Settings

This section describes common settings for configurations using the K7DD unit only and using K7DD Support Tool.

(1) Identify Voltage and Current of Actuator and Select Special CT

Check the electrical wiring of the actuator to be monitored.

Check it beforehand since the information is necessary for the parameter settings on the K7DD. The K7DD can monitor the following three types of electrical wiring states.

- 3P3W2M: 3-Phase, 3-Wire, 2-Watt Meter Method
- 3P4W: 3-phase 4-wire
- Single phase current

Refer to [□□ 3-5 Wiring to the Power Lines \(P.3-13\)](#) for details.



Precautions for Correct Use

Be aware that the K7DD cannot measure the following wiring states:

- 1P2W: Single-phase, 2-wire type
- 3P3W3M: 3-phase, 3-wire 3-watt meter method

Note that the Unit does not support applications where wiring is switched during the course of operation.

Check the ratings (voltage and current) of the actuator to be monitored.

Since the following items are necessary in the K7DD parameter settings, check them in advance.

- Current Input Range
- Voltage Input Range

Prepare a special CT suitable for the power line to monitor.

1. Check the rated voltage and current of the monitored actuator on its nameplate, etc.

2. Select the smallest special CT of which the rated current is within the range.

Refer to [□□ A-1-2 Special CTs \(P.A-6\)](#) for the types of special CTs.

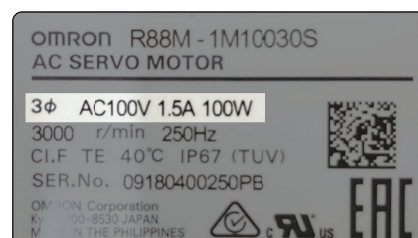

(2) Installation and Wiring

Mount the K7DD to the DIN Track.

1. Pull down the DIN Track mounting hook on the bottom. (The hook is located only on the bottom.)
 2. Raise the DIN Track mounting hook that was pulled down and fix the Unit to the DIN Track.
 3. Install End Plates* on the right and left sides. * Sold separately
- Refer to □ 3-2 *Installation* (P.3-4) for details on how to mount the Unit to the DIN Track.

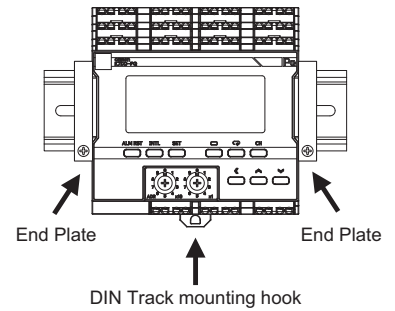

Install wiring between the power line to monitor and the K7DD.

The following diagram shows the wiring of each connection method.

Wiring Example of 3P3W2M Connection (3-phase, 3-wire, 2-watt Meter Method)

1. Install wiring between the monitored 3-phase power line and the K7DD by referring to the figure.
2. Connect the communications cables of the communications converter to the terminal numbers ③ (+) and ④ (-) of the RS-485 (a).

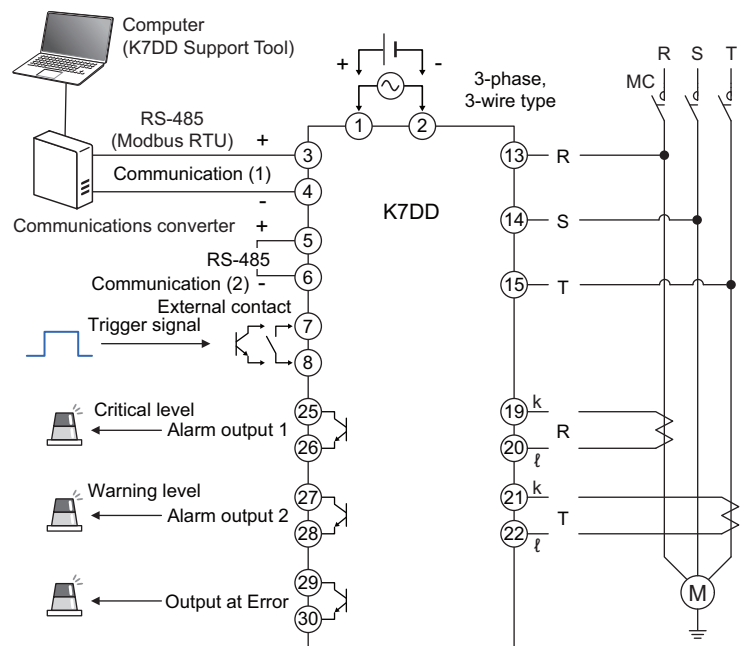

The CT input terminals have polarities (k and l). Refer to □ 3-4 *I/O Wiring* (P.3-8) for details. The active power in case of incorrect wiring is as follows.



CT wiring state	Change from normal state	Example) Active power [kW]
Normal	---	100
Two phases (k, l) are opposite.	Negative value of normal value	-100
Incorrect connection phase (Phase-T on terminals ⑱ and ⑳, Phase-R on ㉑㉒ terminal)	Near 0 [kW]	0
Incorrect connection phase (Phase-S on terminals ⑱ and ⑳)	Near 0 [kW]	0
Incorrect connection phase (Phase-S on ㉑㉒ terminal)	Near 0 [kW]	0

Wiring Example of 3P4W Connection

1. Install wiring between the monitored 3-phase power line and the K7DD by referring to the figure.
2. Connect the communications cables of the communications converter to the terminal numbers ③ (+) and ④ (-) of the RS-485 (a).

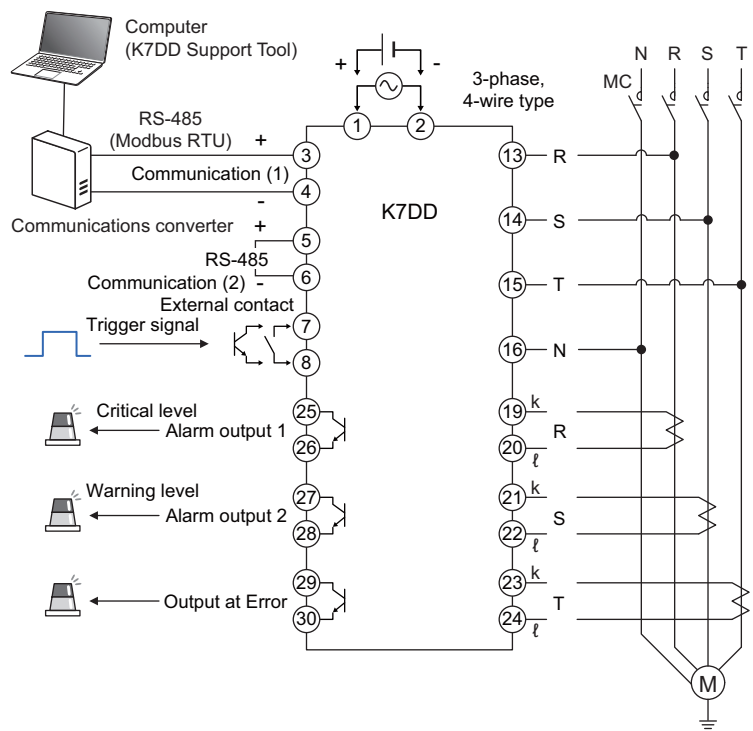

The CT input terminals have polarities (k and ℓ). Refer to [□ 3-4 I/O Wiring \(P.3-8\)](#) for details.
The active power in case of incorrect wiring is as follows.



CT wiring state	Change from normal state	Example) Active power value [kW]
Normal	---	100
One phase (k, ℓ) is opposite.	The value becomes 1/3.	33
Two phases (k, ℓ) are opposite.	The negative value of 1/3 value	-33
Three phases (k, ℓ) are opposite.	Negative value of normal value	-100
Incorrect connection phase (Phase-S on terminals ⑱ and ⑳, Phase-R on ㉑⑒ terminal)	Near 0 [kW]	0

Wiring Example of Single-phase Current Connection

1. Install wiring between the monitored power line and the K7DD by referring to the figure.
2. Connect the communications cables of the communications converter to the terminal numbers (3) (+) and (4) (-) of the RS-485 (a).

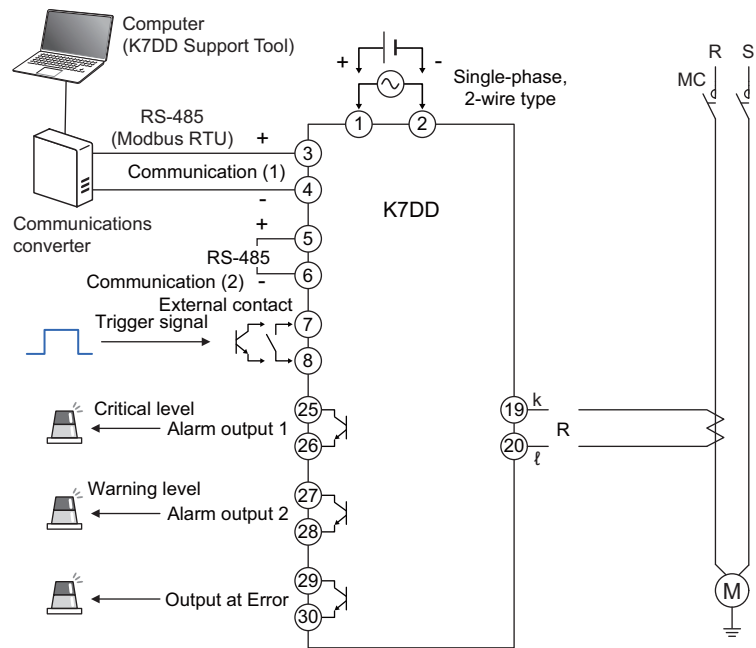

The CT input terminals have polarities (k and l). Refer to [3-4 I/O Wiring \(P.3-8\)](#) for details.

Configuration Procedure with the K7DD Unit Only

(3) K7DD Input Setting

Set the parameters related to Input Setting of K7DD (Initial Setting Level).

Configuration with Key Operations

Make input settings on the Initial Setting Level.

1. When you press the Level Key (⊖) for 3 seconds or more on the Operation Level, you are moved to the Initial Setting Level.

Refer to [6-6 Initial Setting Level \(LVL ⊖\)](#) (P.6-20) for details on how to change the setting parameters.

Setting parameter	11-seg	Setting range	Setting value
Wiring state	<i>WRNG</i>	Set the connection state of the monitoring target. $\bar{0}$: 3P3W2M $\bar{1}$: 3P4W $\bar{2}$: Single-phase current	$\bar{0}$
Current Input Range	$\bar{L} - \bar{L}n$	Set the current input range according to the CT to use. 5 A, 25 A, 100 A, 200 A, 400 A	$5R$
Voltage Input Range	$\bar{V} - \bar{V}n$	Set the voltage input range according to the rated voltage of the device. 150 V, 300 V, 600 V	$150V$
Feature Calculation Cycle	<i>FCRP</i>	Sets the period to be recorded as normal data during teaching. Up to 100 seconds can be set in 50 ms increments. Setting range: 1 to 2000 (Unit: 50 ms/sec) Refer to <i>FCRP Feature Calculation Cycle</i> (P.6-22) in "6-6 Initial Setting Level (LVL ⊖)" .	1

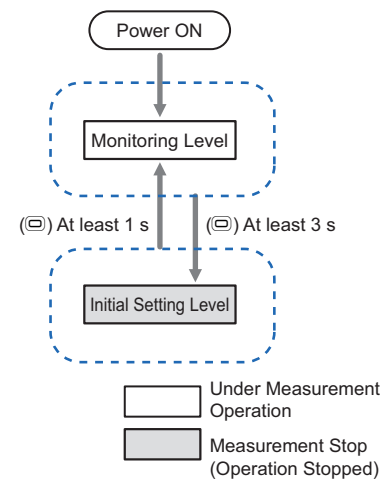

2. When you press the Level Key (⊖) for 1 second or more on the Initial Setting Level, you are moved to the Monitoring Level after software reset.

(4) Operation Settings for Alarm Output

Set the alarm output operation.

The following two setting parameters are related to the alarm output operation.

- Alarm Threshold Calculation Sensitivity
- Alarm Type

Note, however, that the alarm type (Upper limit alarm/Lower limit alarm) can be set on the Support Tool only. (Default value: Upper limit alarm)

•Alarm Threshold Calculation Sensitivity

This value is used for calculating the threshold value at the completion of teaching.

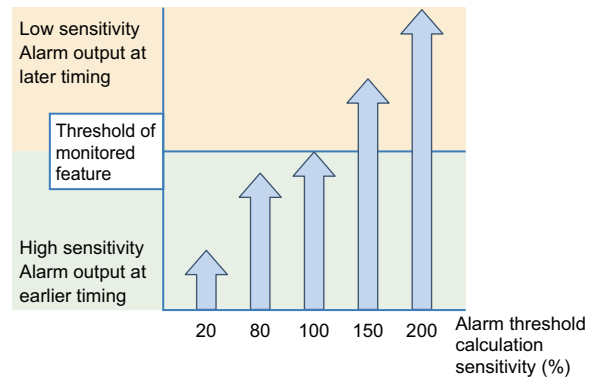

The alarm threshold calculation sensitivity adjusts the alarm judgment when the monitored feature exceeds the critical/warning thresholds. Adjust sensitivity in the range from 20 to 200% (default value: 80%). The default value is set to generate an alarm output at a slightly earlier timing for error data.



Configuration with Key Operations

Configure the alarm threshold calculation sensitivity on the Initial Setting Level.

1. When you press the Level Key (⊖) for 3 seconds or more on the Operation Level, you are moved to the Initial Setting Level.

Refer to  6-6 Initial Setting Level (LVL ) (P.6-20) for details on how to change the setting parameters.

Setting parameter	11-seg	Setting range	Setting value
Alarm Threshold Calculation Sensitivity	AE \bar{O} F	Set the alarm threshold calculation sensitivity for the measured power. This value is used for calculating the threshold value at the completion of teaching. The smaller the value, the faster the alarm is output, and the larger the value, the later the alarm is output. 20% to 200%	80%

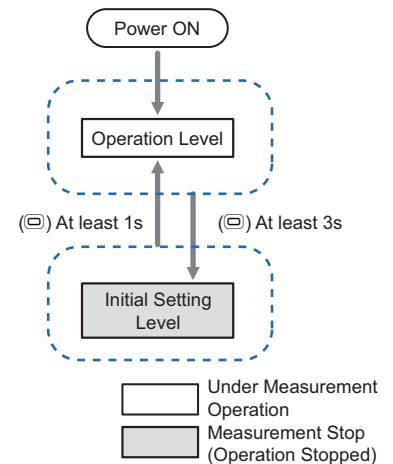

(5) Simplified Threshold Settings (Teaching)

Perform teaching with the simplified threshold setting function to configure the feature threshold settings.

● What is Simplified Threshold Setting?

This function selects feature values, and automatically calculates and sets critical/warning thresholds based on the normal data and abnormal data to be monitored. Obtaining normal and abnormal data here refers to teaching.

Condition monitoring of the device becomes available after the teaching is completed. For devices that cannot simulate an error, you need to continue teaching until the relevant error actually occurs. Since a long period of time is required for such errors to occur, do not forget to complete the teaching before starting maintenance.

Refer to [□ 4-3 Simplified Threshold Settings \(P.4-4\)](#) for details on the simplified threshold settings.

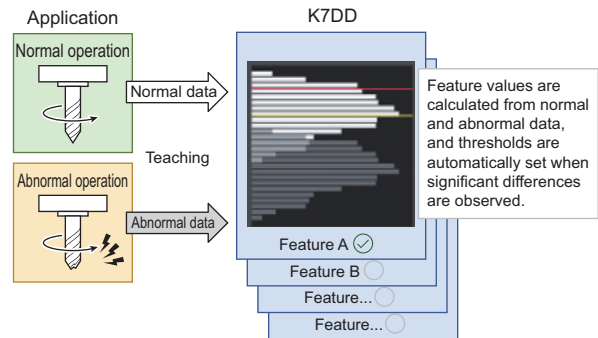

Configuration with Key Operations

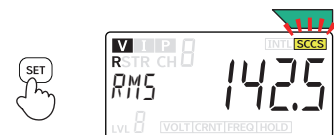
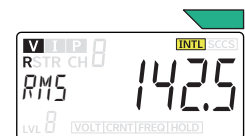
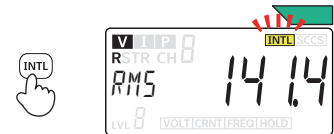

1. Start the normal operation of the application.
 - Before starting teaching, normal operation of the application for a period longer than the feature value calculation cycle is required.
2. Start teaching. Press the [INTL key (Normal Data Acquisition key)] for 3 seconds while the Monitoring Level is being displayed.
 - Data during normal operation is acquired as normal data. If successful, the [INTL] lights up. If it does not light, data acquisition has failed.
3. After [INTL] lights up, acquisition of abnormal data starts continuously.
 - Simulate the error on the device to be monitored.
 - If the error cannot be simulated, operate the device in normal operation until the error occurs.
4. Press the [SET key (Abnormal Data Acquisition key)] for 3 seconds after the abnormal data has been acquired. The teaching is then completed.
 - If the abnormal data is acquired correctly, [INTL] turns off and [SCCS] lights up. From among several types of features, the K7DD selects the one with significant change as the monitored feature based on the obtained normal and abnormal data, and sets its maximum value as the threshold.



- Upon completion of teaching, the critical and warning thresholds are calculated to the same value. If the device is still operational when the alarm is issued in actual operation, increase the critical threshold accordingly. On the other hand, if you want to issue an alarm at an earlier timing, decrease the warning threshold. In either case, it is advisable to make adjustments so that the alarm can be notified at two different timings.

(6-1) Check the Notification Status of the K7DD

Check the Notification Status of the K7DD.

	Normal	Warning	Critical
Status			
Alarm output indicator	Green	Yellow	Red
Transistor output	None	Alarm output 2: Number 27 to 28 terminals	Alarm output 1: Number 25 to 26 terminals

When a warning or critical alarm is observed, check the monitored device and perform maintenance as needed.

If there was no need for maintenance, review the alarm thresholds by repeating the procedure from step (4).

(6-2) Check the K7DD Operation after Maintenance

Confirm that the K7DD status is normal after maintenance.

Once the warning or critical status has been checked and the device maintenance has been completed, confirm that the K7DD operates normally.

If the device does not return to the normal state, the device condition after maintenance may be different from its normal condition at the time of the teaching.

In such cases, take the following actions:

- [Action 1] Redo the teaching.
- [Action 2] Adjust the warning/critical thresholds.
- [Action 3] Review maintenance as another error may have occurred.

2-3 Configuration with K7DD Support Tool

Flow of Configuration with the K7DD Support Tool

Steps (1) and (2) are common to [□□ 2-2 Configuration with the K7DD Unit Only](#) and [□□ 2-3 Configuration with K7DD Support Tool](#). Refer to *Common Settings* (P.2-6) in the previous section. Install K7DD Support Tool onto the computer before proceeding with configuration. Download the software from the OMRON website.

https://www.ia.omron.com/k7dd_tool

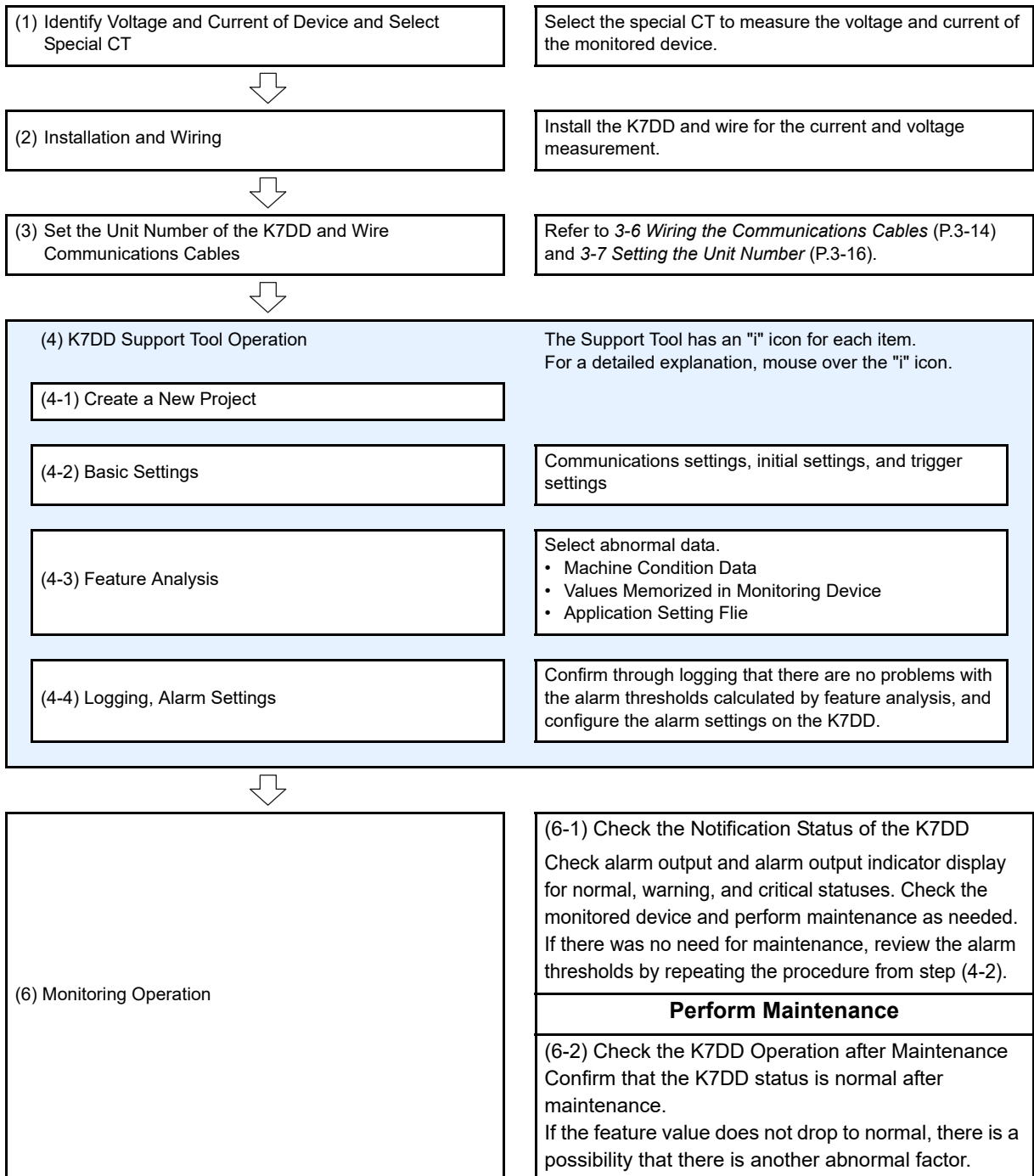

2-3-1 Settings with Application Setting File

The Application Setting File contains feature values effective for each application that have been verified by OMRON.



The Application Setting File can be downloaded from the following website:
https://www.ia.omron.com/k7dd_tool

When selecting abnormal data in step (4-3) Feature Analysis in the previous section, select "Application Configuration File" and proceed with the settings.

2-3-2 To capture sudden errors

The K7DD can detect not only feature value anomalies due to equipment deterioration, but also sudden errors in the processing machine, such as blade breakage.

The Unit stores internally the maximum or minimum value of the feature values measured in the past. You can set alarm thresholds using this data.

When selecting abnormal data in step (4-3) Feature Analysis in the previous section, select "Value Recorded in Monitored Device" and proceed with the settings.

3

Installation and Wiring

This section describes the installation and wiring of the K7DD and special CTs. Be sure to read and understand *Precautions for Safe Use (P.-7)* before installing and wiring.

3-1	Dimensions	3-2
3-2	Installation	3-4
3-3	How to Connect to the Push-In Plus Terminal Blocks	3-5
3-4	I/O Wiring	3-8
3-5	Wiring to the Power Lines	3-13
3-6	Wiring the Communications Cables	3-14
3-7	Setting the Unit Number	3-16

3-1 Dimensions

K7DD

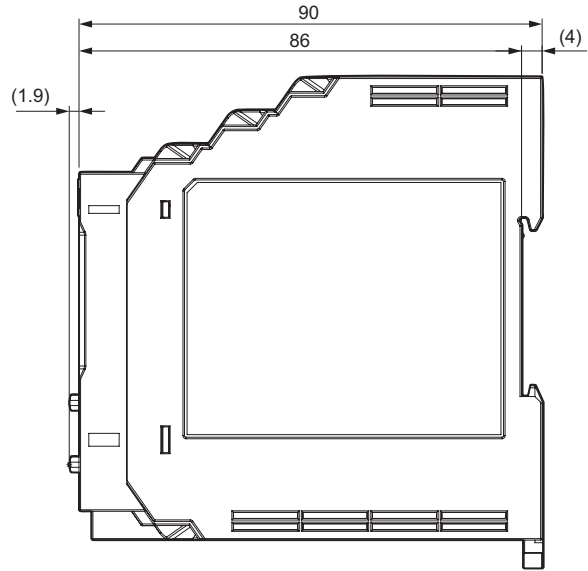
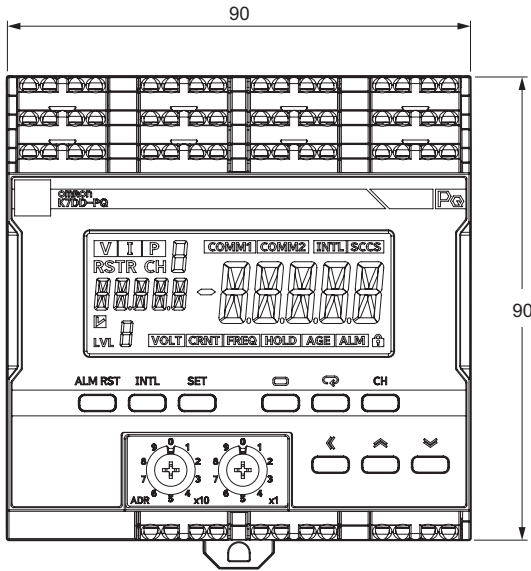

(Unit: mm)

Special CT (Current Transformer)

K6CM-CICB005-C
K6CM-CICB005

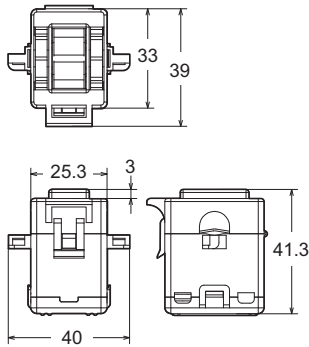

CT through-hole
inside diameters

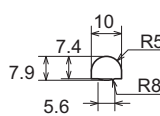

K6CM-CICB025-C
K6CM-CICB025

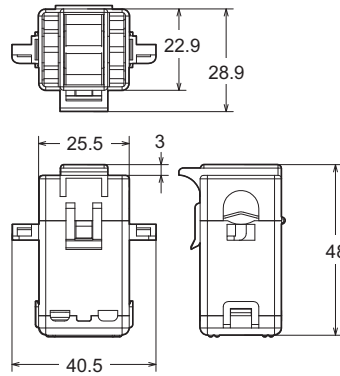

CT through-hole
inside diameters

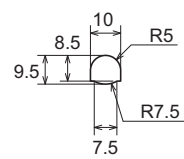

(Unit: mm)

K6CM-CICB100-C
K6CM-CICB100

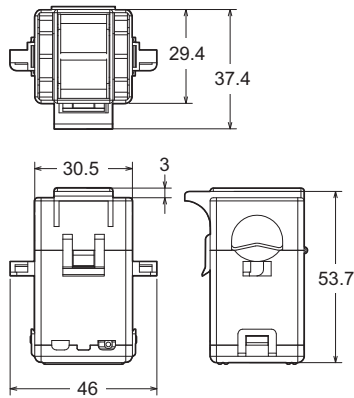

K6CM-CICB200-C
K6CM-CICB200

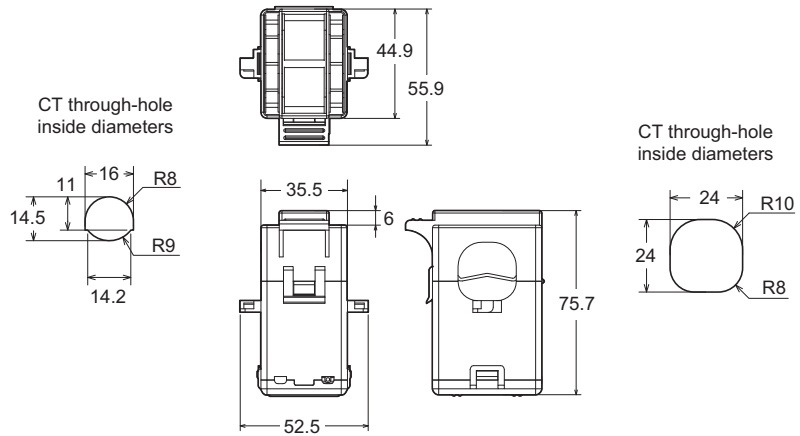

K6CM-CICB400-C
K6CM-CICB400

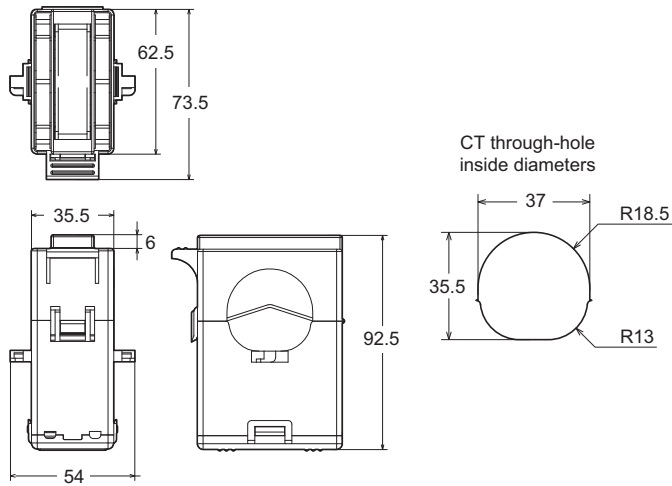

(Unit: mm)

CT-supplied cable

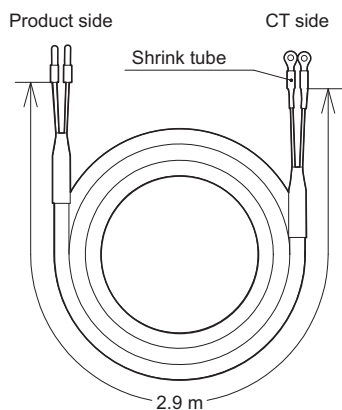

Note: The CT-supplied cable is attached to the CT.



- The "-C" at the end of the special CTs refer to the models compliant with UL certification. Models without "-C" can be used if UL certification is not required. The ratings and specifications are common to all of them.
- To comply with UL certification for the special CT, refer to *Conformance to Safety Standards (P-9)*.

3-2 Installation

Mounting to DIN Track

- Pull down the DIN Track mounting hook on the bottom of the K7DD.
- Next, hook the upper hook onto the DIN Track and push in the Unit.
- Finally, raise the DIN Track mounting hook that was pulled down and fix the Unit to the DIN Track.

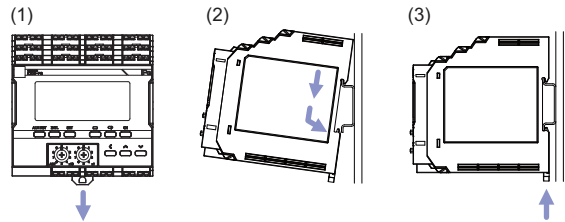

● Installation Orientation

Install and use the K7DD with upright installation direction.

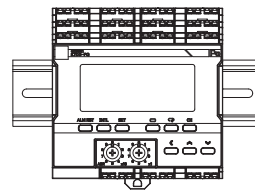

Installation of End Plates

- Install End Plates on the right and left sides of the K7DD.
Install an End Plate at each end of the K7DD.

To install an End Plate, 1) hook the bottom on the bottom of the track, 2) hook the top of the Plate on the top of the track, and then tighten the screw to lock the Plate in place.

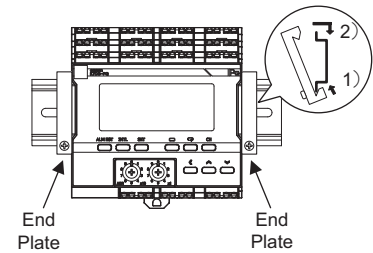

● Recommended DIN Track

Model	Specifications	Manufacturer
PFP-100N	1,000 mm long × 35 mm wide × 7.3 mm high	OMRON
PFP-50N	500 mm long × 35 mm wide × 7.3 mm high	OMRON

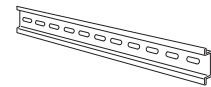

● Recommended End Plates

Model	Specifications	Manufacturer
PFP-M	For PFP-100N/PFP-50N	OMRON

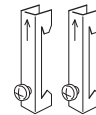

Removing from the DIN Track

- Pull out the DIN Track mounting hook with a flat-blade screwdriver and lift the Unit from the bottom to remove it.
- The K7DD can be easily installed and removed if the distance to other devices is 30 mm or above.

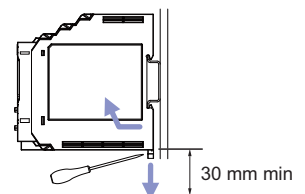

3-3 How to Connect to the Push-In Plus Terminal Blocks

Part Names

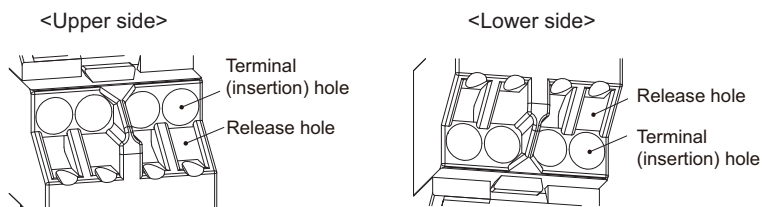

Name	Function
Terminal (insertion) hole	Used to insert wires with ferrules, solid wires, and stranded wires.
Release hole	Releases the wire when the provided flat-blade screwdriver is inserted. Also used when you insert stranded wires.

Connecting Wires with Ferrules and Solid Wires

Insert the ferrule or solid wire straight into the terminal block until the end touches the terminal block.

If you use a ferrule with a conductor length of 10 mm, a part of the conductor may be visible after the ferrule is inserted into the terminal block. Even in that case, the insulation distance required for the product is still satisfied.

If it is difficult to insert fine solid wires, insert the wire with a screwdriver inserted into the release hole, and then remove the screwdriver while ensuring that the fine solid wire is still held.

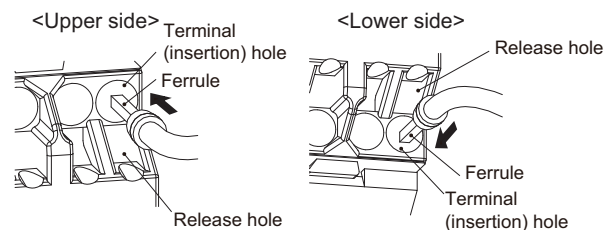

Connecting Stranded Wires

- Hold a flat-blade screwdriver at an angle and insert it into the release hole. The angle should be between 10° and 15° inclusive.

If the flat-blade screwdriver is inserted correctly, you can feel the spring in the release hole.



The terminal block may be damaged if you insert the screwdriver with excessive force. Operate the screwdriver with a force of 15 N or less.

- Insert the wire straight into the terminal block until the end touches the terminal block.
- Remove the flat-blade screwdriver from the release hole.

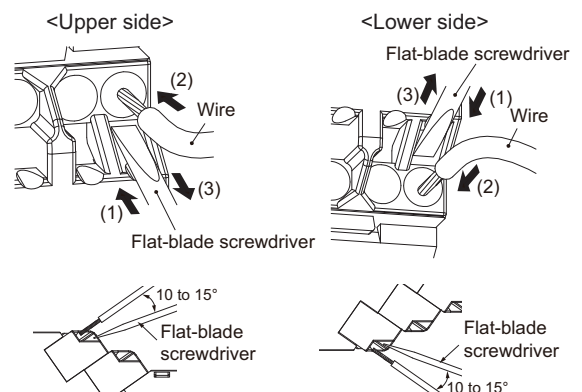

Checking Connections

After the insertion, pull gently on the wire to make sure that it does not come off and that the wire is securely fastened to the terminal block.

When you use a stranded wire, make sure that the stranded wire does not bend or touch the adjacent terminal.

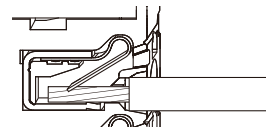

Removing Wires from the Push-In Plus Terminal Blocks

Use the following procedure to remove wires from the terminal block.

The same method is used to remove stranded wires, solid wires, and ferrules.

- Hold a flat-blade screwdriver at an angle and insert it into the release hole. The angle should be between 10° and 15° inclusive. If the flat-blade screwdriver is inserted correctly, you can feel the spring in the release hole.

- Remove the wire.
- Remove the flat-blade screwdriver from the release hole.

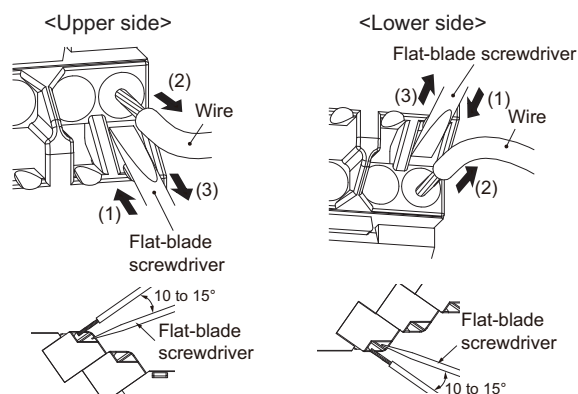

Push-In Plus Terminal Blocks Specifications

● Specifications

Item	Specifications
Construction	Push-in compatible with 1-pole 2-terminal crossover wiring Front-in and front-release Hands-free
Applicable wires	Ferrules, solid wires, and stranded wires
Applicable wire size	0.25 mm ² to 1.5 mm ² (AWG 24 to AWG 16)
Wire insertion force	8 N max. for AWG 20 wire
Screwdriver insertion force	15 N max.
Wire stripping length	8 mm [*] , 10 mm, or 12 mm [*] Without ferrules
Ferrule length	8 mm or 10 mm
Current capacity	10 A (per pole)
Number of insertions	50 times

● Recommended ferrules

Applicable wire		Ferrule, Conductor length (mm)	Stripping length (mm) (ferrules used)	Recommended ferrules		
(mm ²)	AWG			Manufactured by Phoenix Contact	Manufactured by Weidmuller	Manufactured by Wago
0.25	24	8	10	AI 0,25-8	H0.25/12	FE-0.25-8N-YE
		10	12	AI 0,25-10	-	-
0.34	22	8	10	AI 0,34-8	H0.34/12	FE-0.34-8N-TQ
		10	12	AI 0,34-10	-	-
0.5	20	8	10	AI 0,5-8	H0.5/14	FE-0.5-8N-WH
		10	12	AI 0,5-10	H0.5/16	FE-0.5-10N-WH
0.75	18	8	10	AI 0,75-8	H0.75/14	FE-0.75-8N-GY
		10	12	AI 0,75-10	H0.75/16	FE-0.75-10N-GY
1/1.25	18/17	8	10	AI 1-8	H1.0/14	FE-1.0-8N-RD
		10	12	AI 1-10	H1.0/16	FE-1.0-10N-RD
1.25/1.5	17/16	8	10	AI 1,5-8	H1.5/14	FE-1.5-8N-BK
		10	12	AI 1,5-10	H1.5/16	FE-1.5-10N-BK
Recommended crimp tool				CRIMPFOX6 CRIMPFOX6T-F CRIMPFOX10S	PZ6 roto	Variocrimp4

- Note 1. Make sure that the outer diameter of the wire coating is smaller than the inner diameter of the insulation sleeve of the recommended ferrule.
 2. Make sure that the ferrule processing dimensions conform to the figure on the right.

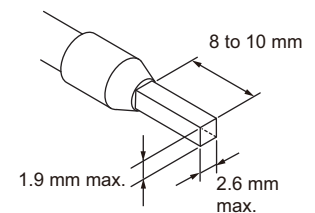

● Recommended Flat-blade Screwdrivers

Model	Manufacturer
ESD 0,40×2,5	Wera
SZS 0,4×2,5 SZF 0-0,4×2,5*	Phoenix Contact
0.4×2.5×75 302	Wiha
AEF.2,5×75	Facom
210-719	Wago
SDI 0.4×2.5×75	Weidmuller

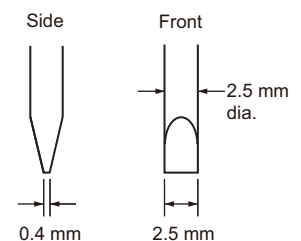

- * You can purchase the SZF 0-0,4×2,5 flat-blade screwdriver made by PHOENIX CONTACT with OMRON model XW4Z-00B.

3-4 I/O Wiring

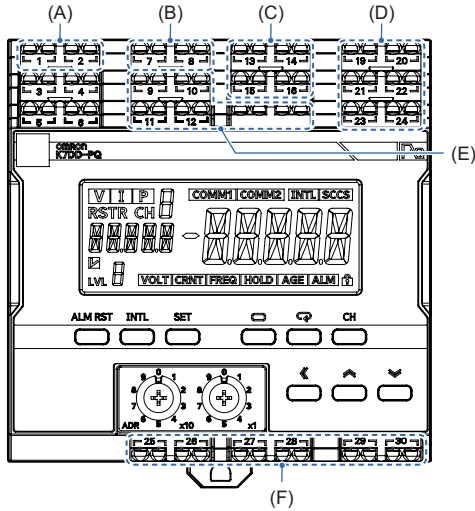

Symbol	Name
(A)	(1), (2): Operation power supply
(B)	(7), (8): Trigger Input 1
(C)	(13): Voltage input 1 (14): Voltage input 2 (15): Voltage input 3 (16): Voltage input 4
(D)	(19), (20): CT (Current) Input 1 (21), (22): CT (Current) Input 2 (23), (24): CT (Current) Input 3
(E)	(9), (10), (11), (12): Unused
(F)	(25), (26): Alarm output 1 (27), (28): Alarm output 2 (29), (30): Output at Error

Operation Power Supply Terminals

The operation power supply terminals are the number 1 and 2 terminals. There are polarities in the 24 V DC specifications.

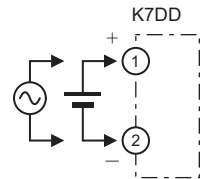

Trigger Input Terminals

The trigger input terminals are the number 7 and 8 terminals.

Connect the collector to the number 7 terminal and the emitter to the number 8 terminal.

Logging start/stop is executed by external trigger signals.

The specifications of the trigger input terminals are as follows:

Item	Specifications
Input type	NPN open-collector
Residual voltage at short circuit	1.5 V max.
Open leakage current	0.1 mA max.
ON current at short circuit	Approx. 7 mA

Make sure that the specifications of the residual voltage at short circuit and open leakage current are satisfied.

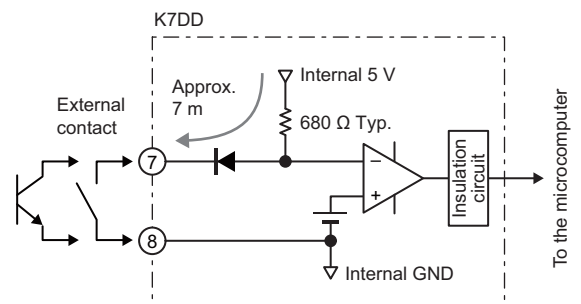

Voltage Input Terminals

The voltage input terminals are the number 13, 14, 15, and 16 terminals. Which terminal is to be connected depends on the type of power line.

● 3-phase 3-wire

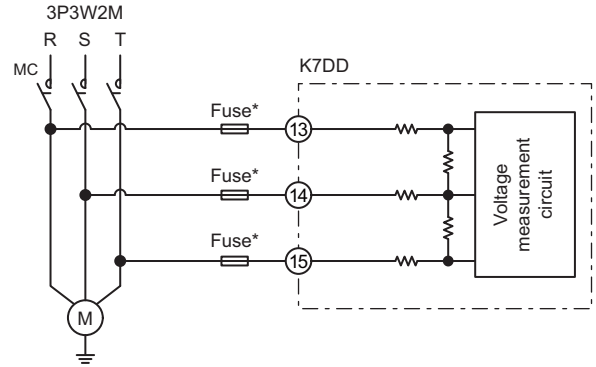

The R, S, T, and N power lines should be correctly wired to their corresponding terminals. Otherwise, correct data cannot be measured.

● 3-phase 4-wire

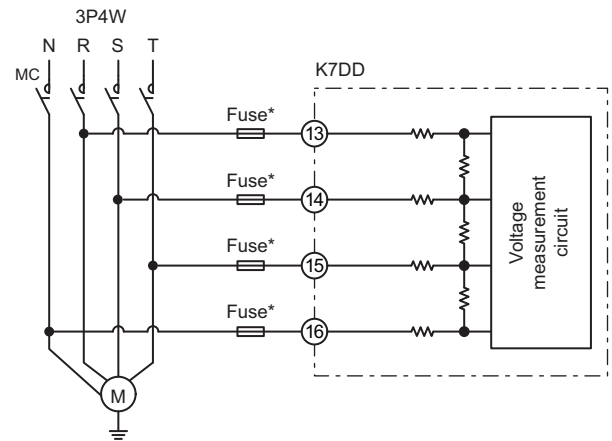

CT Input Terminals

There are three channels of CT input terminals.

- CT input 1: Number 19 and 20 terminals (CH1)
- CT input 2: Number 21 and 22 terminals (CH2)
- CT input 3: Number 23 and 24 terminals (CH3)

Which terminal is to be connected depends on the type of power line.

The following CT polarities are available.

- Number 19 terminal: K
- Number 20 terminal: L
- Number 21 terminal: K
- Number 22 terminal: L
- Number 23 terminal: K
- Number 24 terminal: L

•3-phase 3-wire

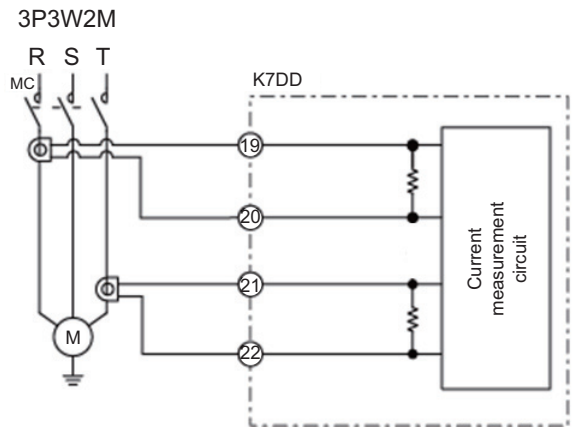

•3-phase 4-wire

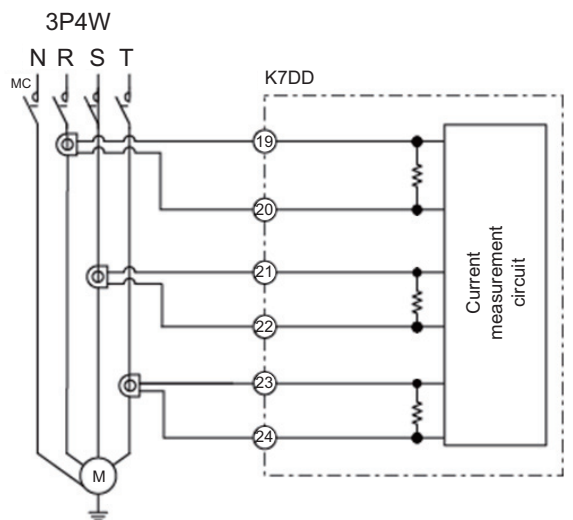

•Single-phase current

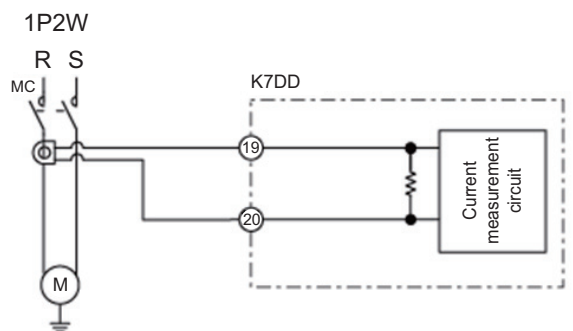

● **Installation of the special CTs**

- All the special CTs connected to one unit of K7DD must have the same ratings.
- Make sure that the special CT settings on the K7DD match the ratings of the special CTs to be used.
- Check the directions of the power supply side (K) and load side (L) before making the connections. The measurement will not be correct if the direction is wrong.
- Release the split/fastening hook and clamp the special CT on the line for each phase and then press the hook firmly until you hear it lock into place.
- Do not ground the special CT. Doing so may result in malfunction.

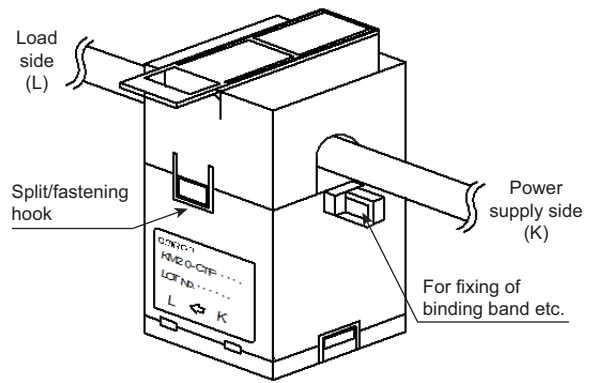

Transistor Output Terminals

There are three transistor output terminals.

- Alarm output 1: Number 25 and 26 terminals
Output an alarm when the feature value has exceeded the alarm threshold (critical) set for the feature value.
- Alarm output 2: Number 27 and 28 terminals
Output an alarm when the feature value has exceeded the alarm threshold (warning) set for the feature value.
- Output at Error: Number 29 and 30 terminals
Output an alarm when a self-diagnosis error has occurred in the K7DD.

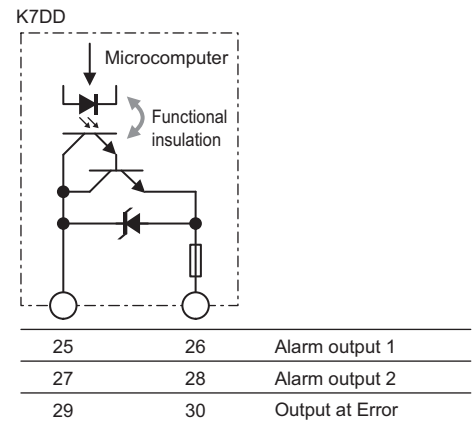

3-5 Wiring to the Power Lines

This section describes the wiring of the power lines that enable the K7DD to measure.

For Single-Phase AC

- **Single-Phase Current**

Connect a single special CT, and connect it to the number 19 and 20 terminals of the K7DD. Make sure to connect the cables according to the directions of polarity terminals k and l on the CT.

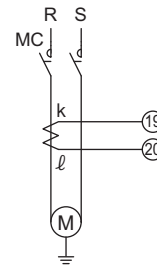

For 3-Phase AC

- **3-Phase, 3-Wire, 2-Watt Meter Method (3P3W2M)**

Connect 3 wires of voltage input and 2 special CTs.

Connect the voltage inputs together closer to the power source than to the special CTs. Make sure to connect the cables according to the directions of polarity terminals k and l on the CT.

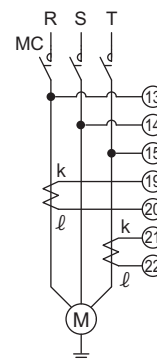

- **3-Phase, 4-Wire (3P4W)**

Connect 4 wires of voltage input and 3 special CTs.

Connect the voltage inputs together closer to the power source than to the special CTs. Make sure to connect the cables according to the directions of polarity terminals k and l on the CT.

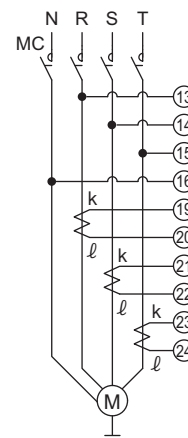

3-6 Wiring the Communications Cables

When you use the communications function, wire communications cables.

The K7DD has two lines of communications ports: RS-485 communications 1 terminals and communications 2 terminals. Use the communications 1 terminals in priority.

Connect the devices such as the PC on which the K7DD Support Tool is installed and the host system (PLC, etc.).

The communications protocol is Modbus RTU.

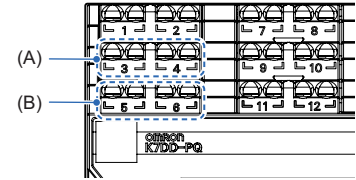

Symbol	Name
(A)	(3), (4): RS-485 communications 1 terminals
(B)	(5), (6): RS-485 communications 2 terminals

● Example of Connection to K7DD Support Tool

The communications cables are used to make initial settings of the K7DD with the K7DD Support Tool. Use the number 3 and 4 (communications 1 terminals) of the Push-In Plus terminal block.

Connect the plus (+) cable to the number 3 terminal and the minus (-) cable to the number 4 terminal on the K7DD.

Crossover wiring is available as this is a Push-In Plus terminal block.

The connection configuration of Master:Slave is 1:1 or 1:N. For the 1:N connection, you can connect up to 32 Units including the host system (master).

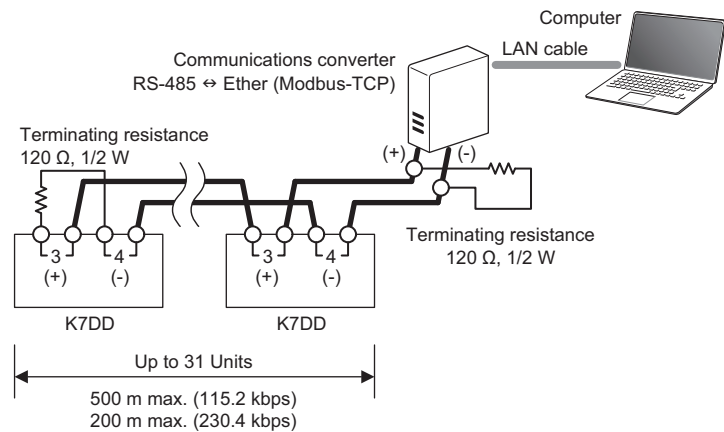

The total cable strength depends on the baud rate.

For a baud rate up to 115.2 kbps, the total should be 500 m max. For a baud rate of 230.4 kbps, it should be 200 m max.

Install a terminating resistance of 120 Ω, 1/2 W at both ends of the transmission path. Use shielded twisted-pair cables (AWG 24 to AWG 16).

● Initial Setting of Communications Converter

The setting should be in accordance with the Modbus RTU communications setting of the K7DD. Set the communications-related parameters, following the instruction manual of the communications converter.

In this procedure, set the communications parameters shown at right:

Setting parameter	Setting
Baud Rate	115.2kbps
Data Length	8bit
Stop Bits	1bit
Parity	Even



The data length and stop bits of the communications protocol Modbus RTU for the K7DD are fixed internally.

- Data Length: Always 8 bits
- Stop Bits: Always 1 bit (with Even or Odd parity)
Always 2 bits (with None parity)



Make sure that both the K7DD and the communications converter have the same RS-485 (Modbus RTU) communications settings (baud rate, data length, stop bits, and parity).



Some communications converter models may require a driver to be installed. Install the driver properly, following the instruction manual of the communications converter.



Use a commercially available product for the communications converter. OMRON performed an evaluation test on the MGateMB3170 manufactured by MOXA.



The number of simultaneous connections of K7DDs using the Support Tool depends on the performance of the computer.
OMRON have verified the operation of the system with five simultaneous connections.

3-7 Setting the Unit Number

When you use the communications function, set a unit number for the K7DD.

You can set a number from 01 to 99. A power ON reset process (level key operation on the Initial Setting Level or Communications Setting Level, or cycling of the power supply) is required. Make sure that the power is OFF when you set the unit number.

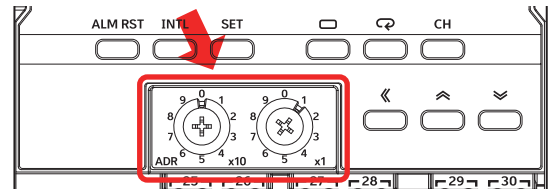

One host system (master) and up to thirty one K7DD units (slaves) can be connected on the same communications line. The unit number is used to distinguish between slaves. The unit number is common to both the communications 1 terminals and communications 2 terminals.



Use 01 to 99 as the unit number. The slave address "00" is broadcast in the Modbus RTU protocol.



The power ON reset is a reset process inside the K7DD. It is executed by doing as follows:

- Cycling the power supply
- Executing the Software Reset Command via communications
- Moving to the Monitoring Level with key operations (by pressing the Level Key for 1 second or more in the operation stopped state)

The master executes a command by specifying the unit number in the communications command. Therefore, the slaves connected on the same communications line must not have duplicate unit numbers.

If the unit number is duplicated, there will be a clash between the responses from multiple slaves, which will result in a communications error.

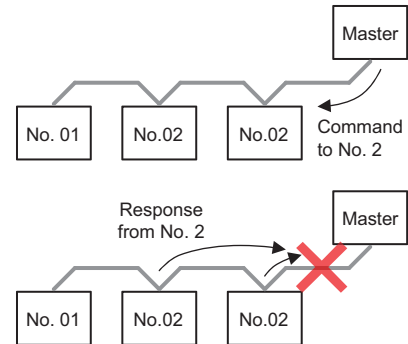

Set the following addresses for communications settings with the K7DD Support Tool.

- IP address: IP address of the communications converter
- Slave address: Unit number of the K7DD



The default values of the communications settings on the K7DD (Modbus RTU) are as follows. These values are used for explanation.

- Baud Rate: 115.2 kbps
- Data Length: Always 8 bits
- Stop Bits: 1 bit
- Parity: Even

The communication settings with the K7DD Support Tool should be in accordance with those of Ethernet on the computer (Modbus TCP).

- Computer (master): Static IP address
- K7DD (slave): Unit number

4

K7DD Function

The functions of the K7DD are separately described in Chapter 4 K7DD Function, and Chapter 5 Support Tool Function.

This chapter describes the main functions of the K7DD, such as measurement function, simplified threshold setting function, alarm function, and error-related functions.

4-1	K7DD Functions	4-2
4-2	Feature Measurement	4-3
4-3	Simplified Threshold Settings	4-4
4-3-1	Overview	4-4
4-3-2	Conditions to Use	4-5
4-3-3	Description of Operation	4-6
4-4	Alarm	4-9
4-4-1	Types of Alarm Notification Methods	4-9
4-4-2	Releasing the Alarm Latch	4-10
4-4-3	Alarm Types	4-10
4-5	Measurement Error	4-11
4-5-1	Types of Notification of Measurement Errors	4-11
4-6	Self-diagnosis Error	4-13

4-1 K7DD Functions

The main functions of the K7DD are given in the following table.

Function name	Description	Reference
Feature Measurement	Nine types of feature values are measured. The K7DD unit can monitor 9 types of feature values. In the Support Tool, all 142 types of feature values can be monitored.	-4-2
Simplified Threshold Setting	This function selects feature values, and automatically calculates and sets critical/warning thresholds based on the normal data and abnormal data to be monitored.	-4-3
Alarm Function	This function detects and notifies when a feature value falls into the alarm range determined by critical/warning thresholds.	-4-4
Measurement Error	This function notifies you that the measured voltage, current, or frequency has exceeded the display range. <ul style="list-style-type: none"> • R.M.S. Voltage Out-of-Range Error [VOLT] • R.M.S. Current Out-of-Range Error [CRNT] • Frequency Out-of-Range Error [FREQ] 	-4-5
Self-diagnosis Error	This function notifies you when the K7DD is unable to perform its intended functions.	-4-6

4-2 Feature Measurement

In order to determine how much the target device has deteriorated, the K7DD calculates 142 types of feature values based on the current and voltage, and records them as measurement values. The K7DD unit can monitor 9 types of feature values. The Support Tool can monitor the measurement results of all feature values. Refer to Chapter 5 for details on all feature values.

The feature values that can be monitored on the K7DD unit are as follows:

ID	Feature value	Description	Unit	Monitorable wiring state	
				3P3W2M 3P4W	Single phase current
0	R.M.S. voltage	The R.M.S. value is the AC value that actually does the work, representing "the value of AC voltage that produces the same power as that of DC".	[V]	✓	×
4	Voltage fundamental amplitude	The fundamental used in the K7DD indicates the power frequency (ID141). It is an amplitude of the voltage component of the fundamental.	[V]	✓	×
5	Voltage total harmonic distortion	This value represents the ratio of the magnitude of all harmonic components to the magnitude of the voltage fundamental, expressed as a percentage. It is a measure of how much the total harmonic component distorts the fundamental waveform.	[%]	✓	×
6	R.M.S. current	The R.M.S. value is the AC value that actually does the work, representing "the value of AC current that produces the same power as that of DC".	[A]	✓	✓
10	Current fundamental amplitude	The fundamental used in the K7DD indicates the power frequency (ID141). It is an amplitude of the current component of the fundamental.	[A]	✓	✓
136	Current total harmonic distortion	This value represents the ratio of the magnitude of all harmonic components to the magnitude of the current fundamental, expressed as a percentage. It is a measure of how much the total harmonic component distorts the fundamental waveform.	[%]	✓	✓
137	Active power	Refers to the power that is actually consumed as power.	[kW]	✓	×
140	Power factor	Represents the ratio of active power to apparent power. The power factor (PF) is calculated as an R.M.S. value that includes harmonic components. The larger the harmonic current component, the lower the power factor.	[-]	✓	×
141	Power frequency	This is a numerical expression of how many times an AC wave is repeated per second.	[Hz]	✓	✓

For the feature monitoring range, refer to the table in [□ 6-3-1 Feature Value Range for Monitoring](#).

4-3 Simplified Threshold Settings

4-3-1 Overview

In order to detect a deterioration error that always appears, the simplified threshold setting function automatically selects feature values and sets thresholds based on the data from the teaching performed until an error actually occurs.

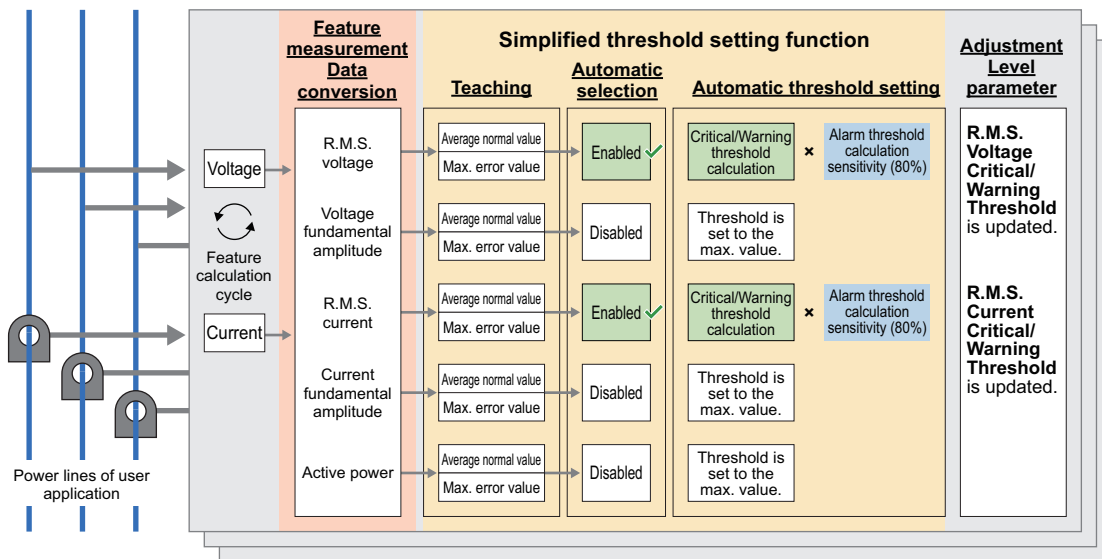

● Parameters Related to the Simplified Threshold Setting Function

Feature Calculation Cycle...This is a parameter that must be set to an appropriate value depending on the device operation.

Alarm Threshold Calculation Sensitivity...This parameter is used to calculate the threshold.

4-3-2 Conditions to Use

The conditions to use are as follows:

- The user can operate the K7DD while the device is in operation.
- Normal average value can be obtained under the condition that the product is considered to be normal, such as immediately after maintenance/inspection or when it is brand new.
- The device is specified to operate standalone in its operating conditions.
- The device operates in a constant cycle.
- The appropriate feature calculation cycle has been set according to the device operation. The following shows examples.

Example 1) A device that does not stop the motor before or after a cycle

Device example: End milling with processing machine

Set the time per cycle t including start/end as the feature calculation cycle.

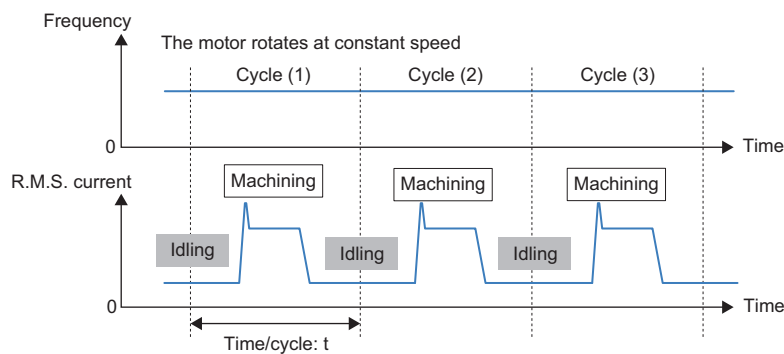

Example 2) A device that stops the motor before or after a cycle

Device example: Deep hole drilling with processing machine

Set $1/3$ to $1/2$ of the operation time per cycle t as the feature calculation cycle.

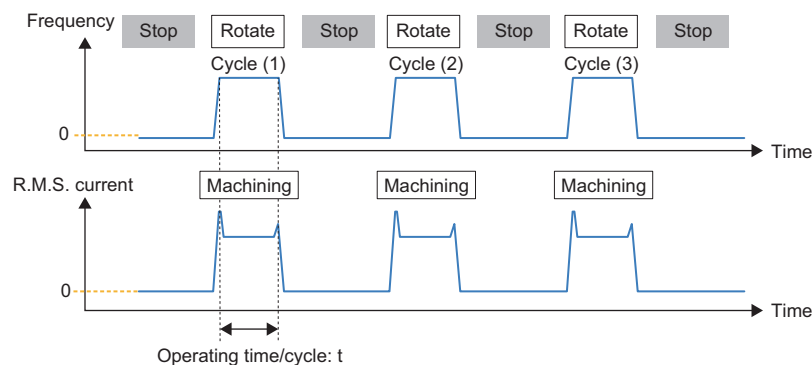

Unsuitable Error Modes and Applications

The following lists the error modes and applications for which the simplified threshold setting function is not suitable.

- Instantaneous errors
Errors that appear in a shorter time than the feature calculation cycle may prevent proper detection of feature values.
- Applications where errors cause a drop in voltage, current, or power
If the load on the device or the motor torque drops, detection of feature values may not be possible.

- Motors of full-voltage starting
A high frequency of inrush currents can push up the average feature value and thereby obscure errors. In an environment with voltage fluctuations of 10% or more in voltage measurement regardless of device operation, such fluctuations may be falsely judged as a voltage change due to device malfunction. Similarly, if there are voltage fluctuations of 10% or more during teaching, such fluctuations may be judged as valid features that can capture an error.
- Applications that produce regenerative power
When measuring regenerative power, the active power increases in the negative direction. When using the simplified threshold setting, the alarm judgment is not possible since the status is judged as occurrence of an upper limit alarm.
- Devices with a short motor rotation time in one cycle
The inrush currents account for a larger portion of the measured data, thus making it difficult to detect an error. Monitoring with a tool using the trigger function is recommended for devices with an operating time (t) of 10 seconds or less per cycle.

4-3-3 Description of Operation

The operation of the simplified threshold setting is explained in the figure below. This assumes that the K7DD input settings have been completed. Refer to [□ 2-2 Configuration with the K7DD Unit Only \(P.2-4\)](#) for input setting procedures.

● Operating Conditions

Wiring state: 3P3W2M or 3P4W

Trigger mode: Continuous mode (default value)

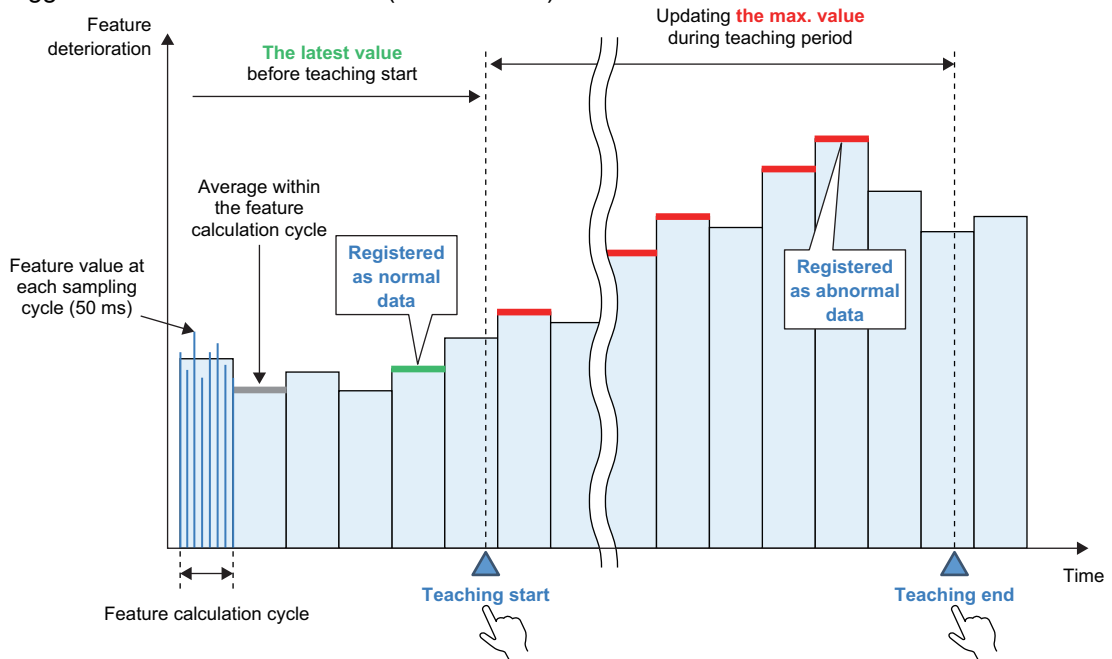

- The normal data to be registered changes depending on the feature calculation cycle and the timing of teaching start.



Case 1: When the 3 second period after key pressing falls within a feature calculation cycle

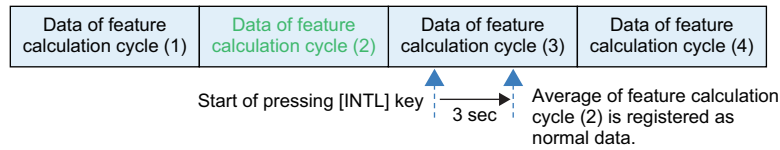

Case 2: The 3 second period after key pressing falls across two feature calculation cycles.

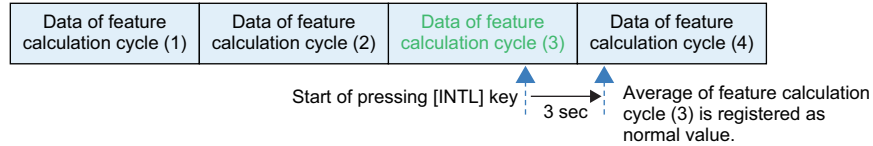

● Description

(1) Normal operation of the application

Before starting teaching, normal operation of the application for a period longer than the feature value calculation cycle is required. Inside K7DD, the average value data for the feature calculation cycle is always calculated. Therefore, if there is a power failure during this period, start teaching after the time for the feature calculation cycle has elapsed.



(2) Teaching start

Pressing the [INTL] key for 3 seconds after the end of normal operation starts teaching for the simplified threshold setting. The [INTL] lights up as a sign of starting. At this time, the average value calculated in the feature calculation cycle is registered as normal data. *1 At the same time, the update of the maximum value for each feature starts. The information is stored inside the K7DD.



*1. If a measurement error has occurred, [INTL] does not light and normal data registration has failed. In such cases, start teaching again.

(3) Teaching period

Continue normal operation during the teaching period until an application error occurs. During this time, the K7DD has been updating the maximum value for each feature.



(4) Teaching end

Press the [SET] key for 3 seconds after the error occurs. The maximum value of each feature that has been updated is fixed, the features required for monitoring are automatically selected, and critical/warning thresholds are automatically set. However, if the difference between normal and abnormal data is small*1, automatic selection and setting will not work.

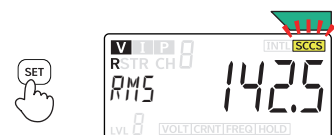

*1. The maximum value is smaller than 1.1 times the normal data.

● Feature Values to Be Selected

The feature values to be selected for monitoring by the simplified threshold setting function are the following 5 types among the 9 types displayed at the Monitoring Level.

- R.M.S. Voltage
- Voltage Fundamental Amplitude
- R.M.S. Current
- Current Fundamental Amplitude
- Active Power

Among them, the feature values selected to be necessary for monitoring by the teaching function are called "monitored features". The threshold of the feature not selected is set to the maximum value*1. In addition, the thresholds of features other than these 5 types are also set to the maximum value.

*1. The maximum value for each feature is "32761". The decimal point position changes depending on the setting range.

● Critical/Warning Threshold Calculation and Alarm Threshold Calculation Sensitivity

The thresholds for the monitored and selected feature values are calculated and set according to the alarm threshold calculation sensitivity.

The default value for the alarm threshold calculation sensitivity is 80%. The value is set to 80% so that the alarm output is issued at a slightly earlier timing, compared to the condition where the maximum abnormal value has been taught.

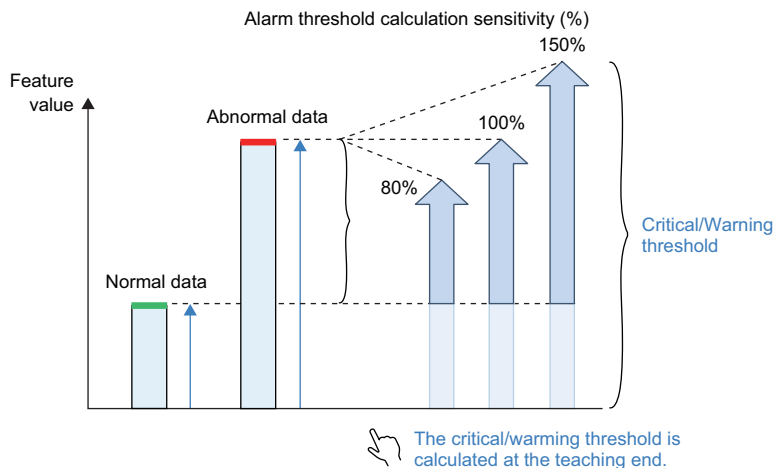

● Adjustment of Critical/Warning Thresholds

Upon completion of teaching, the critical and warning thresholds are calculated to the same value. If the device is still operational when the alarm is issued in actual operation, increase the critical threshold accordingly. On the other hand, if you want to issue an alarm at an earlier timing, decrease the warning threshold. In either case, it is advisable to make adjustments so that the alarm can be notified at two different timings.

4-4 Alarm

The alarm function of the K7DD detects and notifies you when a monitored feature falls into the alarm range determined by the critical/warning thresholds.

The parameters related to the alarm function are as follows:

Parameter	Description
Alarm type	This is the parameter that can be set in the Support Tool. There are two parameter types: Upper limit alarm and lower limit alarm.

This section describes details of the alarm types after describing the specifications common to all alarm functions: notification methods and latch cancel actions when an alarm occurs.

4-4-1 Types of Alarm Notification Methods

There are three types of alarm notification methods. Occurrence of an alarm at critical level or warning level triggers notification actions.

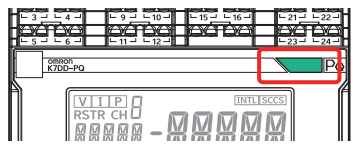
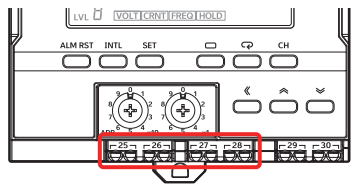
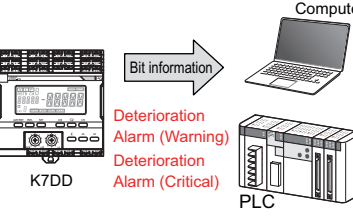
Notification method	Description	Interface
(1) Alarm output indicator	Green: Normal, Yellow: Warning, Red: Critical If the status is different across multiple channels, the display color is decided in the priority order: red (critical) > yellow (warning) > green (normal).	
(2) Alarm output	When an alarm occurs, the transistor output is turned OFF. Critical level: Number 25 to 26 terminals (Alarm Output 1) Warning level: Number 27 to 28 terminals (Alarm Output 2)	
(3) Alarm status (communications)	When an alarm occurs, the target Bit of the monitoring status turns ON. Refer to 7-7-5 Details about Status Information (P.7-25) for details on the monitoring status.	

4-4-2 Releasing the Alarm Latch

Once the result of the alarm judgment is turned ON, the status will be latched (continued) until released. The following three methods are available for releasing the alarm latch.

Method to release the latch	Description
Releasing with key operation	Refer to 6-8 Operation Command with Key Operation (P.6-25) for details.
Operation command via communications, Alarm Latch Cancel	Refer to 7-5 Operation Command (P.7-7) for details.
Cycling the power supply (including a power ON reset)	It is released by cycling the power supply of the K7DD or by a power ON reset executed when you move to the other level with key operation. Refer to Procedure for Moving from Level to Level (P.6-3) in 6-1 Levels for details.

4-4-3 Alarm Types

The K7DD allows you to set two alarm types. The settings are available from the Support Tool or via communications.

Type	Description of operation
Upper limit alarm (default)	The alarm judgment result is turned ON/OFF under the following conditions. <ul style="list-style-type: none"> • Turns OFF if the feature value is less than the critical/warning threshold. • Turns ON if the feature value is equal to or greater than the critical/warning threshold.
Lower limit alarm	The alarm judgment result is turned ON/OFF under the following conditions. <ul style="list-style-type: none"> • Turns OFF if the feature value is greater than the critical/warning threshold. • Turns ON if the feature value is equal to or less than the critical/warning threshold.

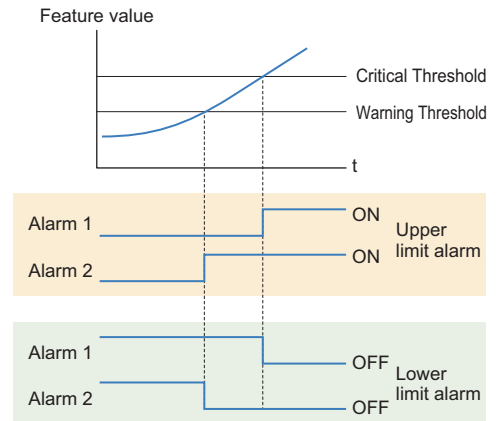



4-5 Measurement Error

The measurement error is a function to notify you that the service condition needs adjusting and improving to monitor the power condition. The details of measurement errors are given in the following table.

Measurement error type	Description
Voltage Value Out-of-Range Error	Notifies you that the voltage value has exceeded the display range. The voltage value out-of-range error occurs when the voltage value exceeds the display range. This error is reset when the voltage value goes into the range. It requires no setting or operation. If a voltage value out-of-range error occurs, the alarm will not be judged as an alarm.
Current Value Out-of-Range Error	Notifies you that the current value has exceeded the display range. The current value out-of-range error occurs when the current value exceeds the display range. This error is reset when the current value goes into the range. It requires no setting or operation. If a current value out-of-range error occurs, the alarm will not be judged as an alarm.
Frequency Out-of-Range Error	Notifies you that the frequency has exceeded the display range. The frequency out-of-range error occurs when the frequency exceeds the display range. This error is reset when the frequency goes into the range. It requires no setting or operation. If a frequency out-of-range error occurs, the alarm will not be judged as an alarm.

4-5-1 Types of Notification of Measurement Errors

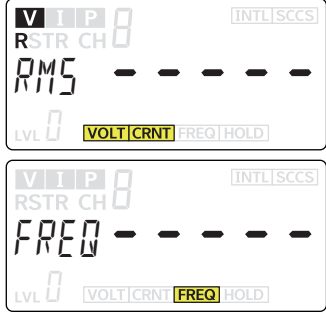
There are three types of measurement error notification methods as follows:

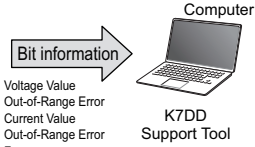
Notification method	Description	Interface
(1) Single light display	The single light of the display is lit. Voltage Value Out-of-Range Error: VOLT Current Value Out-of-Range Error: CRNT Frequency Out-of-Range Error: FREQ	
(2) Main display	<ul style="list-style-type: none"> Voltage Value Out-of-Range Error or Current Value Out-of-Range Error Displays "-----". Frequency Out-of-Range Error Displays "-----". 	
(3) Measurement status (communications)	When a measurement occurs, the target Bit of the measurement status turns ON. Refer to 7-7 Variable Area Map (P.7-17) for details on the measurement status.	 

● Occurrence Conditions and Reset Conditions for Measurement Errors

This section shows the types of measurement errors and the error occurrence/reset conditions.

Error type	Error occurrence condition	Error reset condition
Voltage Value Out-of-Range Error	The voltage value went out of the range.	The voltage value went into the range.
Current Value Out-of-Range Error	The current value went out of the range.	The current value went into the range.
Frequency Out-of-Range Error	The frequency went out of the range.	The frequency went into the range.

If the measured values frequently go out of range, review the following items:

- Voltage Input Range
- Current Input Range
- Ratings of special CTs

4-6 Self-diagnosis Error

The self-diagnosis error is an abnormal state in which the K7DD cannot perform the functions that it was primarily meant to perform. An error has occurred in the internal memory operation. If the self-diagnosis error has occurred in the K7DD, it will behave in one of the following two patterns.

Pattern 1

- The alarm output indicator is lit in red.
- All the displays in the front section are not lit.
- Both the alarm output and the output at error are OFF (contact open).

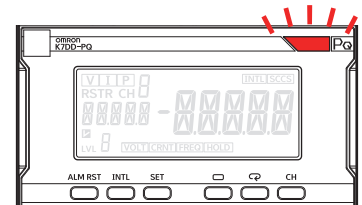

Pattern 2

- The alarm output indicator is lit in red.
- The display shows *ERR/1000*.
- Both the alarm output and the output at error are OFF (contact open).

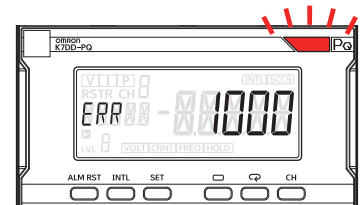

Corrective action

- Cycle the power supply. If operation returns to normal, then noise may have caused the problem. Check for noise.
- If the Unit does not recover, contact your OMRON representative.

5

Support Tool Function

The functions of the K7DD are separately described in Chapter 4 K7DD Function, and Chapter 5 Support Tool Function.

This section describes the support tools for the K7DD, including all feature measurement functions, feature selection support/alarm threshold setting support functions, state diagnosis, and arrival prediction function.

5

5-1	Support Tool Functions	5-2
5-2	All Feature Measurement and Trigger Measurement Simulation	5-3
5-2-1	All Feature Measurement	5-3
5-2-2	Trigger Measurement Simulation	5-5
5-3	Abnormal Data Registration	5-6
5-4	Feature Selection Support/Alarm Threshold Setting Support	5-7
5-5	Digital Maintenance Log/ Arrival Prediction	5-8

5-1 Support Tool Functions

The functions of the K7DD Support Tool are given in the following table.

Function name	Description	Ref.
All feature measurement and trigger measurement simulation	The K7DD can monitor 9 types of feature values on its display. In the Support Tool, all 142 types of feature values can be monitored. In addition, you can set the measurement timing while observing the waveform in trigger simulations.	-5-1
Abnormal data registration	The Support Tool allows you to select abnormal data to register from among the following: <ul style="list-style-type: none"> • Device status data [Error]...Data measured by actually allowing an error to occur • Application configuration file...Abnormal data validated by OMRON beforehand • Measurement value stored in the K7DD...Data of the maximum and minimum values of each feature recorded in the K7DD monitoring operation 	-5-2
Feature selection support/Alarm threshold setting support	This function automatically selects feature values effective for monitoring based on both normal and abnormal data, and also calculates thresholds at the same time.	-5-3
Digital Maintenance Log	With this function, you can record the progress of each abnormality and the change rate of the feature values in the current device condition, for each of the pre-registered abnormal device conditions.	-5-4
Arrival prediction	This function calculates the progress of an abnormality from the condition diagnosis results and helps predict when the error will reach the alarm level. This will assist the maintenance planning of the device.	-5-5

5-2 All Feature Measurement and Trigger Measurement Simulation

5-2-1 All Feature Measurement

In order to determine how much the target device has deteriorated, the K7DD calculates 142 types of feature values based on the current and voltage, and records them as measurement values. The Support Tool can monitor the measurement results of all feature values. The feature values that can be checked in the K7DD Support Tool are as shown in the table below. The shaded areas in the table indicate feature values used in the Support Tool.

ID	Feature value	Tool display	Description	Unit	Monitorable wiring state	
					3P3W2M 3P4W	Single phase current
0	R.M.S. voltage	VRMS	The R.M.S. value is the AC value that actually does the work, representing "the value of AC voltage that produces the same power as that of DC".	[V]	✓	×
1	Voltage waveform peak+	VPeak+	This is the maximum value of the AC voltage on the positive side.	[V]	✓	×
2	Voltage waveform peak-	VPeak-	This is the maximum value of the AC voltage on the negative side.	[V]	✓	×
3	Voltage unbalance	VUnb	This value represents the ratio of the unbalance of each voltage in a 3-phase AC where the phases differ by 120°.	[%]	✓	×
4	Voltage fundamental amplitude	VFnd	The fundamental wave in the K7DD refers to the power frequency of ID141. This is the amplitude of the voltage component of the fundamental wave.	[V]	✓	×
5	Voltage total harmonic distortion	VTHD	This value represents the ratio of the magnitude of all harmonic components to the magnitude of the voltage fundamental, expressed as a percentage. It is a measure of how much the total harmonic component distorts the fundamental waveform.	[%]	✓	×
6	R.M.S. Current	IRMS	The R.M.S. value is the AC value that actually does the work, representing "the value of AC current that produces the same power as that of DC".	[A]	✓	✓
7	Current waveform peak+	IPeak+	This is the maximum value of the AC current on the positive side.	[A]	✓	✓
8	Current waveform peak-	IPeak-	This is the maximum value of the AC current on the negative side.	[A]	✓	✓
9	Current unbalance	IUnb	This value represents the ratio of the unbalance of each current in a 3-phase AC where the phases differ by 120°.	[%]	✓	×
10	Current fundamental amplitude	IFnd	The fundamental wave in the K7DD refers to the power frequency of ID141. This is the amplitude of the current component of the fundamental wave.	[A]	✓	✓
11	0.5th order harmonic current	Io.5	The waveform of 0.5 times the frequency of the fundamental frequency (power frequency) is called the 0.5th order harmonic current. Observing this value allows for identifying the ratio of harmonic components included for each order.	[%]	✓	✓

ID	Feature value	Tool display	Description	Unit	Monitorable wiring state	
					3P3W2M 3P4W	Single phase current
12	1.5th order harmonic current	I1.5	The waveform of 1.5 times the frequency of the fundamental frequency (power frequency) is called the 1.5th order harmonic current. Observing this value allows for identifying the ratio of harmonic components included for each order.	[%]	✓	✓
13	2nd order harmonic current	I2	The waveform of 2 times the frequency of the fundamental frequency (power frequency) is called the 2nd order harmonic current. Observing this value allows for identifying the ratio of harmonic components included for each order.	[%]	✓	✓
⋮	⋮	⋮	⋮	⋮	⋮	⋮
134	62.5th order harmonic current	I62.5	The waveform of 62.5 times the frequency of the fundamental frequency (power frequency) is called the 62.5th order harmonic current. Observing this value allows for identifying the ratio of harmonic components included for each order.	[%]	✓	✓
135	63rd order harmonic current	I63	The waveform of 63 times the frequency of the fundamental frequency (power frequency) is called the 63rd order harmonic current. Observing this value allows for identifying the ratio of harmonic components included for each order.	[%]	✓	✓
136	Current total harmonic distortion	ITHD	This value represents the ratio of the magnitude of all harmonic components to the magnitude of the current fundamental, expressed as a percentage. It is a measure of how much the total harmonic component distorts the fundamental waveform.	[%]	✓	✓
137	Active power	PAct	Refers to the power that is actually consumed as power.	[kW]	✓	×
138	Reactive power	PReact	Refers to the power which is not used as actual power. This power only goes back and forth between the load and the power supply, without being consumed.	[kvar]	✓	×
139	Apparent power	PAprnt	This is the power where active and reactive power are combined (in vectorial terms). It is the product of the R.M.S. voltage and the R.M.S. current, which, as the name implies, is the ostensible (apparent) electric power.	[kVA]	✓	×
140	Power factor	PF	Represents the ratio of active power to apparent power. The power factor (PF) is calculated as an R.M.S. value that includes harmonic components. The larger the harmonic current component, the lower the power factor.	[-]	✓	×
141	Power frequency	FREQ	This is a numerical expression of how many times an AC wave is repeated per second. Measurement range: 40 Hz to 250 Hz	[Hz]	✓	✓

5-2-2 Trigger Measurement Simulation

The Support Tool allows you to configure trigger settings on the K7DD. Triggers can be used to set the timing of feature measurement of the K7DD, enabling accurate condition monitoring.

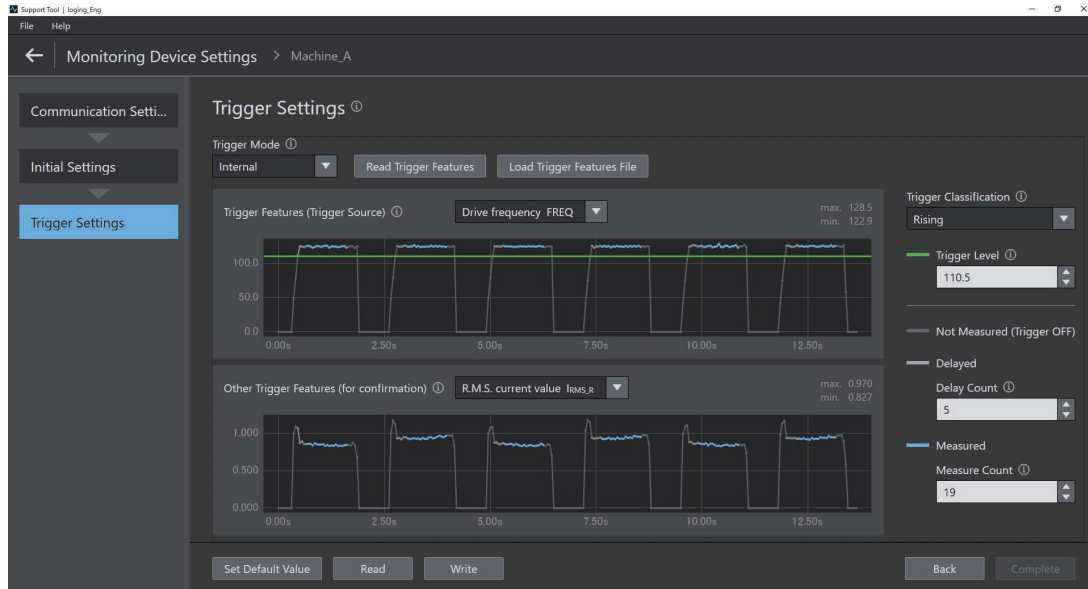

Hovering the mouse over *i* on the window displays tips and explanations. Perform settings according to the instructions.

5-3 Abnormal Data Registration

Using the Support Tool, you can select the abnormal data necessary to perform condition monitoring using feature values.

Method A: Machine Condition Data (Abnormal)...The data measured by actually generating an error is used as abnormal data.

Method B: Application Setting File...The data validated by OMRON beforehand is used as abnormal data.

Method C: Values Memorized in Monitoring Device...The data of the maximum/minimum value of each feature recorded by the K7DD monitoring operation is used as abnormal data.

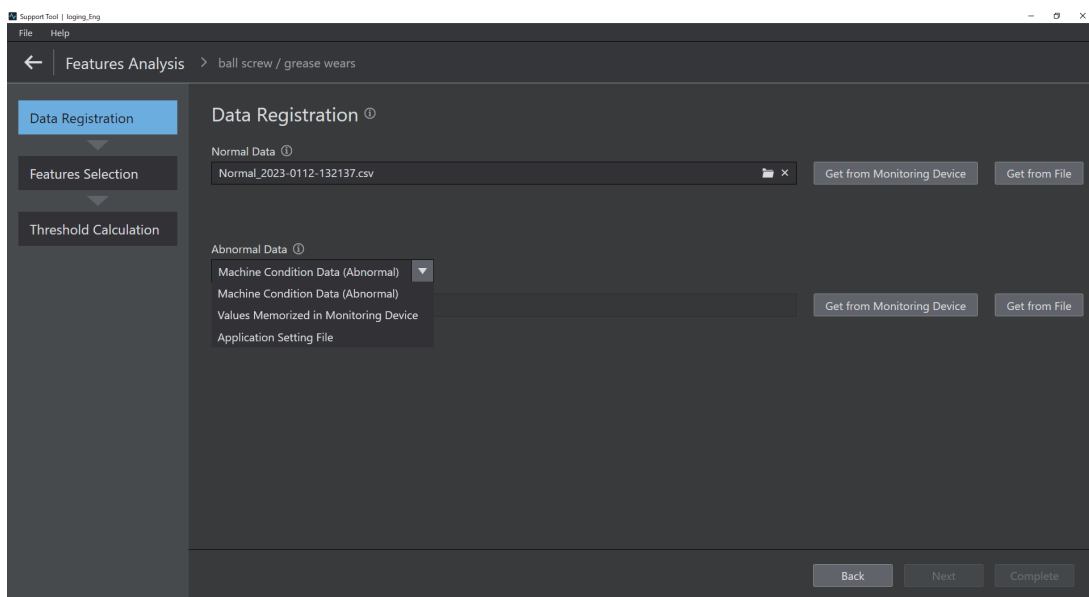

Hovering the mouse over *i* on the window displays tips and explanations. Perform settings according to the instructions.

5-4 Feature Selection Support/Alarm Threshold Setting Support

This function automatically selects features to be monitored based on both normal and abnormal data, and also calculates alarm thresholds at the same time.

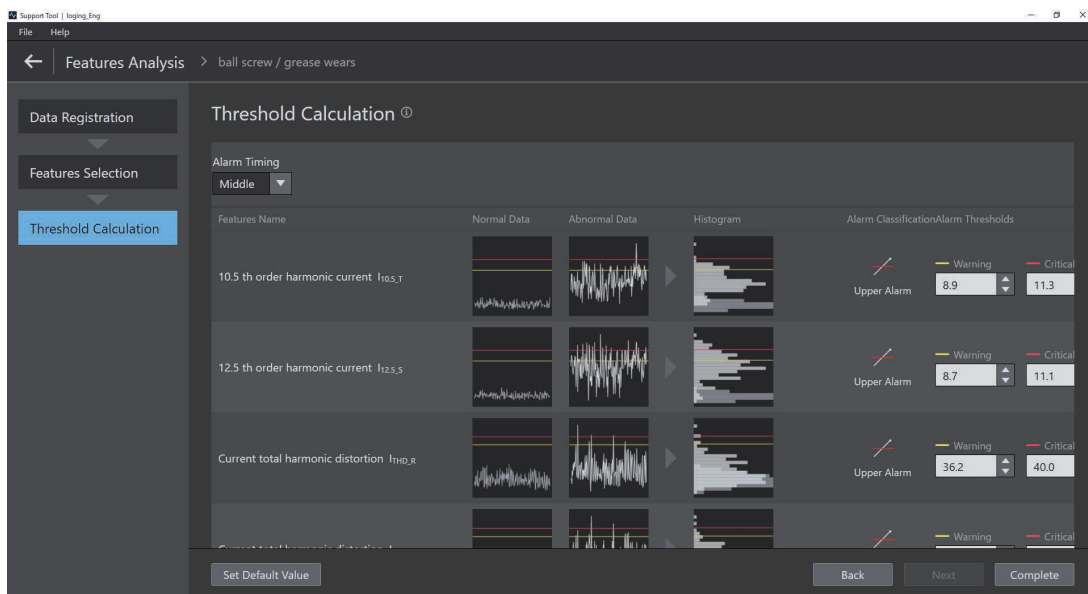
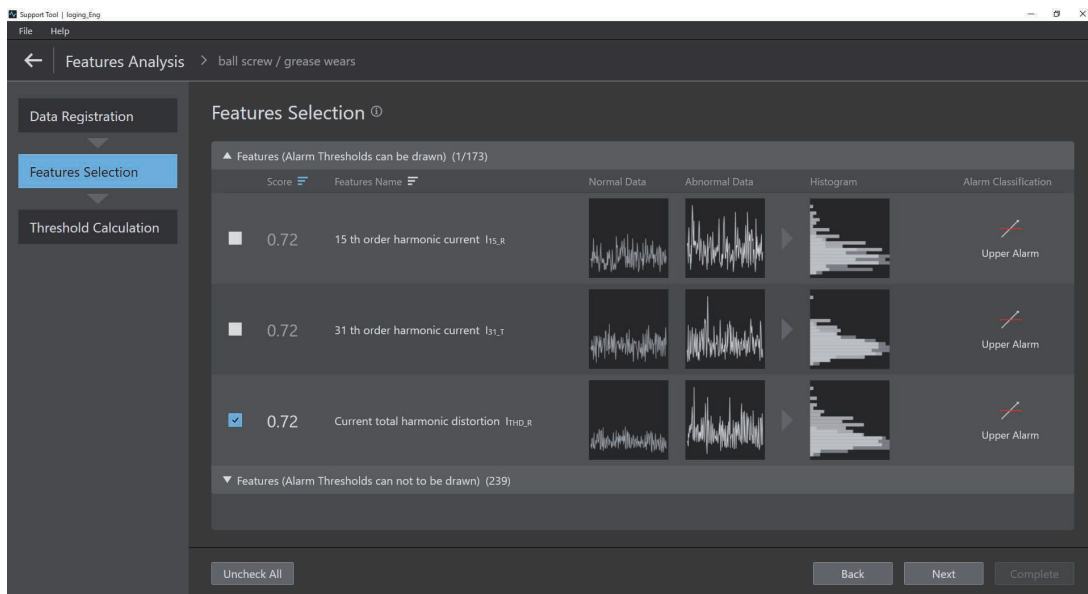

Hovering the mouse over *i* on the window displays tips and explanations. Perform settings according to the instructions.



"Application Setting File" is available for registering abnormal data. An application configuration file contains feature values and alarm threshold setting information for specific application errors that have been validated by OMRON beforehand. You can select feature values and set alarm thresholds without reproducing any errors. The files can be downloaded from i-web (https://www.ia.omron.com/k7dd_tool).

5-5 Digital Maintenance Log/ Arrival Prediction

K7DD Support Tool allows you to record data acquired from the K7DD and to perform analysis, such as predicting the occurrence of errors.

Digital Maintenance Log: You can keep a maintenance record by estimating the progress of an abnormal condition from pre-registered normal/abnormal data and data acquired during condition diagnosis, or directly entering the device status in text form.

Arrival prediction: Calculates the progress of an abnormality from the condition diagnosis results and helps predict when the error will reach the alarm level.

This will assist the maintenance planning of the device.

In addition, if any error other than the registered error condition occurs, the change in feature values is displayed.

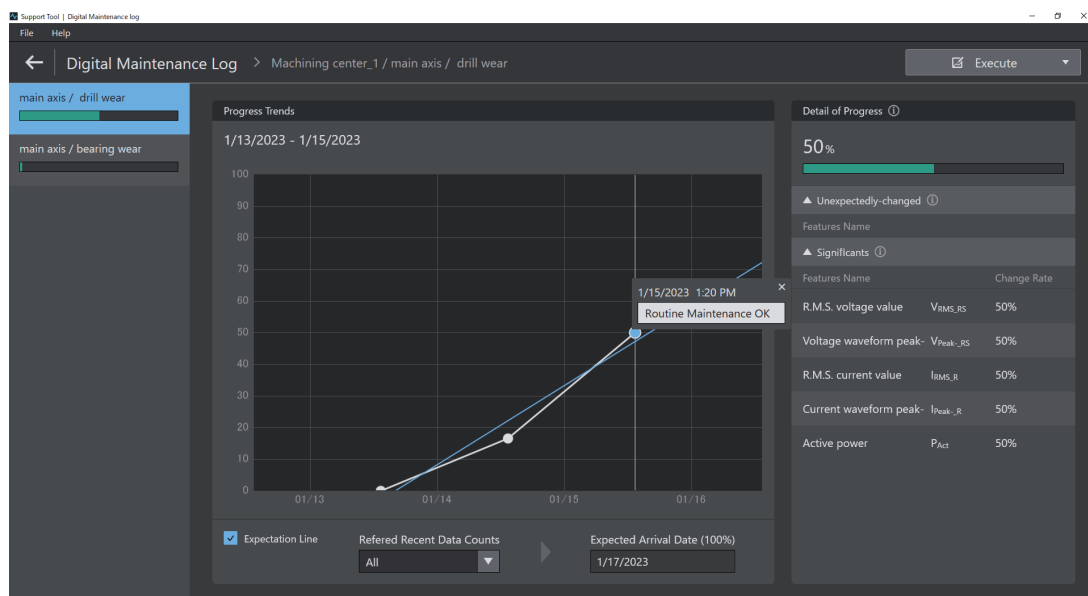

Hovering the mouse over *i* on the window displays tips and explanations. Perform settings according to the instructions.



Using K7DD Parameters

This section describes how to use the K7DD parameters.

6-1	Levels	6-2
6-2	Setting Parameters and Setting Values	6-4
6-2-1	Parameter Flow	6-5
6-3	Display of Measurement Value Mark	6-6
6-3-1	Feature Value Range for Monitoring	6-7
6-4	Monitoring Level	6-9
6-4-1	Switching Measurement Values and Displayed Channels	6-9
6-4-2	Parameters on Monitoring Level	6-10
6-5	Adjustment Level (LVL <i>A</i>)	6-13
6-5-1	Moving to Adjustment Level	6-13
6-5-2	Setting Parameters on Adjustment Level	6-14
6-6	Initial Setting Level (LVL <i>I</i>)	6-20
6-6-1	Moving to Initial Setting Level	6-20
6-6-2	Parameters on Initial Setting Level	6-21
6-7	Communications Setting Level (LVL <i>C</i>)	6-23
6-7-1	Moving to Communications Setting Level	6-23
6-7-2	Setting Parameters on Communications Setting Level	6-24
6-8	Operation Command with Key Operation	6-25

6-1 Levels

The setting parameters are grouped into “levels.”
Levels are divided into four types for the K7DD.

Level	Measurement operation	Description
Monitoring	Possible	This is a level on which to monitor measurement values. The Unit is on this level immediately after the power is turned ON.
Adjustment	Possible	This is a setting level for adjustment.
Initial Setting	Stop	This is a level on which to make basic initial settings.
Communications Setting	Stop	This is a level on which to make communications settings.

● LVL Display

The display indicates the following characters corresponding to each level.

LVL display character	Level
Blank	Monitoring
LVL <i>A</i>	Adjustment
LVL <i>D</i>	Initial Setting
LVL <i>I</i>	Communications Setting

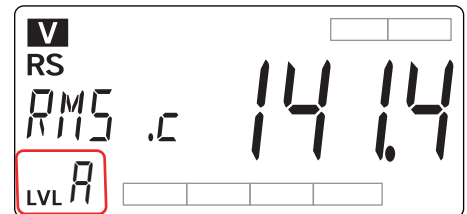

Procedure for Moving from Level to Level

- **To Adjustment Level**

Pressing the Level Key (⊞) on the Monitoring Level (for less than 1 second) moves you to the Adjustment Level.

- **To Initial Setting Level**

On the Monitoring Level or Adjustment Level, when you press the Level Key (⊞) for 1 second or more, the main display starts to flash. Then, keeping the key held down for 2 seconds or more moves you to the Initial Setting Level. To return to the Monitoring Level, press the Level Key (⊞) for 1 second or more.

- **To Communications Setting Level**

Pressing the Level Key (⊞) on the Initial Setting Level (for less than 1 second) moves you to the Communications Setting Level. To return to the Monitoring Level, press the Level Key (⊞) for 1 second or more.

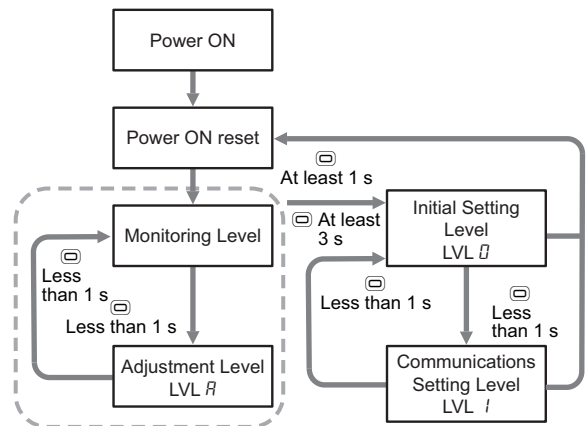

The measured values and alarm outputs are cleared when the level is moved from the Monitoring Level or Adjustment Level to the Initial Setting Level.

6-2 Setting Parameters and Setting Values

● Setting parameters

The setting items on each level are called “setting parameters.”

The setting parameters can be switched over with the Mode Key (Ⓜ).

The setting parameters can be switched over among CH1, CH2, and CH3 with the Channel Key (U).

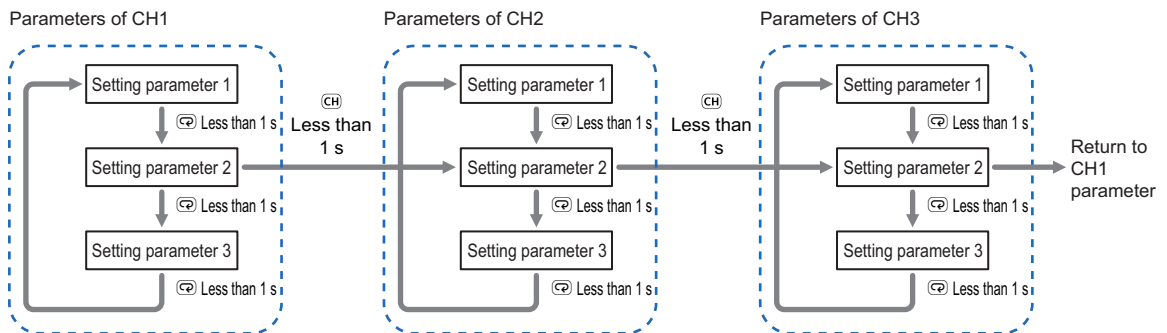

● Display or Change of Setting Value

Go through the following steps to display or change the setting value.

1. Press the Mode Key (Ⓜ) several times to display the setting parameter to change.

- The setting parameter characters are displayed on the main display.



2. Use the Shift Key (⇐), the Up Key (⬆), or the Down Key (⬇) to change the setting value.

- If no key operation is performed for 5 seconds, the setting value will be saved.

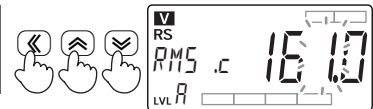

3. Press the Mode Key (Ⓜ) to move to the next setting parameter.

- The changed setting value is saved in the internal memory.

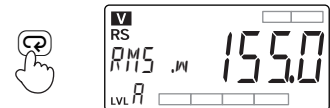

6-2-1 Parameter Flow

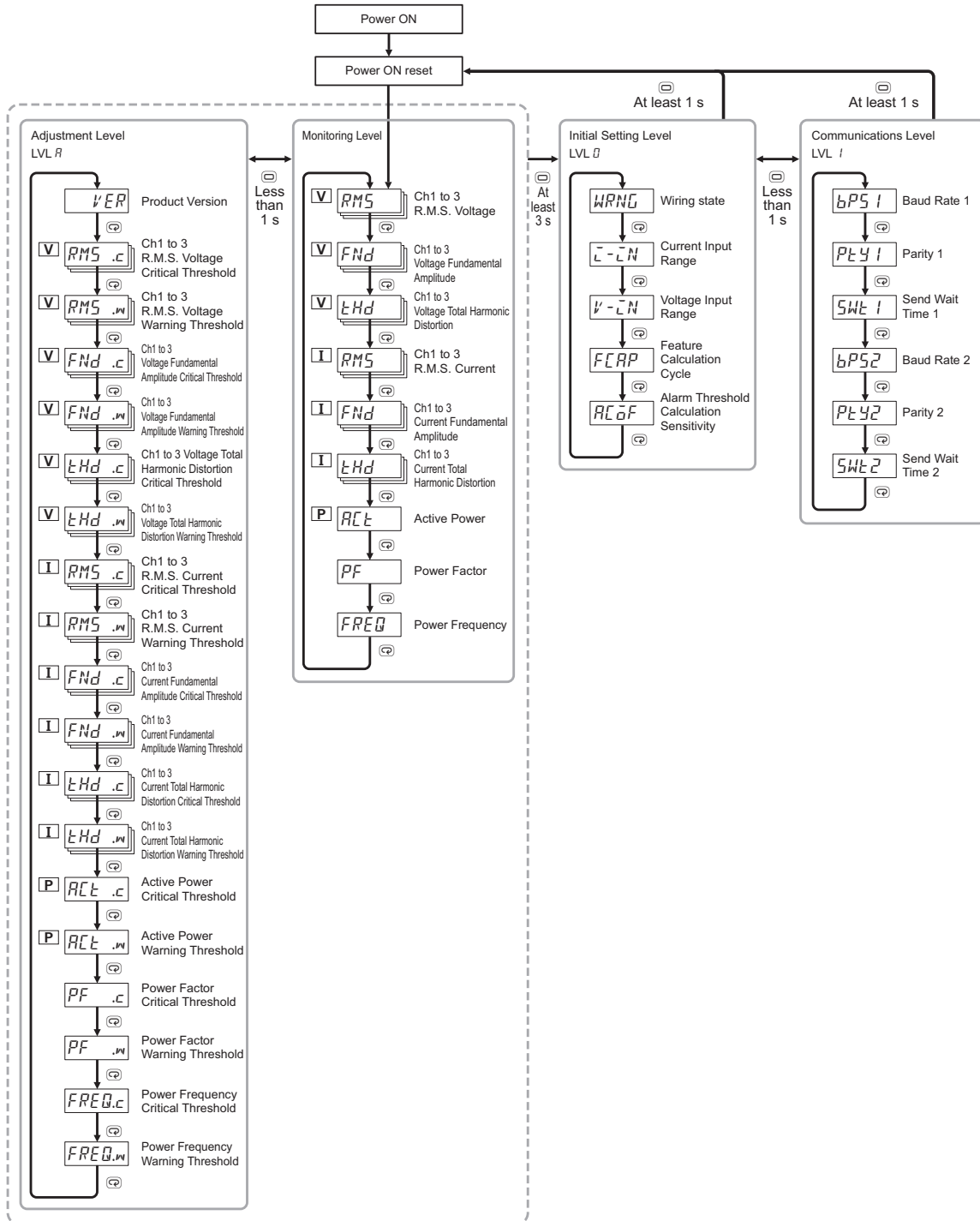

 **Precautions for Correct Use**

When you move to the Initial Setting Level, the contacts of alarm outputs 1 and 2 turn OFF.

6-3 Display of Measurement Value Mark

The measurement value display (a) and (b) indicate the following marks according to the wiring state.

Wiring state	Feature value system	Displayed channel		
		CH1	CH2	CH2
3-phase 3-wire	Voltage system	RS	ST	TR
	Current system	R	S	T
3-phase 4-wire	Voltage system	R	S	T
	Current system	R	S	T
Single-phase current	Current system	CH1	CH2	CH3

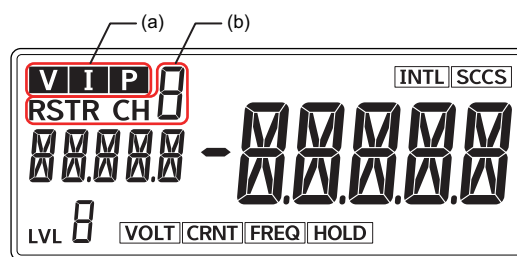

Display	Meaning
(a)	Lights according to the feature value displayed in the parameter display. V: R.M.S. voltage, voltage fundamental amplitude, and voltage total harmonic distortion I: R.M.S. current, current fundamental amplitude, current total harmonic distortion P: Active power Not lit: Power factor, power frequency
(b)	Displays the channel of the measured feature value based on the wiring state and the feature value system. See the table on the left.

● Examples of Wiring State and Displayed Measurement Value Mark

Wiring state	CH1	CH2	CH3
3-phase 3-wire Voltage system parameters			
3-phase 3-wire Current system parameters			
3-phase 4-wire Voltage system parameters			
3-phase 4-wire Current system parameters			
Single-phase current Current system parameters *1			

*1. When the wiring state is single-phase current, only CH1 is the measurement target. Even when the CT is connected to CH2 or CH3, it will not be measured.

6-3-1 Feature Value Range for Monitoring

The following table lists the range of feature values displayed on the Monitoring Level and Adjustment Level. The shaded areas in the table indicate feature values used in the K7DD Support Tool.

ID	Feature value	Range condition	Monitoring range *1		Unit
			Min.	Max.	
0	R.M.S. voltage	150 V	0.0	165.0	[V]
		300 V	0.0	330.0	[V]
		600 V	0.0	660.0	[V]
1	Voltage waveform peak+	150 V	0.0	600.0	[V]
		300 V	0.0	1200.0	[V]
		600 V	0.0	2400.0	[V]
2	Voltage waveform peak-	150 V	-600.0	0.0	[V]
		300 V	-1200.0	0.0	[V]
		600 V	-2400.0	0.0	[V]
3	Voltage unbalance	---	0.0	100.0	[%]
4	Voltage fundamental amplitude	150 V	0.0	233.4	[V]
		300 V	0.0	466.7	[V]
		600 V	0.0	933.4	[V]
5	Voltage total harmonic distortion	---	0.0	100.0	[%]
6	R.M.S. current	5 A	0.000	5.500	[A]
		25 A	0.0	27.5	[A]
		100 A	0.0	110.0	[A]
		200 A	0.0	220.0	[A]
		400 A	0.0	440.0	[A]
7	Current waveform peak+	5 A	0.000	20.000	[A]
		25 A	0.0	100.0	[A]
		100 A	0.0	400.0	[A]
		200 A	0.0	800.0	[A]
		400 A	0.0	1600.0	[A]
8	Current waveform peak-	5 A	-20.000	0.000	[A]
		25 A	-100.0	0.0	[A]
		100 A	-400.0	0.0	[A]
		200 A	-800.0	0.0	[A]
		400 A	-1600.0	0.0	[A]
9	Current unbalance	---	0.0	100.0	[%]
10	Current fundamental amplitude	5 A	0.000	7.779	[A]
		25 A	0.0	38.9	[A]
		100 A	0.0	155.6	[A]
		200 A	0.0	311.2	[A]
		400 A	0.0	622.3	[A]

ID	Feature value	Range condition	Monitoring range *1		Unit
			Min.	Max.	
11	0.5th order harmonic current	---	0.0	100.0	[%]
12	1.5th order harmonic current	Same as above.	Same as above.	Same as above.	Same as above.
13	2nd order harmonic current				
:					
134	62.5th order harmonic current				
135	63rd order harmonic current				
136	Current total harmonic distortion	---	0.0	100.0	[%]
137	Active Power	Current: 5A	-10.890	10.890	[kW]
		Current: Other than 5A	-871.2	871.2	[kW]
138	Reactive power	Current: 5A	-10.890	10.890	[kvar]
		Current: Other than 5A	-871.2	871.2	[kvar]
139	Apparent power	Current: 5A	0.000	10.890	[kVA]
		Current: Other than 5A	0.0	871.2	[kVA]
140	Power factor	---	-1.00	1.00	[-]
141	Power frequency	---	0.0	250.0	[Hz]

*1. If the input of voltage, current, or power frequency is out of the allowable range, the feature value will not be calculated and "----" will be displayed. When the value is read via communications, it is handled as "0".

6-4 Monitoring Level

The Monitoring Level is a level on which to display the values that the K7DD measured.

Turning ON the power executes the power ON reset process to move you to the Monitoring Level.

Monitoring Level (LVL0)

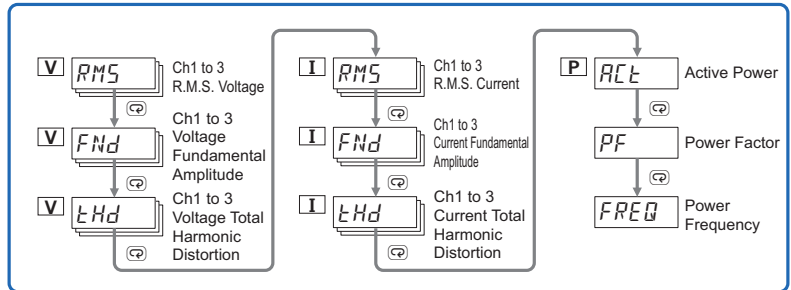

6-4-1 Switching Measurement Values and Displayed Channels

- Use the Mode Key (Ⓢ) to switch measurement values to display.
- Use the Channel Key (CH) to switch channels to display.

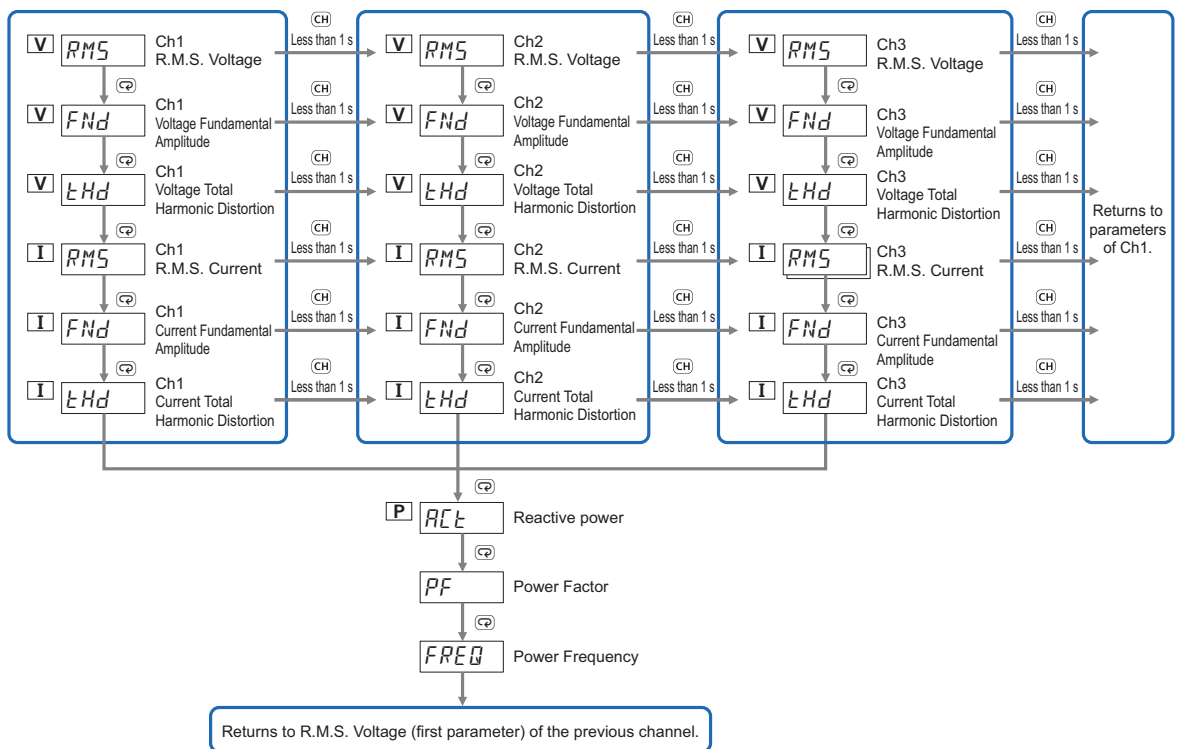

6-4-2 Parameters on Monitoring Level

The parameters on the Monitoring Level display the following values.

V *RMS* R.M.S. Voltage

This is the R.M.S. voltage of measured signals.

The monitoring range varies depending on the voltage input range.

Range	Monitoring range
150 V	0.0 to 165.0 (V)
300V	0.0 to 330.0 (V)
600 V	0.0 to 660.0 (V)



Setting-related page

- 4-2 Feature Measurement (P. 4-3)
- 4-3 Simplified Threshold Settings (P. 4-4)

V *FNd* Voltage Fundamental Amplitude

This is the voltage fundamental amplitude of measured signals.

The monitoring range varies depending on the voltage input range.

Range	Monitoring range
150 V	0.0 to 233.4 (V)
300 V	0.0 to 466.7 (V)
600 V	0.0 to 933.4 (V)



Setting-related page

- 4-2 Feature Measurement (P. 4-3)
- 4-3 Simplified Threshold Settings (P. 4-4)

V *tHd* Voltage Total Harmonic Distortion

This is the voltage total harmonic distortion of measured signals.

Range	Monitoring range
---	0.0 to 100.0 (%)



Setting-related page



- 4-2 Feature Measurement (P. 4-3)

I *RMS* R.M.S. Current

This is the R.M.S. current of measured signals.
The monitoring range varies depending on the current input range.

Range	Monitoring range
5 A	0.000 to 5.500 (A)
25 A	0.0 to 27.5 (A)
100 A	0.0 to 110.0 (A)
200 A	0.0 to 220.0 (A)
400 A	0.0 to 440.0 (A)

i Setting-related page



-  4-2 Feature Measurement (P. 4-3)
-  4-3 Simplified Threshold Settings (P. 4-4)

I *FNd* Current Fundamental Amplitude

This is the current fundamental amplitude of measured signals.
The monitoring range varies depending on the current input range.

Range	Monitoring range
5 A	0.000 to 7.779 (A)
25 A	0.0 to 38.9 (A)
100 A	0.0 to 155.6 (A)
200 A	0.0 to 311.2 (A)
400 A	0.0 to 622.3 (A)

i Setting-related page

-  4-2 Feature Measurement (P. 4-3)
-  4-3 Simplified Threshold Settings (P. 4-4)

I *tHd* Current Total Harmonic Distortion

This is the current total harmonic distortion of measured signals.

Range	Monitoring range
---	0.0 to 100.0 (%)

i Setting-related page

-  4-2 Feature Measurement (P. 4-3)

P *ACT* Active Power

This is the active power of measured signals.



The monitoring range varies depending on the current input range.

If this parameter shows a negative value, the wiring may be wrong. Refer to *Wiring Example of 3P3W2M Connection (3-phase, 3-wire, 2-watt Meter Method)* (P.2-7), *Wiring Example of 3P4W Connection* (P.2-8) in  2-2 *Configuration with the K7DD Unit Only* for details.

Range	Monitoring range
5A current, All voltages	-10.890 to 10.890 (kW)
Current other than 5A, All voltages	-871.2 to 871.2 (kW)



Setting-related page

-  4-2 *Feature Measurement* (P. 4-3)
-  4-3 *Simplified Threshold Settings* (P. 4-4)

PF Power Factor

This is the power factor of measured signals.

Range	Monitoring range
---	-1.00 to 1.00 (-)



Setting-related page

-  4-2 *Feature Measurement* (P. 4-3)

FREQ Power Frequency

This is the power frequency of measured signals.

Range	Monitoring range
---	0.0 to 250.0 (Hz)



Setting-related page

-  4-2 *Feature Measurement* (P. 4-3)

6-5 Adjustment Level (LVL R)

The Adjustment Level is a level that has the parameters required to be adjusted for using the K7DD.

Pressing the Level Key (⊖) on the Monitoring Level (for less than 1 second) moves you to the Adjustment Level.

Adjustment Level (LVL R)

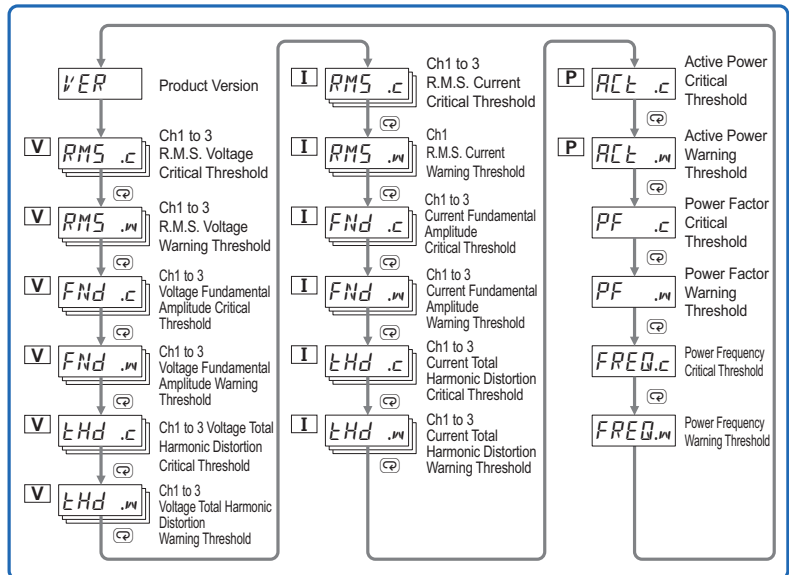

6-5 Adjustment Level (LVL R)

6

6-5-1 Moving to Adjustment Level

1. Press the Level Key (⊖) on the Monitoring Level (for less than 1 second) to move to the Adjustment Level.

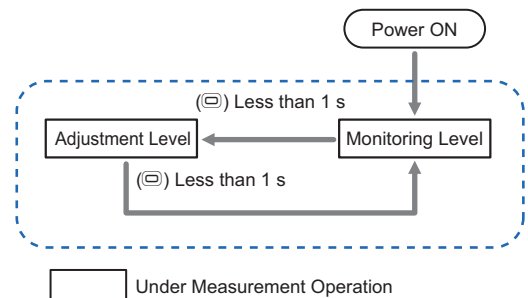

6-5-1 Moving to Adjustment Level

- Once the Adjustment Level is entered, *R* is displayed on the “LVL” display.”
- To return to the Monitoring Level, press the Level Key (⊖) for less than 1 second.

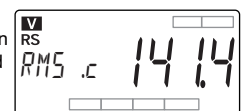
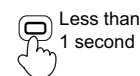
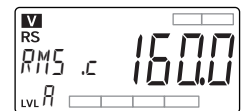

6-5-2 Setting Parameters on Adjustment Level

If a set value of the Adjustment Level is "32761," it means that the maximum value has been set. If the threshold is set to the maximum, it means that the alarm is essentially disabled since the measurement value does not fall into the alarm range.

For the setting range, refer to [□ A-2 Parameters List \(P.A-9\)](#).

VER Product Version

This parameter displays the product version of the K7DD.

V RMS .C R.M.S. Voltage Critical Threshold

Set the alarm threshold (critical) for the R.M.S. voltage of the measurement target.

The alarm will be turned ON if the R.M.S. voltage exceeds this threshold (critical).

Range	Valid setting range
150 V	0.0 to 165.0 (V)
300 V	0.0 to 330.0 (V)
600 V	0.0 to 660.0 (V)



Setting-related page

- [□ 4-2 Feature Measurement \(P. 4-3\)](#)
- [□ 4-3 Simplified Threshold Settings \(P. 4-4\)](#)

V RMS .W R.M.S. Voltage Warning Threshold

Set the alarm threshold (warning) for the R.M.S. voltage of the measurement target.

The alarm will be turned ON if the R.M.S. voltage exceeds this threshold (warning).

Range	Valid setting range
150 V	0.0 to 165.0 (V)
300 V	0.0 to 330.0 (V)
600 V	0.0 to 660.0 (V)



Setting-related page

- [□ 4-2 Feature Measurement \(P. 4-3\)](#)
- [□ 4-3 Simplified Threshold Settings \(P. 4-4\)](#)

V *FNd* .c Voltage Fundamental Amplitude Critical Threshold

Set the alarm threshold (critical) for the voltage fundamental amplitude of the measurement target.

The alarm will be turned ON if the voltage fundamental amplitude exceeds this threshold (critical).

Range	Valid setting range
150 V	0.0 to 233.4 (V)
300 V	0.0 to 466.7 (V)
600 V	0.0 to 933.4 (V)

i Setting-related page

 4-2 Feature Measurement (P. 4-3)

 4-3 Simplified Threshold Settings (P. 4-4)

V *FNd* .w Voltage Fundamental Amplitude Warning Threshold

Set the alarm threshold (warning) for the voltage fundamental amplitude of the measurement target.

The alarm will be turned ON if the voltage fundamental amplitude exceeds this threshold (warning).

Range	Valid setting range
150 V	0.0 to 233.4 (V)
300 V	0.0 to 466.7 (V)
600 V	0.0 to 933.4 (V)

i Setting-related page

 4-2 Feature Measurement (P. 4-3)

 4-3 Simplified Threshold Settings (P. 4-4)

V *tHd* .c Voltage Total Harmonic Distortion Critical Threshold

Set the alarm threshold (critical) for the voltage total harmonic distortion of the measurement target.

The alarm will be turned ON if the voltage total harmonic distortion exceeds this threshold (critical).

Range	Valid setting range
---	0.0 to 100.0 (%)

i Setting-related page

 4-2 Feature Measurement (P. 4-3)

V *THd* **Voltage Total Harmonic Distortion Warning Threshold**

Set the alarm threshold (warning) for the voltage total harmonic distortion of the measurement target.

The alarm will be turned ON if the voltage total harmonic distortion exceeds this threshold (warning).

Range	Valid setting range
---	0.0 to 100.0 (%)



Setting-related page

4-2 Feature Measurement (P. 4-3)

I *RMS* **R.M.S. Current Critical Threshold**

Set the alarm threshold (critical) for the R.M.S. current of the measurement target.

The alarm will be turned ON if the R.M.S. current exceeds this threshold (critical).

Range	Valid setting range
5 A	0.000 to 5.500 (A)
25 A	0.0 to 27.5 (A)
100 A	0.0 to 110.0 (A)
200 A	0.0 to 220.0 (A)
400 A	0.0 to 440.0 (A)



Setting-related page

4-2 Feature Measurement (P. 4-3)

4-3 Simplified Threshold Settings (P. 4-4)

I *RMS* **R.M.S. Current Warning Threshold**

Set the alarm threshold (warning) for the R.M.S. current of the measurement target.

The alarm will be turned ON if the R.M.S. current exceeds this threshold (warning).

Range	Valid setting range
5 A	0.000 to 5.500 (A)
25 A	0.0 to 27.5 (A)
100 A	0.0 to 110.0 (A)
200 A	0.0 to 220.0 (A)
400 A	0.0 to 440.0 (A)



Setting-related page

4-2 Feature Measurement (P. 4-3)

4-3 Simplified Threshold Settings (P. 4-4)

I *FNd* .c Current Fundamental Amplitude Critical Threshold

Set the alarm threshold (critical) for the fundamental amplitude of the measurement target.

The alarm will be turned ON if the fundamental amplitude exceeds this threshold (critical).

Range	Valid setting range
5 A	0.000 to 7.779 (A)
25 A	0.0 to 38.9 (A)
100 A	0.0 to 155.6 (A)
200 A	0.0 to 311.2 (A)
400 A	0.0 to 622.3 (A)

i Setting-related page

4-2 Feature Measurement (P. 4-3)

4-3 Simplified Threshold Settings (P. 4-4)

I *FNd* .w Current Fundamental Amplitude Warning Threshold

Set the alarm threshold (warning) for the current fundamental amplitude of the measurement target.

The alarm will be turned ON if the fundamental amplitude exceeds this threshold (warning).

Range	Valid setting range
5 A	0.000 to 7.779 (A)
25 A	0.0 to 38.9 (A)
100 A	0.0 to 155.6 (A)
200 A	0.0 to 311.2 (A)
400 A	0.0 to 622.3 (A)

i Setting-related page

4-2 Feature Measurement (P. 4-3)

4-3 Simplified Threshold Settings (P. 4-4)

I *tHd* .c Current Total Harmonic Distortion Critical Threshold

Set the alarm threshold (critical) for the current total harmonic distortion of the measurement target.

The alarm will be turned ON if the current total harmonic distortion exceeds this threshold (critical).

Range	Valid setting range
---	0.0 to 100.0 (%)

i Setting-related page

4-2 Feature Measurement (P. 4-3)

I *THd* **.W** Voltage Total Harmonic Distortion Warning Threshold

Set the alarm threshold (warning) for the current total harmonic distortion of the measurement target.

The alarm will be turned ON if the current total harmonic distortion exceeds this threshold (warning).

Range	Valid setting range
---	0.0 to 100.0 (%)



Setting-related page

4-2 Feature Measurement (P. 4-3)

P *ACT* **.C** Active Power Critical Threshold

Set the alarm threshold (critical) for the active power of the measurement target.

The alarm will be turned ON if the active power exceeds this threshold (critical).

Range	Valid setting range
5A current, All voltages	-10.890 to 10.890 (kW)
Current other than 5A, All voltages	-871.2 to 871.2 (kW)



Setting-related page

4-2 Feature Measurement (P. 4-3)

4-3 Simplified Threshold Settings (P. 4-4)

P *ACT* **.W** Active Power Warning Threshold

Set the alarm threshold (warning) for the active power of the measurement target.

The alarm will be turned ON if the active power exceeds this threshold (warning).

Range	Valid setting range
5A current, All voltages	-10.890 to 10.890 (kW)
Current other than 5A, All voltages	-871.2 to 871.2 (kW)



Setting-related page

4-2 Feature Measurement (P. 4-3)

4-3 Simplified Threshold Settings (P. 4-4)

PF .c Power Factor Critical Threshold

Set the alarm threshold (critical) for the power factor of the measurement target.

The alarm will be turned ON if the power factor exceeds this threshold (critical).

Range	Valid setting range
---	-1.00 to 1.00 (-)



Setting-related page

4-2 Feature Measurement (P. 4-3)

PF .w Power Factor Warning Threshold

Set the alarm threshold (warning) for the power factor of the measurement target.

The alarm will be turned ON if the power factor exceeds this threshold (warning).

Range	Valid setting range
---	-1.00 to 1.00 (-)



Setting-related page

4-2 Feature Measurement (P. 4-3)

FREQ.c Power Frequency Critical Threshold

Set the alarm threshold (critical) for the power frequency of the measurement target.

The alarm will be turned ON if the power frequency exceeds this threshold (critical).

Range	Valid setting range
All	0.0 to 250.0 (Hz)



Setting-related page

4-2 Feature Measurement (P. 4-3)

FREQ.w Power Frequency Warning Threshold

Set the alarm threshold (warning) for the power frequency of the measurement target.

The alarm will be turned ON if the power frequency exceeds this threshold (warning).

Range	Valid setting range
All	0.0 to 250.0 (Hz)



Setting-related page

4-2 Feature Measurement (P. 4-3)

6-6 Initial Setting Level (LVL 0)

The Initial Setting Level is a level that has the parameters required to be set first for using the K7DD.

Initial Setting Level (LVL 0)

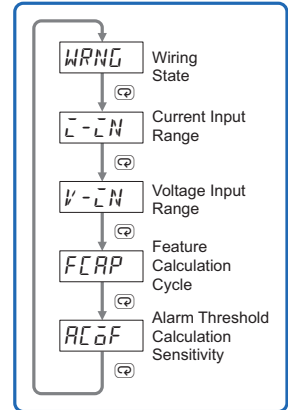

6-6-1 Moving to Initial Setting Level

1. When you press the Level Key (Ⓚ) for 3 seconds or more on the Monitoring Level or Adjustment Level, the level is moved to the Initial Setting Level.

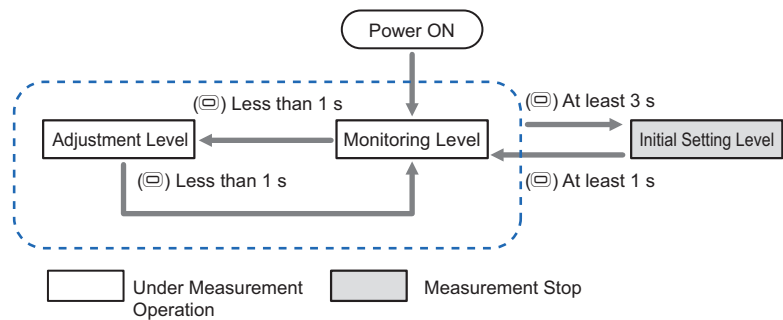

- Once the Initial Setting Level is entered, 0 is displayed on the “LVL display.”



- To return to the Monitoring Level, press the Level Key (Ⓚ) for 1 second or more. You are moved to the Monitoring Level after the software reset.

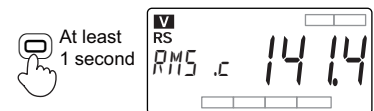



6-6-2 Parameters on Initial Setting Level

\overline{WRNG} Wiring State

Set the wiring state of the measurement target.

Range of setting values	Default value
$\overline{0}$: 3P3W2M (3-phase 3-wire)	$\overline{0}$
$\overline{1}$: 3P4W (3-phase 4-wire)	
$\overline{2}$: Single-phase current only	

Setting-related page

-  (3) *K7DD Input Setting* (P. 2-10) of 2-2 *Configuration with the K7DD Unit Only*
-  6-3 *Display of Measurement Value Mark* (P. 6-6)

$\overline{L-LN}$ Current Input Range

Set the current input range.

Range of setting values	Default value
$\overline{5A}$: 0 to 5 (A)	$\overline{5A}$
$\overline{25A}$: 0 to 25 (A)	
$\overline{100A}$: 0 to 100 (A)	
$\overline{200A}$: 0 to 200 (A)	
$\overline{400A}$: 0 to 400 (A)	

Setting-related page

-  (3) *K7DD Input Setting* (P. 2-10) of 2-2 *Configuration with the K7DD Unit Only*

$\overline{V-LN}$ Voltage Input Range

Set the voltage input range.

Range of setting values	Default value
$\overline{150V-10}$: 0 to 150 (V)	$\overline{150V}$
$\overline{300V-10V}$: 0 to 300 (V)	
$\overline{600V-10V}$: 0 to 600 (V)	

Setting-related page

-  (3) *K7DD Input Setting* (P. 2-10) of 2-2 *Configuration with the K7DD Unit Only*

FCAP Feature Calculation Cycle

Set the feature calculation cycle.

The calculation cycle (sampling cycle) is 50 ms.

Setting Example:

If the cycle of the application is 5 seconds.

$$5000 \text{ ms} \div 50 \text{ ms} = 100$$

In this case, set the feature calculation cycle to 100.

When using the simplified threshold setting function, it is necessary to set the value according to the device operation.

Refer to [□ 4-3-2 Conditions to Use \(P.4-5\)](#) for details.

Range of setting values	Default value
1 to 2000 (50 ms)	1

For the maximum setting of 2000, the calculation cycle is 100 seconds (2000 x 50 ms).



Setting-related page

- [□ \(3\) K7DD Input Setting \(P. 2-10\) of 2-2 Configuration with the K7DD Unit Only](#)
- [□ 4-3 Simplified Threshold Settings \(P. 4-4\)](#)

ACOF Alarm Threshold Calculation Sensitivity

Set the alarm threshold calculation sensitivity.

This value is used for calculating the threshold value at the completion of teaching.

Range of setting values	Default value
20.0 to 200.0 (%)	80.0 (%)



Setting-related page

- [□ \(4\) Operation Settings for Alarm Output \(P. 2-11\) of 2-2 Configuration with the K7DD Unit Only](#)
- [□ 4-3 Simplified Threshold Settings \(P. 4-4\)](#)

6-7 Communications Setting Level (LVL *i*)

The Communications Setting Level is a level where you set the parameters required for serial communications (Modbus RTU) between the K7DD and external devices.

Communications Setting Level (LVL *i*)

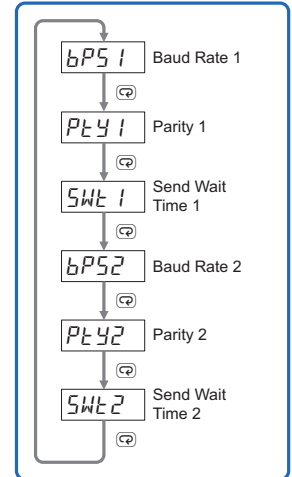

6-7-1 Moving to Communications Setting Level

1. Pressing the Level Key (☐) on the Monitoring Level or Adjustment Level for 3 seconds or more moves you to the Initial Setting Level.

2. Pressing the Level Key (☐) on the Initial Setting Level (for less than 1 second) moves you to the Communications Setting Level.

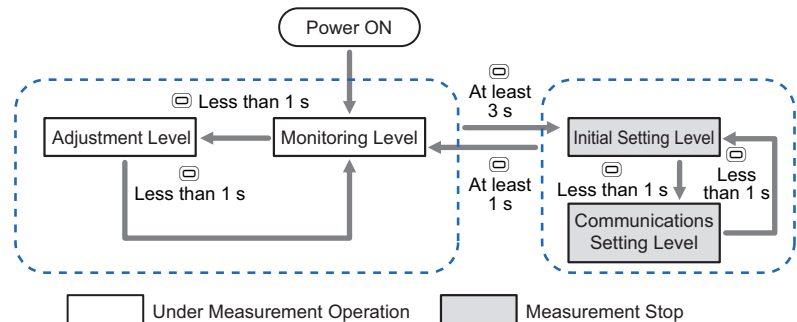

- Once the Communications Setting Level is entered, *i* is displayed on the “LVL display.”



- To return to the Monitoring Level, press the Level Key (☐) for 1 second or more. You are moved to the Monitoring Level after the software reset.

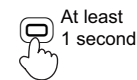

6-7-2 Setting Parameters on Communications Setting Level

bps //bps² Baud Rate 1/Baud Rate 2

Set the baud rate of the communications terminal 1 or 2.

Range of setting values	Default value
9.6 (kbps) 19.2 (kbps) 38.4 (kbps) 57.6 (kbps) 115.2 (kbps) 230.4 (kbps)	115.2



Setting-related page

Initial Setting of Communications Converter (P.3-14) of 3-6 Wiring the Communications Cables

PEY //PEY² Parity 1/Parity 2

Set the parity of the communications terminal 1 or 2.

When the set value is changed from "Even" or "Odd" to "None," the internal stop bit is changed from 1 bit to 2 bits. Similarly, if the set value is changed from "None" to "Even" or "Odd," the internal stop bit is changed from 2 bits to 1 bit.

Range of setting values	Default value
NONE: None EVEN: Even odd: Odd	EVEN



Setting-related page

Initial Setting of Communications Converter (P.3-14) of 3-6 Wiring the Communications Cables

SWT //SWT² Send Wait Time 1/Send Wait Time 2

Set the send wait time of the communications terminal 1 or 2.

This is a wait time from when the K7DD receives a command from the host system until it returns a response. If the response comes so fast that the host system cannot receive it properly, increase this setting value. If you want to make the communications response time faster, decrease this setting value.

Range of setting values	Default value
0 to 99 (ms)	20 (ms)

6-8 Operation Command with Key Operation

The following Operation Commands can be executed with key operations on the K7DD.

Operation Command	Description
Normal Data Acquisition Command	Starts or cancels the acquisition of normal data.
Abnormal Data Acquisition Command	Terminates the acquisition of abnormal data.
Alarm Latch Cancel Command	Releases the alarm latch.

Normal Data Acquisition Command

● Procedure

1. Display the channel for which to acquire the normal data on the Monitoring Level or Adjustment Level, and press the INTL Key for 3 seconds or more.
The parameter display starts to flash at high speed.
After 3 seconds have elapsed, acquisition of the normal data for all channels is started.

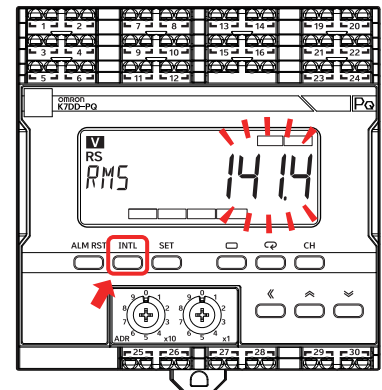

Abnormal Data Acquisition Command

● Procedure

1. Display the channel for which to acquire the abnormal data on the Monitoring Level or Adjustment Level, and press the SET key for 3 seconds or more.
The parameter display starts to flash at high speed.
After 3 seconds have elapsed, acquisition of the abnormal data for all channels is started.

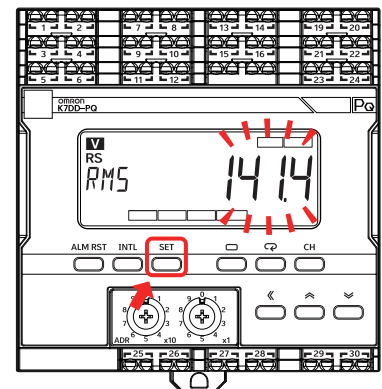

Alarm Latch Cancel Command

● Procedure

1. Press the [ALM RST] key for 3 seconds or more on the Monitoring Level or Adjustment Level.
The parameter display starts to flash at high speed.
After 3 seconds have elapsed, the alarm latch is released for all channels.

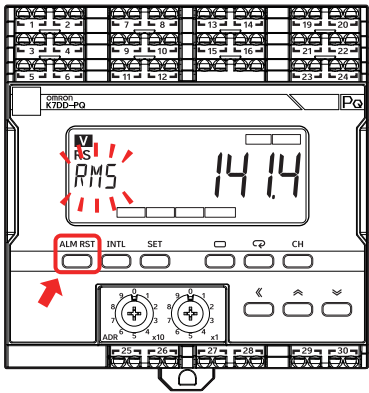



Communications

7-1	Communications	7-2
7-2	Communications Overview	7-3
7-3	To Monitor All Feature Values Together (Read Variable Area)	7-5
7-3-1	Reading Measurement Values/Statuses	7-5
7-4	Changing Setting Parameters (Write Variable Area)	7-6
7-4-1	Writing Setting Parameters	7-6
7-5	Operation Command	7-7
7-6	Modbus RTU Communications Format	7-9
7-6-1	Frame Configurations	7-9
7-6-2	Read Variable Area Command	7-12
7-6-3	Write Variable Area Command	7-13
7-6-4	Operation Command or Write Variable Area Command (Single)	7-15
7-7	Variable Area Map	7-17
7-7-1	Variable Area Map Descriptions	7-17
7-7-2	Common Variable Area	7-19
7-7-3	Variable Area for Each Channel	7-23
7-7-4	K7DD Information Area	7-24
7-7-5	Details about Status Information	7-25

7-1 Communications

The K7DD supports serial communications (Modbus RTU).

It can remotely collect the measurement value, status, and other data from a remote location, making it possible to intensively monitor devices having a rotation mechanism dispersed throughout the factory.

There are two communications ports: RS-485 communications 1 and RS-485 communications 2. These ports are used to connect the K7DD Support Tool or host system, such as PLC. When using these ports, use the RS-485 communications 1 first.

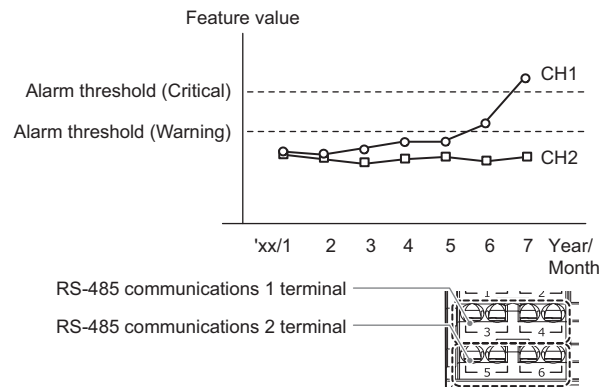

7-2 Communications Overview

Communications Method

This is a master/slave system in which multiple K7DDs (slaves) are connected to one host system (master).

The K7DDs (slaves) connected to the same communications line are distinguished each other by a unit number.

The commands sent by the master reach all the slaves, but the unit number for respective slaves is embedded in the command frame, which allows the slaves to determine whether a command is addressed to itself and to return a response only to a command addressed to itself.

Refer to [□ 3-7 Setting the Unit Number \(P.3-16\)](#) for information on how to set the unit number.

The host system (master) sends a command frame, and the K7DD (slave) returns a response frame corresponding to the command. One command frame is paired with one response frame.

The communications start with the master sending a command frame. Even if there is some change in status that should be notified to the slave, it cannot be notified without an inquiry from the master. Therefore, the master must poll at appropriate intervals to determine the slave status.

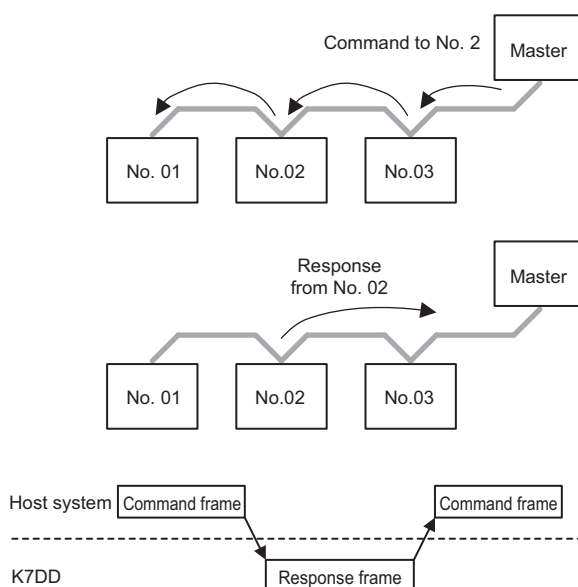

Types of Communications Commands

The following three types of communications commands are available for the K7DD.

Communications command	Description
Read Variable Area	Reads the variable area.
Write Variable Area	Writes the variable area.
Operation Command	Executes the following operations for the K7DD. <ul style="list-style-type: none"> • Software resets • Parameter initialization • Transition to operation stop status • Alarm latch cancel

The K7DD has an internal register called the "variable area", where the measurement values, status information, and setting parameters for each channel are assigned.

The Read Variable Area Command is used to read the measurement values, status information, and setting parameters. The Write Variable Area Command is used to write the setting parameters.

The Operation Commands are used to execute software resets, parameter initialization, etc. for K7DD without accessing the variable area.

Refer to [7-6 Modbus RTU Communications Format \(P.7-9\)](#) for information on the command frame/response frame configuration.

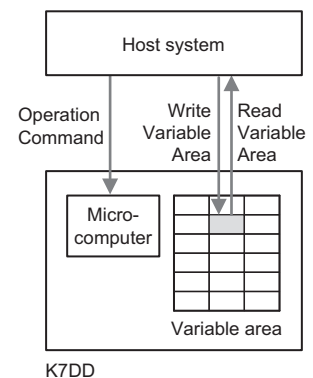

7-3 To Monitor All Feature Values Together (Read Variable Area)

7-3-1 Reading Measurement Values/Statuses

The K7DD can read the measurement values, statuses and setting parameters together at once, using the Read Variable Area Command.

With the Read Variable Area Command, the K7DD can read addresses by specifying them one by one or multiple addresses together by specifying an area. The latter case is useful as the read operation can be completed with one command/one response.

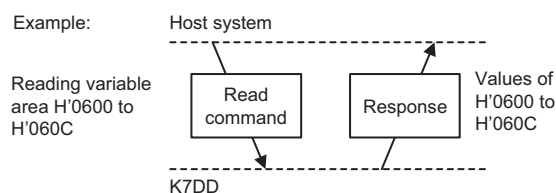

Refer to [□ 7-7 Variable Area Map \(P.7-17\)](#) for details on the variable area to specify.

The setting parameters can be read regardless of the status of the K7DD. The reading operation does not affect the K7DD operation.

7-4 Changing Setting Parameters (Write Variable Area)

7-4-1 Writing Setting Parameters

The Write Variable Area Command allows you to change the setting parameters.

With the Write Variable Area Command, the K7DD can write addresses by specifying them one by one or multiple addresses together by specifying an area. The latter case is useful as the write operation can be completed with one command/one response.

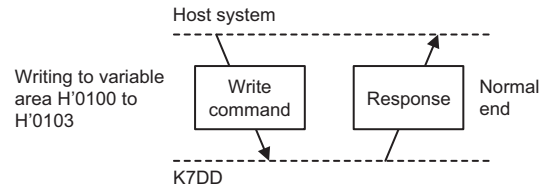

Sending this command changes and saves the setting parameters in the non-volatile memory in the K7DD.

Some setting parameters can be reflected immediately after writing, and others can be reflected after restart. Refer to the tables in [□ 7-7 Variable Area Map \(P.7-17\)](#) for information on which parameters can be reflected immediately or after restart.

For example, Feature Calculation Cycle is a parameter that can be reflected after restart. If the value of the Feature Calculation Cycle parameter is changed with a communications command (for changing setting parameters) after transition to the operation stop status, the power ON reset process must be executed by the Software Reset Command or other ways.

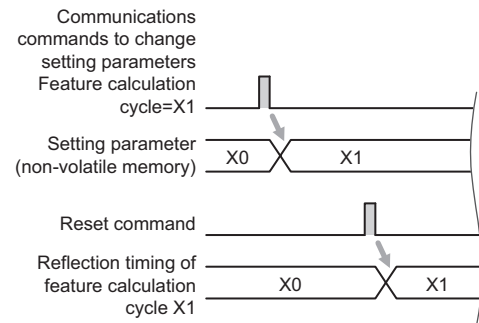

7-5 Operation Command

The following four types of Operation Commands are available.

Operation Command	Description
Software Reset Command	Performs a forced power ON reset.
Parameter Initialization Command	Resets all setting parameters to the factory default settings.
Operation Stop State Transition Command	Moves you to the operation stopped state.
Alarm Latch Cancel Command	Turns OFF the latched alarm status.

The Operation Commands are specified by a command code in the command frame.

□ 7-6 *Modbus RTU Communications Format* (P.7-9) describes the command frame/response frame configuration.

Software Reset Command

This command executes the power ON reset process, as with a reset process that runs when the power turns ON.

The power ON reset process puts the K7DD in the same initial state as after the power is turned ON. The Software Reset Command can be accepted on any levels.

The Software Reset Command can be used in the following cases.

- (1) To clear the latched alarm output.
- (2) To forcibly return to the Operation Level from a level other than the Operation Level (such as the Initial Setting Level) by remote operation.
(For example, if you leave the work site while the Unit is still on the Initial Setting Level selected with key operations, measurement will not start as it is not on the Operation Level.)
- (3) To enable a new setting value after changing a setting parameter with the Write Variable Area Command.

As for (3), the power ON reset process is required to enable a newly set value.

Refer also to □ 7-4 *Changing Setting Parameters (Write Variable Area)* (P.7-6).

Parameter Initialization Command

This command initializes the setting values of all the setting parameters except those on the Communications Setting Level.

The command can be accepted on the Initial Setting Level or Communications Setting Level where operations are stopped.

To enable the setting values that have been reset to their defaults, execute the power ON reset process by cycling the power supply, sending the Software Reset Command, or operating the keys.

The setting values can be initialized only by this operation command for communications.

To reset the setting values to their defaults by operating the K7DD, refer to the default values on the table in *A-2 Parameters List* (P.A-9).

Operation Stop State Transition Command

This command moves you to the Initial Setting Level where operations are stopped and can be accepted on the Operation Level or Adjustment Level where operations are performed.

In order to set the setting values on the Initial Setting Level or Communications Setting Level, you need to enter the operation stopped state.

To resume operation, the power ON reset process is required.

The power ON reset process can be executed by the following operations.

- Cycling the power supply
- Executing the Software Reset Command via communications
- Moving to the Operation Level with key operations (by pressing the Level Key for 1 second or more in the operation stopped state)

Alarm Latch Cancel Command

Turns OFF the latched alarm status.

When an alarm occurs, it is in the latched (retained) state. The alarm is unlatched when this command is sent with the measurement value falling short of the alarm value.

7-6 Modbus RTU Communications Format

Modbus RTU is a standard communications control method based on Modbus RTU mode (PI-MBUS-300 Rev. J) which is a communication protocol developed by Modicon. In the following description, hexadecimal values are expressed by adding the prefix “H” to the beginning, e.g., “H’02.”

7-6-1 Frame Configurations

Command Frame

A command frame starts with a silent interval of at least 3.5 character times and ends with a silent interval of at least 3.5 character times.

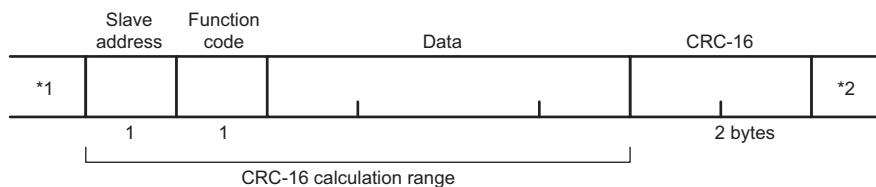

*1	Silent interval of 3.5 character times minimum.
Slave address	A number used to identify a destination device. Specify the unit number of the K7DD. The unit number can be set between H’01 to H’63 hexadecimal (01 to 99 decimal). To broadcast this value, specify H’00. However, in the case of broadcasting, no response is returned.
Function code	The function code is a 1-byte hexadecimal code that indicates the type of command sent from the host device.
Data	This is the text data associated with the specified function code. Specify the variable area address, setting values for setting parameters, etc. in hexadecimal format.
CRC-16	Cyclic Redundancy Check This check code is calculated with the data from the slave address to the end of the data. The check code is 2-byte hexadecimal.
*2	Silent interval of 3.5 character times minimum.

CRC-16 Calculation Method

Messages are processed one byte at a time in the work memory (a 16-bit register known as the CRC register).

- (1) The CRC register is initialized to H’FFFF.
- (2) An XOR operation is performed on the content of the CRC register and the first byte of the message, and the result is returned to the CRC register.
- (3) The MSB is packed with “0” and the CRC register is shifted 1 bit to the right.
- (4) If the bit shifted from the LSB is “0,” step (3) is repeated (next bit-shift processing).
If the bit shifted from the LSB is “1,” an XOR operation is performed on the content of the CRC register and H’A001, and the result is returned to the CRC register.
- (5) Steps (3) and (4) are repeated until 8 bits are shifted.

- (6) CRC processing continues to the end of the message, as XOR operations are performed on the content of the CRC register and the next byte of the message, and step (3) is repeated. The result is returned to the CRC register.
- (7) The result of the CRC calculation (value in the CRC register) is appended to the last byte of the message.

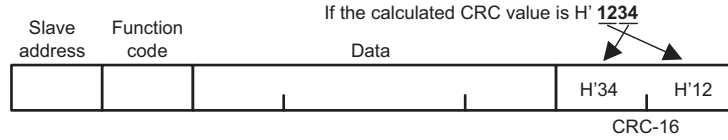

Response Frame

● Normal Operation:

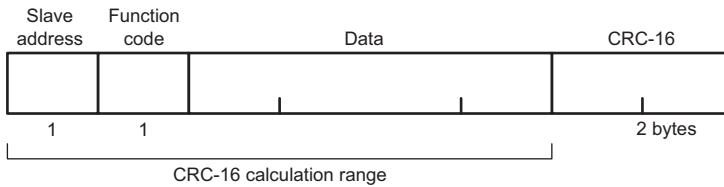

● Command Frame Error:

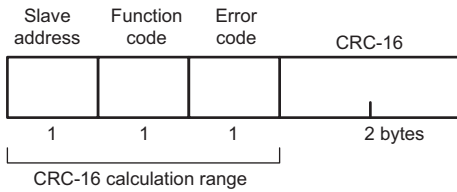

Slave address	The number specified in the command frame is entered as-is.
Function code	This is a received function code. As for the response frame when an error occurs, H'80 is added to the received function code to indicate an error response. Example: If the received function code is H'03, the error response is H'83.
Data	The body text of the response.
Error code	This code indicates the kind of error that occurred. Refer to the table below.
CRC-16	Cyclic Redundancy Check This check code is calculated with the data from the slave address to the end of the data. The check code is 2-byte hexadecimal.

● **Error Code:**

Completion code	Name	Description
H'01	Function code error	An unsupported function code was received.
H'02	Variable address error	The variable address was accessed in excess of H'FFFF.
H'03	Variable data error	<ul style="list-style-type: none"> • The number of elements specified in the command frame data and the number of data do not match. • The byte count is not two times the number of elements specified in the command frame data. • The number of elements exceeds the allowed range. • The write data specified in the command frame data is out of the setting range.
H'04	Operation error	No response can be made in this system state.

● **No Response:**

In the following cases, the received command is not processed and no response is returned, resulting in a timeout at the host system.

- The slave address in the command does not match the unit number.
- A parity error, framing error, or overrun error occurred due to a problem such as a transfer error.
- A CRC-16 code error occurred in the received command frame.
- There was an interval of 3.5 character times minimum between data packets that make up the command frame.
- A command frame exceeding the communication buffer was received.
- A command frame of the minimum size was not received (less than 4 bytes).
- The length of a command exceeded the minimum/maximum range determined by each function code.

In the following case, the received command is processed but no response is given.

- Broadcasting is specified (slave address: H'00)

7-6-2 Read Variable Area Command

● Command Frame:

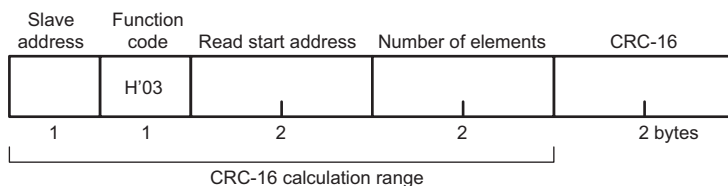

Slave address	A number used to identify a destination device. Specify the unit number of the K7DD. The unit number can be set between H'01 to H'63 hexadecimal (01 to 99 decimal).
Function code	The Read Variable Area Command's function code is H'03.
Read start address	Specify the address of the variable area to start reading in 2-byte hexadecimal. Refer to 7-7 Variable Area Map (P.7-17) .
Number of elements	Specify the number of variables to read. You can specify up to 125 variables (H'007D).
CRC-16	This check code is calculated with the data from the slave address to the end of the data.

● Response Frame:

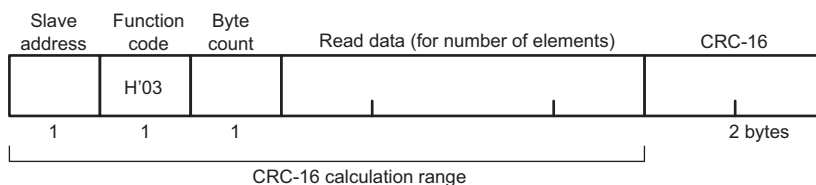

Slave address	The number specified in the command frame is entered as-is.
Function code	This is a received function code. H'80 is added if an error occurs.
Byte count	Contains the number of bytes of read data. The byte count is a hexadecimal.
Read data	Contains the read data value.
CRC-16	This check code is calculated with the data from the slave address to the end of the data.

● Response Codes:

Function code	Error code	Error name	Description
H'03	---	Normal end	The command ended normally.
H'83	H'02	Variable address error	The variable address was accessed in excess of H'FFFF.
	H'03	Variable data error	The number of elements exceeds the allowed range.
	H'04	Operation error	No response can be made in this system state.

Examples of Sending and Receiving Data

In these examples, measurement values are read from the slave with unit number 1. The variable address for CH1 R.M.S. voltage is H'1010.

● Command Frame:

Slave address	Function code	Read start address	Number of elements	CRC-16
H'01	H'03	H'1010	H'0001	H'810F

● Response Frame:

Slave address	Function code	Byte count	Read data (for number of elements)	CRC-16
H'01	H'03	H'02		

7-6-3 Write Variable Area Command

● Command Frame:

Slave address	Function code	Write start address	Number of elements	Byte count	Write data (for number of elements)	CRC-16
	H'10					
1	1	2	2	1		2 bytes

CRC-16 calculation range

Slave address	A number used to identify a destination device. Specify the unit number of the K7DD. The unit number can be set between H'01 to H'63 hexadecimal (01 to 99 decimal).
Function code	The Write Variable Area Command's function code is H'10.
Write start address	Specify the address of the variable area to start writing in 2-byte hexadecimal. Refer to □□ 7-4 Changing Setting Parameters (Write Variable Area) (P.7-6) .
Number of elements	Specify the number of variables to write. You can specify up to 123 variables (H'007B).
Byte count	Specify the number of bytes of data to write in hexadecimal format.
CRC-16	This check code is calculated with the data from the slave address to the end of the data.

● Response Frame:

Slave address	Function code	Write start address	Number of elements	CRC-16
	H'10			
1	1	2	2	2 bytes

CRC-16 calculation range

Slave address	The number specified in the command frame is entered as-is.
Function code	This is a received function code. H'80 is added if an error occurs.
Data	Contains the number of bytes of read data. The byte count is a hexadecimal.
Error code	Contains the read data value.
CRC-16	This check code is calculated with the data from the slave address to the end of the data.

● **Response Codes:**

Function code	Error code	Error name	Description
H'10	---	Normal end	The command ended normally.
H'90	H'02	Variable address error	The variable address was accessed in excess of H'FFFF.
	H'03	Variable data error	<ul style="list-style-type: none"> The number of data does not match the number of elements. The byte count is not two times the number of elements. The write data is out of the setting range.
	H'04	Operation error	<ul style="list-style-type: none"> No response can be made in this system state.

Examples of Sending and Receiving Data

Rewrite setting parameters for the slave with unit number 1.

The variable addresses for the CH1 R.M.S. Voltage Critical Threshold/ CH1 R.M.S. Voltage Warning Threshold are H'1300 to H'1301.

● **Command Frame:**

Slave address	Function code	Write start address	Number of elements	Byte count	Write data (for number of elements)	CRC-16
H'01	H'10	H'1300	H'0002	H'04		

● **Response Frame:**

Slave address	Function code	Write start address	Number of elements	CRC-16
H'01	H'10	H'1300	H'0002	H'454C

7-6-4 Operation Command or Write Variable Area Command (Single)

Command Frame:

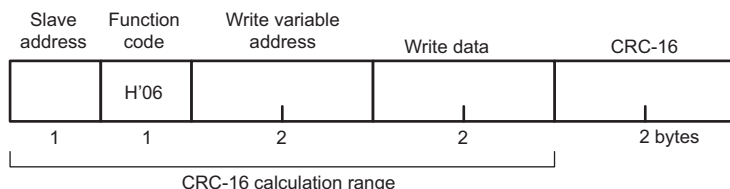

Slave address	A number used to identify a destination device. Specify the unit number of the K7DD. The unit number can be set between H'00 to H'63 hexadecimal (0 to 99 decimal).
Function code	The function code of Operation Command or Write Variable Area Command (single) is H'06.
Write variable address	For the Operation Command, specify a command code (H'D000 to H'D003). Refer to □□ Command Codes and Related Information: (P.7-15) for details. For the Write Variable Area Command (single), specify an address of the variable area to start writing in 2-byte hexadecimal. Refer to □□ 7-4 Changing Setting Parameters (Write Variable Area) (P.7-6) .
Write data	For the Operation Command, specify related information. Refer to □□ Command Codes and Related Information: (P.7-15) for details. For the Write Variable Area Command (single), specify write data.
CRC-16	This check code is calculated with the data from the slave address to the end of the data.

Command Codes and Related Information:

Command code	Operation Command	Related information byte
H'D000	Software Reset	0001: Run
H'D001	Parameter Initialization	0001: Run
H'D002	Operation Stop Status Transition	0001: Run
H'D003	Alarm Latch Cancel	00FF: Run
H'D004 to H'D008	Prohibited to use	---

Response Frame:

When the command is executed successfully, the response returns the same data sent in the command frame.

Response Codes:

Function code	Error code	Error name	Description
H'06	-	Normal end	The command ended normally.
H'86	H'03	Variable address error	The write data is out of the setting range.
	H'04	Operation error	No response can be made in this system state.

Examples of Sending and Receiving Data

The Software Reset Command is sent to the slave with unit number 1.

● Command Frame/Response Frame:

Slave address	Function code	Write variable address	Write data	CRC-16
H'01	H'06	H'D000	H'0001	H'70CA

7-7 Variable Area Map

7-7-1 Variable Area Map Descriptions

Since the K7DD can monitor 3 channels, variable addresses are also provided for 3 channels. Hexadecimal values are expressed by H'**.

- The variable addresses of CH1 start with H'1000.

Example:

Channel	Variable address	Variable name
CH1	H'1000	Measurement Status
	H'1001	Monitoring Status
	H'1002 to H'100F	Reserved
	H'1010 H'1011 : H'109C H'109D	CH Feature [ID:0] Monitoring CH Feature [ID:1] Monitoring : CH Feature [ID:140] Monitoring CH Feature [ID:141] Monitoring
⋮	⋮	⋮

- The variable addresses of CH2 start with H'3000.

Example:

Channel	Variable address	Variable name
CH2	H'3000	Measurement Status
	H'3001	Monitoring Status
	H'3002 to H'300F	Reserved
	H'3010 H'3011 : H'309C H'309D	CH Feature [ID:0] Monitoring CH Feature [ID:1] Monitoring : CH Feature [ID:140] Monitoring CH Feature [ID:141] Monitoring
⋮	⋮	⋮

- The variable addresses of CH3 start with H'5000.

Example:

Channel	Variable address	Variable name
Both CH1 and CH2	H'5000	Measurement Status
	H'5001	Monitoring Status
	H'5002 to H'500F	Reserved
	H'5010 H'5011 : H'509C H'509D	CH Feature [ID:0] Monitoring CH Feature [ID:1] Monitoring : CH Feature [ID:140] Monitoring CH Feature [ID:141] Monitoring
• • •	• • •	• • •

- The variable addresses of CH1, CH2, and CH3 start with H'0000.

Example:

Channel	Variable address	Variable name
Common to CH1, CH2, and CH3	H'0000	K7DD Status
	H'0001 to H'0070	Reserved
	H'0080 H'0081 H'0082 : H'00A4 H'00A5 H'00A6	Monitored Feature [0] Monitor Ch 1 Monitored Feature [0] Monitor Ch 2 : Monitored Feature [0] Monitor Ch 1 : Monitored Feature [12] Monitor Ch 1 Monitored Feature [12] Monitor Ch 2 Monitored Feature [12] Monitor Ch 1
• • •	• • •	• • •

 This manual describes only the variable addresses of CH1 so as to simplify the description. When you use a variable address of CH2, change the beginning of the variable address of CH1 into 3 or 4 before use. When you use a variable address of CH3, change the beginning of the variable address of CH1 into 5 or 6 before use.

Example: (CH1) H'1000 → (CH2) H'3000 → (CH3) H'5000
(CH1) H'2000 → (CH2) H'4000 → (CH3) H'6000

To write via communications a variable whose setting reflection timing is “After restart,” you need to execute the Operation Stop Status Transition Command (Operation Command) or move to the Initial Setting Level with Key operations beforehand.

Setting reflection timing
Immediately
After restart

7-7-2 Common Variable Area

Specify the address to access each variable.

Hexadecimal values are expressed by H**.

Variable address	Variable name	Description	Setting reflection timing																												
H'0000	K7DD Status	This is a monitored value. It is the parameter exclusive to communications. It is the data that brings together the status of the K7DD. Refer to □ 7-7-5 Details about Status Information (P.7-25) for details about the bits.	---																												
H'0001 to H'007F	Reserved	Do not access.	---																												
H'0080 H'0081 H'0082 : : H'00A4 H'00A5 H'00A6	Monitored Feature [0] Monitor Ch 1 Monitored Feature [0] Monitor Ch 2 Monitored Feature [0] Monitor Ch 3 : : Monitored Feature [12] Monitor Ch 1 Monitored Feature [12] Monitor Ch 2 Monitored Feature [12] Monitor Ch 3	This is a monitored value. This indicates the feature value set as a monitored feature. 13 types are allocated for each channel. H'FFFF to H'008D (-1 to 141) Default value <table border="1" data-bbox="778 837 1315 1391"> <thead> <tr> <th>Variable name</th> <th>Allocated feature (ID)</th> </tr> </thead> <tbody> <tr> <td>Monitored Feature [0]</td> <td>R.M.S. Voltage (0)</td> </tr> <tr> <td>Monitored Feature [1]</td> <td>Voltage Fundamental Amplitude (4)</td> </tr> <tr> <td>Monitored Feature [2]</td> <td>Voltage Total Harmonic Distortion (5)</td> </tr> <tr> <td>Monitored Feature [3]</td> <td>R.M.S. Current (6)</td> </tr> <tr> <td>Monitored Feature [4]</td> <td>Current fundamental amplitude (10)</td> </tr> <tr> <td>Monitored Feature [5]</td> <td>Current Total Harmonic Distortion (136)</td> </tr> <tr> <td>Monitored Feature [6]</td> <td>Active Power (137)</td> </tr> <tr> <td>Monitored Feature [7]</td> <td>Power Factor (140)</td> </tr> <tr> <td>Monitored Feature [8]</td> <td>Frequency (141)</td> </tr> <tr> <td>Monitored Feature [9]</td> <td>Disabled (-1)</td> </tr> <tr> <td>Monitored Feature [10]</td> <td>Disabled (-1)</td> </tr> <tr> <td>Monitored Feature [11]</td> <td>Disabled (-1)</td> </tr> <tr> <td>Monitored Feature [12]</td> <td>Disabled (-1)</td> </tr> </tbody> </table>	Variable name	Allocated feature (ID)	Monitored Feature [0]	R.M.S. Voltage (0)	Monitored Feature [1]	Voltage Fundamental Amplitude (4)	Monitored Feature [2]	Voltage Total Harmonic Distortion (5)	Monitored Feature [3]	R.M.S. Current (6)	Monitored Feature [4]	Current fundamental amplitude (10)	Monitored Feature [5]	Current Total Harmonic Distortion (136)	Monitored Feature [6]	Active Power (137)	Monitored Feature [7]	Power Factor (140)	Monitored Feature [8]	Frequency (141)	Monitored Feature [9]	Disabled (-1)	Monitored Feature [10]	Disabled (-1)	Monitored Feature [11]	Disabled (-1)	Monitored Feature [12]	Disabled (-1)	---
Variable name	Allocated feature (ID)																														
Monitored Feature [0]	R.M.S. Voltage (0)																														
Monitored Feature [1]	Voltage Fundamental Amplitude (4)																														
Monitored Feature [2]	Voltage Total Harmonic Distortion (5)																														
Monitored Feature [3]	R.M.S. Current (6)																														
Monitored Feature [4]	Current fundamental amplitude (10)																														
Monitored Feature [5]	Current Total Harmonic Distortion (136)																														
Monitored Feature [6]	Active Power (137)																														
Monitored Feature [7]	Power Factor (140)																														
Monitored Feature [8]	Frequency (141)																														
Monitored Feature [9]	Disabled (-1)																														
Monitored Feature [10]	Disabled (-1)																														
Monitored Feature [11]	Disabled (-1)																														
Monitored Feature [12]	Disabled (-1)																														
H'00A7 to H'00FF	Reserved	Do not access.	---																												
H'0100	Measurement Delay Time	This is a setting parameter. This indicates the waiting time from the trigger point to measurement start. H'0000 to H'1770 (0 to 6000 [CCF]) Default value: H'0000 (0[CCF]) [CCF] is a unit when the feature calculation cycle is 1.	Immediately																												
H'0101	Measurement Time	This is a setting parameter. It expresses a time from the measurement start to the end. H'0001 to H'1770 (1 to 6000 [CCF]) Default value: H'0001 (1[CCF]) [CCF] is a unit when the feature calculation cycle is 1.	Immediately																												
H'0102	Internal Trigger Level	This is a setting parameter. It is the level of the internal trigger. A trigger point is assumed when the feature value as the internal trigger source exceeds this variable value. H'8007 to H'7FF9 (-32761 to 32761 [digit]) Default value: H'7FF9 (32761[digit])	Immediately																												

Variable address	Variable name	Description	Setting reflection timing
H'0103	Internal Trigger Hysteresis	This is a setting parameter. It is the hysteresis of the internal trigger. After measurement is started by the internal trigger, measurement continues until the internal trigger source drops as much as this hysteresis. H'0001 to H'2710 (1 to 10000 [digit]) Default value: H'000A (10[digit])	Immediately
H'0104 to H'01FF	Reserved	Do not access.	---
H'0200	Monitored Feature [0] Critical Threshold-Ch1	These are setting parameters. They are the critical threshold and warning threshold of the monitored feature assigned to [0] through [12]. These setting parameters are addressed for each channel of 1 to 3. For information on the setting ranges, refer to  A-2 <i>Parameters List</i> (P.A-9).	Immediately
H'0201	Monitored Feature [0] Warning Threshold-Ch 1		
H'0202	Monitored Feature [0] Critical Threshold-Ch2		
H'0203	Monitored Feature [0] Warning Threshold-Ch2		
H'0204	Monitored Feature [0] Critical Threshold-Ch3		
H'0205	Monitored Feature [0] Warning Threshold-Ch3		
:	:		
H'0248	Monitored Feature [12] Critical Threshold-Ch1		
H'0249	Monitored Feature [12] Warning Threshold-Ch1		
H'024A	Monitored Feature [12] Critical Threshold-Ch2		
H'024B	Monitored Feature [12] Warning Threshold-Ch2		
H'024C	Monitored Feature [12] Critical Threshold-Ch3		
H'024D	Monitored Feature [12] Warning Threshold-Ch3		
H'024E to H'0300	Reserved		
H'0301	Wiring State	This is a setting parameter. Set the electrical wiring of the actuator to be monitored. H'0000: 3P3W2M (default value), H'0001: 3P4W, H'0002: Single-phase current only	After restart
H'0302	Current Input Range	This is a setting parameter. H'0000: 0 to 5 A (default value), H'0001: 0 to 25 A, H'0002: 0 to 100 A, H'0003: 0 to 200 A, H'0004: 0 to 400 A	After restart
H'0303	Voltage Input Range	This is a setting parameter. H'0000: 0 to 150 V (default value), H'0001: 0 to 300 V, H'0002: 0 to 600 V	After restart
H'0304	Feature Calculation Cycle	This is a setting parameter. It is a cycle at which the K7DD calculates the feature values. Set the parameter according to the device operation. H'0001 to H'07D0 (1 to 2000) Unit 50 msec, Default value: H'0001 (1)	After restart
H'0305	Alarm Threshold Calculation Sensitivity	This is a setting parameter. It is an adjustment parameter for calculating thresholds when performing simplified threshold settings of the K7DD function. H'00C8 to H'07D0 (20.0 to 200.0%) Default value: H'0320 (80.0%)	After restart
H'0306 to H'03FF	Reserved	Do not access.	---

Variable address	Variable name	Description	Setting reflection timing
H'0400	Trigger Mode *1	This is a setting parameter. Set the mode of the trigger. H'0000: Continuous (default value), H'0001: External, H'0002: Internal	After restart
H'0401	Trigger Type *1	This is a setting parameter. Set the type of the trigger. H'0000: Rising (default value), H'0001: Falling, H'0002: Level	After restart
H'0402	Internal Trigger Source	This is a setting parameter. Set the feature value used as the trigger source. H'0000: Ch1 R.M.S. Voltage (default value) H'0001: Ch2 R.M.S. Voltage H'0002: Ch3 R.M.S. Voltage H'0003: Ch1 R.M.S. Current H'0004: Ch2 R.M.S. Current H'0005: Ch3 R.M.S. Current H'0006: Ch1 Frequency H'0007: Reserved H'0008: Reserved H'0009: Active Power H'000A: Power Factor	After restart
H'0403 to H'04FF	Reserved	Do not access.	---
H'0500	Baud Rate 1	This is a setting parameter. Set the baud rate of the communications terminal 1. H'0000: 9.6 k, H'0001: 19.2 k, H'0002: 38.4 k, H'0003: 57.6 k, H'0004: 115.2 k (default value), H'0005: 230.4 kbps	After restart
H'0501	Parity 1	This is a setting parameter. Set the parity of the communications terminal 1. H'0000: None, H'0001: Even (default value), H'0002: Odd	After restart
H'0502	Send Wait Time 1	This is a setting parameter. Set the send wait time of the communications terminal 1. H'0000 to H'0063 (0 to 99 ms), Default value: H'0014 (20 ms)	After restart
H'0503	Baud Rate 2	This is a setting parameter. Set the baud rate of the communications terminal 2. H'0000: 9.6 k, H'0001: 19.2 k, H'0002: 38.4 k, H'0003: 57.6 k, H'0004: 115.2 k (default value), H'0005: 230.4 kbps	After restart
H'0504	Parity 2	This is a setting parameter. Set the parity of the communications terminal 2. H'0000: None, H'0001: Even (default value), H'0002: Odd	After restart
H'0505	Send Wait Time 2	This is a setting parameter. Set the send wait time of the communications terminal 2. H'0000 to H'0063 (0 to 99 ms), Default value: H'0014 (20 ms)	After restart
H'0506 to H'05FF	Reserved	Do not access.	---
H'0600 H'0601 : : H'068D	Monitored Feature [0] Alarm Type Monitored Feature [1] Alarm Type : : Monitored Feature [141] Alarm Type	This is a setting parameter. It is an alarm type set for each of the feature values having 142 types of IDs. Refer to  6-3-1 Feature Value Range for Monitoring for information on the list of feature values and IDs and the setting ranges.	After restart
H'068E to H'06FF	Reserved	Do not access.	---

*1 When selecting External (H'0001) as the trigger mode and Level (H'0002) as the trigger type, set the feature calculation cycle to the default value (H'0001: 1). Otherwise, correct measurement may not be achieved.

Variable address	Variable name	Description	Setting reflection timing																												
H'0700 H'0701 : H'070C	Monitored Feature [0] Setting Monitored Feature [1] Setting : Monitored Feature [12] Setting	<p>This is a setting parameter. It is the ID of the feature value to be monitored, specified among a number of features. 13 types are allocated for each channel. H'FFFF to H'008D (-1 to 141) Default value</p> <table border="1"> <thead> <tr> <th>Variable name</th> <th>Allocated feature (ID)</th> </tr> </thead> <tbody> <tr> <td>Monitored Feature [0]</td> <td>R.M.S. Voltage (0)</td> </tr> <tr> <td>Monitored Feature [1]</td> <td>Voltage Fundamental Amplitude (4)</td> </tr> <tr> <td>Monitored Feature [2]</td> <td>Voltage Total Harmonic Distortion (5)</td> </tr> <tr> <td>Monitored Feature [3]</td> <td>R.M.S. Current (6)</td> </tr> <tr> <td>Monitored Feature [4]</td> <td>Current fundamental amplitude (10)</td> </tr> <tr> <td>Monitored Feature [5]</td> <td>Current Total Harmonic Distortion (136)</td> </tr> <tr> <td>Monitored Feature [6]</td> <td>Active Power (137)</td> </tr> <tr> <td>Monitored Feature [7]</td> <td>Power Factor (140)</td> </tr> <tr> <td>Monitored Feature [8]</td> <td>Frequency (141)</td> </tr> <tr> <td>Monitored Feature [19]</td> <td>Disabled (-1)</td> </tr> <tr> <td>Monitored Feature [10]</td> <td>Disabled (-1)</td> </tr> <tr> <td>Monitored Feature [11]</td> <td>Disabled (-1)</td> </tr> <tr> <td>Monitored Feature [12]</td> <td>Disabled (-1)</td> </tr> </tbody> </table>	Variable name	Allocated feature (ID)	Monitored Feature [0]	R.M.S. Voltage (0)	Monitored Feature [1]	Voltage Fundamental Amplitude (4)	Monitored Feature [2]	Voltage Total Harmonic Distortion (5)	Monitored Feature [3]	R.M.S. Current (6)	Monitored Feature [4]	Current fundamental amplitude (10)	Monitored Feature [5]	Current Total Harmonic Distortion (136)	Monitored Feature [6]	Active Power (137)	Monitored Feature [7]	Power Factor (140)	Monitored Feature [8]	Frequency (141)	Monitored Feature [19]	Disabled (-1)	Monitored Feature [10]	Disabled (-1)	Monitored Feature [11]	Disabled (-1)	Monitored Feature [12]	Disabled (-1)	After restart
Variable name	Allocated feature (ID)																														
Monitored Feature [0]	R.M.S. Voltage (0)																														
Monitored Feature [1]	Voltage Fundamental Amplitude (4)																														
Monitored Feature [2]	Voltage Total Harmonic Distortion (5)																														
Monitored Feature [3]	R.M.S. Current (6)																														
Monitored Feature [4]	Current fundamental amplitude (10)																														
Monitored Feature [5]	Current Total Harmonic Distortion (136)																														
Monitored Feature [6]	Active Power (137)																														
Monitored Feature [7]	Power Factor (140)																														
Monitored Feature [8]	Frequency (141)																														
Monitored Feature [19]	Disabled (-1)																														
Monitored Feature [10]	Disabled (-1)																														
Monitored Feature [11]	Disabled (-1)																														
Monitored Feature [12]	Disabled (-1)																														
H'070D to H'0FFF	Reserved	Do not access.	---																												

7-7-3 Variable Area for Each Channel

This manual describes only the variable addresses of CH1 so as to simplify the description.

When you use a variable address of CH2, change the beginning of the variable address of CH1 into 3 or 4 before use.

When you use a variable address of CH3, change the beginning of the variable address of CH1 into 5 or 6 before use.

Example: (CH1) H'1000 → (CH2) H'3000 → (CH3) H'5000
(CH1) H'2000 → (CH2) H'4000 → (CH3) H'6000

Specify the address to access each variable.

Hexadecimal values are expressed by H'**.

Variable address	Variable name	Description	Setting reflection timing
H'1000	Measurement Status	This is a monitored value. It is the parameter exclusive to communications. It is the data that aggregates the measurement status. Refer to 7-7-5 Details about Status Information (P.7-25) for details about the bits.	---
H'1001	Monitoring Status	This is a monitored value. It is the parameter exclusive to communications. It is the data that aggregates the monitoring status. Refer to 7-7-5 Details about Status Information (P.7-25) for details about the bits.	---
H'1002 to H'100F	Reserved	Do not access.	---
H'1010 H'1011 : H'109C H'109D	CH Feature [ID:0] Monitoring CH Feature [ID:1] Monitoring : CH Feature [ID:140] Monitoring CH Feature [ID:141] Monitoring	These are monitored values. Each feature value has the IDs of 142 types. For the list of feature values and IDs, refer to 6-3-1 Feature Value Range for Monitoring .	---
H'109E to H'12FF	Reserved	Do not access.	---
H'1300 H'1301 H'1302 H'1303 : H'141A H'141B	CH Feature [ID:0] Critical Threshold CH Feature [ID:0] Warning Threshold CH Feature [ID:1] Critical Threshold CH Feature [ID:1] Warning Threshold : CH Feature [ID:141] Critical Threshold CH Feature [ID:141] Warning Threshold	These are setting parameters. They are the critical threshold and warning threshold of each feature value. Each feature value has the IDs of 142 types. For the list of feature values, IDs, and the setting ranges, refer to 6-3-1 Feature Value Range for Monitoring .	Immediately
H'141C to H'2FFF	Reserved	Do not access.	---

7-7-4 K7DD Information Area

Specify the address to access each variable.

Hexadecimal values are expressed by H**.

Variable address	Variable name	Description
H'C000 to H'C002	Reserved	Do not access.
H'C003	Major Revision	Indicates a major revision of the firmware version. Example: H'0001 for version 1.2
H'C004	Minor Revision	Indicates a minor revision of the firmware version. Example: H'0002 for version 1.2
H'C005 to H'C006	Serial Number	This is the parameter exclusive to communications. It is a product-unique serial number. H'00000000 to H'FFFFFFFF (0 to 4294967295) Variable address H'C005 is the more-significant digit and H'C006 is the less-significant digit.
H'C007 to H'C009	Reserved	Do not access.
H'C00A to H'C019	Product Model	This is the parameter exclusive to communications. Indicates a model of the K7DD in ASCII code. The model is left-aligned. The remaining areas are filled with ASCII space codes (H'20). (Example) When the model is K7DD-PQMA, H'4B3744442D50514D4120... When the model is K7DD-PQMD, H'4B3744442D50514D4420...
H'C01A to H'C01D	Product Code	This is the parameter exclusive to communications. This is a JAN/EAN code for the K7DD. 4549734776646: K7DD-PQMA 4549734776653: K7DD-PQMD Example: When the code is read for the K7DD, it becomes H'0XXXXXXXXXXXX00, with H'0 appended to the most-significant digit and H'00 appended to the least-significant digit. Variable address H'C01A is the most-significant digit and H'C01D is the least-significant digit.
H'C01E to H'FFFF	Reserved	Do not access.

7-7-5 Details about Status Information

Variable address	Variable name	B12-15	B11	B10	B9	B8	B2-7	B1	B0	Bit name	Description
H'0000	K7DD Status									Comprehensive Deterioration Alarm (Warning)	0: Comprehensive Deterioration Alarm (Warning) did not occur 1: Deterioration Alarm (Warning) occurred in a channel
										Comprehensive Deterioration Alarm (Critical)	0: Comprehensive Deterioration Alarm (Critical) did not occur 1: Deterioration Alarm (Critical) occurred in a channel
										-	Not used: Always 0
										Operation	0: Operation stopped 1: During operation
										Operation Stopped	0: During operation 1: Operation stopped
										K7DD Error *1	0: K7DD Error did not occur 1: K7DD Error occurred
										Input Circuit Error *1	0: Input Circuit Error did not occur 1: Input Circuit Error occurred.
-	Not used: Always 0										

*1 When this bit is 1, an error has occurred in the K7DD. Refer to  Section 8 Troubleshooting (P. 8-1) for details.

Variable address	Variable name	B8-15	B7	B4-6	B3	B2	B1	B0	Bit name	Description
H'1000	Measurement Status								Frequency Out-of-Range Error	0: Frequency Out-of-Range Error did not occur 1: Frequency Out-of-Range Error occurred
									Voltage Value Out-of-Range Error	0: Voltage Value Out-of-Range Error did not occur 1: Voltage Value Out-of-Range Error occurred
									Current Value Out-of-Range Error	0: Current Value Out-of-Range Error did not occur 1: Current Value Out-of-Range Error occurred
									Measurement Value Holding	0: Measurement value holding is not fulfilled 1: Measurement value holding is fulfilled
									-	Not used: Always 0
									Normal Data Acquisition Status	0: Normal data acquisition is not fulfilled 1: Normal data acquisition is fulfilled
									-	Not used: Always 0

Variable address	Variable name	B2	B1	B0	Bit name	Description
H'1001	Monitoring Status				Deterioration Alarm (Warning)	0: Deterioration Alarm (Warning) did not occur 1: Deterioration Alarm (Warning) occurred
					Deterioration Alarm (Critical)	0: Deterioration Alarm (Critical) did not occur 1: Deterioration Alarm (Critical) occurred
					-	Not used: Always 0

8

Troubleshooting

8-1 Troubleshooting	8-2
---------------------------	-----

8-1 Troubleshooting

Check the following table if the K7DD does not perform the expected operation.

When	Problems	Cause	Possible correction	Remarks
At power ON	When the power is turned ON, [FREQ] (Frequency Out-of-Range Error) is lit and the main display shows "----".	The frequency may not be measured because no current is input.	Check the wiring of the CTs.	3-4 I/O Wiring (P.3-8)
	The main display shows "----".	No voltage or current may be input.	Check that the power supply is turned ON. Check also that the wiring is completed correctly.	3-4 I/O Wiring (P.3-8) 3-5 Wiring to the Power Lines (P.3-13)
		The input of the voltage or current may be too small.	Review the input range.	Current Input Range, Voltage Input Range in 6-6-2 Parameters on Initial Setting Level (P.6-21)
In operation	Cannot start teaching with the simplified threshold setting. The [INTL] does not light during teaching.	Teaching does not start if a measurement error has occurred.	Remove the cause of the measurement error.	4-5 Measurement Error (P.4-11)
		The wiring state may not be 3P3W2M or 3P4W.	<ul style="list-style-type: none"> Review the parameters on the Initial Setting Level, and review also the wiring state parameters. 	4-3-3 Description of Operation (P.4-6) 6-6-2 Parameters on Initial Setting Level (P.6-21)
		The trigger mode has not been set to continuous mode.	Set the trigger mode to continuous mode using the Support Tool or via communications, and perform power ON reset.	4-3-3 Description of Operation (P.4-6) 5-2-2 Trigger Measurement Simulation (P.5-5)
	The alarm output indicator does not light green even when the alarm latch cancel command is issued.	The alarm latch cancel command may have been issued when the monitored feature has entered the alarm range determined by the critical/warning thresholds.	Check the Adjustment Level parameters and review the set values for the critical/warning thresholds.	4-4 Alarm (P.4-9) 6-5 Adjustment Level (LVL \bar{A}) (P.6-13)
	<ul style="list-style-type: none"> The single light of "VOLT," "CRNT," or "FREQ" is lit. The parameter display is indicated as "-----". 	A measurement error may have occurred.	If this symptom occurs frequently, review the followings. <ul style="list-style-type: none"> Voltage Input Range Current Input Range Ratings of special CTs 	4-5 Measurement Error (P.4-11)
At communications connection	The communications connection does not work well.	The slave address specified in the communication command from the host may not match the unit number of the K7DD.	Check if the slave address numbers in the communication command are correct.	7-6-1 Frame Configurations (P.7-9)
		The stop bit of the communication command may not match that of the K7DD side. When the communication parity setting of the K7DD is changed between Even/Odd and None, the stop bit setting is automatically changed between 1 bit and 2 bits.	Check if the communication parity and communication stop bit on the host side match.	Initial Setting of Communications Converter in 3-6 Wiring the Communications Cables (P.3-14)
	The unit error bit/input circuit error bit in the "Unit Status" became 1.	A self-diagnosis error has occurred.	<ul style="list-style-type: none"> Cycle the power supply. If operation returns to normal, then noise may have caused the problem. Check for noise. If the Unit does not recover, contact your OMRON representative. 	4-6 Self-diagnosis Error (P.4-13)

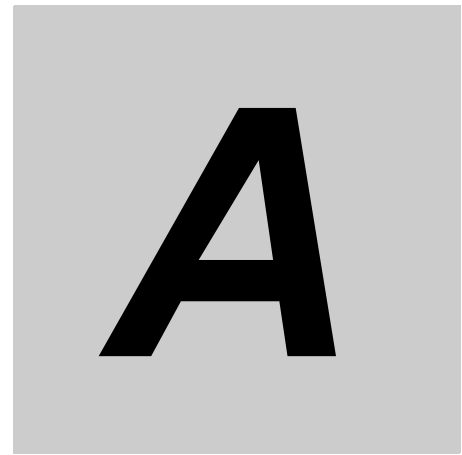

Appendices

A-1 Specifications	A-2
A-1-1 K7DD	A-2
A-1-2 Special CTs	A-6
A-1-3 Applicable Standards	A-8
A-2 Parameters List	A-9
A-3 Parameter Flow	A-12
A-4 Feature Calculations	A-13
A-4-1 Feature Values of Voltage System	A-13
A-4-2 Feature Values of Current System	A-15
A-4-3 Feature Values of Power Consumption, Power Factor and Power Frequency	A-17

A-1 Specifications

A-1-1 K7DD

Ratings and Specifications

Item		Specifications
Operation power supply	Power supply voltage and frequency	K7DD-PQMA: 100 to 240 V AC, 50/60 Hz K7DD-PQMD: 24 V DC
	Operating power supply voltage range	85% to 110% of the rated voltage
	Operating frequency range	45 to 65 Hz
	Power consumption	K7DD-PQMA: 15.7 VA max. (100 to 240 V AC) K7DD-PQMD: 5.2 W max. (24 V DC)
	Recommend external fuse	T2A, time delay, high-breaking capacity
CH1 voltage input CH2 voltage input CH3 voltage input	Measurement accuracy	☐ <i>A-4 Feature Calculations (P.A-13)</i>
	Input range	☐ <i>A-4 Feature Calculations (P.A-13)</i>
	Recommend external fuse	Class CC, Class J, or Class T with a rated current of 7 A or less
CH1 CT input CH2 CT input CH3 CT input	Measurement accuracy	☐ <i>A-4 Feature Calculations (P.A-13)</i>
	Input range	☐ <i>A-4 Feature Calculations (P.A-13)</i>
Trigger input	Input type	No-voltage contact and open collector are available.
	Residual voltage at short circuit	1.5 V max.
	Open leakage current	0.1 mA max.
	ON current at short circuit	Approx. 7 mA
RS-485 communications 1 RS-485 communications 2	Transmission path connection method	RS-485: Multidrop
	Communications method	RS-485 (2-wire, half duplex)
	Cable length	When the baud rate is 115.2 kbps or less, the maximum length is 500 m with a shielded twisted-pair cable. When the baud rate is 230.4 kbps, the maximum length is 200 m with a shielded twisted-pair cable.
	Protocol	Modbus RTU
	Baud rate	9.6 kbps/ 19.2 kbps/ 38.4 kbps/ 57.6 kbps/ 115.2 kbps/ 230.4 kbps
	Data length	Always 8 bits
	Stop bits	Always 1 bit (with Even or Odd parity) Always 2 bits (with None parity)
	Connection configurations	1:1 or 1:N
	Maximum number of Units	32 Units (including the host system)
	Parity	None/Even/Odd
Send wait time	0 to 99 ms	

Item		Specifications
Transistor output (Alarm output, Output at Error)	Contact form	NPN open-collector
	Rated voltage	24 V DC (maximum voltage: 26.4 V DC)
	Maximum current	50 mA
	Leakage current at power OFF	0.1 mA max.
	Residual voltage	1.5 V max.
Ambient operating temperature		-10 to 55°C (with no condensation or icing)
Ambient operating humidity		25% to 85% RH (with no condensation)
Storage temperature		-20 to 65°C (with no condensation or icing)
Altitude		2,000 m max.
Insulation resistance		20 MΩ min. Between the power supply terminals and the other terminals; Between all the terminals and the case; Between (communications terminals + trigger input terminals + alarm output terminals) and the other terminals; Between (voltage input terminals + CT input terminals) and the other terminals
Dielectric strength		2,000 V AC for 1 minute Between the power supply terminals and the other terminals; Between all the terminals and the case; Between (communications terminals + trigger input terminals + alarm output terminals) and the other terminals; Between (voltage input terminals + CT input terminals) and the other terminals
Vibration resistance		Frequency 10 to 55 Hz, 0.35-mm single amplitude, acceleration 50 m/s ² , 10 sweeps each in X, Y and Z directions for 5 min
Shock resistance		100 m/s ² , 3 times each in X, Y, and Z axes, 6 directions
Degree of protection		IP20
Terminal block type		Push-In Plus
Exterior color		Black (Munsell N 1.5)
Mounting		DIN Track
Weight		Approx. 360 g
Wiring material	Wire type	Solid or Stranded wire
	Wiring material	Copper
	Recommended wires	0.25 to 1.5 mm ² AWG24 to AWG16
	Stripping length	8 mm*, 10 mm, 12 mm *without ferrules
Installation environment		Operation voltage: EN/IEC 61010-1 Pollution Degree 2, Overvoltage category II
		Measurement circuit: EN/IEC 61010-2-030 Pollution Degree 2, CAT II 600 V or CAT III 300 V
Industrial electromagnetic environment		EN/IEC 61326-1 Industrial electromagnetic environment

Measurement Specifications

Item		Specifications	Conditions
Input range (Displayable range)	Current	5 A range: 0.275 to 5.5 A 25 A range: 1.375 to 27.5 A 100 A range: 5.5 to 110.0 A 200 A range: 11.0 to 220.0 A 400 A range: 22.0 to 440.0 A	<ul style="list-style-type: none"> Defined by R.M.S. values using a sine wave. The power frequency must be within the acceptable range.
	Voltage	150 V range: 8.3 to 165.0 V 300 V range: 16.5 to 330.0 V 600 V range: 33.0 to 660.0 V	
	Power frequency	40 to 250 Hz	Sine-wave or single-order harmonic content must be 20% or less.
Input ratings (Measurement accuracy guarantee range)	Current	5 A range: 1.0. to 5.0 A 25 A range: 5.0 to 25.0 A 100 A range: 25.0 to 100.0 A 200 A range: 100.0 to 200.0 A 400 A range: 200.0 to 400.0 A	<ul style="list-style-type: none"> Defined by R.M.S. values using a sine wave. The power frequency must be within the acceptable range.
	Voltage	150 V range: 75.0 to 150.0 V 300 V range: 150.0 to 300.0 V 600 V range: 300.0 to 600.0 V	
	Power frequency	45 to 245 Hz	Since wave
Measurement accuracy (Ambient temperature: 10 to 30°C)	Current	Absolute accuracy: 0.5%FS±1digit Repeat accuracy: ±1%rdg±1digit	<ul style="list-style-type: none"> Not including accuracy variation of CTs The power frequency must be within the rated range.
	Voltage	Absolute accuracy: 0.5%FS±1digit Repeat accuracy: ±1%rdg±1digit	
	Active/reactive power	Absolute accuracy: ±2%FS±1digit Repeat accuracy: ±1%rdg±1digit	<ul style="list-style-type: none"> Active power: Power factor 0.5 to 1 Reactive power: Power factor 0 to 0.5 The power frequency must be within the rated range.
	Power frequency	Absolute accuracy: 0.5%FS±1digit Repeat accuracy: ±1%rdg±1digit	Sine wave

* Refer to  5-2-1 All Feature Measurement (P.5-3) for information on the parameters that can be measured.

Push-In Plus Terminal Blocks Specifications

Item	Specifications																																																																																											
Construction	Push-in compatible with 1-pole 2-terminal crossover wiring Hands free Front-in and front-release																																																																																											
Applicable wires	Ferrules, solid wires, or stranded wires																																																																																											
Applicable wire size	0.25 mm ² to 1.5 mm ² (AWG 24 to AWG 16)																																																																																											
Wire insertion force	8 N max. for AWG 20 wire																																																																																											
Screwdriver press force	15 N max.																																																																																											
Wire stripping length	8 mm*, 10 mm, 12 mm *without ferrules																																																																																											
Ferrule length	8 mm or 10 mm																																																																																											
Recommended flat-blade screwdrivers	OMRON: XW4Z-00B etc.																																																																																											
Current capacity	10 A (per pole)																																																																																											
Number of insertions	50 times																																																																																											
Recommended ferrules	<table border="1"> <thead> <tr> <th colspan="2">Applicable wire</th> <th rowspan="2">Ferrule, Conductor length (mm)</th> <th rowspan="2">Stripping length (mm) (Ferrules used)</th> <th colspan="3">Recommended ferrules</th> </tr> <tr> <th>(mm²)</th> <th>AWG</th> <th>Phoenix Contact</th> <th>Weidmuller</th> <th>Wago</th> </tr> </thead> <tbody> <tr> <td rowspan="2">0.25</td> <td rowspan="2">24</td> <td>8</td> <td>10</td> <td>AI 0,25-8</td> <td>H0.25/12</td> <td>FE-0.25-8N-YE</td> </tr> <tr> <td>10</td> <td>12</td> <td>AI 0,25-10</td> <td>-</td> <td>-</td> </tr> <tr> <td rowspan="2">0.34</td> <td rowspan="2">22</td> <td>8</td> <td>10</td> <td>AI 0,34-8</td> <td>H0.34/12</td> <td>FE-0.34-8N-TQ</td> </tr> <tr> <td>10</td> <td>12</td> <td>AI 0,34-10</td> <td>-</td> <td>-</td> </tr> <tr> <td rowspan="2">0.5</td> <td rowspan="2">20</td> <td>8</td> <td>10</td> <td>AI 0,5-8</td> <td>H0.5/14</td> <td>FE-0.5-8N-WH</td> </tr> <tr> <td>10</td> <td>12</td> <td>AI 0,5-10</td> <td>H0.5/16</td> <td>FE-0.5-10N-WH</td> </tr> <tr> <td rowspan="2">0.75</td> <td rowspan="2">18</td> <td>8</td> <td>10</td> <td>AI 0,75-8</td> <td>H0.75/14</td> <td>FE-0.75-8N-GY</td> </tr> <tr> <td>10</td> <td>12</td> <td>AI 0,75-10</td> <td>H0.75/16</td> <td>FE-0.75-10N-GY</td> </tr> <tr> <td rowspan="2">1/1.25</td> <td rowspan="2">18/17</td> <td>8</td> <td>10</td> <td>AI 1-8</td> <td>H1.0/14</td> <td>FE-1.0-8N-RD</td> </tr> <tr> <td>10</td> <td>12</td> <td>AI 1-10</td> <td>H1.0/16</td> <td>FE-1.0-10N-RD</td> </tr> <tr> <td rowspan="2">1.25/1.5</td> <td rowspan="2">17/16</td> <td>8</td> <td>10</td> <td>AI 1,5-8</td> <td>H1.5/14</td> <td>FE-1.5-8N-BK</td> </tr> <tr> <td>10</td> <td>12</td> <td>AI 1,5-10</td> <td>H1.5/16</td> <td>FE-1.5-10N-BK</td> </tr> <tr> <td colspan="4">Recommended crimp tool</td> <td>CRIMPFOX6 CRIMPFOX6T-F CRIMPFOX10S</td> <td>PZ6 roto</td> <td>Variocrimp4</td> </tr> </tbody> </table>	Applicable wire		Ferrule, Conductor length (mm)	Stripping length (mm) (Ferrules used)	Recommended ferrules			(mm ²)	AWG	Phoenix Contact	Weidmuller	Wago	0.25	24	8	10	AI 0,25-8	H0.25/12	FE-0.25-8N-YE	10	12	AI 0,25-10	-	-	0.34	22	8	10	AI 0,34-8	H0.34/12	FE-0.34-8N-TQ	10	12	AI 0,34-10	-	-	0.5	20	8	10	AI 0,5-8	H0.5/14	FE-0.5-8N-WH	10	12	AI 0,5-10	H0.5/16	FE-0.5-10N-WH	0.75	18	8	10	AI 0,75-8	H0.75/14	FE-0.75-8N-GY	10	12	AI 0,75-10	H0.75/16	FE-0.75-10N-GY	1/1.25	18/17	8	10	AI 1-8	H1.0/14	FE-1.0-8N-RD	10	12	AI 1-10	H1.0/16	FE-1.0-10N-RD	1.25/1.5	17/16	8	10	AI 1,5-8	H1.5/14	FE-1.5-8N-BK	10	12	AI 1,5-10	H1.5/16	FE-1.5-10N-BK	Recommended crimp tool				CRIMPFOX6 CRIMPFOX6T-F CRIMPFOX10S	PZ6 roto	Variocrimp4
Applicable wire		Ferrule, Conductor length (mm)	Stripping length (mm) (Ferrules used)			Recommended ferrules																																																																																						
(mm ²)	AWG			Phoenix Contact	Weidmuller	Wago																																																																																						
0.25	24	8	10	AI 0,25-8	H0.25/12	FE-0.25-8N-YE																																																																																						
		10	12	AI 0,25-10	-	-																																																																																						
0.34	22	8	10	AI 0,34-8	H0.34/12	FE-0.34-8N-TQ																																																																																						
		10	12	AI 0,34-10	-	-																																																																																						
0.5	20	8	10	AI 0,5-8	H0.5/14	FE-0.5-8N-WH																																																																																						
		10	12	AI 0,5-10	H0.5/16	FE-0.5-10N-WH																																																																																						
0.75	18	8	10	AI 0,75-8	H0.75/14	FE-0.75-8N-GY																																																																																						
		10	12	AI 0,75-10	H0.75/16	FE-0.75-10N-GY																																																																																						
1/1.25	18/17	8	10	AI 1-8	H1.0/14	FE-1.0-8N-RD																																																																																						
		10	12	AI 1-10	H1.0/16	FE-1.0-10N-RD																																																																																						
1.25/1.5	17/16	8	10	AI 1,5-8	H1.5/14	FE-1.5-8N-BK																																																																																						
		10	12	AI 1,5-10	H1.5/16	FE-1.5-10N-BK																																																																																						
Recommended crimp tool				CRIMPFOX6 CRIMPFOX6T-F CRIMPFOX10S	PZ6 roto	Variocrimp4																																																																																						

Specifications of K7DD Support Tool

- System requirements

Supported OS	Windows10 (Version 1607 or later)/11 (English or Japanese) 32-bit (Windows10 only)/64-bit edition
Computer specifications	CPU: 32-bit or 64 bit processor of 1 GHz or faster RAM: 1 GB or more, or 2 GB or more (for 64-bit processor) Reserved disk space: 16 GB or more, or 20 GB or more (for 64-bit processor) Monitor resolution: 1920×1080 Dependencies: .NET6 Others: LAN port for network connection

A-1-2 Special CTs

Models

When UL certification is required

Model	Primary-side rated current	Secondary-side rated current
K6CM-CICB005-C	5 A	Dedicated output
K6CM-CICB025-C	25 A	
K6CM-CICB100-C	100 A	
K6CM-CICB200-C	200 A	
K6CM-CICB400-C	400 A	

Note Special CTs are supplied with connecting cables.

When UL certification is not required

Model	Primary-side rated current	Secondary-side rated current
K6CM-CICB005	5 A	Dedicated output
K6CM-CICB025	25 A	
K6CM-CICB100	100 A	
K6CM-CICB200	200 A	
K6CM-CICB400	400 A	

Note Special CTs are supplied with connecting cables.



The CT input terminals can be connected in either direction of the special CT regardless of polarity.

Ratings and Specifications

The ratings and specifications are common to all UL certification-compliant models. *1

Item	Model	K6CM-CICB005	K6CM-CICB025	K6CM-CICB100	K6CM-CICB200	K6CM-CICB400
Construction	Internal split type					
Primary-side rated current		5 A	25 A	100 A	200 A	400 A
Rated voltage	600 V AC					
Secondary winding	3,000 turns				6000 turns	
Insulation resistance	Between output terminal and case: 50 mΩ min					
Dielectric strength	Between output terminal and case: 2,000 V AC for 1 minute					
Protective element	7.5 V clamp element					
Allowable number of attachments and detachments	100 times					
Diameter of applicable wire *2		7.9 mm dia. max.	9.5 mm dia. max.	14.5 mm dia. max.	24.0 mm dia. max.	35.5 mm dia. max.
Operating temperature and humidity range	-20 to 60°C, 25% to 85% (with no condensation or icing)					
Storage temperature and humidity range	-30 to +65°C, 25% to 85% (with no condensation or icing)					
Supplied cable length	2.9 m					
Supplied cable terminal	K7DD side: Ferrule, CT side: Round crimp terminal					
Degree of protection	IP20					

*1 To comply with UL certification for the special CT, refer to *Conformance to Safety Standards* (P.-9).

*2 When you use a flat wire, refer to the outline dimensional drawing of the relevant CT and use a CT with a larger diameter. Make sure to use the CT within the range of its rated current.

The frequency characteristics of CTs are as follows:

K6CM-CICB005-C
K6CM-CICB005

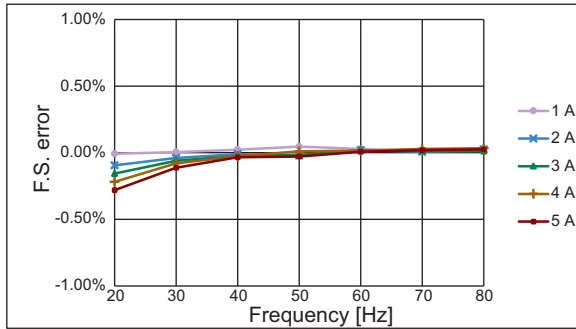

K6CM-CICB025-C
K6CM-CICB025

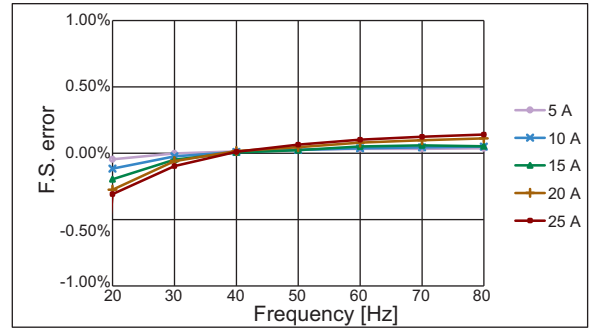

K6CM-CICB100-C
K6CM-CICB100

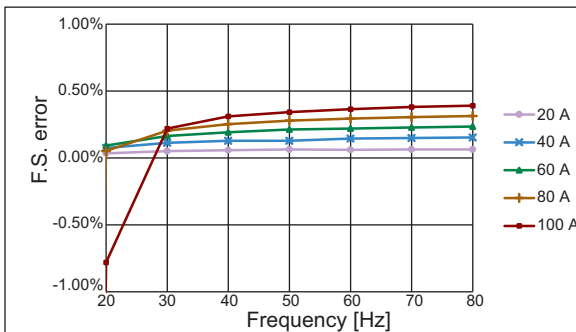

K6CM-CICB200-C
K6CM-CICB200

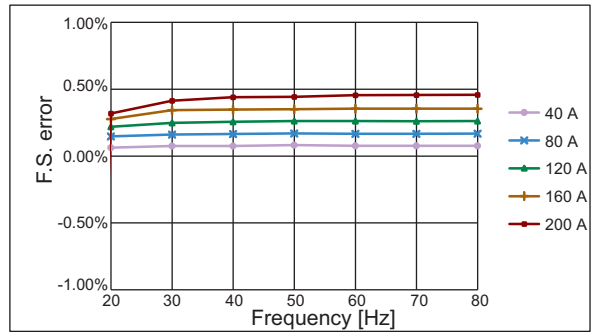

K6CM-CICB400-C
K6CM-CICB400

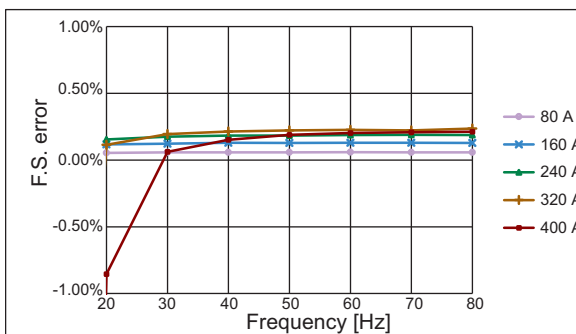

A-1-3 Applicable Standards

Applicable standards	Details	
CE UKCA	Installation environment	Pollution Degree 2, Overvoltage category II, Measurement category II, III *1 Based on EN 61010-1 and EN61010-2-030
	EMC	EN 61326-1 EMI: Class A, EMS: Industrial environments
UL (North America)	UL 61010-1, CAN/CSA C22.2 No. 61010-1 Pollution Degree 2, Overvoltage category II UL 61010-2-030, CAN/CSA C22.2 No. 61010-2-030 Measurement category II, III *1 * UL-recognized (cURus)	
Korean Radio Waves Act	KS C 9610-6-2, KS C 9811	
RCM	EN 61326-1	
WEEE II	---	

*1 Up to 600 V and 300 V respectively for the measurement category II and III

A-2 Parameters List

This section shows the parameters to be displayed on the main display of the K7DD.

Refer to [□ 7-7 Variable Area Map \(P.7-17\)](#) for parameters exclusive to communications.

Level	Parameter name	Type and characters	Setting (monitoring) range	Default value
Monitoring	R.M.S. Voltage	<input type="checkbox"/> RMS	150 V range: 0.0 to 165.0 (V) 300 V range: 0.0 to 330.0 (V) 600 V range: 0.0 to 660.0 (V)	Only monitored value displayed
	Voltage Fundamental Amplitude	<input type="checkbox"/> FNd	150 V range: 0.0 to 233.4 (V) 300 V range: 0.0 to 466.7 (V) 600 V range: 0.0 to 933.4 (V)	Only monitored value displayed
	Voltage Total Harmonic Distortion	<input type="checkbox"/> tHd	0.0 to 100.0 (%)	Only monitored value displayed
	R.M.S. Current	<input type="checkbox"/> RMS	5 A range: 0.000 to 5.500 (A) 25 A range: 0.0 to 27.5 (A) 100 A range: 0.0 to 110.0 (A) 200 A range: 0.0 to 220.0 (A) 400 A range: 0.0 to 440.0 (A)	Only monitored value displayed
	Current Fundamental Amplitude	<input type="checkbox"/> FNd	5 A range: 0.000 to 7.779 (A) 25 A range: 0.0 to 38.9 (A) 100 A range: 0.0 to 155.6 (A) 200 A range: 0.0 to 311.2 (A) 400 A range: 0.0 to 622.3 (A)	Only monitored value displayed
	Current Total Harmonic Distortion	<input type="checkbox"/> tHd	0.0 to 100.0 (%)	Only monitored value displayed
	Active Power	<input type="checkbox"/> PRLt	5A current range, All voltage ranges: -10.890 to 10.890 (kW) Current ranges other than 5A, All voltage ranges: -871.2 to 871.2 (kW)	Only monitored value displayed
	Power Factor	PF	-1.00 to 1.00	Only monitored value displayed
	Power Frequency	FREQ	40.0 to 250.0 (Hz)	Only monitored value displayed
Adjustment	Product Version	VER	Displays the current software version.	
	R.M.S. Voltage Critical Threshold	<input type="checkbox"/> RMS .c	-3276.1 to 3276.1 (V)	3276.1 (V)
	R.M.S. Voltage Warning Threshold	<input type="checkbox"/> RMS .w	-3276.1 to 3276.1 (V)	3276.1 (V)
	Voltage Fundamental Amplitude Critical Threshold	<input type="checkbox"/> FNd .c	-3276.1 to 3276.1 (V)	3276.1 (V)

Level	Parameter name	Type and characters	Setting (monitoring) range	Default value
Adjustment	Voltage Fundamental Amplitude Warning Threshold	<input type="checkbox"/> <i>FNd .w</i>	-3276.1 to 3276.1 (V)	3276.1 (V)
	Voltage Total Harmonic Distortion Critical Threshold	<input type="checkbox"/> <i>tHd .c</i>	-3276.1 to 3276.1 (%)	3276.1(%)
	Voltage Total Harmonic Distortion Warning Threshold	<input type="checkbox"/> <i>tHd .w</i>	-3276.1 to 3276.1 (%)	3276.1(%)
	R.M.S. Current Critical Threshold	<input type="checkbox"/> <i>RMS .c</i>	5 A range: -32.761 to 32.761 (A) 25 A range: -3276.1 to 3276.1 (A) 100 A range: -3276.1 to 3276.1 (A) 200 A range: -3276.1 to 3276.1 (A) 400 A range: -3276.1 to 3276.1 (A)	5 A range: 32.761 (A) 25 A range: 3276.1 (A) 100 A range: 3276.1 (A) 200 A range: 3276.1 (A) 400 A range: 3276.1 (A)
	R.M.S. Current Warning Threshold	<input type="checkbox"/> <i>RMS .w</i>	5 A range: -32.761 to 32.761 (A) 25 A range: -3276.1 to 3276.1 (A) 100 A range: -3276.1 to 3276.1 (A) 200 A range: -3276.1 to 3276.1 (A) 400 A range: -3276.1 to 3276.1 (A)	5 A range: 32.761 (A) 25 A range: 3276.1 (A) 100 A range: 3276.1 (A) 200 A range: 3276.1 (A) 400 A range: 3276.1 (A)
	Current Fundamental Amplitude Critical Threshold	<input type="checkbox"/> <i>FNd .c</i>	5 A range: -32.761 to 32.761 (A) 25 A range: -3276.1 to 3276.1 (A) 100 A range: -3276.1 to 3276.1 (A) 200 A range: -3276.1 to 3276.1 (A) 400 A range: -3276.1 to 3276.1 (A)	5 A range: 32.761 (A) 25 A range: 3276.1 (A) 100 A range: 3276.1 (A) 200 A range: 3276.1 (A) 400 A range: 3276.1 (A)
	Current Fundamental Amplitude Warning Threshold	<input type="checkbox"/> <i>FNd .w</i>	5 A range: -32.761 to 32.761 (A) 25 A range: -3276.1 to 3276.1 (A) 100 A range: -3276.1 to 3276.1 (A) 200 A range: -3276.1 to 3276.1 (A) 400 A range: -3276.1 to 3276.1 (A)	5 A range: 32.761 (A) 25 A range: 3276.1 (A) 100 A range: 3276.1 (A) 200 A range: 3276.1 (A) 400 A range: 3276.1 (A)
	Current Total Harmonic Distortion Critical Threshold	<input type="checkbox"/> <i>tHd .c</i>	-3276.1 to 3276.1 (%)	3276.1 (%)
	Current Total Harmonic Distortion Warning Threshold	<input type="checkbox"/> <i>tHd .w</i>	-3276.1 to 3276.1 (%)	3276.1 (%)
	Active Power Critical Threshold	<input type="checkbox"/> <i>RLt .c</i>	5A current range, All voltage ranges: -32.761 to 32.761 (kW) Current ranges other than 5A, All voltage ranges: -3276.1 to 3276.1 (kW)	5A current range, All voltage ranges: 32.761 (kW) Current ranges other than 5A, All voltage ranges: 3276.1 (kW)
	Active Power Warning Threshold	<input type="checkbox"/> <i>RLt .w</i>	5A current range, All voltage ranges: -32.761 to 32.761 (kW) Current ranges other than 5A, All voltage ranges: -3276.1 to 3276.1 (kW)	5A current range, All voltage ranges: 32.761 (kW) Current ranges other than 5A, All voltage ranges: 3276.1 (kW)

Level	Parameter name	Type and characters	Setting (monitoring) range	Default value
Adjustment	Power Factor Critical Threshold	<i>PF .C</i>	-327.61 to 327.61	327.61
	Power Factor Warning Threshold	<i>PF .W</i>	-327.61 to 327.61	327.61
	Power Frequency Critical Threshold	<i>FREQ.C</i>	-3276.1 to 3276.1 (Hz)	3276.1 (Hz)
	Power Frequency Warning Threshold	<i>FREQ.W</i>	-3276.1 to 3276.1 (Hz)	3276.1 (Hz)
Initial Setting	Wiring State	<i>WRNG</i>	0: 3P3W2M (3-phase 3-wire) 1: 3P4W (3-phase 4-wire) 2: Single-phase current	0
	Current Input Range	<i>I - IN</i>	0: 0 to 5 (A) 1: 0 to 25 (A) 2: 0 to 100 (A) 3: 0 to 200 (A) 4: 0 to 400 (A)	0
	Voltage Input Range	<i>V - IN</i>	0: 0 to 150 (V) 1: 0 to 300 (V) 2: 0 to 600 (V)	0
	Feature Calculation Cycle	<i>FCRP</i>	1 to 2000 (50 ms)	1
	Alarm Threshold Calculation Sensitivity	<i>ALOF</i>	20.0 to 200.0 (%)	80.0 (%)
Communications Setting	Baud Rate 1 Baud Rate 2	<i>bPS1</i> <i>bPS2</i>	9.6 (kbps) 19.2 (kbps) 38.4 (kbps) 57.6 (kbps) 115.2 (kbps) 230.4 (kbps)	115.2 (kbps)
	Parity 1 Parity 2	<i>PEV1</i> <i>PEV2</i>	<i>NONE</i> : None <i>EVEN</i> : Even <i>odd</i> : Odd	<i>EVEN</i>
	Send Wait Time 1 Send Wait Time 2	<i>SWT1</i> <i>SWT2</i>	0 to 99 (ms)	20 (ms)

A-3 Parameter Flow

This section shows the parameters displayed on the main display of the K7DD.

Refer to [7-7 Variable Area Map \(P.7-17\)](#) for parameters exclusive to communications.

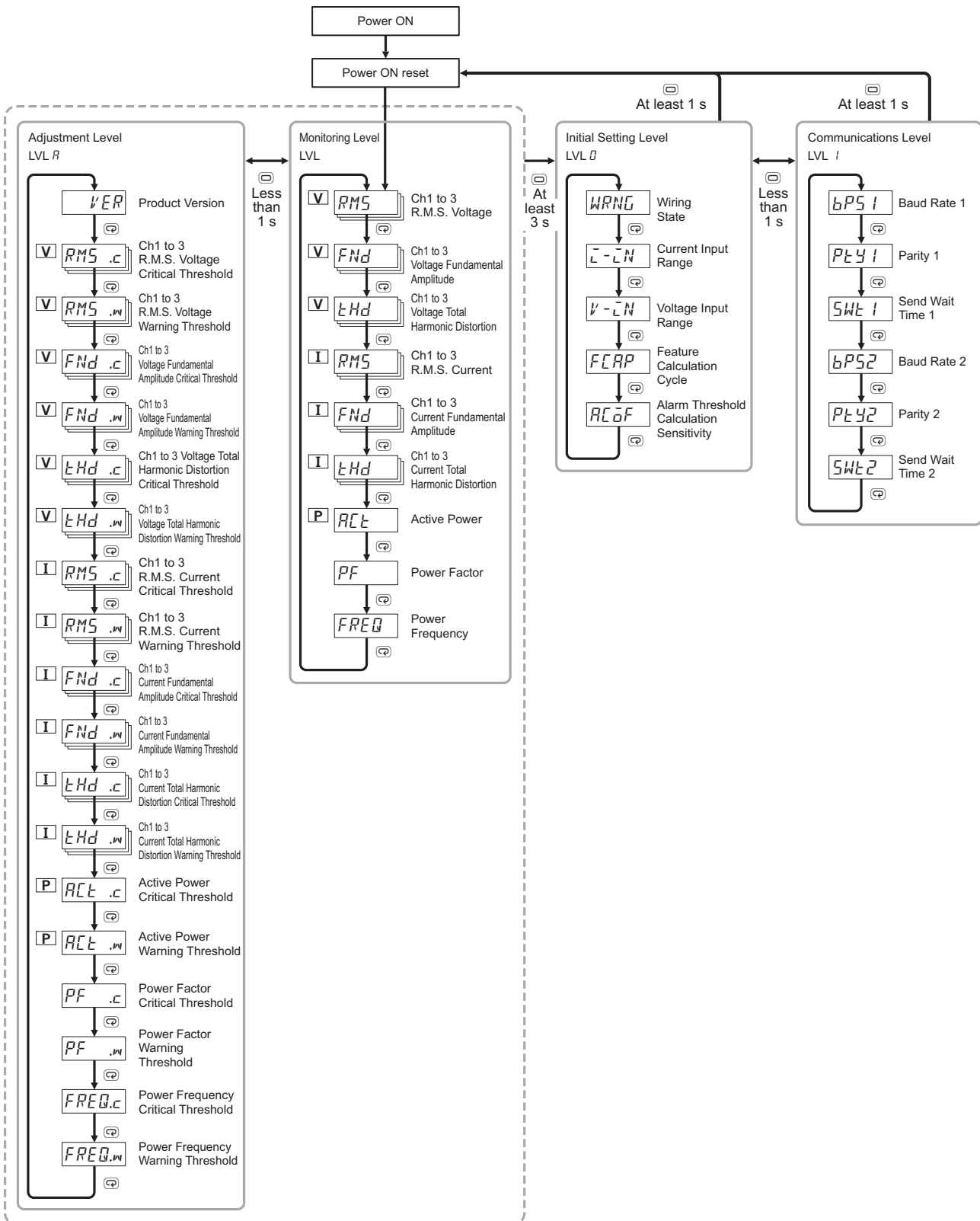

A-4 Feature Calculations

This section provides the mathematical equations for the feature values calculated by the K7DD.

A-4-1 Feature Values of Voltage System

ID	Feature	Wiring state	
		3P3W2M	3P4W
0	R.M.S. voltage VRMS	$V_{RMS(12)} = \sqrt{\frac{1}{M} \sum_{s=0}^{M-1} (V_{(12)s})^2}$ $V_{(12)s} = V_{(1)s} - V_{(2)s}$ $V_{RMS(23)} = \sqrt{\frac{1}{M} \sum_{s=0}^{M-1} (V_{(23)s})^2}$ $V_{(23)s} = V_{(2)s} - V_{(3)s}$ $V_{RMS(31)} = \sqrt{\frac{1}{M} \sum_{s=0}^{M-1} (V_{(31)s})^2}$ $V_{(31)s} = V_{(3)s} - V_{(1)s}$ <p>s : Sampling point M : Number of samplings</p>	$V_{RMS(c)} = \sqrt{\frac{1}{M} \sum_{s=0}^{M-1} (V_{(c)s})^2}$ <p>c : Measuring channel (1 to 3) s : Sampling point M : Number of samplings</p>
1	Voltage waveform peak+ VPeak+	$V_{Peak(1)+} = V_{(12)s}$ Max. value among samplings $V_{Peak(2)+} = V_{(23)s}$ Max. value among samplings $V_{Peak(3)+} = V_{(31)s}$ Max. value among samplings <p>s : Sampling point M : Number of samplings</p>	$V_{Peak(c)+} = V_{(c)s}$ Max. value among samplings <p>c : Measuring channel (1 to 3) s : Sampling point M : Number of samplings</p>
2	Voltage waveform peak- VPeak-	$V_{Peak(1)-} = V_{(12)s}$ Min. value among samplings $V_{Peak(2)-} = V_{(23)s}$ Min. value among samplings $V_{Peak(3)-} = V_{(31)s}$ Min. value among samplings <p>s : Sampling point M : Number of samplings</p>	$V_{Peak(c)-} = V_{(c)s}$ Min. value among samplings <p>c : Measuring channel (1 to 3) s : Sampling point M : Number of samplings</p>

ID	Feature	Wiring state	
		3P3W2M	3P4W
3	Voltage unbalance VUnb	$V_{Unb} = \sqrt{\frac{1 - \sqrt{3 - 6\beta}}{1 + \sqrt{3 - 6\beta}}} \times 100 \text{ [%]}$ $\beta = \frac{V1_{(12)}^4 + V1_{(23)}^4 + V1_{(31)}^4}{(V1_{(12)}^2 + V1_{(23)}^2 + V1_{(31)}^2)^2}$ $V1_{(12)} = \sqrt{V1_{(1)}^2 + V1_{(2)}^2 - 2 \times V1_{(1)} \times V1_{(2)} \times \cos\theta1_{(12)}}$ $V1_{(23)} = \sqrt{V1_{(2)}^2 + V1_{(3)}^2 - 2 \times V1_{(2)} \times V1_{(3)} \times \cos\theta1_{(23)}}$ $V1_{(31)} = \sqrt{V1_{(3)}^2 + V1_{(1)}^2 - 2 \times V1_{(3)} \times V1_{(1)} \times \cos\theta1_{(31)}}$ <p>V1₍₁₎, V1₍₂₎, V1₍₃₎ : Fundamental wave voltage θ1₍₁₂₎, θ1₍₂₃₎, θ1₍₃₁₎ : Angle defined by each fundamental wave voltage</p>	<p>V1₍₁₂₎, V1₍₂₃₎, V1₍₃₁₎: Fundamental wave of voltage between lines</p>
4	Voltage fundamental amplitude VFnd	<p>Primary harmonics (fundamental wave) when calculating harmonics of voltage between lines</p> $V_{Fnd(12)} = V1_{(12)}$ $V_{Fnd(23)} = V1_{(23)}$ $V_{Fnd(31)} = V1_{(31)}$	<p>Primary harmonics (fundamental wave) when calculating harmonics of phase voltage</p> $V_{Fnd} = V1_{(c)}$ <p>c : Measuring channel (1 to 3)</p>
5	Voltage total harmonic distortion VTHD	$V_{THD(1)} = \frac{\sqrt{\sum_{k=2}^K V_{k(12)}^2}}{V1_{(12)}} \times 100$ $V_{THD(2)} = \frac{\sqrt{\sum_{k=2}^K V_{k(23)}^2}}{V1_{(23)}} \times 100$ $V_{THD(3)} = \frac{\sqrt{\sum_{k=2}^K V_{k(31)}^2}}{V1_{(31)}} \times 100$ <p>K : 63 k : Harmonic order V1 : Fundamental wave</p>	$V_{THD(c)} = \frac{\sqrt{\sum_{k=2}^K V_{k(c)}^2}}{V1_{(c)}} \times 100$ <p>c : Measuring channel (1 to 3) K : 63 k : Harmonic order V1 : Fundamental wave</p>

A-4-2 Feature Values of Current System

ID	Feature	Wiring state		
		3P3W2M	3P4W	Single phase current
6	R.M.S. current IRMS	$I_{RMS(1)} = \sqrt{\frac{1}{M} \sum_{s=0}^{M-1} (I_{(1)s})^2}$ $I_{RMS(2)} = \sqrt{\frac{1}{M} \sum_{s=0}^{M-1} (-I_{(1)s} - I_{(2)s})^2}$ $I_{RMS(3)} = \sqrt{\frac{1}{M} \sum_{s=0}^{M-1} (I_{(2)s})^2}$ <p>s : Sampling point M : Number of samplings</p>	$I_{RMS(c)} = \sqrt{\frac{1}{M} \sum_{s=0}^{M-1} (I_{(c)s})^2}$ <p>c : Measuring channel (1 to 3) s : Sampling point M : Number of samplings</p>	$I_{RMS(c)} = \sqrt{\frac{1}{M} \sum_{s=0}^{M-1} (I_{(c)s})^2}$ <p>c : Measuring channel (1) s : Sampling point M : Number of samplings</p>
7	Current waveform peak+ I_{Peak+}	$I_{Peak(c)+} = I_{(c)s}$ Max. value among samplings s : Sampling point c : Measuring channel (1 to 3) M : Number of samplings		$I_{Peak(c)+} = I_{(c)s}$ Max. value among samplings s : Sampling point c : Measuring channel (1) M : Number of samplings
8	Current waveform peak- I_{Peak-}	$I_{Peak(c)-} = I_{(c)s}$ Min. value among samplings s : Sampling point c : Measuring channel (1 to 3) M : Number of samplings		$I_{Peak(c)-} = I_{(c)s}$ Min. value among samplings s : Sampling point c : Measuring channel (1) M : Number of samplings
9	Current unbalance I_{Unb}	$I_{Unb} = \sqrt{\frac{1 - \sqrt{3 - 6\beta}}{1 + \sqrt{3 - 6\beta}}} \times 100 [\%]$ $\beta = \frac{I_{(12)}^4 + I_{(23)}^4 + I_{(31)}^4}{(I_{(12)}^2 + I_{(23)}^2 + I_{(31)}^2)^2}$ <p>I₁(12), I₁(23), I₁(31): Fundamental wave of current between lines</p> $I_{(12)} = \sqrt{I_{(1)}^2 + I_{(2)}^2 - 2 \times I_{(1)} \times I_{(2)} \times \cos\theta_{1(12)}}$ $I_{(23)} = \sqrt{I_{(2)}^2 + I_{(3)}^2 - 2 \times I_{(2)} \times I_{(3)} \times \cos\theta_{1(23)}}$ $I_{(31)} = \sqrt{I_{(3)}^2 + I_{(1)}^2 - 2 \times I_{(3)} \times I_{(1)} \times \cos\theta_{1(31)}}$ <p>I₁(1), I₁(2), I₁(3) : Fundamental wave current θ₁(12), θ₁(23), θ₁(31) : Angle defined by each fundamental wave current</p>		---

ID	Feature	Wiring state			
		3P3W2M	3P4W	Single phase current	
10	Current fundamental amplitude I_{Fnd}	Primary harmonics (fundamental wave) $I_{1(c)}$ when calculating harmonics c : Measuring channel (1 to 3)		Primary harmonics (fundamental wave) $I_{1(c)}$ when calculating harmonics c : Measuring channel (1)	
11	0.5th order harmonic current I_{0.5} = I_{HD0.5}	$I_{HDk(c)} = \frac{I_{k(c)}}{I_{1(c)}} \times 100 \text{ [%]}$ c : Measuring channel (1 to 3) k : Harmonic order (0.5, 1.5 to 62.5, 63) I1: Fundamental wave		$I_{HDk(c)} = \frac{I_{k(c)}}{I_{1(c)}} \times 100 \text{ [%]}$	
12	1.5th order harmonic current I_{1.5} = I_{HD1.5}			c : Measuring channel (1) k : Harmonic order (0.5, 1.5 to 62.5, 63) I1: Fundamental wave	
:	:				
135	63rd order harmonic current I₆₃ = I_{HD63}				
136	Current total harmonic distortion I_{THD}	$I_{THD(c)} = \frac{\sqrt{\sum_{k=2}^K I_{k(c)}^2}}{I_{1(c)}} \times 100$ c : Measuring channel (1 to 3) K : 63 k : Integer order harmonics (2 to 63) I1: Fundamental wave		$I_{THD(c)} = \frac{\sqrt{\sum_{k=2}^K I_{k(c)}^2}}{I_{1(c)}} \times 100$ c : Measuring channel (1) K : 63 k : Integer order harmonics (2 to 63) I1: Fundamental wave	

A-4-3 Feature Values of Power Consumption, Power Factor and Power Frequency

ID	Feature	Wiring state		Single phase current
		3P3W2M	3P4W	
137	Active power P_{Act} = P	$P = P_1 + P_2$ $= \frac{1}{M} \sum_{s=0}^{M-1} (V_{(12)s} \times I_{(1)s}) + \frac{1}{M} \sum_{s=0}^{M-1} (-V_{(23)s} \times I_{(2)s})$ <p>s : Sampling point M : Number of samplings</p>	$P = P_1 + P_2 + P_3$ $= \frac{1}{M} \sum_{s=0}^{M-1} (V_{(1)s} \times I_{(1)s}) + \frac{1}{M} \sum_{s=0}^{M-1} (V_{(2)s} \times I_{(2)s}) + \frac{1}{M} \sum_{s=0}^{M-1} (V_{(3)s} \times I_{(3)s})$ <p>s : Sampling point M : Number of samplings * The voltage should be phase voltage.</p>	---
138	Reactive power P_{React} = Q	$Q = Q_1 + Q_2$ $= si \sqrt{S_1^2 - P_1^2} + si \sqrt{S_2^2 - P_2^2}$ <p>* The polarity sign "si" indicates the lag/lead polarity, with positive in lag and negative in lead.</p>	$Q = Q_1 + Q_2 + Q_3$ $= si \sqrt{S_1^2 - P_1^2} + si \sqrt{S_2^2 - P_2^2} + si \sqrt{S_3^2 - P_3^2}$ <p>* The polarity sign "si" indicates the lag/lead polarity, with positive in lag and negative in lead.</p>	---
		<p><How to calculate polarity sign> Calculate the primary harmonic reactive power (k=1) using the equation below, and add a sign opposite to the one derived.</p> $Q_{k(1)} = V_{kr(12)} \times I_{ki(1)} - V_{ki(12)} \times I_{kr(1)}$ $Q_{k(2)} = (-V_{kr(23)}) \times I_{ki(2)} - (-V_{ki(23)}) \times I_{kr(2)}$ <p>k : Harmonic order</p>	<p><How to calculate polarity sign> Calculate the primary harmonic reactive power (k=1) using the equation below, and add a sign opposite to the one derived.</p> $Q_{k(c)} = V_{kr(c)} \times I_{ki(c)} - V_{ki(c)} \times I_{kr(c)}$ <p>c : Measuring channel (1 to 3) k : Harmonic order</p>	---
139	Apparent power P_{Aprnt} = S	$S = \frac{\sqrt{3}}{2} (S_1 + S_2)$ $= \frac{\sqrt{3}}{2} \{ (V_{RMS(12)} \times I_{RMS(1)}) + (V_{RMS(23)} \times I_{RMS(2)}) \}$	$S = S_1 + S_2 + S_3$ $= (V_{RMS(1)} \times I_{RMS(1)}) + (V_{RMS(2)} \times I_{RMS(2)}) + (V_{RMS(3)} \times I_{RMS(3)})$ <p>* The voltage should be phase voltage.</p>	---
140	Power factor PF	$PF = si \left \frac{P}{S} \right $ <p>* The polarity sign "si" is obtained from the sign of reactive power Q.</p>		---
141	Power frequency FREQ = f	<p>f = 1/T T: Cycle (current for CH1)</p>		---



INDEX



Index

Alphanumeric characters

□	15, 1-8, 6-2
!	15, 1-8, 6-2
#	15, 1-8, 6-2
3-phase 3 wire 2 meter method (3P3W2M)	3-13
3-phase 4-wire (3P4W)	3-13

A

Abnormal Data Acquisition Command	6-25
Active Power	A-9
Active Power Critical Threshold	A-10
Active Power Warning Threshold	A-10
Adjustment Level	6-13
alarm	4-9
alarm latch	12, 4-10
Alarm Latch Cancel Command	6-26, 7-8
Alarm Threshold Calculation Sensitivity	7-20, A-11
altitude	A-3
ambient operating humidity	A-3
ambient operating temperature	A-3
appearance	1-6
applicable standards	A-8
applicable wire size	A-5
applicable wires	A-5

B

baud rate	A-2
Baud Rate 1	7-21, A-11
Baud Rate 2	7-21, A-11

C

cable length	A-2
CH	12
CH Feature Critical Threshold	7-23
CH Feature Monitoring	7-23
channel	12
command frame	7-9
communications method	7-3, A-2
Communications Setting Level	6-23
Configuration with the K7DD Unit Only	2-4
connecting stranded wires	3-5
connecting wires with ferrules and solid wires	3-5
connection configurations	A-2
construction	A-5
contact form	A-3
CRC-16	7-9, 7-10
CRC-16 calculation method	7-9
CT	12
CT input terminals	3-11
current capacity	A-5

Current Fundamental Amplitude	A-9
Current Fundamental Amplitude Critical Threshold	A-10
Current Fundamental Amplitude Warning Threshold	A-10
Current Input Range	7-20, A-11
Current Total Harmonic Distortion	A-9
Current Total Harmonic Distortion Critical Threshold	A-10
Current Total Harmonic Distortion Warning Threshold	A-10

D

data length	A-2
degree of protection	A-3
dielectric strength	A-3
dimensions	3-2
DIN Track mounting hook	1-6

E

Error Code	7-11
example configuration (1)	1-12
example configuration (2)	1-12
example of connection to k7dd software tool	3-14
exterior color	A-3

F

Feature Calculation Cycle	7-20, A-11
Feature Calculations	A-13
Feature Value Range for Monitoring	6-7
ferrule length	A-5
flashing	12
flashing at high speed	12
for 3-phase AC	3-13
for single-phase AC	3-13
frequency characteristics of CTs	A-7
front section	1-7

H

how to connect to the Push-In Plus terminal blocks	3-5
How to Select Features and Configure Alarm Thresholds	2-2

I

I/O wiring	3-8
industrial electromagnetic environment	A-3
Initial Setting Level	6-20
input range	A-2
installation and wiring	2-7, 3-1
installation environment	A-3
installation of End Plates	3-4
insulation resistance	A-3

internal block diagram	1-11
Internal Trigger Hysteresis	7-20
Internal Trigger Level	7-19
Internal Trigger Source	7-21

K

K7DD Status	7-19
-------------------	------

L

leakage current when power turning OFF	A-3
Levels	6-2
LVL display	15, 6-2

M

main display/parameter display	15
Major Revision	7-24
maximum current	A-3
maximum number of Units	A-2
measurement accuracy	A-2
Measurement Delay Time	7-19
measurement error	4-11
Current Value Out-of-Range Error	4-11
Frequency Out-of-Range Error	4-11
Voltage Value Out-of-Range Error	4-11
measurement specifications	A-4
Measurement Status	7-23
Measurement Time	7-19
measurement value	6-9
Measurement Value Mark	6-6
Minor Revision	7-24
Modbus RTU	12
monitored features	4-8
Monitoring Level	6-9
Monitoring Status	7-23
mounting	A-3
mounting to DIN Track	3-4

N

no response	7-11
Normal Data Acquisition Command	6-25
number of insertions	A-5

O

Occurrence Conditions and Reset Conditions for Measurement Errors	4-12
operating frequency range	A-2
operating power supply voltage range	A-2
Operation Command	12, 6-25, 7-7, 7-15
Alarm Latch Cancel Command	7-8
Operation Stop Status Transition Command	7-8
Parameter Initialization Command	7-7
Software Reset Command	7-7
operation power supply terminals	3-8

P

parameter	12, A-9
parameter flow	6-5, A-12
parity	A-2
Parity 1	7-21, A-11
Parity 2	7-21, A-11
% FS	12
power consumption	A-2
Power Factor	A-9
Power Factor Critical Threshold	A-11
Power Factor Warning Threshold	A-11
Power Frequency	A-9
Power Frequency Critical Threshold	A-11
Power Frequency Warning Threshold	A-11
power ON reset	12, 3-16, 4-10, 6-9, 7-7
power supply voltage and frequency	A-2
procedure for moving from level to level	6-3
Product Code	7-24
Product Model	7-24
Product Version	A-9
protocol	A-2
Push-In Plus terminal blocks specifications	3-6, A-5

R

R.M.S. Current	A-9
R.M.S. Current Critical Threshold	A-10
R.M.S. Current Warning Threshold	A-10
R.M.S. Voltage	A-9
R.M.S. Voltage Critical Threshold	A-9
R.M.S. Voltage Warning Threshold	A-9
rated voltage	A-3
ratings and specifications	A-2
recommend external fuse	A-2
recommended DIN Track	3-4
recommended End Plates	3-4
recommended ferrules	3-7, A-5
recommended flat-blade screwdrivers	3-7, A-5
recommended wires	A-3
removing from the DIN Track	3-4
removing wires from the Push-In Plus terminal blocks	3-6
residual voltage	A-3
response frame	7-10

S

screwdriver press force	A-5
self-diagnosis error	4-13
send wait time	A-2
Send Wait Time 1	7-21, A-11
Send Wait Time 2	7-21, A-11
Serial Number	7-24
setting parameters	6-4
setting values	6-4
shock resistance	A-3
Special CT	12, A-6
models	A-6
ratings and specifications	A-6

specifications	A-2
Specifications of K7DD Support Tool	A-5
Status	7-25
K7DD Status	7-25
Measurement Status	7-25
Monitoring Status	7-26
stop bits	A-2
storage temperature	A-3
stripping length (without ferrules)	A-3
switching displayed channels	6-4, 6-9

T

terminal block type	A-3
terminal section	1-9
To Monitor with the K7DD	2-2
transistor output terminals	3-12
transmission path connection method	A-2
trigger input terminals	3-9
Trigger Mode	7-21
Trigger Type	7-21
troubleshooting	8-2
types of alarm notification methods	4-9
Alarm Output	4-9
Alarm Output Indicator	4-9
Alarm Status (Communications)	4-9
types of communications commands	7-4

U

unit number	3-16
-------------------	------

V

variable areas	7-19, 7-23
vibration resistance	A-3
Voltage Fundamental Amplitude	A-9
Voltage Fundamental Amplitude Critical Threshold	A-9
Voltage Fundamental Amplitude Warning Threshold	A-10
Voltage Input Range	7-20, A-11
voltage input terminals	3-10
Voltage Total Harmonic Distortion	A-9
Voltage Total Harmonic Distortion Critical Threshold	A-10
Voltage Total Harmonic Distortion Warning Threshold	A-10

W

weight	A-3
wire insertion force	A-5
wire stripping length	A-5
wire type	A-3
wiring material	A-3
Wiring State	7-20, A-11
write variable area command (single)	7-15

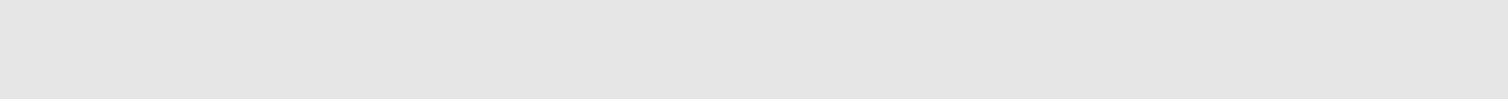

OMRON Corporation Industrial Automation Company

Kyoto, JAPAN

Contact : www.ia.omron.com

Regional Headquarters

OMRON EUROPE B.V.

Wegalaan 67-69, 2132 JD Hoofddorp
The Netherlands
Tel: (31) 2356-81-300 Fax: (31) 2356-81-388

OMRON ELECTRONICS LLC

2895 Greenspoint Parkway, Suite 200
Hoffman Estates, IL 60169 U.S.A.
Tel: (1) 847-843-7900 Fax: (1) 847-843-7787

OMRON ASIA PACIFIC PTE. LTD.

438B Alexandra Road, #08-01/02 Alexandra
Technopark, Singapore 119968
Tel: (65) 6835-3011 Fax: (65) 6835-2711

OMRON (CHINA) CO., LTD.

Room 2211, Bank of China Tower,
200 Yin Cheng Zhong Road,
PuDong New Area, Shanghai, 200120, China
Tel: (86) 21-5037-2222 Fax: (86) 21-5037-2200

Authorized Distributor:

©OMRON Corporation 2023 All Rights Reserved.
In the interest of product improvement,
specifications are subject to change without notice.

Cat. No. N233-E1-01

0223