

Heater Condition Monitoring Device

User's Manual K7TM



1
Overview

2
Procedures

3
Installation and
Wiring

4
Function

5
Using Parameters

6
Remote Monitoring

7
Logging by K7TM
Configuration Tool

8
Troubleshooting

A
Appendices

I
Index

NOTE

All rights reserved. No part of this publication may be reproduced, stored in a retrieval system, or transmitted, in any form, or by any means, mechanical, electronic, photocopying, recording, or otherwise, without the prior written permission of OMRON.

No patent liability is assumed with respect to the use of the information contained herein. Moreover, because OMRON is constantly striving to improve its high-quality products, the information contained in this manual is subject to change without notice. Every precaution has been taken in the preparation of this manual. Nevertheless, OMRON assumes no responsibility for errors or omissions. Neither is any liability assumed for damages resulting from the use of the information contained in this publication.

Trademarks

- Microsoft, Windows Excel, and Visual Basic are either registered trademarks or trademarks of Microsoft Corporation in the United States and other countries.
- Modbus is a registered trademark or trademark of Schneider Electric USA, Inc. in Japan, the United States or other countries.

Other company names and product names in this document are the trademarks or registered trademarks of their respective companies.

Copyrights

Microsoft product screen shots reprinted with permission from Microsoft Corporation.

Preface

Thank you for purchasing a K7TM Heater Condition Monitoring Device. This manual describes how to use the K7TM.

Read this manual thoroughly and be sure you understand it before attempting to use the K7TM correctly according to the information provided. Keep this manual in a safe place for easy reference.

A PDF version of this manual can be downloaded from the OMRON website. (<https://www.omron.com>)

Terms and Conditions Agreement

Warranty, Limitations of Liability

Warranties

- **Exclusive Warranty**

Omron's exclusive warranty is that the Products will be free from defects in materials and workmanship for a period of twelve months from the date of sale by Omron (or such other period expressed in writing by Omron). Omron disclaims all other warranties, express or implied.

- **Limitations**

OMRON MAKES NO WARRANTY OR REPRESENTATION, EXPRESS OR IMPLIED, ABOUT NON-INFRINGEMENT, MERCHANTABILITY OR FITNESS FOR A PARTICULAR PURPOSE OF THE PRODUCTS. BUYER ACKNOWLEDGES THAT IT ALONE HAS DETERMINED THAT THE PRODUCTS WILL SUITABLY MEET THE REQUIREMENTS OF THEIR INTENDED USE.

Omron further disclaims all warranties and responsibility of any type for claims or expenses based on infringement by the Products or otherwise of any intellectual property right.

- **Buyer Remedy**

Omron's sole obligation hereunder shall be, at Omron's election, to (i) replace (in the form originally shipped with Buyer responsible for labor charges for removal or replacement thereof) the non-complying Product, (ii) repair the non-complying Product, or (iii) repay or credit Buyer an amount equal to the purchase price of the non-complying Product; provided that in no event shall Omron be responsible for warranty, repair, indemnity or any other claims or expenses regarding the Products unless Omron's analysis confirms that the Products were properly handled, stored, installed and maintained and not subject to contamination, abuse, misuse or inappropriate modification. Return of any Products by Buyer must be approved in writing by Omron before shipment. Omron Companies shall not be liable for the suitability or unsuitability or the results from the use of Products in combination with any electrical or electronic components, circuits, system assemblies or any other materials or substances or environments. Any advice, recommendations or information given orally or in writing, are not to be construed as an amendment or addition to the above warranty.

See <http://www.omron.com/global/> or contact your Omron representative for published information.

Limitation on Liability; Etc

OMRON COMPANIES SHALL NOT BE LIABLE FOR SPECIAL, INDIRECT, INCIDENTAL, OR CONSEQUENTIAL DAMAGES, LOSS OF PROFITS OR PRODUCTION OR COMMERCIAL LOSS IN ANY WAY CONNECTED WITH THE PRODUCTS, WHETHER SUCH CLAIM IS BASED IN CONTRACT, WARRANTY, NEGLIGENCE OR STRICT LIABILITY.

Further, in no event shall liability of Omron Companies exceed the individual price of the Product on which liability is asserted.

Application Considerations

Suitability of Use

Omron Companies shall not be responsible for conformity with any standards, codes or regulations which apply to the combination of the Product in the Buyer's application or use of the Product. At Buyer's request, Omron will provide applicable third party certification documents identifying ratings and limitations of use which apply to the Product. This information by itself is not sufficient for a complete determination of the suitability of the Product in combination with the end product, machine, system, or other application or use. Buyer shall be solely responsible for determining appropriateness of the particular Product with respect to Buyer's application, product or system. Buyer shall take application responsibility in all cases.

NEVER USE THE PRODUCT FOR AN APPLICATION INVOLVING SERIOUS RISK TO LIFE OR PROPERTY OR IN LARGE QUANTITIES WITHOUT ENSURING THAT THE SYSTEM AS A WHOLE HAS BEEN DESIGNED TO ADDRESS THE RISKS, AND THAT THE OMRON PRODUCT(S) IS PROPERLY RATED AND INSTALLED FOR THE INTENDED USE WITHIN THE OVERALL EQUIPMENT OR SYSTEM.

Programmable Products

Omron Companies shall not be responsible for the user's programming of a programmable Product, or any consequence thereof.

Disclaimers

Performance Data

Data presented in Omron Company websites, catalogs and other materials is provided as a guide for the user in determining suitability and does not constitute a warranty. It may represent the result of Omron's test conditions, and the user must correlate it to actual application requirements. Actual performance is subject to the Omron's Warranty and Limitations of Liability.

Change in Specifications

Product specifications and accessories may be changed at any time based on improvements and other reasons. It is our practice to change part numbers when published ratings or features are changed, or when significant construction changes are made. However, some specifications of the Product may be changed without any notice. When in doubt, special part numbers may be assigned to fix or establish key specifications for your application. Please consult with your Omron's representative at any time to confirm actual specifications of purchased Product.

Errors and Omissions

Information presented by Omron Companies has been checked and is believed to be accurate; however, no responsibility is assumed for clerical, typographical or proofreading errors or omissions.

Safety Precautions





Definition of Precautionary Information

The following notation is used in this manual to provide precautions required to ensure safe usage of the K7TM Heater Condition Monitoring Device.











The safety precautions that are provided are extremely important to safety. Always read and heed the information provided in all safety precautions. The following notation is used.

 CAUTION	Indicates a potentially hazardous situation which, if not avoided, may result in minor or moderate injury, or property damage.
Precautions for Safe Use	Precautions on what to do and what not to do to ensure safe usage of the Product.
Precautions for Correct Use	Precautions on what to do and what not to do to ensure proper operation and performance.

Symbols

Symbol		Meaning
Caution		<ul style="list-style-type: none"> General Caution Indicates unspecified general cautions, warnings, and dangers.
		<ul style="list-style-type: none"> Electrical Shock Caution Indicates possibility of electric shock under specific conditions.
Prohibition		<ul style="list-style-type: none"> General Prohibition Indicates unspecified general prohibitions.
		<ul style="list-style-type: none"> Disassembly Prohibition Indicates prohibitions the disassembly of a device because of the possibility of injuries due to electric shock.
Mandatory Caution		<ul style="list-style-type: none"> General instructions Indicates instructions on unspecified general action.



⚠ CAUTION

Minor injury due to electric shock may occasionally occur. Do not touch the Product except for any buttons (keys) while power is being supplied.	
Electric shock may occasionally occur. Always turn OFF the power supplies to the load and the Product before wiring the special CT and voltage input.	
Touching an electrode may occasionally result in electric shock. Keep the terminal cover on the output side of the special CT securely closed.	
Minor electric shock, fire, or malfunction may occasionally occur. Do not allow metal objects, conductors, or cuttings from installation work to enter the Product.	
Minor electric shock, fire, or Product failure may occasionally occur. For the wire passing through the primary side of the special CT, be sure to use an insulated wire with basic insulation or higher degree of insulation. When clamping a busbar or other conductive material, ensure basic insulation or higher level of insulation, e.g., by covering it with an insulating material.	
Minor injury due to explosion may occasionally occur. Do not use the Product where subject to flammable or explosive gas.	
Minor electric shock, fire, or malfunction may occasionally occur. Do not disassemble, modify, or repair the Product or touch the interior of the Product.	
Property damage may occasionally occur due to ignition. Always make sure that the wires are connected properly before turning ON the power supply.	
Property damage may occasionally occur due to ignition. When wiring, make sure that the wiring material is properly inserted all the way into each terminal hole of the Product.	
Property damage may occasionally occur. Take appropriate measures such as performing periodic inspection of the Product and installing a monitoring device on a separate line.	





Take adequate security measures against DDoS attacks (Distributed Denial of Service attacks), computer viruses and other technologically harmful programs, unauthorized access and other possible attacks before using this product.

Security Measures

<p>Anti-virus protection Install the latest commercial-quality antivirus software on the computer connected to the control/monitor system and maintain to keep the software up-to-date.</p>	
--	---

<p>Security measures to prevent unauthorized access Take the following measures to prevent unauthorized access to our products.</p> <ul style="list-style-type: none"> • Install physical controls so that only authorized personnel can access control/monitor systems and equipment. • Reduce connections to control/monitor systems and equipment via networks to prevent access from untrusted devices. • Install firewalls to shut down unused communications ports and limit communications hosts and isolate control/monitor systems and equipment from the IT network. • Use a virtual private network (VPN) for remote access to control/monitor systems and equipment. • Scan virus to ensure safety of SD cards or other external storages before connecting them to control/monitor systems and equipment. 	
<p>Data input and output protection Validate backups and ranges to cope with unintentional modification of input/output data to control/monitor systems and equipment.</p> <ul style="list-style-type: none"> • Checking the scope of data • Checking validity of backups and preparing data for restore in case of falsification and abnormalities • Safety design, such as emergency shutdown, in case of data tampering and abnormalities 	
<p>Data recovery Backup data and keep the data up-to-date periodically to prepare for data loss.</p>	

Security Measures of K7TM Configuration Tool

<p>To prevent computer viruses, install antivirus software on a computer where you use this software. Make sure to keep the antivirus software updated.</p>	
<p>Keep your computer's OS updated to avoid security risks caused by a vulnerability in the OS. Manage usernames and passwords in the OS or this software carefully to protect them from unauthorized uses.</p>	
<p>Always use the highest version of this software to add new features, increase operability, and enhance security.</p>	
<p>Set up a firewall (E.g., disabling unused communication ports, limiting communication hosts, etc.) on a network for a control/monitor system and devices to separate them from other IT networks. Make sure to connect to the control/monitor system inside the firewall.</p>	
<p>Use a virtual private network (VPN) for remote access to a control/monitor system and devices from this software.</p>	

Precautions for Safe Use

- (1) Do not store, install, or use the Product in the following locations:
 - Outdoor or locations subject to direct sunlight
 - Locations subject to rain and wind damage
 - Locations subject to excessive vibration or shock
 - Locations subject to rapid temperature changes
 - Locations prone to icing and dew condensation
 - Locations subject to water or oil
 - Locations subject to dust or corrosive gases (particularly sulfurizing gases, ammonia, etc.)
 - Locations subject to influence of static electricity and noise
 - Locations subject to bugs and small animals
 - Locations subject to electromagnetic fields
 - Locations subject to a load
- (2) A switch or circuit breaker should be provided close to this unit. The switch or circuit breaker should be within easy reach of the operator, and must be marked as a disconnecting means for this unit.
- (3) Mount the Product in the correct direction for installation.
- (4) Use the wire given in this manual.
- (5) When wiring, wire by enough length.
- (6) Do not bend a wire past its natural bending radius or pull on it with excessive force. Doing so may cause wire disconnection, or damage to the terminal block.
- (7) Make sure the crimp terminals for wiring are of the specified size.
- (8) Do not connect anything to unused terminals.
- (9) Do not wire anything to the release holes.
- (10) The terminal block may be damaged if you insert a flat-blade screwdriver in the release hole with excessive force. When inserting a flat-blade screwdriver into the release holes, operate with a force of 15·N or less.
- (11) The Product may be subject to radio disturbances. Do not install the Product near equipment that generates high frequencies or surges.
- (12) To prevent inductive noise, wire the lines connected to the Product separately from power lines carrying high voltages or currents. Also, do not wire in parallel with or on the same cables as power lines. Other measures for reducing noise are to separate from ducts including noisy lines.
- (13) When discarding the Product, properly dispose of it as industrial waste.
- (14) Be sure to use terminals of operation power supply carefully, because they have hazardous voltage.
- (15) Make sure that the operation power supply voltage and the load voltage and current are within the specifications of the Product.
- (16) Use the load within the range of its ratings and specifications. Failure to do so may result in a load failure before a load error is detected.
- (17) Connect the voltage input and the current input on the primary side of the special CT correctly to the same load.
- (18) Always use the special CT that is specified by OMRON's model number.
- (19) Clamp the primary wire of the special CT correctly. After clamping, make sure until it clicks into place.

- (20) The measurement accuracy may deteriorate due to the influence of external magnetic fields. Install the special CT as far away as possible from electric wires with large current flows, except for those to be measured.
- (21) For RS-485 communications and transistor output, check the polarity of the terminals and wire them correctly to avoid incorrect wiring.
- (22) Use the cable within the length that is rated in the specification requirements for the wiring between the sensor and the Product.
- (23) Transistor output that detects a load error is a function to notify that the set threshold value is exceeded. Do not use this function for control, etc.
- (24) Do not continue to use the Product if the front surface peels.
- (25) Periodically check that the LCD display and LED indicators operate correctly. Depending on the operating environment, the display or indicators may fail due to deterioration.

Precautions for Correct Use

- (1) In crossover wiring, connecting more than one K7TM in parallel may allow a large amount of current to flow. Keep the current to 10 A or less per terminal.
- (2) Confirm that wire does not stick up after wiring of stranded cable.
- (3) The terminal block may be damaged if specialized tool is not used. Use a recommended flat-blade screwdriver to insert into a release hole on the terminal block.
- (4) If an error occurs during the operation of the Product, stop the operation immediately and make suitable corrections such as replacement.
- (5) If you accidentally drop the Product, the inside of the Product may be damaged, so do not use it.
- (6) Do not use any liquids such as paint thinner, similar solvents or alcohol to clean the Product. Clean it with a soft, dry cloth.
- (7) Do not use the Product for loads that switch at high speed, such as inverters. Failure to do so may cause large measurement errors in the resistance of the load.
- (8) When replacing the load or changing the usage conditions, perform the initial settings of the Product again. Failure to do so may cause false detection of a load error.
- (9) Do not ground the terminal on the output side of the special CT. Failure to do so may result in unstable measurement.
- (10) Make sure that the setting values registered in the Product match the specifications of the load and special CT that are actually used.

Regulations and Standards

Conformance to Safety Standards

- The protection provided by the device may be impaired if the device is used in a manner that is not specified by the manufacturer.
- To use the Product, install it as an embedded device within a control panel.
- To use the special CT, install it in the same control panel as the Product with a sufficient clearance from other devices.
- For the special CT, use one with –C suffixed to the model.
- For the operation power supply and voltage inputs, use recommended fuses that are externally installed.
- Use the voltage and CT inputs under conditions specified for the measurement category.
- The maximum temperature of the terminal block is 65°C. Therefore, use wires with a rated temperature of 65°C or higher.
- For the wire passing through the primary side of the special CT, use an insulated wire with basic insulation or higher degree of insulation that complies with Table 1.
- Using Table 2 as a guideline, select such a wire as the case temperature of the special CT will be 65°C or less.

Table 1

Load (heater) circuit voltage	AWM (Appliance Wiring Material) Wires Rated voltage and size	
	Overvoltage category II Measurement category II	Overvoltage category III Measurement category III
> 300 ≤ 600 V	600 V min. 1 AWG min.	
> 150 ≤ 300 V	300 V min. No restriction on size	600 V min. 1 AWG min.
≤ 150 V	150 V min. No restriction on size	150 V min. No restriction on size

Table 2

Special CT model	Wire size	Ambient operating temperature of K7TM and special CT
K6CM-CICB005-C	24 AWG min. (0.25 mm ² min.)	55°C max.
K6CM-CICB025-C	12 AWG min. (3.5mm ² min.)	55°C max.
K6CM-CICB100-C	4 AWG (22 mm ²)	45°C max.
	2 AWG (35 mm ²)	50°C max.
K6CM-CICB200-C	1 AWG min. (50mm ² min.)	55°C max.
	2/0 AWG (70 mm ²)	45°C max.
K6CM-CICB400-C	3/0 AWG min. (95 mm ² min.)	50°C max.
	3/0 AWG min. × 2 (95 mm ² min. × 2)	40°C max.

● Measurement Category

The measurement category classifies the places and equipment which you can connect to the measurement terminals, as prescribed in EN/IEC 61010-2-030.

Each category is as follows.

CAT II: Energy-consuming equipment with an energy supply from fixed wiring equipment (such as a power outlet)

CAT III: Equipment in fixed wiring equipment that particularly demands equipment reliability and effectiveness

CAT IV: Equipment to use at the electrical service entry

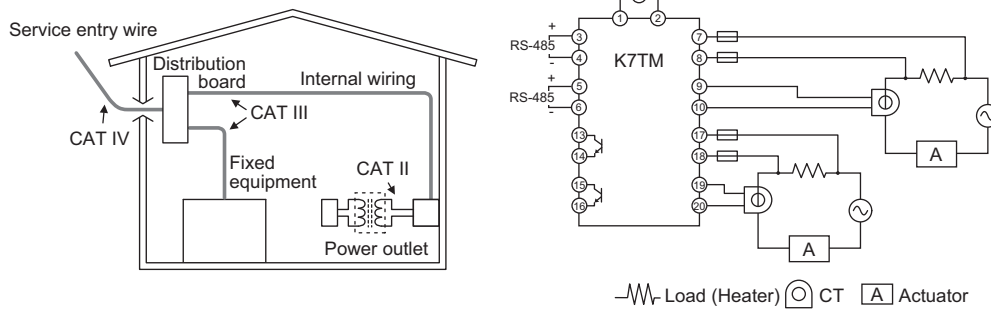

Conformance to EN/IEC Standards

This is a Class A product. In residential areas it may cause radio interference, in which case the user may be required to take adequate measures to reduce interference.

Terminology

Term	Abbreviation	Description
% FS	-	This shows a percentage to the input range (at full scale).
Alarm latch	-	Once an alarm turns ON, this function keeps it ON until the alarm latch is released.
Apparent power	-	The apparent power is the product of the voltage and current supplied to an AC device. The unit is VA (volt-ampere). Generally, it shows the capacity of an AC device or an AC power supply, e.g., what volt of voltage can pass what ampere of current to a transformer, electric motor, etc.
Channel	CH	The units of the resistance value measurement loop for the Heater Condition Monitoring Device.
CP	-	An acronym for Circuit Protector. This is used to protect the circuits and devices of equipment from overcurrent.
CT	-	An acronym for Current Transformer. This is a current sensor that can measure alternating current on a non-contact basis. When you run the power cable through the ring-shaped core, the sensor measures the induced voltage to the secondary winding around the core to detect an alternating current value.
Evaluation data	-	A resistance value obtained from the K7TM at the time of registration of a reference resistance value.
Flashing	-	This means that the display flashes at 1-s intervals (lit for 0.5 s and out for 0.5 s).
Flashing at high speed	-	This means that the display flashes at 0.5-s intervals (lit for 0.25 s and out for 0.25 s).
Measurement value	-	Measurement values, such as a voltage value, current value, resistance value, reference resistance value change rate, and power, which the K7TM calculates.
Measurement Value Calculation Cycle	-	This shows the cycle in which the K7TM calculates the measurement values.
Modbus RTU	-	This is a standard communications control method that conforms to Modicon Inc.'s RTU-mode Modbus Protocol (PI-MBUS-300 Rev. J).
Moving average	-	After every sampling, including the current sampling data, the past n data are averaged and displayed. There is a link with the last data.
Normal Fluctuation Deviation	-	A normal resistance value fluctuation range when the heater temperature is stabilized.
Normal Fluctuation Deviation Reference	-	A resistance value regarded as a reference of the normal fluctuation deviation. This becomes a reference resistance value, immediately after reference resistance value registration. After that, it becomes an average value of the past 10 resistance values measured in the stabilized state.
Operation Command	-	A generic term for the signals that command operation of devices. In the K7TM, operation command signals are given and executed via communications or key operations.

Term	Abbreviation	Description
Parameter	-	There are two types of parameters: the parameter that the user can set, and the parameter that accesses a monitored value. The parameter that can be set is called a "setting parameter." In addition, the parameter that can be accessed only via communications is called a "parameter exclusive to communications."
Partial burnout	-	Partial burnout of a heater means that one of the heaters connected in parallel has burned out and the remaining heaters are still functioning.
Power controller	-	In response to 4 to 20 mA analog signals of mainly the temperature controller (digital controller), manual setting with adjuster, or the like, this device steplessly adjust the amount of power of the heater by means of phase control or optimum cycle control.
Power ON reset	-	Power ON reset is a reset process inside the K7TM. It is executed by doing as follows: <ul style="list-style-type: none"> • Cycling the power supply • Executing the Software Reset Command via communications • Moving to the Operation Level with key operation (by pressing the Level Key for 1 second or more in the operation stopped state)
Reference Resistance Value	-	A resistance value of the heater in a normal state. With this resistance value regarded as a reference value, the K7TM calculates the reference resistance value change rate and determines an alarm to detect heater deterioration.
Resistance Value Change Rate	-	A change percentage of the heater resistance value to the reference resistance value. This is defined by the following formula. $\text{Resistance Value Change Rate} = 100 \times \frac{\left(\frac{\text{Present Resistance Value} - \text{Reference Resistance Value}}{\text{Reference Resistance Value}} \right)}{\text{Reference Resistance Value}} [\%]$
Special CT	-	CT (Current Transformer) recommended for the Heater Condition Monitoring Device. Use the CT with a rated current and voltage, according to the heater to monitor.
SSR	-	An acronym for Solid State Relay. This is a relay with no mechanical moving parts. Use the relay for heater control, in combination with the controller with time-proportional voltage outputs for driving SSR. It has no contact, so the life lasts semi-permanently.
Stabilization	-	This shows that the heater temperature is stable. By means of the stabilization discrimination method, the K7TM determines stabilization on the basis of the resistance value change rate and power or temperature etc.
Temperature characteristics	-	In this manual, it means the properties of the heater resistance value changing with a temperature rise. In order to correctly measure the resistance value change due to heater deterioration, the Heater Condition Monitoring Device K7TM has adopted such a measurement method as cancels changes in the resistance value due to the temperature characteristics of the heater.

Manual Structure

Page Structure and Symbols

5 Using Parameters

5-9 Operation Command with Key Operation

The following operation commands can be executed with key operations on the K7TM.

Operation Command	Description
Reference Resistance Value Registration Start Command	Starts to register the reference resistance value of each measurement channel.
Reference Resistance Value Registration Cancel Command	Cancels the reference resistance value evaluation of each measurement channel.
Alarm Latch Cancel Command	Releases the alarm latch for all channels.
Parameter Initialization Command	Initializes the setting values on all the setting levels except the communications setting level.

Reference Resistance Value Registration Start Command

● Procedure

1. Display the channel for which to register the reference resistance value on the Operation Level, and press the REF Key for 3 seconds or more.

- After the main display flashes at high speed, RDY Indicator flashes.
- When registration succeeded, RDY Indicator changes to the lit state.
- When registration failed, RDY Indicator goes out.

The Reference Resistance Value Registration Start instruction can be executed under the following conditions:

- You are on the Operation Level, and also the measurement value display automatic scroll is disabled.
- Parameters on the Adjustment Level (Common), Adjustment Level (Power), or Adjustment Level (Temperature) are displayed.
- No A/D error has occurred in the relevant channel.



5 - 33

5-9 Operation Command with Key Operation

Level 2 heading

Level 2 heading

A step in a procedure

Special information

Manual name

Level 1 heading

Level 2 heading

Page tab

Indicates a procedure.

Icons indicate precautions, additional information, or reference information.

Gives the current headings.

Gives the number of the main section.

Icons

Special information in this user's manual is classified as follows:



Precautions for Correct Use

Precautions on what to do and what not to do to ensure proper operation and performance.



Setting-related page

In *Section 5 Using Parameters*, this indicates the page related to the setting level.



Additional information to read as required.

This information is provided to increase understanding or make operation easier.



Tool Operating Procedure

In *Section 2 Procedures*, this indicates the procedure to perform with the K7TM Configuration Tool.



Configuration with Key Operations

In *Section 2 Procedures*, this indicates the procedure to perform with key operations on the K7TM.



No. Troubleshooting**

This indicates the position in *Section 2 Procedures* that provides more detailed information about trouble and countermeasures.

Notation on Main Display and LVL/Measurement Value Display

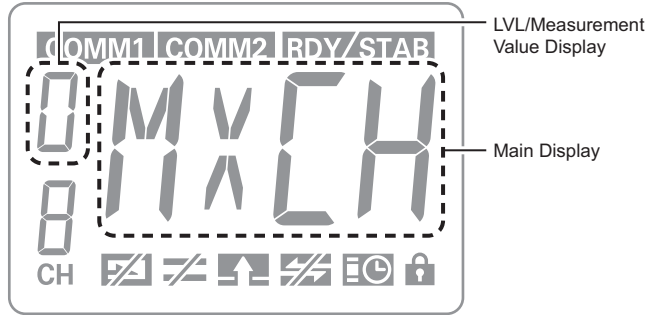

Main Display

The following tables show the correspondence between the symbols displayed on the main display and alphabet characters.

<i>R</i>	<i>b</i>	<i>l</i>	<i>d</i>	<i>E</i>	<i>F</i>	<i>G</i>	<i>H</i>	<i>z</i>	<i>J</i>	<i>K</i>	<i>L</i>	<i>M</i>
A	B	C	D	E	F	G	H	I	J	K	L	M

<i>N</i>	<i>o</i>	<i>P</i>	<i>q</i>	<i>R</i>	<i>S</i>	<i>t</i>	<i>U</i>	<i>v</i>	<i>W</i>	<i>x</i>	<i>y</i>	<i>Z</i>
N	O	P	Q	R	S	T	U	V	W	X	Y	Z

LVL/Measurement Value Display

The following tables show the correspondence between the numerals and characters displayed on the LVL/Measurement value display.

● LVL Display

Character	Meaning	
<i>A</i>	A	Shows that you are on the Adjustment Level (Common).
<i>B</i>	B	Shows that you are on the Adjustment Level (Power).
<i>C</i>	C	Shows that you are on the Adjustment Level (Temperature).
<i>0</i>	0	Shows that you are on the Initial Setting Level.
<i>1</i>	1	Shows that you are on the Communications Setting 1 Level.
<i>2</i>	2	Shows that you are on the Communications Setting 2 Level.

● Measurement Value Display

Character	Meaning	
<i>Δ</i>	Δ	Reference Resistance Value Change Rate
<i>R</i>	R	Resistance Value
<i>V</i>	V	Voltage Value
<i>I</i>	I	Current Value
<i>S</i>	S	Power
<i>T</i>	T	Temperature
<i>A</i>	A	Alarm Status

Revision History

A manual revision code appears as a suffix to the catalog number on the back cover of the manual.

Cat. No.	N227-E1-03
-----------------	-------------------

↑ Revision code

Revision code	Date	Revised content
01	December 2021	Original production
02	January 2022	Page 4-32: Added Running Time function.
03	September 2022	Added information on <i>Safety Precautions</i> .

Sections in this Manual

1	Overview	1
2	Procedures	2
3	Installation and Wiring	3
4	Function	4
5	Using Parameters	5
6	Remote Monitoring	6
7	Logging by K7TM Configuration Tool	7
8	Troubleshooting	8
A	Appendices	A
I	Index	I

CONTENTS

Preface	1
Terms and Conditions Agreement.....	2
Warranty, Limitations of Liability	2
Application Considerations	3
Disclaimers	3
Safety Precautions	4
Definition of Precautionary Information.....	4
Symbols	4
Precautions for Safe Use	7
Precautions for Correct Use.....	9
Regulations and Standards	10
Conformance to Safety Standards.....	10
Conformance to EN/IEC Standards.....	11
Terminology	12
Manual Structure	14
Page Structure and Symbols	14
Icons	15
Notation on Main Display and LVL/Measurement Value Display	16
Revision History	18
Sections in this Manual	19

Section 1 Overview

1-1 Overview.....	1-2
1-2 Features.....	1-4
1-3 Model Number Legend.....	1-7
1-4 Part Names and Functions	1-8
1-5 Internal Block Diagram	1-13
1-6 Example Configurations for Use.....	1-14

Section 2 Procedures

2-1 Overview.....	2-2
Detection of Heater Deterioration	2-2
Stabilization Discrimination Method for Heater Temperature	2-3
2-2 Flow of Operation	2-4
Advance Preparation	2-4
Configuration with Tool (Also Configurable with Key Operations).....	2-4
2-3 Advance Preparation.....	2-5
(1) Checking the Heater and Selecting the Special CT	2-5
Example of Selecting the Special CT	2-6
(2) Installation and Wiring	2-7

Example Wiring for Stabilization Discrimination Method (Power)	2-7
Example Wiring for Stabilization Discrimination Method (Temperature)	2-8
2-4 Configuration with Tool (Also Configurable with Key Operations)	2-9
(3) Communications Setting	2-9
(3-1) Switch Setting for K7TM, Installation of Tool, and Initial Setting of Communications Converter	2-9
(3-2) Communications Setting of Tool and Communications Test	2-12
(4) Initial Setting of K7TM	2-15
(4-1) Input Setting of K7TM	2-16
(4-2) Operation Setting of K7TM	2-17
(4-3) Selection of Method	2-18
(4-4) Communications Setting between K7TM and PLC (Only for Stabilization Discrimination Method (Temperature))	2-20
(4-5) Setting of Temperature Information (Only for Stabilization Discrimination Method (Temperature))	2-22
(5) Preparations (Registration)	2-24
(5-1) Preparations before Reference Resistance Value Registration	2-25
(5-2) Setting of Registration Targets and Execution of Registration	2-26
(5-3) Completion of Reference Resistance Value Registration	2-28
(6) Preparations (Adjustment)	2-29
Setup Window	2-29
(6-1) Adjustment (Common)	2-30
(6-2) Adjustment (Stabilization Discrimination Method: Power)	2-32
(6-3) Adjustment (Stabilization Discrimination Method: Temperature)	2-34
(7) Operation Setting of K7TM (Stabilization Discrimination Method (Power) and Stabilization Discrimination Method (Temperature))	2-36
(7-1) Output Setting of K7TM	2-37
(7-2) Alarm Setting of K7TM	2-39
(8) Starting Operation	2-41
2-5 Adjustment When Device Status Is Changed	2-42
Stabilization Discrimination Method (Power) and Stabilization Discrimination Method (Temperature) ..	2-42
Stabilization Discrimination Method (Temperature) Only	2-43
2-5-1 How to Calculate the Heater Deterioration Alarm Values at K7TM Replacement	2-44
Formulas	2-44
Calculation Examples	2-44
2-5-2 How to Calculate the Heater Deterioration Alarm Values after Partial Burnout Occurrence ...	2-45
Formulas	2-45
Calculation Examples	2-46
2-5-3 How to Calculate the Heater Deterioration Alarm Values after Temperature Set Point Change	2-47
Formulas	2-47
Calculation Examples	2-47
2-6 Troubleshooting	2-48
2-6-1 Troubleshooting for Procedures	2-48
2-7 Adjustment for Heater Running for a Short Time (Less than 35 Minutes)	2-52
2-7-1 Adjusting the Setting Value of <i>Measurement Value Calculation Cycle</i>	2-52
2-7-2 To Use Heater with Shortest Run Time of 20 Seconds	2-53
2-8 Adjustment When Reference Resistance Value Registration Failed	2-54
2-8-1 Stabilization Discrimination Method (Power) and Stabilization Discrimination Method (Temperature) ..	2-54
Trends in Voltage Value and Current Value Graphs	2-54
2-8-2 Stabilization Discrimination Method (Power)	2-56
Trends in Power and Resistance Value Graphs: Case 1	2-56
Trends in Power and Resistance Value Graphs: Case 2	2-58
Trends in Power and Resistance Value Graphs: Case 3	2-61
2-8-3 Stabilization Discrimination Method (Temperature)	2-64
Trends in Temperature and Resistance Value Graphs: Case 1	2-64
Trends in Temperature and Resistance Value Graphs: Case 2	2-65
Trends in Temperature and Resistance Value Graphs: Case 3	2-67
2-8-4 How to Predict Early That Registration Fails (Optional)	2-70

Section 3 Installation and Wiring

3-1	Dimensions	3-2
3-2	Installation.....	3-4
3-3	How to Connect to the Push-In Plus Terminal Blocks	3-6
3-4	I/O Wiring.....	3-9
3-5	Connections of Heaters with External Devices	3-11
3-6	Wiring the Communications Cables	3-14
3-7	Setting the Unit Number	3-16

Section 4 Function

4-1	Functions	4-2
4-2	Measurement Values	4-4
4-3	Measuring Changes over the Years in Heater	4-6
4-3-1	Measurement Principles.....	4-6
4-3-2	Function to Detect Heater Deterioration.....	4-6
4-3-3	Measurement Operation of K7TM.....	4-7
4-3-4	Measurement Operation of K7TM in Operation	4-8
4-3-5	Conditions for Moving from Waiting for Stabilization to Stabilized.....	4-9
4-3-6	Conditions for Moving from Stabilized to Waiting for Stabilization.....	4-11
4-3-7	Timing Charts.....	4-13
4-4	Alarm	4-18
4-4-1	Types of Alarm Notification Methods.....	4-18
4-4-2	Polarity of Transistor Output When Alarm Occurs	4-19
4-4-3	Releasing the Alarm Latch.....	4-20
4-4-4	Heater Deterioration Alarm	4-20
4-4-5	Last Resistance Value Change Rate Alarm	4-21
4-4-6	Heater Burnout Alarm	4-24
4-5	Measurement Error.....	4-26
4-5-1	Types of Notification of Measurement Errors	4-27
4-5-2	Actions for Measurement Errors	4-27
4-6	Logging Function	4-30
4-6-1	Function and Application.....	4-30
4-7	Running Time.....	4-32
4-8	Self-diagnosis Error	4-33

Section 5 Using Parameters

5-1	Levels	5-2
5-2	Setting Parameters and Setting Values	5-4
5-2-1	Setting Change Protection	5-6
5-2-2	Parameters.....	5-7
5-3	Operation Level	5-8
5-3-1	Switching Measurement Values and Displayed Channels	5-8
5-3-2	Display of Measurement Value Mark	5-9
5-3-3	Measurement Value Display Automatic Scroll	5-9
5-3-4	Parameters on Operation Level	5-10
5-4	Adjustment Level (Common) (LVL R).....	5-13
5-4-1	Moving to Adjustment Level (Common).....	5-13
5-4-2	Parameters on Adjustment Level (Common).....	5-14

5-5	Adjustment Level (Power) (LVL \bar{b})	5-19
5-5-1	Moving to Adjustment Level (Power)	5-19
5-5-2	Parameters on Adjustment Level (Power)	5-20
5-6	Adjustment Level (Temperature) (LVL \bar{c})	5-22
5-6-1	Moving to Adjustment Level (Temperature)	5-22
5-6-2	Parameters on Adjustment Level (Temperature)	5-23
5-7	Initial Setting Level (LVL \bar{d})	5-25
5-7-1	Moving to Initial Setting Level	5-25
5-7-2	Parameters on Initial Setting Level	5-26
5-8	Communications Setting 1 or 2 Level (LVL \bar{f} or \bar{g})	5-30
5-8-1	Moving to Communications Setting Level	5-30
5-8-2	Parameters on Communications Setting 1 or 2 Level	5-31
5-8-3	Unit Number	5-32
5-9	Operation Command with Key Operation	5-33

Section 6 Remote Monitoring

6-1	Remote Monitoring	6-2
6-2	Communications Overview	6-3
6-3	Variable Area Map	6-5
6-3-1	Variable Area Map Descriptions	6-5
6-3-2	Variable Areas of Both 1CH and 2CH	6-6
6-3-3	Variable Areas of 1CH (Change Beginning Address into 2 for Variable Areas of 2CH)	6-8
6-3-4	Read-Only Variable Areas	6-12
6-3-5	Details about Status Information	6-13
6-4	To Monitor All Measurement Values Together (Reading Variable Areas)	6-16
6-5	Operation Command	6-17
6-6	Checking (Reading) Parameters	6-19
6-7	Changing (Writing) Setting Parameters	6-20
6-8	Modbus RTU Communications Format	6-21
6-8-1	Frame Configurations	6-21
6-8-2	Read Variable Area Command	6-24
6-8-3	Write Variable Area Command	6-25
6-8-4	Operation Command or Write Variable Area Command (Single)	6-27

Section 7 Logging by K7TM Configuration Tool

7-1	Overview	7-2
7-1-1	Logging-related Target Sheets	7-2
7-2	Logging of Measurement Value	7-4
7-3	Reading of Log	7-7

Section 8 Troubleshooting

8-1	Troubleshooting	8-2
------------	------------------------------	------------

Section A Appendices

A-1	Specifications	A-2
A-1-1	K7TM.....	A-2
	Ratings and Specifications	A-2
	Measurement Specifications.....	A-5
	Push-In Plus Terminal Blocks Specifications.....	A-6
	Specifications of K7TM Configuration Tool.....	A-7
A-1-2	Special CTs	A-7
	Models	A-7
	Ratings and Specifications	A-8
A-1-3	Applicable Standards	A-10
A-2	Parameters List.....	A-11
A-3	Parameter Flow	A-15
A-4	Operation of Reference Resistance Value Registration.....	A-16
A-4-1	Corrections When Reference Resistance Value Registration Failed (Adjustments with Key Operation).....	A-17

Index



1

Overview

This section describes the overview, features, model number legend, part names and functions, internal block diagram, and example configurations for use of the K7TM.

1-1 Overview	1-2
1-2 Features	1-4
1-3 Model Number Legend	1-7
1-4 Part Names and Functions	1-8
1-5 Internal Block Diagram	1-13
1-6 Example Configurations for Use	1-14

1-1 Overview

What is the K7TM?

The K7TM is a device for supporting condition monitoring of heaters by measuring the resistance values of the heaters.

The Unit calculates a resistance value by measuring the voltage at both ends of the heater and its current, so it can measure the resistance value of even the live heater.

In addition, by collecting the resistance value data of heaters measured, the Unit can catch signs of heater deterioration or identify trouble-prone heaters to analyze the cause from the data.

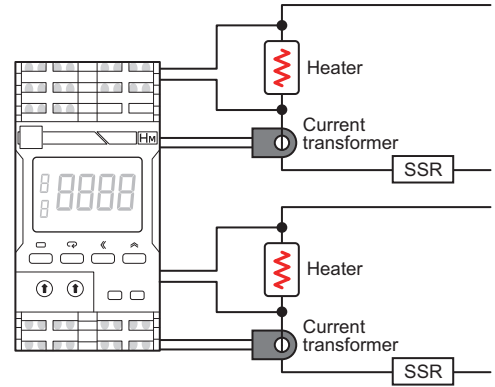

Heaters and Equipment Which Can Use the K7TM

The K7TM can monitor the resistance values of resistance heating heaters.

The resistance heating heaters are used in a variety of equipment, such as electric furnaces and injection molding machines.

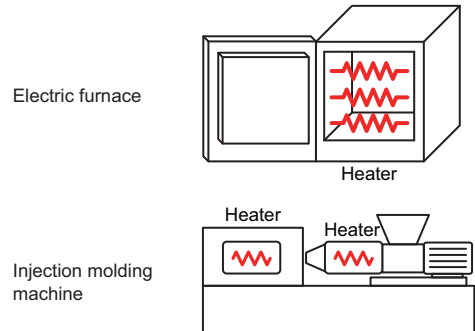

Mechanism by Which Heaters Deteriorate

A heater that is turned ON generates heat, and a heating element (conductor) of the heater is oxidized by that heat. As the heating element becomes more oxidized, the cross-sectional area becomes smaller, resulting in burnout. As the cross-sectional area becomes smaller, the resistance value of the heater becomes larger. This is the mechanism by which heaters are deteriorated by oxidation.

From the foregoing, in order to notice that some heater will burn out soon, it is important to monitor changes in the resistance value.

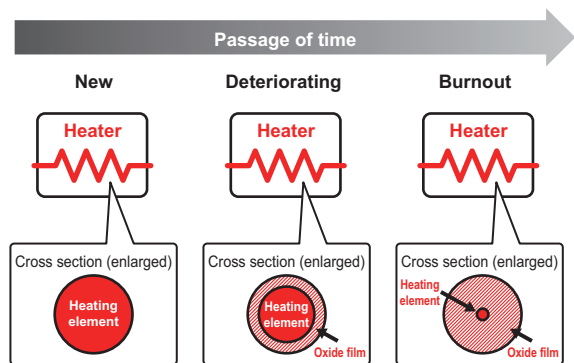

$$\text{Resistance value} = \text{Resistivity} \times \frac{\text{Length of heating element}}{\text{Thickness of heating element}}$$

so the resistance value becomes larger as the thickness (cross-sectional area) of the heating element becomes smaller.

What the K7TM Can Realize

The K7TM measures the voltage at both ends of a heater and its current by synchronizing them at high speed, so it can measure the resistance value of the heater that is controlled.

Previously, we used to replace a heater after burnout occurred or replace it periodically to prevent the heater from burning out.

Using the K7TM now allows you to check data to see if there is any change over the years in the heater resistance value; on the basis of that data, you can decide when to replace the heater. This will bring about the following effects:

- Preventing an unexpected equipment stop or product defects from being caused by heater burnout
- Reducing the loss due to early heater replacement
- Making heater deterioration visible as a value, so you can establish the maintenance method that does not depend on specific persons

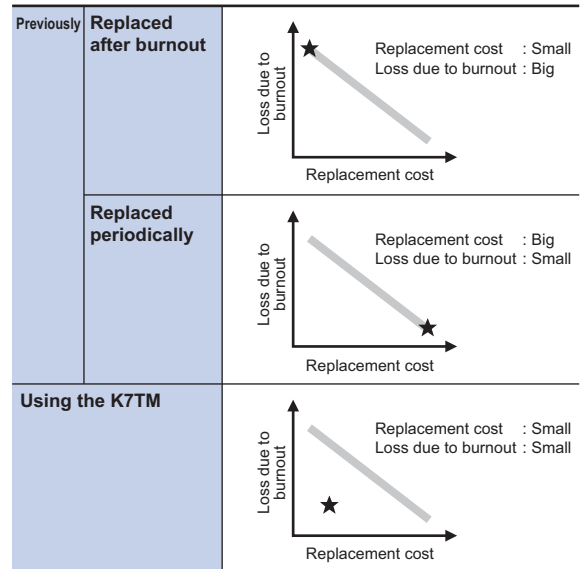

1-2 Features

The following features make the K7TM convenient to use.

Detects Changes in the Resistance Value at a Fixed Heater Temperature

Resistance values of a heater change with its own temperature changes. If changes in the resistance value due to temperature characteristics of the heater are misjudged to be changes in the resistance value due to deterioration, the degree of deterioration can no longer be monitored correctly.

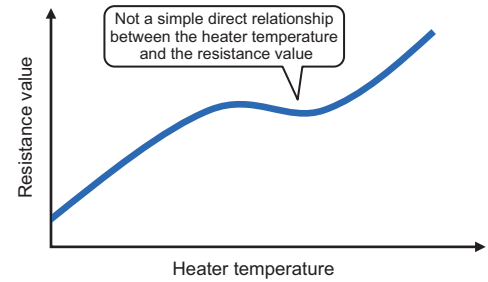

The K7TM has a function that monitors the resistance values at the same temperature of the heater. This can remove the changes in the resistance value due to temperature characteristics of the heater, and allow you to monitor only the changes in the resistance value due to deterioration.

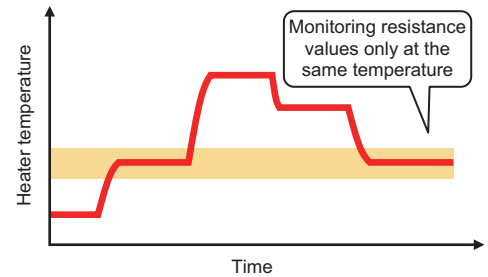

Can Catch Changes in the Heater Resistance Value While Equipment Is Running

Usually, the resistance value of a heater is measured by using a tester, with the power supply turned off. However, there is no need to stop production for resistance value measurement, because the K7TM calculates a resistance value by measuring the voltage and current when electricity is running down the heater. The resistance value can be measured even if equipment works on a 24-hour, 365-day basis.

Can Measure the Resistance Value Stably in Various Heater Control Methods

A heater is always switching-controlled by SSR, power controller, and relay. This switching control will cause intermittent waveforms of the voltage and current of the heater, making the measured resistance value unstable.

The K7TM measures the voltage and current by synchronizing them at high speed, so it can measure the resistance value stably in various heater control methods.

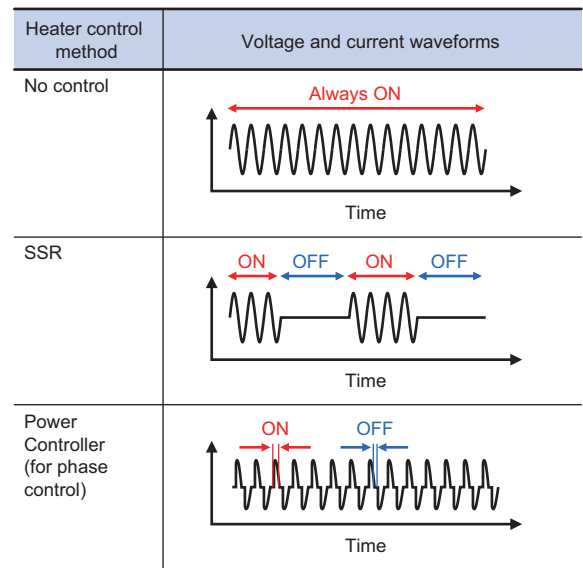

Can Set Two Levels of Alarms

The K7TM has a function that gives two levels of alarms, “Warning” and “Critical.” If the resistance value change rate exceeds the 1st-level threshold and the 2nd-level threshold, the alarm “Warning” and the alarm “Critical” will be activated respectively.

(Application example)

For example, when you notice that the resistance value change rate has gone in the “Warning” range, you will get ready to replace the heater before that goes in the “Critical” range.

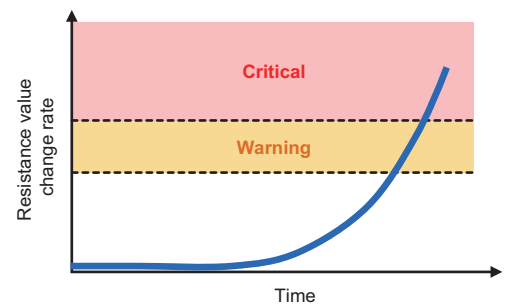

Easy Retrofitting to the Equipment

If you can pull out the voltage wires at both ends of a heater and install a current transformer (CT), the K7TM can measure the resistance value. Even for the existing equipment, it is not necessary to change wiring on a large scale.

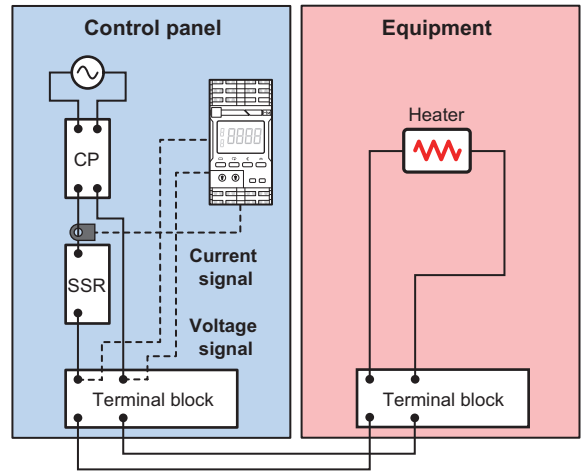

Enables Remote Trend Monitoring

Using the communications function that the K7TM has allows you to monitor the measured resistance values remotely. The data can be checked from a remote location without having to go to the equipment, saving you the trouble of going to the site for inspection.

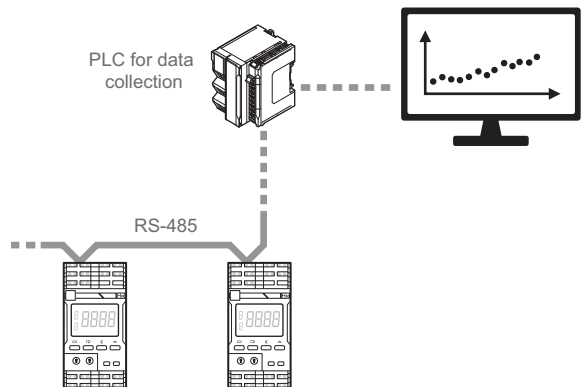

1-3 Model Number Legend

This section shows the model number legend of the K7TM.

K7TM - A 2 M □
 (1) (2) (3) (4) (5)

(1)	(2)	(3)	(4)	(5)	Meaning
Base model	Input type	Number of channels	Unit type	Power supply voltage	
K7TM					Heater Condition Monitoring Device
	A				Voltage and Current
		2			2 channels
			M		K7TM
				A	100 to 240 V AC power supply
				D	24 V AC/DC power supply

Refer to *A-1 Specifications* on page A-2 for the specifications of each model.

1-4 Part Names and Functions

Appearance

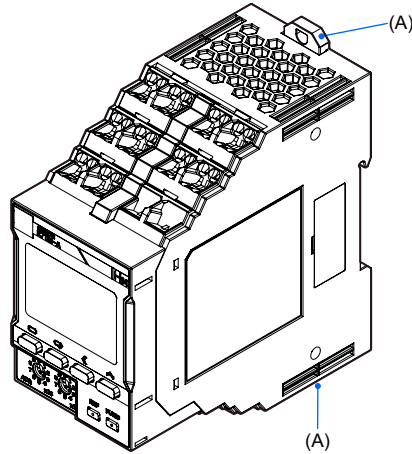





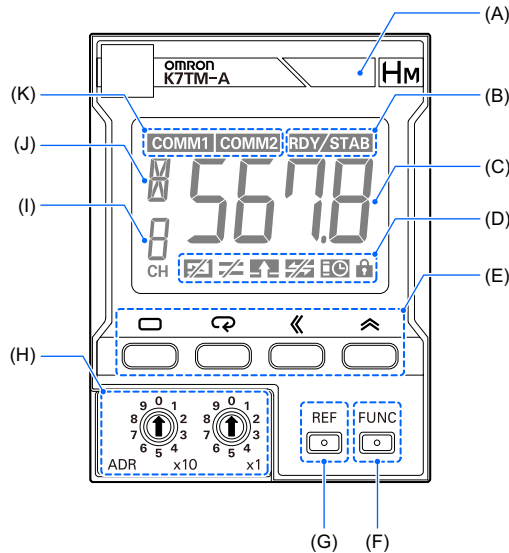











Symbol	Name	Function
(A)	DIN Track mounting hook	Used for mounting to the DIN Track.

Front Section



Symbol	Name	Function	
(A)	Alarm output indicator	Indicates the alarm judgment results in three colors. Green: Normal Yellow: Warning (At least one of the heater deterioration alarm (warning) and the last resistance value change rate alarm has occurred.) Red: Critical (At least one of the heater deterioration alarm (critical) and the heater burnout alarm has occurred.) It will turn red also if any other fatal failure occurs. The red light overrides the yellow light. Not lit: It is not lit when the measurement operation has stopped.	
(B)	Monitoring step indicator display	RDY Indicator	Indicates the registration status of a reference resistance value of the current channel. Not lit: Reference resistance value not registered Flashing: Reference resistance value under evaluation Lit: Reference resistance value registered
		STAB Indicator	Indicates the monitoring status of the current channel. Not lit: Waiting for stabilization*1 Lit: Stabilized Flashing: Unstabilization error
(C)	Main display	Indicates a measurement value or a set value.	
(D)	Status display	IN Indicator	Indicates whether there are voltage and current inputs. Not lit: Voltage and current input on all channels*1 Flashing: Voltage and current not input except on the current channel Lit: Voltage and current not input on the current channel
		FAIL Indicator	Indicates the occurrence status of a measurement error. Not lit: A measurement error not generated on all channels*1 Flashing: A measurement error generated except on the current channel Lit: A measurement error generated on the current channel
		ALM Indicator	Indicates that an alarm has occurred. Not lit: An alarm not generated on all channels*1 Flashing: An alarm generated except on the current channel Lit: An alarm generated on the current channel
		AGE Indicator	Lights when it is time to replace the K7TM (guideline).
		LOCK Indicator	Lights when setting change protection is enabled.

Symbol	Name	Function		
(E)	Operation Keys	Level Key ()	Selects the setting level.	
		Mode Key ()	Switches setting parameter displays, on the setting level that allows you to change the parameter. Switches measurement value displays (reference resistance value change rate, resistance value, voltage value, current value, power, temperature, and alarm status), on the Operation Level.	
		Shift Key ()	Moves from the parameter name display state to the monitoring state. Puts the parameter value into the changeable state. Used for digit shift, in the setting change state.	
		Up Key ()	Increments the value when the parameter is in the setting change state. Switches channels of the measurement value or parameter to display, in the measurement value display state or the parameter display state.	
(F)	FUNC Key (Function Key)	Releases the alarm latch.		
(G)	REF Key (Reference Key)	Starts resistance reference value registration for the current channel. When the reference resistance value is under evaluation, cancels reference resistance value registration.		
(H)	Unit number setting switch	Sets the unit number.		
(I)	CH display	Indicates the channel of the currently displayed parameter.		
(J)	LVL/Measurement value display	Operation Level: Indicates the currently displayed measurement value mark. Other levels: Indicates the mark showing the setting level*2.		
		Level	Measurement value mark	Meaning
		Operation Level		Reference Resistance Value Change Rate
				Resistance Value
				Voltage Value
				Current Value
				Power
				Temperature
				Alarm Status
		Setting level	Level mark	Meaning
		Adjustment Level (Common)		Shows that you are on the Adjustment Level (Common).
Adjustment Level (Power)		Shows that you are on the Adjustment Level (Power).		
Adjustment Level (Temperature)		Shows that you are on the Adjustment Level (Temperature).		
Initial Setting Level		Shows that you are on the Initial Setting Level.		
Communications Setting 1 Level		Shows that you are on the Communications Setting 1 Level.		
Communications Setting 2 Level		Shows that you are on the Communications Setting 2 Level.		
(K)	Communications display	COMM1 Indicator	Lit when the communications 1 terminals (for host system) received a command to the local address.	
		COMM2 Indicator	Lit when the communications 2 terminals (for K7TM Configuration Tool or IoT gateway) performed normal communications.	

*1. Not lit also when the measurement operation has stopped.

*2. Refer to 5-1 Levels on page 5-2 for the setting level.

Terminal Section

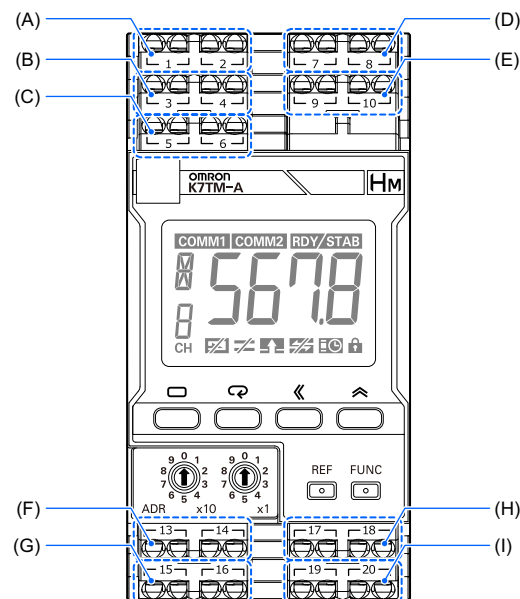

Symbol	Terminal Numbers	Name	Function
(A)	1 and 2	Operation power supply	To be connected with the operation power supply to the K7TM.
(B)	3 and 4	RS-485 communications 1	To be connected with the RS-485 communications line. This is a communications terminal for communicating with the host system. Number 3: +, Number 4: -
(C)	5 and 6	RS-485 communications 2	To be connected with the RS-485 communications line. This is a communications terminal for communicating with the K7TM Configuration Tool or the IoT gateway. Number 5: +, Number 6: -
(D)	7 and 8	CH1 voltage input	To be connected with both ends of a heater to measure the voltage applied to the heater. This is the first input of the two measurable channels.
(E)	9 and 10	CH1 CT input	To be connected with the CT, connected to a heater current measuring point, to measure the current running down the heater. This is the first input of the two measurable channels.
(F)	13 and 14	Alarm output	Compares the resistance value change rate and the alarm threshold to produce an alarm output. Number 13: Collector of the NPN transistor, Number 14: Emitter of the NPN transistor.
(G)	15 and 16	Output at Error	Produces an output at error, in case of a measurement error or a self-diagnosis error. Number 15: Collector of the NPN transistor, Number 16: Emitter of the NPN transistor.
(H)	17 and 18	CH2 voltage input	To be connected with both ends of a heater to measure the voltage applied to the heater. This is the second input of the two measurable channels.

Symbol	Terminal Numbers	Name	Function
(I)	19 and 20	CH2 CT input	The CT connected to the heater current measurement point is wired to this terminal, and the K7TM measures the heater current. This is the second input of the two measurable channels.



Install wiring according to *Section 3 Installation and Wiring*.

1-5 Internal Block Diagram

The internal block diagram of the K7TM is shown below.

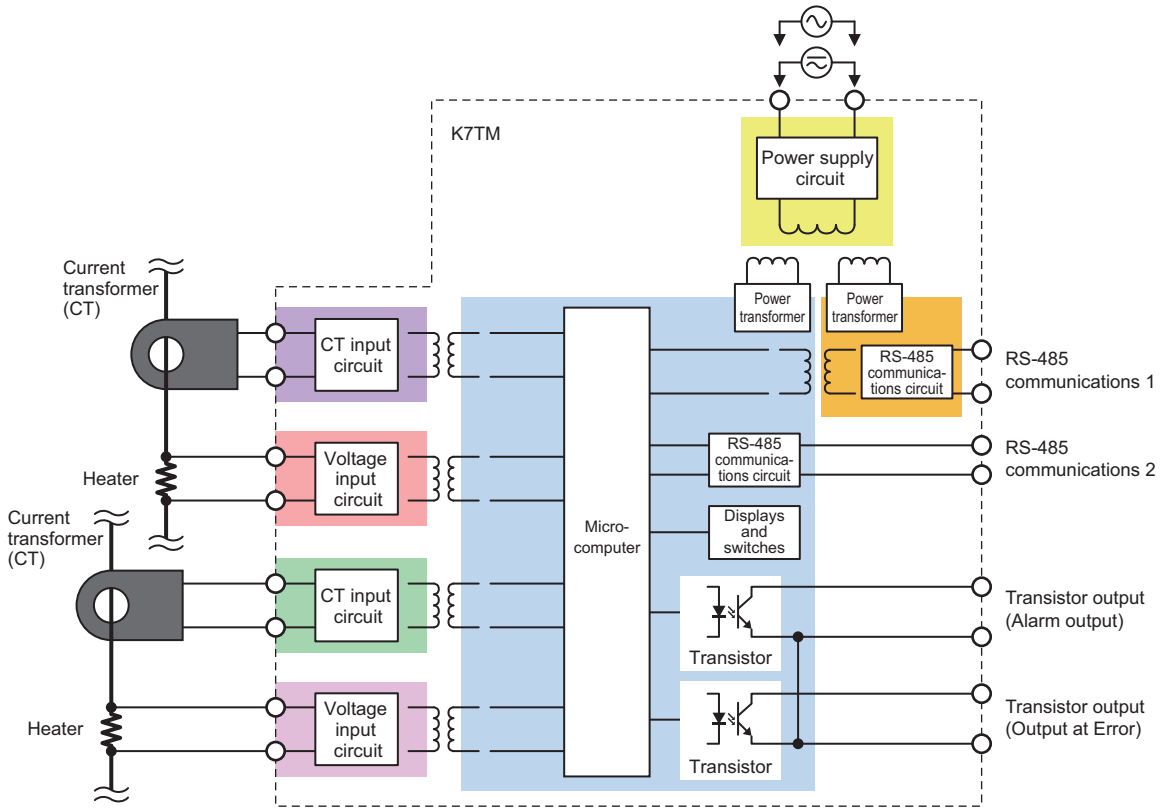

1-6 Example Configurations for Use

Example Configuration (1)

This is a typical configuration for using the K7TM.

The PLC for data collection reads the resistance values measured by the K7TM. The PLC for data collection displays the read resistance value data on the touch panel in graphical form etc.

The K7TM Configuration Tool is used for configuring the K7TM.

The K7TM has two communications ports of RS-485. One is for communications with the host system such as the PLC for data collection, and the other is for communications with the K7TM Configuration Tool. The communications protocol is compatible with Modbus RTU.

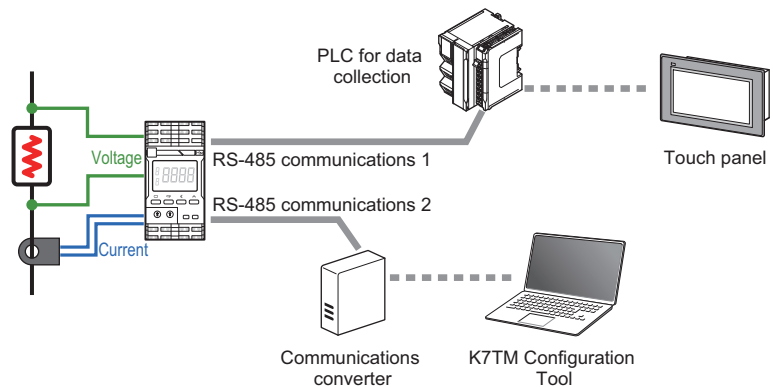

Example Configuration (2)

This is a configuration for reading the resistance values of heaters remotely.

The PLC for data collection reads the resistance values measured by the K7TM.

The PLC for data collection passes the resistance value data to the computer for production control away from the equipment, and they are controlled centrally.

The K7TM is configured by relaying the data from the computer for production control through the PLC for data collection.*

* The K7TM Configuration Tool cannot be connected to the K7TM via PLC.

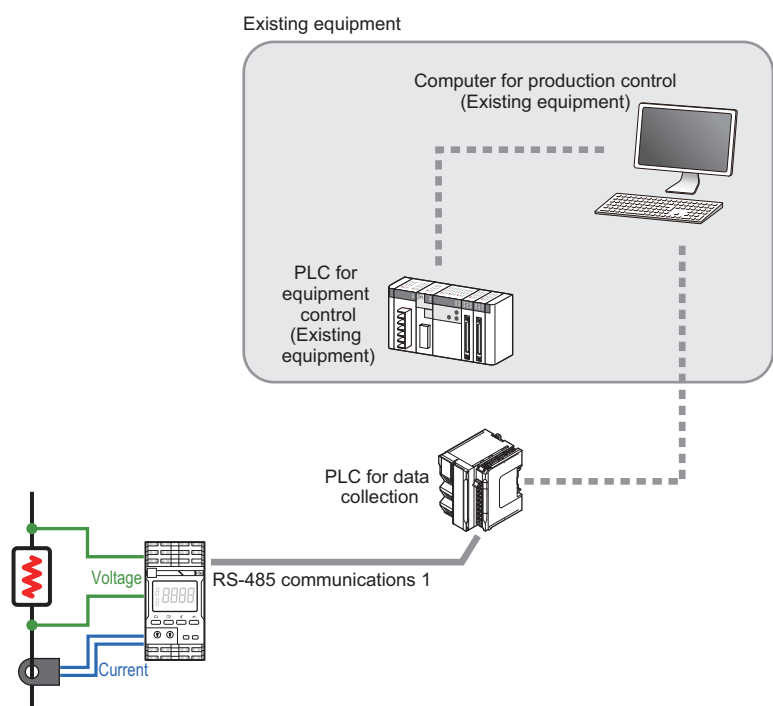

Example Configuration (3)

This is a configuration for using the K7TM with a small number of devices.

If the measured resistance value change rate exceeds the threshold, the warning lamp is lit with the transistor output signal.

The K7TM Configuration Tool is used for configuring the K7TM.

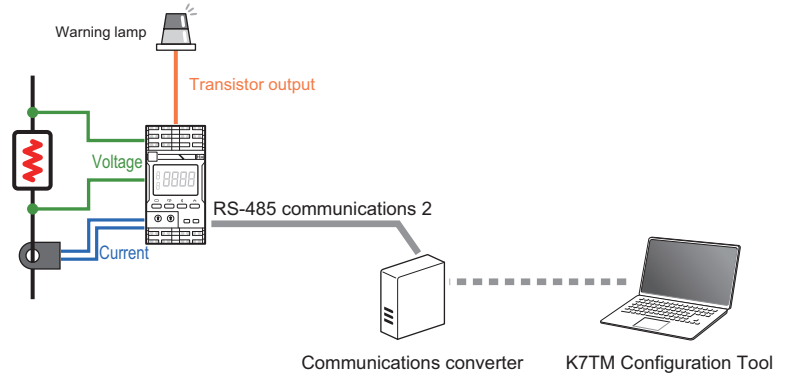

2

Procedures

This section describes the procedures from preparations to startup of the K7TM.

2-1 Overview	2-2
2-2 Flow of Operation	2-4
2-3 Advance Preparation	2-5
(1) Checking the Heater and Selecting the Special CT	2-5
(2) Installation and Wiring	2-7
2-4 Configuration with Tool (Also Configurable with Key Operations)	2-9
(3) Communications Setting	2-9
(4) Initial Setting of K7TM	2-15
(5) Preparations (Registration)	2-24
(6) Preparations (Adjustment)	2-29
(7) Operation Setting of K7TM (Stabilization Discrimination Method (Power) and Stabilization Discrimination Method (Temperature))	2-36
(8) Starting Operation	2-41
2-5 Adjustment When Device Status Is Changed	2-42
2-5-1 How to Calculate the Heater Deterioration Alarm Values at K7TM Replacement	2-44
2-5-2 How to Calculate the Heater Deterioration Alarm Values after Partial Burnout Occurrence	2-45
2-5-3 How to Calculate the Heater Deterioration Alarm Values after Temperature Set Point Change	2-47
2-6 Troubleshooting	2-48
2-6-1 Troubleshooting for Procedures	2-48
2-7 Adjustment for Heater Running for a Short Time (Less than 35 Minutes)	2-52
2-7-1 Adjusting the Setting Value of <i>Measurement Value Calculation Cycle</i>	2-52
2-7-2 To Use Heater with Shortest Run Time of 20 Seconds	2-53
2-8 Adjustment When Reference Resistance Value Registration Failed	2-54
2-8-1 Stabilization Discrimination Method (Power) and Stabilization Discrimination Method (Temperature)	2-54
2-8-2 Stabilization Discrimination Method (Power)	2-56
2-8-3 Stabilization Discrimination Method (Temperature)	2-64
2-8-3 Stabilization Discrimination Method (Temperature)	2-64
2-8-4 How to Predict Early That Registration Fails (Optional)	2-70

2-1 Overview

Detection of Heater Deterioration

- Heater deterioration is detected on the basis of changes in the resistance value. The resistance value before deterioration is called a “reference resistance value,” and heater deterioration is detected with this resistance value regarded as a reference.
- The K7TM Configuration Tool is used for configuration. (K7TM key operations can also be used for configuration.)
Refer to *Section 7 Logging by K7TM Configuration Tool* on page 7-1 for the overview, functions, and screen descriptions of the K7TM Configuration Tool.
- Refer to *(4-3) Selection of Method* on page 2-18 for details on the stabilization discrimination method.

Stabilization Discrimination Method for Heater Temperature

The K7TM has two stabilization discrimination methods for heater temperature: *Power* and *Temperature*.

The default value is *Power*. External connections and settings vary with the stabilization discrimination method.

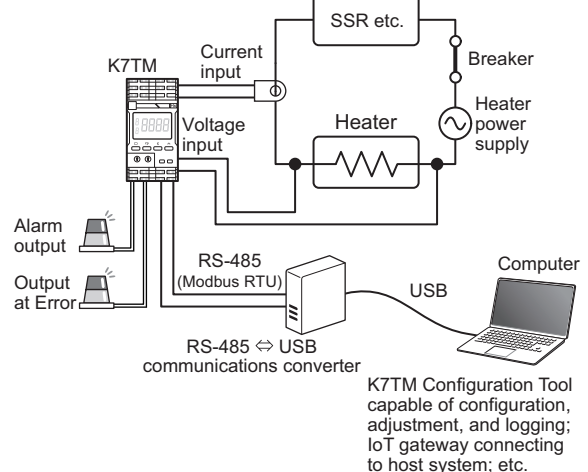
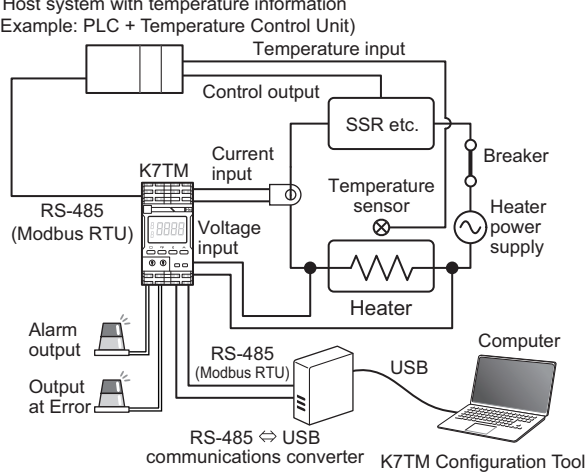
Stabilization Discrimination Method	Function	Configuration Diagram
<p>Stabilization Discrimination Method (Power)</p>	<p>This method estimates the stabilization temperature from heater power, and automatically judges whether the heater is deteriorated.</p> <p>No PLC or host system is required for determining stabilization, so the trends of the heater condition can be monitored easily compared with the stabilization discrimination method (temperature). This is an OMRON-specific method.</p>	
<p>Stabilization Discrimination Method (Temperature)</p>	<p>This method inputs the heater control temperature from the PLC or the host system to the K7TM via serial communications (Modbus RTU).</p> <p>The K7TM determines that the temperature is stabilized, and automatically judges whether the heater is deteriorated.</p> <p>If the heater temperature can be measured accurately by the temperature sensor, deterioration measurement might be rather stable compared with the stabilization discrimination method (power).</p>	

2-2 Flow of Operation

Advance Preparation

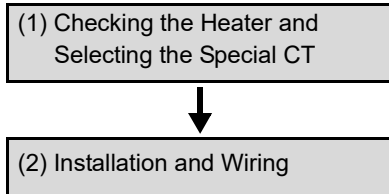

Configuration with Tool (Also Configurable with Key Operations)

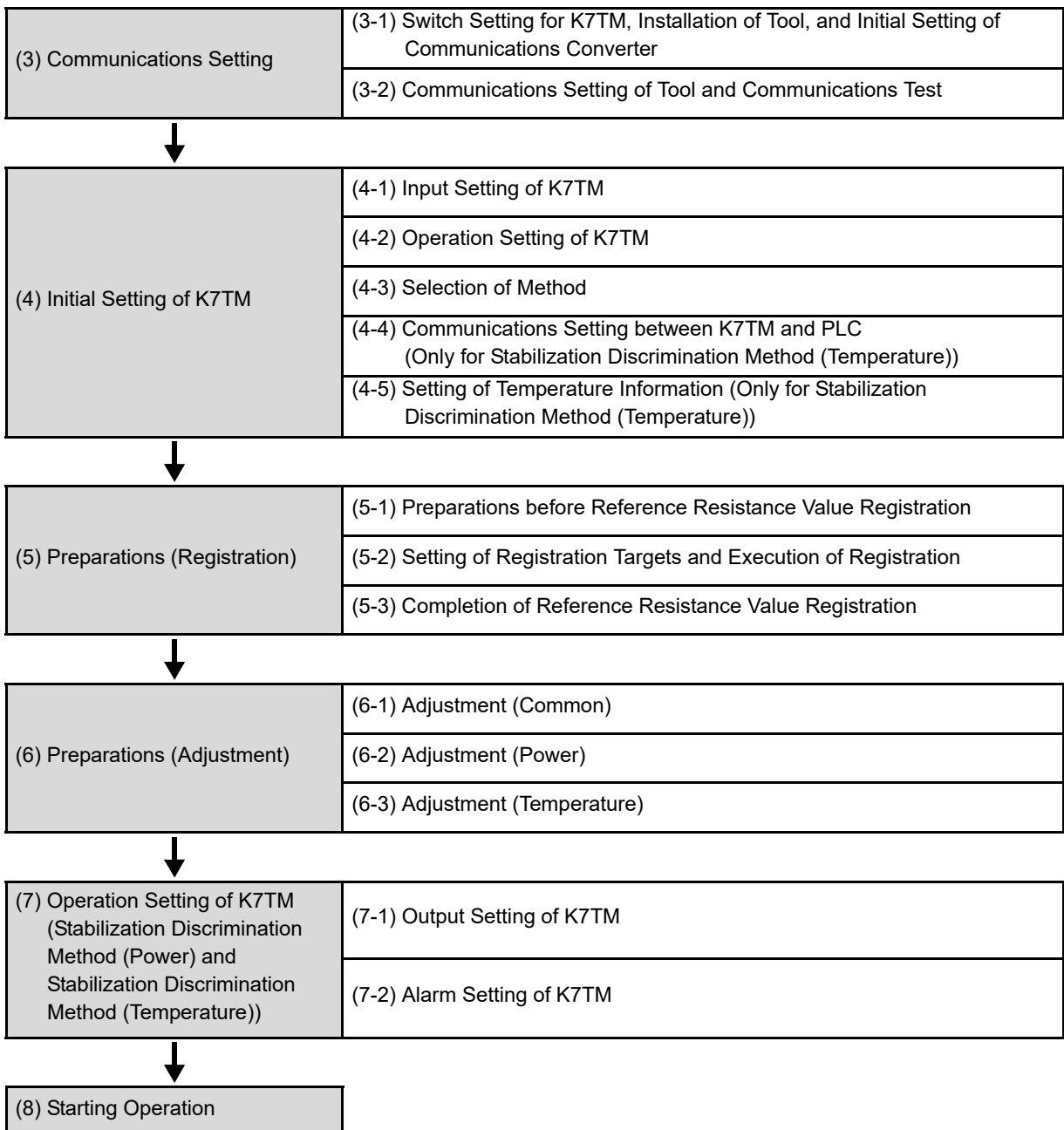

2-3 Advance Preparation

This section describes the procedures until the end of that for starting operation, taking a system that measures one single-phase heater as an example.

(1) Checking the Heater and Selecting the Special CT

Check the heater to monitor.

The K7TM targets the resistance heating heater.
The representative examples are shown below.

- Sheathed heater
- Cartridge heater
- Band heater
- Cast heater
- SiC (silicon carbide) heater
- Ceramic heater



Precautions for Correct Use

Be aware that the K7TM cannot measure the resistance values of the following heaters:

- Induction heater
- Steam heater
- Oil fan heater or gas fan heater

Check whether the heater runs for the time period required for deterioration detection.

The K7TM is designed so that a deterioration detection algorithm will work when the heater to monitor runs for 35 minutes or more (2,000 seconds = 100 seconds × 10 times × 2).

Check whether the heater to monitor runs for 35 minutes or more.

However, if the run time of the heater to monitor is 20 seconds or more, you can use a deterioration detection algorithm by adjusting the parameters.

■ Parameters for adjustment

Setting parameter	Setting level	Display	Default value
Measurement Value Calculation Cycle	Initial Setting Level	<i>MVCP</i>	100 seconds
Resistance Value Moving Average Count	Adjustment Level (Common)	<i>AVER</i>	Low (10 times)
Power Moving Average Count	Adjustment Level (Common)	<i>AVEP</i>	Low (10 times)



The run time of a heater shows the time during which it is stable around the set point after the temperature reaches the set point.



No. 1 Troubleshooting

If the run time of the heater to monitor is less than 35 minutes, can't it be monitored?

Prepare a special CT suitable for the heater to monitor.

1. Use a formula to determine the rated current [A] of the special CT from the capacity [kW] of the heater to monitor and the voltage input [V] applied to the heater.
2. Select the minimum special CT that accepts the current obtained by the formula.

Formula for rated current [A] of special CT

$$\text{Rated Current [A]} = \frac{\text{Heater Rated Capacity [kW]} \times 1,000}{\text{Heater Rated Voltage [V]}}$$

- Selectable Voltage Range [V]
 - 120
 - 240
 - 480
 - 600
- Selectable CT Range [A]
 - 5
 - 25
 - 100
 - 200
 - 400
 - 600

Example of Selecting the Special CT

- For one single-phase heater
 Heater to monitor of 100 V / 1 kW:
 Voltage Input Range = 120 [V]
 CT Input Range = 25 [A]

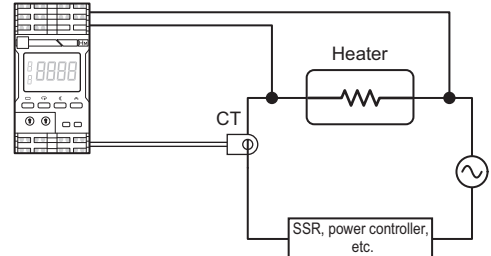

- For multiple single-phase heaters in parallel
 Three heaters of 100 V / 1 kW each, connected in parallel:
 Voltage Input Range = 120 [V]
 CT Input Range = 100 [A]

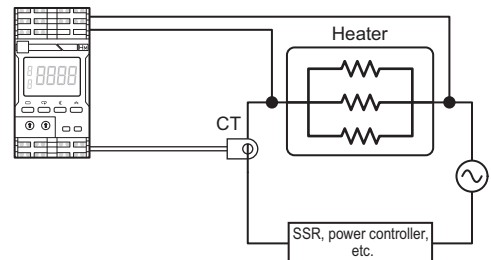

When you use one CT to monitor three heaters of 100 V / 1 kW connected in parallel, the power attains 3 kW (= 1 kW × 3), resulting in 3 kW ÷ 100 V = 30 A; therefore, select the CT input range of 100 [A].

Set the “voltage input range” and “CT input range” selected here, to the K7TM in (4) Initial Setting. In the following procedures, descriptions are based on the setting example *For one single-phase heater*.

(2) Installation and Wiring

Mount the K7TM to the DIN Track.

1. Pull down the DIN Track mounting hook on the bottom.
2. Next, hook the upper hook onto the DIN Track and push in the Unit.
3. Raise the DIN Track mounting hook that was pulled down and fix the Unit to the DIN Track.
4. Install End Plates* on the right and left sides. * Sold separately

Refer to 3-2 *Installation* on page 3-4 for details on how to mount the Unit to the DIN Track.

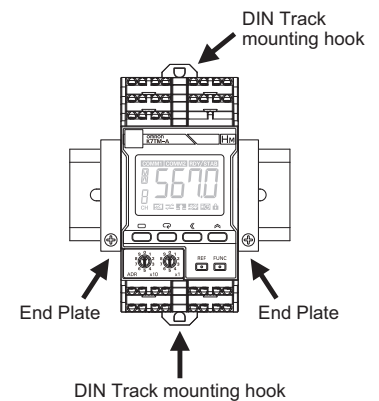

Install wiring between the heater to monitor and the K7TM.

Example Wiring for Stabilization Discrimination Method (Power)

1. Install wiring between the heater to monitor and the K7TM in consultation with the figure.
2. Connect the communications cables of the communications converter to the terminal numbers (5) (+) and (6) (-).

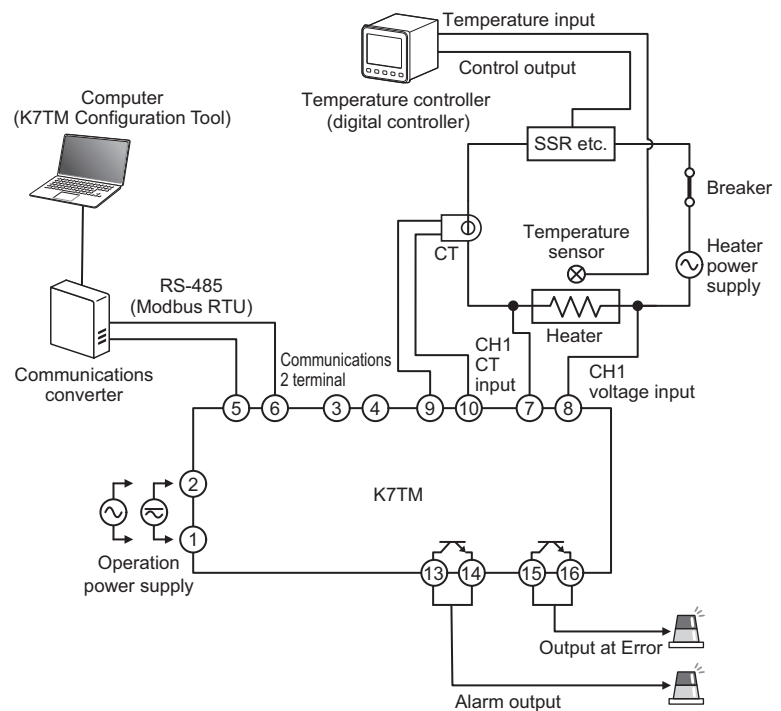

The CT input terminals can be connected in either direction of the special CT regardless of polarity.

Example Wiring for Stabilization Discrimination Method (Temperature)

To use the stabilization discrimination method (temperature) for measuring heater deterioration, include the PLC or other host system.

1. Add the PLC or other host system, and input the process value (PV) of the heater to the K7TM via communications.

Refer to *Connection with Host System in 3-6 Wiring the Communications Cables* on page 3-14 for details on wiring.

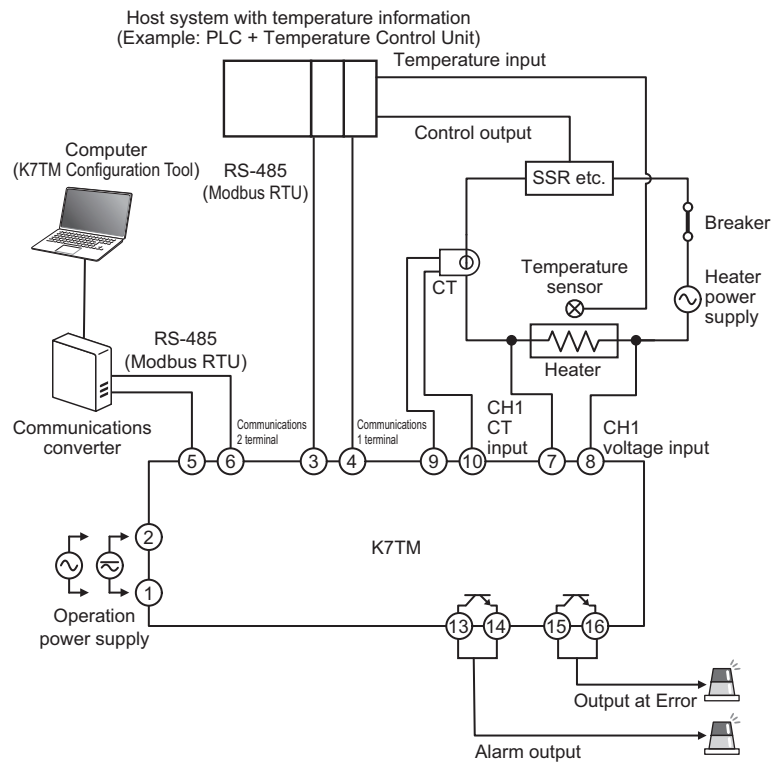

The CT input terminals can be connected in either direction of the special CT regardless of polarity.

2-4 Configuration with Tool (Also Configurable with Key Operations)

The K7TM Configuration Tool is a tool for “configuration,” “adjustment,” and “logging” of the K7TM. Section 2 describes “configuration” and “adjustment.”

Refer to *Section 7 Logging by K7TM Configuration Tool* on page 7-1 for “logging.”

This procedure (3) is not required when you configure the K7TM with its key operations without using the Tool.

(3) Communications Setting

(3-1) Switch Setting for K7TM, Installation of Tool, and Initial Setting of Communications Converter

Set the unit number of the K7TM.

- For setting, use the unit number setting switches on the K7TM front.
You can set a number from 01 to 99. Make the setting when the power is OFF. In the following procedures, descriptions are based on “01.”
- Turn ON the power. The setting is applied after a power ON reset.

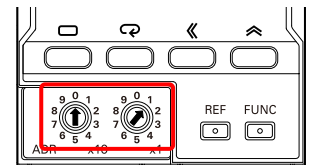

No. 2 Troubleshooting

Power will not be turned ON. The power-on state is unstable, such as a flickering display.



In the communications protocol Modbus RTU, the unit number to use is 01 to 99. Slave address 00 will be broadcast in the Modbus RTU protocol.



The power ON reset is a reset process inside the K7TM. It is executed by doing as follows:

- Cycling the power supply
- Executing the Software Reset Command via communications
- Moving to the Operation Level with key operation (by pressing the Level Key for 1 second or more in the operation stopped state)

Install the K7TM Configuration Tool onto your computer.

1. Connect the K7TM and the computer (K7TM Configuration Tool) in consultation with the figure.

The K7TM Configuration Tool can configure up to eight K7TM Units.

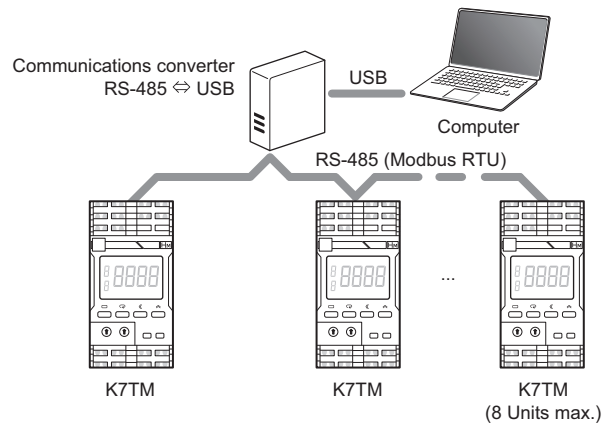

2. Download the K7TM Configuration Tool from the website.
https://www.ia.omron.com/k7tm_tool

The K7TM Configuration Tool can be used just by decompressing the file, because it uses a macro book of Microsoft® Excel.



- It may take time for the K7TM Configuration Tool to be started or saved.
- When you perform the functions of the K7TM Configuration Tool, the drawing, calculation, and edit processing of Excel are stopped depending on the timing.
- While using the K7TM Configuration Tool, you are recommended not to operate other Excel files. Operating other Excel files will cause the K7TM Configuration Tool to operate unstably.
- The mouse cursor is in the following state during the processing of the K7TM Configuration Tool.



• System requirements

Supported OS	Windows 10 (64-bit edition), English or Japanese *1
Computer specifications	1 GHz or faster CPU, 1 GB or more of RAM, and 16 GB or more of required disk space
Excel	Excel 2013, 2016, or 2019; 32-bit or 64-bit edition; English or Japanese *2
RS-485–USB Communications converter	Use a commercially available product. *3
Maximum number of connected K7TM Units	8 Units

- *1. Japanese characters may be garbled if the system locale of the computer that uses the K7TM Configuration Tool is not *Japanese (Japan)*.
- *2. When you use the K7TM Configuration Tool with Excel 2013 or Excel 2016, set **Measurement Value Calculation Cycle** on the **Initial Setting of K7TM** Sheet of the K7TM Configuration Tool to 100 seconds or less. (Default setting: 100 s) It may become unstable if you set a value that exceeds 100 seconds.

Category	Parameter name	Setting range	Unit Number (1st)	
			CH1	CH2
Input Setting of K7TM	Maximum Number of Channels	1 to 2 [CH]		
	CT Input Range	0 - 5 [A]		
		1 - 25 [A]		
		2 - 100 [A]	1	1
		3 - 200 [A]		
4 - 400 [A]				
Voltage Input Range	5 - 600 [A]			
	0 - 120 [V]			
	1 - 240 [V]	0	0	
Operation Setting of K7TM	2 - 480 [V]			
	3 - 600 [V]			
	Measurement Value Calculation Cycle	1 to 999 [s]	100	100
Selection of Method	Stabilization Discrimination Method	0 - md-1 (power)		
		1 - md-2 (temperature)	0	0

*3. OMRON performed an evaluation test on the SI-35USB-2 manufactured by LINE EYE. (The driver version is V2.12.18.)

- Sheet structure of K7TM Configuration Tool

Sheets for Configuration

- **Communications Setting**
- **Initial Setting of K7TM *1**
- **Operation Setting of K7TM *1**

Sheets for Adjustment

- **Preparations (Registration)**
- **_1 to _8 *2**
- **Preparations (Adjustment) *1**

Sheets for Logging

- **Logging of Measurement Value**
- **Reading of Log**

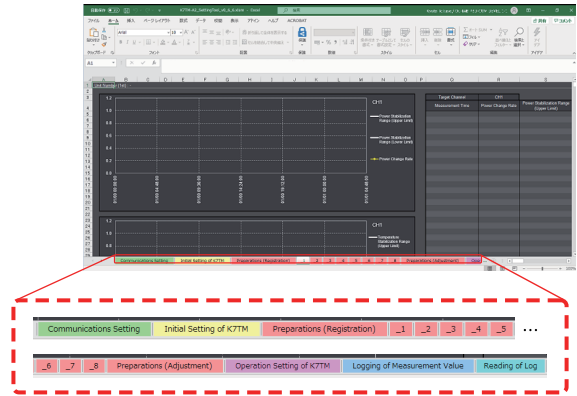

The Sheets are arranged from left in order of scene

- *1. If any of the cells of all the parameters of the target Units is blank, nothing will be written even if you click the **Write** Button on these sheets. Do not leave them blank.
- *2. The **_1** Sheet corresponds to the Unit Number (1st). Similarly, the sheets correspond up to the Unit Number (8th).

Make the initial setting of the communications converter.

1. Set the communications-related parameters, following the instruction manual of the communications converter. In this procedure, set the following communications parameters:

Setting parameter	Setting
Baud Rate	115.2 kbps
Data Length	8 bits
Stop Bits	1 bit
Parity	Even



The data length and stop bits of the communications protocol Modbus RTU are fixed internally.

- Data length: Always 8 bits
- Stop bits: Always 1 bit (with parity being even or odd)
Always 2 bits (with parity being none)



Make sure that both the K7TM and the communications converter have the same RS-485 (Modbus RTU) communications settings (baud rate, data length, stop bits, and parity).



Some communications converter models may require a driver to be installed. Install the driver properly, following the instruction manual of the communications converter.

(3-2) Communications Setting of Tool and Communications Test

Make the communications setting of the K7TM Configuration Tool.

● Setup Window

1. Start the K7TM Configuration Tool, and display the **Communications Setting Sheet**.

Communications port		Search
Baud Rate [kbps]	115.2	
Parity	Even	
Timeout Time [s]	2	
Execution Results of Communications Test		
Unit Number (1st)		
Unit Number (2nd)		
Unit Number (3rd)		
Unit Number (4th)		
Unit Number (5th)		
Unit Number (6th)		
Unit Number (7th)		
Unit Number (8th)		

Communications Setting Sheet



Tool Operating Procedure

1. Select a communications port.

Clicking the **Search** Button will display the selectable candidates on a pull-down menu. Choose the port where the communications converter is connected.

If your communications converter is not found in the candidates, check whether the driver of the communications converter is installed correctly.

2. Set the communications parameters of the K7TM Configuration Tool.

Select a baud rate and parity from the pull-down menus, and enter an integer value of 2 to 3,600 [s] to the timeout time.

The baud rate and parity need to be the same as those on the K7TM.

The following table shows the default values of the communications settings on the K7TM.

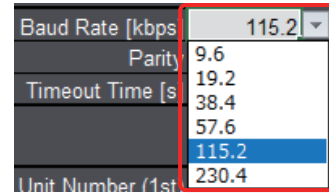

Setting parameter	Setting range	Setting value
Baud Rate [kbps]	Set the baud rate of the communications terminals.	115.2
Parity	Set the parity of the communications terminals.	Even
Timeout Time [s]	This means the time between when the K7TM Configuration Tool sent a communications command and when it is judged to be no response. This is a setting value for the Tool only.	2

In case of a CRC error, the K7TM Configuration Tool retries communications multiple times. If retries are made, it will take time before you know that communications failed.

If communications processing failed when an IoT gateway is used, check whether the problem is solved by extending the timeout time on the K7TM Configuration Tool.

When Timeout Time is extended, the total processing time will be longer even if communications processing is executed normally. You are recommended to set the shortest possible timeout time as long as succeeding in communications.

Using an IoT gateway will increase the possibility of a failure in communications, so you are not recommended to use the **Registration of Reference Resistance Value** function. If communications fail during registration, collection of the subsequent log data will be disabled, which may prevent you from investigating the cause of a possible failure in registration.

3. Check whether you can communicate with the K7TM correctly.

Enter the Unit number of the connected K7TM, and click the **Communications test** Button.

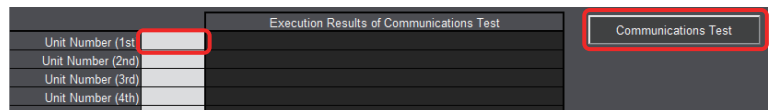

The result of communications test is displayed on the Execution results field. If it is *OK* (Software Ver. x.x), communications are successful. (Ver. x.x is a firmware version of the K7TM.)

Display	Meaning
OK (Software Ver. x.x)	Displays when the communications test succeeded.
NG	Displays when the communications test failed.
	The communications converter is not recognized.

 **No. 3 Troubleshooting**

NG message is displayed in **Execution Results of Communications Test** of the K7TM Configuration Tool, disabling communications.

 **No. 4 Troubleshooting**

The unit number, if changed, will not be reflected.

 **Configuration with Key Operations**

Make settings at the Communications Setting 2 Level.

1. When you press the Level Key (⊖) for 3 seconds or more on the Operation Level and press the Level Key (⊖) twice (for less than 1 second) on the Initial Setting Level, you are moved to the Communications Setting 2 Level.

Refer to *5-8 Communications Setting 1 or 2 Level (LVL 1 0P 29)* on page 5-30 for details on how to change the setting parameters.

Setting parameter	11-seg	Setting range	Setting value
Baud Rate 2	<i>bP5</i>	Set the baud rate of the communications 2 terminals.	115.2 [kbps]
Parity 2	<i>PRTY</i>	Set the parity of the communications 2 terminals.	<i>EVEN</i> (Even)
Send Wait Time 2	<i>SDWT</i>	Set the send wait time of the communications 2 terminals.	20 [s]

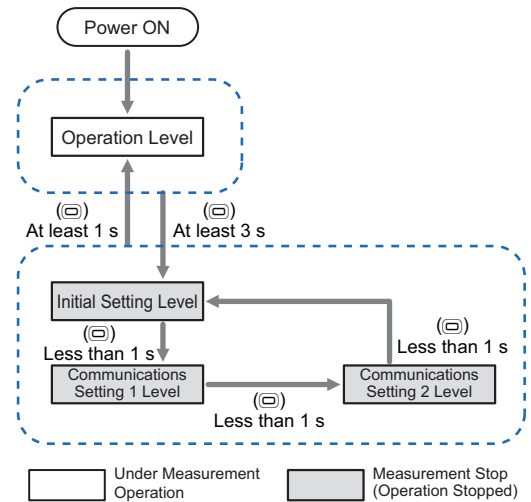

(4) Initial Setting of K7TM

When you connect to the K7TM for the first time, set the parameters on the Initial Setting Level related to inputs, operation, and stabilization discrimination methods.

● Setup Window

It consists of the following categories. The parameters are described in this order of category.

- (4-1) Input Setting of K7TM
- (4-2) Operation Setting of K7TM
- (4-3) Selection of Method
- (4-4) Communications Setting between K7TM and PLC (Only for Stabilization Discrimination Method (Temperature))
- (4-5) Setting of Temperature Information (Only for Stabilization Discrimination Method (Temperature))

			Unit Number (1st)	
			CH1	CH2
Category	Parameter name	Setting range		
Input Setting of K7TM	Maximum Number of Channels	1 to 2 [CH] 0 : 5 [A] 1 : 25 [A] 2 : 100 [A] 3 : 200 [A] 4 : 400 [A] 5 : 600 [A]		
	CT Input Range	0 : 120 [V] 1 : 240 [V] 2 : 480 [V] 3 : 600 [V]		
	Voltage Input Range	0 : 120 [V] 1 : 240 [V] 2 : 480 [V] 3 : 600 [V]		
	Measurement Value Calculation Cycle	1 to 999 [s]		
	Stabilization Discrimination Method	0 : md-1 (power) 1 : md-2 (temperature)		
Operation Setting of K7TM	Stabilization Discrimination Method	0 : 9.6 [kbps] 1 : 19.2 [kbps] 2 : 38.4 [kbps] 3 : 57.6 [kbps] 4 : 115.2 [kbps] 5 : 230.4 [kbps]		
	Baud Rate 1	0 : None 1 : Even 2 : Odd		
	Parity 1	0 to 99 [ms]		
	Sand Wait Time 1	0 to 9999 [°C/F]		
	Temperature Set Point	1 to 999 [°C/F]		
Communications Setting between K7TM and PLC (Stabilization Discrimination Method (Temperature))	Temperature Stabilization Range	1 to 999 [s]		
	Temperature Data Write Cycle			
	Execution results >>			

Initial Setting of K7TM Sheet



Tool Operating Procedure

Before starting the initial setting procedure, read the parameters set in the K7TM out to the Tool.

1. Display the **Initial Setting of K7TM Sheet**.

2. Click the **Read** Button.
The setting parameters in the K7TM are read out to the Tool.

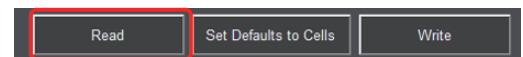

			Unit Number (1st)	
			CH1	CH2
Category	Parameter name	Setting range		
Input Setting of K7TM	Maximum Number of Channels	1 to 2 [CH] 0 : 5 [A] 1 : 25 [A] 2 : 100 [A] 3 : 200 [A] 4 : 400 [A] 5 : 600 [A]	1	1
	CT Input Range	0 : 120 [V] 1 : 240 [V] 2 : 480 [V] 3 : 600 [V]	0	0
	Voltage Input Range	0 : 120 [V] 1 : 240 [V] 2 : 480 [V] 3 : 600 [V]		
	Measurement Value Calculation Cycle	1 to 999 [s]	100	100
	Stabilization Discrimination Method	0 : md-1 (power) 1 : md-2 (temperature)	0	0
Operation Setting of K7TM	Stabilization Discrimination Method	0 : 9.6 [kbps] 1 : 19.2 [kbps] 2 : 38.4 [kbps] 3 : 57.6 [kbps] 4 : 115.2 [kbps] 5 : 230.4 [kbps]		
	Baud Rate 1	0 : None 1 : Even 2 : Odd		
	Parity 1	0 to 99 [ms]		
	Sand Wait Time 1	0 to 9999 [°C/F]	0	0
	Temperature Set Point	1 to 999 [°C/F]	10	10
Communications Setting between K7TM and PLC (Stabilization Discrimination Method (Temperature))	Temperature Stabilization Range	1 to 999 [s]	40	40
	Temperature Data Write Cycle			
	Execution results >>		OK	OK



When reading the setting parameters ended normally, OK message is displayed in the **Execution results** field.

When reading the setting parameters failed, NG message is displayed in the **Execution results** field.

If the **Execution results** field is unchanged, the communications converter is not recognized.

(4-1) Input Setting of K7TM

Set the parameters related to Input Setting of K7TM (Initial Setting Level).



Tool Operating Procedure

1. Review the read parameters.

In this procedure, set the following values:

Setting parameter	Setting	Setting value
Maximum Number of Channels	Set the number of input channels to use.	1 [CH]
CT Input Range	Set the CT input range, according to the CT to use.	1 (25 [A])
Voltage Input Range	Set the voltage input range, according to the voltage applied to the heater.	0 (120 [V])

Category	Parameter name	Setting range	Unit Number (1st)	
			CH1	CH2
Input Setting of K7TM	Maximum Number of Channels	1 to 2 [CH]	1	1
	CT Input Range	0 - 5 [A]		
		1 - 25 [A]		
		2 - 100 [A]		
		3 - 200 [A]		
		4 - 400 [A]		
Voltage Input Range	5 - 600 [A]			
	0 - 120 [V]	0	0	
	1 - 240 [V]			
	2 - 480 [V]			
Operation Setting of K7TM	Measurement Value Calculation Cycle	1 to 999 [s]	100	100

No. 5 Troubleshooting

CH2 is in the inactive state.

Configuration with Key Operations

Make settings at the Initial Setting Level.

1. When you press the Level Key (⊖) for 3 seconds or more on the Operation Level, you are moved to the Initial Setting Level.

Refer to 5-7 Initial Setting Level (LVL 09 on page 5-25 for details on how to change the setting parameters.

In this procedure, set the following values:

Setting parameter	11-seg	Setting	Setting value
Maximum Number of Channels	MxCH	Set the number of input channels to use.	1 [CH]
Voltage Input Range	VN-V	Set the voltage input range, according to the voltage applied to the heater.	120V
CT Input Range	CT-E	Set the CT input range, according to the CT to use.	25A

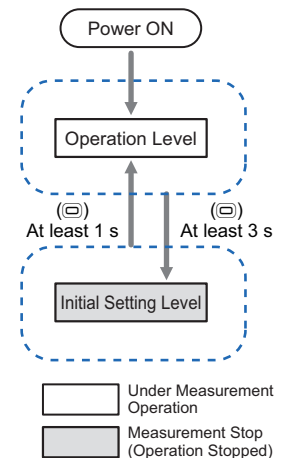

No. 6 Troubleshooting

CH2 is not displayed on the K7TM.

(4-2) Operation Setting of K7TM

Set the Measurement Value Calculation Cycle parameters on the Initial Setting Level.

Tool Operating Procedure

1. Review the read parameters.

In this procedure, set the following values:

Setting parameter	Setting	Setting value
Measurement Value Calculation Cycle	Set the cycle in which to calculate the measurement values.	100 [s]

Category	Parameter name	Setting range	Unit Number (1st)	
			CH1	CH2
Input Setting of K7TM	Maximum Number of Channels	1 to 2 [CH] 0 : 5 [A]		1
	CT Input Range	1 : 25 [A]		
		2 : 100 [A]	1	1
		3 : 200 [A]		
		4 : 400 [A]		
Voltage Input Range	5 : 600 [A]			
	0 : 120 [V]		0	
	1 : 240 [V]		0	
Operation Setting of K7TM	Measurement Value Calculation Cycle	1 to 999 [s]	100	100
		0 : md-1 (power)		
		1 : md-2 (temperature)		



If the run time of the heater is shorter than 35 minutes, adjust the measurement value calculation cycle. Refer to 2-7 *Adjustment for Heater Running for a Short Time (Less than 35 Minutes)* on page 2-52 for details.

Precautions for Correct Use

When you use the K7TM Configuration Tool with Excel 2013 or Excel 2016, set **Measurement Value Calculation Cycle** to 100 seconds or less. (Default setting: 100 s)
It may become unstable if you set a value that exceeds 100 seconds.

Configuration with Key Operations

Make settings at the Initial Setting Level.

1. When you press the Level Key (⊖) for 3 seconds or more on the Operation Level, you are moved to the Initial Setting Level.

Refer to 5-7 *Initial Setting Level (LVL ⊖)* on page 5-25 for details on how to change the setting parameters.

In this procedure, set the following values:

Setting parameter	11-seg	Setting	Setting value
Measurement Value Calculation Cycle	MVCP	Set the cycle in which to calculate the measurement values.	100 [s]

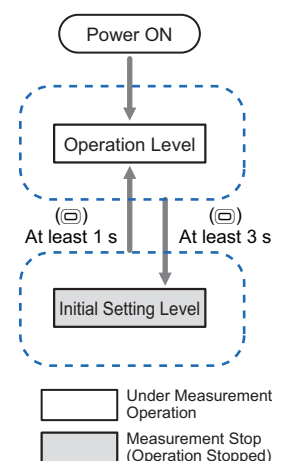

(4-3) Selection of Method

To watch changes over the years in the heater resistance value, it is necessary to always monitor the resistance values at the same temperature so that they may not be affected by changes in the resistance value due to temperature characteristics.

The K7TM has two methods for monitoring heater deterioration.

Select *Power* or *Temperature* from the Stabilization Discrimination Method setting parameters (Initial Setting Level).

Set the Stabilization Discrimination Method parameters on the Initial Setting Level.



Tool Operating Procedure

1. Select a stabilization discrimination method at **Selection of Method** from the following:

0: *md-1 (Power)*

1: *md-2 (Temperature)*

- Usually, choose the default value 0: *md-1 (Power)*.
- When 1: *md-2 (Temperature)* is selected, temperature information is written in the K7TM from the PLC or other host system of the equipment that controls the temperature of a target heater.

Category	Parameter name	Setting range	Unit Number (1st)	
			CH1	CH2
Input Setting of K7TM	Maximum Number of Channels	1 to 2 [CH] 0 - 5 [A] 1 - 25 [A]	1	
	CT Input Range	2 - 100 [A] 3 - 200 [A] 4 - 400 [A] 5 - 600 [A]	1	1
	Voltage Input Range	0 - 120 [V] 1 - 240 [V]	0	0
		2 - 400 [V] 3 - 600 [V]		
	Operation Setting of K7TM	Measurement Value Calculation Cycle	1 to 999 [s]	100
Selection of Method	Stabilization Discrimination Method	0 - <i>md-1 (power)</i> 1 - <i>md-2 (temperature)</i>	0	0
		0 - 9.6 [kbps]		



Refer to *Example Wiring for Stabilization Discrimination Method (Temperature)* on page 2-8 for connection between the PLC or other host system and the K7TM.

●When Stabilization Discrimination Method (Power) is Selected

2. Click the **Write** Button to write the settings so far into the K7TM.

In order to reflect the written settings, the K7TM executes a power ON reset.

Check that OK message is displayed in the **Execution results** field when writing to the K7TM succeeded.

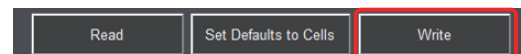

Display	Meaning
OK	Displays when reading and writing succeeded.
NG	Displays when reading and writing failed.
	The communications converter is not recognized.

3. Go to the procedure (5) *Preparations (Registration)* on page 2-24.

(Skip the procedure (4-4) *Communications Setting between K7TM and PLC (Only for Stabilization Discrimination Method (Temperature))* on page 2-20.)

●When Stabilization Discrimination Method (Temperature) is Selected

2. Proceed to the next procedure (4-4) *Communications Setting between K7TM and PLC (Only for Stabilization Discrimination Method (Temperature))* on page 2-20.

 Configuration with Key Operations

Make settings at the Initial Setting Level.

1. When you press the Level Key (⊖) for 3 seconds or more on the Operation Level, you are moved to the Initial Setting Level.

Refer to 5-7 *Initial Setting Level (LVL 0 0)* on page 5-25 for details on how to change the setting parameters.

- Usually, choose the default value $Md-1$ (Power).
- When $Md-2$ (Temperature) is selected, temperature information needs writing into the K7TM from the PLC or other host system of the equipment that controls the temperature of a target heater.

Setting parameter	11-seg	Setting	Setting value
Stabilization Discrimination Method	MEd	Set the method by which to monitor the heater.	$Md-1$ (Power)

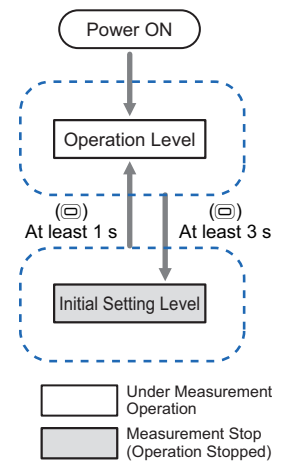

(4-4) Communications Setting between K7TM and PLC (Only for Stabilization Discrimination Method (Temperature))

Only when the stabilization discrimination method (temperature) is selected, make the settings for communications with the host system.

Make the communications setting between K7TM and PLC.



Tool Operating Procedure

1. At **Communications Setting between K7TM and PLC (Stabilization Discrimination Method: Temperature)**, make the settings for communications between the K7TM and the PLC or other host system.

In this procedure, set the following values:

Setting parameter	Setting	Setting value
Baud Rate 1	Set the baud rate of the communications 1 terminals.	4 (115.2 [kbps])
Parity 1	Set the parity of the communications 1 terminals.	1 (Even)
Send Wait Time 1	Set the send wait time of the communications 1 terminals.	20 [ms]

Category	Parameter name	Setting range	Unit Number (1st)	
			CH1	CH2
Input Setting of K7TM	Maximum Number of Channels	1 to 2 [CH]	1	
	CT Input Range	0 - 5 [A]	1	
		1 - 25 [A]		
		2 - 100 [A]		
		3 - 200 [A]		
		4 - 400 [A]		
Voltage Input Range	5 - 600 [A]			
	0 - 120 [V]	0		
	1 - 240 [V]	0		
Operation Setting of K7TM	Measurement Value Calculation Cycle	2 - 480 [V]		
		3 - 600 [V]		
		1 to 999 [s]	100	100
Selection of Method	Stabilization Discrimination Method	0 - md-1 (power)	1	
		1 - md-2 (temperature)	1	0
Communications Setting between K7TM and PLC (Stabilization Discrimination Method: Temperature)	Baud Rate 1	0 - 9.6 [kbps]		
		1 - 19.2 [kbps]		
		2 - 38.4 [kbps]	4	
		3 - 57.6 [kbps]		
		4 - 115.2 [kbps]		
Parity 1	Parity 1	5 - 230.4 [kbps]		
		0 - None	1	
Send Wait Time 1	Send Wait Time 1	1 - Even		
		2 - Odd		
		0 to 99 [ms]	20	

Configuration with Key Operations

Make settings at the Communications Setting 1 Level.

1. When you press the Level Key (⊖) for 3 seconds or more on the Operation Level and press the Level Key (⊖) once (for less than 1 second) on the Initial Setting Level, you are moved to the Communications Setting 1 Level.

Refer to 5-8 *Communications Setting 1 or 2 Level (LVL 1 設定 2)* on page 5-30 for details on how to change the setting parameters.

In this procedure, set the following values:

Setting parameter	11-seg	Setting	Setting value
Baud Rate 1	<i>bP5</i>	Set the baud rate of the communications 1 terminals.	115.2 [kbps]
Parity 1	<i>PRTY</i>	Set the parity of the communications 1 terminals.	<i>EVEN</i> : Even
Send Wait Time 1	<i>SDWT</i>	Set the send wait time of the communications 1 terminals.	20 [ms]

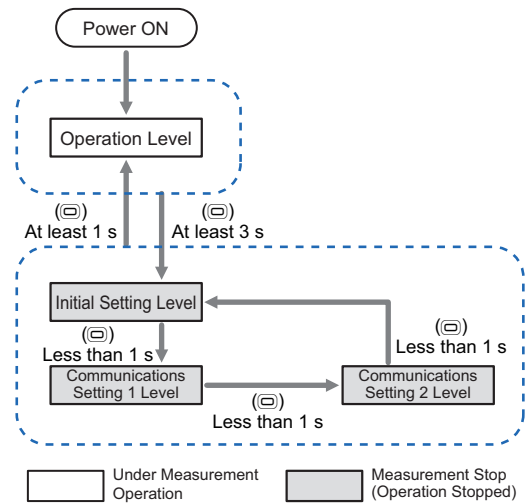

(4-5) Setting of Temperature Information (Only for Stabilization Discrimination Method (Temperature))

Only when the stabilization discrimination method (temperature) is selected, set temperature information.

Set the parameters on the Adjustment Level (Temperature).



Tool Operating Procedure

1. At **Setting of Temperature Information (Stabilization Discrimination Method: Temperature)**, set the parameters on the Adjustment Level (Temperature).

In this procedure, set the following values:

Setting parameter	Setting	Setting value
Temperature Set Point	Set the reference for temperature stabilization range that the K7TM judged to be stabilized.	60 [°C/°F]
Temperature Stabilization Range	Set the temperature stabilization range that the K7TM judged to be stabilized.	10 [°C/°F]
Temperature Data Write Cycle	Set the time during which the K7TM waits for temperature to be written from the host system.	10 [s]

Category	Parameter name	Setting range	Unit Number (1st)	
			CH1	CH2
Input Setting of K7TM	Maximum Number of Channels	1 to 2 [CH]	1	
	CT Input Range	0 - 5 [A]	1	
		1 - 25 [A]	1	
		2 - 100 [A]	1	
3 - 200 [A]		1		
4 - 400 [A]		1		
Voltage Input Range	5 - 500 [A]	1		
	0 - 120 [V]	0		
	1 - 240 [V]	0		
	2 - 480 [V]	0		
	3 - 500 [V]	0		
Operation Setting of K7TM	Measurement Value Calculation Cycle	1 to 999 [s]	100	100
Selection of Method	Stabilization Discrimination Method	0 - md-1 (power)	1	0
		1 - md-2 (temperature)	1	0
Communications Setting between K7TM and PLC (Stabilization Discrimination Method: Temperature)	Baud Rate 1	0 - 9.6 [kbps]	4	
		1 - 19.2 [kbps]	4	
		2 - 38.4 [kbps]	4	
		3 - 57.6 [kbps]	4	
		4 - 115.2 [kbps]	4	
Parity 1	0 - None	1		
	1 - Even	1		
Send/Wait Times 1	0 - 99 [ms]	20		
	0 to 99 [ms]	20		
Setting of Temperature Information (Stabilization Discrimination Method: temperature)	Temperature Set Point	0 to 9999 [°C/°F]	60	0
	Temperature Stabilization Range	1 to 9999 [°C/°F]	10	10
	Temperature Data Write Cycle	1 to 999 [s]	10	10

2. Click the **Write** Button to write the settings so far into the K7TM.

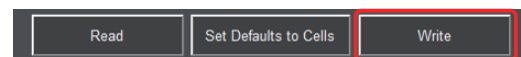

Check that OK message is displayed in the **Execution results** field.

Display	Meaning
OK	Displays when reading and writing succeeded.
NG	Displays when reading and writing failed.
	The communications converter is not recognized.

3. Execute a communications instruction from the host system to check that the K7TM is communicating with the host system successfully.

- Communications normal operation

The temperature monitor display changes to the written temperature. Whenever temperature is written, **COMM1** Indicator will light.

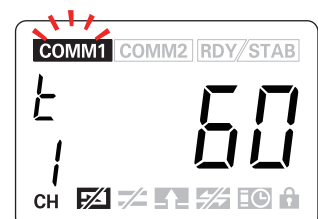

- Communications error

The main display flashes, and **FAIL** Indicator lights or flashes.

FAIL Indicator flashing: A measurement error (temperature data not-refreshed error) generated except on the current channel

FAIL Indicator lit: A measurement error (temperature data not-refreshed error) generated on the current channel

The temperature written last displays and flashes on the main display.

If temperature has never been written, 0 displays and flashes.

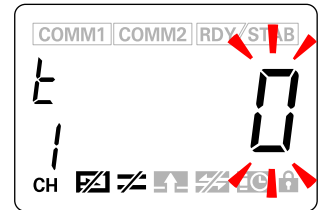
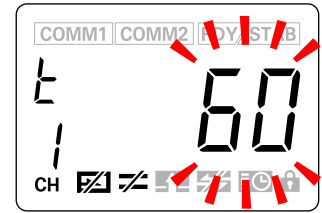

Configuration with Key Operations

Make settings at the Adjustment Level (Temperature).

1. When you press the Level Key () on the Operation Level three times (for less than 1 second), you are moved to the Adjustment Level (Temperature).

Refer to 5-6 *Adjustment Level (Temperature)* (LVL ) on page 5-22 for details on how to change the setting parameters.

In this procedure, set the following values:

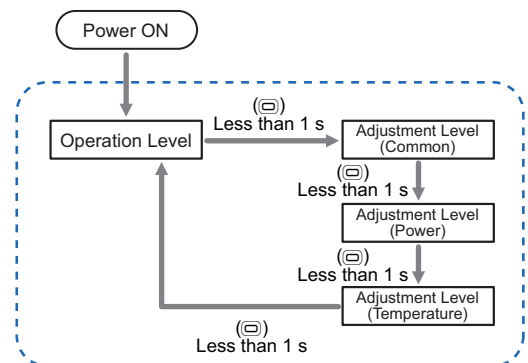

Setting parameter	11-seg	Setting	Setting value
Temperature Set Point	$t-5v$	Set the reference for temperature stabilization range that the K7TM judged to be stabilized.	60 [°C/°F]
Temperature Stabilization Range	$t-5b$	Set the temperature stabilization range that the K7TM judged to be stabilized.	10 [°C/°F]
Temperature Data Write Cycle	$tWCP$	Set the time during which the K7TM waits for temperature to be written from the host system.	10 [s]

(5) Preparations (Registration)

Register *Reference Resistance Value*, obtained by measuring the heater to monitor, in the K7TM.



Using an IoT gateway will increase the possibility of a failure in communications, so you are not recommended to use the **Registration of Reference Resistance Value** function.

If communications fail during registration, collection of the subsequent log data will be disabled, which may prevent you from investigating the cause of a possible failure in registration.

● Setup Window

1. Display the **Preparations (Registration)** Sheet.

		Registration Target		Registration Status	
		CH1	CH2	CH1	CH2
Unit Number (1st)	1	<input type="checkbox"/>	<input type="checkbox"/>		
Unit Number (2nd)	-	<input type="checkbox"/>	<input type="checkbox"/>		
Unit Number (3rd)	-	<input type="checkbox"/>	<input type="checkbox"/>		
Unit Number (4th)	-	<input type="checkbox"/>	<input type="checkbox"/>		
Unit Number (5th)	-	<input type="checkbox"/>	<input type="checkbox"/>		
Unit Number (6th)	-	<input type="checkbox"/>	<input type="checkbox"/>		
Unit Number (7th)	-	<input type="checkbox"/>	<input type="checkbox"/>		
Unit Number (8th)	-	<input type="checkbox"/>	<input type="checkbox"/>		

Check Boxes for Registration Targets

When this sheet is displayed, each of the check boxes showing registration targets enters the active or inactive state.

You can put checkmarks in the active check boxes, but cannot put checkmarks in the inactive check boxes.

		Registration Target	
		CH1	CH2
Unit Number (1st)	1	<input type="checkbox"/>	<input type="checkbox"/>
Unit Number (2nd)	-	<input type="checkbox"/>	<input type="checkbox"/>
Unit Number (3rd)	-	<input type="checkbox"/>	<input type="checkbox"/>
Unit Number (4th)	-	<input type="checkbox"/>	<input type="checkbox"/>
Unit Number (5th)	-	<input type="checkbox"/>	<input type="checkbox"/>
Unit Number (6th)	-	<input type="checkbox"/>	<input type="checkbox"/>
Unit Number (7th)	-	<input type="checkbox"/>	<input type="checkbox"/>
Unit Number (8th)	-	<input type="checkbox"/>	<input type="checkbox"/>

● Conditions for active state

The check boxes of channels where all the following conditions are satisfied will be in the active state.

- A unit number shall be set on the **Communications Setting** Sheet.
- A stabilization discrimination method shall be set on the **Initial Setting of K7TM** Sheet.
- For CH2, the maximum number of channels shall be set to 2 on the **Initial Setting of K7TM** Sheet.

● Conditions for inactive state

The conditions for active state are not satisfied.

Note that the box will be unchecked if it enters the inactive state.

(5-1) Preparations before Reference Resistance Value Registration

Check the following before starting registration of the reference resistance value.

- Perform registration in the environment where you start usual temperature control.
- When you start *Registration of Reference Resistance Value*, the optimum timing when temperature becomes stable will be detected automatically, and the resistance value obtained at this time will be registered as a reference resistance value.

Start temperature control of the heater.

- Wait until the device temperature becomes stable.

No. 7 Troubleshooting

Although the voltage and the current are not 0, the status display **IN** Indicator lights and the inputs are judged to be none.

(5-2) Setting of Registration Targets and Execution of Registration

When the device temperature has become stable, start registration of reference resistance value.



Tool Operating Procedure

1. Click the **Include Set Channels in Registration Targets** Button.

All the active check boxes are checked.

To uncheck all the CH boxes, click the **Exclude All Channels from Registration Targets** Button.



		Registration Target	
		CH1	CH2
Unit Number (1st)	1	<input checked="" type="checkbox"/>	<input type="checkbox"/>
Unit Number (2nd)	-	<input type="checkbox"/>	<input type="checkbox"/>

2. Click the **Start** Button.

In the Unit that has registration targets with checkmarks, registration of reference resistance value is started.



Refer to **Registration Status Cells** on page 2-27 for indications in Registration Status cells.

Registration Status		
CH1		CH2
Waiting for Evaluation to Start		

In case of initial settings, it takes about 17 minutes before *Waiting for Evaluation to Start* changes to *Under Evaluation*.

Registration Status		
CH1		CH2
Under Evaluation		

The monitoring step indicator **RDY** on the K7TM flashes at 1-s intervals.

No. 8 Troubleshooting

Reference resistance value registration will not be started.
(RDY Indicator does not flash at 1-s intervals.)

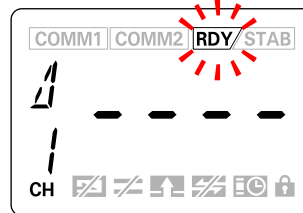

When registration of reference resistance value succeeded, the following are displayed.

- K7TM Configuration Tool:
The Registration Status cell indication changes from **Under Evaluation** to **Succeeded**.
- K7TM:
RDY Indicator changes from the flashing state to the lit state.

Registration Status		
CH1		CH2
Succeeded		

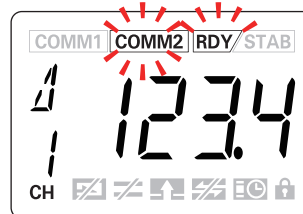

To cancel registration of reference resistance value, click the **Cancel All** Button.



● Registration Status Cells

The **Registration Status** cells display the registration status of reference resistance value.

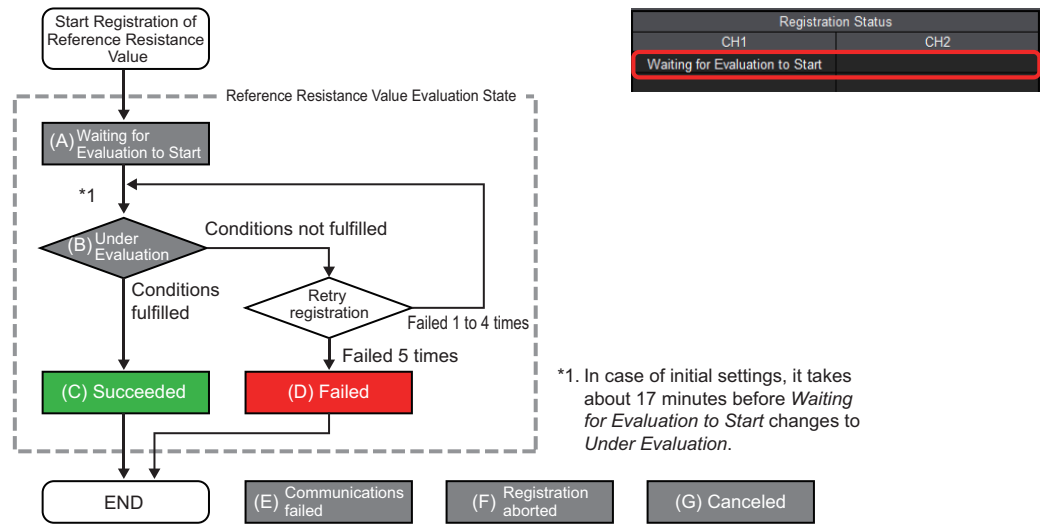

Symbol	Display	Meaning
(A)	Waiting for Evaluation to Start	Displays until the evaluation by the K7TM is started after the operation command was sent to the K7TM.
(B)	Under Evaluation	Displays when the value is being evaluated by the K7TM.
(C)	Succeeded	Displays when registration succeeded.
(D)	Failed	Displays when registration failed.
(E)	Communications failed	Displays when communications failed.
(F)	Registration aborted	Displays when registration was aborted because a measurement error or an alarm occurred during evaluation.
(G)	Canceled	Displays when you canceled the evaluation by clicking the Cancel All Button.
---		The communications converter is not recognized. *2

*2. If the communications converter loses the recognition by the computer during communications processing, the processing will end with the former display state maintained.

If the communications converter loses the recognition by the computer during the processing of *Registration of Reference Resistance Value*, which is a function of this sheet, the registration status displayed on the K7TM Configuration Tool and the actual registration status of the K7TM may not match.

For example, the above mismatch will occur if the mouse cursor is not in the following state when the registration status is *Waiting for Evaluation to Start* or *Under Evaluation*. Check the progress by seeing the **RDY** Indicator flashing on the K7TM.



🔍 No. 9 Troubleshooting

Failed or *Registration aborted* is displayed in the Registration Status cell, disabling the registration of reference resistance value.

The K7TM retries an evaluation of the reference resistance value until it fails 5 times. If you start adjusting the setting values after all of the five retries failed, the total time required for registration, including adjustment, will be longer.

Refer to 2-8-4 *How to Predict Early That Registration Fails (Optional)* on page 2-70 for how to predict early that registration of reference resistance value fails without waiting for five failures.

Configuration with Key Operations

1. Press the **REF** Key in the lower right of the K7TM front for 3 seconds or more.

The main display flashes at high speed at 0.5-s intervals, and Start Registration of Reference Resistance Value.

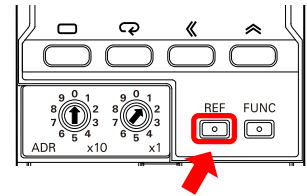

While the reference resistance value is under evaluation, the monitoring step indicator **RDY** flashes at 1-s intervals.

Since the K7TM automatically judges whether the heater is operating stably, this state lasts for a while (it takes 35 minutes or more in case of factory default settings).



No.10 Troubleshooting

Even if you press and hold the **REF** Key on the K7TM, **RDY** Indicator will not flash and reference resistance value registration will not be started.



If you press the **REF** Key for 3 seconds or more in the reference resistance value evaluation state (while **RDY** Indicator is flashing), the reference resistance value registration will be canceled.

(5-3) Completion of Reference Resistance Value Registration

Check **RDY** Indicator to see that the reference resistance value is registered in the K7TM.

When the reference resistance value is registered successfully, the monitoring step indicator **RDY** will change from the flashing state to the lit state.

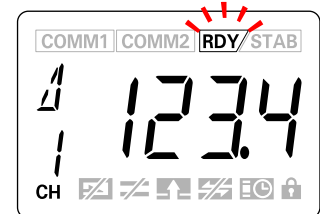

No.11 Troubleshooting

The flashing **RDY** Indicator goes out, not entering the lit state.

(6) Preparations (Adjustment)

If the registration ended in failure in the procedure (5) Preparations (Registration) on page 2-24, adjust parameters following this procedure, and retry the registration.

Refer to 2-8 Adjustment When Reference Resistance Value Registration Failed on page 2-54 for specific adjustment methods. This section describes how to change the setting values.

Setup Window

1. Display the **Preparations (Adjustment)** Sheet.

It consists of the following categories.

- (6-1) Adjustment (Common)
- (6-2) Adjustment (Stabilization Discrimination Method: Power)
- (6-3) Adjustment (Stabilization Discrimination Method: Temperature)

Category	Parameter name	Setting range
Adjustment (Common)	Resistance Value Moving Average Count	0 : Low 1 : Middle 2 : High
	Normal Fluctuation Deviation	0.1 to 999.9 [%]
	Measurement Voltage Lower Limit Value	3.0 to 99.9 [%FS]
	Measurement Current Lower Limit Value	3.5 to 99.9 [%FS]
Adjustment (Power)	Power Moving Average Count	0 : Low 1 : Middle 2 : High
	Power Stabilization Range	0.1 to 999.9 [%]
Adjustment (Temperature)	Temperature Stabilization Range	1 to 9999 [°C/°F]

Execution results >>

 **Tool Operating Procedure**

- 1.** Click the **Read** Button.
The setting parameters in the K7TM are read out to the Tool.

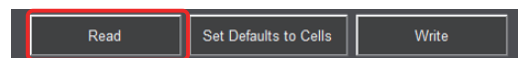

Category	Parameter name	Setting range	Unit Number (1st)	
			CH1	CH2
Adjustment (Common)	Resistance Value Moving Average Count	0 : Low 1 : Middle 2 : High	0	0
	Normal Fluctuation Deviation	0.1 to 999.9 [%]	1.0	1.0
	Measurement Voltage Lower Limit Value	3.0 to 99.9 [%FS]	3.0	3.0
	Measurement Current Lower Limit Value	3.5 to 99.9 [%FS]	3.5	3.5
Adjustment (Power)	Power Moving Average Count	0 : Low 1 : Middle 2 : High	0	0
	Power Stabilization Range	0.1 to 999.9 [%]	20.0	20.0
Adjustment (Temperature)	Temperature Stabilization Range	1 to 9999 [°C/°F]	10	10

Execution results >> OK OK

OK message is displayed in the **Execution results** field.

If the **Execution results** field is unchanged, the communications converter is not recognized.



 **No. 5 Troubleshooting**

CH2 is in the inactive state.

(6-1) Adjustment (Common)

Set the parameters of Adjustment (Common).



Tool Operating Procedure

1. Adjust the read parameters.

In this procedure, set the following values:

Setting parameter	Setting	Setting value
Resistance Value Moving Average Count	Set the moving average count for resistance value.	0 (Low)
Normal Fluctuation Deviation	Set the range of resistance values required for the K7TM determining that the heater temperature is stabilized.	1.0 [%]
Measurement Voltage Lower Limit Value	Set the lowest voltage conditions for calculating resistance values.	3.0 [% FS]
Measurement Current Lower Limit Value	Set the lowest current conditions for calculating resistance values.	3.5 [% FS]

2. Click the **Write** Button to write the settings into the K7TM.

Check that OK message is displayed in the **Execution results** field.

Category	Parameter name	Setting range	Unit Number (1st)	
			CH1	CH2
Adjustment (Common)	Resistance Value Moving Average Count	0 : Low 1 : Middle 2 : High	0	0
	Normal Fluctuation Deviation	0.1 to 99.9 [%]	1.0	1.0
	Measurement Voltage Lower Limit Value	3.0 to 99.9 [%FS]	3.0	3.0
	Measurement Current Lower Limit Value	3.5 to 99.9 [%FS]	3.5	3.5
Adjustment (Power)	Power Moving Average Count	0 : Low 1 : Middle 2 : High	0	0
	Power Stabilization Range	0.1 to 999.9 [%]	20.0	20.0
Adjustment (Temperature)	Temperature Stabilization Range	1 to 9999 [°C/°F]	10	10

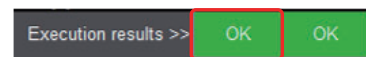
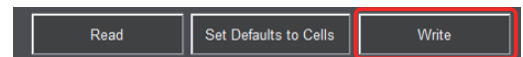

Display	Meaning
OK	Displays when reading and writing succeeded.
NG	Displays when reading and writing failed.
	The communications converter is not recognized.

 **Configuration with Key Operations**

Make settings at the Adjustment Level (Common).

1. When you press the Level Key () on the Operation Level once (for less than 1 second), you are moved to the Adjustment Level (Common).

Refer to 5-4 *Adjustment Level (Common)* (LVL R₂) on page 5-13 for details on how to change the setting parameters.

In this procedure, set the following values:

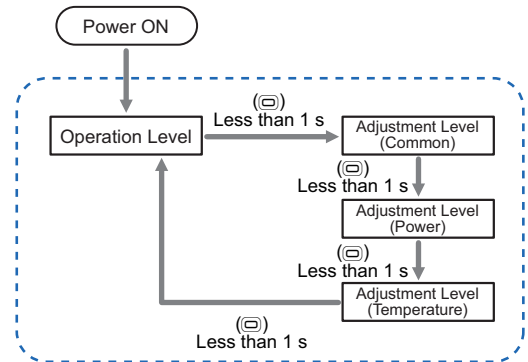

Setting parameter	11-seg	Setting	Setting value
Resistance Value Moving Average Count	<i>RV_{ER}</i>	Set the moving average count for resistance value.	<i>L₀W</i> (Moving Average Count of 10)
Normal Fluctuation Deviation	<i>NF_d</i>	Set the range of resistance values required for the K7TM determining that the heater temperature is stabilized.	1.0 [%]
Measurement Voltage Lower Limit Value	<i>V_{M_LN}</i>	Set the lowest voltage conditions for calculating resistance values.	3.0 [% FS]
Measurement Current Lower Limit Value	<i>IM_LN</i>	Set the lowest current conditions for calculating resistance values.	3.5 [% FS]

(6-2) Adjustment (Stabilization Discrimination Method: Power)

Set the parameters of Adjustment (Stabilization Discrimination Method: Power).



Tool Operating Procedure

1. Adjust the read parameters.

In this procedure, set the following values:

Setting parameter	Setting	Setting value
Power Moving Average Count*1	Set the moving average count for power.	1 (Middle)
Power Stabilization Range	Set the range of powers that the K7TM judges to be stabilized.	20.0 [%]

*1. *Power Moving Average Count* can be adjusted even if the stabilization discrimination method is temperature. To adjust it, change the setting value with key operation.

2. Click the **Write** Button to write the settings into the K7TM.

Check that OK message is displayed in the **Execution results** field.

Category	Parameter name	Setting range	Unit Number (1st)	
			CH1	CH2
Adjustment (Common)	Resistance Value Moving Average Count	0 : Low 1 : Middle 2 : High	0	0
	Normal Fluctuation Deviation	0.1 to 999.9 [%]	1.0	1.0
	Measurement Voltage Lower Limit Value	3.0 to 99.9 [VFS]	3.0	3.0
	Measurement Current Lower Limit Value	3.5 to 99.9 [NFS]	3.5	3.5
Adjustment (Power)	Power Moving Average Count	0 : Low 1 : Middle 2 : High	1	0
	Power Stabilization Range	0.1 to 999.9 [%]	20.0	20.0
Adjustment (Temperature)	Temperature Stabilization Range	1 to 9999 [°C/°F]	10	10

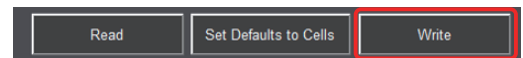

Display	Meaning
OK	Displays when reading and writing succeeded.
NG	Displays when reading and writing failed.
	The communications converter is not recognized.

 **Configuration with Key Operations**

Make settings at the Adjustment Level (Common) and the Adjustment Level (Power).

1. When you press the Level Key (⊖) on the Operation Level twice (for less than 1 second), you are moved to the Adjustment (Power) Level. Refer to 5-5 Adjustment Level (Power) (LVL b 2 on page 5-19 for details on how to change the setting parameters.

Setting parameter	Setting Level	11 -seg	Setting	Setting value
Power Moving Average Count	Adjustment Level (Common)	REV	Set the moving average count for power.	Md
Power Stabilization Range	Adjustment Level (Power)	PW-b	Set the range of powers that the K7TM judges to be stabilized.	20.0 [%]

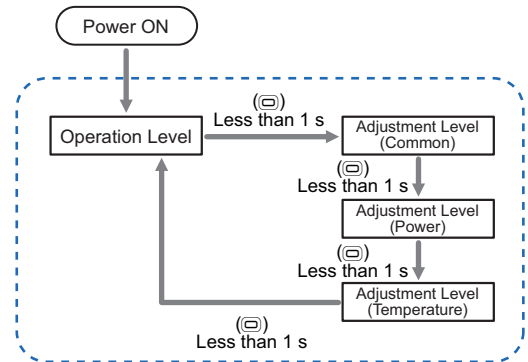

(6-3) Adjustment (Stabilization Discrimination Method: Temperature)

Set the parameters of Adjustment (Stabilization Discrimination Method: Temperature).



Tool Operating Procedure

1. Adjust the read parameters.

In this procedure, set the following values:

Setting parameter	Setting	Setting value
Temperature Stabilization Range	Set the temperature stabilization range that the K7TM judged to be stabilized.	10 [°C/°F]

2. Click the **Write** Button to write the settings into the K7TM.

Check that OK message is displayed in the **Execution results** field.

Category	Parameter name	Setting range	Unit Number (1st)	
			CH1	CH2
Adjustment (Common)	Resistance Value Moving Average Count	0 : Low 1 : Middle 2 : High	0	0
	Normal Fluctuation Deviation	0.1 to 999.9 [%]	1.0	1.0
	Measurement Voltage Lower Limit Value	3.0 to 99.9 [%FS]	3.0	3.0
	Measurement Current Lower Limit Value	3.5 to 99.9 [%FS]	3.5	3.5
Adjustment (Power)	Power Moving Average Count	0 : Low 1 : Middle 2 : High	0	0
	Power Stabilization Range	1 to 999 [°C/°F]	10	10
Adjustment (Temperature)	Temperature Stabilization Range	1 to 999 [°C/°F]	10	10

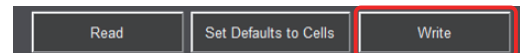

Display	Meaning
OK	Displays when reading and writing succeeded.
NG	Displays when reading and writing failed.
	The communications converter is not recognized.



When the stabilization discrimination method is temperature, the K7TM Configuration Tool does not allow *Power Moving Average Count* to be changed. To adjust it, change the setting value with key operation.

 **Configuration with Key Operations**

Make settings at the Adjustment Level (Temperature).

1. When you press the Level Key (⊖) on the Operation Level three times (for less than 1 second), you are moved to the Adjustment Level (Temperature).

Refer to 5-6 *Adjustment Level (Temperature)* (LVL 5 on page 5-22 for details on how to change the setting parameters.

In this procedure, set the following values:

Setting parameter	11-seg	Setting	Setting value
Temperature Stabilization Range	t-5b	Set the temperature stabilization range that the K7TM judged to be stabilized.	10 [°C/°F]

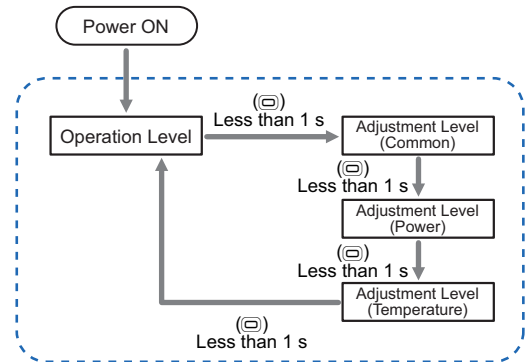

(7) Operation Setting of K7TM (Stabilization Discrimination Method (Power) and Stabilization Discrimination Method (Temperature))

The sections so far have described the procedures for initial settings of K7TM and preparations for monitoring. The sections hereafter will describe the operation setting procedures for the K7TM monitoring the resistance values of heaters continuously.

● Setup Window

1. Display the **Operation Setting of K7TM** Sheet.

It consists of the following categories.

- (7-1) Output Setting of K7TM
- (7-2) Alarm Setting of K7TM

Category	Parameter name	Setting range	Unit Number (1st)	
			CH1	CH2
Output Setting of K7TM	Alarm Polarity	0 : Normally open 1 : Normally close		
	Alarm Output Level	0 : Low 1 : High		
	Logging Cycle	10 to 9999 [10 times]		
	Use Running Time	0 : OFF 1 : ON		
	Heater Deterioration Alarm Value (Warning)	0.1 to 999.9 [%]		
Alarm Setting of K7TM	Heater Deterioration Alarm Value (Critical)	0.1 to 999.9 [%]		
	Last Resistance Value Change Rate Alarm Value	0.1 to 999.9 [%]		
	Heater Burnout Alarm Value (Voltage)	0.0 to 99.9 [%FS]		
	Heater Burnout Alarm Value (Current)	0.0 to 99.9 [%FS]		
	Execution results >>			



Tool Operating Procedure

2. Click the **Read** Button.

The setting parameters in the K7TM are read out to the Tool.

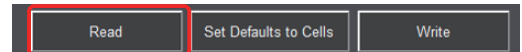

Category	Parameter name	Setting range	Unit Number (1st)	
			CH1	CH2
Output Setting of K7TM	Alarm Polarity	0 : Normally open 1 : Normally close	1	
	Alarm Output Level	0 : Low 1 : High	1	
	Logging Cycle	10 to 9999 [10 times]	100	100
	Use Running Time	0 : OFF 1 : ON	0	
	Heater Deterioration Alarm Value (Warning)	0.1 to 999.9 [%]	3.0	3.0
Alarm Setting of K7TM	Heater Deterioration Alarm Value (Critical)	0.1 to 999.9 [%]	5.0	5.0
	Last Resistance Value Change Rate Alarm Value	0.1 to 999.9 [%]	25.0	25.0
	Heater Burnout Alarm Value (Voltage)	0.0 to 99.9 [%FS]	4.0	4.0
	Heater Burnout Alarm Value (Current)	0.0 to 99.9 [%FS]	4.0	4.0
	Execution results >> OK OK			

OK message is displayed in the **Execution results** field.



No. 5 Troubleshooting

CH2 is in the inactive state.

(7-1) Output Setting of K7TM

Set the Output Setting-related parameters.



Tool Operating Procedure

1. Adjust the read parameters.

In this procedure, set the following values:

Setting parameter	Setting	Setting value
Alarm Polarity	Set whether to turn the alarm output contacts ON or OFF during normal operation.	1 (Normally close)
Alarm Output Level	Set the level where the alarm output is produced when an alarm occurs.	1 (High)
Logging Cycle	Set the cycle in which to keep a log of the reference resistance value change rate, voltage value, current value, and record time.	100
Use Running Time	Set whether to inform you with the status display AGE Indicator that the K7TM has reached an approximate period in which it stops functioning at its full capacity due to the deterioration of the electrolytic capacitor characteristics.	0 (OFF)

Category	Parameter name	Setting range	Unit Number (19)	
			CH1	CH2
Output Setting of K7TM	Alarm Polarity	0 - Normally open 1 - Normally close	1	
	Alarm Output Level	0 - Low 1 - High	1	
	Logging Cycle	10 to 9999 [10 times]	100	100
	Use Running Time	0 - OFF 1 - ON	0	
Alarm Setting of K7TM	Heater Deterioration Alarm Value (Warning)	0.1 to 999.9 [%]	3.0	3.0
	Heater Deterioration Alarm Value (Critical)	0.1 to 999.9 [%]	5.0	5.0
	Last Resistance Value Change Rate Alarm Value	0.1 to 99.9 [%]	25.0	25.0
	Heater Burnout Alarm Value (Voltage)	0.0 to 99.9 [%FS]	40.0	40.0
	Heater Burnout Alarm Value (Current)	0.0 to 99.9 [%FS]	1.0	1.0

You can use default values for the following setting parameters in the **Output Setting of K7TM** category. Change them as required.

Refer to 5-7 *Initial Setting Level (LVL 0.2)* on page 5-25 for details.



- Use Running Time
- Alarm Polarity
- Alarm Output Level
- Logging Cycle

 **Configuration with Key Operations**

Make settings at the Initial Setting Level.

1. When you press the Level Key (⊖) for 3 seconds or more on the Operation Level, you are moved to the Initial Setting Level.

Refer to 5-7 Initial Setting Level (LVL 0.9 on page 5-25 for details on how to change the setting parameters.

In this procedure, set the following values:

Setting parameter	11-seg	Setting	Setting value
Alarm Polarity	N̄ON̄	Set whether to turn the alarm output contacts ON or OFF during normal operation.	N̄- \bar{C} (Normally close)
Alarm Output Level	RLVL	Set the level where the alarm output is produced when an alarm occurs.	H̄ \bar{C} H̄ (Critical)
Logging Cycle	L̄OP	Set the cycle in which to keep a log of the reference resistance value change rate, voltage value, current value, and record time.	100
Use Running Time	R̄LE	Set whether to inform you with the status display AGE Indicator that the K7TM has reached an approximate period in which it stops functioning at its full capacity due to the deterioration of the electrolytic capacitor characteristics.	\bar{O} FF (Not used)

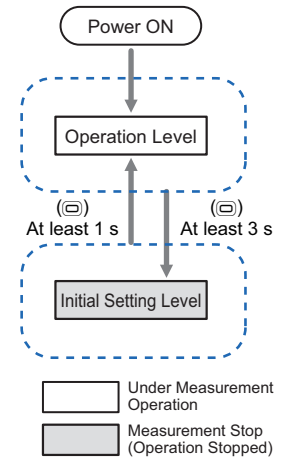

(7-2) Alarm Setting of K7TM

Set the Alarm Setting-related parameters.

Tool Operating Procedure

1. Set the alarm values at Alarm Setting of K7TM.

In this procedure, set the following values:

Setting parameter	Setting	Setting value
Heater Deterioration Alarm Value (Warning)	Set the alarm value (warning) for heater deterioration.	3.0 [%]
Heater Deterioration Alarm Value (Critical)	Set the alarm value (critical) for heater deterioration.	5.0 [%]
Last Resistance Value Change Rate Alarm	Set the alarm value for last resistance value change rate alarm value.	25.0 [%]
Heater Burnout Alarm Value (Voltage)	Set the voltage conditions for heater burnout alarm.	40.0 [% FS]
Heater Burnout Alarm Value (Current)	Set the current conditions for heater burnout alarm.	1.0 [% FS]

2. Click the **Write** Button to write the settings into the K7TM.

Check that OK message is displayed in the **Execution results** field.

Category	Parameter name	Setting range	Unit Number (19)	
			CH1	CH2
Output Setting of K7TM	Alarm Polarity	0 - Normally open 1 - Normally close	1	
	Alarm Output Level	0 - Low 1 - High	1	
	Logging Cycle	10 to 9999 [10 times]	100	100
	Use Running Time	0 - OFF 1 - ON	0	
	Heater Deterioration Alarm Value (Warning)	0.1 to 999.9 [%]	3.0	3.0
Alarm Setting of K7TM	Heater Deterioration Alarm Value (Critical)	0.1 to 999.9 [%]	5.0	5.0
	Last Resistance Value Change Rate Alarm Value	0.1 to 999.9 [%]	25.0	25.0
	Heater Burnout Alarm Value (Voltage)	0.0 to 99.9 [%FS]	40.0	40.0
	Heater Burnout Alarm Value (Current)	0.0 to 99.9 [%FS]	1.0	1.0

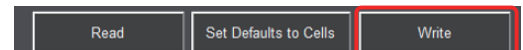

Display	Meaning
OK	Displays when reading and writing succeeded.
NG	Displays when reading and writing failed.
	The communications converter is not recognized.



The change rate of resistance value due to deterioration varies with the heater type. In deciding the thresholds of change rates for heater deterioration alarms, evaluate them on your device and usage conditions.

 **Configuration with Key Operations**

Make settings at the Adjustment Level (Common).

1. Press the Level Key (⊖) on the Operation Level (for less than 1 second) to move to the Adjustment Level (Common).

Refer to 5-4 Adjustment Level (Common) (LVL R.2 on page 5-13 for details on how to change the setting parameters.

In this procedure, set the following values:

Setting parameter	11-seg	Setting	Setting value
Heater Deterioration Alarm Value (Warning)	R_{LM1}	Set the alarm value (warning) for heater deterioration.	3.0 [%]
Heater Deterioration Alarm Value (Critical)	R_{LM2}	Set the alarm value (critical) for heater deterioration.	5.0 [%]
Last Resistance Value Change Rate Alarm	R_{LR}	Set the alarm value for last resistance value change rate alarm value.	25.0 [%]
Heater Burnout Alarm Value (Voltage)	$H_b - V$	Set the voltage conditions for heater burnout alarm.	40.0 [% FS]
Heater Burnout Alarm Value (Current)	$H_b - R$	Set the current conditions for heater burnout alarm.	1.0 [% FS]

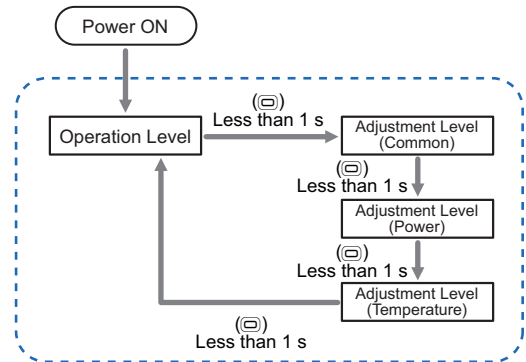

(8) Starting Operation

- The K7TM starts operation after the reference resistance value registration (**RDY** Indicator is lit).

Perform temperature control as usual. The K7TM monitors the change rates of heater resistance while deciding the right timing automatically.

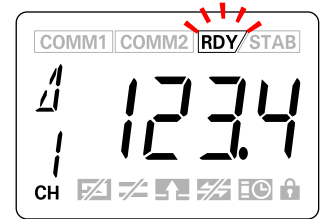

- **STAB** Indicator is lit while the reference resistance value change rates are being monitored.

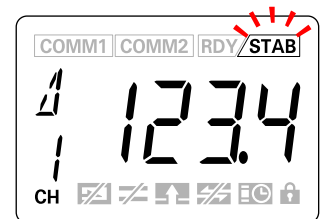

Assuming that the K7TM breaks down and is replaced ahead of the heater to monitor, you will need to record the reference resistance value change rate before K7TM replacement (with **STAB** Indicator lit). Also, the heater deterioration alarm values before replacement are required for the setting after replacement.

Condition monitoring can be continued by calculating the heater deterioration alarm values after replacement from this reference resistance value change rate and the heater deterioration alarm values before K7TM replacement and then reflecting them in the setting. Refer to *2-5 Adjustment When Device Status Is Changed* on page 2-42 for how to adjust the heater deterioration alarm values after K7TM replacement.

The following examples show how to record the reference resistance value change rate.

Example:

- Manual recording by making an inspection once a month or once a week.
- Periodic log reading via communications. (Refer to *4-6 Logging Function* on page 4-30 for details.)

2-5 Adjustment When Device Status Is Changed

If there is any change in device conditions from the original ones, such as replacing the K7TM or changed characteristics of the heating target, the stabilization conditions and the reference value will change, preventing correct detection of deterioration. The corrections are shown below.

Stabilization Discrimination Method (Power) and Stabilization Discrimination Method (Temperature)

Change in device status	Correction
Replacing the K7TM	<p>(1) Preparations before change Record the following values from the K7TM before replaced. They are used for the calculation in (3).</p> <ul style="list-style-type: none"> • Reference Resistance Value Change Rate before replacement (with STAB Indicator lit) • Heater Deterioration Alarm Value (Warning)/(Critical) <p>(2) Re-registration of reference resistance value Replace the K7TM, make the initial setting, and then re-register the reference resistance value.</p> <p>(3) Reconfiguration of heater deterioration alarm values Refer to 2-5-1 <i>How to Calculate the Heater Deterioration Alarm Values at K7TM Replacement</i> on page 2-44 for how to calculate the alarm values to reconfigure.</p>
The characteristics of the heating target changed, so the temperature fluctuation increased.	<p>Check that the K7TM is in the stabilized step. If does not make the transition to the stabilized step, review the stabilization conditions. Refer to 4-3-5 <i>Conditions for Moving from Waiting for Stabilization to Stabilized</i> on page 4-9 for details on the stabilization conditions.</p>
The target heater was replaced.	Re-register the reference resistance value.
Partial burnout occurred in the heater. (To continue using it)	<p>(1) Re-registration of reference resistance value Re-register the reference resistance value. Record the reference resistance value before re-registration. It is used for the calculation in (2).</p> <p>(2) Reconfiguration of heater deterioration alarm values Reconfigure the alarm values. Refer to 2-5-2 <i>How to Calculate the Heater Deterioration Alarm Values after Partial Burnout Occurrence</i> on page 2-45 for how to calculate the alarm values to reconfigure.</p>
Some target heaters (multiple) were replaced.	<p>If new heaters and old heaters coexist, the thresholds of alarms might be inappropriate. In this case, it will be difficult to detect heater deterioration.</p> <p>Used in this state is an application that monitors resistance value changes and determines the trends toward deterioration.</p> <p>If you replaced all the heaters together, you can detect heater deterioration by registering the reference resistance values again.</p>

Stabilization Discrimination Method (Temperature) Only

Change in device status	Correction
<p>The temperature set for monitoring heaters changed.</p>	<p>(1) Preparations before change Before re-registration, record the following values. They are used for the calculation in (4).</p> <ul style="list-style-type: none"> • Reference Resistance Value Change Rate before change (in stabilized state) • Heater Deterioration Alarm Value (Warning)/(Critical) <p>(2) Review of temperature set point Reconfigure the temperature set point.</p> <p>(3) Re-registration of reference resistance value Re-register the reference resistance value.</p> <p>(4) Reconfiguration of heater deterioration alarm values Reconfigure the alarm values. Refer to 2-5-3 <i>How to Calculate the Heater Deterioration Alarm Values after Temperature Set Point Change</i> on page 2-47 for how to calculate the alarm values to reconfigure.</p>

2-5-1 How to Calculate the Heater Deterioration Alarm Values at K7TM Replacement

If you replace only the K7TM without replacing heaters after monitoring operation, you also need to change the heater deterioration alarm values.

Calculate the “heater deterioration alarm values” in the following order: formulas (1) to (3).

To calculate it, you need the “reference resistance value change rate” before K7TM replacement (with STAB Indicator lit) and the “heater deterioration alarm value (warning)/(critical)” before change.

Formulas

Formula (1)

$$\text{Estimated Resistance Value before Deterioration before K7TM Replacement } [\Omega] = \text{(a) Reference Resistance Value When Re-registered after K7TM Replacement } [\Omega] \times \frac{100}{100 + \text{(b) Reference Resistance Value Change Rate before K7TM Replacement } [\%]}$$

Formula (2)

$$\text{Resistance Value to Trigger Alarm } [\Omega] = \text{(1) Estimated Resistance Value before Deterioration before K7TM Replacement } [\Omega] \times \frac{100 + \text{(c) Heater Deterioration Alarm Value before K7TM Replacement } [\%]}{100}$$

Formula (3)

$$\text{Heater Deterioration Alarm Value to Reconfigure } [\%] = \frac{\text{(2) Resistance Value to Trigger Alarm } [\Omega]}{\text{(a) Reference Resistance Value When Re-registered after K7TM Replacement } [\Omega]} \times 100 - 100$$

Calculation Examples

The following are examples of reconfiguring the heater deterioration alarms. (a) Reference Resistance Value after Re-registration is assumed to be 15.3 Ω. You will find (1), (2), (3), (a), (b), and (c) in the above formulas.

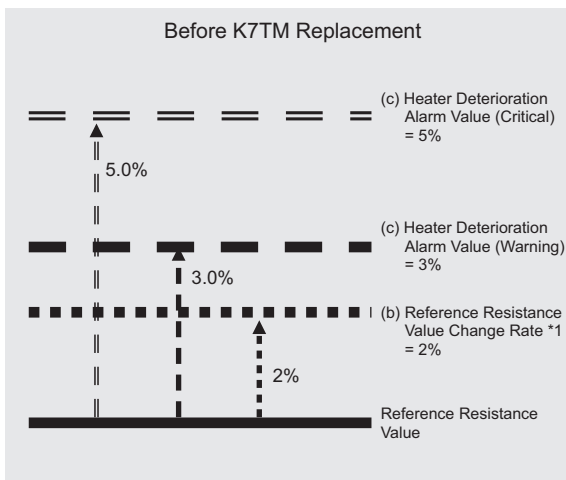

*1. Record the (b) Reference Resistance Value Change Rate before re-registration in advance.

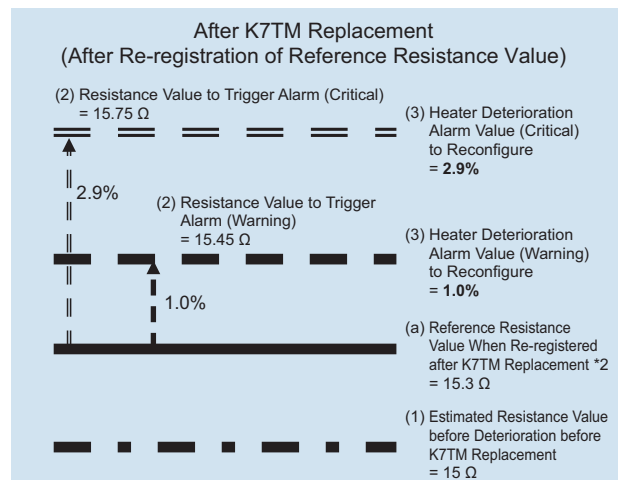

*2. This is a value calculated by the K7TM. Check it with the reference resistance value on the Adjustment Level (Common).

2-5-2 How to Calculate the Heater Deterioration Alarm Values after Partial Burnout Occurrence

If you keep using a heater without replacing it after partial burnout occurred, you also need to change the heater deterioration alarm values.

The calculation formulas of changing the alarm values before configured are shown, under the following preconditions.

Preconditions:

- All the heater resistance values shall be the same at the time of registration.
- The resistance value rising speed (deterioration increasing speed) shall be the same at all the heaters.

Formulas

Formula (1)

$$\begin{array}{l} \text{Estimated Resistance} \\ \text{Value before Deterioration,} \\ \text{at Number of Heaters after} \\ \text{Partial Burnout } [\Omega] \end{array} = \begin{array}{l} \text{(a) Reference Resistance Value} \\ \text{before Re-registration } [\Omega] \end{array} \times \frac{\begin{array}{l} \text{(b) Number of Heaters before Burnout} \\ \text{(b') Number of Heaters after Burnout} \end{array}}$$

Formula (2)

$$\begin{array}{l} \text{Resistance Value to Trigger} \\ \text{Alarm } [\Omega] \end{array} = \begin{array}{l} \text{(1) Estimated Resistance Value} \\ \text{before Deterioration, at} \\ \text{Number of Heaters after} \\ \text{Partial Burnout } [\Omega] \end{array} \times \frac{\begin{array}{l} \text{(c) Heater Deterioration Alarm Value} \\ \text{before Burnout } [\%] \end{array}}{100 + \frac{\text{(c) Heater Deterioration Alarm Value}}{100}}$$

Formula (3)

$$\begin{array}{l} \text{Heater Deterioration Alarm} \\ \text{Value to Reconfigure } [\%] \end{array} = \frac{\begin{array}{l} \text{(2) Resistance Value to Trigger} \\ \text{Alarm } [\Omega] \end{array}}{\begin{array}{l} \text{(d) Reference Resistance Value} \\ \text{after Re-registration } [\Omega] \end{array}} \times 100 - 100$$

Calculation Examples

The following are examples of reconfiguring the heater deterioration alarms after partial burnout occurred. (d) Reference Resistance Value after Re-registration is assumed to be 10.1 Ω.

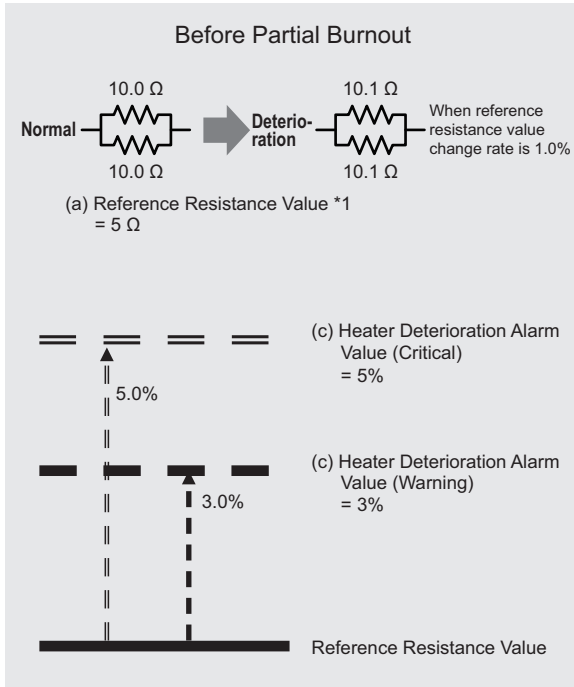

*1. Record the (a) Reference Resistance Value before re-registration in advance.

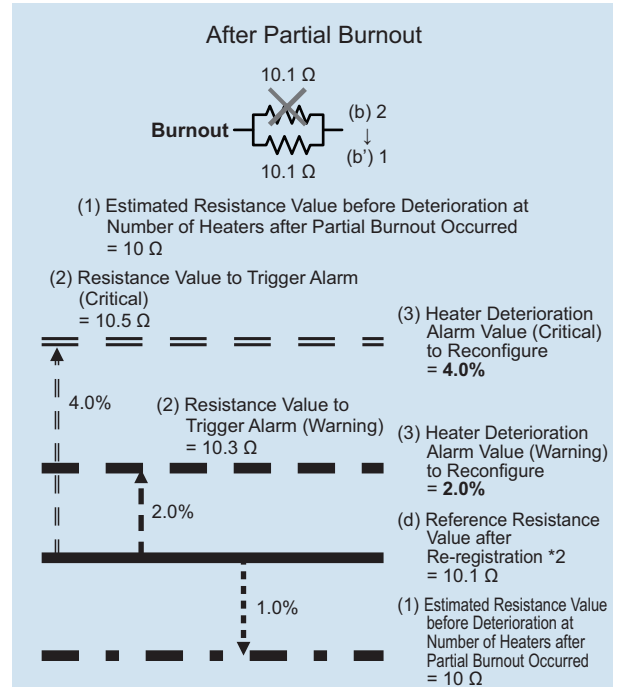

*2. This is a value calculated by the K7TM. Check it with the reference resistance value on the Adjustment Level (Common).

2-5-3 How to Calculate the Heater Deterioration Alarm Values after Temperature Set Point Change

If you change the temperature set point of the heater control after monitoring operation, you also need to change the heater deterioration alarm values.

Calculate the “heater deterioration alarm values” in the following order: formula (1) to formula (3). To calculate it, you need the “reference resistance value change rate” before set point change and the “heater deterioration alarm value (warning)/(critical)” before change.

Formulas

Formula (1)

$$\begin{aligned} \text{Estimated Resistance Value before Deterioration at Temperature after Change } [\Omega] &= \text{(a) Reference Resistance Value after Re-registration } [\Omega] \times \frac{100}{100 + \text{(b) Reference Resistance Value Change Rate before Set Point Change } [\%]} \end{aligned}$$

Formula (2)

$$\begin{aligned} \text{Resistance Value to Trigger Alarm } [\Omega] &= \text{(1) Estimated Resistance Value before Deterioration at Temperature after Change } [\Omega] \times \frac{100 + \text{(c) Heater Deterioration Alarm Value before Change } [\%]}{100} \end{aligned}$$

Formula (3)

$$\begin{aligned} \text{Heater Deterioration Alarm Value to Reconfigure } [\%] &= \frac{\text{(2) Resistance Value to Trigger Alarm } [\Omega]}{\text{(a) Reference Resistance Value after Re-registration } [\Omega]} \times 100 - 100 \end{aligned}$$

Calculation Examples

The following are examples of reconfiguring the heater deterioration alarms. (a) Reference Resistance Value after Re-registration is assumed to be 15.3 Ω. You will find (1), (2), (3), (a), (b), and (c) in the above formulas.

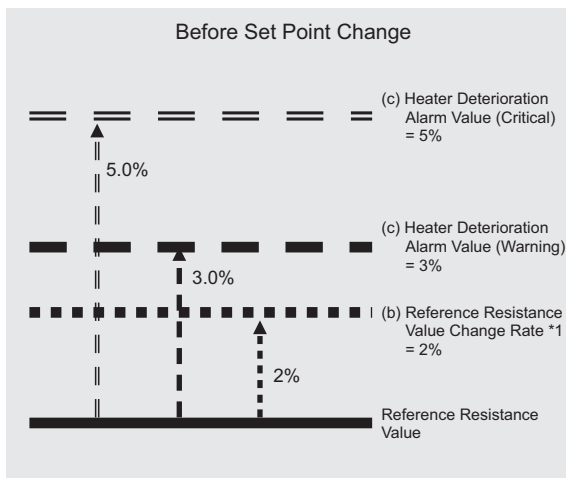

*1. Record the (b) Reference Resistance Value Change Rate before re-registration in advance.

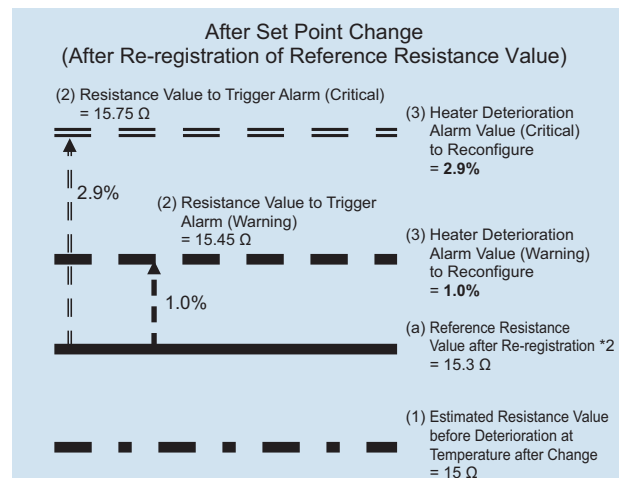









*2. This is a value calculated by the K7TM. Check it with the reference resistance value on the Adjustment Level (Common).



2-6 Troubleshooting

2-6-1 Troubleshooting for Procedures

If the K7TM does not operate properly after performing the procedure, see the correction in the table below corresponding to the reference number “ No. **” in the procedure.

Reference number	Problems	Cause	Countermeasure	Reference
 No. 1	If the run time of the heater to monitor is less than 35 minutes, can't it be monitored?	If the K7TM parameters for adjustment remain default values, the deterioration detection algorithm will not work.	Changing the initial settings will allow you to register the reference resistance value even if the run time is less than 35 minutes.	2-7 <i>Adjustment for Heater Running for a Short Time (Less than 35 Minutes)</i> on page 2-52
 No. 2	Power will not be turned ON. The power-on state is unstable, such as a flickering display.	A wire may have been connected to the release hole in a Push-In Plus terminal block.	Check again that the wire is securely connected to the terminal (insertion) hole. Also check the other terminals.	3-3 <i>How to Connect to the Push-In Plus Terminal Blocks</i> on page 3-6
 No. 3	NG message is displayed in Execution Results of Communications Test of the K7TM Configuration Tool, disabling communications.	The communications setting may not be matched.	Check that the setting parameters (Baud Rate, Parity, and Send Wait Time) on the Communications Setting 2 Level of the K7TM are the same as those of the K7TM Configuration Tool.	<i>Section 5 Using Parameters</i> on page 5-1
		Connection of communications cables might be faulty.	Correct the connection of communications cables.	3-6 <i>Wiring the Communications Cables</i> on page 3-14
		There is a possibility that you have not entered a unit number in the Unit Number field.	After entering the unit number set on the K7TM in the Unit Number field of the K7TM Configuration Tool, click the Communications test Button again.	(3) <i>Communications Setting</i> on page 2-9 under 2-4 <i>Configuration with Tool (Also Configurable with Key Operations)</i>
		There is a possibility that the computer in use has not recognized the communications converter.	Check whether the communications converter is recognized.	(3) <i>Communications Setting</i> on page 2-9 under 2-4 <i>Configuration with Tool (Also Configurable with Key Operations)</i>

Reference number	Problems	Cause	Countermeasure	Reference
 No. 4	The unit number, if changed, will not be reflected.	There is a possibility that you have not performed a power ON reset since you changed the unit number. To reflect the changed unit number, a power ON reset is required.	Perform a power on reset after changing the unit number.	(3) <i>Communications Setting</i> on page 2-9 under 2-4 <i>Configuration with Tool (Also Configurable with Key Operations)</i>
 No. 5	When the K7TM Configuration Tool is used, CH2 is in the inactive state on the Initial Setting of K7TM Sheet, Preparations (Adjustment) Sheet, and Operation Setting of K7TM Sheet.	There is a possibility that <i>Maximum Number of Channels</i> is set to 1.	Change the <i>Maximum Number of Channels</i> setting value on the Initial Setting of K7TM Sheet to 2.	5-7-2 <i>Parameters on Initial Setting Level</i> on page 5-26
 No. 6	CH2 is not displayed on the K7TM.	<i>Maximum Number of Channels</i> (Initial Setting Level) of the K7TM is set to 1.	Change the <i>Maximum Number of Channels</i> (Initial Setting Level) setting value to 2.	5-7-2 <i>Parameters on Initial Setting Level</i> on page 5-26
 No. 7	Although the voltage and the current are not 0, the status display IN Indicator lights and the inputs are judged to be none.	The voltage value may be not more than Measurement Voltage Lower Limit Value × Voltage Input Range, or the current value may be not more than Measurement Current Lower Limit Value × CT Input Range.	Check the voltage input range and CT input range for improper settings.	(1) <i>Checking the Heater and Selecting the Special CT</i> on page 2-5 under 2-3 <i>Advance Preparation</i>
 No. 8	Even if the operation command <i>Reference Resistance Value Registration Start</i> is sent via communications, reference resistance value registration will not be started. (RDY Indicator does not flash at 1-s intervals.)	There is a possibility that operation is in the stopped state (Initial Setting Level, Communications Setting 1 Level, or Communications Setting 2 Level).	Perform a power ON reset by cycling the power supply, sending the Software Reset Command, or other method.	5-9 <i>Operation Command with Key Operation</i> on page 5-33
		There is a possibility that an A/D error has occurred (<i>ERRR</i> is flashing on the main display).	First, turn the power OFF then back ON again. If operation returns to normal, then noise may have caused the problem. Check for noise. If the indication remains unchanged, contact your OMRON representative.	4-5 <i>Measurement Error</i> on page 4-26

Reference number	Problems	Cause	Countermeasure	Reference
 No. 9	When the K7TM Configuration Tool is used, even if you click the Start Button on the <i>Preparations (Registration) Sheet</i> , <i>Failed</i> or <i>Registration aborted</i> will be displayed in the Registration Status cell, disabling the registration of reference resistance value.	When <i>Failed</i> is displayed, the conditions for reference resistance value registration are not satisfied.	Make suitable corrections, seeing Section A-4 and Section 2-8.	<i>2-8 Adjustment When Reference Resistance Value Registration Failed</i> on page 2-54 <hr/> <i>A-4 Operation of Reference Resistance Value Registration</i> on page A-16
		When <i>Registration aborted</i> is displayed, a measurement error or a heater burnout alarm has occurred.	After clearing the measurement error or the heater burnout alarm, try <i>(5) Preparations (Registration)</i> again.	<i>(5) Preparations (Registration)</i> on page 2-24 under 2-4 <i>Configuration with Tool (Also Configurable with Key Operations)</i> <hr/> <i>4-4-6 Heater Burnout Alarm</i> on page 4-24 <hr/> <i>4-5 Measurement Error</i> on page 4-26
 No. 10	Even if you press and hold the REF Key on the K7TM, RDY Indicator will not flash and reference resistance value registration will not be started.	There is a possibility that the measurement value display automatic scroll is enabled.	Press the Mode Key (Ⓞ) for 3 seconds or more to cancel the measurement value display automatic scroll.	<i>5-3-3 Measurement Value Display Automatic Scroll</i> on page 5-9
		There is a possibility that operation is in the stopped state (Initial Setting Level, Communications Setting 1 Level, or Communications Setting 2 Level).	Move to the Operation Level, Adjustment Level (Common), Adjustment Level (Power), or Adjustment Level (Temperature).	<i>5-9 Operation Command with Key Operation</i> on page 5-33
		There is a possibility that an A/D error has occurred (<i>ERRR</i> is flashing on the main display).	First, turn the power OFF then back ON again. If operation returns to normal, then noise may have caused the problem. Check for noise. If the indication remains unchanged, contact your OMRON representative.	<i>4-5 Measurement Error</i> on page 4-26

Reference number	Problems	Cause	Countermeasure	Reference
 No.11	The flashing RDY Indicator goes out, not entering the lit state.	If the flashing RDY Indicator went out, the registration of reference resistance value has failed.	Use the K7TM Configuration Tool to log data, and readjust the setting value.	<i>2-8 Adjustment When Reference Resistance Value Registration Failed</i> on page 2-54
		A measurement error or a heater burnout alarm occurred, so the registration of reference resistance value has failed.	After clearing the measurement error or the heater burnout alarm, try (5) Preparations (Registration) again.	<i>(5) Preparations (Registration)</i> on page 2-24
				<i>4-5 Measurement Error</i> on page 4-26 <i>4-4-6 Heater Burnout Alarm</i> on page 4-24

2-7 Adjustment for Heater Running for a Short Time (Less than 35 Minutes)

When you use the K7TM with factory default settings, the heater is required to run for 35 minutes or more. *1

If the run time of the heater is less than 35 minutes, the following adjustment will be required.

- *1. The K7TM is designed so that a deterioration detection algorithm will work when the heater to monitor runs for 35 minutes or more. Refer to (1) *Checking the Heater and Selecting the Special CT* on page 2-5 under 2-3 Advance Preparation for details.

2-7-1 Adjusting the Setting Value of Measurement Value Calculation Cycle

The measurement value calculation cycle is a setting value of the cycle in which voltage value, current value, power, resistance value, and others are calculated. The default value is 100 seconds.

The following constraint is imposed on the measurement value calculation cycle of the K7TM, and the run time.

- Case where Stabilization Discrimination Method is Power

Run Time of Equipment > Measurement Value Calculation Cycle × (Resistance Value Moving Average Count or Power Moving Average Count, whichever is larger) × 2

- Case where Stabilization Discrimination Method is Temperature

Run Time of Equipment > Measurement Value Calculation Cycle × (Resistance Value Moving Average Count) × 2

Initial Setting Level
LVL 0

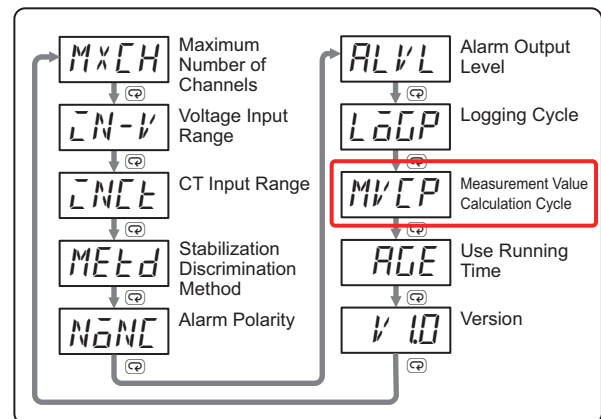

Precautions for Correct Use

When you use the K7TM Configuration Tool with Excel 2013 or Excel 2016, set **Measurement Value Calculation Cycle** to 100 seconds or less. (Default setting: 100 s)
It may become unstable if you set a value that exceeds 100 seconds.

2-7-2 To Use Heater with Shortest Run Time of 20 Seconds

The following is a case where the measurement value calculation cycle (default of 100 seconds) is set to the shortest value of 1 second.

If you set the measurement value calculation cycle to 1 second, the heater needs to run for 20 seconds (1 second \times 10 times \times 2).

However, the control cycle on the temperature control needs setting to 0.5 second (1/2 of 1 second).

Refer to the following Precautions for Correct Use for details.

Setting level	Parameter	Characters	Setting value
Initial Setting Level	Measurement Value Calculation Cycle	<i>MVCP</i>	1 second
Adjustment Level (Common)	Resistance Value Moving Average Count	<i>RVER</i>	Low (10 times)
Adjustment Level (Common)	Power Moving Average Count	<i>RVER</i>	Low (10 times)



Be aware that if you shorten the measurement value calculation cycle, the current value and the voltage value will fluctuate more widely.



Precautions for Correct Use

You are recommended to set an integral multiple of the ON/OFF cycle of heater output, to the measurement value calculation cycle. Unless the measurement value calculation cycle is an integral multiple of the ON/OFF cycle, the current value, voltage value, and power will not be stable.

The following constraints are imposed on the case where you change the measurement value calculation cycle while the heater control method is ON/OFF control or cycle control.

Measurement Value Calculation Cycle > ON/OFF Cycle of Heater Output

The measurement value calculation cycle shall be an integral multiple of the ON/OFF cycle of heater output.

- Setting of measurement value calculation cycle

This example shows a case where the ON/OFF cycle of heater output is 2 seconds and 50% of output (ON time is 1 second) is produced.

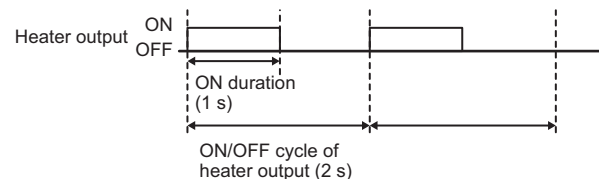

Set an integral multiple of 2 so that the cycle will be at least 4 seconds or more.

2-8 Adjustment When Reference Resistance Value Registration Failed

Whether the stabilization discrimination method (power) or (temperature), the K7TM could fail to register the reference resistance value of the heater. In that case, seeing the graph of data logged by the K7TM Configuration Tool, make adjustments according to the trends.

The procedures are shown below.

2-8-1 Stabilization Discrimination Method (Power) and Stabilization Discrimination Method (Temperature)

Trends in Voltage Value and Current Value Graphs

- Problem
The voltage value is less than measurement voltage lower limit value, or the current value is less than measurement current lower limit value.
- Countermeasure
Increase the measurement value calculation cycle.

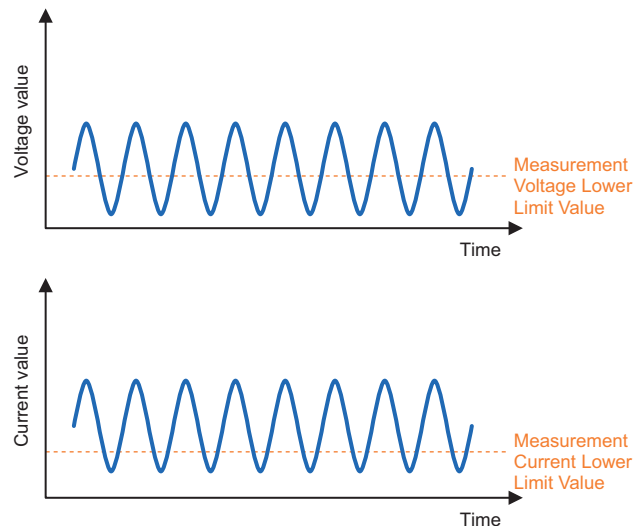

 **Tool Operating Procedure**

1. Display the **Initial Setting of K7TM Sheet**.
2. Increase the measurement value calculation cycle.
Example: 100 [s] to 200 [s]

 **Precautions for Correct Use**

When you use the K7TM Configuration Tool with Excel 2013 or Excel 2016, set **Measurement Value Calculation Cycle** to 100 seconds or less. (Default setting: 100 s)
It may become unstable if you set a value that exceeds 100 seconds.

Category	Parameter name	Setting range	Unit Number (1st)		
			CH1	CH2	
Input Setting of K7TM	Maximum Number of Channels	1 to 2 [CH]		1	
	CT Input Range	0 - 5 [A]			
		1 - 25 [A]			
		2 - 100 [A]	1	1	
		3 - 200 [A]			
Voltage Input Range	4 - 400 [A]				
	5 - 800 [A]				
	0 - 120 [V]	0	0		
Operation Setting of K7TM	Measurement Value Calculation Cycle	1 to 999 [s]	200	100	
	Stabilization Discrimination Method	1: mV/2 (Temperature)	0	0	
Communications Setting between K7TM and PLC (Stabilization Discrimination Method: Temperature)	Baud Rate 1	0 - 9.6 [kbps]			
		1 - 19.2 [kbps]			
		2 - 38.4 [kbps]		4	
		3 - 57.6 [kbps]			
		4 - 115.2 [kbps]			
	Parity 1	0 - None			
		1 - Even		1	
	Setting of Temperature Information (Stabilization Discrimination Method: Temperature)	Send Wait Time 1	0 to 99 [ms]		20
		Temperature Set Point	0 to 9999 [°C/°F]	0	0
		Temperature Stabilization Range	1 to 9999 [°C/°F]	10	10
	Temperature Data Write Cycle	1 to 999 [s]	10	10	

3. Display the **Preparations (Registration) Sheet**.
4. Click the **Start** Button to register the reference resistance value again.

Succeeded	Succeeded in registration of reference resistance value
Failed	Failed in registration of reference resistance value

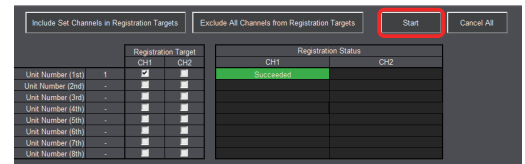

 **Configuration with Key Operations**

- Make settings at the Initial Setting Level.
1. Press the Level Key (⊖) for 3 seconds or more on the Operation Level to move to the Initial Setting Level.
 2. Increase the measurement value calculation cycle (MVEP).
Example: 100 [s] to 200 [s]
Refer to 5-7 Initial Setting Level (LVL 09 on page 5-25 for details on how to change the setting parameters.

Setting parameter	11-seg	Setting	Setting value
Measurement Value Calculation Cycle	MVEP	Set the cycle in which to calculate the measurement values.	200 [s]

3. Press the **REF** Key in the lower right of the K7TM front for 3 seconds or more, and register the reference resistance value again.

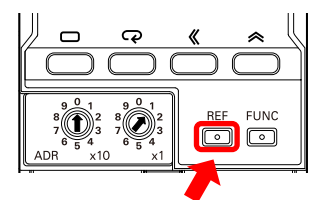
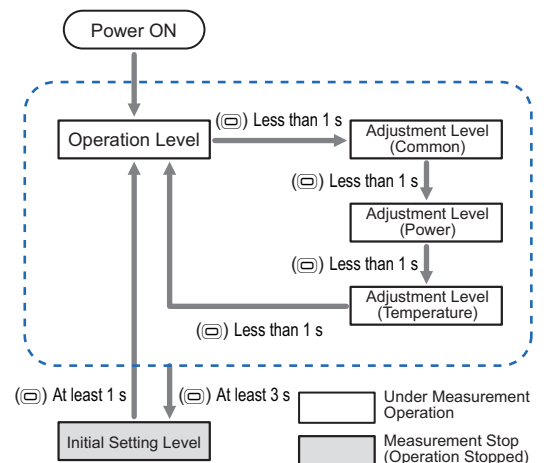

2-8-2 Stabilization Discrimination Method (Power)

Trends in Power and Resistance Value Graphs: Case 1

- Problem**
 The power change rate was not inside the power stabilization range, but it is likely to go into the range with the course of time. (For example, temperature is rising in equipment.)
- Countermeasure**
 It may go into the power stabilization range with the course of time. Perform registration of reference resistance value again.

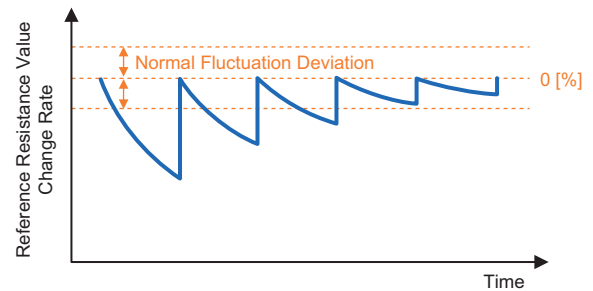
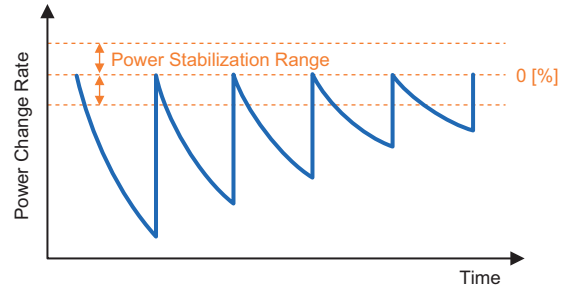

Tool Operating Procedure

1. Display the **Preparations (Registration) Sheet**.
2. Click the **Start** Button to register the reference resistance value again.

Succeeded	Succeeded in registration of reference resistance value
Failed	Failed in registration of reference resistance value

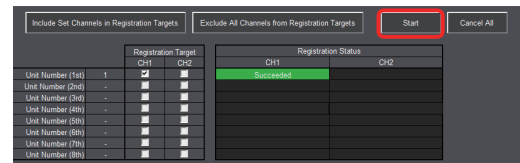

Configuration with Key Operations

1. Press the **REF** Key in the lower right of the K7TM front for 3 seconds or more.

The main display flashes at high speed at 0.5-s intervals. Pressing it for another 3 seconds or more will execute the operation command *Reference Resistance Value Registration Start*.

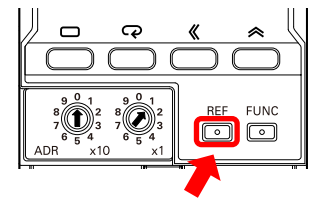

2. The monitoring step indicator **RDY** flashes. Since the K7TM automatically judges whether the heater is operating stably, this state lasts for a while (it takes 35 minutes or more in case of factory default settings).

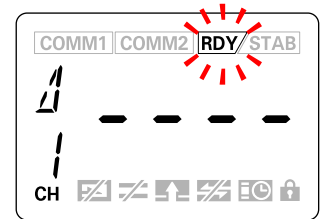

You can check the reference resistance value at the Adjustment Level (Common).

1. Press the Level Key () on the Operation Level (for less than 1 second) to move to the Adjustment Level (Common).

Refer to 5-4 *Adjustment Level (Common)* (LVL R₂ on page 5-13 for details on the *Reference Resistance Value* setting parameter.

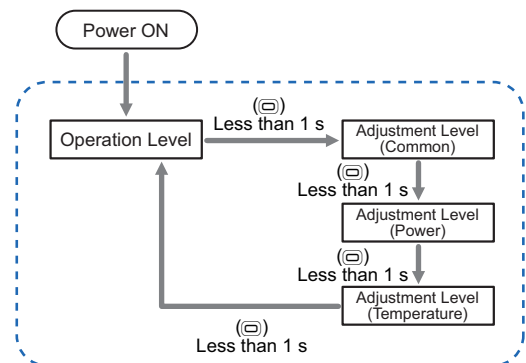

Setting parameter	11-seg	Setting	Monitoring range
Reference Resistance Value	REFR	This is a reference resistance value registered by the operation command <i>Reference Resistance Value Registration Start</i> .	Same range as Resistance Value [Ω]

Trends in Power and Resistance Value Graphs: Case 2

- **Problem**
Even if time passes, the power change rate is not likely to go into the power stabilization range.
- **Countermeasures**
 - Increase the power moving average count.
 - If the power moving average count is already set at High (40 times), increase the power stabilization range larger than fluctuations in the power change rate.
 - After the setting change above, perform registration of reference resistance value again.

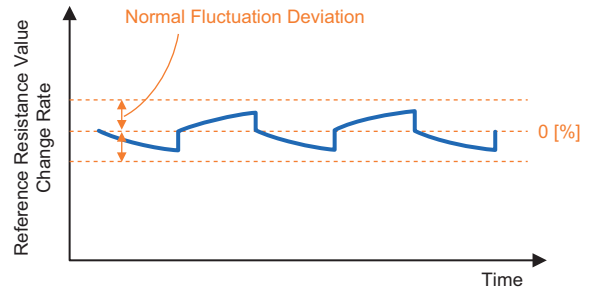
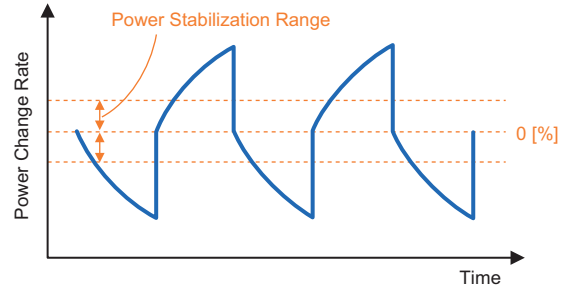

Increasing the power moving average count will help decrease fluctuations in the power change rate.
On the other hand, much data will be needed for moving average, so the evaluation time will be longer.

• How to Increase the Power Moving Average Count



Tool Operating Procedure

1. Display the **Preparations (Adjustment)** Sheet.
2. Change the setting value of the power moving average count from 0: *Low* to 1: *Middle*.
3. Display the **Preparations (Registration)** Sheet.
4. Click the **Start** Button to register the reference resistance value again.

Category	Parameter name	Setting range	Unit Number (1st)	
			CH1	CH2
Adjustment (Common)	Resistance Value Moving Average Count	0 : Low 1 : Middle 2 : High	0	0
	Normal Fluctuation Deviation	0.1 to 999.9 [%]	1.0	1.0
	Measurement Voltage Lower Limit Value	3.0 to 99.9 [%FS]	3.0	3.0
	Measurement Current Lower Limit Value	3.5 to 99.9 [%FS]	3.5	3.5
Adjustment (Power)	Power Moving Average Count	0 : Low 1 : Middle 2 : High	1	0
	Power Stabilization Range	0.1 to 999.9 [%]	20.0	20.0
Adjustment (Temperature)	Temperature Stabilization Range	1 to 9999 [°C/°F]	10	10

Include Set Channels in Registration Targets		Exclude All Channels from Registration Targets		Start	Cancel All
Unit Number (1st)	Registration Target		Registration Status		
	CH1	CH2	CH1	CH2	
Unit Number (1st)	1	<input checked="" type="checkbox"/>	CH1	Succeeded	
Unit Number (2nd)	-	<input type="checkbox"/>			
Unit Number (3rd)	-	<input type="checkbox"/>			
Unit Number (4th)	-	<input type="checkbox"/>			
Unit Number (5th)	-	<input type="checkbox"/>			
Unit Number (6th)	-	<input type="checkbox"/>			
Unit Number (7th)	-	<input type="checkbox"/>			
Unit Number (8th)	-	<input type="checkbox"/>			

Succeeded	Succeeded in registration of reference resistance value
Failed	Failed in registration of reference resistance value

Configuration with Key Operations

Make settings at the Adjustment Level (Common).

1. Press the Level Key (⊖) on the Operation Level (for less than 1 second) to move to the Adjustment Level (Common).
2. Change the setting value of the Power Moving Average Count (R_{VEP}) from L_āH to M_ād.

Refer to 5-4 Adjustment Level (Common) (LVL R_ā) on page 5-13 for details on how to change the setting parameters.

Setting parameter	11-seg	Setting	Setting value
Power Moving Average Count	R _{VEP}	Set the moving average count for power.	M _ā d

3. Press the REF Key in the lower right of the K7TM front for 3 seconds or more, and register the reference resistance value again.

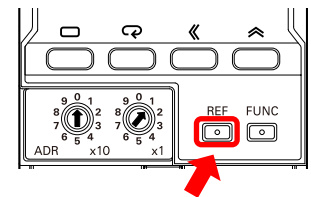
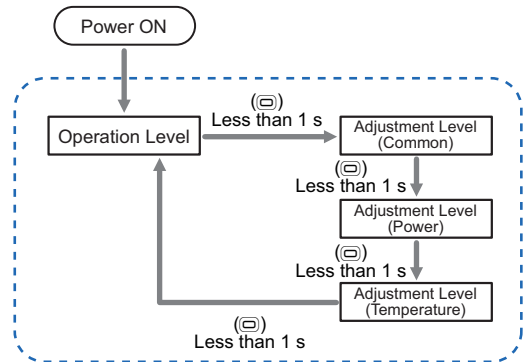

How to Increase the Power Stabilization Range

Tool Operating Procedure

1. Display the Preparations (Adjustment) Sheet.
2. Increase the setting value of the power stabilization range.
Example: 20.0 [%] to 30.0 [%]
3. Display the Preparations (Registration) Sheet.
4. Click the Start Button to register the reference resistance value again.

Category	Parameter name	Setting range	Unit Number (1st)	
			CH1	CH2
Adjustment (Common)	Resistance Value Moving Average Count	0 : Low 1 : Middle 2 : High	0	0
	Normal Fluctuation Deviation	0.1 to 999.9 [%]	1.0	1.0
	Measurement Voltage Lower Limit Value	3.0 to 99.9 [%FS]	3.0	3.0
Adjustment (Power)	Measurement Current Lower Limit Value	3.3 to 99.9 [%FS]	3.5	3.5
	Power Moving Average Count	0 : Low 1 : Middle 2 : High	2	0
	Power Stabilization Range	0.1 to 999.9 [%]	30.0	20.0
Adjustment (Temperature)	Temperature Stabilization Range	1 to 9999 [°C/°F]	10	10

Include Set Channels in Registration Targets		Exclude All Channels from Registration Targets		Start	Cancel All
Registration Target		Registration Status			
Unit Number (1st)	CH1	CH2	CH1	CH2	
Unit Number (1st)	1	☑	☑	☑	
Unit Number (2nd)	-	☐	☐	☐	
Unit Number (3rd)	-	☐	☐	☐	
Unit Number (4th)	-	☐	☐	☐	
Unit Number (5th)	-	☐	☐	☐	
Unit Number (6th)	-	☐	☐	☐	
Unit Number (7th)	-	☐	☐	☐	
Unit Number (8th)	-	☐	☐	☐	

Succeeded	Succeeded in registration of reference resistance value
Failed	Failed in registration of reference resistance value

 **Configuration with Key Operations**

Make settings at the Adjustment Level (Power).

1. Press the Level Key (⊖) on the Operation Level twice (for less than 1 second) to move to the Adjustment Level (Power).
2. Increase the setting value of the Power Stabilization Range ($PW-b$).

Example: 20.0 [%] to 30.0 [%]
 Refer to 5-5 Adjustment Level (Power) (LVL b) on page 5-19 for details on how to change the setting parameters.

Setting parameter	11-seg	Setting	Setting value
Power Stabilization Range	$PW-b$	Set the range of powers that the K7TM judges to be stabilized.	30.0 [%]

3. Press the REF Key in the lower right of the K7TM front for 3 seconds or more, and register the reference resistance value again.

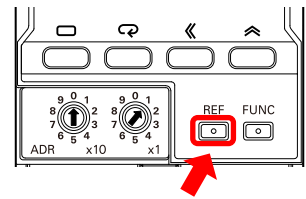
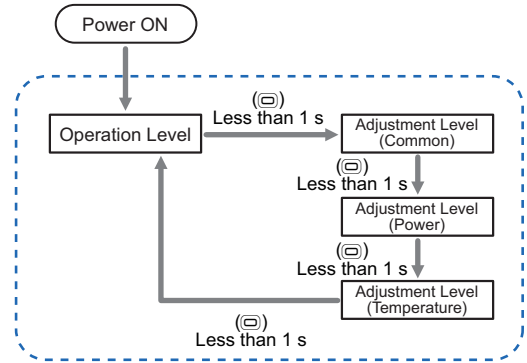

Trends in Power and Resistance Value Graphs: Case 3

- **Problem**
Even if time passes, the reference resistance value change rate is not likely to go into the normal fluctuation deviation.
- **Countermeasures**
 - Increase the resistance value moving average count.
 - If the resistance value moving average count is already set at High (40 times), increase the normal fluctuation deviation larger than fluctuations in the reference resistance value change rate.
 - After the setting change above, perform registration of reference resistance value again.

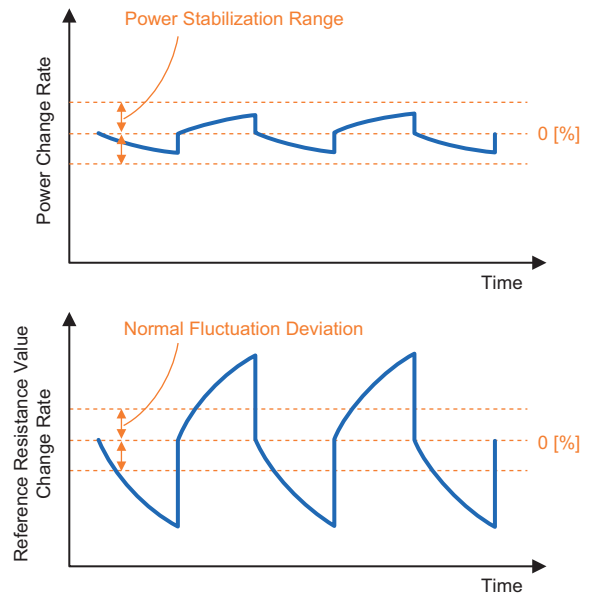

Increasing the resistance value moving average count will help decrease fluctuations in the reference resistance value change rate. On the other hand, much data will be needed for moving average, so the evaluation time will be longer.

• How to Increase the Resistance Value Moving Average Count

Tool Operating Procedure

1. Display the **Preparations (Adjustment)** Sheet.
2. Change the setting value of the resistance value moving average count from 0: Low to 1: Middle.
3. Display the **Preparations (Registration)** Sheet.
4. Click the **Start** Button to register the reference resistance value again.

Category	Parameter name	Setting range	Unit Number (1st)	
			CH1	CH2
Adjustment (Common)	Resistance Value Moving Average Count	0: Low 1: Middle 2: High	1	0
	Normal Fluctuation Deviation	0.1 to 999.9 [%]	1.0	1.0
	Measurement Voltage Lower Limit Value	3.0 to 99.9 [%F.S]	3.0	3.0
	Measurement Current Lower Limit Value	3.5 to 99.9 [%F.S]	3.5	3.5
Adjustment (Power)	Power Moving Average Count	0: Low 1: Middle 2: High	0	0
	Power Stabilization Range	0.1 to 999.9 [%]	20.0	20.0
Adjustment (Temperature)	Temperature Stabilization Range	1 to 9999 [°C/°F]	10	10

Include Set Channels in Registration Targets		Exclude All Channels from Registration Targets		Start	Cancel All	
Registration Target		Registration Status				
Unit Number (1st)	CH1	CH2	CH1	CH2		
Unit Number (2nd)	<input checked="" type="checkbox"/>	<input checked="" type="checkbox"/>	Succeeded			
Unit Number (3rd)	<input checked="" type="checkbox"/>	<input checked="" type="checkbox"/>				
Unit Number (4th)	<input checked="" type="checkbox"/>	<input checked="" type="checkbox"/>				
Unit Number (5th)	<input checked="" type="checkbox"/>	<input checked="" type="checkbox"/>				
Unit Number (6th)	<input checked="" type="checkbox"/>	<input checked="" type="checkbox"/>				
Unit Number (7th)	<input checked="" type="checkbox"/>	<input checked="" type="checkbox"/>				
Unit Number (8th)	<input checked="" type="checkbox"/>	<input checked="" type="checkbox"/>				

Succeeded	Succeeded in registration of reference resistance value
Failed	Failed in registration of reference resistance value

Configuration with Key Operations

Make settings at the Adjustment Level (Common).

1. Press the Level Key (⊖) on the Operation Level (for less than 1 second) to move to the Adjustment Level (Common).
2. Change the setting value of the Resistance Value Moving Average Count (*RVER*) from *LdW* to *Md*.

Refer to 5-4 Adjustment Level (Common) (*LVL Rg* on page 5-13 for details on how to change the setting parameters.

Setting parameter	11-seg	Setting	Setting value
Resistance Value Moving Average Count	<i>RVER</i>	Set the moving average count for resistance value.	<i>Md</i>

3. Press the REF Key in the lower right of the K7TM front for 3 seconds or more, and register the reference resistance value again.

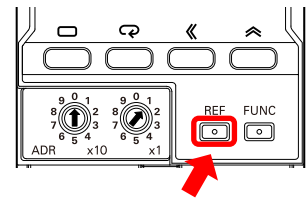
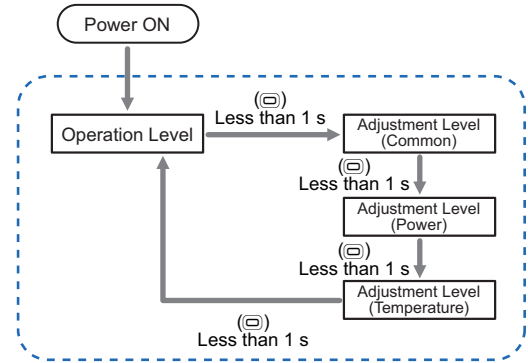

● How to Increase the Normal Fluctuation Deviation

Tool Operating Procedure

1. Display the Preparations (Adjustment) Sheet.
2. Increase the setting value of the normal fluctuation deviation.
Example: 1.0 [%] to 3.0 [%]
3. Display the Preparations (Registration) Sheet.
4. Click the Start Button to register the reference resistance value again.

Category	Parameter name	Setting range	Unit Number (1st)	
			CH1	CH2
Adjustment (Common)	Resistance Value Moving Average Count	0 - Low 1 - Middle 2 - High	2	0
	Normal Fluctuation Deviation	0.1 to 999.9 [%]	3.0	1.0
	Measurement Voltage Lower Limit Value	3.0 to 99.9 [%FS]	3.0	3.0
	Measurement Current Lower Limit Value	3.5 to 99.9 [%FS]	3.5	3.5
Adjustment (Power)	Power Moving Average Count	0 - Low 1 - Middle 2 - High	0	0
	Power Stabilization Range	0.1 to 999.9 [%]	20.0	20.0
Adjustment (Temperature)	Temperature Stabilization Range	1 to 9999 [°C/°F]	10	10

Include Set Channels in Registration Targets			Exclude All Channels from Registration Targets			Start	Cancel All
Registration Target			Registration Status				
Unit Number (1st)	CH1	CH2	CH1		CH2		
Unit Number (1st)	■	■	Succeeded				
Unit Number (2nd)	-	■					
Unit Number (4th)	-	■					
Unit Number (5th)	-	■					
Unit Number (6th)	-	■					
Unit Number (7th)	-	■					
Unit Number (8th)	-	■					

Succeeded	Succeeded in registration of reference resistance value
Failed	Failed in registration of reference resistance value

 **Configuration with Key Operations**

Make settings at the Adjustment Level (Common).

1. Press the Level Key (⊖) on the Operation Level once (for less than 1 second) to move to the Adjustment Level (Common).
2. Increase the setting value of the Normal Fluctuation Deviation (NF_d).
Example: 1.0 [%] to 3.0 [%]

Refer to 5-4 Adjustment Level (Common) (LVL R_d) on page 5-13 for details on how to change the setting parameters.

Setting parameter	11-seg	Setting	Setting value
Normal Fluctuation Deviation	NF_d	Set the range of resistance values required for the K7TM determining that the heater temperature is stabilized.	3.0 [%]

3. Press the REF Key in the lower right of the K7TM front for 3 seconds or more, and register the reference resistance value again.

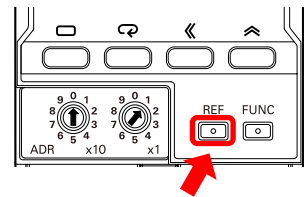
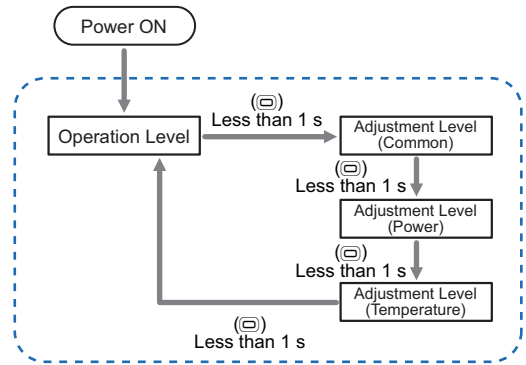

2-8-3 Stabilization Discrimination Method (Temperature)

Trends in Temperature and Resistance Value Graphs: Case 1

- **Problem**
Temperature is still rising in the heater, so it has not gone into the temperature stabilization range.
- **Countermeasure**
In order to retry registration of reference resistance value, execute the operation command Reference Resistance Value Registration Start.

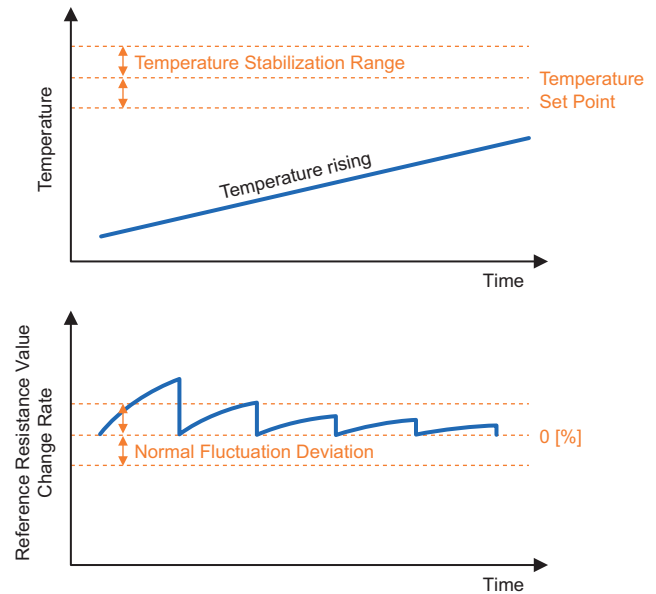

Tool Operating Procedure

1. Display the **Preparations (Registration)** Sheet.
2. Click the **Start** Button to register the reference resistance value again. Refer to (5) *Preparations (Registration)* on page 2-24 for details.

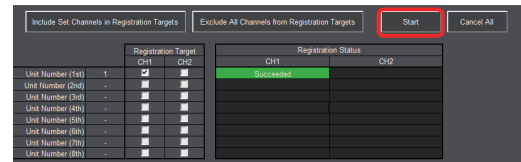

Configuration with Key Operations

1. Press the **REF** Key in the lower right of the K7TM front for 3 seconds or more.

The main display flashes at high speed at 0.5-s intervals. Pressing it for another 3 seconds or more will execute the operation command *Reference Resistance Value Registration Start*.
2. The monitoring step indicator **RDY** flashes.
Since the K7TM automatically judges whether the heater is operating stably, this state lasts for a while (it takes 35 minutes or more in case of factory default settings).

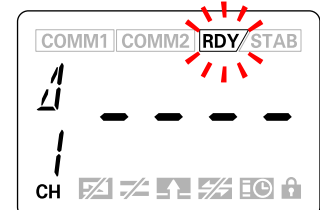
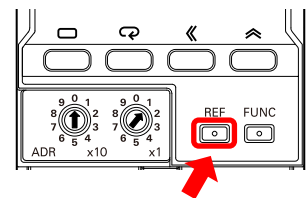

You can check the reference resistance value at the Adjustment Level (Common).

1. Press the Level Key (⊖) on the Operation Level (for less than 1 second) to move to the Adjustment Level (Common).

Refer to 5-4 Adjustment Level (Common) (LVL R₂) on page 5-13 for details on how to check the Reference Resistance Value setting parameter.

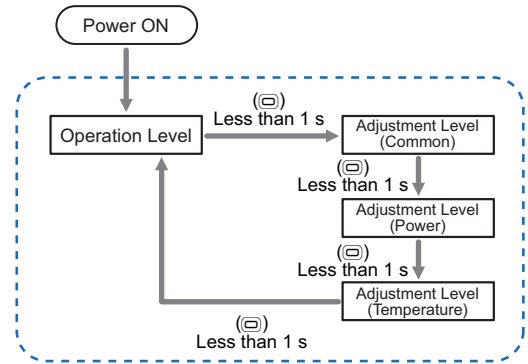

Setting parameter	11-seg	Setting	Monitoring range
Reference Resistance Value	REFR	This is a reference resistance value registered by the operation command <i>Reference Resistance Value Registration Start.</i>	Same range as Resistance Value [Ω]

Trends in Temperature and Resistance Value Graphs: Case 2

- Problem
Even if time passes, the temperature is not likely to go into the temperature stabilization range.
- Countermeasures
 - Increase the temperature stabilization range larger than fluctuations in the temperature.
 - After the setting change above, perform registration of reference resistance value again.

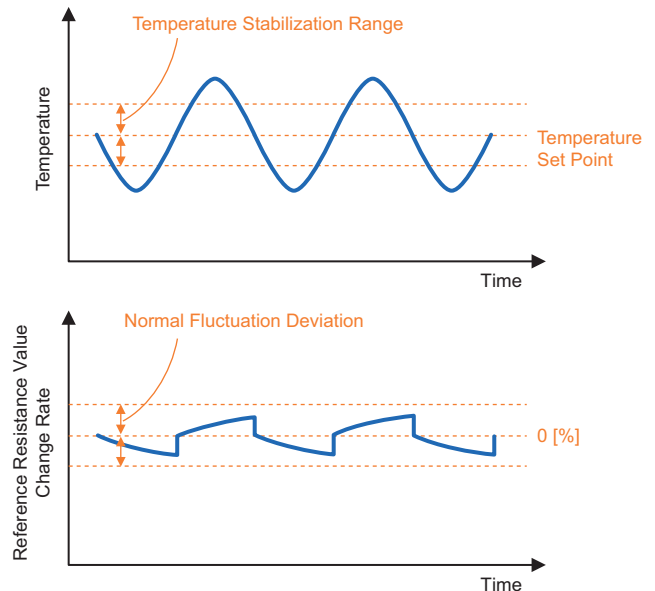



Tool Operating Procedure

1. Display the **Preparations (Adjustment)** Sheet.
2. Increase the setting value of the temperature stabilization range.
Example: 10 [°C/°F] to 20 [°C/°F]
3. Display the **Preparations (Registration)** Sheet.
4. Click the **Start** Button to register the reference resistance value again.
Refer to (5) *Preparations (Registration)* on page 2-24 for details.

Category	Parameter name	Setting range	Unit Number (1st)	
			CH1	CH2
Adjustment (Common)	Resistance Value Moving Average Count	0 : Low 1 : Middle 2 : High	0	0
	Normal Fluctuation Deviation	0.1 to 999.9 [%]	1.0	1.0
	Measurement Voltage Lower Limit Value	3.0 to 99.9 [%FS]	3.0	3.0
Adjustment (Power)	Measurement Current Lower Limit Value	3.5 to 99.9 [%FS]	3.5	3.5
	Power Moving Average Count	0 : Low 1 : Middle 2 : High	0	0
Adjustment (Temperature)	Power Stabilization Range	0.1 to 999.9 [%]	20.0	20.0
	Temperature Stabilization Range	1 to 9999 [°C/°F]	20	10

Include Set Channels in Registration Targets			Exclude All Channels from Registration Targets		Start	Cancel All
Unit Number (1st)	Registration Target		Registration Status		CH1	CH2
	CH1	CH2	CH1	CH2		
1	<input checked="" type="checkbox"/>	<input checked="" type="checkbox"/>	Succeeded			
Unit Number (2nd)	<input type="checkbox"/>	<input type="checkbox"/>				
Unit Number (3rd)	<input type="checkbox"/>	<input type="checkbox"/>				
Unit Number (4th)	<input type="checkbox"/>	<input type="checkbox"/>				
Unit Number (5th)	<input type="checkbox"/>	<input type="checkbox"/>				
Unit Number (6th)	<input type="checkbox"/>	<input type="checkbox"/>				
Unit Number (7th)	<input type="checkbox"/>	<input type="checkbox"/>				
Unit Number (8th)	<input type="checkbox"/>	<input type="checkbox"/>				



Configuration with Key Operations

Increase the setting value of the temperature stabilization range.
Example: 10 [°C/°F] to 20 [°C/°F]

1. Press the Level Key (Ⓞ) on the Operation Level three times (for less than 1 second) to move to the Adjustment Level (Temperature).
Refer to 5-6 *Adjustment Level (Temperature)* (LVL ㉔ on page 5-22 for details on how to change the setting parameters.

Setting parameter	11-seg	Setting	Setting value
Temperature Stabilization Range	㉔ - 5b	Set the temperature stabilization range that the K7TM judged to be stabilized.	20 [°C/°F]

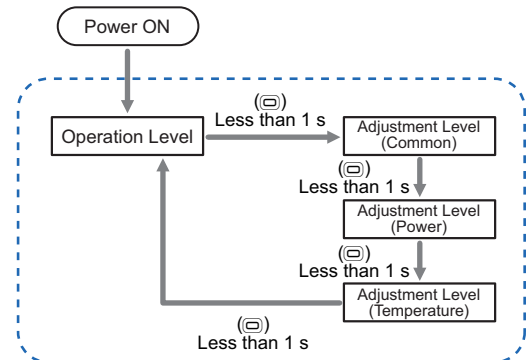

2. Press the **REF** Key in the lower right of the K7TM front for 3 seconds or more, and register the reference resistance value again.

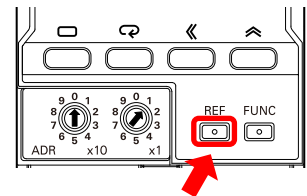

Trends in Temperature and Resistance Value Graphs: Case 3

- **Problem**
Even if time passes, the reference resistance value change rate is not likely to go into the normal fluctuation deviation.
- **Countermeasures**
 - Increase the resistance value moving average count.
 - If the resistance value moving average count is already set at High (40 times), increase the normal fluctuation deviation larger than fluctuations in the reference resistance value change rate.
 - After the setting change above, perform registration of reference resistance value again.

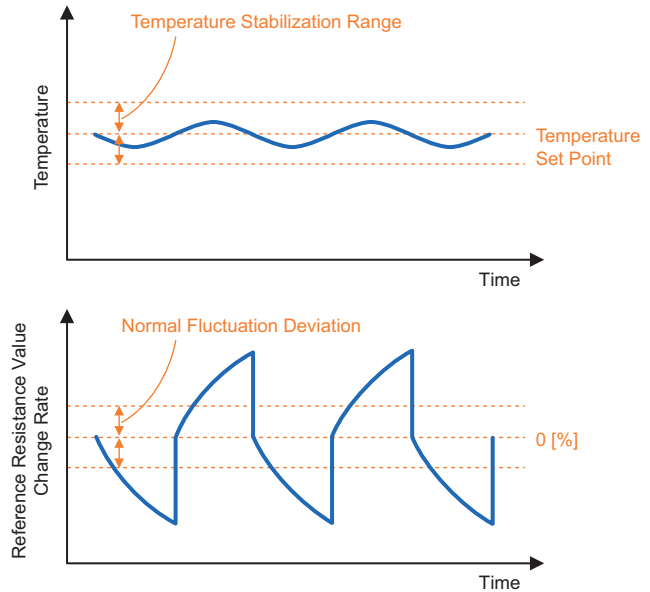

Increasing the resistance value moving average count will help decrease fluctuations in the reference resistance value change rate.
On the other hand, much data will be needed for moving average, so the evaluation time will be longer.



How to Increase the Resistance Value Moving Average Count



Tool Operating Procedure

1. Display the **Preparations (Adjustment)** Sheet.
2. Change the setting value of the Resistance Value Moving Average Count from 0: *Low* to 1: *Middle*.
3. Display the **Preparations (Registration)** Sheet.
4. Click the **Start** Button to register the reference resistance value again.

Category	Parameter name	Setting range	Unit Number (1st)	
			CH1	CH2
Adjustment (Common)	Resistance Value Moving Average Count	0: Low 1: Middle 2: High	1	0
	Normal Fluctuation Deviation	0.1 to 999.9 [%]	3.0	1.0
	Measurement Voltage Lower Limit Value	3.0 to 99.9 [%FS]	3.0	3.0
	Measurement Current Lower Limit Value	3.5 to 99.9 [%FS]	3.5	3.5
Adjustment (Power)	Power Moving Average Count	0: Low 1: Middle 2: High	0	0
	Power Stabilization Range	0.1 to 999.9 [%]	20.0	20.0
Adjustment (Temperature)	Temperature Stabilization Range	1 to 9999 [°C/°F]	10	10

Include Set Channels in Registration Targets		Exclude All Channels from Registration Targets		Start	Cancel All	
Registration Target		Registration Status				
Unit Number (1st)	CH1	CH2	CH1	CH2		
Unit Number (2nd)	<input checked="" type="checkbox"/>	<input checked="" type="checkbox"/>	Succeeded			
Unit Number (3rd)	<input checked="" type="checkbox"/>	<input checked="" type="checkbox"/>				
Unit Number (4th)	<input checked="" type="checkbox"/>	<input checked="" type="checkbox"/>				
Unit Number (5th)	<input checked="" type="checkbox"/>	<input checked="" type="checkbox"/>				
Unit Number (6th)	<input checked="" type="checkbox"/>	<input checked="" type="checkbox"/>				
Unit Number (7th)	<input checked="" type="checkbox"/>	<input checked="" type="checkbox"/>				
Unit Number (8th)	<input checked="" type="checkbox"/>	<input checked="" type="checkbox"/>				

Succeeded	Succeeded in registration of reference resistance value
Failed	Failed in registration of reference resistance value

Configuration with Key Operations

Make settings at the Adjustment Level (Common).

1. Press the Level Key (⊖) on the Operation Level (for less than 1 second) to move to the Adjustment Level (Common).
2. Change the setting value of the Resistance Value Moving Average Count (RVER) from LOW to MCD.

Refer to 5-4 Adjustment Level (Common) (LVL RES on page 5-13 for details on how to change the setting parameters).

Setting parameter	11-seg	Setting	Setting value
Resistance Value Moving Average Count	RVER	Set the moving average count for resistance value.	MCD

3. Press the REF Key in the lower right of the K7TM front for 3 seconds or more, and register the reference resistance value again.

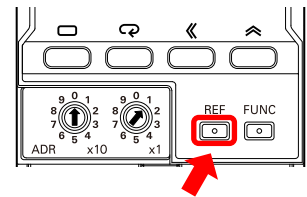
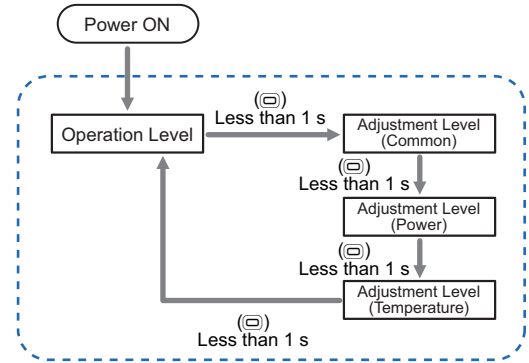

● How to Increase the Normal Fluctuation Deviation

Tool Operating Procedure

1. Display the Preparations (Adjustment) Sheet.
2. Increase the setting value of the normal fluctuation deviation.
Example: 1.0 [%] to 3.0 [%]
3. Display the Preparations (Registration) Sheet.
4. Click the Start Button to register the reference resistance value again.

Succeeded	Succeeded in registration of reference resistance value
Failed	Failed in registration of reference resistance value

Category	Parameter name	Setting range	Unit Number (1st)	
			CH1	CH2
Adjustment (Common)	Resistance Value Moving Average Count	0 : Low 1 : Middle 2 : High	2	0
	Normal Fluctuation Deviation	0.1 to 999.9 [%]	3.0	1.0
	Measurement Value Lower Limit Value	0.0 to 999.9 [%FS]	2.0	0.0
	Measurement Current Lower Limit Value	3.5 to 99.9 [%FS]	3.5	3.5
Adjustment (Power)	Power Moving Average Count	0 : Low 1 : Middle 2 : High	0	0
	Power Stabilization Range	0.1 to 999.9 [%]	20.0	20.0
Adjustment (Temperature)	Temperature Stabilization Range	1 to 9999 [°C/°F]	10	10

Include Set Channels in Registration Targets		Exclude All Channels from Registration Targets		Start	Cancel All
Unit Number (1st)	CH1	CH2		Registration Status CH1: Succeeded CH2:	
Unit Number (2nd)					
Unit Number (3rd)					
Unit Number (4th)					
Unit Number (5th)					
Unit Number (6th)					
Unit Number (7th)					
Unit Number (8th)					

 **Configuration with Key Operations**

Make settings at the Adjustment Level (Common).

1. Press the Level Key (⊖) on the Operation Level once (for less than 1 second) to move to the Adjustment Level (Common).
2. Increase the setting value of the Normal Fluctuation Deviation (NF_d).
Example: 1.0 [%] to 3.0 [%]

Refer to 5-4 *Adjustment Level (Common)* (*LVL R_d*) on page 5-13 for details on how to change the setting parameters.

Setting parameter	11-seg	Setting	Setting value
Normal Fluctuation Deviation	NF_d	Set the range of resistance values required for the K7TM determining that the heater temperature is stabilized.	3.0 [%]

3. Press the **REF** Key in the lower right of the K7TM front for 3 seconds or more, and register the reference resistance value again.

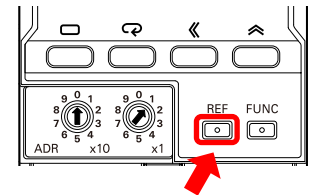
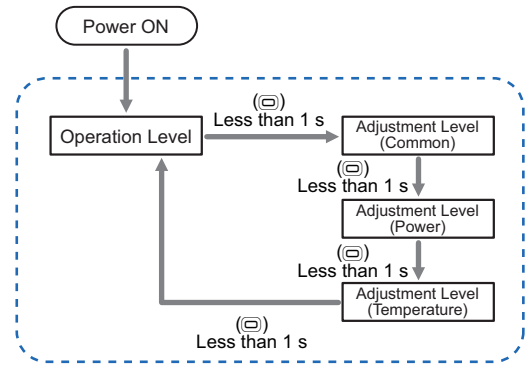

2-8-4 How to Predict Early That Registration Fails (Optional)

The K7TM retries an evaluation of the reference resistance value until it fails 5 times. If you start adjusting the setting values after all of the five retries failed, the total time required for registration, including adjustment, will be longer. (In case of initial settings, it will take about 1.7 hours if the five retries failed.)

If you can predict early that registration of reference resistance value fails without waiting for five failures, it may be possible to cancel the registration and adjust the setting parameters at an early stage, shortening the total time it takes to register the reference resistance value.



This procedure is optional. It is not always required.

To perform this procedure, it is necessary to render in real time the K7TM monitored values in graph form. You are recommended to use the K7TM Configuration Tool.

The following describes how to predict early that registration fails taking, as an example, the graph used in *Trends in Power and Resistance Value Graphs: Case 2* under 2-8-2 *Stabilization Discrimination Method (Power)*.

The graph in the right figure shows that the registration of reference resistance value has failed because the power change rate did not go into the power stabilization range 5 times. For the 3rd and subsequent times, 1st and 2nd waveforms are repeated. Therefore, if canceling the registration when the power change rate goes out of the power stabilization range on the 3rd try, you can shorten the time it takes until 4th and 5th retries fail.

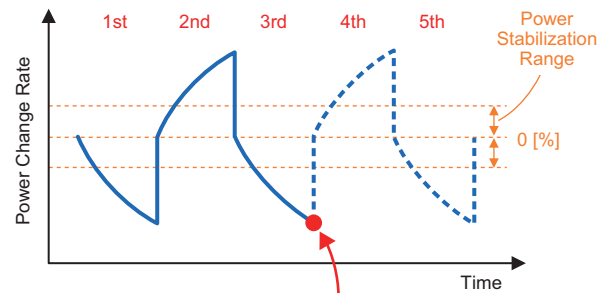

At this stage, you can predict that it is not likely to go into the power stabilization range.



Tool Operating Procedure

1. Start registration of reference resistance value, according to the procedure (5-2) *Setting of Registration Targets and Execution of Registration*.
2. After the registration starts, open the _1 Sheet*1 of the K7TM Configuration Tool. The graph of the power change rate under evaluation is refreshed in real time.
3. Cancel the registration if the power change rate is not likely to go into the power stabilization range. To cancel the registration, open the **Preparations (Registration) Sheet**, and click the **Cancel All Button**.
4. Make suitable corrections, according to the procedure *Trends in Power and Resistance Value Graphs: Case 2 under 2-8-2 Stabilization Discrimination Method (Power)*.

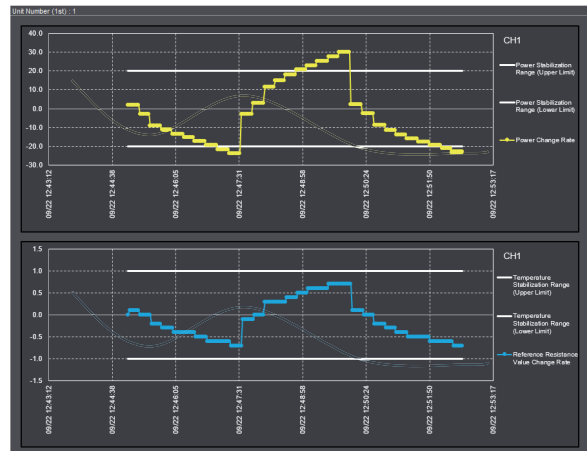

*1. The _1 Sheet corresponds to the Unit Number (1st). Similarly, the sheets correspond up to the Unit Number (8th).

So far, the description has taken *Trends in Power and Resistance Value Graphs: Case 2 under 2-8-2 Stabilization Discrimination Method (Power)* as an example. For the other cases, perform the same procedure seeing 2-8-1 to 2-8-3.

3

Installation and Wiring

This section describes the installation and wiring of the K7TM and special CTs. Be sure to read and understand *Precautions for Safe Use* on page 7 before installing and wiring.

3-1	Dimensions	3-2
3-2	Installation	3-4
3-3	How to Connect to the Push-In Plus Terminal Blocks	3-6
3-4	I/O Wiring	3-9
3-5	Connections of Heaters with External Devices	3-11
3-6	Wiring the Communications Cables	3-14
3-7	Setting the Unit Number	3-16

3-1 Dimensions

K7TM

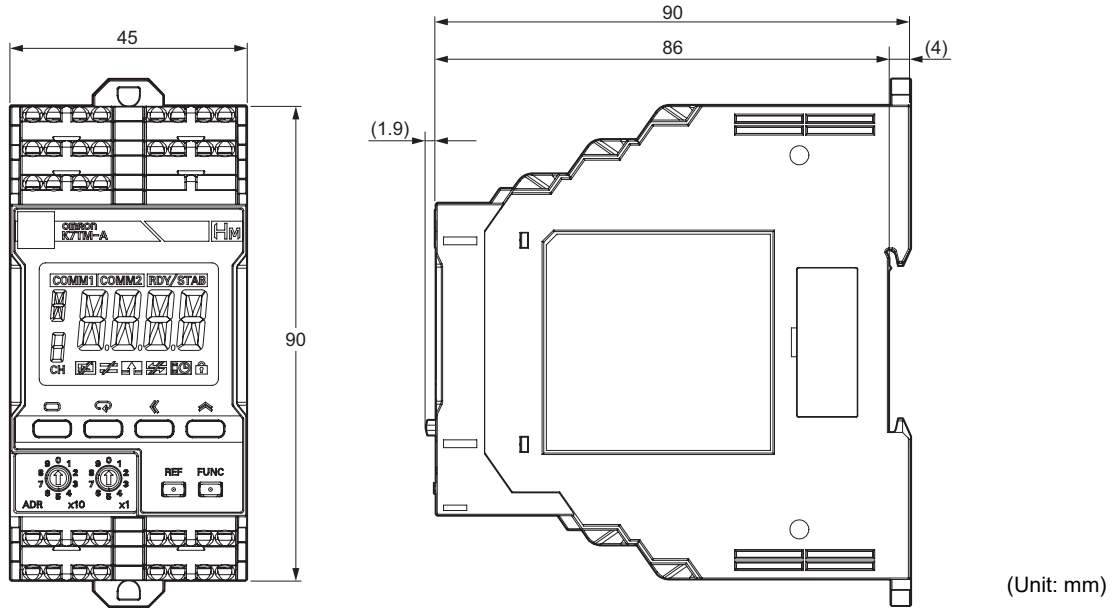

Special CT (Current Transformer)

K6CM-CICB005-C
K6CM-CICB005

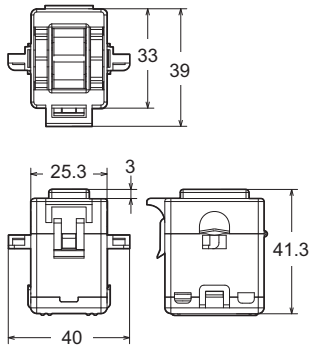

CT through-hole
inside diameters

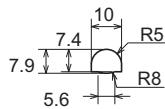

K6CM-CICB025-C
K6CM-CICB025

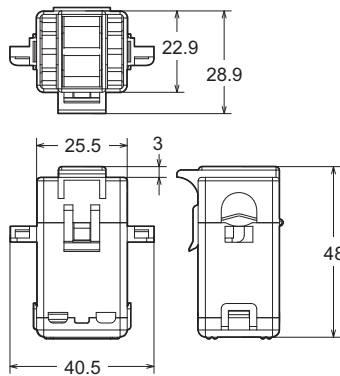

CT through-hole
inside diameters

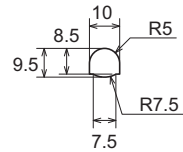

(Unit: mm)

K6CM-CICB100-C
K6CM-CICB100

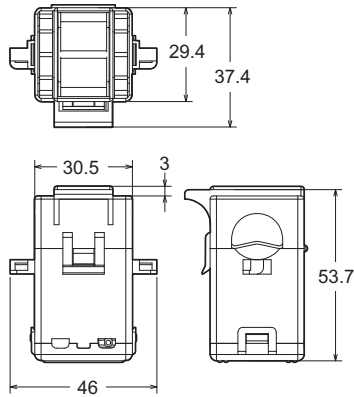

K6CM-CICB200-C
K6CM-CICB200

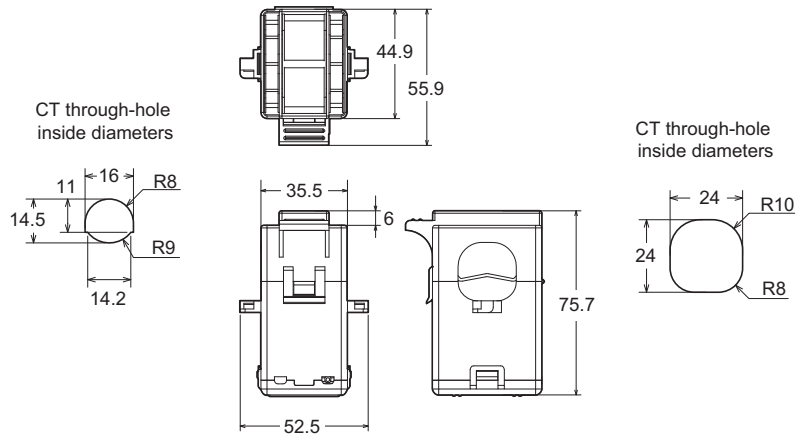

K6CM-CICB400-C
K6CM-CICB400
K6CM-CICB600

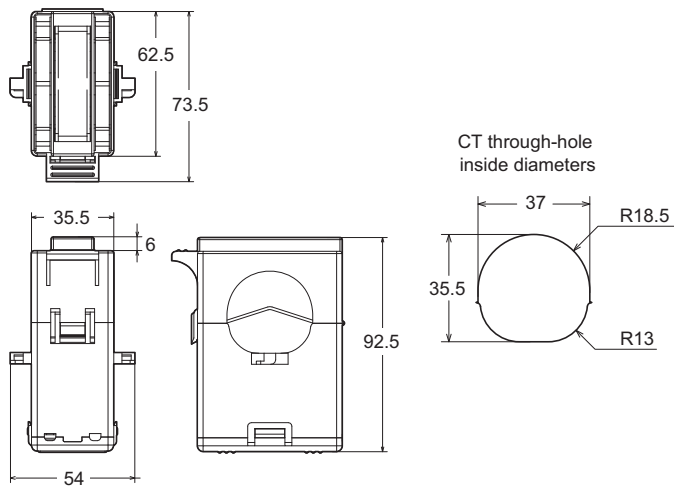

(Unit: mm)

CT-supplied cable

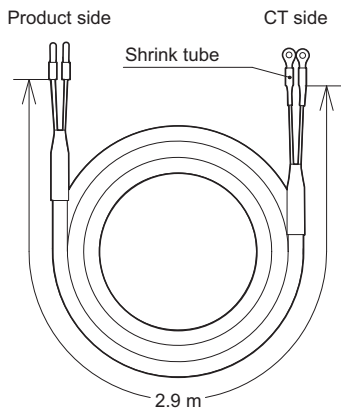

Note: The CT-supplied cable is attached to the CT.

- The "-C" at the end of the special CTs refer to the models compliant with UL certification. Models without "-C" can be used if UL certification is not required. The ratings and specifications are common to all of them.
- To comply with UL certification for the special CT, refer to *Conformance to Safety Standards* on page 10.

The CT input terminals can be connected in either direction of the special CT regardless of polarity.

3-2 Installation

Mounting to DIN Track

- Pull down the DIN Track mounting hook on the bottom of the K7TM.
- Next, hook the upper hook onto the DIN Track and push in the Unit.
- Finally, raise the DIN Track mounting hook that was pulled down and fix the Unit to the DIN Track.

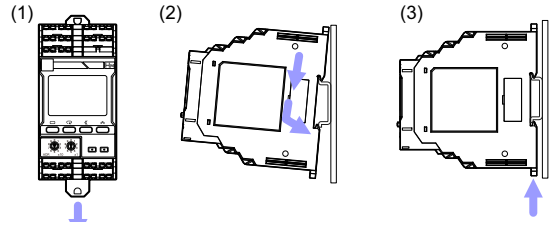

● Installation Orientation

Install and use the K7TM with upright installation direction.

Upright installation direction

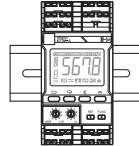

Installation of End Plates

- Install End Plates on the right and left sides of the K7TM.
Install an End Plate on each end of the K7TM.

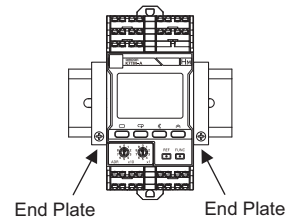

● Recommended DIN Track

Model	Specifications	Manufacturer
PFP-100N	1,000 mm long × 35 mm wide × 7.3 mm high	OMRON
PFP-50N	500 mm long × 35 mm wide × 7.3 mm high	OMRON

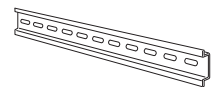

● Recommended End Plates

Model	Specifications	Manufacturer
PFP-M	For PFP-100N/PFP-50N	OMRON

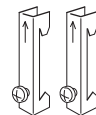

Removing from the DIN Track

- Pull out the DIN Track mounting hook with a flat-blade screwdriver and lift the Unit from the bottom to remove it.
- The K7TM can be easily installed and removed if the distance to other devices is 30 mm above.

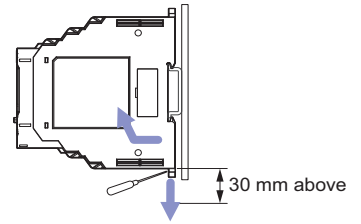

3-3 How to Connect to the Push-In Plus Terminal Blocks

Part Names

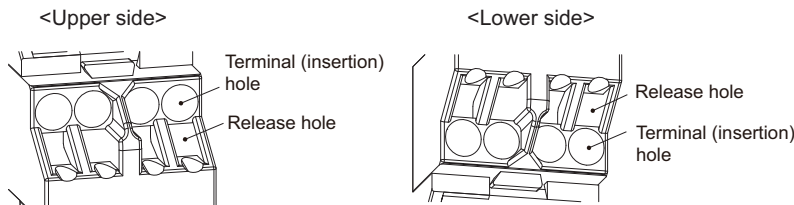

Name	Function
Terminal (insertion) hole	Used to insert wires with ferrules, solid wires, and stranded wires.
Release hole	Releases the wire when the specified flat-blade screwdriver is inserted. Also used when you insert stranded wires.

Connecting Wires with Ferrules and Solid Wires

Insert the ferrule or solid wire straight into the terminal block until the end touches the terminal block.

If you use a ferrule with a conductor length of 10 mm, part of the conductor may be visible after the ferrule is inserted into the terminal block, but the product insulation distance will still be satisfied.

If it is difficult to insert fine solid wires, insert the wire with a screwdriver inserted into the release hole, and then remove the screwdriver while ensuring that the fine solid wire is still held.

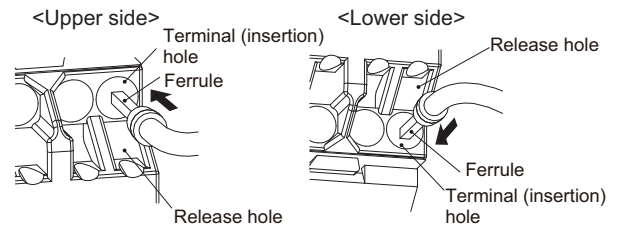

Connecting Stranded Wires

- Hold a flat-blade screwdriver at an angle and insert it into the release hole. The angle should be between 10° and 15°.

If the flat-blade screwdriver is inserted correctly, you will feel the spring in the release hole.



The terminal block may be damaged if you insert the screwdriver with excessive force. Operate the screwdriver with a force of 15 N or less.

- Insert the wire straight into the terminal block until the end touches the terminal block.
- Remove the flat-blade screwdriver from the release hole.

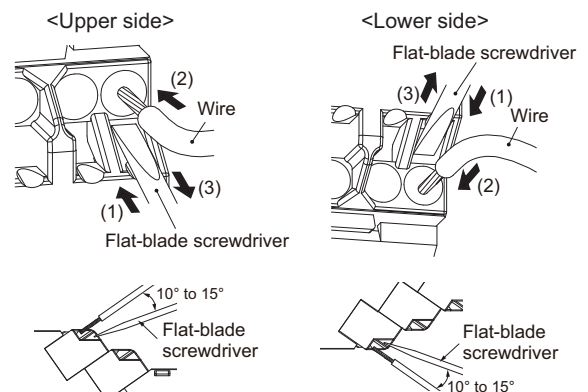

Checking Connections

After the insertion, pull gently on the wire to make sure that it will not come off and the wire is securely fastened to the terminal block.

When you use a stranded wire, make sure that the stranded wire does not bend or touch the adjacent terminal.

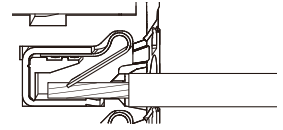

Removing Wires from the Push-In Plus Terminal Blocks

Use the following procedure to remove wires from the terminal block.

The same method is used to remove stranded wires, solid wires, and ferrules.

- Hold a flat-blade screwdriver at an angle and insert it into the release hole. The angle should be between 10° and 15°.

If the flat-blade screwdriver is inserted correctly, you will feel the spring in the release hole.

- Remove the wire.
- Remove the flat-blade screwdriver from the release hole.

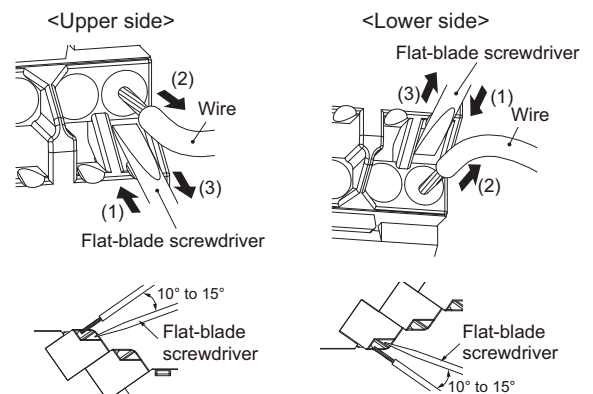

Push-In Plus Terminal Blocks Specifications

● Specifications

Item	Specifications
Construction	Push-in compatible with 1-pole 2-terminal crossover wiring Front-in and front-release Hands-free
Applicable wires	Ferrules, solid wires, and stranded wires
Applicable wire size	0.25 mm ² to 1.5 mm ² (AWG 24 to AWG 16)
Wire insertion force	8 N max. for AWG 20 wire
Screwdriver insertion force	15 N max.
Wire stripping length	8 mm*, 10 mm, or 12 mm
Ferrule length	8 mm or 10 mm
Current capacity	10 A (per pole)
Number of insertions	50 times

● Recommended Ferrules

Applicable wire		Ferrule, Conductor length (mm)	Stripping length (mm) (ferrules used)	Recommended ferrules		
(mm ²)	AWG			Manufactured by Phoenix Contact	Manufactured by Weidmuller	Manufactured by Wago
0.25	24	8	10	AI 0,25-8	H0.25/12	FE-0.25-8N-YE
		10	12	AI 0,25-10	-	-
0.34	22	8	10	AI 0,34-8	H0.34/12	FE-0.34-8N-TQ
		10	12	AI 0,34-10	-	-
0.5	20	8	10	AI 0,5-8	H0.5/14	FE-0.5-8N-WH
		10	12	AI 0,5-10	H0.5/16	FE-0.5-10N-WH
0.75	18	8	10	AI 0,75-8	H0.75/14	FE-0.75-8N-GY
		10	12	AI 0,75-10	H0.75/16	FE-0.75-10N-GY
1/1.25	18/17	8	10	AI 1-8	H1.0/14	FE-1.0-8N-RD
		10	12	AI 1-10	H1.0/16	FE-1.0-10N-RD
1.25/1.5	17/16	8	10	AI 1,5-8	H1.5/14	FE-1.5-8N-BK
		10	12	AI 1,5-10	H1.5/16	FE-1.5-10N-BK
Recommended crimp tool				CRIMPFOX6 CRIMPFOX6T-F CRIMPFOX10S	PZ6 roto	Variocrimp4

Note 1. Make sure that the outer diameter of the wire coating is smaller than the inner diameter of the insulation sleeve of the recommended ferrule.
 2. Make sure that the ferrule processing dimensions conform to the figure on the right.

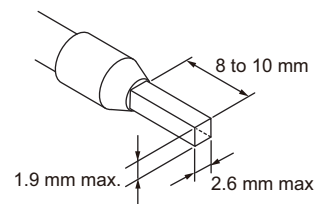

● Recommended Flat-blade Screwdrivers

Model	Manufacturer
ESD 0,40×2,5	Wera
SZS 0,4×2,5 SZF 0-0,4×2,5*	Phoenix Contact
0.4×2.5×75 302	Wiha
AEF.2,5×75	Facom
210-719	Wago
SDI 0.4×2.5×75	Weidmuller

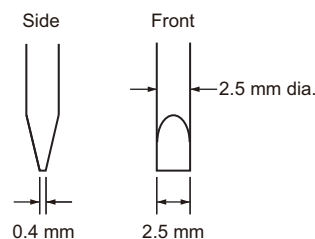

* You can purchase the SZF 0-0,4×2,5 flat-blade screwdriver made by PHOENIX CONTACT with OMRON model XW4Z-00B.

3-4 I/O Wiring

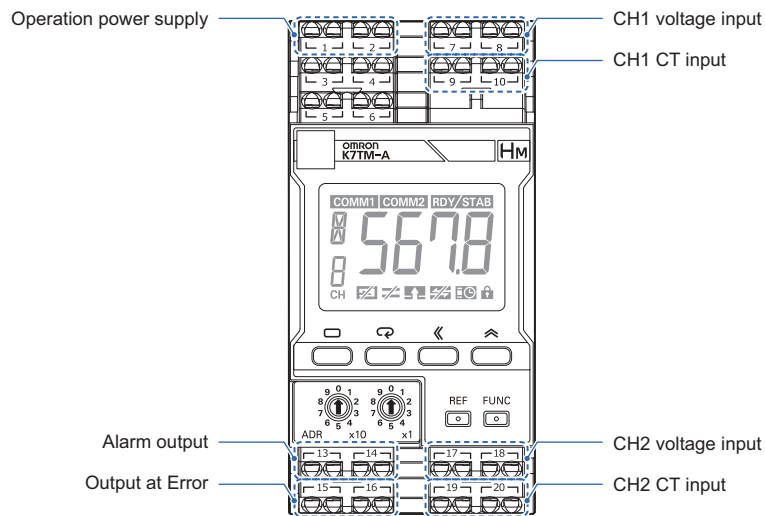

Operation Power Supply Terminals

The operation power supply terminals are the number 1 and 2 terminals. There is no polarity even in the 24 V DC specifications.

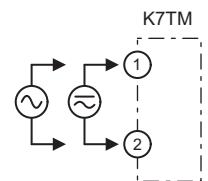

Voltage Input Terminals

There are two channels of voltage input terminals.

- CH1 voltage input: Number 7 and 8 terminals
- CH2 voltage input: Number 17 and 18 terminals

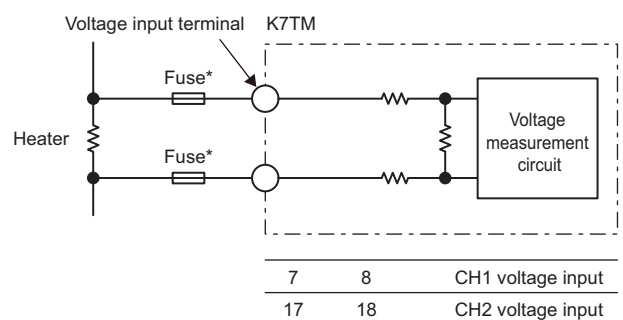

* The recommend external fuse is Class CC, Class J, or Class T with a rated current of 7 A or less.

CT Input Terminals

There are two channels of CT input terminals.

- CH1 CT input: Number 9 and 10 terminals
- CH2 CT input: Number 19 and 20 terminals

* Always use special CTs.
Refer to *Special CT (Current Transformer)* on page 3-2 for details.

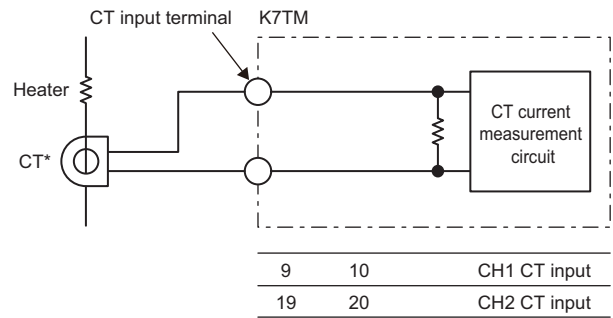

The CT input terminals can be connected in either direction of the special CT regardless of polarity.

Transistor Output Terminals

There are two transistor output terminals.

- Alarm output: Number 13 and 14 terminals
Output an alarm when a load error is detected.
- Output at Error: Number 15 and 16 terminals
Output an alarm when an error occurs in the K7TM.

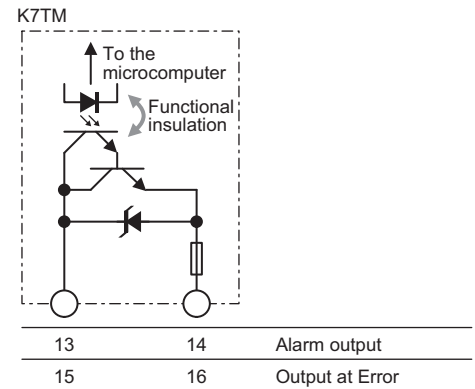

3-5 Connections of Heaters with External Devices

These are connection diagrams of heaters, which are measurement targets, and external devices, which are required for basic measurement operation.

For Single-Phase Heater (Independent)

- The voltage is input to the K7TM from both ends of a heater.
- The current is input to the K7TM via the CT that connects to the line through which the current of a heater runs.

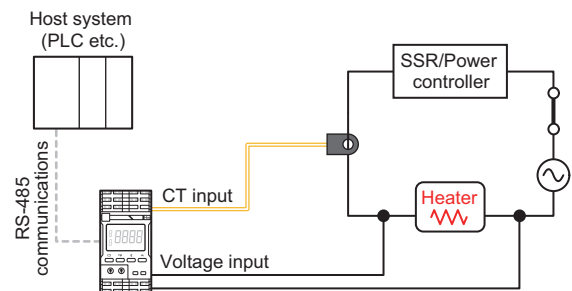

For Single-Phase Heaters (Multiple)

• Condition Monitoring for Each Heater

Connect a CT to each line through which the current of a single heater runs.

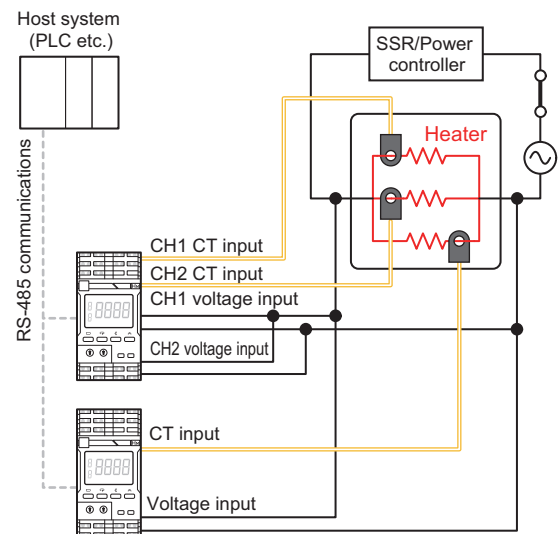

Precautions for Correct Use

- If it is not possible to clamp any CT to the wire through which the current of a single heater runs because the heaters are covered with an enclosure, the Unit cannot identify which heaters are deteriorating.
- The K7TM cannot be used if the wire through which the current of a single heater runs exceeds the operating temperature range (-20 to 60°C) of the special CT.

Example in which the Unit cannot be used:

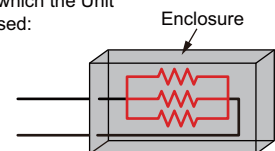

Example in which the Unit cannot be used:

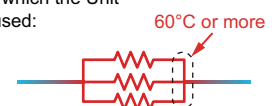

● **Condition Monitoring for Multiple Heaters Connected in Parallel**

Connect a CT to the resultant current line of multiple heaters. In this case, you can measure the resultant resistance of the heaters.

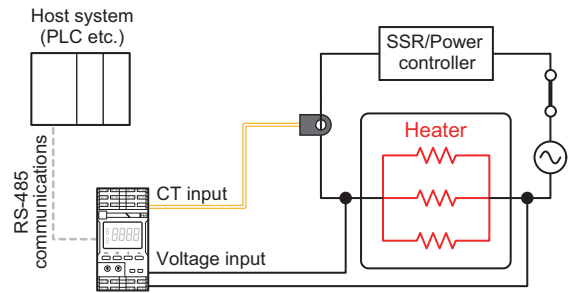

Precautions for Correct Use

When multiple heaters are connected in parallel, the K7TM cannot identify which heaters are deteriorating. If you need to identify the deteriorating heaters, attach a special CT for each heater to monitor their conditions.

For Three-Phase Heaters (Heaters Connected in Delta Form)

Connect the voltage inputs and current inputs of the K7TM to the places where the phase voltage and phase current of each heater can be measured.

The power supply for loads can be used in either form: star connection or delta connection.

If multiple heaters are connected in parallel to each phase, select a wiring pattern of the K7TM as described in Section 1.6.2.

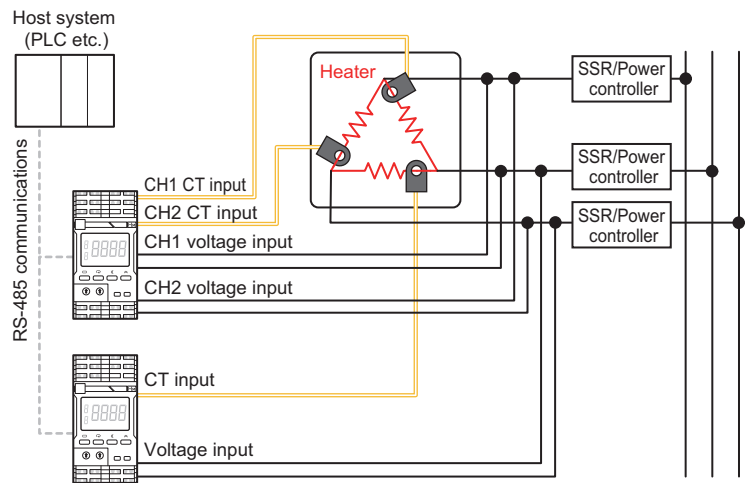

Precautions for Correct Use

- If it is not possible to clamp any CT to the wire through which the current of a single heater runs because the heaters are covered with an enclosure, the Unit cannot identify which heaters are deteriorating.
- The K7TM cannot be used if the wire through which the current of a single heater runs exceeds the operating temperature range (-20 to 60°C) of the special CT.

Example in which the Unit cannot be used:

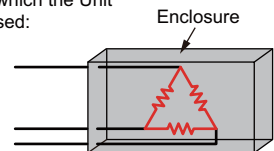

Example in which the Unit cannot be used:

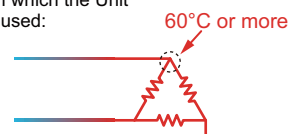

For Three-Phase Heaters (Heaters Connected in Star Form)

Connect the voltage inputs and current inputs of the K7TM to the places where the phase voltage and phase current of each heater can be measured.

The power supply can be used in either form: star connection or delta connection.

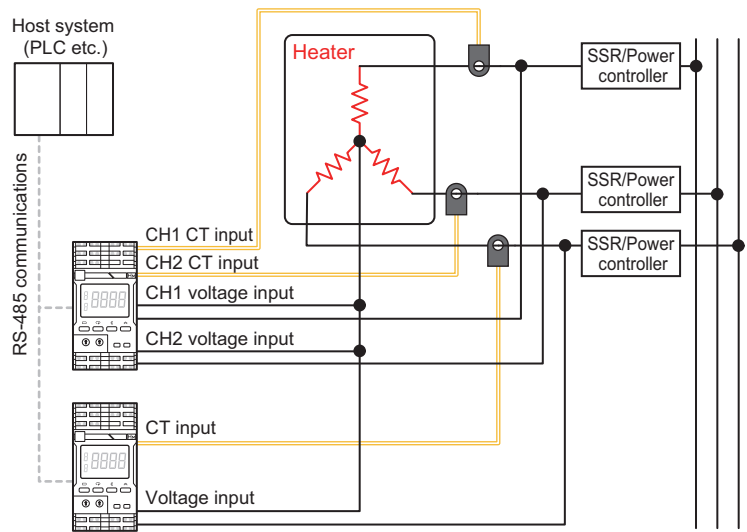

Precautions for Correct Use

The K7TM cannot be used for such equipment as prevents any voltage terminal from being connected to the neutral point of three-phase heaters because the heaters are covered with an enclosure.

Example in which the Unit cannot be used:

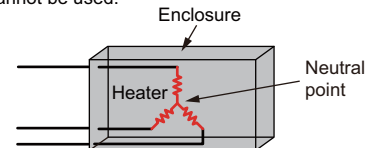

3-6 Wiring the Communications Cables

When you use the communications function, wire communications cables.

The K7TM has two lines of communications ports:
communications 1 terminals (for host system) and
communications 2 terminals (for K7TM Configuration Tool or IoT gateway). Install wiring according to your system configuration.

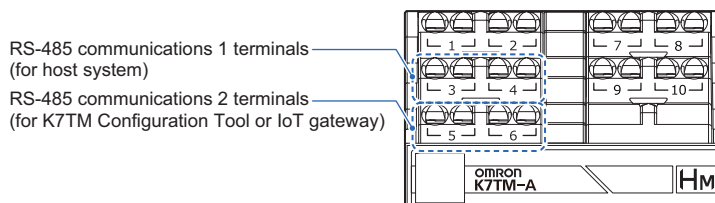

● Connection with Host System

For communications between the PLC or other host system and the K7TM, use the number 3 and 4 (communications 1 terminals) of the Push-In Plus terminal block.

Connect (+) to the number 3 terminal and (-) to the number 4 terminal on the K7TM.

Crossover wiring is available as this is a Push-In Plus terminal block.

The connection configuration of Master:Slave is 1:1 or 1:N.

In the case of the 1:N connection configuration, you can connect up to 32 Units including the host system that is the master.

The total cable length is 500 m max.*

* If the maximum baud rate is 230.4 kbps, it is 200 m max.

Install a terminating resistance of 120 Ω, 1/2 W on both ends of the transmission path of RS-485 including the host system.

Use twisted-pair cables (AWG 24 to AWG 16).

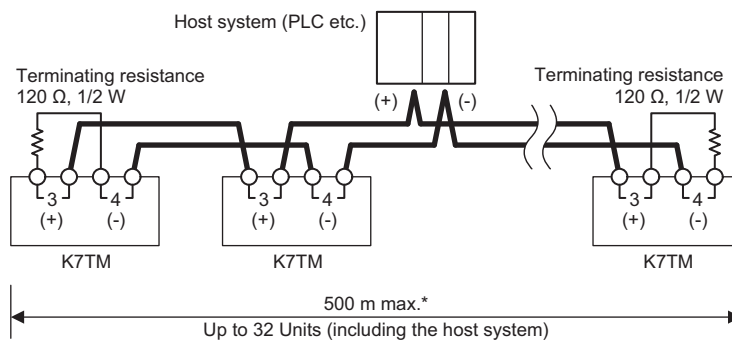

● Connection with K7TM Configuration Tool

Whether the stabilization discrimination method is *Power* or *Temperature*, the cables are used for making an initial setting of the K7TM with the K7TM Configuration Tool.

Use the number 5 and 6 (communications 2 terminals) of the Push-In Plus terminal block.

Connect (+) to the number 5 terminal and (-) to the number 6 terminal on the K7TM.

Crossover wiring is available as this is a Push-In Plus terminal block.

The connection configuration of Master:Slave is 1:1 or 1:N. In the case of the 1:N connection configuration, you can connect up to 32 Units including the host system that is the master.

The total cable length is 500 m max.*

* If the maximum baud rate is 230.4 kbps, it is 200 m max.

Install a terminating resistance of 120 Ω , 1/2 W on both ends of the transmission path of RS-485 including the communications converter.

Use twisted-pair cables (AWG 24 to AWG 16).

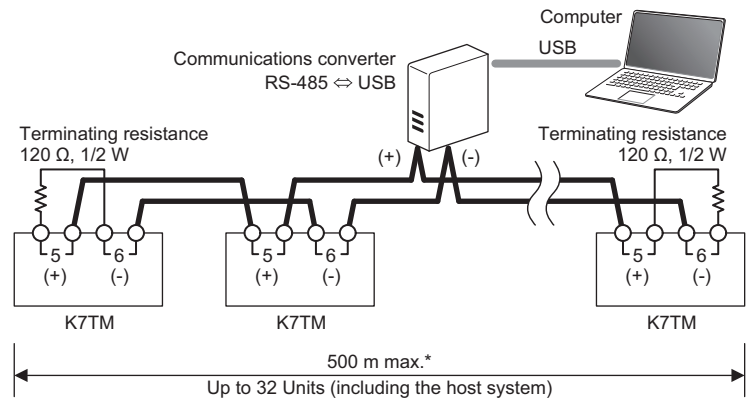

3-7 Setting the Unit Number

When you use the communications function, set a unit number for the K7TM.

You can set a number from 01 to 99.

Make the setting when the power is OFF. The setting will be reflected after you cycle the power supply. The unit number is common to both the communications 1 terminals and communications 2 terminals.

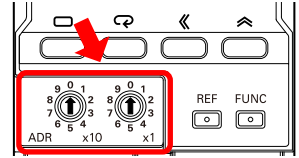

Up to one master host system and 31 slave K7TM Units can be connected on the same communications line. The unit number is used to distinguish between slaves.



Use 01 to 99 as the unit number. Slave address 00 will be broadcast in the Modbus RTU protocol.

The master executes a command by specifying the unit number in the communications command. Therefore, the slaves connected on the same communications line must not have duplicate unit numbers.

If the unit number is duplicated, there will be a clash between the responses from multiple slaves, which will result in a communications error.

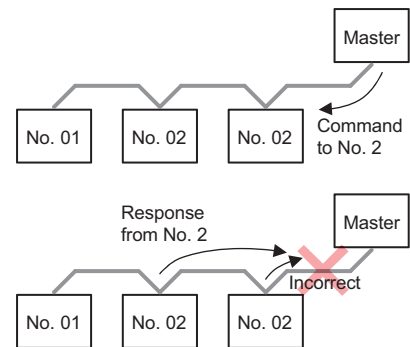

4

Function

This section describes the function list, stabilization discrimination methods, alarm functions, and measurement-related functions of the K7TM.

4-1	Functions	4-2
4-2	Measurement Values	4-4
4-3	Measuring Changes over the Years in Heater	4-6
4-3-1	Measurement Principles	4-6
4-3-2	Function to Detect Heater Deterioration	4-6
4-3-3	Measurement Operation of K7TM	4-7
4-3-4	Measurement Operation of K7TM in Operation	4-8
4-3-5	Conditions for Moving from Waiting for Stabilization to Stabilized	4-9
4-3-6	Conditions for Moving from Stabilized to Waiting for Stabilization	4-11
4-3-7	Timing Charts	4-13
4-4	Alarm	4-18
4-4-1	Types of Alarm Notification Methods	4-18
4-4-2	Polarity of Transistor Output When Alarm Occurs	4-19
4-4-3	Releasing the Alarm Latch	4-20
4-4-4	Heater Deterioration Alarm	4-20
4-4-5	Last Resistance Value Change Rate Alarm	4-21
4-4-6	Heater Burnout Alarm	4-24
4-5	Measurement Error	4-26
4-5-1	Types of Notification of Measurement Errors	4-27
4-5-2	Actions for Measurement Errors	4-27
4-6	Logging Function	4-30
4-6-1	Function and Application	4-30
4-7	Running Time	4-32
4-8	Self-diagnosis Error	4-33

4-1 Functions

The main functions of the K7TM are given in the following table.

Function name	Description	Reference		
Measurement Value Monitoring	Current Value	The current effective value [A] of a heater is displayed.	4-2 <i>Measurement Values</i>	
	Voltage Value	The voltage effective value [V] of a heater is displayed.		
	Resistance Value	The resistance value [Ω] of a heater is displayed.		
	Reference Resistance Value Change Rate	A change rate [%] of Reference Resistance Value is displayed.		
	Last Resistance Value Change Rate	This is a rate of change between present resistance values (with moving average processing*1) and past resistance values (with moving average processing*1). The value can only be checked via communications. *1: The moving average count is 10 times by default.		
	Power	The apparent power [kVA] of a heater is displayed.		
Heater Change-Over-the-Years Measurement	Stabilization Discrimination Method (Power)	This is a method in which to judge whether a heater is deteriorated while canceling the influence of temperature characteristics of the heater by means of the power calculated by the K7TM.	4-3 <i>Measuring Changes over the Years in Heater</i>	
	Stabilization Discrimination Method (Temperature)	This is a method in which to judge whether a heater is deteriorated while canceling the influence of temperature characteristics of the heater on the basis of the heater temperature data that the K7TM received from the host system.		
Alarm	Heater Deterioration Alarm	This is an alarm that detects heater deterioration. The alarm will turn ON if the reference resistance value change rate exceeds the alarm value. Two levels of alarm values can be set.	4-4 <i>Alarm</i>	
	Last Resistance Value Change Rate Alarm	This is an alarm that detects a rapid increase in the resistance value.		
	Heater Burnout Alarm	This is an alarm that detects heater burnout.		
	Alarm Polarity	This is a function to reverse an alarm output.		4-4-2 <i>Polarity of Transistor Output When Alarm Occurs</i>
	Alarm Output Level	This is a function to set a level at which an alarm is output. You can select a warning level or a critical level for the level at which an alarm is output.		

Function name		Description	Reference
Measurement Error	Resistance Value Out-of-Range Error	This is a function to notify you that the resistance value has exceeded the display range.	4-5 <i>Measurement Error</i>
	Voltage Value Out-of-Range Error	This is a function to notify you that the voltage value has exceeded the display range.	
	Current Value Out-of-Range Error	This is a function to notify you that the current value has exceeded the display range.	
	Temperature Data Not-refreshed Error	This is a function to notify you that temperature data is no longer written from the host system.	
	Not-stabilized Error	This is a function to notify you that the stabilized state was not brought about for a certain period of time or longer.	
	A/D Error	This is a function to notify you that an error has occurred in the A/D converter inside the K7TM.	
Logging	Log Data	This is a function to keep a log of the past 30 measurement values.	4-6 <i>Logging Function</i>
Running Time	---	This is a function to inform you of when to replace the K7TM.	4-7 <i>Running Time</i>
Self-diagnosis Error	---	This is an error that causes the K7TM to be unable to perform the functions that it was primarily meant to perform. The output is shared with measurement errors.	4-8 <i>Self-diagnosis Error</i>
Communications	Monitoring	Reads monitored values such as measurement values.	Section 6 <i>Remote Monitoring</i>
	Setting	Can read or write setting values such as alarm values.	
	Status	Displays the status.	
	Operation Command	Executes operation commands with key operations.	

4-2 Measurement Values

In order to determine how a heater is deteriorated, the K7TM calculates the resistance value of the heater as a measurement value.

The voltage value and current value that are measured in that process can also be checked as measurement values.

The measurement values that the K7TM handles are given in the following table.

Measurement value	Description	Monitoring range
Reference Resistance Value Change Rate	<p>The resistance value change rate is calculated on the basis of the <i>Reference Resistance Value</i>. It is refreshed for each <i>Measurement Value Calculation Cycle</i>.</p> $\text{Reference Resistance Value Change Rate} = \frac{\text{Resistance Value} - \text{Reference Resistance Value}}{\text{Reference Resistance Value}} \times 100-100 (\%)$ <p>This is a measurement value by which to determine a heater deterioration alarm.</p>	-100.0% to 999.9%
Resistance Value	<p>This is a resistance value of the heater. It is refreshed for each <i>Measurement Value Calculation Cycle</i>. Moving average processing is applied according to the setting of <i>Resistance Value Moving Average Count</i> before refreshment.</p>	0.000 to 9.999 Ω 10.00 to 99.99 Ω 100.0 to 999.9 Ω
Voltage Value	<p>This is a voltage value applied to the heater. It is refreshed for each <i>Measurement Value Calculation Cycle</i>. This is a measurement value by which to determine a heater burnout alarm.</p>	120 [V] range, 0.0 to 132.0 240 [V] range, 0.0 to 264.0 480 [V] range, 0.0 to 528.0 600 [V] range, 0.0 to 660.0
Current Value	<p>This is a current value applied to the heater. It is refreshed for each <i>Measurement Value Calculation Cycle</i>. This is a measurement value by which to determine a heater burnout alarm.</p>	5 [A] range, 0.00 to 5.50 25 [A] range, 0.0 to 27.5 100 [A] range, 0.0 to 110.0 200 [A] range, 0.0 to 220.0 400 [A] range, 0.0 to 440.0 600 [A] range, 0.0 to 650.0
Last Resistance Value Change Rate (Communications only)	<p>This is a resistance value change rate based on the resistance value before <i>Resistance Value Moving Average Count</i> × <i>Measurement Value Calculation Cycle</i>. The value can only be checked via communications. It is refreshed for each <i>Measurement Value Calculation Cycle</i>. This is a measurement value by which to determine a last resistance value change rate alarm.</p>	-100.0% to 200.0%
Power	<p>This is an apparent power of the heater. It is refreshed for each <i>Measurement Value Calculation Cycle</i>. Moving average processing is applied according to the setting of <i>Power Moving Average Count</i> before refreshment. This measurement value is used for determining stabilization in the stabilization discrimination method (power).</p>	0.0 to 429.0 kVA

Measurement value	Description	Monitoring range
Temperature	This is a temperature used as a reference for checking the heater for stability. It is refreshed by the value written from the host system to the K7TM. It is used when you select <i>Temperature</i> for the <i>Stabilization Discrimination Method</i> on the Initial Setting Level.	-1,999 to 9,999°C/°F

These measurement values are parameters of the operation level. Refer to 5-1 *Levels* on page 5-2 for details.



The measurement values to be displayed on the operation level can be scrolled automatically at intervals of 5 seconds. Refer to 5-3-3 *Measurement Value Display Automatic Scroll* on page 5-9 for details.

4-3 Measuring Changes over the Years in Heater

4-3-1 Measurement Principles

As a heater deteriorates more, the resistance value of the heater gradually becomes larger.

If only these changes in the resistance value due to deterioration can be measured, a change over the years in the heater can be detected. However, the resistance value is changed mainly by two factors.

- (1) Changes in the resistance value due to a temperature rise in the heater itself
- (2) Changes over the years in the resistance value that gradually becomes larger as the heating element becomes more oxidized because the heater repeats heat generation

The Unit cannot judge whether the change is due to a temperature rise or a change over the years, merely by always measuring the resistance value only.

To make a judgment, the Unit needs to monitor the resistance values during the time when there are no changes in the resistance value due to a temperature rise; if the Unit can do this, it will be able to monitor the trends toward deterioration due to changes over the years.

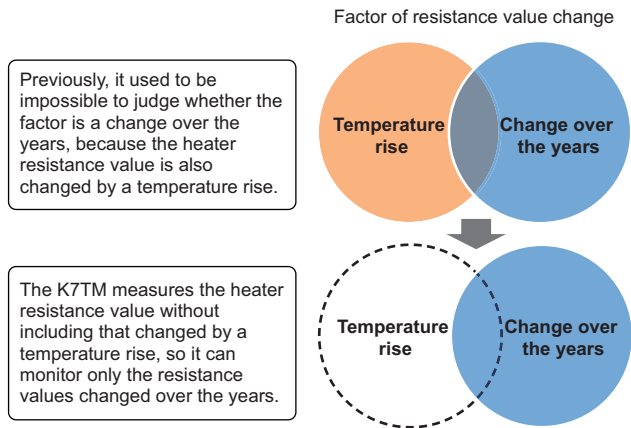

4-3-2 Function to Detect Heater Deterioration

The K7TM uses the following method to detect heater deterioration. Refer to 4-3-1 *Measurement Principles* on page 4-6 for details.

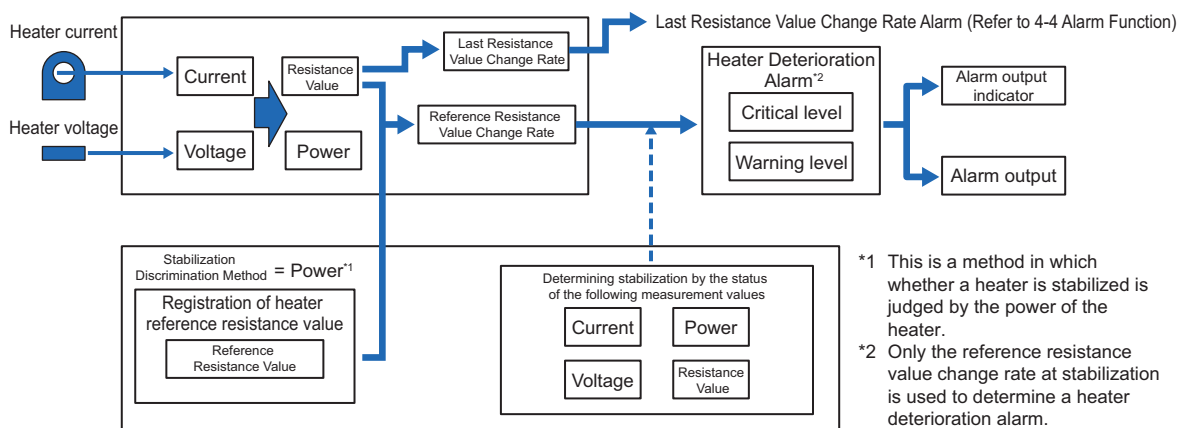

- The K7TM computes the resistance value and power of a heater from the heater current and voltage, and calculates the last resistance value change rate and the reference resistance value change rate.
- A heater deterioration alarm is output on the basis of the reference resistance value change rate. There are two levels: warning level and critical level.
- The Last Resistance Value Change Rate Alarm is output on the basis of the last resistance value change rate.

4-3-3 Measurement Operation of K7TM

The time when there are no changes in the resistance value due to a temperature rise refers to the state in which the heater temperature is stable in a certain temperature zone.

In the K7TM, the heater resistance value at this stably operating time is set automatically as a reference resistance value; from this point on, monitoring starts at the stably operating time.

The stably operating state is called **Stabilized**; during this time, resistance values are compared with the reference resistance value, and only the resistance changes (reference resistance value change rates) due to changes over the years are to be measured.

The K7TM has an algorithm that judges whether heater temperature is in the stabilized state by the power running down the heater.

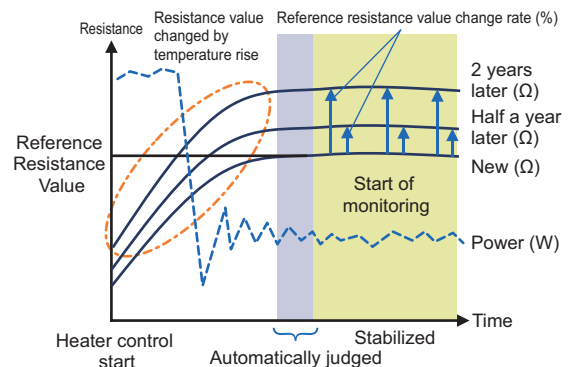

K7TM Alone Determining Stable Operation (Stabilization Discrimination Method = Power)

This is a method in which to judge when to make measurements while determining that a heater is operating stably by means of the power information calculated on the basis of the actually measured current and voltage.

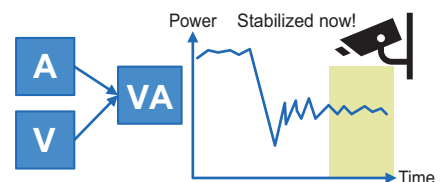

Acquiring Temperature Information outside the K7TM (Stabilization Discrimination Method = Temperature)

Temperature information is acquired via PLC of the equipment that controls the temperature of a target heater. This is a method in which to judge when to make measurements while determining that the heater is operating stably by means of this temperature information.

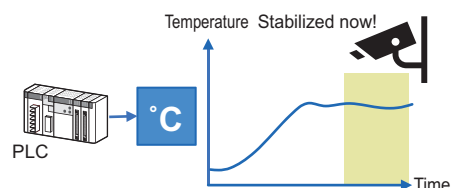

In such a device as its heater and temperature sensor are in a short distance, that temperature can be used, as a heater temperature, directly for determining stabilization.

4-3-4 Measurement Operation of K7TM in Operation

This section describes the measurement operation of the K7TM.

Timing of Power ON

There is no limitation on when to turn ON the K7TM and when to turn ON a heater.

- If only the K7TM is ON, the **IN** Indicator will light, showing that voltage and current are not input.
- When the heater is turned ON, the **IN** Indicator will not light.
- If, although both the heater and the K7TM are ON, the **IN** Indicator is lit, check whether the voltage input lines, CT, and K7TM are connected correctly or whether the CT is clamped correctly.

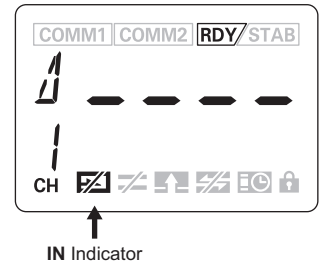

Start of Heater Control and Timing of Heater Deterioration Alarm

While temperature is rising to the set point after a heater starts to be controlled, the K7TM is in the waiting for stabilization state without determining a heater deterioration alarm.

Only when the heater temperature (power) is in the stabilized state, the Unit determines an alarm on the basis of the resistance change rate.

As is described above, the K7TM in operation has only two steps: Waiting for stabilization and Stabilized. The **STAB** Indicator is lit in the stabilized step.

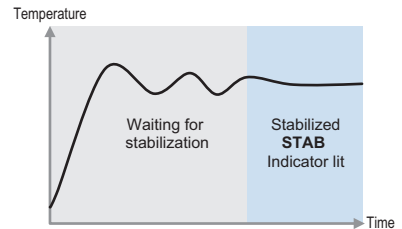

	Waiting for stabilization	Stabilized
STAB Indicator	Not lit	Lit
Heater Deterioration Alarm	Not to be determined	To be determined

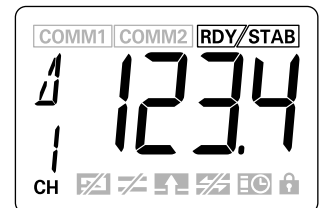

Operation State

The state in which the stabilized **STAB** Indicator is lit is an operation state in which heater deterioration alarms are ready to be determined.

You are notified of warning and critical on the basis of the thresholds set in the heater deterioration alarms.

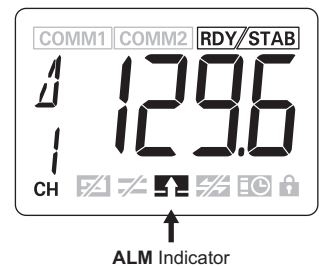

4-3-5 Conditions for Moving from Waiting for Stabilization to Stabilized

To move from *Waiting for stabilization* to *Stabilized*, all of the following four conditions must be satisfied. The description is an example case where the resistance value moving average count is Low (10 times), power moving average count is Low (10 times), and measurement value calculation cycle is 100 seconds.

- The condition 1 has two stabilization discrimination methods: temperature and power.
- This is based on the premise that no measurement error has occurred.

Condition 1: Power or Temperature Is Stabilized

● Case of Stabilization Discrimination Method = Power

- Power Moving Average Count > Resistance Value Moving Average Count

The condition will be satisfied when the power goes into the power stabilization range continuously as many times as the power moving average count.

- Power Moving Average Count < Resistance Value Moving Average Count

The condition will be satisfied when the power goes into the power stabilization range continuously as many times as the resistance value moving average count.

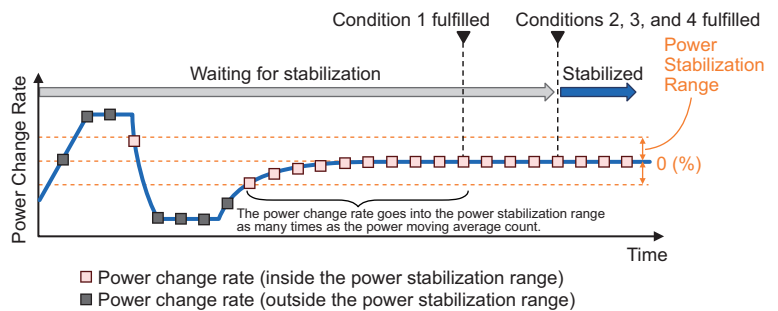

● Case of Stabilization Discrimination Method = Temperature

The condition will be satisfied when the temperature is inside the temperature stabilization range for a period of **Resistance Value Moving Average Count × Measurement Value Calculation Cycle**.

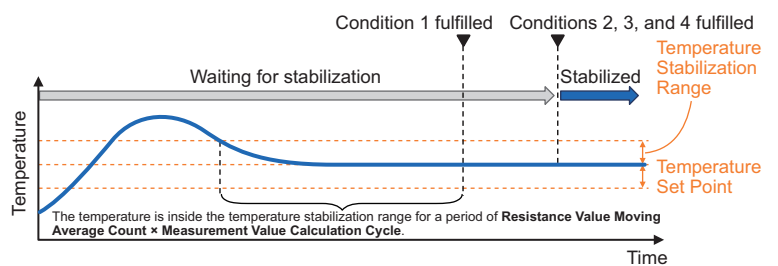

Condition 2: Resistance Value Is Stabilized

● Case of Stabilization Discrimination Method = Power

- Power Moving Average Count > Resistance Value Moving Average Count

The condition will be satisfied when the resistance value change rate from normal fluctuation deviation reference*1 goes into the normal fluctuation deviation continuously as many times as the power moving average count.

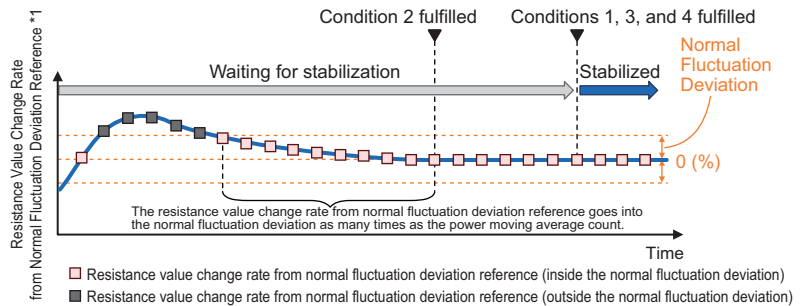

- Power Moving Average Count < Resistance Value Moving Average Count

The condition will be satisfied when the resistance value change rate from normal fluctuation deviation reference*1 goes into the normal fluctuation deviation continuously as many times as the resistance value moving average count.

● Case of Stabilization Discrimination Method = Temperature

The condition will be satisfied when the resistance value change rate from normal fluctuation deviation reference*1 goes into the normal fluctuation deviation continuously as many times as the resistance value moving average count.

- *1. Formula for resistance value change rate from normal fluctuation deviation reference

$$\frac{\text{Resistance Value}}{\text{Normal Fluctuation Deviation Reference}} \times 100 - 100 (\%)$$

Condition 3: Voltage Value Is Not Less than a Certain Value

The condition will be satisfied when the voltage value becomes not less than the measurement voltage lower limit value.

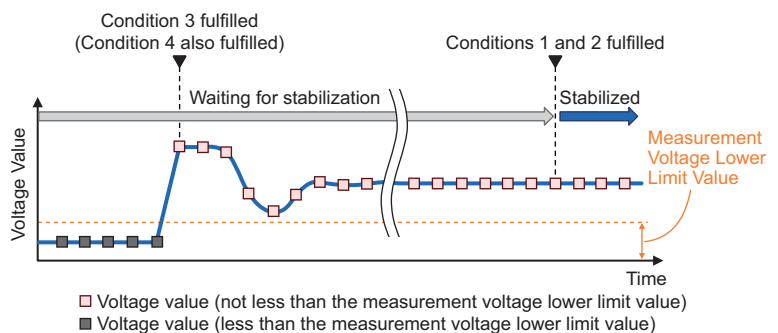

Condition 4: Current Value Is Not Less than a Certain Value

The condition will be satisfied when the current value becomes not less than the measurement current lower limit value.

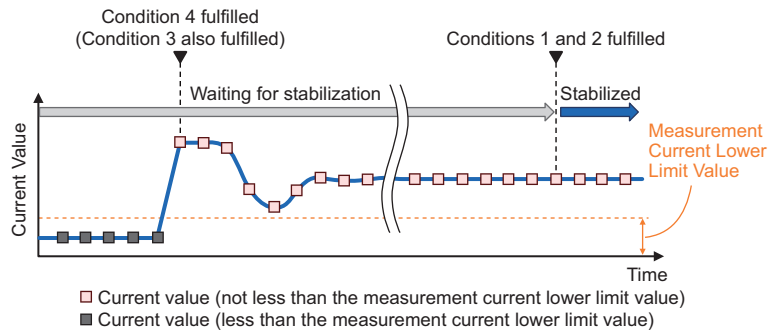

4-3-6 Conditions for Moving from Stabilized to Waiting for Stabilization

If any one of the following conditions 1 to 4 is fulfilled, the Unit will move to the waiting for stabilization state.

Also, if a measurement error occurs, the Unit will move to the waiting for stabilization state.

Condition 1: Power or Temperature Is No Longer Stabilized

● Case of Stabilization Discrimination Method = Power

The condition will be satisfied when the power change rate goes out of the power stabilization range.

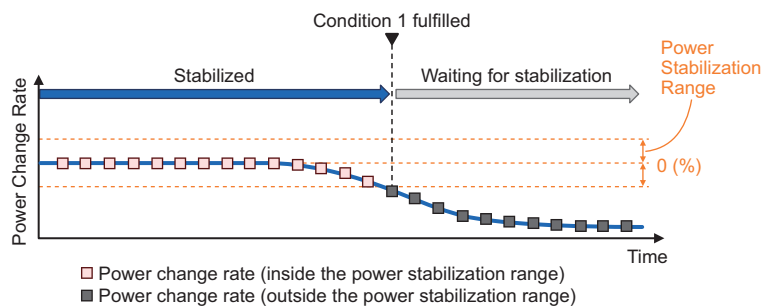

● Case of Stabilization Discrimination Method = Temperature

The condition will be satisfied when the temperature goes out of the temperature stabilization range.

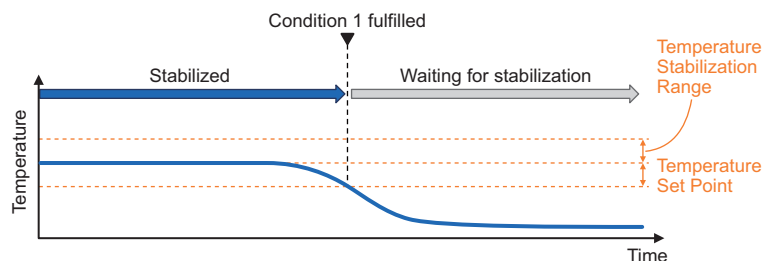

Condition 2: Resistance Value Is No Longer Stabilized

The condition will be satisfied when the resistance value change rate from normal fluctuation deviation reference goes out of the normal fluctuation deviation.

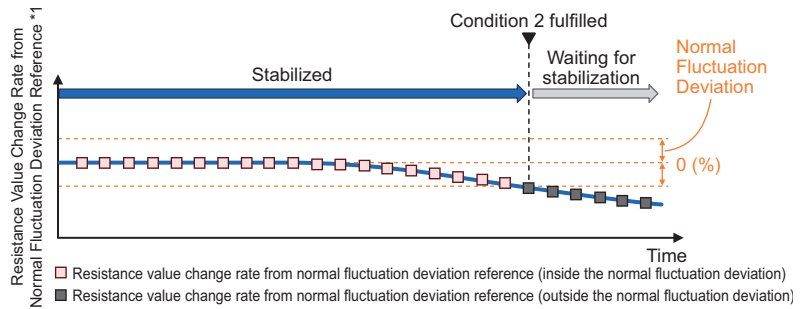

*1. Formula for resistance value change rate from normal fluctuation deviation reference

$$\frac{\text{Resistance Value}}{\text{Normal Fluctuation Deviation Reference}} \times 100 - 100 (\%)$$

Condition 3: Voltage Value Is Less than a Certain Value

The condition will be satisfied when the voltage value becomes less than the measurement voltage lower limit value.

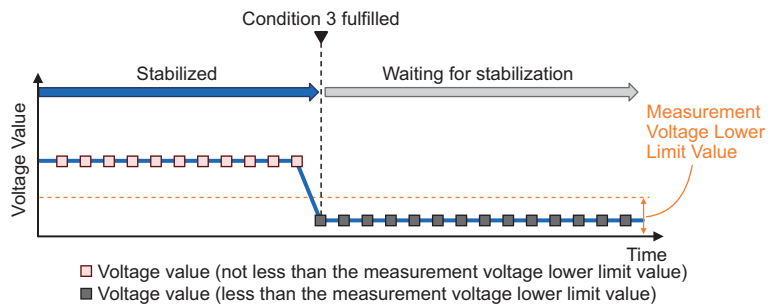

Condition 4: Current Value Is Less than a Certain Value

The condition will be satisfied when the current value becomes less than the measurement current lower limit value.

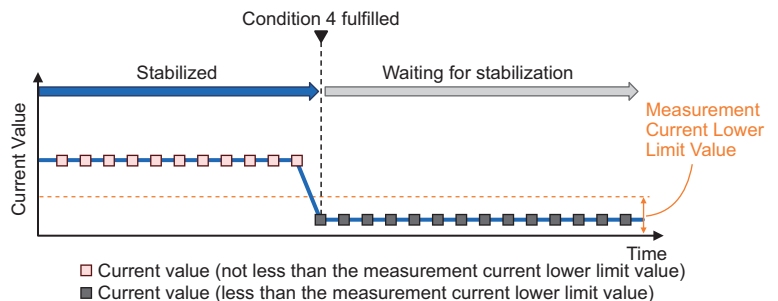

4-3-7 Timing Charts

This section describes the operation of the K7TM after initial settings, i.e., registration of the reference resistance value (RDY Indicator lit).

Timing charts are used to describes the K7TM operation from power ON to heater control stop.

First, a timing chart for stabilization discrimination method = power is used for description, and then a timing chart for stabilization discrimination method = temperature is used for description.

Timing Chart for Stabilization Discrimination Method = Power

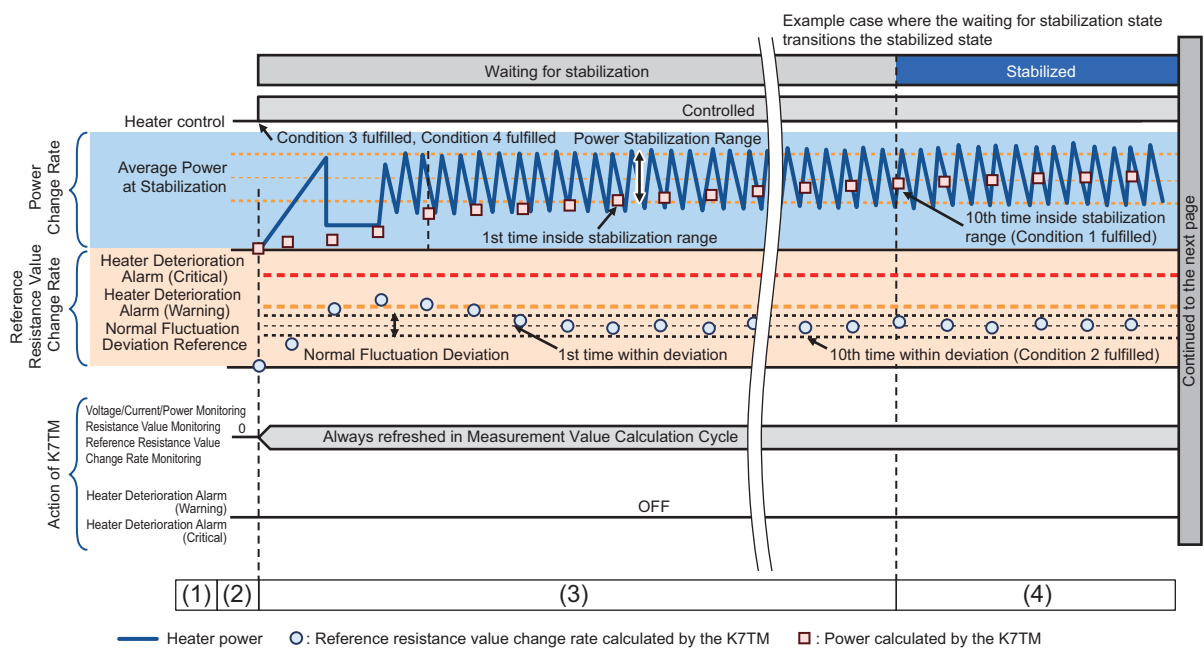

● Description

(1) Power ON

In the K7TM, if the K7TM is ON but a heater is OFF, the **IN** Indicator will light to show that voltage and current are not input, and “- - - -” is displayed on the main display.

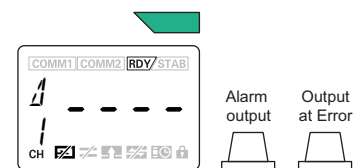

(2) Heater control start

When the heater starts to be controlled and electricity runs down the heater, the voltage and current will be measured for the K7TM, and the **IN** Indicator will not light.

The value of reference resistance value change rate is displayed on the main display.

The condition 3 and condition 4 required for the stabilized state are fulfilled at this point.

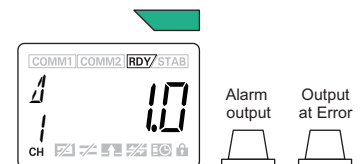

(3) Waiting for stabilization

The K7TM makes the transition to the waiting for stabilization step until the heater control is stabilized. No deterioration alarm is ready to be determined until conditions for the transition from the waiting for stabilization to the stabilized step are satisfied.

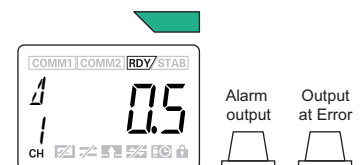

(4) Stabilized

When conditions for the transition to the stabilized step are satisfied, **STAB** Indicator showing the stabilized state will light. A deterioration alarm is determined on the basis of the calculated resistance value.

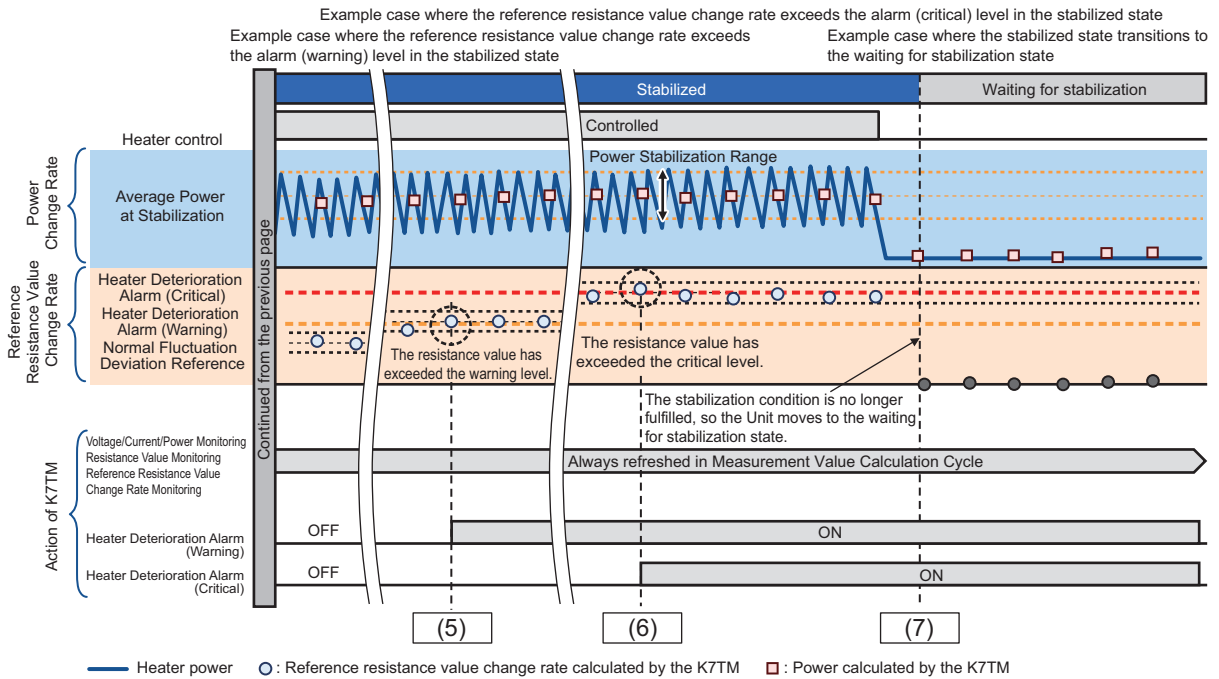
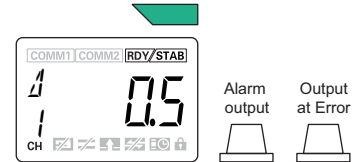

● Description

(5) Deterioration alarm (warning)

If the resistance value measured in stabilized state exceeds a deterioration alarm (warning) level (default value: 3%), the following parts will react.

- The alarm output indicator is lit in yellow.
- **ALM** Indicator is lit.

The alarm output level is *Critical* by default. If the setting is *Warning or Critical*, the alarm output will be set to ON (transistor output ON to OFF*1).

*1. When the default alarm polarity is *Normally close*

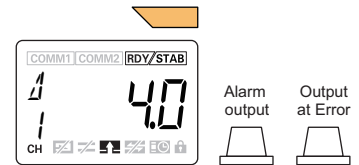

(6) Deterioration alarm (critical)

If the resistance value measured in stabilized state exceeds a deterioration alarm (critical) level (default value: 5%), the following parts will react.

- The alarm output indicator is lit in red.
- The alarm output is ON (transistor output OFF).

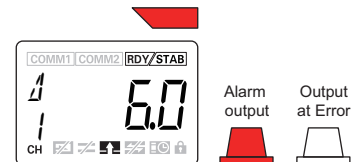

(7) Heater control stop

When the heater is turned OFF, the voltage and current fall short of the measurement voltage lower limit value or the measurement current lower limit value set in the K7TM, so it returns to the waiting for stabilization step because conditions for moving from the stabilized to the waiting for stabilization state are satisfied.

The **IN** Indicator will light to show that voltage and current are not input.

The alarm becomes latched, so the following states are maintained.

- The alarm output indicator is lit in red.
- **ALM** Indicator is lit.
- The alarm output is ON (transistor output OFF).

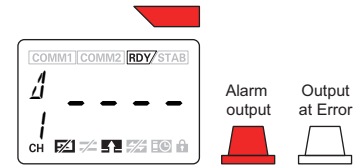

Refer to 4-4-3 Releasing the Alarm Latch on page 4-20 for releasing the latch.

Timing Chart for Stabilization Discrimination Method = Temperature

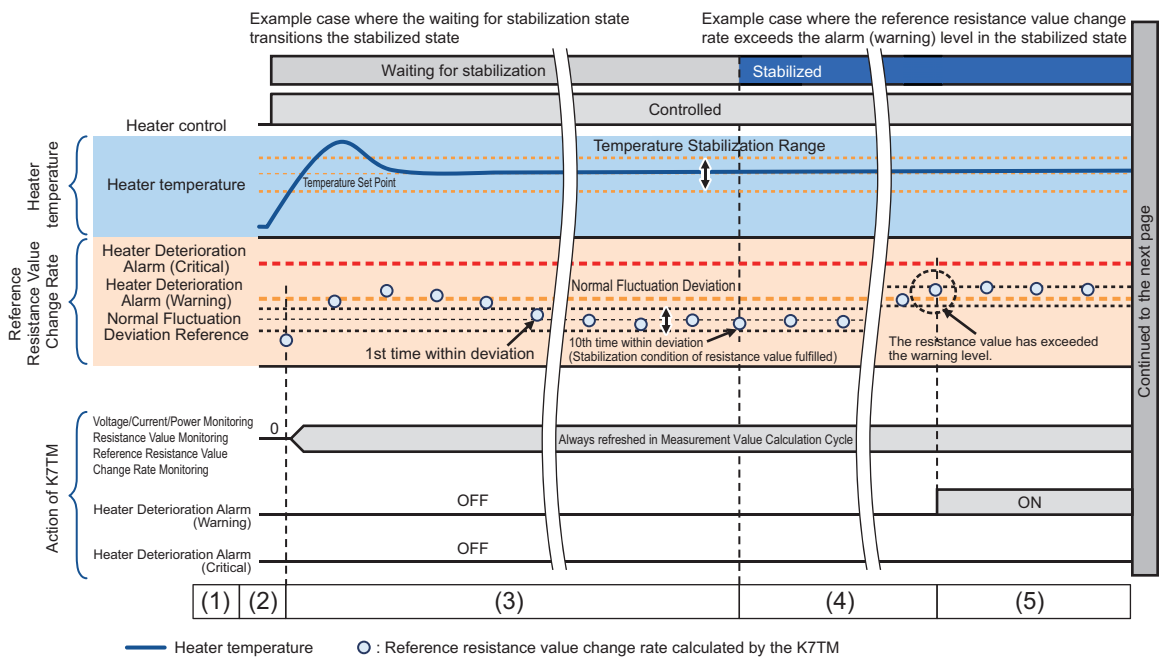

● Description

(1) Power ON

In the K7TM, if the K7TM is ON but a heater is OFF, the **IN** Indicator will light to show that voltage and current are not input.

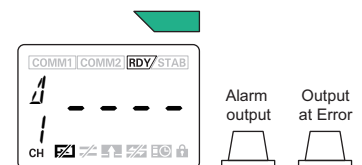

(2) Heater control start

When the heater starts to be controlled and electricity runs down the heater, the voltage and current will be measured for the K7TM, and the **IN** Indicator will not light.

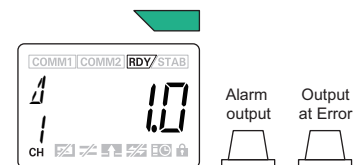

(3) Waiting for stabilization

The K7TM makes the transition to the waiting for stabilization step until the heater control is stabilized.
No deterioration alarm is ready to be determined until conditions for the transition from the waiting for stabilization to the stabilized step are satisfied.

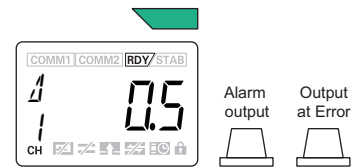

(4) Stabilized

When conditions for the transition to the stabilized step are satisfied, **STAB** Indicator showing the stabilized state will light. A heater deterioration alarm is determined on the basis of the calculated reference resistance value change rate.

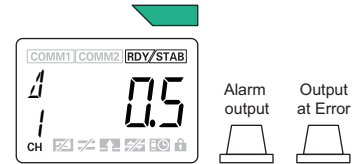

(5) Deterioration alarm (warning)

If the resistance value measured in stabilized state exceeds a deterioration alarm (warning) level (default value: 3%), the following parts will react.

- The alarm output indicator is lit in yellow.

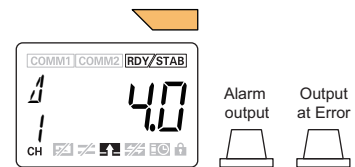

The alarm output level is *Critical* by default. If the setting is *Warning or Critical*, the alarm output will be set to ON (transistor output ON to OFF*1).

*1. When the default alarm polarity is *Normally close*

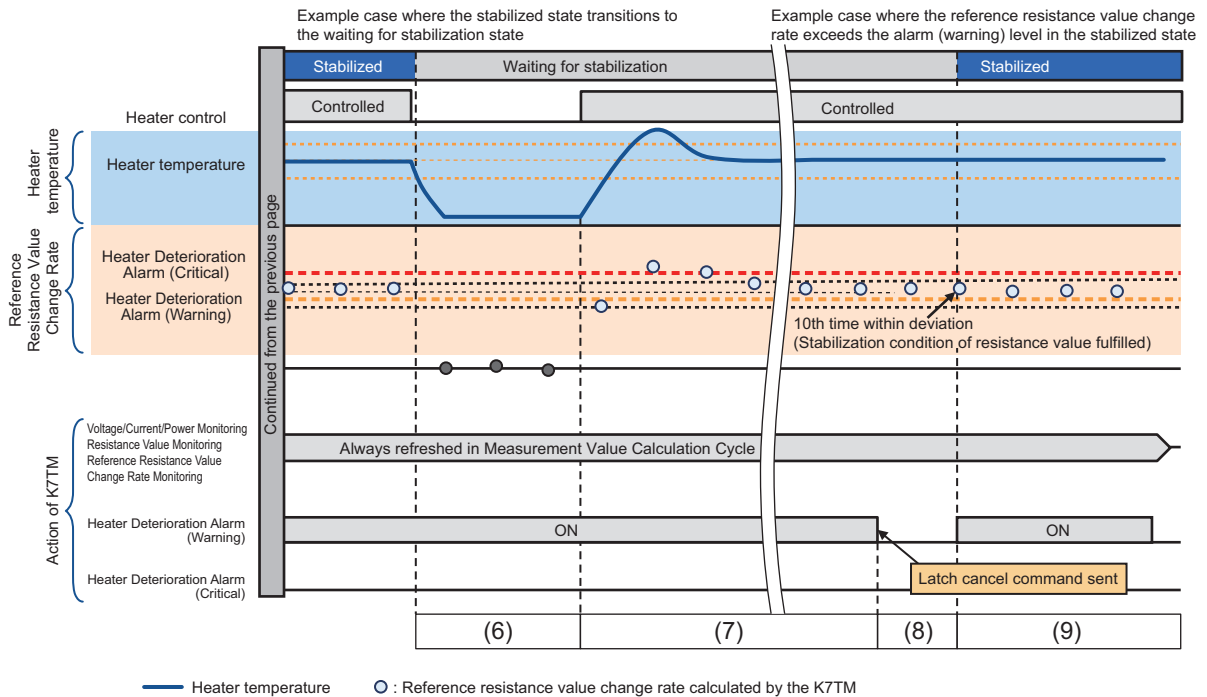

● Description

(6) Heater control stop

When electricity runs down the heater, the heater voltage and current fall short of the minimum voltage threshold or the minimum current threshold set in the K7TM, so conditions for the transition from the stabilized to the waiting for stabilization state are satisfied. The Unit returns from the stabilized to the waiting for stabilization step, and **STAB** Indicator is not lit. At this time, the **IN** Indicator will light to show that voltage and current are not input. The alarm becomes latched, so the following states are maintained.

- The alarm output indicator is lit in yellow.
- **ALM** Indicator is lit.

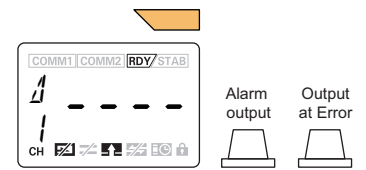

(7) Heater control restart

The **IN** Indicator goes out because voltage and current are input. Because of the waiting for stabilization step, an alarm will not be determined even if the reference resistance value change rate exceeds the heater deterioration alarm value (critical). The alarm status is latched, so the following states are maintained.

- The alarm output indicator is lit in yellow.

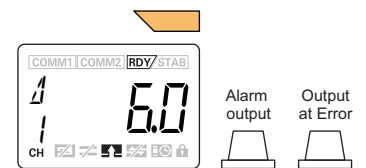

(8) Alarm latch cancel

Here, the alarm latch is released. Refer to 4-4-3 *Releasing the Alarm Latch* on page 4-20 for releasing the latch. Releasing the latch by any one of the methods will bring about the following states.

- The alarm output indicator is lit in yellow to green.

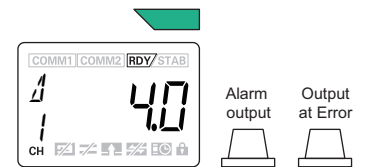

(9) Alarm operation when the Unit makes the transition to the stabilized step

In the waiting for stabilization state, no deterioration alarm is ready to be determined; the deterioration alarm (warning) will turn ON as soon as the Unit makes the transition to the stabilized step (**STAB** Indicator lit).

- The alarm output indicator is lit in yellow.

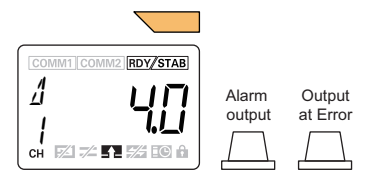

4-4 Alarm



There are three types of alarm functions. They can be set for each channel.

Alarm type	Description
Heater Deterioration Alarm	This is an alarm that detects heater deterioration. The Unit determines an alarm on the basis of the measurement value: Reference Resistance Value Change Rate. You can set two thresholds: warning level and critical level.
Last Resistance Value Change Rate Alarm	This is an alarm that detects a rapid change in the resistance value. The Unit determines an alarm on the basis of the measurement value: Reference Resistance Value Change Rate.
Heater Burnout Alarm	This is an alarm that detects heater burnout. The Unit determines an alarm on the basis of the measurement values: voltage value and current value.

This section describes details of each alarm function after describing the specifications common to all alarm functions: notification methods and actions when an alarm occurs.

4-4-1 Types of Alarm Notification Methods

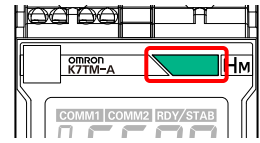
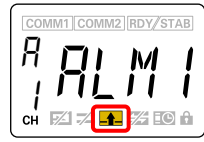
There are five types of alarm notification methods. Occurrence of any one of the alarms triggers notification actions.

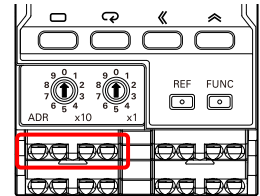
Notification method	Description	Interface
(1) Alarm output indicator	Green: Normal Yellow: Warning Red: Critical If the status is different across multiple channels, the display color is decided in the priority order: red (critical) > yellow (warning) > green (normal).	
(2) ALM Indicator	Not lit: An alarm is not generated on all channels. Flashing: An alarm is generated except on the current channel. Lit: An alarm is generated on the current channel.	
(3) Alarm status parameter	The alarm factor can be identified by the alarm status parameter on the operation level. <i>ALM1</i> shows a heater deterioration alarm value (warning). For the other alarm status, refer to the items of alarm status in 5-3-4 <i>Parameters on Operation Level</i> on page 5-10.	
(4) Alarm output	When an alarm occurs, the transistor output is turned OFF. (Alarm output terminal number 13 and 14) * The ON/OFF logic can be changed by the <i>Alarm Polarity</i> setting parameter. * The <i>Alarm Output Level</i> allows you to select which to use for output: warning level and critical level.	

Notification method	Description	Interface
(5) Alarm status (communications)	When an alarm occurs, the Bit of the alarm generated in the alarm status turns ON. Refer to 6-3 Variable Area Map on page 6-5 for details on the alarm status.	<p>The diagram illustrates the interface for alarm status. On the left is the K7TM device, which has a display and several indicator lights. An arrow labeled 'Bit information' points from the K7TM to a computer (laptop) on the right. Below the K7TM, a list of alarm types is provided: Heater Deterioration Alarm (Warning), Heater Deterioration Alarm (Critical), Last Resistance Value Change Rate Alarm, and Heater Burnout Alarm. To the right of the computer is a PLC (Programmable Logic Controller) unit.</p>

4-4-2 Polarity of Transistor Output When Alarm Occurs

This section shows how the alarm output indicator and the alarm output behave by occurrence status of the three alarm types.

The alarm output behavior varies with the following parameters.

- Alarm Output Level
- Alarm Polarity

Status of alarm	Display	Transistor output			
		Setting of Alarm Output Level: Warning or Critical		Setting of Alarm Output Level: Critical (default)	
	Color of alarm output indicator	Alarm Polarity = Normally open	Alarm Polarity = Normally close	Alarm Polarity = Normally open	Alarm Polarity = Normally close (default)
No alarms have occurred.	Green	OFF	ON	OFF	ON
At least one of the following alarms has occurred. <ul style="list-style-type: none"> • Heater Deterioration Alarm (Warning) • Last Resistance Value Change Rate Alarm 	Yellow	ON	OFF	OFF	ON
At least one of the following alarms has occurred. <ul style="list-style-type: none"> • Heater Deterioration Alarm (Critical) • Heater Burnout Alarm 	Red	ON	OFF	ON	OFF

Refer to 5-7 Initial Setting Level (LVL \square \square) on page 5-25 for the method to set the alarm output level. Refer to 5-7 Initial Setting Level (LVL \square \square) on page 5-25 also for the method to set the alarm polarity.

4-4-3 Releasing the Alarm Latch

The alarm becomes latched (retained).

The following three methods are available for releasing the latch.

Method to release the latch	Description
Releasing with key operation	Refer to <i>5-9 Operation Command with Key Operation</i> on page 5-33 for details.
Operation command via communications, <i>Alarm Latch Cancel</i>	Refer to <i>6-5 Operation Command</i> on page 6-17 for details.
Cycling the power supply (including a power ON reset)	It is released by cycling the power supply of the K7TM or by a power ON reset executed when you move to the other level with key operation. Refer to <i>Procedure for Moving from Level to Level</i> on page 5-3 in <i>5-1 Levels</i> for details.

4-4-4 Heater Deterioration Alarm

Function and Application

The heater deterioration alarm is a function to detect heater deterioration. The Unit determines an alarm on the basis of the measurement value: reference resistance value change rate. You can set two thresholds: warning level and critical level.

Setting an appropriate threshold reminds you of performing maintenance before the heater fails, which can prevent an unexpected stop.

Function Details

Set an alarm value to the reference resistance value change rate, and the alarm will be output if the reference resistance value change rate exceeds the alarm value.

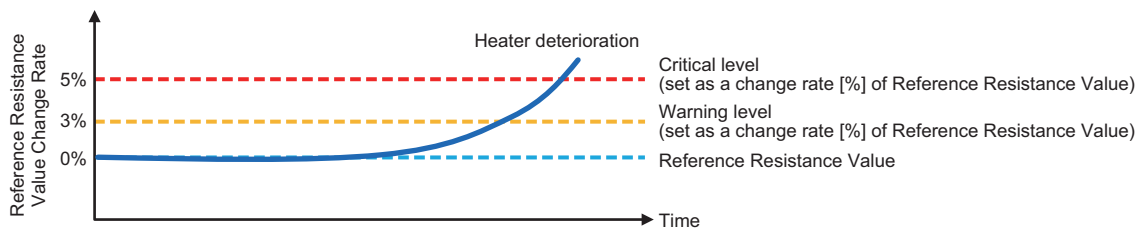

Precautions for Correct Use

The heater deterioration alarm is determined while the heater is in the stabilized state (while **STAB** Indicator is lit).

If the reference resistance value is not registered (while **RDY** Indicator is not lit), the heater deterioration alarm will not be determined.

	Waiting for stabilization, STAB Indicator not lit	Stabilized, STAB Indicator lit
Heater Deterioration Alarm	Not to be determined	To be determined

ON/OFF conditions for the heater deterioration alarm are given in the following table.

Heater Deterioration Alarm	ON/OFF conditions
ON condition	When a reference resistance value change rate exceeds the alarm level in the stabilized state
OFF condition	When you send the alarm latch cancel command When you cycle the power supply (execute a power ON reset) of the K7TM

Application Method

● Setting Parameters

Set the heater deterioration alarm value (warning) and the heater deterioration alarm value (critical).
(Warning) 3% by default
(Critical) 5% by default

Parameter name	Description	Reference
Heater Deterioration Alarm Value (Warning)	The alarm will be turned ON if the <i>Reference Resistance Value Change Rate</i> exceeds this alarm value. The alarm output level operates as <i>Warning</i> . It can be set for each channel. 3% by default This is a parameter of the adjustment level (common).	5-4 <i>Adjustment Level (Common)</i> (LVL R3)
Heater Deterioration Alarm Value (Critical)	The alarm will be turned ON if the <i>Reference Resistance Value Change Rate</i> exceeds this alarm value. The alarm output level operates as <i>Critical</i> . It can be set for each channel. 5% by default This is a parameter of the adjustment level (common).	

4-4-5 Last Resistance Value Change Rate Alarm

Function and Application

The last resistance value change rate alarm is a function to detect that the heater resistance value increases suddenly. The Unit determines an alarm on the basis of the measurement value: resistance value. The alarm output level operates as *Warning*.

It will be detected if, for example, any one of the multiple heaters connected in parallel is burned out, which can prevent the quality of workpieces from declining because of a temperature fall.

Function Details

The alarm will be output if the last resistance value change rate exceeds the last resistance value change rate alarm value.

The formula for the last resistance value change rate is as follows:

$$(1) \text{ Last Resistance Value Change Rate [\%]} = \frac{(3) \text{ Current Resistance Value}}{(2) \text{ Resistance Value before those calculated by Resistance Value Moving Average Count}} \times 100 - 100$$

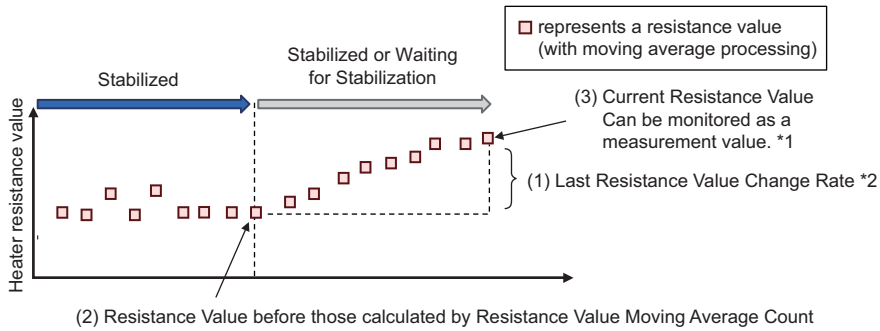

*1. Refer to 5-3 *Operation Level* on page 5-8 for details on the resistance value that is a measurement value.
 *2. The last resistance value change rate is a measurement value exclusive to communications. Refer to 6-3 *Variable Area Map* on page 6-5 for details.

● Conditions for Determining the Alarm

The following three conditions are required for determining the last resistance value change rate alarm. When all of these conditions are satisfied, the alarm will be determined.

Condition 1:

(2) Resistance Value before those calculated by Resistance Value Moving Average Count shall be a resistance value calculated in the stabilized state.

Condition 2:

All the resistance values, between (3) Current Resistance Value and (2) Resistance Value before those calculated by Resistance Value Moving Average Count, shall have been calculated successfully.

Condition 3:

(3) Current Resistance Value shall be a resistance value calculated in the stabilized or the waiting for stabilization state.

Application Method

● Setting Parameters

Set the *Last Resistance Value Change Rate Alarm Value*.

Parameter name	Description	Reference
Last Resistance Value Change Rate Alarm Value	The alarm will be turned ON if the <i>Last Resistance Value Change Rate</i> exceeds this alarm value. The alarm output level operates as <i>Warning</i> . It can be set for each channel. 25% by default This is a parameter of the adjustment level (common).	5-4 <i>Adjustment Level (Common)</i> (LVL R2)



Precautions for Correct Use

Make sure that the last resistance value change rate alarm to set matches the heater device to use (the number of heaters and the connection status). Refer to *Additional Information* on this page.

● Limiting Conditions for Use as Partial Heater Burnout

(1) Detectable section

It is detected only when the value has changed while the K7TM judges this to be in the stabilized state.

(2) Time between partial burnout occurrence and detection

The approximate time between partial burnout occurrence and detection is **Resistance Value Moving Average Count × Measurement Value Calculation Cycle**.

(3) Alarm occurrence attributable also to other factors than partial burnout

The alarm may occur even if the heater temperature changes a lot.

Example: Temperature change due to temperature set point change in the heater that the K7TM judges to be in the stabilized state

Example: Temperature change due to putting workpieces in or accessing the electric furnace door



Additional Information

This is a last resistance value change rate when burnout has occurred in one of the multiple heaters of the same capacity connected in parallel. Set the alarm value in consultation with the table below.

	Number of heaters connected in parallel			
	2	3	4	5
Last Resistance Value Change Rate	100%	50%	33%	25%

Every numeric shows a percentage of the resistance value, with the resistance before burnout regarded as 100%, after one heater is burned out.

The values on this table are based on the theoretical calculation. In practice, you are recommended to set a value smaller than those on the table because it may be affected by variations in the resistance values of heaters.

[Theoretical formula]

$$\text{Last Resistance Value Change Rate} = \frac{\text{Number of heaters connected in parallel}}{(\text{Number of heaters connected in parallel} - 1)} \times 100 - 100$$

4-4-6 Heater Burnout Alarm

Function and Application

The heater burnout alarm is a function to detect heater burnout. The Unit determines an alarm on the basis of the measurement values: voltage value and current value. The alarm output level operates as *Critical*.



Precautions for Correct Use

If a voltage value out-of-range error or a current value out-of-range error occurs (**FAIL** Indicator is lit or flashing), the heater burnout alarm will not be determined.

Function Details

The alarm will be output when the voltage value is 40% or more*1 of the voltage input range and the input current reaches 1% or less*2 of the CT input range.

- *1. It is adjustable with a heater burnout alarm value (voltage). Refer to *5-4 Adjustment Level (Common) (LVL R 9)* on page 5-13 for details.
- *2. It is adjustable with a heater burnout alarm value (current). Refer to *5-4 Adjustment Level (Common) (LVL R 9)* on page 5-13 for details.

Application Method

Although the heater burnout alarm requires no setting or operation, it needs adjusting in the following cases.

● To Know Heater Burnout Alarm Earlier

It takes the K7TM at least 100 seconds (default value of measurement value calculation cycle) to detect heater burnout after occurrence. To shorten this time, adjust the **Measurement Value Calculation Cycle** setting parameter (*MV CP*).

Refer to *5-7 Initial Setting Level (LVL 0 9)* on page 5-25 for details.

● Using Rated Voltage at 54 V or Less

If you use a transformer to decrease the commercial power supply (100 V etc.) to 54 V or less, the heater burnout alarm will not output because the voltage cannot exceed voltage conditions for detecting heater burnout.

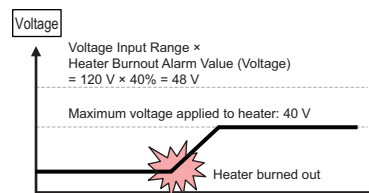

- Even if a heater is burned out, the voltage cannot exceed 48 V, so a heater burnout alarm cannot be detected.
- Considering a voltage error of 0.5% at full scale, when the applied voltage is less than 54 V, the threshold needs reviewing.
 $48 \text{ V} + 120 \text{ V} \times 0.5\% = 54 \text{ V}$

When you adjust the setting values of the heater burnout alarm, you are recommended to adjust the threshold to satisfy the conditions (1) to (4).

[Conditions]

- (1) Max. voltage applied to heater > Voltage Input Range × Heater Burnout Alarm Value (Voltage) + Voltage Input Range × 0.5% (error in % FS)
- (2)
$$\frac{\text{Voltage Input Range} \times \text{Heater Burnout Alarm Value (Voltage)}}{\text{CT Input Range} \times \text{Heater Burnout Alarm Value (Current)}} > \frac{\text{Heater rated voltage}^2}{\text{Heater rated capacity}} \times 6$$
- (3) Heater Burnout Alarm Value (Voltage) > 0.5% (error of voltage in % FS)
- (4) Heater Burnout Alarm Value (Current) > 0.5% (error of current in % FS)

4-5 Measurement Error

The measurement error is a function to notify you that the service condition needs adjusting and improving to monitor the heater condition.

The details of measurement errors are given in the following table.

Measurement error type	Description
Resistance Value Out-of-Range Error	<p>Notifies you that the resistance value has exceeded the display range.</p> <ul style="list-style-type: none"> The resistance value out-of-range error occurs when the resistance value exceeds 999.9 Ω to exceed the display range. This error is reset when the resistance value goes into the range. It requires no setting or operation.
Voltage Value Out-of-Range Error	<p>Notifies you that the voltage value has exceeded the display range.</p> <ul style="list-style-type: none"> The voltage value out-of-range error occurs when the voltage value exceeds the display range. This error is reset when the voltage value goes into the range. It requires no setting or operation. If a voltage value out-of-range error occurs, the heater burnout alarm will not be determined.
Current Value Out-of-Range Error	<p>Notifies you that the current value has exceeded the display range.</p> <ul style="list-style-type: none"> The current value out-of-range error occurs when the current value exceeds the display range. This error is reset when the current value goes into the range. It requires no setting or operation. If a current value out-of-range error occurs, the heater burnout alarm will not be determined.
Temperature Data Not-refreshed Error	<p>Notifies you that temperature data is no longer written from the host system. Refer to <i>Details on Temperature Data Not-refreshed Error</i> on page 4-29 for details.</p>
Not-stabilized Error	<p>Notifies you that the stabilized state was not brought about for a certain period of time or longer. Refer to <i>Details on Not-stabilized Error</i> on page 4-29 for details.</p>
A/D Error	<p>Notifies you that the internal A/D converter of the K7TM failed.</p> <ul style="list-style-type: none"> The A/D converter error occurs when the internal A/D converter of the K7TM failed. Calculating measurement values is stopped for only the relevant channel in which the A/D error occurred.

This section describes details of each measurement error after describing the specifications common to all measurement errors: notification methods and actions when an error occurs.

4-5-1 Types of Notification of Measurement Errors

There are three types of measurement error notification methods as follows:

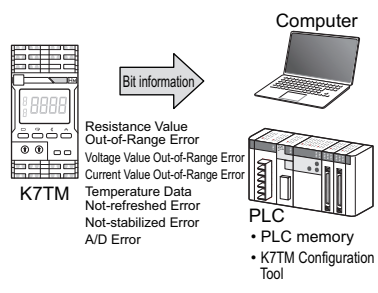
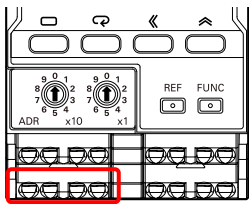
Notification method	Description	Interface
(1) FAIL Indicator	Not lit: A measurement error not generated on all channels Flashing: A measurement error generated except on the current channel Lit: A measurement error generated on the current channel	FAIL Indicator 
(2) Monitoring status (communications)	When a measurement error occurs, the Bit of the error generated in the monitoring status turns ON. Refer to 6-3 Variable Area Map on page 6-5 for details on the monitoring status.	
(3) Output at Error	When a measurement error occurs, the transistor output is turned OFF. (Output at Error terminal number 15 and 16) The ON/OFF logic of the transistor output cannot be changed.	

4-5-2 Actions for Measurement Errors

● Occurrence Conditions and Reset Conditions for Measurement Errors

This section shows the types of measurement errors and the error occurrence/reset conditions.



Error type	Error occurrence condition	Error reset condition
Resistance Value Out-of-Range Error	The resistance value went out of the range.	The resistance value went into the range.
Voltage Value Out-of-Range Error	The voltage value went out of the range.	The voltage value went into the range.
Current Value Out-of-Range Error	The current value went out of the range.	The current value went into the range.
Temperature Data Not-refreshed Error*1	The temperature data is not refreshed for <i>Temperature Data Refresh Wait Time</i> or longer.	The temperature data was refreshed.
Not-stabilized Error*2	The waiting for stabilization state continued for the time of <i>Logging Cycle</i> × 5.	The stabilized state was brought about.
A/D Error	The A/D converter in the K7TM was broken. Or, the A/D converter was malfunctioned by the influence of noise.	It is recovered by eliminating the influence of noise and cycling the power supply. If the Unit does not recover, contact your OMRON representative.

*1. Only applicable to the case where the stabilization discrimination method is temperature.

*2. The not-stabilized error is detected in the waiting for stabilization state only.

Notification Actions for Measurement Errors

In case of measurement errors, the notification actions of communications status, LCD display, and transistor output are given in the following table.

Error type	Actions for errors			
	Communications	Display		Output
	Measurement Error Status	Status Indicator	Other displays * If the error channel is displayed	Output at Error
Resistance Value Out-of-Range Error	The resistance value out-of-range error Bit is ON.	 FAIL Indicator An error has occurred in the displayed channel: Lit An error has occurred except in the displayed channel: Flashing	When a resistance value is displayed, the value is flashing.	ON to OFF Turns OFF if any one of the errors occurs.
Voltage Value Out-of-Range Error	The voltage value out-of-range error Bit is ON.		When a voltage value is displayed, the value is flashing.	
Current Value Out-of-Range Error	The current value out-of-range error Bit is ON.		When a current value is displayed, the value is flashing.	
Temperature Data Not-refreshed Error	The temperature data not-refreshed error Bit is ON.		When a temperature is displayed, the value is flashing.	
Not-stabilized Error	The not-stabilized error Bit is ON.		 STAB The STAB Indicator is flashing.	
A/D Error	The A/D error Bit is ON.		<i>ERRR</i> is flashing on the main display.	

Details on Temperature Data Not-refreshed Error

This error is detected only when the stabilization discrimination method is temperature. The temperature data not-refreshed error will occur if no temperature data was written for the time of *Temperature Data Write Cycle* × 3 after temperature data was written last. This error is reset when temperature data is written. It is necessary to set the *Temperature Data Write Cycle* setting parameter according to the cycle in which to write temperature data into the K7TM from the host system.

The following is an example case where the temperature data write cycle is 2 s.

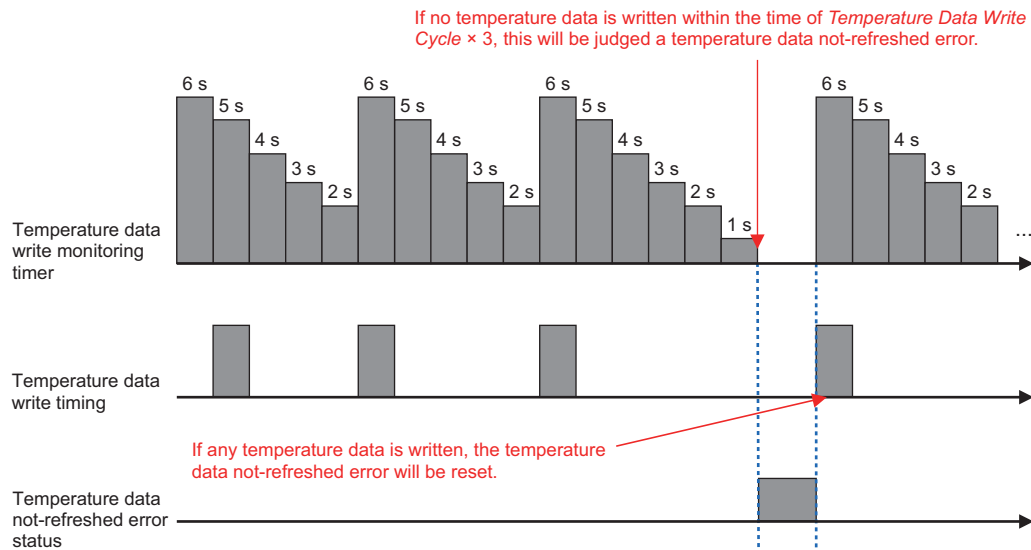

Details on Not-stabilized Error

The not-stabilized error will occur if the stabilized state was never brought about during the period of *Logging Cycle* × 5.

This error is reset when the stabilized state is brought about.

It requires no setting or operation.

4-6 Logging Function

4-6-1 Function and Application

The logging function is a function to provide logs for the user who uses the K7TM on a stand-alone basis. It can be used by means of the communications function.

It will be useful in adjusting the alarm value while seeing the logged reference resistance value change rate, if the user connects the K7TM with the K7TM Configuration Tool in replacing the heater.

Keeping logs allows transitions in equipment deterioration to be visualized as values. Accumulating the data might makes it possible to conduct the data analysis required for predictive maintenance.

Function Details

● Items to Be Logged

Items to be logged are shown below.

Log group	Item	Number of logs
Resistance monitoring log	Reference Resistance Value Change Rate	30
	Voltage Value	
	Current Value	
	Record Time *1	

*1. The total power ON time [in seconds] of the K7TM is recorded.

The addresses of log data are H'1300 to H'13D0.

Refer to the variable area map in 6-3-3 *Variable Areas of 1CH (Change Beginning Address into 2 for Variable Areas of 2CH)* on page 6-8 for details.

● Logging Timing

Logs are saved on a first-in-first-out basis with the individual timing below.

Resistance monitoring log:	In the stabilized state, the reference resistance value change rates are calculated and saved by <i>Logging Cycle</i> . The logging cycle is 100 times by default.
----------------------------	---

● Timing of Logging

The following two setting parameters are related to logging.

- Logging Cycle (default value: 100 (in 10 times))
- Measurement Value Calculation Cycle (default value: 100 (in seconds))

The following gives a description of logging at default values.

The resistance monitoring log items are calculated once every 100 seconds of the measurement value calculation cycle.

For the logging cycle, the K7TM keeps a log once every 1,000 times: 100×10 times.

That is, the pace is once every 100,000 seconds (1,000 times \times 100 seconds). (However, the number of times is counted in the stabilized state only.)

Converted into hours, it is $100,000 \div 60 \text{ seconds} \div 60 \text{ minutes} = 27.7$ hours. The frequency is approximately a day.

Since the number of logs is up to 30, the K7TM retains about a month of logs.

To accumulate a month or more of data, read the logs with the external host system or the K7TM Configuration Tool.

● How to Read a Log

Reading a log requires refreshing the log to be stopped by the operation command *Log Refresh Start/Stop*. You cannot read it unless refreshing the log has stopped. No log is saved while refreshing the log has stopped. After reading the log, you will need to send the operation command *Log Refresh Start* to resume saving log data.



Precautions for Correct Use

The accuracy of the total power ON time is low, so use it as a guideline value.

In addition, if you turn OFF the K7TM in operation many times a day, the total power ON time will not progress and the *Record Time* will not be recorded correctly.

The total power ON time means the total number of hours, measured in seconds, for which the K7TM is energized.

4-7 Running Time

The K7TM is equipped with electrolytic capacitors. The electrolyte inside the electrolytic capacitors penetrates the sealing rubber and evaporates as time passes. This causes deterioration of characteristics, such as decreasing the capacitance. Due to this deterioration of the electrolytic capacitor characteristics, the K7TM decreases its performance as time passes.

The running time function calculates an approximate period until the K7TM stops functioning at its full capacity due to the deterioration of the electrolytic capacitor characteristics.

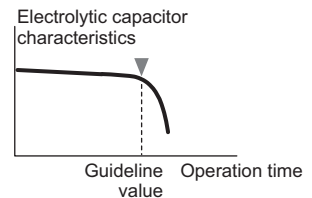

The **AGE** Indicator will light when the approximate value is reached. You can use this function as a guideline for K7TM replacement.

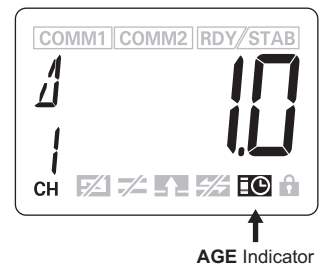

The running time function can be selected from the *Use Running Time* setting parameter. The default value is OFF (Not used). Refer to *5-7 Initial Setting Level (LVL 02)* on page 5-25 for how to operate the *Use Running Time* setting parameter.

Regardless of the setting value of the *Use Running Time* setting parameter, the communications commands can read the current running time as a proportion of the guideline value.



The running time function provides an indication of when the deterioration of the electrolytic capacitors will prevent the K7TM functioning at its full capacity. It does not provide information on failures occurring due to other causes.

If the running time function is disabled by the influence of a failure, noise, etc., you will be notified of that by K7TM Status (Bit 14: Running Time Measurement Error) of the communications function. Refer to *6-3-5 Details about Status Information* on page 6-13 for address and Bit configurations.

If a running time measurement error has occurred, first turn the power OFF then back ON again. If operation returns to normal (Bit is OFF), then noise may have caused the problem. Check for noise. If operation does not return to normal, contact your OMRON representative.

4-8 Self-diagnosis Error

The self-diagnosis error is an abnormal state in which the K7TM cannot perform the functions that it was primarily meant to perform.

An error has occurred in the internal memory operation.

If the self-diagnosis error has occurred in the K7TM, it will behave in one of the following two patterns.

Pattern 1

- The alarm output indicator is lit in red.
- All the displays in the front section are not lit.
- The communications terminal 1 and the communications terminal 2 are both disabled.
- Both the alarm output and the output at error are OFF.

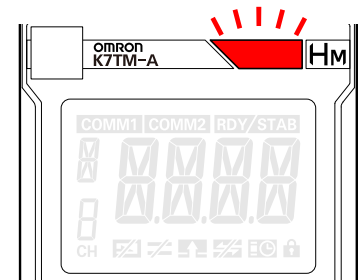

Pattern 2

- The alarm output indicator is lit in red.
- *ERR* is lit on the main display.
- The communications terminal 1 and the communications terminal 2 are both disabled.
- Both the alarm output and the output at error are OFF.

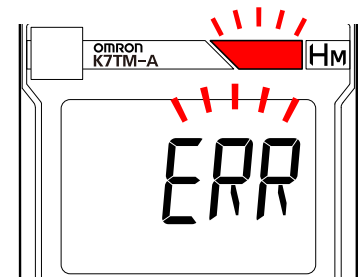

Corrective Action

- Cycle the power supply. If operation returns to normal, then noise may have caused the problem. Check for noise.
- If the Unit does not recover, contact your OMRON representative.



Additional Information

Section 8 Troubleshooting on page 8-1

5

Using Parameters

This section describes using parameters with key operations on the K7TM.

5-1	Levels	5-2
5-2	Setting Parameters and Setting Values	5-4
5-2-1	Setting Change Protection	5-6
5-2-2	Parameters	5-7
5-3	Operation Level	5-8
5-3-1	Switching Measurement Values and Displayed Channels	5-8
5-3-2	Display of Measurement Value Mark	5-9
5-3-3	Measurement Value Display Automatic Scroll	5-9
5-3-4	Parameters on Operation Level	5-10
5-4	Adjustment Level (Common) (LVL <i>F</i>)	5-13
5-4-1	Moving to Adjustment Level (Common)	5-13
5-4-2	Parameters on Adjustment Level (Common)	5-14
5-5	Adjustment Level (Power) (LVL <i>b</i>)	5-19
5-5-1	Moving to Adjustment Level (Power)	5-19
5-5-2	Parameters on Adjustment Level (Power)	5-20
5-6	Adjustment Level (Temperature) (LVL <i>⌈</i>)	5-22
5-6-1	Moving to Adjustment Level (Temperature)	5-22
5-6-2	Parameters on Adjustment Level (Temperature)	5-23
5-7	Initial Setting Level (LVL <i>⌋</i>)	5-25
5-7-1	Moving to Initial Setting Level	5-25
5-7-2	Parameters on Initial Setting Level	5-26
5-8	Communications Setting 1 or 2 Level (LVL <i>!</i> or <i>⌋</i>)	5-30
5-8-1	Moving to Communications Setting Level	5-30
5-8-2	Parameters on Communications Setting 1 or 2 Level	5-31
5-8-3	Unit Number	5-32
5-9	Operation Command with Key Operation	5-33

5-1 Levels

The parameters are grouped into “levels.”
Levels are divided into seven types for the K7TM.

Level	Measurement operation	Description
Operation	Possible.	This is a level on which to display measurement values. The Unit is on this level immediately after the power is turned ON.
Adjustment (Common)	Possible.	This is a setting level for adjustment.
Adjustment (Power)	Possible.	This is a level on which to make adjustments required when the stabilization discrimination method is <i>Power</i> .
Adjustment (Temperature)	Possible.	This is a level on which to make adjustments required when the stabilization discrimination method is <i>Temperature</i> .
Initial Setting	Stops.	This is a level on which to make basic initial settings.
Communications Setting 1	Stops.	This is a level on which to make communications settings for communications 1 terminals*1.
Communications Setting 2	Stops.	This is a level on which to make communications settings for communications 2 terminals*2.

*1. These are communications terminals to connect the host system.

*2. These are communications terminals to connect the K7TM Configuration Tool, IoT gateway, etc.

● LVL/Measurement Value Displays

On the Operation Level, the LVL/measurement value display represents the currently displayed measurement value as a mark.

On the other levels, their respective characters are displayed.

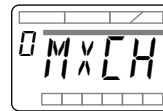

Characters	Level
Measurement value displayed	Operation
R	Adjustment (Common)
b	Adjustment (Power)
ε	Adjustment (Temperature)
0	Initial Setting
1	Communications Setting 1
2	Communications Setting 2

Procedure for Moving from Level to Level

- **To Adjustment Level (Common)**

Pressing the Level Key (⊖) on the Operation Level (for less than 1 second) moves you to the Adjustment Level (Common).

- **To Adjustment Level (Power)**

Pressing the Level Key (⊖) on the Adjustment Level (Common) (for less than 1 second) moves you to the Adjustment Level (Power). Pressing the Level Key (⊖) on the Adjustment Level (Power) (for less than 1 second) moves you to the Adjustment Level (Temperature).

- **To Adjustment Level (Temperature)**

Pressing the Level Key (⊖) on the Adjustment Level (Power) (for less than 1 second) moves you to the Adjustment Level (Temperature). To return to the Operation Level, press the Level Key (⊖) (for less than 1 second).

- **To Initial Setting Level**

On the Operation Level, Adjustment Level (Common), Adjustment Level (Power), or Adjustment Level (Temperature), when you press the Level Key (⊖) for 1 second or more, the main display starts to flash at high speed. Then, keeping the key held down for 2 seconds or more moves you to the Initial Setting Level. To return to the Operation Level, press the Level Key (⊖) for 1 second or more.

- **To Communications Setting 1 Level**

Pressing the Level Key (⊖) on the Initial Setting Level (for less than 1 second) moves you to the Communications Setting 1 Level. To return to the Operation Level, press the Level Key (⊖) for 1 second or more.

- **To Communications Setting 2 Level**

Pressing the Level Key (⊖) on the Communications Setting 1 Level (for less than 1 second) moves you to the Communications Setting 2 Level. To return to the Initial Setting Level, press the Level Key (⊖) (for less than 1 second). To return to the Operation Level, press the Level Key (⊖) for 1 second or more.

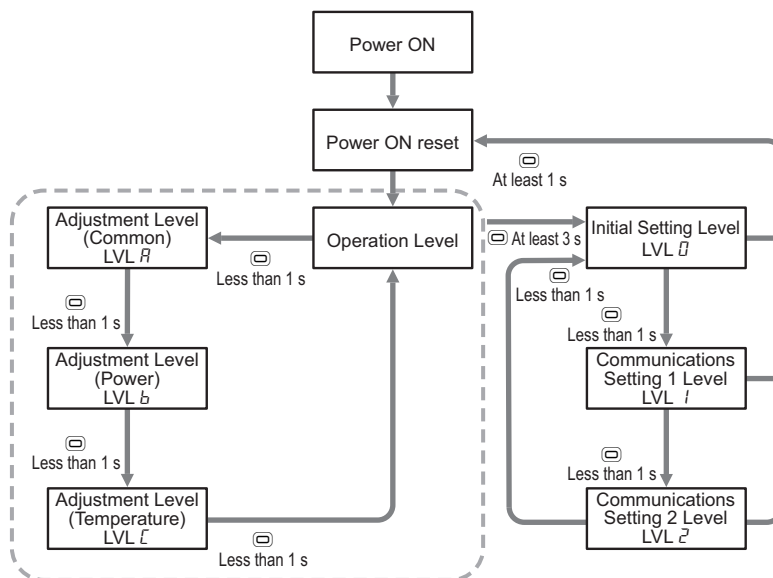

After returning from a level where measurement has stopped (Initial Setting, Communications Setting 1, or Communications Setting 2) to the Operation Level, the power ON reset process is always executed to clear measurement values and alarm outputs.

5-2 Setting Parameters and Setting Values

● Setting Parameters

Setting items on each level are called “setting parameters.”

The setting parameters can be switched with the Mode Key (Ⓞ).

The setting parameters can be switched between 1CH and 2CH with the Up Key (Ⓢ). *

* If the *Maximum Number of Channels* on the Initial Setting Level is set to 1, channels will not be switched.

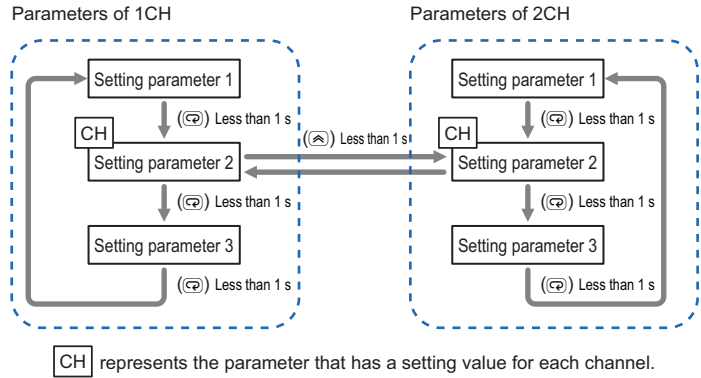

● Setting Value

A value set for each setting parameter is called the “setting value.”

The state where the setting value is displayed is called the “monitoring state,” and the state where it can be changed is called the “setting change state.”

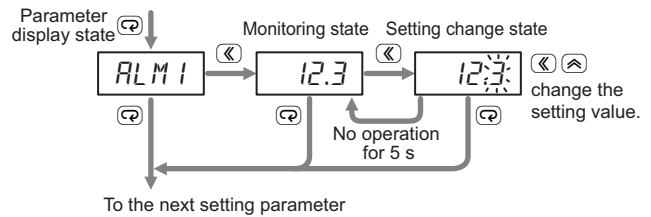

● Display or Change of Setting Value

Use the following operations to display or change the setting value.

1. Press the Level Key (Ⓞ) and the Mode Key (Ⓞ) several times to display the setting parameter to change.

- The setting parameter characters are displayed on the main display.



2. Press the Shift Key (Ⓢ) to enter the monitoring state.

- The setting value is displayed.
- If you only want to check the setting value, press the Mode Key here to move to the next setting parameter.

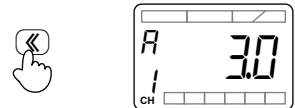

3. Press the Shift Key again to move to the setting change state.

- The changeable numeric starts to flash.

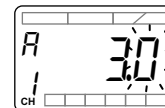
**4.** Use the Shift Key and the Up Key (⬆) to change the setting value.

- If no key operation is performed for 5 seconds, the setting value will be saved and the system will return to the monitoring state.

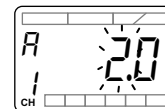
**5.** Press the Mode Key to move to the next setting parameter.

- The changed setting value is saved in the internal memory.



5-2-1 Setting Change Protection

The K7TM can protect the setting values from being changed with key operations.

You can protect the setting values to prevent them being inadvertently overwritten due to unintentional key operations.

Setting it to ON (Prohibited) yields the following results:

- You can enter the monitoring state, but you will not be able to enter the setting change state.
- The **LOCK** Indicator will light on the front display to show that the Unit has been protected.

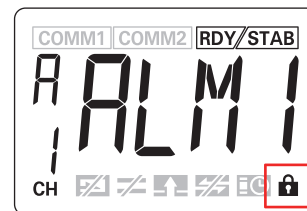
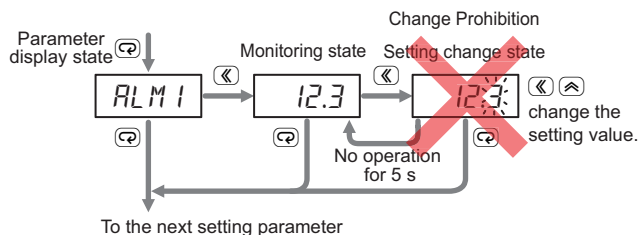

● How to Enable Setting Change Protection

You can enable the setting change protection at one of the following levels.

- Operation Level
- Adjustment Level (Common) with parameters displayed
- Adjustment Level (Power) with parameters displayed
- Adjustment Level (Temperature) with parameters displayed

Press and hold both the Mode Key (⏏) and the Level (⏏) Key for 3 seconds or more. After the main display flashes at high speed, the **LOCK** Indicator will light.

The same operation applies to canceling the setting change protection.

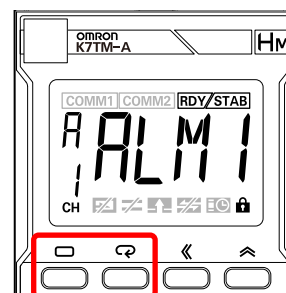

5-2-2 Parameters

The following figure gives an overall image of the parameters.

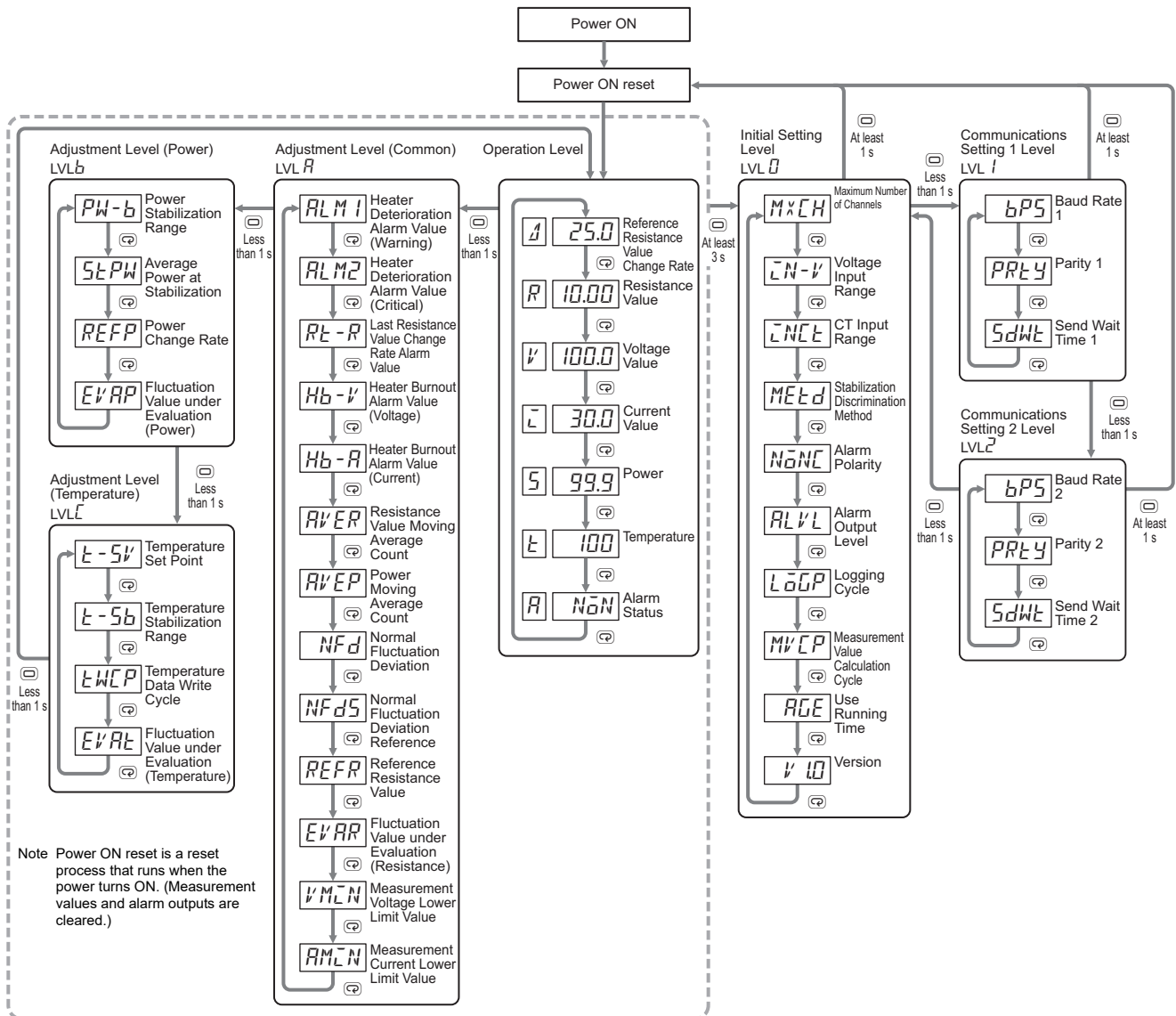

Precautions for Correct Use

When you move to the Initial Setting Level, the alarm output and output at error contacts turn OFF, regardless of the setting value of the *Alarm Polarity* setting parameter.

If it is set to normally close, turning the output OFF will have the same meaning as an alarm to external devices.

As an example of a countermeasure to this, provide a switch that can short-circuit the alarm output and output at error contacts, and use it to short-circuit the contacts during setting parameter operations and to release the short circuit after returning to the Operation Level.

5-3 Operation Level

The Operation Level is a level on which to display measurement values that the K7TM measured.

Turning ON the power executes the power ON reset process to move you to the Operation Level.

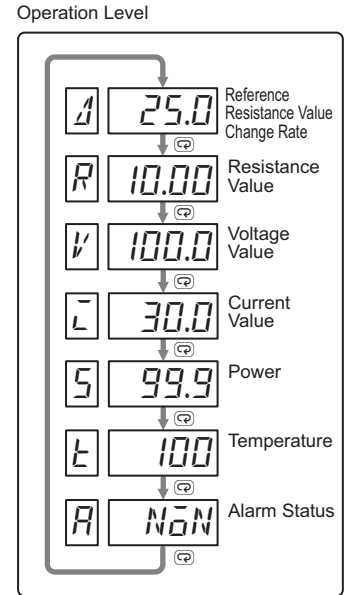

5-3-1 Switching Measurement Values and Displayed Channels

- Use the Mode Key (Ⓢ) to switch measurement values to display.
- Use the Up Key (⏶) to switch channels to display.



When the *Maximum Number of Channels* is 1CH, even if you press the Up Key (⏶), measurement values will not be switched but the measurement values of 1CH will be displayed.

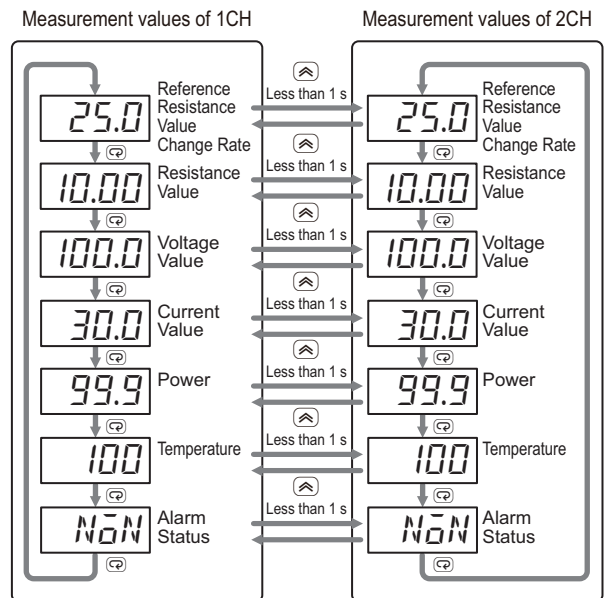

5-3-2 Display of Measurement Value Mark

A mark for each of the currently measured values is displayed on the LVL/measurement value display.

Measurement value mark	Meaning
Δ	Reference Resistance Value Change Rate
R	Resistance Value
V	Voltage Value
I	Current Value
S	Power
t	Temperature
R	Alarm Status

Reference Resistance Value Change Rate

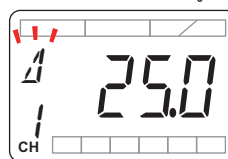

Current Value

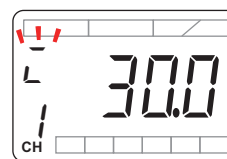

Resistance Value

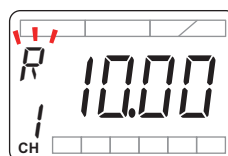

Power



Voltage Value

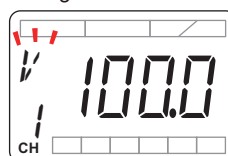

Temperature

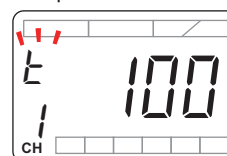

Alarm Status

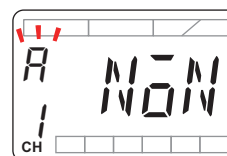

5-3-3 Measurement Value Display Automatic Scroll

Only the three measurement values to be displayed on the Operation Level are scrolled automatically at intervals of 5 seconds. You can check them with no key operation during inspection. For two channels of measurements, the values are scrolled automatically from 1CH to 2CH, and then the first measurement value of 1CH comes back.

● Target Measurement Values

The following measurement values are targeted for the measurement value display automatic scroll.

- Reference Resistance Value Change Rate
- Resistance Value
- Alarm Status

● Procedure

1. On the Operation Level, press the Mode Key (⊞) for 3 seconds or more.

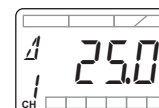

- After the main display flashes at high speed, the automatic scroll becomes enabled.

- To cancel the automatic scroll, press the Mode Key (Ⓢ) for 3 seconds or more.

While the automatic scroll is enabled, the following cannot be executed. When you use them, disable the automatic scroll.



- Operation command with key operation, *Reference Resistance Value Registration Start*
- Operation command with key operation, *Reference Resistance Value Registration Cancel*
- Changing displayed measurement values or displayed channels with key operation

5-3-4 Parameters on Operation Level

For parameters on the Operation Level, you can only display the monitored values but cannot set them.

Reference Resistance Value Change Rate

The resistance value change rate is calculated on the basis of the *Reference Resistance Value*.

It is refreshed for each *Measurement Value Calculation Cycle*.

Monitoring range

-100.0 to 999.9 (%)

$$\text{Reference Resistance Value Change Rate} = \frac{\text{Resistance Value} - \text{Reference Resistance Value}}{\text{Reference Resistance Value}} \times 100 - 100 (\%)$$



Setting-related page

4-2 *Measurement Values* (P. 4-4)
Resistance Value (Operation Level) (P. 5-10)
Reference Resistance Value (Adjustment Level (Common)) (P. 5-17)
Measurement Value Calculation Cycle (Initial Setting Level) (P. 5-28)

Resistance Value

This is a resistance value of the heater.

It is refreshed for each *Measurement Value Calculation Cycle*.

Moving average processing is applied according to the setting of *Resistance Value Moving Average Count* before refreshment.

Monitoring range

0.000 to 9.999 (Ω)
 10.00 to 99.99 (Ω)
 100.0 to 999.9 (Ω)



Setting-related page

4-2 *Measurement Values* (P. 4-4)
Resistance Value Moving Average Count (Adjustment Level (Common)) (P. 5-15)
Measurement Value Calculation Cycle (Initial Setting Level) (P. 5-28)

Voltage Value

This is a voltage value applied to the heater.
It is refreshed for each *Measurement Value Calculation Cycle*.

Monitoring range

120 V range: 0.0 to 132.0 (V)
240 V range: 0.0 to 264.0 (V)
480 V range: 0.0 to 528.0 (V)
600 V range: 0.0 to 660.0 (V)



Setting-related page

4-2 Measurement Values (P. 4-4)
Measurement Value Calculation Cycle (Initial Setting Level) (P. 5-28)

Current Value

This is a current value applied to the heater.
It is refreshed for each *Measurement Value Calculation Cycle*.

Monitoring range

5 A range: 0.00 to 5.50 (A)
25 A range: 0.0 to 27.5 (A)
100 A range: 0.0 to 110.0 (A)
200 A range: 0.0 to 220.0 (A)
400 A range: 0.0 to 440.0 (A)
600 A range: 0.0 to 650.0 (A)



Setting-related page

4-2 Measurement Values (P. 4-4)
Measurement Value Calculation Cycle (Initial Setting Level) (P. 5-28)

Power

This is an apparent power of the heater.
It is refreshed for each *Measurement Value Calculation Cycle*.
Moving average processing is applied according to the setting of
Power Moving Average Count before refreshment.

Monitoring range

0.0 to 429.0 (kVA)



Setting-related page

4-2 Measurement Values (P. 4-4)
Power Moving Average Count (Adjustment Level (Common)) (P. 5-16)
Measurement Value Calculation Cycle (Initial Setting Level) (P. 5-28)

Temperature

This is a temperature used as a reference for checking the heater for stability.

It is refreshed by the value written from the host system to the K7TM.

It is used when you select *Temperature* for the *Stabilization Discrimination Method* on the Initial Setting Level.

Monitoring range

-1,999 to 9,999 (°C/°F)



Setting-related page

4-2 *Measurement Values* (P. 4-4)

Stabilization Discrimination Method (Initial Setting Level) (P. 5-27)

Alarm Status

This parameter displays the present alarm status.

The *Alarm Status* that can be checked via communications is displayed.

Monitoring range	Description
<i>NōN</i>	Normal
<i>RLM1</i>	Heater Deterioration Alarm (Warning)
<i>RLM2</i>	Heater Deterioration Alarm (Critical)
<i>RL-R</i>	Last Resistance Value Change Rate Alarm Value
<i>Hb</i>	Heater Burnout Alarm



Setting-related page

4-4 *Alarm* (P. 4-18)

6-3-5 *Details about Status Information* (P. 6-13)



If multiple alarms occur, they are displayed in the priority order: HB > ALM2 > RT-R > ALM1.

5-4 Adjustment Level (Common) (LVL R)

The Adjustment Level (Common) is a level that has the parameters required to be adjusted for using the K7TM.

Pressing the Level Key (⊖) on the Operation Level (for less than 1 second) moves you to the Adjustment Level (Common).

Adjustment Level (Common)
LVL R

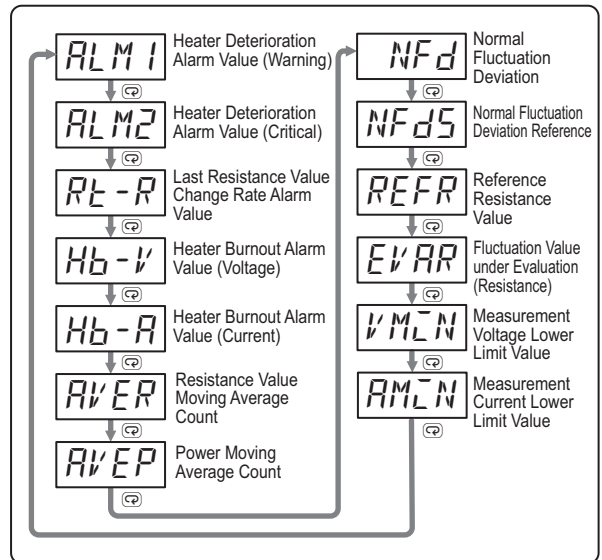

5-4 Adjustment Level (Common) (LVL R)

5

5-4-1 Moving to Adjustment Level (Common)

5-4-1 Moving to Adjustment Level (Common)

1. Press the Level Key (⊖) on the Operation Level (for less than 1 second) to move to the Adjustment Level (Common).

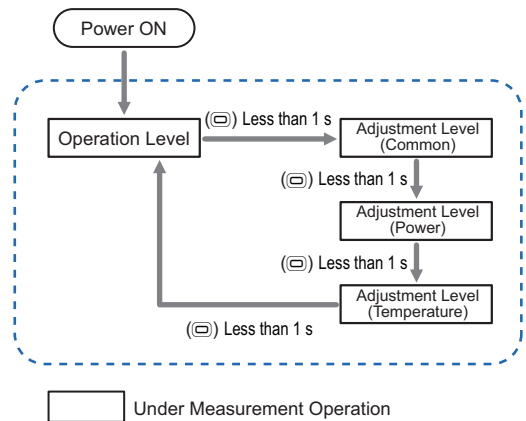

- When you have reached the Adjustment Level (Common), R is displayed on the “LVL/measurement value display.”



- To return to the Operation Level, press the Level Key (⊖) 3 times within 1 second.

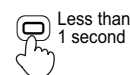

5-4-2 Parameters on Adjustment Level (Common)

ALM1 Heater Deterioration Alarm Value (Warning)

Set the alarm value (warning) for heater deterioration.

The alarm will be turned ON if the *Reference Resistance Value Change Rate* exceeds this alarm value.

Range of setting values	Default value
0.1 to 999.9 (%)	3.0 (%)

 **Setting-related page**

4-4-4 Heater Deterioration Alarm (P. 4-20)

Reference Resistance Value Change Rate (Operation Level) (P. 5-10)

ALM2 Heater Deterioration Alarm Value (Critical)

Set the alarm value (critical) for heater deterioration.

The alarm will be turned ON if the *Reference Resistance Value Change Rate* exceeds this alarm value.

Range of setting values	Default value
0.1 to 999.9 (%)	5.0 (%)

 **Setting-related page**

4-4-4 Heater Deterioration Alarm (P. 4-20)

Reference Resistance Value Change Rate (Operation Level) (P. 5-10)

RL-R Last Resistance Value Change Rate Alarm Value

Set the alarm value for last resistance value change rate alarm value.

The alarm will be turned ON if the *Last Resistance Value Change Rate* exceeds this alarm value.

If the setting value is larger than 200%, the alarm will be disabled.

Range of setting values	Default value
0.1 to 999.9 (%)	25.0 (%)

 **Setting-related page**

4-2 Measurement Values (P. 4-4)

4-4-5 Last Resistance Value Change Rate Alarm (P. 4-21)

Hb-V Heater Burnout Alarm Value (Voltage)

Set the voltage conditions for heater burnout alarm.

The alarm will be turned ON if the voltage value reaches Voltage Input Range × Heater Burnout Alarm Value (Voltage) or more and the current value reaches CT Input Range × Heater Burnout Alarm Value (Current) or less.

Range of setting values	Default value
0.0 to 99.9 (% FS)	40.0 (% FS)



Setting-related page

4-4-6 Heater Burnout Alarm (P. 4-24)

Voltage Input Range (Initial Setting Level) (P. 5-26)

CT Input Range (Initial Setting Level) (P. 5-26)

Hb-A Heater Burnout Alarm Value (Current)

Set the current conditions for heater burnout alarm.

The alarm will be turned ON if the voltage value reaches Voltage Input Range × Heater Burnout Alarm Value (Voltage) or more and the current value reaches CT Input Range × Heater Burnout Alarm Value (Current) or less.

Range of setting values	Default value
0.0 to 99.9 (% FS)	1.0 (% FS)



Setting-related page

4-4-6 Heater Burnout Alarm (P. 4-24)

Voltage Input Range (Initial Setting Level) (P. 5-26)

CT Input Range (Initial Setting Level) (P. 5-26)

AVER Resistance Value Moving Average Count

Set the moving average count for resistance value.

Range of setting values	Default value
<i>L0W</i> (Moving Average Count of 10)	<i>L0W</i>
<i>M0DL E</i> (Moving Average Count of 20)	
<i>H0EH</i> (Moving Average Count of 40)	



Setting-related page

Resistance Value (Operation Level) (P. 5-10)

AVEP Power Moving Average Count

Set the moving average count for power.

Range of setting values	Default value
L0W (Moving Average Count of 10)	L0W
MdLE (Moving Average Count of 20)	
HGH (Moving Average Count of 40)	



Setting-related page

Power (Operation Level) (P. 5-11)

NFd Normal Fluctuation Deviation

Set the range of resistance values required for the K7TM determining that the heater temperature is stabilized.

The stabilization range of resistance values is as follows:

Normal Fluctuation Deviation Reference ×
(100% - Normal Fluctuation Deviation [%]) to
Normal Fluctuation Deviation Reference ×
(100% + Normal Fluctuation Deviation [%])

Range of setting values	Default value
0.1 to 999.9 (%)	1.0 (%)



Setting-related page

Resistance Value (Operation Level) (P. 5-10)

Normal Fluctuation Deviation Reference (Adjustment Level (Common)) (P. 5-16)

NFd5 Normal Fluctuation Deviation Reference

This is a moving average value of the past 10 resistance values calculated in the stabilized state.

It is a reference value for normal fluctuation deviation.

For this parameter, you can only display the monitored values.

Monitoring range
Same range as Resistance Value
0.000 to 9.999 (Ω)
10.00 to 99.99 (Ω)
100.0 to 999.9 (Ω)



Setting-related page

Resistance Value (Operation Level) (P. 5-10)

Normal Fluctuation Deviation (Adjustment Level (Common)) (P. 5-16)

REFR Reference Resistance Value

This is a reference resistance value registered by the operation command *Reference Resistance Value Registration Start*.

In the following case, the reference resistance value is a temporarily registered value.

- Reference Resistance Value Evaluation State

For this parameter, you can only display the monitored values.

Monitoring range

Same range as Resistance Value
0.000 to 9.999 (Ω)
10.00 to 99.99 (Ω)
100.0 to 999.9 (Ω)



Setting-related page

5-9 Operation Command with Key Operation (P. 5-33)

6-5 Operation Command (P. 6-17)

A-4 Operation of Reference Resistance Value Registration (P. A-16)

EVAR Fluctuation Value under Evaluation (Resistance)

In the *Reference Resistance Value Evaluation State*, the value for which the reference resistance value change rate has fluctuated most sharply will be displayed.

For this parameter, you can only display the monitored values.

Monitoring range

Same range as Reference
Resistance Value Change Rate
-100.0 to 999.9 (%)



Setting-related page

Reference Resistance Value Change Rate (Operation Level) (P. 5-10)

A-4-1 Corrections When Reference Resistance Value Registration Failed (Adjustments with Key Operation) (P. A-17)

VMLN Measurement Voltage Lower Limit Value

Set the lowest voltage conditions for calculating resistance values.

While the voltage value is low, the Unit will not calculate any resistance value because an error in resistance values is large.

Usually, use the default value as it is.

Range of setting values	Default value
3.0 to 99.9 (% FS)	3.0 (% FS)



Setting-related page

Condition 3 (P. 4-10) under 4-3-5 Conditions for Moving from Waiting for Stabilization to Stabilized

Condition 3 (P. 4-12) under 4-3-6 Conditions for Moving from Stabilized to Waiting for Stabilization

AMCN Measurement Current Lower Limit Value

Set the lowest current conditions for calculating resistance values.

While the current value is low, the Unit will not calculate any resistance value because an error in resistance values is large.

Usually, use the default value as it is.

Range of setting values	Default value
3.5 to 99.9 (% FS)	3.5 (% FS)



Setting-related page

Condition 3 (P. 4-10) under *4-3-5 Conditions for Moving from Waiting for Stabilization to Stabilized*

Condition 3 (P. 4-12) under *4-3-6 Conditions for Moving from Stabilized to Waiting for Stabilization*

5-5 Adjustment Level (Power) (LVL b)

The Adjustment Level (Power) is a level that has the parameters required to be adjusted when the stabilization discrimination method for heater temperature is *Power*.

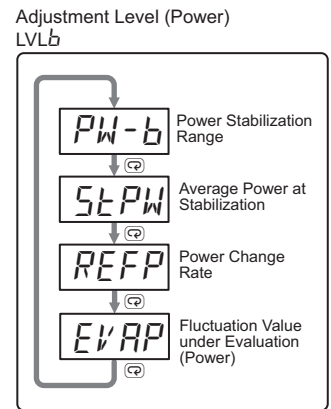

5-5-1 Moving to Adjustment Level (Power)

1. Press the Level Key (⊖) on the Operation Level (for less than 1 second) to move to the Adjustment Level (Common).

2. Pressing the Level Key (⊖) on the Adjustment Level (Common) (for less than 1 second) moves you to the Adjustment Level (Power).

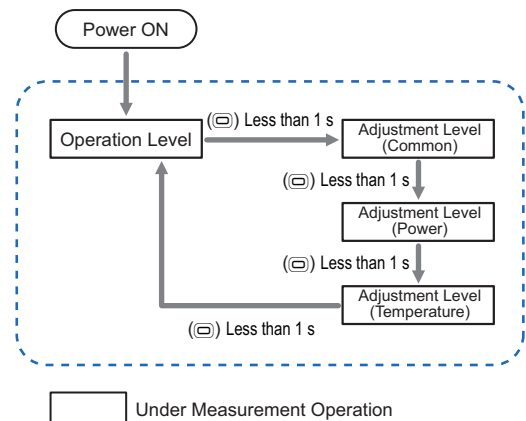

- When you have reached the Adjustment Level (Power), *b* is displayed on the “LVL/measurement value display.”

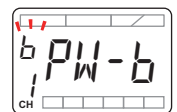

- To return to the Operation Level, press the Level Key (⊖) 2 times within 1 second.

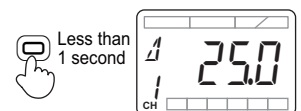

5-5-2 Parameters on Adjustment Level (Power)

PM-b Power Stabilization Range

Set the range of powers that the K7TM judges to be stabilized.

The stabilization range of powers is as follows:
Average Power at Stabilization × (100% - Power Stabilization Range [%]) to Average Power at Stabilization × (100% + Power Stabilization Range [%])

Range of setting values	Default value
0.1 to 999.9 (%)	20.0 (%)

 **Setting-related page**

Average Power at Stabilization (Adjustment Level (Power)) (P. 5-20)

STPW Average Power at Stabilization

This is an average power at stabilization registered by the operation command, *Reference Resistance Value Registration Start*.
For this parameter, you can only display the monitored values.

Monitoring range

Same range as Power
0.0 to 429.0 (kVA)

 **Setting-related page**

5-9 Operation Command with Key Operation (P. 5-33)

6-5 Operation Command (P. 6-17)

A-4 Operation of Reference Resistance Value Registration (P. A-16)

REFP Power Change Rate

This is a power change rate based on the *Average Power at Stabilization*.

It is refreshed for each *Measurement Value Calculation Cycle*.
For this parameter, you can only display the monitored values.

Monitoring range

-100.0 to 999.9 (%)

 **Setting-related page**

Average Power at Stabilization (Adjustment Level (Power)) (P. 5-20)

Measurement Value Calculation Cycle (Initial Setting Level) (P. 5-28)

EVAP Fluctuation Value under Evaluation (Power)

In the *Reference Resistance Value Evaluation State*, the value for which the power change rate has fluctuated most sharply will be displayed.

For this parameter, you can only display the monitored values.

Monitoring range

-100.0 to 999.9 (%)



Setting-related page

Power Change Rate (Adjustment Level (Power)) (P. 5-20)

A-4-1 Corrections When Reference Resistance Value Registration Failed (Adjustments with Key Operation) (P. A-17)

5-6 Adjustment Level (Temperature) (LVL)

The Adjustment Level (Temperature) is a level that has the parameters required to be adjusted when the stabilization discrimination method for heater temperature is *Temperature*.

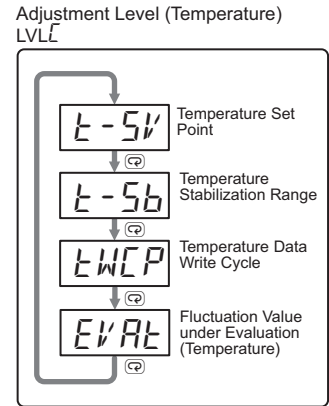

5-6-1 Moving to Adjustment Level (Temperature)

1. Press the Level Key (Ⓚ) on the Operation Level (for less than 1 second) to move to the Adjustment Level (Common).
2. Press the Level Key (Ⓚ) on the Adjustment Level (Common) (for less than 1 second) to move to the Adjustment Level (Power).
3. Pressing the Level Key (Ⓚ) on the Adjustment Level (Power) (for less than 1 second) moves you to the Adjustment Level (Temperature).

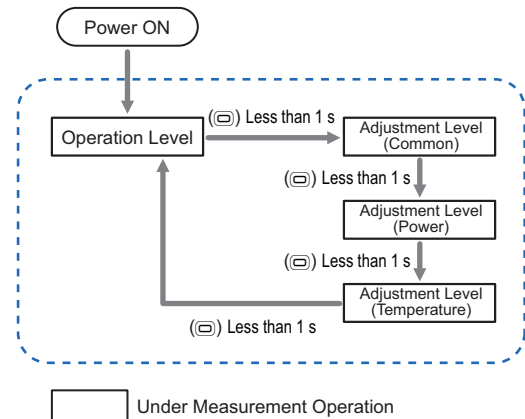

- When you have reached the Adjustment Level (Temperature), LVL is displayed on the “LVL/measurement value display.”
- To return to the Operation Level, press the Level Key (Ⓚ) for less than 1 second.

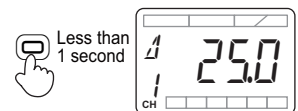
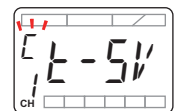

5-6-2 Parameters on Adjustment Level (Temperature)

$t-51$ Temperature Set Point

Set the reference for temperature stabilization range that the K7TM judged to be stabilized.

Range of setting values	Default value
0 to 9,999 (°C/°F)	0 (°C/°F)

 **Setting-related page**

Temperature Stabilization Range (Adjustment Level (Temperature))
(P. 5-23)

$t-5b$ Temperature Stabilization Range

Set the temperature stabilization range that the K7TM judged to be stabilized.

The stabilization range of temperatures is as follows:

(Temperature Set Point - Temperature

Stabilization Range) to (Temperature Set Point + Temperature Stabilization Range)

Range of setting values	Default value
1 to 9,999 (°C/°F)	10 (°C/°F)

 **Setting-related page**

Temperature Stabilization Range (Adjustment Level (Temperature))
(P. 5-23)

$tWCP$ Temperature Data Write Cycle

Set the time during which the K7TM waits for temperature to be written from the host system.

A measurement error will occur if no temperature data was written for *Temperature Data Write Cycle* × 3 or longer time after temperature data was written last.

Range of setting values	Default value
1 to 999 (s)	10 (s)

 **Setting-related page**

Temperature Set Point (Adjustment Level (Temperature)) (P. 5-23)

EVRL Fluctuation Value under Evaluation (Temperature)

In the *Reference Resistance Value Evaluation State*, the value for which temperature is most different from the temperature set point will be displayed.

For this parameter, you can only display the monitored values.

Monitoring range

Same range as Temperature -1,999 to 9,999 (°C/°F)
--



Setting-related page

Temperature (Operation Level) (P. 5-12)

Temperature Set Point (Adjustment Level (Temperature)) (P. 5-23)

A-4-1 Corrections When Reference Resistance Value Registration Failed (Adjustments with Key Operation) (P. A-17)

5-7 Initial Setting Level (LVL 0)

The Initial Setting Level is a level that has the parameters required to be set first for using the K7TM.

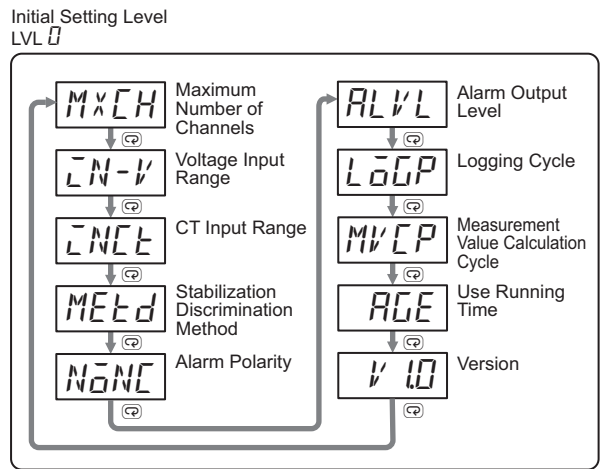

5-7 Initial Setting Level (LVL 0)

5

5-7-1 Moving to Initial Setting Level

5-7-1 Moving to Initial Setting Level

1. On the Operation Level, Adjustment Level (Common), Adjustment Level (Power), or Adjustment Level (Temperature), when you press the Level Key (⊖) for 3 seconds or more, you will move to the Initial Setting Level.

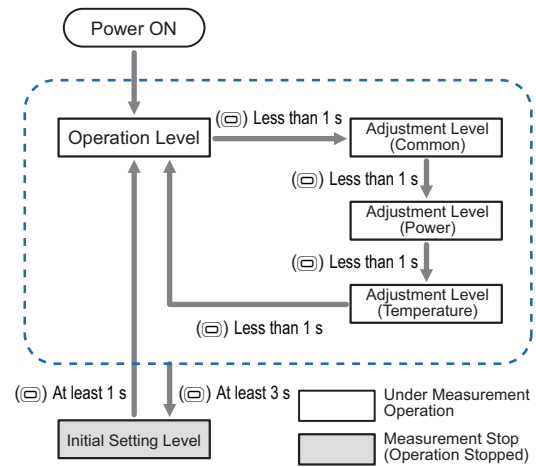

- When you have reached the Initial Setting Level, 0 is displayed on the “LVL/measurement value display.”

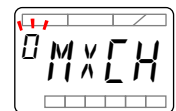

- To return to the Operation Level, press the Level Key (⊖) for 1 second or more.

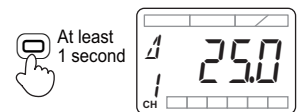

5-7-2 Parameters on Initial Setting Level

MxCH Maximum Number of Channels

Set the number of input channels to use.

This is a setting common to all channels.

Range of setting values	Default value
1 to 2	1



Setting-related page

5-3-1 Switching Measurement Values and Displayed Channels (P. 5-8)

V Voltage Input Range

Set the voltage input range, according to the voltage applied to the heater.

Range of setting values	Default value
120V 240V 480V 600V	120V



Setting-related page

(1) Checking the Heater and Selecting the Special CT (P. 2-5) under 2-3 Advance Preparation

CT CT Input Range

Set the CT input range, according to the CT to use.

Range of setting values	Default value
5A 25A 100A 200A 400A 600A	25A



Setting-related page

(1) Checking the Heater and Selecting the Special CT (P. 2-5) under 2-3 Advance Preparation

MED Stabilization Discrimination Method

Set the method by which to monitor the heater.

Range of setting values	Default value
$Md-1$: Power	$Md-1$
$Md-2$: Temperature	



Setting-related page

Stabilization Discrimination Method for Heater Temperature (P. 2-3) under 2-1 Overview
(4-3) Selection of Method (P. 2-18) under 2-4 Configuration with Tool (Also Configurable with Key Operations)
4-3 Measuring Changes over the Years in Heater (P. 4-6)

NONE Alarm Polarity

Set whether to turn the alarm output contacts ON or OFF during normal operation.

If the setting value is set to $N-\bar{o}$ (normally open), the output contacts will be OFF during normal operation. If it is set to $N-\bar{c}$ (normally close), the output contacts will be ON. That is, when the alarm output turns ON (alarm occurs), the output contacts will turn ON if the setting value is $N-\bar{o}$ or OFF if the setting value is $N-\bar{c}$.

This is a setting common to all channels.

Range of setting values	Default value
$N-\bar{o}$: Normally open $N-\bar{c}$: Normally close	$N-\bar{c}$



Setting-related page

4-4-2 Polarity of Transistor Output When Alarm Occurs (P. 4-19)

When the K7TM is turned OFF, the output contacts turn OFF regardless of the alarm polarity setting value. The difference between normally open and normally close is not only that the logic is reversed when an alarm occurs. When setting the alarm polarity, also consider whether to handle turning the output contacts OFF when the power is unintentionally turned OFF in the same way as when no alarm occurs, or as when an alarm occurs.

Note that the output contacts turn OFF regardless of the alarm polarity setting value, not only when the K7TM power is turned OFF, but also when it is moved to the Initial Setting Level, or when a self-diagnosis error occurs.

	Output contacts ON	Output contacts OFF
Normally open	When an alarm occurs	When no alarm occurs During Power OFF When moving to Initial Setting Level When a self-diagnosis error occurs
Normally close	When no alarm occurs	When an alarm occurs During Power OFF When moving to Initial Setting Level When a self-diagnosis error occurs

ALVL Alarm Output Level

Set the level where the alarm output is produced when an alarm occurs.

This is a setting common to all channels.

Range of setting values	Default value
LOW: Warning or Critical HIGH: Critical	HIGH



Setting-related page

4-4-2 Polarity of Transistor Output When Alarm Occurs (P. 4-19)

LOGP Logging Cycle

Set the cycle in which to keep a log of the reference resistance value change rate, voltage value, current value, and record time.

The Unit keeps a log whenever the measurement values are calculated as many times as the count set in the *Logging Cycle* in the stabilized state.

Example: When the measurement value calculation cycle is set to the default of 100 seconds, log data is recorded once every 27 hours ($\approx 100 \text{ seconds} \times 1,000 \text{ times}$).

Range of setting values	Default value
10 to 9,999 (in 10 times)	100 (in 10 times) (approx. 1 day)



Setting-related page

4-6 Logging Function (P. 4-30)

Measurement Value Calculation Cycle (Initial Setting Level) (P. 5-28)

MVCP Measurement Value Calculation Cycle

Set the cycle in which to calculate the measurement values.

Range of setting values	Default value
1 to 999 (s)	100 (s)



Setting-related page

(4-2) Operation Setting of K7TM (P. 2-17) under 2-4 Configuration with Tool (Also Configurable with Key Operations)

2-7-1 Adjusting the Setting Value of Measurement Value Calculation Cycle (P. 2-52)

AGE Use Running Time

Set whether to inform you with the status display **AGE** Indicator that the K7TM has reached an approximate period in which it stops functioning at its full capacity due to the deterioration of the electrolytic capacitor characteristics.

This is a setting common to all channels.

Range of setting values	Default value
$\bar{a}FF$: Not used $\bar{a}N$: Used	$\bar{a}FF$



Setting-related page

4-7 Running Time (P. 4-32)

V 1.0 Version

Displays the current software version. This parameter only lets you see the software version. It cannot be changed.

Range of setting values	Default value
---	---



The "1.0" part varies with the current software version.

5-8 Communications Setting 1 or 2 Level (LVL 1 or 2)

The Communications Setting Level is a level where you set the parameters required for the serial communications (Modbus RTU) between the K7TM and external devices.

The parameters are grouped as follows, according to the devices to be connected.

- Communications Setting 1 Level: Intended for the host system (host computer, PLC, etc.)
- Communications Setting 2 Level: Intended for the K7TM Configuration Tool or the IoT gateway

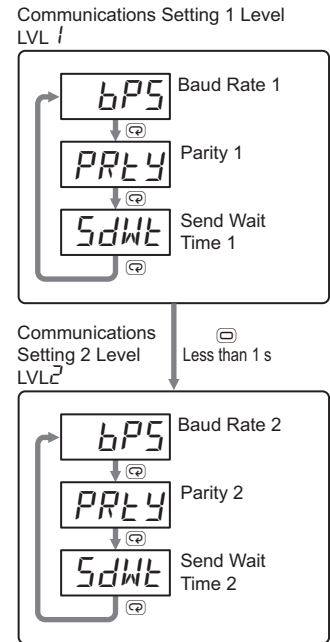

5-8-1 Moving to Communications Setting Level

1. On the Operation Level, Adjustment Level (Common), Adjustment Level (Power), or Adjustment Level (Temperature), when you press the Level Key (⊖) for 3 seconds or more, you will move to the Initial Setting Level.
2. Pressing the Level Key (⊖) on the Initial Setting Level (for less than 1 second) moves you to the Communications Setting 1 Level.
3. Pressing the Level Key (⊖) on the Communications Setting 1 Level (for less than 1 second) moves you to the Communications Setting 2 Level.

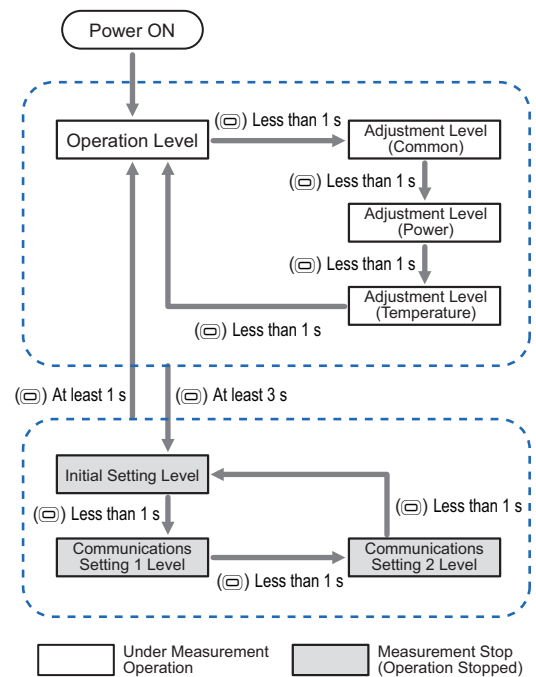

- When you have reached the Communications Setting Level, 1 or 2 is displayed on the “LVL/measurement value display.”



- To return to the Operation Level, press the Level Key (⏏) for 1 second or more.



5-8-2 Parameters on Communications Setting 1 or 2 Level

bps Baud Rate 1 and 2

Set the baud rate of the communications 1 terminals or the communications 2 terminals.

Range of setting values	Default value
9.6 [kbps] 19.2 [kbps] 38.4 [kbps] 57.6 [kbps] 115.2 [kbps] 230.4 [kbps]	115.2 [kbps]

This is a setting common to all channels.



Setting-related page

(3) Communications Setting (P. 2-9) under 2-4 Configuration with Tool
(Also Configurable with Key Operations)

PRTY Parity 1 and 2

Set the parity of the communications 1 terminals or the communications 2 terminals.

Range of setting values	Default value
NONE: None EVEN: Even ODD: Odd	EVEN

This is a setting common to all channels.



Setting-related page

(3) Communications Setting (P. 2-9) under 2-4 Configuration with Tool
(Also Configurable with Key Operations)

5dwt Send Wait Time 1 and 2

Set the send wait time of the communications 1 terminals or the communications 2 terminals.

This is a wait time from when the K7TM receives a command from the host system until it returns a response. If the response comes so fast that the host system cannot receive it properly, increase this setting value. If you want to make the communications response time faster, decrease this setting value.

This is a setting common to all channels.

Range of setting values	Default value
0 to 99 [ms]	20 [ms]

i **Setting-related page**

(3-2) *Communications Setting of Tool and Communications Test* (P. 2-12) under 2-4 *Configuration with Tool (Also Configurable with Key Operations)*
 (4-4) *Communications Setting between K7TM and PLC (Only for Stabilization Discrimination Method (Temperature))* (P. 2-20) under 2-4 *Configuration with Tool (Also Configurable with Key Operations)*

5-8-3 Unit Number

Use the unit number setting switches on the front to set the unit number. The setting range is from 01 to 99. Make the setting when the power is OFF. The setting will be reflected after you cycle the power supply.

The unit number is common to both the communications 1 terminals and communications 2 terminals.

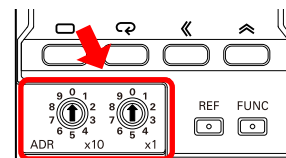

The data length and stop bits of the communications protocol Modbus RTU are fixed internally.

- Data length: Always 8 bits
- Stop bits: Always 1 bit (with parity being even or odd)
 Always 2 bits (with parity being none)

5-9 Operation Command with Key Operation

The following operation commands can be executed with key operations on the K7TM.

Operation Command	Description
Reference Resistance Value Registration Start Command	Starts to register the reference resistance value of each measurement channel.
Reference Resistance Value Registration Cancel Command	Cancels the reference resistance value evaluation of each measurement channel.
Alarm Latch Cancel Command	Releases the alarm latch for all channels.
Parameter Initialization Command	Initializes the setting values on all the setting levels except the communications setting level.

Reference Resistance Value Registration Start Command

● Procedure

1. Display the channel for which to register the reference resistance value on the Operation Level, and press the **REF** Key for 3 seconds or more.

- After the main display flashes at high speed, **RDY** Indicator flashes.
- When registration succeeded, **RDY** Indicator changes to the lit state.
- When registration failed, **RDY** Indicator will not light.

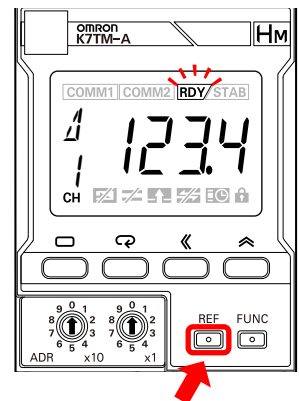

The Reference Resistance Value Registration Start instruction can be executed under the following conditions:



- Parameters on the Operation Level are displayed, with the measurement value display automatic scroll disabled.
- Parameters on the Adjustment Level (Common), Adjustment Level (Power), or Adjustment Level (Temperature) are displayed.
- No A/D error has occurred in the relevant channel.



Precautions for Correct Use

If a measurement error has occurred, clear the measurement error and then send the operation command.

If a heater burnout alarm has occurred (including a latched state), release the alarm latch and then send the operation command.

Reference Resistance Value Registration Cancel Command

● Procedure

1. Display the channel for which to cancel the reference resistance value registration on the Operation Level, and press the **REF** Key for 3 seconds or more.

- The main display starts to flash at high speed; after 3 seconds have elapsed, the reference resistance value registration is canceled for the displayed channel, and **RDY** Indicator goes out.

The Reference Resistance Value Registration Cancel command can be executed under the following conditions:



- Parameters on the Operation Level are displayed, with the measurement value display automatic scroll disabled.
- Parameters on the Adjustment Level (Common), Adjustment Level (Power), or Adjustment Level (Temperature) are displayed.
- No A/D error has occurred in the relevant channel.

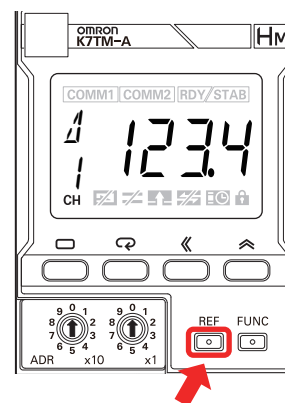

Alarm Latch Cancel Command

● Procedure

1. With parameters displayed on the Operation Level, Adjustment Level (Common), Adjustment Level (Power), or Adjustment Level (Temperature), press the **FUNC** Key for 3 seconds or more.

- The main display starts to flash at high speed; after 3 seconds have elapsed, the alarm latch is released for all channels, and **ALM** Indicator goes out.

The Alarm Latch Cancel Command can be executed under the following conditions:



- Operation Level
- Parameters on the Adjustment Level (Common), Adjustment Level (Power), or Adjustment Level (Temperature) are displayed.

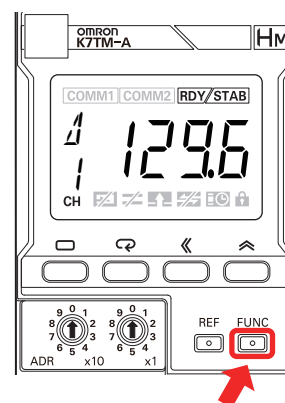

Parameter Initialization

● Procedure

1. With parameters displayed on the Initial Setting Level, Communications Setting 1 Level, or Communications Setting 2 Level, press both the Mode (◀) Key and the **FUNC** Key for 3 seconds or more.

- The main display starts to flash at high speed; after 3 seconds have elapsed, the parameter initialization is executed.

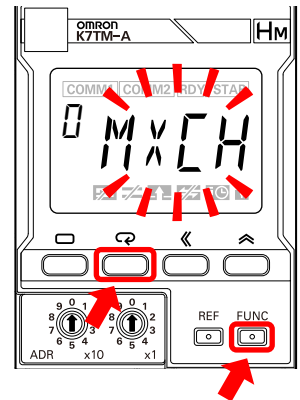

2. Press the Level Key (⊖) for 1 second or more.

- You are moved to the Operation Level, and a power ON reset is executed.
- The parameter initialization becomes enabled after a power ON reset.

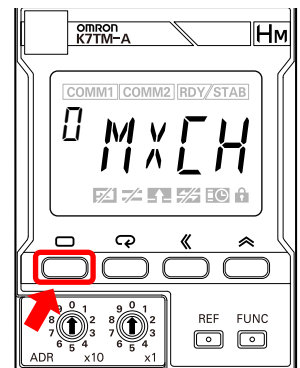

The power ON reset is a reset process inside the K7TM. It is executed by doing as follows:



- Cycling the power supply
- Executing the Software Reset Command via communications
- Moving to the Operation Level with key operation (by pressing the Level Key for 1 second or more in the operation stopped state)



- This command initializes the setting parameters except on the Communications Setting Level.
- The K7TM status, total power on time, running time value, and log data will not be initialized.

6

Remote Monitoring

6-1 Remote Monitoring	6-2
6-2 Communications Overview	6-3
6-3 Variable Area Map	6-5
6-3-1 Variable Area Map Descriptions	6-5
6-3-2 Variable Areas of Both 1CH and 2CH	6-6
6-3-3 Variable Areas of 1CH (Change Beginning Address into 2 for Variable Areas of 2CH)	6-8
6-3-4 Read-Only Variable Areas	6-12
6-3-5 Details about Status Information	6-13
6-4 To Monitor All Measurement Values Together (Reading Variable Areas)	6-16
6-5 Operation Command	6-17
6-6 Checking (Reading) Parameters	6-19
6-7 Changing (Writing) Setting Parameters	6-20
6-8 Modbus RTU Communications Format	6-21
6-8-1 Frame Configurations	6-21
6-8-2 Read Variable Area Command	6-24
6-8-3 Write Variable Area Command	6-25
6-8-4 Operation Command or Write Variable Area Command (Single)	6-27

6-1 Remote Monitoring

The K7TM supports serial communications (Modbus RTU).

It can remotely collect the measurement value, status, and other logs from a remote location, making it possible to intensively monitor the trends toward deterioration of many heaters dispersed throughout the factory.

There are two communications ports: RS-485 communications 1 for connecting the PLC or other host system, and RS-485 communications 2 for connecting the computer with the K7TM Configuration Tool installed.

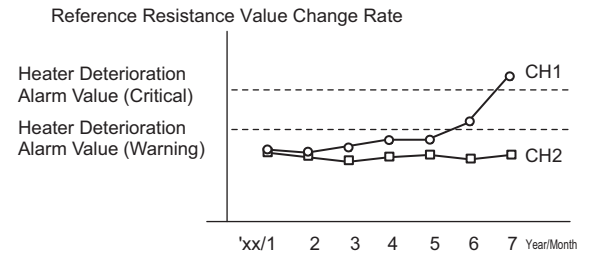

RS-485 communications 1 terminals
(for host system)

RS-485 communications 2 terminals
(for K7TM Configuration Tool or IoT gateway)

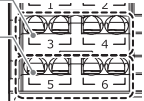

6-2 Communications Overview

Communications Method

This is a master/slave system in which multiple K7TM slave Units are connected to one master host system.

Slave Units connected to the same communications line are distinguished by a unit number.

The commands sent by the master reach all the slaves, but the unit number is embedded in the command frame, so that the slave determines whether a command is addressed to itself and only returns a response to a command addressed to itself.

Refer to *3-7 Setting the Unit Number* on page 3-16 for the procedure to set the unit number.

The master host system sends a command frame, and the K7TM slave Unit returns a response frame corresponding to the contents of the command. One command frame and one response frame make a pair.

The starting point of communications is the command frame sent from the master. When a change in status occurs that should be notified to the slave, it cannot be notified unless there is an inquiry from the master. Therefore, the master must poll at appropriate intervals to determine the slave status.

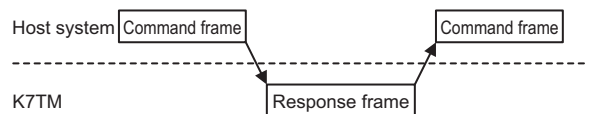
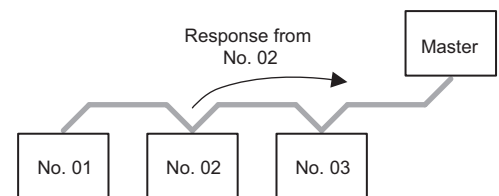
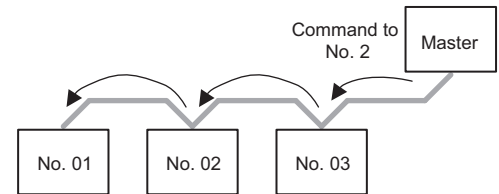

Types of Communications Commands

The following three types are the types of communications commands for the K7TM.

Communications command	Description
Read Variable Area	Reads the variable area.
Write Variable Area	Writes the variable area.
Operation Command	Executes the following for the K7TM. <ul style="list-style-type: none"> • Software resets • Parameter initialization • Operation stop • Alarm latch cancel • Reference resistance value registration start/cancel • Log refresh start/stop

The K7TM has an internal register called the “variable area,” where the measurement values, status information, and setting parameters for each channel are assigned.

Read Variable Area is used to read the measurement values, status information, and setting parameters. Write Variable Area is used to write the setting parameters.

Operation Command is used to execute software resets, parameter initialization, etc. for K7TM without accessing the variable area.

Refer to *6-8 Modbus RTU Communications Format* on page 6-21 for the command frame/response frame configuration.

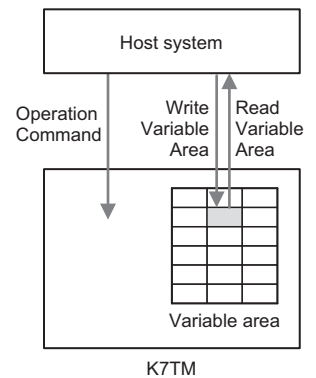

6-3 Variable Area Map

6-3-1 Variable Area Map Descriptions

The K7TM can monitor two channels of heaters, so it also has two channels of variable addresses. Hexadecimal values are expressed by H'**.

- The variable addresses of 1CH start with H'1000.

Example:

Target channel	Variable address	Variable name
1CH	H'1000	Reference Resistance Value Change Rate
	H'1001	Resistance Value (MSD)
	H'1002	Resistance Value (LSD)
	H'1003	Voltage Value
	H'1004	Current Value
•	•	•
•	•	•

- The variable addresses of 2CH start with H'2000.

Example:

Target channel	Variable address	Variable name
2CH	H'2000	Reference Resistance Value Change Rate
	H'2001	Resistance Value (MSD)
	H'2002	Resistance Value (LSD)
	H'2003	Voltage Value
	H'2004	Current Value
•	•	•
•	•	•

- The variable addresses of both 1CH and 2CH start with H'0000.

Example:

Target channel	Variable address	Variable name
Both 1CH and 2CH	H'0000	K7TM Status
	H'0001	Total Power ON Time (MSD)
	H'0002	Total Power ON Time (LSD)
	H'0003	Running Time Value
•	•	•
•	•	•



This manual describes only the variable addresses of 1CH so as to simplify the description.

When you use a variable address of 2CH, change the beginning of the variable address of 1CH into 2 before use.

Example: H'1000 to H'2000

To write via communications a variable whose setting reflection timing is “After restart,” you need to execute the operation command, Operation Stop Command, or move to the Initial Setting Level with key operation beforehand.

Setting reflection timing

Immediately

After restart

6-3-2 Variable Areas of Both 1CH and 2CH

Specify the address to access each variable.

Hexadecimal values are expressed by H'**.

Variable address	Variable name	Description	Setting reflection timing
H'0000	K7TM Status	This is a monitored value. It is the parameter exclusive to communications. It is the data that brings together the status of the K7TM. Refer to 6-3-5 <i>Details about Status Information</i> on page 6-13 for details about the bits.	Immediately
H'0001	Total Power ON Time (MSD)	This is a monitored value. It is the parameter exclusive to communications. It is the total power ON time (MSD) that has elapsed after the K7TM is first used. This is a monitored value. H'0000 to H'FFFF (in seconds)	Immediately
H'0002	Total Power ON Time (LSD)	This is a monitored value. It is the parameter exclusive to communications. It is the total power ON time (LSD) that has elapsed after the K7TM is first used. H'0000 to H'FFFF (in seconds)	Immediately
H'0003	Running Time Value	This is a monitored value. It is the parameter exclusive to communications. It expresses in percent how soon the K7TM will reach an approximate period until the Unit stops functioning at its full capacity due to the deterioration of the electrolytic capacitor characteristics. H'0000 to H'0064 (0% to 100%)	Immediately
H'0004 to H'007F	Unused	H'0000	---
H'0080	Measurement Value Display Automatic Scroll	This is a setting parameter. H'0000: Not used (default value), H'0001: Used	Immediately
H'0081	Setting Change Protection	This is a setting parameter. H'0000: Permitted (default value), H'0001: Prohibited	Immediately
H'0082 to H'00FF	Unused	H'0000	---
H'0100	Maximum Number of Channels	This is a setting parameter. Set the number of input channels to use. H'0001 (1 channel) (default value), H'0002 (2 channels)	After restart
H'0101	Use Running Time	This is a setting parameter. H'0000: Not used (default value), H'0001: Used	After restart
H'0102	Alarm Polarity	This is a setting parameter. H'0000: Normally open, H'0001: Normally close (default value)	After restart
H'0103	Alarm Output Level	This is a setting parameter. H'0000: Warning or Critical, H'0001: Critical (default value)	After restart
H'0104 to H'0117	Unused	H'0000	---
H'0118	Baud Rate 1	This is a setting parameter. Set the baud rate of the communications 1 terminals. H'0000: 9.6 k, H'0001: 19.2 k, H'0002: 38.4 k, H'0003: 57.6 k, H'0004: 115.2 k (default value), H'0005: 230.4 kbps	After restart
H'0119	Parity 1	This is a setting parameter. Set the parity of the communications 1 terminals. H'0000: None, H'0001: Even (default value), H'0002: Odd	After restart
H'011A	Send Wait Time 1	This is a setting parameter. Set the send wait time of the communications 1 terminals. H'0000 to H'0063 (0 to 99 ms), Default value: H'0014 (20 ms)	After restart
H'011B to H'0124	Unused	H'0000	---

Variable address	Variable name	Description	Setting reflection timing
H'0125	Baud Rate 2	This is a setting parameter. Set the baud rate of the communications 2 terminals. H'0000: 9.6 k, H'0001: 19.2 k, H'0002: 38.4 k, H'0003: 57.6 k, H'0004: 115.2 k (default value), H'0005: 230.4 kbps	After restart
H'0126	Parity 2	This is a setting parameter. Set the parity of the communications 2 terminals. H'0000: None, H'0001: Even (default value), H'0002: Odd	After restart
H'0127	Send Wait Time 2	This is a setting parameter. Set the send wait time of the communications 2 terminals. H'0000 to H'0063 (0 to 99 ms), Default value: H'0014 (20 ms)	After restart
H'0128 to H'0FFF	Unused	H'0000	---

6-3-3 Variable Areas of 1CH (Change Beginning Address into 2 for Variable Areas of 2CH)

Variable address	Variable name	Description	Setting reflection timing
H'1000	Reference Resistance Value Change Rate *1	This is a monitored value. H'FC18 to H'270F (-100.0% to 999.9%)	Immediately
H'1001	Resistance Value (MSD) *1	This is a monitored value. This is a resistance value of the heater. It is refreshed for each <i>Measurement Value Calculation Cycle</i> . According to the setting of <i>Resistance Value Moving Average Count</i> , it is refreshed by the value calculated in moving average processing.	Immediately
H'1002	Resistance Value (LSD) *1	Range • Communications 000.000 to 999.900 Example: For 999.900, MSD is H'000F, LSD is H'41DC • HMI 0.000 to 9.999 10.00 to 99.99 100.0 to 999.9	
H'1003	Voltage Value *1	This is a monitored value. 120 [V] range: H'0000 to H'0528 (0.0 to 132.0 V) 240 [V] range: H'0000 to H'0A50 (0.0 to 264.0 V) 480 [V] range: H'0000 to H'14A0 (0.0 to 528.0 V) 600 [V] range: H'0000 to H'19C8 (0.0 to 660.0 V)	Immediately
H'1004	Current Value *1	This is a monitored value. 5 [A] range: H'0000 to H'0226 (0.00 to 5.50 A) 25 [A] range: H'0000 to H'0113 (0.0 to 27.5 A) 100 [A] range: H'0000 to H'044C (0.0 to 110.0 A) 200 [A] range: H'0000 to H'0898 (0.0 to 220.0 A) 400 [A] range: H'0000 to H'1130 (0.0 to 440.0 A) 600 [A] range: H'0000 to H'1964 (0.0 to 650.0 A)	Immediately
H'1005	Power *1	This is a monitored value. H'0000 to H'10C2 (0.0 to 429.0 kVA)	Immediately
H'1006	Last Resistance Value Change Rate	This is a monitored value. It is the parameter exclusive to communications. H'FC18 to H'07D0 (-100.0% to 200.0%)	Immediately
H'1007 to H'101A	Unused	H'0000	---
H'101B	Monitoring Status	This is a monitored value. It is the parameter exclusive to communications. It is the data that brings together the monitoring status. Refer to <i>6-3-5 Details about Status Information</i> on page 6-13 for details about the bits.	Immediately
H'101C	Measurement Error Status	This is a monitored value. It is the parameter exclusive to communications. It is the data that brings together the measurement error status. Refer to <i>6-3-5 Details about Status Information</i> on page 6-13 for details about the bits.	Immediately
H'101D	Alarm status	This is a monitored value. It is the data that brings together the alarm status. Refer to <i>6-3-5 Details about Status Information</i> on page 6-13 for details about the bits. It can also be checked at <i>Alarm Status</i> on the Operation Level.	Immediately

*1. When the K7TM main display is "----," the readout value is 0.

Variable address	Variable name	Description	Setting reflection timing
H'101E to H'1032	Unused	H'0000	---
H'1033	Reference Resistance Value Registration Evaluation Count	This is a monitored value. It is the parameter exclusive to communications. H'0000 to H'0005 (0 to 5 times)	Immediately
H'1034	Fluctuation Value under Evaluation (Resistance) *1	This is a monitored value. In the <i>Reference Resistance Value Evaluation State</i> , the value for which the reference resistance value change rate has fluctuated most sharply will be retained. It has the same range as that of Reference Resistance Value Change Rate. H'FC18 to H'270F (-100.0% to 999.9%)	Immediately
H'1035	Normal Fluctuation Deviation Reference (MSD)	This is a monitored value. This is a moving average value of the past 10 resistance values calculated in the stabilized state. It is a reference value for normal fluctuation deviation. It has the same range as that of Resistance Value.	Immediately
H'1036	Normal Fluctuation Deviation Reference (LSD)		
H'1037	Reference Resistance Value (MSD) *1	This is a monitored value. This is a reference resistance value registered by the operation command, <i>Reference Resistance Value Registration Start</i> . It has the same range as that of Resistance Value.	Immediately
H'1038	Reference Resistance Value (LSD) *1		
H'1039	Average Power at Stabilization *1	This is a monitored value. It is the average power at stabilization registered by the operation command, <i>Reference Resistance Value Registration Start</i> . It has the same range as that of Power. H'0000 to H'10C2 (0.0 to 429.0 kVA)	Immediately
H'103A	Power Change Rate *1	This is a monitored value. This is a power change rate based on the <i>Average Power at Stabilization</i> . It is refreshed for each <i>Measurement Value Calculation Cycle</i> . H'FC18 to H'270F (-100.0% to 999.9%)	Immediately
H'103B	Fluctuation Value under Evaluation (Power) *1	This is a monitored value. In the <i>Reference Resistance Value Evaluation State</i> , the value for which the power change rate has fluctuated most sharply will be retained. H'FC18 to H'270F (-100.0% to 999.9%)	Immediately
H'103C	Fluctuation Value under Evaluation (Temperature) *2	This is a monitored value. In the <i>Reference Resistance Value Evaluation State</i> , the value for which temperature is most different from the temperature set point will be retained. It has the same range as that of H'1100 Temperature. H'F831 to H'270F (-1,999 to 9,999°C/°F)	Immediately
H'103D to H'10FF	Unused	H'0000	---
H'1100	Temperature *1	This is a setting parameter written from the host system. However, it is not refreshed in the operation stopped state. Write it in the operating state. When you write this parameter, it is reflected in 1 second. To check it by reading, wait for 1 second. H'F831 to H'270F (-1,999 to 9,999°C/°F)	Immediately
H'1101	Manipulated Variable	This is a setting parameter written from the host system. It is the parameter exclusive to communications. H'FBB4 to H'044C (-110.0 to 110.0)	Immediately

*1. When the K7TM main display is "----," the readout value is 0.

*2. When the K7TM main display is "----," the readout value is 0 or a temperature set point.

Variable address	Variable name	Description	Setting reflection timing
H'1102 to H'1116	Unused	H'0000	---
H'1117	Heater Deterioration Alarm Value (Warning)	This is a setting parameter. H'0001 to H'270F (0.1% to 999.9%), Default value: H'001E (3.0%)	Immediately
H'1118	Heater Deterioration Alarm Value (Critical)	This is a setting parameter. H'0001 to H'270F (0.1% to 999.9%), Default value: H'0032 (5.0%)	Immediately
H'1119	Last Resistance Value Change Rate Alarm Value	This is a setting parameter. H'0001 to H'270F (0.1% to 999.9%), Default value: H'00FA (25.0%)	Immediately
H'111A	Heater Burnout Alarm Value (Voltage)	This is a setting parameter. H'0000 to H'03E7 (0.0% to 99.9% FS), Default value: H'0190 (40.0% FS)	Immediately
H'111B	Heater Burnout Alarm Value (Current)	This is a setting parameter. H'0000 to H'03E7 (0.0% to 99.9% FS), Default value: H'000A (1.0% FS)	Immediately
H'111C	Measurement Voltage Lower Limit Value	This is a setting parameter. H'001E to H'03E7 (3.0% to 99.9% FS), Default value: H'001E (3.0% FS)	Immediately
H'111D	Measurement Current Lower Limit Value	This is a setting parameter. H'0023 to H'03E7 (3.5% to 99.9% FS), Default value: H'0023 (3.5% FS)	Immediately
H'111E	Resistance Value Moving Average Count	This is a setting parameter. H'0000: Low (Moving Average Count of 10) (default value), H'0001: Middle (Moving Average Count of 20), H'0002: High (Moving Average Count of 40)	Immediately
H'111F	Power Moving Average Count	This is a setting parameter. H'0000: Low (Moving Average Count of 10) (default value), H'0001: Middle (Moving Average Count of 20), H'0002: High (Moving Average Count of 40)	Immediately
H'1120	Normal Fluctuation Deviation	This is a setting parameter. H'0001 to H'270F (0.1% to 999.9%), Default value: H'000A (1.0%)	Immediately
H'1121	Power Stabilization Range	This is a setting parameter. H'0001 to H'270F (0.1% to 999.9%), Default value: H'00C8 (20.0%)	Immediately
H'1122	Temperature Data Write Cycle	This is a setting parameter. H'0001 to H'03E7 (1 to 999 s), Default value: H'000A (10 s)	Immediately
H'1123	Temperature Set Point	This is a setting parameter. H'0000 to H'270F (0 to 9,999°C/°F), Default value: H'0000 (0°C/°F)	Immediately
H'1124	Temperature Stabilization Range	This is a setting parameter. H'0001 to H'270F (1 to 9,999°C/°F), Default value: H'000A (10°C/°F)	Immediately
H'1125 to H'11FF	Unused	H'0000	---
H'1200	Voltage Input Range	This is a setting parameter. H'0000: 120 V (default value), H'0001: 240 V, H'0002: 480 V, H'0003: 600 V	After restart
H'1201	CT Input Range	This is a setting parameter. H'0000: 5 A, H'0001: 25 A (default value), H'0002: 100 A, H'0003: 200 A, H'0004: 400 A, H'0005: 600 A	After restart
H'1202	Measurement Value Calculation Cycle	This is a setting parameter. H'0001 to H'03E7 (1 to 999 s), Default value: H'0064 (100 s)	After restart

Variable address	Variable name	Description	Setting reflection timing
H'1203	Stabilization Discrimination Method	This is a setting parameter. H'0000: Power (default value), H'0001: Temperature	After restart
H'1204	Logging Cycle	This is a setting parameter. H'000A to H'270F (10 to 9,999 times), Default value: H'0064 (100 times)	After restart
H'1205 to H'12FF	Unused	H'0000	---
H'1300 ⋮ H'131D	Log Data [1] (Reference Resistance Value Change Rate) ⋮ Log Data [30] (Reference Resistance Value Change Rate)	This is a monitored value. It is the parameter exclusive to communications. The reference resistance value change rate is recorded for each cycle set in the <i>Logging Cycle</i> . Log Data [1] is the oldest data. It is possible to record Log Data [1], [2], ..., and up to [30]. H'FC18 to H'270F (-100.0 to 999.9), Default value: H'0000 (0.0%)	Immediately
H'131E to H'1331	Unused	H'0000	---
H'1332 ⋮ H'134F	Log Data [1] (Voltage) ⋮ Log Data [30] (Voltage)	This is a monitored value. It is the parameter exclusive to communications. The voltage is recorded for each cycle set in the <i>Logging Cycle</i> . Log Data [1] is the oldest data. Logs are stored on a first-in-first-out basis. It is possible to record Log Data [1], [2], ..., and up to [30]. It has the same range as that of Voltage Value.	Immediately
H'1350 to H'1363	Unused	H'0000	---
H'1364 ⋮ H'1381	Log Data [1] (Current) ⋮ Log Data [30] (Current)	This is a monitored value. It is the parameter exclusive to communications. The current is recorded for each cycle set in the <i>Logging Cycle</i> . Log Data [1] is the oldest data. Logs are stored on a first-in-first-out basis. It is possible to record Log Data [1], [2], ..., and up to [30]. It has the same range as that of Current Value.	Immediately
H'1382 to H'1395	Unused	H'0000	---
H'1396 ⋮ H'13D0	Record Time [1] (for Reference Resistance Value Change Rate/Voltage/Current) ⋮ Record Time [30] (for Reference Resistance Value Change Rate/Voltage/Current)	This is a monitored value. It is the parameter exclusive to communications. It records the time when the log data was recorded. The time is recorded as Total Power ON Time. Log Data [1] is the oldest data. Logs are stored on a first-in-first-out basis. It is possible to record Log Data [1], [2], ..., and up to [30]. The record time is 4-byte data. Read two addresses for that. Example H'1396: Record Time [1] (MSD) H'1397: Record Time [1] (LSD) H'1398: Record Time [2] (MSD) H'1399: Record Time [2] (LSD)	Immediately
H'13D1 to H'13FF	Unused	H'0000	---

6-3-4 Read-Only Variable Areas

Variable address	Variable name	Description
H'C003	Major Revision	Indicates a major revision of the firmware version. Example: H'0001 for version 1.2
H'C004	Minor Revision	Indicates a minor revision of the firmware version. Example: H'0002 for version 1.2
H'C005 to H'C006	Serial Number	This is a parameter exclusive to communications. This is a product-unique serial number. H'00000000 to H'FFFFFFF (0 to 4294967295) Variable address H'C005 is the most-significant digit and H'C006 is the least-significant digit.
H'C007 to H'C009	Unused	This is an used area. H'0000 is read.
H'C00A to H'C019	Product Model	This is a parameter exclusive to communications. Indicates a model of the K7TM in ASCII code. The model is left-aligned. The remaining areas are filled with ASCII space codes (H'20). Example: For the K7TM-A2MA, H'4B37544D2D41324D412020...
H'C01A to H'C01D	Product Code	This is a parameter exclusive to communications. This is a JAN/EAN code for the K7TM. 4549734725385: K7TM-A2MA 4549734725392: K7TM-A2MD Example: When the code is read for the K7TM, it becomes H'0XXXXXXXXXXXXX00, with H'0 appended to the most-significant digit and H'00 appended to the least-significant digit. Variable address H'C01A is the most-significant digit and H'C01D is the least-significant digit.

6-3-5 Details about Status Information

Variable address	Variable name	B15	B14	B13-11	B10	B9	B8	B7-4	B3	B2	B1	B0	Bit name	Description
H'0000	K7TM Status												Heater Deterioration Alarm (Warning)	0: Heater Deterioration Alarm (Warning) did not occur 1: Heater Deterioration Alarm (Warning) occurred in a channel
													Heater Deterioration Alarm (Critical)	0: Heater Deterioration Alarm (Critical) did not occur 1: Heater Deterioration Alarm (Critical) occurred in a channel
													Last Resistance Value Change Rate Alarm	0: Last Resistance Value Change Rate Alarm did not occur 1: Last Resistance Value Change Rate Alarm occurred in a channel
													Heater Burnout Alarm	0: Heater Burnout Alarm did not occur 1: Heater Burnout Alarm occurred in a channel
													-	Not used: Always 0
													Operation	0: Operation stopped 1: During operation
													Operation Stopped	0: During operation 1: Operation stopped
													K7TM Error	0: K7TM Error did not occur 1: K7TM Error occurred
													-	Not used: Always 0
													Running Time Measurement Error	0: Running Time Measurement Error did not occur 1: Running Time Measurement Error occurred
													Running Time	0: <i>Running Time Value</i> is less than 100% 1: <i>Running Time Value</i> reached 100%

Variable address	Variable name	B 15-8	B 7	B 6	B 5	B 4	B 3	B 2	B 1	B 0	Bit name	Description	
H'101B	Monitoring Status										Reference Resistance Value Evaluation State	0: Not in reference resistance value evaluation state 1: In reference resistance value evaluation state	
											Reference Resistance Value Registration Succeeded or Not	0: Not succeeded in registration of reference resistance value 1: Succeeded in registration of reference resistance value	
											Reference Resistance Value Temporarily Registered or Not	0: Reference resistance value not temporarily registered 1: Reference resistance value temporarily registered	
											Reference Resistance Value Registered or Not	0: Reference resistance value not registered 1: Reference resistance value already registered	
											Stabilized State	0: No stabilization conditions are fulfilled 1: All stabilization conditions are fulfilled	
											Stabilization Condition (Power/Temperature)	Case of Stabilization Discrimination Method = Power	0: Stabilization condition of Power is not fulfilled 1: Stabilization condition of Power is fulfilled
												Case of Stabilization Discrimination Method = Temperature	0: Stabilization condition of Temperature is not fulfilled 1: Stabilization condition of Temperature is fulfilled
											Stabilization Condition (Resistance Value)	0: Resistance Out-of-Range Error did not occur 1: Resistance Out-of-Range Error occurred	
											Input Present or Not	0: Voltage is less than Measurement Voltage Lower Limit Value or Current is less than Measurement Current Lower Limit Value 1: Voltage is at least Measurement Voltage Lower Limit Value and Current is at least Measurement Current Lower Limit Value	
											-	Not used: Always 0	

Variable address	Variable name	B 15-6	B5	B4	B3	B2	B1	B0	Bit name	Description
H'101C	Measurement Error Status								Resistance Value Out-of-Range Error	0: Resistance Value Out-of-Range Error did not occur 1: Resistance Value Out-of-Range Error occurred
									Voltage Value Out-of-Range Error	0: Voltage Value Out-of-Range Error did not occur 1: Voltage Value Out-of-Range Error occurred
									Current Value Out-of-Range Error	0: Current Value Out-of-Range Error did not occur 1: Current Value Out-of-Range Error occurred
									Temperature Data Not-refreshed Error	0: Temperature Data Not-refreshed Error did not occur 1: Temperature Data Not-refreshed Error occurred
									Not-stabilized Error	0: Not-stabilized Error did not occur 1: Not-stabilized Error occurred
									A/D Error	0: A/D Error did not occur 1: A/D Error occurred
									-	Not used: Always 0

Variable	Variable name	B15-4	B3	B2	B1	B0	Bit name	Description
H'101D	Alarm status						Heater Deterioration Alarm (Warning)	0: Heater Deterioration Alarm (Warning) did not occur 1: Heater Deterioration Alarm (Warning) occurred
							Heater Deterioration Alarm (Critical)	0: Heater Deterioration Alarm (Critical) did not occur 1: Heater Deterioration Alarm (Critical) occurred
							Last Resistance Value Change Rate Alarm	0: Last Resistance Value Change Rate Alarm did not occur 1: Last Resistance Value Change Rate Alarm occurred
							Heater Burnout Alarm	0: Heater Burnout Alarm did not occur 1: Heater Burnout Alarm occurred
							-	Not used: Always 0

6-4 To Monitor All Measurement Values Together (Reading Variable Areas)

The K7TM can read all the measurement values and statuses together using the Read Variable Area command.

The Read Variable Area command can read single specified addresses one by one, but it can also read multiple addresses together by specifying an area. The latter case is convenient, as the read operation can be completed with one command/one response.

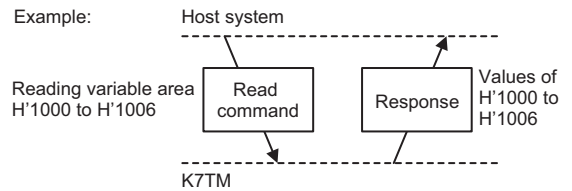

Refer to 6-3 *Variable Area Map* on page 6-5 for details on the variable area to specify.

6-5 Operation Command

The following six types of operation commands are available.

Operation Command	Description
Software Reset Command	Performs a forced power ON reset.
Parameter Initialization Command	Initializes the setting values of all the setting parameters except those on the Communications Setting Level.
Operation Stop Command	Moves you to the Initial Setting Level, which is an operation stopped state.
Alarm Latch Cancel Command	Turns OFF the latched alarm status.
Reference Resistance Value Registration Start/Cancel Command	Starts/Cancel registering the reference resistance value.
Log Refresh Start/Stop Command	Starts/Stops refreshing the logs.

Operation commands are specified by a command code in the command frame.

6-8 *Modbus RTU Communications Format* on page 6-21 describes the command frame/response frame configuration.

Software Reset Command

This command executes a power ON reset process, as with a reset process that runs when the power turns ON.

The power ON reset puts the K7TM in the same initial state as after the power is turned ON.

The Software Reset Command can be accepted at any level.

The Software Reset Command can be used in the following cases.

- (1) To clear the latched alarm output.
- (2) To forcibly return to the Operation Level from a level other than the Operation Level (such as the Initial Setting Level) by remote operation. (For example, if you leave the work site with the Unit still on the Initial Setting Level selected with key operation, measurement will not start as it is not on the Operation Level.)
- (3) To enable the new setting value after changing a setting parameter with the Write Variable Area command.

The reason for (3) is that the power ON reset process is required when setting reflection timing is "After restart."

Also refer to 6-7 *Changing (Writing) Setting Parameters* on page 6-20.

Parameter Initialization Command

This command initializes the setting values of all the setting parameters except those on the Communications Setting Level.

A power ON reset process is required to enable the setting values that were returned to the default values. Execute the power ON reset process by cycling the power supply, sending the Software Reset Command, or operating the key.

Operation Stop Command

This command moves you to the Initial Setting Level, which is an operation stopped state.

The command is accepted at the Operation Level, Adjustment Level (Common), Adjustment Level (Power), or Adjustment Level (Temperature), which is an operation stopped state.

In order to set the setting values on the Initial Setting Level, Communications Setting 1 Level, or Communications Setting 2 Level, you need to enter the operation stopped state.

To resume operation, a power ON reset is required.

The power on reset can be executed by doing as follows:

- Cycling the power supply
- Executing the Software Reset Command via communications
- Moving to the Operation Level with key operation (by pressing the Level Key for 1 second or more in the operation stopped state)

Alarm Latch Cancel Command

This command turns OFF the latched alarm status.

When an alarm occurs, it is in the latched (retained) state. The alarm is unlatched when this command is sent with the measurement value falling short of the alarm value.

Reference Resistance Value Registration Start/Cancel Command

This command starts/cancels registering the reference resistance value.

The K7TM automatically judges that the heater is operating stably (in the stabilized state), and registers the reference resistance value.

The **RDY** Indicator flashes when this command is sent. When registering the reference resistance value is completed, **RDY** Indicator becomes in the lit state.

The cancel command is accepted while the **RDY** Indicator is flashing. The registration of reference resistance value will be stopped, and the **RDY** Indicator will not light.

Refer to (5) *Preparations (Registration)* on page 2-24 in *2-4 Configuration with Tool (Also Configurable with Key Operations)* for operation for the reference resistance value registration.

Log Refresh Start/Stop Command

This command starts/stops refreshing a resistance monitoring log.

In the resistance monitoring log, the reference resistance value change rates while the heater is stabilized are calculated and logged in the Logging Cycle (100 × 10 times by default).

(When the measurement value calculation cycle is set to the default of 100 seconds, log data is recorded once every 27 hours (≈ 100 seconds × 1,000 times).)

Refer to *4-6 Logging Function* on page 4-30 for details on the resistance monitoring log data.

6-6 Checking (Reading) Parameters

The Read Variable Area command allows you to read the parameters.

The Read Variable Area command can read single specified addresses one by one, but it can also read multiple addresses together by specifying an area. The latter case is convenient, as the read operation can be completed with one command/one response.

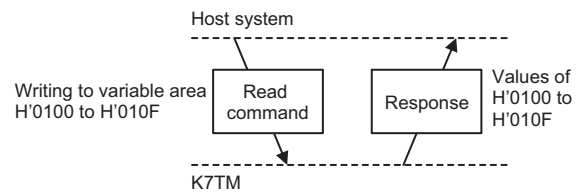

The parameters can be read regardless of the state where the K7TM is. The reading operation does not affect the K7TM operation.

6-7 Changing (Writing) Setting Parameters

The Write Variable Area command allows you to change the setting parameters.

The Write Variable Area command can write single specified addresses one by one, but it can also write multiple addresses together by specifying an area. The latter case is convenient, as the write operation can be completed with one command/one response.

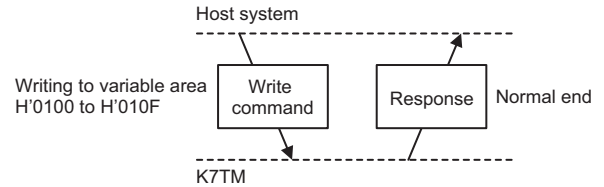

Sending the command changes and saves the setting parameters in the non-volatile memory in the K7TM.

Some setting parameters are reflected in operation immediately after writing, and others are reflected in operation after reset. Refer to the tables in 6-3 *Variable Area Map* on page 6-5 for whether they are reflected in operation immediately.

For example, *Alarm Polarity* is a parameter that is reflected in operation after reset.

If the setting value of *Alarm Polarity* is changed with a communications command for changing setting parameters, a power ON reset process must be executed with the Software Reset Command etc.

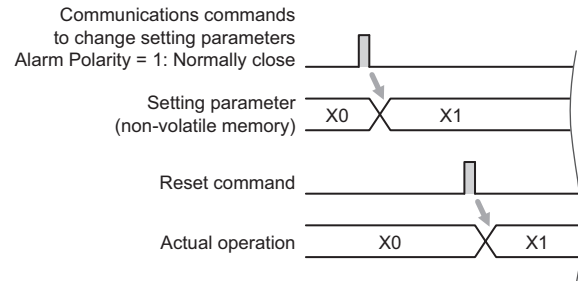

6-8 Modbus RTU Communications Format

Modbus RTU is a standard communications control method that conforms to Modicon Inc.'s RTU-mode Modbus Protocol (PI-MBUS-300 Rev. J). In the following description, hexadecimal values are expressed by adding the prefix "H" to the beginning, e.g., "H'02."

6-8-1 Frame Configurations

Command Frame

A command frame starts with a silent interval of at least 3.5 character times and ends with a silent interval of at least 3.5 character times.

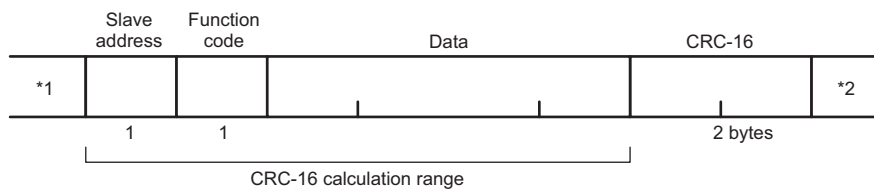

*1	Silent interval of 3.5 character times minimum.
Slave address	This number specifies the transmission's destination. Specify the unit number of the K7TM. The unit number can be set between H'01 to H'63 hexadecimal (01 to 99 decimal). To broadcast this value, specify H'00. However, in the case of broadcasting, no response is returned.
Function code	The function code is a 1-byte hexadecimal code that indicates the type of command sent from the host device.
Data	This is the text data associated with the specified function code. Specify the variable area address, setting values for setting parameters, etc. in hexadecimal format.
CRC-16	Cyclic Redundancy Check This check code is calculated with the data from the slave address to the end of the data. The check code is 2-byte hexadecimal.
*2	Silent interval of 3.5 character times minimum.

CRC-16 Calculation Method

Messages are processed one byte at a time in the work memory (a 16-bit register known as the CRC register).

- (1) The CRC register is initialized to H'FFFF.
- (2) An XOR operation is performed on the content of the CRC register and the first byte of the message, and the result is returned to the CRC register.
- (3) The MSB is packed with "0" and the CRC register is shifted 1 bit to the right.
- (4) If the bit shifted from the LSB is "0," step (3) is repeated (next bit-shift processing).
If the bit shifted from the LSB is "1," an XOR is performed on the content of the CRC register and H'A001, and the result is returned to the CRC register.
- (5) Steps (3) and (4) are repeated until 8 bits are shifted.
- (6) CRC processing continues to the end of the message, as XOR operations are performed on the content of the CRC register and the next byte of the message, step (3) is repeated, and the result is returned to the CRC register.
- (7) The result of the CRC calculation (value in the CRC register) is appended to the last byte of the message.

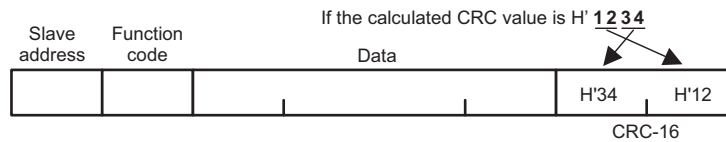

Response Frame

● Normal Operation:

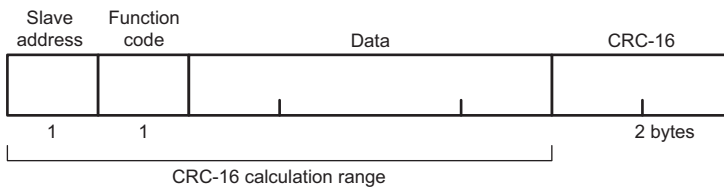

● Command Frame Error:

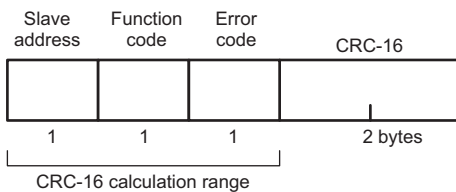

Slave address	The number specified in the command frame is entered as-is.
Function code	This is a received function code. However, H'80 is added to the received function code to indicate that the response is an error response for the response frame when an error occurs. Example: If the received function code is H'03, the error response is H'83.
Data	The body text of the response.
Error code	This code indicates the kind of error that occurred. Refer to the table below.

CRC-16	<p>Cyclic Redundancy Check</p> <p>This check code is calculated with the data from the slave address to the end of the data.</p> <p>The check code is 2-byte hexadecimal.</p>
---------------	---

● Error Code:

Completion code	Name	Description
H'01	Function code error	An unsupported function code was received.
H'02	Variable address error	The variable address was accessed in excess of H'FFFF.
H'03	Variable data error	<ul style="list-style-type: none"> • The number of elements specified in the command frame data and the number of data do not match. • The byte count is not two times the number of elements specified in the command frame data. • The number of elements exceeds the allowed range. • The write data specified in the command frame data is out of the setting range.
H'04	Operation error	<ul style="list-style-type: none"> • No response can be made in this system state. • Log data is read with refreshing the log not stopped.

● No Response

In the following cases, the received command will not be processed and a response will not be returned. Therefore, a timeout error will occur in the host system.

- The slave address in the received command does not match the unit number.
- A parity error, framing error, or overrun error occurred due to a problem such as a transfer error.
- A CRC-16 code error occurred in the received command frame.
- There was an interval of 3.5 character times minimum between data packets that make up the command frame.

In addition, in the following case, the received command will be processed but no response will be made.

- Broadcasting is specified (slave address: H'00)

6-8-2 Read Variable Area Command

● Command Frame:

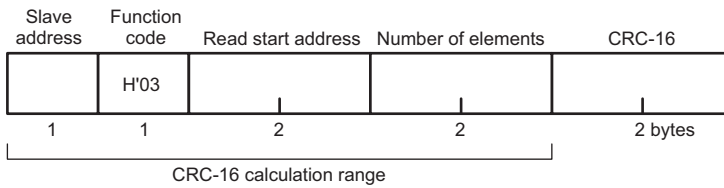

Slave address	This number specifies the transmission's destination. Specify the unit number of the K7TM. The unit number can be set between H'01 to H'63 hexadecimal (01 to 99 decimal).
Function code	The Read Variable Area command's function code is H'03.
Read start address	Specify the address of the variable area to start reading in 2-byte hexadecimal. Refer to 6-3 <i>Variable Area Map</i> on page 6-5.
Number of elements	Specify the number of variables to read. You can specify up to 125 variables (H'007D).
CRC-16	This check code is calculated with the data from the slave address to the end of the data.

● Response Frame:

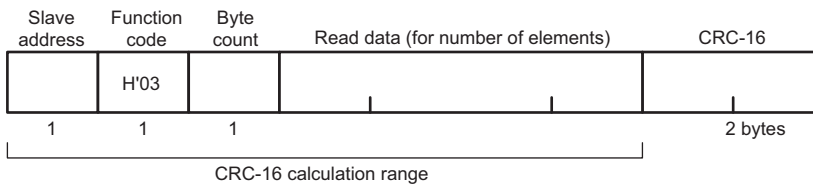

Slave address	The number specified in the command frame is entered as-is.
Function code	This is a received function code. However, H'80 is added if an error occurs.
Byte count	Contains the number of bytes of read data. The byte count is a hexadecimal.
Read data	Contains the read data value.
CRC-16	This check code is calculated with the data from the slave address to the end of the data.

● Response Codes:

Function code	Error code	Error name	Description
H'03	-	Normal end	The command ended normally.
H'83	H'02	Variable address error	The variable address was accessed in excess of H'FFFF.
	H'03	Variable data error	The number of elements exceeds the allowed range.
	H'04	Operation error	<ul style="list-style-type: none"> • A self-diagnosis error has occurred. • Log data is read with refreshing the log not stopped.

Example

Read measurement values from the slave with unit number 1.
The variable addresses for measurement values are H'1000 to H'1006.

● Command Frame:

Slave address	Function code	Read start address	Number of elements	CRC-16
H'01	H'03	H'1000	H'0006	H'C108

● Response Frame:

Slave address	Function code	Byte count	Read data (for number of elements)	CRC-16
H'01	H'03	H'0C		

6-8-3 Write Variable Area Command

● Command Frame:

Slave address	Function code	Write start address	Number of elements	Byte count	Write data (for number of elements)	CRC-16
	H'10					
1	1	2	2	1		2 bytes

CRC-16 calculation range

Slave address	This number specifies the transmission's destination. Specify the unit number of the K7TM. The unit number can be set between H'01 to H'63 hexadecimal (01 to 99 decimal).
Function code	The Write Variable Area command's function code is H'10.
Write start address	Specify the address of the variable area to start writing in 2-byte hexadecimal. Refer to 6-3 <i>Variable Area Map</i> on page 6-5.
Number of elements	Specify the number of variables to write. You can specify up to 123 variables (H'007B).
Byte count	Specify the number of bytes of data to write in hexadecimal format.
CRC-16	This check code is calculated with the data from the slave address to the end of the data.

● Response Frame:

Slave address	Function code	Write start address	Number of elements	CRC-16
	H'10			
1	1	2	2	2 bytes

CRC-16 calculation range

Slave address	The number specified in the command frame is entered as-is.
Function code	This is a received function code. However, H'80 is added if an error occurs.
Data	Contains the number of bytes of read data. The byte count is a hexadecimal.

Error code	Contains the read data value.
CRC-16	This check code is calculated with the data from the slave address to the end of the data.

● **Response Codes:**

Function code	Error code	Error name	Description
H'10	---	Normal end	The command ended normally.
H'90	H'02	Variable address error	The variable address was accessed in excess of H'FFFF.
	H'03	Variable data error	<ul style="list-style-type: none"> The number of data does not match the number of elements. The byte count is not two times the number of elements. The write data is out of the setting range.
	H'04	Operation error	<ul style="list-style-type: none"> A self-diagnosis error has occurred. A variable whose setting reflection timing is "After restart" was written in the operating state.

Example

Rewrite setting parameters for the slave with unit number 1.

The variable addresses for rewriting each alarm value are H'1117 to H'111B.

● **Command Frame:**

Slave address	Function code	Write start address	Number of elements	Byte count	Write data (for number of elements)	CRC-16
H'01	H'10	H'1117	H'0005	H'0A		

● **Response Frame:**

Slave address	Function code	Write start address	Number of elements	CRC-16
H'01	H'10	H'1117	H'0005	H'B532

6-8-4 Operation Command or Write Variable Area Command (Single)

● Command Frame:

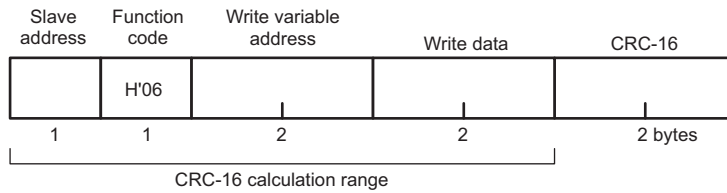

Slave address	This number specifies the transmission's destination. Specify the unit number of the K7TM. The unit number can be set between H'01 to H'63 hexadecimal (01 to 99 decimal).
Function code	The function code of operation command or write variable area command (single) is H'06.
Write variable address	For the operation command, specify a command code (H'D000 to H'D005). Refer to <i>Command Codes and Related Information</i> : on page 6-27 for details. For the write variable area command (single), specify an address of the variable area to start writing in 2-byte hexadecimal. Refer to <i>6-3 Variable Area Map</i> on page 6-5.
Write data	For the operation command, specify related information. Refer to <i>Command Codes and Related Information</i> : on page 6-27 for details. For the write variable area command (single), specify write data.
CRC-16	This check code is calculated with the data from the slave address to the end of the data.

● Command Codes and Related Information:

Command code	Operation Command	Related information	
		Upper byte	Lower byte
H'D000	Software Reset Command	0001: Run	
H'D001	Parameter Initialization Command	0001: Run	
H'D002	Operation Stop Command	0001: Run	
H'D003	Alarm Latch Cancel Command	0001: Run for 1CH 0002: Run for 2CH 00FF: Run for All CH	
H'D004	Reference Resistance Value Registration Start/Cancel Command	00: Cancel 01: Start	01: Run for 1CH 02: Run for 2CH FF: Run for All CH
H'D005	Log Refresh Start/Stop Command	00: Stop 01: Start	01: Run for 1CH 02: Run for 2CH FF: Run for All CH

● Response Frame:

When the command is executed normally, the response returns the same data sent in the command frame.

- **Response Codes:**

Function code	Error code	Error name	Description
H'06	-	Normal end	The command ended normally.
H'86	H'03	Variable data error	The write data is out of the setting range.
	H'04	Operation error	A self-diagnosis error has occurred.

Example

Execute the Software Reset Command to the slave with unit number 1.

- **Command Frame/Response Frame:**

Slave address	Function code	Write variable address	Write data	CRC-16
H'01	H'06	H'D000	H'0001	H'70CA



Logging by K7TM Configuration Tool

This section describes logging by the K7TM Configuration Tool.

7-1 Overview	7-2
7-1-1 Logging-related Target Sheets	7-2
7-2 Logging of Measurement Value	7-4
7-3 Reading of Log	7-7

7-1 Overview

The K7TM Configuration Tool is a tool for “configuration,” “adjustment,” and “logging” of the K7TM. A macro book of Microsoft® Excel is used. Using the K7TM Configuration Tool allows you to perform configuration and adjustment more easily than K7TM key operations.

In addition, reading the logs stored in the K7TM enables simple trend monitoring. It is possible to monitor long-term trends by periodically reading a maximum of 30 data stored inside the K7TM and putting them in chronological order.

Refer to 4-6 *Logging Function* on page 4-30 for details and specifications of log data. Section 7 describes “logging.”

Refer to *Section 2 Procedures* on page 2-1 for “configuration” and “adjustment.”

7-1-1 Logging-related Target Sheets

The logging-related target Sheet names of the K7TM Configuration Tool are following two:

- **Logging of Measurement Value**
Logs resistance values, voltages, and other measurement values in real time. This logging is for the adjustments for registering a reference resistance value.
- **Reading of Log**
Reads the logs saved in the K7TM.

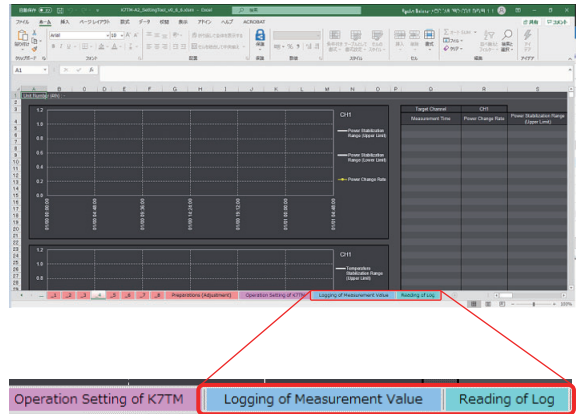

Overview of Logging of Measurement Value

The **Logging of Measurement Value** Sheet allows you to read measurement values and render them in graph form.

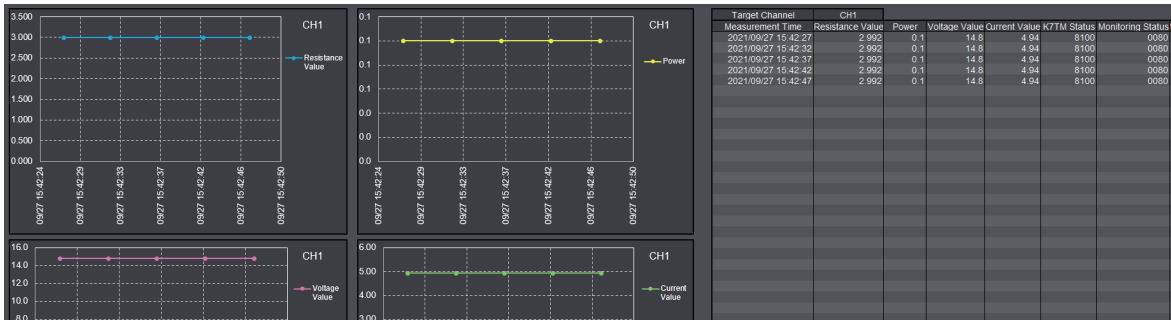

Overview of Reading of Log

You can read (up to 30) logs saved in the K7TM.

Read										
Unit Number (1st)		1								
Target Channel		CH1								
Measurement Time	Reference Resistance Value	Change Rate	Voltage Value	Current Value	Measurement Time	Reference Resistance Value	Change Rate	Voltage Value	Current Value	
18400		0.0	63.0	3.33	2678		0.0	65.7	6.64	
18500		0.0	63.0	3.33	2778		0.0	65.7	6.64	
18600		0.0	62.9	3.33	2878		0.0	65.7	6.64	
18700		-0.1	62.9	3.33	2978		0.0	65.7	6.64	
18800		0.0	62.9	3.33	3078		0.0	65.7	6.64	
18900		-0.1	62.9	3.33	3178		0.0	65.7	6.64	
19000		0.0	62.9	3.33	3278		0.0	65.7	6.64	
19100		-0.1	62.9	3.33	3378		0.0	65.7	6.64	
19200		-0.1	62.9	3.33	3478		0.0	65.7	6.64	
19300		-0.1	62.9	3.33	3578		0.0	65.7	6.64	
19400		-0.1	62.9	3.33	3678		0.0	65.7	6.64	
19500		-0.1	62.9	3.33	3778		0.0	65.7	6.64	
19600		-0.1	62.9	3.33	3878		0.0	65.7	6.64	

7-2 Logging of Measurement Value

This section describes how to use **Logging of Measurement Value**.

- (1) Setting the Target Unit Number
- (2) Start of Logging
- (3) Stop of Logging
- (4) Clearance of Logging Data

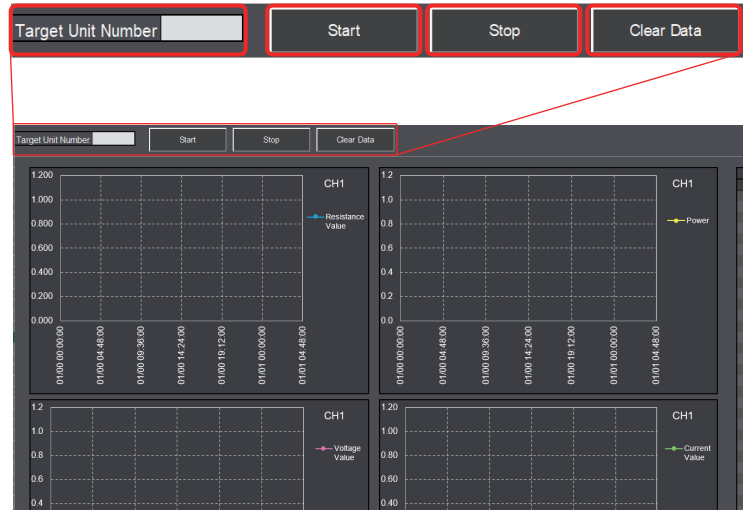

(1) Setting the Target Unit Number

You can select a Unit number of the K7TM targeted for logging.

Select a target Unit number to display, from the pull-down menu of target Unit number. This number is linked to the Unit number set on the **Communications Setting Sheet**.

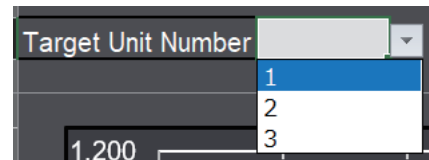

If communications failed, the following message is displayed.

Processing is canceled because communications processing failed in the following channel.



CHn*1

Use the communications test function to check that communications are available, and then try again.

*1. The Unit numbers from 1 to 99 go in n.

(2) Start of Logging

Click the **Start** Button. Communications will start. Values go in the graph and the data area.

The channels targeted for reading are determined by the maximum number of channels specified on the **Initial Setting of K7TM** Sheet. When the maximum number of channels is 1, CH1 is targeted. When the maximum number of channels is 2, CH1 and CH2 are targeted.

If the total of measurement value data lines reaches 1,000, reading will be aborted.

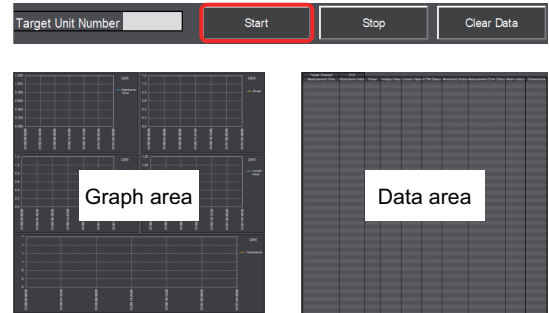

● Measurement Values to Be Read

Measurement value type	Brief description	Reference
Resistance Value	This is a resistance value of the heater.	5-3 <i>Operation Level</i> on page 5-8
Power	This is an apparent power of the heater.	
Voltage Value	This is a voltage value applied to the heater.	
Current Value	This is a current value applied to the heater.	
Temperature *1	This is a temperature used as a reference for checking the heater for stability.	
K7TM Status	It is the data that brings together the status of the K7TM.	6-3-2 <i>Variable Areas of Both 1CH and 2CH</i> on page 6-6
Monitoring Status	It is the data that brings together the monitoring status.	6-3-3 <i>Variable Areas of 1CH (Change Beginning Address into 2 for Variable Areas of 2CH)</i> on page 6-8
Measurement Error Status	It is the data that brings together the measurement error status.	Refer to 6-3-5 <i>Details about Status Information</i> on page 6-13 for details about the bits.
Alarm Status	It is the data that brings together the alarm status.	

*1. It is read only when the stabilization discrimination method in the K7TM is temperature.

● Read Interval

The read interval is determined by the stabilization discrimination method.

<Case where Stabilization Discrimination Method is Power>

Measurement Value Calculation Cycle [s]

<Case where Stabilization Discrimination Method is Temperature>

Measurement Value Calculation Cycle [s] or Temperature Data Write Cycle [s], whichever is shorter

If communications failed, the following message is displayed.



Processing is canceled because communications processing failed in the following channel.

CHn*1

Use the communications test function to check that communications are available, and then try again.

*1. The Unit numbers from 1 to 99 go in n.



The read interval should be used as a guideline. Logging is not always executed at specified read intervals.



If CH1 and CH2 are different in read interval, logging will be executed at read intervals, whichever is shorter.

(3) Stop of Logging

You can stop logging.

Click the **Stop** Button. The graph generation and data read operation that were executed by (2) Start will be aborted. Graphs and data in cells will remain as they are.

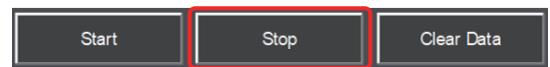

(4) Clearance of Logging Data

You can clear the logging data.

Click the **Clear Data** Button. The displayed data will be cleared.

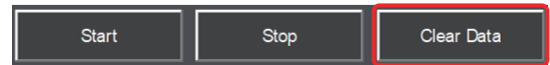

7-3 Reading of Log

This section describes how to use **Reading of Log**.

- (1) Checking the Target Unit Number
- (2) Reading of Log

Read											
Unit Number (1st)	1				Target Channel	CH2					
Target Channel	CH1				Measurement Time	Reference	Resistance	Value	Change Rate	Voltage Value	Current Value

(1) Checking the Target Unit Number

Check the Unit number of the K7TM targeted for log reading.

All the Units whose Unit numbers are set on the **Communications Setting Sheet** are targeted for reading.

Unit Number (1st)	1					
Target Channel	CH1					
Measurement Time	Reference	Resistance	Value	Change Rate	Voltage Value	Current Value

Target Channel	CH2					
Measurement Time	Reference	Resistance	Value	Change Rate	Voltage Value	Current Value

(2) Reading of Log

Click the **Start** Button. Communications will start.

Read values will go in cells.

Read									
Unit Number (1st)	1				Target Channel	CH1			
Measurement Time	Reference	Resistance	Value	Change Rate	Voltage Value	Current Value			



Precautions for Correct Use

If communications failed during execution of this function, the K7TM will be in the state where refreshing the log remains stopped and no log is saved.

In this case, click the **Read** Button again to complete the processing successfully.

● Logs to Be Read

Logs targeted for reading are shown below. Refer to *4-6 Logging Function* on page 4-30 for the timing at which logs are recorded in the K7TM.

Values from 1 to 30 go in * in the table below, meaning that all of log data will be targeted.

Log description (Parameter name)	Brief description	Reference
Record Time [*] (for Reference Resistance Value Change Rate/Voltage/Current)	It records the time when the log data was recorded. The time is recorded as Total Power ON Time (s).	6-3-3 Variable Areas of 1CH (Change Beginning Address into 2 for Variable Areas of 2CH) on page 6-8
Log Data [*] Reference Resistance Value Change Rate	Log data of reference resistance value change rate.	6-3-3 Variable Areas of 1CH (Change Beginning Address into 2 for Variable Areas of 2CH) on page 6-8
Log Data [*] (Voltage)	Log data of voltage.	
Log Data [*] (Current)	Log data of current.	5-3-4 Parameters on Operation Level on page 5-10

8

Troubleshooting

8-1	Troubleshooting	8-2
-----	-----------------------	-----

8-1 Troubleshooting

Check the following table if the K7TM does not perform the expected operation.

When	Problems	Cause	Possible correction	Remarks
At power ON	No resistance value is calculated. The voltage value is 0.	The voltage line may not be connected.	Check the wiring of voltage.	3-4 I/O Wiring on page 3-9
	No resistance value is calculated. The current value is 0.	The current line may not be connected.	Check the wiring of current.	
	Power will not be turned ON. The power-on state is unstable, such as a flickering display.	A wire may have been connected to the release hole in a Push-In Plus terminal block.	Check again that the wire is securely connected to the terminal (insertion) hole. Also check the other terminals.	3-3 How to Connect to the Push-In Plus Terminal Blocks on page 3-6
At initial setting	Even if you try to change via communications the setting of the Initial Setting Level, Communications Setting 1 Level, or Communications Setting 2 Level, it cannot be changed because of a communications error.	The K7TM may not be in the operation stopped state. To change via communications the setting of the Initial Setting Level, Communications Setting 1 Level, or Communications Setting 2 Level, you need to put the K7TM into the operation stopped state.	Send the operation command, <i>Operation Start/ Stop</i> , to put the K7TM into the operation stopped state, before changing the setting value. After the change is completed, send <i>Operation Start/ Stop</i> again to put the K7TM into the operating state.	6-5 Operation Command on page 6-17
	Initialization will not be executed even if the operation command, <i>Parameter Initialization</i> , is executed.	A power ON reset may not be executed after the operation command, <i>Parameter Initialization</i> , was executed. To reflect the <i>Parameter Initialization</i> , a power ON reset is required.	After the operation command, <i>Parameter Initialization</i> , was executed, perform a power ON reset.	5-9 Operation Command with Key Operation on page 5-33 6-5 Operation Command on page 6-17
In checking the communications connection with Stabilization Discrimination Method (Temperature) used	Temperature is indicated as ----.	The RS-485 wiring may not be connected between the K7TM and the host system.	Check the RS-485 wiring.	3-6 Wiring the Communications Cables on page 3-14
		The communications setting may not be configured correctly.	Check the communications setting of the host system and the K7TM.	5-8 Communications Setting 1 or 2 Level (LVL 1 \bar{OP} \bar{Z}) on page 5-30
	Temperature is displayed and flashing on the temperature display. (A temperature data not-refreshed error has occurred.)	The RS-485 wiring may not be connected between the K7TM and the host system.	Check the RS-485 wiring.	3-6 Wiring the Communications Cables on page 3-14
		The communications setting may not be configured correctly.	Check the communications setting of the host system and the K7TM.	5-8 Communications Setting 1 or 2 Level (LVL 1 \bar{OP} \bar{Z}) on page 5-30
		The <i>Temperature Data Write Cycle</i> setting parameter of the K7TM and the temperature data transmission interval of the host system may not be consistent.	Increase the temperature data write cycle, or shorten the temperature data transmission interval of the host system.	<i>Details on Temperature Data Not-refreshed Error</i> on page 4-29 under 4-5-2 <i>Actions for Measurement Errors</i>

When	Problems	Cause	Possible correction	Remarks
In operation	Temperature is displayed and flashing on the temperature display. (A temperature data not-refreshed error has occurred.)	The RS-485 wiring may not be connected between the K7TM and the host system.	Check the RS-485 wiring.	3-6 <i>Wiring the Communications Cables</i> on page 3-14
		The communications setting may not be configured correctly.	Check the communications setting of the host system and the K7TM.	5-8 <i>Communications Setting 1 or 2 Level (LVL 1 or 2)</i> on page 5-30
		The <i>Temperature Data Write Cycle</i> setting parameter of the K7TM and the temperature data transmission interval of the host system may not be consistent.	Increase the temperature data write cycle, or shorten the temperature data transmission interval of the host system.	<i>Details on Temperature Data Not-refreshed Error</i> on page 4-29 under 4-5-2 <i>Actions for Measurement Errors</i>
	The STAB Indicator flashes, and the K7TM does not enter the waiting for stabilization state.	The equipment has stopped for a long time.	The error is cleared after the equipment operates.	<i>Details on Not-stabilized Error</i> on page 4-29 under 4-5-2 <i>Actions for Measurement Errors</i>
		The equipment is used under the conditions different from those where the reference resistance value was registered.	Register the reference resistance value again.	(5) <i>Preparations (Registration)</i> on page 2-24 under 2-4 <i>Configuration with Tool (Also Configurable with Key Operations)</i>
If you do not want to change the reference resistance value, check whether the equipment is not changed.			2-5 <i>Adjustment When Device Status Is Changed</i> on page 2-42	

When	Problems	Cause	Possible correction	Remarks
In operation	The STAB Indicator flashes, and the K7TM does not enter the waiting for stabilization state.	<ul style="list-style-type: none"> ■ Stabilization Discrimination Method (Power) Power may be fluctuating. 	If the fluctuating power of the equipment persists, increase the power moving average count. If the moving average count is already maximized, extend the power stabilization range.	<i>2-8 Adjustment When Reference Resistance Value Registration Failed</i> on page 2-54
		<ul style="list-style-type: none"> ■ Stabilization Discrimination Method (Temperature) Temperature may be fluctuating. 	If the fluctuating temperature of the equipment persists, extend the temperature stabilization range.	
		<ul style="list-style-type: none"> ■ Stabilization Discrimination Method (Power) and (Temperature) both The resistance value fluctuates and is not within the normal fluctuation deviation. 	If the fluctuating resistance value persists, extend the resistance value moving average count value.	
		<ul style="list-style-type: none"> ■ Stabilization Discrimination Method (Power) and (Temperature) both The resistance value is stable outside the normal fluctuation deviation. 	The heater may be partially burned out. Inspect the heater.	
	<p>The K7TM is in the following states.</p> <ul style="list-style-type: none"> • The alarm output indicator is lit in red. • All the displays in the front section are not lit, or <i>ERR</i> is lit on the main display. • Both the communications terminals 1 and 2 are disabled. • Both the alarm output and the output at error are OFF. 	A self-diagnosis error has occurred.	<ul style="list-style-type: none"> • Cycle the power supply. If operation returns to normal, then noise may have caused the problem. Check for noise. • If the Unit does not recover, contact your OMRON representative. 	<i>4-8 Self-diagnosis Error</i> on page 4-33
	An alarm is not output, though the reference resistance value change rate is beyond the heater deterioration alarm value.	The stabilized state (STAB Indicator lit) may not be brought about.	Wait for the stabilized state (STAB Indicator lit) to be brought about.	<i>4-4-4 Heater Deterioration Alarm</i> on page 4-20
	Although the voltage and the current are not 0, the status display IN Indicator lights and the inputs are judged to be none.	The voltage value may be not more than Measurement Voltage Lower Limit Value × Voltage Input Range, or the current value may be not more than Measurement Current Lower Limit Value × CT Input Range.	Check the voltage input range and CT input range for improper settings.	<i>(1) Checking the Heater and Selecting the Special CT</i> on page 2-5 under <i>2-3 Advance Preparation</i>

When	Problems	Cause	Possible correction	Remarks
At communications connection	The communications connection does not work well.	The unit number of the K7TM may be different from that of the connection destination (computer (K7TM Configuration Tool) or host system).	Turn the Unit number setting switch on the K7TM front section to adjust the unit number to the connection destination.	(3) <i>Communications Setting</i> on page 2-9 under 2-4 <i>Configuration with Tool (Also Configurable with Key Operations)</i>
		The communications setting of the K7TM is different from that of the connection destination (computer (K7TM Configuration Tool), communications converter, or host system).	Check whether the communications setting parameters (Baud Rate and Parity) are the same.	
	The resistance value, normal fluctuation deviation reference, and reference resistance value cannot be read correctly via communications.	The resistance value, normal fluctuation deviation reference, and reference resistance value are divided into MSD and LSD. Only the MSD or only the LSD may have been read.	Read both the MSD and the LSD.	6-3-3 <i>Variable Areas of 1CH (Change Beginning Address into 2 for Variable Areas of 2CH)</i> on page 6-8



Appendices

A-1	Specifications	A-2
A-1-1	K7TM	A-2
	Ratings and Specifications	A-2
	Measurement Specifications	A-5
	Push-In Plus Terminal Blocks Specifications	A-6
	Specifications of K7TM Configuration Tool	A-7
A-1-2	Special CTs	A-7
	Models	A-7
	Ratings and Specifications	A-8
A-1-3	Applicable Standards	A-10
A-2	Parameters List	A-11
A-3	Parameter Flow	A-15
A-4	Operation of Reference Resistance Value Registration	A-16
A-4-1	Corrections When Reference Resistance Value Registration Failed (Adjustments with Key Operation)	A-17

A-1 Specifications

A-1-1 K7TM

Ratings and Specifications

Item		Specifications	
Operation power supply	Power supply voltage and frequency	K7TM-A2MA: 100 to 240 V AC, 50/60 Hz K7TM-A2MD: 24 V AC, 50/60 Hz, 24 V DC	
	Operating power supply voltage range	85% to 110% of the rated voltage	
	Operating frequency range	45 to 65 Hz	
	Power consumption		K7TM-A2MA: 8.5 VA max. (100 to 240 V AC)
			K7TM-A2MD: 5.2 VA max. (24 V AC)/ 2.9 W max. (24 V DC)
Recommend external fuse		T2A, time delay, high-breaking capacity	
CH1 voltage input CH2 voltage input	Measurement accuracy	$\pm 0.5\%$ FS ± 1 digit	
	Input range	0 to 600 V AC, 50/60 Hz	
	Recommend external fuse	Class CC, Class J, or Class T with a rated current of 7 A or less	
CH1 CT input CH2 CT input	Measurement accuracy	$\pm 0.5\%$ FS ± 1 digit	
	Input range	0 to 600 A AC, 50/60 Hz	

Item		Specifications
RS-485 communications 1 RS-485 communications 2	Transmission path connection method	RS-485: Multidrop
	Communications method	RS-485 (2-wire, half duplex)
	Cable length	When the baud rate is 115.2 kbps or less, the maximum length is 500 m with a twisted-pair cable. When the baud rate is 230.4 kbps, the maximum length is 200 m with a twisted-pair cable.
	Protocol	Modbus RTU
	Baud rate	9.6 kbps/ 19.2 kbps/ 38.4 kbps/ 57.6 kbps/ 115.2 kbps/ 230.4 kbps
	Data length	Always 8 bits
	Stop bits	Always 1 bit (with parity being even/odd) Always 2 bits (with parity being none)
	Connection configurations	1:1 or 1:N
	Maximum number of Units	32 Units (including the host system)
	Parity	None/Even/Odd
Send wait time	0 to 99 ms	
Transistor output (Alarm output, Output at Error)	Contact form	NPN open collector (Can be set to normally close or normally open)
	Rated voltage	24 V DC (maximum voltage: 26.4 V DC)
	Maximum current	50 mA
	Leakage current when power turning OFF	0.1 mA max.
	Residual voltage	1.5 V max.
Ambient operating temperature	-10 to 55°C	
Ambient operating humidity	25% to 85%	
Storage temperature	-20 to 65°C (with no condensation or icing)	
Altitude	2,000 m max.	
Insulation resistance	20 mΩ min. Between the external terminals and the case; Between the power supply terminals and the other terminals; Between (voltage input terminals + CT input terminals) and (communications terminals + transistor output terminals); Between the voltage input terminals and the CT input terminals; Between the channels of voltage inputs; Between the channels of CT inputs	
Dielectric strength	2,000 V AC for 1 minute Between the external terminals and the case; Between the power supply terminals and the other terminals; Between (voltage input terminals + CT input terminals) and (communications terminals + transistor output terminals); Between the voltage input terminals and the CT input terminals; Between the channels of voltage inputs; Between the channels of CT inputs	
Vibration resistance	Frequency 10 to 55 Hz, 0.35-mm single amplitude, acceleration 50 m/s ² , 10 sweeps of 5 min each in X, Y, and Z directions	

Item		Specifications
Shock resistance		100 m/s ² , 3 times each in X, Y, and Z axes, 6 directions
Degree of protection		IP20
Terminal block type		Push-In Plus
Exterior color		Black (Munsell N 1.5)
Mounting		DIN Track
Weight		Approx. 200 g
Wiring material	Wire type	Solid or Stranded wire
	Wiring material	Copper
	Recommended wires	0.25 to 1.5 mm ² AWG 24 to AWG 16
	Stripping length (without ferrules)	8 mm
Installation environment		Operation voltage: EN/IEC 61010-1 Pollution Degree 2, Overvoltage category II
		Measurement circuit: EN/IEC 61010-2-030 Pollution Degree 2, CAT II 600 V or CAT III 300 V
Industrial electromagnetic environment		EN/IEC 61326-1 Industrial electromagnetic environment

Measurement Specifications

Item	Specifications
Input range	<p>Current</p> <p>Rated 5 A AC: 0.00 to 5.00 A AC Rated 25 A AC: 0.0 to 25.0 A AC Rated 100 A AC: 0.0 to 100.0 A AC Rated 200 A AC: 0.0 to 200.0 A AC Rated 400 A AC: 0.0 to 400.0 A AC Rated 600 A AC: 0.0 to 600.0 A AC Rated frequency: 50/60 Hz</p> <p>Voltage</p> <p>Rated 120 V AC: 0.0 to 120.0 V AC Rated 240 V AC: 0.0 to 240.0 V AC Rated 480 V AC: 0.0 to 480.0 V AC Rated 600 V AC: 0.0 to 600.0 V AC Rated frequency: 50/60 Hz</p>
Measurable range	<p>Current</p> <p>Rated 5 A AC: 0.00 to 5.50 A AC Rated 25 A AC: 0.0 to 27.5 A AC Rated 100 A AC: 0.0 to 110.0 A AC Rated 200 A AC: 0.0 to 220.0 A AC Rated 400 A AC: 0.0 to 440.0 A AC Rated 600 A AC: 0.0 to 650.0 A AC</p> <p>Voltage</p> <p>Rated 120 V AC: 0.0 to 132.0 V AC Rated 240 V AC: 0.0 to 264.0 V AC Rated 480 V AC: 0.0 to 528.0 V AC Rated 600 V AC: 0.0 to 660.0 V AC</p>
Measurement accuracy	<p>Measurement accuracy of voltage and current: $\pm 0.5\%$ FS ± 1 digit to the input range</p> <p>Conditions:</p> <ul style="list-style-type: none"> • When sine waves are input continuously • Variations in CTs are not included. <p>Repeat accuracy of resistance value (reference value): $\pm 1\%$ rdg ± 1 digit</p> <p>Conditions:</p> <ul style="list-style-type: none"> • When sine waves are input continuously • Variations in CTs are not included.
Measurement target	Resistance heating heater

Push-In Plus Terminal Blocks Specifications

Item	Specifications						
Construction	Push-in compatible with 1-pole 2-terminal crossover wiring Hands-free Front-in and front-release						
Applicable wires	Ferrules, solid wires, or stranded wires						
Applicable wire size	0.25 mm ² to 1.5 mm ² (AWG 24 to AWG 16)						
Wire insertion force	8 N max. for AWG 20 wire						
Screwdriver press force	15 N max.						
Wire stripping length	10 mm or 12 mm						
Ferrule length	8 mm or 10 mm						
Recommended flat-blade screwdrivers	OMRON: XW4Z-00B etc.						
Current capacity	10 A (per pole)						
Number of insertions	50 times						
Recommended ferrules	Applicable wire		Ferrule, Conductor length (mm)	Stripping length (mm) (Ferrules used)	Recommended ferrules		
	(mm ²)	AWG			Phoenix Contact	Weidmuller	Wago
	0.25	24	8	10	AI 0,25-8	H0.25/12	FE-0.25-8N-YE
			10	12	AI 0,25-10	-	-
	0.34	22	8	10	AI 0,34-8	H0.34/12	FE-0.34-8N-TQ
			10	12	AI 0,34-10	-	-
	0.5	20	8	10	AI 0,5-8	H0.5/14	FE-0.5-8N-WH
			10	12	AI 0,5-10	H0.5/16	FE-0.5-10N-WH
	0.75	18	8	10	AI 0,75-8	H0.75/14	FE-0.75-8N-GY
			10	12	AI 0,75-10	H0.75/16	FE-0.75-10N-GY
	1/1.25	18/17	8	10	AI 1-8	H1.0/14	FE-1.0-8N-RD
			10	12	AI 1-10	H1.0/16	FE-1.0-10N-RD
	1.25/1.5	17/16	8	10	AI 1,5-8	H1.5/14	FE-1.5-8N-BK
		10	12	AI 1,5-10	H1.5/16	FE-1.5-10N-BK	
Recommended crimp tool				CRIMPFOX6 CRIMPFOX6T-F CRIMPFOX10S	PZ6 roto	Variocrimp4	

Specifications of K7TM Configuration Tool

- System requirements

Supported OS	Windows 10 (64-bit edition), English or Japanese *1
Computer specifications	1 GHz or faster CPU, 1 GB or more of RAM, and 16 GB or more of required disk space
Excel	Excel 2013, 2016, or 2019; 32-bit or 64-bit edition; English or Japanese *2
RS-485–USB Communications converter	Use a commercially available product. *3
Maximum number of connected K7TM Units	8 Units

*1. Japanese characters may be garbled if the system locale of the computer that uses the K7TM Configuration Tool is not *Japanese (Japan)*.

*2. When you use the K7TM Configuration Tool with Excel 2013 or Excel 2016, set **Measurement Value Calculation Cycle** on the **Initial Setting of K7TM** Sheet of the K7TM Configuration Tool to 100 seconds or less. (Default setting: 100 s)
It may become unstable if you set a value that exceeds 100 seconds.

Category	Parameter name	Setting range	Unit Number (1st)	
			CH1	CH2
Input Setting of K7TM	Maximum Number of Channels	1 to 2 [CH]		1
	CT Input Range	0 - 3 [A]		
		1 - 25 [A]		
		2 - 100 [A]	1	1
		3 - 200 [A]		
4 - 400 [A]				
Voltage Input Range	5 - 600 [A]			
	0 - 120 [V]			
	1 - 240 [V]	0	0	
	2 - 480 [V]			
	3 - 600 [V]			
Operation Setting of K7TM	Measurement Value Calculation Cycle	1 to 999 [s]	100	100
Selection of Method	Stabilization Discrimination Method	0 - md-1 (power)	0	0
		1 - md-2 (temperature)	0	0

*3. OMRON performed an evaluation test on the SI-35USB-2 manufactured by LINE EYE. (The driver version is V2.12.18.)

A-1-2 Special CTs

Models

When UL certification is required

Model	Primary-side rated current	Secondary-side rated current
K6CM-CICB005-C	5 A	Dedicated output
K6CM-CICB025-C	25 A	
K6CM-CICB100-C	100 A	
K6CM-CICB200-C	200 A	
K6CM-CICB400-C	400 A	

Note Special CTs are supplied with connecting cables.

When UL certification is not required

Model	Primary-side rated current	Secondary-side rated current
K6CM-CICB005	5 A	Dedicated output
K6CM-CICB025	25 A	
K6CM-CICB100	100 A	
K6CM-CICB200	200 A	
K6CM-CICB400	400 A	
K6CM-CICB600	600 A	

Note Special CTs are supplied with connecting cables.



The CT input terminals can be connected in either direction of the special CT regardless of polarity.

Ratings and Specifications

The ratings and specifications are common to all UL certification-compliant models. *1

Item	Model	K6CM -CICB005	K6CM -CICB025	K6CM -CICB100	K6CM -CICB200	K6CM -CICB400	K6CM -CICB600
Construction	Internal split type						
Primary-side rated current	5 A	25 A	100 A	200 A	400 A	600 A	
Rated voltage	600 V AC						
Secondary winding	3,000 turns				6,000 turns	9,000 turns	
Insulation resistance	Between output terminal and case: 50 mΩ min						
Dielectric strength	Between output terminal and case: 2,000 V AC for 1 minute						
Protective element	7.5 V clamp element						
Allowable number of attachments and detachments	100 times						
Diameter of wire attachable *2	7.9 mm dia. max.	9.5 mm dia. max.	14.5 mm dia. max.	24.0 mm dia. max.	35.5 mm dia. max.		
Operating temperature and humidity range	-20 to 60°C, 25% to 85% (with no condensation or icing)						
Storage temperature and humidity range	-30 to 65°C, 25% to 85% (with no condensation or icing)						
Supplied cable length	2.9 m						
Supplied cable terminal	K7TM side: Ferrule, CT side: Round crimp terminal						
Degree of protection	IP20						

*1. To comply with UL certification for the special CT, refer to *Conformance to Safety Standards* on page 10.

*2. When you use a flat wire, refer to the outline dimensional drawing of the relevant CT and use a CT with a larger diameter. However, use the CT within the range of its rated current.

The frequency characteristics of CTs are as follows:

K6CM-CICB005-C
K6CM-CICB005

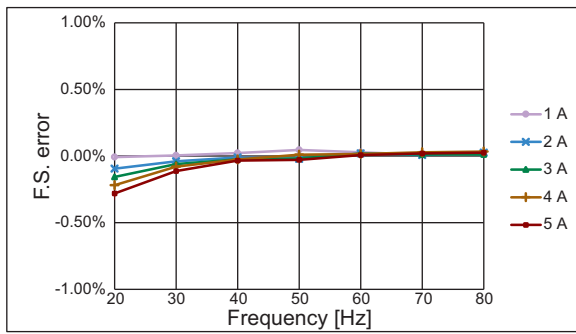

K6CM-CICB025-C
K6CM-CICB025

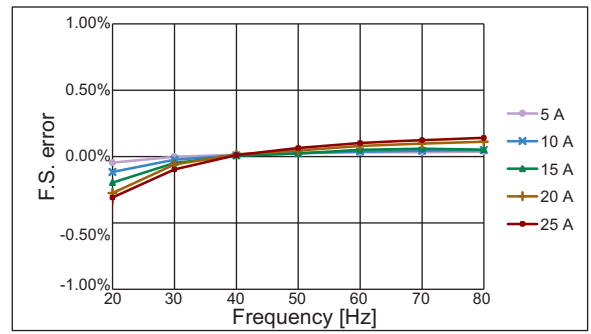

K6CM-CICB100-C
K6CM-CICB100

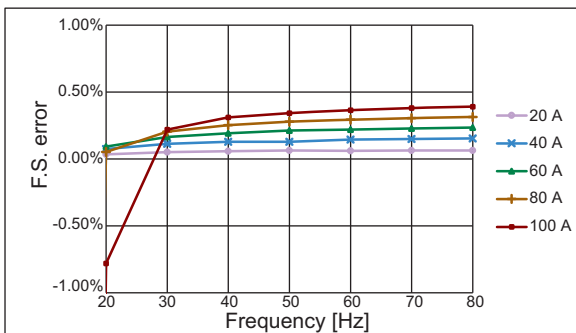

K6CM-CICB200-C
K6CM-CICB200

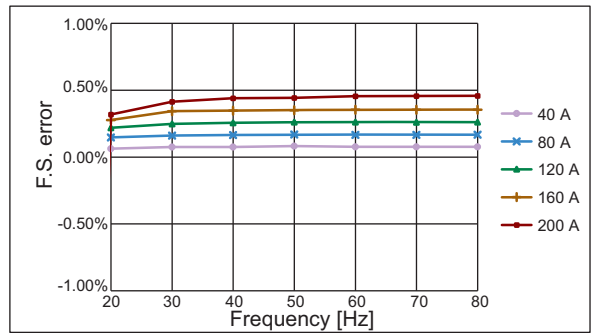

K6CM-CICB400-C
K6CM-CICB400

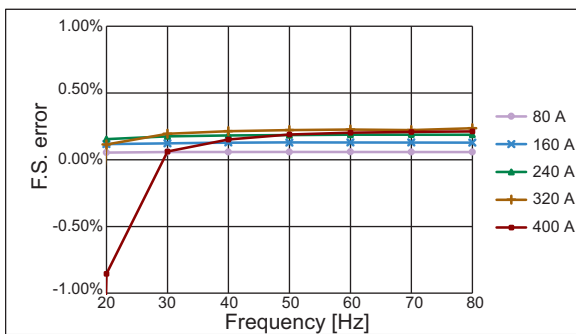

K6CM-CICB600

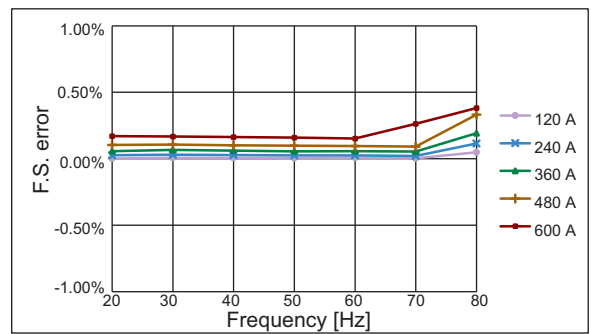

A-1-3 Applicable Standards

Applicable standards	Details	
EU Directives * Self-declaration	Installation environment	Pollution Degree 2, Overvoltage category II, Measurement category II, III *1 Based on EN 61010-1 and EN 61010-2-030
	EMC	EN 61326-1 EMI: Class A, EMS: Industrial environments
UL	UL 61010-1, CAN/CSA C22.2 No. 61010-1 Pollution Degree 2, Overvoltage category II UL 61010-2-030, CAN/CSA C22.2 No. 61010-2-030 Measurement category II, III *1 * UL-recognized (cURus)	
Korean Radio Waves Act	KS C 9610-6-2, KS C 9811	
RCM	---	
UKCA	---	
WEEE II	---	

*1. Up to 600 V and 300 V respectively for the measurement category II and III

A-2 Parameters List

This section shows the parameters to be displayed on the main display of the K7TM.
Refer to 6-3 *Variable Area Map* on page 6-5 for parameters exclusive to communications.

Level	Parameter name	Characters	Setting (monitoring) range	Default value
Operation	Reference Resistance Value Change Rate	Δ	-100.0 to 999.9 (%)	Monitored value just displayed
	Resistance Value	R	0.000 to 9.999 (Ω) 10.00 to 99.99 (Ω) 100.0 to 999.9 (Ω)	Monitored value just displayed
	Voltage Value	V	120 V range: 0.0 to 132.0 (V) 240 V range: 0.0 to 264.0 (V) 480 V range: 0.0 to 528.0 (V) 600 V range: 0.0 to 660.0 (V)	Monitored value just displayed
	Current Value	I	5 A range: 0.00 to 5.50 (A) 25 A range: 0.0 to 27.5 (A) 100 A range: 0.0 to 110.0 (A) 200 A range: 0.0 to 220.0 (A) 400 A range: 0.0 to 440.0 (A) 600 A range: 0.0 to 650.0 (A)	Monitored value just displayed
	Power	S	0.0 to 429.0 (kVA)	Monitored value just displayed
	Temperature	t	-1,999 to 9,999 ($^{\circ}\text{C}/^{\circ}\text{F}$)	Monitored value just displayed
	Alarm Status	R	$N\bar{0}N$: Normal $R\bar{L}M\bar{1}$: Heater Deterioration Alarm (Warning) $R\bar{L}M\bar{2}$: Heater Deterioration Alarm (Critical) $R\bar{L} - R$: Last Resistance Value Change Rate Alarm Value $H\bar{b}$: Heater Burnout Alarm	Monitored value just displayed

Level	Parameter name	Characters	Setting (monitoring) range	Default value
Adjustment (Common)	Heater Deterioration Alarm Value (Warning)	<i>RLM1</i>	0.1 to 999.9 (%)	3.0 (%)
	Heater Deterioration Alarm Value (Critical)	<i>RLM2</i>	0.1 to 999.9 (%)	5.0 (%)
	Last Resistance Value Change Rate Alarm Value	<i>RL-R</i>	0.1 to 999.9 (%)	25.0 (%)
	Heater Burnout Alarm Value (Voltage)	<i>Hb-V</i>	0.0 to 99.9 (% FS)	40.0 (% FS)
	Heater Burnout Alarm Value (Current)	<i>Hb-R</i>	0.0 to 99.9 (% FS)	1.0 (% FS)
	Resistance Value Moving Average Count	<i>RV ER</i>	<i>LdW</i> : Moving Average Count of 10 <i>Md</i> : Moving Average Count of 20 <i>HdH</i> : Moving Average Count of 40	<i>LdW</i>
	Power Moving Average Count	<i>PV EP</i>	<i>LdW</i> : Moving Average Count of 10 <i>Md</i> : Moving Average Count of 20 <i>HdH</i> : Moving Average Count of 40	<i>LdW</i>
	Normal Fluctuation Deviation	<i>NFd</i>	0.1 to 999.9 (%)	1.0 (%)
	Normal Fluctuation Deviation Reference	<i>NFdS</i>	Same range as Resistance Value 0.000 to 9.999 (Ω) 10.00 to 99.99 (Ω) 100.0 to 999.9 (Ω)	Monitored value just displayed
	Reference Resistance Value	<i>REFR</i>	Same range as Resistance Value 0.000 to 9.999 (Ω) 10.00 to 99.99 (Ω) 100.0 to 999.9 (Ω)	Monitored value just displayed
	Fluctuation Value under Evaluation (Resistance)	<i>EV RR</i>	Same range as Reference Resistance Value Change Rate -100.0 to 999.9 (%)	Monitored value just displayed
	Measurement Voltage Lower Limit Value	<i>VMLN</i>	3.0 to 99.9 (% FS)	3.0 (% FS)
	Measurement Current Lower Limit Value	<i>AMLN</i>	3.5 to 99.9 (% FS)	3.5 (% FS)

Level	Parameter name	Characters	Setting (monitoring) range	Default value
Adjustment (Power)	Power Stabilization Range	<i>PW-b</i>	0.1 to 999.9 (%)	20.0 (%)
	Average Power at Stabilization	<i>SEPW</i>	Same range as Power 0.0 to 429.0 (kVA)	Monitored value just displayed
	Power Change Rate	<i>REFP</i>	-100.0 to 999.9 (%)	Monitored value just displayed
	Fluctuation Value under Evaluation (Power)	<i>EVFP</i>	-100.0 to 999.9 (%)	Monitored value just displayed
Adjustment (Temperature)	Temperature Set Point	<i>T-SP</i>	0 to 9,999 (°C/°F)	0 (°C/°F)
	Temperature Stabilization Range	<i>T-Sb</i>	1 to 9,999 (°C/°F)	10 (°C/°F)
	Temperature Data Write Cycle	<i>TWCP</i>	1 to 999 (s)	10 (s)
	Fluctuation Value under Evaluation (Temperature)	<i>EVRE</i>	Same range as Temperature -1,999 to 9,999 (°C/°F)	Monitored value just displayed

Level	Parameter name	Characters	Setting (monitoring) range	Default value
Initial Setting	Maximum Number of Channels	<i>MxCH</i>	1 to 2	1
	Voltage Input Range	<i>VN-V</i>	<i>120V</i> <i>240V</i> <i>480V</i> <i>600V</i>	<i>120V</i>
	CT Input Range	<i>VNCE</i>	<i>5A</i> <i>25A</i> <i>100A</i> <i>200A</i> <i>400A</i> <i>600A</i>	<i>25A</i>
	Stabilization Discrimination Method	<i>MEEd</i>	<i>Md-1</i> : Power <i>Md-2</i> : Temperature	<i>Md-1</i>
	Alarm Polarity	<i>NONE</i>	<i>N-o</i> : Normally open <i>N-c</i> : Normally close	<i>N-c</i>
	Alarm Output Level	<i>ALVL</i>	<i>L-w</i> : Warning or Critical <i>H-cH</i> : Critical	<i>H-cH</i>
	Logging Cycle	<i>LGP</i>	10 to 9,999 (in 10 times)	100 (in 10 times) (approx. 1 day)
	Measurement Value Calculation Cycle	<i>MVCP</i>	1 to 999 (s)	100 (s)
	Use Running Time	<i>RGE</i>	<i>oFF</i> : Not used <i>oN</i> : Used	<i>oFF</i>
	Version	<i>V 1.0</i>	Displays the current software version.	
Communications Setting 1, 2	Baud Rate 1 and 2	<i>bPS</i>	<i>9.6</i> (kbps) <i>19.2</i> (kbps) <i>38.4</i> (kbps) <i>57.6</i> (kbps) <i>115.2</i> (kbps) <i>230.4</i> (kbps)	<i>115.2</i> (kbps)
	Parity 1 and 2	<i>PRtY</i>	<i>NONE</i> : None <i>EVEN</i> : Even <i>oDD</i> : Odd	<i>EVEN</i>
	Send Wait Time 1 and 2	<i>SDWE</i>	0 to 99 (ms)	20 (ms)

A-3 Parameter Flow

This section shows the parameters to be displayed on the main display of the K7TM. Refer to 6-3 Variable Area Map on page 6-5 for parameters exclusive to communications.

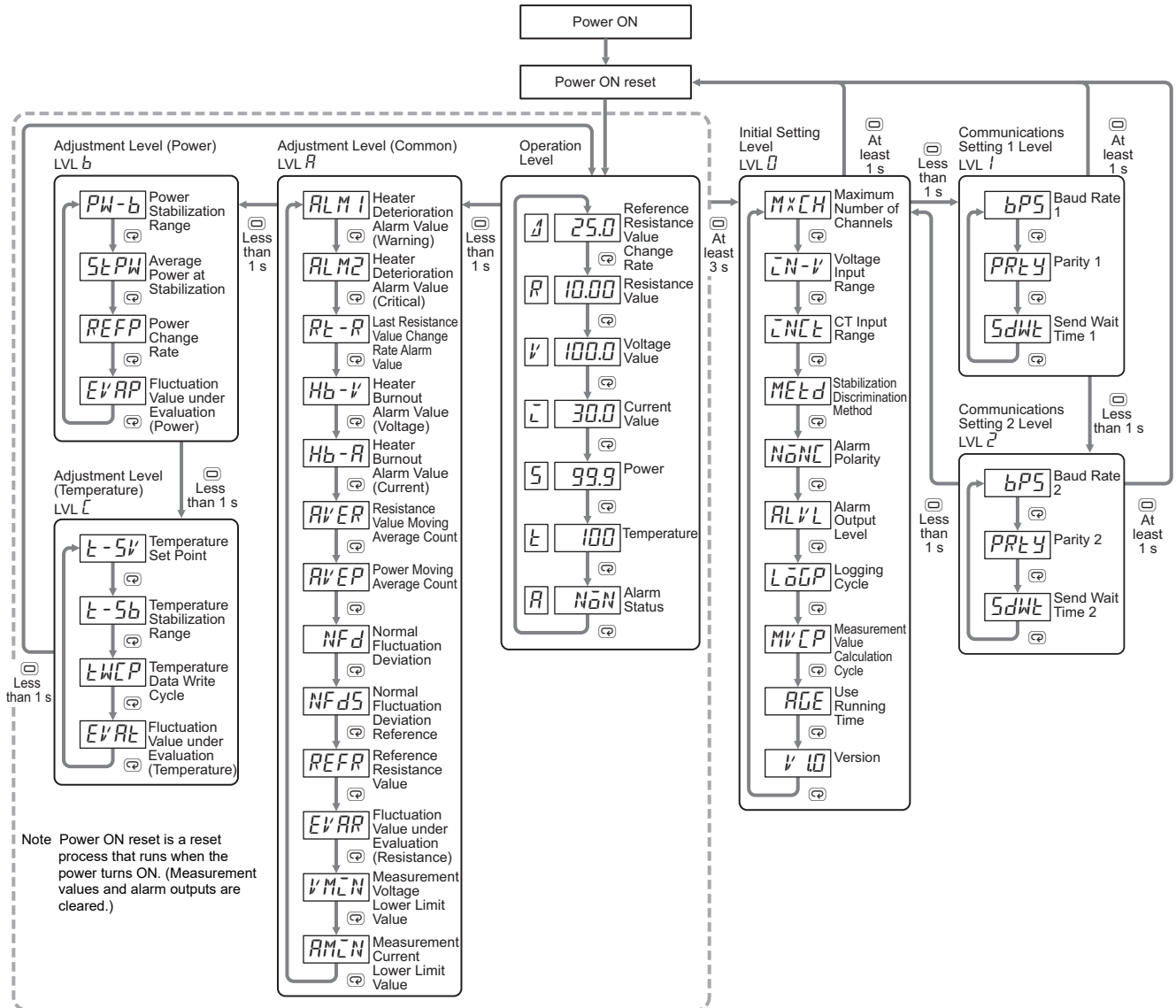

A-4 Operation of Reference Resistance Value Registration

This section describes the operation of reference resistance value registration. The description is based on the operation flow for reference resistance value.

(A) Waiting for Evaluation to Start

The K7TM has a wait time so as to use the stable resistance value as a reference value.

After receiving the operation command, *Reference Resistance Value Registration Start*, it waits for evaluation for either of the following two time periods, whichever is longer.

- *Measurement Value Calculation Cycle* × *Resistance Value Moving Average Count* *1
- *Measurement Value Calculation Cycle* × *Power Moving Average Count*

(B) Acquiring Evaluation Data

The K7TM acquires the evaluation data for registering a resistance value for either of the following two time periods, whichever is longer.

- *Measurement Value Calculation Cycle* × *Resistance Value Moving Average Count* *1
- *Measurement Value Calculation Cycle* × *Power Moving Average Count*

(C) Judgment on Registration of Reference Resistance Value

When the acquisition of evaluation data is completed, the K7TM judges whether all the following conditions are fulfilled. *2

• Condition 1

Case where Stabilization Discrimination Method is Power

All the power change rate shall be inside the power stabilization range, during the period of *Acquiring Evaluation Data*.

(The reference of power stabilization range is a power at the start of *Acquiring Evaluation Data*.)

Case where Stabilization Discrimination Method is Temperature

All the temperature shall be inside the temperature stabilization range, during the period of *Acquiring Evaluation Data*.

• Condition 2

All the reference resistance value change rate shall be within the normal fluctuation deviation, during the period of *Acquiring Evaluation Data*.

(The reference of normal fluctuation deviation is a resistance value at the start of *Acquiring Evaluation Data*.)

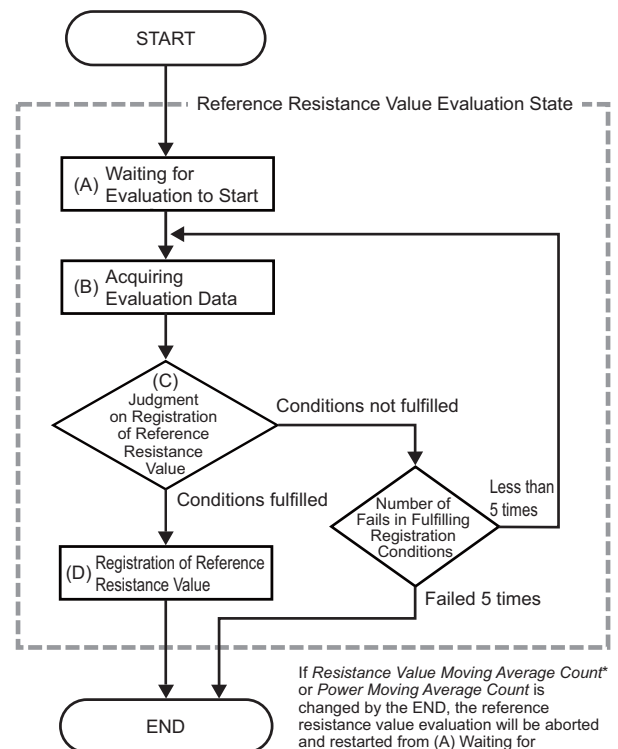

If *Resistance Value Moving Average Count** or *Power Moving Average Count* is changed by the END, the reference resistance value evaluation will be aborted and restarted from (A) Waiting for Evaluation to Start.

* In the case of stabilization discrimination method (temperature), this applies only when *Resistance Value Moving Average Count* is changed.

- Condition 3
All the voltage shall be *Measurement Voltage Lower Limit Value* or more, during the period of *Acquiring Evaluation Data*.
- Condition 4
All the current shall be *Measurement Current Lower Limit Value* or more, during the period of *Acquiring Evaluation Data*.
When all the conditions are fulfilled, (D) *Registration of Reference Resistance Value* is executed.
If the conditions are not fulfilled, the procedure will be redone from (B) *Acquiring Evaluation Data*.
However, if they failed to be fulfilled 5 times, the procedure will end without registering the reference resistance value.

The flashing pattern of **RDY** Indicator tells how many times registering the reference resistance value is retried.



Example:
When the number of retries is 3, flashing three times is repeated at intervals of 1 s.



(D) Registration of Reference Resistance Value

When the conditions are satisfied in (C) Judgment on Registration of Reference Resistance Value above, the resistance value obtained at this time is registered as a reference resistance value.

- *1. In the case of stabilization discrimination method (temperature), only the period of *Measurement Value Calculation Cycle* × *Resistance Value Moving Average* is applicable.
- *2. If any of the following occurs, reference resistance value registration will be canceled immediately. After removing the cause of the error, try the reference resistance value registration again.
 - A measurement error occurs.
 - A heater burnout alarm occurs.

A-4-1 Corrections When Reference Resistance Value Registration Failed (Adjustments with Key Operation)

If the reference resistance value registration fails and the K7TM Configuration Tool cannot be used, you will need to make adjustments with key operation.

To register the reference resistance value with key operation, press the **REF** Key in the lower right of the K7TM front for 3 seconds or more. The **RDY** Indicator will flash showing it is in the reference resistance value evaluation state.

When the registration succeeds, the **RDY** Indicator will change from the flashing state to the lit state. However, if the flashing **RDY** Indicator went out, the registration of reference resistance value has failed.

The corrections for each stabilization discrimination method are shown below.



- The reference resistance value registration requires multiple parameters to be adjusted, so usually use the K7TM Configuration Tool. Making adjustments with key operation takes a longer time as compared with the K7TM Configuration Tool.
- Refer to *2-8 Adjustment When Reference Resistance Value Registration Failed* on page 2-54 for details on parameter adjustments.
- When the measurement value calculation cycle, resistance value moving average count, and power moving average count are default values, it will take a minimum of 35 minutes for the registration to succeed.

Case of Stabilization Discrimination Method (Power)

Checking the four monitored values, find a correction according to the flow.

• Monitored values to check

Setting level	Parameter name	11-seg	Meaning of indicated value
Adjustment Level (Common) LVL R	Fluctuation Value under Evaluation (Resistance)	$E \nabla RR$	In the <i>Reference Resistance Value Evaluation State</i> , the value for which the reference resistance value change rate has fluctuated most sharply will be displayed. After the reference resistance value registration failed, the reference resistance value change rate that fluctuated most sharply with a reference resistance value registration evaluation count of 5 is displayed.
Adjustment Level (Power) LVL b	Fluctuation Value under Evaluation (Power)	$E \nabla RP$	In the <i>Reference Resistance Value Evaluation State</i> , the value for which the power change rate has fluctuated most sharply will be displayed. After the reference resistance value registration failed, the power change rate that fluctuated most sharply with a reference resistance value registration evaluation count of 5 is displayed.
Operation Level	Voltage Value	∇ (Measurement value mark)	The present voltage value applied to the heater is displayed.
Operation Level	Current Value	$\bar{\nabla}$ (Measurement value mark)	The present current value applied to the heater is displayed.

• Correction finding flow

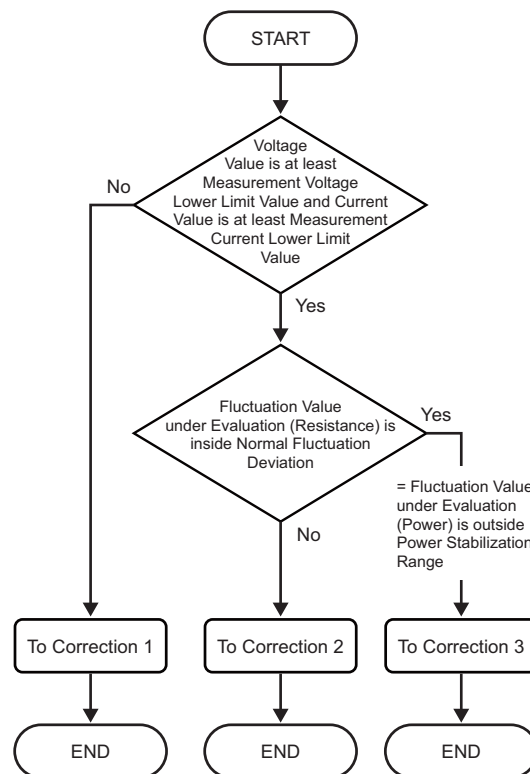

• Correction

Correction number	Cause	Step
Correction 1	The equipment is not running, and power is not supplied to the heater.	<ol style="list-style-type: none"> 1. Run the equipment, and supply power to the heater. 2. Execute the reference resistance value registration.
	The measurement value calculation cycle is shorter than the ON/OFF cycle of the heater.	<ol style="list-style-type: none"> 1. Set the measurement value calculation cycle to an integral multiple of the ON/OFF cycle of the heater. 2. Execute the reference resistance value registration.
Correction 2	The resistance value of the heater is not stable.	<ol style="list-style-type: none"> 1. Increase the resistance value moving average count. * If the resistance value moving average count is already set at High (40 times), make sure that the normal fluctuation deviation is larger than the fluctuation value under evaluation (resistance). 2. Execute the reference resistance value registration.
Correction 3	The power of the heater is not stable.	<ol style="list-style-type: none"> 1. Increase the power moving average count. * If the power moving average count is already set at High (40 times), make sure that the power stabilization range is larger than the fluctuation value under evaluation (power). 2. Execute the reference resistance value registration.

 **Setting-related page**

• ---	Voltage Value	<i>Operation Level (P. 5-11)</i>
• ---	Current Value	<i>Operation Level (P. 5-11)</i>
• <i>RV ER</i>	Resistance Value Moving Average Count	<i>Adjustment Level (Common) (LVL R) (P. 5-15)</i>
• <i>RV EP</i>	Power Moving Average Count	<i>Adjustment Level (Common) (LVL R) (P. 5-16)</i>
• <i>NF d</i>	Normal Fluctuation Deviation	<i>Adjustment Level (Common) (LVL R) (P. 5-16)</i>
• <i>EV RR</i>	Fluctuation Value under Evaluation (Resistance)	<i>Adjustment Level (Common) (LVL R) (P. 5-17)</i>
• <i>PW - b</i>	Power Stabilization Range	<i>Adjustment Level (Power) (LVL b) (P. 5-20)</i>
• <i>EV RP</i>	Fluctuation Value under Evaluation (Power)	<i>Adjustment Level (Power) (LVL b) (P. 5-21)</i>

Case of Stabilization Discrimination Method (Temperature)

Checking the four monitored values, find a correction according to the flow.

• Monitored values to check

Setting level	Parameter name	11-seg	Meaning of indicated value
Adjustment Level (Common) LVL R	Fluctuation Value under Evaluation (Resistance)	EVRR	In the <i>Reference Resistance Value Evaluation State</i> , the value for which the reference resistance value change rate has fluctuated most sharply will be displayed. After the reference resistance value registration failed, the reference resistance value change rate that fluctuated most sharply with a reference resistance value registration evaluation count of 5 is displayed.
Adjustment Level (Temperature) LVL L	Fluctuation Value under Evaluation (Temperature)	EVRL	In the <i>Reference Resistance Value Evaluation State</i> , the value for which temperature is most different from the temperature set point will be displayed. After the reference resistance value registration failed, the temperature that is most different from the temperature set point with a reference resistance value registration evaluation count of 5 is displayed.
Operation Level	Voltage Value	V	The present voltage value applied to the heater is displayed.
Operation Level	Current Value	I	The present current value applied to the heater is displayed.

• Correction finding flow

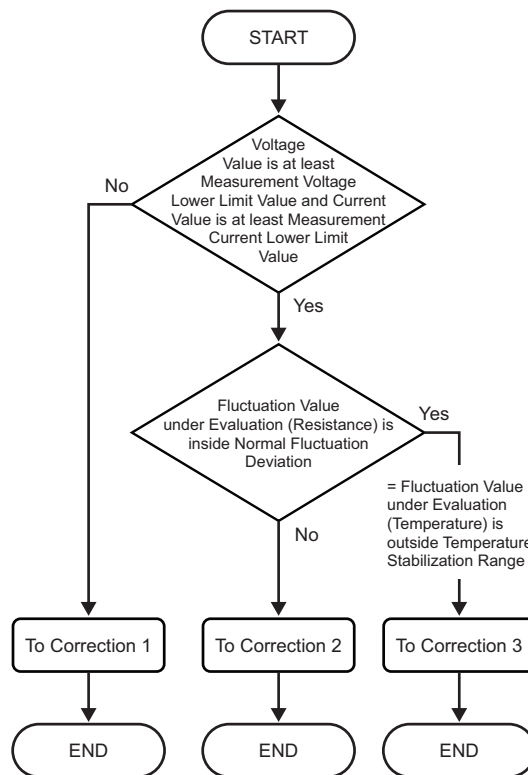

• Correction

Correction number	Cause	Step
Correction 1	The equipment is not running, and power is not supplied to the heater.	<ol style="list-style-type: none"> 1. Run the equipment, and supply power to the heater. 2. Execute the reference resistance value registration.
	The measurement value calculation cycle is shorter than the ON/OFF cycle of the heater.	<ol style="list-style-type: none"> 1. Set the measurement value calculation cycle to an integral multiple of the ON/OFF cycle of the heater. 2. Execute the reference resistance value registration.
Correction 2	The resistance value of the heater is not stable.	<ol style="list-style-type: none"> 1. Increase the resistance value moving average count. * If the resistance value moving average count is already set at High (40 times), make sure that the normal fluctuation deviation is larger than the fluctuation value under evaluation (resistance). 2. Execute the reference resistance value registration.
Correction 3	The temperature of the heater is not stable.	<ol style="list-style-type: none"> 1. Increase the temperature stabilization range so that the fluctuation value under evaluation (temperature) may go into the stabilization range. 2. Execute the reference resistance value registration.
	The temperature is still rising, and far from the temperature set point.	<ol style="list-style-type: none"> 1. Wait until the temperature reaches around the temperature set point. 2. Execute the reference resistance value registration.

 **Setting-related page**

• ---	Voltage Value	<i>Operation Level (P. 5-11)</i>
• ---	Current Value	<i>Operation Level (P. 5-11)</i>
• <i>RV ER</i>	Resistance Value Moving Average Count	<i>Adjustment Level (Common) (LVL R) (P. 5-15)</i>
• <i>NF d</i>	Normal Fluctuation Deviation	<i>Adjustment Level (Common) (LVL R) (P. 5-16)</i>
• <i>EV RR</i>	Fluctuation Value under Evaluation (Resistance)	<i>Adjustment Level (Common) (LVL R) (P. 5-17)</i>
• <i>t - 5b</i>	Temperature Stabilization Range	<i>Adjustment Level (Power) (LVL b) (P. 5-23)</i>
• <i>EV R t</i>	Fluctuation Value under Evaluation (Temperature)	<i>Adjustment Level (Power) (LVL b) (P. 5-24)</i>

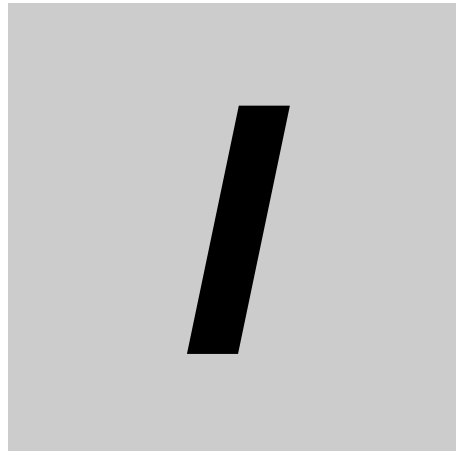

Index



Index

Numerics

\varnothing	17, 1-10
l	17, 1-10
z	17, 1-10
R	17, 1-10
b	17, 1-10
E	17, 1-10
d	17, 1-10
\bar{c}	17, 1-10
R	17, 1-10
S	17, 1-10
t	17, 1-10
v	17, 1-10

A

A/D error	4-28
Adjustment (Common)	2-30
Adjustment (Power)	2-32
Adjustment (Temperature)	2-34
adjustment for heater running for a short time (less than 35 minutes)	2-52
Adjustment Level (Common)	1-10, 5-13
Adjustment Level (Power)	1-10, 5-19
Adjustment Level (Temperature)	1-10, 5-22
Adjustment When Reference Resistance Value Registration Failed	2-54
advance preparation	2-4
AGE Indicator	1-9
alarm	4-18
alarm latch	12, 4-20
Alarm Latch Cancel Command	5-34
alarm output	1-11
alarm setting of K7TM	2-39
ALM Indicator	1-9
altitude	A-3
ambient operating humidity	A-3
ambient operating temperature	A-3
apparent power	12
appearance	1-8
applicable standards	A-10
applicable wire size	A-6
applicable wires	A-6

B

baud rate	A-3
-----------	-----

C

cable length	A-3
CH	12
CH display	1-10
CH1 CT input	1-11

CH1 voltage input	1-11
CH2 CT input	1-12
CH2 voltage input	1-11
changing (writing) setting parameters	6-20
channel	12
checking (reading) parameters	6-19
checking the heater	2-5
checking the target Unit number	7-7
clearance of logging data	7-6
COMM1 Indicator	1-10
COMM2 Indicator	1-10
command frame	6-21
communications display	1-10
communications method	6-3, A-3
Communications Setting 1 Level	1-10
Communications Setting 1 or 2 Level	5-30
Communications Setting 2 Level	1-10
communications setting between K7TM and PLC	2-20
communications setting of tool	2-12
communications test	2-12
Completion of Reference Resistance Value Registration	2-28
condition monitoring for each heater	3-11
condition monitoring for multiple heaters connected in parallel	3-12
configuration with tool (also configurable with key operations)	2-4
connecting stranded wires	3-6
connecting wires with ferrules and solid wires	3-6
connection configurations	A-3
connection with host system	3-14
connection with K7TM Configuration Tool	3-15
construction	A-6
contact form	A-3
Corrections When Reference Resistance Value Registration Failed (Adjustments with Key Operation)	A-17
CP	12
CRC-16	6-21, 6-23
CRC-16 calculation method	6-22
CT	12
CT input terminals	3-10
current capacity	A-6
Current Value	4-4

D

data length	A-3
degree of protection	A-4
details on temperature data not-refreshed error	4-29
detection of heater deterioration	2-2
dielectric strength	A-3
dimensions	3-2
DIN Track mounting hook	1-8

E

error code	6-23
evaluation data	12
example configuration (1)	1-14
example configuration (2)	1-14
example configuration (3)	1-15
example of selecting the special CT	2-6
example wiring for stabilization discrimination method (power)	2-7
example wiring for stabilization discrimination method (temperature)	2-8
execution of registration	2-26
exterior color	A-4

F

FAIL Indicator	1-9
ferrule length	A-6
flashing	12
flashing at high speed	12
frequency characteristics of CTs	A-9
front section	1-9
FUNC Key (Function Key)	1-10

H

heater burnout alarm	4-24
Heater Deterioration Alarm	4-20
how to connect to the Push-In Plus terminal blocks	3-6
how to predict early that registration fails	2-70
how to read a log	4-31

I

I/O wiring	3-9
IN Indicator	1-9
industrial electromagnetic environment	A-4
Initial Setting Level	1-10, 5-25
initial setting of communications converter	2-9
initial setting of K7TM	2-15
input range	A-2, A-5
input setting of K7TM	2-16
installation and wiring	2-7, 3-1
installation environment	A-4
installation of End Plates	3-4
installation of tool	2-9
insulation resistance	A-3
internal block diagram	1-13
items to be logged	4-30

K

K7TM Configuration Tool	2-9
-------------------------------	-----

L

Last Resistance Value Change Rate (Communications only) 4-4	4-4
Last Resistance Value Change Rate Alarm	4-21

leakage current when power turning OFF	A-3
Level Key (O)	1-10
Level Mark	1-10
Levels	5-2
LOCK Indicator	1-9
logging	4-30, 7-1, 7-4
logging timing	4-30
logs to be read	7-8
LVL display	17
LVL/Measurement value display	17, 1-10, 5-2

M

Main Display	16, 1-9
maximum current	A-3
maximum number of Units	A-3
measurable range	A-5
measurement accuracy	A-2, A-5
measurement error	4-26
A/D error	4-26
Current Value Out-of-Range Error	4-26
Not-stabilized Error	4-26
Resistance Value Out-of-Range Error	4-26
Temperature Data Not-refreshed Error	4-26
Voltage Value Out-of-Range Error	4-26
measurement specifications	A-5
measurement target	A-5
measurement value	12, 5-8
Current Value	4-4
Last Resistance Value Change Rate (Communications only)	4-4
power	4-4
Reference Resistance Value Change Rate	4-4
Resistance Value	4-4
Temperature	4-5
Voltage Value	4-4
Measurement Value Calculation Cycle	12
measurement value display	17, 1-10
Measurement Value Display Automatic Scroll	5-9
Measurement Value Mark	5-9
measurement values to be read	7-5
Modbus RTU	12, 6-21
Mode Key (M)	1-10
monitoring state	5-4
monitoring step indicator display	1-9
mounting	A-4
mounting to DIN Track	3-4
moving average	12

N

no response	6-23
Normal Fluctuation Deviation	12
Normal Fluctuation Deviation Reference	12
Notification Actions for Measurement Errors	4-28
Current Value Out-of-Range Error	4-28
Not-stabilized Error	4-28
Resistance Value Out-of-Range Error	4-28
Temperature Data Not-refreshed Error	4-28
Voltage Value Out-of-Range Error	4-28

number of insertionsA-6

O

Occurrence Conditions and Reset Conditions for

Measurement Errors 4-27
operating frequency range A-2
operating power supply voltage range A-2
Operation Command 12, 5-33, 6-17, 6-27
 Alarm Latch Cancel Command 6-18
 Log Refresh Start/Stop Command 6-18
 Operation Stop Command 6-18
 Parameter Initialization Command 6-17
 Reference Resistance Value Registration Start/Cancel
 Command 6-18
 Software Reset Command 6-17
operation keys 1-10
Operation Level 1-10, 5-8
Operation of Reference Resistance Value Registration A-16
operation power supply 1-11
operation power supply terminals 3-9
operation setting of K7TM 2-17, 2-36
Output at Error 1-11
output setting of K7TM 2-37

P

parameter 13, A-11
parameter exclusive to communications
 K7TM Status 6-6
 Last Resistance Value Change Rate 6-8
 Log Data (Current) 6-11
 Log Data (Reference Resistance Value Change Rate)
 6-11
 Log Data (Voltage) 6-11
 Measurement Error Status 6-8
 Monitoring Status 6-8
 product code 6-12
 product model 6-12
 Record Time (for Reference Resistance Value Change
 Rate/Voltage/Current) 6-11
 Reference Resistance Value Registration Evaluation
 Count 6-9
 Running Time Value 6-6
 serial number 6-12
 Total Power ON Time (LSD) 6-6
 Total Power ON Time (MSD) 6-6
parameter flow A-15
Parameter Initialization 5-35
parameter that accesses a monitored value
 Alarm Status 5-12, 6-8, A-11
 Average Power at Stabilization 6-9, A-13
 Current Value 5-11, 6-8, A-11
 Fluctuation Value under Evaluation (Power) 6-9, A-13
 Fluctuation Value under Evaluation (Resistance) 6-9,
 A-12
 Fluctuation Value under Evaluation (Temperature) .. 6-9,
 A-13
 K7TM Status 6-6
 Last Resistance Value Change Rate 6-8

Log Data (Current) 6-11
Log Data (Reference Resistance Value Change Rate) .
6-11
Log Data (Voltage) 6-11
Major Revision 6-12
Measurement Error Status 6-8
Minor Revision 6-12
Monitoring Status 6-8
Normal Fluctuation Deviation Reference A-12
Normal Fluctuation Deviation Reference (LSD) 6-9
Normal Fluctuation Deviation Reference (MSD) 6-9
Power 5-11, 6-8, A-11
Power Change Rate 6-9, A-13
Record Time (for Reference Resistance Value Change
Rate/Voltage/Current) 6-11
Reference Resistance Value A-12
Reference Resistance Value (LSD) 6-9
Reference Resistance Value (MSD) 6-9
Reference Resistance Value Change Rate
..... 5-10, 6-8, A-11
Reference Resistance Value Registration Evaluation
Count 6-9
Resistance Value 5-10, A-11
Resistance Value (LSD) 6-8
Resistance Value (MSD) 6-8
Running Time Value 6-6
Temperature 5-12, A-11
Total Power ON Time (LSD) 6-6
Total Power ON Time (MSD) 6-6
Version 5-29, A-14
Voltage Value 5-11, 6-8, A-11
parity A-3
partial burnout 13
% FS 12
polarity of transistor output 4-19
power 4-4
power consumption A-2
power controller 13
power ON reset
..... 13, 2-9, 4-20, 4-21, 5-3, 5-7, 5-8, 5-35, 6-17, A-15
power supply voltage and frequency A-2
preparations (adjustment) 2-29
preparations (registration) 2-24
Preparations before Reference Resistance Value
Registration 2-25
procedure for moving from level to level 5-3
protocol A-3
Push-In Plus terminal blocks specifications 3-7, A-6

R

rated voltage A-3
ratings and specifications A-2
RDY Indicator 1-9
read interval 7-5
reading of log 7-7
recommend external fuse A-2
recommended DIN Track 3-4
recommended End Plates 3-4

recommended ferrules	3-8, A-6
recommended flat-blade screwdrivers	3-8, A-6
recommended wires	A-4
REF Key (Reference Key)	1-10
Reference Resistance Value	13
Reference Resistance Value Change Rate	4-4
Reference Resistance Value Registration Cancel Command	5-34
Reference Resistance Value Registration Start Command	5-33
registration status cells	2-27
removing from the DIN Track	3-5
removing wires from the Push-In Plus terminal blocks	3-7
residual voltage	A-3
resistance heating heater	1-2, 2-5, A-5
band heater	2-5
cartridge heater	2-5
cast heater	2-5
ceramic heater	2-5
sheathed heater	2-5
SiC (silicon carbide) heater	2-5
resistance monitoring log	4-30
Resistance Value	4-4
Resistance Value Change Rate	13
response frame	6-22
RS-485 communications 1	1-11
RS-485 communications 2	1-11

S

screwdriver press force	A-6
selecting the special CT	2-5
selection of method	2-18
send wait time	A-3
setting change protection	5-6
setting change state	5-4
setting of registration targets	2-26
setting of temperature information	2-22
setting parameters	5-4, 5-7
Alarm Output Level	5-28, 6-6, A-14
Alarm Polarity	5-27, 6-6, A-14
Average Power at Stabilization	5-20
Baud Rate 1	6-6
Baud Rate 1 and 2	5-31, A-14
Baud Rate 2	6-7
CT Input Range	5-26, 6-10, A-14
Fluctuation Value under Evaluation (Power)	5-21
Fluctuation Value under Evaluation (Resistance)	5-17
Fluctuation Value under Evaluation (Temperature)	5-24
Heater Burnout Alarm Value (Current)	5-15, 6-10, A-12
Heater Burnout Alarm Value (Voltage)	5-15, 6-10, A-12
Heater Deterioration Alarm Value (Critical)	5-14, 6-10, A-12
Heater Deterioration Alarm Value (Warning)	5-14, 6-10, A-12
Last Resistance Value Change Rate Alarm Value	5-14, 6-10, A-12
Logging Cycle	5-28, 6-11, A-14

Manipulated Variable	6-9
Maximum Number of Channels	5-26, 6-6, A-14
Measurement Current Lower Limit Value	5-18, 6-10, A-12
Measurement Value Calculation Cycle	5-28, 6-10, A-14
Measurement Value Display Automatic Scroll	6-6
Measurement Voltage Lower Limit Value	5-17, 6-10, A-12
Normal Fluctuation Deviation	5-16, 6-10, A-12
Normal Fluctuation Deviation Reference	5-16
Parity 1	6-6
Parity 1 and 2	5-31, A-14
Parity 2	6-7
Power Change Rate	5-20
Power Moving Average Count	5-16, 6-10, A-12
Power Stabilization Range	5-20, 6-10, A-13
Reference Resistance Value	5-17
Resistance Value Moving Average Count	5-15, 6-10, A-12
Send Wait Time 1	6-6
Send Wait Time 1 and 2	5-32, A-14
Send Wait Time 2	6-7
Setting Change Protection	6-6
Stabilization Discrimination Method	5-27, 6-11, A-14
Temperature	6-9
Temperature Data Write Cycle	5-23, 6-10, A-13
Temperature Set Point	5-23, 6-10, A-13
Temperature Stabilization Range	5-23, 6-10, A-13
Use Running Time	5-29, 6-6, A-14
Voltage Input Range	5-26, 6-10, A-14
setting the target unit number	7-4
setting values	5-4
Shift Key (S)	1-10
shock resistance	A-4
single-phase heater (independent)	3-11
single-phase heaters (multiple)	3-11
special CT	13, A-7
models	A-7
ratings and specifications	A-7, A-8
specifications	A-2
SSR	13
STAB Indicator	1-9
stabilization	13
stabilization discrimination method for heater temperature	2-3
start of heater control and timing of heater deterioration alarm	4-8
start of logging	7-5
starting operation	2-41
Status	6-13
Alarm status	6-15
K7TM Status	6-13
Measurement Error Status	6-15
Monitoring Status	6-14
status display	1-9
stop bits	A-3
stop of logging	7-6
storage temperature	A-3

stripping length (without ferrules)	A-4
switch setting for K7TM	2-9
switching displayed channels	5-8

wire type	A-4
wiring material	A-4
write variable area command (single)	6-27

T

Temperature	4-5
temperature characteristics	13
terminal block type	A-4
terminal section	1-11
three-phase heaters (heaters connected in delta form)	3-12
three-phase heaters (heaters connected in star form) .	3-13
timing charts	4-13
timing of logging	4-30
timing of power ON	4-8
transistor output terminals	3-10
Transmission	A-3
transmission path connection method	A-3
Trends in Power and Resistance Value Graphs Case 1	2-56
Trends in Power and Resistance Value Graphs Case 2	2-58
Trends in Power and Resistance Value Graphs Case 3	2-61
Trends in Temperature and Resistance Value Graphs Case 1	2-64
Trends in Temperature and Resistance Value Graphs Case 2	2-65
Trends in Temperature and Resistance Value Graphs Case 3	2-67
Trends in Voltage Value and Current Value Graphs	2-54
troubleshooting	2-48, 8-2
types of alarm notification methods	4-18
Alarm output	4-18
Alarm Output Indicator	1-9, 4-18
Alarm Status (Communications)	4-19
Alarm Status Parameter	4-18
ALM Indicator	4-18
types of communications commands	6-4

U

unit number	3-16, 5-32
unit number setting switch	1-10
Up Key (U)	1-10

V

variable area map	6-5
variable areas	6-6
vibration resistance	A-3
voltage input terminals	3-9
Voltage Value	4-4

W

weight	A-4
wire insertion force	A-6
wire stripping length	A-6

OMRON Corporation Industrial Automation Company

Kyoto, JAPAN

Contact : www.ia.omron.com

Regional Headquarters

OMRON EUROPE B.V.

Wegalaan 67-69, 2132 JD Hoofddorp
The Netherlands
Tel: (31) 2356-81-300 Fax: (31) 2356-81-388

OMRON ELECTRONICS LLC

2895 Greenspoint Parkway, Suite 200
Hoffman Estates, IL 60169 U.S.A.
Tel: (1) 847-843-7900 Fax: (1) 847-843-7787

OMRON ASIA PACIFIC PTE. LTD.

438B Alexandra Road, #08-01/02 Alexandra
Technopark, Singapore 119968
Tel: (65) 6835-3011 Fax: (65) 6835-2711

OMRON (CHINA) CO., LTD.

Room 2211, Bank of China Tower,
200 Yin Cheng Zhong Road,
PuDong New Area, Shanghai, 200120, China
Tel: (86) 21-5037-2222 Fax: (86) 21-5037-2200

Authorized Distributor:

©OMRON Corporation 2021-2022 All Rights Reserved.
In the interest of product improvement,
specifications are subject to change without notice.

Cat. No. N227-E1-03

0922