

Insulation Resistance Monitoring Device

User's Manual
K7GE-MG

1
Overview

2
Procedure

3
Installation and
Wiring

4
Functions Related to
Measurement

5
Using Setting
Parameters

6
Remote Monitoring

Troubleshooting

A
Appendices

I
Index



NOTE

All rights reserved. No part of this publication may be reproduced, stored in a retrieval system, or transmitted, in any form, or by any means, mechanical, electronic, photocopying, recording, or otherwise, without the prior written permission of OMRON.

No patent liability is assumed with respect to the use of the information contained herein. Moreover, because OMRON is constantly striving to improve its high-quality products, the information contained in this manual is subject to change without notice. Every precaution has been taken in the preparation of this manual. Nevertheless, OMRON assumes no responsibility for errors or omissions. Neither is any liability assumed for damages resulting from the use of the information contained in this publication.

Trademarks

- Microsoft, Windows is either registered trademarks or trademarks of Microsoft Corporation in the United States and other countries.
- Megger is a registered trademark or trademark of Megger Group Limited.
- Modbus is a registered trademark or trademark of Schneider Electric USA, Inc. in Japan, the United States or other countries.

Other company names and product names in this document are the trademarks or registered trademarks of their respective companies.

Copyrights

Microsoft product screen shots reprinted with permission from Microsoft Corporation.

Preface

Thank you for purchasing a K7GE-MG Insulation Resistance Monitoring Device. This manual describes how to use the K7GE-MG.

Read this manual thoroughly and be sure you understand it before attempting to use the K7GE-MG correctly according to the information provided. Keep this manual in a safe place for easy reference. A PDF version of this manual can be downloaded from the OMRON website. (<http://www.omron.com>)

In this manual, "K7GE-MG" refers to the K7GE-MG with its Main Unit connected to the Probe Units.

It is assumed that the load that the K7GE-MG measures is a motor. Before you use it for other equipment such as a heater or transformer, carefully study the operating specifications of the K7GE-MG.

Terms and Conditions Agreement

Warranty, Limitations of Liability

Warranties

- **Exclusive Warranty**

Omron's exclusive warranty is that the Products will be free from defects in materials and workmanship for a period of twelve months from the date of sale by Omron (or such other period expressed in writing by Omron). Omron disclaims all other warranties, express or implied.

- **Limitations**

OMRON MAKES NO WARRANTY OR REPRESENTATION, EXPRESS OR IMPLIED, ABOUT NON-INFRINGEMENT, MERCHANTABILITY OR FITNESS FOR A PARTICULAR PURPOSE OF THE PRODUCTS. BUYER ACKNOWLEDGES THAT IT ALONE HAS DETERMINED THAT THE PRODUCTS WILL SUITABLY MEET THE REQUIREMENTS OF THEIR INTENDED USE.

Omron further disclaims all warranties and responsibility of any type for claims or expenses based on infringement by the Products or otherwise of any intellectual property right.

- **Buyer Remedy**

Omron's sole obligation hereunder shall be, at Omron's election, to (i) replace (in the form originally shipped with Buyer responsible for labor charges for removal or replacement thereof) the non-complying Product, (ii) repair the non-complying Product, or (iii) repay or credit Buyer an amount equal to the purchase price of the non-complying Product; provided that in no event shall Omron be responsible for warranty, repair, indemnity or any other claims or expenses regarding the Products unless Omron's analysis confirms that the Products were properly handled, stored, installed and maintained and not subject to contamination, abuse, misuse or inappropriate modification. Return of any Products by Buyer must be approved in writing by Omron before shipment. Omron Companies shall not be liable for the suitability or unsuitability or the results from the use of Products in combination with any electrical or electronic components, circuits, system assemblies or any other materials or substances or environments. Any advice, recommendations or information given orally or in writing, are not to be construed as an amendment or addition to the above warranty.

See <http://www.omron.com/global/> or contact your Omron representative for published information.

Limitation on Liability; Etc

OMRON COMPANIES SHALL NOT BE LIABLE FOR SPECIAL, INDIRECT, INCIDENTAL, OR CONSEQUENTIAL DAMAGES, LOSS OF PROFITS OR PRODUCTION OR COMMERCIAL LOSS IN ANY WAY CONNECTED WITH THE PRODUCTS, WHETHER SUCH CLAIM IS BASED IN CONTRACT, WARRANTY, NEGLIGENCE OR STRICT LIABILITY.

Further, in no event shall liability of Omron Companies exceed the individual price of the Product on which liability is asserted.

Application Considerations

Suitability of Use

Omron Companies shall not be responsible for conformity with any standards, codes or regulations which apply to the combination of the Product in the Buyer's application or use of the Product. At Buyer's request, Omron will provide applicable third party certification documents identifying ratings and limitations of use which apply to the Product. This information by itself is not sufficient for a complete determination of the suitability of the Product in combination with the end product, machine, system, or other application or use. Buyer shall be solely responsible for determining appropriateness of the particular Product with respect to Buyer's application, product or system. Buyer shall take application responsibility in all cases.

NEVER USE THE PRODUCT FOR AN APPLICATION INVOLVING SERIOUS RISK TO LIFE OR PROPERTY OR IN LARGE QUANTITIES WITHOUT ENSURING THAT THE SYSTEM AS A WHOLE HAS BEEN DESIGNED TO ADDRESS THE RISKS, AND THAT THE OMRON PRODUCT(S) IS PROPERLY RATED AND INSTALLED FOR THE INTENDED USE WITHIN THE OVERALL EQUIPMENT OR SYSTEM.

Programmable Products

Omron Companies shall not be responsible for the user's programming of a programmable Product, or any consequence thereof.

Disclaimers

Performance Data

Data presented in Omron Company websites, catalogs and other materials is provided as a guide for the user in determining suitability and does not constitute a warranty. It may represent the result of Omron's test conditions, and the user must correlate it to actual application requirements. Actual performance is subject to the Omron's Warranty and Limitations of Liability.

Change in Specifications

Product specifications and accessories may be changed at any time based on improvements and other reasons. It is our practice to change part numbers when published ratings or features are changed, or when significant construction changes are made. However, some specifications of the Product may be changed without any notice. When in doubt, special part numbers may be assigned to fix or establish key specifications for your application. Please consult with your Omron's representative at any time to confirm actual specifications of purchased Product.

Errors and Omissions

Information presented by Omron Companies has been checked and is believed to be accurate; however, no responsibility is assumed for clerical, typographical or proofreading errors or omissions.

Safety Precautions

Definition of Precautionary Information





The following notation is used in this manual to provide precautions required to ensure safe usage of the K7GE-MG Insulation Resistance Monitoring Device.

The safety precautions that are provided are extremely important to safety. Always read and heed the information provided in all safety precautions.









The following notation is used.

 CAUTION	Indicates a potentially hazardous situation which, if not avoided, may result in minor or moderate injury, or in property damage.
Precautions for Safe Use	Precautions on what to do and what not to do to ensure safe usage of the product.
Precautions for Correct Use	Precautions on what to do and what not to do to ensure proper operation and performance.

Symbols

Symbol		Meaning
Caution		<ul style="list-style-type: none"> General Caution Indicates non-specific general cautions, warnings, and dangers.
		<ul style="list-style-type: none"> Electrical Shock Caution Indicates possibility of electric shock under specific conditions.
Prohibition		<ul style="list-style-type: none"> General Prohibition Indicates non-specific general prohibitions.
		<ul style="list-style-type: none"> Disassembly Prohibition Indicates prohibitions when there is a possibility of injury, such as from electric shock, as the result of disassembly.
Mandatory Caution		<ul style="list-style-type: none"> General Caution Indicates non-specific general cautions, warnings, and dangers.



CAUTION

Minor injury due to electric shock may occasionally occur. Do not touch the Product except for any buttons (keys) while power is being supplied.	
Always connect the protective earthing terminal (⊕) to a ground. Use AWG 16 for the protective conductor.	
If the wiring material is inserted in a shallow position, it may cause property damage due to ignition. When wiring, make sure that the wiring material is properly inserted all the way into the terminal block.	
If used the Product with incorrect wiring, it may cause property damage due to ignition. Make sure the cable is connected properly when the power supply is turned ON.	
Minor electric shock, fire, or malfunction may occasionally occur. Do not allow metal objects, conductors, or cuttings from installation work to enter the Product.	
Perform periodic inspection to the Product. A malfunction in the Product may occasionally prevent monitoring impossible or alarm outputs, resulting in property damage to connected equipment or devices. To maintain safety in the event of malfunction of the Product, take appropriate safety measures, such as installing a monitoring device on a separate line.	
Minor injury due to explosion may occasionally occur. Do not use the Product where subject to flammable or explosive gas.	
Minor electric shock, fire, or malfunction may occasionally occur. Do not disassemble, modify, or repair the Product or touch the interior of the Product.	

Take adequate security measures against DDoS attacks (Distributed Denial of Service attacks), computer viruses and other technologically harmful programs, unauthorized access and other possible attacks before using this product.

Security Measures

<p>Anti-virus protection Install the latest commercial-quality antivirus software on the computer connected to the control/monitor system and maintain to keep the software up-to-date.</p>	
--	---

<p>Security measures to prevent unauthorized access</p> <p>Take the following measures to prevent unauthorized access to our products.</p> <ul style="list-style-type: none"> • Install physical controls so that only authorized personnel can access control/monitor systems and equipment. • Reduce connections to control/monitor systems and equipment via networks to prevent access from untrusted devices. • Install firewalls to shut down unused communications ports and limit communications hosts and isolate control/monitor systems and equipment from the IT network. • Use a virtual private network (VPN) for remote access to control/monitor systems and equipment. • Scan virus to ensure safety of SD cards or other external storages before connecting them to control/monitor systems and equipment. 	
<p>Data input and output protection</p> <p>Validate backups and ranges to cope with unintentional modification of input/output data to control/monitor systems and equipment.</p> <ul style="list-style-type: none"> • Checking the scope of data • Checking validity of backups and preparing data for restore in case of falsification and abnormalities • Safety design, such as emergency shutdown, in case of data tampering and abnormalities 	
<p>Data recovery</p> <p>Backup data and keep the data up-to-date periodically to prepare for data loss.</p>	

Precautions for Safe Use

- (1) Do not use or store the Product in the following locations:
 - Outdoor or locations subject to direct sunlight
 - Locations subject to rain and wind damage
 - Locations subject to excessive vibration or shock
 - Locations subject to rapid temperature changes
 - Locations prone to icing and dew condensation
 - Locations subject to water or oil
 - Locations subject to dust or corrosive gases (particularly sulfurizing gases, ammonia, etc.)
 - Locations subject to influence of static electricity and noise
 - Locations subject to bugs and small animals
- (2) A switch or circuit breaker should be provided close to this Unit. The switch or circuit breaker should be within easy reach of the operator, and must be marked as a disconnecting means for this Unit.
- (3) Mount the Product in the correct direction for installation.
- (4) Be sure to use power terminals carefully, because power supply terminals have hazardous voltage.
- (5) Use the wire given in this manual.
- (6) Use the power supply voltage within the range of the specifications and rated values. Use the input voltage within the range of the specifications and rated values.
- (7) Make sure the crimp terminals for wiring are of the specified size.
- (8) Do not connect anything to terminals that are not being used.
- (9) Confirm the wiring the input and output terminals correctly before power is supplied.
- (10) The terminal block may be damaged if you insert a flat-blade screwdriver in the release hole with excessive force. When inserting a flat-blade screwdriver into the release holes, operate with a force of 15•N or less.
- (11) K7GE-MG may be subject to radio disturbances. Do not install the Product near equipment that generates high frequencies or surges.
- (12) The maximum terminal temperature is 80°C. Use wires with a heat resistance of 80°C min to wire the terminals.
- (13) Make sure the LCD and the LEDs for output indicators operate correctly. Depending on the operating environment, the Product parts may deteriorate faster than expected, causing the indicators to fail.
- (14) Use the cable within the length that is rated in the specification requirements for the wiring between the sensor and the Product. As for the requirements on the cable distance, refer to *3-6 Wiring the Communications Cable* on page 3-13.
- (15) In order to prevent inductive noise, wire the lines connected to the Product separately from power lines carrying high voltages or currents. Also, do not wire in parallel with or on the same cables as power lines. Other measures for reducing noise are to separate from ducts including noisy lines.
- (16) Do not continue to use the Product if the front surface peels.
- (17) The alarm output function is a function for the output of an alarm when the set threshold value is below. Do not use this function for control, etc.
- (18) Use this Product inside the control panel to prevent external noise.
- (19) When discarding the Product, properly dispose of it as industrial waste.
- (20) Never touch the charging terminal of the load while the K7GE-MG is in measurement operation.
- (21) K7GE-MG cannot be used for legal inspection. Be sure to use a periodically calibrated measuring instrument for legal inspection.
- (22) When wiring, wire by enough length.

- (23) Check terminal polarity when wiring and wire all connections correctly. Do not wire the input and output terminals incorrectly.
- (24) K7GE-MG provides 50 VDC of Megger voltage. Do not use on equipment that may be damaged by this voltage.
- (25) Use and store the Product in a location where the ambient temperature and humidity are within the specified ranges. If applicable, provide forced cooling.
- (26) Please read and understand this manual before using K7GE-MG.

Precaution for Correct Use

Observe the following operating methods to prevent failure and malfunction.

- (1) During periodic inspection, installation of an additional sensor, or adjustment of sensor position, use the Product after ensuring that correct operation can be performed.
- (2) When mounting K7GE-MG on a DIN Track, follow the installation method described in *Mounting to DIN Track* on page 3-4 to install it correctly.
- (3) Confirm that wire does not stick up after wiring of stranded cable.
- (4) In case of crossover wiring, install these by 10 A per 1 terminal because when Products are connected more than one in parallel, quite many electric currents to be called off.
- (5) The terminal block may be damaged if specialized tool is not used. Use a recommended flat-blade screwdriver to inserted into a release hole on the terminal block.
- (6) This Product is designed for use by qualified personnel with a knowledge of electrical systems. Read this manual carefully before using the Product.
- (7) Use the power supply voltage, input power, and other power supplies and transformers with suitable capacities and rated outputs.
- (8) Use a power supply that will reach the rated voltage within 1 second after the power is turned ON.
- (9) Do not install the Product close contact with the heating element.
- (10) Do not install the Product near equipment that generates high frequencies or surges.
- (11) Install the Product so that the load doesn't span the Product body.
- (12) If an error occurs during K7GE-MG operation, stop operation immediately and make suitable corrections such as replacement.
- (13) Do not use K7GE-MG for safety devices or applications that could result in loss of life.
- (14) Make sure to connect Main Unit and Probe Units before use.
- (15) Make sure that the number of additional Probe Units is within the specified range.
- (16) Be sure to install a magnetic contactor, etc. between the power supply and the load, and wire K7GE-MG on the secondary side of it.
- (17) Do not turn ON power to the load while K7GE-MG is measuring.
- (18) Set the "Motor stop waiting time" setting value to at least the time from when the contactor is turned off until the load completely stops.
- (19) If you accidentally drop K7GE-MG, the inside of the Product may be damaged, so do not use it.
- (20) Do not wire anything to the release holes.
- (21) Do not tilt or twist a flat-blade screwdriver while it is inserted into a release hole on the terminal block. The terminal block may be damaged.
- (22) Insert a flat-blade screwdriver into the release holes at an angle. The terminal block may be damaged if you insert the screwdriver straight in.
- (23) Do not allow the flat-blade screwdriver to fall out while it is inserted into a release hole.
- (24) Do not bend a wire past its natural bending radius or pull on it with excessive force. Doing so may cause the wire disconnection.
- (25) Do not insert more than one wire into each terminal insertion hole.
- (26) Do not use any liquids such as paint thinner, similar solvents or alcohol to clean the Product. Clean it with a soft, dry cloth.

Regulations and Standards

Conformance to Safety Standards

- For wiring from the Probe Unit to the load, use a Class CC, Class J, or Class T fuse with a rated current of 7A or less.
- The protection provided by the device may be impaired if the device is used in a manner that is not specified by the manufacturer.
- To use the Product, install it as an embedded device within a control panel.
- The table below shows the nominal voltage and measurement circuit connections available for each measurement category in the Main Power Supply System Configurations. Do not use the device under conditions that exceed this category and conditions.

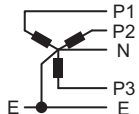
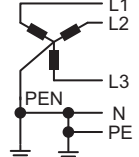
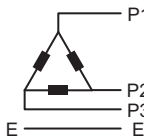
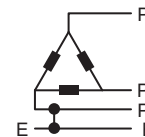
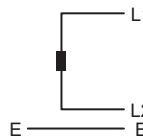
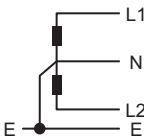
Main Power Supply System Configurations					
	<p>3-phase, 4-wire type (neutral point grounding)</p> <p>TT</p>  <p>TN-C-S</p> 	<p>3-phase, 3-wire type (no grounding)</p> 	<p>3-phase, 3-wire type (single-phase grounding)</p> 	<p>Single-phase, 2-wire type AC or DC</p> 	<p>Single-phase (split phase), 2-wire type AC or DC</p> 
CAT III	Phase voltage/line voltage 277 V/480 V	Line voltage 300 V	Line voltage 300 V	Line voltage 240 V	Phase voltage/line voltage 240 V/480 V
CAT II	347 V/600 V in addition to the above	480 V in addition to the above	480 V in addition to the above	480 V in addition to the above	Same as above
Connection to measurement circuit	<p>TT: Connect E in the diagram above to the No. 7 terminal (PE) of the K7GE-MGM. Connect P1 and P2 to the No. 1 and No. 3 terminals of the K7GE-MG1.</p> <p>TN-C-S: Connect PE in the diagram above to the No. 7 terminal (PE) of the K7GE-MGM. Connect L1 and L2 to the No. 1 and No. 3 terminals of the K7GE-MG1.</p>	<p>Connect E in the diagram above to the No. 7 terminal (PE) of the K7GE-MGM. Connect P1 and P2 to the No. 1 and No. 3 terminals of the K7GE-MG1.</p>	<p>Connect E in the diagram above to the No. 7 terminal (PE) of the K7GE-MGM. Connect L1 and L2 to the No. 1 and No. 3 terminals of the K7GE-MG1.</p>		

● Measurement Category

The measurement category classifies the places and equipment which you can connect to the measurement terminals, as prescribed in EN/IEC 61010-2-030. Each category is as follows.

- CAT I: Equipment to connect to circuits where measures are taken to limit transient overvoltages to low levels
- CAT II: Energy-consuming equipment with an energy supply from fixed wiring equipment (such as a power outlet)
- CAT III: Equipment in fixed wiring equipment that particularly demands equipment reliability and effectiveness
- CAT IV: Equipment to use at the electrical service entry

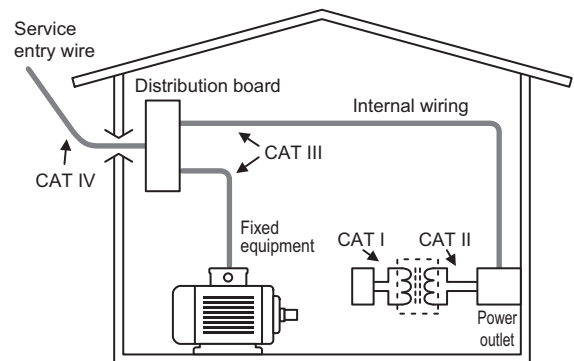

Conformance to EN/IEC Standards

This is a class A product. In residential areas it may cause radio interference, in which case the user may be required to take adequate measures to reduce interference.

Terminology

Term	Abbreviation	Description
CompoWay/F	-	CompoWay/F is OMRON's standard communications format for general serial communications. This format uses a standard frame format as well as the well-established FINS commands used for OMRON's PLCs. Therefore, it can simplify communications between components and the host.
FINS (Factory Interface Network Service)	FINS	The FINS protocol provides message communications between controllers in OMRON FA networks.
Modbus RTU	-	This is a standard communications control method that conforms to Modicon Inc.'s RTU-mode Modbus Protocol (PI-MBUS-300 Rev. J).
Channels	CH	The units of the insulation measurement loop for the Insulation Resistance Monitoring Device.
Power ON reset	-	A reset process that runs when the power turns ON.
Protective earthing	PE	The protective earth to connect to the housing of a device to bring the housing to the same potential as the ground and allow ground fault currents to flow to ground.
K7GE-MG	-	"K7GE-MG" refers to the K7GE-MG with its Main Unit connected to the Probe Units.
Megohmmeter	-	An instrument that measures the insulation resistance of electrical products and indoor wiring, also called an insulation resistance meter.
Megger voltage	-	The voltage that the device applies to measure the insulation resistance. The K7GE-MG applies 50 VDC.
Megger method	-	A method to measure resistance values by connecting a measuring circuit between a ground-insulated charged section that is connected to the power line and a non-charged section such as a grounded motor frame.
Parasitic capacitance	-	The capacitance that exists between the charging terminal of the load and the terminal such as between PE. Also called stray capacitance.

Manual Structure

Page Structure

5 Using Setting Parameters

5-13 Communications Setting Parameters

Level	Characters	Range of setting values	Default value	Description
Communications Setting	PSEL	CWF/MOD	CWF	Protocol selection CWF (CompoWay/FY)MOD (Modbus RTU)
	bP5	9,6/19,2/38,4/57,6 (kbps)	9,6	Baud rate
	LEN	7/8 (bit)	7	Data length
	StCt	1/2 (bit)	2	Stop bits
	PRPY	NONE/EVEN/ODD	EVEN	Parity None/Even/Odd
	SDWt	0 to 99 (ms)	20	Send wait time

Set the setting parameters related to RS-485 communications.

Use the Unit Number Setting Switch on the Main Unit front part to set the unit number. The setting is applied after a power ON reset.

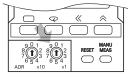



The Send Wait Time setting parameter is the wait time from when the K7GE-MG receives a command from the host system until it returns a response. If the response comes so fast that the host system cannot receive it properly, increase this setting value. If you want to make the communications response time faster, decrease this setting value.

 When the Modbus RTU protocol is selected, regardless of the setting value of the setting parameter, the data length is fixed internally at 8 bits, and the stop bit is fixed internally at 1 bit when the parity is even/odd or fixed internally at 2 bits when the parity is none. Use it with caution.



The operation procedure for the Baud Rate setting parameter is shown as follows:



Procedure

1. At the Operation Level, press the Level Key for 3 seconds or more to switch to the Initial Setting Level.

 - The LVL/CH display indicates *D*, and LVL lights up to indicate that the system is at the Initial Setting Level.
2. Press the Level Key at the Initial Setting Level (for less than 1 second) to switch to the Communications Setting Level.



3. Press the Mode Key several times to display bP5.

Insulation Resistance Monitoring Device User's Manual (N224)
5 - 25

Level 1 heading

Level 2 heading

Special information
Icons indicate precautions, additional information, or reference information.

A step in a procedure
Indicates a procedure.



Manual name

Level 2 heading
Gives the current headings.

Page tab
Gives the number of the main section.

Icons

Special information in this manual is classified as follows:

Icon	Meaning
	Additional information to read as required. This information is provided to increase understanding or give hints on operation.
 No. **	This indicates the position in <i>Section 2 Procedure</i> that provides more detailed information about trouble and countermeasures.

Revision History

A manual revision code appears as a suffix to the catalog number on the front cover of the manual.

Man.No.	N224-E1-03
----------------	-------------------

↑
Revision code

Revision code	Date	Revised content
01	January 2021	Original production
02	April 2021	Pages 2-4 and 3-12: Corrected a fusing current value.
03	September 2022	<ul style="list-style-type: none">• Added information on <i>Safety Precautions</i>.• Pages 3-15, 3-16 and 3-17: Corrected connection diagrams.

Sections in this Manual

1	Overview	1
2	Procedure	2
3	Installation and Wiring	3
4	Functions Related to Measurement	4
5	Using Setting Parameters	5
6	Remote Monitoring	6
7	Troubleshooting	7
A	Appendices	A
I	Index	I

CONTENTS

Preface	1
Terms and Conditions Agreement.....	2
Warranty, Limitations of Liability	2
Application Considerations	3
Disclaimers	3
Safety Precautions	4
Definition of Precautionary Information.....	4
Symbols	4
Precautions for Safe Use	7
Precaution for Correct Use.....	9
Regulations and Standards	10
Conformance to Safety Standards.....	10
Conformance to EN/IEC Standards.....	11
Terminology	12
Manual Structure	13
Page Structure.....	13
Icons	13
Revision History	14
Sections in this Manual	15
CONTENTS.....	16

Section 1 Overview

1-1 Overview.....	1-2
1-2 Features.....	1-3
1-3 Model Number Legend.....	1-6
1-4 Insulation Resistance Measurement and Monitoring System.....	1-7
1-5 Nomenclature and Functions	1-8
1-6 Internal Block Diagram	1-14
1-7 System Configurations	1-16
1-8 Safety Precautions	1-18

Section 2 Procedure

2-1 Procedure.....	2-2
(1) Advance Preparation.....	2-2
(2) Installation and Wiring.....	2-3
(3) Initial Setting.....	2-5
(4) Test Operation with Manual Measurement	2-7
(5) Starting Operation	2-8
Troubleshooting.....	2-10

Section 3 Installation and Wiring

3-1	Dimensions	3-2
3-2	Installation.....	3-3
3-3	Setting the Channel Number	3-6
3-4	How to Connect to the Push-In Plus Terminal Blocks	3-7
3-5	I/O Wiring.....	3-10
3-6	Wiring the Communications Cable	3-13
3-7	Setting the Unit Number	3-14
3-8	Connecting to a Load or Contactor	3-15
	Cases Where Insulation Resistance is Measured Without Disconnecting Motors	3-18

Section 4 Functions Related to Measurement

4-1	Automatic Measurement.....	4-2
4-1-1	Trigger Input	4-2
4-1-2	Measurement Steps.....	4-4
4-1-3	Measurement Step Indicator Operation	4-7
4-1-4	Timing Charts	4-8
4-1-5	Measurement Value Display Automatic Scroll	4-16
4-2	Manual Measurement	4-17
4-3	Measuring Range and Measuring Accuracy	4-21
4-4	Voltage Monitoring	4-22
4-5	Current Limiter.....	4-23
4-6	Reset Key	4-25
4-7	System Error	4-26
4-8	Running Time.....	4-27
4-9	Calculating the Measuring Time Using the Elapsed Time	4-28

Section 5 Using Setting Parameters

5-1	Levels	5-2
5-2	Setting Parameters and Setting Values.....	5-4
5-3	Maximum Number of Channels.....	5-6
5-4	Alarm Values 1 and 2.....	5-9
5-5	Alarm Polarity	5-11
5-6	Trigger Signal Reverse.....	5-13
5-7	Motor Stop Waiting Time	5-15
5-8	Time to Wait to Stabilize.....	5-17
5-9	Average Processing	5-19
5-10	Use Running Time	5-21
5-11	Software Version	5-23
5-12	Setting Change Protection	5-24
5-13	Communications Setting Parameters.....	5-26

Section 6 Remote Monitoring

6-1	Remote Monitoring	6-2
6-2	Communications Overview	6-3
6-3	Variable Area Map	6-5
6-4	Monitoring (Reading) Measurement Values	6-8
6-5	Operation Command	6-9
6-6	Checking (Reading) Setting Parameters	6-12
6-7	Changing (Writing) Setting Parameters	6-13
6-8	CompoWay/F Communications Format	6-14
6-8-1	Frame Configurations.....	6-14
6-8-2	Read Variable Area Command	6-17
6-8-3	Write Variable Area Command.....	6-18
6-8-4	Operation Command.....	6-20
6-9	Modbus RTU Communications Format	6-22
6-9-1	Frame Configurations.....	6-22
6-9-2	Read Variable Area Command	6-25
6-9-3	Write Variable Area Command.....	6-26
6-9-4	Operation Command.....	6-27

Section 7 Troubleshooting

7-1	Troubleshooting	7-2
------------	------------------------------	------------

Appendices

A-1	Specifications	A-2
	Ratings and Specifications	A-2
	Measurement Specifications.....	A-3
	Input Specifications of Trigger Input Terminals	A-3
	Output Specifications of Transistor Output Terminals	A-4
	Input Specifications of Voltage Input Terminals.....	A-4
	Communications Specifications.....	A-5
A-2	Setting Parameters List	A-6
A-3	Setting Parameter Flow	A-7
A-4	K7GE-MG Logging Tool	A-8

Index

1

Overview

This section describes the features, model number legend, nomenclature and functions, system configuration, and safety precautions of the K7GE-MG.

1-1 Overview	1-2
1-2 Features	1-3
1-3 Model Number Legend	1-6
1-4 Insulation Resistance Measurement and Monitoring System	1-7
1-5 Nomenclature and Functions	1-8
1-6 Internal Block Diagram	1-14
1-7 System Configurations	1-16
1-8 Safety Precautions	1-18

1-1 Overview

The K7GE-MG is a device that automatically measures the insulation resistance of a load and supports trend monitoring.

Periodic inspections by manpower may cause a unexpected machine stoppage due to a decrease in insulation resistance of equipment before the next inspection. The K7GE-MG provides automatic monitoring of the insulation resistance of each load and allows planned maintenance.

The K7GE-MG measures the insulation resistance by the same detection principle (Megger method) as a Megohmmeter.

To measure the insulation resistance using the K7GE-MG, it is necessary to combine one Main Unit with at least one Probe Unit.

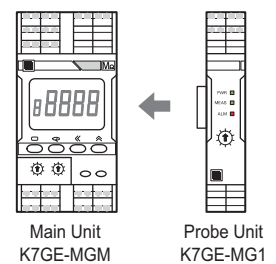

The functions of the Main Unit and Probe Unit are shown in the figure on the right.

The Main Unit corresponds to a Megohmmeter, and the Probe Unit corresponds to a measurement probe with internal contacts. The Main Unit turns ON these contacts in sequence and measure multiple loads individually.

Up to eight Probe Units can be connected to one Main Unit.

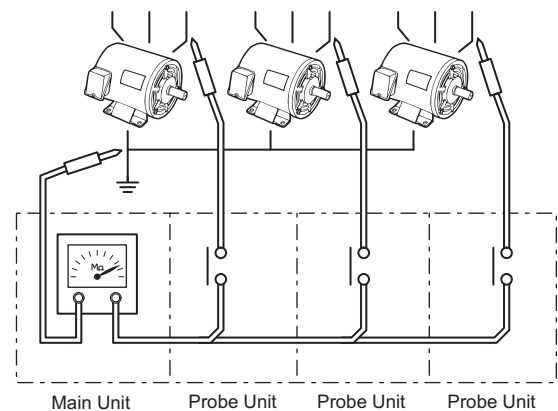

K7GE-MG supports a motor as a measurement load. If you want to measure other loads such as a heater or transformer, carefully study the operating specifications of the K7GE-MG before use.

1-2 Features

The following features make the K7GE-MG convenient and safe to use.

Uses the Same Detection Principle as a Megohmmeter

The K7GE-MG measures the insulation resistance by the same detection principle (Megger method) as a Megohmmeter. Therefore, the inspection data of the Megohmmeter can be used, and the smooth introduction of this system is possible.

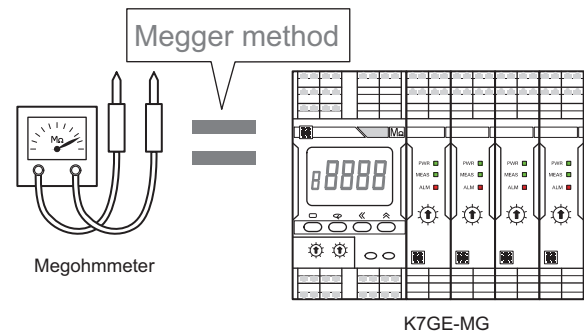

More Support for the Safety Functions

- The K7GE-MG is always monitoring the OFF state of the loads and the power line. K7GE-MG does not start measurement even if it receives a measurement start signal during load operation. In addition, K7GE-MG will stop the measurement immediately if the load restarts during the measurement.

- In addition, the K7GE-MG is equipped with an overcurrent limit circuit. This limits the following overcurrents to safe levels:
 - Instantaneous overcurrent that flows when the load is restarted during measurement.
 - Overcurrent that flows when the insulation resistance value is extremely low.

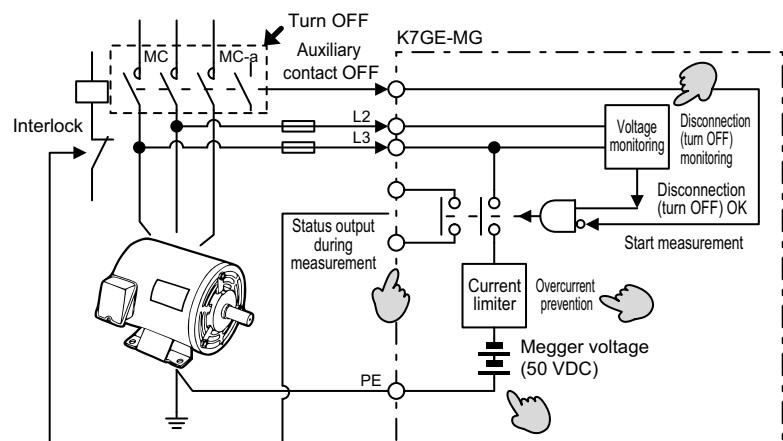

Note The above diagram shows only the parts of the internal circuit of the K7GE-MG that are necessary for explanation.

- To reduce equipment damage and prevent electric shock, the K7GE-MG has a low Megger voltage of 50 VDC*.

* Even if the Megger voltage is 50 VDC, it does not affect the measurement accuracy.

- The K7GE-MG provides a contact output that indicates that measurement is in progress. You can design an interlock circuit that prevents the load from restarting during the measurement.

Supports Multiple Channel Measurement

K7GE-MG can be measured up to eight channels per Main Unit by adding more Probe Units. This reduces cost and installation space per channel.

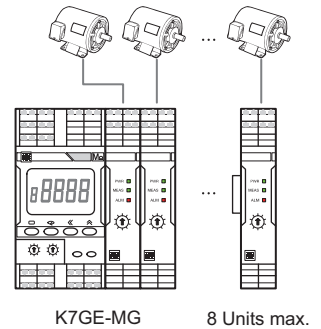

Periodic Inspection by a Megohmmeter Is Possible with the K7GE-MG Installed

The K7GE-MG is cut off from the load by the internal dry contact except during measurement. This allows inspection using a Megohmmeter without disconnecting the wiring.

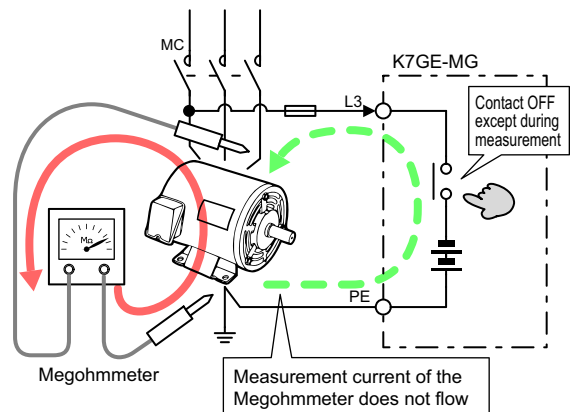

Note The above diagram shows only the parts of the internal circuit of the K7GE-MG that are necessary for explanation.

Easy Retrofitting to the Equipment

- The signal wire of the K7GE-MG can be connected in parallel with the secondary output terminal of the contactor and the PE terminal of the load. Therefore, it is not necessary to perform large-scale wiring again.
- If you connect the auxiliary contact of the contactor to the trigger input terminal of the K7GE-MG, you can use it as a measurement start signal. It contributes to the reduction of parts because no additional sequence is required.

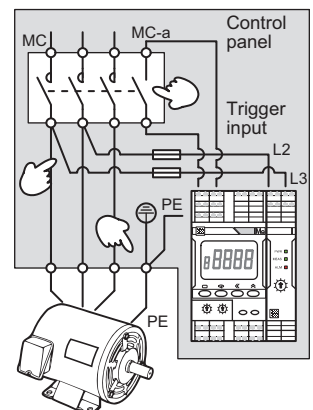

Enables Remote Trend Monitoring

- K7GE-MG automatically collects the measured values of loads with the communications function. You can monitor the equipment from a remote location. Remote monitoring greatly reduces the man-hours required to measure and collect data with the Megohmmeter while patrolling FA systems and facilities.

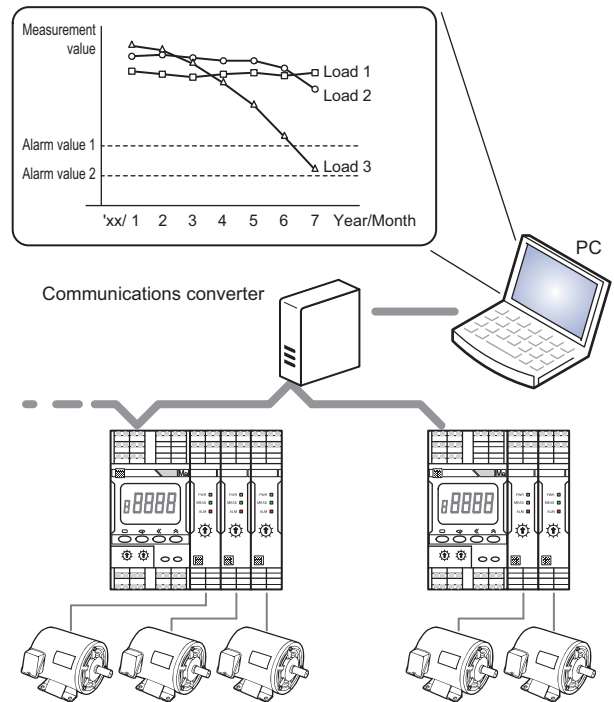

1-3 Model Number Legend

This section shows the model number legend of the K7GE-MG Main Unit and Probe Units.

- Main Unit

K7GE-MG M □
 (1) (2) (3)

(1)	(2)	(3)	Meaning
Base model	Unit type	Power supply voltage	
K7GE-MG			Insulation Resistance Monitoring Device
	M		Main Unit
		A	100 to 240 VAC power supply
		D	24 VAC/VDC power supply

- Probe Unit

K7GE-MG 1
 (1) (2)

(1)	(2)	Meaning
Base model	Unit type	
K7GE-MG		Insulation Resistance Monitoring Device
	1	Probe Unit

Refer to *A-1 Specifications* on page A-2 for the specifications of each model.

1-4 Insulation Resistance Measurement and Monitoring System

K7GE-MG is automated according to the procedure of manual measurement and monitoring by Megohmmeter.

The flowchart of measurement and monitoring of K7GE-MG is shown below together with manual measurement by Megohmmeter.

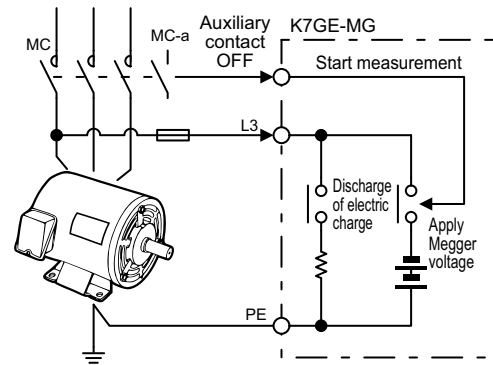
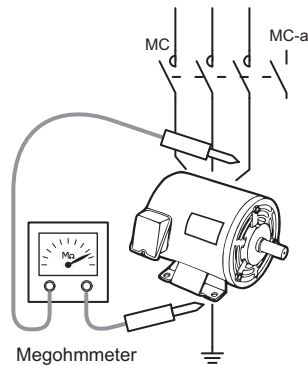

Note The above diagram shows only the parts of the internal circuit of the K7GE-MG that are necessary for explanation.

Step	Manual measurement by the Megohmmeter	Step	Automatic measurement by the K7GE-MG
0	Load operation in progress	0	Waits until the auxiliary contact turns OFF (trigger signal ON)
1	Turn OFF the contactor and disconnect the loads from the power line	1	Trigger signal ON with the contactor OFF → Measurement operation starts when the trigger signal is ON
2	Wait for the loads to stop completely (visual)	2	Waits for the loads to stop completely (automatic standby based on setting parameters, default value: 10 s)
3	Wait for the discharge of electric charge accumulated in the wiring (Decide the time through experience or residual voltage measurement)	3	Performs forced discharge of electric charge by the built-in resistor of the K7GE-MG (Waits for 20 s while limiting the peak value of the discharge current to 1 mA max.)
4	Place the probe on the load and apply Megger voltage	4	Internal contact of the Probe Unit turns ON, and application of the Megger voltage starts
5	Wait for the measurement value to stabilize (charging time to the wiring capacity)	5	Applies Megger voltage until the measurement value stabilizes (Continues the measurement for the time set in the Time to Wait to Stabilize setting parameter, default value: 60 s)
6	Read the insulation resistance value	6	Measures the insulation resistance value
7	Remove the probe from the load	7	The contact of the Probe Unit turns OFF, and application of the Megger voltage stops
8	Determine if the measurement value is normal or an error	8	Compares the set alarm value and measurement value, and performs alarm output
9	If there is more than one load, measure the next load	9	If there is more than one load, measures the next load
10	Record the measurement value and end the series of operations	10	Check the measurement value from the display on the front part, or read and record it remotely

1-5 Nomenclature and Functions



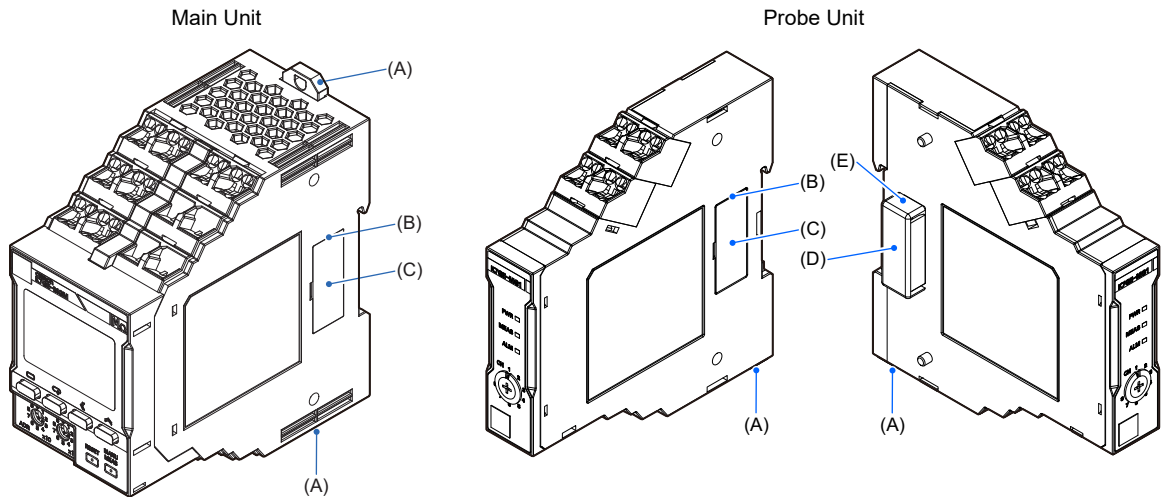

Appearance

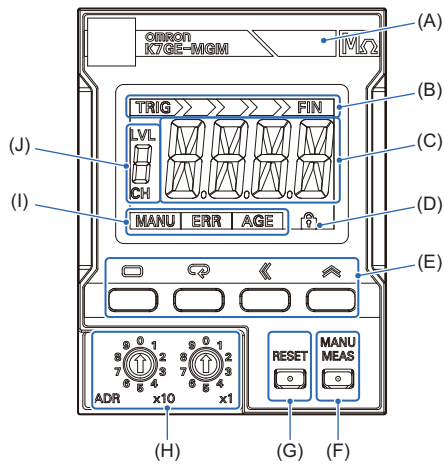

Symbol	Name	Operation
(A)	DIN Track mounting hook	Used for mounting to the DIN Track.
(B)	Right connector	Connects the Probe Unit.
(C)	Right connector cover	A cover for preventing the entry of dust and dirt into the connectors. Remove this cover when combining the Main Unit and Probe Units, and during expansion of Probe Units. However, use the Probe Unit on the extreme right without removing this connector cover.
(D)	Left connector cover	A cover for preventing the entry of dust and dirt into the connectors. Remove this cover when combining the Main Unit and Probe Units, and during expansion of Probe Units.
(E)	Left connector	Connects to the Right connector.

Front Section: Main Unit



Symbol	Name	Operation	
(A)	Alarm output indicator	Displays the alarm judgment results of automatic measurement in three colors. Green: Normal Yellow: Warning (Alarm 1 occurrence) Red: Critical (Alarm 2 occurrence) If the status is different across multiple channels, the display color is decided in the priority order of red (critical) > yellow (warning) > green (normal).	
(B)	Measurement step indicator	The automatic measurement operation consists of several steps. This indicator shows the progress of the step from the start to the end of the measurement.	
(C)	Main display	The following contents are displayed in the operating status of the Main Unit. Measuring operation: The remaining seconds until the measurement completes are counted down After measurement completed: The insulation resistance measurement value, or characters indicating measurement failure Setting level: The setting parameter name, or setting value Error occurs: The characters indicating the error status	
(D)	Protect indicator	Indicates that the protect function of the setting parameter is set.	
(E)	Operation keys	Level Key ()	Selects the setting level.
		Mode Key ()	Selects the setting parameter of the Initial Setting Level and Communications Setting Level. Displays the measurement value of each channel at the Operation Level. Also used to select between enabling/disabling of measurement value display automatic scroll.
		Shift Key ()	Sets the parameter value to a changeable state. Used for digit shift in the changeable state.
		Up Key ()	Increments the value when the parameter is in a changeable state.
(F)	Manual Measurement Key	Selects to start or end manual measurement. Manual measurement is used to check the operation when the system is started up. Automatic measurement requires a trigger signal to start measurement, but manual measurement does not require a trigger signal. You can use manual measurement in the same way as a Megohmmeter.	
(G)	Reset Key	Selects to return to the power reset status. Even if the measuring operation is in progress, priority is given to the Reset Key, and measurement stops to return to the power reset status. The Reset Key is enabled only in the Operation Level.	

Symbol	Name	Operation	
(H)	Unit Number Setting Switch	Sets to set the unit number during communications.	
(I)	Status display	MANU	Indicates the manual measurement state.
		ERR	Indicates that a system error occurred.
		AGE	Indicates that it is time to replace the Main Unit (guideline).
(J)	LVL/CH display	Displays the level*, or the value of the channel number.	
		LVL	Indicates that the value displayed in the LVL/CH display is the "Level".
		CH	Indicates that the value displayed in the LVL/CH display is the "Channel".

* Refer to 5-1 Levels on page 5-2 for information on the levels.

Front Section: Probe Unit

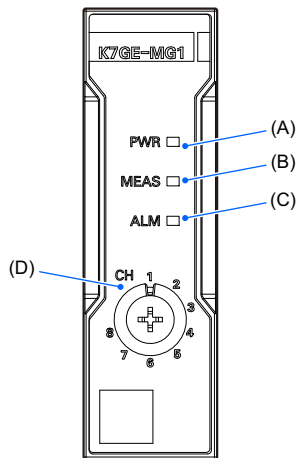

Symbol	Name	Operation
(A)	PWR indicator (green)	Indicates that the Probe Unit power is ON.
(B)	MEAS indicator (green)	Indicates that measurement is in progress for the load connected to the Probe Unit.
(C)	ALM indicator (red)	Indicates that an alarm occurred in the load connected to the Probe Unit.
(D)	Channel Number Setting Switch	Sets a unique channel number for each Unit when multiple Probe Units are added.

Terminal Section: Main Unit

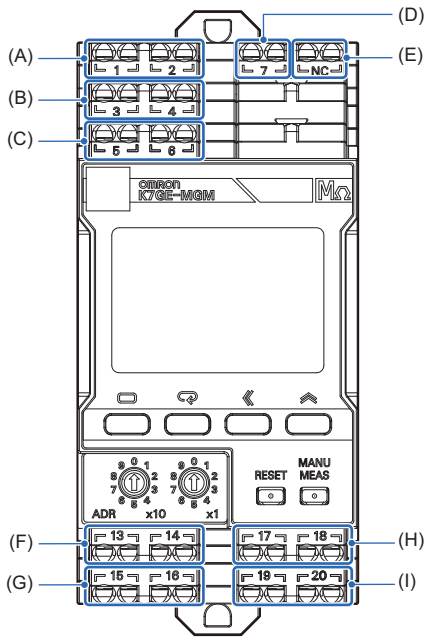

Symbol	Terminal Number	Name	Operation
(A)	1 and 2	Operation power supply	Connect the operation power supply to the Main Unit.
(B)	3 and 4	Trigger input	Input terminals of the external contact from where a trigger signal is applied. No. 3: Collector of the NPN transistor, No. 4: Emitter of the NPN transistor
(C)	5 and 6	RS-485	Connect the RS-485 communications line. No. 5: +, No. 6: -
(D)	7	PE	A protective earthing terminal.
(E)	NC	NC	Do not connect anything to this terminal.
(F)	13 and 14	ALM 1 output	Compares the measurement value and alarm value 1, and outputs an alarm. No. 13: Collector of the NPN transistor, No. 14: Emitter of the NPN transistor
(G)	15 and 16	ALM 2 output	Compares the measurement value and alarm value 2, and outputs an alarm. No. 15: Collector of the NPN transistor, No. 16: Emitter of the NPN transistor
(H)	17 and 18	Status output during measurement	Provides notification that measurement is in progress. The output is normally open (OFF) You can use this output to design an interlock circuit to prevent accidental restart of the load during measurement operation. No. 17: Collector of the NPN transistor, No. 18: Emitter of the NPN transistor
(I)	19 and 20	Self-diagnosis error output	Provides notification about system error in the Main Unit. The output is normally closed (ON). No. 19: Collector of the NPN transistor, No. 20: Emitter of the NPN transistor



Perform the wiring according to *Section 3 Installation and Wiring*.

Terminal Section: Probe Unit

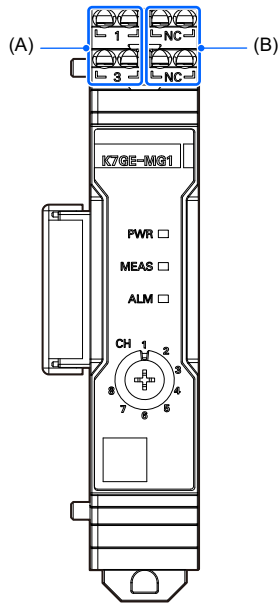

Symbol	Terminal Number	Name	Operation
(A)	1 and 3	Voltage input	Connect the load terminals. No. 1: Connect the R-phase in a 3-phase system, and the L-phase in a single-phase system No. 3: Connect the S-phase in a 3-phase system, and the N-phase in a single-phase system Use the terminal No. 1 to discharge the electric charge and apply the Megger voltage.
(B)	NC	NC	Do not connect anything to this terminal.

1-6 Internal Block Diagram

This is an internal block diagram of the state when the Main Unit and the Probe Units are connected. The following describes the main configuration elements.

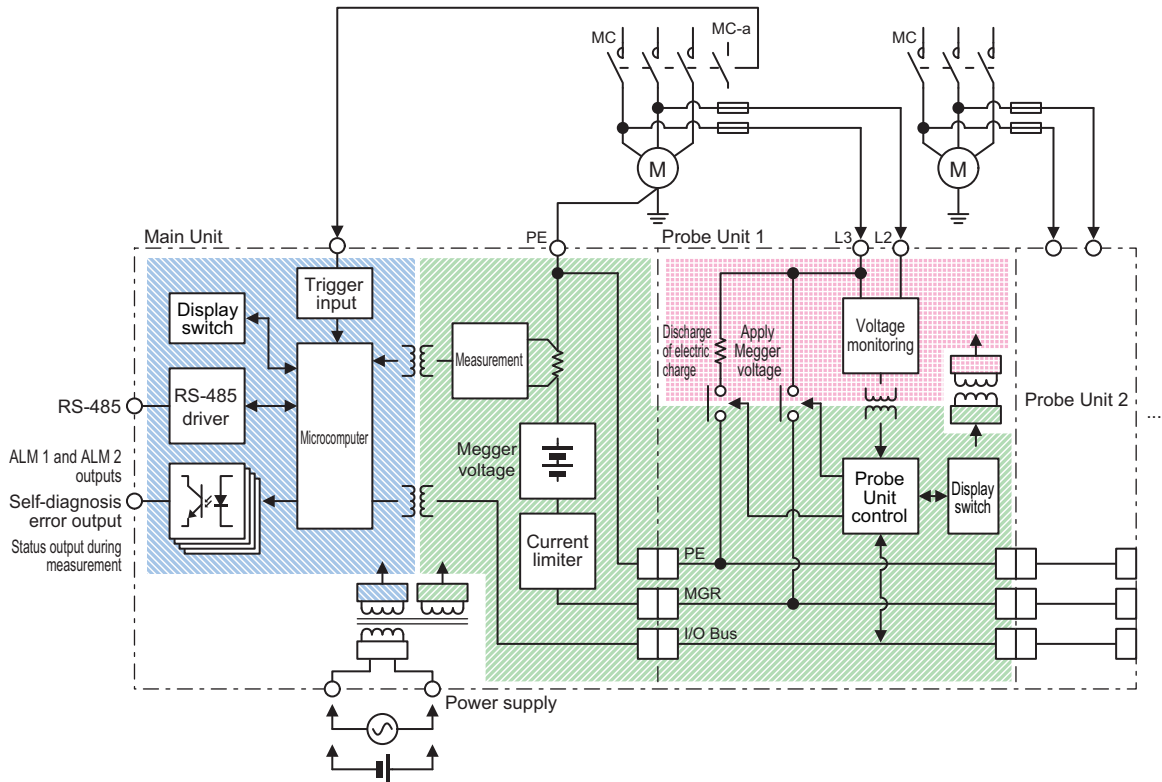

● Trigger Input

Connect an external contact, and then starts the measurement operation by a signal from this contact.

When the auxiliary contact of a contactor is connected to a trigger input terminal as an external contact, the measurement operation can be started at the time the contactor is turned OFF, that is, when the load is turned OFF from the power line.

● Voltage Monitoring

The voltage in the load lines is monitored to determine whether the load is turned ON or turned OFF. This monitoring is performed at all times, and even when the measurement start signal is input, the measurement operation does not start if the load is turned ON. Also, even if measurement is progressing normally, it immediately stops if the load is turned ON during the measurement.

● Discharge of Electric Charge

A parasitic capacitance component due to the wiring is present between the charged sections of the load and the PE. Therefore, even if the contactor is turned OFF, the electric charge accumulated in the parasitic capacitance component is not discharged immediately. It would take several minutes for the electric charge to be discharged naturally, so this circuit forcibly discharges the charge. In the case of a simple short circuit, excessive short-circuit current flows instantaneously, and therefore, by having a resistance component, the current can be limited to a level where it does not cause any problem. This processing for the discharge of electric charge is performed before the application of a Megger voltage.

- **Megger Voltage**

Generates a voltage of 50 VDC.

- **Apply Megger Voltage**

Turns ON the internal contact and applies Megger voltage to the load.

- **Measurement**

Measures the current flowing through the insulation resistance. Since Megger voltage is a known value, the insulation resistance value can be calculated from the Megger voltage and the current value.

- **Current Limiter**

If the load is turned ON when applying a Megger voltage, it is detected by the voltage monitoring circuit and the measurement operation stops. However, due to a slight time lag, excessive current flows between the charged sections of the load and the PE at the moment the load is turned ON. The same thing happens when the insulation resistance value is extremely low even if the load is properly turned OFF. To protect the load and the peripheral equipment, as well as the internal circuit of the K7GE-MG from such an overcurrent, the K7GE-MG is equipped with a current limiter circuit which limits the overcurrent.

1-7 System Configurations

Minimum Configuration

This is the minimum configuration for monitoring the insulation resistance using the K7GE-MG.

The auxiliary contact of the contactor inserted in front of the load can be used as the measurement start signal (trigger signal).

You can check the measurement value from the display on the front part.

The alarm output can be used for external notification. There are two alarm outputs, and by setting a threshold value for each alarm output, judgment can be performed in two stages.

The K7GE-MG has the "Status output during measurement" terminal that is turned on during measurement operation. This allows you to design an interlock circuit that will not restart the load during measurement operation.

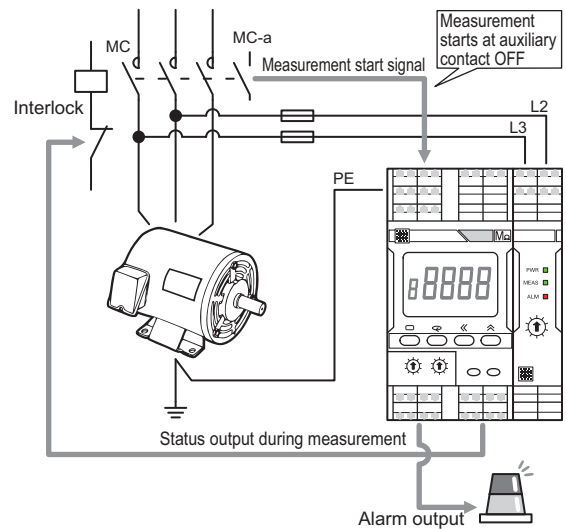

Measurement of Multiple Channels

This configuration is used when monitoring multiple loads collectively.

Design a system configuration that simultaneously turns ON and OFF the contactors installed on the loads. The K7GE-MG performs sequential measurement for one load at a time upon receiving the measurement start signal (trigger signal). However, a load that is turned ON at the time of measurement is treated as "measurement failed".



In an application such as a duplex alternating pump, you can use the K7GE-MG by constructing a sequence in which a trigger signal is input at the time all loads (pumps) are simultaneously OFF (when neither water supply nor draining is performed). In cases where it is not possible to realize the timing when all loads are simultaneously OFF, use two sets of the K7GE-MG Main Unit + Probe Units.

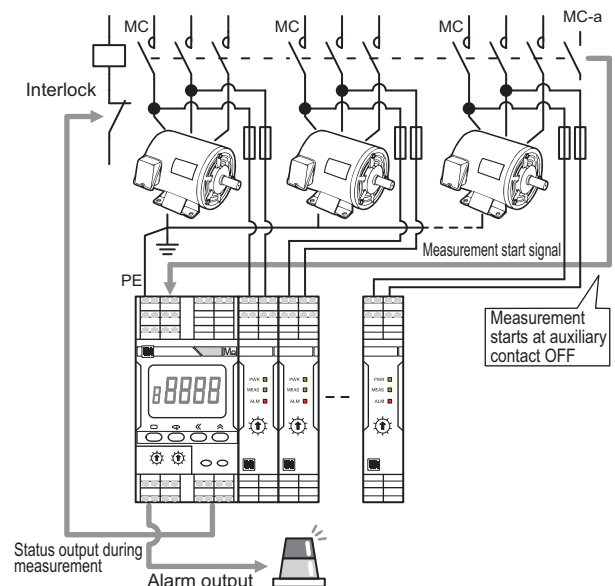

Remote Monitoring by the PLC or PC

This configuration is used when performing remote monitoring of the measurement values with a PLC or PC as the host.

When a PC is used as the host, you can use the K7GE-MG by converting the RS-485 to USB or Ethernet using a commercial communications converter.

The protocol is compatible with CompoWay/F and Modbus RTU.

The K7GE-MG does not have a function to retain the past measurement value data. Also, data is lost when the power is turned OFF. Therefore, read the measurement values when the measurement ends and before the next measurement starts, and before the power of the Main Unit is turned OFF.

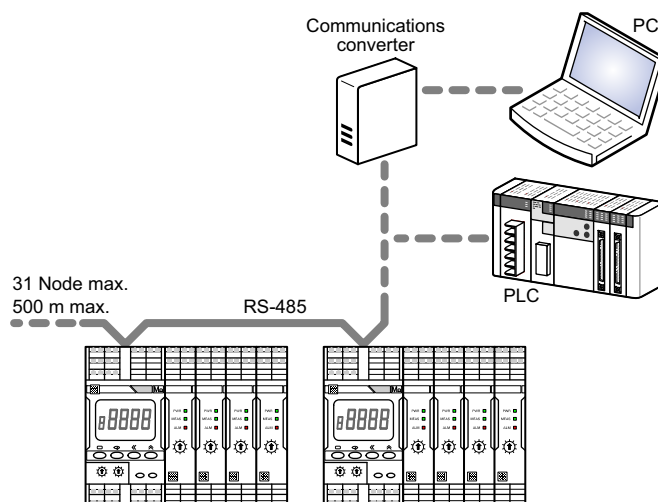

To know the timing of measurement end, you can use status output during measurement in the K7GE-MG. Status output during measurement turns ON when the measurement operation starts and turns OFF when measurement ends. This change from ON to OFF is the timing when measurement ends. You can also use the communications commands to read the flags synchronous with the status output during measurement.

Customization of HMI from the Touch Panel

This configuration is used when a touch panel is installed on the front panel to customize the HMI for checking the measurement values and performing the alarm reset operation.

A connection is established with the touch panel via the RS-485, and the touch panel is used as the master.

The protocol is compatible with CompoWay/F and Modbus RTU.

The K7GE-MG does not support the multi-master system. Therefore, to further connect a host system and perform remote monitoring, connect the host system to the touch panel, and perform operations such as reading the measurement values or changing the setting parameters of the K7GE-MG via the touch panel.

Refer to the manual of the touch panel in use for details on communications between the host system and the touch panel.

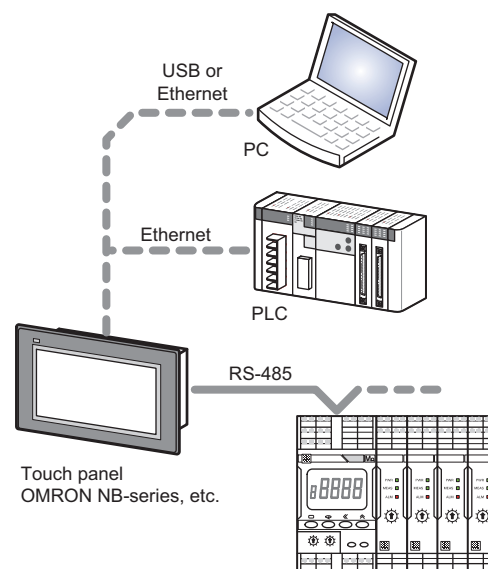

1-8 Safety Precautions



Be sure to install the contactor in front of the load to be measured.

The K7GE-MG uses the same Megger method as a Megohmmeter for detecting insulation resistance. The Megger method measures resistance values with a measuring circuit connected between the charged section and the non-charged section. The charged section is usually connected to the power line and insulated from the ground. Also, the non-charged section is a grounded section such as a motor frame. The measurement circuit of K7GE-MG is connected between different insulated circuits. Therefore, if the charged sections turn ON during measurement, it may result in a ground-fault accident.

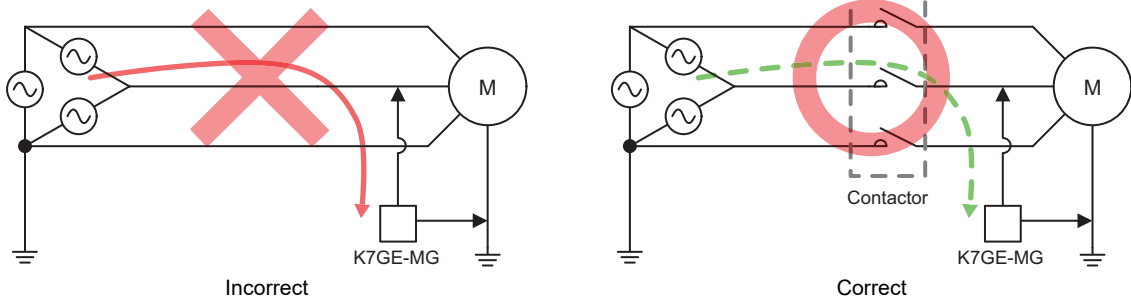

Also, although the voltage is low, applying a Megger voltage to the output circuit of the secondary coil of the inverter may cause an inverter failure.

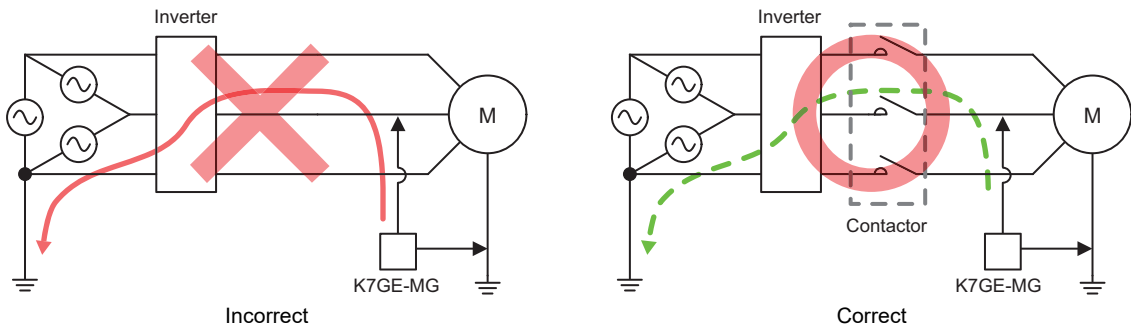

2

Procedure

This section describes the procedure from preparation to startup of the K7GE-MG.

2-1 Procedure	2-2
(1) Advance Preparation	2-2
(2) Installation and Wiring	2-3
(3) Initial Setting	2-5
(4) Test Operation with Manual Measurement	2-7
(5) Starting Operation	2-8
Troubleshooting	2-10

2-1 Procedure

The procedure for starting actual operation is shown using a system that measures three loads as an example.

The procedure is described in the following five steps.

Steps
(1) Advance Preparation
(2) Installation and Wiring
(3) Initial Setting
(4) Test Operation with Manual Measurement
(5) Starting Operation

The "❓ No. **" in the following description is the reference number in *Troubleshooting* at the end of this section. Refer to the corresponding number when the operation does not run normally even after following the procedure.

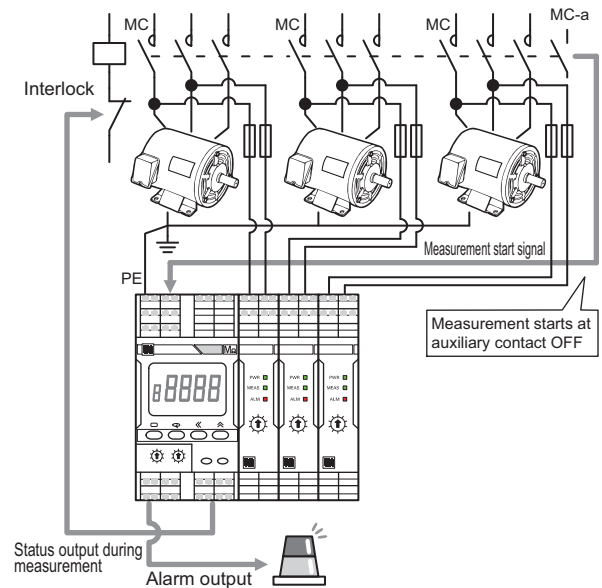

(1) Advance Preparation

Examine the time until the load stops.

- Measure the time until the load stops after the contactor is turned OFF. Use the setting value of the Motor Stop Waiting Time setting parameter as a guide.



Use the value of the load that took the longest time from among the three loads as a guide.

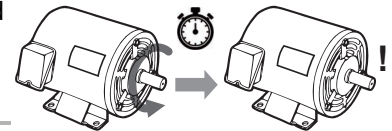

Use a Megohmmeter to measure the insulation resistance during normal operation of the target load.

- This is the reference value for deciding the Alarm Value 1 and 2 setting parameters.

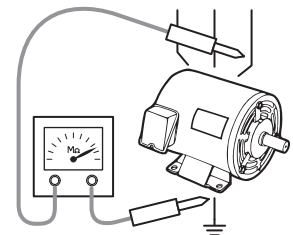

(2) Installation and Wiring

Connect three Probe Units to one Main Unit.

- Remove the right connector cover of the Main Unit and the left connector cover of the Probe Units.



Use the Probe Unit on the right end with the right connector cover attached.

- Join the connectors together. Make sure that the connectors are connected firmly without any gap between the Units.

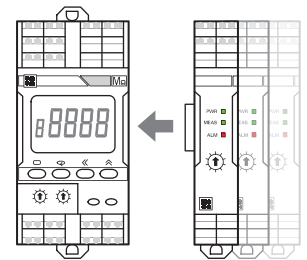
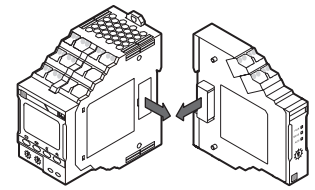

Mounting to DIN Track.

- Pull down the DIN Track mounting hook under the Main Unit and Probe Units to mount the Units on the DIN Track.
- Secure with the DIN Track mounting hook.
- Install an end plate* on the left and right sides. * Sold separately



Be sure to connect the Units together before mounting them on the DIN Track.

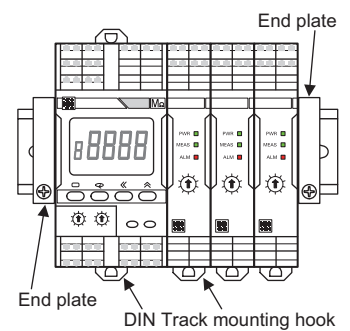

Wire all connections.

- To be safe, always attach a fuse (7 A max., fast-blow type) in the wiring from the Probe Unit to the load.
- The figure shows a simplified view of the wiring for status output during measurement, and ALM 1 and ALM 2 outputs. Use a suitable relay according to the switching capacity of the output transistor.
- The K7GE-MG provides an output transistor with specifications of 24 VDC (+10%) and 50 mA max.

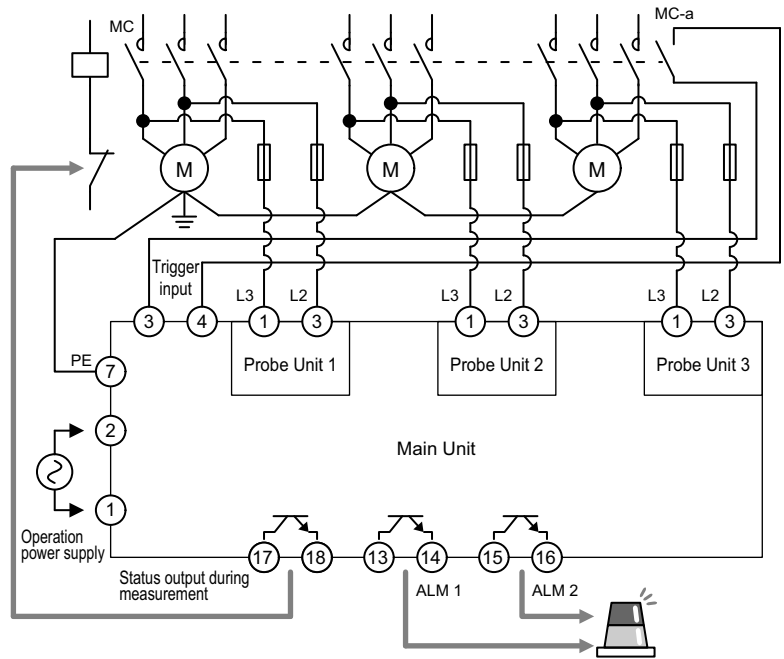

Supply the operation power from a system different from that of the load. If the same system is used, the power supply to the K7GE-MG will turn OFF when the load contactor turns OFF, and you may not be able to perform measurement.

(3) Initial Setting

Set the channel numbers of the Probe Units.

- Set the channel number of the first Probe Unit to 1 with the rotary DIP switch on the front.



Observe that it is not a DIP switch on the Main Unit side.

- In the same way, set the channel number of the second Probe Unit to 2 and that of the third Probe Unit to 3.



Always set the channel number to a serial number starting from 1. The K7GE-MG will not operate properly if the channel numbers are not set sequentially from 1 such as 2, 3 and 4 or 1, 2 and 4.

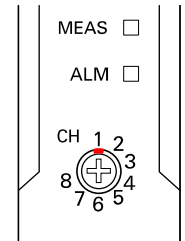

Turn ON the power supply to the Main Unit.

- The Operation Level is displayed immediately after the power is turned ON.
---- indicates measurement standby.

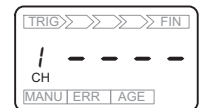

No.1*

* This is reference number in *Troubleshooting* described at the end. If the K7GE-MG does not operate properly after performing the procedure, see the reference number.

Move to the Initial Setting Level.

- Press the Level Key for at least 3 seconds to move from the Operation Level to the Initial Setting Level.
In the Initial Setting Level, LVL and are displayed together on the LVL/CH display.



Set the total number of channels.

The total number of channels is used to perform the processing in the case of a measurement failure when the Main Unit can no longer recognize the Probe Units due to a malfunction, etc.

- If the main display part does not display *MxCH*, press the Mode Key several times to display *MxCH*.



- Press the Shift Key to display the setting value.
The setting value is displayed.



- Press the Shift key again to change the setting value.
The digits that can be changed start flashing.



- Press the Up Key several times to set the setting value to 3.
In this example, the total number of channels is set to 3 because three Probe Units are used.

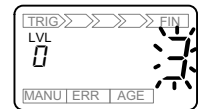

- Press the Mode Key to define the changes.
The setting value is overwritten, and the next setting parameter will be displayed.



Repeat the process to set the other parameters.

Parameter name	Characters	Setting value	Description
Alarm Value 1	ALM1	xx.x (MΩ)	If the measurement value dropped below the alarm value, the alarm output indicator is lit yellow and ALM 1 (warning) will be output. One alarm value 1 is provided in common for all channels.
Alarm Value 2	ALM2	xx.x (MΩ)	If the measurement value dropped below the alarm value, the alarm output indicator is lit red and ALM 2 (critical) will be output. One alarm value 2 is provided in common for all channels.
Motor Stop Waiting Time	MELT	xxx (seconds)	Set the time until the load stops after the contactor turns OFF plus a margin. (Use the time measured during advance preparation as a guide.)

If you want to use a user-specified critical threshold, set it to alarm value 2. Alarm value 1 is set between the normal value measured during advance preparation and alarm value 2.
If you do not have a user-defined critical threshold, the alarm value 2 can be set to 1 MΩ recommended by IEC 60034-1 and the motor manufacturer. Alarm value 1 is set between the normal value measured during advance preparation and alarm value 2.

Return to the Operation Level.

- Press the Level Key for at least 1 second to return to the Operation Level.
---- indicates measurement standby.

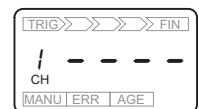

No.2

(4) Test Operation with Manual Measurement

Make sure the load contactor is turned OFF.

- Immediately after returning to Operation Level, the measurement standby is established without starting measurement even if the auxiliary contact of the contactor is turned OFF. Perform manual measurement in this state.

 No.3

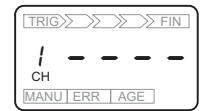

Select the channel to perform manual measurement.

- Press the Mode Key several times to set the channel number to perform manual measurement.

 No.4



Manual measurement is started.

- Press the Manual Measurement Key at least for 3 seconds to start manual measurement. MANU indicator will light.

 No.5

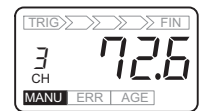

Make sure the measurement value is suitable.

- Make sure the measurement value stabilizes within 60 seconds.



If the measurement value does not stabilize even within 60 seconds, return to the Initial Setting Level, and increase the setting value of the Time to Wait to Stabilize ($St\ Wt$) setting parameter. Up to 99 seconds can be set.

This setting value is used for the waiting time from when a Megger voltage is applied during automatic measurement until the measurement value stabilizes.

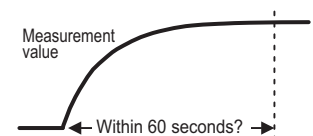

- Make sure that the measurement value is not significantly different from the value previously measured with the Megohmmeter.

 No.6



If the measurement value is not stable due to the influence of noise, change the setting value of the Average processing (Avg) setting parameter to ON (with averaging processing) in the Initial Setting Level. When this parameter is set to ON, the average value of eight measurements is treated as the measurement value.

After xx seconds



Manual measurement is ended.

- Press the Manual Measurement Key for 1 second to end manual measurement, and the K7GE-MG will return to measurement standby in the Operation Level. In addition, the measurement will be ended automatically 3 minutes after the start of manual measurement.

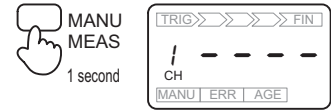

Perform manual measurement for the remaining channels as well.

- Repeat the process to perform manual measurement for the remaining channels as well, and check the measurement values.

(5) Starting Operation

Turn ON the load contactor.

- Make sure the peripheral equipment including loads are operating correctly.

Turn OFF the load contactor.

- Automatic measurement is started. TRIG indicator will light on the measurement step indicator. The main display part shows the approximate number of seconds required to complete the measurement, and it will be counted down.
- The discharge of electric charge is performed after the time set in the Motor Stop Waiting Time setting parameter has elapsed. The measurement step indicator moves to the next step. The first arrow indicates that the discharge of electric charge is in progress. The MEAS indicator on channel 1 of the Probe Unit will light in measurement operation. This process always requires 20 seconds.
- A Megger voltage is applied and it is held for approximately 60 seconds until the measurement value stabilizes. The measurement step indicator moves to next step. The second arrow indicates waiting for stability.
- Sampling is performed. It takes about 1 second. The measurement step indicator moves to next step. The third arrow indicates that measurement is in progress.

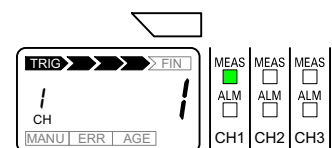
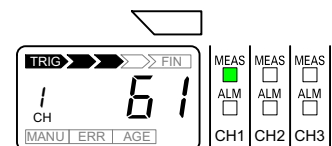
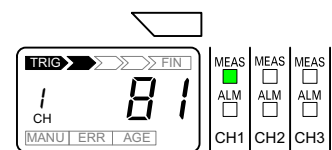
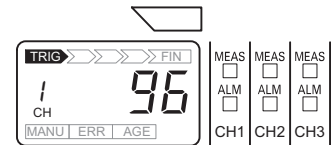

- The measurement of channel 1 is completed, the alarm judgment is performed for the confirmed measurement value, and the results are applied in the alarm output, the alarm output indicator, and the ALM indicator of the Probe Unit. Next, the measurement for channel 2 will start. The MEAS indicator on channel 2 of the Probe Unit will light. You can perform the Motor Stop Waiting Time setting parameter only during the first measurement. The procedure for channel 2 onward will be started from the discharge of electric charge.
- When the measurement is complete for all channels, the confirmed measurement values are displayed on the main display part. FIN indicator will light on the measurement step indicator.

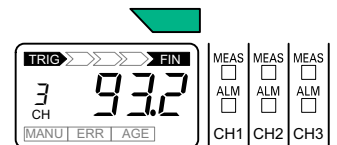
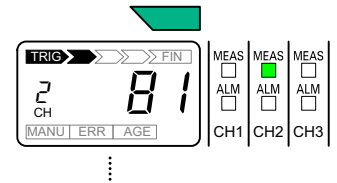

Check the results of automatic measurement.

- Press the Mode Key to display the measurement results of each channel.

 No.7

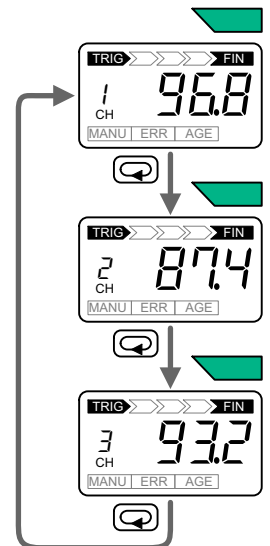





Start actual operation.

- Start actual operation if there is no problem in the series of operations of the K7GE-MG and the operation of peripheral equipment including loads and the measurement values.

Troubleshooting

If the K7GE-MG does not operate properly after performing the procedure, see the correction in the table below corresponding to the reference number "□? No. **" in the procedure.

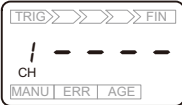
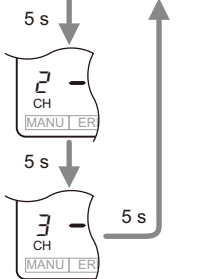
No.	Problems	Cause	Correction
1	ERR indicator is lit, and 8888 is displayed. 	A system error occurred. The channel numbers of the Probe Units may be duplicated.	Check again that the channel numbers of the Probe Units are correctly set to consecutive numbers starting from 1.
2	PSEL is displayed in the LVL 1. 	The Level Key (□) was pressed for less than 1 second, which caused the K7GE-MG to move to the Communications Setting Level.	Press the key for at least 1 second. Press the Level key (□) for at least 1 second to return to the Operating Level even in the Communications Setting Level.
3	TRIG indicator lights on the measurement step indicator, and countdown of seconds starts on the main display part. 	After returning to the Operation Level, the auxiliary contact of the contactor is turned OFF, so the trigger signal is accepted and automatic measurement is started.	Press the Reset Key for at least 3 seconds to forcibly end the measurement. If the trigger signal occurs unintentionally, check the wiring of the trigger input terminal again.
	TRIG flashes. 	After returning to the Operation Level, the auxiliary contact of the contactor is turned OFF, so the trigger signal is accepted and automatic measurement is started. However, the auxiliary contact is immediately turned ON and the measurement is interrupted.	You can perform manual measurement even in this state. If the trigger signal occurs unintentionally, check the wiring of the trigger input terminal again.
4	The channel display does not change even after pressing the Mode Key (↻). 	The Maximum Number of Channels setting parameter may not be set correctly.	Check again that the setting value is set to 3, which is the total number of Probe Units.
	The channel display is scrolled automatically every 5 seconds. 	The Mode Key (↻) was pressed for 3 seconds, which resulted in measurement value display automatic scroll.	Press the Mode Key (↻) again for 3 seconds to cancel automatic scroll.

No.	Problems	Cause	Correction
5	The manual measurement does not start but the main display part flashes when the Manual Measurement Key is pressed.	The Mode Key (☞) was pressed for 3 seconds, which resulted in measurement value display automatic scroll. Manual measurement cannot start during automatic scroll.	Press the Mode Key (☞) again for 3 seconds to cancel Measurement Value Display Automatic Scroll, and then press the Manual Measurement Key.
	Even if MANU indicator is lit, the measured value is not displayed.	The measurement is aborted because the safety function is activated. This function is enabled when the load is turned ON or the insulation resistance is detected extremely low. If the load is not completely stopped, it may be determined that the load is turned ON.	Make sure that the load is completely stopped before performing the manual measurement. Also, check the wiring between the load, contactor, and K7GE-MG again.
		The Main Unit cannot recognize the Probe Unit of this channel. The Units may not be connected properly.	Check the connection between the Units again.
6	The measurement value is significantly different from the value measured by the Megohmmeter.	It is possible that the manual measurement was performed with the electric charge remaining on the wiring and other parts.	The manual measurement does not allow forced discharge of electric charge. In the same way as measuring with a Megohmmeter, wait for the charge to be completely discharged before performing manual measurement.
7	The measurement value is not displayed on the channel, but <i>FALL</i> is flashing.	The measurement for this channel is stopped because either the load was turned ON during measurement, or the K7GE-MG detected that the insulation resistance is extremely low.	Check again that until the start of automatic measurement, the contactors of all loads turn OFF, and all loads stop completely within the time period of the Motor Stop Waiting Time setting parameter. Also, check the wiring between the load, contactor, and K7GE-MG again.
		The Main Unit cannot recognize the Probe Unit of this channel. The Units may not be connected properly.	Check the connection between the Units again.

3

Installation and Wiring

This section describes the installation and wiring of the K7GE-MG device. Before you proceed with installation and wiring, be sure to thoroughly read *Precautions for Safe Use* on page 7.

3-1	Dimensions	3-2
3-2	Installation	3-3
3-3	Setting the Channel Number	3-6
3-4	How to Connect to the Push-In Plus Terminal Blocks	3-7
3-5	I/O Wiring	3-10
3-6	Wiring the Communications Cable	3-13
3-7	Setting the Unit Number	3-14
3-8	Connecting to a Load or Contactor	3-15

3-1 Dimensions

Main Unit

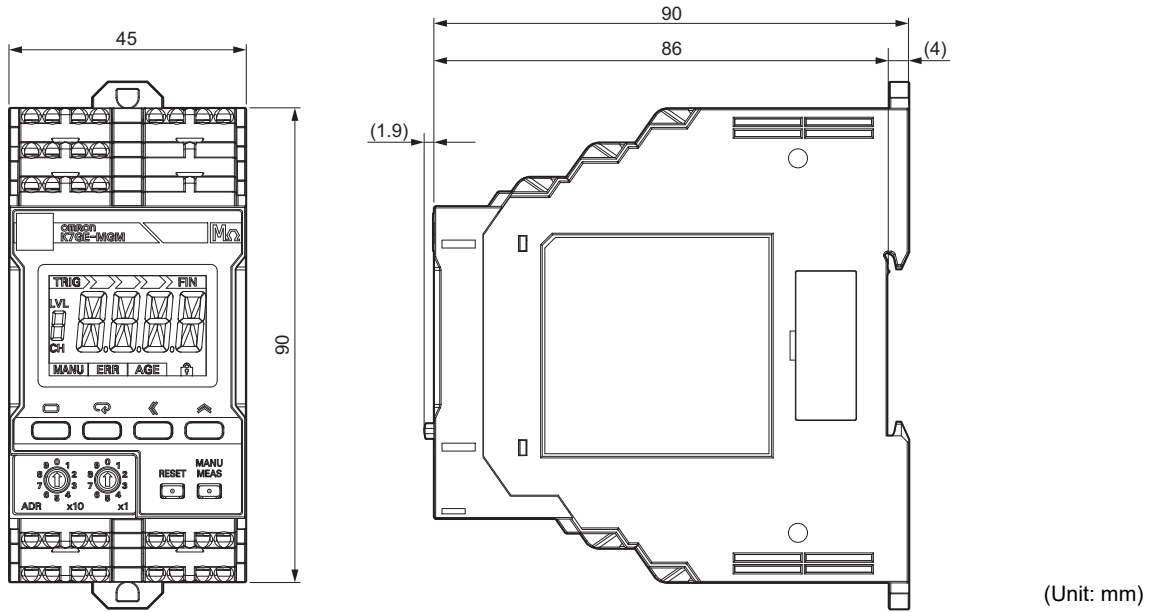

Probe Unit

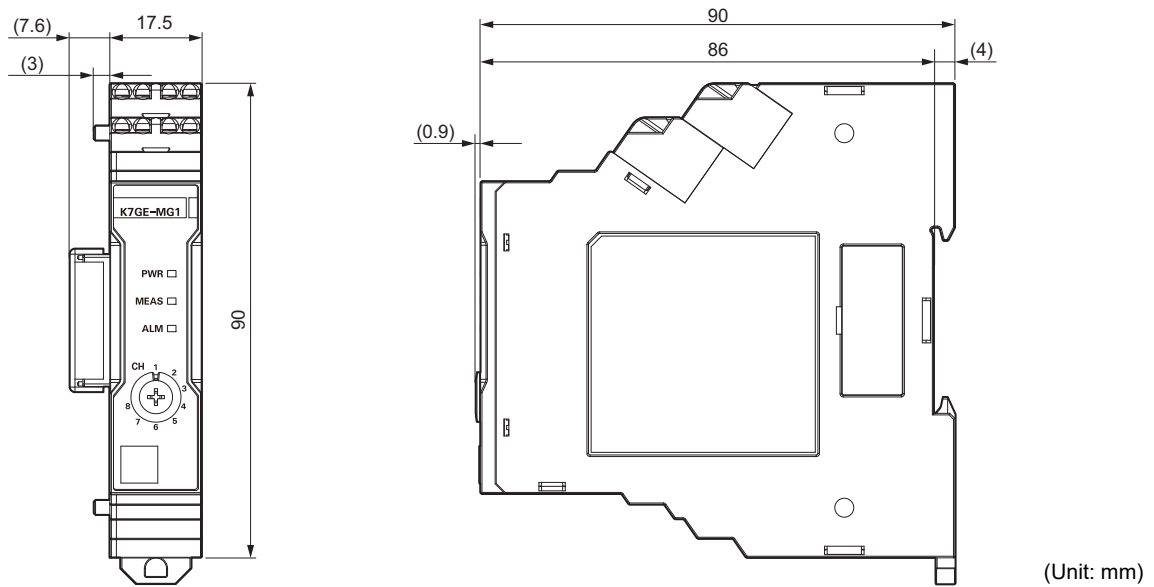

3-2 Installation

Combining Units

- Remove the right connector cover of the Main Unit and the left connector cover of the Probe Units.

To prevent dust from entering and failure of the internal circuit due to static electricity, remove the connector covers immediately before connecting the Units.

Remove the right connector cover by using your nail to lift the notch.

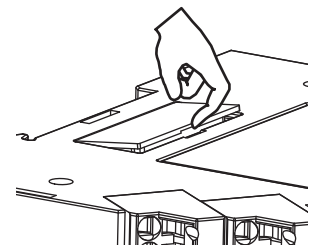
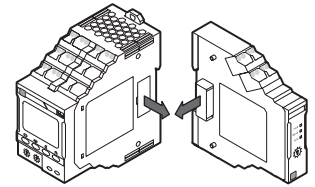

Since the left connector cover is held in place, it may be difficult to remove it simply by pulling up.

As shown in the figure, you can easily remove the cover by pushing one of the short sides of the cover and holding up the other short side.

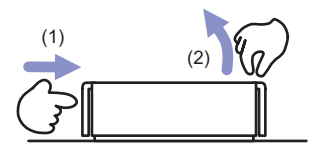

Also, to improve the electrical contact reliability during Unit connection, the pins of the left connector of the Probe Units are kept slightly higher than the height of the case. Be careful when handling as the pins may be damaged if you drop them.

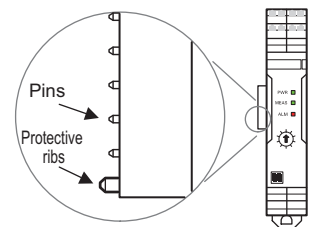

- Join the connectors together.

Make sure that the connectors are connected firmly without any gap between the Units.

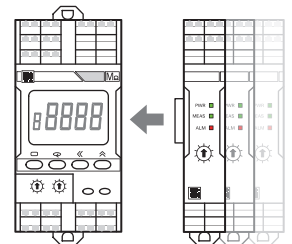

Make sure to connect the Units before you mount on the DIN Track.

If you connect the Units by sliding them on the DIN Track after mounting on the DIN Track, the connectors may be damaged.

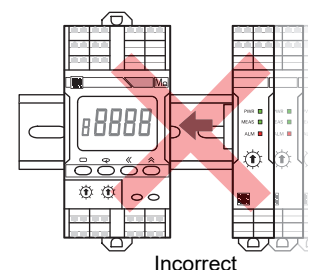

Incorrect

Mounting to DIN Track

- Mounting method

After connecting the Units, pull down all DIN Track mounting hooks on the bottom. Next, hook the upper hook of the K7GE-MG onto the DIN Track and push in the Units. Finally, raise all the DIN Track mounting hooks that were pulled down and fix the K7GE-MG to the DIN Track.

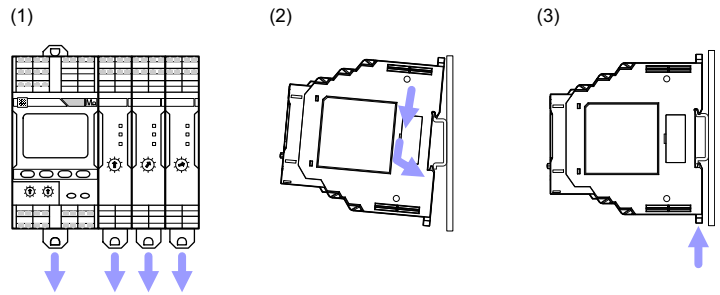

- Dismounting method

Pull out the DIN Track mounting hooks with a flat-blade screwdriver and lift the Unit from the bottom to remove it. Leave at least 30 mm of space between the K7GE-MG and other devices to allow easy installation and removal.

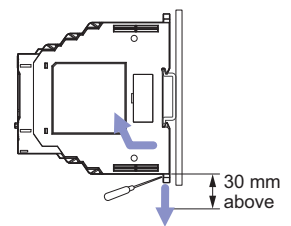

- Install an end plate on the left and right sides.

To prevent a faulty contact between the connectors due to vibrations, mount the Units without any gap so that they are pinched between the end plates. Up to one Main Unit and eight Probe Units can be installed between End Plates.

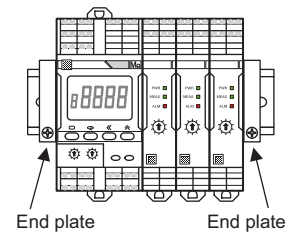

- Install the K7GE-MG in the horizontal or vertical direction as much as possible, although there is no restriction on the mounting direction.

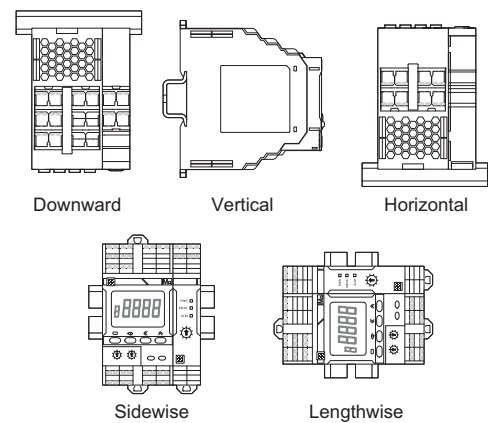

- Recommended DIN Track

Model	Specifications	Manufacturer
PFP-100N	1,000 × 35 × 7.3 mm (L × W × H)	OMRON
PFP-50N	500 × 35 × 7.3 mm (L × W × H)	OMRON

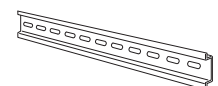

- Recommended end plates

Model	Specifications	Manufacturer
PFP-M	For PFP-100N/PFP-50N	OMRON

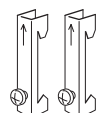

Replacing the Units

- If a Unit is to be replaced due to a failure, turn OFF the power, remove all wires, and then remove the K7GE-MG from the DIN Track.

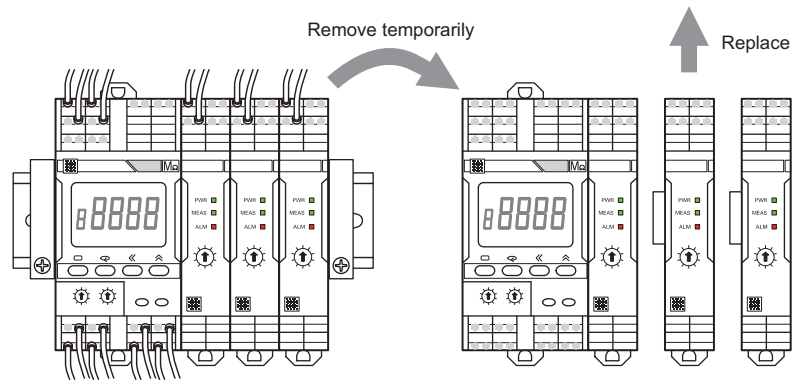

3-3 Setting the Channel Number

Set the channel numbers of the Probe Units.

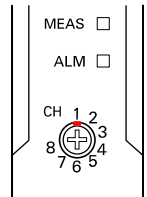

When setting only one Probe Unit, set the channel number to 1.
 When setting two or more Probe Units, always set the channel number starting from 1 and then in order such as 2, 3, etc., and n.

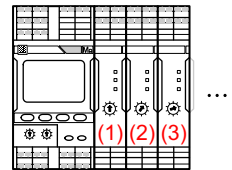

Although operation will be performed normally even if the channel numbers are not set in the order of 1, 2, and 3, etc., from the left side, there must not be any missing or duplicate numbers.

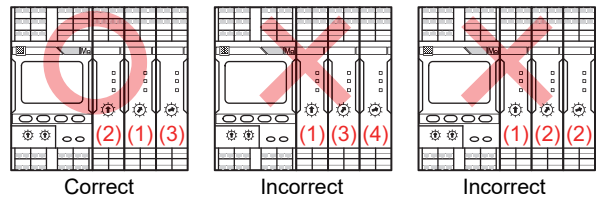

If a number is missing in the channel number setting, "measurement failed" occurs when the measurement is performed for the missing channel, and if a number is duplicate, "system error" occurs at the same time when the power is turned ON. Observe that in either case measurement will not be performed normally.

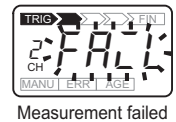

Measurement failed



System error

If the number of Probe Units is increased to multiple Units, it is necessary to set the channel number with the Channel Number Setting Switch, and also set the total number of channels (number of Probe Units) in the Maximum Number of Channels setting parameter of the Initial Setting Level. Observe that if you use this setting parameter with the default value, the Probe Units with channel number 2 and later may be out of the scope of measurement.

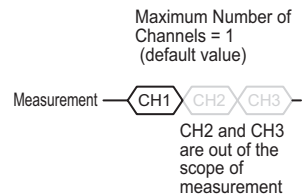

Refer to 5-3 *Maximum Number of Channels* on page 5-6 for the operation method of the Maximum Number of Channels setting parameter.

3-4 How to Connect to the Push-In Plus Terminal Blocks

Nomenclature

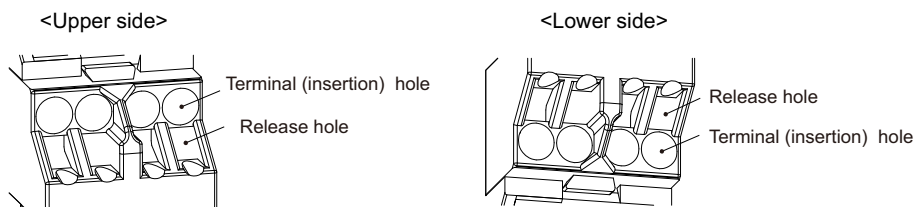

Name	Operation
Terminal (insertion) hole	Used to insert wires with ferrules, solid wires, and stranded wires.
Release hole	Releases the wire when the specified flat-blade screwdriver is inserted. Also used when inserting stranded wires.

Connecting Wires with Ferrules and Solid Wires

Insert the ferrule or solid wire straight into the terminal block until the end touches the terminal block.

If you use a ferrule with a conductor length of 10 mm, part of the conductor may be visible after the ferrule is inserted into the terminal block, but the product insulation distance will still be satisfied.

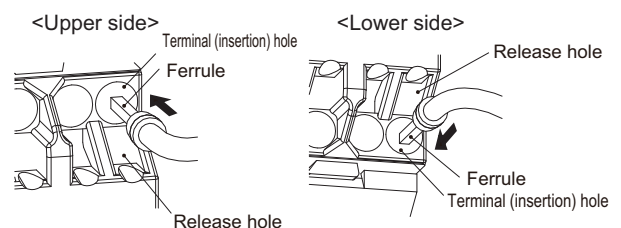

If it is difficult to insert fine solid wires, insert the wire with a screwdriver inserted into the release hole, and then remove the screwdriver while ensuring that the fine solid wire is still held.

Connecting Stranded Wires

- Hold a flat-blade screwdriver at an angle and insert it into the release hole. The angle should be between 10° and 15° .

If the flat-blade screwdriver is inserted correctly, you will feel the spring in the release hole.



The terminal block may be damaged if you insert the screwdriver with excessive force. Operate the screwdriver with a force of 15 N or less.

- With the flat-blade screwdriver still inserted into the release hole, insert the wire into the terminal hole until it strikes the terminal block.
- Remove the flat-blade screwdriver from the release hole.

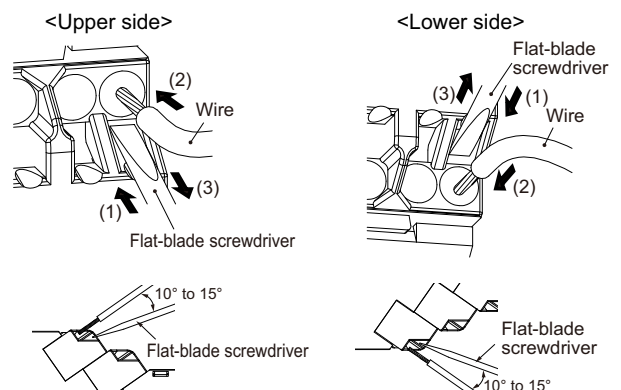

Checking Connection

After the insertion, pull gently on the wire to make sure that it will not come off and the wire is securely fastened to the terminal block.

When you use a stranded wire, make sure the stranded wire does not bend and touch the adjacent terminal.

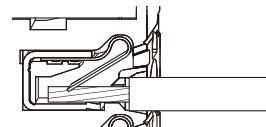

Removing Wires from the Push-In Plus Terminal Blocks

Use the following procedure to remove wires from the terminal block.

The same method is used to remove stranded wires, solid wires, and ferrules.

- Hold a flat-blade screwdriver at an angle and insert it into the release hole. The angle should be between 10° and 15°. If the flat-blade screwdriver is inserted correctly, you will feel the repellent force of the spring.

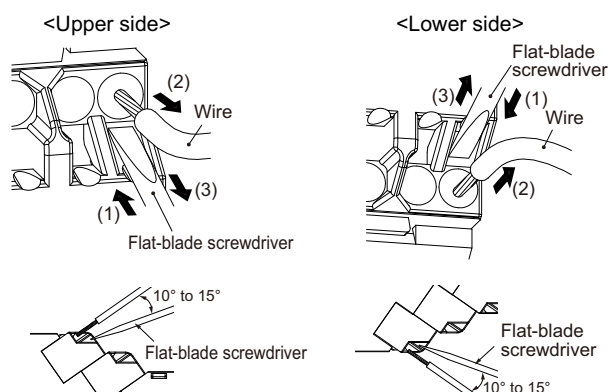

- Remove the wire.
- Remove the flat-blade screwdriver from the release hole.

Push-In Plus Terminal Blocks Specifications

● Specifications

Item	Specifications
Construction	Push-in compatible with 1-pole 2-terminal crossover wiring Front-in front and front-release Hands-free
Applicable wires	Ferrules, solid wires or stranded wires
Applicable wire size	0.25 to 1.5 mm ² (AWG 24 to AWG 16)
Wire insertion force	8 N max. for AWG 20 wire
Screwdriver insertion force	15 N max.
Wire stripping length	8 mm*, 10 mm or 12 mm * Without ferrules
Ferrule length	8 mm or 10 mm
Current capacity	10 A (per pole)
Number of insertions	50 times

● Recommended Ferrules

Applicable wire		Ferrule, Conductor length (mm)	Stripping length (mm) (Ferrules used)	Recommended ferrules		
(mm ²)	AWG			Manufactured by Phoenix Contact	Manufactured by Weidmuller	Manufactured by Wago
0.25	24	8	10	AI 0,25-8	H0.25/12	FE-0.25-8N-YE
		10	12	AI 0,25-10	-	-
0.34	22	8	10	AI 0,34-8	H0.34/12	FE-0.34-8N-TQ
		10	12	AI 0,34-10	-	-
0.5	20	8	10	AI 0,5-8	H0.5/14	FE-0.5-8N-WH
		10	12	AI 0,5-10	H0.5/16	FE-0.5-10N-WH
0.75	18	8	10	AI 0,75-8	H0.75/14	FE-0.75-8N-GY
		10	12	AI 0,75-10	H0.75/16	FE-0.75-10N-GY
1/1.25	18/17	8	10	AI 1-8	H1.0/14	FE-1.0-8N-RD
		10	12	AI 1-10	H1.0/16	FE-1.0-10N-RD
1.25/1.5	17/16	8	10	AI 1,5-8	H1.5/14	FE-1.5-8N-BK
		10	12	AI 1,5-10	H1.5/16	FE-1.5-10N-BK
Recommended crimp tool				CRIMPFOX6 CRIMPFOX6T-F CRIMPFOX10S	PZ6 roto	Variocrimp4

- Note 1. Make sure that the outer diameter of the wire coating is smaller than the inner diameter of the insulation sleeve of the recommended ferrule.
 2. Make sure that the ferrule processing dimensions conform to the figure on the right.

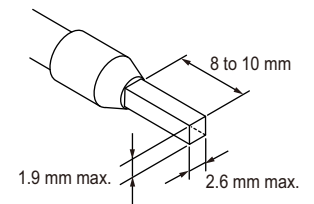

● Recommended Flat-blade Screwdrivers

Model	Manufacturer
ESD 0,40×2,5	Wera
SZS 0,4×2,5 SZF 0-0,4×2,5*	Phoenix Contact
0.4×2.5×75 302	Wiha
AEF.2,5×75	FACOM
210-719	Wago
SDI 0.4×2.5×75	Weidmuller

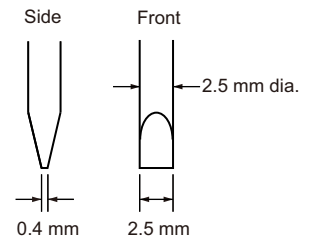

* You can purchase the SZF 0-0,4 × 2,5 flat-blade screwdriver made by PHOENIX CONTACT with OMRON model XW4Z-00B.

3-5 I/O Wiring

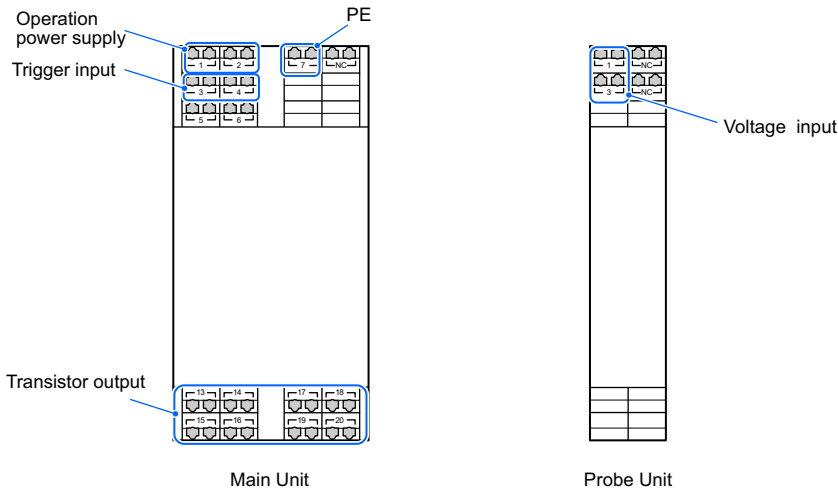

Operation Power Supply Terminals

The operation power supply terminals are the No. 1 and No. 2 terminals on the Main Unit. There is no polarity even in the 24 VDC specifications.

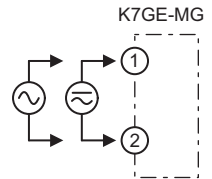

Trigger Input Terminals

The specifications of the trigger input terminal are as follows:

Item	Specifications
Input type	No-voltage contact and open collector are possible.
Residual voltage at short circuit	1.5 V max.
Open leakage current	0.1 mA max.
ON current at short circuit	Approx. 7 mA

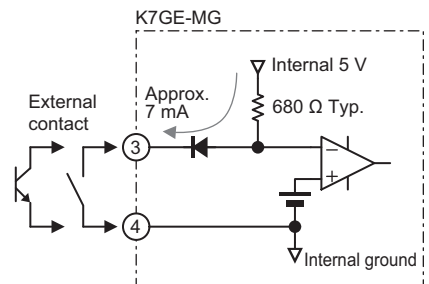

In the case of an NPN open collector, the collector is connected to the No. 3 terminal, and the emitter is connected to the No. 4 terminal. Make sure that the values for the residual voltage at short circuit and open leakage current are within the specifications.

The ON current at short circuit is approx. 7 mA. In the case of a no-voltage contact, take note of the drive capacity of micro loads.

PE Terminals

Earth the PE terminal (No. 7) to the ground.
Use AWG 16 for the protective conductor.

When Megger voltage is applied, the measurement current flows from the PE terminal through the insulation resistance of the load, and returns via the L3 terminal (No. 1) of the Probe Unit.

When more than one load is to be measured, perform wiring such that the frame ground of all the loads are earthed to the ground. If there is more than one Main Unit, do not perform crossover wiring for the PE terminals, and earth each PE terminal to the ground. A load that is not earthed to the ground cannot be measured correctly because the path of the measurement current is not established.

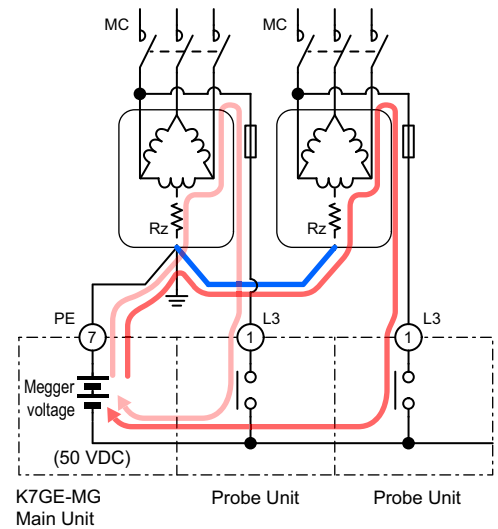

Transistor Output Terminals

The specifications of the transistor output terminal are as follows:

Item	Specifications
Contact form	NPN open collector
Rated voltage	24 VDC (maximum voltage: 26.4 VDC)
Maximum current	50 mA
Leakage current when power turning OFF	0.1 mA max.
Residual voltage	1.5 V max.

If the drive capacity is not sufficient, use an appropriate relay for relaying.

K7GE-MG

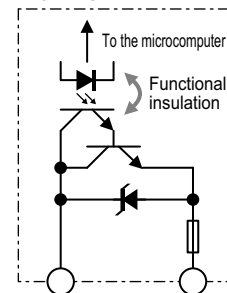

13	14	ALM 1 output
15	16	ALM 2 output
17	18	Status output during measurement
19	20	Self-diagnosis error output

Voltage Input Terminals

Connected between the load wires of the secondary output terminal of the contactor.

The S-phase in a 3-phase system, and the N-phase in a single-phase system is connected to the L2 terminal (No. 3).

The R-phase in a 3-phase system, and the L-phase in a single-phase system is connected to the L3 terminal (No. 1).

Discharge of electric charge and application of the Megger voltage is performed at the L3 terminal.

If the internal circuit components of the K7GE-MG are in a normal state, a current of 3 mA or more will not flow in the L2 and L3 terminals. However, to prevent electric shock accidents due to a short circuit failure of the internal circuit components, be sure to insert a fuse in the L2 and L3 terminals.

Select a fast-blow fuse with a fusing current of 7 A or less, and a rated voltage equal to or more than the line voltage. If a fuse with a fusing current of more than 7 A is used, ensure that the wire connected to the PE terminal has a diameter that allows a sufficient flow of the fusing current.

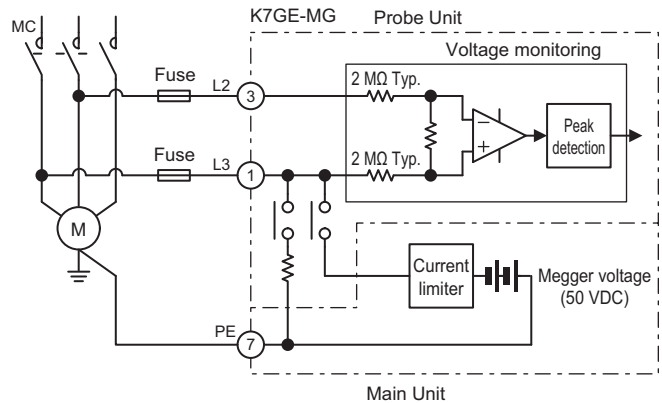

Note The above diagram shows only the parts of the internal circuit of the K7GE-MG that are necessary for explanation.

3-6 Wiring the Communications Cable

When you use the communications function, wire a communications cable.

Connect (+) to the No. 5 terminal and (-) to the No. 6 terminal on the Main Unit.

Crossover wiring is possible as this is a Push-In Plus terminal block.

The connection configuration of Master:Slave is 1:1 or 1:N. In the case of the 1:N connection configuration, you can connect up to 32 Units including the host system that is the master.

The total cable length is 500 m max.

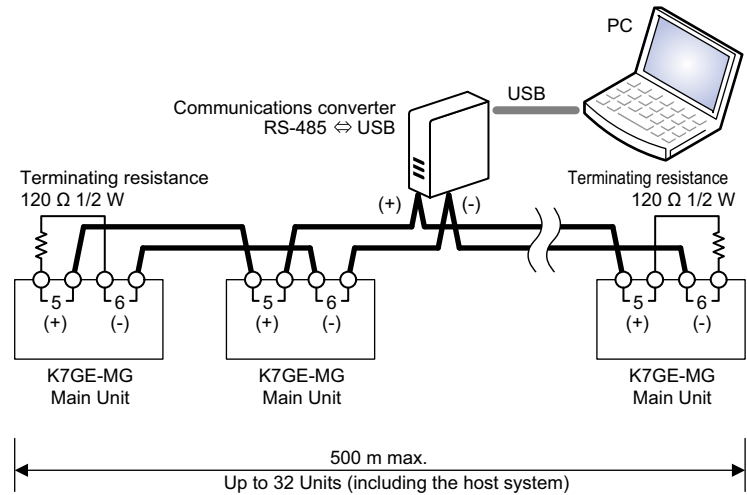

Install a terminating resistance of 120 Ω, 1/2 W on both ends of the transmission path. Use a twisted-pair cable (AWG 24 to AWG 16) as the cable.

3-7 Setting the Unit Number

When you use the communications function, set a unit number for the Main Unit.

You can set a number from 00 to 99. The power ON reset process (Reset Key operation or turning the power ON again) is required. Make the settings when the power is OFF.

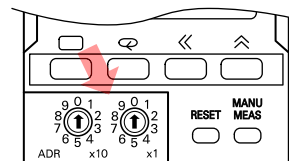

Up to one master host system and 31 slave Main Units can be connected on the same communications. The unit number is used to distinguish between slaves.



If Modbus RTU is selected as the protocol, use a unit number between 01 and 99.

If you communicate with the slave with unit number 00, slave address 00 will be broadcast in the Modbus RTU protocol. However, the K7GE-MG does not support broadcasting.

The master executes a command by specifying the unit number in the communications command. Therefore, the slaves connected on the same communications line must not have duplicate unit numbers.

If the unit number is duplicated, there will be a clash between the responses from multiple slaves, which will result in a communications error.

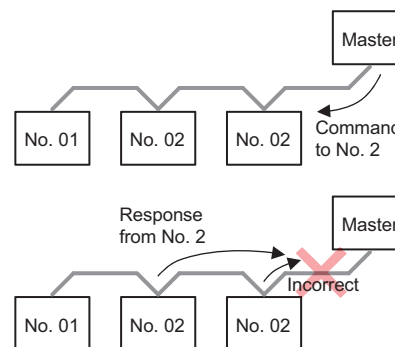

When the Load Is an Inverter-driven Motor

Install a contactor between the inverter output and the motor.

If a noise filter is to be inserted at the output side of the inverter, insert it between the inverter output and the primary output terminal of the contactor.



Do not connect any other device such as a transformer or a filter between the contactor and the motor. Doing so may cause incorrect measurement.

Connect the voltage input of the Probe Unit of the K7GE-MG to the secondary output terminal (motor side) of the contactor.



Make sure that it is not connected to the primary side (power supply side). It cannot be measured correctly and may cause a hazardous condition.

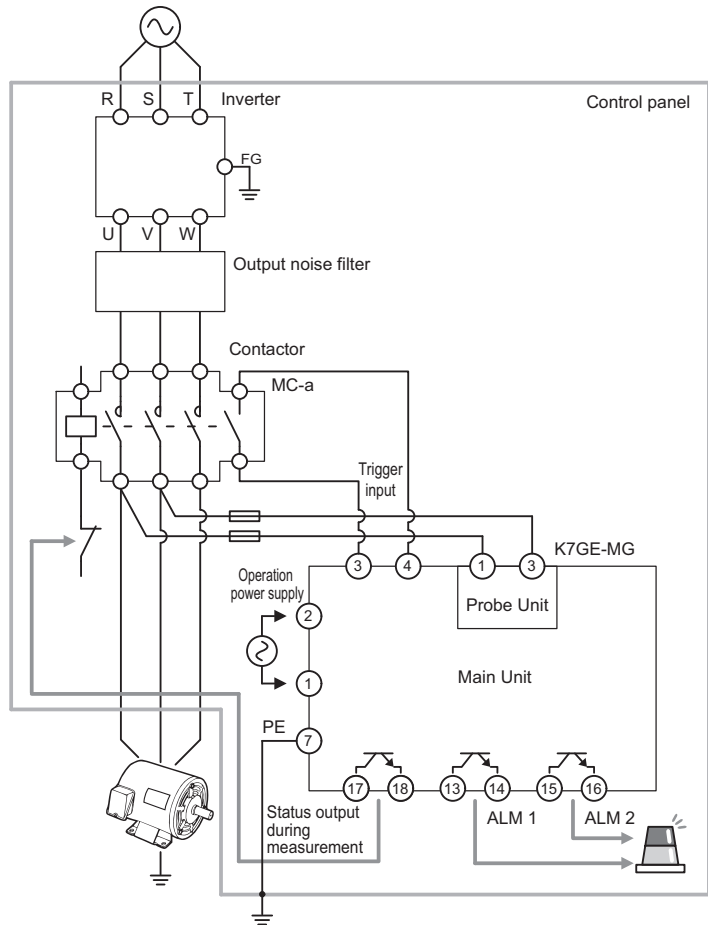

The figure shows a simplified view of the wiring for status output during measurement, and ALM 1 and ALM 2 outputs. Use an appropriate relay for relaying in consideration of the switching capacity of the output transistor. The specifications of the output transistor for the K7GE-MG are 24 VDC (+10%), 50 mA max.

When the Load Is a Servo Motor

Install a contactor between the Servo Drive output and the motor.

The contactor is required only in the power line. Relays the motor power cables other than the power line to the terminal blocks and connect it to the Servo Drive directly.

Connect the voltage input of the Probe Unit of the K7GE-MG to the secondary output terminal (motor side) of the contactor.

Turn the contactor ON and OFF when the Servo Drive power is OFF.

Do not connect any other device such as a transformer or a filter between the contactor and the motor. Doing so may cause incorrect measurement.

Make sure that it is not connected to the primary side (power supply side). It cannot be measured correctly and may cause a hazardous condition.

If the contactor is turned OFF while the Servo Drive is turned ON, the rotating shaft of the motor will be in a free. If the contactor is turned on after that, the motor may perform unintended operation and can be dangerous.

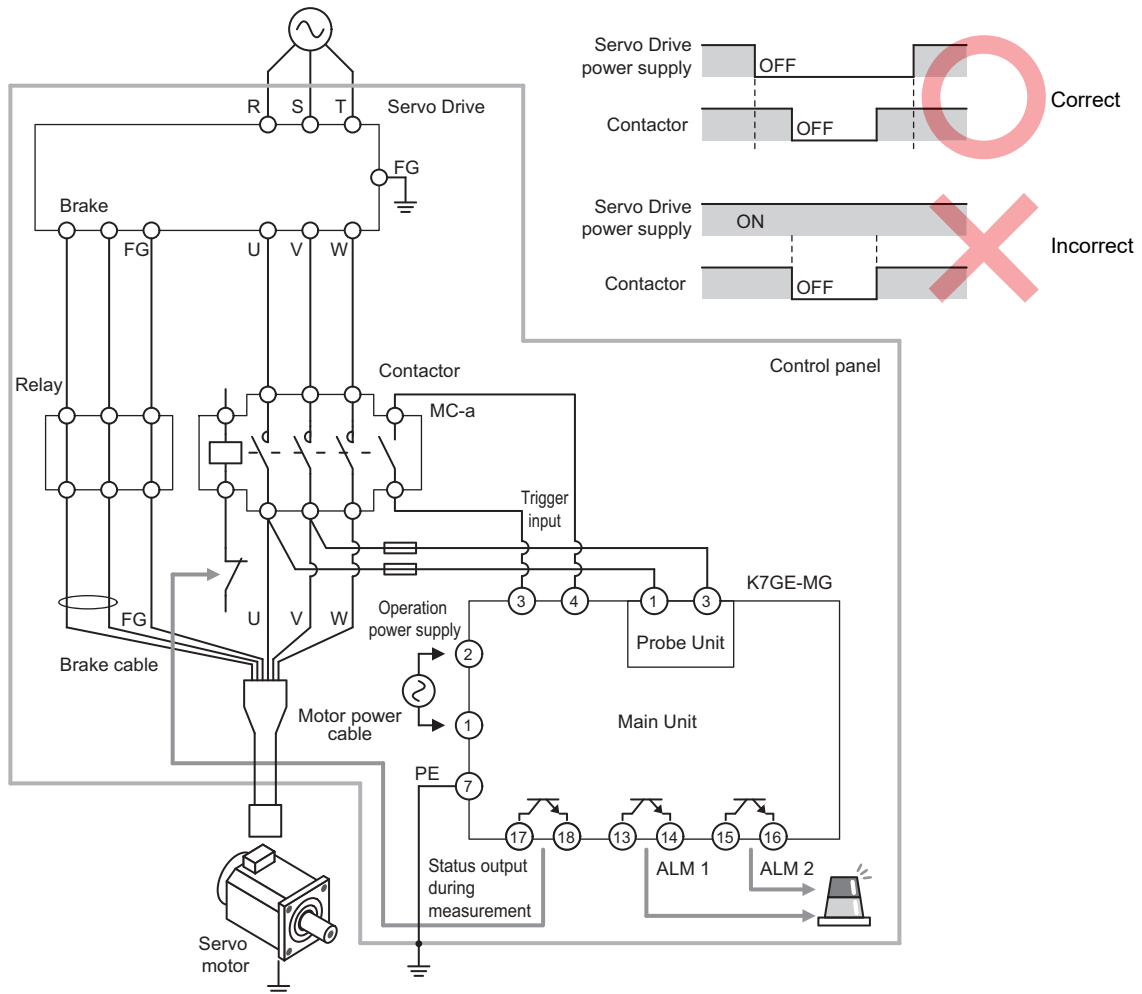

The figure shows a simplified view of the wiring for status output during measurement, and ALM 1 and ALM 2 outputs. Use an appropriate relay for relaying in consideration of the switching capacity of the output transistor. The specifications of the output transistor for the K7GE-MG are 24 VDC (+10%), 50 mA max.

Cases Where Insulation Resistance is Measured Without Disconnecting Motors

In order to accurately measure insulation resistance of a motor using a Megohmmeter, motors must be disconnected from power lines and then a Megger voltage must be applied to them individually. In practice, however, it is time-consuming to disconnect and reconnect power lines, and insulation resistance values, in some cases, are measured without disconnecting wiring, because they are useful for time-trend monitoring even if they are not accurate.

Below is a description of connection methods for automatically measuring insulation resistance by replacing a Megohmmeter with the K7GE-MG without disconnecting wiring.

For safety reasons and to obtain accurate measurement values, each individual motor is considered to have one contactor installed. Accordingly, OMRON does not recommend the following connection methods to be used.

When the Load Is a 3-phase Induction Motor (not recommended)

For a case where multiple motors are turned ON and OFF by a single contactor, connect the voltage input of the Probe Unit of the K7GE-MG to the secondary output terminal of the contactor.

The figure shows a simplified view of the wiring for the “status output during measurement” terminal, and ALM 1 and ALM 2 outputs. Use an appropriate relay for relaying in consideration of the switching capacity of the output transistor.

The specifications of the output transistor for the K7GE-MG are 24 VDC (+10%), 50 mA max.

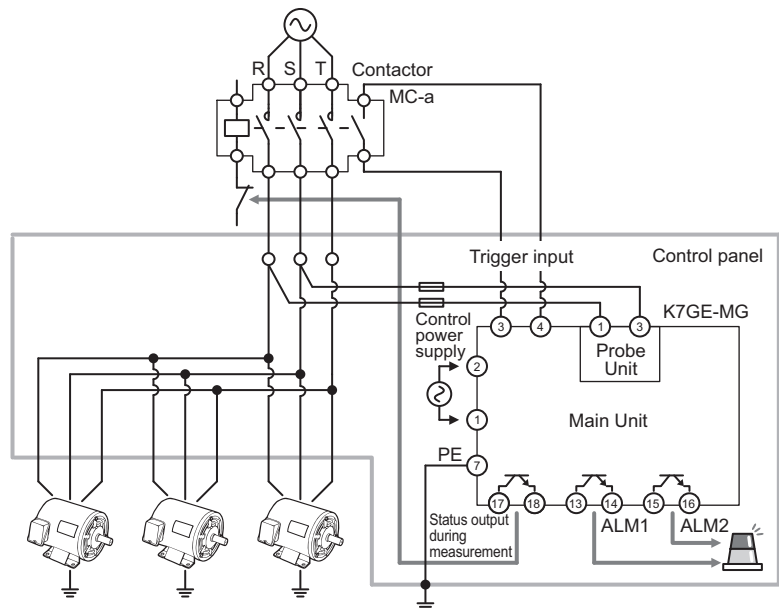

The system must be designed not to turn power lines ON while the K7GE-MG is measuring. The “status output during measurement” terminal can be used to check whether the K7GE-MG is measuring or not.

● Reasons for non-recommendation

If a contactor is not used for each motor, an accurate measurement will not be possible because a Megger voltage is applied not only to the motor being measured but also to other motors at the same time.

The figure shows an example in which the insulation resistance of one of the three motors has dropped to 10 MΩ. Even though the right-most motor is supposed to be measured, the measured value is 9.8 MΩ which is the parallel resistance of three motors (1000 MΩ, 10 MΩ and 1000 MΩ).

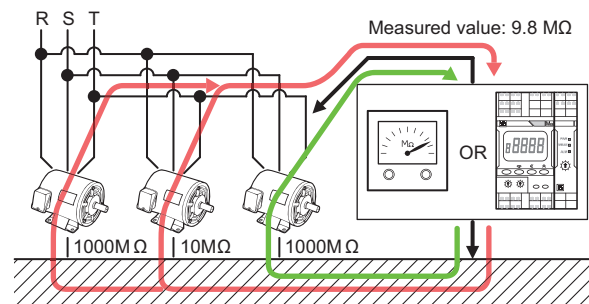

This problem is not specific to the K7GE-MG. It also occurs in measurements using conventional Megohmmeters.

If you wish to use this connection for time-trend monitoring, ensure that you fully understand "Reasons for non-recommendation" described above before using it.

When the Load Is an Inverter-driven Motor (not recommended)

Connect the voltage input of the Probe Unit of the K7GE-MG to the secondary output terminal of the inverter.

If a contactor is not used on the secondary coil of the inverter, the auxiliary contact cannot be used. In that case, a separate contact for the timing of measurement start is required at the trigger input terminal.

The figure shows a simplified view of the wiring for the “status output during measurement” terminal, and ALM 1 and ALM 2 outputs. Use an appropriate relay for relaying in consideration of the switching capacity of the output transistor.

The specifications of the output transistor for the K7GE-MG are 24 VDC (+10%), 50 mA max.

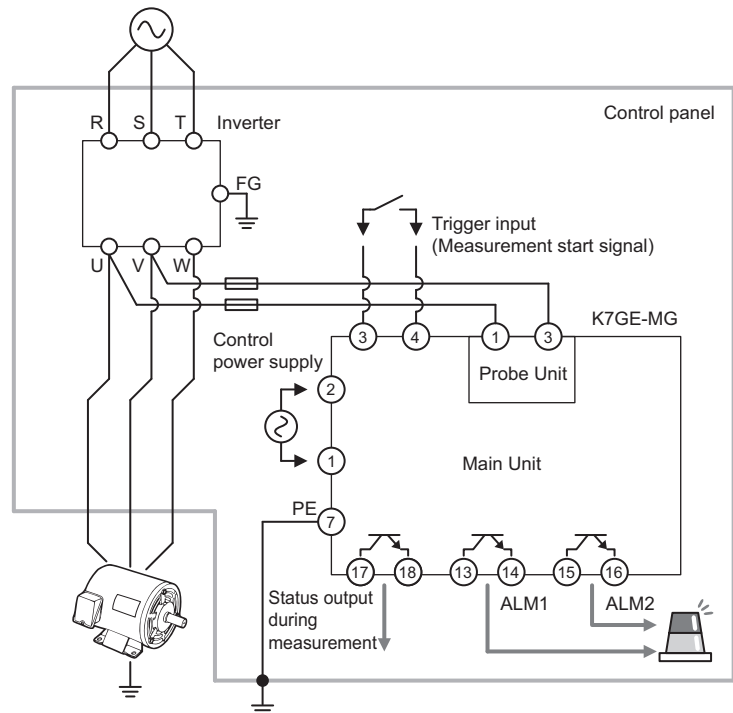

The system must be designed not to turn power lines ON while the K7GE-MG is measuring. The “status output during measurement” terminal can be used to check whether the K7GE-MG is measuring or not.

● Reasons for non-recommendation

If a contactor is not used on the secondary coil of the inverter, a Megger voltage will be applied between the output terminal of the inverter and FG. Due to such unexpected voltage application, OMRON cannot guarantee that the output circuit of the inverter can work without failure or malfunction.

Before using such an inverter, confirm with its manufacturer to make sure there are no problems with application of a Megger voltage. The Megger voltage of the K7GE-MG is 50 VDC.



This problem is not specific to the K7GE-MG. It also occurs in measurements using conventional Megohmmeters.

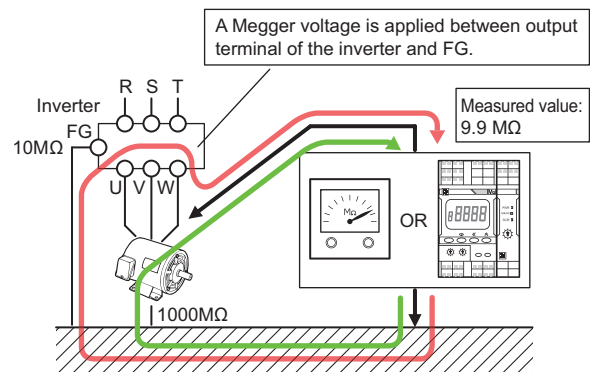

Note that even if the output circuit of the inverter can be used without problems, accurate measurements cannot be made because a Megger voltage is simultaneously applied to the inverter as well as to the motor to be measured.

The figure shows an example in which the insulation resistance of the motor is 1000 MΩ and of the inverter is 10 MΩ. Even though only the motor is supposed to be measured, the measured value is 9.9 MΩ which is the parallel resistance of the inverter (10 MΩ) and motor (1000 MΩ).



This problem is not specific to the K7GE-MG. It also occurs in measurements using conventional Megohmmeters.

If you wish to use this connection for time-trend monitoring, ensure that you fully understand "Reasons for non-recommendation" described above before using it.

When the Load Is a Servo Motor (not recommended)

Connect the voltage input of the Probe Unit of the K7GE-MG to the output terminal of the Servo Drive.

If a contactor is not used on the secondary coil of the Servo Drive., the auxiliary contact cannot be used.

In that case, a separate contact for the timing of measurement start is required at the trigger input terminal.

The figure shows a simplified view of the wiring for the “status output during measurement” terminal, and ALM 1 and ALM 2 outputs. Use an appropriate relay for relaying in consideration of the switching capacity of the output transistor. The specifications of the output transistor for the K7GE-MG are 24 VDC (+10%), 50 mA max.

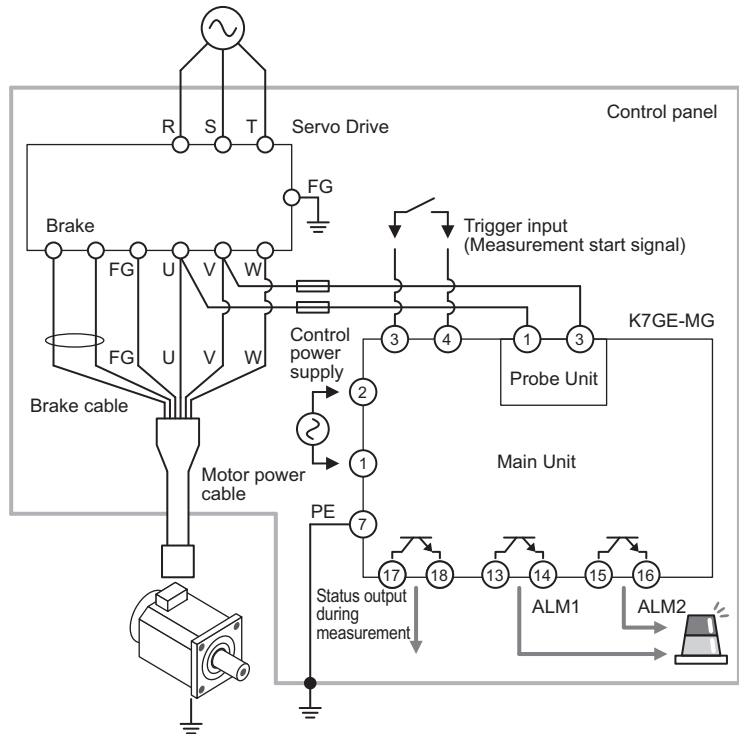

The system must be designed not to turn power lines ON while the K7GE-MG is measuring. The “status output during measurement” terminal can be used to check whether the K7GE-MG is measuring or not.

● Reasons for non-recommendation

If a contactor is not used on the secondary coil of the Servo Drive, a Megger voltage will be applied between the output terminal of the Servo Drive and FG. Due to such unexpected voltage application, OMRON cannot guarantee that the output circuit of the Servo Drive can work without failure or malfunction.

Before using such a Servo Drive, confirm with its manufacturer to make sure there are no problems with application of a Megger voltage. The Megger voltage of the K7GE-MG is 50 VDC.



This problem is not specific to the K7GE-MG. It also occurs in measurements using conventional Megohmmeters.

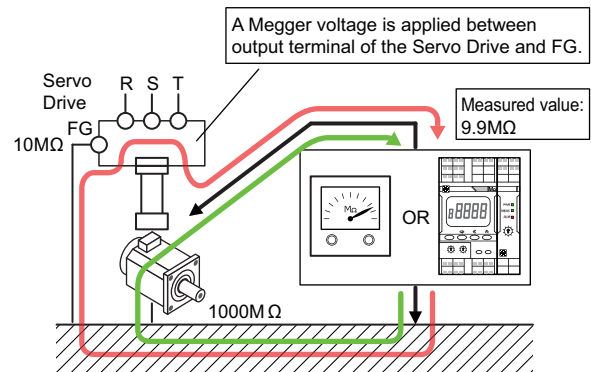

Note that even if the output circuit of the Servo Drive can be used without problems, accurate measurements cannot be made because a Megger voltage is simultaneously applied to the Servo Drive as well as to the motor to be measured.

The figure shows an example in which the insulation resistance of the motor is 1000 MΩ and of the Servo Drive is 10 MΩ. Even though only the motor is supposed to be measured, the measured value is 9.9 MΩ which is the parallel resistance of the Servo Drive (10 MΩ) and motor (1000 MΩ).



This problem is not specific to the K7GE-MG. It also occurs in measurements using conventional Megohmmeters.

If you wish to use this connection for time-trend monitoring, ensure that you fully understand "Reasons for non-recommendation" described above before using it.

4

Functions Related to Measurement

This section describes automatic measurement and manual measurement of the K7GE-MG, as well as the functions related to measurement.

4

4-1	Automatic Measurement	4-2
4-1-1	Trigger Input	4-2
4-1-2	Measurement Steps	4-4
4-1-3	Measurement Step Indicator Operation	4-7
4-1-4	Timing Charts	4-8
4-1-5	Measurement Value Display Automatic Scroll	4-16
4-2	Manual Measurement	4-17
4-3	Measuring Range and Measuring Accuracy	4-21
4-4	Voltage Monitoring	4-22
4-5	Current Limiter	4-23
4-6	Reset Key	4-25
4-7	System Error	4-26
4-8	Running Time	4-27
4-9	Calculating the Measuring Time Using the Elapsed Time	4-28

4-1 Automatic Measurement

The K7GE-MG normally operates with automatic measurement. Automatic measurement is performed in synchronization with the trigger signal.

The following describes the operation of automatic measurement.

4-1-1 Trigger Input

Trigger by an External Contact

The K7GE supports connecting the auxiliary contact of the contactor that turns the power of the load ON or OFF to the trigger input terminal. In addition, it also supports control using the I/O ports of the PLC, and the signal logic can be reversed with the setting parameters.

Therefore, "trigger input ON" cannot simply distinguish whether the trigger signal is an external contact or a measurement start signal.

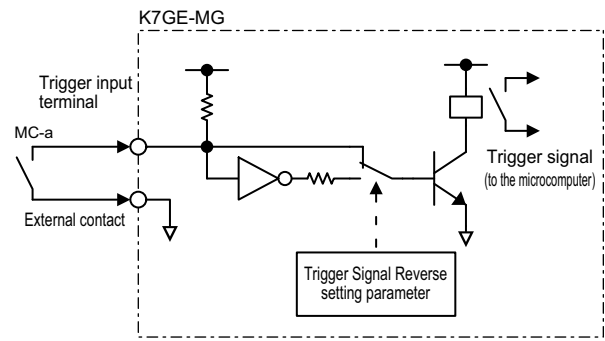

Trigger input circuit (conceptual diagram)

Thus, in this manual, trigger signal ON means enabled (measurement start signal is enabled) and trigger signal OFF means disabled.

The table on the right shows the relationship between the external contact, Trigger Signal Reverse setting parameter, and trigger signal connected to the trigger input terminal. The auxiliary contact of the contactor is used as the measurement start signal. The initial value of the setting parameter is set so that the trigger signal is turned ON (enabled) when the external contact is turned OFF (contactor is turned OFF).

External contact	Trigger Signal Reverse setting parameter	Trigger signal
OFF	OFF (default value)	ON
	ON	OFF
ON	OFF (default value)	OFF
	ON	ON



Observe that this manual describes the measurement start signal as a trigger signal rather than an external contact, such as a time chart description.

Trigger by a Communications Command

Automatic measurement can be started by giving a trigger signal to the K7GE-MG from a communications command as well as an external contact. However, the operation is slightly different from that of an external contact. To keep the trigger signal ON, the external contacts must be kept OFF*. However, in the case of the communications command, the trigger signal is kept ON with a one-shot command.

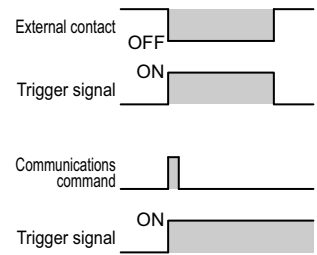

* When the setting value of the Trigger Signal Reverse setting parameter changes to OFF.

Overlapping between the timing of the trigger by an external contact and the trigger by a communications command is a post-win. For example, if the measurement operation starts by an external contact and a communications command is input before the measurement operation completes, the measurement started by the external contact is reset, and a new measurement operation by the communications command starts.



We recommend using either external contact or communications command, as the operation is difficult to see from the outside.

4-1-2 Measurement Steps

Automatic measurement consists of four steps.

- Motor stop standby
- Discharge of electric charge
- Waiting for stability
- Sampling

Automatic measurement is started with trigger signal

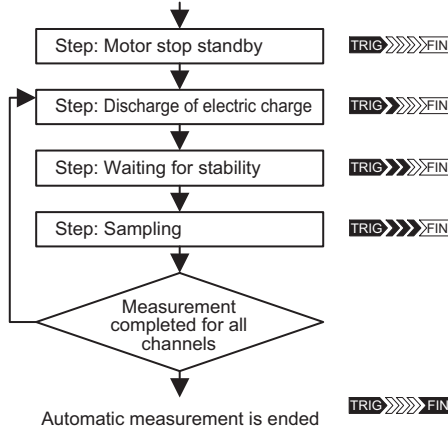

Note If the trigger input is a communications command, TRIG indicator will not light.

Even when measuring multiple channels, the motor stop standby step is performed only once at the beginning of the measurement operation. Other than that, the steps are executed each time measurement is performed for each channel.

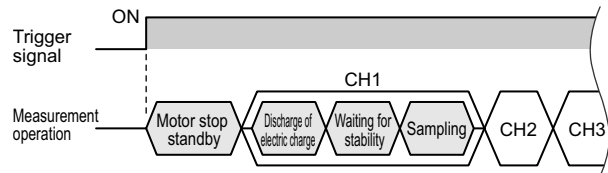

The time required for automatic measurement changes depending on the setting values of the setting parameters. However, if the setting parameters are set to the default values, the time required for automatic measurement is approx. 91 seconds in the minimum configuration of one Probe Unit, and approx. 658 seconds in the maximum configuration of eight Probe Units.

Motor Stop Standby

If the auxiliary contact of the contactor that turns ON/OFF the power of the load is connected to the trigger input terminal, the trigger signal for measurement start can be easily created. However, since the auxiliary contact is linked to the contactor, the trigger signal turns ON at the time when the contactor turns OFF*.

* When the setting value of the Trigger Signal Reverse setting parameter changes to OFF.

If the load is a motor, it does not stop immediately when it is disconnected from the power, but stops gradually in due course of time by slowing down. A line voltage is generated during the time the motor is rotating. Therefore, even if the trigger signal turns ON, it is necessary to wait for the measurement to stop completely.

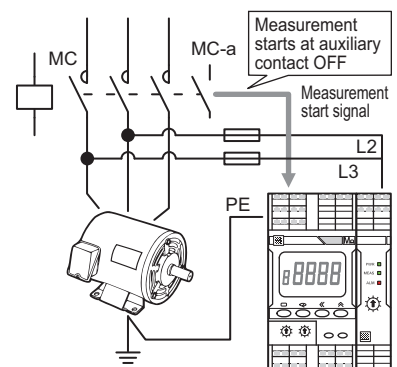

The first step of automatic measurement is to wait for the time until the motor stops completely.

The time until the stop of the motor varies depending on the size of the motor and the inertia of the equipment being driven. Therefore, the waiting time can be adjusted by the Motor Stop Waiting Time setting parameter (0 to 299 seconds).

Refer to 5-7 *Motor Stop Waiting Time* on page 5-15 for the operation method of the Motor Stop Waiting Time setting parameter.

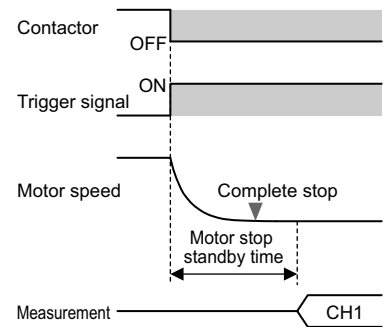

Discharge of Electric Charge TRIG >>>> FIN

A parasitic capacitance component is present between the load including the wiring from the contactor and the ground. Therefore, even if the contactor is turned OFF, the electric charge accumulated in the capacity component is not discharged immediately. It would take several minutes for the electric charge to be discharged naturally, so this step forcibly discharges the charge.

The time for this step is fixed as 20 seconds.

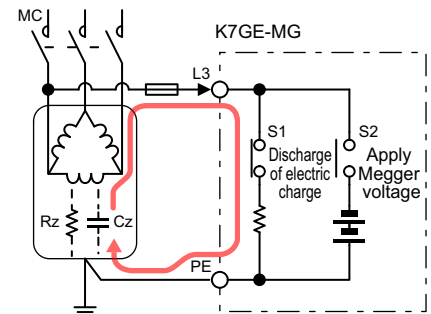

Note The above diagram shows only the parts of the internal circuit of the K7GE-MG that are necessary for explanation.

Waiting for Stability TRIG >>>> FIN

In this step, the application of the Megger voltage starts, but due to the parasitic capacitance component, it may take some time for the measurement value to reach the final value. In this step, the K7GE-MG waits for a fixed period of time with the Megger voltage still applied in order to adopt the stable final value as the measurement value.

The time until the value becomes stable varies depending on the status of the equipment and wiring. Therefore, the waiting time can be adjusted by the Time to Wait to Stabilize setting parameter (0 to 99 seconds).

Refer to 5-8 *Time to Wait to Stabilize* on page 5-17 for the operation method of the Time to Wait to Stabilize setting parameter.

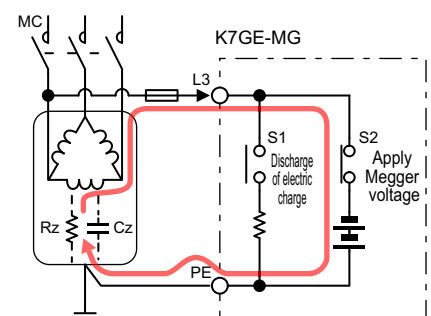

Note The above diagram shows only the parts of the internal circuit of the K7GE-MG that are necessary for explanation.

Sampling TRIG >>>> FIN

In this step, the measurement value is confirmed, and an alarm judgment is performed.

Depending on whether or not average processing is performed for the measurement values, the time taken for this step is 0.8 seconds or 6.4 seconds.

Whether or not to perform average processing can be set by the Average Processing setting parameter. Refer to *5-9 Average Processing* on page 5-19 for the operation method.

The alarm judgment is performed based on the confirmed measurement value, and an alarm is output.

The threshold value used in the alarm judgment can be set by the Alarm Value 1 and Alarm Value 2 setting parameters. Refer to *5-4 Alarm Values 1 and 2* on page 5-9 for the operation method.

If there is another channel to measure, the measurement is performed from the second step "Discharge of electric charge".

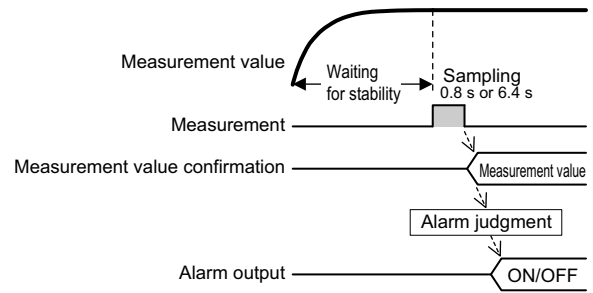

Automatic Measurement Is Ended TRIG >>>> FIN

This is the state when automatic measurement of all channels is complete.

FIN indicator is lit on the measurement step indicator.

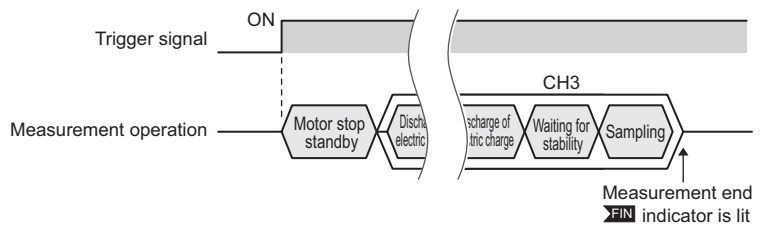

4-1-3 Measurement Step Indicator Operation

The relationship between the progress of the steps and the measurement step indicator is described with an example in which three Probe Units are connected.

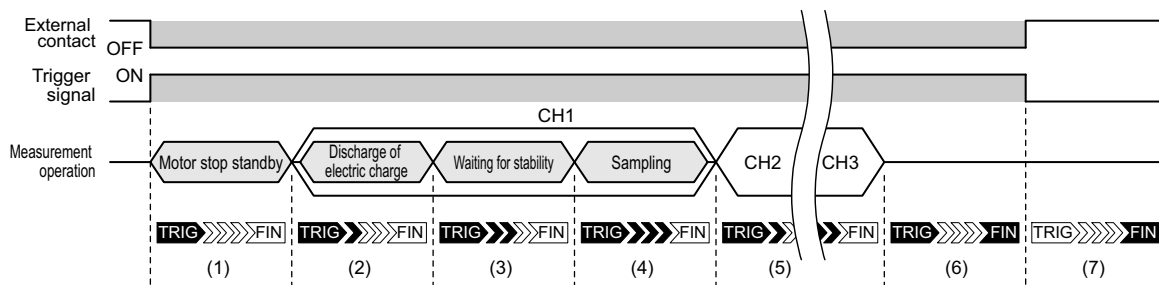

- (1) The trigger signal turns ON when the external contact changes from ON to OFF*, and the measurement operation starts. The first step of the measurement operation is motor stop standby.

* When the setting value of the Trigger Signal Reverse setting parameter is OFF

Linking to the external contact occurs and TRIG indicator is lit on the measurement step indicator. (If the trigger signal is from a communications command, TRIG indicator is not lit.)

- (2) The processing shifts to the discharge of electric charge step of channel 1. The first arrow of the measurement step indicator is lit to indicate that the discharge of electric charge is in progress.
- (3) The processing shifts to the waiting for stability step. Megger voltage is applied to the load of channel 1, and the K7GE-MG waits for a fixed period of time. The second arrow of the measurement step indicator is lit to indicate that the K7GE-MG is waiting for stability.
- (4) The processing shifts to the sampling step. The measurement values are read. The third arrow of the measurement step indicator is lit to indicate that sampling is in progress. The alarm judgment is performed based on the confirmed measurement value, and an alarm is output.
- (5) The measurement operation shifts to channel 2. For channel 2, the processing starts from the discharge of electric charge step.
- (6) The series of measurement operations ends. FIN indicator is lit on the measurement step indicator to indicate the end of the measurement operation.
- (7) Since the measurement step indicator TRIG is linked to the external contact, it turns OFF when the external contact turns ON. Even when TRIG indicator is not lit, the confirmed measurement values are retained. This state continues until automatic measurement starts again with the next trigger signal ON, or measurement standby occurs as a result of reset.

4-1-4 Timing Charts

Timing Charts for Measurement Start/End/Stop

The relationship between the timing of measurement start, end, and stop during automatic measurement by a trigger signal, and each display and contact output is described using a specific example.

The configuration and initial settings are as follows:

- Connect the contactor auxiliary contact of the load to the trigger input terminal
- Connect three Probe Units
- The channel number setting of each Unit is channel 1, 2, and 3 from the left
- Set the setting value of the Maximum Number of Channels setting parameter to 3
- Set the setting value of the Trigger Signal Reverse setting parameter to OFF

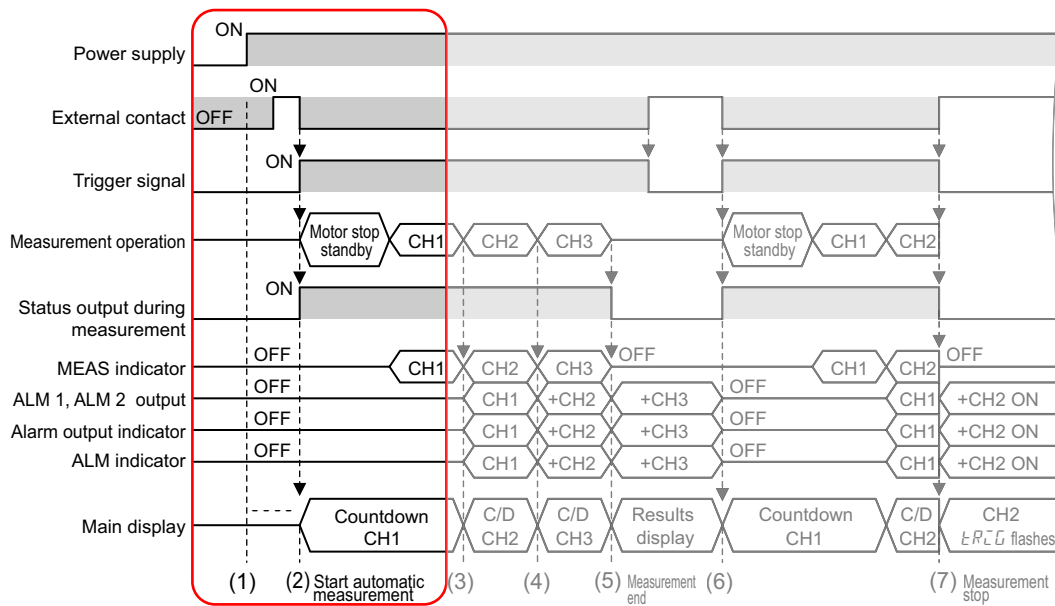
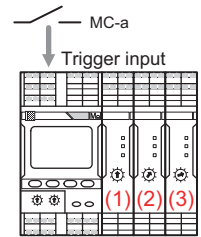

(1) Power ON

Even if the external contact is already OFF when the K7GE-MG power is turned ON, enabled trigger signals are not accepted. - - - - is displayed on the main display part, indicating measurement standby.

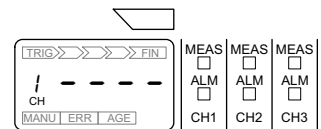

(2) Start automatic measurement

The trigger signal turns ON when the external contact changes from ON to OFF, and automatic measurement starts. The following parts operate simultaneously with the start of automatic measurement.

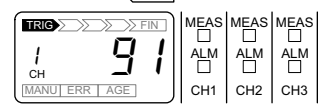

- Status output during measurement turns ON
- TRIG indicator is lit on the measurement step indicator
- The countdown until the measurement completes for channel 1 is displayed on the main display part

Measurement is performed for channel 1 after motor stop standby.

When measurement starts, the MEAS indicator on the Probe Unit of channel 1 turns ON, which indicates that measurement is in progress.

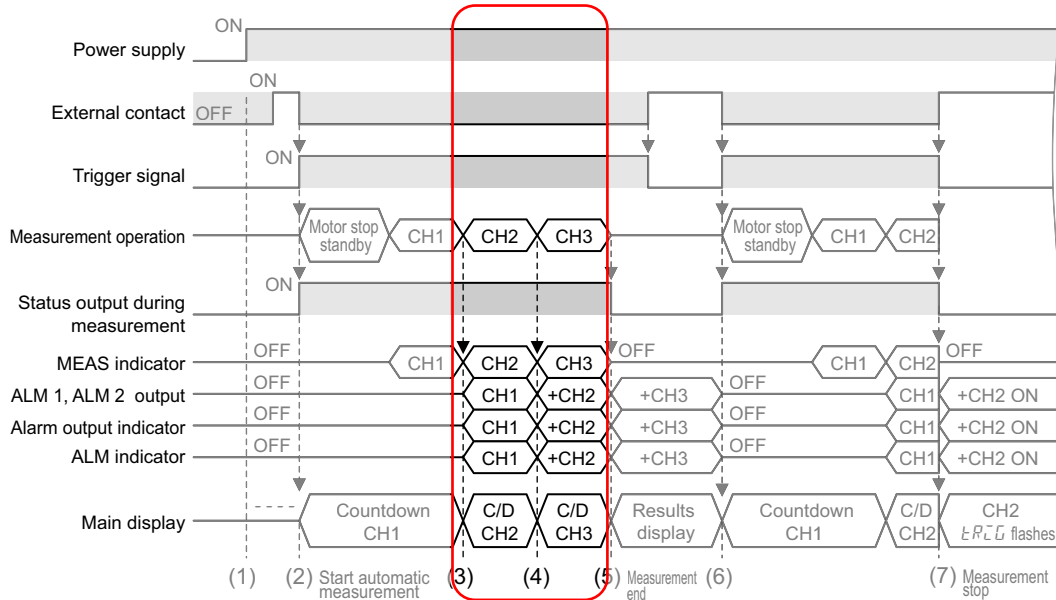
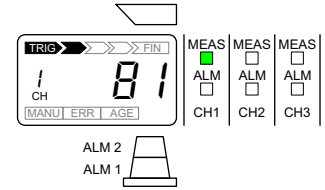

(3) Measurement moves from channel 1 to channel 2
The following parts operate simultaneously with the confirmation of the measurement value for channel 1.

- The results of alarm judgment for CH1 are reflected in ALM 1/ALM 2 output
- The results of alarm judgment for CH1 are reflected in the alarm output indicator
- The results of alarm judgment for CH1 are reflected in the ALM indicator of the Probe Unit
- The MEAS indicator of CH1 is not lit and the MEAS indicator of CH2 is lit
- The countdown until the measurement completes for channel 2 is displayed on the main display part

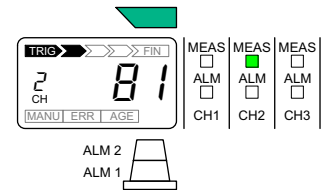

The above display example shows a case in which no alarm occurs for channel 1.
Alarm output indicator: Green
ALM indicator: Not lit
ALM 1 output: OFF

(4) Measurement moves from channel 2 to channel 3
The following parts operate simultaneously with the confirmation of the measurement value for channel 2.

- The results of alarm judgment for CH2 are reflected in ALM 1/ALM 2 output*
- The results of alarm judgment for CH2 are reflected in the alarm output indicator*
- The results of alarm judgment for CH2 are reflected in the ALM indicator of the Probe Unit
- The MEAS indicator of CH2 is not lit and the MEAS indicator of CH3 is lit
- The countdown until the measurement completes for channel 3 is displayed on the main display part

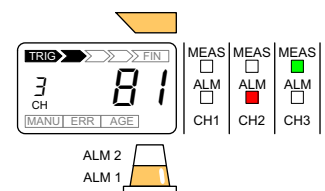

The above display example shows a case in which an alarm (warning) occurs for channel 2.
Alarm output indicator: Yellow
ALM indicator: Lit
ALM 1 output: ON

* The parameters that are turned ON in the judgment results for CH1 will not turn OFF.

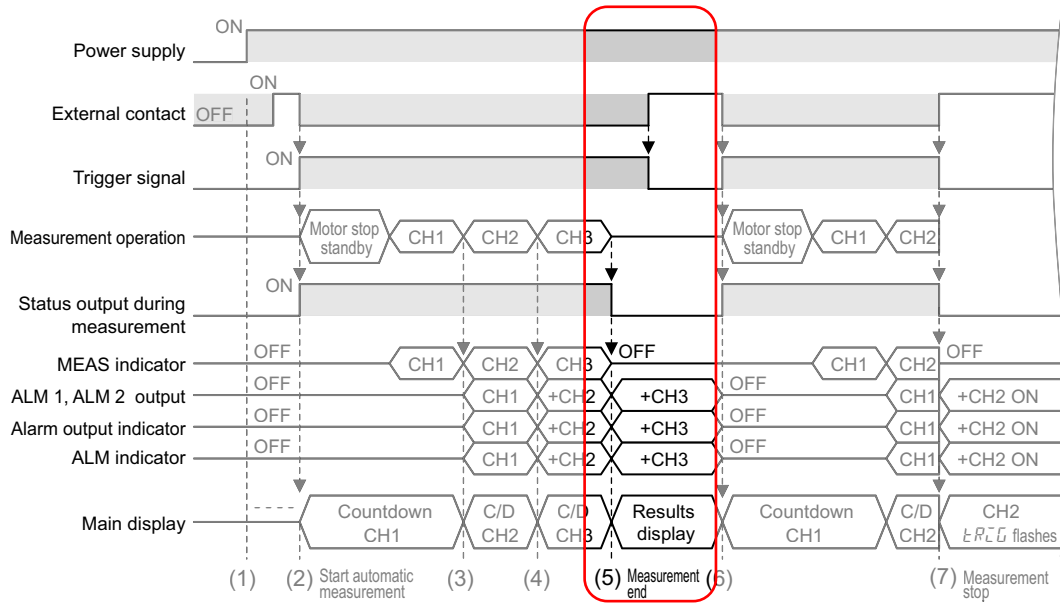

(5) Measurement end

The following parts operate simultaneously with the confirmation of the measurement value for channel 3.

- Status output during measurement turns OFF
- The results of alarm judgment for CH3 are reflected in ALM 1/ALM 2 output*
- The results of alarm judgment for CH3 are reflected in the alarm output indicator*
- The results of alarm judgment for CH3 are reflected in the ALM indicator of the Probe Unit
- The MEAS indicator of CH3 is not lit

* The parameters that are turned ON in the judgment results for CH1 and CH2 will not turn OFF.

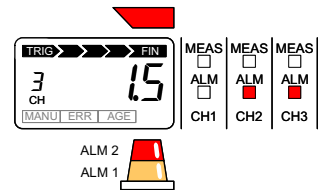

The above display example shows a case in which an alarm (critical) occurs for channel 3.
 Alarm output indicator: Red
 CH3 ALM indicator: Lit
 ALM 1 output: ON
 ALM 2 output: ON

Since there are three Probe Units, the measurement operation ends when the measurement for channel 3 ends.

The measurement results of channel 3 are displayed on the main display part. The measurement results of channel 1 to 3 can be referenced with the Mode Key (↻).

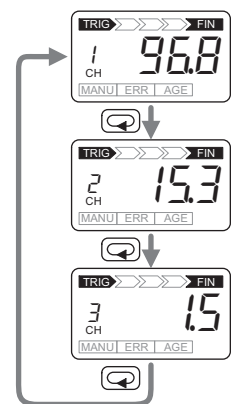

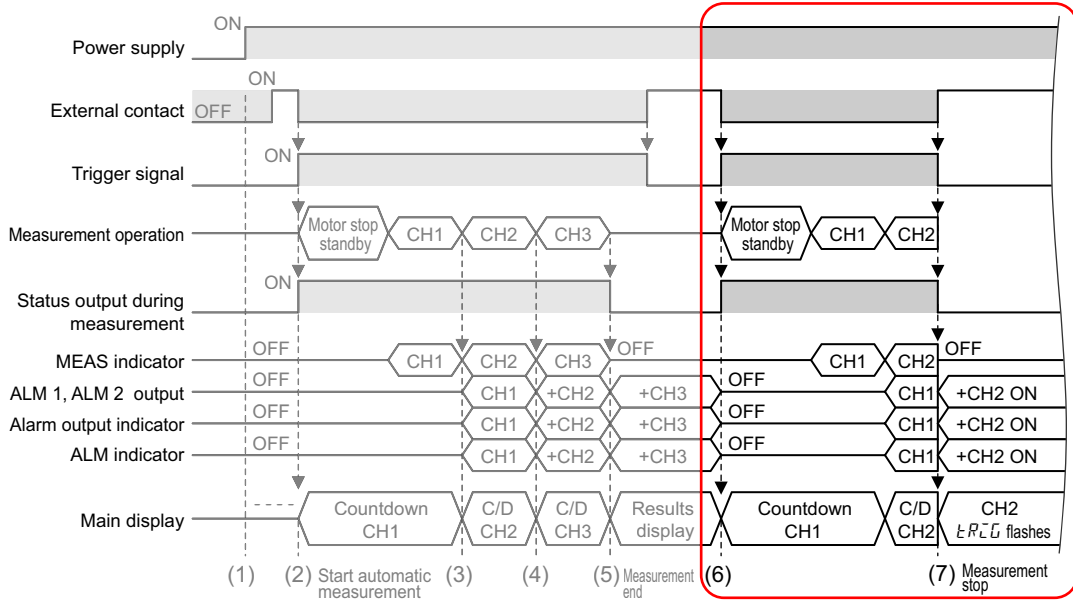

(6) Restart automatic measurement

Here, in order to explain the operation of (7) Measurement stop, the measurement is restarted by a trigger signal that changes the external contact from ON to OFF.

The previous measurement values, ALM 1/ALM 2 output, alarm output indicator, and the ALM indicator of the Probe Unit are all cleared (turned OFF).

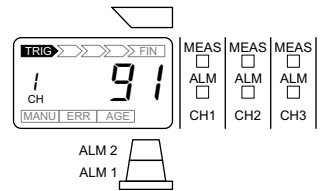

(7) Measurement stop

Here, the operation when the external contact turns ON (the trigger signal is OFF) during the measurement for channel 2 is described. In such a case, the measurement operation stops. The following parts operate simultaneously with the stop of measurement.

- Status output during measurement turns OFF
- Linking to the external contact occurs and TRIG turns OFF on the measurement step indicator
- ∞ flashes on the main display part, indicating the stop of measurement due to trigger signal OFF
- ALM 1 output and ALM 2 output turn ON*
- The alarm output indicator is lit red*
- The ALM indicator of the CH2 Probe Unit is lit*

* Since the measurement value of channel 2 cannot be identified when measurement is stopped, the measurement value is treated as 0 MΩ internally, and alarm judgment is performed.

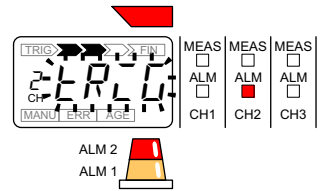

If you display the measurement results using the Mode Key (↺), the measurement value is displayed for channel 1 and ∞ flashes for channel 2. Also, --- is displayed for channel 3 to indicate measurement standby.

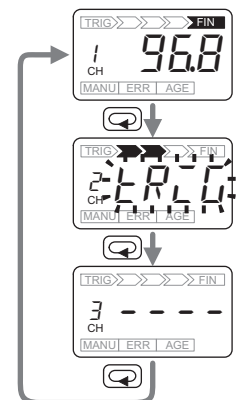

Timing Chart for Measurement Failure

The operation when measurement fails during automatic measurement is described using a specific example.

The configuration and initial settings are as follows:

- Connect the output contact of the PLC to the trigger input terminal
- Connect three Probe Units
- The channel number setting of each Unit is channel 1, 2, and 3 from the left
- Set the setting value of the Maximum Number of Channels setting parameter to 3
- Set the setting value of the Trigger Signal Reverse setting parameter to ON

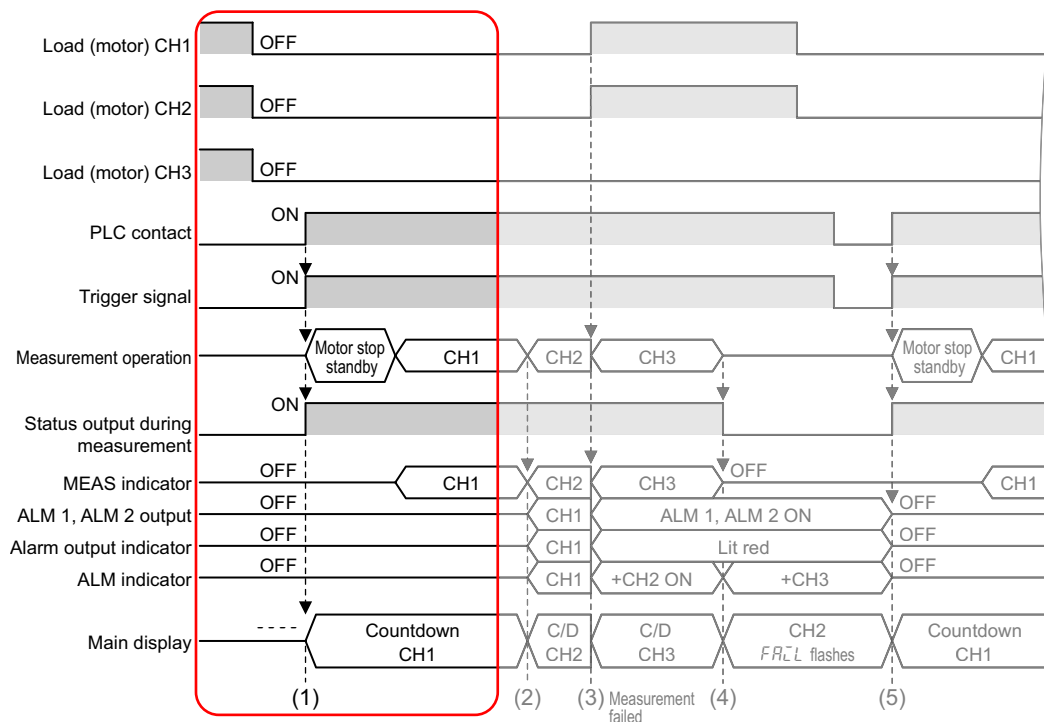
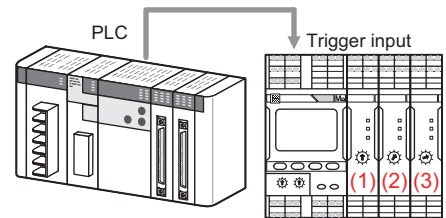

(1) Start automatic measurement

The trigger signal turns ON when the PLC contact changes from OFF to ON*, and measurement starts.

* When the setting value of the Trigger Signal Reverse setting parameter is ON

The following parts operate simultaneously with the start of automatic measurement.

- Status output during measurement turns ON
- TRIG indicator is lit on the measurement step indicator
- The countdown until the measurement completes for channel 1 is displayed on the main display part

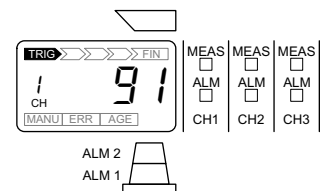

Measurement is performed for channel 1 after motor stop standby.

When measurement starts, the MEAS indicator on the Probe Unit of channel 1 turns ON, which indicates that measurement is in progress.

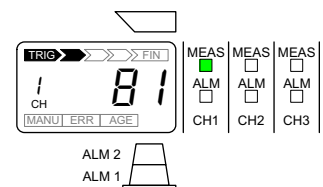

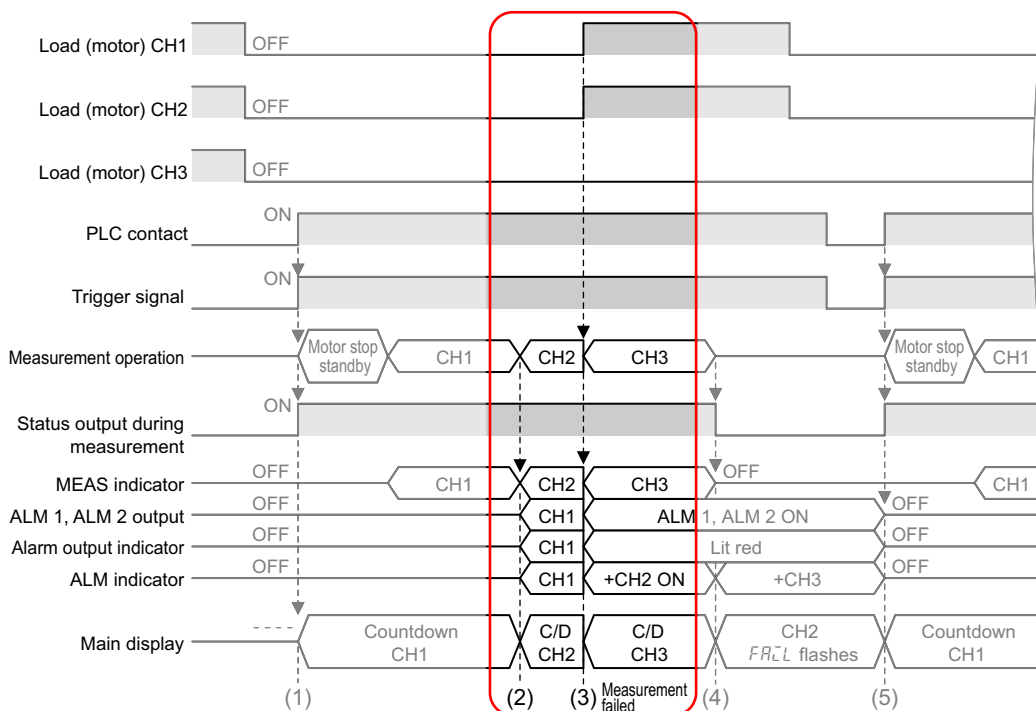

(2) Measurement moves from channel 1 to channel 2

The following parts operate simultaneously with the confirmation of the measurement value for channel 1.

- The results of alarm judgment for CH1 are reflected in ALM 1/ALM 2 output
- The results of alarm judgment for CH1 are reflected in the alarm output indicator
- The results of alarm judgment for CH1 are reflected in the ALM indicator of the Probe Unit
- The MEAS indicator of CH1 is not lit and the MEAS indicator of CH2 is lit
- The countdown until the measurement completes for channel 2 is displayed on the main display part

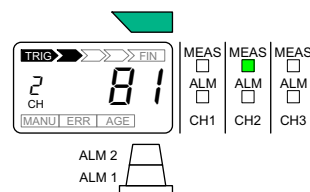

The above display example shows a case in which no alarm occurs for channel 1.

- Alarm output indicator: Green
- ALM indicator: Not lit
- ALM 1 output: OFF

(3) Measurement failed

Here, the operation when the loads of channel 1 and 2 restart unintentionally during the measurement for channel 2 is described. In such a case, the safety function activates, the measurement operation of channel 2 stops, and the measurement moves to the next channel 3.

The following parts operate simultaneously with the failure of measurement.

- The countdown until the measurement completes for channel 3 is displayed on the main display part
- ALM 1 output and ALM 2 output turn ON*
- The alarm output indicator is lit red*
- The ALM indicator of the CH2 Probe Unit is lit*
- The MEAS indicator of CH2 is not lit and the MEAS indicator of CH3 is lit

* Since the measurement value of channel 2 cannot be identified when the measurement fails, the measurement value is treated as 0 MΩ internally, and alarm judgment is performed. Although channel 1 is restarted, the measurement is already complete. Therefore, there is no change in the alarm judgment and the measurement value.

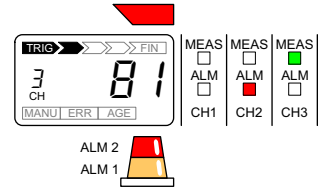

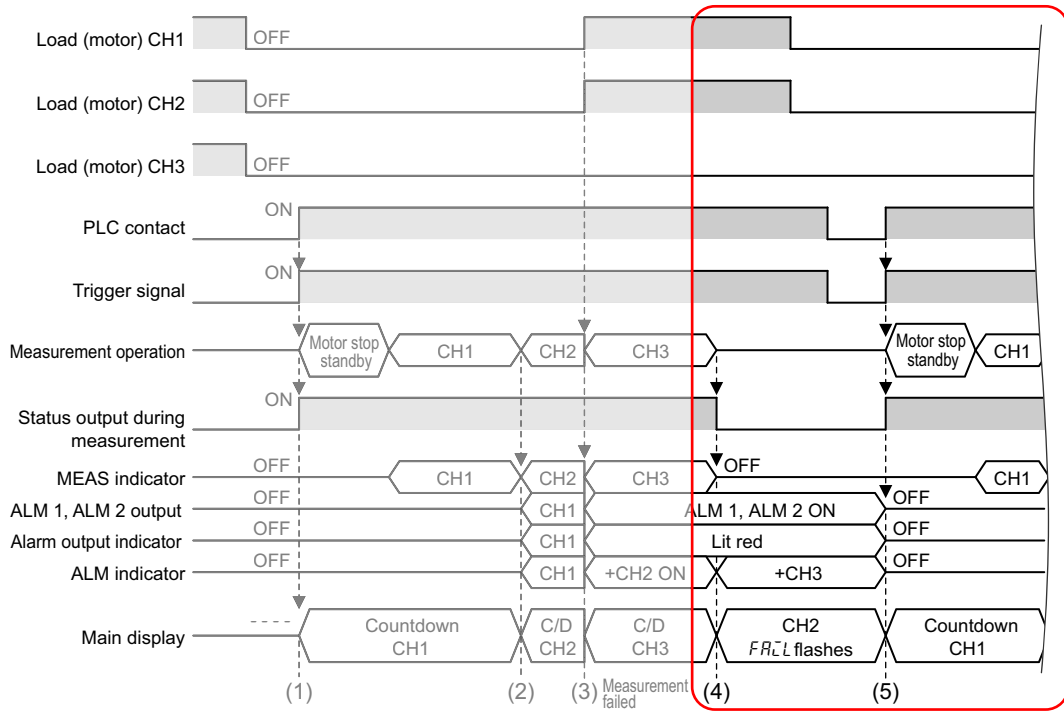

(4) Measurement end

The following parts operate simultaneously with the confirmation of the measurement value for channel 3.

- Status output during measurement turns OFF
- The results of alarm judgment for CH3 are reflected in the ALM indicator of the Probe Unit
- The MEAS indicator of CH3 turns OFF

The alarm-related output/display due to measurement failure of channel 2 are as follows:

- ALM 1/ALM 2 output are in the ON state
- The alarm output indicator turns red to indicate a critical alarm

Since there are three Probe Units, the measurement operation ends when the measurement for channel 3 ends.

The measurement results of channel 3 are displayed on the main display part. If the measurement results are referenced with the Mode Key (↻), the measurement values are displayed for channel 1 and channel 3, and *FRLL* flashes for channel 2 to indicate "measurement failed".

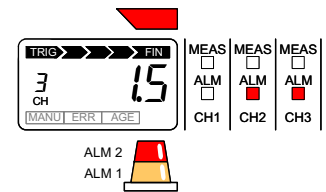

The above display example shows a case in which an alarm (critical) occurs for channel 3.

- CH3 ALM indicator: Lit
- Shown as follows due to measurement failure of channel 2
- Alarm output indicator: Red
- CH3 ALM indicator: Lit
- ALM 1 output: ON
- ALM 2 output: ON

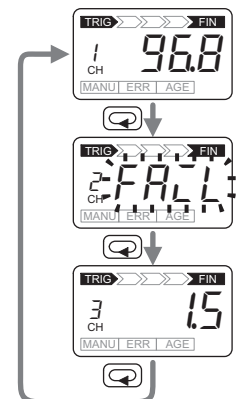

(5) Restart automatic measurement

The trigger signal turns ON when the PLC contact changes from OFF to ON, and measurement starts again.

Status output during measurement turns ON simultaneously with measurement start.

The previous measurement values, ALM 1 and ALM 2 outputs, ALM indicator of the Probe Unit, and the alarm output indicator are all cleared (turned OFF) simultaneously with measurement start.

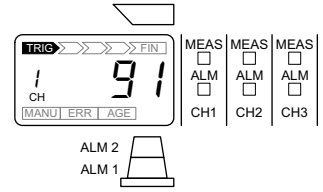

4-1-5 Measurement Value Display Automatic Scroll

If you press the Mode Key (↻) when the measurement values are confirmed, the measurement values for each channel are displayed sequentially each time the Mode Key (↻) is pressed (manual scroll).

If you press the Mode Key (↻) for at least 3 seconds, the display moves automatically every 5 seconds even without pressing the key each time (automatic scroll).

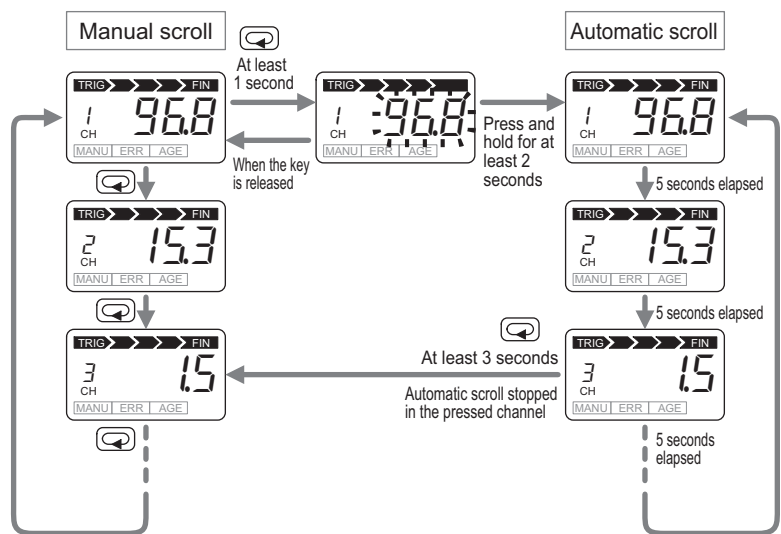

Press the Mode Key (↻) again for at least 3 seconds during automatic scroll to return to manual scroll.

During automatic scroll, the measurement results of multiple channels can be checked without operating the keys. Therefore, it can be conveniently used when checking the measurement values of multiple systems and multiple channels such as during patrolling.

If automatic scroll display is set, the automatic scroll continues until the operation for canceling automatic scroll by the Mode Key (↻) is performed. It also continues when the power is turned ON again.

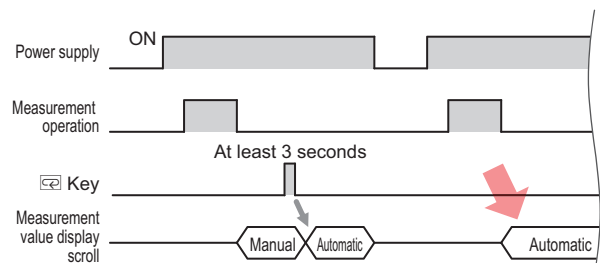

4-2 Manual Measurement

K7GE-MG is basically used in automatic measurement in synchronization with the trigger signal. In addition, K7GE-MG is also equipped with a manual measurement function which corresponds to a Megohmmeter. Manual measurement does not require a trigger signal and can be started manually and measured continuously. Therefore, it can be conveniently used at system startup and maintenance.

Differences from Automatic Measurement

The measurement operation during manual measurement does not have multiple measurement steps as in automatic measurement, and sampling is continuously performed right from the time monitoring is started.

The differences from automatic measurement are as follows:

	Automatic measurement	Manual measurement
Time of use	Normal operation	When starting the system, during maintenance
Measurement operation	Synchronous with the trigger signal	Continuous monitoring
Measurement steps	Motor stop standby/Discharge of electric charge/Waiting for stability/Sampling	None The measurement step indicator is also not required
Alarm judgment	Yes	No
Alarm output	Yes	No
Average processing of measurement values	Supported	Supported

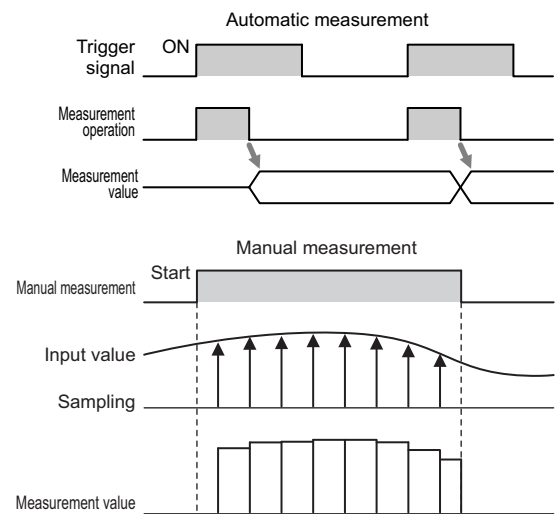

Manual measurement does not have the discharge of electric charge step. Start the K7GE-MG when the electric charge has been sufficiently discharged. If the K7GE-MG is started when some electric charge is remaining, measurement cannot be performed correctly.



Alarm judgment is not performed during manual measurement. Also, all confirmed measurement values, alarm outputs, etc. are cleared when manual measurement is started. Use it with caution.

The setting value of the Average Processing setting parameter is enabled even in manual measurement. When you perform the Average Processing setting parameter on the measurement values, the display refresh period is approximately 0.8 seconds or 6.4 seconds.

Refer to 5-9 *Average Processing* on page 5-19 for the operation method of the Average Processing setting parameter.

Starting and Ending Manual Measurement

Manual measurement can be started by pressing the Manual Measurement Key for at least 3 seconds when the channel to measure is selected in the measuring stopped* state in the Operation Level. During manual measurement, MANU indicator is lit.

* The measuring stopped state is either the measurement standby state, or the state in which a series of measurement operations are complete and the K7GE-MG is waiting for the next trigger signal ON.

Manual measurement cannot start while automatic measurement is in progress.

To be able to start manual measurement, the K7GE-MG must be in the Operation Level, and whether or not the current level is the Operation Level can be known when CH indicator is lit.

Refer to 5-1 Levels on page 5-2 for details on the levels.

Press the Manual Measurement Key for at least 1 second during manual measurement to end manual measurement.

Even if the external contact is OFF* during manual measurement, enabled trigger signals are not accepted.

Similarly, automatic measurement start by a communications command is also not accepted.

* Relationship between the external contact and trigger signal when the setting value of the Trigger Signal Reverse setting parameter is OFF.

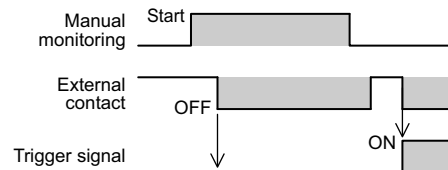
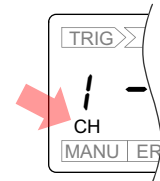
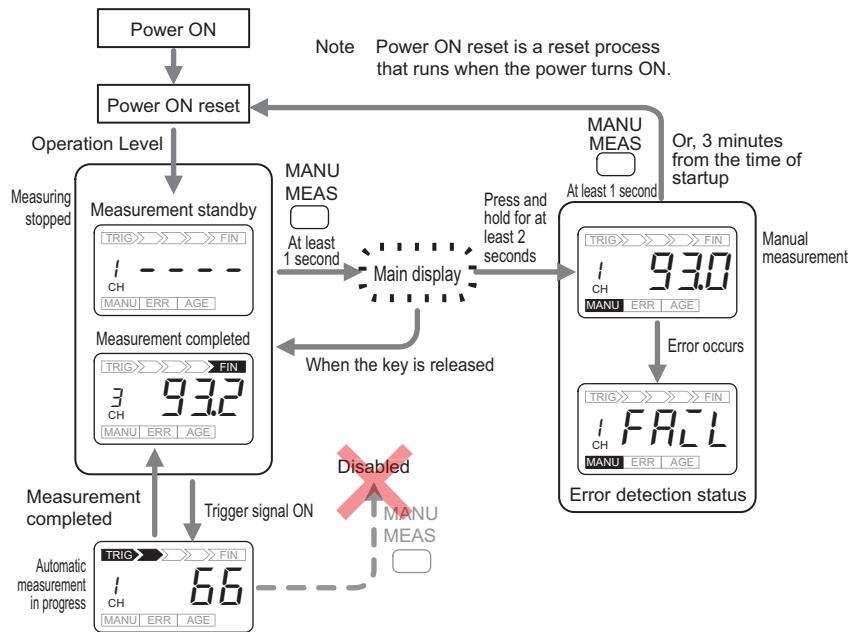

It takes a few tens of seconds for the measurement value to stabilize after the operation power supply of the K7GE-MG is turned ON. Start manual measurement after 1 minute or more has passed since the operation power supply is turned ON.

Error Detection during Manual Measurement

If a measurement error occurs during manual measurement, the application of the Megger voltage stops, FR_{LL} is displayed to indicate "measurement failed", and this state is maintained (error detection status).

The following three errors may be detected during the execution of manual measurement.

- The voltage monitoring function activates. (Load restart)
- The current limiter activates. (When the insulation resistance is extremely low, etc.)
- The Main Unit cannot recognize the Probe Unit. (Hardware error, etc.)

The K7GE-MG can be recovered from the error detection status by pressing the Manual Measurement Key for at least 1 second.

(This is also possible by the power ON reset process by pressing the Reset Key for at least 3 seconds.)

Procedure

The procedure of manual measurement is described as follows:

1. Make sure the load contactor is turned OFF.

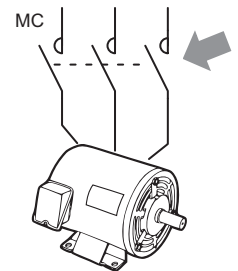

2. Make sure the electric charge accumulated in the wiring is sufficiently discharged.

- Similar to the use of a Megohmmeter, either wait for sufficient time to elapse based on your experience, or use a voltmeter to ensure that there is no residual voltage due to the electric charge.

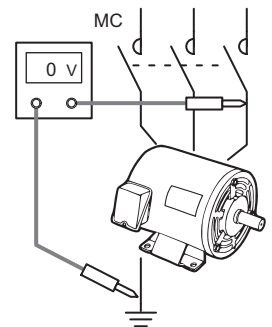

3. Make sure the K7GE-MG is in the measuring stopped state in the Operation Level.

- If automatic measurement is in progress, wait for measurement to complete.

Press the Reset Key for at least 3 seconds to forcibly end automatic measurement and return the K7GE-MG to the measuring stopped (measurement standby) state. However, all measurement values will be cleared in this case.

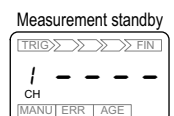

Or, measurement completed state

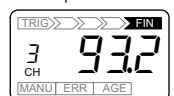

4. Select the channel to perform manual measurement.

- Press the Mode Key several times to set the channel number to perform manual measurement.

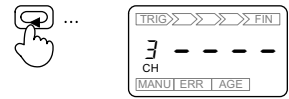

5. Manual measurement is started.

- Press the Manual Measurement Key for at least 3 seconds to start manual measurement.

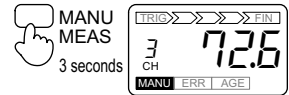

6. Wait for the measurement value to stabilize, and then read the value.

- Due to a capacity component such as the wiring, it may take some time for the measurement value to stabilize. Read the measurement value after waiting for the value to stabilize.

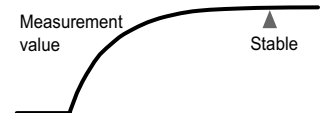

7. Manual measurement is ended.

- Press the Manual Measurement Key for 1 second to end manual measurement, and the K7GE-MG will return to measurement standby in the Operation Level. In addition, the measurement will be ended automatically 3 minutes after the start of manual measurement.

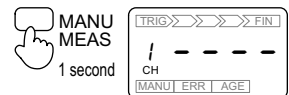

8. If necessary, perform manual measurement for the remaining channels as well.

- Repeat the process to perform manual measurement for the other channels as well, and check the measurement values.

4-3 Measuring Range and Measuring Accuracy

The measuring range is between 0.1 and 99.9 MΩ.

The alarm judgment is treated as 0 MΩ for inputs less than 0.1 MΩ and as 99.9 MΩ for inputs greater than 99.9 MΩ.

The display shows 0.0 for inputs less than 0.1 MΩ and flashes 99.9 for inputs greater than 99.9 MΩ.

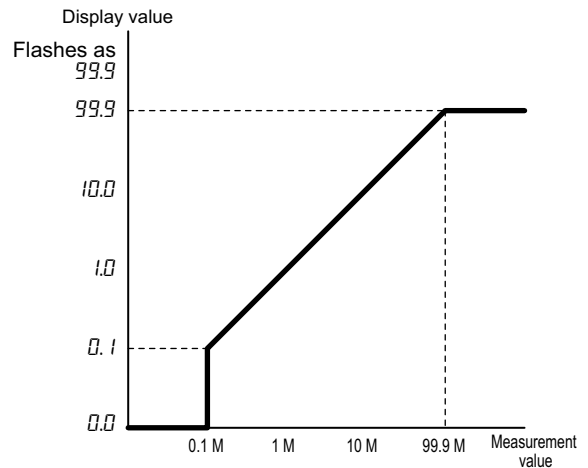

The measuring accuracy is as follows:

$\pm 5\%$ rdg. ± 1 digit (at ambient temperature -10 to 55°C and ambient humidity 25% to 65%)

"rdg." is the abbreviation for "reading" and refers to the read value (displayed numeric value). $\pm 5\%$ rdg. indicates the following range:

$(\text{Read value}) \times (1 - 0.05)$ to $(\text{Read value}) \times (1 + 0.05)$

"digit" is the minimum resolution of the read value. In the K7GE-MG, the minimum resolution of the read value is 0.1 MΩ. Therefore, ± 1 digit becomes ± 0.1 MΩ.

Thus, for example, if the read value is assumed to be 10.0, the upper and lower limit values will become as follows.

Lower limit value: $10.0 \times (1 - 0.05) - 0.1 = 9.4$ MΩ

Upper limit value: $10.0 \times (1 + 0.05) + 0.1 = 10.6$ MΩ.

That is, the true value will be in the range of 9.4 to 10.6 MΩ.

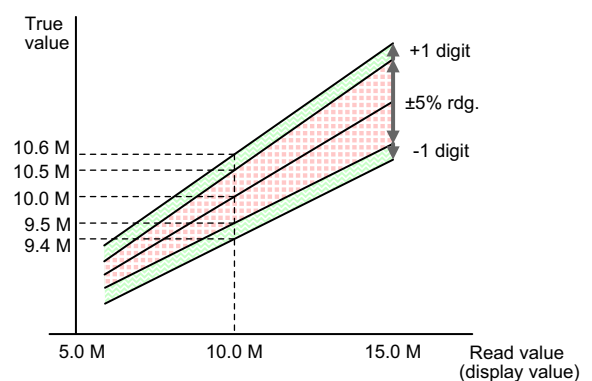

4-4 Voltage Monitoring

The voltage in the load lines is monitored to determine whether the load is turned ON or turned OFF. This monitoring is performed at all times, and even when the trigger signal is ON or when the K7GE-MG moves to manual measurement, the measurement operation is not started if the load is turned ON. Also, even if measurement is progressing normally, it immediately stops if the load is turned ON during the measurement.

If the load is determined to be turned ON following trigger signal ON, it results in "measurement failed", and the alarm output turns ON. Refer to *Timing Chart for Measurement Failure* on page 4-12 in 4-1-4 *Timing Charts* on page 4-8 for information on the operation when measurement fails.

Next, the judgment conditions for the voltage monitoring function are described.

The voltage value and voltage waveform differ depending on the type of load and the drive method. To detect the waveform, the K7GE-MG monitors the peak value of the waveform.

The threshold value is set as approx. 20 V, and if the absolute value of the peak value is larger than this, it is judged that voltage is present (load turned ON), and if it is smaller than this, it is judged that voltage is absent (load turned OFF).

Therefore, this function is also applicable to loads having a 24 VDC drive.

Moreover, in the case of alternating current waveforms such as sine waves, thyristor control, and inverter control, a frequency of 20 Hz or more is required. For a frequency lower than 20 Hz, it takes too much time from the detection of a waveform until the detection of the next waveform, and it may be judged that voltage is absent (load turned OFF).

The highest voltage that can be monitored is 600 VAC rms (+10%) of sine waves or commercial frequencies.

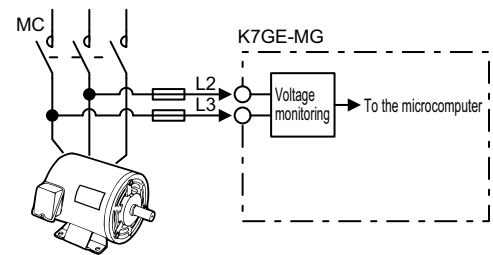

Note The above diagram shows only the parts of the internal circuit of the K7GE-MG that are necessary for explanation.

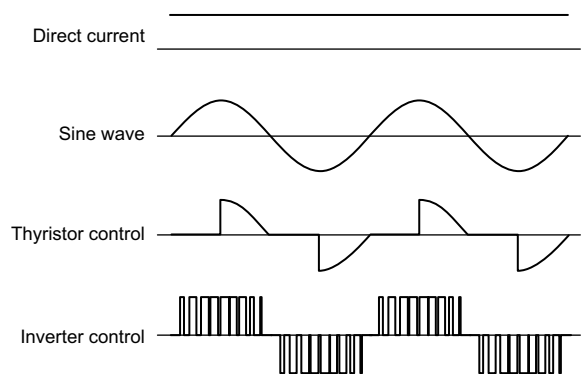

4-5 Current Limiter

This function is used to limit the current flowing through a path to a fixed value (under 3 mA) when applying a Megger voltage.

Due to the flow of overcurrent in the measurement path, the load and the peripheral equipment, as well as the internal circuit of the K7GE-MG may be damaged. Therefore, the overcurrent is limited with the current limiter function. The current limiter of the K7GE-MG is composed of analog components having few delay elements. Therefore, the response speed is extremely fast (μ -second order), and the overcurrent can be instantly suppressed.

Next, the cases when the current limiter activates are described.

In the normal state, the measurement current returns to the measurement circuit of the K7GE-MG via the insulation resistance of the load.

Since the Megger voltage of the K7GE-MG is 50 VDC and the lower limit value of the measuring range is 0.1 M Ω , the maximum value of the measurement current is $50 \text{ V} \div 0.1 \text{ M}\Omega = 0.5 \text{ mA}$.

Therefore, the current limiter does not activate if measurement can be performed normally.

The current limiter activates in the following three types of cases.

● When the Insulation Resistance is Extremely Low

When the contactor turns OFF, the load and power line properly turn OFF and the measurement current also passes through the insulation resistance, but the insulation resistance itself is extremely low. For example, when the motor coil is in a metallic case and a short-circuit state.

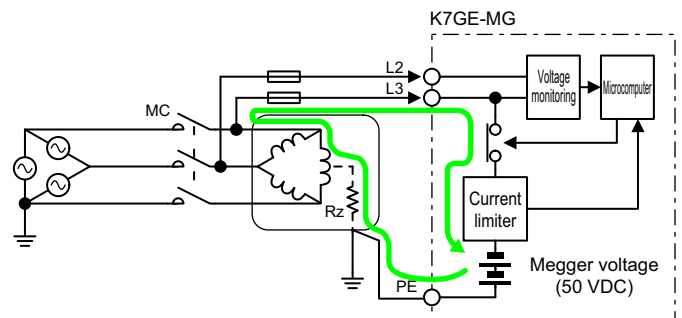

Note The above diagram shows only the parts of the internal circuit of the K7GE-MG that are necessary for explanation.

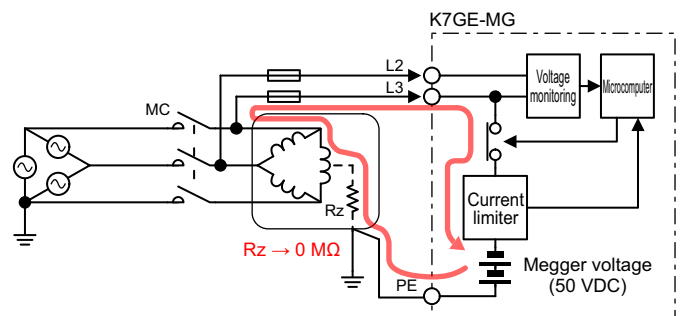

Note The above diagram shows only the parts of the internal circuit of the K7GE-MG that are necessary for explanation.

● When the Load Restarts

If the load restarts when applying a Megger voltage, the voltage of the power supply for driving the load is applied between L3 and PE in the figure shown on the right. If a current limiter is not present, a large short-circuit current will flow via the Megger voltage generation circuit of the K7GE-MG.

In such a case, the voltage monitoring function activates due to the generation of line voltage. However, because of the intervening software, an instantaneous response of μ -second order cannot be performed. Until that time, the overcurrent is limited by the current limiter.

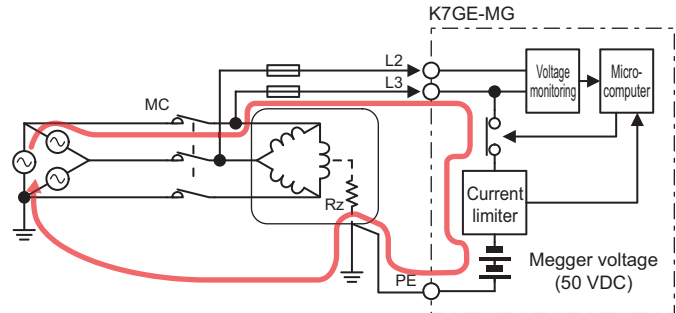

Note The above diagram shows only the parts of the internal circuit of the K7GE-MG that are necessary for explanation.

● When the Drive Voltage Becomes Zero While the Contactor is ON

In this case, the line voltage is zero. Therefore, the voltage monitoring function judges that the load is turned OFF.

If the Megger voltage is applied even though the line voltage is zero, the current flows in a path as shown in the figure on the right without passing through the insulation resistance of the load. If a current limiter is not present, a short-circuit current will flow.

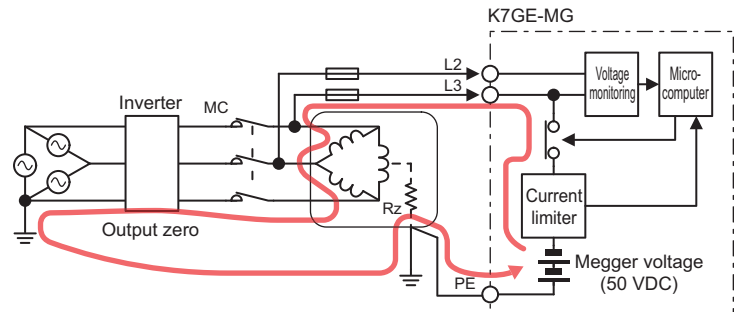

Note The above diagram shows only the parts of the internal circuit of the K7GE-MG that are necessary for explanation.

In either case, the current limiter will be operated immediately to avoid hazardous situations. If the current limiter operates, the K7GE-MG immediately stops measuring and is cut off from the load, similar to the voltage monitoring function.

Also, even when the current limiter activates, "measurement failed" occurs, and the alarm output turns ON. Refer to *Timing Chart for Measurement Failure* on page 4-12 in 4-1-4 *Timing Charts* on page 4-8 for information on the operation when measurement fails.

4-6 Reset Key

Press the Reset Key in the Operation Level for at least 3 seconds to perform the power ON reset process and return to the default.

The defined measurement values, alarm outputs, and alarm output indicator are all cleared.

Even if automatic measurement is in progress, pressing the Reset Key will force the measurement to end. The same applies to manual measurement.

This key can also be used to clear the alarm output after checking its status at the work site during the occurrence of an alarm.

Also, if there are many channels, it takes around 10 minutes from the start till the end of automatic measurement, but if automatic measurement is started unintentionally, this key can be used to stop it immediately.

The reset operation can also be executed by a communications command.



The Reset Key is disabled in the Initial Setting Level, Communications Setting Level, and Protect Level. Use it with caution.

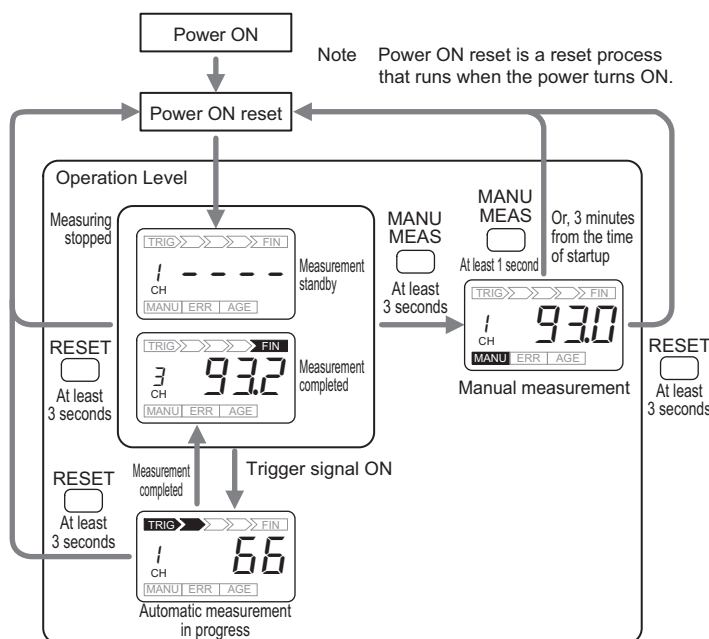

4-7 System Error

A system error is an error which causes the K7GE-MG to be unable to perform the functions that it was primarily meant to perform.

In a normal state in which a system error does not occur, self-diagnosis error output is turned ON, but due to the occurrence of a system error, the self-diagnosis error output is turned OFF, and an external notification is sent.

The display and output when a system error occurs are as follows:

	Name	Operation
Main Unit	Main display	8888 is lit
	ERR indicator	Lit
	Self-diagnosis error output	OFF (normally ON)
	ALM 1 and ALM 2 output	All OFF
	Alarm output indicator	Not lit
	LVL/CH display	Not lit
	Other indicators	All not lit
Probe Unit	MEAS indicator ALM indicator	Not lit
	Discharge of electric charge	Stops
	Apply Megger voltage	Stops

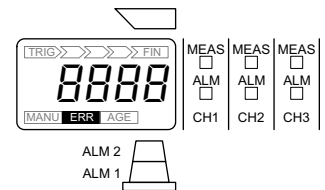

A system error occurs due to the following two causes.

- Duplication of the channel numbers of Probe Units
- Hardware failure

If a system error occurs, first of all, make sure that there is no duplication of the channel numbers of Probe Units. If the same channel number is set, correct it and turn ON the power again. If the K7GE-MG can be started normally, you can use it in this condition.

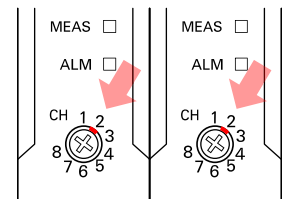

If the channel numbers are not duplicated, a hardware failure has occurred. Contact your OMRON representative for repairs.

4-8 Running Time

The K7GE-MG has a built-in electrolytic capacitor. The electrolytic capacitor is impregnated with electrolytic solution that starts to penetrate the sealing rubber from the time of manufacture. As time elapses, the internal electrolytic solution continues to evaporate, resulting in decreased electrostatic capacity and deterioration in other characteristics. Over time, the characteristic deterioration of the electrolytic capacitor prevents the K7GE-MG from being utilized to its full capacity.

The running time function calculates the approximate time until the K7GE-MG stops functioning at its full capacity due to the deterioration of the electrolytic capacitor characteristics, based on the calculated level of deterioration.

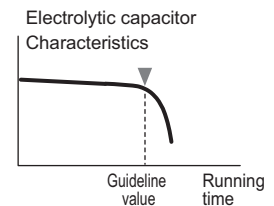

AGE indicator will light when the time for the K7GE-MG to stop functioning is reached. You can use this function as a guideline for K7GE-MG replacement.

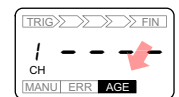

The Running Time function can be selected from the Use Running Time setting parameter. The default value is OFF (not used). Refer to *5-10 Use Running Time* on page 5-21 for the procedure of the Use Running Time setting parameter.

Regardless of the setting value of the Use Running Time setting parameter, the communications commands can read the current running time as a proportion of the guideline value.



The running time function provides an indication of when the deterioration of the electrolytic capacitor will prevent the K7GE-MG functioning at its full capacity. It does not provide information on failures occurring due to other causes.

4-9 Calculating the Measuring Time Using the Elapsed Time

The measuring time calculated function calculates the measured time using the clock of the host system.

The K7GE-MG is not equipped with a clock, but you can use this function to know indirectly the measurement time.

As soon as the measurement starts by trigger signal ON, the stopwatch inside the K7GE-MG starts ticking. After the measurement is complete and the measurement value is confirmed, the Elapsed Time is read by the communications command, and the elapsed time of the stopwatch at the time of reception of the communications command is returned. In the host system, the read elapsed time is subtracted from the time of execution of the command by the clock function of the host system, and is set as the time of measurement of the measurement value.

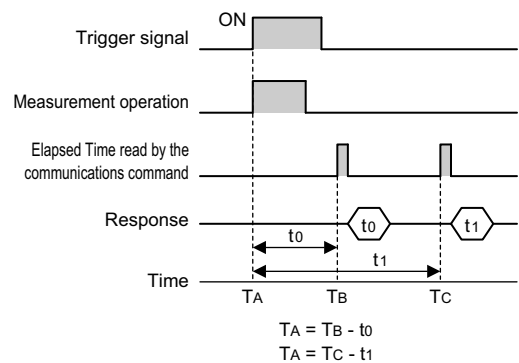

If the K7GE-MG has many measurement channels, it takes approximately 10 minutes from the trigger signal ON to the completion of measurement. This function calculates the time when the trigger signal is ON. Therefore, you can know the approximate measurement time, not the measurement time for each channel.

The time calculated by the stopwatch is reset to start by the following trigger signal ON. Read the Elapsed Time before performing the following operations. If the Elapsed Time is read after performing these operations, undefined numerical values will be read.

- Moving to other than the Operation Level
- Starting manual measurement
- Operating the Reset Key
- Resetting the software with communications command execution

We recommend reading the measurement value and the elapsed time at the same time, otherwise an undefined value may be read.



The elapsed time can be read only by a communications command.

5

Using Setting Parameters

This section describes the K7GE-MG setting parameters.

5-1	Levels	5-2
5-2	Setting Parameters and Setting Values	5-4
5-3	Maximum Number of Channels	5-6
5-4	Alarm Values 1 and 2	5-9
5-5	Alarm Polarity	5-11
5-6	Trigger Signal Reverse	5-13
5-7	Motor Stop Waiting Time	5-15
5-8	Time to Wait to Stabilize	5-17
5-9	Average Processing	5-19
5-10	Use Running Time	5-21
5-11	Software Version	5-23
5-12	Setting Change Protection	5-24
5-13	Communications Setting Parameters	5-26

5-1 Levels

The setting items are grouped into "levels".
 Levels are divided into four types for the K7GE-MG.

Level	Measurement operation	Description
Operation	Possible	Normal operation state in which measurement operation is performed when a trigger signal is received. This is the level immediately after the power is turned ON. The alarm results are reflected in the display, output, and communications status at this level only. At other levels, all alarm results are OFF.
Initial Setting	Stops	Make initial settings such as alarm values and motor stop waiting time. At this level, measurement operation is not performed even if a trigger signal is received.
Communications Setting	Stops	Make initial settings related to communications, such as the protocol and baud rate. At this level, measurement operation is not performed even if a trigger signal is received.
Protect	Stops	Make settings to prevent unintentional key operations. At this level, measurement operation is not performed even if a trigger signal is received.

The LVL/CH display shows a level when LVL is lit and a channel number when CH is lit.

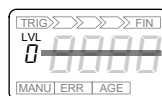

Characters	Level
<i>i</i> CH	Operation
LVL- <i>0</i>	Initial Setting
LVL <i>i</i>	Communications Setting
LVL <i>p</i>	Protect

Note The Operation Level characters "1CH" is an example of when the channel number is 1.

● **Moving to the Protect Level**

At the Operation Level, the main display part starts to flash when the Level Key and Mode Key together (□ + ↻) are pressed for at least 1 second. Press and hold down the keys for at least 2 seconds to move to the Protect Level. To return to the Operation Level, press the Level Key and Mode Key together (□ + ↻) for at least 1 second.

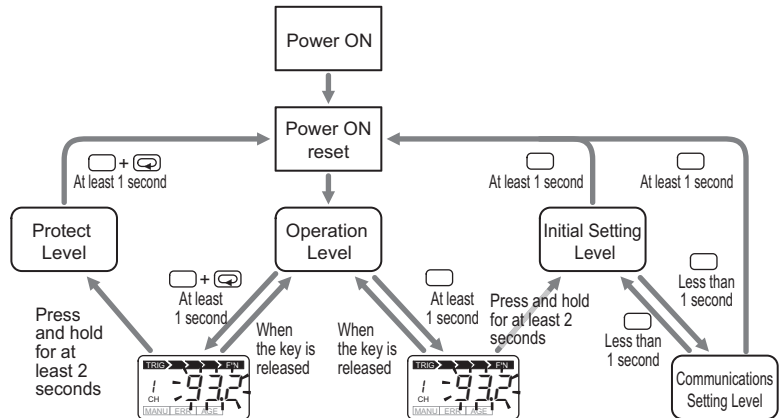

Note Power ON reset is a reset process that runs when the power turns ON.

● **Moving to the Initial Setting Level**

At the Operation Level, the main display part starts to flash when the Level Key (□) is pressed for at least 1 second. Press and hold down the keys for 2 more seconds to move to the Initial Setting Level. To return to the Operation Level, press the Level Key (□) for at least 1 second.

● **Moving to the Communications Setting Level**

Press the Level Key (□) at the Initial Setting Level (for less than 1 second) to move to the Communications Setting Level. To return to the Initial Setting Level, press the Level Key (□) (for less than 1 second). To return to the Operation Level, press the Level Key (□) for at least 1 second.

After returning from any level to the Operation Level, the power ON reset process is always executed to clear all measurement values and alarm outputs and return to the measurement standby state.

5-2 Setting Parameters and Setting Values

The setting items for each level are called "setting parameters".

The setting parameters can be moved with the Mode Key (⇨).

The value set for each setting parameter is called the "setting value".

The state where the setting values are displayed is called the "monitoring state", and the state where they can be changed is called the "setting change state".

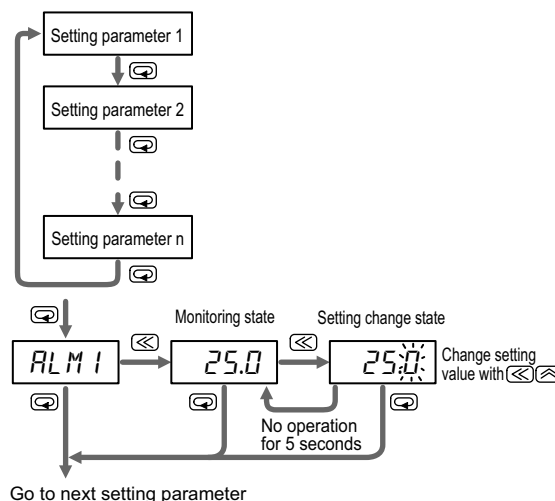

Use the following operations to display or change the setting values.

1. Press the Mode Key several times to display the setting parameter to change.

- The setting parameter characters are displayed on the main display part.



2. Press the Shift Key to enter the monitoring state.

- The setting value is displayed.
- If you only want to check the setting value, press the Mode Key to move to the next setting parameter.



3. Press the Shift Key again to move to the setting change state.

- The value that can be changed starts flashing.



4. Use the Shift Key and Up Key to change the setting value.

- If no key operation is performed for 5 seconds, the setting value is saved and the system returns to the monitoring state.



5. Use the Mode Key to save the setting value.

- The changed setting value is saved in the internal memory.

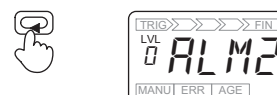

The following figure gives an overall image of the setting parameters.

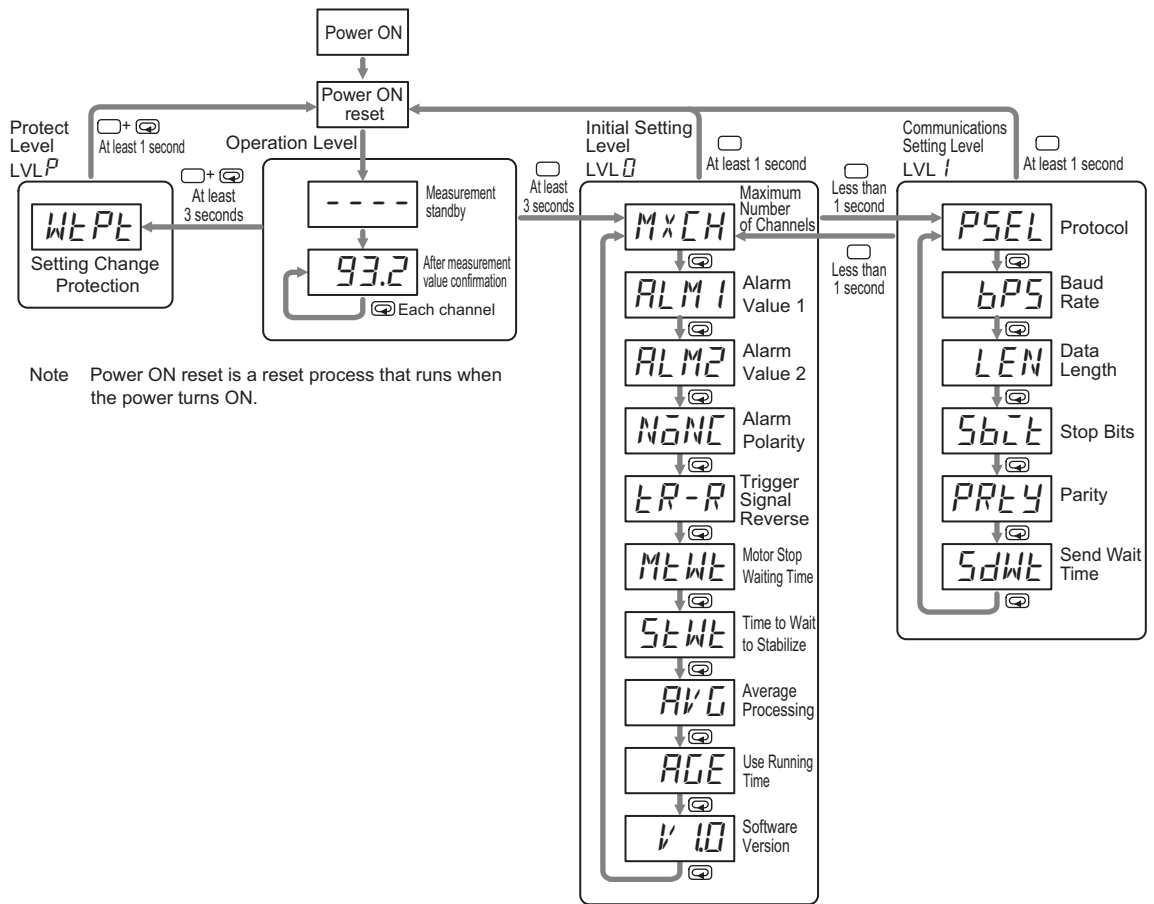

When moving to a level other than the Operation Level, the ALM 1 and ALM 2 output contacts turn OFF, regardless of the setting value of the Alarm Polarity setting parameter.

 When set to normally close, turning the output OFF has the same meaning as an alarm to external devices. As an example of a countermeasure to this, provide a switch that can short-circuit the output contacts of the ALM 1 and ALM 2 outputs, and use it to short-circuit the contacts during setting parameter operations and to release the short circuit after returning to the Operation Level.

5-3 Maximum Number of Channels

Level	Characters	Range of setting values	Default value	Description
Initial Setting	<i>MxEH</i>	1 to 8 (CH)	1	Total number of channels

Set the total number of channels (number of Probe Units connected to the Main Unit). This information is used for processing in the case of a measurement failure when the Main Unit can no longer recognize the Probe Units due to a malfunction, etc.

The following describes the relationship between the setting value of the Maximum Number of Channels setting parameter and the measurement operation using an example of three connected Probe Units.

Case 1 (normal operation 1)

- The channel number setting of each Unit is channel 1, 2, and 3 from the left. The maximum number of channels setting value is 3.
- This is a normal operation pattern. Measures sequentially from channel 1 to channel 3 and then ends the measurement operation.

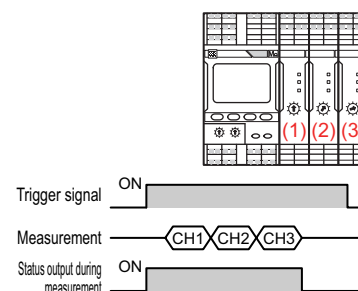

Case 2 (normal operation 2)

- The channel number setting of each Unit is channel 2, 1, and 3 from the left. The maximum number of channels setting value is 3.
- This is a normal operation, in the same way as case 1. However, it measures the channel numbers in ascending order.

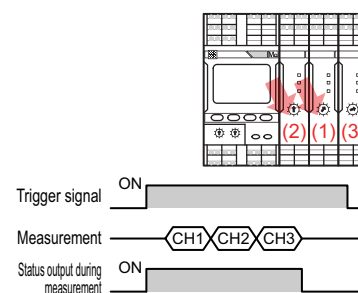

Case 3 (measurement failed due to a malfunction)

- The channel number setting of each Unit is channel 1, 2, and 3 from the left. The maximum number of channels setting value is 3. The Main Unit cannot recognize channel 2 due to a malfunction.

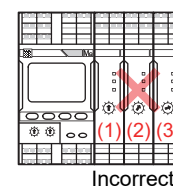

- Channel 2 measurement fails and channel 3 measurement continues.

When the measurement values are displayed after the measurements are complete, channel 2 appears as *FRLL*. As the measurement value of channel 2 is deemed to be 0 MΩ internally, the ALM 1 and ALM 2 outputs turn ON* and the alarm output indicator turns red.

* If the setting value of the Alarm Polarity setting parameter is n-c (normally close), the alarm outputs turn ON and the output transistor contacts turn OFF.

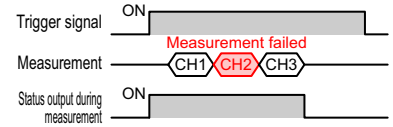

Case 4 (set channel number and setting value of the maximum number of channels do not match)

- The channel number setting of each Unit is channel 2, 3, 4 from the left.
The maximum number of channels setting value is 3.
- Measurement failed because channel 1 does not exist.
Channel 4 is not measured because the maximum number of channels setting value is 3.

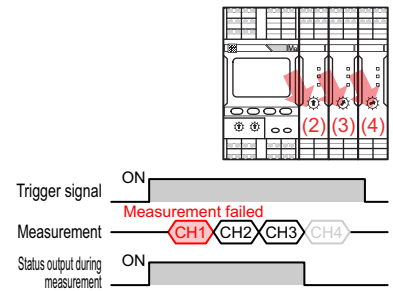

The operation procedure for the Maximum Number of Channels setting parameter is shown as follows:

Procedure

1. Press the Level Key for at least 3 seconds in the Operation Level to move to the Initial Setting Level.

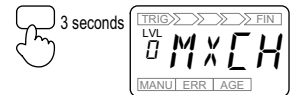

- The LVL/CH display will indicate \square , and the LVL indicator will light to show that the Initial Setting Level has been entered.
The *MxCH* setting parameter is displayed on the main display part.

2. Press the Shift Key to enter the monitoring state.



- The setting value is displayed.

3. Press the Shift Key again to move to the setting change state.



- The value that can be changed starts flashing.

4. Use the Up Key to change the setting value.



5. Press the Mode Key to move to the next setting parameter.

- The changed setting value is saved in the internal memory.



6. Press the Level Key for at least 1 second to return to the Operation Level.

- The LVL/CH display will indicate *i*, and the CH indicator will light to show that the Operation Level has been entered.
- - - - indicates measurement standby.



1 second

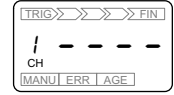

5-4 Alarm Values 1 and 2

Level	Characters	Range of setting values	Default value	Description
Initial Setting	ALM1	0.0 to 99.9 (MΩ)	20.0	ALM 1 output alarm threshold value (warning)
	ALM2	0.0 to 99.9 (MΩ)	1.0	ALM 2 output alarm threshold value (critical)

Set the ALM 1 output and ALM 2 output alarm threshold values. Set the warning level value as Alarm Value 1 and the critical level value as Alarm Value 2.

If there are rules in the company, set that value in alarm value 2. Set alarm value 1 to a value between the normal value that is known from daily inspections and alarm value 2.

If there are no rules in the company, set alarm value 2 to 1 MΩ, which is generally regarded as the error threshold in IEC 60034-1 and by motor manufacturers. Set alarm value 1 to a value between the normal value that is known from daily inspections and alarm value 2.

Alarm value 1 is a single value common for all channels. Similarly, alarm value 2 is a single value common for all channels.

If the measurement value becomes equal to or less than alarm value 1, the ALM 1 output turns ON* and the alarm output indicator turns yellow. If the value becomes equal to or less than alarm value 2, the ALM 2 output turns ON and the alarm output indicator turns red.

* If the setting value of the Alarm Polarity setting parameter is n-c (normally close), the alarm outputs turn ON and the output transistor contacts turn OFF.

It is possible to reverse the alarm value 1 and alarm value 2 settings, but note that the alarm output indicator will not turn yellow in this case.

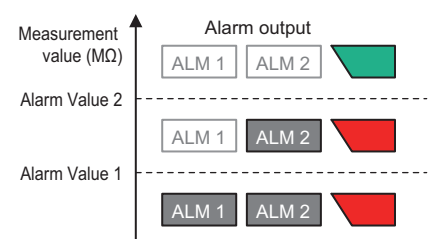
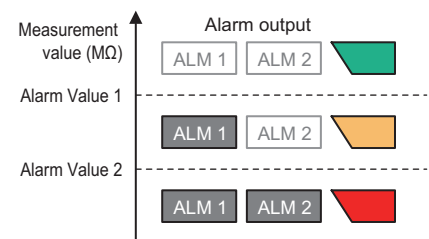

The operation procedure for the Alarm Value 1 setting parameter is shown as follows:

Procedure

1. Press the Level Key for at least 3 seconds in the Operation Level to move to the Initial Setting Level.

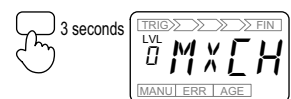

- The LVL/CH display will indicate \square , and the LVL indicator will light to show that the Initial Setting Level has been entered.

2. Press the Mode Key several times to display *ALM 1*.



3. Press the Shift Key to enter the monitoring state.



- The setting value is displayed.

4. Press the Shift Key again to move to the setting change state.



- The value that can be changed starts flashing.

5. Use the Up Key and Shift Key to change the setting value.

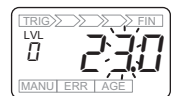

6. Press the Mode Key to move to the next setting parameter.



- The changed setting value is saved in the internal memory.

7. Press the Level Key for at least 1 second to return to the Operation Level.

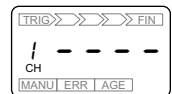

- The LVL/CH display will indicate *I*, and the CH indicator will light to show that the Operation Level has been entered.
 - - - - indicates measurement standby.

Follow the same procedure for alarm value 2.

5-5 Alarm Polarity

Level	Characters	Range of setting values	Default value	Description
Initial Setting	<i>NONE</i>	n-o/ n-c	n-c	ALM 1 alarm output and ALM 2 alarm output polarity n-o (normally open)/n-c (normally close)

Set whether to turn the alarm output contacts ON or OFF during normal operation.

Alarm Polarity is a setting parameter common for ALM 1 output and ALM 2 output.

If the setting value is set to n-o (normally open), the output contacts are OFF during normal operation. If it is set to n-c (normally close), the output contacts are ON. That is, when the alarm output turns ON (alarm occurs), the output contacts turn ON if the setting value is n-o or OFF if the setting value is n-c.

When the K7GE-MG power is turned OFF, the output contacts turn OFF regardless of the alarm polarity setting value. The difference between normally open and normally close is not only that the logic is reversed when an alarm occurs. When selecting them, also consider whether to handle turning the output contacts OFF when the power is unintentionally turned OFF in the same way as when no alarm occurs, or as when an alarm occurs.

Note that the output contacts turn OFF regardless of the alarm polarity setting value, not only when the K7GE-MG power is turned OFF, but also when the K7GE-MG is moved to a level other than the Operation Level, or when a system error occurs.

	Output contacts ON	Output contacts OFF
Normally open	When an alarm occurs	When no alarm occurs During Power OFF Other than the Operation Level When a system error occurs
Normally close	When no alarm occurs	When an alarm occurs During Power OFF Other than the Operation Level When a system error occurs

The operation procedure for the Alarm Polarity setting parameter is shown as follows:

Procedure

1. Press the Level Key for at least 3 seconds in the Operation Level to move to the Initial Setting Level.

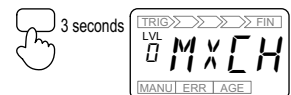

- The LVL/CH display will indicate *MxCH*, and the LVL indicator will light to show that the Initial Setting Level has been entered.

2. Press the Mode Key several times to display *NONE*.



3. Press the Shift Key to enter the monitoring state.

- The setting value is displayed.

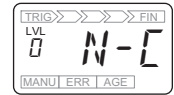

4. Press the Shift Key again to move to the setting change state.

- The value that can be changed starts flashing.

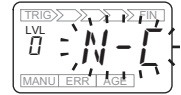

5. Use the Up Key to change the setting value.

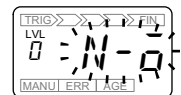

6. Press the Mode Key to move to the next setting parameter.

- The changed setting value is saved in the internal memory.

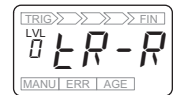

7. Press the Level Key for at least 1 second to return to the Operation Level.

- The LVL/CH display will indicate *l*, and the CH indicator will light to show that the Operation Level has been entered.
 - - - - indicates measurement standby.



1 second

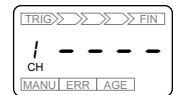

5-6 Trigger Signal Reverse

Level	Characters	Range of setting values	Default value	Description
Initial Setting	$\bar{L}R-R$	OFF/ON	OFF	External contact ON/OFF logic that turns the trigger signal ON

In the K7GE-MG, automatic measurement starts when the trigger signal turns ON.

Trigger Signal Reverse sets whether the external contacts connected to the trigger input terminals turning OFF is treated as trigger signal ON (enabled), or the external contacts turning ON is treated as trigger signal ON.

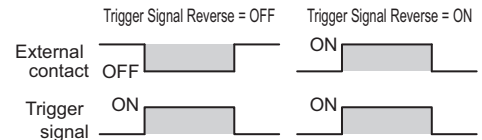

The operation procedure for the Trigger Signal Reverse setting parameter is shown as follows:

Procedure

1. Press the Level Key for at least 3 seconds in the Operation Level to move to the Initial Setting Level.



- The LVL/CH display will indicate \bar{L} , and the LVL indicator will light to show that the Initial Setting Level has been entered.

2. Press the Mode Key several times to display $\bar{L}R-R$.



3. Press the Shift Key to enter the monitoring state.



- The setting value is displayed.

4. Press the Shift Key again to move to the setting change state.



- The value that can be changed starts flashing.

5. Use the Up Key to change the setting value.



6. Press the Mode Key to move to the next setting parameter.



- The changed setting value is saved in the internal memory.

7. Press the Level Key for at least 1 second to return to the Operation Level.



- The LVL/CH display will indicate I , and the CH indicator will light to show that the Operation Level has been entered.
---- indicates measurement standby.

5-7 Motor Stop Waiting Time

Level	Characters	Range of setting values	Default value	Description
Initial Setting	<i>MEWL</i>	0 to 299 (s)	10	Wait time for the load to completely stop after trigger signal ON

Set the wait time from trigger signal ON until the measurement operation starts.

If the auxiliary contact of the contactor that turns ON/OFF the power of the load is connected to the trigger input terminal, the trigger signal for measurement start can be easily created. However, since the auxiliary contact is linked to the contactor, the trigger signal turns ON at the time when the contactor turns OFF.

If the load is a motor, it does not stop immediately when it is disconnected from the power, but stops gradually in due course of time by slowing down. A line voltage is generated during the time the motor is rotating, therefore, even if the trigger signal turns ON, it is necessary to wait for the measurement to stop completely.

The time until the stop of the motor varies depending on the size of the motor and the inertia of the equipment being driven. Therefore, first measure the time for the motor to be measured to completely stop. Add some margin to that time to calculate the setting value of the motor stop waiting time.

When measuring multiple channels, determine the setting value from the motor that takes the longest time to come to a complete stop.

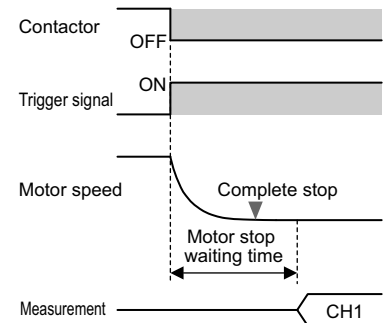
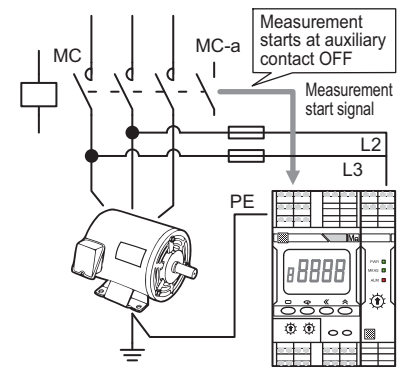

The operation procedure for the Motor Stop Waiting Time setting parameter is shown as follows:

Procedure

1. Press the Level Key for at least 3 seconds in the Operation Level to move to the Initial Setting Level.

- The LVL/CH display will indicate $\bar{0}$, and the LVL indicator will light to show that the Initial Setting Level has been entered.

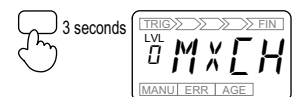

2. Press the Mode Key several times to display *MEWL*.



3. Press the Shift Key to enter the monitoring state.

- The setting value is displayed.



4. Press the Shift Key again to move to the setting change state.

- The value that can be changed starts flashing.



5. Use the Up Key and Shift Key to change the setting value.



6. Press the Mode Key to move to the next setting parameter.

- The changed setting value is saved in the internal memory.

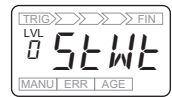

7. Press the Level Key for at least 1 second to return to the Operation Level.

- The LVL/CH display will indicate *l*, and the CH indicator will light to show that the Operation Level has been entered.
 - - - - indicates measurement standby.



1 second

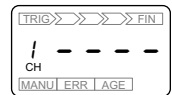

5-8 Time to Wait to Stabilize

Level	Characters	Range of setting values	Default value	Description
Initial Setting	SEWE	0 to 99 (s)	60	Wait time for the measurement value to stabilize after the Megger voltage is applied

Set the time for the measurement value to stabilize after the Megger voltage is applied.

Due to the parasitic capacitance component between the load including the wiring from the contactor and the ground, it may take some time for the measurement value to reach its final value after the Megger voltage is applied. To adopt the stable final value as the measurement value, the measurement is performed after the Time to Wait to Stabilize elapses.

As measurements are performed sequentially on each channel in the case of multiple channels, the wait time for stabilization occurs for each channel.

As the Time to Wait to Stabilize setting parameter is a single value common for all channels, if the stabilization time differs according to the load, determine the setting value from the load that requires the longest time to stop.

Since some motor manufacturers recommend using a value of "1 minute" for Megohmmeter measurements, the default value is set to 60 seconds for the K7GE-MG. In most cases, the default value can be used. However, change the setting value according to the situation if stabilization takes more time due to a long wiring run to the contactor, or conversely, if you want to shorten the measurement time because the value stabilizes immediately.

The operation procedure for the Time to Wait to Stabilize setting parameter is shown as follows:

Procedure

1. Press the Level Key for at least 3 seconds in the Operation Level to move to the Initial Setting Level.

- The LVL/CH display will indicate \square , and the LVL indicator will light to show that the Initial Setting Level has been entered.

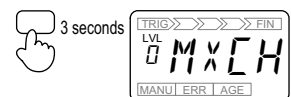

2. Press the Mode Key several times to display SEWE.

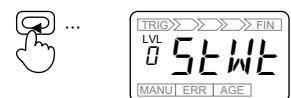

3. Press the Shift Key to enter the monitoring state.

- The setting value is displayed.

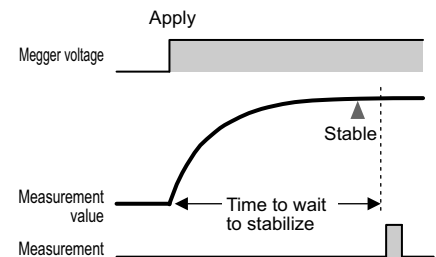

4. Press the Shift Key again to move to the setting change state.

- The value that can be changed starts flashing.



5. Use the Up Key and Shift Key to change the setting value.



6. Press the Mode Key to move to the next setting parameter.

- The changed setting value is saved in the internal memory.



7. Press the Level Key for at least 1 second to return to the Operation Level.

- The LVL/CH display will indicate *l*, and the CH indicator will light to show that the Operation Level has been entered.
 - - - - indicates measurement standby.



1 second

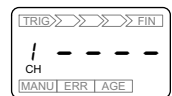

5-9 Average Processing

Level	Characters	Range of setting values	Default value	Description
Initial Setting	AVG	OFF/ON	OFF	Select whether or not to perform average processing on measurement values OFF (no average processing)/ON (with average processing)

Set whether or not to perform average processing on the measurement values.

When the setting value is ON (with average processing), the average value of eight measurements is adopted as the measurement value. As each measurement takes approx. 0.8 seconds, eight measurements take approx. 6.4 seconds.

Use this setting if external noise causes the measurement values to be unstable even after the time to wait to stabilize elapses.

You can determine whether or not average processing is necessary by using the manual measurement function installed in the K7GE-MG. As the average processing setting is also applied to manual measurement, determine the setting according to whether there is a difference in the stability of the manual measurement values when the average processing setting value is set to ON and OFF.

The operation procedure for the Average Processing setting parameter is shown as follows:

Procedure

1. Press the Level Key for at least 3 seconds in the Operation Level to move to the Initial Setting Level.

- The LVL/CH display will indicate \square , and the LVL indicator will light to show that the Initial Setting Level has been entered.



2. Press the Mode Key several times to display AVG.



3. Press the Shift Key to enter the monitoring state.

- The setting value is displayed.

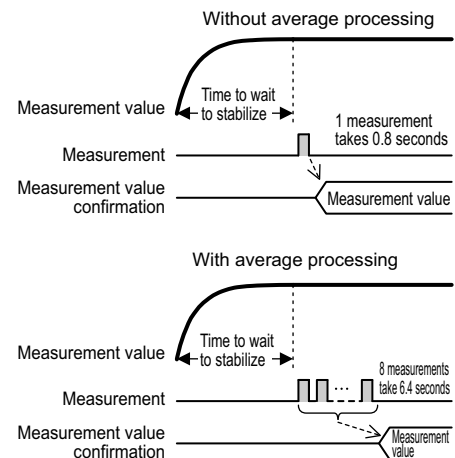

4. Press the Shift Key again to move to the setting change state.

- The value that can be changed starts flashing.



5. Use the Up Key to change the setting value.

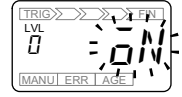

6. Press the Mode Key to move to the next setting parameter.

- The changed setting value is saved in the internal memory.



7. Press the Level Key for at least 1 second to return to the Operation Level.

- The LVL/CH display will indicate *l*, and the CH indicator will light to show that the Operation Level has been entered.
 - - - - indicates measurement standby.



1 second

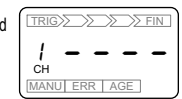

5-10 Use Running Time

Level	Characters	Range of setting values	Default value	Description
Initial Setting	AGE	OFF/ON	OFF	Select whether or not to use the running time function OFF (not used)/ON (used)

Set whether or not to use the running time function.

This parameter is set whether or not AGE indicator is lit when the replacement time guideline value is reached.

Regardless of this setting value, the communications commands can read the current running time as a proportion of the guideline value.

Refer to *4-8 Running Time* on page 4-27 for details on the running time function.

The operation procedure for the Use Running Time setting parameter is shown as follows:

Procedure

1. Press the Level Key for at least 3 seconds in the Operation Level to move to the Initial Setting Level.

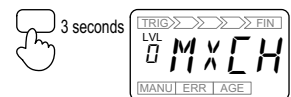

- The LVL/CH display will indicate \square , and the LVL indicator will light to show that the Initial Setting Level has been entered.

2. Press the Mode Key several times to display AGE.



3. Press the Shift Key to enter the monitoring state.



- The setting value is displayed.

4. Press the Shift Key again to move to the setting change state.



- The value that can be changed starts flashing.

5. Use the Up Key to change the setting value.



6. Press the Mode Key to move to the next setting parameter.

- The changed setting value is saved in the internal memory.



7. Press the Level Key for at least 1 second to return to the Operation Level.

- The LVL/CH display will indicate *i*, and the CH indicator will light to show that the Operation Level has been entered.
- - - - indicates measurement standby.



1 second

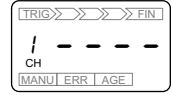

5-11 Software Version

Level	Characters	Range of setting values	Default value	Description
Initial Setting	V 1.0*	---	---	Displays the software version of the K7GE-MG

* The "1.0" part changes according to the current software version

Displays the current software version of the K7GE-MG.

This setting parameter only lets you see the software version. It cannot be changed.

The operation procedure for the Software Version setting parameter is shown as follows:

Procedure

1. Press the Level Key for at least 3 seconds in the Operation Level to move to the Initial Setting Level.

- The LVL/CH display will indicate \bar{V} , and the LVL indicator will light to show that the Initial Setting Level has been entered.



2. Press the Mode Key several times to display V*.0.

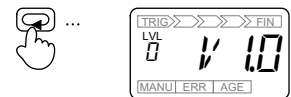

3. Press the Level Key for at least 1 second to return to the Operation Level.

- The LVL/CH display will indicate \bar{V} , and the CH indicator will light to show that the Operation Level has been entered.
 - - - - indicates measurement standby.

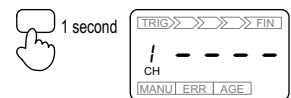

5-12 Setting Change Protection

Level	Characters	Range of setting values	Default value	Description
Protect	WLPt	OFF/ON	OFF	Use key operations to enable or disable changing of setting values OFF (enabled)/ON (disabled)

Use key operations to enable or disable changing of setting values.

You can protect the setting values to prevent them being inadvertently overwritten due to unintentional key operations.

Setting it ON (disabled) allows you to see the settings values of the Initial Setting Level and Communications Setting Level but prevents moving to the setting change state. The protect indicator will light on the front display part to show that the K7GE-MG has been protected.

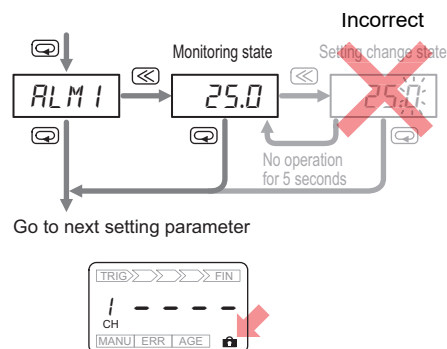

The operation procedure for the Setting Change Protection setting parameter is shown as follows:

Procedure

1. Press the Level Key and Mode Key together for at least 3 seconds in the Operation Level to move to the Initial Setting Level.



- The LVL/CH display will indicate P, and LVL indicator will light to show that the Protect Level has been entered.
- WLPt is displayed on the main display part.

2. Press the Shift Key to enter the monitoring state.



3. Press the Shift Key again to move to the setting change state.



- The value that can be changed starts flashing.

4. Use the Up Key to change the setting value.



5. Press the Mode Key.

- The changed setting value is saved in the internal memory.

**6.** Press the Level Key and Mode Key together for at least 1 second to return to the Operation Level.

- The LVL/CH display will indicate *!*, and the CH indicator will light to show that the Operation Level has been entered.
 - - - - indicates measurement standby.
- The protect indicator indicator is lit to indicate that setting change protection is enabled.

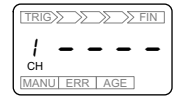
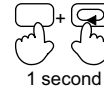

5-13 Communications Setting Parameters

Level	Characters	Range of setting values	Default value	Description
Communications Setting	<i>PSEL</i>	CWF/MOD	CWF	Protocol selection CWF (CompoWay/F)/MOD (Modbus RTU)
	<i>bPS</i>	9.6/19.2/38.4/57.6 (kbps)	9.6	Baud rate
	<i>LEN</i>	7/8 (bit)	7	Data length
	<i>StBt</i>	1/2 (bit)	2	Stop bits
	<i>PRtY</i>	NONE/EVEN/ODD	EVEN	Parity None/Even/Odd
	<i>SDWt</i>	0 to 99 (ms)	20	Send wait time

Set the setting parameters related to RS-485 communications.

Use the Unit Number Setting Switch on the Main Unit front part to set the unit number. The setting is applied after a power ON reset.

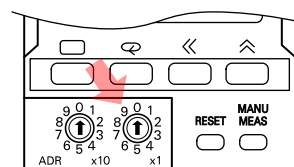

The Send Wait Time setting parameter is the wait time from when the K7GE-MG receives a command from the host system until it returns a response. If the response comes so fast that the host system cannot receive it properly, increase this setting value. If you want to make the communications response time faster, decrease this setting value.



When the Modbus RTU protocol is selected, regardless of the setting value of the setting parameter, the data length is fixed internally at 8 bits, and the stop bit is fixed internally at 1 bit when the parity is even/odd or fixed internally at 2 bits when the parity is none. Use it with caution.

The operation procedure for the Baud Rate setting parameter is shown as follows:

Procedure

1. Press the Level Key for at least 3 seconds in the Operation Level to move to the Initial Setting Level.



- The LVL/CH display will indicate *MxCH*, and the LVL indicator will light to show that the Initial Setting Level has been entered.

2. Press the Level Key at the Initial Setting Level (for less than 1 second) to move to the Communications Setting Level.

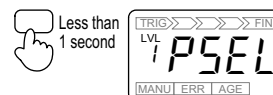

3. Press the Mode Key several times to display *bPS*.

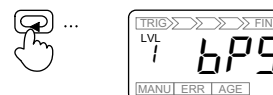

4. Press the Shift Key to enter the monitoring state.

- The setting value is displayed.

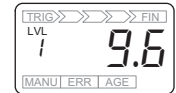

5. Press the Shift Key again to move to the setting change state.

- The value that can be changed starts flashing.



6. Use the Up Key to change the setting value.

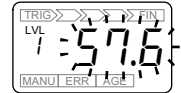

7. Press the Mode Key to move to the next setting parameter.

- The changed setting value is saved in the internal memory.



8. Press the Level Key for at least 1 second to return to the Operation Level.

- The LVL/CH display will indicate *!*, and the CH indicator will light to show that the Operation Level has been entered.
---- indicates measurement standby.
- Press the Level Key at the Communications Setting Level for less than 1 second to return to the Initial Setting Level.



1 second

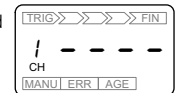

Less than 1 second



Follow the same procedure for other communications setting parameters.

6

Remote Monitoring

6-1 Remote Monitoring	6-2
6-2 Communications Overview	6-3
6-3 Variable Area Map	6-5
6-4 Monitoring (Reading) Measurement Values	6-8
6-5 Operation Command	6-9
6-6 Checking (Reading) Setting Parameters	6-12
6-7 Changing (Writing) Setting Parameters	6-13
6-8 CompoWay/F Communications Format	6-14
6-8-1 Frame Configurations	6-14
6-8-2 Read Variable Area Command	6-17
6-8-3 Write Variable Area Command	6-18
6-8-4 Operation Command	6-20
6-9 Modbus RTU Communications Format	6-22
6-9-1 Frame Configurations	6-22
6-9-2 Read Variable Area Command	6-25
6-9-3 Write Variable Area Command	6-26
6-9-4 Operation Command	6-27

6-1 Remote Monitoring

The K7GE-MG provides the communications function that can automatically collect the measurement values of each load from a remote location. This allows for central trend monitoring of insulation resistance values for many loads distributed around the factory.

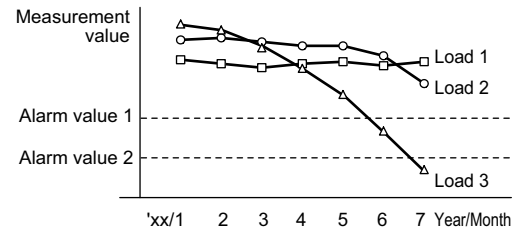

6-2 Communications Overview

Communications Method

This is a master/slave system in which multiple K7GE-MG slave Units are connected to one master host system.

Slave Units connected to the same communications line are distinguished by a unique unit number.

The commands sent by the master reach all the slaves, but the unit number is embedded in the command frame, so that the slave determines whether a command is addressed to itself and only returns a response to a command addressed to itself.

Refer to *3-7 Setting the Unit Number* on page 3-14 for the procedure to set the unit number.

The master host system sends a command frame, and the K7GE-MG slave Unit returns a response frame corresponding to the contents of the command. One command frame and one response frame make a pair.

The starting point of communications is the command frame sent from the master. When a change in status occurs that should be notified to the slave, it cannot be notified unless there is an inquiry from the master. Therefore, the master must poll at appropriate intervals to determine the slave status.

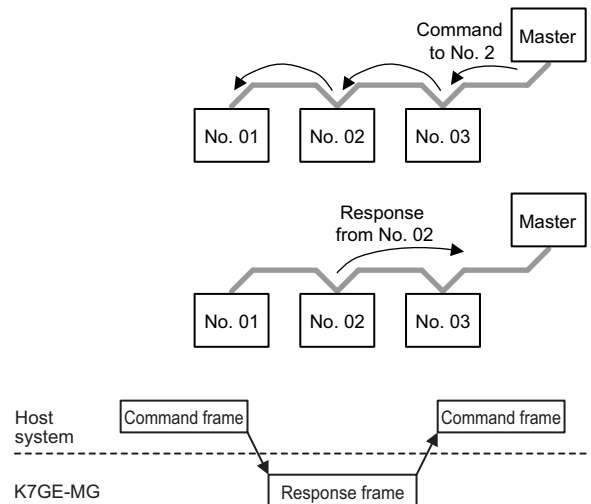

Types of Communications Commands

The following three types are the types of communications commands for the K7GE-MG.

Communications commands	Description
Read Variable Area	Reads the variable area.
Write Variable Area	Writes the variable area.
Operation Command	This service performs operations of Automatic Measurement Start, Software Reset, and Parameter Initialization.

The K7GE-MG has an internal register called the "variable area", where the measurement values, status information, and setting parameters for each channel are assigned. Read Variable Area is used to read the measurement values, status information, and setting parameters. Write Variable Area is used to write the setting parameters. Operation Command is used to execute Automatic Measurement Start, Software Reset, and Parameter Initialization for K7GE-MG without accessing the variable area.

6-8 CompoWay/F Communications Format and *6-9 Modbus RTU Communications Format* describe the command frame/response frame configuration.

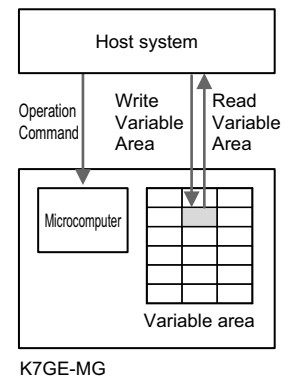

6-3 Variable Area Map

The following variables are assigned to the variable area.

Measurement value/status: Variables for reading only. The addresses are H'0001 to H'0013.

Setting parameters: Variables for reading and writing. The addresses are H'0020 to H'002F.

Product data: Variables that can only be read when the protocol is Modbus RTU.
The addresses are H'C003 to H'C006 and H'C00A to H'C01D.

Specify the address to access each variable.

H'** represents a hexadecimal value.

Variable address	Variable name	Description
H'0000	Reserved for the System	-
H'0001	Running Time Value	H'0000 to H'0064 (0% to 100%)
H'0002	Elapsed Time	H'0000 to H'AE60 (0 to 44,640 min) The time from trigger signal input to reading (minutes).
H'0003	K7GE-MG Status	Refer to <i>Details about status information</i> on page 6-7 for details about the bits.
H'0004	CH1 Measurement Value	H'0000 to H'03E7* (0.0 to 99.9 MΩ) The insulation resistance measurement value. * When converting a decimal number to a hexadecimal number, remove the decimal point before conversion. Example: 99.9 → 999 → H'03E7
H'0005	CH1 Status	Refer to <i>Details about status information</i> on page 6-7 for details about the bits.
H'0006	CH2 Measurement Value	Same as CH1.
H'0007	CH2 Status	
H'0008	CH3 Measurement Value	
H'0009	CH3 Status	
H'000A	CH4 Measurement Value	
H'000B	CH4 Status	
H'000C	CH5 Measurement Value	
H'000D	CH5 Status	
H'000E	CH6 Measurement Value	
H'000F	CH6 Status	
H'0010	CH7 Measurement Value	
H'0011	CH7 Status	
H'0012	CH8 Measurement Value	
H'0013	CH8 Status	
H'0014 to H'001F	Unused	H'0000
H'0020	Protocol	The setting parameter. H'0000: CompoWay/F (default value), H'0001: Modbus RTU
H'0021	Baud Rate	The setting parameter. H'0000: 9.6 k (default value), H'0001: 19.2 k, H'0002: 38.4 k, H'0003: 57.6 kbps
H'0022	Data Length	The setting parameter. H'0000: 7 bits (default value), H'0001: 8 bits
H'0023	Stop Bits	The setting parameter. H'0000: 1 bit, H'0001: 2 bits (default value)
H'0024	Parity	The setting parameter. H'0000: None, H'0001: Even (default value), H'0002: Odd
H'0025	Send Wait Time	The setting parameter. H'0000 to H'0063 (0 to 99 ms) Default value: H'0014 (20 ms)
H'0026	Setting Change Protection	The setting parameter. H'0000: OFF (default value), H'0001: ON

Variable address	Variable name	Description
H'0027	Maximum Number of Channels	The setting parameter. H'0001 to H'0008 (1 to 8 channels) Default value: H'0001 (1 channel)
H'0028	Alarm Value 1	The setting parameter. H'0000 to H'03E7 (0.0 to 99.9 MΩ) Default value: H'00C8 (20.0 MΩ)
H'0029	Alarm Value 2	The setting parameter. H'0000 to H'03E7 (0.0 to 99.9 MΩ) Default value: H'000A (1.0 MΩ)
H'002A	Alarm Polarity	The setting parameter. H'0000: Normally open, H'0001: Normally close (default value)
H'002B	Trigger Signal Reverse	The setting parameter. H'0000: OFF edge (default value), H'0001: ON edge
H'002C	Motor Stop Waiting Time	The setting parameter. H'0000 to H'012B (0 to 299 s) Default value: H'000A (10 s)
H'002D	Time to Wait to Stabilize	The setting parameter. H'0000 to H'0063 (0 to 99 s) Default value: H'003C (60 s)
H'002E	Average Processing	The setting parameter. H'0000: No average processing (default value), H'0001: With average processing
H'002F	Use Running Time	The setting parameter. H'0000: Not used (default value), H'0001: Used

The following variable areas are read-only variables that can be accessed only when the protocol is Modbus RTU.

Variable address	Variable name	Description
H'C003	Major Revision	Indicates a major revision of the firmware version. Example: H'0001 for version 1.2
H'C004	Minor Revision	Indicates a minor revision of the firmware version. Example: H'0002 for version 1.2
H'C005 to H'C006	Serial Number	The unique product serial number. H'00000000 to H'FFFFFFF (0 to 4294967295) Variable address H'C005 is the most-significant digit and H'C006 is the least-significant digit.
H'C007 to H'C009	Unused	H'0000
H'C00A to H'C019	Product Name	Indicates the Main Unit product name in ASCII code. The product name is left-aligned. The remaining areas are filled with ASCII space codes (H'20). Example: For the K7GE-MGMA, H'4B3747452D4D474D412020...
H'C01A to H'C01D	Product Code	The JAN/EAN code for the Main Unit. The code for the K7GE-MGMA is 4549734673921. The code for the K7GE-MGMD is 4549734673938. Example: When the code is read for the K7GE-MGMA, it becomes H'0454973467392100, with H'0 appended to the most-significant digit and H'00 appended to the least-significant digit. Variable address H'C01A is the most-significant digit and H'C01D is the least-significant digit.

Details about status information

Variable address	Variable name	B15-8	B7	B6	B5	B4	B3	B2	B1	B0	Bit name	Description
H'0003	K7GE-MG Status										Comprehensive alarm 1	0: Alarm 1 did not occur in any channel 1: Alarm 1 occurred in a channel
											Comprehensive alarm 2	0: Alarm 2 did not occur in any channel 1: Alarm 2 occurred in a channel
											Operation Level	0: Current level is not Operation Level 1: Current level is Operation Level
											Automatic measurement in progress	0: No automatic measurement for any channel 1: Automatic measurement is in progress for a channel
											Manual measurement	0: No manual measurement 1: Manual measurement in progress
											Running time	0: Running Time Value is less than 100% 1: Running Time Value reached 100%
											-	Not used: Always 0
											Trigger input contacts	0: Trigger input terminal external contacts OFF 1: Trigger input terminal external contacts ON
											-	Not used: Always 0

Variable address	Variable name	B15-8	B7	B6	B5	B4	B3	B2	B1	B0	Bit name	Description
H'0005	CH1 Status										CH1 alarm 1	0: Alarm 1 did not occur in CH1 1: Alarm 1 occurred in CH1
											CH1 Alarm 2	0: Alarm 2 did not occur in CH1 1: Alarm 2 occurred in CH1
											-	Not used: Always 0
											CH1 automatic measurement	0: No automatic measurement in CH1 1: Automatic measurement in progress in CH1
											CH1 measurement failed	0: Measurement did not fail in CH1 1: Measurement failed in CH1
											CH1 automatic measurement stopped	0: Automatic measurement not stopped in CH1 1: Automatic measurement stopped (trigger released) in CH1
											-	Not used: Always 0
											-	Not used: Always 0
											-	Not used: Always 0

6-4 Monitoring (Reading) Measurement Values

Read the measurement values and statuses using the Read Variable Area command.

The Read Variable Area command can read single specified addresses one by one, but it can also read multiple addresses together by specifying an area. The latter case is convenient, as the read operation can be completed with one command/one response.

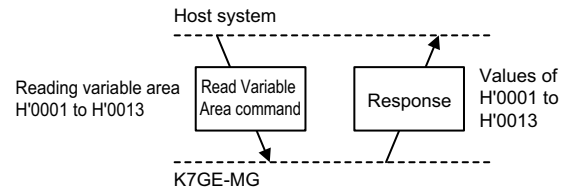

The area to specify is H'0001 to H'0013. Refer to 6-3 *Variable Area Map* on page 6-5.

Read Timing

If the load stop time schedule is predetermined, the read timing considers when measurement is clearly complete, including the time taken from load stop to measurement. (For example, 1 hour after load stop.)

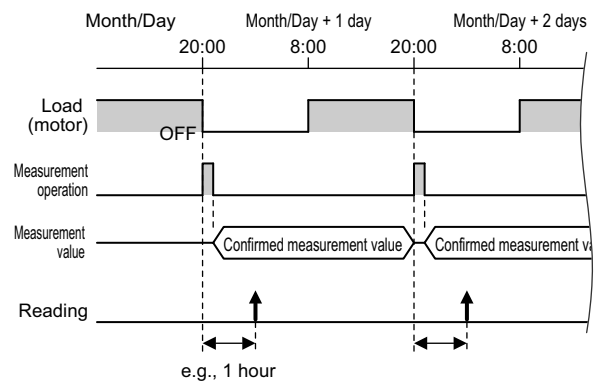

For applications with irregular load stop timing, such as a duplex alternating pump, the simplest method is to read the measurement values at a relatively short cycle (for example, every 10 minutes), and then discard the data if the measurement value is not a confirmed measurement value.

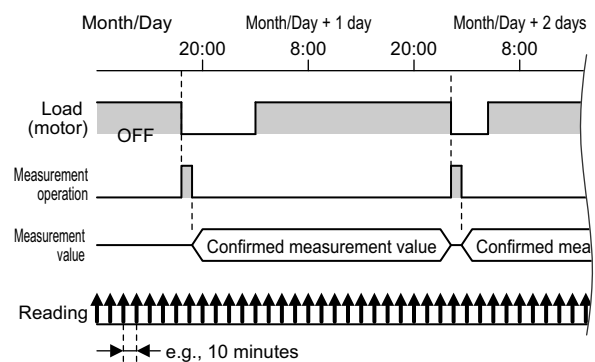

In the unconfirmed state, the read measurement value is H'0000 and this is used to determine if the data is valid data.

However, strictly speaking, the measured result could be 0.0 MΩ (H'0000). Therefore, for better determination accuracy, also consider whether or not the alarm is ON. If the measured result is 0.0 MΩ, the alarm is always ON.



Normally, the confirmed measurement values as a result of a measurement are retained until the next measurement starts. However, if manual measurement is performed or if the level is switched to the Initial Setting Level by a key operation on the front part of the K7GE-MG, the value is cleared even if reading is not yet performed. Take care when making a key operation before reading.

6-5 Operation Command

The following three types of operation commands are available.

Operation Command	Description
Automatic Measurement Start Command	Functions as the trigger signal to start automatic measurement.
Software Reset Command	Performs a forced power ON reset.
Parameter Initialization Command	Returns the setting values of all setting parameters to the factory default values.

Operation commands are specified by a command code in the command frame.

6-8 *CompoWay/F Communications Format* on page 6-14 and 6-9 *Modbus RTU Communications Format* on page 6-22 describe the command frame/response frame configuration.

Automatic Measurement Start Command

Automatic measurement starts regardless of whether the external contacts connected to the trigger input terminals are ON or OFF.

The Automatic Measurement Start Command operation is slightly different from operation due to a trigger signal from external contacts. To keep the trigger signal ON, the external contacts must be kept OFF*. However, with the Automatic Measurement Start Command, the trigger signal is kept ON with a one-shot command.

* When the setting value of the Trigger Signal Reverse setting parameter is OFF



To stop a measurement started by the Automatic Measurement Start Command, execute a Software Reset Command from the communications commands.

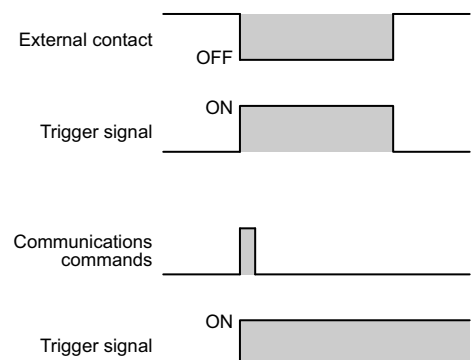

Overlapping between the timing of the trigger by an external contact and the Automatic Measurement Start Command from the communications commands is a post-win. For example, if the measurement operation starts by an external contact and the Automatic Measurement Start Command is input before the measurement operation completes, the measurement started by the external contact is reset, and a new measurement operation by the measurement start command starts.



While it is possible to use the external contact and communications command together, it becomes difficult to understand the operation when seen from the outside, and therefore, it is recommended to use either of the two.

● Timing to Execute the Automatic Measurement Start Command

Execute the Automatic Measurement Start Command when all the following conditions are met.

- (1) The load contactor is OFF (turned OFF from power line).
- (2) The K7GE-MG is in the Operation Level.
- (3) The K7GE-MG is not performing manual measurement.
- (4) The K7GE-MG is not performing automatic measurement.

If the contactor auxiliary contact is connected to the trigger input terminal of the K7GE-MG, (1) can be determined from the trigger input contact bit (H'0003.B7*) = 0 in the K7GE-MG Status variables.

* Indicates bit 7 at the address H'0003 variable area.

(2) can be determined from the Operation Level bit (H'0003.B2) = 1 in the K7GE-MG Status variables. If you execute the automatic measurement start command at a level other than Operation Level such as Initial Setting Level, the operation error response will be returned from the K7GE-MG and the command will not be accepted.

(3) can be determined from the manual measurement bit (H'0003.B4) = 0 in the K7GE-MG Status variables. If you execute the automatic measurement start command during manual measurement, the K7GE-MG will return the response of the operation error and the command will not be accepted.

(4) can be determined from the automatic measurement bit (H'0003.B3) = 0 in the K7GE-MG Status variables. If you execute the automatic measurement start command during automatic measurement, the operation error does not occur. The measurement operation in progress is interrupted and a new measurement operation is started. As all the confirmed measurement values up to that point are cleared, it is recommended that you wait until the series of measurement operations is complete if automatic measurement is in progress.

Software Reset Command

The power ON reset process is executed in the same way as when the Reset Key on the Main Unit front part is pressed.

A power ON reset puts the K7GE-MG in the same initial state as after the power is turned ON.

Refer to *4-6 Reset Key* on page 4-25 for information on the operation when the Reset Key is pressed.

Unlike the Reset Key, the Software Reset Command can be accepted at levels other than the Operation Level.

The Software Reset Command can be used in the following cases.

- (1) To clear an alarm output after reading the measurement values and statuses.
- (2) To stop automatic measurement that was started unintentionally.
- (3) To forcibly return to the Operation Level from a level other than the Operation Level (such as the Initial Setting Level) by remote operation.
(For example, if you leave the work site with the K7GE-MG still in the Initial Setting Level selected by key operation, automatic measurement will not start at the time it should when the contactor turns OFF as the K7GE-MG is not in the Operation Level.)
- (4) To enable the new setting value after changing a setting parameter with the Write Variable Area command.

The reason for (4) is that a power ON reset is required to enable the new setting values.

Also refer to *6-7 Changing (Writing) Setting Parameters* on page 6-13.

Parameter Initialization Command

Returns the setting values of all setting parameters to the factory default values.

A power ON reset is required to enable the setting values that were returned to the default values. Perform a power ON reset by turning the power OFF and back ON again, issuing a Software Reset Command, or operating the Reset Key.



When the Parameter Initialization Command is executed, the communications setting parameters are also initialized. Communications will no longer be possible if a power ON reset is performed when the protocol used was changed from the default state.

Before performing a power ON reset, use the Write Variable Area command to change at least the communications setting parameter to a setting value that matches the current host system environment.

6-6 Checking (Reading) Setting Parameters

Read the setting parameters using the Read Variable Area command.

The Read Variable Area command can read single specified addresses one by one, but it can also read multiple addresses together by specifying an area. The latter case is convenient, as the read operation can be completed with one command/one response.

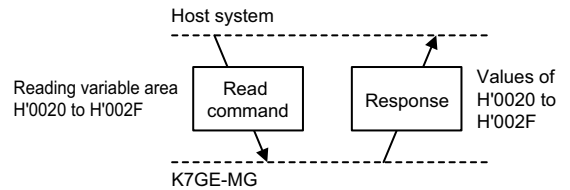

The area to specify is H'0020 to H'002F. Refer to *6-3 Variable Area Map* on page 6-5.

The setting parameters can be read regardless of whether automatic measurement is being performed. The reading operation does not affect the K7GE-MG operation.

6-7 Changing (Writing) Setting Parameters

Change the setting parameters using the Write Variable Area command.

The Write Variable Area command can write single specified addresses one by one, but it can also write multiple addresses together by specifying an area. The latter case is convenient, as the write operation can be completed with one command/one response.

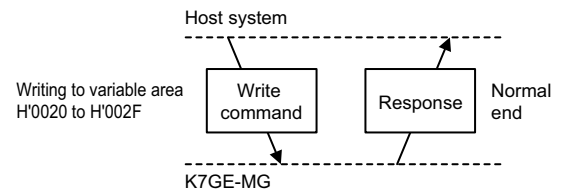

The area to specify is H'0020 to H'002F. Refer to 6-3 *Variable Area Map* on page 6-5.

Issuing the command changes and saves the setting parameters in the non-volatile memory in the K7GE-MG.

However, a power ON reset is required to operate the Unit based on the new setting values. For example, if alarm value 1 is changed with the communications command for changing the setting parameters, a power ON reset must be performed with a Software Reset Command, etc. to enable alarm judgment with the new threshold value.

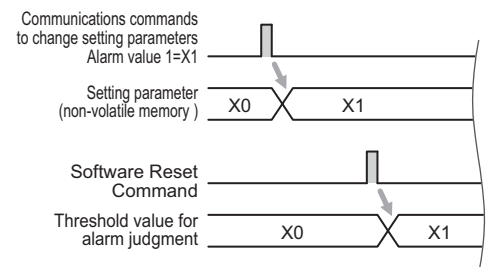

Therefore, when issuing the command to change the setting parameters, you do not have to worry about the status, such as whether or not automatic measurement is in progress. However, you should consider the timing for the reset, such as waiting until any measurement in progress is complete.

6-8 CompoWay/F Communications Format

Change the setting parameters using the Write Variable Area command.

CompoWay/F is OMRON's standard communications format for general serial communications. This format uses a standard frame format as well as the well-established FINS* commands used for OMRON's PLCs. Therefore, it can simplify communications between multiple components and between a PC and component.

* FINS (Factory Interface Network Service)

The FINS protocol provides message communications between controllers in OMRON FA networks.

In the following description, hexadecimal values are expressed by adding the prefix "H" before the number, e.g., "H'02". Also, ASCII characters are expressed by enclosing several letters or numbers in single quotation marks, e.g., '00'.

6-8-1 Frame Configurations

Command Frame

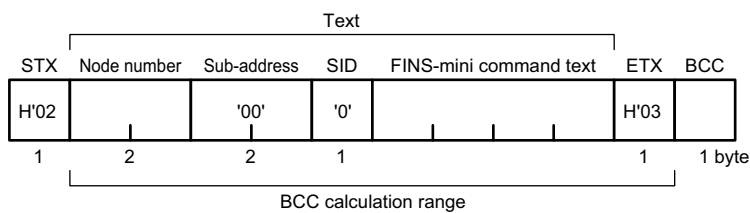

STX	This code indicates the beginning of the communications frame. Always set this code in the first byte (H'02).																					
Node number	This number specifies the transmission's destination. Specify the unit number of the K7GE-MG Main Unit. Set BCD '00' to '99'.																					
Sub-address	Always set the sub-address to '00'.																					
SID (Service ID)	Always set the service ID to '0'.																					
FINS-mini command text	This is the command text area. For details, refer to <i>FINS-mini Text</i> on page 6-16.																					
ETX	This code indicates the end of the text. (H'03)																					
BCC	This is the Block Check Character. A value found by calculating the exclusive OR of the bytes from the node number up to ETX. BCC calculation example: <div style="text-align: center;"> <table border="1" style="margin: 0 auto;"> <thead> <tr> <th>STX</th> <th>Node number</th> <th>Sub-address</th> <th>SID</th> <th>FINS-mini command text</th> <th>ETX</th> <th>BCC</th> </tr> </thead> <tbody> <tr> <td>H'02</td> <td>'00'</td> <td>'00'</td> <td>'0'</td> <td>'0503'</td> <td>H'03</td> <td>H'35</td> </tr> <tr> <td></td> <td>H'30 H'30</td> <td>H'30 H'30</td> <td>H'30</td> <td>H'30 H'35 H'30 H'33</td> <td>H'03</td> <td></td> </tr> </tbody> </table> <p>$H'30 \oplus H'30 \oplus H'30 \oplus H'30 \oplus H'30 \oplus H'30 \oplus H'35 \oplus H'30 \oplus H'33 \oplus H'03 = H'35$ \oplus: XOR (exclusive OR) calculation</p> </div>	STX	Node number	Sub-address	SID	FINS-mini command text	ETX	BCC	H'02	'00'	'00'	'0'	'0503'	H'03	H'35		H'30 H'30	H'30 H'30	H'30	H'30 H'35 H'30 H'33	H'03	
STX	Node number	Sub-address	SID	FINS-mini command text	ETX	BCC																
H'02	'00'	'00'	'0'	'0503'	H'03	H'35																
	H'30 H'30	H'30 H'30	H'30	H'30 H'35 H'30 H'33	H'03																	

Response Frame

Normal operation:

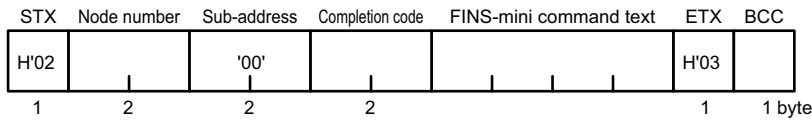

Specified FINS command could not be executed:

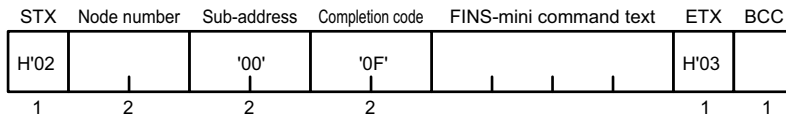

Command frame error:

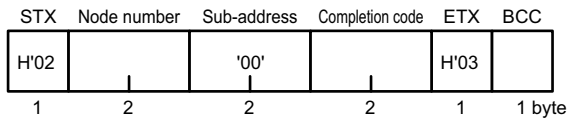

No response to command frames that are not completed up to the ETX.BCC character.

STX	This code indicates the beginning of the communications frame. This code is always set as the first byte (H'02).
Node number	The number specified in the command frame is entered as-is.
Sub-address	Always set the sub-address to '00'.
Completion code	The result of executing the command frame is entered. Refer to <i>Completion code</i> on page 6-16.
FINS-mini command text	This is the command response text area. For details, refer to <i>FINS-mini Text</i> on page 6-16.
ETX	This code indicates the end of the text. (H'03)
BCC	This is the Block Check Character. A value found by calculating the exclusive OR of the bytes from the node number up to ETX.

Completion code

Completion code	Name	Description
'00'	Normal end	The command execution ended normally without error.
'0F'	FINS command error	The specified FINS command could not be executed. Use the FINS response code to determine the detailed cause.
'10'	Parity error	The total sum of bits whose received data is "1" does not match the setting value of the Parity setting parameter.
'11'	Framing error	Indicates that the stop bit of the command frame character was "0".
'12'	Overrun error	An attempt was made to transfer more new data when the reception data buffer was already full.
'13'	BCC error	The received BCC value and the calculated BCC value do not match.
'14'	Format error	<ul style="list-style-type: none"> The FINS-mini command text contains characters other than '0' to '9', and 'A' to 'F'. There was no SID and FINS-mini command text, or no FINS-mini command text. "MRC/SRC" was not included in the FINS-mini command text.
'16'	Sub-address error	<ul style="list-style-type: none"> There was no sub-address, SID, and FINS-mini text. Sub-address was less than two characters, and there was no DIS and FINS-mini command text.
'18'	Frame length error	The received frame exceeded the specified number of bytes.

FINS-mini Text

The FINS-mini command text/FINS-mini response text is the base text for command/response communications.

Command text:

The FINS-mini command text adds the required data after the MRC (Main Request Code) and SRC (Sub-Request Code).

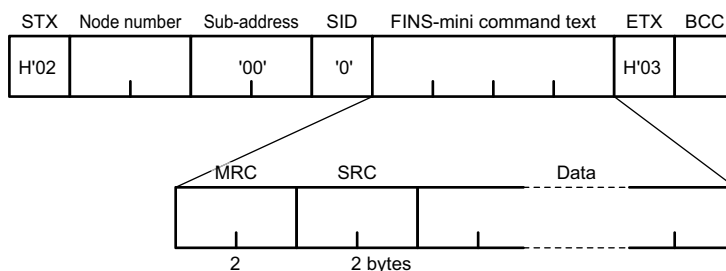

Response text:

The FINS-mini response text adds the MRES (Main Response Code), SRES (Sub-Response Code), and other required data after the MRC/SRC.

The response text when the specified FINS command cannot be executed contains the MRC/SRC and MRES/SRES only.

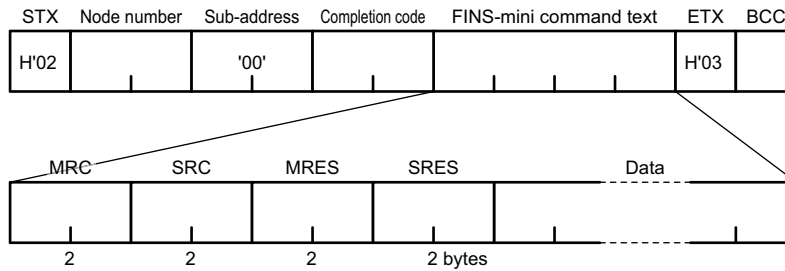

The FINS-mini commands that the K7GE-MG supports are as follows:

MRC/SRC	Command
'0101'	Read Variable Area
'0102'	Write Variable Area
'3005'	Operation Command

6-8-2 Read Variable Area Command

The FINS-mini text of the Read Variable Area command is as follows:

Command text:

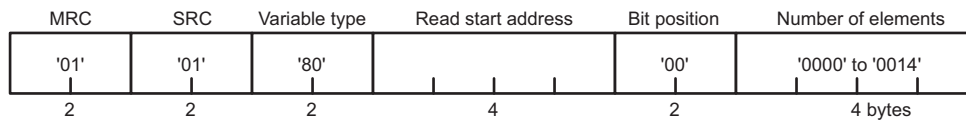

MRC/SRC	The Read Variable Area command. Specify '0101'.
Variable type	Specify '80' for the K7GE-MG.
Read start address	Specify the address of the variable area to start reading. Refer to 6-3 <i>Variable Area Map</i> on page 6-5.
Bit position	Always set the bit position to '00'.
Number of elements	Specify the number of variables to read. You can specify up to 20 variables (H'0014).

Response text:

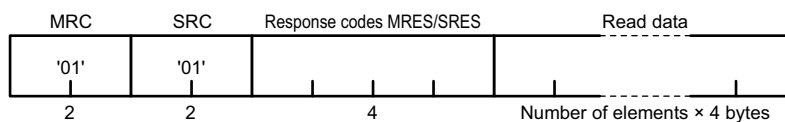

MRC/SRC	The content from the command text is entered as-is.
Response code	The result of executing the command is entered. Refer to <i>Response codes:</i> on page 6-18.
Read data	Contains the read value.

Response codes:

Response code	Error name	Description
'0000'	Normal end	The command ended normally.
'0401'	Unsupported command	The service function for the relevant command is not supported.
'1001'	Command too long	The command is too long.
'1002'	Command too short	The command is too short.
'1101'	Area type error	The variable type is wrong.
'110B'	Response too long	The number of elements exceeds 20 (H'0014).
'1100'	Parameter error	Bit position is not '00'.
'2203'	Operation error	A system error occurred.

Example:

Assume that the measurement value and status is read from the slave with unit number 10. The variable area addresses for the measurement value and status are H'0001 to H'0013.

Command frame:

FINS-mini command text										
STX	Node number	Sub-address	SID	MRC/SRC	Variable type	Read start address	Bit position	Number of elements	ETX	BCC
H'02	'10'	'00'	'0'	'0101'	'80'	'0001'	'00'	'0013'	H'03	H'39

Response frame:

STX	Node number	Sub-address	Completion code	MRC/SRC	MRES/SRES	Measurement value/status data	ETX	BCC
H'02	'10'	'00'	'00'	'0101'	'0000'		H'03	

Number of elements (19) × 4 bytes

6-8-3 Write Variable Area Command

The FINS-mini text of the Write Variable Area command is as follows:

Command text:

MRC	SRC	Variable type	Write start address	Bit position	Number of elements	Write data
'01'	'02'	'80'		'00'	'0000' to '0012'	
2	2	2	4	2	4 bytes	Number of elements × 4 bytes

MRC/SRC	The Write Variable Area command. Specify '0102'.
Variable type	Specify '80' for the K7GE-MG.
Write start address	Specify the address of the variable area to start writing. Refer to 6-3 <i>Variable Area Map</i> on page 6-5.
Bit position	Always set the bit position to '00'.
Number of elements	Specify the number of variables to write. You can specify up to 18 variables (H'0012).
Write data	Enter the value to write.

Response text:

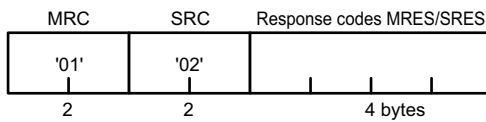

MRC/SRC	The content from the command text is entered as-is.
Response code	The result of executing the command is entered. Refer to the table below.

Response codes:

Response code	Error name	Description
'0000'	Normal end	The command ended normally.
'0401'	Unsupported command	The service function for the relevant command is not supported.
'1002'	Command too short	The command is too short.
'1101'	Area type error	The variable type is wrong.
'1003'	Number of elements/data mismatch	The number of data does not match the specified number of elements.
'1100'	Parameter error	<ul style="list-style-type: none"> • Bit position is not '00'. • The write data is out of the setting range.
'2203'	Operation error	A system error occurred.

Example:

Assume that the setting parameters are written for the slave with unit number 25.

The variable area addresses of the setting parameters are H'0020 to H'002F.

Command frame:

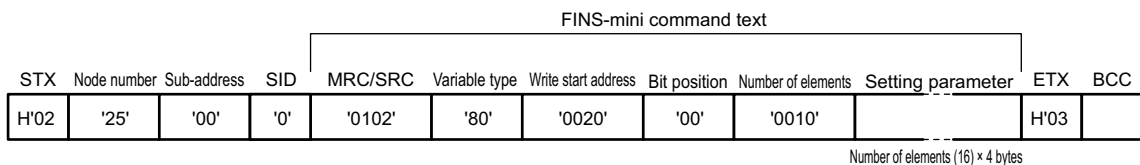

Response frame:

STX	Node number	Sub-address	Completion code	MRC/SRC	MRES/SRES	ETX	BCC
H'02	'25'	'00'	'00'	'0102'	'0000'	H'03	H'07

6-8-4 Operation Command

The FINS-mini text of the Operation Command is as follows:

Command text:

MRC	SRC	Command code	Related information
'30'	'05'		'00'
2	2	2	2 bytes

MRC/SRC	The Operation Command. Specify '3005'.
Command code	Enter the command code that indicates the type of Operation Command. Refer to the table below.
Related information	Information related to the Operation Command. Enter '00' for the K7GE-MG.

Command codes:

Command code	Operation Command	Related information	Command description
'01'	Automatic Measurement Start Command	'00'	Measurement starts regardless of whether the external contacts connected to the trigger input terminals are ON or OFF.
'06'	Software Reset Command	'00'	The power ON reset process is executed in the same way as when the Reset Key on the Main Unit front part is pressed. The K7GE-MG enters the same initial state as after the power is turned ON.
'0B'	Parameter Initialization Command	'00'	Returns the setting values of all setting parameters to the factory default values.

Response text:

MRC	SRC	Response codes MRES/SRES
'30'	'05'	
2	2	4 bytes

MRC/SRC	The content from the command text is entered as-is.
Response code	The result of executing the command is entered. Refer to the table below.

Response codes:

Response code	Error name	Description
'0000'	Normal end	The command ended normally.
'0401'	Unsupported command	The service function for the relevant command is not supported.
'1001'	Command too long	The command is too long.
'1002'	Command too short	The command is too short.
'1100'	Parameter error	The command code and related information are incorrect.
'2203'	Operation error	<ul style="list-style-type: none"> • A system error occurred. • An operation error also occurs if an Automatic Measurement Start Command is executed during manual measurement or at a level other than the Operation Level.

Example:

Assume that an Automatic Measurement Start Command is executed for the slave with unit number 32.

Command frame:

FINS-mini command text								
STX	Node number	Sub-address	SID	MRC/SRC	Command code	Related information	ETX	BCC
H'02	'32'	'00'	'0'	'3005'	'01'	'00'	H'03	H'35

Response frame:

STX	Node number	Sub-address	Completion code	MRC/SRC	MRES/SRES	ETX	BCC
H'02	'32'	'00'	'00'	'3005'	'0000'	H'03	H'04

6-9 Modbus RTU Communications Format

Modbus RTU is a standard communications control method that conforms to Modicon Inc.'s RTU-mode Modbus Protocol (PI-MBUS-300 Rev. J). In the following description, hexadecimal values are expressed by adding the prefix "H" before the number, e.g., "H'02".

6-9-1 Frame Configurations

Command Frame

A command frame starts with a silent interval of at least 3.5 character times and ends with a silent interval of at least 3.5 character times.

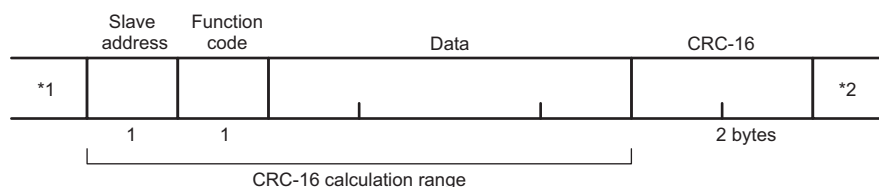

*1	Silent interval of 3.5 character times minimum.
Slave address	This number specifies the transmission's destination. Specify the unit number of the K7GE-MG Main Unit. H'01 to H'63 (01 to 99) in hexadecimal format.
Function code	The function code is a 1-byte hexadecimal code that indicates the type of command sent from the host device.
Data	This is the text data associated with the specified function code. Specify the variable area address, setting values for setting parameters, etc. in hexadecimal format.
CRC-16	Cyclic Redundancy Check This check code is calculated with the data from the slave address to the end of the data. The check code is 2-byte hexadecimal.
*2	Silent interval of 3.5 character times minimum.

CRC-16 Calculation Method

Messages are processed one byte at a time in the work memory (a 16-bit register known as the CRC register).

- (1) The CRC register is initialized to H'FFFF.
- (2) An XOR operation is performed on the content of the CRC register and the first byte of the message, and the result is returned to the CRC register.
- (3) The MSB is packed with zeros and the CRC register is shifted 1 bit to the right.
- (4) If the bit shifted from the LSB is "0", step (3) is repeated (next bit-shift processing).
If the bit shifted from the LSB is "1", an XOR is performed on the content of the CRC register and H'A001, and the result is returned to the CRC register.
- (5) Steps (3) and (4) are repeated until 8 bits are shifted.

- (6) CRC processing continues to the end of the message, as XOR operations are performed on the content of the CRC register and the next byte of the message, step (3) is repeated, and the result is returned to the CRC register.
- (7) The result of the CRC calculation (value in the CRC register) is appended to the last byte of the message.

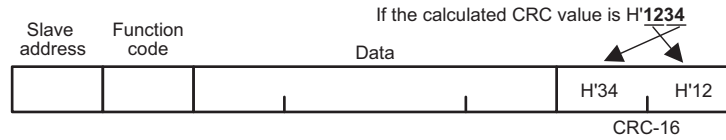

Response Frame

Normal operation:

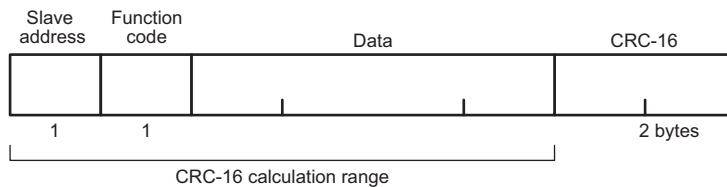

Command frame error:

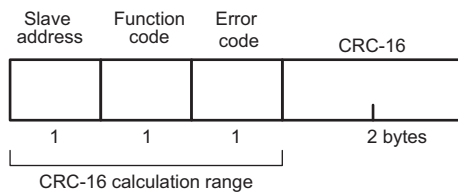

Slave address	The number specified in the command frame is entered as-is.
Function code	This is the received function code. However, H'80 is added to the received function code to indicate that the response is an error response for the response frame when an error occurs. Example: If the received function code is H'03, the error response is H'83.
Data	The body text of the response.
Error code	This code indicates the kind of error that occurred. Refer to the table below.
CRC-16	Cyclic Redundancy Check This check code is calculated with the data from the slave address to the end of the data. The check code is 2-byte hexadecimal.

Error code:

Completion code	Name	Description
H'01	Function code error	An unsupported function code was received.
H'02	Variable address error	The write variable address of the Operation Command is neither H'0000 nor H'FFFF.
H'03	Variable data error	<ul style="list-style-type: none"> • The number of elements specified in the command frame data and number of data do not match. • The byte count is not two times the number of elements specified in the command frame data. • The number of elements exceeds the allowed range. • The Operation Command specified in the command frame data has an incorrect command code or related information. • The write data specified in the command frame data is out of the setting range.
H'04	Operation error	<ul style="list-style-type: none"> • A system error occurred. • An operation error also occurs if a measurement start command is executed during manual measurement or at a level other than the Operation Level.

● No Response

In the following cases, the received command will not be processed and a response will not be returned. Therefore, a timeout error will occur in the host system.

- The slave address in the received command does not match the unit number.
- A parity error, framing error, or overrun error occurred due to a problem such as a transfer error.
- A CRC-16 code error occurred in the received command frame.
- There was a time interval of more than 3.5 character times between data packets that make up the command frame.

6-9-2 Read Variable Area Command

Command frame:

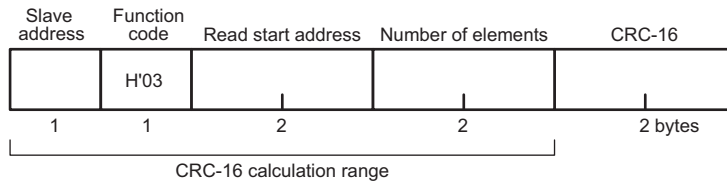

Slave address	This number specifies the transmission's destination. Specify the unit number of the K7GE-MG Main Unit. The unit number can be set between H'01 to H'63 hexadecimal (01 to 99 decimal).
Function code	The Read Variable Area command's function code is H'03.
Read start address	Specify the address of the variable area to start reading in 2-byte hexadecimal. Refer to 6-3 <i>Variable Area Map</i> on page 6-5.
Number of elements	Specify the number of variables to read. You can specify up to 46 variables (H'002E).
CRC-16	This check code is calculated with the data from the slave address to the end of the data.

Response frame:

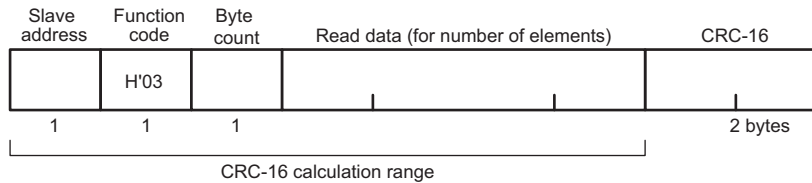

Slave address	The number specified in the command frame is entered as-is.
Function code	This is the received function code. However, H'80 is added if an error occurs.
Byte count	Contains the number of bytes of read data. The byte count is a hexadecimal.
Read data	Contains the read data value.
CRC-16	This check code is calculated with the data from the slave address to the end of the data.

Response codes:

Function code	Error code	Error name	Description
H'03	-	Normal end	The command ended normally.
H'83	H'03	Variable data error	The number of elements exceeds the allowed range.
	H'04	Operation error	A system error occurred.

Example:

Assume that the measurement value and status is read from the slave with unit number 10. The variable area addresses for the measurement value and status are H'0001 to H'0013.

Command frame:

Slave address	Function code	Read start address	Number of elements	CRC-16
H'0A	H'03	H'0001	H'0013	H'54BC

Response frame:

Slave address	Function code	Byte count	Read data (for number of elements)	CRC-16
H'0A	H'03	H'26		

6-9-3 Write Variable Area Command

Command frame:

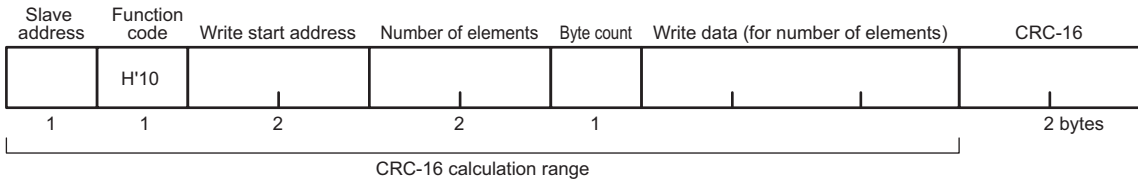

Slave address	This number specifies the transmission's destination. Specify the unit number of the K7GE-MG Main Unit. The unit number can be set between H'01 to H'63 hexadecimal (01 to 99 decimal).
Function code	The Write Variable Area command's function code is H'10.
Write start address	Specify the address of the variable area to start writing in 2-byte hexadecimal. Refer to 6-3 <i>Variable Area Map</i> on page 6-5.
Number of elements	Specify the number of variables to write. You can specify up to 44 variables (H'002C).
Byte count	Specify the number of bytes of data to write in hexadecimal format.
CRC-16	This check code is calculated with the data from the slave address to the end of the data.

Response frame:

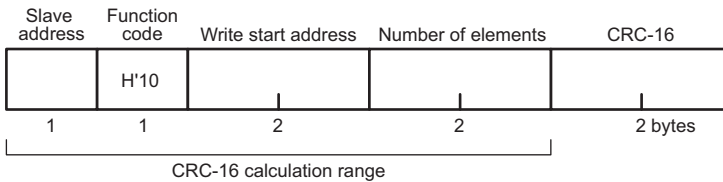

Slave address	The number specified in the command frame is entered as-is.
Function code	This is the received function code. However, H'80 is added if an error occurs.
Write start address	This is the received write start address.
Number of elements	This is the received number of elements.
CRC-16	This check code is calculated with the data from the slave address to the end of the data.

Response codes:

Function code	Error code	Error name	Description
H'10	-	Normal end	The command ended normally.
H'90	H'03	Variable data error	<ul style="list-style-type: none"> The number of data does not match the number of elements. The byte count is not two times the number of elements. The write data is out of the setting range.
	H'04	Operation error	A system error occurred.

Example:

Assume that the setting parameters are written for the slave with unit number 25.

The variable area addresses of the setting parameters are H'0020 to H'002F.

Command frame:

Slave address	Function code	Write start address	Number of elements	Byte count	Write data (for number of elements)	CRC-16
H'19	H'10	H'0020	H'0010	H'20		

Response frame:

Slave address	Function code	Write start address	Number of elements	CRC-16
H'19	H'10	H'0020	H'0010	H'C3D7

6-9-4 Operation Command

Command frame:

Slave address	Function code	Write variable address	Write data	CRC-16
	H'06	H'0000		
1	1	2	2	2 bytes

CRC-16 calculation range

Slave address	This number specifies the transmission's destination. Specify the unit number of the K7GE-MG Main Unit. H'01 to H'63 (01 to 99) in hexadecimal format.
Function code	The Operation Command's function code is H'06.
Write variable address	Specify either H'0000 or H'FFFF.
Write data	Specify the command code and related information. Refer to the table below.
CRC-16	This check code is calculated with the data from the slave address to the end of the data.

Command codes and related information:

Command code and related information	Operation Command	Command description
H'0100	Automatic Measurement Start Command	Measurement starts regardless of whether the external contacts connected to the trigger input terminals are ON or OFF.
H'0600	Software Reset Command	The power ON reset process is executed in the same way as when the Reset Key on the Main Unit front part is pressed. The K7GE-MG enters the same initial state as after the power is turned ON.
H'0B00	Parameter Initialization Command	Returns all setting parameters to the factory default values.

Response frame:

When the command is executed normally, the response returns the same data sent in the command frame.

Response codes:

Function code	Error code	Error name	Description
H'06	-	Normal end	The command ended normally.
H'86	H'02	Variable address error	The write variable address of the Operation Command is neither H'0000 nor H'FFFF.
	H'03	Variable data error	The command code and related information are incorrect.
	H'04	Operation error	<ul style="list-style-type: none"> A system error occurred. An operation error also occurs if an Automatic Measurement Start Command is executed during manual measurement or at a level other than the Operation Level.

Example:

Execute the Automatic measurement start command to the slave with unit number 32.

Command frame/Response frame:

Slave address	Function code	Write variable address	Write data	CRC-16
H'20	H'06	H'0000	H'0100	H'8EEB





Troubleshooting

7-1 Troubleshooting 7-2



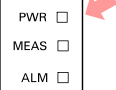



7-1 Troubleshooting

Check the following table if the K7GE-MG does not perform the expected operation.

No.	When	Problems	Cause	Correction	Reference	
1	At power ON	Power supply is unstable, such as a flickering display.	A wire may be connected to the release hole in a Push-In Plus terminal block.	Check again that the wire is securely connected to the terminal hole. Also check the other terminals.	3-4 <i>How to Connect to the Push-In Plus Terminal Blocks</i> on page 3-7	
2	At power ON	Sudden alarm output when attempting to check the setting parameters.	When moving to a level other than the Operation Level, the ALM 1 and ALM 2 output contacts turn OFF, regardless of the setting value of the Alarm Polarity setting parameter. An external device may have judged this to be an alarm.	As an example of a countermeasure to this, provide a switch that can short-circuit the output contacts of the ALM 1 and ALM 2, and use it to short-circuit the contacts during setting parameter operations and to release the short circuit after returning to the Operation Level.	4-5 <i>Current Limiter</i> on page 4-23	
3	At power ON	ERR indicator is lit, and 8888 is displayed. → A system error occurred.	 The channel numbers of the Probe Units may be duplicated.	Check that the channel numbers of the Probe Units are correctly set to consecutive numbers starting from 1.	3-3 <i>Setting the Channel Number</i> on page 3-6	
			If the channel numbers are not duplicated, a hardware failure has occurred.	It is necessary to perform repair work. Contact your OMRON representative.	-	
4	At power ON	The PWR indicator is not lit on some Probe Units.	 PWR <input type="checkbox"/> MEAS <input type="checkbox"/> ALM <input type="checkbox"/>	The connectors are not mated properly between the Units.	Check the connections between the Units again.	3-2 <i>Installation</i> on page 3-3
			If there is no improvement in operation, the Probe Unit may have a hardware failure.	It is necessary to perform repair work. Contact your OMRON representative.	-	

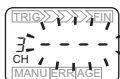
No.	When	Problems	Cause	Correction	Reference
5	At power ON	The auxiliary contact of the contactor is connected to the trigger input terminal. The K7GE-MG power was turned ON while the contactor was OFF, but automatic measurement does not start.	The K7GE-MG starts automatic measurement at the time when the external contacts of the trigger input terminal turn from ON to OFF* after the power is turned ON. Measurement does not start if the contacts are already OFF when the power is turned ON.	This operation specification prevents automatic measurement from starting unintentionally. After turning ON the K7GE-MG power, turn the external contacts from ON to OFF*.	4-1-4 <i>Timing Charts</i> on page 4-8
			* When the setting value of the Trigger Signal Reverse setting parameter is OFF.		
6	Automatic measurement in progress	 TRIG flashes and both ALM 1 and ALM 2 outputs turn ON. → Measurement is aborted.	Measurement started due to the external contacts of the trigger input terminal, but the external contacts turned ON* before the measurement was completed. If the auxiliary contact of the contactor is connected to the trigger input terminal, the load was restarted during the measurement.	Review the entire system so that the external contacts remain OFF* during the measurement.	
			* When the setting value of the Trigger Signal Reverse setting parameter is OFF.		
7	After completion of the automatic measurement	 The measurement value is not displayed on the channel, but FRCL is flashing. Both ALM 1 and ALM 2 outputs are ON. → Measurement failed for this channel.	The load connected to this channel may not have completely stopped when measurement of the channel started.	Increase the setting value of the Motor Stop Waiting Time setting parameter so that measurement starts after the load completely stops.	4-1-3 <i>Measurement Step Indicator Operation</i> on page 4-7
			The load on this channel may have turned ON during the measurement.	Review the entire system so that the load does not turn ON during the measurement.	
			The measurement for this channel is stopped because the K7GE-MG detected that the insulation resistance is extremely low.	Measure the insulation resistance of the load on this channel with a Megohmmeter.	
			No Probe Unit exists on this channel.	Check that the channel numbers of the Probe Units are correctly set to consecutive numbers starting from 1.	
			The Main Unit cannot recognize the Probe Unit of this channel. The connectors are not mated properly between the Units.	Check the connections between the Units again.	
			If there is no improvement in operation, the Probe Unit may have a hardware failure.	It is necessary to perform repair work. Contact your OMRON representative.	

No.	When	Problems	Cause	Correction	Reference
8	After completion of the automatic measurement	The measurement value cannot be seen for a channel although the measurement is complete. → The Probe Unit of this channel has not been measured.	The Probe Unit will not be measured if the channel number is greater than the setting value of the Maximum Number of Channels setting parameter.	Set the channel numbers in the order 1, 2, 3, and n. Also, set the Maximum Number of Channels setting parameter to the total number of channels (number of Probe Units).	3-2 <i>Installation</i> on page 3-3 5-3 <i>Maximum Number of Channels</i> on page 5-6
9	After completion of the automatic measurement	The measurement value is smaller than the value measured with the Megohmmeter.	Due to the parasitic capacitance component between the load including the wiring from the contactor and the ground, it may take some time for the measurement value to reach its final value after the Megger voltage is applied. The K7GE-MG measures the measurement value with a stable final value. Therefore, it is measured after the time set by the Time to Wait to Stabilize setting parameter. However, the measurement value may not have been stable at the time of measurement.	Use a Megohmmeter or the manual measurement function of the K7GE-MG to measure the time until the final value stabilizes. Set the Time to Wait to Stabilize setting parameter to the measured time with a small margin added.	5-8 <i>Time to Wait to Stabilize</i> on page 5-17
10	After completion of the automatic measurement	The measurement value varies with each measurement.	This may be an effect of external noise. The K7GE-MG is designed for superior removal of the 50/60 Hz induced noise due to the high-resistance measurements. However, it may not be able to completely remove large asynchronous noise (such as inverter noise).	Set the Average Processing setting parameter to ON. Also, take measures such as maintaining a distance between the input line of the K7GE-MG and the power line of the inverter that is operating.	5-9 <i>Average Processing</i> on page 5-19

No.	When	Problems	Cause	Correction	Reference
11	At manual measurement	The required channel does not appear when the Mode Key () is pressed to select the channel for manual measurement.	The channel numbers and Maximum Number of Channels setting parameter of the Probe Units may not be set correctly.	Set the channel numbers in the order 1, 2, 3, and n. Also, set the Maximum Number of Channels setting parameter to the total number of channels (number of Probe Units).	3-2 <i>Installation</i> on page 3-3 5-3 <i>Maximum Number of Channels</i> on page 5-6
			The measurement value display may be automatically scrolling because the Mode Key () was pressed for 3 seconds.	Press the Mode Key () again for 3 seconds to cancel automatic scroll.	
12	At manual measurement	The manual measurement does not start but the main display part flashes when the Manual Measurement Key is pressed. 	The Mode Key () was pressed for 3 seconds, which resulted in measurement value display automatic scroll. manual measurement cannot start during automatic scroll.	Press the Mode Key () again for 3 seconds to cancel Measurement Value Display Automatic Scroll, and then press the Manual Measurement Key.	
13	At manual measurement	Even if MANU indicator is lit, the measured value is not displayed. 	The measurement is aborted because the safety function is activated. This function is enabled when the load is turned ON or the insulation resistance is detected extremely low. If the load is not completely stopped, it may be determined that the load is turned ON.	Make sure that the load is completely stopped before performing the manual measurement. Measure the insulation resistance of the load on this channel with a Megohmmeter. Also, check the wiring between the load, contactor, and K7GE-MG again.	4-2 <i>Manual Measurement</i> on page 4-17
14	At manual measurement	The measurement value changes significantly from measurement to measurement. Or, the measurement value is significantly different from the value measured by the Megohmmeter.	It is possible that the manual measurement was performed with the electric charge remaining on the wiring and other parts.	The manual measurement does not allow forced discharge of electric charge. In the same way as measuring with a Megohmmeter, wait for the charge to be completely discharged before performing manual measurement.	

No.	When	Problems	Cause	Correction	Reference
15	During communications	The read measurement value sometimes becomes 0 MΩ.	Reading may have occurred at the time when the measurement value was not confirmed (during measurement standby or automatic measurement).	The easiest countermeasure is to discard the 0 MΩ data if there is no problem with the measurement value when it is read again after waiting until the measurement is complete. For a stricter read timing, ensure that the measurement value is always a confirmed value by reading when the Main Unit status output during measurement turns from ON to OFF or, for communications, poll the automatic measurement bit of the K7GE-MG status variable and perform reading when it turns from ON to OFF.	6-3 Variable Area Map on page 6-5
			The measurement may have failed or stopped. You can check the failed or stopped measurement by the measurement failed bit or measurement stopped bit of the channel status variable.	If measurement failed, refer to troubleshooting No.7 and take corrective measures. If measurement stopped, refer to troubleshooting No.6 and take corrective measures.	6-3 Variable Area Map on page 6-5
16	During communications	Automatic measurement is not performed at the usual time. (The read measurement value is the same as the previous measurement, and the measurement time is the same as the previous measurement.)	The external contacts connected to the trigger input terminal may not be working properly.	Check the external contacts for contact defects.	-
			The system may be at a level other than the Operation Level (such as the Initial Setting Level) due to a key operation.	You can use the Operation Level bit of the K7GE-MG status variable to check whether it is at the Operation Level. Make sure that the K7GE-MG is not at the Operation Level, and execute a Software Reset Command to return it to the Operation Level.	6-3 Variable Area Map on page 6-5

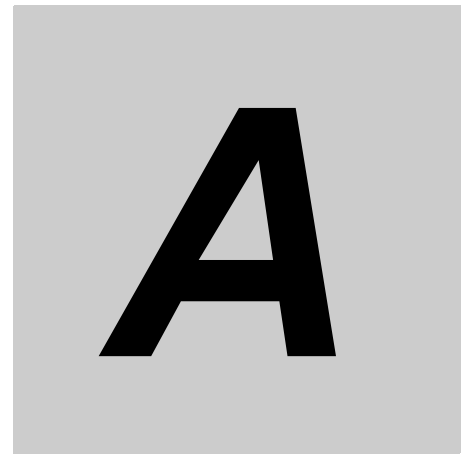

Appendices

A-1 Specifications	A-2
Ratings and Specifications	A-2
Measurement Specifications	A-3
Input Specifications of Trigger Input Terminals	A-3
Output Specifications of Transistor Output Terminals	A-4
Input Specifications of Voltage Input Terminals	A-4
Communications Specifications	A-5
A-2 Setting Parameters List	A-6
A-3 Setting Parameter Flow	A-7
A-4 K7GE-MG Logging Tool	A-8

A-1 Specifications

Ratings and Specifications

Item	Specifications
Power supply voltage and frequency	K7GE-MGMA 100 to 240 VAC, 50/60 Hz K7GE-MGMD 24 VAC, 50/60 Hz, 24 VDC
Operating voltage range	85% to 110% of the rated voltage
Operating frequency range	45 to 65 Hz
Power consumption	Maximum Unit configuration: one Main Unit and eight Probe Units 12.9 VA max. (100 to 240 VAC)/ 7.8 VA max. (24 VAC)/4.7 W max. (24 VDC) Minimum Unit configuration: one Main Unit and one Probe Unit 8.4 VA max. (100 to 240 VAC)/ 4.6 VA max. (24 VAC)/2.5 W max. (24 VDC)
Ambient operating temperature	-10 to 55°C (with no condensation or icing)
Ambient operating humidity	25% to 85% (with no condensation)
Storage temperature	-20 to 65°C
Altitude	2,000 m max.
Recommended fuse	T2A, time delay, high-breaking capacity (for Main Unit operating power supply) Tripping current: 7 A max., fast-blow (for Probe Unit voltage input)
Insulation resistance	20 MΩ min. Between all external terminals and the case, between all power supply terminals and all other terminals, between PE terminal, and trigger input terminal, all communications terminals and all transistor output terminals 1,000 MΩ min. Between Probe Unit voltage monitoring terminal and PE terminal
Dielectric strength	2,000 VAC for 1 minute Between all external terminals and the case, between all power supply terminals and all other terminals, between PE terminal, and trigger input terminal, all communications terminals and all transistor output terminals 1,000 VDC for 1 minute Between Probe Unit voltage monitoring terminal and PE terminal
Vibration resistance	Frequency: 10 to 55 Hz, 0.35-mm single amplitude, acceleration 50 m/s ² , 10 sweeps of 5 min each in X, Y, and Z directions
Shock resistance	100 m/s ² , 3 times each in X, Y, and Z axes, 6 directions
Degree of protection	IP20
Terminal block type	Push-In Plus
Exterior color	Black (Munsell N 1.5)
Mounting	DIN Track mounting
Weight	Main Unit: Approx. 156 g Probe Unit: Approx. 63 g
Installation environment	Operation power supply: EN/IEC 61010-1 Over-voltage category II Pollution degree 2 Measurement circuit: EN/IEC 61010-2-030 Pollution degree 2 The measurement category is in accordance with <i>Conformance to Safety Standards</i> on page 10.

Item		Specifications
Electromagnetic environment		EN/IEC 61326-1 Industrial electromagnetic environment
Safety standards		UL 61010-1 Korean Radio Waves Act (KN 61000-6-2, KN 11) RCM
Wiring material	Wire type	Solid wire or stranded wire
	Wiring material	Copper
	Recommended wire	0.25 to 1.5 mm ² AWG 24 to AWG 16
	Stripping length Without ferrules	8 mm

Measurement Specifications

Item	Specifications
Measurement range	0.1 to 99.9 M Ω (0.0 M Ω for less than 0.1 M Ω)
Measuring accuracy	$\pm 5\%$ rdg. ± 1 digit (at ambient temperature -10 to 55°C and ambient humidity 25% to 65%)
Megger voltage	50 VDC
Measurement operation	Perform one measurement operation for each trigger. One-shot trigger.
Average count	Disabled (1 time)/Enabled (8 times)
Measurement target	Single-phase/3-phase AC induction motors An inverter-driven motor requires a contactor on the secondary coil of the inverter. Similarly, a servo motor requires a contactor on the secondary coil of the Servo Drive. A Motor with a star-delta starter must be connected to a star or delta for measurement. Also able to measure DC motors.

Input Specifications of Trigger Input Terminals

Item	Specifications
Input type	No-voltage contact and open collector are possible.
Residual voltage at short circuit	1.5 V max.
Open leakage current	0.1 mA max.
ON current at short circuit	Approx. 7 mA
Minimum detection time	Received as a valid continuous input for at least 50 ms for both ON and OFF.

Output Specifications of Transistor Output Terminals

Item	Specifications
Contact form	NPN open collector
Rated voltage	24 VDC (maximum voltage: 26.4 VDC)
Maximum current	50 mA
Leakage current when power turning OFF	0.1 mA max.
Residual voltage	1.5 V max.

Input Specifications of Voltage Input Terminals

Item	Specifications
System voltage (All are specified as line voltage)	AC waveform: <Single-phase, 2-wire, N-phase ground> Sine waveform: 100 to 600 VAC, -15% to 10% 50/60±5 Hz Thyristor waveform: 100 to 600 VAC, -15% to 10% 50/60±5 Hz (Dia.: 0° to 150°) Inverter waveform: 100 to 600 VAC, -15% to 10% 20 to 85 Hz <3-phase, 3-wire, S-phase ground> Sine waveform: 100 to 480 VAC, -15% to 10% 50/60±5 Hz Thyristor waveform: 100 to 480 VAC, -15% to 10% 50/60±5 Hz (Dia.: 0° to 150°) Inverter waveform: 100 to 480 VAC, -15% to 10% 20 to 85 Hz <3-phase, 4-wire, N-phase ground> Sine waveform: 100 to 600 VAC, -15% to 10% 50/60±5 Hz Thyristor waveform: 100 to 600 VAC, -15% to 10% 50/60±5 Hz (Dia.: 0° to 150°) Inverter waveform: 100 to 600 VAC, -15% to 10% 20 to 85 Hz DC waveform: 24 to 480 VDC, -15% to 10%

Communications Specifications

Item	Specifications
Physical layer	RS-485
Transmission path connection method	RS-485: Multidrop
Communications method	RS-485 (2-wire, half duplex)
Synchronization method	Asynchronous
Connection configurations	Master and Slave configurations are 1:1 or 1:N connections.
Maximum number of Units	32 (including one host system)
Cable length	Total 500 m max. (twisted-pair cable)
Baud rate	9.6, 19.2, 38.4 or 57.6 kbps
Data length	7/8 bits
Stop bits	1/2 bits
Error detection	Vertical parity (none/even/odd) BCC (with CompoWay/F selected), CRC-16 (with Modbus RTU selected)
Flow control	None
Retry function	None
Buffer	97 bytes
Send wait time	0 to 99 ms
Protocol	CompoWay/F and Modbus RTU

A-2 Setting Parameters List

Enter the setting value to use the parameter.

Level	Parameter name	Characters	Setting range	Description	Setting value
Protect	Setting Change Protection	WLPt	OFF/ON	Use key operations to change the setting value Enabled/Disabled	
Initial Setting	Maximum Number of Channels	MxCH	1 to 8	Total number of channels	
	Alarm Value 1	ALM1	0.0 to 99.9 MΩ	Alarm threshold value (warning) Default value: 20.0	
	Alarm Value 2	ALM2	0.0 to 99.9 MΩ	Alarm threshold value (critical) Default value: 1.0	
	Alarm Polarity	NaNC	n-o/n-c	Alarm output polarity Normally open/Normally close	
	Trigger Signal Reverse	TR-R	OFF/ON	Start measurement when trigger contact input is OFF/Start measurement when trigger contact input is ON	
	Motor Stop Waiting Time	MtWt	0 to 299 s	Time from trigger input to load stopping Default value: 10	
	Time to Wait to Stabilize	StWt	0 to 99 s	Time for the measurement value to stabilize after the Megger voltage is applied Default value: 60	
	Average Processing	AVG	OFF/ON	Average processing of measurement values None/Yes	
	Use Running Time	RGE	OFF/ON	Running time estimation function Not used/Used	
Communications Setting	Protocol	PSEL	CWF/MOD	Protocol selection CompoWay/F / Modbus RTU	
	Baud Rate	bPS	9.6/19.2/38.4/57.6 kbps	Baud rate Default value: 9.6	
	Data Length	LEN	7/8 bits	Data length Default value: 7	
	Stop Bits	StBt	1/2 bits	Stop bits Default value: 2	
	Parity	PRtY	NONE/EVEN/ODD	Parity Default value: EVEN	
	Send Wait Time	StWt	0 to 99 ms	Response wait time from the host Default value: 20	

Note Highlighted values indicate default settings.

A-3 Setting Parameter Flow

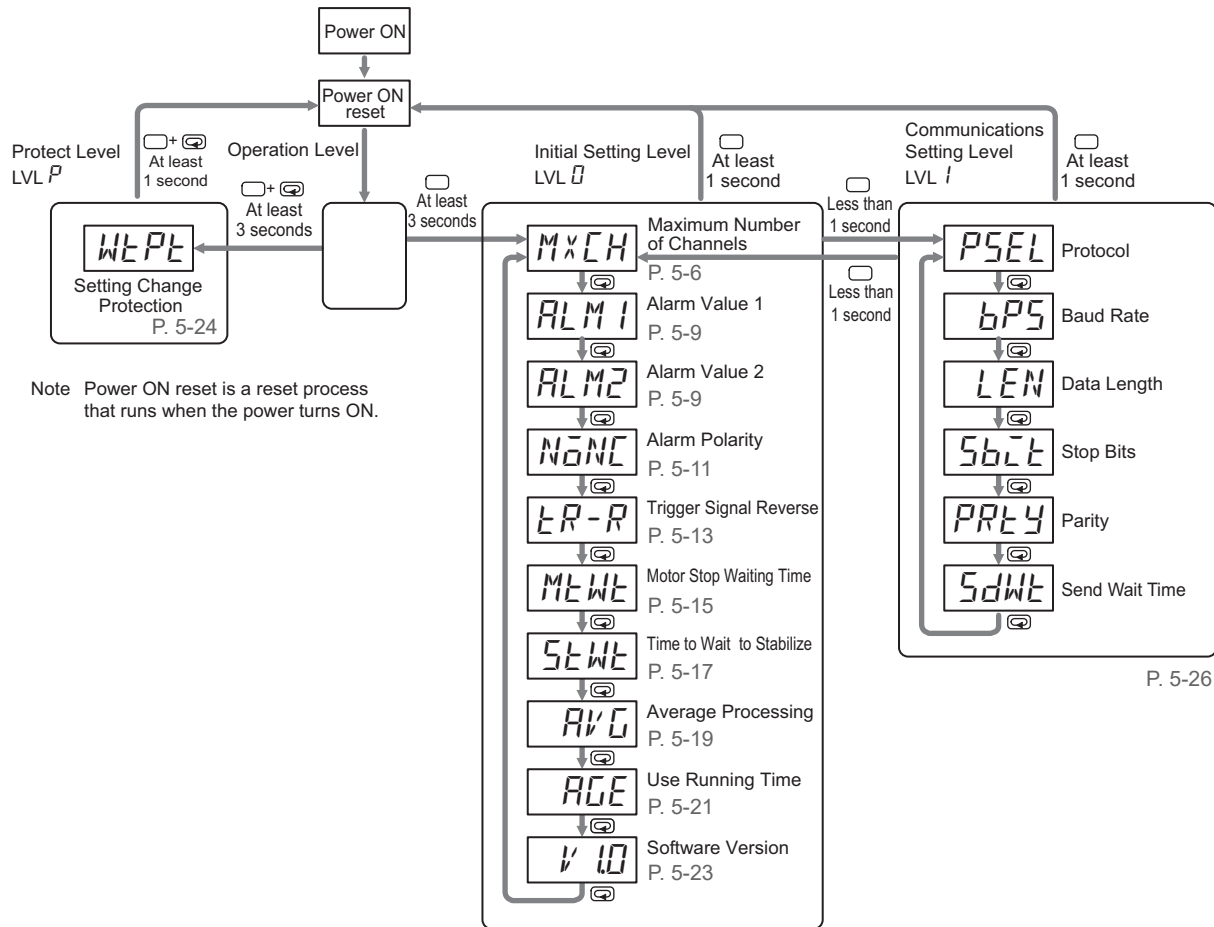

Note Power ON reset is a reset process that runs when the power turns ON.

P. 5-26

A-4 K7GE-MG Logging Tool

The K7GE-MG Logging Tool (this tool) makes it easy to perform remote monitoring.

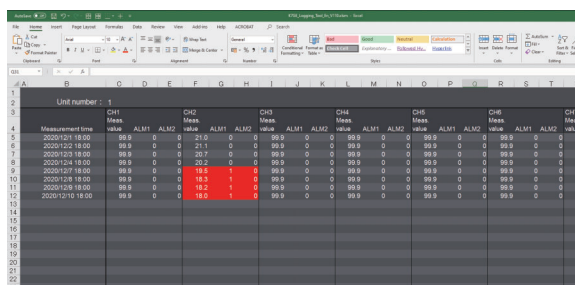

The main specifications of this tool are as follows:

- Data for up to five sets of the monitoring device can be logged.
- A maximum of eight Probe Units can be included in one set.
- The measurement values and alarm status data for each set can be logged. Up to 1,000 values of data can be logged.
- The setting parameters can be read and written.

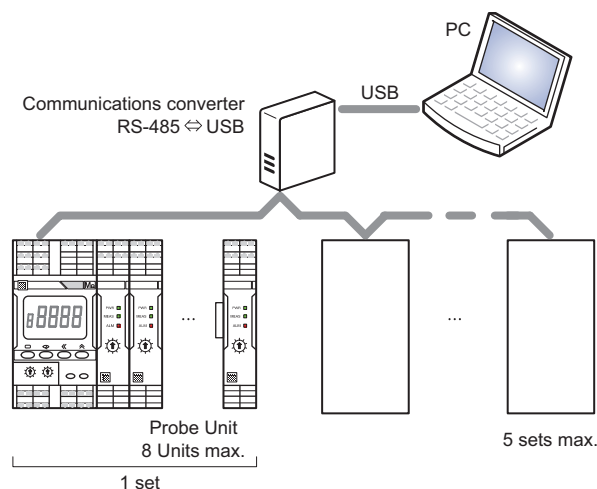

The system requirements are as follows.

Supported OS	Windows 10 64-bit edition, English or Japanese
PC specifications	1 GHz or faster CPU, 1 GB or more of RAM, and 16 GB or more of reserved disk area
Excel	Excel 2019 32-bit or 64-bit edition, English or Japanese * For Excel 2013/2016 32-bit edition, OMRON performed a connection test only on the Japanese version in combination with the Japanese version of Windows 10.
RS485-USB communications converter	Use a commercially available product. * OMRON performed an evaluation test on the SI-35USB-2 manufactured by LINE EYE. (The driver version is V2.12.18.)

Refer to Help in this tool for details on using this tool.

You can download the latest version of this tool from the following OMRON website.

https://www.ia.omron.com/k7ge_tool

In the interest of product improvement, the K7GE-MG Logging Tool specifications are subject to change without notice.

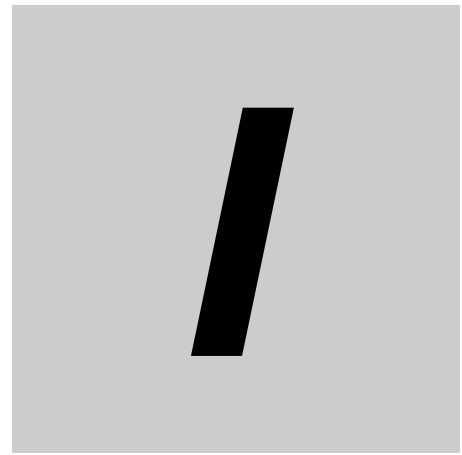

Index



Index

A	
Alarm Polarity	5-11
Alarm Values 1 and 2	5-9
Apply Megger voltage	1-15
Automatic measurement is ended	4-6
Automatic Measurement Start Command	6-9
Average Processing	5-19
B	
Baud Rate	5-26
C	
CH	11
Channels	11
Command frame (CompoWay/F)	6-14
Command frame (Modbus RTU)	6-22
Communications method	6-3
Communications Setting Level	5-3
Communications setting parameters	5-26
Communications specifications	A-5
CompoWay/F	11
CRC-16 calculation method	6-22
Current limiter	1-15
D	
Data Length	5-26
Discharge of electric charge	1-14, 4-5
F	
Factory Interface Network Service	11
FINS	11
FINS-mini text	6-16
I	
Initial Setting Level	5-3
Initialize Command	6-11
Input specifications of trigger input terminals	A-3
Input specifications of voltage input terminals	A-4
K	
K7GE-MG	11
L	
Level	5-2
M	
Main Unit	11, 1-2, 1-6, 1-8, 1-9, 1-12, 3-2
Maximum Number of Channels	5-6
Measurement	1-15
Measurement specifications	A-3
Measurement values and status	6-5
Megger method	11
Megger voltage	11, 1-15
Megohmmeter	11
Modbus RTU	11
Monitoring state	5-4
Motor stop standby	4-4
Motor Stop Waiting Time	5-15
O	
Operation Level	5-3
Operation power supply terminals	3-10
Output specifications of transistor output terminals	A-4
P	
Parasitic capacitance	11
Parity	5-26
PE	11
PE terminals	3-11
Power ON reset	11
Probe Unit	11, 1-2, 1-6, 1-8, 1-11, 1-13, 3-2
Product data	6-5
Protect Level	5-3
Protective earthing	11
Protocol selection	5-26
R	
Ratings and specifications	A-2
Recommended ferrules	3-9
Recommended flat-blade screwdrivers	3-9
Response frame (CompoWay/F)	6-15
Response frame (Modbus RTU)	6-23
S	
Sampling	4-6
Send Wait Time	5-26
Setting Change Protection	5-24
Setting change state	5-4
Setting parameter	5-4, 5-5, 6-5, A-6, A-7
Setting value	5-4
Software Reset Command	6-10
Software Version	5-23
Specifications of the Push-In Plus terminal blocks	3-8
Stop Bits	5-26
T	
Time to Wait to Stabilize	5-17
Transistor output terminals	3-11

Trigger by a communications command4-3
Trigger by an external contact4-2
Trigger input 1-12, 1-14, 4-2
Trigger input terminals3-10
Trigger signal 1-12, 1-16, 4-2, 4-8, 5-13
Trigger Signal Reverse5-13
Types of communications commands6-4

U

Use Running Time5-21

V

Voltage input terminals3-12
Voltage monitoring 1-14

W

Waiting for stability4-5

OMRON Corporation Industrial Automation Company

Kyoto, JAPAN

Contact : www.ia.omron.com

Regional Headquarters

OMRON EUROPE B.V.

Wegalaan 67-69, 2132 JD Hoofddorp
The Netherlands
Tel: (31) 2356-81-300 Fax: (31) 2356-81-388

OMRON ELECTRONICS LLC

2895 Greenspoint Parkway, Suite 200
Hoffman Estates, IL 60169 U.S.A.
Tel: (1) 847-843-7900 Fax: (1) 847-843-7787

OMRON ASIA PACIFIC PTE. LTD.

438B Alexandra Road, #08-01/02 Alexandra
Technopark, Singapore 119968
Tel: (65) 6835-3011 Fax: (65) 6835-2711

OMRON (CHINA) CO., LTD.

Room 2211, Bank of China Tower,
200 Yin Cheng Zhong Road,
PuDong New Area, Shanghai, 200120, China
Tel: (86) 21-5037-2222 Fax: (86) 21-5037-2200

Authorized Distributor:

©OMRON Corporation 2021-2022 All Rights Reserved.
In the interest of product improvement,
specifications are subject to change without notice.

Cat. No. N224-E1-03 0922 (0922)