

OMRON

Smart Power Monitor

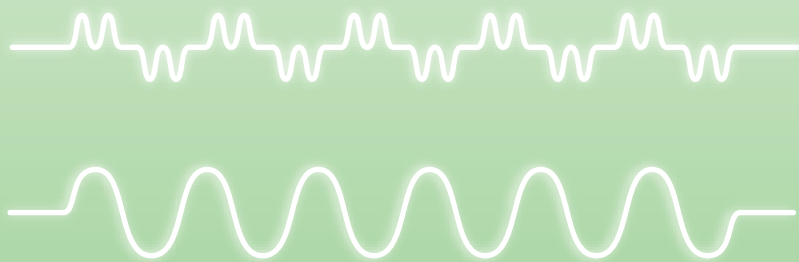

KM50

Cut Energy Losses

Communications Manual

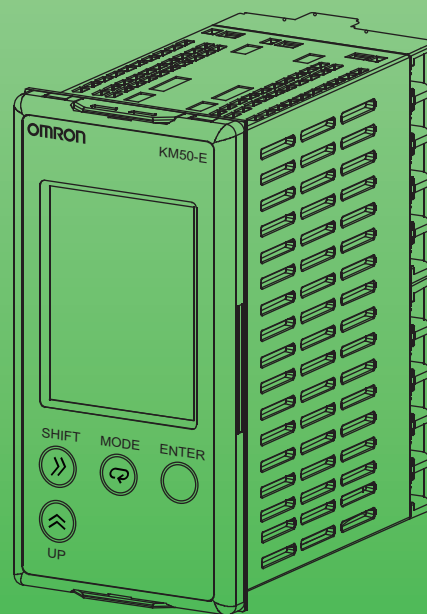
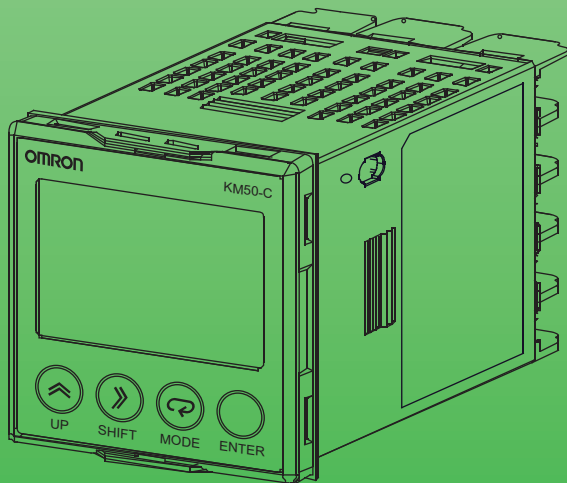

Introduction

Serial communications can be used for the KM50-C/-E.

This manual describes the communications functions that are supported by the KM50-C/-E.

Read and understand this manual before attempting to use communications, and use the communications functions correctly.

Keep this manual in a safe and convenient location so that it can be used as reference whenever required.

Read and Understand this Manual

Please read and understand this manual before using the product. Please consult your OMRON representative if you have any questions or comments.

Warranty and Limitations of Liability

WARRANTY

OMRON's exclusive warranty is that the products are free from defects in materials and workmanship for a period of one year (or other period if specified) from date of sale by OMRON.

OMRON MAKES NO WARRANTY OR REPRESENTATION, EXPRESS OR IMPLIED, REGARDING NON-INFRINGEMENT, MERCHANTABILITY, OR FITNESS FOR PARTICULAR PURPOSE OF THE PRODUCTS. ANY BUYER OR USER ACKNOWLEDGES THAT THE BUYER OR USER ALONE HAS DETERMINED THAT THE PRODUCTS WILL SUITABLY MEET THE REQUIREMENTS OF THEIR INTENDED USE. OMRON DISCLAIMS ALL OTHER WARRANTIES, EXPRESS OR IMPLIED.

LIMITATIONS OF LIABILITY

OMRON SHALL NOT BE RESPONSIBLE FOR SPECIAL, INDIRECT, OR CONSEQUENTIAL DAMAGES, LOSS OF PROFITS OR COMMERCIAL LOSS IN ANY WAY CONNECTED WITH THE PRODUCTS, WHETHER SUCH CLAIM IS BASED ON CONTRACT, WARRANTY, NEGLIGENCE, OR STRICT LIABILITY.

In no event shall the responsibility of OMRON for any act exceed the individual price of the product on which liability is asserted.

IN NO EVENT SHALL OMRON BE RESPONSIBLE FOR WARRANTY, REPAIR, OR OTHER CLAIMS REGARDING THE PRODUCTS UNLESS OMRON'S ANALYSIS CONFIRMS THAT THE PRODUCTS WERE PROPERLY HANDLED, STORED, INSTALLED, AND MAINTAINED AND NOT SUBJECT TO CONTAMINATION, ABUSE, MISUSE, OR INAPPROPRIATE MODIFICATION OR REPAIR.

Application Considerations

SUITABILITY FOR USE

OMRON shall not be responsible for conformity with any standards, codes, or regulations that apply to the combination of products in the customer's application or use of the products.

At the customer's request, OMRON will provide applicable third party certification documents identifying ratings and limitations of use that apply to the products. This information by itself is not sufficient for a complete determination of the suitability of the products in combination with the end product, machine, system, or other application or use.

The following are some examples of applications for which particular attention must be given. This is not intended to be an exhaustive list of all possible uses of the products, nor is it intended to imply that the uses listed may be suitable for the products:

- Outdoor use, uses involving potential chemical contamination or electrical interference, or conditions or uses not described in this manual.
- Nuclear energy control systems, combustion systems, railroad systems, aviation systems, medical equipment, amusement machines, vehicles, safety equipment, and installations subject to separate industry or government regulations.
- Systems, machines, and equipment that could present a risk to life or property.

Please know and observe all prohibitions of use applicable to the products.

NEVER USE THE PRODUCTS FOR AN APPLICATION INVOLVING SERIOUS RISK TO LIFE OR PROPERTY WITHOUT ENSURING THAT THE SYSTEM AS A WHOLE HAS BEEN DESIGNED TO ADDRESS THE RISKS, AND THAT THE OMRON PRODUCTS ARE PROPERLY RATED AND INSTALLED FOR THE INTENDED USE WITHIN THE OVERALL EQUIPMENT OR SYSTEM.

PROGRAMMABLE PRODUCTS

OMRON shall not be responsible for the user's programming of a programmable product, or any consequence thereof.

Disclaimers

CHANGE IN SPECIFICATIONS

Product specifications and accessories may be changed at any time based on improvements and other reasons.

It is our practice to change model numbers when published ratings or features are changed, or when significant construction changes are made. However, some specifications of the products may be changed without any notice. When in doubt, special model numbers may be assigned to fix or establish key specifications for your application on your request. Please consult with your OMRON representative at any time to confirm actual specifications of purchased products.

DIMENSIONS AND WEIGHTS

Dimensions and weights are nominal and are not to be used for manufacturing purposes, even when tolerances are shown.

PERFORMANCE DATA

Performance data given in this manual is provided as a guide for the user in determining suitability and does not constitute a warranty. It may represent the result of OMRON's test conditions, and the users must correlate it to actual application requirements. Actual performance is subject to the OMRON Warranty and Limitations of Liability.

ERRORS AND OMISSIONS

The information in this document has been carefully checked and is believed to be accurate; however, no responsibility is assumed for clerical, typographical, or proofreading errors, or omissions.

© OMRON, 2010

All rights reserved. No part of this publication may be reproduced, stored in a retrieval system, or transmitted, in any form, or by any means, mechanical, electronic, photocopying, recording, or otherwise, without the prior written permission of OMRON.

No patent liability is assumed with respect to the use of the information contained herein. Moreover, because OMRON is constantly striving to improve its high-quality products, the information contained in this manual is subject to change without notice. Every precaution has been taken in the preparation of this manual. Nevertheless, OMRON assumes no responsibility for errors or omissions. Neither is any liability assumed for damages resulting from the use of the information contained in this publication.

Safety Precautions

● Definition of Precautionary Information

The following notation is used in this manual to provide precautions that are required to ensure safe usage of the KM50-C/-E.

The safety precautions that are provided are extremely important to safety. Always read and heed the information provided in all safety precautions.

The following notation is used.

Meanings of Signal Words







Caution

Indicates a potentially hazardous situation which, if not avoided, may result in minor or moderate injury, or property damage.

● Symbols

Symbol	Meaning
	<ul style="list-style-type: none">● Disassembly Prohibition Indicates prohibitions when there is a possibility of injury, such as from electric shock, as the result of disassembly.
	<ul style="list-style-type: none">● General Mandatory Caution Indicates non-specific general actions that are required by the user.
	<ul style="list-style-type: none">● Electrical Shock Caution Indicates the possibility of electric shock under specific conditions.

● Safety Precautions

 Caution	
<p>Property damage may occasionally occur due to fire. Tighten terminal screws to the specified tightening torque. The recommended tightening torque is 0.69 to 0.88 N·m. Confirm that the screws are straight (i.e., not at an angle) after tightening them.</p>	
<p>Minor or moderate bodily harm or property damage may occasionally occur due to explosion. Do not use the product near inflammable or explosive gas.</p>	
<p>Destruction or rupture may occasionally occur. Make sure that the power supply voltage is within specifications.</p>	
<p>Destruction or rupture may occasionally occur. The voltage input circuit and CT secondary circuit are not isolated. If a Special CT is grounded, incorrect wiring will short-circuit the voltage input and the secondary circuit of the CT. To prevent failure, do not ground a Special CT. The Power Monitor uses a Special CT. Correct measurements can be made even if the CT is not grounded.</p>	
<p>Electric shock may occasionally occur. Always turn OFF the power supply before connecting CTs.</p>	
<p>Electric shock may occasionally occur. Do not touch any of the terminals while the power is being supplied.</p>	
<p>Electric shock may occasionally occur. The voltage input circuit and CT secondary circuit are not isolated. Do not touch the secondary side of the Special CT.</p>	
<p>Electrical shock, minor injury, fire, or equipment malfunction may occasionally occur. Do not attempt to disassemble, modify, or repair the product.</p>	

Precautions for Safe Use

The following items must be observed to prevent failure to operate and malfunctions of the product and to prevent adverse effects on performance and functions of the product.

- 1) Do not store, install, or use the product in the following locations.
 - Locations that are greatly affected by vibration or shock
 - Unstable locations
 - Outdoors or locations that are subject to direct sunlight, wind, or rain
 - Locations where the specified range of temperature or humidity would be exceeded
 - Locations that are subject to rapid changes in temperature or humidity where condensation or icing may occur
 - Locations that are affected by static electricity or noise
 - Locations that are subject to corrosive gas (particularly sulfide or ammonia gas)
 - Locations that are subject to dust or iron powder
 - Locations that are subject to flooding or oil
 - Locations that are affected by electric or magnetic fields
 - Locations that are subject to splashing brine
- 2) Install the product in a panel with a panel thickness of 1 to 5 mm for the KM50-C and with a thickness of 1 to 8 mm for the KM50-E.
If a suitable panel thickness is not used or the product is installed incorrectly, the product may come free from the mounting.
- 3) Do not attempt to pull the internal part of the product out of the case.
Pulling out the internal part of the product will increase the contact resistance of the internal terminals, possibly damaging measurement accuracy.
- 4) Read and understand this manual before attempting to install, use, or maintain the product.
Electric shock, injury, accidents, failure, or malfunction may occur.
- 5) Always check the wiring and confirm that it is correct before turning ON the power supply.
Incorrect or improper wiring may result in electrical shock, injury, accidents, failure, or malfunction.
- 6) Use power supplies and wires with suitable specifications for the control power supply and the power supply for inputs and other parts of the system. Failure, burning, or electrical shock may result.
- 7) Do not install the product near sources of heat, such as devices with coils or windings.
- 8) Check all terminal numbers before wiring.
- 9) Do not connect anything to unused terminals.
- 10) Use crimp terminals that are suitable for M3.5 screws.
- 11) Install the product well separated from devices with strong high-frequency noise (such as high-frequency welders or sewing machines) or devices that generate surge.
- 12) To prevent inductive noise, wire the lines connected to the product separately from power lines carrying high voltages or currents. Do not wire in parallel with or in the same cable as power lines. Other measures for reducing noise include running lines in separate ducts and using shields.
- 13) Do not touch conductive metal parts on the product or the CT terminals while power is being supplied.
- 14) Do not use the product for measurement on the secondary side of an inverter.
- 15) Do not block the ventilation holes in or the areas around the product to ensure proper dissipation of heat.
- 16) Touch grounded metal to discharge any static electricity before touching the product.
- 17) Do not remove the terminal blocks from the product. Doing so may cause failure or malfunction.
- 18) Do not continue to use the product if the front surface peels or becomes cracked.
Water may enter the product.
- 19) Install and suitably label a switch or circuit breaker that complies with relevant requirements of IEC 60947-1 and IEC 60947-3 so that the operator can immediately turn OFF the power supply.
- 20) When using the product in an Overvoltage Category III environment, externally install varistors between the power supply and voltage measurement inputs to the product.
- 21) Use only the Special CTs and Special CT Cable specified by OMRON.
 - Special CTs: KM20-CTF-5A, KM20-CTF-50A, KM20-CTF-100A,
KM20-CTF-200A, KM20-CTF-400A, and KM20-CTF-600A
 - Special CT Cable: KM20-CTF-CB3 (3 m)
- 22) The Power Monitor is a Class A product (for use in industrial environments). In residential environment areas, it may cause radio interference. If it causes radio interference, the user may be required to take adequate measures to reduce interference.

Installation Precautions

● Maintaining Product Life

Use the KM50 within the following temperature and humidity ranges.

Temperature: –10 to 55°C (with no icing or condensation), Humidity: 25% to 85%

When the KM50 is installed in a control panel, ensure that the temperature around the KM50 (not the temperature around the panel) does not exceed 55°C.

Some of the electronic components used in the KM50 have limited service lives. The life of these components depends on the ambient temperature. The service lives will be shorter at higher temperatures and longer at lower temperatures. The life of the KM50 can thus be extended by lowering the internal temperature. If more than one KM50-E Power Monitor is mounted side by side or top to bottom, the heat generated by the Power Monitors will cause the internal temperatures to increase, shortening the lives of the Power Monitors. To prevent the internal temperature from increasing, forced cooling, such as fans to cool the Power Monitors, must be considered.

● Noise Countermeasures

To prevent inductive noise, wire the lines connected to the terminal block on the KM50 separately from power lines carrying high voltages or currents. Do not wire in parallel with or in the same cable as power lines. Other measures for reducing noise include running lines in separate ducts and using shields.

Attach surge absorbers or noise filters to nearby equipment that generates noise (particularly equipment with a high inductance component, such as motors, transformers, or magnetic coils).

Install the product as far as possible away from devices with strong high-frequency noise (such as high-frequency welders or sewing machines) or devices that generate surge.

● Waterproof Performance

The KM50 provides the following degree of protection. Any parts for which a degree of protection is not given or for which the degree of protection is given as IP□0 are not waterproof to any degree.

Front panel: IP66 (with enclosed Waterproof Packing), Rear case: IP20, Terminal section: IP00

Precautions for Correct Use

- 1) Make sure that all parameters are set suitably for the measurement target.
- 2) This product is not a Special Measuring Instrument that has passed testing by a specified body under the Measurement Act of Japan. It cannot be used to certify power consumption under Japanese law.
- 3) Do not use solvents, such as paint thinners, to clean the product. Use commercially available alcohol instead.
- 4) Make sure the rated voltage is reached within 2 seconds after the power is turned ON.
Otherwise, the product may not operate correctly.
- 5) When discarding the product, properly dispose of it as industrial waste according to all applicable local ordinances.
- 6) If a water-proof structure is required, install the enclosed Waterproof Packing. Depending on the application environment, the Waterproof Packing can deteriorate, shrink, or harden. We recommend that you replace it periodically.
Waterproof Packing: Y92S-29 for the KM50-C and Y92S-P5 for the KM50-E
- 7) Remove the protective film from the front of the product before using the product.
- 8) Wire the middle row (terminals 11 to 15 for the KM50-C and terminals 21 to 30 for the KM50-E) last.
- 9) Provide a separate power supply for the KM50-E from the measurement voltage.
- 10) Reception interference may occur if the KM50 is installed near radios, televisions, or other wireless devices.

Preoperational Checks

Read the *Instruction Sheet* that is provided with the KM50 and check the following items.

Process	Item to check	Description
Immediately after purchase	External appearance	After you purchase the KM50, make sure there are no dents in the KM50 or the packaging box. If there is internal damage, correct measurements may not be possible depending on the location of the damage.
	Model number and specifications	Make sure that the specifications of the product you purchased match the required specifications.
Installation	Installation location	Do not block the area around the KM50 to ensure proper dissipation of heat. Do not block the ventilation holes in the KM50. Provide space between the KM50 Power Monitors when installing them side by side to prevent wiring from coming into contact with adjacent Power Monitors.
Wiring	Terminal wiring	When tightening terminal screws, do not subject the terminals to excessive stress. Tighten the terminal screws to a torque of 0.69 to 0.88 N·m and then make sure there are no loose screws. Check terminal polarity and wire all terminals correctly.
	Power supply and voltage inputs	Wire the power supply and voltage inputs correctly. Incorrect wiring may damage internal circuits.
Application environment	Ambient temperature	The ambient operating temperature of the KM50 is -10 to 55°C (with no condensation or icing). To extend the service life, install the KM50 to maintain the ambient temperature as low as possible. If higher temperatures are unavoidable, consider using forced cooling with a fan.
	Vibration and shock	Make sure that the vibration and shock in the installation environment do not exceed the specified specifications. (Install the KM50 as far away from conductors to prevent subjecting the KM50 to vibration and shock.)
	Foreign matter	Install the KM50 so that liquids and other foreign matter will not enter it. If sulfuric gas, chloride gas, or other corrosive gases are generated in the installation environment, remove the source of the gas, install exhaust fans, or take other measures to remove the gas.

Revision History

A manual revision code appears as a suffix to the catalog number on the back cover of the manual.

Cat. No. ???

Revision code	Date	Revised content
A	June 2010	Original production
B	March 2011	Made revisions for version upgrade.

About this Manual

This manual is divided according to the communications protocol.

Read the section for the system that you are using.

Information is provided together for the KM50-C and KM50-E.

Information that applies only to the KM50-E is marked "KM50-E only."

There is a parameter called Instantaneous Power in the Basic Level of the Measurement Mode. This parameter has been changed to Active Power to avoid confusion.

Related Manuals

This manual describes the communications functions that are supported by the KM50-C/-E.

Refer to the *Smart Power Monitor Operation Manual* (KM50-C: Cat. No. N163, KM50-E: Cat. No. N164) for information on the functions of the Power Monitor.

Table of Contents

Introduction	I
Safety Precautions.....	IV
Precautions for Safe Use	VI
Installation Precautions.....	VII
Precautions for Correct Use.....	VIII
Preoperational Checks.....	IX
Revision History	IX
Table of Contents.....	XI
Section 1 Overview	1-1
1.1 Communications Protocols.....	1-2
■ Introduction	1-2
■ Communications Specifications.....	1-3
■ Transmission Procedure.....	1-3
■ Interface	1-3
■ Wiring.....	1-4
■ Communications Parameters	1-4
Section 2 CompoWay/F Communications Protocol	2-1
2.1 Data Formats.....	2-2
■ Command Frame.....	2-2
■ BCC Calculation Example	2-3
■ Response Frame	2-3
■ Communications Data	2-4
■ End Code Examples.....	2-4
2.2 Structure of Command Text	2-5
■ PDU (Protocol Data Unit) Structure.....	2-5
■ Variable Areas and Parameter Areas.....	2-5
■ Area Definitions	2-6
■ Type Codes	2-6
■ Addresses.....	2-7
■ Number of Elements.....	2-7
■ List of Services	2-7
2.3 Detailed Descriptions of Services.....	2-8
■ Read Variable Area	2-8
■ Read Parameter Area.....	2-10
■ Write Parameter Area.....	2-12
■ Read Controller Attributes	2-14
■ Read Controller Status	2-15
■ Read Time Data.....	2-16
■ Write Time Data.....	2-17
■ Echoback Test.....	2-18

	■ Operation Command	2-19
2.4	Response Codes.....	2-21
Section 3	CompoWay/F Communications Data.....	3-1
3.1	Variable Area	3-3
3.2	Status Information	3-44
3.3	Parameter Area.....	3-45
Section 4	Modbus Communications Protocol	4-1
4.1	Data Formats	4-2
	■ Command Frames	4-2
	■ Response Frames	4-3
	■ Error Codes.....	4-4
4.2	Function List.....	4-5
4.3	Variable Area	4-6
	■ Addresses	4-6
	■ Number of Elements	4-6
	■ Set Values.....	4-6
4.4	Detailed Descriptions of Services.....	4-7
	■ Read Variable Area	4-7
	■ Write Variable Area.....	4-9
	■ Operation Command	4-11
	■ Echoback Test.....	4-13
Section 5	Modbus Communications Data	5-1
5.1	Variable Area	5-3
5.2	Status Information	5-40
5.3	Variable Area Setting Ranges	5-41
Appendices	A-1
	ASCII Table	A-2
	Troubleshooting	A-3

Index



Section 1 Overview

1. 1	Communications Protocols	1-2
	■ Introduction	1-2
	■ Communications Specifications	1-3
	■ Transmission Procedure	1-3
	■ Interface	1-3
	■ Wiring	1-4
	■ Communications Parameters	1-4

1.1 Communications Protocols

■ Introduction

Communications can be used to monitor measurement data, collect measurement data, and change settings for the KM50-C/-E from a host (e.g., computer). A program must be created for the host. This manual describes communications from the viewpoint of the host.

CompoWay/F is a general-purpose OMRON serial communications protocol. The CompoWay/F protocol supports standard frame formats and FINS*-compliant commands, which are widely used by OMRON Programmable Controllers and other devices, for easy communications between a host and components.

* FINS (Factory Interface Network Service) is a protocol for messaging between controllers on OMRON FA networks.

Modbus is a communications protocol that complies with the RTU Mode of the Modbus protocol (PI-MBUS-300 Rev. J) from Schneider Electric. Modbus is a registered trademark of Schneider Electric. It supports the same functions as those provided by CompoWay/F for reading variable areas, writing variable areas, executing operation commands, and executing echoback testing.

The following communications functions are supported by the KM50-C/-E.

- Reading/writing parameters
- Operation commands
- Changing the operating mode

The following conditions apply to the communications functions.

Writing parameters is possible only in one of the Setting Modes.

Changes to parameters that are made in a Setting Mode are enabled by changing to Measurement Mode.

■ Communications Specifications

Communications protocol	CompoWay/F	Modbus (RTU)
Transmission path connections	Multidrop	
Communications method	Two-wire, half-duplex	
Sync method	Start-stop	
Baud rate	1.2, 4.8, 9.6 , 19.2, 38.4 kbps	
Transmission code	ASCII	Binary
Data length	7 or 8 bits	Always 8 bits (no setting available)
Stop bits	1 or 2 bits	Automatically set according to the setting of the vertical parity (no setting available). No vertical parity: 2 bits Odd or even vertical parity: 1 bit
Error detection	Vertical parity (even , odd, or none) BCC (block check character)	Vertical parity (even , odd, or none) CRC-16 (Cyclical Redundancy Check)
Flow control	None	
Interface	RS-485	
Retry function	None	
Communications response transmission wait time	0 to 99 ms, default: 20 ms	

- * Default settings are given above with a gray background.
- * CompoWay/F is the default communications protocol.
- * The baud rate, data length, number of stop bits, and vertical parity can all be set individually.

■ Transmission Procedure

The host (e.g., computer) sends a command frame. The KM50-C/-E returns a response according to the contents of the command. One response frame is always returned for each command frame. The operation of command frames and response frames is illustrated below.

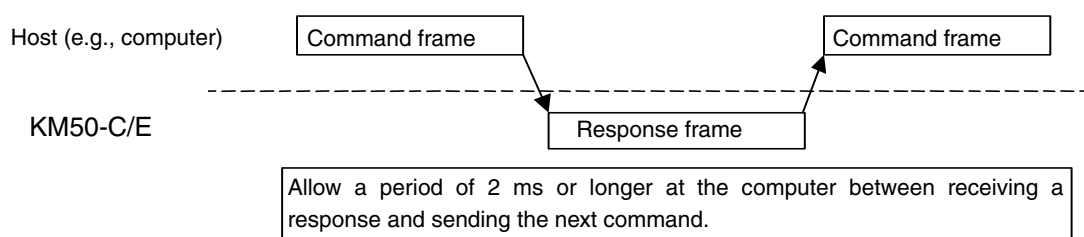

■ Interface

The host must perform communications that comply with an RS-485 interface.
Use the K3SC to convert between the RS-485 and an RS-232C interface.

■ Wiring

● RS-485

- The connection configuration is 1:1 or 1:N. For a 1:N configuration, up to 31 KM50-C/-E nodes can be connected for CompoWay/F and up to 99 KM50-C/-E nodes can be connected for Modbus.

The host (e.g., computer) is not counted as a node for these limits.

- The maximum total cable length is 500 m.
- Use shielded twisted-pair cables with wires of AWG24 to AWG14 (cross-sectional areas of 0.205 to 2.081 mm²).
- Terminating resistance must be connected to the nodes at the ends of the transmission path (including the host).

Use a terminating resistance of 120 Ω (1/2 W) at each end.

The communications specifications of the host must match those of the KM50-C/-E. For a 1:N configuration, the communications specifications of all nodes must match. Each node, however, must have a unique communications unit number. This manual describes how to set the communications specifications for the KM50-C/-E. Refer to user documentation for your host to set the host communications specifications.

■ Communications Parameters

The communications specifications for the KM50-C/-E are set in Communications Setting Mode.

The following table lists the communications parameters and set values.

Parameter	Set values	Default setting
Communications Protocol	CompoWay/F or Modbus	CompoWay/F
Unit Number	00 to 99	01
Baud Rate	1.2, 4.8, 9.6, 19.2, or 38.4 (kbits/s)	9.6 (kbits/s)
Data Length	7 or 8 (bits)	7 (bits)
Stop Bits	1 or 2 (bits)	2 (bits)
Vertical Parity	Even, odd, or none	Even
Transmission Wait Time	00 to 99 (ms)	20 (ms)

● Communications Parameters

Changes to the settings are enabled when you return to Measurement Mode.

• Protocol Selection (*B0.P5L*)

Select the communications protocol. You can select either CompoWay/F or Modbus.

If Modbus is selected, the data length will always be 8 bits and the number of stop bits will be set automatically according to the vertical parity.

No vertical parity: 2 bits

Odd or even vertical parity: 1 bit

• Communications Unit Number (*B1.UN0*)

The communications unit number is used to differentiate between different nodes when communicating from the host. The communications unit number can be set to integers between 0 to 99.

The default setting is 1. If the same communications unit number is set for more than one node, normal operation will not be possible.

• Baud Rate (*B2.bP5*)

Set the baud rate for communications with the host. The baud rate settings are as follows:

1.2 (1.2kbps), 2.4 (2.4kbps), 4.8 (4.8kbps), 9.6 (9.6kbps), 19.2 (19.2kbps), or 38.4 (38.4kbps)

• Data Length (*B3.LEN*)

Set the communications data bit length. The bit length can be 7 bits or 8 bits.

• Stop Bits (*B4.5bt*)

Set the number of communications stop bits. Either one or two stop bits can be set.

• Vertical Parity (*B5.PRT*)

Select the vertical parity. The parity can be set to none, even, or odd.

• Transmission Wait Time (*B6.5dW*)

The transmission wait time can be set to between 0 and 99 ms in 1-ms increments. The default setting is 20 ms.

Section 2 CompoWay/F Communications Protocol

This section describes performing communications using the CompoWay/F protocol.

2.1	Data Formats	2-2
	■ Command Frame	2-2
	■ BCC Calculation Example	2-3
	■ Response Frame	2-3
	■ Communications Data	2-4
	■ End Code Examples	2-4
2.2	Structure of Command Text	2-5
	■ PDU (Protocol Data Unit) Structure	2-5
	■ Variable Areas and Parameter Areas	2-5
	■ Area Definitions	2-6
	■ Type Codes	2-6
	■ Addresses	2-7
	■ Number of Elements	2-7
	■ List of Services	2-7
2.3	Detailed Descriptions of Services	2-8
	■ Read Variable Area	2-8
	■ Read Parameter Area	2-10
	■ Write Parameter Area	2-12
	■ Read Controller Attributes	2-14
	■ Read Controller Status	2-15
	■ Read Time Data	2-16
	■ Write Time Data	2-17
	■ Echoback Test	2-18
	■ Operation Command	2-19
2.4	Response Codes	2-21

2.1 Data Formats

In this manual, hexadecimal numbers are indicated by "hex" placed after the number. All other numbers indicate ASCII characters. The numbers below the various parts of the frame are the number of bytes.

■ Command Frame

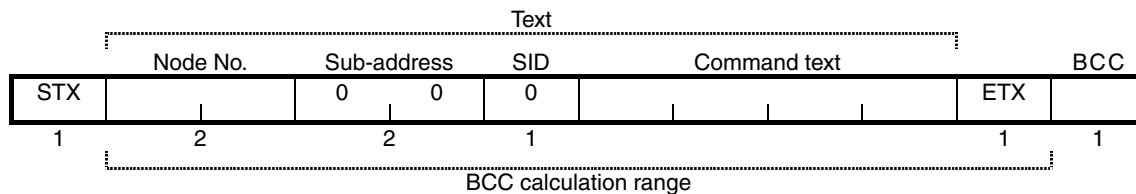

STX	This code (02 hex) indicates the beginning of a communications frame. Always place this code in the first byte. If the STX is received during data reception, reception will be started over from where the STX is received.
Node No.	<ul style="list-style-type: none"> • The node number indicates the destination of the frame. • For the KM50-C/-E, specify the communications unit number. • Either a number from 00 to 99 or "XX" (uppercase) can be set for the node number. • "XX" specifies broadcasting. Responses are not returned for broadcast command frames. • Responses are also not returned if any other node numbers are specified.
Sub-address	This is not used by the KM50-C/-E. Always set it to 00.
SID (service ID)	This is not used by the KM50-C/-E. Always set it to 00.
Command text	This is the command text. Refer to <i>2.2 Structure of Command Text</i> for details.
ETX	This code (03 hex) indicates the end of a communications frame.
BCC	This is the block check character. The BCC is found by taking the exclusive OR of the bytes from the node number through the ETX.

■ BCC Calculation Example

The BCC (Block Check Character) is determined by finding the exclusive OR of the bytes from the node number through the ETX. The 8-bit result is written to the BCC byte at the end of the frame.

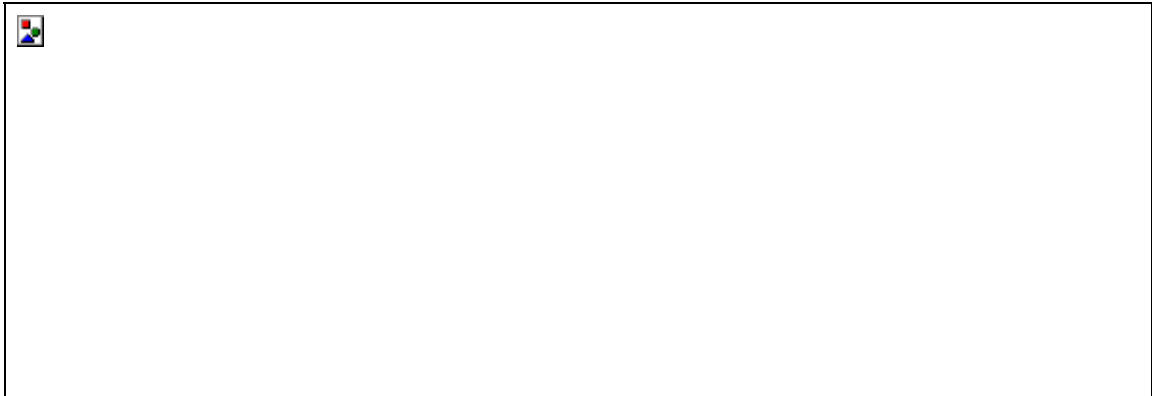

■ Response Frame

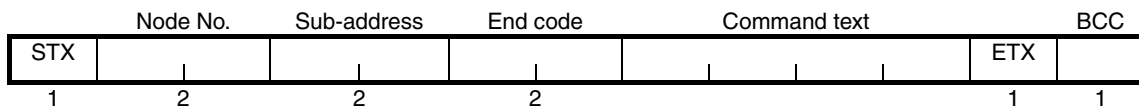

End code	Name	Description	Error detection priority
00	Normal completion	The command ended normally without error.	None
0F	FINS command error	The specified FINS command could not be executed. The FINS response code should indicate why the command could not be executed.	7
10	Parity error	The sum total of "1" bits in the received data does not match the set value of the communications parity bit.	2
11	Framing error	The stop bit is 0.	1
12	Overrun error	An attempt was made to transfer new data when the reception data buffer was already full.	3
13	BCC error	The calculated BCC value is different from the received BCC value.	6
14	Format error	<ul style="list-style-type: none"> The command text contains characters other than 0 to 9 and A to F. This error does not apply to echoback tests. (Refer to <i>Echoback Test</i> for details.) There was no SID and command text. There was no command text. The MRC/SRC was not included in command text. 	5
18	Frame length error	The received frame exceeds the specified (supported) number of bytes.	4

- An end code is returned for each command frame received by the addressed node.
- No response will be returned unless the command frame contains all elements up to the ETX and BCC.
- The "error detection priority" indicates the priority when two or more errors occur simultaneously.

■ Communications Data

Communications protocol	Set value (monitor value)	Negative values	Decimal points
CompoWay/F	8-digit hexadecimal	Two's complement	Data is converted to hexadecimal without the decimal point. Example: 105.0 → 1050 → 0000 041A hex

■ End Code Examples

The following examples show the end codes that are returned when the command could not be processed normally.

Example 1: Sub-address Less Than Two Characters, No SID, and No Command Text

• Command

	Node No.		BCC
STX		ETX	

One sub-address character is missing.

• Response

	Node No.	Sub-address	End code	BCC
STX		0 0	1 4	ETX

The sub-address is 00 and the end code is 14 (format error).

Example 2: No Command Text

• Command

	Node No.	Sub-address	SID	BCC
STX		0 0	0	ETX

• Response

	Node No.	Sub-address	End code	BCC
STX		0 0	1 4	ETX

The end code is 14 (format error).

Example 3: No Node Number

• Command

		BCC
STX	ETX	

One node number character is missing.

• Response

No response is returned.

2. 2 Structure of Command Text

■ PDU (Protocol Data Unit) Structure

An MRC (Main Request Code) and SRC (Sub-Request Code) followed by the various required data are sent as the command text.

- **Service Request PDU**

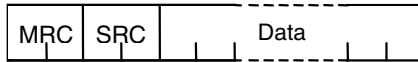

The MRES (Main Response Code) and SRES (Sub-Response Code) are sent in the response frame following the above MRC/SRC.

- **Service Response PDU (Normal Response)**



If the specified command text could not be executed, the service response PDU will contain only the MRC/SRC and MRES/SRES.

■ Variable Areas and Parameter Areas

The KM50-C/-E use two areas for data communications. The variable area is accessed to read measurement values.

The variable area is separated into areas for the three types of measurement values, instantaneous, maximum, and minimum, and an area to read the measurement log. The addresses of the variables and measurement values are specified to read the measurement values and measurement log.

The parameter area is used to read and write the current parameter settings. The address of the parameter to read or write is specified to monitor or change the set value.

Tables of the variable area and parameter area are provided in *Section 3 CompoWay/F Communications Data*.

Other commands do not use the variable and parameter areas.

■ Area Definitions

There are two areas: the variable area and the parameter area.

The codes for each area are defined as follows:

● Variable Area

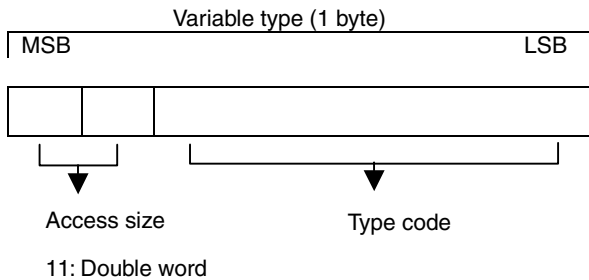

● Parameter Area

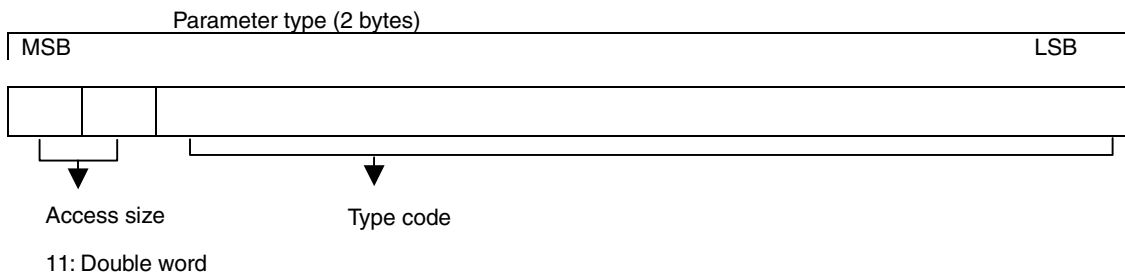

The variable type is converted to 2-byte ASCII or the parameter type is converted to 4-byte ASCII and loaded to the frame.

■ Type Codes

The type codes for the variable area are given in the following table.

Variable type	Contents		Remarks
C0	Instantaneous measurement values ^{*1}		Log for current day
C2	Maximum measurement values ^{*1}		
C3	Minimum measurement values ^{*1}		
C8	Instantaneous measurement values ^{*2}		
CA	Maximum measurement values ^{*2}		
CB	Minimum measurement values ^{*2}		
D0	Total power consumption log	Every 5-minute period ^{*4}	Log for the last day
D1		Every 5 minutes ^{*4}	
D4		Every hour ^{*4}	
D5	Total power consumption log	Every day ^{*4}	Log for the last 8 days
D6	Pulse input ON times	Every day ^{*4}	
D7	Specific power consumption log	Every day ^{*4}	
D8	Pulse count log	Every day ^{*4}	
DB	Total power consumption log	Every month ^{*4}	For the last 13 months
DC ^{*3}	Total operating power	Refer to note. ^{*4}	5-minute-period data for up to one day ago Total power consumptions and times, and ratios, for every day for last 8 days
DD ^{*3}	Total standby power		
DE ^{*3}	Total stopped power		
E0	Maximum value log	Every day ^{*4}	Log for the last 8 days
E1	Minimum value log	Every day ^{*4}	
E2	Alarm history		Log of the last 10 alarms

- *1 The command system is adjusted to that of the KM20-B40 and KM100. Using these variable types is convenient when adding to an existing KM-series system.
- *2 This is the command system for the KM50-C/-E.
The read commands are the same as those indicated with "*1," but the items were reordered to make reading easier. Using these variable types is convenient for new systems.
- *3 These type codes are used only for the KM50-E.
- *4 The time units for the measurement values are as follows:
Every 5-minute period: Values measure over a 5-minute period, e.g., 00:05 to 00:10.
Every 5 minutes: Values measured every 5 minutes for 2 days.
(Total from when the power is turned ON or the Power Monitor is reset.)
Every hour: Values measured over a 1-hour period.
Every day: Values measured over a 1-day period.
Every month: Values measured over a 1-month period.
- *5 The history of alarms that occurred in the past is not saved when power is interrupted.
Only alarms that occur after power supply is turned ON are in the history.

The type codes for the parameter area are given in the following table.

Parameter type	Contents	Remarks
C000	Setting parameters	

■ Addresses

An address is appended to each variable type. Express addresses in 2-byte hexadecimal and append them for the specified access size.

■ Number of Elements

The number of elements is expressed in 2-byte hexadecimal.

The specification range for the number of elements depends on the command. Refer to the descriptions of individual services for details.

■ List of Services

MRC	SRC	Name of service	Processing
01	01	Read Variable Area	This service reads from the variable area.
02	01	Read Parameter Area	This service reads from the parameter area.
02	02	Write Parameter Area	This service writes to the parameter area.
05	03	Read Controller Attributes	This service reads the model number and communications buffer size.
06	01	Read Controller Status	This service reads the operating status.
07	01	Read Time Data	This service reads the time data.
07	02	Write Time Data	This service writes the time data.
08	01	Echoback Test	This service performs an echoback test.
30	05	Operation Command	This service performs the following operations according to the command. <ul style="list-style-type: none"> • Reset Total Power Consumption • Reset Maximum/Minimum • Reset Software • Initialize Settings (restore defaults)

* Services will not be accepted and responses will not be returned while the Power Monitor is starting (i.e., from when the wait display appears at startup until the instantaneous power is displayed).

2.3 Detailed Descriptions of Services

■ Read Variable Area

This service reads from the variable area.

• Service Request PDU

MRC	SRC	Variable type	Read start address	Bit position	No. of elements
0 1	0 1	0 0
2	2	2	4	2	4

(Numbers below the frame are the number of bytes.)

• Service Response PDU

MRC	SRC	Response code	Read data (for the number of elements)
0 1	0 1
2	2	4	8 × n (n = 0 to 11)

(1) Variable Type and Read Start Address

For details on variable types and read start addresses, refer to *SECTION 3 CompoWay/F Communications Data*.

(2) Bit Position

Bit access is not supported by the KM50-C.
Always use 00.

(3) Number of Elements

Specify the number of variables to read.

No. of elements	Processing
0000	The read operation is not performed (i.e., read data is not appended to the service response PDU), and processing ends in a normal completion.
0001 to 000B	Up to 11 elements (0B hex) is read, and processing ends in a normal completion.

* If the read start address is in the variable area and the read end address (read start address + number of elements) exceeds the last address in the variable area, the data to the end of the variable area will be read and processing will end in a normal completion.

Example 1: The last address is specified as the read start address and two elements is specified.



Only the value at the last address will be read.

Example 2: One less than the last address is specified as the read start address and 13 elements is specified (0D hex).

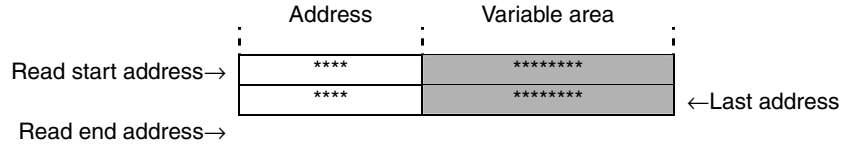

The number of elements exceeds the specification range, so only the data to the last address in the area is read.

(4) Response Code

• Normal Completion

Response code	Name	Description
0000	Normal completion	No errors were detected.

• Error Completion

Response code	Error name	Cause
1001	Command too long	The command is too long.
1002	Command too short	The command is too short.
1101	Area type error	The variable type is wrong.
1103	Start address out-of-range error	The read start address is out of range.
110B	Response too long	The number of elements exceeds the maximum value.
1100	Parameter error	Bit position is not 00.

● Communications Example for Read Variable Area

Instantaneous voltage 1 was measured at 101.2 V and instantaneous voltage 2 was measured at 102.3 V. Here, these two values are read with one command.

Service Request PDU

0 1 0 1 C 0 0 0 0 4 0 0 0 0 0 2
 MRC SRC Variable type Read start address Bit position No. of elements (Reads two measurement values.)

Service Response PDU

0 1 0 1 0 0 0 0 0 0 0 0 0 3 F 4 0 0 0 0 0 3 F F
 MRC SRC Response code Voltage 1 Voltage 2

The KM50 returns measurement values converted to hexadecimal without decimal points.

0000 03F4 hex = 1012 decimal

Section 3 CompoWay/F Communications Data specifies one place below the decimal point for the set value/monitor value for instantaneous voltage 1, so the value is 101.2 V. This also applies to instantaneous voltage 2, i.e., 0000 03FF hex = 1023 decimal, or 102.3 V.

Read Parameter Area

This service reads from the parameter area.

Service Request PDU

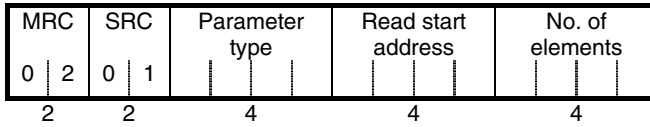

(Numbers below the frame are the number of bytes.)

Service Response PDU

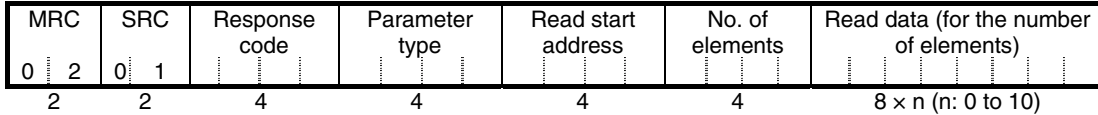

(1) Parameter Type and Read Start Address

For details on parameter types and read start addresses, refer to *SECTION 3 CompoWay/F Communications Data*.

(2) Number of Elements

Specify the number of parameters to read.

No. of elements	Processing
8000	The read operation is not performed (i.e., read data is not appended to the service response PDU), and processing ends in a normal completion.
8001 to 800A	Up to 10 elements (0A hex) is read, and processing ends in a normal completion.

* Setting range for the number of elements (8001 to 800A): Always set the MSB of the number of elements to 1.

* If the read start address is in the parameter area and the read end address (read start address + number of elements) exceeds the last address in the parameter area, the data to the end of the parameter area will be read and processing will end in a normal completion.

Example 1: The last address is specified as the read start address and two elements is specified.

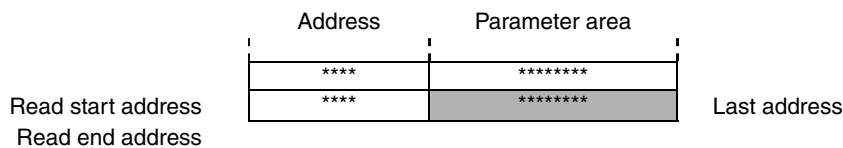

Only the value at the last address will be read.

Example 2: One less than the last address is specified as the read start address and 13 elements is specified (0D hex).

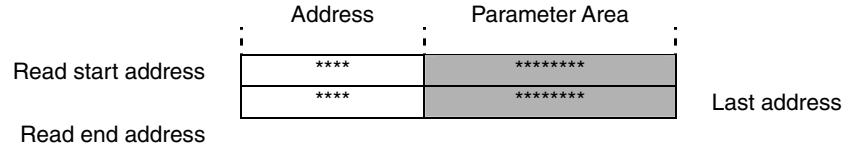

The number of elements exceeds the specification range, so only the data to the last address in the area is read.

(3) Response code

- Normal Completion

Response code	Name	Description
0000	Normal completion	No errors were detected.

- Error Completion

Response code	Error name	Cause
1001	Command too long	The command is too long.
1002	Command too short	The command is too short.
1101	Area type error	The area type (variable or parameter) is wrong.
1103	Start address out-of-range error	The read start address is out of range.
110B	Response too long	The number of elements exceeds the maximum value.
1100	Parameter error	Bit position is not 00.

● Communications Example for Read Parameter Area

The CT ratio is set to 150:5 (for a 5-A CT) and the low cut current is set to 1.0%. Here, these two settings are read with one command.

Service Request PDU

0 2 0 1 C 0 0 0 0 0 0 0 4 8 0 0 2
 MRC SRC Parameter type Read start address No. of elements
 (Reads two parameter values.)

Service Response PDU

0 2 0 1 0 0 0 0 C 0 0 0 0 0 0 0 4 8 0 0 2
 MRC SRC Response code Parameter type Read start address No. of elements

0 0 0 0 0 0 9 6 0 0 0 0 0 0 0 A
 Rated Primary Current Low-cut Current

Section 3 CompoWay/F Communications Data specifies 0000 0001 to 0000 270F hex for the set value/monitor value for the rated primary current. A value of 96 hex is 150 decimal, so the current is 150 A.

Section 3 CompoWay/F Communications Data specifies 0000 0001 to 0000 00C7 hex for the low-cut current. A value of A hex is 10 decimal, so the low-cut current is 1.0% (there is always one place below the decimal point).

Write Parameter Area

This service writes to the parameter area.
Execute this service after changing to a Setting Mode.

Service Request PDU

MRC	SRC	Parameter type	Write start address	No. of elements	Write data (for the number of elements)
0 2	0 2
2	2	4	4	4	8 × n (n: 0 to 10)

(Numbers below the frame are the number of bytes.)

Service Response PDU

MRC	SRC	Response code
0 2	0 2
2	2	4

(1) Parameter Type and Write Start Address

For details on parameter types and write start addresses, refer to *SECTION 3 CompoWay/F Communications Data*.

(2) Number of Elements

Specify the number of parameters to write.

No. of elements	Processing
8000	The write operation is not performed (i.e., write data is not appended to the service request PDU), and processing ends in a normal completion.
8001 to 800A	Up to 10 elements (0A hex) is written, and processing ends in a normal completion.

* Setting range for the number of elements (8001 to 800A): Always set the MSB of the number of elements to 1.

(3) Response Code

Normal Completion

Response code	Name	Description
0000	Normal completion	No errors were detected.

Error Completion

Response code	Error name	Cause
1002	Command too short	The command is too short.
1101	Area type error	The area type (variable or parameter) is wrong.
1103	Start address out-of-range error	The write start address is out of range.
1100	Parameter error	The write data is out of range.
2203	Operation error	The service cannot be executed because the Power Monitor is not in a Setting Mode.

● Changing Set Values

Set the parameters while the Power Monitor is in a Setting Mode

However, even if the set values are changed, the changes will not be applied in the Setting Mode.

Changes to parameters that are made in a Setting Mode are enabled by changing to Measurement Mode.

● Communications Example for Write Parameter Area

Here, the Special CT type is set to 50A.

(It is assumed that the Power Monitor is already in a Setting Mode.)

Service Request PDU

<u>0 2</u>	<u>0 2</u>	<u>C 0 0 0</u>	<u>0 0 1 9</u>	<u>8 0 0 1</u>	<u>0 0 0 0 0 0 0 1</u>
MRC	SRC	Parameter type	Write start address	No. of elements	Write data

Service Response PDU

<u>0 2</u>	<u>0 2</u>	<u>0 0 0 0</u>
MRC	SRC	Response code

The following are given for set value/monitor value of the Special CT type in 5.3 *Parameter Area*.

0000 0000 hex:	KM20-CTF-5A (5A)
0000 0001 hex:	KM20-CTF-50A (50A)
0000 0002 hex:	KM20-CTF-100A (100A)
0000 0003 hex:	KM20-CTF-200A (200A)
0000 0004 hex:	KM20-CTF-400A (400A)
0000 0005 hex:	KM20-CTF-600A (600 A)

Therefore, 0000 0001 hex means 50A.

Read Controller Attributes

This service reads the model number and communications buffer size.

• Service Request PDU

MRC	SRC
0 5	0 3
2	2

• Service Response PDU

MRC	SRC	Response code	Model	Buffer size
0 5	0 3	0 0 7 8
2	2	4	10	4

(1) Model

The model number is expressed in 10 bytes of ASCII. When 10 bytes are not required, the remaining bytes are padded with spaces.

Example: The following model number is given for the KM50-C1-FLK.

Model	K	M	5	0	-	C	1			
-------	---	---	---	---	---	---	---	--	--	--

"-FLK" is not returned in the response.

(2) Buffer Size

The communications buffer size is expressed in 2-byte hexadecimal, and read after being converted to 4 bytes of ASCII.

The buffer size is 120 bytes (0078 hex).

(3) Response Code

• Normal Completion

Response code	Name	Description
0000	Normal completion	No errors were detected.

• Error Completion

Response code	Error name	Cause
1001	Command too long	The command is too long.

Read Controller Status

This service reads the operating status and error status.

Service Request PDU

MRC	SRC
0 6	0 1
2	2

Service Response PDU

MRC	SRC	Response code	Operating status	Related information
0 6	0 1			
2	2	4	2	2

(1) Operating Status

Operating status	Description
00	Measurements are being performed normally.
01	Measurements are stopped.

(2) Related Information

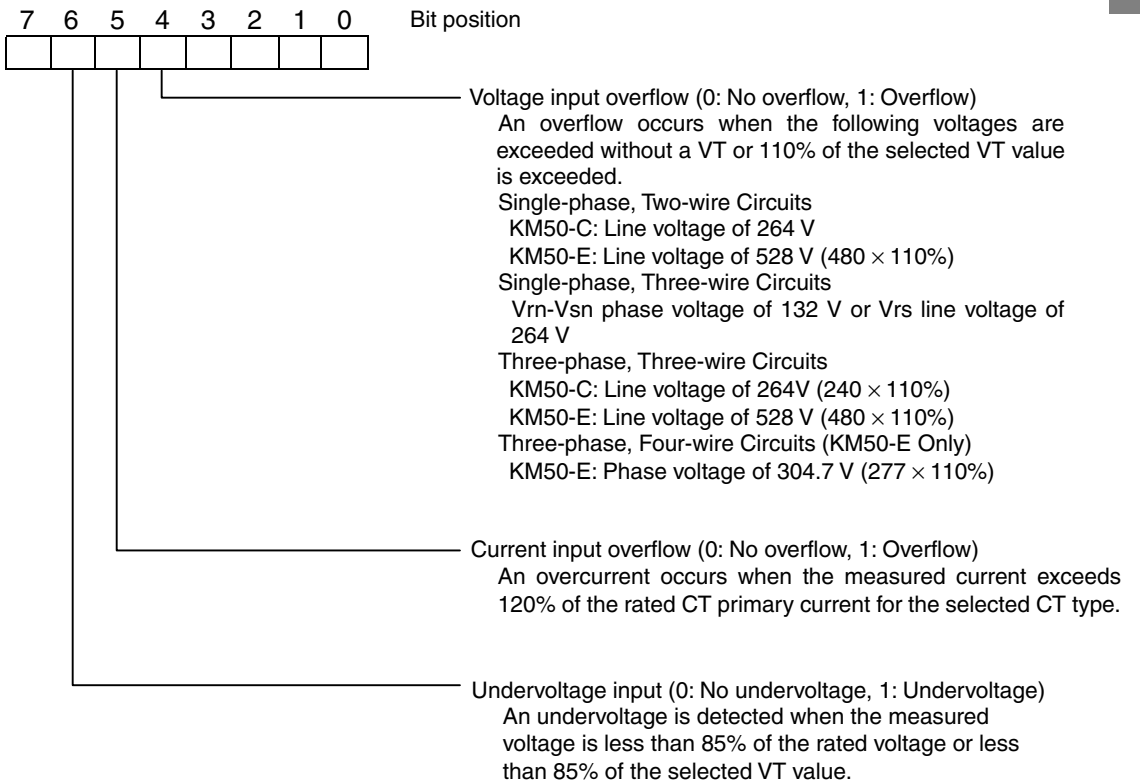

(3) Response Code

Normal Completion

Response code	Name	Description
0000	Normal completion	No errors were detected.

Error Completion

Response code	Error name	Cause
1001	Command too long	The command is too long.

Read Time Data

This service reads the time data.

- Service Request PDU

MRC	SRC
0 7	0 1
2	2

- Service Response PDU

MRC	SRC	Response code	Year	Month	Day	Hour	Minutes
0 7	0 1
2	2	4	2	2	2	2	2

(1) Time Data

The present time of the internal clock is read using two digits each for the year (last two digits), month, day, hour (universal time).

All values from the year through the minutes are given as decimal values.

(2) Response Code

- Normal Completion

Response code	Name	Description
0000	Normal completion	No errors were detected.

- Error Completion

Response code	Error name	Cause
1001	Command too long	The command is too long.

Communications Example for Read Time Data

Here, the time is read as 23:59, January 10, 2010.

Service Request PDU

0 7 0 1
MRC SRC

Service Response PDU

0 7 0 1 0 0 0 0 1 0 0 1 1 0 2 3 5 9
MRC SRC Response code

Write Time Data

This service writes the time data. The seconds will be treated as 00.

Execute this service after changing to a Setting Mode.

The internal clock will start as soon as a normal completion is achieved for the write service.

Service Request PDU

MRC	SRC	Year	Month	Day	Hour	Minutes
0 7	0 2
2	2	2	2	2	2	2

Service Response PDU

MRC	SRC	Response code
0 7	0 2
2	2	4

(1) Time Data

The present time of the internal clock is written using two digits each for the year (last two digits), month, day, hour (universal time).

All values from the year through the minutes are given as decimal values.

(2) Response Code

Normal Completion

Response code	Name	Description
0000	Normal completion	No errors were detected.

Error Completion

Response code	Error name	Cause
1001	Command too long	The command is too long.

Communications Example for Write Time Data

Here, the time is set to 23:59 on January 10, 2010.

Service Request PDU

0 7 0 2 1 0 0 1 1 0 2 3 5 9
MRC SRC Time data

Service Response PDU

0 7 0 2 0 0 0 0
MRC SRC Response code

Echoback Test

This service performs an echoback test.

- Service Request PDU

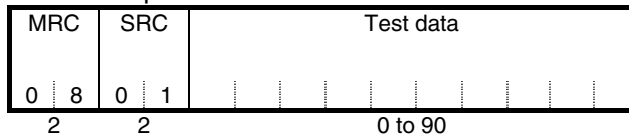

- Service Response PDU

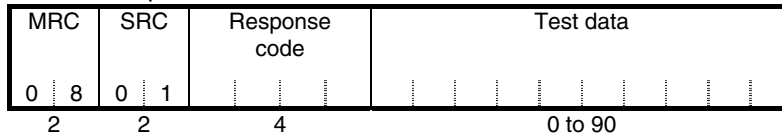

(1) Test Data

Set between 0 and 90 bytes of user-defined test data.

Set the test data within the ranges shown below according to the communications data length.

Communications data length	Test data
8 bits	ASCII 20 to 7E hex or A1 to FE hex
7 bits	ASCII 20 to 7E hex

(2) Response Code

- Normal Completion

Response code	Name	Description
0000	Normal completion	No errors were detected.

- Error Completion

Response code	Error name	Cause
1001	Command too long	The command is too long.

- Communications Example for Echoback Test

Here, 1234 is sent as the test data.

Service Request PDU

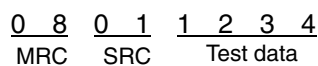

Service Response PDU

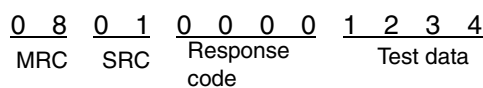

■ Operation Command

Use this service to perform remote control for the KM50-C/-E.

- Service Request PDU

MRC	SRC	Com- mand code	Related infor- mation
3 0	0 5		
2	2	2	2

- Service Response PDU

MRC	SRC	Response code
3 0	0 5	
2	2	4

(1) Command Code and Related Information

Command code	Command	Related information
03	Reset Total Power Consumption	00
04	Go to Measurement Mode	00
07	Go to Operation Setting Mode	00
08	Go to Protection Setting Mode	00
09	Initialize Measurement Log	00
	Initialize Settings	01
	Initialize Professional Level	02
	Initialize All	03
12	Reset Maximum Measurement Values	00
13	Reset Minimum Measurement Values	00
99	Reset Software	00

* Command code "09" can be used only in a Setting Mode.

(2) Response Code

- Normal Completion

Response code	Name	Description
0000	Normal completion	No errors were detected.

- Error Completion

Response code	Error name	Cause
1001	Command too long	The command is too long.
1002	Command too short	The command is too short.
1100	Parameter error	The command code or related information is wrong.
2203	Operation error	The service cannot be executed because the Power Monitor is not in a Setting Mode.

(3) Operation Commands and Precautions

● Reset Total Power Consumption

The total power consumptions are reset to 0.

The consumptions are totaled again as soon as they are reset.

● Go to Measurement Mode

The Power Monitor is changed to Measurement Mode.

When moving to Measurement Mode, the Power Monitor saves changes to settings to EEPROM and is reset. After being reset, the Power Monitor operates with the new settings.

● Go to Operation Setting Mode

The Power Monitor is changed to Operation Setting Mode.

Change to this mode before changing any parameters.

● Go to Protection Setting Mode

The Power Monitor is changed to Protection Setting Mode.

● Initialize Measurement Log

All measurement log data is initialized.

● Initialize Settings

All parameters are returned to the default settings.

● Initialize Professional Level

The measurement values for the day in the Professional Level of Measurement Mode are initialized.

● Initialize All

All of the following are initialized: total power consumptions, measurement log, settings, and Professional Level.

● Reset Maximum/Minimum

The maximum and minimum measurement values are reset.

Reset Maximum: The maximum values are reset to 0 (the minimum value).

Reset Minimum: The minimum values are reset to the maximum values for the currently selected VT or CT (type and ratio).

● Reset Software

The CPU is reset and the Power Monitor enters the same status as when it is turned ON.

No response is returned for this operation command (there is no service response PDU).

2.4 Response Codes

Normal Completion

Response code	Name	Description	Error detection priority
0000	Normal completion	No errors were detected.	None

Error Completion

Response code	Name	Description	Error detection priority
0401	Unsupported command	The service function for the relevant command is not supported.	1
1001	Command too long	The command is too long.	2
1002	Command too short	The command is too short.	3
1101	Area type error	The area type (variable or parameter) is wrong.	4
1103	Start address out-of-range error	The read/write start address is out of range.	5
1003	Number of elements/data mismatch	The amount of data does not match the number of elements.	6
110B	Response too long	The response exceeds the communications buffer size.	7
1100	Parameter error	Bit position is not 00. The write data is out of range. The command code or related information for an operation command is wrong. The time data is not correct.	8
2203	Operation error	The operation command cannot be processed.	9

Section 3 CompoWay/F Communications Data

This section lists the data that can be used for CompoWay/F communications.

3.1	Variable Area	3-3
	● Communications Data.....	3-3
	● Variable Area.....	3-3
	● C0 (Previous): Instantaneous Value Level	3-3
	● C1 (Previous): Average Value Level.....	3-6
	● C2 (Previous): Maximum Value Level.....	3-7
	● C3 (Previous): Minimum Value Level.....	3-7
	● C8 (New): Instantaneous Value Level	3-8
	● C9 (New): Average Value Level.....	3-11
	● CA (New): Maximum Value Level.....	3-11
	● CB (New): Minimum Value Level	3-11
	● D0: Total Power Consumption for Every Five-minute Period (0.1-kWh increments).....	3-12
	● D0: Total Power Consumption Every Five-minute Period (0.001-kWh increments).....	3-13
	● D1: Total Power Consumption Every Five Minutes (0.1-kWh increments).....	3-14
	● D1: Total Power Consumption Every Five Minutes (0.001-kWh increments).....	3-15
	● D2: Total □□ Power Consumption Every Five-minute Period (0.1-kWh increments).....	3-16
	● D2: Total □□ Power Consumption Every Five-minute Period (0.001-kWh increments).....	3-17
	● D3: Total □□ Power Consumption Every Five Minutes (0.1-kWh increments).....	3-18
	● D3: Total □□ Power Consumption Every Five Minutes (0.001-kWh increments).....	3-19
	● D4: Total Power Consumption for Every Hour (0.1-kWh increments)	3-20
	● D4: Total Power Consumption for Every Hour (0.001-kWh increments)....	3-21
	● D5: Total Power Consumption for Every Day (0.1-kWh increments)	3-22
	● D5: Total Power Consumption for Every Day (0.001-kWh increments)	3-22
	● D6: Pulse Input ON Time for Every Day	3-23
	● D7: Specific Power Consumption for Every Day	3-23
	● D8: Pulse Input Count for Every Day	3-24
	● DB: Total Power Consumption for Every Month (0.1-kWh increments)	3-25
	● DB: Total Power Consumption for Every Month (0.001-kWh increments) .	3-26
	● DC: HIGH Total Power Consumption Every Five-minute Period (0.001-kWh increments).....	3-27
	● DC: HIGH Total Power Consumption Every Day (0.001-kWh increments)	3-28
	● DC: HIGH Total Power Consumption Ratio for Every Day.....	3-28
	● DC: HIGH Total Time for Every Day	3-29
	● DC: HIGH Total Time Ratio for Every Day.....	3-29
	● DD: MIDDLE Total Power Consumption Every Five-minute Period (0.001-kWh increments).....	3-30
	● DD: MIDDLE Total Power Consumption Every Day (0.001-kWh increments).....	3-31
	● DD: MIDDLE Total Power Consumption Ratio for Every Day	3-31
	● DD: MIDDLE Total Time for Every Day	3-32
	● DD: MIDDLE Total Time Ratio for Every Day.....	3-32
	● DE: LOW Total Power Consumption Every Five-minute Period (0.001-kWh increments).....	3-33
	● DE: LOW Total Power Consumption Every Day (0.001-kWh increments)	3-34
	● DE: LOW Total Power Consumption Ratio for Every Day	3-34
	● DE: LOW Total Time for Every Day	3-35
	● DE: LOW Total Time Ratio for Every Day.....	3-35
	● E0: Maximum Measurement Values	3-36

- E1: Minimum Measurement Values3-39
- E2: Alarm History3-42
- 3.2 Status Information3-44
- 3.3 Parameter Area3-45
 - Parameter Area.....3-45

3.1 Variable Area

● Communications Data

Set values and monitor values are given in hexadecimal. Negative values are given as two's complements. Values are converted to hexadecimal without the decimal point.

● Variable Area

- The KM50 variable area contains parameters that are in the same structure as those of the KM100 and KM20-B40 (labeled below as "previous"), as well as parameters that are in the data structure of the KM50-C (labeled below as "new"). Variable types C0 to C3 are the previous types and C8 to CB are the new types. Other variable types are the same.
- The hexadecimal values that are given in the set value/monitor value column, are the setting/monitoring ranges of the CompoWay/F. The actual ranges are given in parentheses. Refer to the relevant parameters for textual descriptions.

● C0 (Previous): Instantaneous Value Level

Variable type	Address	Parameter name	Set value (monitor value)
C0	0000	Instantaneous Voltage 1 (V)	0000 0000 to 000F 423F hex (0.0 to 99,999.9) *One digit to the right of the decimal point (fixed).
C0	0001	Instantaneous Voltage 2 (V)	Same as above.
C0	0002	Instantaneous Current 1 (A)	0000 0000 to 0098 967F hex (0.00 to 99,999.99) *Two digits to the right of the decimal point (fixed).
C0	0003	Instantaneous Current 2 ¹ (A)	Same as above.
C0	0004	Maximum Active Power (W)	C465 3601 to 3B9A C9FF hex (-9,999,999.99 to 9,999,999.99) *Two digits to the right of the decimal point (fixed).
C0	0005	Instantaneous Reactive Power (kvar)	Same as above.
C0	0006	Instantaneous Power Factor	FFFF FF9C to 0000 0064 hex (-1.00 to 1.00) *Two digits to the right of the decimal point (fixed).
C0	0007	Instantaneous Frequency (Hz)	0000 01C2 to 0000 028A hex (45.0 to 65.0) *One digit to the right of the decimal point (fixed).
C0	0008	Total Power Consumption (kWh)	0000 0000 to 05F5 E0FF hex (0.0 to 9,999,999.9) *One digit to the right of the decimal point (fixed).
C0	000A	Status	Refer to 3.2 3.2 Status Information.
C0	000B	Version	Example: 0000 0100 hex = version 1.00
C0	000C	Instantaneous Voltage 3 ² (V)	0000 0000 to 0001 869F hex (0.0 to 9,999.9) *One digit to the right of the decimal point (fixed).
C0	000D	Instantaneous Current 3 ¹ (A)	0000 0000 to 0098 967F hex (0.00 to 99,999.99) *Two digits to the right of the decimal point (fixed).
C0	000E	Instantaneous Active Power (W)	C465 3601 to 3B9A C9FF hex (-99,999,999.9 to 99,999,999.9) *One digit to the right of the decimal point (fixed).
C0	000F	Instantaneous Reactive Power (var)	Same as above.
C0	0010	Calculated CO ₂ (total power consumption) (kgCO ₂)	0000 0000 to 3B9A C9FF hex (0.0 to 99,999,999.9) *One digit to the right of the decimal point (fixed).
C0	0011 ¹⁶	Total Pulse Input Count for the Day (pulses)	0000 0000 to 0001 869F hex (0 to 99,999)
C0	0012	Specific Power Consumption (kWh/pulse)	0000 0000 to 05F5 E0FF hex (0.000 to 99,999.999) *Three digits to the right of the decimal point (fixed).
C0	0013	Pulse Input ON Time	0000 0000 to 0000 HHMM hex HH (hour): 0 to 18 hex (0 to 24) MM (minutes): 0 to 3B hex (0 to 59)
C0	0014 ¹³	HIGH Total Power Consumption (kWh)	0000 0000 to 05F5 E0FF hex (0.000 to 99,999.999) *Three digits to the right of the decimal point (fixed).
C0	0015 ¹³	HIGH Total Power Consumption Ratio ¹⁴	0000 0000 to 0000 03E8 hex (0.000 to 1.000) *Three digits to the right of the decimal point (fixed).
C0	0016 ¹³	HIGH Total Time	0000 0000 to 0000 HHMM hex HH (hour): 0 to 18 hex (0 to 24) MM (minutes): 0 to 3B hex (0 to 59)

Variable type	Address	Parameter name	Set value (monitor value)
C0	0017 ³	HIGH Total Time Ratio ⁴	0000 0000 to 0000 03E8 hex (0.000 to 1.000) *Three digits to the right of the decimal point (fixed).
C0	0018 ³	MIDDLE Total Power Consumption (kWh)	0000 0000 to 05F5 E0FF hex (0.000 to 99,999.999) *Three digits to the right of the decimal point (fixed).
C0	0019 ³	MIDDLE Total Power Consumption Ratio ⁴	0000 0000 to 0000 03E8 hex (0.000 to 1.000) *Three digits to the right of the decimal point (fixed).
C0	001A ³	MIDDLE Total Time	0000 0000 to 0000 HHMM hex HH (hour): 0 to 18 hex (0 to 24) MM (minutes): 0 to 3B hex (0 to 59)
C0	001B ³	MIDDLE Total Time Ratio ⁴	0000 0000 to 0000 03E8 hex (0.000 to 1.000) *Three digits to the right of the decimal point (fixed).
C0	001C ³	LOW Total Power Consumption (kWh)	0000 0000 to 05F5 E0FF hex (0.000 to 99,999.999) *Three digits to the right of the decimal point (fixed).
C0	001D ³	LOW Total Power Consumption Ratio ⁴	0000 0000 to 0000 03E8 hex (0.000 to 1.000) *Three digits to the right of the decimal point (fixed).
C0	001E ³	LOW Total Time	0000 0000 to 0000 HHMM hex HH (hour): 0 to 18 hex (0 to 24) MM (minutes): 0 to 3B hex (0 to 59)
C0	001F ³	LOW Total Time Ratio ⁴	0000 0000 to 0000 03E8 hex (0.000 to 1.000) *Three digits to the right of the decimal point (fixed).
C0	0020	Total Power Consumption (Wh)	0000 0000 to 3B9A C9FF hex (0 to 999,999,999)
C0	0021	Total Active Power Consumption (GWh)	0000 0000 to 0000 00009 hex (0 to 9)
C0	0022	Total Active Power Consumption (Wh)	0000 0000 to 3B9A C9FF hex (0 to 999,999,999)
C0	0023	Total Regenerated Energy (GWh)	0000 0000 to 0000 00009 hex (0 to 9)
C0	0024	Total Regenerated Energy (Wh)	0000 0000 to 3B9A C9FF hex (0 to 999,999,999)
C0	0025	Total Leading Reactive Power Consumption (Gvarh)	0000 0000 to 0000 00009 hex (0 to 9)
C0	0026	Total Leading Reactive Power Consumption (varh)	0000 0000 to 3B9A C9FF hex (0 to 999,999,999)
C0	0027	Total Lagging Reactive Power Consumption (Gvarh)	0000 0000 to 0000 00009 hex (0 to 9)
C0	0028	Total Lagging Reactive Power Consumption (varh)	0000 0000 to 3B9A C9FF hex (0 to 999,999,999)
C0	0029	Total Reactive Power Consumption (Gvarh)	0000 0000 to 0000 00009 hex (0 to 9)
C0	002A	Total Reactive Power Consumption (varh)	0000 0000 to 3B9A C9FF hex (0 to 999,999,999)
C0	002B ³	Three-state HIGH Total Power Consumption (GWh)	0000 0000 to 0000 00009 hex (0 to 9)
C0	002C ³	Three-state HIGH Total Power Consumption (Wh)	0000 0000 to 3B9A C9FF hex (0 to 999,999,999)
C0	002D ³	Three-state HIGH Total Time (minutes)	0000 0000 to 0098 967F hex (0 to 9,999,999)
C0	002E ³	Three-state MIDDLE Total Power Consumption (GWh)	0000 0000 to 0000 00009 hex (0 to 9)
C0	002F ³	Three-state MIDDLE Total Power Consumption (Wh)	0000 0000 to 3B9A C9FF hex (0 to 999,999,999)
C0	0030 ³	Three-state MIDDLE Total Time (minutes)	0000 0000 to 0098 967F hex (0 to 9,999,999)
C0	0031 ³	Three-state LOW Total Power Consumption (GWh)	0000 0000 to 0000 00009 hex (0 to 9)
C0	0032 ³	Three-state LOW Total Power Consumption (Wh)	0000 0000 to 3B9A C9FF hex (0 to 999,999,999)
C0	0033 ³	Three-state LOW Total Time (minutes)	0000 0000 to 0098 967F hex (0 to 9,999,999)
C0	0034 ⁶	Total Pulse Input Count 1 (pulses)	0000 0000 to 3B9A C9FF hex (0 to 999,999,999)
C0	0035 ⁶	Total Pulse Input Count 2 (pulses)	0000 0000 to 3B9A C9FF hex (0 to 999,999,999)
C0	0036 ⁶	Sum Total Pulse Input Count (pulses)	0000 0000 to 3B9A C9FF hex (0 to 999,999,999)
C0	0037 ⁶	Pulse Input Count 1 for the Day (pulses)	0000 0000 to 0001 869F hex (0 to 99,999)

Variable type	Address	Parameter name	Set value (monitor value)
C0	0038 ¹⁶	Pulse Input Count 2 for the Day (pulses)	0000 0000 to 0001 869F hex (0 to 99,999)
C0	0039	Temperature (°C or F) ⁵	FFFF FF6A to 0000 0578 hex (-15.0 to 140.0) *One digit to the right of the decimal point (fixed). Note: In the range of -15.0 to 60.0 for Celsius, and 5.0 to 140.0 for Fahrenheit.
C0	003A	Converted Monetary Cost (upper digits) ⁸	0000 0000 to 3B9A C9FF hex (0 to 999,999,999) *Indicates values above 1M. Starts from 0 if the value exceeds the range.
C0	003B	Converted Monetary Cost (lower digits) ⁸	0000 0000 to 3B9A C9FF hex (0 to 999,999,999) *Three digits to the right of the decimal point (fixed). Starts from 0 if the value exceeds the range.
C0	003C ³	HIGH Total Power Consumption Converted to Monetary Cost (upper digits) ⁸	0000 0000 to 3B9A C9FF hex (0 to 999,999,999) *Indicates values above 1M. Starts from 0 if the value exceeds the range.
C0	003D ³	HIGH Total Power Consumption Converted to Monetary Cost (lower digits) ⁸	0000 0000 to 3B9A C9FF hex (0 to 999,999,999) *Three digits to the right of the decimal point (fixed). Starts from 0 if the value exceeds the range.
C0	003E ³	MIDDLE Total Power Consumption Converted to Monetary Cost (upper digits) ⁸	0000 0000 to 3B9A C9FF hex (0 to 999,999,999) *Indicates values above 1M. Starts from 0 if the value exceeds the range.
C0	003F ³	MIDDLE Total Power Consumption Converted to Monetary Cost (lower digits) ⁸	0000 0000 to 3B9A C9FF hex (0 to 999,999,999) *Three digits to the right of the decimal point (fixed). Starts from 0 if the value exceeds the range.
C0	0040 ³	LOW Total Power Consumption Converted to Monetary Cost (upper digits) ⁸	0000 0000 to 3B9A C9FF hex (0 to 999,999,999) *Indicates values above 1M. Starts from 0 if the value exceeds the range.
C0	0041 ³	LOW Total Power Consumption Converted to Monetary Cost (lower digits) ⁸	0000 0000 to 3B9A C9FF hex (0 to 999,999,999) *Three digits to the right of the decimal point (fixed). Starts from 0 if the value exceeds the range.
C0	0042	Pulse Conversion Value 1 (upper digits) ⁸	0000 0000 to 3B9A C9FF hex (0 to 999,999,999) *Indicates values above 1M. Starts from 0 if the value exceeds the range.
C0	0043	Pulse Conversion Value 1 (lower digits) ⁸	0000 0000 to 3B9A C9FF hex (0 to 999,999,999) *Three digits to the right of the decimal point (fixed). Starts from 0 if the value exceeds the range.
C0	0044	Pulse Conversion Value 2 (upper digits) ⁸	0000 0000 to 3B9A C9FF hex (0 to 999,999,999) *Indicates values above 1M. Starts from 0 if the value exceeds the range.
C0	0045	Pulse Conversion Value 2 (lower digits) ⁸	0000 0000 to 3B9A C9FF hex (0 to 999,999,999) *Three digits to the right of the decimal point (fixed). Starts from 0 if the value exceeds the range.

*1 Currents 1, 2, and 3 that are read with the previous addresses are in the following order for the wiring methods. These are in a different order from currents 1, 2, and 3 that are read with the new address.

Wiring method	Previous addresses			New addresses		
	Current 1	Current 2	Current 3	Current 1	Current 2	Current 3
Single-phase, 2-wire	IR	---	---	IR	---	---
Single-phase, 3-wire	IR	IT	IN	IR	IN	IT
Three-phase, 3-wire	IR	IT	IS	IR	IS	IT
Three-phase, 4-wire	IR	IT	IS	IR	IS	IT

---: These values will read as 0.

*2 The order of voltages 1, 2, and 3 that are read with the previous addresses are as follows:

Wiring method	Previous/new addresses		
	Voltage 1	Voltage 2	Voltage 3
Single-phase, 2-wire	Vrs	---	---
Single-phase, 3-wire	Vrn	Vsn	Vrs
Three-phase, 3-wire	Vrs	Vst	Vtr
Three-phase, 4-wire	Vrn	Vsn	Vtn

---: These values will read as 0.

*3 These addresses can be read only with the KM50-E. They cannot be read with the KM50-C.

*4 The ratios for various values read as 1.000 for 100% for the status from the start time until the end time.

*5 Temperatures are read out in the unit that has been set. Conversion between Celsius and Fahrenheit is made using the following formulas. If both values are required, convert the temperature in the host device.



*6 The pulse input counts are counter values that are reset on a daily basis. The total pulse input count is not reset on a daily basis, rather it is reset to zero when the count upper limit is reached, and starts counting again. Counter 1 and counter 2 are individual count values that can be read separately. The total counter reads the sum of counter 1 and counter 2. A summary is shown in the following table.

Parameter	Read out value	Reset condition
Pulse Input Count 1 for the Day	Input count for input 1	Reset on a daily basis.
Pulse Input Count 2 for the Day	Input count for input 2	
Total Pulse Input Count for the Day	Sum of input counts for inputs 1 and 2	
Total Pulse Input Count 1	Input count for input 1	Reset when upper limit is reached.
Total Pulse Input Count 2	Input count for input 2	
Sum Total Pulse Input Count	Sum of input counts for inputs 1 and 2	

*7 Values after Recovering from a Power Interruption

The following measurement values are saved to the memory for every 5-minute period. Therefore, when the power supply is turned ON, the last value that was saved for a five-minute period while the Power Monitor was ON will be read out, rather than the value right before the power was interrupted. The measurement will continue.

Total power consumptions, pulse input ON time, pulse input count, specific power consumption, and three-state total power consumptions

*8 Digits That Are Read Out

The upper digits and lower digits of a converted value can be read out separated. However, there are only seven significant digits when the upper and lower digits are combined.

● C1 (Previous): Average Value Level

This variable type is not used by the KM50-C/-E.

(The KM50-C/-E do not support averaging for the data logging cycle.)

● C2 (Previous): Maximum Value Level

Variable type	Address	Parameter name	Set value (monitor value)
C2	0000	Maximum Voltage 1 ^{*2} (V)	0000 0000 to 000F 423F hex (0.0 to 99,999.9) *One digit to the right of the decimal point (fixed).
C2	0001	Maximum Voltage 2 ^{*2} (V)	Same as above.
C2	0002	Maximum Current 1 (A)	0000 0000 to 0098 967F hex (0.00 to 99,999.99) *Two digits to the right of the decimal point (fixed).
C2	0003	Maximum Current 2 ^{*1} (A)	Same as above.
C2	0004	Maximum Active Power (kW)	C465 3601 to 3B9A C9FF hex (–9,999,999.99 to 9,999,999.99) *Two digits to the right of the decimal point (fixed).
C2	0005	Maximum Reactive Power (kvar)	Same as above.
C2	0006	Maximum Voltage 3 ^{*2} (V)	0000 0000 to 000F 423F hex (0.0 to 99,999.9) *One digit to the right of the decimal point (fixed).
C2	0007	Maximum Current 3 ^{*1} (A)	0000 0000 to 0098 967F hex (0.00 to 99,999.99) *Two digits to the right of the decimal point (fixed).
C2	0008	Maximum Power Factor	FFFF FF9C to 0000 0064 hex (–1.00 to 1.00) *Two digits to the right of the decimal point (fixed).
C2	0009	Maximum Active Power (W)	C465 3601 to 3B9A C9FF hex (–99,999,999.9 to 99,999,999.9) *One digit to the right of the decimal point (fixed).
C2	000A	Maximum Reactive Power (var)	Same as above.

**1, *2: See notes for C0 variable type.

● C3 (Previous): Minimum Value Level

Variable type	Address	Parameter name	Set value (monitor value)
C3	0000	Minimum Voltage 1 ^{*2} (V)	0000 0000 to 000F 423F hex (0.0 to 99,999.9) *One digit to the right of the decimal point (fixed).
C3	0001	Minimum Voltage 2 ^{*2} (V)	Same as above.
C3	0002	Minimum Current 1 (A)	0000 0000 to 0098 967F hex (0.00 to 99,999.99) *Two digits to the right of the decimal point (fixed).
C3	0003	Minimum Current 2 ^{*1} (A)	Same as above.
C3	0004	Minimum Active Power (kW)	C465 3601 to 3B9A C9FF hex (–9,999,999.99 to 9,999,999.99) *Two digits to the right of the decimal point (fixed).
C3	0005	Minimum Reactive Power (kvar)	0000 0000 to 3B9A C9FF hex (0.00 to 9,999,999.99) *Two digits to the right of the decimal point (fixed).
C3	0006	Minimum Voltage 3 ^{*2} (V)	0000 0000 to 000F 423F hex (0.0 to 99,999.9) *One digit to the right of the decimal point (fixed).
C3	0007	Minimum Current 3 ^{*1} (A)	0000 0000 to 0098 967F hex (0.00 to 99,999.99) *Two digits to the right of the decimal point (fixed).
C3	0008	Minimum Power Factor	FFFF FF9C to 0000 0064 hex (–1.00 to 1.00) *Two digits to the right of the decimal point (fixed).
C3	0009	Minimum Active Power (W)	C465 3601 to 3B9A C9FF hex (–99,999,999.9 to 99,999,999.9) *One digit to the right of the decimal point (fixed).
C3	000A	Minimum Reactive Power (var)	Same as above.

*1, *2: See notes for C0 variable type.

● C8 (New): Instantaneous Value Level

Variable type	Address	Parameter name	Set value (monitor value)
C8	0000	Instantaneous Voltage 1 ² (V)	0000 0000 to 000F 423F hex (0.0 to 99,999.9) *One digit to the right of the decimal point (fixed).
C8	0001	Instantaneous Voltage 2 ² (V)	Same as above.
C8	0002	Instantaneous Voltage 3 ² (V)	Same as above.
C8	0003	Instantaneous Current 1 (A)	0000 0000 to 0098 967F hex (0.000 to 9,999.999) *Three digits to the right of the decimal point (fixed).
C8	0004	Instantaneous Current 2 ¹ (A)	Same as above.
C8	0005	Instantaneous Current 3 ¹ (A)	Same as above.
C8	0006	Instantaneous Power Factor	FFFF FF9C to 0000 0064 hex (-1.00 to 1.00) *Two digits to the right of the decimal point (fixed).
C8	0007	Instantaneous Frequency (Hz)	0000 01C2 to 0000 028A hex (45.0 to 65.0) *One digit to the right of the decimal point (fixed).
C8	0008	Instantaneous Active Power (W)	C465 3601 to 3B9A C9FF hex (-99,999,999.9 to 99,999,999.9) *One digit to the right of the decimal point (fixed).
C8	0009	Instantaneous Active Power (kW)	C465 3601 to 3B9A C9FF hex (-9,999,999.99 to 9,999,999.99) *Two digits to the right of the decimal point (fixed).
C8	000A	Instantaneous Reactive Power (var)	C465 3601 to 3B9A C9FF hex (-99,999,999.9 to 99,999,999.9) *One digit to the right of the decimal point (fixed).
C8	000B	Instantaneous Reactive Power (kvar)	C465 3601 to 3B9A C9FF hex (-9,999,999.99 to 9,999,999.99) *Two digits to the right of the decimal point (fixed).
C8	000C	Total Power Consumption (kWh)	0000 0000 to 05F5 E0FF hex (0.0 to 9,999,999.9) *One digit to the right of the decimal point (fixed).
C8	000D	Calculated CO ₂ (total power consumption) (kgCO ₂)	0000 0000 to 3B9A C9FF hex (0.0 to 99,999,999.9) *One digit to the right of the decimal point (fixed).
C8	000E ⁶	Total Pulse Input Count for the Day (pulses)	0000 0000 to 0001 869F hex (0 to 99,999)
C8	000F	Specific Power Consumption (kWh/pulse)	0000 0000 to 05F5 E0FF hex (0.000 to 99,999.999) *Three digits to the right of the decimal point (fixed).
C8	0010	Pulse Input ON Time	0000 0000 to 0000 HHMM hex HH (hour): 0 to 18 hex (0 to 24) MM (minutes): 0 to 3B hex (0 to 59)
C8	0011	Status	Refer to 3.2.3.2 Status Information.
C8	0012	Version	Example: 0000 0100 hex = version 1.00
C8	0013 ³	HIGH Total Power Consumption	0000 0000 to 05F5 E0FF hex (0.000 to 99,999.999) *Three digits to the right of the decimal point (fixed).
C8	0014 ³	HIGH Total Power Consumption Ratio ⁴	0000 0000 to 0000 03E8 hex (0.000 to 1.000) *Three digits to the right of the decimal point (fixed).
C8	0015 ³	HIGH Total Time	0000 0000 to 0000 HHMM hex HH (hour): 0 to 18 hex (0 to 24) MM (minutes): 0 to 3B hex (0 to 59)
C8	0016 ³	HIGH Total Time Ratio ⁴	0000 0000 to 0000 03E8 hex (0.000 to 1.000) *Three digits to the right of the decimal point (fixed).
C8	0017 ³	MIDDLE Total Power Consumption	0000 0000 to 05F5 E0FF hex (0.000 to 99,999.999) *Three digits to the right of the decimal point (fixed).
C8	0018 ³	MIDDLE Total Power Consumption Ratio ⁴	0000 0000 to 0000 03E8 hex (0.000 to 1.000) *Three digits to the right of the decimal point (fixed).
C8	0019 ³	MIDDLE Total Time	0000 0000 to 0000 HHMM hex HH (hour): 0 to 18 hex (0 to 24) MM (minutes): 0 to 3B hex (0 to 59)
C8	001A ³	MIDDLE Total Time Ratio ⁴	0000 0000 to 0000 03E8 hex (0.000 to 1.000) *Three digits to the right of the decimal point (fixed).
C8	001B ³	LOW Total Power Consumption	0000 0000 to 05F5 E0FF hex (0.000 to 99,999.999) Three digits to the right of the decimal point (fixed).
C8	001C ³	LOW Total Power Consumption Ratio ⁴	0000 0000 to 0000 03E8 hex (0.000 to 1.000) *Three digits to the right of the decimal point (fixed).
C8	001D ³	LOW Total Time	0000 0000 to 0000 HHMM hex HH (hour): 0 to 18 hex (0 to 24) MM (minutes): 0 to 3B hex (0 to 59)
C8	001E ³	LOW Total Time Ratio ⁴	0000 0000 to 0000 03E8 hex (0.000 to 1.000) *Three digits to the right of the decimal point (fixed).
C8	001F	Total Power Consumption (Wh)	0000 0000 to 3B9A C9FF hex (0 to 999,999,999)
C8	0020	Total Active Power Consumption (GWh)	0000 0000 to 0000 00009 hex (0 to 9)

Variable type	Address	Parameter name	Set value (monitor value)
C8	0021	Total Active Power Consumption (Wh)	0000 0000 to 3B9A C9FF hex (0 to 999,999,999)
C8	0022	Total Regenerated Energy (GWh)	0000 0000 to 0000 00009 hex (0 to 9)
C8	0023	Total Regenerated Energy (Wh)	0000 0000 to 3B9A C9FF hex (0 to 999,999,999)
C8	0024	Total Leading Reactive Power Consumption (Gvarh)	0000 0000 to 0000 00009 hex (0 to 9)
C8	0025	Total Leading Reactive Power Consumption (varh)	0000 0000 to 3B9A C9FF hex (0 to 999,999,999)
C8	0026	Total Lagging Reactive Power Consumption (Gvarh)	0000 0000 to 0000 00009 hex (0 to 9)
C8	0027	Total Lagging Reactive Power Consumption (varh)	0000 0000 to 3B9A C9FF hex (0 to 999,999,999)
C8	0028	Total Reactive Power Consumption (Gvarh)	0000 0000 to 0000 00009 hex (0 to 9)
C8	0029	Total Reactive Power Consumption (varh)	0000 0000 to 3B9A C9FF hex (0 to 999,999,999)
C8	002A ⁻³	Three-state HIGH Total Power Consumption (GWh)	0000 0000 to 0000 00009 hex (0 to 9)
C8	002B ⁻³	Three-state HIGH Total Power Consumption (Wh)	0000 0000 to 3B9A C9FF hex (0 to 999,999,999)
C8	002C ⁻³	Three-state HIGH Total Time (minutes)	0000 0000 to 0098 967F hex (0 to 9,999,999)
C8	002D ⁻³	Three-state MIDDLE Total Power Consumption (GWh)	0000 0000 to 0000 00009 hex (0 to 9)
C8	002E ⁻³	Three-state MIDDLE Total Power Consumption (Wh)	0000 0000 to 3B9A C9FF hex (0 to 999,999,999)
C8	002F ⁻³	Three-state MIDDLE Total Time (minutes)	0000 0000 to 0098 967F hex (0 to 9,999,999)
C8	0030 ⁻³	Three-state LOW Total Power Consumption (GWh)	0000 0000 to 0000 00009 hex (0 to 9)
C8	0031 ⁻³	Three-state LOW Total Power Consumption (Wh)	0000 0000 to 3B9A C9FF hex (0 to 999,999,999)
C8	0032 ⁻³	Three-state LOW Total Time (minutes)	0000 0000 to 0098 967F hex (0 to 9,999,999)
C8	0033 ⁻⁶	Total Pulse Input Count 1 (pulses)	0000 0000 to 3B9A C9FF hex (0 to 999,999,999)
C8	0034 ⁻⁶	Total Pulse Input Count 2 (pulses)	0000 0000 to 3B9A C9FF hex (0 to 999,999,999)
C8	0035 ⁻⁶	Sum Total Pulse Input Count (pulses)	0000 0000 to 3B9A C9FF hex (0 to 999,999,999)
C8	0036 ⁻⁶	Pulse Input Count 1 for the Day (pulses)	0000 0000 to 0001 869F hex (0 to 99,999)
C8	0037 ⁻⁶	Pulse Input Count 2 for the Day (pulses)	0000 0000 to 0001 869F hex (0 to 99,999)
C8	0038	Temperature (°C or °F) ⁻⁵	FFFF FF6A to 0000 0578 hex (-15.0 to 140.0) *One digit to the right of the decimal point (fixed). Note: In the range of -15.0 to 60.0 for Celsius, and 5.0 to 140.0 for Fahrenheit.
C8	0039	Converted Monetary Cost (upper digits) ⁻⁸	0000 0000 to 3B9A C9FF hex (0 to 999,999,999) Indicates values above 1M. Starts from 0 if the value exceeds the range.
C8	003A	Converted Monetary Cost (lower digits) ⁻⁸	0000 0000 to 3B9A C9FF hex (0 to 999,999,999) *Three digits to the right of the decimal point (fixed). Starts from 0 if the value exceeds the range.
C8	003B ⁻³	HIGH Total Power Consumption Converted to Monetary Cost (upper digits) ⁻⁸	0000 0000 to 3B9A C9FF hex (0 to 999,999,999) *Indicates values above 1M. Starts from 0 if the value exceeds the range.
C8	003C ⁻³	HIGH Total Power Consumption Converted to Monetary Cost (lower digits) ⁻⁸	0000 0000 to 3B9A C9FF hex (0 to 999,999,999) *Three digits to the right of the decimal point (fixed). Starts from 0 if the value exceeds the range.
C8	003D ⁻³	MIDDLE Total Power Consumption Converted to Monetary Cost (upper digits) ⁻⁸	0000 0000 to 3B9A C9FF hex (0 to 999,999,999) *Indicates values above 1M. Starts from 0 if the value exceeds the range.
C8	003E ⁻³	MIDDLE Total Power Consumption Converted to	0000 0000 to 3B9A C9FF hex (0 to 999,999,999) *Three digits to the right of the decimal point (fixed). Starts from

Variable type	Address	Parameter name	Set value (monitor value)
		Monetary Cost (lower digits) ^{*8}	0 if the value exceeds the range.
C8	003F ^{*3}	LOW Total Power Consumption Converted to Monetary Cost (upper digits) ^{*8}	0000 0000 to 3B9A C9FF hex (0 to 999,999,999) *Indicates values above 1M. Starts from 0 if the value exceeds the range.
C8	0040 ^{*3}	LOW Total Power Consumption Converted to Monetary Cost (lower digits) ^{*8}	0000 0000 to 3B9A C9FF hex (0 to 999,999,999) *Three digits to the right of the decimal point (fixed). Starts from 0 if the value exceeds the range.
C8	0041	Pulse Conversion Value 1 (upper digits) ^{*8}	0000 0000 to 3B9A C9FF hex (0 to 999,999,999) *Indicates values above 1M. Starts from 0 if the value exceeds the range.
C8	0042	Pulse Conversion Value 1 (lower digits) ^{*8}	0000 0000 to 3B9A C9FF hex (0 to 999,999,999) *Three digits to the right of the decimal point (fixed). Starts from 0 if the value exceeds the range.
C8	0043	Pulse Conversion Value 2 (upper digits) ^{*8}	0000 0000 to 3B9A C9FF hex (0 to 999,999,999) *Indicates values above 1M. Starts from 0 if the value exceeds the range.
C8	0044	Pulse Conversion Value 2 (lower digits) ^{*8}	0000 0000 to 3B9A C9FF hex (0 to 999,999,999) *Three digits to the right of the decimal point (fixed). Starts from 0 if the value exceeds the range.

*1, *2: See the notes for the C0 variable type.

*3: These addresses can be read only with the KM50-E. They cannot be read for the KM50-C.

*4: The ratios for various values read as 1.000 for 100% for the status from the start time until the end time.

*5: Temperatures are read out in the unit that has been set. Conversion between Celsius and Fahrenheit is made using the following formulas. If both values are required, convert the temperature in the host device.



If a compensation is set, it will be added or subtracted from the measurement value for either unit.

Example: When the temperature is 23.0°C (Celsius)/73.4°F (Fahrenheit) and the compensation value is +10.0, the displayed temperature becomes 23.0 + 10.0 = 32.0 (°C: Celsius) or 73.4 + 10.0 = 83.4 (°F: Fahrenheit).

*6: The pulse input counts are counter values that are reset on a daily basis. The total pulse input count is not reset on a daily basis, rather it is reset to zero when the count upper limit is reached, and starts counting again. Counter 1 and counter 2 are individual count values that can be read separately. The total counter reads the sum of counter 1 and counter 2. A summary is shown in the following table.

Parameter	Read out value	Reset condition
Pulse Input Count 1 for the Day	Input count for input 1	Reset on a daily basis.
Pulse Input Count 2 for the Day	Input count for input 2	
Total Pulse Input Count for the Day	Sum of input counts for inputs 1 and 2	
Total Pulse Input Count 1	Input count for input 1	Reset when upper limit is reached.
Total Pulse Input Count 2	Input count for input 2	
Total Pulse Input Count	Sum of input counts for inputs 1 and 2	

*7: Values after Recovering from a Power Interruption

The following measurement values are saved to the memory for every five-minute period. Therefore, when the power supply is turned ON, the last value that was saved for a five-minute period while the Power Monitor was ON will be read out, rather than the value right before the power was interrupted. The measurement will continue. Total power consumptions, pulse input ON time, pulse input count, specific power consumption, and three-state total power consumptions

*8: Digits That Are Read Out

The upper digits and lower digits of a converted value can be read out separated. However, there are only seven significant digits when the upper and lower digits are combined.

● C9 (New): Average Value Level

This variable type is not used by the KM50-C/-E.

(The KM50-C/-E do not support averaging for the data logging cycle.)

● CA (New): Maximum Value Level

Variable type	Address	Parameter name	Set value (monitor value)
CA	0000	Maximum Voltage 1 ^{*2} (V)	0000 0000 to 000F 423F hex (0.0 to 99,999.9) *One digit to the right of the decimal point (fixed).
CA	0001	Maximum Voltage 2 ^{*2} (V)	Same as above.
CA	0002	Maximum Voltage 3 ^{*2} (V)	Same as above.
CA	0003	Maximum Current 1 (A)	0000 0000 to 0098 967F hex (0.000 to 9,999.999) *Three digits to the right of the decimal point (fixed).
CA	0004	Maximum Current 2 ^{*1} (A)	Same as above.
CA	0005	Maximum Current 3 ^{*1} (A)	Same as above.
CA	0006	Maximum Power Factor	FFFF FF9C to 0000 0064 hex (-1.00 to 1.00) *Two digits to the right of the decimal point (fixed).
CA	0007	Maximum Active Power (W)	C465 3601 to 3B9A C9FF hex (-99,999,999.9 to 99,999,999.9) *One digit to the right of the decimal point (fixed).
CA	0008	Maximum Active Power (kW)	C465 3601 to 3B9A C9FF hex (-9,999,999.99 to 9,999,999.99) *Two digits to the right of the decimal point (fixed).
CA	0009	Maximum Reactive Power (var)	C465 3601 to 3B9A C9FF hex (-99,999,999.9 to 99,999,999.9) *One digit to the right of the decimal point (fixed).
CA	000A	Maximum Reactive Power (kvar)	C465 3601 to 3B9A C9FF hex (-9,999,999.99 to 9,999,999.99) *Two digits to the right of the decimal point (fixed).

*1, *2: See notes for C0 variable type.

● CB (New): Minimum Value Level

Variable type	Address	Parameter name	Set value (monitor value)
CB	0000	Minimum Voltage 1 ^{*2} (V)	0000 0000 to 000F 423F hex (0.0 to 99,999.9) *One digit to the right of the decimal point (fixed).
CB	0001	Minimum Voltage 2 ^{*2} (V)	Same as above.
CB	0002	Minimum Voltage 3 ^{*2} (V)	Same as above.
CB	0003	Minimum Current 1 (A)	0000 0000 to 0098 967F hex (0.000 to 9,999.999) *Three digits to the right of the decimal point (fixed).
CB	0004	Minimum Current 2 ^{*1} (A)	Same as above.
CB	0005	Minimum Current 3 ^{*1} (A)	Same as above.
CB	0006	Minimum Power Factor	FFFF FF9C to 0000 0064 hex (-1.00 to 1.00) *Two digits to the right of the decimal point (fixed).
CB	0007	Minimum Active Power (W)	C4653601 to 3B9AC9FF hex (-99,999,999.9 to 99,999,999.9) *One digit to the right of the decimal point (fixed).
CB	0008	Minimum Active Power (kW)	C465 3601 to 3B9A C9FF hex (-9,999,999.99 to 9,999,999.99) *Two digits to the right of the decimal point (fixed).
CB	0009	Minimum Reactive Power (var)	C465 3601 to 3B9A C9FF hex (-99,999,999.9 to 99,999,999.9) *One digit to the right of the decimal point (fixed).
CB	000A	Minimum Reactive Power (kvar)	C465 3601 to 3B9A C9FF hex (-9,999,999.99 to 9,999,999.99) *Two digits to the right of the decimal point (fixed).

*1, *2: See notes for C0 variable type.

● D0: Total Power Consumption for Every Five-minute Period (0.1-kWh increments)

The total power consumption for every five-minute period can be read.

The total power consumption for every five-minute period can be read for only two days, the present day and the previous day.

Specify the address for the time period to read in the service request PDU.

Example for Address 0001: The total power consumption from 00:05 to 00:10 will be read.

(The total power consumption for the specified five-minute period will be read.)

The total power consumption for every five-minute period for the present day cannot be read for times that are in the future compared to the present time in the KM50 internal clock. If the total power consumption is read for future times, the service response PDU will be returned with a measurement value of 0.

The addresses are listed in the following table.

(Addresses are incremented by one for each five-minute period, so some addresses have been omitted.)

Variable type	Address	Parameter name	Set value (monitor value)
D0	0000	Total Power Consumption for 00:00 to 00:05 Today (kWh)	0000 0000 to 05F5 E0FF hex (0.0 to 9,999,999.9) *One digit to the right of the decimal point (fixed).
D0	0001	Total Power Consumption for 00:05 to 00:10 Today (kWh)	Same as above.
D0	0002	Total Power Consumption for 00:10 to 00:15 Today (kWh)	Same as above.
...
(Omitted)			
...
D0	011E	Total Power Consumption for 23:50 to 23:55 Today (kWh)	Same as above.
D0	011F	Total Power Consumption for 23:55 to 24:00 Today (kWh)	Same as above.
D0	0120	Total Power Consumption for 00:00 to 00:05 Yesterday (kWh)	Same as above.
D0	0121	Total Power Consumption for 00:05 to 00:10 Yesterday (kWh)	Same as above.
D0	0122	Total Power Consumption for 00:10 to 00:15 Yesterday (kWh)	Same as above.
...
(Omitted)			
...
D0	023E	Total Power Consumption for 23:50 to 23:55 Yesterday (kWh)	Same as above.
D0	023F	Total Power Consumption for 23:55 to 24:00 Yesterday (kWh)	Same as above.

● D0: Total Power Consumption Every Five-minute Period (0.001-kWh increments)

KM50-E Only

The total power consumption for every five-minute period can be read.

The total power consumption for every five-minute period can be read for only two days, the present day and the previous day.

Specify the address for the time period to read in the service request PDU.

Example for Address 0001: The total power consumption from 00:05 to 00:10 will be read.

(The total power consumption for the specified five-minute period will be read.)

The total power consumption for every five-minute period for the present day cannot be read for times that are in the future compared to the present time in the KM50 internal clock. If the total power consumption is read for future times, the service response PDU will be returned with a measurement value of 0.

If the read value exceeds 9,999 kWh, the precision of the lowest digit will be lost, so FFFF FFFF will be returned as the measurement value in the service response PDU. If that occurs, read the measurement value for 0.1-kWh increments.

The addresses are listed in the following table.

(Addresses are incremented by one for each five-minute period, so some addresses have been omitted.)

Variable type	Address	Parameter name	Set value (monitor value)
D0	0800	Total Power Consumption for 00:00 to 00:05 Today (kWh)	0000 0000 to 0098 967F hex (0.000 to 9,999.999) *Three digits to the right of the decimal point (fixed).
D0	0801	Total Power Consumption for 00:05 to 00:10 Today (kWh)	Same as above.
D0	0802	Total Power Consumption for 00:10 to 00:15 Today (kWh)	Same as above.
...
(Omitted)			
...
D0	091E	Total Power Consumption for 23:50 to 23:55 Today (kWh)	Same as above.
D0	091F	Total Power Consumption for 23:55 to 24:00 Today (kWh)	Same as above.
D0	0920	Total Power Consumption for 00:00 to 00:05 Yesterday (kWh)	Same as above.
D0	0921	Total Power Consumption for 00:05 to 00:10 Yesterday (kWh)	Same as above.
D0	0922	Total Power Consumption for 00:10 to 00:15 Yesterday (kWh)	Same as above.
...
(Omitted)			
...
D0	0A3E	Total Power Consumption for 23:50 to 23:55 Yesterday (kWh)	Same as above.
D0	0A3F	Total Power Consumption for 23:55 to 24:00 Yesterday (kWh)	Same as above.

● D1: Total Power Consumption Every Five Minutes (0.1-kWh increments)

The total power consumption every five minutes can be read.

The total power consumption every five minutes can be read for only two days, the present day and the previous day.

Specify the address for the time period to read in the service request PDU.

Example for Address 0001: The total power consumption at 00:10 will be read.

(The total power consumption for the specified time will be read.)

The total power consumption every five minutes for the present day cannot be read for times that are in the future compared to the present time in the KM50 internal clock. If the total power consumption is read for future times, the service response PDU will be returned with a measurement value of 0.

The addresses are listed in the following table.

(Addresses are incremented by one for each five minutes, so some addresses have been omitted.)

Variable type	Address	Parameter name	Set value (monitor value)
D1	0000	Total Power Consumption for 00:05 Today (kWh)	0000 0000 to 05F5 E0FF hex (0.0 to 9,999,999.9) *One digit to the right of the decimal point (fixed).
D1	0001	Total Power Consumption for 00:10 Today (kWh)	Same as above.
D1	0002	Total Power Consumption for 00:15 Today (kWh)	Same as above.
...
(Omitted)			
...
D1	011E	Total Power Consumption for 23:55 Today (kWh)	Same as above.
D1	011F	Total Power Consumption for 24:00 Today (kWh)	Same as above.
D1	0120	Total Power Consumption for 00:05 Yesterday (kWh)	Same as above.
D1	0121	Total Power Consumption for 00:10 Yesterday (kWh)	Same as above.
D1	0122	Total Power Consumption for 00:15 Yesterday (kWh)	Same as above.
...
(Omitted)			
...
D1	023E	Total Power Consumption for 23:55 Yesterday (kWh)	Same as above.
D1	023F	Total Power Consumption for 24:00 Yesterday (kWh)	Same as above.

● D1: Total Power Consumption Every Five Minutes (0.001-kWh increments)

The total power consumption every five minutes can be read.

The total power consumption every five minutes can be read for only two days, the present day and the previous day.

Specify the address for the time period to read in the service request PDU.

Example for Address 0001: The total power consumption at 00:10 will be read.

(The total power consumption for the specified time will be read.)

The total power consumption every five minutes for the present day cannot be read for times that are in the future compared to the present time in the KM50 internal clock. If the total power consumption is read for future times, the service response PDU will be returned with a measurement value of 0.

If the read value exceeds 9,999 kWh, the precision of the lowest digit will be decreased, so FFFF FFFF will be returned as the measurement value in the service response PDU. If that occurs, read the measurement value for 0.1-kWh increments.

The addresses are listed in the following table.

(Addresses are incremented by one for each five minutes, so some addresses have been omitted.)

Variable type	Address	Parameter name	Set value (monitor value)
D1	0800	Total Power Consumption for 00:05 Today (kWh)	0000 0000 to 0098 967F hex (0.000 to 9,999.999) *Three digits to the right of the decimal point (fixed).
D1	0801	Total Power Consumption for 00:10 Today (kWh)	Same as above.
D1	0802	Total Power Consumption for 00:15 Today (kWh)	Same as above.
...
(Omitted)			
...
D1	091E	Total Power Consumption for 23:55 Today (kWh)	Same as above.
D1	091F	Total Power Consumption for 24:00 Today (kWh)	Same as above.
D1	0920	Total Power Consumption for 00:05 Yesterday (kWh)	Same as above.
D1	0921	Total Power Consumption for 00:10 Yesterday (kWh)	Same as above.
D1	0922	Total Power Consumption for 00:15 Yesterday (kWh)	Same as above.
...
(Omitted)			
...
D1	0A3E	Total Power Consumption for 23:55 Yesterday (kWh)	Same as above.
D1	0A3F	Total Power Consumption for 24:00 Yesterday (kWh)	Same as above.

● D2: Total Power Consumption Every Five-minute Period (0.1-kWh increments)

The total power consumption can be read for every five-minute period for any of four total power consumptions. The total power consumption for every five-minute period can be read for only two days, the present day and the previous day.

(: Regenerative, leading reactive, lagging reactive, or reactive)

To read the total power consumption, specify the address of the time that you want to read and send a service request PDU.

Example for Address 0001: The total power consumption from 00:05 to 00:10 will be read.

(The total power consumption for the specified five-minute period will be read.)

The total power consumption for every five-minute period for the present day cannot be read for times that are in the future compared to the present time in the KM50 internal clock. If a value is read for a future time, the service response PDU will be returned with a measurement value of 0.

The address are listed in the following table.

(Addresses are incremented by one for each five minutes. Some addresses have been omitted in the following table.)

Variable type	Address	Parameter	Set value (monitor value)
D2	0000	Total <input type="checkbox"/> <input type="checkbox"/> Power Consumption for 00:00 to 00:05 Today (kWh)	0000 0000 to 05F5 E0FF hex (0.0 to 9,999,999.9) *One digit to the right of the decimal point (fixed).
D2	0001	Total <input type="checkbox"/> <input type="checkbox"/> Power Consumption for 00:05 to 00:10 Today (kWh)	Same as above.
D2	0002	Total <input type="checkbox"/> <input type="checkbox"/> Power Consumption for 00:10 to 00:15 Today (kWh)	Same as above.
...
(Omitted)			
...
D2	011E	Total <input type="checkbox"/> <input type="checkbox"/> Power Consumption for 23:50 to 23:55 Today (kWh) NTPxDeleteMe	Same as above.
D2	011F	Total <input type="checkbox"/> <input type="checkbox"/> Power Consumption for 23:55 to 24:00 Today (kWh)	Same as above.
D2	0120	Total <input type="checkbox"/> <input type="checkbox"/> Power Consumption for 00:00 to 00:05 Yesterday (kWh)	Same as above.
D2	0121	Total <input type="checkbox"/> <input type="checkbox"/> Power Consumption for 00:05 to 00:10 Yesterday (kWh)	Same as above.
D2	0122	Total <input type="checkbox"/> <input type="checkbox"/> Power Consumption for 00:10 to 00:15 Yesterday (kWh)	Same as above.
...
(Omitted)			
...
D2	023E	Total <input type="checkbox"/> <input type="checkbox"/> Power Consumption for 23:50 to 23:55 Yesterday (kWh)	Same as above.
D2	023F	Total <input type="checkbox"/> <input type="checkbox"/> Power Consumption for 23:55 to 24:00 Yesterday (kWh)	Same as above.

● D2: Total □□ Power Consumption Every Five-minute Period (0.001-kWh increments)

The total power consumption can be read for every five-minute period for any of four total power consumptions. The total □□ power consumption for every five-minute period can be read for only two days, the present day and the previous day.

(□□: Regenerative, leading reactive, lagging reactive, or reactive)

Specify the address for the time to read in the service request PDU.

Example for Address 0001: The total □□ power consumption from 00:05 to 00:10 will be read.

(The total □□ power consumption for the specified five-minute period will be read.)

The total power consumption for every five-minute period for the present day cannot be read for times that are in the future compared to the present time in the KM50 internal clock. If a value is read for a future time, the service response PDU will be returned with a measurement value of 0. If the read value exceeds 9,999 kWh, the precision of the lowest digit will be lost, so FFFF FFFF will be returned as the measurement value in the service response PDU. If that occurs, read the measurement value for 0.1-kWh increments.

The address are listed in the following table.

Addresses are incremented by one for each five minutes. Some addresses have been omitted in the following table.

Variable type	Address	Parameter	Set value (monitor value)
D2	0800	Total □□ Power Consumption for 00:00 to 00:05 Today (kWh)	0000 0000 to 0098 967F hex (0.000 to 9,999.999) *Three digits to the right of the decimal point (fixed).
D2	0801	Total □□ Power Consumption for 00:05 to 00:10 Today (kWh)	Same as above.
D2	0802	Total □□ Power Consumption for 00:10 to 00:15 Today (kWh)	Same as above.
...
(Omitted)			
...
D2	091E	Total □□ Power Consumption for 23:50 to 23:55 Today (kWh)	Same as above.
D2	091F	Total □□ Power Consumption for 23:55 to 24:00 Today (kWh)	Same as above.
D2	0920	Total □□ Power Consumption for 00:00 to 00:05 Yesterday (kWh)	Same as above.
D2	0921	Total □□ Power Consumption for 00:05 to 00:10 Yesterday (kWh)	Same as above.
D2	0922	Total □□ Power Consumption for 00:10 to 00:15 Yesterday (kWh)	Same as above.
...
(Omitted)			
...
D2	0A3E	Total □□ Power Consumption for 23:50 to 23:55 Yesterday (kWh)	Same as above.
D2	0A3F	Total □□ Power Consumption for 23:55 to 24:00 Yesterday (kWh)	Same as above.

● D3: Total □□ Power Consumption Every Five Minutes (0.1-kWh increments)

The total power consumption can be read for every five minutes for any of four total power consumptions. The total □□ power consumption every five minutes can be read for only two days, the present day and the previous day.

(□□: Regenerative, leading reactive, lagging reactive, or reactive)

Specify the address for the time to read in the service request PDU.

Example for Address 0001: The total □□ power consumption for 00:10 will be read.

(The total □□ power consumption for the specified time will be read.)

The total □□ power consumption every five minutes for the present day cannot be read for times that are in the future compared to the present time in the KM50 internal clock. If a value is read for a future time, the service response PDU will be returned with a measurement value of 0.

The address are listed in the following table.

(Addresses are incremented by one for each five minutes. Some addresses have been omitted in the following table.)

Variable type	Address	Parameter	Set value (monitor value)
D3	0000	Total □□ Power Consumption for 00:05 Today (kWh)	0000 0000 to 05F5 E0FF hex (0.0 to 9,999,999.9) *One digit to the right of the decimal point (fixed).
D3	0001	Total □□ Power Consumption for 00:10 Today (kWh)	Same as above.
D3	0002	Total □□ Power Consumption for 00:15 Today (kWh)	Same as above.
...
(Omitted)			
...
D3	011E	Total □□ Power Consumption for 23:55 Today (kWh)	Same as above.
D3	011F	Total □□ Power Consumption for 24:00 Today (kWh)	Same as above.
D3	0120	Total □□ Power Consumption for 00:05 Yesterday (kWh)	Same as above.
D3	0121	Total □□ Power Consumption for 00:10 Yesterday (kWh)	Same as above.
D3	0122	Total □□ Power Consumption for 00:15 Yesterday (kWh)	Same as above.
...
(Omitted)			
...
D3	023E	Total □□ Power Consumption for 23:55 Yesterday (kWh)	Same as above.
D3	023F	Total □□ Power Consumption for 24:00 Yesterday (kWh)	Same as above.

● D3: Total □□ Power Consumption Every Five Minutes (0.001-kWh increments)

The total power consumption can be read for every five minutes for any of four total power consumptions. The total □□ power consumption every five minutes can be read for only two days, the present day and the previous day.

(□□: Regenerative, leading reactive, lagging reactive, or reactive)

Specify the address for the time to read in the service request PDU.

Example for Address 0001: The total □□ power consumption for 00:10 will be read.

(The total □□ power consumption for the specified time will be read.)

The total □□ power consumption every five minutes for the present day cannot be read for times that are in the future compared to the present time in the KM50 internal clock. If a value is read for a future time, the service response PDU will be returned with a measurement value of 0.

If the read value exceeds 9,999 kWh, the precision of the lowest digit will be lost, so FFFF FFFF will be returned as the measurement value in the service response PDU. If that occurs, read the measurement value for 0.1-kWh increments.

The address are listed in the following table.

Addresses are incremented by one for each five minutes. Some addresses have been omitted in the following table.

Variable type	Address	Parameter	Set value (monitor value)
D3	0800	Total □□ Power Consumption for 00:05 Today (kWh)	0000 0000 to 0098 967F hex (0.000 to 9,999.999) *Three digits to the right of the decimal point (fixed).
D3	0801	Total □□ Power Consumption for 00:10 Today (kWh)	Same as above.
D3	0802	Total □□ Power Consumption for 00:15 Today (kWh)	Same as above.
...
(Omitted)			
...
D3	091E	Total □□ Power Consumption for 23:55 Today (kWh)	Same as above.
D3	091F	Total □□ Power Consumption for 24:00 Today (kWh)	Same as above.
D3	0920	Total □□ Power Consumption for 00:05 Yesterday (kWh)	Same as above.
D3	0921	Total □□ Power Consumption for 00:10 Yesterday (kWh)	Same as above.
D3	0922	Total □□ Power Consumption for 00:15 Yesterday (kWh)	Same as above.
...
(Omitted)			
...
D3	0A3E	Total □□ Power Consumption for 23:55 Yesterday (kWh)	Same as above.
D3	0A3F	Total □□ Power Consumption for 24:00 Yesterday (kWh)	Same as above.

● D4: Total Power Consumption for Every Hour (0.1-kWh increments)

The total power consumption for every hour can be read.

The total power consumption for every hour can be read for only two days, the present day and the previous day.

Specify the address for the time period to read in the service request PDU.

The total power consumption for every hour for the present day cannot be read for times that are in the future compared to the present time in the KM50 internal clock. If the total power consumption is read for future times, the service response PDU will be returned with a measurement value of 0.

The addresses are listed in the following table.

(Addresses are incremented by one for each hour, so some addresses have been omitted.)

Variable type	Address	Parameter name	Set value (monitor value)
D4	0000	Total Power Consumption for 00:00 to 01:00 Today (kWh)	0000 0000 to 05F5 E0FF hex (0.0 to 9,999,999.9) *One digit to the right of the decimal point (fixed).
D4	0001	Total Power Consumption for 01:00 to 02:00 Today (kWh)	Same as above.
D4	0002	Total Power Consumption for 02:00 to 03:00 Today (kWh)	Same as above.
...
(Omitted)			
...
D4	0016	Total Power Consumption for 22:00 to 23:00 Today (kWh)	Same as above.
D4	0017	Total Power Consumption for 23:00 to 24:00 Today (kWh)	Same as above.
D4	0018	Total Power Consumption for 00:00 to 01:00 Yesterday (kWh)	Same as above.
D4	0019	Total Power Consumption for 01:00 to 02:00 Yesterday (kWh)	Same as above.
D4	001A	Total Power Consumption for 02:00 to 03:00 Yesterday (kWh)	Same as above.
...
(Omitted)			
...
D4	002E	Total Power Consumption for 22:00 to 23:00 Yesterday (kWh)	Same as above.
D4	002F	Total Power Consumption for 23:00 to 24:00 Yesterday (kWh)	Same as above.

● D4: Total Power Consumption for Every Hour (0.001-kWh increments)

The total power consumption for every hour can be read.

The total power consumption for every hour can be read for only two days, the present day and the previous day.

Specify the address for the time period to read in the service request PDU.

The total power consumption for every hour for the present day cannot be read for times that are in the future compared to the present time in the KM50 internal clock. If the total power consumption is read for future times, the service response PDU will be returned with a measurement value of 0. If the read value exceeds 9,999 kWh, the precision of the lowest digit will be decreased, so FFFF FFFF will be returned as the measurement value in the service response PDU. If that occurs, read the measurement value for 0.1-kWh increments.

The addresses are listed in the following table.

(Addresses are incremented by one for each hour, so some addresses have been omitted.)

Variable type	Address	Parameter name	Set value (monitor value)
D4	0800	Total Power Consumption for 00:00 to 01:00 Today (kWh)	0000 0000 to 0098 967F hex (0.000 to 9,999.999) *Three digits to the right of the decimal point (fixed).
D4	0801	Total Power Consumption for 01:00 to 02:00 Today (kWh)	Same as above.
D4	0802	Total Power Consumption for 02:00 to 03:00 Today (kWh)	Same as above.
...
(Omitted)			
...
D4	0816	Total Power Consumption for 22:00 to 23:00 Today (kWh)	Same as above.
D4	0817	Total Power Consumption for 23:00 to 24:00 Today (kWh)	Same as above.
D4	0818	Total Power Consumption for 00:00 to 01:00 Yesterday (kWh)	Same as above.
D4	0819	Total Power Consumption for 01:00 to 02:00 Yesterday (kWh)	Same as above.
D4	081A	Total Power Consumption for 02:00 to 03:00 Yesterday (kWh)	Same as above.
...
(Omitted)			
...
D4	082E	Total Power Consumption for 22:00 to 23:00 Yesterday (kWh)	Same as above.
D4	082F	Total Power Consumption for 23:00 to 24:00 Yesterday (kWh)	Same as above.

● D5: Total Power Consumption for Every Day (0.1-kWh increments)

The total power consumption for every day can be read.

The total power consumption for every day can be read for the present day and the last eight days.

Specify the address for the day to read in the service request PDU.

Variable type	Address	Parameter name	Set value (monitor value)
D5	0000	Present Total Power Consumption for Today (kWh)	0000 0000 to 05F5 E0FF hex (0.0 to 9,999,999.9) *One digit to the right of the decimal point (fixed).
D5	0001	Total Power Consumption for 00:00 to 24:00 One Day Ago (kWh)	Same as above.
D5	0002	Total Power Consumption for 00:00 to 24:00 Two Days Ago (kWh)	Same as above.
D5	0003	Total Power Consumption for 00:00 to 24:00 Three Days Ago (kWh)	Same as above.
D5	0004	Total Power Consumption for 00:00 to 24:00 Four Days Ago (kWh)	Same as above.
D5	0005	Total Power Consumption for 00:00 to 24:00 Five Days Ago (kWh)	Same as above.
D5	0006	Total Power Consumption for 00:00 to 24:00 Six Days Ago (kWh)	Same as above.
D5	0007	Total Power Consumption for 00:00 to 24:00 Seven Days Ago (kWh)	Same as above.
D5	0008	Total Power Consumption for 00:00 to 24:00 Eight Days Ago (kWh)	Same as above.

● D5: Total Power Consumption for Every Day (0.001-kWh increments)

The total power consumption for every day can be read.

The total power consumption for every day can be read for the present day and the last eight days.

Specify the address for the day to read in the service request PDU.

If the read value exceeds 9,999 kWh, the precision of the lowest digit will be decreased, so FFFF FFFF will be returned as the measurement value in the service response PDU. If that occurs, read the measurement value for 0.1-kWh increments.

Variable type	Address	Parameter name	Set value (monitor value)
D5	0800	Present Total Power Consumption for Today (kWh)	0000 0000 to 0098 967F hex (0.000 to 9,999.999) *Three digits to the right of the decimal point (fixed).
D5	0801	Total Power Consumption for 00:00 to 24:00 One Day Ago (kWh)	Same as above.
D5	0802	Total Power Consumption for 00:00 to 24:00 Two Days Ago (kWh)	Same as above.
D5	0803	Total Power Consumption for 00:00 to 24:00 Three Days Ago (kWh)	Same as above.
D5	0804	Total Power Consumption for 00:00 to 24:00 Four Days Ago (kWh)	Same as above.
D5	0805	Total Power Consumption for 00:00 to 24:00 Five Days Ago (kWh)	Same as above.
D5	0806	Total Power Consumption for 00:00 to 24:00 Six Days Ago (kWh)	Same as above.
D5	0807	Total Power Consumption for 00:00 to 24:00 Seven Days Ago (kWh)	Same as above.
D5	0808	Total Power Consumption for 00:00 to 24:00 Eight Days Ago (kWh)	Same as above.

● D6: Pulse Input ON Time for Every Day

The pulse ON time for every day can be read.

The pulse input ON time for every day can be read for the present day and the last eight days.

Specify the address for the day to read in the service request PDU.

Variable type	Address	Parameter name	Set value (monitor value)
D6	0000	Present Pulse Input ON Time for Today	0000 HHMM hex HH (hour): 0 to 18 hex (0 to 24) MM (minutes): 0 to 3B hex (0 to 59)
D6	0001	Pulse Input ON Time One Day Ago	Same as above.
D6	0002	Pulse Input ON Time Two Days Ago	Same as above.
D6	0003	Pulse Input ON Time Three Days Ago	Same as above.
D6	0004	Pulse Input ON Time Four Days Ago	Same as above.
D6	0005	Pulse Input ON Time Five Days Ago	Same as above.
D6	0006	Pulse Input ON Time Six Days Ago	Same as above.
D6	0007	Pulse Input ON Time Seven Days Ago	Same as above.
D6	0008	Pulse Input ON Time Eight Days Ago	Same as above.

● D7: Specific Power Consumption for Every Day

The specific power consumption for every day can be read.

The specific power consumption for every day can be read for the present day and the last eight days.

Specify the address for the day to read in the service request PDU.

If the read value exceeds 99,999.999 kWh/pulse, the precision of the lowest digit will be lost, so FFFF FFFF will be returned as the measurement value in the service response PDU.

Variable type	Address	Parameter name	Set value (monitor value)
D7	0000	Present Specific Power Consumption for Today (kWh/pulse)	0000 0000 to 05F5 E0FF hex (0.000 to 99,999.999) *Three digits to the right of the decimal point (fixed).
D7	0001	Specific Power Consumption for One Day Ago (kWh/pulse)	Same as above.
D7	0002	Specific Power Consumption for Two Days Ago (kWh/pulse)	Same as above.
D7	0003	Specific Power Consumption for Three Days Ago (kWh/pulse)	Same as above.
D7	0004	Specific Power Consumption for Four Days Ago (kWh/pulse)	Same as above.
D7	0005	Specific Power Consumption for Five Days Ago (kWh/pulse)	Same as above.
D7	0006	Specific Power Consumption for Six Days Ago (kWh/pulse)	Same as above.
D7	0007	Specific Power Consumption for Seven Days Ago (kWh/pulse)	Same as above.
D7	0008	Specific Power Consumption for Eight Days Ago (kWh/pulse)	Same as above.

- D8: Pulse Input Count for Every Day

The pulse input count for every day can be read.

The pulse input count for every day can be read for the present day and the last eight days.

Specify the address for the day to read in the service request PDU.

Variable type	Address	Parameter name	Set value (monitor value)
D8	0000	Present Pulse Input Count Today (pulses)	0000 0000 to 0001 869F hex (0 to 99,999)
D8	0001	Pulse Input Count One Day Ago (pulses)	Same as above.
D8	0002	Pulse Input Count Two Days Ago (pulses)	Same as above.
D8	0003	Pulse Input Count Three Days Ago (pulses)	Same as above.
D8	0004	Pulse Input Count Four Days Ago (pulses)	Same as above.
D8	0005	Pulse Input Count Five Days Ago (pulses)	Same as above.
D8	0006	Pulse Input Count Six Days Ago (pulses)	Same as above.
D8	0007	Pulse Input Count Seven Days Ago (pulses)	Same as above.
D8	0008	Pulse Input Count Eight Days Ago (pulses)	Same as above.

● DB: Total Power Consumption for Every Month (0.1-kWh increments)

The total power consumption for every month can be read.

The total power consumption for every month can be read for the present month and the last 13 months.

Specify the address for the month to read in the service request PDU.

Variable type	Address	Parameter name	Set value (monitor value)
DB	0000	Total Power Consumption This Month from 1st to Present Day (kWh)	0000 0000 to 05F5 E0FF hex (0.0 to 9,999,999.9) *One digit to the right of the decimal point (fixed).
DB	0001	Total Power Consumption One Month Ago from 1st to Last Day (kWh)	Same as above.
DB	0002	Total Power Consumption Two Months Ago from 1st to Last Day (kWh)	Same as above.
DB	0003	Total Power Consumption Three Months Ago from 1st to Last Day (kWh)	Same as above.
DB	0004	Total Power Consumption Four Months Ago from 1st to Last Day (kWh)	Same as above.
DB	0005	Total Power Consumption Five Months Ago from 1st to Last Day (kWh)	Same as above.
DB	0006	Total Power Consumption Six Months Ago from 1st to Last Day (kWh)	Same as above.
DB	0007	Total Power Consumption Seven Months Ago from 1st to Last Day (kWh)	Same as above.
DB	0008	Total Power Consumption Eight Months Ago from 1st to Last Day (kWh)	Same as above.
DB	0009	Total Power Consumption Nine Months Ago from 1st to Last Day (kWh)	Same as above.
DB	000A	Total Power Consumption 10 Months Ago from 1st to Last Day (kWh)	Same as above.
DB	000B	Total Power Consumption 11 Months Ago from 1st to Last Day (kWh)	Same as above.
DB	000C	Total Power Consumption 12 Months Ago from 1st to Last Day (kWh)	Same as above.
DB	000D	Total Power Consumption 13 Months Ago from 1st to Last Day (kWh)	Same as above.

● DB: Total Power Consumption for Every Month (0.001-kWh increments)

The total power consumption for every month can be read.

The total power consumption for every month can be read for the present month and the last 13 months.

Specify the address for the month to read in the service request PDU.

If the read value exceeds 9,999 kWh, the precision of the lowest digit will be decreased, so FFFF FFFF will be returned as the measurement value in the service response PDU. If that occurs, read the measurement value for 0.1-kWh increments.

Variable type	Address	Parameter name	Set value (monitor value)
DB	0800	Total Power Consumption This Month from 1st to Present Day (kWh)	0000 0000 to 0098 967F hex (0.000 to 9,999.999) *Three digits to the right of the decimal point (fixed).
DB	0801	Total Power Consumption One Month Ago from 1st to Last Day (kWh)	Same as above.
DB	0802	Total Power Consumption Two Months Ago from 1st to Last Day (kWh)	Same as above.
DB	0803	Total Power Consumption Three Months Ago from 1st to Last Day (kWh)	Same as above.
DB	0804	Total Power Consumption Four Months Ago from 1st to Last Day (kWh)	Same as above.
DB	0805	Total Power Consumption Five Months Ago from 1st to Last Day (kWh)	Same as above.
DB	0806	Total Power Consumption Six Months Ago from 1st to Last Day (kWh)	Same as above.
DB	0807	Total Power Consumption Seven Months Ago from 1st to Last Day (kWh)	Same as above.
DB	0808	Total Power Consumption Eight Months Ago from 1st to Last Day (kWh)	Same as above.
DB	0809	Total Power Consumption Nine Months Ago from 1st to Last Day (kWh)	Same as above.
DB	080A	Total Power Consumption 10 Months Ago from 1st to Last Day (kWh)	Same as above.
DB	080B	Total Power Consumption 11 Months Ago from 1st to Last Day (kWh)	Same as above.
DB	080C	Total Power Consumption 12 Months Ago from 1st to Last Day (kWh)	Same as above.
DB	080D	Total Power Consumption 13 Months Ago from 1st to Last Day (kWh)	Same as above.

● DC: HIGH Total Power Consumption Every Five-minute Period (0.001-kWh increments)

KM50-E Only

The HIGH total power consumption for every five-minute period can be read.

The HIGH total power consumption for every five-minute period can be read for only two days, the present day and the previous day.

Specify the address for the time period to read in the service request PDU.

Example for Address 0001: The HIGH total power consumption from 00:05 to 00:10 will be read.

(The HIGH total power consumption for the specified time will be read.)

The HIGH total power consumption for every five-minute period for the present day cannot be read for times that are in the future compared to the present time in the KM50 internal clock. If the HIGH total power consumption is read for future times, the service response PDU will be returned with a measurement value of 0.

The addresses are listed in the following table.

(Addresses are incremented by one for each five minutes, so some addresses have been omitted.)

Variable type	Address	Parameter name	Set value (monitor value)
DC	0000	HIGH Total Power Consumption for 00:00 to 00:05 Today (kWh)	0000 0000 to 0098 967F hex (0.000 to 9,999.999) *Three digits to the right of the decimal point (fixed).
DC	0001	HIGH Total Power Consumption for 00:05 to 00:10 Today (kWh)	Same as above.
DC	0002	HIGH Total Power Consumption for 00:10 to 00:15 Today (kWh)	Same as above.
...
(Omitted)			
...
DC	011E	HIGH Total Power Consumption for 23:50 to 23:55 Today (kWh)	Same as above.
DC	011F	HIGH Total Power Consumption for 23:55 to 24:00 Today (kWh)	Same as above.
DC	0120	HIGH Total Power Consumption for 00:00 to 00:05 Yesterday (kWh)	Same as above.
DC	0121	HIGH Total Power Consumption for 00:05 to 00:10 Yesterday (kWh)	Same as above.
DC	0122	HIGH Total Power Consumption for 00:10 to 00:15 Yesterday (kWh)	Same as above.
...
(Omitted)			
...
DC	023E	HIGH Total Power Consumption for 23:50 to 23:55 Yesterday (kWh)	Same as above.
DC	023F	HIGH Total Power Consumption for 23:55 to 24:00 Yesterday (kWh)	Same as above.

● DC: HIGH Total Power Consumption Every Day (0.001-kWh increments) **KM50-E Only**

The HIGH total power consumption for every day can be read.

The HIGH total power consumption for every day can be read for the present day and the last eight days.

Specify the address for the day to read in the service request PDU.

If the read value exceeds 99,999.999 kWh, the precision of the lowest digit will be lost, so FFFF FFFF will be returned as the measurement value in the service response PDU.

Variable type	Address	Parameter name	Set value (monitor value)
DC	0800	Present HIGH Total Power Consumption for Today (kWh)	0000 0000 to 05F5 E0FF hex (0.000 to 99,999.999) *Three digits to the right of the decimal point (fixed).
DC	0801	HIGH Total Power Consumption for 00:00 to 24:00 One Day Ago (kWh)	Same as above.
DC	0802	HIGH Total Power Consumption for 00:00 to 24:00 Two Days Ago (kWh)	Same as above.
DC	0803	HIGH Total Power Consumption for 00:00 to 24:00 Three Days Ago (kWh)	Same as above.
DC	0804	HIGH Total Power Consumption for 00:00 to 24:00 Four Days Ago (kWh)	Same as above.
DC	0805	HIGH Total Power Consumption for 00:00 to 24:00 Five Days Ago (kWh)	Same as above.
DC	0806	HIGH Total Power Consumption for 00:00 to 24:00 Six Days Ago (kWh)	Same as above.
DC	0807	HIGH Total Power Consumption for 00:00 to 24:00 Seven Days Ago (kWh)	Same as above.
DC	0808	HIGH Total Power Consumption for 00:00 to 24:00 Eight Days Ago (kWh)	Same as above.

● DC: HIGH Total Power Consumption Ratio for Every Day **KM50-E Only**

The HIGH total power consumption ratio for every day can be read.

The HIGH total power consumption ratio for every day can be read for the present day and the last eight days.

Specify the address for the day to read in the service request PDU.

Variable type	Address	Parameter name	Set value (monitor value)
DC	0900	Present HIGH Total Power Consumption Ratio for Today	0000 0000 to 0000 03E8 hex (0.000 to 1.000) *Three digits to the right of the decimal point (fixed).
DC	0901	HIGH Total Power Consumption Ratio for 00:00 to 24:00 One Day Ago	Same as above.
DC	0902	HIGH Total Power Consumption Ratio for 00:00 to 24:00 Two Days Ago	Same as above.
DC	0903	HIGH Total Power Consumption Ratio for 00:00 to 24:00 Three Days Ago	Same as above.
DC	0904	HIGH Total Power Consumption Ratio for 00:00 to 24:00 Four Days Ago	Same as above.
DC	0905	HIGH Total Power Consumption Ratio for 00:00 to 24:00 Five Days Ago	Same as above.
DC	0906	HIGH Total Power Consumption Ratio for 00:00 to 24:00 Six Days Ago	Same as above.
DC	0907	HIGH Total Power Consumption Ratio for 00:00 to 24:00 Seven Days Ago	Same as above.
DC	0908	HIGH Total Power Consumption Ratio for 00:00 to 24:00 Eight Days Ago	Same as above.

● DC: HIGH Total Time for Every Day **KM50-E Only**

The HIGH total time for every day can be read.

The HIGH total time for every day can be read for the present day and the last eight days.

Specify the address for the day to read in the service request PDU.

Variable type	Address	Parameter name	Set value (monitor value)
DC	0A00	Present HIGH Total Time for Today	0000 HHMM hex HH (hour): 0 to 18 hex (0 to 24) MM (minutes): 0 to 3B hex (0 to 59)
DC	0A01	HIGH Total Time for One Day Ago	Same as above.
DC	0A02	HIGH Total Time for Two Days Ago	Same as above.
DC	0A03	HIGH Total Time for Three Days Ago	Same as above.
DC	0A04	HIGH Total Time for Four Days Ago	Same as above.
DC	0A05	HIGH Total Time for Five Days Ago	Same as above.
DC	0A06	HIGH Total Time for Six Days Ago	Same as above.
DC	0A07	HIGH Total Time for Seven Days Ago	Same as above.
DC	0A08	HIGH Total Time for Eight Days Ago	Same as above.

● DC: HIGH Total Time Ratio for Every Day **KM50-E Only**

The HIGH total time ratio for every day can be read.

The HIGH total time ratio for every day can be read for the present day and the last eight days.

Specify the address for the day to read in the service request PDU.

Variable type	Address	Parameter name	Set value (monitor value)
DC	0B00	Present HIGH Total Time Ratio for Today	0000 0000 to 0000 03E8 hex (0.000 to 1.000) *Three digits to the right of the decimal point (fixed).
DC	0B01	HIGH Total Time Ratio for One Day Ago	Same as above.
DC	0B02	HIGH Total Time Ratio for Two Days Ago	Same as above.
DC	0B03	HIGH Total Time Ratio for Three Days Ago	Same as above.
DC	0B04	HIGH Total Time Ratio for Four Days Ago	Same as above.
DC	0B05	HIGH Total Time Ratio for Five Days Ago	Same as above.
DC	0B06	HIGH Total Time Ratio for Six Days Ago	Same as above.
DC	0B07	HIGH Total Time Ratio for Seven Days Ago	Same as above.
DC	0B08	HIGH Total Time Ratio for Eight Days Ago	Same as above.

● DD: MIDDLE Total Power Consumption Every Five-minute Period (0.001-kWh increments) **KM50-E Only**

The MIDDLE total power consumption for every five-minute period can be read.

The MIDDLE total power consumption for every five-minute period can be read for only two days, the present day and the previous day.

Specify the address for the time period to read in the service request PDU.

Example for Address 0001: The MIDDLE total power consumption from 00:00 to 00:10 will be read.

(The MIDDLE total power consumption for the specified time will be read.)

The MIDDLE total power consumption for every five-minute period for the present day cannot be read for times that are in the future compared to the present time in the KM50 internal clock. If the MIDDLE total power consumption is read for future times, the service response PDU will be returned with a measurement value of 0.

The address are listed in the following table.

(Addresses are incremented by one for each five minutes, so some addresses have been omitted.)

Variable type	Address	Parameter name	Set value (monitor value)
DD	0000	MIDDLE Total Power Consumption for 00:00 to 00:05 Today (kWh)	0000 0000 to 0098 967F hex (0.000 to 9,999.999) *Three digits to the right of the decimal point (fixed).
DD	0001	MIDDLE Total Power Consumption for 00:05 to 00:10 Today (kWh)	Same as above.
DD	0002	MIDDLE Total Power Consumption for 00:10 to 00:15 Today (kWh)	Same as above.
...
(Omitted)			
...
DD	011E	MIDDLE Total Power Consumption for 23:50 to 23:55 Today (kWh)	Same as above.
DD	011F	MIDDLE Total Power Consumption for 23:55 to 24:00 Today (kWh)	Same as above.
DD	0120	MIDDLE Total Power Consumption for 00:00 to 00:05 Yesterday (kWh)	Same as above.
DD	0121	MIDDLE Total Power Consumption for 00:05 to 00:10 Yesterday (kWh)	Same as above.
DD	0122	MIDDLE Total Power Consumption for 00:10 to 00:15 Yesterday (kWh)	Same as above.
...
(Omitted)			
...
DD	023E	MIDDLE Total Power Consumption for 23:50 to 23:55 Yesterday (kWh)	Same as above.
DD	023F	MIDDLE Total Power Consumption for 23:50 to 24:00 Yesterday (kWh)	Same as above.

● DD: MIDDLE Total Power Consumption Every Day (0.001-kWh increments)

KM50-E Only

The MIDDLE total power consumption for every day can be read.

The MIDDLE total power consumption for every day can be read for the present day and the last eight days.

Specify the address for the day to read in the service request PDU.

If the read value exceeds 99,999.999 kWh, the precision of the lowest digit will be lost, so FFFF FFFF will be returned as the measurement value in the service response PDU.

Variable type	Address	Parameter name	Set value (monitor value)
DD	0800	Present MIDDLE Total Power Consumption for Today (kWh)	0000 0000 to 05F5 E0FF hex (0.000 to 99,999.999) *Three digits to the right of the decimal point (fixed).
DD	0801	MIDDLE Total Power Consumption for 00:00 to 24:00 One Day Ago (kWh)	Same as above.
DD	0802	MIDDLE Total Power Consumption for 00:00 to 24:00 Two Days Ago (kWh)	Same as above.
DD	0803	MIDDLE Total Power Consumption for 00:00 to 24:00 Three Days Ago (kWh)	Same as above.
DD	0804	MIDDLE Total Power Consumption for 00:00 to 24:00 Four Days Ago (kWh)	Same as above.
DD	0805	MIDDLE Total Power Consumption for 00:00 to 24:00 Five Days Ago (kWh)	Same as above.
DD	0806	MIDDLE Total Power Consumption for 00:00 to 24:00 Six Days Ago (kWh)	Same as above.
DD	0807	MIDDLE Total Power Consumption for 00:00 to 24:00 Seven Days Ago (kWh)	Same as above.
DD	0808	MIDDLE Total Power Consumption for 00:00 to 24:00 Eight Days Ago (kWh)	Same as above.

● DD: MIDDLE Total Power Consumption Ratio for Every Day **KM50-E Only**

The MIDDLE total power consumption ratio for every day can be read.

The MIDDLE total power consumption ratio for every day can be read for the present day and the last eight days.

Specify the address for the day to read in the service request PDU.

Variable type	Address	Parameter name	Set value (monitor value)
DD	0900	Present MIDDLE Total Power Consumption Ratio for Today	0000 0000 to 0000 03E8 hex (0.000 to 1.000) *Three digits to the right of the decimal point (fixed).
DD	0901	MIDDLE Total Power Consumption Ratio for 00:00 to 24:00 One Day Ago (kWh)	Same as above.
DD	0902	MIDDLE Total Power Consumption Ratio for 00:00 to 24:00 Two Days Ago (kWh)	Same as above.
DD	0903	MIDDLE Total Power Consumption Ratio for 00:00 to 24:00 Three Days Ago (kWh)	Same as above.
DD	0904	MIDDLE Total Power Consumption Ratio for 00:00 to 24:00 Four Days Ago (kWh)	Same as above.
DD	0905	MIDDLE Total Power Consumption Ratio for 00:00 to 24:00 Five Days Ago (kWh)	Same as above.
DD	0906	MIDDLE Total Power Consumption Ratio for 00:00 to 24:00 Six Days Ago (kWh)	Same as above.
DD	0907	MIDDLE Total Power Consumption Ratio for 00:00 to 24:00 Seven Days Ago (kWh)	Same as above.
DD	0908	MIDDLE Total Power Consumption Ratio for 00:00 to 24:00 Eight Days Ago (kWh)	Same as above.

● DD: MIDDLE Total Time for Every Day **KM50-E Only**

The total operating time for every day can be read.

The MIDDLE total time for every day can be read for the present day and the last eight days.

Specify the address for the day to read in the service request PDU.

Variable type	Address	Parameter name	Set value (monitor value)
DD	0A00	Present MIDDLE Total Time for Today	0000 HHMM hex HH (hour): 0 to 18 hex (0 to 24) MM (minutes): 0 to 3B hex (0 to 59)
DD	0A01	MIDDLE Total Time for One Day Ago	Same as above.
DD	0A02	MIDDLE Total Time for Two Days Ago	Same as above.
DD	0A03	MIDDLE Total Time for Three Days Ago	Same as above.
DD	0A04	MIDDLE Total Time for Four Days Ago	Same as above.
DD	0A05	MIDDLE Total Time for Five Days Ago	Same as above.
DD	0A06	MIDDLE Total Time for Six Days Ago	Same as above.
DD	0A07	MIDDLE Total Time for Seven Days Ago	Same as above.
DD	0A08	MIDDLE Total Time for Eight Days Ago	Same as above.

● DD: MIDDLE Total Time Ratio for Every Day **KM50-E Only**

The MIDDLE total time ratio for every day can be read.

The MIDDLE total time ratio for every day can be read for the present day and the last eight days.

Specify the address for the day to read in the service request PDU.

Variable type	Address	Parameter name	Set value (monitor value)
DD	0B00	Present MIDDLE Total Time Ratio for Today	0000 0000 to 0000 03E8 hex (0.000 to 1.000) *Three digits to the right of the decimal point (fixed).
DD	0B01	MIDDLE Total Time Ratio for One Day Ago	Same as above.
DD	0B02	MIDDLE Total Time Ratio for Two Days Ago	Same as above.
DD	0B03	MIDDLE Total Time Ratio for Three Days Ago	Same as above.
DD	0B04	MIDDLE Total Time Ratio for Four Days Ago	Same as above.
DD	0B05	MIDDLE Total Time Ratio for Five Days Ago	Same as above.
DD	0B06	MIDDLE Total Time Ratio for Six Days Ago	Same as above.
DD	0B07	MIDDLE Total Time Ratio for Seven Days Ago	Same as above.
DD	0B08	MIDDLE Total Time Ratio for Eight Days Ago	Same as above.

● DE: LOW Total Power Consumption Every Five-minute Period (0.001-kWh increments)

KM50-E Only

The LOW total power consumption for every five-minute period can be read.

The LOW total power consumption for every five-minute period can be read for only two days, the present day and the previous day.

Specify the address for the time period to read in the service request PDU.

Example for Address 0001: The LOW total power consumption from 00:00 to 00:10 will be read.

(The LOW total power consumption for the specified time will be read.)

The LOW total power consumption for every five-minute period for the present day cannot be read for times that are in the future compared to the present time in the KM50 internal clock. If the LOW total power consumption is read for future times, the service response PDU will be returned with a measurement value of 0.

The addresses are listed in the following table.

(Addresses are incremented by one for each five minutes, so some addresses have been omitted.)

Variable type	Address	Parameter name	Set value (monitor value)
DE	0000	LOW Total Power Consumption for 00:00 to 00:05 Today (kWh)	0000 0000 to 0098 967F hex (0.000 to 9,999.999) *Three digits to the right of the decimal point (fixed).
DE	0001	LOW Total Power Consumption for 00:05 to 00:10 Today (kWh)	Same as above.
DE	0002	LOW Total Power Consumption for 00:10 to 00:15 Today (kWh)	Same as above.
...
(Omitted)			
...
DE	011E	LOW Total Power Consumption for 23:50 to 23:55 Today (kWh)	Same as above.
DE	011F	LOW Total Power Consumption for 23:55 to 24:00 Today (kWh)	Same as above.
DE	0120	LOW Total Power Consumption for 00:00 to 00:05 Yesterday (kWh)	Same as above.
DE	0121	LOW Total Power Consumption for 00:05 to 00:10 Yesterday (kWh)	Same as above.
DE	0122	LOW Total Power Consumption for 00:10 to 00:15 Yesterday (kWh)	Same as above.
...
(Omitted)			
...
DE	023E	LOW Total Power Consumption for 23:50 to 23:55 Yesterday (kWh)	Same as above.
DE	023F	LOW Total Power Consumption for 23:55 to 24:00 Yesterday (kWh)	Same as above.

● DE: LOW Total Power Consumption Every Day (0.001-kWh increments) **KM50-E Only**

The LOW total power consumption for every day can be read.

The LOW total power consumption for every day can be read for the present day and the last eight days.

Specify the address for the day to read in the service request PDU.

If the read value exceeds 99,999.999 kWh, the precision of the lowest digit will be lost, so FFFF FFFF will be returned as the measurement value in the service response PDU.

Variable type	Address	Parameter name	Set value (monitor value)
DE	0800	Present LOW Total Power Consumption for Today (kWh)	0000 0000 to 0098 967F hex (0.000 to 9,999.999) *Three digits to the right of the decimal point (fixed).
DE	0801	LOW Total Power Consumption for 00:00 to 24:00 One Day Ago (kWh)	Same as above.
DE	0802	LOW Total Power Consumption for 00:00 to 24:00 Two Days Ago (kWh)	Same as above.
DE	0803	LOW Total Power Consumption for 00:00 to 24:00 Three Days Ago (kWh)	Same as above.
DE	0804	LOW Total Power Consumption for 00:00 to 24:00 Four Days Ago (kWh)	Same as above.
DE	0805	LOW Total Power Consumption for 00:00 to 24:00 Five Days Ago (kWh)	Same as above.
DE	0806	LOW Total Power Consumption for 00:00 to 24:00 Six Days Ago (kWh)	Same as above.
DE	0807	LOW Total Power Consumption for 00:00 to 24:00 Seven Days Ago (kWh)	Same as above.
DE	0808	LOW Total Power Consumption for 00:00 to 24:00 Eight Days Ago (kWh)	Same as above.

● DE: LOW Total Power Consumption Ratio for Every Day **KM50-E Only**

The LOW total power consumption ratio for every day can be read.

The LOW total power consumption ratio for every day can be read for the present day and the last eight days.

Specify the address for the day to read in the service request PDU.

Variable type	Address	Parameter name	Set value (monitor value)
DE	0900	Present LOW Total Power Consumption Ratio for Today	0000 0000 to 0000 03E8 hex (0.000 to 1.000) *Three digits to the right of the decimal point (fixed).
DE	0901	LOW Total Power Consumption Ratio for 00:00 to 24:00 One Day Ago (kWh)	Same as above.
DE	0902	LOW Total Power Consumption Ratio for 00:00 to 24:00 Two Days Ago (kWh)	Same as above.
DE	0903	LOW Total Power Consumption Ratio for 00:00 to 24:00 Three Days Ago (kWh)	Same as above.
DE	0904	LOW Total Power Consumption Ratio for 00:00 to 24:00 Four Days Ago (kWh)	Same as above.
DE	0905	LOW Total Power Consumption Ratio for 00:00 to 24:00 Five Days Ago (kWh)	Same as above.
DE	0906	LOW Total Power Consumption Ratio for 00:00 to 24:00 Six Days Ago (kWh)	Same as above.
DE	0907	LOW Total Power Consumption Ratio for 00:00 to 24:00 Seven Days Ago (kWh)	Same as above.
DE	0908	LOW Total Power Consumption Ratio for 00:00 to 24:00 Eight Days Ago (kWh)	Same as above.

● DE: LOW Total Time for Every Day **KM50-E Only**

The LOW total time for every day can be read.

The LOW total time for every day can be read for the present day and the last eight days.

Specify the address for the day to read in the service request PDU.

Variable type	Address	Parameter name	Set value (monitor value)
DE	0A00	Present LOW Total Time for Today	0000 HHMM hex HH (hour): 0 to 18 hex (0 to 24) MM (minutes): 0 to 3B hex (0 to 59)
DE	0A01	LOW Total Time for One Day Ago	Same as above.
DE	0A02	LOW Total Time for Two Days Ago	Same as above.
DE	0A03	LOW Total Time for Three Days Ago	Same as above.
DE	0A04	LOW Total Time for Four Days Ago	Same as above.
DE	0A05	LOW Total Time for Five Days Ago	Same as above.
DE	0A06	LOW Total Time for Six Days Ago	Same as above.
DE	0A07	LOW Total Time for Seven Days Ago	Same as above.
DE	0A08	LOW Total Time for Eight Days Ago	Same as above.

● DE: LOW Total Time Ratio for Every Day **KM50-E Only**

The LOW total time ratio for every day can be read.

The LOW total time ratio for every day can be read for the present day and the last eight days.

Specify the address for the day to read in the service request PDU.

Variable type	Address	Parameter name	Set value (monitor value)
DE	0B00	Present LOW Total Time Ratio for Today	0000 0000 to 0000 03E8 hex (0.000 to 1.000) *Three digits to the right of the decimal point (fixed).
DE	0B01	LOW Total Time Ratio for One Day Ago	Same as above.
DE	0B02	LOW Total Time Ratio for Two Days Ago	Same as above.
DE	0B03	LOW Total Time Ratio for Three Days Ago	Same as above.
DE	0B04	LOW Total Time Ratio for Four Days Ago	Same as above.
DE	0B05	LOW Total Time Ratio for Five Days Ago	Same as above.
DE	0B06	LOW Total Time Ratio for Six Days Ago	Same as above.
DE	0B07	LOW Total Time Ratio for Seven Days Ago	Same as above.
DE	0B08	LOW Total Time Ratio for Eight Days Ago	Same as above.

● E0: Maximum Measurement Values

The maximum measurement values can be read.

The maximum measurement values for every day can be read for the present day and the last eight days. However, the reactive power can be read only for the present day.

Specify the address for the day and measurement item to read in the service request PDU.

The maximum value and the time when the value was recorded can be read. You can read both the measurement time and measurement value, only the measurement time, or only the measurement value.

Addresses are defined as follows:

0 △△

0: The first digit of the address is always 0.

: Indicates the day. 0: Present day, 1: One day ago, 2: Two days ago, ..., 8: Eight days ago

△△: Indicates the measurement time or the measurement item.

Variable type	Address	Parameter name		Set value (monitor value)
E0	0000	Voltage 1 Today	Measurement Time	0000 HHMM hex HH (hour): 0 to 17 hex (0 to 23), MM (minutes): 0 to 3B hex (0 to 59)
E0	0001		Measurement Value (V)	0000 0000 to 000F 423F hex (0.0 to 99,999.9) *One digit to the right of the decimal point (fixed).
E0	0002	Voltage 2 Today	Measurement Time	0000 HHMM hex HH (hour): 0 to 17 hex (0 to 23), MM (minutes): 0 to 3B hex (0 to 59)
E0	0003		Measurement Value (V)	0000 0000 to 000F 423F hex (0.0 to 99,999.9) *One digit to the right of the decimal point (fixed).
E0	0004	Voltage 3 Today	Measurement Time	0000 HHMM hex HH (hour): 0 to 17 hex (0 to 23), MM (minutes): 0 to 3B hex (0 to 59)
E0	0005		Measurement Value (V)	0000 0000 to 000F 423F hex (0.0 to 99,999.9) *One digit to the right of the decimal point (fixed).
E0	0006	Current 1 Today	Measurement Time	0000 HHMM hex HH (hour): 0 to 17 hex (0 to 23), MM (minutes): 0 to 3B hex (0 to 59)
E0	0007		Measurement Value (A)	0000 0000 to 0098 967F hex (0.000 to 99,999.999) *Three digits to the right of the decimal point (fixed).
E0	0008	Current 2 Today	Measurement Time	0000 HHMM hex HH (hour): 0 to 17 hex (0 to 23), MM (minutes): 0 to 3B hex (0 to 59)
E0	0009		Measurement Value (A)	0000 0000 to 0098 967F hex (0.000 to 99,999.999) *Three digits to the right of the decimal point (fixed).
E0	000A	Current 3 Today	Measurement Time	0000 HHMM hex HH (hour): 0 to 17 hex (0 to 23), MM (minutes): 0 to 3B hex (0 to 59)
E0	000B		Measurement Value (A)	0000 0000 to 0098 967F hex (0.000 to 99,999.999) *Three digits to the right of the decimal point (fixed).
E0	000C	Power Factor Today	Measurement Time	0000 HHMM hex HH (hour): 0 to 17 hex (0 to 23), MM (minutes): 0 to 3B hex (0 to 59)
E0	000D		Measurement Value	FFFF FF9C to 0000 0064 hex (-1.00 to 1.00) *Two digits to the right of the decimal point (fixed).
E0	000E	Active Power Today	Measurement Time	0000 HHMM hex HH (hour): 0 to 17 hex (0 to 23), MM (minutes): 0 to 3B hex (0 to 59)
E0	000F		Measurement Value (W)	C465 3601 to 3B9A C9FF hex (-99,999,999.9 to 99,999,999.9) *One digit to the right of the decimal point (fixed).
E0	0010	Active Power Today	Measurement Time	0000 HHMM hex HH (hour): 0 to 17 hex (0 to 23), MM (minutes): 0 to 3B hex (0 to 59)
E0	0011		Measurement Value (kW)	C465 3601 to 3B9A C9FF hex (-9,999,999.99 to 9,999,999.99) *Two digits to the right of the decimal point (fixed).
E0	0012	Reactive Power Today	Measurement Time	0000 HHMM hex HH (hour): 0 to 17 hex (0 to 23), MM (minutes): 0 to 3B hex (0 to 59)
E0	0013		Measurement Value (var)	C465 3601 to 3B9A C9FF hex (-99,999,999.9 to 99,999,999.9) *One digit to the right of the decimal point (fixed).

Variable type	Address	Parameter name		Set value (monitor value)
E0	0014	Reactive Power Today	Measurement Time	0000 HHMM hex
E0	0015		Measurement Value (kvar)	C465 3601 to 3B9A C9FF hex (–9,999,999.99 to 9,999,999.99) *Two digits to the right of the decimal point (fixed).
E0	0100	Voltage 1 One Day Ago	Measurement Time	0000 HHMM hex HH (hour): 0 to 17 hex (0 to 23), MM (minutes): 0 to 3B hex (0 to 59)
E0	0101		Measurement Value (V)	0000 0000 to 000F 423F hex (0.0 to 99,999.9) *One digit to the right of the decimal point (fixed).
E0	0102	Voltage 2 One Day Ago	Measurement Time	0000 HHMM hex HH (hour): 0 to 17 hex (0 to 23), MM (minutes): 0 to 3B hex (0 to 59)
E0	0103		Measurement Value (V)	0000 0000 to 000F 423F hex (0.0 to 99,999.9) *One digit to the right of the decimal point (fixed).
E0	0104	Voltage 3 One Day Ago	Measurement Time	0000 HHMM hex HH (hour): 0 to 17 hex (0 to 23), MM (minutes): 0 to 3B hex (0 to 59)
E0	0105		Measurement Value (V)	0000 0000 to 000F 423F hex (0.0 to 99,999.9) *One digit to the right of the decimal point (fixed).
E0	0106	Current 1 One Day Ago	Measurement Time	0000 HHMM hex HH (hour): 0 to 17 hex (0 to 23), MM (minutes): 0 to 3B hex (0 to 59)
E0	0107		Measurement Value (A)	0000 0000 to 0098 967F hex (0.000 to 99,999.999) *Three digits to the right of the decimal point (fixed).
E0	0108	Current 2 One Day Ago	Measurement Time	0000 HHMM hex HH (hour): 0 to 17 hex (0 to 23), MM (minutes): 0 to 3B hex (0 to 59)
E0	0109		Measurement Value (A)	0000 0000 to 0098 967F hex (0.000 to 99,999.999) *Three digits to the right of the decimal point (fixed).
E0	010A	Current 3 One Day Ago	Measurement Time	0000 HHMM hex HH (hour): 0 to 17 hex (0 to 23), MM (minutes): 0 to 3B hex (0 to 59)
E0	010B		Measurement Value (A)	0000 0000 to 0098 967F hex (0.000 to 99,999.999) *Three digits to the right of the decimal point (fixed).
E0	010C	Power Factor One Day Ago	Measurement Time	0000 HHMM hex HH (hour): 0 to 17 hex (0 to 23), MM (minutes): 0 to 3B hex (0 to 59)
E0	010D		Measurement Value	FFFF FF9C to 0000 0064 hex (–1.00 to 1.00) *Two digits to the right of the decimal point (fixed).
E0	010E	Active Power One Day Ago	Measurement Time	0000 HHMM hex HH (hour): 0 to 17 hex (0 to 23), MM (minutes): 0 to 3B hex (0 to 59)
E0	010F		Measurement Value (W)	C465 3601 to 3B9A C9FF hex (–99,999,999.9 to 99,999,999.9) *One digit to the right of the decimal point (fixed).
E0	0110	Active Power One Day Ago	Measurement Time	0000 HHMM hex HH (hour): 0 to 17 hex (0 to 23), MM (minutes): 0 to 3B hex (0 to 59)
E0	0111		Measurement Value (kW)	C465 3601 to 3B9A C9FF hex (–9,999,999.99 to 9,999,999.99) *Two digits to the right of the decimal point (fixed).
...
E0	0700	Voltage 1 Seven Days Ago	Measurement Time	0000 HHMM hex HH (hour): 0 to 17 hex (0 to 23), MM (minutes): 0 to 3B hex (0 to 59)
E0	0701		Measurement Value (V)	0000 0000 to 000F 423F hex (0.0 to 99,999.9) *One digit to the right of the decimal point (fixed).
E0	0702	Voltage 2 Seven Days Ago	Measurement Time	0000 HHMM hex HH (hour): 0 to 17 hex (0 to 23), MM (minutes): 0 to 3B hex (0 to 59)
E0	0703		Measurement Value (V)	0000 0000 to 000F 423F hex (0.0 to 99,999.9) *One digit to the right of the decimal point (fixed).
E0	0704	Voltage 3 Seven Days Ago	Measurement Time	0000 HHMM hex HH (hour): 0 to 17 hex (0 to 23), MM (minutes): 0 to 3B hex (0 to 59)
E0	0705		Measurement Value (V)	0000 0000 to 000F 423F hex (0.0 to 99,999.9) *One digit to the right of the decimal point (fixed).
E0	0706	Current 1 Seven Days Ago	Measurement Time	0000 HHMM hex HH (hour): 0 to 17 hex (0 to 23), MM (minutes): 0 to 3B hex (0 to 59)
E0	0707		Measurement Value (A)	0000 0000 to 0098 967F hex (0.000 to 99,999.999) *Three digits to the right of the decimal point (fixed).
E0	0708	Current 2 Seven Days Ago	Measurement Time	0000 HHMM hex HH (hour): 0 to 17 hex (0 to 23), MM (minutes): 0 to 3B hex (0 to 59)
E0	0709		Measurement Value (A)	0000 0000 to 0098 967F hex (0.000 to 99,999.999) *Three digits to the right of the decimal point (fixed).
E0	070A	Current 3 Seven Days Ago	Measurement Time	0000 HHMM hex HH (hour): 0 to 17 hex (0 to 23), MM (minutes): 0 to 3B hex (0 to 59)
E0	070B		Measurement Value (A)	0000 0000 to 0098 967F hex (0.000 to 99,999.999) *Three digits to the right of the decimal point (fixed).
E0	070C	Power Factor Seven Days Ago	Measurement Time	0000 HHMM hex HH (hour): 0 to 17 hex (0 to 23), MM (minutes): 0 to 3B hex (0 to 59)
E0	070D		Measurement Value	FFFF FF9C to 0000 0064 hex (–1.00 to 1.00) *Two digits to the right of the decimal point (fixed).

Variable type	Address	Parameter name	Set value (monitor value)
E0	070E	Active Power Seven Days Ago	Measurement Time 0000 HHMM hex
E0	070F		Measurement Value (W) C465 3601 to 3B9A C9FF hex (-99,999,999.9 to 99,999,999.9) *One digit to the right of the decimal point (fixed).
E0	0710	Active Power Seven Days Ago	Measurement Time 0000 HHMM hex HH (hour): 0 to 17 hex (0 to 23), MM (minutes): 0 to 3B hex (0 to 59)
E0	0711		Measurement Value (kW) C465 3601 to 3B9A C9FF hex (-9,999,999.99 to 9,999,999.99) *Two digits to the right of the decimal point (fixed).
E0	0800	Voltage 1 Eight Days Ago	Measurement Time 0000 HHMM hex HH (hour): 0 to 17 hex (0 to 23), MM (minutes): 0 to 3B hex (0 to 59)
E0	0801		Measurement Value (V) 0000 0000 to 000F 423F hex (0.0 to 99,999.9) *One digit to the right of the decimal point (fixed).
E0	0802	Voltage 2 Eight Days Ago	Measurement Time 0000 HHMM hex HH (hour): 0 to 17 hex (0 to 23), MM (minutes): 0 to 3B hex (0 to 59)
E0	0803		Measurement Value (V) 0000 0000 to 000F 423F hex (0.0 to 99,999.9) *One digit to the right of the decimal point (fixed).
E0	0804	Voltage 3 Eight Days Ago	Measurement Time 0000 HHMM hex HH (hour): 0 to 17 hex (0 to 23), MM (minutes): 0 to 3B hex (0 to 59)
E0	0805		Measurement Value (V) 0000 0000 to 000F 423F hex (0.0 to 99,999.9) *One digit to the right of the decimal point (fixed).
E0	0806	Current 1 Eight Days Ago	Measurement Time 0000 HHMM hex HH (hour): 0 to 17 hex (0 to 23), MM (minutes): 0 to 3B hex (0 to 59)
E0	0807		Measurement Value (A) 0000 0000 to 0098 967F hex (0.000 to 99,999.999) *Three digits to the right of the decimal point (fixed).
E0	0808	Current 2 Eight Days Ago	Measurement Time 0000 HHMM hex HH (hour): 0 to 17 hex (0 to 23), MM (minutes): 0 to 3B hex (0 to 59)
E0	0809		Measurement Value (A) 0000 0000 to 0098 967F hex (0.000 to 99,999.999) *Three digits to the right of the decimal point (fixed).
E0	080A	Current 3 Eight Days Ago	Measurement Time 0000 HHMM hex HH (hour): 0 to 17 hex (0 to 23), MM (minutes): 0 to 3B hex (0 to 59)
E0	080B		Measurement Value (A) 0000 0000 to 0098 967F hex (0.000 to 99,999.999) *Three digits to the right of the decimal point (fixed).
E0	080C	Power Factor Eight Days Ago	Measurement Time 0000 HHMM hex HH (hour): 0 to 17 hex (0 to 23), MM (minutes): 0 to 3B hex (0 to 59)
E0	080D		Measurement Value FFFF FF9C to 0000 0064 hex (-1.00 to 1.00) *Two digits to the right of the decimal point (fixed).
E0	080E	Active Power Eight Days Ago	Measurement Time 0000 HHMM hex HH (hour): 0 to 17 hex (0 to 23), MM (minutes): 0 to 3B hex (0 to 59)
E0	080F		Measurement Value (W) C465 3601 to 3B9A C9FF hex (-99,999,999.9 to 99,999,999.9) *One digit to the right of the decimal point (fixed).
E0	0810	Active Power Eight Days Ago	Measurement Time 0000 HHMM hex HH (hour): 0 to 17 hex (0 to 23), MM (minutes): 0 to 3B hex (0 to 59)
E0	0811		Measurement Value (kW) C465 3601 to 3B9A C9FF hex (-9,999,999.99 to 9,999,999.99) *Two digits to the right of the decimal point (fixed).

*The new order is used for currents 1, 2, 3 (see notes for C0 variable type).

● E1: Minimum Measurement Values

The minimum measurement values can be read.

The minimum measurement values for every day can be read for the present day and the last eight days. However, the reactive power can be read only for the present day.

Specify the address for the day and measurement item to read in the service request PDU.

The minimum value and the time when the value was recorded can be read.

You can read both the measurement time and measurement value, only the measurement time, or only the measurement value.

Addresses are defined as follows:

0 △△

0: The first digit of the address is always 0.

: Indicates the day. 0: Present day, 1: One day ago, 2: Two days ago, ..., 8: Eight days ago

△△: Indicates the measurement time or the measurement item.

Variable type	Address	Parameter name		Set value (monitor value)
E1	0000	Voltage 1 Today	Measurement Time	0000 HHMM hex HH (hour): 0 to 17 hex (0 to 23), MM (minutes): 0 to 3B hex (0 to 59)
E1	0001		Measurement Value (V)	0000 0000 to 000F 423F hex (0.0 to 99,999.9) *One digit to the right of the decimal point (fixed).
E1	0002	Voltage 2 Today	Measurement Time	0000 HHMM hex HH (hour): 0 to 17 hex (0 to 23), MM (minutes): 0 to 3B hex (0 to 59)
E1	0003		Measurement Value (V)	0000 0000 to 000F 423F hex (0.0 to 99,999.9) *One digit to the right of the decimal point (fixed).
E1	0004	Voltage 3 Today	Measurement Time	0000 HHMM hex HH (hour): 0 to 17 hex (0 to 23), MM (minutes): 0 to 3B hex (0 to 59)
E1	0005		Measurement Value (V)	0000 0000 to 000F 423F hex (0.0 to 99,999.9) *One digit to the right of the decimal point (fixed).
E1	0006	Current 1 Today	Measurement Time	0000 HHMM hex HH (hour): 0 to 17 hex (0 to 23), MM (minutes): 0 to 3B hex (0 to 59)
E1	0007		Measurement Value (A)	0000 0000 to 0098 967F hex (0.000 to 99,999.999) *Three digits to the right of the decimal point (fixed).
E1	0008	Current 2 Today	Measurement Time	0000 HHMM hex HH (hour): 0 to 17 hex (0 to 23), MM (minutes): 0 to 3B hex (0 to 59)
E1	0009		Measurement Value (A)	0000 0000 to 0098 967F hex (0.000 to 99,999.999) *Three digits to the right of the decimal point (fixed).
E1	000A	Current 3 Today	Measurement Time	0000 HHMM hex HH (hour): 0 to 17 hex (0 to 23), MM (minutes): 0 to 3B hex (0 to 59)
E1	000B		Measurement Value (A)	0000 0000 to 0098 967F hex (0.000 to 99,999.999) *Three digits to the right of the decimal point (fixed).
E1	000C	Power Factor Today	Measurement Time	0000 HHMM hex HH (hour): 0 to 17 hex (0 to 23), MM (minutes): 0 to 3B hex (0 to 59)
E1	000D		Measurement Value	FFFF FF9C to 0000 0064 hex (-1.00 to 1.00) *Two digits to the right of the decimal point (fixed).
E1	000E	Active Power Today	Measurement Time	0000 HHMM hex HH (hour): 0 to 17 hex (0 to 23), MM (minutes): 0 to 3B hex (0 to 59)
E1	000F		Measurement Value (W)	C465 3601 to 3B9A C9FF hex (-99,999,999.9 to 99,999,999.9) *One digit to the right of the decimal point (fixed).
E1	0010	Active Power Today	Measurement Time	0000 HHMM hex HH (hour): 0 to 17 hex (0 to 23), MM (minutes): 0 to 3B hex (0 to 59)
E1	0011		Measurement Value (kW)	C465 3601 to 3B9A C9FF hex (-9,999,999.99 to 9,999,999.99) *Two digits to the right of the decimal point (fixed). *Two digits to the right of the decimal point (fixed).
E1	0012	Reactive Power Today	Measurement Time	0000 HHMM hex HH (hour): 0 to 17 hex (0 to 23), MM (minutes): 0 to 3B hex (0 to 59)
E1	0013		Measurement Value (var)	C465 3601 to 3B9A C9FF hex (-99,999,999.9 to 99,999,999.9) *One digit to the right of the decimal point (fixed).

Variable type	Address	Parameter name	Set value (monitor value)
E1	0014	Reactive Power Today	Measurement Time 0000 HHMM hex
E1	0015		Measurement Value (kvar) C465 3601 to 3B9A C9FF hex (-9,999,999.99 to 9,999,999.99) *Two digits to the right of the decimal point (fixed).
E1	0100	Voltage 1 One Day Ago	Measurement Time 0000 HHMM hex HH (hour): 0 to 17 hex (0 to 23), MM (minutes): 0 to 3B hex (0 to 59)
E1	0101		Measurement Value (V) 0000 0000 to 000F 423F hex (0.0 to 99,999.9) *One digit to the right of the decimal point (fixed).
E1	0102	Voltage 2 One Day Ago	Measurement Time 0000 HHMM hex HH (hour): 0 to 17 hex (0 to 23), MM (minutes): 0 to 3B hex (0 to 59)
E1	0103		Measurement Value (V) 0000 0000 to 000F 423F hex (0.0 to 99,999.9) *One digit to the right of the decimal point (fixed).
E1	0104	Voltage 3 One Day Ago	Measurement Time 0000 HHMM hex HH (hour): 0 to 17 hex (0 to 23), MM (minutes): 0 to 3B hex (0 to 59)
E1	0105		Measurement Value (V) 0000 0000 to 000F 423F hex (0.0 to 99,999.9) *One digit to the right of the decimal point (fixed).
E1	0106	Current 1 One Day Ago	Measurement Time 0000 HHMM hex HH (hour): 0 to 17 hex (0 to 23), MM (minutes): 0 to 3B hex (0 to 59)
E1	0107		Measurement Value (A) 0000 0000 to 0098 967F hex (0.000 to 99,999.999) *Three digits to the right of the decimal point (fixed).
E1	0108	Current 2 One Day Ago	Measurement Time 0000 HHMM hex HH (hour): 0 to 17 hex (0 to 23), MM (minutes): 0 to 3B hex (0 to 59)
E1	0109		Measurement Value (A) 0000 0000 to 0098 967F hex (0.000 to 99,999.999) *Three digits to the right of the decimal point (fixed).
E1	010A	Current 3 One Day Ago	Measurement Time 0000 HHMM hex HH (hour): 0 to 17 hex (0 to 23), MM (minutes): 0 to 3B hex (0 to 59)
E1	010B		Measurement Value (A) 0000 0000 to 0098 967F hex (0.000 to 99,999.999) *Three digits to the right of the decimal point (fixed).
E1	010C	Power Factor One Day Ago	Measurement Time 0000 HHMM hex HH (hour): 0 to 17 hex (0 to 23), MM (minutes): 0 to 3B hex (0 to 59)
E1	010D		Measurement Value FFFF FF9C to 0000 0064 hex (-1.00 to 1.00) *Two digits to the right of the decimal point (fixed).
E1	010E	Active Power One Day Ago	Measurement Time 0000 HHMM hex HH (hour): 0 to 17 hex (0 to 23), MM (minutes): 0 to 3B hex (0 to 59)
E1	010F		Measurement Value (W) C465 3601 to 3B9A C9FF hex (99,999,999.9 to 99,999,999.9) *One digit to the right of the decimal point (fixed).
E1	0110	Active Power One Day Ago	Measurement Time 0000 HHMM hex HH (hour): 0 to 17 hex (0 to 23), MM (minutes): 0 to 3B hex (0 to 59)
E1	0111		Measurement Value (kW) C465 3601 to 3B9A C9FF hex (-9,999,999.99 to 99,999,999.9) *Two digits to the right of the decimal point (fixed).
...
E1	0700	Voltage 1 Seven Days Ago	Measurement Time 0000 HHMM hex HH (hour): 0 to 17 hex (0 to 23), MM (minutes): 0 to 3B hex (0 to 59)
E1	0701		Measurement Value (V) 0000 0000 to 000F 423F hex (0.0 to 99,999.9) *One digit to the right of the decimal point (fixed).
E1	0702	Voltage 2 Seven Days Ago	Measurement Time 0000 HHMM hex HH (hour): 0 to 17 hex (0 to 23), MM (minutes): 0 to 3B hex (0 to 59)
E1	0703		Measurement Value (V) 0000 0000 to 000F 423F hex (0.0 to 99,999.9) *One digit to the right of the decimal point (fixed).
E1	0704	Voltage 3 Seven Days Ago	Measurement Time 0000 HHMM hex HH (hour): 0 to 17 hex (0 to 23), MM (minutes): 0 to 3B hex (0 to 59)
E1	0705		Measurement Value (V) 0000 0000 to 000F 423F hex (0.0 to 99,999.9) *One digit to the right of the decimal point (fixed).
E1	0706	Current 1 Seven Days Ago	Measurement Time 0000 HHMM hex HH (hour): 0 to 17 hex (0 to 23), MM (minutes): 0 to 3B hex (0 to 59)
E1	0707		Measurement Value (A) 0000 0000 to 0098 967F hex (0.000 to 99,999.999) *Three digits to the right of the decimal point (fixed).
E1	0708	Current 2 Seven Days Ago	Measurement Time 0000 HHMM hex HH (hour): 0 to 17 hex (0 to 23), MM (minutes): 0 to 3B hex (0 to 59)
E1	0709		Measurement Value (A) 0000 0000 to 0098 967F hex (0.000 to 99,999.999) *Three digits to the right of the decimal point (fixed).
E1	070A	Current 3 Seven Days Ago	Measurement Time 0000 HHMM hex HH (hour): 0 to 17 hex (0 to 23), MM (minutes): 0 to 3B hex (0 to 59)
E1	070B		Measurement Value (A) 0000 0000 to 0098 967F hex (0.000 to 99,999.999) *Three digits to the right of the decimal point (fixed).
E1	070C	Power Factor Seven Days Ago	Measurement Time 0000 HHMM hex HH (hour): 0 to 17 hex (0 to 23), MM (minutes): 0 to 3B hex (0 to 59)
E1	070D		Measurement Value FFFF FF9C to 0000 0064 hex (1.00 to 1.00) *Two digits to the right of the decimal point (fixed).
E1	070E	Active Power Seven Days Ago	Measurement Time 0000 HHMM hex HH (hour): 0 to 17 hex (0 to 23), MM (minutes): 0 to 3B hex (0 to 59)
E1	070F		Measurement Value (W) C465 3601 to 3B9A C9FF hex (-99,999,999.9 to 99,999,999.9) *One digit to the right of the decimal point (fixed).

Variable type	Address	Parameter name	Set value (monitor value)
E1	0710	Active Power Seven Days Ago	Measurement Time 0000 HHMM hex HH (hour): 0 to 17 hex (0 to 23), MM (minutes): 0 to 3B hex (0 to 59)
E1	0711		Measurement Value (kW) C465 3601 to 3B9A C9FF hex (9,999,999.99 to 9,999,999.99) *Two digits to the right of the decimal point (fixed).
E1	0800	Voltage 1 Eight Days Ago	Measurement Time 0000 HHMM hex HH (hour): 0 to 17 hex (0 to 23), MM (minutes): 0 to 3B hex (0 to 59)
E1	0801		Measurement Value (V) 0000 0000 to 000F 423F hex (0.0 to 99,999.9) *One digit to the right of the decimal point (fixed).
E1	0802	Voltage 2 Eight Days Ago	Measurement Time 0000 HHMM hex HH (hour): 0 to 17 hex (0 to 23), MM (minutes): 0 to 3B hex (0 to 59)
E1	0803		Measurement Value (V) 0000 0000 to 000F 423F hex (0.0 to 99,999.9) *One digit to the right of the decimal point (fixed).
E1	0804	Voltage 3 Eight Days Ago	Measurement Time 0000 HHMM hex HH (hour): 0 to 17 hex (0 to 23), MM (minutes): 0 to 3B hex (0 to 59)
E1	0805		Measurement Value (V) 0000 0000 to 000F 423F hex (0.0 to 99,999.9) *One digit to the right of the decimal point (fixed).
E1	0806	Current 1 Eight Days Ago	Measurement Time 0000 HHMM hex HH (hour): 0 to 17 hex (0 to 23), MM (minutes): 0 to 3B hex (0 to 59)
E1	0807		Measurement Value (A) 0000 0000 to 0098 967F hex (0.000 to 99,999.999) *Three digits to the right of the decimal point (fixed).
E1	0808	Current 2 Eight Days Ago	Measurement Time 0000 HHMM hex HH (hour): 0 to 17 hex (0 to 23), MM (minutes): 0 to 3B hex (0 to 59)
E1	0809		Measurement Value (A) 0000 0000 to 0098 967F hex (0.000 to 99,999.999) *Three digits to the right of the decimal point (fixed).
E1	080A	Current 3 Eight Days Ago	Measurement Time 0000 HHMM hex HH (hour): 0 to 17 hex (0 to 23), MM (minutes): 0 to 3B hex (0 to 59)
E1	080B		Measurement Value (A) 0000 0000 to 0098 967F hex (0.000 to 99,999.999) *Three digits to the right of the decimal point (fixed).
E1	080C	Power Factor Eight Days Ago	Measurement Time 0000 HHMM hex HH (hour): 0 to 17 hex (0 to 23), MM (minutes): 0 to 3B hex (0 to 59)
E1	080D		Measurement Value FFFF FF9C to 0000 0064 hex (1.00 to 1.00) *Two digits to the right of the decimal point (fixed).
E1	080E	Active Power Eight Days Ago	Measurement Time 0000 HHMM hex HH (hour): 0 to 17 hex (0 to 23), MM (minutes): 0 to 3B hex (0 to 59)
E1	080F		Measurement Value (W) C465 3601 to 3B9A C9FF hex (-99,999,999.9 to 99,999,999.9) *One digit to the right of the decimal point (fixed).
E1	0810	Active Power Eight Days Ago	Measurement Time 0000 HHMM hex HH (hour): 0 to 17 hex (0 to 23), MM (minutes): 0 to 3B hex (0 to 59)
E1	0811		Measurement Value (kW) C465 3601 to 3B9A C9FF hex (-9,999,999.99 to 9,999,999.99) *Two digits to the right of the decimal point (fixed).

*The new order is used for currents 1, 2, 3 (see notes for C0 variable type).

● E2: Alarm History

The history of alarms that occurred in the past can be read.

Up to 10 alarms that occurred in the past can be read out. The smaller the address is, the newer the information is. If more than 10 alarms occur, the oldest alarms in the history will be deleted.

Data is not saved when power is interrupted. Only the alarms that occur while power supply is ON can be read out from the history.

The 13 types of alarms that are listed in the following table can be read out. (This includes "No alarm.")

Table: List of Alarm Types

Read out value	Alarm type
0000 0000 hex	No alarm
0000 0001 hex	Instantaneous active power upper limit alarm
0000 0002 hex	Instantaneous active power lower limit alarm
0000 0003 hex	Instantaneous regenerative power upper limit alarm
0000 0004 hex	Instantaneous regenerative power lower limit alarm
0000 0005 hex	Current upper limit alarm
0000 0006 hex	Current lower limit alarm
0000 0007 hex	Voltage upper limit alarm
0000 0008 hex	Voltage lower limit alarm
0000 0009 hex	Power factor upper limit alarm
0000 000A hex	Power factor lower limit alarm
0000 000B hex	Instantaneous active power lower limit alarm
0000 000C hex	Instantaneous reactive power lower limit alarm

Variable type	Address	Parameter	Set value (monitor value)
E2	0000	Alarm Type	Refer to <i>Table: List of Alarm Types</i> .
E2	0001	Alarm Record 1	Date and Time of Occurrence
E2	0002		Date and Time Cleared
E2	0003	Alarm Record 2	Alarm Type
E2	0004		Date and Time of Occurrence
E2	0005		Date and Time Cleared
E2	0006	Alarm Record 3	Alarm Type
E2	0007		Date and Time of Occurrence
E2	0008		Date and Time Cleared
E2	0009	Alarm Record 4	Alarm Type
E2	000A		Date and Time of Occurrence
E2	000B		Date and Time Cleared
E2	000C	Alarm Record 5	Alarm Type
E2	000D		Date and Time of Occurrence
E2	000E		Date and Time Cleared
E2	000F	Alarm Record 6	Alarm Type
E2	0010		Date and Time of Occurrence
E2	0011		Date and Time Cleared
E2	0012	Alarm Record 7	Alarm Type
E2	0013		Date and Time of Occurrence
E2	0014		Date and Time Cleared

Variable type	Address	Parameter	Set value (monitor value)
E2	0015	Alarm Record 8	Alarm Type
E2	0016		Date and Time of Occurrence
E2	0017		Date and Time Cleared
E2	0018	Alarm Record 9	Alarm Type
E2	0019		Date and Time of Occurrence
E2	001A		Date and Time Cleared
E2	001B	Alarm Record 10	Alarm Type
E2	001C		Date and Time of Occurrence
E2	001D		Date and Time Cleared

* MDDhhyy MM: Month (00 to 0C (12) hex) DD: Date (00 to 1F (31) hex)
hh: Hour (00 to 17 (23) hex) mm: Minute (00 to 3B (59) hex)

3.2 Status Information

The following bit information is returned. If the previous variable type (C0) is used, only bits 00 to 15 are returned. If the new variable type (C8) is used, all bits are returned.

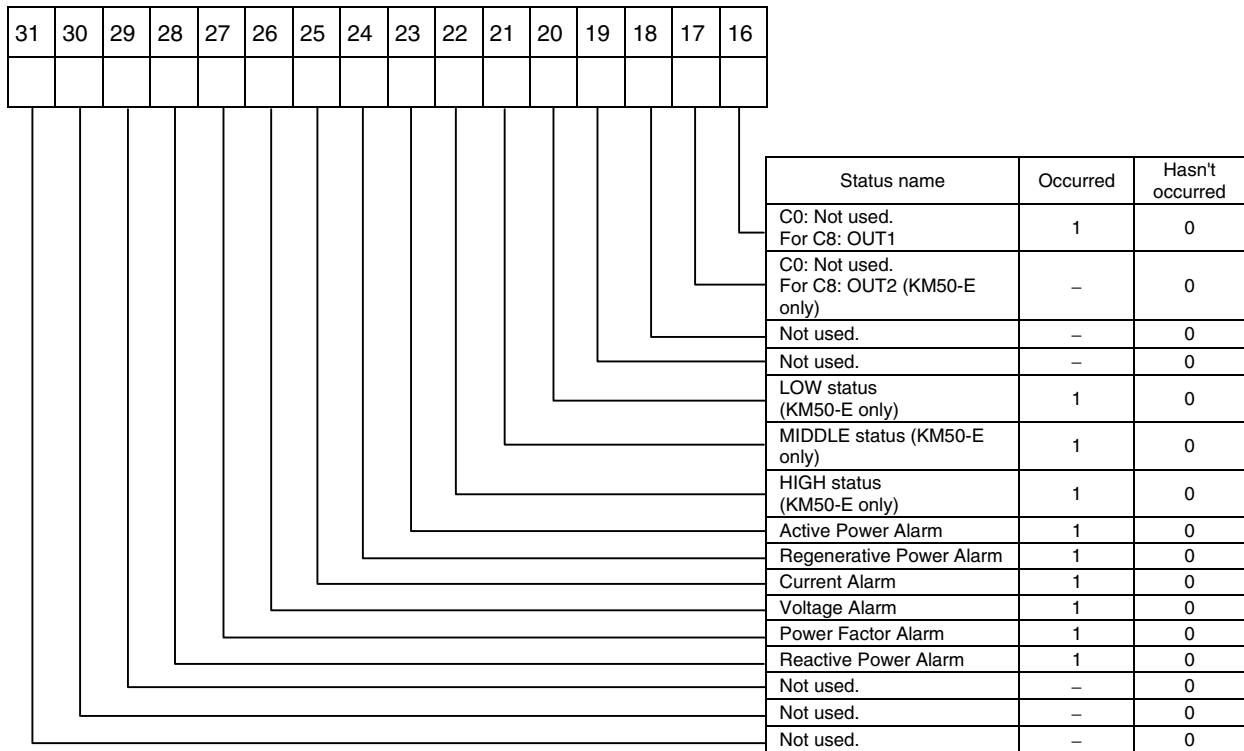
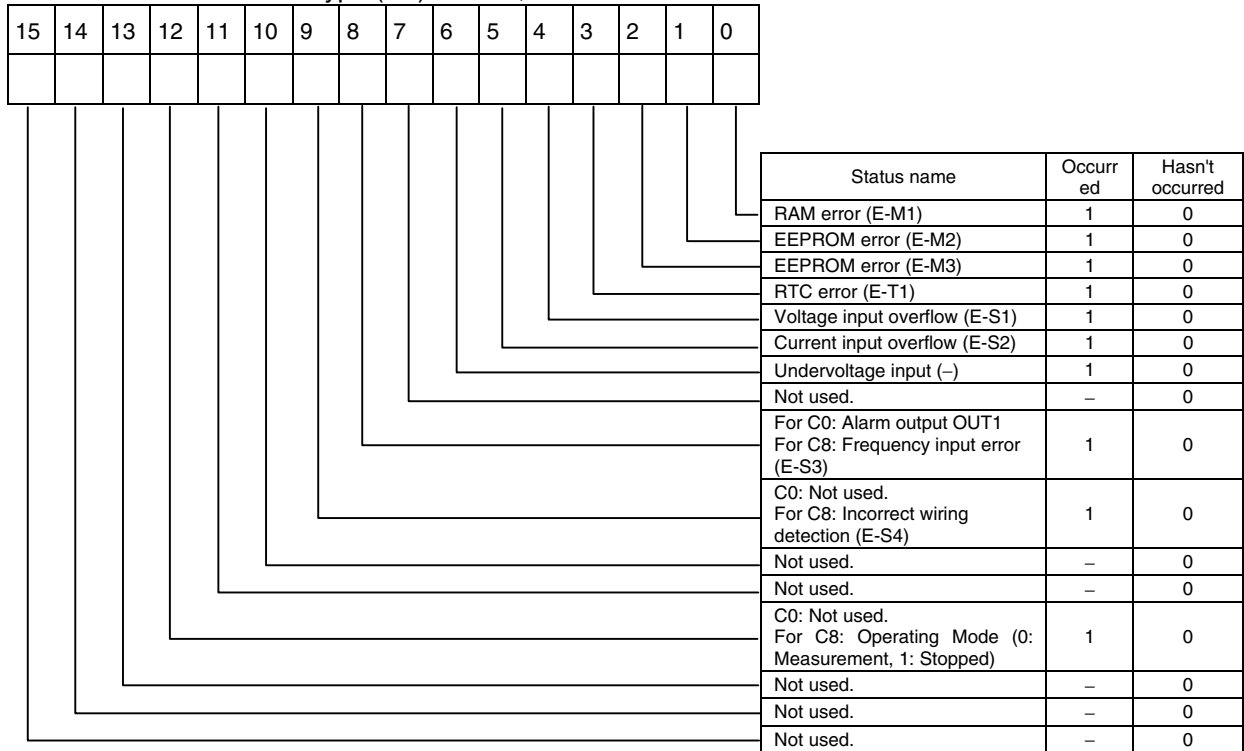

An alarm occurs (status 1 (ON)) when an alarm output (active power, regenerative power, current, voltage, power factor, or reactive power) exceeds the upper limit or lower limit threshold.

3.3 Parameter Area

● Parameter Area

- Addresses are arranged so that the same addresses are used for the KM50 parameters as those used for KM100 and KM20-B40 parameters. There are therefore places where some addresses are not used.
- If an address that is not assigned to a parameter is read, FFFF FFFF hex will be returned.
- If an address that is not assigned to a parameter is written, a start address out-of-range error will be returned.

Parameter type	Address	Parameter name	Default setting	Set value (monitor value)
C000	0000	Applicable Circuit	2	0000 0000 hex: Single-phase, two-wire circuit 0000 0001 hex: Single-phase, three-wire circuit 0000 0002 hex: Three-phase, three-wire circuit 0000 0003 hex: Three-phase, four-wire circuit (KM50-E only)
C000	0003	VT Primary Voltage	none	0000 0000 hex: none 0000 0001 hex: 220 V 0000 0002 hex: 440 V 0000 0003 hex: 3,300 V 0000 0004 hex: 6,600 V 0000 0005 hex: 11,000 V 0000 0006 hex: 22,000 V 0000 0007 hex: 33,000 V
C000	0004	Rated Primary Current	5	0000 0005 to 0000 270F hex (5 to 9,999)
C000	0005	Low-cut Current	0.6%	0000 0000 to 0000 00C7 hex (0.1% to 19.9%) *One digit to the right of the decimal point (fixed).
C000	0008	Pulse Output Unit	100 Wh	0000 0000 hex: 1 Wh 0000 0001 hex: 10 Wh 0000 0002 hex: 100 Wh 0000 0003 hex: 1 kWh 0000 0004 hex: 2 kWh 0000 0005 hex: 5 kWh 0000 0006 hex: 10 kWh 0000 0007 hex: 20 kWh 0000 0008 hex: 50 kWh 0000 0009 hex: 100 kWh
C000	000B	Display Refresh Period	1 s	0000 0000 hex: OFF 0000 0001 hex: 0.5 s 0000 0002 hex: 1 s 0000 0003 hex: 2 s 0000 0004 hex: 4 s
C000	000C	Display ON Time	0	0000 0000 to 0000 0063 hex (0 to 99 minutes) Setting of 0: Always lit.
C000	000F	Simple Measurement	OFF	0000 0000 hex: OFF (normal measurement) 0000 0001 hex: ON (simple measurement)
C000	0010	Fixed Voltage for Simple Measurement* ¹	110.0	0000 0001 to 0001 869F hex (0.1 to 9,999.9 V) *One digit to the right of the decimal point (fixed).
C000	0011	Power Factor for Simple Measurement	1.00	0000 0001 to 0000 0064 hex (0.01 to 1.00) *Two digits to the right of the decimal point (fixed).
C000	0012	Unit Number	01	0000 0000 to 0000 0063 hex (0 to 99)
C000	0013	Baud Rate	9.6 kbps	0000 0000 hex: 1.2 kbps 0000 0001 hex: 2.4 kbps 0000 0002 hex: 4.8 kbps 0000 0003 hex: 9.6 kbps 0000 0004 hex: 19.2 kbps 0000 0005 hex: 38.4 kbps

Parameter type	Address	Parameter name	Default setting	Set value (monitor value)
C000	0014	Data Length* ²	7 bits	0000 0000 hex: 7 bits 0000 0001 hex: 8 bits
C000	0015	Stop Bits* ³	2 bits	0000 0000 hex: 1 bit 0000 0001 hex: 2 bits
C000	0016	Vertical Parity	Even	0000 0000: None 0000 0001 hex: Even 0000 0002 hex: Odd
C000	0017	Transmission Wait Time	20 ms	0000 0000 to 0000 0063 hex (0 to 99 ms)
C000	0018	Protection Setting	0	0000 0000 hex: Protection level 0 0000 0001 hex: Protection level 1 0000 0002 hex: Protection level 2
C000	0019	Special CT Type	2	0000 0000 hex: KM20-CTF-5A (5 A) 0000 0001 hex: KM20-CTF-50A (50 A) 0000 0002 hex: KM20-CTF-100A (100 A) 0000 0003 hex: KM20-CTF-200A (200 A) 0000 0004 hex: KM20-CTF-400A (400 A) 0000 0005 hex: KM20-CTF-600A (600 A)
C000	001B	CO ₂ Coefficient	0.387	0000 0000 to 0001 869F hex (0.000 to 99.999 kg-CO ₂ /kWh) *Three digits to the right of the decimal point (fixed).
C000	001C	Protocol Selection	Compo-Way/F	0000 0000 hex: CompoWay/F 0000 0001 hex: Modbus
C000	001D	Average Count	8 times	0000 0000 hex: OFF 0000 0001 hex: 2 times 0000 0002 hex: 4 times 0000 0003 hex: 8 times 0000 0004 hex: 16 times 0000 0005 hex: 32 times 0000 0006 hex: 64 times 0000 0007 hex: 128 times 0000 0008 hex: 256 times 0000 0009 hex: 512 times 0000 000A hex: 1,024 times
C000	001E	Event Input Setting	P.CSP	0000 0000 hex: P.CSP (pulse input count) 0000 0001 hex: H-ON (pulse input ON time measurement) 0000 0002 hex: 0000 0002 hex: 3-ST (Three-state Classification) (KM50-E only)
C000	001F	Event Input 1 NPN/PNP Input Mode Setting	PNP	0000 0000 hex: PNP 0000 0001 hex: NPN
C000	0020	Event Input 2 NPN/PNP Input Mode Setting	PNP	0000 0000 hex: PNP 0000 0001 hex: NPN
C000	0021	Event Input 1 Input Mode Setting	N-O	0000 0000 hex: N-O (normally open) 0000 0001 hex: N-C (normally closed)
C000	0022	Event Input 2 Input Mode Setting	N-O	0000 0000 hex: N-O (normally open) 0000 0001 hex: N-C (normally closed)
C000	0023	Measurement Start Time	00:00	0000 0000 to 0000 HHMM hex (00:00 to 23:59) HH (hour): 00 to 17 hex (00 to 23) MM (minutes): 00 to 3B hex (00 to 59)
C000	0024	Measurement End Time	24:00	0000 HHMM to 0000 HHMM hex (00:01 to 24:00) HH (hour): 00 to 18 hex (0 to 24) MM (minutes): 00 to 3B hex (00 to 59)
C000	0025 ⁵	Buzzer	ON	0000 0000 hex: OFF 0000 0001 hex: ON
C000	0026 ⁵	Three-state Target ⁹	NONE	0000 0000 hex: Power 0000 0001 hex: Current 0000 0002 hex: Voltage 0000 0003 hex: NONE
C000	0027 ⁵	Three-state HIGH Threshold ⁵	50.0%	0000 0001 to 0000 05DC hex (0.1% to 150.0%) *One digit to the right of the decimal point (fixed).
C000	0028 ⁵	Three-state LOW Threshold ⁶	10.0%	0000 0000 to 0000 05DB hex (0.0% to 149.9%) *One digit to the right of the decimal point (fixed).
C000	0029 ⁵	Three-state Hysteresis	0.0%	0000 0000 to 0000 00C7 hex (0.0% to 19.9%) *One digit to the right of the decimal point (fixed).
C000	002A ⁷	Active Power Alarm Setting	OFF	0000 0000 hex: OFF 0000 0001 hex: ON

Parameter type	Address	Parameter name	Default setting	Set value (monitor value)
C000	002B ⁸	Active Power Alarm Upper Limit Threshold	80.0%	0000 0000 to 0000 05DC hex (0.0% to 150.0%) *One digit to the right of the decimal point (fixed).
C000	002C	Active Power Alarm Hysteresis	5.0%	0000 0000 to 0000 00C7 hex (0.0% to 19.9%) *One digit to the right of the decimal point (fixed).
C000	002D	Active Power Alarm OFF Delay	3.0 s	0000 0000 to 0000 03E7 hex (0.0 to 99.9 s) *One digit to the right of the decimal point (fixed).
C000	002E	Total Power Consumption Selection	Regeneration	0000 0000 hex: Regenerated Energy 0000 0001 hex: Total Leading Reactive Power Consumption 0000 0002 hex: Total Lagging Reactive Power Consumption 0000 0003 hex: Total Reactive Power Consumption
C000	0030	Active Power Alarm ON Delay	0.0 s	0000 0000 to 0000 03E7 hex (0.0 to 99.9 s) *One digit to the right of the decimal point (fixed).
C000	0031 ¹⁸	Active Power Alarm Lower Limit Threshold	0.0%	0000 0000 to 0000 05DC hex (0.0% to 150.0%) *One digit to the right of the decimal point (fixed).
C000	0032 ¹⁸	Regenerative Power Alarm Upper Limit Threshold	80.0%	0000 0000 to 0000 05DC hex (0.0% to 150.0%) *One digit to the right of the decimal point (fixed).
C000	0033	Regenerative Power Alarm Hysteresis	5.0%	0000 0000 to 0000 00C7 hex (0.0% to 19.9%) *One digit to the right of the decimal point (fixed).
C000	0034	Regenerative Power Alarm OFF Delay	3.0 s	0000 0000 to 0000 03E7 hex (0.0 to 99.9 s) *One digit to the right of the decimal point (fixed).
C000	0035	Regenerative Power Alarm ON Delay	0.0 s	0000 0000 to 0000 03E7 hex (0.0 to 99.9 s) *One digit to the right of the decimal point (fixed).
C000	0036 ¹⁸	Regenerative Power Alarm Lower Limit Threshold	0.0%	0000 0000 to 0000 05DC hex (0.0% to 150.0%) *One digit to the right of the decimal point (fixed).
C000	0037 ¹⁸	Current Alarm Upper Limit Threshold	110.0%	0000 0000 to 0000 04B0 hex (0.0% to 120.0%) *One digit to the right of the decimal point (fixed).
C000	0038	Current Alarm Hysteresis	5.0%	0000 0000 to 0000 00C7 hex (0.0% to 19.9%) *One digit to the right of the decimal point (fixed).
C000	0039	Current Alarm OFF Delay	3.0 s	0000 0000 to 0000 03E7 hex (0.0 to 99.9 s) *One digit to the right of the decimal point (fixed).
C000	003A	Current Alarm ON Delay	0.0 s	0000 0000 to 0000 03E7 hex (0.0 to 99.9 s) *One digit to the right of the decimal point (fixed).
C000	003B ⁸	Current Alarm Lower Limit Threshold	0.0%	0000 0000 to 0000 04B0 hex (0.0% to 120.0%) *One digit to the right of the decimal point (fixed).
C000	003C ⁸	Voltage Alarm Upper Limit Threshold	110.0%	0000 0000 to 0000 04B0 hex (0.0% to 120.0%) *One digit to the right of the decimal point (fixed).
C000	003D	Voltage Alarm Hysteresis	5.0%	0000 0000 to 0000 00C7 hex (0.0% to 19.9%) *One digit to the right of the decimal point (fixed).
C000	003E	Voltage Alarm OFF Delay	3.0 s	0000 0000 to 0000 03E7 hex (0.0 to 99.9 s) *One digit to the right of the decimal point (fixed).
C000	003F	Voltage Alarm ON Delay	0.0 s	0000 0000 to 0000 03E7 hex (0.0 to 99.9 s) *One digit to the right of the decimal point (fixed).
C000	0040 ¹⁸	Voltage Alarm Lower Limit Threshold	0.0%	00000000 to 000004B0 hex (0.0% to 120.0%) *One digit to the right of the decimal point (fixed).
C000	0041 ¹⁸	Power Factor Alarm Upper Limit Threshold	100%	0000 0000 to 0000 0064 hex (0% to 100%)
C000	0042	Power Factor Alarm Hysteresis	5%	0000 0000 to 0000 0013 hex (0% to 19%) *One digit to the right of the decimal point (fixed).
C000	0043	Power Factor Alarm OFF Delay	3.0s	0000 0000 to 0000 03E7 hex (0.0 to 99.9 s) *One digit to the right of the decimal point (fixed).
C000	0044	Power Factor Alarm ON Delay	0.0s	0000 0000 to 0000 03E7 hex (0.0 to 99.9 s) *One digit to the right of the decimal point (fixed).
C000	0045 ¹⁸	Power Factor Alarm Lower Limit Threshold	0%	0000 0000 to 0000 0064 hex (0% to 100%)
C000	0046 ¹⁸	Reactive Power Alarm Upper Limit Threshold	80.0%	0000 0000 to 0000 05DC hex (0.0% to 150.0%) *One digit to the right of the decimal point (fixed).
C000	0047	Reactive Power Alarm Hysteresis	5.0%	0000 0000 to 0000 00C7 hex (0.0% to 19.9%) *One digit to the right of the decimal point (fixed).
C000	0048	Reactive Power Alarm OFF Delay	3.0 s	0000 0000 to 0000 03E7 hex (0.0 to 99.9 s) *One digit to the right of the decimal point (fixed).

Parameter type	Address	Parameter name	Default setting	Set value (monitor value)
C000	0049	Reactive Power Alarm ON Delay	0.0 s	0000 0000 to 0000 03E7 hex (0.0 to 99.9 s) *One digit to the right of the decimal point (fixed).
C000	004A ⁸	Reactive Power Alarm Lower Limit Threshold	0.0%	0000 0000 to 0000 05DC hex (0.0% to 150.0%) *One digit to the right of the decimal point (fixed).
C000	004B	Output Terminal 1 Function Setting	Pulse output	0000 0000 hex: OFF 0000 0001 hex: Pulse output 0000 0002 hex: Alarm output
C000	004C ⁵	Output Terminal 2 Function Setting	Alarm Output	0000 0000 hex: OFF 0000 0001 hex: Pulse output 0000 0002 hex: Alarm output
C000	004D	Active Power Alarm Setting (Output Terminal 1)	OFF	0000 0000 hex: OFF 0000 0001 hex: ON
C000	004E	Regenerative Power Alarm Setting (Output Terminal 1)	OFF	0000 0000 hex: OFF 0000 0001 hex: ON
C000	004F	Current Alarm Setting (Output Terminal 1)	OFF	0000 0000 hex: OFF 0000 0001 hex: ON
C000	0050	Voltage Alarm Setting (Output Terminal 1)	OFF	0000 0000 hex: OFF 0000 0001 hex: ON
C000	0051	Power Factor Alarm Setting (Output Terminal 1)	OFF	0000 0000 hex: OFF 0000 0001 hex: ON
C000	0052	Reactive Power Alarm Setting (Output Terminal 1)	OFF	0000 0000 hex: OFF 0000 0001 hex: ON
C000	0053 ^{5,7}	Reactive Power Alarm Setting (Output Terminal 2)	OFF	0000 0000 hex: OFF 0000 0001 hex: ON
C000	0054 ⁵	Regenerative Power Alarm Setting (Output Terminal 2)	OFF	0000 0000 hex: OFF 0000 0001 hex: ON
C000	0055 ⁵	Current Alarm Setting (Output Terminal 2)	OFF	0000 0000 hex: OFF 0000 0001 hex: ON
C000	0056 ⁵	Voltage Alarm Setting (Output Terminal 2)	OFF	0000 0000 hex: OFF 0000 0001 hex: ON
C000	0057 ⁵	Power Factor Alarm Setting (Output Terminal 2)	OFF	0000 0000 hex: OFF 0000 0001 hex: ON
C000	0058 ⁵	Reactive Power Alarm Setting (Output Terminal 2)	OFF	0000 0000 hex: OFF 0000 0001 hex: ON
C000	0059	Automatic Rotation Function	OFF	0000 0000 hex: OFF 0000 0001 hex: ON
C000	005A	Transition Time	3 s	0000 0001 to 0000 0063 hex (1 to 99 s)
C000	005B	Active Power Display Selection	Display.	0000 0000 hex: Do not display. 0000 0001 hex: Display.
C000	005C	Total Power Consumption Display Selection	Display.	0000 0000 hex: Do not display. 0000 0001 hex: Display.
C000	005D	Current 1 Display Selection	Display.	0000 0000 hex: Do not display. 0000 0001 hex: Display.
C000	005E	Current 2 Display Selection	Display.	0000 0000 hex: Do not display. 0000 0001 hex: Display.
C000	005F	Current 3 Display Selection	Display.	0000 0000 hex: Do not display. 0000 0001 hex: Display.
C000	0060	Voltage 1 Display Selection	Display.	0000 0000 hex: Do not display. 0000 0001 hex: Display.
C000	0061	Voltage 2 Display Selection	Display.	0000 0000 hex: Do not display. 0000 0001 hex: Display.
C000	0062	Voltage 3 Display Selection	Display.	0000 0000 hex: Do not display. 0000 0001 hex: Display.
C000	0063	Power Factor Display Selection	Display.	0000 0000 hex: Do not display. 0000 0001 hex: Display.

Parameter type	Address	Parameter name	Default setting	Set value (monitor value)
C000	0064	Reactive Power Display Selection	Display.	0000 0000 hex: Do not display. 0000 0001 hex: Display.
C000	0065	Frequency Display Selection	Display.	0000 0000 hex: Do not display. 0000 0001 hex: Display.
C000	0066	Calculated CO ₂ Display Selection	Display.	0000 0000 hex: Do not display. 0000 0001 hex: Display.
C000	0067	Converted Monetary Cost Display Selection	Display.	0000 0000 hex: Do not display. 0000 0001 hex: Display.
C000	0068	General-purpose Pulse Conversion 1 Display Selection	Display.	0000 0000 hex: Do not display. 0000 0001 hex: Display.
C000	0069	General-purpose Pulse Conversion 2 Display Selection	Display.	0000 0000 hex: Do not display. 0000 0001 hex: Display.
C000	006A	Time Display Selection	Display.	0000 0000 hex: Do not display. 0000 0001 hex: Display.
C000	006B	Pulse Input Count Display Selection	Display.	0000 0000 hex: Do not display. 0000 0001 hex: Display.
C000	006C	Specific Power Consumption Display Selection	Display.	0000 0000 hex: Do not display. 0000 0001 hex: Display.
C000	006D	Pulse Input ON Time Selection	Display.	0000 0000 hex: Do not display. 0000 0001 hex: Display.
C000	006E ⁵	HIGH Total Power Consumption Display Selection	Display.	0000 0000 hex: Do not display. 0000 0001 hex: Display.
C000	006F ⁵	MIDDLE Total Power Consumption Display Selection	Display.	0000 0000 hex: Do not display. 0000 0001 hex: Display.
C000	0070 ⁵	LOW Total Power Consumption Display Selection	Display.	0000 0000 hex: Do not display. 0000 0001 hex: Display.
C000	0071 ⁵	HIGH Total Time Display Selection	Display.	0000 0000 hex: Do not display. 0000 0001 hex: Display.
C000	0072 ⁵	MIDDLE Total Time Display Selection	Display.	0000 0000 hex: Do not display. 0000 0001 hex: Display.
C000	0073 ⁵	LOW Total Time Display Selection	Display.	0000 0000 hex: Do not display. 0000 0001 hex: Display.
C000	0074	Total Regenerated Energy Display Selection	Display.	0000 0000 hex: Do not display. 0000 0001 hex: Display.
C000	0075	Total Leading Reactive Power Consumption Display Selection	Display.	0000 0000 hex: Do not display. 0000 0001 hex: Display.
C000	0076	Total Lagging Reactive Power Consumption Display Selection	Display.	0000 0000 hex: Do not display. 0000 0001 hex: Display.
C000	0077	Total Reactive Power Consumption Display Selection	Display.	0000 0000 hex: Do not display. 0000 0001 hex: Display.
C000	0078	Temperature Display Selection	Display.	0000 0000 hex: Do not display. 0000 0001 hex: Display.
C000	0079	Product Information	Display.	0000 0000 hex: Do not display. 0000 0001 hex: Display.
C000	007A ⁵	HIGH Display Color	Green	0000 0000 hex: Green 0000 0001 hex: Orange 0000 0002 hex: Red
C000	007B ⁵	MIDDLE Display Color	Orange	0000 0000 hex: Green 0000 0001 hex: Orange 0000 0002 hex: Red
C000	007C ⁵	LOW Display Color	Red	0000 0000 hex: Green 0000 0001 hex: Orange 0000 0002 hex: Red
C000	007D	Temperature Unit	Celsius	0000 0000 hex: Celsius (C) 0000 0001 hex: Fahrenheit (F)
C000	007E	Temperature Compensation	0 (°C or °F)	FFFF FE0C to 0000 01F4 hex (-50.0 to 50.0) *One digit to the right of the decimal point (fixed).

Parameter type	Address	Parameter name	Default setting	Set value (monitor value)
C000	007F	Incorrect Wiring Detection	Incorrect wiring detected.	0000 0000 hex: No incorrect wiring detected. 0000 0001 hex: Incorrect wiring detected.
C000	0080	Conversion to Monetary Cost Rate Setting	10.000	0000 000 to 0001 869F hex (0 to 99.999) Three digits to the right of the decimal point (fixed).
C000	0081	Currency Setting	_JPY (204A 5059 hex)	Input 1-byte one character in ASCII. 0 to 9: 30 to 39 hex A to Z: 41 to 5A hex /, -, space: 2F, 2D, 20 hex
C000	0082	Pulse Conversion 1 Target	Pulse Input Count 1 for the Day	0000 0000 hex: Total Pulse Input Count for the Day 0000 0001 hex: Pulse Input Count 1 for the Day 0000 0002 hex: Pulse Input Count 2 for the Day 0000 0003 hex: Sum Total Pulse Input Count 0000 0004 hex: Total Pulse Input Count 1 0000 0005 hex: Total Pulse Input Count 2
C000	0083	Pulse Conversion 2 Target	Pulse Input Count 2 for the Day	0000 0000 hex: Total Pulse Input Count for the Day 0000 0001 hex: Pulse Input Count 1 for the Day 0000 0002 hex: Pulse Input Count 2 for the Day 0000 0003 hex: Sum Total Pulse Input Count 0000 0004 hex: Total Pulse Input Count 1 0000 0005 hex: Total Pulse Input Count 2
C000	0084	Coefficient Setting 1	1	0000 0000 to 0000 270F hex (0 to 9,999)
C000	0085	Coefficient Setting 2	1	0000 0000 to 0000 270F hex (0 to 9,999)
C000	0086	Decimal Point Position Setting 1	0000	0000 0000 hex: 0000 (No decimal points) 0000 0001 hex: 000.0 (One place below the decimal point) 0000 0002 hex: 00.00 (Two places below the decimal point) 0000 0003 hex: 0.000 (Three places below the decimal point)
C000	0087	Decimal Point Position Setting 2	0000	0000 0000 hex: 0000 (No decimal points) 0000 0001 hex: 000.0 (One place below the decimal point) 0000 0002 hex: 00.00 (Two places below the decimal point) 0000 0003 hex: 0.000 (Three places below the decimal point)
C000	0088	Display Unit Setting 1	M3-1 (4D33 2 F31 hex)	Input 1-byte one character in ASCII. 0 to 9: 30 to 39 hex A to Z: 41 to 5A hex /: 2F hex, -: 2D hex, space: 20 hex
C000	0089	Display Unit Setting 2	M3-2 (4D33 2 F32 hex)	Input 1-byte one character in ASCII. 0 to 9: 30 to 39 hex A to Z: 41 to 5A hex /: 2F hex, -: 2D hex, space: 20 hex
C000	008A	VT Secondary Voltage	110 V	0000 0000 hex : 110 V 0000 0001 hex : 220 V

*1: The fixed voltage for simple measurement can be set in increments of 0.1 V. This voltage could be set in increments of 1 V for the KM100.

*2: The data length will be 8 bits if Modbus is set as the communications protocol.

*3: If Modbus is set as the communications protocol, the number of stop bits will be set automatically according to the vertical parity.

No vertical parity: 2 bits

Odd or even vertical parity: 1 bit

*4: The conversion coefficient varies with the region. Please check the home page of your power company. The default setting is the CO₂ coefficient for Kyushu Electric Power Company for 2009.

*5: These addresses are used only for the KM50-E. They cannot be read or written with the KM50-C.

- *6: Always set the LOW threshold to a lower value than the HIGH threshold. You cannot set the values so that the HIGH threshold is lower than or equal to the LOW threshold.
- *7: Addresses 002A (Active Power Alarm Setting), 004D, and 0053 have the following relation.
Addresses 002A and 004D (Active Power Alarm Setting (Output Terminal 1)) are for the same parameter for KM50-C.
Addresses 002A and 0053 (Active Power Alarm Setting (Output Terminal 2)) are for the same parameter for KM50-E.
- *8: The alarm function is disabled if the upper limit threshold is set to the maximum value or the lower limit threshold is set to the minimum value.
- *9: If 3-ST (KM-E only) is set for the event input, the Three-state Target is changed to NONE. To set the Three-state Target to something other than NONE, set the Event Input Setting to the Pulse Input Count or ON Time Measurement before selecting a target.



Section 4 Modbus Communications Protocol

This section describes performing communications using the Modbus protocol.

4.1	Data Formats	4-2
	■ Command Frames	4-2
	■ Response Frames	4-3
	■ Error Codes	4-4
4.2	Function List	4-5
4.3	Variable Area	4-6
	■ Addresses	4-6
	■ Number of Elements	4-6
	■ Set Values	4-6
4.4	Detailed Descriptions of Services	4-7
	■ Read Variable Area	4-7
	■ Write Variable Area	4-9
	■ Operation Command	4-11
	■ Echoback Test	4-13

4.1 Data Formats

Frames that comply with the Modbus RTU communications protocol are used as the unit of data for commands from the host (e.g., a computer) and responses from the KM50-C/-E. The format of command frames and response frames is given below.

In this manual, numbers followed by "hex," such as "02 hex," are hexadecimal numbers.

Alphanumeric characters that are given in quotation marks, like this "00," are ASCII characters.

■ Command Frames

When using RTU mode, start with a silent interval of at least 3.5 characters and end with a silent interval of at least 3.5 characters.

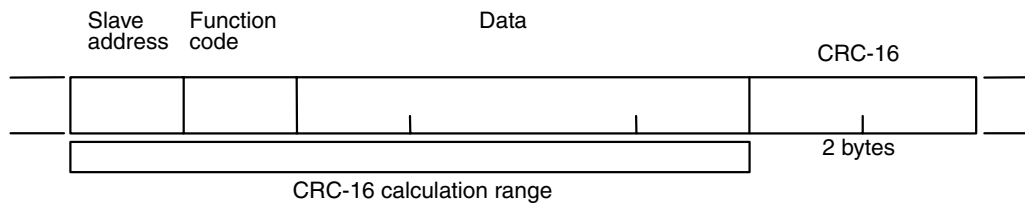

	Silent interval of 3.5 characters min.
Slave address	Specify the unit number. The slave address can be set to between 00 and 63 hex (0 and 99). Specify 00 hex for broadcasting. Responses are not returned for broadcast command frames.
Function code	The function code is a 1-byte hexadecimal code that indicates the type of command sent from the host (e.g., a computer).
Data	This is the text data that is associated with the specified function code. Specify the required data, such as the variable address, parameter setting, etc. (Set the hexadecimal.)
CRC-16	Cyclical Redundancy Check: This check code is calculated with the data from the slave address to the end of the data. The check code is 2-byte hexadecimal.
	Silent interval of 3.5 characters min.

● CRC-16 Calculation Example

Messages are processed one byte at a time in the work memory (a 16-bit register known as the CRC register).

- (1) The CRC register is initialized to FFFF hex.
- (2) An XOR operation is performed on the content of the CRC register and the first byte of the message, and the result is returned to the CRC register.
- (3) The MSB is packed with zeroes and the CRC register is shifted one bit to the right.
- (4) If the bit shifted from the LSB is 0, step 3 is repeated (i.e., the next bit-shift process is performed).

If the bit shifted from the LSB is 1, an XOR is performed on the content of the CRC register and A001 hex, and the result is returned to the CRC register.

- (5) Steps 3 and 4 are repeated until 8 bits are shifted.
- (6) CRC processing continues to the end of the message, as XOR operations are performed on the content of the CRC register and the next byte of the message, step 3 is repeated, and the result is returned to the CRC register.
- (7) The result of the CRC calculation (i.e., the value in the CRC register) is appended to the last byte of the message.

Example of Appending the Calculation Result

When the calculated CRC value is 1234 hex, the CRC value is appended to the command frame as shown below.



■ Response Frames

● Normal Response Frames

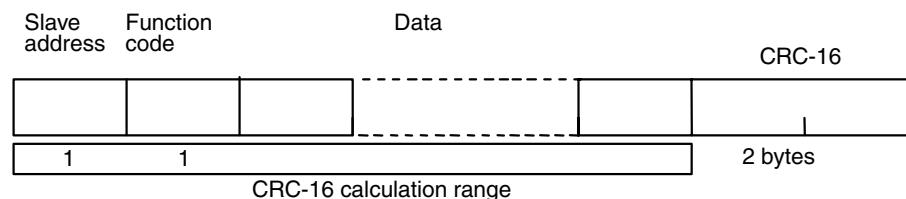

● Error Response Frames

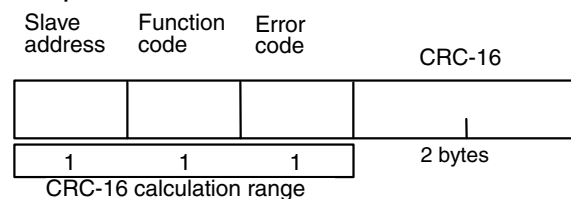

Slave address	The number specified in the command frame is entered as-is. This is the unit number of the node returning the response.
Function code	This is the received function code. However, a hexadecimal value of 80 hex is added to indicate that the response is an error response. Example: Received function code = 03 hex Function code in the response frame when an error occurred = 83 hex Function code in the response frame for an unsupported function code=80 hex
Error code	This code indicates the kind of error that occurred.
CRC-16	Cyclical Redundancy Check: This check code is calculated with the data from the slave address to the end of the data. The check code is 2-byte hexadecimal.

■ Error Codes

End code	Name	Description	Error detection priority
01 hex	Function code error	An unsupported function code was received.	1
02 hex	Variable address error	The specified variable address (area number or address in area) is out-of-range.	2
03 hex	Variable data error	The amount of data does not match the number of elements. The byte count is not 4 times the number of elements. The response exceeds the communications buffer size. The command code or related information for an operation command is wrong. The write data is out of range.	3
04 hex	Operation error	The set value in the write data is not allowed in the present operating mode. The operation command cannot be processed.	4

● No Response

In the following cases, the received command will not be processed and a response will not be returned.

Consequently, a timeout error will occur at the host.

- The slave address in the received command does not match the communications unit number.
- A parity error, framing error, or overrun error occurred due to a problem such as a transfer error.
- A CRC-16 code error was detected in the received command frame.
- There was a time interval of more than 3.5 characters between data packets that make up a command frame.

In the following case, the command will be processed (if the function is supported), but no response will be required.

- Broadcast commands (slave address of 00 hex).

4.2 Function List

The following table lists the function codes.

- Function Code List

Function code	Name	Processing
03 (03 hex)	Read Variable (Multiple)	This function reads from the variable area. It is possible to read two or more consecutive variables.
16 (10 hex)	Write Variable (Multiple)	This function writes to the variable area. It is possible to write two or more consecutive variables. It is also possible to broadcast this function.
06 (06 hex)	Write Variable (Operation Command)	This function writes an operation command. It is also possible to broadcast this function.
08 (08 hex)	Echoback Test	This function performs an echoback test.

4.3 Variable Area

The variable area is the region of memory used to exchange data with the KM50-C/-E through communications.

Operations such as reading the process value and reading/writing parameters are performed on the variable area. Operation commands, however, do not use the variable area.

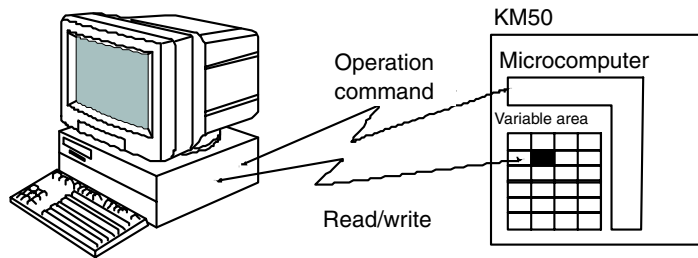

■ Addresses

An address is appended to each variable type.

Express addresses in 2-byte hexadecimal and append them for the specified access size.

■ Number of Elements

The number of elements is expressed in 2-byte hexadecimal. The setting range for the number of elements depends on the command.

Each element consists of two bytes of data, so multiples of two elements are specified. By specifying multiples of 2 for the number of elements, data is read and written in units of four bytes.

Example: To read one elements, multiple 1 by 2 to get the number of elements to specify, i.e., 2.

■ Set Values

The values read from the variable area or written to the variable area are expressed in hexadecimal, ignoring the decimal point. (Negative values are given as two's complements.)

Example: 105.0 decimal = 0000 041A hex

The variables are 8-digit hexadecimal values. Negative values are given as two's complements.

The values are hexadecimal values with no decimal point.

4. 4 Detailed Descriptions of Services

■ Read Variable Area

To read from the variable area, set the required data in the command frame, as shown in the following diagram.

• Command Frame

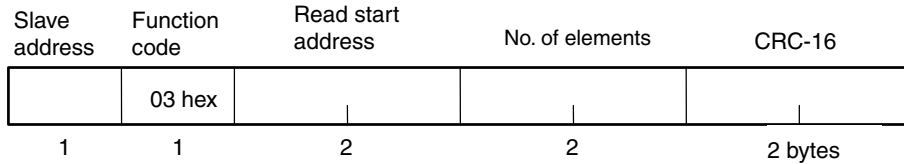

(Numbers below the frame are the number of bytes.)

Name	Description
Slave address	Specify the unit number of the KM50-C/-E. The slave address can be set to between 01 and 63 hex (1 and 99).
Function code	The function code for Read Variable Area is 03 hex.
Read start address	Specify the address containing the data to be read. Refer to 5.1 <i>Variable Area</i> for the addresses.
Number of elements	Specify two times the number of data items as the number of elements to be read. The setting range for the number of elements is 0002 to 0014 hex (2 to 20).
CRC-16	This check code is calculated with the data from the slave address to the end of the data. For details on the CRC-16 calculation, refer to <i>CRC-16 Calculation Example</i> on page 4-3.

• Response Frame

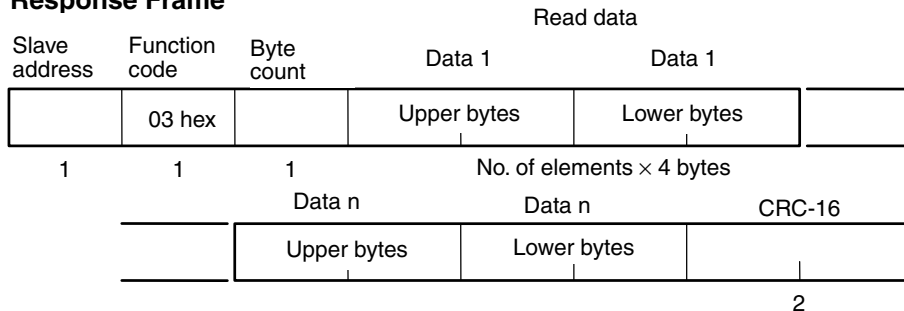

Name	Description
Slave address	The value from the command frame is entered as-is.
Function code	This is the received function code. However, a hexadecimal value of 80 hex is added to indicate that the response is an error response. Example: Received function code = 03 hex Function code in the response frame when an error occurred = 83 hex
Byte count	Gives the number of bytes of read data.
Number of elements	Gives the number of data items that were read.
CRC-16	This check code is calculated with the data from the slave address to the end of the data. For details on the CRC-16 calculation, refer to <i>CRC-16 Calculation Example</i> on page 4-3.

• Response Codes

Function code	Error code	Error name	Cause
83 hex	02 hex	Variable address error	The read start variable address is incorrect. The variable area number is incorrect. The address in the variable area is out of range.
	03 hex	Variable data error	The number of elements exceeds the specified range. The range is 0002 to 0014 hex (2 to 20).
	04 hex	Operation error	The command could not be accepted because of communications area conditions.
03 hex	–	Normal completion	No errors were detected.

● Example Command and Response

The following example is for reading Instantaneous Voltage 1.

(In this case, the slave address is 01 hex.)

Command: 01 03 00 00 00 02 C4 0B (CRC-16)

Response: 01 03 04 00 00 09 60 FC 4B (CRC-16)

Write Variable Area

To write data to the variable area, set the required data in the command frame, as shown in the following diagram.

Execute this service after changing to a Setting Mode.

Command Frame

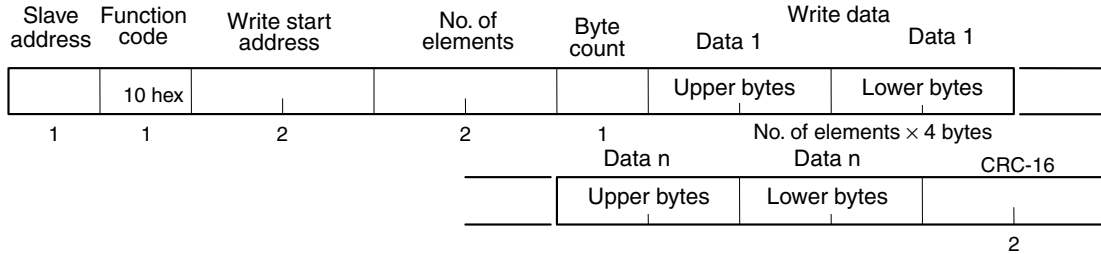

Name	Description
Slave address	Specify the unit number of the KM50. The slave address can be set to between 01 and 63 hex (1 and 99).
Function code	The function code for Write Variable Area is 10 hex.
Write start address	Specify the starting address where the data will be written. Refer to 5.1 Variable Area for the addresses.
Number of elements	Specify two times the number of data items as the number of elements to be written. The range is 0002 to 0014 hex (2 to 20).
Byte count	Specify the number of bytes of write data.
CRC-16	This check code is calculated with the data from the slave address to the end of the data. For details on the CRC-16 calculation, refer to <i>CRC-16 Calculation Example</i> on page 4-3.

Response Frame

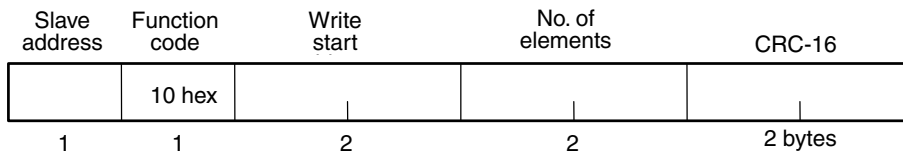

Name	Description
Slave address	The value from the command frame is entered as-is.
Function code	This is the received function code. However, a hexadecimal value of 80 hex is added to indicate that the response is an error response. Example: Received function code = 10 hex Function code in the response frame when an error occurred = 90 hex
Write start address	This is the received write start address.
Number of elements	This is the received number of elements.
CRC-16	This check code is calculated with the data from the slave address to the end of the data. For details on the CRC-16 calculation, refer to <i>CRC-16 Calculation Example</i> on page 4-3.

• Response Codes

Function code	Error code	Error name	Cause
90 hex	02 hex	Variable address error	The write start address is incorrect. The variable area number is incorrect. The address in the variable area is out of range.
	03 hex	Variable data error	The amount of data does not match the number of elements. The byte count does not match the number of elements. The write data is out of range.
	04 hex	Operation error	The Controller cannot write the data in its present operating status.
10 hex	–	Normal completion	No errors were detected.

● Example Command and Response

The following example is for writing data to change the applicable circuit to a single-phase, two-wire circuit.

(In this case, the slave address is 01 hex.)

Applicable circuit: Single-phase, two-wire

- Address: F000 hex, Write data: 0000 0000 hex

Command: 01 10 F0 00 00 02 04 00 00 00 00 F7 AB (CRC-16)

Response: 01 10 F0 00 00 02 72 C8 (CRC-16)

■ Operation Command

Use this service to perform remote control for the KM50-C/-E.

• Command Frame

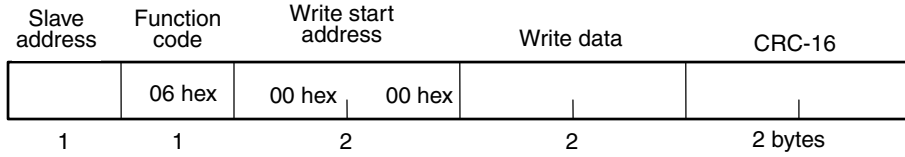

• Response Frame

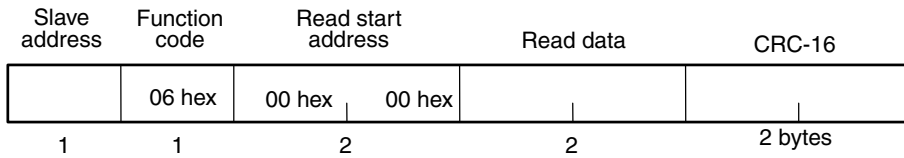

(1) Write start address

Set to 0000 hex for an operation command.

(2) Command Code and Related Information

The write data is the command code plus the related information. Four digits are used.

The following operation commands are supported.

Command code	Command	Related information
03	Reset Total Power Consumption	00
04	Go to Measurement Mode	00
07	Go to Operation Setting Mode	00
08	Go to Protection Setting Mode	00
09	Initialize Measurement Log	00
	Initialize Settings	01
	Initialize Professional Level	02
	Initialize All	03
12	Reset Maximum	00
13	Reset Minimum	00
99	Reset Software	00

*Command code "09" (initialize commands) can be used only in a Setting Mode.

(3) Response Codes

• Normal Completion

Function code	Error code	Error name	Description
06 hex	-	Normal completion	No errors were detected.

- Error Completion

Function code	Error code	Error name	Description
86 hex	02 hex	Variable address error	The write start address is not 0000 hex.
	03 hex	Variable data error	The write data is incorrect. The command code or related information is incorrect.
	04 hex	Operation error	The Controller cannot write the data in its present operating status.

- Example Command and Response

The following example is for Reset Total Power Consumption. (In this case, the slave address is 01 hex.)

Reset Total Power Consumption (command code: 03, related information: 00)

Command: 01 06 00 00 03 00 89 3A (CRC-16)

Response: 01 06 00 00 03 00 89 3A (CRC-16)

(5) Operation Commands and Precautions

- Reset Total Power Consumption
The total power consumptions are reset to 0.
The consumptions are totaled again as soon as they are reset.
- Go to Measurement Mode
The Power Monitor is changed to Measurement Mode.
When moving to Measurement Mode, the Power Monitor saves changes to settings to EEPROM and is reset. After being reset, the Power Monitor operates with the new settings.
- Go to Operation Setting Mode
The Power Monitor is changed to Operation Setting Mode.
Change to this mode before changing any parameters.
- Go to Protection Setting Mode
The Power Monitor is changed to Protection Setting Mode.
- Initialize Measurement Log
All measurement log data is initialized.
- Initialize Settings
All parameters are returned to the default settings.
- Initialize Professional Level
The measurement values in the Professional Level are initialized.
- Initialize All
All of the following are initialized: total power consumptions, measurement log, settings, and Professional Level.
- Reset Maximum/Minimum
The maximum and minimum measurement values are reset.
Reset Maximum: The maximum values are reset to 0 (the minimum value).
Reset Minimum: The minimum values are reset to the maximum values for the currently selected VT or CT (type and ratio).
- Reset Software
The CPU is reset and the Power Monitor enters the same status as when it is turned ON.
No response is returned for this operation command (there is no service response PDU).

Echoback Test

• Command Frame

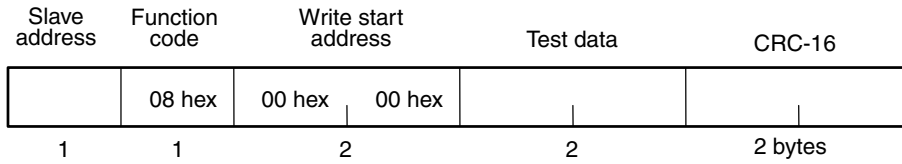

• Response Frame

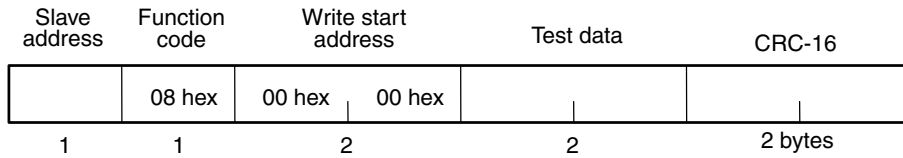

- If the command is executed normally, the response returns the data that was sent in the command.

(1) Test Data

Enter any 2-byte hexadecimal data.

(2) Response Codes

Function code	Error code	Name	Description
88 hex	03 hex	Variable data error	The data following the function code was not the fixed data (00 hex, 00 hex).
08 hex	–	Normal completion	No errors were detected.

• Example Command and Response

The following example is for Echoback Test.

(In this case, the test data is 1234 hex and the slave address is 01 hex.)

Command : 01 08 00 00 12 34 ED 7C (CRC-16)

Response : 01 08 00 00 12 34 ED 7C (CRC-16)

Section 5 Modbus Communications Data

This section lists the data that can be used for Modbus communications.

5. 1	Variable Area	5-3
	● Communications Data.....	5-3
	● Variable Area.....	5-3
	● Addresses	5-3
	● Addresses 0000 to 0044: Instantaneous Values	5-4
	● Addresses 0080 to 009F hex: Average Values	5-8
	● Addresses 00A0 to 00B3: Maximum Values	5-8
	● Addresses 00C0 to 00D3: Minimum Values	5-8
	● Addresses 1000 to 123F hex: Total Power Consumption for Every Five-minute Period (0.1-kWh Increments)	5-9
	● Addresses 1400 to 163F hex: Total Power Consumption for Every Five Minutes (0.1-kWh Increments).....	5-10
	● Addresses 1800 to 1A3F hex: Total □□ Power Consumption for Every Five-minute Period (0.1-kWh Increments)	5-11
	● Addresses 1C00 to 1E3F hex: Total □□ Power Consumption Every Five Minutes (0.1-kWh Increments).....	5-12
	● Addresses 2000 to 202F hex: Total Power Consumption for Every Hour (0.1-kWh Increments).....	5-13
	● Addresses 2100 to 212F hex: Total Power Consumption for Every Hour (0.001-kWh Increments).....	5-14
	● Addresses 2200 to 2208 hex: Total Power Consumption for Every Day (0.1-kWh Increments).....	5-15
	● Addresses 2300 to 2308 hex: Total Power Consumption for Every Day (0.001-kWh Increments).....	5-15
	● Addresses 2400 to 2408 hex: Pulse Input ON Time for Every Day.....	5-16
	● Addresses 2600 to 2608 hex: Specific Power Consumption for Every Day	5-16
	● Addresses 2700 to 2708 hex: Pulse Input Count for Every Day	5-17
	● Addresses 2E00 to 2E0D hex: Total Power Consumption for Every Month (0.1-kWh Increments).....	5-17
	● Addresses 2F00 to 2F0D hex: Total Power Consumption for Every Month (0.001-kWh Increments).....	5-18
	● Addresses 3000 to 38011: Maximum Measurement Values	5-19
	● Addresses 4000 to 4811: Minimum Measurement Values	5-22
	● Addresses 5000 to 523F hex: HIGH Total Power Consumption Every Five-minute Period (0.001-kWh increments)	5-25
	● Addresses 5300 to 553F hex: MIDDLE Total Power Consumption Every Five-minute Period (0.001-kWh increments)	5-26
	● Addresses 5600 to 583F hex: LOW Total Power Consumption Every Five-minute Period (0.001-kWh increments)	5-27
	● Addresses 6000 to 6008 hex: HIGH Total Power Consumption Every Day (0.001-kWh increments).....	5-28
	● Addresses 6100 to 6108 hex: HIGH Total Power Consumption Ratio Every Day	5-28
	● Addresses 6200 to 6208 hex: HIGH Total Time Every Day	5-29
	● Addresses 6300 to 6308 hex: HIGH Total Time Ratio Every Day.....	5-29
	● Addresses 6400 to 6408 hex: MIDDLE Total Power Consumption Every Day (0.001-kWh increments).....	5-30
	● Addresses 6500 to 6508 hex: MIDDLE Total Power Consumption Ratio Every Day	5-30
	● Addresses 6600 to 6608 hex: MIDDLE Total Time Every Day.....	5-31
	● Addresses 6700 to 6708 hex: MIDDLE Total Time Ratio Every Day	5-31
	● Addresses 6800 to 6808 hex: LOW Total Power Consumption Every Day (0.001-kWh increments).....	5-32
	● Addresses 6900 to 6908 hex: LOW Total Power Consumption Ratio Every Day	5-32

- Addresses 6A00 to 6A08 hex: LOW Total Time Every Day 5-33
- Addresses 6B00 to 6B08 hex: LOW Total Time Ratio Every Day.....5-33
- Addresses 7000 to 723F hex: Total Power Consumption Every Five-minute Period (0.001-kWh increments)5-34
- Addresses 7400 to 723F 763F: Total Power Consumption Every Five Minutes (0.001-kWh Increments)5-35
- Addresses 7800 to 7A3F hex: Total Power Consumption for Every Five-minute Period (0.001-kWh Increments)5-36
- Addresses 7C00 to 7E3F hex: Total Power Consumption Every Five Minutes (0.001-kWh Increments)5-37
- Addresses 8000 to 801D hex: Alarm History5-38
- 5. 2 Status Information5-40
- 5. 3 Variable Area Setting Ranges.....5-41
 - Variable Area Setting Ranges.....5-41
 - Addresses F000 to F080.....5-41
 - Addresses FF00 to FF065-47

5.1 Variable Area

● Communications Data

Set values and monitor values are given in hexadecimal. Negative values are given as two's complements. Values are converted to hexadecimal without the decimal point.

● Variable Area

- For the CompoWay/F format, the KM50-C/-E variable area contains parameters that are in the same structure as those of the KM100 and KM20-B40 (labeled below as "previous"), as well as parameters that are in the data structure of the KM50-C/-E (labeled below as "new"). For the Modbus format, only the new data structure is supported.
- The hexadecimal values that are given in the set value/monitor value column are the setting/monitoring ranges of Modbus. The actual ranges are given in parentheses. Refer to the relevant parameters for textual descriptions.

● Addresses

Start address	End address	Data
0000	0044	Instantaneous Value Level
0080	009F	Average Value Level (This level is not used by the KM50-C/-E.)
00A0	00B3	Maximum Value Level
00C0	00D3	Minimum Value Level
1000	123F	Total Power Consumption for Every Five-minute Period
1400	163F	Total Power Consumption for Every Five Minutes
1800	1A3F	Total <input type="checkbox"/> <input type="checkbox"/> Power Consumption Every 5-minute Period
1C00	1E3F	Total <input type="checkbox"/> <input type="checkbox"/> Power Consumption Every 5 Minutes
2000	202F	Total Power Consumption for Every Hour
2100	212F	Total Power Consumption for Every Hour ¹
2200	2208	Total Power Consumption for Every Day
2300	2308	Total Power Consumption for Every Day ¹
2400	2408	Pulse Input ON Time for Every Day
2600	2608	Specific Power Consumption for Every Day
2700	2708	Pulse Input Count Every Day
2E00	2E0D	Total Power Consumption for Every Month
2F00	2F0D	Total Power Consumption for Every Month
3000	3811	Maximum Measurement Value for Every Day
4000	4811	Minimum Measurement Value for Every Day
5000	523F	HIGH Total Power Consumption for Every Five-minute Period ¹
5300	553F	MIDDLE Total Power Consumption for Every Five-minute Period ¹
5600	583F	LOW Total Power Consumption for Every Five-minute Period ¹
6000	6008	HIGH Total Power Consumption for Every Day ¹
6100	6108	HIGH Total Power Consumption Ratio for Every Day ¹
6200	6208	HIGH Total Time for Every Day ¹
6300	6308	HIGH Total Time Ratio for Every Day ¹
6400	6408	MIDDLE Total Power Consumption for Every Day ¹
6500	6508	MIDDLE Total Power Consumption Ratio for Every Day ¹
6600	6608	MIDDLE Total Time for Every Day ¹
6700	6708	MIDDLE Total Time Ratio for Every Day ¹
6800	6808	LOW Total Power Consumption for Every Day ¹
6900	6908	LOW Total Power Consumption Ratio for Every Day ¹
6A00	6A08	LOW Total Time for Every Day ¹
6B00	6B08	LOW Total Time Ratio for Every Day ¹
7000	723F	Total Power Consumption for Every Five-minute Period
7400	763F	Total Power Consumption for Every Five Minutes
7800	7A3F	Total <input type="checkbox"/> <input type="checkbox"/> Power Consumption Every 5-minute Period
7C00	7E3F	Total <input type="checkbox"/> <input type="checkbox"/> Power Consumption Every 5 Minutes

Start address	End address	Data
8000	801D	Alarm History
F000	F081	Parameter Table 1
FF00	FF06	Parameter Table 2

*1. These addresses are used only for the KM50-E. They cannot be used for the KM50-C.

*2. □□: Regenerative, leading reactive, lagging reactive, or reactive

● Addresses 0000 to 0044: Instantaneous Values

Address	Parameter name	Set value (monitor value)
0000	Instantaneous Voltage 1 ^{*1} (V)	0000 0000 to 000F 423F hex (0.0 to 99,999.9) *One digit to the right of the decimal point (fixed).
0001	Instantaneous Voltage 2 ^{*1} (V)	Same as above.
0002	Instantaneous Voltage 3 ^{*1} (V)	Same as above.
0003	Instantaneous Current 1 ^{*2} (A)	0000 0000 to 0098 967F hex (0.000 to 9,999.999) *Three digits to the right of the decimal point (fixed).
0004	Instantaneous Current 2 ^{*2} (A)	Same as above.
0005	Instantaneous Current 3 ^{*2} (A)	Same as above.
0006	Instantaneous Power Factor	FFFF FF9C to 0000 0064 hex (-1.00 to 1.00) *Two digits to the right of the decimal point (fixed).
0007	Instantaneous Frequency (Hz)	0000 01C2 to 0000 028A hex (45.0 to 65.0) *One digit to the right of the decimal point (fixed).
0008	Instantaneous Active Power (W)	C465 3601 to 3B9A C9FF hex (-99,999,999.9 to 99,999,999.9) *One digit to the right of the decimal point (fixed).
0009	Maximum Active Power (kW)	C465 3601 to 3B9A C9FF hex (-99,999,999.99 to 9,999,999.99) *Two digits to the right of the decimal point (fixed).
000A	Instantaneous Reactive Power (var)	C465 3601 to 3B9A C9FF hex (-99,999,999.9 to 99,999,999.9) *One digit to the right of the decimal point (fixed).
000B	Instantaneous Reactive Power (kvar)	C465 3601 to 3B9A C9FF hex (-99,999,999.99 to 9,999,999.99) *Two digits to the right of the decimal point (fixed).
000C	Total Power Consumption (kWh)	0000 0000 to 05F5 E0FF hex (0.0 to 9,999,999.9) *One digit to the right of the decimal point (fixed).
000D	Calculated CO ₂ (total power consumption) (kgCO ₂)	0000 0000 to 3B9A C9FF hex (0.0 to 99,999,999.9) *One digit to the right of the decimal point (fixed).
000E ^{*6}	Total Pulse Input Count for the Day (pulses)	0000 0000 to 0001 869F hex (0 to 99,999)
000F	Specific Power Consumption (kWh/pulse)	0000 0000 to 05F5 E0FF hex (0.000 to 99,999.999) *Three digits to the right of the decimal point (fixed).
0010	Pulse Input ON Time (h)	0000 0000 to 0000 HHMM hex HH (hour): 0 to 17 hex (0 to 23) MM (minutes): 0 to 3B hex (0 to 59)
0011	Status	Refer to 5.2 Status Information.
0012	Version	Example: 0000 0100 hex
0013 ^{*3}	HIGH Total Power Consumption (kWh)	0000 0000 to 05F5 E0FF hex (0.000 to 99,999.999) *Three digits to the right of the decimal point (fixed).
0014 ^{*3}	HIGH Total Power Consumption Ratio ^{*4}	0000 0000 to 0000 03E8 hex (0.000 to 1.000) *Three digits to the right of the decimal point (fixed).
0015 ^{*3}	HIGH Total Time	0000 0000 to 0000 HHMM hex HH (hour): 0 to 18 hex (0 to 24) MM (minutes): 0 to 3B hex (0 to 59)
0016 ^{*3}	HIGH Total Time Ratio ^{*4}	0000 0000 to 0000 03E8 hex (0.000 to 1.000) *Three digits to the right of the decimal point (fixed).
0017 ^{*3}	MIDDLE Total Power Consumption (kWh)	0000 0000 to 05F5 E0FF hex (0.000 to 99,999.999) *Three digits to the right of the decimal point (fixed).
0018 ^{*3}	MIDDLE Total Power Consumption Ratio ^{*4}	0000 0000 to 0000 03E8 hex (0.000 to 1.000) *Three digits to the right of the decimal point (fixed).
0019 ^{*3}	MIDDLE Total Time	0000 0000 to 0000 HHMM hex HH (hour): 0 to 18 hex (0 to 24) MM (minutes): 0 to 3B hex (0 to 59)
001A ^{*3}	MIDDLE Total Time Ratio ^{*4}	0000 0000 to 0000 03E8 hex (0.000 to 1.000) *Three digits to the right of the decimal point (fixed).
001B ^{*3}	LOW Total Power Consumption (kWh)	0000 0000 to 05F5 E0FF hex (0.000 to 99,999.999) *Three digits to the right of the decimal point (fixed).
001C ^{*3}	LOW Total Power Consumption Ratio ^{*4}	0000 0000 to 0000 03E8 hex (0.000 to 1.000) *Three digits to the right of the decimal point (fixed).
001D ^{*3}	LOW Total Time	0000 0000 to 0000 HHMM hex HH (hour): 0 to 18 hex (0 to 24) MM (minutes): 0 to 3B hex (0 to 59)

Address	Parameter name	Set value (monitor value)
001E ^{*3}	LOW Total Time Ratio ^{*4}	0000 0000 to 0000 03E8 hex (0.000 to 1.000) *Three digits to the right of the decimal point (fixed).
001F	Total Power Consumption (Wh)	0000 0000 to 3B9A C9FF hex (0 to 999,999,999)
0020	Total Active Power Consumption (GWh)	0000 0000 to 0000 00009 hex (0 to 9)
0021	Total Active Power Consumption (Wh)	0000 0000 to 3B9A C9FF hex (0 to 999,999,999)
0022	Total Regenerated Energy (GWh)	0000 0000 to 0000 00009 hex (0 to 9)
0023	Total Regenerated Energy (Wh)	0000 0000 to 3B9A C9FF hex (0 to 999,999,999)
0024	Total Leading Reactive Power Consumption (Gvarh)	0000 0000 to 0000 00009 hex (0 to 9)
0025	Total Leading Reactive Power Consumption (varh)	0000 0000 to 3B9A C9FF hex (0 to 999,999,999)
0026	Total Lagging Reactive Power Consumption (Gvarh)	0000 0000 to 0000 00009 hex (0 to 9)
0027	Total Lagging Reactive Power Consumption (varh)	0000 0000 to 3B9A C9FF hex (0 to 999,999,999)
0028	Total Reactive Power Consumption (Gvarh)	0000 0000 to 0000 00009 hex (0 to 9)
0029	Total Reactive Power Consumption (varh)	0000 0000 to 3B9A C9FF hex (0 to 999,999,999)
002A ^{*3}	Three-state HIGH Total Power Consumption (GWh)	0000 0000 to 0000 00009 hex (0 to 9)
002B ^{*3}	Three-state HIGH Total Power Consumption (Wh)	0000 0000 to 3B9A C9FF hex (0 to 999,999,999)
002C ^{*3}	Three-state HIGH Total Time (minutes)	0000 0000 to 0098 967F hex (0 to 9,999,999)
002D ^{*3}	Three-state MIDDLE Total Power Consumption (GWh)	0000 0000 to 0000 00009 hex (0 to 9)
002E ^{*3}	Three-state MIDDLE Total Power Consumption (Wh)	0000 0000 to 3B9A C9FF hex (0 to 999,999,999)
002F ^{*3}	Three-state MIDDLE Total Time (minutes)	0000 0000 to 0098 967F hex (0 to 9,999,999)
0030 ^{*3}	Three-state LOW Total Power Consumption (GWh)	0000 0000 to 0000 00009 hex (0 to 9)
0031 ^{*3}	Three-state LOW Total Power Consumption (Wh)	0000 0000 to 3B9A C9FF hex (0 to 999,999,999)
0032 ^{*3}	Three-state LOW Total Time (minutes)	0000 0000 to 0098 967F hex (0 to 9,999,999)
0033 ^{*6}	Total Pulse Input Count 1 (pulses)	0000 0000 to 3B9A C9FF hex (0 to 999,999,999)
0034 ^{*6}	Total Pulse Input Count 2 (pulses)	0000 0000 to 3B9A C9FF hex (0 to 999,999,999)
0035 ^{*6}	Sum Total Pulse Input Count (pulses)	0000 0000 to 3B9A C9FF hex (0 to 999,999,999)
0036 ^{*6}	Pulse Input Count 1 for the Day (pulses)	0000 0000 to 0001 869F hex (0 to 99,999)
0037 ^{*6}	Pulse Input Count 2 for the Day (pulses)	0000 0000 to 0001 869F hex (0 to 99,999)
0038	Temperature (°C or °F) ^{*5}	FFFF FF6A to 0000 0578 hex (-15.0 to 140.0) *One digit to the right of the decimal point (fixed). Note: In the range of -15.0 to 60.0 for Celsius, and 5.0 to 140.0 for Fahrenheit.
0039	Converted Monetary Cost (upper digits) ^{*8}	0000 0000 to 3B9A C9FF hex (0 to 999,999,999) *Indicates values above 1M. Starts from 0 if the value exceeds the range.
003A	Converted Monetary Cost (lower digits) ^{*8}	0000 0000 to 3B9A C9FF hex (0 to 999,999,999) *Three digits to the right of the decimal point (fixed). Starts from 0 if the value exceeds the range.
003B ^{*3}	HIGH Total Power Consumption Converted to Monetary Cost (upper digits) ^{*8}	0000 0000 to 3B9A C9FF hex (0 to 999,999,999) *Indicates values above 1M. Starts from 0 if the value exceeds the range.
003C ^{*3}	HIGH Total Power Consumption Converted to Monetary Cost (lower digits) ^{*8}	0000 0000 to 3B9A C9FF hex (0 to 999,999,999) *Three digits to the right of the decimal point (fixed). Starts from 0 if the value exceeds the range.
003D ^{*3}	MIDDLE Total Power Consumption Converted to Monetary Cost (upper digits) ^{*8}	0000 0000 to 3B9A C9FF hex (0 to 999,999,999) *Indicates values above 1M. Starts from 0 if the value exceeds the range.

Address	Parameter name	Set value (monitor value)
003E ³	MIDDLE Total Power Consumption Converted to Monetary Cost (lower digits) ^{3a}	0000 0000 to 3B9A C9FF hex (0 to 999,999.999) *Three digits to the right of the decimal point (fixed). Starts from 0 if the value exceeds the range.
003F ³	LOW Total Power Consumption Converted to Monetary Cost (upper digits) ^{3a}	0000 0000 to 3B9A C9FF hex (0 to 999,999.999) *Indicates values above 1M. Starts from 0 if the value exceeds the range.
0040 ³	LOW Total Power Consumption Converted to Monetary Cost (lower digits) ^{3a}	0000 0000 to 3B9A C9FF hex (0 to 999,999.999) *Three digits to the right of the decimal point (fixed). Starts from 0 if the value exceeds the range.
0041	Pulse Conversion Value 1 (upper digits)	0000 0000 to 3B9A C9FF hex (0 to 999,999.999) Indicates values above 1M. Starts from 0 if the value exceeds the range.
0042	Pulse Conversion Value 1 (lower digits)	0000 0000 to 3B9A C9FF hex (0 to 999,999.999) Three digits to the right of the decimal point (fixed). Starts from 0 if the value exceeds the range.
0043	Pulse Conversion Value 2 (upper digits)	0000 0000 to 3B9A C9FF hex (0 to 999,999.999) Indicates values above 1M. Starts from 0 if the value exceeds the range.
0044	Pulse Conversion Value 2 (lower digits)	0000 0000 to 3B9A C9FF hex (0 to 999,999.999) Three digits to the right of the decimal point (fixed). Starts from 0 if the value exceeds the range.

*1: The order of voltages 1, 2, and 3 that are read for each wiring method are as follows:

Wiring method	Voltage 1	Voltage 2	Voltage 3
Single-phase, two-wire	Vrs	---	---
Single-phase, three-wire	Vrn	Vsn	Vrs
Three-phase, three-wire	Vrs	Vst	Vtr
Three-phase, four-wire	Vrn	Vsn	Vtn

---: These values will read as 0.

*2: The order of current 1, 2, and 3 that are read for each wiring method are as follows:

Wiring method	Current 1	Current 2	Current 3
Single-phase, two-wire	IR	---	---
Single-phase, three-wire	IR	IN	IT
Three-phase, three-wire	IR	IS	IT
Three-phase, four-wire	IR	IS	IT

---: These values will read as 0.

*3: These addresses are used only for the KM50-E. They cannot be read for the KM50-C.

*4: The ratios for various values read as 1.000 for 100% for the status from the start time until the end time.

*5: Temperatures are read out in the unit that has been set. Conversion between Celsius and Fahrenheit is made using the following formulas. If both values are required, convert the temperature in the host device.

$$F (\text{Fahrenheit}) = 9 / 5 \times C (\text{Celsius}) + 32 + \text{Temperature Compensation}$$

$$C (\text{Celsius}) = 5 / 9 \times (F (\text{Fahrenheit}) - 32) + \text{Temperature Compensation}$$

If a compensation is set, it will be added or subtracted from the measurement value for either unit.

Example: When the temperature is 23.0°C (Celsius)/73.4°F (Fahrenheit) and the compensation value is +10.0, the displayed temperature becomes 23.0 + 10.0 = 33.0 (°C: Celsius) or 73.4 + 10.0 = 83.4 (°F: Fahrenheit).

*6: The pulse input counts are counter values that are reset on a daily basis. The total pulse input count is not reset on a daily basis, rather it is reset to zero when the count upper limit is reached, and starts counting again. Counter 1 and counter 2 are individual count values that can be read separately. The total counter reads the sum of counter 1 and counter 2. A summary is shown in the following table.

Parameter	Read out value	Reset condition
Pulse Input Count 1 for the Day	Input count for input 1	Reset on a daily basis.
Pulse Input Count 2 for the Day	Input count for input 2	
Total Pulse Input Count for the Day	Sum of input counts for inputs 1 and 2	
Total Pulse Input Count 1	Input count for input 1	Reset when upper limit is reached.
Total Pulse Input Count 2	Input count for input 2	
Sum Total Pulse Input Count	Sum of input counts for inputs 1 and 2	

*7: Measurement Values after Recovering from a Power Interruption

The following measurement values are saved to the memory for every five-minute period. Therefore, when the power supply is turned ON, the last value that was saved for a five-minute period while the Power Monitor was ON will be read out, rather than the value right before the power was interrupted. The measurement will continue. Total power consumptions, pulse input ON time, pulse input count, specific power consumption, and three-state total power consumptions

*8: Digits That Are Read Out

The upper digits and lower digits of a converted value can be read out separated. However, there are only seven significant digits when the upper and lower digits are combined.

● Addresses 0080 to 009F hex: Average Values

These addresses not used by the KM50. The KM50 does not support averaging for the data logging cycle.

● Addresses 00A0 to 00B3: Maximum Values

Address	Parameter name	Set value (monitor value)
00A0	Maximum Voltage 1 ^{*1} (V)	0000 0000 to 000F 423F hex (0.0 to 99,999.9) *One digit to the right of the decimal point (fixed).
00A1	Maximum Voltage 2 ^{*1} (V)	Same as above.
00A2	Maximum Voltage 3 ^{*1} (V)	Same as above.
00A3	Maximum Current 1 ^{*2} (A)	0000 0000 to 0098 967F hex (0.000 to 9,999.999) *Three digits to the right of the decimal point (fixed).
00A4	Maximum Current 2 ^{*2} (A)	Same as above.
00A5	Maximum Current 3 ^{*2} (A)	Same as above.
00A6	Maximum Power Factor	FFFF FF9C to 0000 0064 hex (-1.00 to 1.00) *Two digits to the right of the decimal point (fixed).
00B0	Maximum Active Power (W)	C465 3601 to 3B9A C9FF hex (-99,999,999.9 to 99,999,999.9) *One digit to the right of the decimal point (fixed).
00B1	Maximum Active Power (kW)	C465 3601 to 3B9A C9FF hex (-9,999,999.99 to 9,999,999.99) *Two digits to the right of the decimal point (fixed).
00B2	Maximum Reactive Power (var)	C465 3601 to 3B9A C9FF hex (-99,999,999.9 to 99,999,999.9) *One digit to the right of the decimal point (fixed).
00B3	Maximum Reactive Power (kvar)	C465 3601 to 3B9A C9FF hex (-9,999,999.99 to 9,999,999.99) *Two digits to the right of the decimal point (fixed).

*1, *2: See notes for addresses 0000 to 0012.

● Addresses 00C0 to 00D3: Minimum Values

Address	Parameter name	Set value (monitor value)
00C0	Minimum Voltage 1 ^{*1} (V)	0000 0000 to 000F 423F hex (0.0 to 99,999.9) *One digit to the right of the decimal point (fixed).
00C1	Minimum Voltage 2 ^{*1} (V)	Same as above.
00C2	Minimum Voltage 3 ^{*1} (V)	Same as above.
00C3	Minimum Current 1 ^{*2} (A)	0000 0000 to 0098 967F hex (0.000 to 9,999.999) *Three digits to the right of the decimal point (fixed).
00C4	Minimum Current 2 ^{*2} (A)	Same as above.
00C5	Minimum Current 3 ^{*2} (A)	Same as above.
00C6	Minimum Power Factor	FFFF FF9C to 0000 0064 hex (-1.00 to 1.00) *Two digits to the right of the decimal point (fixed).
00D0	Minimum Active Power (W)	C465 3601 to 3B9A C9FF hex (-99,999,999.9 to 99,999,999.9) *One digit to the right of the decimal point (fixed).
00D1	Minimum Active Power (kW)	C465 3601 to 3B9A C9FF hex (-9,999,999.99 to 9,999,999.99) *Two digits to the right of the decimal point (fixed).
00D2	Minimum Reactive Power (var)	C465 3601 to 3B9A C9FF hex (-99,999,999.9 to 99,999,999.9) *One digit to the right of the decimal point (fixed).
00D3	Minimum Reactive Power (kvar)	C465 3601 to 3B9A C9FF hex (-9,999,999.99 to 9,999,999.99) *Two digits to the right of the decimal point (fixed).

*1, *2: See notes for addresses 0000 to 0012.

● Addresses 1000 to 123F hex: Total Power Consumption for Every Five-minute Period (0.1-kWh Increments)

The total power consumption for every five-minute period can be read.

The total power consumption for every five-minute period can be read for only two days, the present day and the previous day.

Specify the address for the time period to read in the service request PDU.

Example for Address 1001: The total power consumption from 00:05 to 00:10 will be read.

(The total power consumption for the specified five-minute period will be read.)

The total power consumption for every five-minute period for the present day cannot be read for times that are in the future compared to the present time in the KM50 internal clock. If the total power consumption is read for future times, the service response PDU will be returned with a measurement value of 0.

Make sure that the number of addresses that can be read out is not exceeded and all of the values are for the same day when reading out more than one element at the same time.

The addresses are listed in the following table.

(Addresses are incremented by one for each five minutes, so some addresses have been omitted.)

Address	Parameter name	Set value (monitor value)
1000	Total Power Consumption for 00:00 to 00:05 Today (kWh)	00000000 to 05F5E0FF hex (0.0 to 9,999,999.9) *One digit to the right of the decimal point (fixed).
1001	Total Power Consumption for 00:05 to 00:10 Today (kWh)	Same as above.
1002	Total Power Consumption for 00:10 to 00:15 Today (kWh)	Same as above.
...
(Omitted)		
...
111E	Total Power Consumption for 23:50 to 23:55 Today (kWh)	Same as above.
111F	Total Power Consumption for 23:55 to 24:00 Today (kWh)	Same as above.
1120	Total Power Consumption for 00:00 to 00:05 Yesterday (kWh)	Same as above.
1121	Total Power Consumption for 00:05 to 00:10 Yesterday (kWh)	Same as above.
1122	Total Power Consumption for 00:10 to 00:15 Yesterday (kWh)	Same as above.
...
(Omitted)		
...
123E	Total Power Consumption for 23:50 to 23:55 Yesterday (kWh)	Same as above.
123F	Total Power Consumption for 23:55 to 24:00 Yesterday (kWh)	Same as above.

● Addresses 1400 to 163F hex: Total Power Consumption for Every Five Minutes (0.1-kWh Increments)

The total power consumption for every five minutes can be read.

The total power consumption for every five minutes can be read for only two days, the present day and the previous day.

Specify the address for the time period to read in the service request PDU.

Example for Address 1401: The total power consumption at 00:10 will be read.

(The total power consumption for the specified time will be read.)

The total power consumption every five minutes for the present day cannot be read for times that are in the future compared to the present time in the KM50 internal clock. If the total power consumption is read for future times, the service response PDU will be returned with a measurement value of 0.

Make sure that the number of addresses that can be read out is not exceeded and all of the values are for the same day when reading out more than one element at the same time.

The addresses are listed in the following table.

(Addresses are incremented by one for each five minutes, so some addresses have been omitted.)

Address	Parameter name	Set value (monitor value)
1400	Total Power Consumption at 00:05 Today (kWh)	0000 0000 to 05F5 E0FF hex (0.0 to 9,999,999.9) *One digit to the right of the decimal point (fixed).
1401	Total Power Consumption at 00:10 Today (kWh)	Same as above.
1402	Total Power Consumption at 00:15 Today (kWh)	Same as above.
...
(Omitted)		
...
151E	Total Power Consumption at 23:55 Today (kWh)	Same as above.
151F	Total Power Consumption at 24:00 Today (kWh)	Same as above.
1520	Total Power Consumption at 00:05 Yesterday (kWh)	Same as above.
1521	Total Power Consumption at 00:10 Yesterday (kWh)	Same as above.
1522	Total Power Consumption at 00:15 Yesterday (kWh)	Same as above.
...
(Omitted)		
...
163E	Total Power Consumption at 23:55 Yesterday (kWh)	Same as above.
163F	Total Power Consumption at 24:00 Yesterday (kWh)	Same as above.

● Addresses 1800 to 1A3F hex: Total Power Consumption for Every Five-minute Period (0.1-kWh Increments)

The total power consumption can be read for every five-minute period for any of four total power consumptions.

The total power consumption for every five-minute period can be read for only two days, the present day and the previous day.

Specify the address for the time to read in the service request PDU.

Example for Address 1001: The total power consumption from 00:05 to 00:10 will be read.
(The total power consumption for the specified five-minute period will be read.)

The total power consumption for every five-minute period for the present day cannot be read for times that are in the future compared to the present time in the KM50 internal clock. If a value is read for a future time, the service response PDU will be returned with a measurement value of 0.

Make sure that the number of addresses that can be read out is not exceeded and all of the values are for the same day when reading out more than one element at the same time.

The addresses are listed in the following table.

(Addresses are incremented by one for each five minutes. Some addresses have been omitted in the following table.)

Address	Parameter	Set value (monitor value)
1800	Total <input type="checkbox"/> <input type="checkbox"/> Power Consumption for 00:00 to 00:05 Today (kWh)	0000 0000 to 05F5 E0FF hex (0.0 to 9,999,999.9) *One digit to the right of the decimal point (fixed).
1801	Total <input type="checkbox"/> <input type="checkbox"/> Power Consumption for 00:05 to 00:10 Today (kWh)	Same as above.
1802	Total <input type="checkbox"/> <input type="checkbox"/> Power Consumption for 00:10 to 00:15 Today (kWh)	Same as above.
...
(Omitted)		
...
191E	Total <input type="checkbox"/> <input type="checkbox"/> Power Consumption for 23:50 to 23:55 Today (kWh)	Same as above.
191F	Total <input type="checkbox"/> <input type="checkbox"/> Power Consumption for 23:55 to 24:00 Today (kWh)	Same as above.
1920	Total <input type="checkbox"/> <input type="checkbox"/> Power Consumption for 00:00 to 00:05 Yesterday (kWh)	Same as above.
1921	Total <input type="checkbox"/> <input type="checkbox"/> Power Consumption for 00:05 to 00:10 Yesterday (kWh)	Same as above.
1922	Total <input type="checkbox"/> <input type="checkbox"/> Power Consumption for 00:10 to 00:15 Yesterday (kWh)	Same as above.
...
(Omitted)		
...
1A3E	Total <input type="checkbox"/> <input type="checkbox"/> Power Consumption for 23:50 to 23:55 Yesterday (kWh)	Same as above.
1A3F	Total <input type="checkbox"/> <input type="checkbox"/> Power Consumption for 23:55 to 24:00 Yesterday (kWh)	Same as above.

● Addresses 1C00 to 1E3F hex: Total Power Consumption Every Five Minutes (0.1-kWh Increments)

The total power consumption can be read every five minutes for any of four total power consumptions.

The total power consumption every five minutes can be read for only two days, the present day and the previous day.

Specify the address for the time to read in the service request PDU.

Example for Address 1401: The total power consumption for 00:10 will be read.

(The total power consumption for the specified time will be read.)

The total power consumption every five minutes for the present day cannot be read for times that are in the future compared to the present time in the KM50 internal clock. If a value is read for a future time, the service response PDU will be returned with a measurement value of 0.

Make sure that the number of addresses that can be read out is not exceeded and all of the values are for the same day when reading out more than one element at the same time.

The addresses are listed in the following table.

(Addresses are incremented by one for each five minutes. Some addresses have been omitted in the following table.)

Address	Parameter	Set value (monitor value)
1C00	Total <input type="checkbox"/> <input type="checkbox"/> Power Consumption for 00:05 Today (kWh)	0000 0000 to 05F5 E0FF hex (0.0 to 9,999,999.9) One digit to the right of the decimal point (fixed).
1C01	Total <input type="checkbox"/> <input type="checkbox"/> Power Consumption for 00:10 Today (kWh)	Same as above.
1C02	Total <input type="checkbox"/> <input type="checkbox"/> Power Consumption for 00:15 Today (kWh)	Same as above.
...
(Omitted)		
...
1D1E	Total <input type="checkbox"/> <input type="checkbox"/> Power Consumption for 23:55 Today (kWh)	Same as above.
1D1F	Total <input type="checkbox"/> <input type="checkbox"/> Power Consumption for 24:00 Today (kWh)	Same as above.
1D20	Total <input type="checkbox"/> <input type="checkbox"/> Power Consumption for 00:05 Yesterday (kWh)	Same as above.
1D21	Total <input type="checkbox"/> <input type="checkbox"/> Power Consumption for 00:10 Yesterday (kWh)	Same as above.
1D22	Total <input type="checkbox"/> <input type="checkbox"/> Power Consumption for 00:15 Yesterday (kWh)	Same as above.
...
(Omitted)		
...
1E3E	Total <input type="checkbox"/> <input type="checkbox"/> Power Consumption for 23:55 Yesterday (kWh)	Same as above.
1E3F	Total <input type="checkbox"/> <input type="checkbox"/> Power Consumption for 24:00 Yesterday (kWh)	Same as above.

● Addresses 2000 to 202F hex: Total Power Consumption for Every Hour (0.1-kWh Increments)

The total power consumption for every hour can be read.

The total power consumption for every hour can be read for only two days, the present day and the previous day.

Specify the address for the time period to read in the service request PDU.

The total power consumption for every hour for the present day cannot be read for times that are in the future compared to the present time in the KM50 internal clock. If the total power consumption is read for future times, the service response PDU will be returned with a measurement value of 0.

The addresses are listed in the following table.

(Addresses are incremented by one for each hour, so some addresses have been omitted.)

Address	Parameter name	Set value (monitor value)
2000	Total Power Consumption for 00:00 to 01:00 Today (kWh)	0000 0000 to 05F5 E0FF hex (0.0 to 9,999,999.9) *One digit to the right of the decimal point (fixed).
2001	Total Power Consumption for 01:00 to 02:00 Today (kWh)	Same as above.
2002	Total Power Consumption for 02:00 to 03:00 Today (kWh)	Same as above.
...
(Omitted)		
...
2016	Total Power Consumption for 22:00 to 23:00 Today (kWh)	Same as above.
2017	Total Power Consumption for 23:00 to 24:00 Today (kWh)	Same as above.
2018	Total Power Consumption for 00:00 to 01:00 Yesterday (kWh)	Same as above.
2019	Total Power Consumption for 01:00 to 02:00 Yesterday (kWh)	Same as above.
201A	Total Power Consumption for 02:00 to 03:00 Yesterday (kWh)	Same as above.
...
(Omitted)		
...
202E	Total Power Consumption for 22:00 to 23:00 Yesterday (kWh)	Same as above.
202F	Total Power Consumption for 23:00 to 24:00 Yesterday (kWh)	Same as above.

● Addresses 2100 to 212F hex: Total Power Consumption for Every Hour (0.001-kWh Increments)

The total power consumption for every hour can be read.

The total power consumption for every hour can be read for only two days, the present day and the previous day.

Specify the address for the time period to read in the service request PDU.

The total power consumption for every hour for the present day cannot be read for times that are in the future compared to the present time in the KM50 internal clock. If the total power consumption is read for future times, the service response PDU will be returned with a measurement value of 0. If the read value exceeds 9,999 kWh, the precision of the lowest digit will be decreased, so FFFF FFFF will be returned as the measurement value in the service response PDU. If that occurs, read the measurement value for 0.1-kWh increments. The addresses are listed in the following table.

(Addresses are incremented by one for each hour, so some addresses have been omitted.)

Address	Parameter name	Set value (monitor value)
2100	Total Power Consumption for 00:00 to 01:00 Today (kWh)	0000 0000 to 0098 967F hex (0.000 to 9,999.999) *Three digits to the right of the decimal point (fixed).
2101	Total Power Consumption for 01:00 to 02:00 Today (kWh)	Same as above.
2102	Total Power Consumption for 02:00 to 03:00 Today (kWh)	Same as above.
...
(Omitted)		
...
2116	Total Power Consumption for 22:00 to 23:00 Today (kWh)	Same as above.
2117	Total Power Consumption for 23:00 to 24:00 Today (kWh)	Same as above.
2118	Total Power Consumption for 00:00 to 01:00 Yesterday (kWh)	Same as above.
2119	Total Power Consumption for 01:00 to 02:00 Yesterday (kWh)	Same as above.
211A	Total Power Consumption for 02:00 to 03:00 Yesterday (kWh)	Same as above.
...
(Omitted)		
...
212E	Total Power Consumption for 22:00 to 23:00 Yesterday (kWh)	Same as above.
212F	Total Power Consumption for 23:00 to 24:00 Yesterday (kWh)	Same as above.

● **Addresses 2200 to 2208 hex: Total Power Consumption for Every Day (0.1-kWh Increments)**

The total power consumption for every day can be read.

The total power consumption for every day can be read for the present day and the last eight days.

Specify the address for the day to read in the service request PDU.

Address	Parameter name	Set value (monitor value)
2200	Present Total Power Consumption for Today (kWh)	0000 0000 to 05F5 E0FF hex (0.0 to 9,999,999.9) *One digit to the right of the decimal point (fixed).
2201	Total Power Consumption for 00:00 to 24:00 One Day Ago (kWh)	Same as above.
2202	Total Power Consumption for 00:00 to 24:00 Two Days Ago (kWh)	Same as above.
2203	Total Power Consumption for 00:00 to 24:00 Three Days Ago (kWh)	Same as above.
2204	Total Power Consumption for 00:00 to 24:00 Four Days Ago (kWh)	Same as above.
2205	Total Power Consumption for 00:00 to 24:00 Five Days Ago (kWh)	Same as above.
2206	Total Power Consumption for 00:00 to 24:00 Six Days Ago (kWh)	Same as above.
2207	Total Power Consumption for 00:00 to 24:00 Seven Days Ago (kWh)	Same as above.
2208	Total Power Consumption for 00:00 to 24:00 Eight Days Ago (kWh)	Same as above.

● **Addresses 2300 to 2308 hex: Total Power Consumption for Every Day (0.001-kWh Increments)**

The total power consumption for every day can be read.

The total power consumption for every day can be read for the present day and the last eight days.

Specify the address for the day to read in the service request PDU.

If the read value exceeds 9,999 kWh, the precision of the lowest digit will be decreased, so FFFF FFFF will be returned as the measurement value in the service response PDU. If that occurs, read the measurement value for 0.1-kWh increments.

Address	Parameter name	Set value (monitor value)
2300	Present Total Power Consumption for Today (kWh)	0000 0000 to 0098 967F hex (0.000 to 9,999.999) *Three digits to the right of the decimal point (fixed).
2301	Total Power Consumption for 00:00 to 24:00 One Day Ago (kWh)	Same as above.
2302	Total Power Consumption for 00:00 to 24:00 Two Days Ago (kWh)	Same as above.
2303	Total Power Consumption for 00:00 to 24:00 Three Days Ago (kWh)	Same as above.
2304	Total Power Consumption for 00:00 to 24:00 Four Days Ago (kWh)	Same as above.
2305	Total Power Consumption for 00:00 to 24:00 Five Days Ago (kWh)	Same as above.
2306	Total Power Consumption for 00:00 to 24:00 Six Days Ago (kWh)	Same as above.
2307	Total Power Consumption for 00:00 to 24:00 Seven Days Ago (kWh)	Same as above.
2308	Total Power Consumption for 00:00 to 24:00 Eight Days Ago (kWh)	Same as above.

● Addresses 2400 to 2408 hex: Pulse Input ON Time for Every Day

The pulse input ON time for every day can be read.

The pulse input ON time for every day can be read for the present day and the last eight days.

Specify the address for the day to read in the service request PDU.

Address	Parameter name	Set value (monitor value)
2400	Present Pulse Input ON Time for Today	0000 HHMM hex HH (hour): 0 to 17 hex (0 to 23) MM (minutes): 0 to 3B hex (0 to 59)
2401	Pulse Input ON Time for One Day Ago	Same as above.
2402	Pulse Input ON Time for Two Days Ago	Same as above.
2403	Pulse Input ON Time for Three Days Ago	Same as above.
2404	Pulse Input ON Time for Four Days Ago	Same as above.
2405	Pulse Input ON Time for Five Days Ago	Same as above.
2406	Pulse Input ON Time for Six Days Ago	Same as above.
2407	Pulse Input ON Time for Seven Days Ago	Same as above.
2408	Pulse Input ON Time for Eight Days Ago	Same as above.

● Addresses 2600 to 2608 hex: Specific Power Consumption for Every Day

The specific power consumption for every day can be read.

The specific power consumption for every day can be read for the present day and the last eight days. Specify the address for the day to read in the service request PDU.

If the read value exceeds 99,999.999 kWh/pulse, the precision of the lowest digit will be lost, so FFFF FFFF will be returned as the measurement value in the service response PDU.

Address	Parameter name	Set value (monitor value)
2600	Present Specific Power Consumption for Today (kWh/pulse)	0000 0000 to 05F5 E0FF hex (0.000 to 99,999.999) *Three digits to the right of the decimal point (fixed).
2601	Specific Power Consumption for One Day Ago (kWh/pulse)	Same as above.
2602	Specific Power Consumption for Two Days Ago (kWh/pulse)	Same as above.
2603	Specific Power Consumption for Three Days Ago (kWh/pulse)	Same as above.
2604	Specific Power Consumption for Four Days Ago (kWh/pulse)	Same as above.
2605	Specific Power Consumption for Five Days Ago (kWh/pulse)	Same as above.
2606	Specific Power Consumption for Six Days Ago (kWh/pulse)	Same as above.
2607	Specific Power Consumption for Seven Days Ago (kWh/pulse)	Same as above.
2608	Specific Power Consumption for Eight Days Ago (kWh/pulse)	Same as above.

● Addresses 2700 to 2708 hex: Pulse Input Count for Every Day

The pulse input count for every day can be read.

The pulse input count for every day can be read for the present day and the last eight days.

Specify the address for the day to read in the service request PDU.

Address	Parameter name	Set value (monitor value)
2700	Present Pulse Input Count for Today	0000 0000 to 0001 869F hex (0 to 99,999)
2701	Pulse Input Count for One Day Ago	Same as above.
2702	Pulse Input Count for Two Days Ago	Same as above.
2703	Pulse Input Count for Three Days Ago	Same as above.
2704	Pulse Input Count for Four Days Ago	Same as above.
2705	Pulse Input Count for Five Days Ago	Same as above.
2706	Pulse Input Count for Six Days Ago	Same as above.
2707	Pulse Input Count for Seven Days Ago	Same as above.
2708	Pulse Input Count for Eight Days Ago	Same as above.

● Addresses 2E00 to 2E0D hex: Total Power Consumption for Every Month (0.1-kWh Increments)

The total power consumption for every month can be read.

The total power consumption for every month can be read for the present month and the last 13 months.

Specify the address for the month to read in the service request PDU.

Address	Parameter name	Set value (monitor value)
2E00	Total Power Consumption This Month from 1st to Present Day (kWh)	00000000 to 05F5E0FF hex (0.0 to 9,999,999.9) *One digit to the right of the decimal point (fixed).
2E01	Total Power Consumption One Month Ago from 1st to Last Day (kWh)	Same as above.
2E02	Total Power Consumption Two Months Ago from 1st to Last Day (kWh)	Same as above.
2E03	Total Power Consumption Three Months Ago from 1st to Last Day (kWh)	Same as above.
2E04	Total Power Consumption Four Months Ago from 1st to Last Day (kWh)	Same as above.
2E05	Total Power Consumption Five Months Ago from 1st to Last Day (kWh)	Same as above.
2E06	Total Power Consumption Six Months Ago from 1st to Last Day (kWh)	Same as above.
2E07	Total Power Consumption Seven Months Ago from 1st to Last Day (kWh)	Same as above.
2E08	Total Power Consumption Eight Months Ago from 1st to Last Day (kWh)	Same as above.
2E09	Total Power Consumption Nine Months Ago from 1st to Last Day (kWh)	Same as above.
2E0A	Total Power Consumption 10 Months Ago from 1st to Last Day (kWh)	Same as above.
2E0B	Total Power Consumption 11 Months Ago from 1st to Last Day (kWh)	Same as above.
2E0C	Total Power Consumption 12 Months Ago from 1st to Last Day (kWh)	Same as above.
2E0D	Total Power Consumption 13 Months Ago from 1st to Last Day (kWh)	Same as above.

● Addresses 2F00 to 2F0D hex: Total Power Consumption for Every Month (0.001-kWh Increments)

The total power consumption for every month can be read.

The total power consumption for every month can be read for the present month and the last 13 months.

Specify the address for the month to read in the service request PDU.

If the read value exceeds 9,999 kWh, the precision of the lowest digit will be decreased, so FFFF FFFF will be returned as the measurement value in the service response PDU. If that occurs, read the measurement value for 0.1-kWh increments.

Address	Parameter name	Set value (monitor value)
2F00	Total Power Consumption This Month from 1st to Present Day (kWh)	0000 0000 to 0098 967F hex (0.000 to 9,999.999) *Three digits to the right of the decimal point (fixed).
2F01	Total Power Consumption One Month Ago from 1st to Last Day (kWh)	Same as above.
2F02	Total Power Consumption Two Months Ago from 1st to Last Day (kWh)	Same as above.
2F03	Total Power Consumption Three Months Ago from 1st to Last Day (kWh)	Same as above.
2F04	Total Power Consumption Four Months Ago from 1st to Last Day (kWh)	Same as above.
2F05	Total Power Consumption Five Months Ago from 1st to Last Day (kWh)	Same as above.
2F06	Total Power Consumption Six Months Ago from 1st to Last Day (kWh)	Same as above.
2F07	Total Power Consumption Seven Months Ago from 1st to Last Day (kWh)	Same as above.
2F08	Total Power Consumption Eight Months Ago from 1st to Last Day (kWh)	Same as above.
2F09	Total Power Consumption Nine Months Ago from 1st to Last Day (kWh)	Same as above.
2F0A	Total Power Consumption 10 Months Ago from 1st to Last Day (kWh)	Same as above.
2F0B	Total Power Consumption 11 Months Ago from 1st to Last Day (kWh)	Same as above.
2F0C	Total Power Consumption 12 Months Ago from 1st to Last Day (kWh)	Same as above.
2F0D	Total Power Consumption 13 Months Ago from 1st to Last Day (kWh)	Same as above.

● Addresses 3000 to 38011: Maximum Measurement Values

The maximum measurement values can be read.

The maximum measurement values for every day can be read for the present day and the last eight days.

However, the reactive power can be read only for the present day.

Specify the address for the day and measurement item to read in the service request PDU.

The maximum value and the time when the value was recorded can be read.

You can read both the measurement time and measurement value, only the measurement time, or only the measurement value.

Addresses are defined as follows:

3□△△

3: The first digit of the address is always 3.

□: Indicates the day. 0: Present day, 1: One day ago, 2: Two days ago, ..., 8: Eight days ago

△△: Indicates the measurement time or the measurement item.

Address	Parameter name		Set value (monitor value)
3000	Voltage 1 Today	Measurement Time	0000 HHMM hex HH (hour): 0 to 17 hex (0 to 23), MM (minutes): 0 to 3B hex (0 to 59)
3001		Measurement Value (V)	0000 0000 to 000F 423F hex (0.0 to 99,999.9) *One digit to the right of the decimal point (fixed).
3002	Voltage 2 Today	Measurement Time	0000 HHMM hex HH (hour): 0 to 17 hex (0 to 23), MM (minutes): 0 to 3B hex (0 to 59)
3003		Measurement Value (V)	0000 0000 to 000F 423F hex (0.0 to 999,999.9) *One digit to the right of the decimal point (fixed).
3004	Voltage 3 Today	Measurement Time	0000 HHMM hex HH (hour): 0 to 17 hex (0 to 23), MM (minutes): 0 to 3B hex (0 to 59)
3005		Measurement Value (V)	0000 0000 to 000F 423F hex (0.0 to 99,999.9) *One digit to the right of the decimal point (fixed).
3006	Current 1 Today	Measurement Time	0000 HHMM hex HH (hour): 0 to 17 hex (0 to 23), MM (minutes): 0 to 3B hex (0 to 59)
3007		Measurement Value (A)	0000 0000 to 0098 967F hex (0.000 to 99,999.999) *Three digits to the right of the decimal point (fixed).
3008	Current 2 Today	Measurement Time	0000 HHMM hex HH (hour): 0 to 17 hex (0 to 23), MM (minutes): 0 to 3B hex (0 to 59)
3009		Measurement Value (A)	0000 0000 to 0098 967F hex (0.000 to 99,999.999) *Three digits to the right of the decimal point (fixed).
300A	Current 3 Today	Measurement Time	0000 HHMM hex HH (hour): 0 to 17 hex (0 to 23), MM (minutes): 0 to 3B hex (0 to 59)
300B		Measurement Value (A)	0000 0000 to 0098 967F hex (0.000 to 99,999.999) *Three digits to the right of the decimal point (fixed).
300C	Power Factor Today	Measurement Time	0000 HHMM hex HH (hour): 0 to 17 hex (0 to 23), MM (minutes): 0 to 3B hex (0 to 59)
300D		Measurement Value	FFFF FF9C to 0000 0064 hex (-1.00 to 1.00) *Two digits to the right of the decimal point (fixed).
300E	Active Power for Today	Measurement Time	0000 HHMM hex HH (hour): 0 to 17 hex (0 to 23), MM (minutes): 0 to 3B hex (0 to 59)
300F		Measurement Value (W)	C465 3601 to 3B9A C9FF hex (-99,999,999.9 to 99,999,999.9) *One digit to the right of the decimal point (fixed).

Address	Parameter name		Set value (monitor value)
3010	Active Power Today	Measurement Time	0000 HHMM hex HH (hour): 0 to 17 hex (0 to 23), MM (minutes): 0 to 3B hex (0 to 59)
3011		Measurement Value (kW)	C465 3601 to 3B9A C9FF hex (-9,999,999.99 to 9,999,999.99) *Two digits to the right of the decimal point (fixed).
3012	Reactive Power Today	Measurement Time	0000 HHMM hex HH (hour): 0 to 17 hex (0 to 23), MM (minutes): 0 to 3B hex (0 to 59)
3013		Measurement Value (var)	C465 3601 to 3B9A C9FF hex (-99,999,999.9 to 99,999,999.9) *One digit to the right of the decimal point (fixed).
3014	Reactive Power Today	Measurement Time	0000 HHMM hex HH (hour): 0 to 17 hex (0 to 23), MM (minutes): 0 to 3B hex (0 to 59)
3015		Measurement Value (kvar)	C465 3601 to 3B9A C9FF hex (-9,999,999.99 to 9,999,999.99) *Two digits to the right of the decimal point (fixed).
3100	Voltage 1 One Day Ago	Measurement Time	0000 HHMM hex HH (hour): 0 to 17 hex (0 to 23), MM (minutes): 0 to 3B hex (0 to 59)
3101		Measurement Value (V)	0000 0000 to 000F 423F hex (0.0 to 99,999.9) *One digit to the right of the decimal point (fixed).
3102	Voltage 2 One Day Ago	Measurement Time	0000 HHMM hex HH (hour): 0 to 17 hex (0 to 23), MM (minutes): 0 to 3B hex (0 to 59)
3103		Measurement Value (V)	0000 0000 to 000F 423F hex (0.0 to 99,999.9) *One digit to the right of the decimal point (fixed).
3104	Voltage 3 One Day Ago	Measurement Time	0000 HHMM hex HH (hour): 0 to 17 hex (0 to 23), MM (minutes): 0 to 3B hex (0 to 59)
3105		Measurement Value (V)	0000 0000 to 000F 423F hex (0.0 to 99,999.9) *One digit to the right of the decimal point (fixed).
3106	Current 1 One Day Ago	Measurement Time	0000 HHMM hex HH (hour): 0 to 17 hex (0 to 23), MM (minutes): 0 to 3B hex (0 to 59)
3107		Measurement Value (A)	0000 0000 to 0098 967F hex (0.000 to 99,999.999) *Three digits to the right of the decimal point (fixed).
3108	Current 2 One Day Ago	Measurement Time	0000 HHMM hex HH (hour): 0 to 17 hex (0 to 23), MM (minutes): 0 to 3B hex (0 to 59)
3109		Measurement Value (A)	0000 0000 to 0098 967F hex (0.000 to 99,999.999) *Three digits to the right of the decimal point (fixed).
310A	Current 3 One Day Ago	Measurement Time	0000 HHMM hex HH (hour): 0 to 17 hex (0 to 23), MM (minutes): 0 to 3B hex (0 to 59)
310B		Measurement Value (A)	0000 0000 to 0098 967F hex (0.000 to 99,999.999) *Three digits to the right of the decimal point (fixed).
310C	Power Factor One Day Ago	Measurement Time	0000 HHMM hex HH (hour): 0 to 17 hex (0 to 23), MM (minutes): 0 to 3B hex (0 to 59)
310D		Measurement Value	FFFF FF9C to 0000 0064 hex (-1.00 to 1.00) *Two digits to the right of the decimal point (fixed).
310E	Active Power One Day Ago	Measurement Time	0000 HHMM hex HH (hour): 0 to 17 hex (0 to 23), MM (minutes): 0 to 3B hex (0 to 59)
310F		Measurement Value (W)	C465 3601 to 3B9A C9FF hex (-99,999,999.9 to 99,999,999.9) *One digit to the right of the decimal point (fixed).
3110	Active Power One Day Ago	Measurement Time	0000 HHMM hex HH (hour): 0 to 17 hex (0 to 23), MM (minutes): 0 to 3B hex (0 to 59)
3111		Measurement Value (kW)	C465 3601 to 3B9A C9FF hex (9,999,999.99 to 9,999,999.99) *Two digits to the right of the decimal point (fixed).
...
3700	Voltage 1 Seven Days Ago	Measurement Time	0000 HHMM hex HH (hour): 0 to 17 hex (0 to 23), MM (minutes): 0 to 3B hex (0 to 59)
3701		Measurement Value (V)	0000 0000 to 000F 423F hex (0.0 to 99,999.9) *One digit to the right of the decimal point (fixed).
3702	Voltage 2 Seven Days Ago	Measurement Time	0000 HHMM hex HH (hour): 0 to 17 hex (0 to 23), MM (minutes): 0 to 3B hex (0 to 59)
3703		Measurement Value (V)	0000 0000 to 000F 423F hex (0.0 to 99,999.9) *One digit to the right of the decimal point (fixed).
3704	Voltage 3 Seven Days Ago	Measurement Time	0000 HHMM hex HH (hour): 0 to 17 hex (0 to 23), MM (minutes): 0 to 3B hex (0 to 59)
3705		Measurement Value (V)	0000 0000 to 000F 423F hex (0.0 to 99,999.9) *One digit to the right of the decimal point (fixed).
3706	Current 1 Seven Days Ago	Measurement Time	0000 HHMM hex HH (hour): 0 to 17 hex (0 to 23), MM (minutes): 0 to 3B hex (0 to 59)
3707		Measurement Value (A)	0000 0000 to 0098 967F hex (0.000 to 99,999.999) *Three digits to the right of the decimal point (fixed).

Address	Parameter name	Measurement	Set value (monitor value)
3708	Current 2 Seven Days Ago	Measurement Time	0000 HHMM hex
3709		Measurement Value (A)	0000 0000 to 0098 967F hex (0.000 to 99,999.999) *Three digits to the right of the decimal point (fixed).
370A	Current 3 Seven Days Ago	Measurement Time	0000 HHMM hex HH (hour): 0 to 17 hex (0 to 23), MM (minutes): 0 to 3B hex (0 to 59)
370B		Measurement Value (A)	0000 0000 to 0098 967F hex (0.000 to 99,999.999) *Three digits to the right of the decimal point (fixed).
370C	Power Factor Seven Days Ago	Measurement Time	0000 HHMM hex HH (hour): 0 to 17 hex (0 to 23), MM (minutes): 0 to 3B hex (0 to 59)
370D		Measurement Value	FFFF FF9C to 0000 0064 hex (-1.00 to 1.00) *Two digits to the right of the decimal point (fixed).
370E	Active Power Seven Days Ago	Measurement Time	0000 HHMM hex HH (hour): 0 to 17 hex (0 to 23), MM (minutes): 0 to 3B hex (0 to 59)
370F		Measurement Value (W)	C465 3601 to 3B9A C9FF hex (-99,999,999.9 to 99,999,999.9) *One digit to the right of the decimal point (fixed).
3710	Active Power Seven Days Ago	Measurement Time	0000 HHMM hex HH (hour): 0 to 17 hex (0 to 23), MM (minutes): 0 to 3B hex (0 to 59)
3711		Measurement Value (kW)	C465 3601 to 3B9 AC9FF hex (9,999,999.99 to 9,999,999.99) *Two digits to the right of the decimal point (fixed).
3800	Voltage 1 Eight Days Ago	Measurement Time	0000 HHMM hex HH (hour): 0 to 17 hex (0 to 23), MM (minutes): 0 to 3B hex (0 to 59)
3801		Measurement Value (V)	0000 0000 to 000F 423F hex (0.0 to 99,999.9) *One digit to the right of the decimal point (fixed).
3802	Voltage 2 Eight Days Ago	Measurement Time	0000 HHMM hex HH (hour): 0 to 17 hex (0 to 23), MM (minutes): 0 to 3B hex (0 to 59)
3803		Measurement Value (V)	0000 0000 to 000F 423F hex (0.0 to 99,999.9) *One digit to the right of the decimal point (fixed).
3804	Voltage 3 Eight Days Ago	Measurement Time	0000 HHMM hex HH (hour): 0 to 17 hex (0 to 23), MM (minutes): 0 to 3B hex (0 to 59)
3805		Measurement Value (V)	0000 0000 to 000F 423F hex (0.0 to 99,999.9) *One digit to the right of the decimal point (fixed).
3806	Current 1 Eight Days Ago	Measurement Time	0000 HHMM hex HH (hour): 0 to 17 hex (0 to 23), MM (minutes): 0 to 3B hex (0 to 59)
3807		Measurement Value (A)	0000 0000 to 0098 967F hex (0.000 to 99,999.999) *Three digits to the right of the decimal point (fixed).
3808	Current 2 Eight Days Ago	Measurement Time	0000 HHMM hex HH (hour): 0 to 17 hex (0 to 23), MM (minutes): 0 to 3B hex (0 to 59)
3809		Measurement Value (A)	0000 0000 to 0098 967F hex (0.000 to 99,999.999) *Three digits to the right of the decimal point (fixed).
380A	Current 3 Eight Days Ago	Measurement Time	0000 HHMM hex HH (hour): 0 to 17 hex (0 to 23), MM (minutes): 0 to 3B hex (0 to 59)
380B		Measurement Value (A)	0000 0000 to 0098 967F hex (0.000 to 99,999.999) *Three digits to the right of the decimal point (fixed).
380C	Power Factor Eight Days Ago	Measurement Time	0000 HHMM hex HH (hour): 0 to 17 hex (0 to 23), MM (minutes): 0 to 3B hex (0 to 59)
380D		Measurement Value	FFFF FF9C to 0000 0064 hex (-1.00 to 1.00) *Two digits to the right of the decimal point (fixed).
380E	Active Power Eight Days Ago	Measurement Time	0000 HHMM hex HH (hour): 0 to 17 hex (0 to 23), MM (minutes): 0 to 3B hex (0 to 59)
380F		Measurement Value (W)	C465 3601 to 3B9A C9FF hex (-99,999,999.9 to 99,999,999.9) *One digit to the right of the decimal point (fixed).
3810	Active Power Eight Days Ago	Measurement Time	0000 HHMM hex HH (hour): 0 to 17 hex (0 to 23), MM (minutes): 0 to 3B hex (0 to 59)
3811		Measurement Value (kW)	0000 0000 to 3B9A C9FF hex (-9,999,999.99 to 9,999,999.99) *Two digits to the right of the decimal point (fixed).

● Addresses 4000 to 4811: Minimum Measurement Values

The minimum measurement values can be read.

The minimum measurement values for every day can be read for the present day and the last eight days. However, the reactive power can be read only for the present day.

Specify the address for the day and measurement item to read in the service request PDU.

The minimum value and the time when the value was recorded can be read.

You can read both the measurement time and measurement value, only the measurement time, or only the measurement value.

Addresses are defined as follows:

4□△△

4: The first digit of the address is always 4.

□: Indicates the day. 0: Present day, 1: One day ago, 2: Two days ago, ..., 8: Eight days ago

△△: Indicates the measurement time or the measurement item.

Address	Parameter name		Set value (monitor value)
4000	Voltage 1 Today	Measurement Time	0000 HHMM hex HH (hour): 0 to 17 hex (0 to 23), MM (minutes): 0 to 3B hex (0 to 59)
4001		Measurement Value (V)	0000 0000 to 000F 423F hex (0.0 to 99,999.9) *One digit to the right of the decimal point (fixed).
4002	Voltage 2 Today	Measurement Time	0000 HHMM hex HH (hour): 0 to 17 hex (0 to 23), MM (minutes): 0 to 3B hex (0 to 59)
4003		Measurement Value (V)	0000 0000 to 000F 423F hex (0.0 to 99,999.9) *One digit to the right of the decimal point (fixed).
4004	Voltage 3 Today	Measurement Time	0000 HHMM hex HH (hour): 0 to 17 hex (0 to 23), MM (minutes): 0 to 3B hex (0 to 59)
4005		Measurement Value (V)	0000 0000 to 000F 423F hex (0.0 to 99,999.9) *One digit to the right of the decimal point (fixed).
4006	Current 1 Today	Measurement Time	0000 HHMM hex HH (hour): 0 to 17 hex (0 to 23), MM (minutes): 0 to 3B hex (0 to 59)
4007		Measurement Value (A)	0000 0000 to 0098 967F hex (0.000 to 99,999.999) *Three digits to the right of the decimal point (fixed).
4008	Current 2 Today	Measurement Time	0000 HHMM hex HH (hour): 0 to 17 hex (0 to 23), MM (minutes): 0 to 3B hex (0 to 59)
4009		Measurement Value (A)	0000 0000 to 0098 967F hex (0.000 to 99,999.999) *Three digits to the right of the decimal point (fixed).
400A	Current 3 Today	Measurement Time	0000 HHMM hex HH (hour): 0 to 17 hex (0 to 23), MM (minutes): 0 to 3B hex (0 to 59)
400B		Measurement Value (A)	0000 0000 to 0098 967F hex (0.000 to 99,999.999) *Three digits to the right of the decimal point (fixed).
400C	Power Factor Today	Measurement Time	0000 HHMM hex HH (hour): 0 to 17 hex (0 to 23), MM (minutes): 0 to 3B hex (0 to 59)
400D		Measurement Value	FFFF FF9C to 0000 0064 hex (-1.00 to 1.00) *Two digits to the right of the decimal point (fixed).
400E	Active Power Today	Measurement Time	0000 HHMM hex HH (hour): 0 to 17 hex (0 to 23), MM (minutes): 0 to 3B hex (0 to 59)
400F		Measurement Value (W)	C465 3601 to 3B9A C9FF hex (-99,999,999.9 to 99,999,999.9) *One digit to the right of the decimal point (fixed).
4010	Active Power Today	Measurement Time	0000 HHMM hex HH (hour): 0 to 17 hex (0 to 23), MM (minutes): 0 to 3B hex (0 to 59)
4011		Measurement Value (kW)	C465 3601 to 3B9A C9FF hex (-9,999,999.99 to 9,999,999.99) *Two digits to the right of the decimal point (fixed).
4012	Reactive Power Today	Measurement Time	0000 HHMM hex HH (hour): 0 to 17 hex (0 to 23), MM (minutes): 0 to 3B hex (0 to 59)
4013		Measurement Value (var)	C465 3601 to 3B9A C9FF hex (-99,999,999.9 to 99,999,999.9) *One digit to the right of the decimal point (fixed).
4014	Reactive Power Today	Measurement Time	0000 HHMM hex HH (hour): 0 to 17 hex (0 to 23), MM (minutes): 0 to 3B hex (0 to 59)
4015		Measurement Value (kvar)	C465 3601 to 3B9A C9FF hex (-9,999,999.99 to 9,999,999.99) *Two digits to the right of the decimal point (fixed).

Address	Parameter name		Set value (monitor value)
4100	Voltage 1 One Day Ago	Measurement Time	0000 HHMM hex HH (hour): 0 to 17 hex (0 to 23), MM (minutes): 0 to 3B hex (0 to 59)
4101		Measurement Value (V)	0000 0000 to 000F 423F hex (0.0 to 99,999.9) *One digit to the right of the decimal point (fixed).
4102	Voltage 2 One Day Ago	Measurement Time	0000 HHMM hex HH (hour): 0 to 17 hex (0 to 23), MM (minutes): 0 to 3B hex (0 to 59)
4103		Measurement Value (V)	0000 0000 to 000F 423F hex (0.0 to 99,999.9) *One digit to the right of the decimal point (fixed).
4104	Voltage 3 One Day Ago	Measurement Time	0000 HHMM hex HH (hour): 0 to 17 hex (0 to 23), MM (minutes): 0 to 3B hex (0 to 59)
4105		Measurement Value (V)	0000 0000 to 000F 423F hex (0.0 to 99,999.9) *One digit to the right of the decimal point (fixed).
4106	Current 1 One Day Ago	Measurement Time	0000 HHMM hex HH (hour): 0 to 17 hex (0 to 23), MM (minutes): 0 to 3B hex (0 to 59)
4107		Measurement Value (A)	0000 0000 to 0098 967F hex (0.000 to 99,999.999) *Three digits to the right of the decimal point (fixed).
4108	Current 2 One Day Ago	Measurement Time	0000 HHMM hexH" HH (hour): 0 to 17 hex (0 to 23), MM (minutes): 0 to 3B hex (0 to 59)
4109		Measurement Value (A)	0000 0000 to 0098 967F hex (0.000 to 99,999.999) *Three digits to the right of the decimal point (fixed).
410A	Current 3 One Day Ago	Measurement Time	0000 HHMM hex HH (hour): 0 to 17 hex (0 to 23), MM (minutes): 0 to 3B hex (0 to 59)
410B		Measurement Value (A)	0000 0000 to 0098 967F hex (0.000 to 99,999.999) *Three digits to the right of the decimal point (fixed).
410C	Power Factor One Day Ago	Measurement Time	0000 HHMM hex HH (hour): 0 to 17 hex (0 to 23), MM (minutes): 0 to 3B hex (0 to 59)
410D		Measurement Value	FFFF FF9C to 0000 0064 hex (-1.00 to 1.00) *Two digits to the right of the decimal point (fixed).
410E	Active Power One Day Ago	Measurement Time	0000 HHMM hex HH (hour): 0 to 17 hex (0 to 23), MM (minutes): 0 to 3B hex (0 to 59)
410F		Measurement Value (W)	C465 3601 to 3B9A C9FF hex (-99,999,999.9 to 99,999,999.9) *One digit to the right of the decimal point (fixed).
4110	Active Power One Day Ago	Measurement Time	0000 HHMM hex HH (hour): 0 to 17 hex (0 to 23), MM (minutes): 0 to 3B hex (0 to 59)
4111		Measurement Value (kW)	C465 3601 to 3B9A C9FF hex (-9,999,999.99 to 9,999,999.99) *Two digits to the right of the decimal point (fixed).
...
4700	Voltage 1 Seven Days Ago	Measurement Time	0000 HHMM hex HH (hour): 0 to 17 hex (0 to 23), MM (minutes): 0 to 3B hex (0 to 59)
4701		Measurement Value (V)	0000 0000 to 000F 423F hex (0.0 to 99,999.9) *One digit to the right of the decimal point (fixed).
4702	Voltage 2 Seven Days Ago	Measurement Time	0000 HHMM hex HH (hour): 0 to 17 hex (0 to 23), MM (minutes): 0 to 3B hex (0 to 59)
4703		Measurement Value (V)	0000 0000 to 000F 423F hex (0.0 to 99,999.9) *One digit to the right of the decimal point (fixed).
4704	Voltage 3 Seven Days Ago	Measurement Time	0000 HHMM hex HH (hour): 0 to 17 hex (0 to 23), MM (minutes): 0 to 3B hex (0 to 59)
4705		Measurement Value (V)	0000 0000 to 000F 423F hex (0.0 to 99,999.9) *One digit to the right of the decimal point (fixed).
4706	Current 1 Seven Days Ago	Measurement Time	0000 HHMM hex HH (hour): 0 to 17 hex (0 to 23), MM (minutes): 0 to 3B hex (0 to 59)
4707		Measurement Value (A)	0000 0000 to 0098 967F hex (0.000 to 99,999.999) *Three digits to the right of the decimal point (fixed).
4708	Current 2 Seven Days Ago	Measurement Time	0000 HHMM hex HH (hour): 0 to 17 hex (0 to 23), MM (minutes): 0 to 3B hex (0 to 59)
4709		Measurement Value (A)	0000 0000 to 0098 967F hex (0.000 to 99,999.999) *Three digits to the right of the decimal point (fixed).
470A	Current 3 Seven Days Ago	Measurement Time	0000 HHMM hex HH (hour): 0 to 17 hex (0 to 23), MM (minutes): 0 to 3B hex (0 to 59)
470B		Measurement Value (A)	0000 0000 to 0098 967F hex (0.000 to 99,999.999) *Three digits to the right of the decimal point (fixed).
470C	Power Factor Seven Days Ago	Measurement Time	0000 HHMM hex HH (hour): 0 to 17 hex (0 to 23), MM (minutes): 0 to 3B hex (0 to 59)
470D		Measurement Value	FFFF FF9C to 0000 0064 hex (-1.00 to 1.00) *Two digits to the right of the decimal point (fixed).
470E	Active Power Seven Days Ago	Measurement Time	0000 HHMM hex HH (hour): 0 to 17 hex (0 to 23), MM (minutes): 0 to 3B hex (0 to 59)
470F		Measurement Value (W)	C465 3601 to 3B9A C9FF hex (-99,999,999.9 to 99,999,999.9) *One digit to the right of the decimal point (fixed).

Address	Parameter name	Measurement	Set value (monitor value)
4710	Active Power Seven Days Ago	Measurement Time	0000 HHMM hex HH (hour): 0 to 17 hex (0 to 23), MM (minutes): 0 to 3B hex (0 to 59)
4711		Measurement Value (kW)	0000 0000 to 3B9A C9FF hex (0.00 to 9,999,999.99) *Two digits to the right of the decimal point (fixed).
4800	Voltage 1 Eight Days Ago	Measurement Time	0000 HHMM hex HH (hour): 0 to 17 hex (0 to 23), MM (minutes): 0 to 3B hex (0 to 59)
4801		Measurement Value (V)	0000 0000 to 000F 423F hex (0.0 to 99,999.9) *One digit to the right of the decimal point (fixed).
4802	Voltage 2 Eight Days Ago	Measurement Time	0000 HHMM hex HH (hour): 0 to 17 hex (0 to 23), MM (minutes): 0 to 3B hex (0 to 59)
4803		Measurement Value (V)	0000 0000 to 000F 423F hex (0.0 to 99,999.9) *One digit to the right of the decimal point (fixed).
4804	Voltage 3 Eight Days Ago	Measurement Time	0000 HHMM hex HH (hour): 0 to 17 hex (0 to 23), MM (minutes): 0 to 3B hex (0 to 59)
4805		Measurement Value (V)	0000 0000 to 000F 423F hex (0.0 to 99,999.9) *One digit to the right of the decimal point (fixed).
4806	Current 1 Eight Days Ago	Measurement Time	0000 HHMM hex HH (hour): 0 to 17 hex (0 to 23), MM (minutes): 0 to 3B hex (0 to 59)
4807		Measurement Value (A)	0000 0000 to 0098 967F hex (0.000 to 99,999.999) *Three digits to the right of the decimal point (fixed).
4808	Current 2 Eight Days Ago	Measurement Time	0000 HHMM hex HH (hour): 0 to 17 hex (0 to 23), MM (minutes): 0 to 3B hex (0 to 59)
4809		Measurement Value (A)	0000 0000 to 0098 967F hex (0.000 to 99,999.999) *Three digits to the right of the decimal point (fixed).
480A	Current 3 Eight Days Ago	Measurement Time	0000 HHMM hex HH (hour): 0 to 17 hex (0 to 23), MM (minutes): 0 to 3B hex (0 to 59)
480B		Measurement Value (A)	0000 0000 to 0098 967F hex (0.000 to 99,999.999) *Three digits to the right of the decimal point (fixed).
480C	Power Factor Eight Days Ago	Measurement Time	0000 HHMM hex HH (hour): 0 to 17 hex (0 to 23), MM (minutes): 0 to 3B hex (0 to 59)
480D		Measurement Value	FFFF FF9C to 0000 0064 hex (-1.00 to 1.00) *Two digits to the right of the decimal point (fixed).
480E	Active Power Eight Days Ago	Measurement Time	0000 HHMM hex HH (hour): 0 to 17 hex (0 to 23), MM (minutes): 0 to 3B hex (0 to 59)
480F		Measurement Value (W)	C465 3601 to 3B9A C9FF hex (-99,999,999.9 to 99,999,999.9) *One digit to the right of the decimal point (fixed).
4810	Active Power Eight Days Ago	Measurement Time	0000 HHMM hex HH (hour): 0 to 17 hex (0 to 23), MM (minutes): 0 to 3B hex (0 to 59)
4811		Measurement Value (kW)	C465 3601 to 3B9A C9FF hex (-9,999,999.99 to 9,999,999.99) *Two digits to the right of the decimal point (fixed).

● Addresses 5000 to 523F hex: HIGH Total Power Consumption Every Five-minute Period (0.001-kWh increments) **KM50-E Only**

The HIGH total power consumption for every five-minute period can be read.

The HIGH total power consumption for every five-minute period can be read for only two days, the present day and the previous day.

Specify the address for the time period to read in the service request PDU.

Example for Address 5001: The HIGH total power consumption from 00:05 to 00:10 will be read. (The HIGH total power consumption for the specified five-minute period will be read.)

The HIGH total power consumption for every five-minute period for the present day cannot be read for times that are in the future compared to the present time in the KM50 internal clock. If the HIGH total power consumption is read for future times, the service response PDU will be returned with a measurement value of 0.

Make sure that the number of addresses that can be read out is not exceeded and all of the values are for the same day when reading out more than one element at the same time.

The addresses are listed in the following table.

(Addresses are incremented by one for each five minutes, so some addresses have been omitted.)

Address	Parameter name	Set value (monitor value)
5000	HIGH Total Power Consumption for 00:00 to 00:05 Today (kWh)	0000 0000 to 0098 967F hex (0.000 to 9,999.999) *Three digits to the right of the decimal point (fixed).
5001	HIGH Total Power Consumption for 00:05 to 00:10 Today (kWh)	Same as above.
5002	HIGH Total Power Consumption for 00:10 to 00:15 Today (kWh)	Same as above.
...
(Omitted)		
...
511E	HIGH Total Power Consumption for 23:50 to 23:55 Today (kWh)	Same as above.
511F	HIGH Total Power Consumption for 23:55 to 24:00 Today (kWh)	Same as above.
5120	HIGH Total Power Consumption for 00:00 to 00:05 Yesterday (kWh)	Same as above.
5121	HIGH Total Power Consumption for 00:05 to 00:10 Yesterday (kWh)	Same as above.
5122	HIGH Total Power Consumption for 00:10 to 00:15 Yesterday (kWh)	Same as above.
...
(Omitted)		
...
523E	HIGH Total Power Consumption for 23:50 to 23:55 Yesterday (kWh)	Same as above.
523F	HIGH Total Power Consumption for 23:55 to 24:00 Yesterday (kWh)	Same as above.

● Addresses 5300 to 553F hex: MIDDLE Total Power Consumption Every Five-minute Period (0.001-kWh increments) **KM50-E Only**

The MIDDLE total power consumption for every five-minute period can be read.

The MIDDLE total power consumption for every five-minute period can be read for only two days, the present day and the previous day.

Specify the address for the time period to read in the service request PDU.

Example for Address 6001: The MIDDLE total power consumption from 00:05 to 00:10 will be read. (The MIDDLE total power consumption for the specified five-minute period will be read.)

The MIDDLE total power consumption for every five-minute period for the present day cannot be read for times that are in the future compared to the present time in the KM50 internal clock. If the MIDDLE total power consumption is read for future times, the service response PDU will be returned with a measurement value of 0.

Make sure that the number of addresses that can be read out is not exceeded and all of the values are for the same day when reading out more than one element at the same time.

The addresses are listed in the following table.

(Addresses are incremented by one for each five minutes, so some addresses have been omitted.)

Address	Parameter name	Set value (monitor value)
5300	MIDDLE Total Power Consumption for 00:00 to 00:05 Today (kWh)	0000 0000 to 0098 967F hex (0.000 to 9,999.999) *Three digits to the right of the decimal point (fixed).
5301	MIDDLE Total Power Consumption for 00:05 to 00:10 Today (kWh)	Same as above.
5302	MIDDLE Total Power Consumption for 00:10 to 00:15 Today (kWh)	Same as above.
...
(Omitted)		
...
541E	MIDDLE Total Power Consumption for 23:50 to 23:55 Today (kWh)	Same as above.
541F	MIDDLE Total Power Consumption for 23:55 to 24:00 Today (kWh)	Same as above.
5420	MIDDLE Total Power Consumption for 00:00 to 00:05 Yesterday (kWh)	Same as above.
5421	MIDDLE Total Power Consumption for 00:05 to 00:10 Yesterday (kWh)	Same as above.
5422	MIDDLE Total Power Consumption for 00:10 to 00:15 Yesterday (kWh)	Same as above.
...
(Omitted)		
...
553E	MIDDLE Total Power Consumption for 23:50 to 23:55 Yesterday (kWh)	Same as above.
553F	MIDDLE Total Power Consumption for 23:55 to 24:00 Yesterday (kWh)	Same as above.

● Addresses 5600 to 583F hex: LOW Total Power Consumption Every Five-minute Period (0.001-kWh increments) **KM50-E Only**

The LOW total power consumption for every five-minute period can be read.

The LOW total power consumption for every five-minute period can be read for only two days, the present day and the previous day.

Specify the address for the time period to read in the service request PDU.

Example for Address 5601: The LOW total power consumption from 00:05 to 00:10 will be read. (The LOW total power consumption for the specified five-minute period will be read.)

The LOW total power consumption for every five-minute period for the present day cannot be read for times that are in the future compared to the present time in the KM50 internal clock. If the LOW total power consumption is read for future times, the service response PDU will be returned with a measurement value of 0.

Make sure that the number of addresses that can be read out is not exceeded and all of the values are for the same day when reading out more than one element at the same time.

The addresses are listed in the following table.

(Addresses are incremented by one for each five minutes, so some addresses have been omitted.)

Address	Parameter name	Set value (monitor value)
5600	LOW Total Power Consumption for 00:00 to 00:05 Today (kWh)	0000 0000 to 0098 967F hex (0.000 to 9,999.999) *Three digits to the right of the decimal point (fixed).
5601	LOW Total Power Consumption for 00:05 to 00:10 Today (kWh)	Same as above.
5602	LOW Total Power Consumption for 00:10 to 00:15 Today (kWh)	Same as above.
...
(Omitted)		
...
571E	LOW Total Power Consumption for 23:50 to 23:55 Today (kWh)	Same as above.
571F	LOW Total Power Consumption for 23:50 to 24:00 Today (kWh)	Same as above.
5720	LOW Total Power Consumption for 00:00 to 00:05 Yesterday (kWh)	Same as above.
5721	LOW Total Power Consumption for 00:05 to 00:10 Yesterday (kWh)	Same as above.
5722	LOW Total Power Consumption for 00:10 to 00:15 Yesterday (kWh)	Same as above.
...
(Omitted)		
...
583E	LOW Total Power Consumption for 23:50 to 23:55 Yesterday (kWh)	Same as above.
583F	LOW Total Power Consumption for 23:55 to 24:00 Yesterday (kWh)	Same as above.

● **Addresses 6000 to 6008 hex: HIGH Total Power Consumption Every Day (0.001-kWh increments) KM50-E Only**

The HIGH total power consumption for every day can be read.

The HIGH total power consumption for every day can be read for the present day and the last eight days. Specify the address for the day to read in the service request PDU.

If the read value exceeds 99,999.999 kWh, the precision of the lowest digit will be lost, so FFFF FFFF will be returned as the measurement value in the service response PDU.

Address	Parameter name	Set value (monitor value)
6000	Present HIGH Total Power Consumption for Today (kWh)	0000 0000 to 05F5 E0FF hex (0.000 to 99,999.999) *Three digits to the right of the decimal point (fixed).
6001	HIGH Total Power Consumption for 00:00 to 24:00 One Day Ago (kWh)	Same as above.
6002	HIGH Total Power Consumption for 00:00 to 24:00 Two Days Ago (kWh)	Same as above.
6003	HIGH Total Power Consumption for 00:00 to 24:00 Three Days Ago (kWh)	Same as above.
6004	HIGH Total Power Consumption for 00:00 to 24:00 Four Days Ago (kWh)	Same as above.
6005	HIGH Total Power Consumption for 00:00 to 24:00 Five Days Ago (kWh)	Same as above.
6006	HIGH Total Power Consumption for 00:00 to 24:00 Six Days Ago (kWh)	Same as above.
6007	HIGH Total Power Consumption for 00:00 to 24:00 Seven Days Ago (kWh)	Same as above.
6008	HIGH Total Power Consumption for 00:00 to 24:00 Eight Days Ago (kWh)	Same as above.

● **Addresses 6100 to 6108 hex: HIGH Total Power Consumption Ratio Every Day KM50-E Only**

The HIGH total power consumption ratio for every day can be read.

The HIGH total power consumption ratio for every day can be read for the present day and the last eight days.

Specify the address for the day to read in the service request PDU.

Address	Parameter name	Set value (monitor value)
6100	Present HIGH Total Power Consumption Ratio for Today	0000 0000 to 0000 03E8 hex (0.000 to 1.000) *Three digits to the right of the decimal point (fixed).
6101	HIGH Total Power Consumption Ratio for 00:00 to 24:00 One Day Ago	Same as above.
6102	HIGH Total Power Consumption Ratio for 00:00 to 24:00 Two Days Ago	Same as above.
6103	HIGH Total Power Consumption Ratio for 00:00 to 24:00 Three Days Ago	Same as above.
6104	HIGH Total Power Consumption Ratio for 00:00 to 24:00 Four Days Ago	Same as above.
6105	HIGH Total Power Consumption Ratio for 00:00 to 24:00 Five Days Ago	Same as above.
6106	HIGH Total Power Consumption Ratio for 00:00 to 24:00 Six Days Ago	Same as above.
6107	HIGH Total Power Consumption Ratio for 00:00 to 24:00 Seven Days Ago	Same as above.
6108	HIGH Total Power Consumption Ratio for 00:00 to 24:00 Eight Days Ago	Same as above.

● Addresses 6200 to 6208 hex: HIGH Total Time Every Day **KM50-E Only**

The HIGH total time for every day can be read.

The HIGH total time for every day can be read for the present day and the last eight days.

Specify the address for the day to read in the service request PDU.

Address	Parameter name	Set value (monitor value)
6200	Present HIGH Total Time for Today	0000 HHMM hex HH (hour): 0 to 18 hex (0 to 24) MM (minutes): 0 to 3B hex (0 to 59)
6201	HIGH Total Time One Day Ago	Same as above.
6202	HIGH Total Time Two Days Ago	Same as above.
6203	HIGH Total Time Three Days Ago	Same as above.
6204	HIGH Total Time Four Days Ago	Same as above.
6205	HIGH Total Time Five Days Ago	Same as above.
6206	HIGH Total Time Six Days Ago	Same as above.
6207	HIGH Total Time Seven Days Ago	Same as above.
6208	HIGH Total Time Eight Days Ago	Same as above.

● Addresses 6300 to 6308 hex: HIGH Total Time Ratio Every Day **KM50-E Only**

The HIGH total time ratio for every day can be read.

The HIGH total time ratio for every day can be read for the present day and the last eight days.

Specify the address for the day to read in the service request PDU.

Address	Parameter name	Set value (monitor value)
6300	Present HIGH Total Time Ratio for Today	0000 0000 to 0000 03E8 hex (0.000 to 1.000) *Three digits to the right of the decimal point (fixed).
6301	HIGH Total Time Ratio for One Day Ago	Same as above.
6302	HIGH Total Time Ratio for Two Days Ago	Same as above.
6303	HIGH Total Time Ratio for Three Days Ago	Same as above.
6304	HIGH Total Time Ratio for Four Days Ago	Same as above.
6305	HIGH Total Time Ratio for Five Days Ago	Same as above.
6306	HIGH Total Time Ratio for Six Days Ago	Same as above.
6307	HIGH Total Time Ratio for Seven Days Ago	Same as above.
6308	HIGH Total Time Ratio for Eight Days Ago	Same as above.

● Addresses 6400 to 6408 hex: MIDDLE Total Power Consumption Every Day (0.001-kWh increments) **KM50-E Only**

The MIDDLE total power consumption for every day can be read.

The MIDDLE total power consumption for every day can be read for the present day and the last eight days.

Specify the address for the day to read in the service request PDU.

If the read value exceeds 99,999.999 kWh, the precision of the lowest digit will be lost, so FFFF FFFF will be returned as the measurement value in the service response PDU.

Address	Parameter name	Set value (monitor value)
6400	Present MIDDLE Total Power Consumption for Today (kWh)	0000 0000 to 05F5 E0FF hex (0.000 to 99,999.999) *Three digits to the right of the decimal point (fixed).
6401	MIDDLE Total Power Consumption for One Day Ago (kWh)	Same as above.
6402	MIDDLE Total Power Consumption for Two Days Ago (kWh)	Same as above.
6403	MIDDLE Total Power Consumption for Three Days Ago (kWh)	Same as above.
6404	MIDDLE Total Power Consumption for Four Days Ago (kWh)	Same as above.
6405	MIDDLE Total Power Consumption for Five Days Ago (kWh)	Same as above.
6406	MIDDLE Total Power Consumption for Six Days Ago (kWh)	Same as above.
6407	MIDDLE Total Power Consumption for Seven Days Ago (kWh)	Same as above.
6408	MIDDLE Total Power Consumption for Eight Days Ago (kWh)	Same as above.

● Addresses 6500 to 6508 hex: MIDDLE Total Power Consumption Ratio Every Day **KM50-E Only**

The MIDDLE total power consumption ratio for every day can be read.

The MIDDLE total power consumption ratio for every day can be read for the present day and the last eight days.

Specify the address for the day to read in the service request PDU.

Address	Parameter name	Set value (monitor value)
6500	Present MIDDLE Total Power Consumption Ratio for Today (%)	0000 0000 to 0000 03E8 hex (0.000 to 1.000) *Three digits to the right of the decimal point (fixed).
6501	MIDDLE Total Power Consumption Ratio for 00:00 to 24:00 One Day Ago (%)	Same as above.
6502	MIDDLE Total Power Consumption Ratio for 00:00 to 24:00 Two Days Ago (%)	Same as above.
6503	MIDDLE Total Power Consumption Ratio for 00:00 to 24:00 Three Days Ago (%)	Same as above.
6504	MIDDLE Total Power Consumption Ratio for 00:00 to 24:00 Four Days Ago (%)	Same as above.
6505	MIDDLE Total Power Consumption Ratio for 00:00 to 24:00 Five Days Ago (%)	Same as above.
6506	MIDDLE Total Power Consumption Ratio for 00:00 to 24:00 Six Days Ago (%)	Same as above.
6507	MIDDLE Total Power Consumption Ratio for 00:00 to 24:00 Seven Days Ago (%)	Same as above.
6508	MIDDLE Total Power Consumption Ratio for 00:00 to 24:00 Eight Days Ago (%)	Same as above.

● Addresses 6600 to 6608 hex: MIDDLE Total Time Every Day **KM50-E Only**

The MIDDLE total time for every day can be read.

The MIDDLE total time for every day can be read for the present day and the last eight days.

Specify the address for the day to read in the service request PDU.

Address	Parameter name	Set value (monitor value)
6600	Present MIDDLE Total Time for Today	0000 HHMM hex HH (hour): 0 to 18 hex (0 to 24) MM (minutes): 0 to 3B hex (0 to 59)
6601	MIDDLE Total Time for One Day Ago	Same as above.
6602	MIDDLE Total Time for Two Days Ago	Same as above.
6603	MIDDLE Total Time for Three Days Ago	Same as above.
6604	MIDDLE Total Time for Four Days Ago	Same as above.
6605	MIDDLE Total Time for Five Days Ago	Same as above.
6606	MIDDLE Total Time for Six Days Ago	Same as above.
6607	MIDDLE Total Time for Seven Days Ago	Same as above.
6608	MIDDLE Total Time for Eight Days Ago	Same as above.

● Addresses 6700 to 6708 hex: MIDDLE Total Time Ratio Every Day **KM50-E Only**

The MIDDLE total time ratio for every day can be read.

The MIDDLE total time ratio for every day can be read for the present day and the last eight days.

Specify the address for the day to read in the service request PDU.

Address	Parameter name	Set value (monitor value)
6700	Present MIDDLE Total Time Ratio for Today (%)	0000 0000 to 0000 03E8 hex (0.000 to 1.000) *Three digits to the right of the decimal point (fixed).
6701	MIDDLE Total Time Ratio for One Day Ago (%)	Same as above.
6702	MIDDLE Total Time Ratio for Two Days Ago (%)	Same as above.
6703	MIDDLE Total Time Ratio for Three Days Ago (%)	Same as above.
6704	MIDDLE Total Time Ratio for Four Days Ago (%)	Same as above.
6705	MIDDLE Total Time Ratio for Five Days Ago (%)	Same as above.
6706	MIDDLE Total Time Ratio for Six Days Ago (%)	Same as above.
6707	MIDDLE Total Time Ratio for Seven Days Ago (%)	Same as above.
6708	MIDDLE Total Time Ratio for Eight Days Ago (%)	Same as above.

● **Addresses 6800 to 6808 hex: LOW Total Power Consumption Every Day (0.001-kWh increments) KM50-E Only**

The LOW total power consumption for every day can be read.

The LOW total power consumption for every day can be read for the present day and the last eight days.

Specify the address for the day to read in the service request PDU.

If the read value exceeds 99,999.999 kWh, the precision of the lowest digit will be lost, so FFFF FFFF will be returned as the measurement value in the service response PDU.

Address	Parameter name	Set value (monitor value)
6800	Present LOW Total Power Consumption for Today (kWh)	0000 0000 to 05F5 E0FF hex (0.000 to 99,999.999) *Three digits to the right of the decimal point (fixed).
6801	LOW Total Power Consumption for 00:00 to 24:00 One Day Ago (kWh)	Same as above.
6802	LOW Total Power Consumption for 00:00 to 24:00 Two Days Ago (kWh)	Same as above.
6803	LOW Total Power Consumption for 00:00 to 24:00 Three Days Ago (kWh)	Same as above.
6804	LOW Total Power Consumption for 00:00 to 24:00 Four Days Ago (kWh)	Same as above.
6805	LOW Total Power Consumption for 00:00 to 24:00 Five Days Ago (kWh)	Same as above.
6806	LOW Total Power Consumption for 00:00 to 24:00 Six Days Ago (kWh)	Same as above.
6807	LOW Total Power Consumption for 00:00 to 24:00 Seven Days Ago (kWh)	Same as above.
6808	LOW Total Power Consumption for 00:00 to 24:00 Eight Days Ago (kWh)	Same as above.

● **Addresses 6900 to 6908 hex: LOW Total Power Consumption Ratio Every Day KM50-E Only**

The LOW total power consumption ratio for every day can be read.

The LOW total power consumption ratio for every day can be read for the present day and the last eight days.

Specify the address for the day to read in the service request PDU.

Address	Parameter name	Set value (monitor value)
6900	Present LOW Total Power Consumption Ratio for Today (%)	0000 0000 to 0000 03E8 hex (0.000 to 1.000) *Three digits to the right of the decimal point (fixed).
6901	LOW Total Power Consumption Ratio for 00:00 to 24:00 One Day Ago (%)	Same as above.
6902	LOW Total Power Consumption Ratio for 00:00 to 24:00 Two Days Ago (%)	Same as above.
6903	LOW Total Power Consumption Ratio for 00:00 to 24:00 Three Days Ago (%)	Same as above.
6904	LOW Total Power Consumption Ratio for 00:00 to 24:00 Four Days Ago (%)	Same as above.
6905	LOW Total Power Consumption Ratio for 00:00 to 24:00 Five Days Ago (%)	Same as above.
6906	LOW Total Power Consumption Ratio for 00:00 to 24:00 Six Days Ago (%)	Same as above.
6907	LOW Total Power Consumption Ratio for 00:00 to 24:00 Seven Days Ago (%)	Same as above.
6908	LOW Total Power Consumption Ratio for 00:00 to 24:00 Eight Days Ago (%)	Same as above.

● Addresses 6A00 to 6A08 hex: LOW Total Time Every Day **KM50-E Only**

The LOW total time for every day can be read.

The LOW total time for every day can be read for the present day and the last eight days.

Specify the address for the day to read in the service request PDU.

Address	Parameter name	Set value (monitor value)
6A00	Present LOW Total Time for Today	0000 HHMM hex HH (hour): 0 to 18 hex (0 to 24) MM (minutes): 0 to 3B hex (0 to 59)
6A01	LOW Total Time for One Day Ago	Same as above.
6A02	LOW Total Time for Two Days Ago	Same as above.
6A03	LOW Total Time for Three Days Ago	Same as above.
6A04	LOW Total Time for Four Days Ago	Same as above.
6A05	LOW Total Time for Five Days Ago	Same as above.
6A06	LOW Total Time for Six Days Ago	Same as above.
6A07	LOW Total Time for Seven Days Ago	Same as above.
6A08	LOW Total Time for Eight Days Ago	Same as above.

● Addresses 6B00 to 6B08 hex: LOW Total Time Ratio Every Day **KM50-E Only**

The LOW total time ratio for every day can be read.

The LOW total time ratio for every day can be read for the present day and the last eight days.

Specify the address for the day to read in the service request PDU.

Address	Parameter name	Set value (monitor value)
6B00	Present LOW Total Time Ratio for Today (%)	0000 0000 to 0000 03E8 hex (0.000 to 1.000) *Three digits to the right of the decimal point (fixed).
6B01	LOW Total Time Ratio for One Day Ago (%)	Same as above.
6B02	LOW Total Time Ratio for Two Days Ago (%)	Same as above.
6B03	LOW Total Time Ratio for Three Days Ago (%)	Same as above.
6B04	LOW Total Time Ratio for Four Days Ago (%)	Same as above.
6B05	LOW Total Time Ratio for Five Days Ago (%)	Same as above.
6B06	LOW Total Time Ratio for Six Days Ago (%)	Same as above.
6B07	LOW Total Time Ratio for Seven Days Ago (%)	Same as above.
6B08	LOW Total Time Ratio for Eight Days Ago (%)	Same as above.

● Addresses 7000 to 723F hex: Total Power Consumption Every Five-minute Period (0.001-kWh increments) **KM50-E Only**

The total power consumption for every five-minute period can be read.

The total power consumption for every five-minute period can be read for only two days, the present day and the previous day.

Specify the address for the time period to read in the service request PDU.

Example for Address 1001: The total power consumption from 00:05 to 00:10 will be read.

(The total power consumption for the specified five-minute period will be read.)

The total power consumption for every five-minute period for the present day cannot be read for times that are in the future compared to the present time in the KM50 internal clock. If the total power consumption is read for future times, the service response PDU will be returned with a measurement value of 0.

If the read value exceeds 9,999 kWh, the precision of the lowest digit will be decreased, so FFFF FFFF will be returned as the measurement value in the service response PDU. If that occurs, read the measurement value for 0.1-kWh increments.

Make sure that the number of addresses that can be read out is not exceeded and all of the values are for the same day when reading out more than one element at the same time.

The addresses are listed in the following table.

(Addresses are incremented by one for each five minutes, so some addresses have been omitted.)

Address	Parameter name	Set value (monitor value)
7000	Total Power Consumption for 00:00 to 00:05 Today (kWh)	0000 0000 to 0098 967F hex (0.000 to 9,999.999) *Three digits to the right of the decimal point (fixed).
7001	Total Power Consumption for 00:05 to 00:10 Today (kWh)	Same as above.
7002	Total Power Consumption for 00:10 to 00:15 Today (kWh)	Same as above.
...
(Omitted)		
...
711E	Total Power Consumption for 23:50 to 23:55 Today (kWh)	Same as above.
711F	Total Power Consumption for 23:55 to 24:00 Today (kWh)	Same as above.
7120	Total Power Consumption for 00:00 to 00:05 Yesterday (kWh)	Same as above.
7121	Total Power Consumption for 00:05 to 00:10 Yesterday (kWh)	Same as above.
7122	Total Power Consumption for 00:10 to 00:15 Yesterday (kWh)	Same as above.
...
(Omitted)		
...
723E	Total Power Consumption for 23:50 to 23:55 Yesterday (kWh)	Same as above.
723F	Total Power Consumption for 23:55 to 24:00 Yesterday (kWh)	Same as above.

● Addresses 7400 to 723F 763F: Total Power Consumption Every Five Minutes (0.001-kWh Increments)

The total power consumption every five minutes can be read.

The total power consumption every five minutes can be read for only two days, the present day and the previous day.

Specify the address for the time period to read in the service request PDU.

Example for Address 1401: The total power consumption at 00:10 will be read.

(The total power consumption for the specified time will be read.)

The total power consumption every five minutes for the present day cannot be read for times that are in the future compared to the present time in the KM50 internal clock. If the total power consumption is read for future times, the service response PDU will be returned with a measurement value of 0.

If the read value exceeds 9,999 kWh, the precision of the lowest digit will be decreased, so FFFF FFFF will be returned as the measurement value in the service response PDU. If that occurs, read the measurement value for 0.1-kWh increments.

Make sure that the number of addresses that can be read out is not exceeded and all of the values are for the same day when reading out more than one element at the same time.

The addresses are listed in the following table.

(Addresses are incremented by one for each five minutes, so some addresses have been omitted.)

Address	Parameter name	Set value (monitor value)
7400	Total Power Consumption at 00:05 Today (kWh)	0000 0000 to 0098 967F hex (0.000 to 9,999.999) *Three digits to the right of the decimal point (fixed).
7401	Total Power Consumption at 00:10 Today (kWh)	Same as above.
7402	Total Power Consumption at 00:15 Today (kWh)	Same as above.
...
(Omitted)		
...
751E	Total Power Consumption at 23:55 Today (kWh)	Same as above.
751F	Total Power Consumption at 24:00 Today (kWh)	Same as above.
7520	Total Power Consumption at 00:05 Yesterday (kWh)	Same as above.
7521	Total Power Consumption at 00:10 Yesterday (kWh)	Same as above.
7522	Total Power Consumption at 00:15 Yesterday (kWh)	Same as above.
...
(Omitted)		
...
763E	Total Power Consumption at 23:55 Yesterday (kWh)	Same as above.
763F	Total Power Consumption at 24:00 Yesterday (kWh)	Same as above.

● Addresses 7800 to 7A3F hex: Total Power Consumption for Every Five-minute Period (0.001-kWh Increments)

The total power consumption can be read for every five-minute period for any of four total power consumptions.

The total power consumption for every five-minute period can be read for only two days, the present day and the previous day.

Specify the address for the time to read in the service request PDU.

Example for Address 1001: The total power consumption from 00:05 to 00:10 will be read.
(The total power consumption for the specified five-minute period will be read.)

The total power consumption for every five-minute period for the present day cannot be read for times that are in the future compared to the present time in the KM50 internal clock. If a value is read for a future time, the service response PDU will be returned with a measurement value of 0. If the read value exceeds 9,999 kWh, the precision of the lowest digit will be lost, so FFFF FFFF will be returned as the measurement value in the service response PDU. If that occurs, read the measurement value for 0.1-kWh increments.

Make sure that the number of addresses that can be read out is not exceeded and all of the values are for the same day when reading out more than one element at the same time.

The addresses are listed in the following table.

(Addresses are incremented by one for each five minutes. Some addresses have been omitted in the following table.)

Address	Parameter	Set value (monitor value)
7800	Total <input type="checkbox"/> <input type="checkbox"/> Power Consumption for 00:00 to 00:05 Today (kWh)	0000 0000 to 0098 967F hex (0.000 to 9,999.999) Three digits to the right of the decimal point (fixed).
7801	Total <input type="checkbox"/> <input type="checkbox"/> Power Consumption for 00:05 to 00:10 Today (kWh)	Same as above.
7802	Total <input type="checkbox"/> <input type="checkbox"/> Power Consumption for 00:10 to 00:15 Today (kWh)	Same as above.
...
(Omitted)		
...
791E	Total <input type="checkbox"/> <input type="checkbox"/> Power Consumption for 23:50 to 23:55 Today (kWh)	Same as above.
791F	Total <input type="checkbox"/> <input type="checkbox"/> Power Consumption for 23:55 to 24:00 Today (kWh)	Same as above.
7920	Total <input type="checkbox"/> <input type="checkbox"/> Power Consumption for 00:00 to 00:05 Yesterday (kWh)	Same as above.
7921	Total <input type="checkbox"/> <input type="checkbox"/> Power Consumption for 00:05 to 00:10 Yesterday (kWh)	Same as above.
7922	Total <input type="checkbox"/> <input type="checkbox"/> Power Consumption for 00:10 to 00:15 Yesterday (kWh)	Same as above.
...
(Omitted)		
...
7A3E	Total <input type="checkbox"/> <input type="checkbox"/> Power Consumption for 23:50 to 23:55 Yesterday (kWh)	Same as above.
7A3F	Total <input type="checkbox"/> <input type="checkbox"/> Power Consumption for 23:55 to 24:00 Yesterday (kWh)	Same as above.

● Addresses 7C00 to 7E3F hex: Total Power Consumption Every Five Minutes (0.001-kWh Increments)

The total power consumption can be read every five minutes for any of four total power consumptions.

The total power consumption every five minutes can be read for only two days, the present day and the previous day.

Specify the address for the time to read in the service request PDU.

Example for Address 1401: The total power consumption for 00:10 will be read.

(The total power consumption for the specified time will be read.)

The total power consumption every five minutes for the present day cannot be read for times that are in the future compared to the present time in the KM50 internal clock. If a value is read for a future time, the service response PDU will be returned with a measurement value of 0.

If the read value exceeds 9,999 kWh, the precision of the lowest digit will be lost, so FFFF FFFF will be returned as the measurement value in the service response PDU. If that occurs, read the measurement value for 0.1-kWh increments.

Make sure that the number of addresses that can be read out is not exceeded and all of the values are for the same day when reading out more than one element at the same time.

The addresses are listed in the following table.

(Addresses are incremented by one for each five minutes. Some addresses have been omitted in the following table.)

Address	Parameter	Set value (monitor value)
7C00	Total <input type="checkbox"/> <input type="checkbox"/> Power Consumption for 00:05 Today (kWh)	0000 0000 to 0098 967F hex (0.000 to 9,999.999) Three digits to the right of the decimal point (fixed).
7C01	Total <input type="checkbox"/> <input type="checkbox"/> Power Consumption for 00:10 Today (kWh)	Same as above.
7C02	Total <input type="checkbox"/> <input type="checkbox"/> Power Consumption for 00:15 Today (kWh)	Same as above.
...
(Omitted)		
...
7D1E	Total <input type="checkbox"/> <input type="checkbox"/> Power Consumption for 23:55 Today (kWh)	Same as above.
7D1F	Total <input type="checkbox"/> <input type="checkbox"/> Power Consumption for 24:00 Today (kWh)	Same as above.
7D20	Total <input type="checkbox"/> <input type="checkbox"/> Power Consumption for 00:05 Yesterday (kWh)	Same as above.
7D21	Total <input type="checkbox"/> <input type="checkbox"/> Power Consumption for 00:10 Yesterday (kWh)	Same as above.
7D22	Total <input type="checkbox"/> <input type="checkbox"/> Power Consumption for 00:15 Yesterday (kWh)	Same as above.
...
(Omitted)		
...
7E3E	Total <input type="checkbox"/> <input type="checkbox"/> Power Consumption for 23:55 Yesterday (kWh)	Same as above.
7E3F	Total <input type="checkbox"/> <input type="checkbox"/> Power Consumption for 24:00 Yesterday (kWh)	Same as above.

● Addresses 8000 to 801D hex: Alarm History

The history of alarms that occurred in the past can be read.

Up to 10 alarms that occurred in the past can be read out. The smaller the address is, the newer the information is. If more than 10 alarms occur, the oldest alarms in the history will be deleted.

Data is not saved when power is interrupted. Only the alarms that occur while power supply is ON can be read out from the history.

The 13 types of alarms that are listed in the following table can be read out. (This includes "No alarm.")

Table: List of Alarm Types

Read out value	Alarm type
0000 0000 hex	No alarm
0000 0001 hex	Instantaneous active power upper limit alarm
0000 0002 hex	Instantaneous active power lower limit alarm
0000 0003 hex	Instantaneous regenerative power upper limit alarm
0000 0004 hex	Instantaneous regenerative power lower limit alarm
0000 0005 hex	Current upper limit alarm
0000 0006 hex	Current lower limit alarm
0000 0007 hex	Voltage upper limit alarm
0000 0008 hex	Voltage lower limit alarm
0000 0009 hex	Power factor upper limit alarm
0000 000A hex	Power factor lower limit alarm
0000 000B hex	Instantaneous active power lower limit alarm
0000 000C hex	Instantaneous reactive power lower limit alarm

Address	Parameter	Set value (monitor value)
8000	Alarm Type	Refer to <i>Table: List of Alarm Types</i> .
8001	Alarm Record 1	Date and Time of Occurrence
8002		Date and Time Cleared
8003	Alarm Record 2	Alarm Type
8004		Date and Time of Occurrence
8005		Date and Time Cleared
8006	Alarm Record 3	Alarm Type
8007		Date and Time of Occurrence
8008		Date and Time Cleared
8009	Alarm Record 4	Alarm Type
800A		Date and Time of Occurrence
800B		Date and Time Cleared
800C	Alarm Record 5	Alarm Type
800D		Date and Time of Occurrence
800E		Date and Time Cleared
800F	Alarm Record 6	Alarm Type
8010		Date and Time of Occurrence
8011		Date and Time Cleared
8012	Alarm Record 7	Alarm Type
8013		Date and Time of Occurrence
8014		Date and Time Cleared
8015	Alarm Record 8	Alarm Type
8016		Date and Time of Occurrence
8017		Date and Time Cleared

Address	Parameter	Set value (monitor value)
8018	Alarm Record 9	Alarm Type Refer to <i>Table: List of Alarm Types</i> .
8019		Date and Time of Occurrence MMDD hhmm hex*
801A		Date and Time Cleared MMDD hhmm hex*
801B	Alarm Record 10	Alarm Type Refer to <i>Table: List of Alarm Types</i> .
801C		Date and Time of Occurrence MMDD hhmm hex*
801D		Date and Time Cleared MMDD hhmm hex*

* MMDDhhyy MM: Month (00 to 0C (12) hex) DD: Date (00 to 1F (31) hex)
 hh: Hour (00 to 17 (23) hex) mm: Minute (00 to 3B (59) hex)

5.2 Status Information

The following bit information is returned.

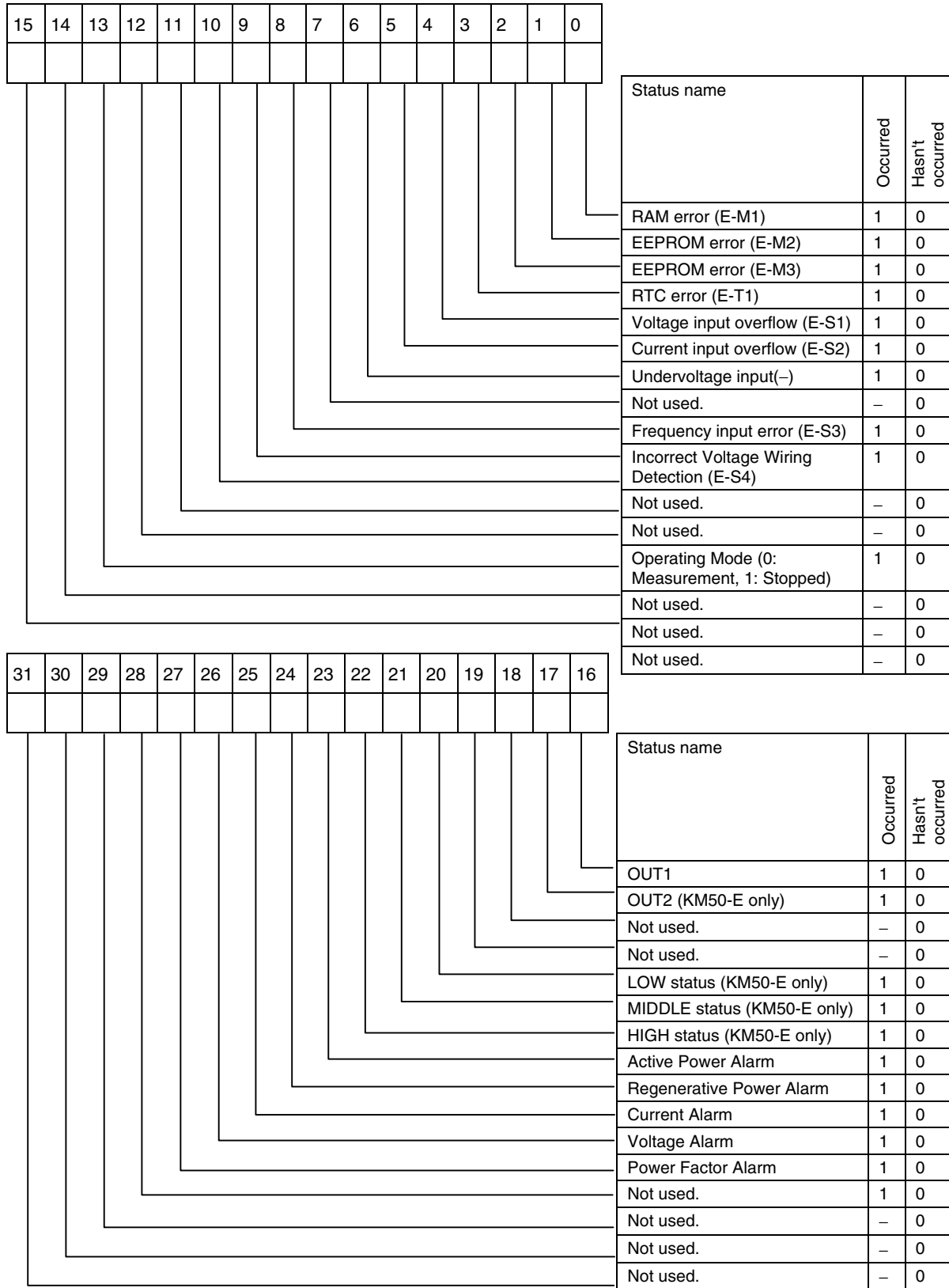

An alarm occurs (status 1 (ON)) when an alarm output (active power, regenerative power, current, voltage, power factor, or reactive power) exceeds the upper limit or lower limit threshold.

5.3 Variable Area Setting Ranges

● Variable Area Setting Ranges

- If an address that is not assigned to a variable area setting range is read, FFFF FFFF hex will be returned.
- If an address that is not assigned to a variable area setting range is written, a start address out-of-range error will be returned.

● Addresses F000 to F080

Address	Parameter name	Default setting	Set value (monitor value)
F000	Applicable Circuit	2	0000 0000 hex: Single-phase, two-wire circuit 0000 0001 hex: Single-phase, three-wire circuit 0000 0002 hex: Three-phase, three-wire circuits 0000 0003 hex: Three-phase, four-wire circuits (KM50-E only)
F001	VT Primary Voltage	none	0000 0000 hex: none 0000 0001 hex: 220 V 0000 0002 hex: 440 V 0000 0003 hex: 3,300 V 0000 0004 hex: 6,600 V 0000 0005 hex: 11,000 V 0000 0006 hex: 22,000 V 0000 0007 hex: 33,000 V
F002	Rated Primary Current	5	0000 0005 to 0000 270F hex (5 to 9,999)
F003	Low-cut Current	0.6%	0000 0000 to 0000 00C7 hex (0.1% to 19.9%) *One digit to the right of the decimal point (fixed).
F004	Pulse Output Unit	100 Wh	0000 0000 hex: 1 Wh 0000 0001 hex: 10 Wh 0000 0002 hex: 100 Wh 0000 0003 hex: 1k Wh 0000 0004 hex: 2k Wh 0000 0005 hex: 5k Wh 0000 0006 hex: 10 kWh 0000 0007 hex: 20 kWh 0000 0008 hex: 50 kWh 0000 0009 hex: 100 kWh
F005	Display Refresh Period	1 s	0000 0000 hex: OFF 0000 0001 hex: 0.5 s 0000 0002 hex: 1 s 0000 0003 hex: 2 s 0000 0004 hex: 4 s
F006	Simple Measurement	OFF	0000 0000 hex: OFF (normal measurement) 0000 0001 hex: ON (simple measurement)
F007	Fixed Voltage for Simple Measurement	110.0	0000 0001 to 0001 869F hex (0.1 to 9,999.9 V) *One digit to the right of the decimal point (fixed).
F008	Power Factor for Simple Measurement	1.00	0000 0001 to 0000 0064 hex (0.01 to 1.00) *Two digits to the right of the decimal point (fixed).
F009	Unit Number	01	0000 0000 to 0000 0063 hex (0 to 99)
F00A	Baud Rate	9.6 kbps	0000 0000 hex: 1.2 kbps 0000 0001 hex: 2.4 kbps 0000 0002 hex: 4.8 kbps 0000 0003 hex: 9.6 kbps 0000 0004 hex: 19.2 kbps 0000 0005 hex: 38.4 kbps
F00B	Data Length ¹	7 bits	0000 0000 hex: 7 bits 0000 0001 hex: 8 bits
F00C	Stop Bits ²	2 bits	0000 0000 hex: 1 bit 0000 0001 hex: 2 bits
F00D	Vertical Parity	Even	0000 0000: None 0000 0001 hex: Even 0000 0002 hex: Odd
F00E	Transmission Wait Time	20 ms	0000 0000 to 0000 0063 hex (0 to 99 ms)

Address	Parameter name	Default setting	Set value (monitor value)
F00F	Protection Setting	0	0000 0000 hex: Protection level 0 0000 0001 hex: Protection level 1 0000 0002 hex: Protection level 2
F010	Special CT Type	2	0000 0000 hex: KM20-CTF-5A (5 A) 0000 0001 hex: KM20-CTF-50A (50 A) 0000 0002 hex: KM20-CTF-100A (100 A) 0000 0003 hex: KM20-CTF-200A (200 A) 0000 0004 hex: KM20-CTF-400A (400 A) 0000 0005 hex: KM20-CTF-600A (600 A)
F011	CO ₂ Coefficient	0.387	0000 0000 to 0001 869F hex (0.000 to 99.999 kg-CO ₂ /kWh) *Three digits to the right of the decimal point (fixed).
F012	Protocol Selection	CompoWay/F	0000 0000 hex: CompoWay/F 0000 0001 hex: Modbus
F013	Average Count	OFF	0000 0000 hex: OFF 0000 0001 hex: 2 times 0000 0002 hex: 4 times 0000 0003 hex: 8 times 0000 0004 hex: 16 times 0000 0005 hex: 32 times 0000 0006 hex: 64 times 0000 0007 hex: 128 times 0000 0008 hex: 256 times 0000 0009 hex: 512 times 0000 000A hex: 1,024 times
F014	Event Input Setting ⁸	P.CSP	0000 0000 hex: P.CSP (pulse input count) 0000 0001 hex: H-ON (pulse input ON time measurement) 0000 0002 hex: 3-ST (Three-state Classification) (KM50-E only)
F015	Event Input 1 NPN/PNP Input Mode Setting	PNP	0000 0000 hex: PNP 0000 0001 hex: NPN
F016	Event Input 2 NPN/PNP Input Mode Setting	PNP	0000 0000 hex: PNP 0000 0001 hex: NPN
F017	Event Input 1 Input Mode Setting	N-O	0000 0000 hex: N-O (normally open) 0000 0001 hex: N-C (normally closed)
F018	Event Input 2 Input Mode Setting	N-O	0000 0000 hex: N-O (normally open) 0000 0001 hex: N-C (normally closed)
F019	Measurement Start Time	00:00	0000 0000 to 0000 HHMM hex (00:00 to 23:59) HH (hour): 00 to 17 hex (0 to 23) MM (minutes): 00 to 3B hex (00 to 59)
F01A	Measurement End Time	24:00	0000 HHMM to 0000 HHMM hex (00:00 to 24:00) HH (hour): 00 to 18 hex (0 to 24) MM (minutes): 00 to 3B hex (00 to 59)
F01B ⁴	Buzzer	ON	0000 0000 hex: OFF 0000 0001 hex: ON
F01C ⁴	Three-state Target ⁸	NONE	0000 0000 hex: Power 0000 0001 hex: Current 0000 0002 hex: Voltage 0000 0003 hex: NONE
F01D ⁴	Three-state HIGH Threshold ⁵	50.0%	0000 0001 to 0000 05DC hex (0.1% to 150.0%) *One digit to the right of the decimal point (fixed).
F01E ⁴	Three-state LOW Threshold ⁵	10.0%	0000 0000 to 0000 05DB hex (0.0% to 149.9%) *One digit to the right of the decimal point (fixed).
F01F ⁴	Three-state Hysteresis	0.0%	0000 0000 to 0000 00C7 hex (0.0% to 19.9%) *One digit to the right of the decimal point (fixed).
F020 ⁶	Active Power Alarm Setting	ON	0000 0000 hex: OFF 0000 0001 hex: ON
F021 ⁷	Active Power Alarm Upper Limit Threshold	80.0%	0000 0000 to 0000 05DC hex (0.0% to 150.0%) *One digit to the right of the decimal point (fixed).
F022	Active Power Alarm Hysteresis	5.0%	0000 0000 to 0000 00C7 hex (0.0% to 19.9%) *One digit to the right of the decimal point (fixed).
F023	Active Power Alarm OFF Delay	3.0 s	0000 0000 to 0000 03E7 hex (0.0 to 99.9 s) *One digit to the right of the decimal point (fixed).
F024	Total Power Consumption Selection	Regeneration	0000 0000 hex: Regenerated Energy 0000 0001 hex: Total Leading Reactive Power Consumption 0000 0002 hex: Total Lagging Reactive Power Consumption 0000 0003 hex: Total Reactive Power Consumption

Address	Parameter name	Default setting	Set value (monitor value)
F026	Active Power Alarm ON Delay	0.0 s	0000 0000 to 0000 03E7 hex (0.0 to 99.9 s) *One digit to the right of the decimal point (fixed).
F027 ⁷	Active Power Alarm Lower Limit Threshold	0.0%	0000 0000 to 0000 05DC hex (0.0% to 150.0%) *One digit to the right of the decimal point (fixed).
F028 ⁷	Regenerative Power Alarm Upper Limit Threshold	80.0%	0000 0000 to 0000 05DC hex (0.0% to 150.0%) *One digit to the right of the decimal point (fixed).
F029	Regenerative Power Alarm Hysteresis	5.0%	0000 0000 to 0000 00C7 hex (0.0% to 19.9%) *One digit to the right of the decimal point (fixed).
F02A	Regenerative Power Alarm OFF Delay	3.0 s	0000 0000 to 0000 03E7 hex (0.0 to 99.9 s) *One digit to the right of the decimal point (fixed).
F02B	Regenerative Power Alarm ON Delay	0.0 s	0000 0000 to 0000 03E7 hex (0.0 to 99.9 s) *One digit to the right of the decimal point (fixed).
F02C ⁷	Regenerative Power Alarm Lower Limit Threshold	0.0%	0000 0000 to 0000 05DC hex (0.0% to 150.0%) *One digit to the right of the decimal point (fixed).
F02D ⁷	Current Alarm Upper Limit Threshold	110.0%	0000 0000 to 0000 04B0 hex (0.0% to 120.0%) *One digit to the right of the decimal point (fixed).
F02E	Current Alarm Hysteresis	5.0%	0000 0000 to 0000 00C7 hex (0.0% to 19.9%) *One digit to the right of the decimal point (fixed).
F02F	Current Alarm OFF Delay	3.0 s	0000 0000 to 0000 03E7 hex (0.0 to 99.9 s) *One digit to the right of the decimal point (fixed).
F030	Current Alarm ON Delay	0.0 s	0000 0000 to 0000 03E7 hex (0.0 to 99.9 s) *One digit to the right of the decimal point (fixed).
F031 ⁷	Current Alarm Lower Limit Threshold	0.0%	0000 0000 to 0000 04B0 hex (0.0% to 120.0%) *One digit to the right of the decimal point (fixed).
F032 ⁷	Voltage Alarm Upper Limit Threshold	110.0%	0000 0000 to 0000 04B0 hex (0.0% to 120.0%) *One digit to the right of the decimal point (fixed).
F033	Voltage Alarm Hysteresis	5.0%	0000 0000 to 0000 00C7 hex (0.0% to 19.9%) *One digit to the right of the decimal point (fixed).
F034	Voltage Alarm OFF Delay	3.0 s	0000 0000 to 0000 03E7 hex (0.0 to 99.9 s) *One digit to the right of the decimal point (fixed).
F035	Voltage Alarm ON Delay	0.0 s	0000 0000 to 0000 03E7 hex (0.0 to 99.9 s) *One digit to the right of the decimal point (fixed).
F036 ⁷	Voltage Alarm Lower Limit Threshold	0.0%	0000 0000 to 0000 04B0 hex (0.0% to 120.0%) *One digit to the right of the decimal point (fixed).
F037 ⁷	Power Factor Alarm Upper Limit Threshold	100%	0000 0000 to 0000 0064 hex (0% to 100%)
F038	Power Factor Alarm Hysteresis	5%	0000 0000 to 0000 0013 hex (0% to 19%) *One digit to the right of the decimal point (fixed).
F039	Power Factor Alarm OFF Delay	3.0 s	0000 0000 to 0000 03E7 hex (0.0 to 99.9 s) *One digit to the right of the decimal point (fixed).
F03A	Power Factor Alarm ON Delay	0.0 s	0000 0000 to 0000 03E7 hex (0.0 to 99.9 s) *One digit to the right of the decimal point (fixed).
F03B ⁷	Power Factor Alarm Lower Limit Threshold	0%	0000 0000 to 0000 0064 hex (0% to 100%)
F03C ⁷	Reactive Power Alarm Upper Limit Threshold	80.0%	0000 0000 to 0000 05DC hex (0.0% to 150.0%) *One digit to the right of the decimal point (fixed).
F03D	Reactive Power Alarm Hysteresis	5.0%	0000 0000 to 0000 00C7 hex (0.0% to 19.9%) *One digit to the right of the decimal point (fixed).
F03E	Reactive Power Alarm OFF Delay	3.0 s	0000 0000 to 0000 03E7 hex (0.0 to 99.9 s) *One digit to the right of the decimal point (fixed).
F03F	Reactive Power Alarm ON Delay	0.0 s	0000 0000 to 0000 03E7 hex (0.0 to 99.9 s) *One digit to the right of the decimal point (fixed).
F040 ⁷	Reactive Power Alarm Lower Limit Threshold	0.0%	0000 0000 to 0000 05DC hex (0.0% to 150.0%) *One digit to the right of the decimal point (fixed).
F041	Output Terminal 1 Function Setting	Pulse output	0000 0000 hex: OFF 0000 0001 hex: Pulse output 0000 0002 hex: Alarm output
F042 ⁴	Output Terminal 2 Function Setting	Alarm Output	0000 0000 hex: OFF 0000 0001 hex: Pulse output 0000 0002 hex: Alarm output
F043 ⁶	Active Power Alarm Setting (Output Terminal 1)	OFF	0000 0000 hex: OFF 0000 0001 hex: ON
F044	Regenerative Power Alarm Setting (Output Terminal 1)	OFF	0000 0000 hex: OFF 0000 0001 hex: ON
F045	Current Alarm Setting (Output Terminal 1)	OFF	0000 0000 hex: OFF 0000 0001 hex: ON

Address	Parameter name	Default setting	Set value (monitor value)
F046	Voltage Alarm Setting (Output Terminal 1)	OFF	0000 0000 hex: OFF 0000 0001 hex: ON
F047	Power Factor Alarm Setting (Output Terminal 1)	OFF	0000 0000 hex: OFF 0000 0001 hex: ON
F048	Reactive Power Alarm Setting (Output Terminal 1)	OFF	0000 0000 hex: OFF 0000 0001 hex: ON
F049 ⁴⁷⁶	Reactive Power Alarm Setting (Output Terminal 2)	OFF	0000 0000 hex: OFF 0000 0001 hex: ON
F04A ⁴	Regenerative Power Alarm Setting (Output Terminal 2)	OFF	0000 0000 hex: OFF 0000 0001 hex: ON
F04B ⁴	Current Alarm Setting (Output Terminal 2)	OFF	0000 0000 hex: OFF 0000 0001 hex: ON
F04C ⁴	Voltage Alarm Setting (Output Terminal 2)	OFF	0000 0000 hex: OFF 0000 0001 hex: ON
F04D ⁴	Power Factor Alarm Setting (Output Terminal 2)	OFF	0000 0000 hex: OFF 0000 0001 hex: ON
F04E ⁴	Reactive Power Alarm Setting (Output Terminal 2)	OFF	0000 0000 hex: OFF 0000 0001 hex: ON
F04F	Automatic Rotation Function	OFF	0000 0000 hex: OFF 0000 0001 hex: ON
F050	Transition Time	3 s	0000 0001 to 0000 0063 hex (1 to 99 s)
F051	Active Power Display Selection	Display.	0000 0000 hex: Do not display. 0000 0001 hex: Display.
F052	Total Power Consumption Display Selection	Display.	0000 0000 hex: Do not display. 0000 0001 hex: Display.
F053	Current 1 Display Selection	Display.	0000 0000 hex: Do not display. 0000 0001 hex: Display.
F054	Current 2 Display Selection	Display.	0000 0000 hex: Do not display. 0000 0001 hex: Display.
F055	Current 3 Display Selection	Display.	0000 0000 hex: Do not display. 0000 0001 hex: Display.
F056	Voltage 1 Display Selection	Display.	0000 0000 hex: Do not display. 0000 0001 hex: Display.
F057	Voltage 2 Display Selection	Display.	0000 0000 hex: Do not display. 0000 0001 hex: Display.
F058	Voltage 3 Display Selection	Display.	0000 0000 hex: Do not display. 0000 0001 hex: Display.
F059	Power Factor Display Selection	Display.	0000 0000 hex: Do not display. 0000 0001 hex: Display.
F05A	Reactive Power Display Selection	Display.	0000 0000 hex: Do not display. 0000 0001 hex: Display.
F05B	Frequency Display Selection	Display.	0000 0000 hex: Do not display. 0000 0001 hex: Display.
F05C	Calculated CO ₂ Display Selection	Display.	0000 0000 hex: Do not display. 0000 0001 hex: Display.
F05D	Conversion to Monetary Cost	Display.	0000 0000 hex: Do not display. 0000 0001 hex: Display.
F05E	General-purpose Pulse Conversion 1 Display Selection	Display.	0000 0000 hex: Do not display. 0000 0001 hex: Display.
F05F	General-purpose Pulse Conversion 2 Display Selection	Display.	0000 0000 hex: Do not display. 0000 0001 hex: Display.
F060	Time Display Selection	Display.	0000 0000 hex: Do not display. 0000 0001 hex: Display.
F061	Pulse Input Count Display Selection	Display.	0000 0000 hex: Do not display. 0000 0001 hex: Display.
F062	Specific Power Consumption Display Selection	Display.	0000 0000 hex: Do not display. 0000 0001 hex: Display.
F063	Pulse Input ON Time Selection	Display.	0000 0000 hex: Do not display. 0000 0001 hex: Display.

Address	Parameter name	Default setting	Set value (monitor value)
F064 ⁻⁴	HIGH Total Power Consumption Display Selection	Display.	0000 0000 hex: Do not display. 0000 0001 hex: Display.
F065 ⁻⁴	MIDDLE Total Power Consumption Display Selection	Display.	0000 0000 hex: Do not display. 0000 0001 hex: Display.
F066 ⁻⁴	LOW Total Power Consumption Display Selection	Display.	0000 0000 hex: Do not display. 0000 0001 hex: Display.
F067 ⁻⁴	HIGH Total Time Display Selection	Display.	0000 0000 hex: Do not display. 0000 0001 hex: Display.
F068 ⁻⁴	MIDDLE Total Time Display Selection	Display.	0000 0000 hex: Do not display. 0000 0001 hex: Display.
F069 ⁻⁴	LOW Total Time Display Selection	Display.	0000 0000 hex: Do not display. 0000 0001 hex: Display.
F06A	Total Regenerated Energy Display Selection	Display.	0000 0000 hex: Do not display. 0000 0001 hex: Display.
F06B	Total Leading Reactive Power Consumption Display Selection	Display.	0000 0000 hex: Do not display. 0000 0001 hex: Display.
F06C	Total Lagging Reactive Power Consumption Display Selection	Display.	0000 0000 hex: Do not display. 0000 0001 hex: Display.
F06D	Total Reactive Power Consumption Display Selection	Display.	0000 0000 hex: Do not display. 0000 0001 hex: Display.
F06E	Temperature Display Selection	Display.	0000 0000 hex: Do not display. 0000 0001 hex: Display.
F06F	Product Information	Display.	0000 0000 hex: Do not display. 0000 0001 hex: Display.
F070 ⁻⁴	HIGH Display Color	Green	0000 0000 hex: Green 0000 0001 hex: Orange 0000 0002 hex: Red
F071 ⁻⁴	MIDDLE Display Color	Orange	0000 0000 hex: Green 0000 0001 hex: Orange 0000 0002 hex: Red
F072 ⁻⁴	LOW Display Color	Red	0000 0000 hex: Green 0000 0001 hex: Orange 0000 0002 hex: Red
F073	Temperature Unit	Celsius	0000 0000 hex: Celsius (C) 0000 0001 hex: Fahrenheit (F)
F074	Temperature Compensation	0 (C or F)	FFFF FE0C to 0000 01F4 hex (-50.0 to 50.0) * One digit to the right of the decimal point (fixed).
F075	Display ON Time	0	0000 0000 to 0000 0063 hex (0 to 99 minutes) * Setting of 0: Always lit.
F076	Incorrect wiring detected.	Incorrect wiring detected.	0000 0000 hex: No incorrect wiring detected. 0000 0001 hex: Incorrect wiring detected.
F077	Conversion to Monetary Cost Rate Setting	10,000	0000 0000' to 0001 869F hex (0 to 99,999) * Three digits to the right of the decimal point (fixed).
F078	Currency Setting	_JPY (204A 5059 hex)	Input 1-byte one character in ASCII. 0 to 9: 30 to 39 hex A to Z: 41 to 5A hex , -, space: 2F, 2D, 20 hex
F079	Pulse Conversion 1 Target	Pulse Input Count 1 for the Day	0000 0000 hex: Total Pulse Input Count for the Day 0000 0001 hex: Pulse Input Count 1 for the Day 0000 0002 hex: Pulse Input Count 2 for the Day 0000 0003 hex: Sum Total Pulse Input Count 0000 0004 hex: Total Pulse Input Count 1 0000 0005 hex: Total Pulse Input Count 2
F07A	Pulse Conversion 2 Target	Pulse Input Count 2 for the Day	0000 0000 hex: Total Pulse Input Count for the Day 0000 0001 hex: Pulse Input Count 1 for the Day 0000 0002 hex: Pulse Input Count 2 for the Day 0000 0003 hex: Sum Total Pulse Input Count 0000 0004 hex: Total Pulse Input Count 1 0000 0005 hex: Total Pulse Input Count 2
F07B	Coefficient Setting 1	1	0000 0000 to 0000 270F hex (0 to 9,999)
F07C	Coefficient Setting 2	1	0000 0000 to 0000 270F hex (0 to 9,999)

Address	Parameter name	Default setting	Set value (monitor value)
F07D	Decimal Point Position Setting 1	0000	0000 0000 hex: 0000 (No decimal points) 0000 0001 hex: 000.0 (One place below the decimal point) 0000 0002 hex: 00.00 (Two places below the decimal point) 0000 0003 hex: 0.000 (Three places below the decimal point)
F07E	Decimal Point Position Setting 2	0000	0000 0000 hex: 0000 (No decimal points) 0000 0001 hex: 000.0 (One place below the decimal point) 0000 0002 hex: 00.00 (Two places below the decimal point) 0000 0003 hex: 0.000 (Three places below the decimal point)
F07F	Display Unit Setting 1	M3-1 (4D33 2F31 hex)	Input 1-byte one character in ASCII. 0 to 9: 30 to 39 hex A to Z: 41 to 5A hex /: 2F hex, -: 2D hex, <i>space</i> : 20 hex
F080	Display Unit Setting 2	M3-1 (4D33 2F31 hex)	Input 1-byte one character in ASCII. 0 to 9: 30 to 39 hex A to Z: 41 to 5A hex /: 2F hex, -: 2D hex, <i>space</i> : 20 hex
F081	VT Secondary Voltage	110 V	0000 0000 hex: 110 V 0000 0001 hex: 220 V

- *1: The data length will be 8 bits if Modbus is set as the communications protocol.
- *2: If Modbus is set as the communications protocol, the number of stop bits will be set automatically according to the vertical parity.
No vertical parity: 2 bits
Odd or even vertical parity: 1 bit
- *3: The conversion coefficient varies with the region. Please check the home page of your power company. The default setting is the CO₂ coefficient for Kyushu Electric Power Company for 2009.
- *4: These addresses are used only for the KM50-E. They cannot be read or written with the KM50-C.
- *5: Always set the LOW threshold to a lower value than the HIGH threshold.
You cannot set the values so that the HIGH threshold is lower than or equal to the LOW threshold.
- *6: Addresses F020 (Active Power Alarm Setting), F043, and F049 have the following relation.
Addresses F020 and F043 (Active Power Alarm Setting (Output Terminal 1)) are for the same parameter for KM50-C.
Addresses F020 and F049 (Active Power Alarm Setting (Output Terminal 2)) are for the same parameter for KM50-E.
The same value can be read out with either address setting.
- *7: The alarm function is disabled if the upper limit threshold is set to the maximum value or the lower limit threshold is set to the minimum value.
- *8: If 3-ST (KM-E only) is set for the event input, the Three-state Target is changed to NONE. To set the Three-state Target to something other than NONE, set the Event Input Setting to the Pulse Input Count or ON Time Measurement before selecting a target.

● Addresses FF00 to FF06

(Reading Time Data, Controller Attributes, and Controller Status)

Address	Parameter name	Set value (monitor value)	Read/write
FF00	Time Data, Month and Day ^{*1}	00YY MMDD hex YY: Year, 2 digits, 00 to 63 hex (00 to 99) MM: Month, 2 digits, 00 to 0C hex (01 to 12) DD: Day, 2 digits, 00 to 1F hex (01 to 31)	Read/write
FF01	Time Data, Hour, and Minutes ^{*1}	0000 HHMM hex HH (hour): 00 to 17 hex (00 to 23) MM (minutes): 00 to 3B hex (00 to 59)	Read/write
FF02	Read Controller Attributes 1 (model)	4B4D 3530 hex 4B (ASCII) = K 4D (ASCII) = M 35 (ASCII) = 5 30 (ASCII) = 0	Read-only
FF03	Read Controller Attributes 2 (model)	2D□□ 312D hex 2D (ASCII) = – The data for □□ depends on the model as given below. KM50-C 43 (ASCII) = C KM50-E 45 (ASCII) = E 31 (ASCII) = 1 2D (ASCII) = –	Read-only
FF04	Read Controller Attributes 3 (model)	464C 4B00 hex 46 (ASCII) = F 4C (ASCII) = L 4B (ASCII) = K	Read-only
FF05	Read Controller Attributes 4 (buffer size)	0000 0078 hex (120 decimal)	Read-only
FF06	Read Controller Status	0000 0000 hex ^{*2}	Read-only

*1: To write the time data, change to Operation Setting Mode and write both of the addresses with one write command. The time data will not be set if these addresses are written to individually. The internal clock will start as soon as a normal completion is achieved for the write service.

*2: Refer to 5.2 *Status Information* for details on the status information.



Appendices

ASCII Table	A-2
Troubleshooting.....	A-3

ASCII Table

	0	1	2	3	4	5	6	7
0	NUL	DLE	SP	0	@	P	`	p
1	SOH	DC1	!	1	A	Q	a	q
2	STX	DC2	"	2	B	R	b	r
3	ETX	DC3	#	3	C	S	c	s
4	EOT	DC4	\$	4	D	T	d	t
5	ENQ	NAK	%	5	E	U	e	u
6	ACK	SYN	&	6	F	V	f	v
7	BEL	ETB	'	7	G	W	g	w
8	BS	CAN	(8	H	X	h	x
9	HT	EM)	9	I	Y	i	y
A	LF	SUB	*	:	J	Z	j	z
B	VT	ESC	+	;	K	[k	{
C	FF	FS	,	<	L	\	l	
D	CR	GS	-	=	M]	m	}
E	SO	RS	.	>	N	^	n	~
F	SI	US	/	?	O	_	o	DEL

Troubleshooting

Check Using the Following Table First

Communications do not operate properly, check any relevant items in the following table before requesting repairs.

If communications still do not operate properly, contact your OMRON representative.

Problem: Communications are not possible or communications errors occur.

Possible cause	Location to check	Reference pages
Communications are not wired properly.	Correct the wiring.	1-4
The communications cable is disconnecting.	Connect the cable connector securely and tighten the screws.	-
The communications cable is broken.	Replace the cable.	-
The communications cable is too long.	The maximum total cable length for RS-485 is 500 m.	1-4
The communications cable is not suitable.	Use shielded twisted-pair communications cables with wires of AWG24 to AWG14 (cross-sectional areas of 0.205 to 2.081 mm ²).	1-4
Too many nodes are connected to the same transmission path.	For RS-485 communications with 1:N connections, up to 31 Power Monitors can be connected for CompoWay/F and up to 99 Power Monitors can be connected for Modbus. (The host (e.g., computer) is not counted as a node for these limits.)	1-4
Terminating resistance is not connected to the ends of the communications path.	Connect terminating resistance or set internal terminating resistance. Attach terminating resistance of 120 Ω (1/2 W) to the end KM50-C/-E.	1-4
Power is not supplied to the Power Monitor.	Applied the specified power supply voltage.	-
Power is not supplied to the communications adapter (e.g., the K3SC).	Applied the specified power supply voltage.	-
The same baud rate and communications method are not set for all nodes on the same transmission path (including the Power Monitors and host).	Set the same baud rate, protocol, data length, number of stop bits, and vertical parity.	1-4
The unit number specified in the command frame is not correct.	Specify the correct unit number.	2-2 4-2
The same unit number is set for another node on the network.	Make sure every node has a unique node number.	1-4
There is a bug in the program in the host.	Use a line monitor to check the command.	-
The host is detecting a no-response error before it receives the response from the Power Monitor.	Reduce the transmission wait time set in the Power Monitor. Increase the response wait time set in the host.	1-5
The host is detecting a no-response error for a broadcast command or a Reset Software command.	The Power Monitor will not return a response for broadcast commands and the Reset Software command.	2-20 4-12
The host is sending the next command before it receives the response from the Power Monitor.	Always read the response before sending the next command. (This does not apply to broadcast commands and the Reset Software command.)	-
The host is sending the next command too quickly after it receives a response from the Power Monitor.	Allow a period of at least 2 ms after receiving a response before sending the next command.	1-3
The transmission path is unstable when the power supply to the Power Monitor is turned ON or interrupted, and the host is interpreting the unstable status as data.	Initialize the reception buffer in the host before sending the first command and after the power supply to the Power Monitor is interrupted.	-
Ambient noise is causing errors in the communications data.	Try communicating with a slower baud rate. Separate the communications cables from the source of the noise. Make sure a shielded twisted-pair cable is being used for the communications cable. Keep the communications cable as short as possible. Do not lay extra cable or loop extra cable. Do not place communications cables and power cables together. Inductive noise may occur. If noise countermeasures do not prove successful, use an optical interface.	-

Index

A		F	
address (CompoWay/F).....	2-7	FINS.....	1-2
addresses (Modbus).....	4-6	function list.....	4-5
area definitions	2-6		
ASCII table.....	A-2		
B		I	
Baud Rate.....	1-4, 1-5	interface	1-3
BCC	2-2, 2-3		
C		L	
command frame (CompoWay/F)	2-2	list of services	2-7
command frame (Modbus)	4-2		
communications data (CompoWay/F) ..	2-4, 3-3		
communications data (Modbus)	5-3		
communications parameters	1-4		
Communications Protocol.....	1-4		
communications specifications.....	1-3		
Communications Unit Number	1-4, 1-5		
CompoWay/F.....	1-2		
CRC-16.....	4-3		
D		M	
data formats (CompoWay/F)	2-2	Modbus	1-2
data formats (Modbus)	4-2	Modbus	4-1
Data Length	1-4, 1-5		
detailed descriptions of services			
(CompoWay/F).....	2-8		
detailed descriptions of services (Modbus) .	4-7		
E		N	
echoback test (CompoWay/F)	2-18	no response (Modbus).....	4-4
echoback test (Modbus)	4-13	node number.....	2-2
end code (CompoWay/F).....	2-4	number of elements (CompoWay/F).....	2-7
error codes	4-4	number of elements (Modbus)	4-6
ETX.....	2-2		
		O	
		operation command (CompoWay/F).....	2-19
		operation command (Modbus).....	4-11
		P	
		parameter area (CompoWay/F)	3-45
		parameter area (Modbus)	5-41
		PDU structure	2-5
		Protocol Selection.....	1-5
		R	
		Read Controller Attributes (CompoWay/F)	2-14
		Read Controller Status (CompoWay/F)	2-15
		Read Parameter Area (CompoWay/F)	2-10
		Read Time Data	2-16
		Read Variable Area (CompoWay/F).....	2-8
		Read Variable Area (Modbus).....	4-7

response codes (CompoWay/F) 2-21
response frame (CompoWay/F) 2-3
response frame (Modbus)..... 4-3
RS-485..... 1-4

S

set values (Modbus) 4-6
SID 2-2
slave address..... 4-2
status information 3-44, 5-40
Stop Bits 1-4, 1-5
STX 2-2
sub-address 2-2

T

transmission procedure 1-3

Transmission Wait Time 1-4, 1-5
troubleshooting.....A-3
type code (variable area) 2-6

V

variable area (CompoWay/F) 3-3
variable area (Modbus) 5-3
Vertical Parity 1-4, 1-5

W

wiring..... 1-4
Write Parameter Area (CompoWay/F) 2-12
Write Time Data 2-17
Write Variable Area (Modbus) 4-9



OMRON Corporation Industrial Automation Company
Tokyo, JAPAN

Contact: www.ia.omron.com

Regional Headquarters

OMRON EUROPE B.V.

Wegalaan 67-69-2132 JD Hoofddorp
The Netherlands
Tel: (31)2356-81-300/Fax: (31)2356-81-388

OMRON ELECTRONICS LLC

One Commerce Drive Schaumburg,
IL 60173-5302 U.S.A.
Tel: (1) 847-843-7900/Fax: (1) 847-843-7787

OMRON ASIA PACIFIC PTE. LTD.

No. 438A Alexandra Road # 05-05/08 (Lobby 2),
Alexandra Technopark,
Singapore 119967
Tel: (65) 6835-3011/Fax: (65) 6835-2711

OMRON (CHINA) CO., LTD.

Room 2211, Bank of China Tower,
200 Yin Cheng Zhong Road,
PuDong New Area, Shanghai, 200120, China
Tel: (86) 21-5037-2222/Fax: (86) 21-5037-2200

Authorized Distributor:

© OMRON Corporation 2009 All Rights Reserved.
In the interest of product improvement,
specifications are subject to change without notice.

Cat. No. N165-E1-02

Printed in Japan