

OMRON

Smart Power Monitor

KM50-E

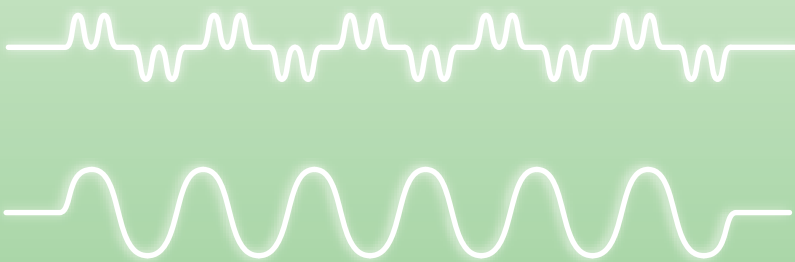

Cut Energy Losses

Operation Manual

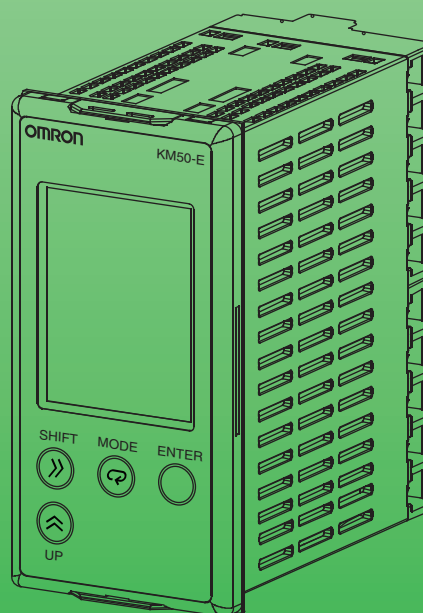

Introduction

Thank you for purchasing an OMRON KM50-E Smart Power Monitor.
This Power Monitor provides the following functions and performance.

- The KM50-E can accept an AC voltage or AC current input to measure the active power, total power consumption, current, voltage, power factor, reactive power, frequency, total regenerated energy^{*1}, total leading reactive power consumption, total lagging reactive power consumption, total reactive power consumption^{*2}, or simple temperatures for single-phase two-wire, single-phase three-wire, three-phase three-wire, or three-phase four-wire circuits.

The total power consumption and pulse input count can also be used to measure the calculated CO₂ emission, converted monetary value, pulse converted value, specific power consumption, and pulse input ON time.

*1. Regenerative power is reverse power, such as the power that can be sold to the power company.

*2. The total reactive power consumption is the sum of the absolute values of total leading reactive power consumption and total lagging reactive power consumption.

- The KM50-E can measure the voltage on a 480-V line.
- The KM50-E supports communications, which can be used to read the measurement values.
- Even if a voltage cannot be input to the voltage input terminals, the KM50-E can accept an AC current input and internally calculate the voltage or other set values to easily measure power consumption (called "Simple Measurement").
- The data logging function saves the measured values in EEPROM every five minutes, every hour, every day, and every month.
- The measured power consumption is classified into HIGH, MIDDLE, and LOW states according to the measured value or event inputs.
- The KM50-E can be used in environments that include the 2nd, 3rd, 5th, 7th, 9th, 11th, and 13th harmonics.
- The KM50-E complies with IEC safety standards and EMC standards.
- The KM50-E is also certified for the Korean S-Mark and UL standard.

This manual provides information that is required to use the KM50-E, including information on functions, performance, and application procedures.

Observe the following when using the KM50-E.

- Only specialists with a knowledge of electrical systems must be allowed to handle or operate the KM50-E.
- Read and understand this manual completely before attempting to use the KM50-E.
- Keep this manual in a safe and convenient location so that it can be used as reference whenever required.

Read and Understand this Manual

Please read and understand this manual before using the product. Please consult your OMRON representative if you have any questions or comments.

Warranty and Limitations of Liability

WARRANTY

OMRON's exclusive warranty is that the products are free from defects in materials and workmanship for a period of one year (or other period if specified) from date of sale by OMRON.

OMRON MAKES NO WARRANTY OR REPRESENTATION, EXPRESS OR IMPLIED, REGARDING NON-INFRINGEMENT, MERCHANTABILITY, OR FITNESS FOR PARTICULAR PURPOSE OF THE PRODUCTS. ANY BUYER OR USER ACKNOWLEDGES THAT THE BUYER OR USER ALONE HAS DETERMINED THAT THE PRODUCTS WILL SUITABLY MEET THE REQUIREMENTS OF THEIR INTENDED USE. OMRON DISCLAIMS ALL OTHER WARRANTIES, EXPRESS OR IMPLIED.

LIMITATIONS OF LIABILITY

OMRON SHALL NOT BE RESPONSIBLE FOR SPECIAL, INDIRECT, OR CONSEQUENTIAL DAMAGES, LOSS OF PROFITS OR COMMERCIAL LOSS IN ANY WAY CONNECTED WITH THE PRODUCTS, WHETHER SUCH CLAIM IS BASED ON CONTRACT, WARRANTY, NEGLIGENCE, OR STRICT LIABILITY.

In no event shall the responsibility of OMRON for any act exceed the individual price of the product on which liability is asserted.

IN NO EVENT SHALL OMRON BE RESPONSIBLE FOR WARRANTY, REPAIR, OR OTHER CLAIMS REGARDING THE PRODUCTS UNLESS OMRON'S ANALYSIS CONFIRMS THAT THE PRODUCTS WERE PROPERLY HANDLED, STORED, INSTALLED, AND MAINTAINED AND NOT SUBJECT TO CONTAMINATION, ABUSE, MISUSE, OR INAPPROPRIATE MODIFICATION OR REPAIR.

Application Considerations

SUITABILITY FOR USE

OMRON shall not be responsible for conformity with any standards, codes, or regulations that apply to the combination of products in the customer's application or use of the products.

At the customer's request, OMRON will provide applicable third party certification documents identifying ratings and limitations of use that apply to the products. This information by itself is not sufficient for a complete determination of the suitability of the products in combination with the end product, machine, system, or other application or use.

The following are some examples of applications for which particular attention must be given. This is not intended to be an exhaustive list of all possible uses of the products, nor is it intended to imply that the uses listed may be suitable for the products:

- Outdoor use, uses involving potential chemical contamination or electrical interference, or conditions or uses not described in this manual.
- Nuclear energy control systems, combustion systems, railroad systems, aviation systems, medical equipment, amusement machines, vehicles, safety equipment, and installations subject to separate industry or government regulations.
- Systems, machines, and equipment that could present a risk to life or property.

Please know and observe all prohibitions of use applicable to the products.

NEVER USE THE PRODUCTS FOR AN APPLICATION INVOLVING SERIOUS RISK TO LIFE OR PROPERTY WITHOUT ENSURING THAT THE SYSTEM AS A WHOLE HAS BEEN DESIGNED TO ADDRESS THE RISKS, AND THAT THE OMRON PRODUCTS ARE PROPERLY RATED AND INSTALLED FOR THE INTENDED USE WITHIN THE OVERALL EQUIPMENT OR SYSTEM.

PROGRAMMABLE PRODUCTS

OMRON shall not be responsible for the user's programming of a programmable product, or any consequence thereof.

Disclaimers

CHANGE IN SPECIFICATIONS

Product specifications and accessories may be changed at any time based on improvements and other reasons.

It is our practice to change model numbers when published ratings or features are changed, or when significant construction changes are made. However, some specifications of the products may be changed without any notice. When in doubt, special model numbers may be assigned to fix or establish key specifications for your application on your request. Please consult with your OMRON representative at any time to confirm actual specifications of purchased products.

DIMENSIONS AND WEIGHTS

Dimensions and weights are nominal and are not to be used for manufacturing purposes, even when tolerances are shown.

PERFORMANCE DATA

Performance data given in this manual is provided as a guide for the user in determining suitability and does not constitute a warranty. It may represent the result of OMRON's test conditions, and the users must correlate it to actual application requirements. Actual performance is subject to the OMRON Warranty and Limitations of Liability.

ERRORS AND OMISSIONS

The information in this document has been carefully checked and is believed to be accurate; however, no responsibility is assumed for clerical, typographical, or proofreading errors, or omissions.

© OMRON, 2010

All rights reserved. No part of this publication may be reproduced, stored in a retrieval system, or transmitted, in any form, or by any means, mechanical, electronic, photocopying, recording, or otherwise, without the prior written permission of OMRON.

No patent liability is assumed with respect to the use of the information contained herein. Moreover, because OMRON is constantly striving to improve its high-quality products, the information contained in this manual is subject to change without notice. Every precaution has been taken in the preparation of this manual. Nevertheless, OMRON assumes no responsibility for errors or omissions. Neither is any liability assumed for damages resulting from the use of the information contained in this publication.

Safety Precautions

● Definition of Precautionary Information

The following notation is used in this manual to provide precautions that are required to ensure safe usage of the KM50-E.

The safety precautions that are provided are extremely important to safety. Always read and heed the information provided in all safety precautions.

The following notation is used.

Meanings of Signal Words







Caution

Indicates a potentially hazardous situation which, if not avoided, may result in minor or moderate injury, or property damage.

● Symbols

Symbol	Meaning
	<ul style="list-style-type: none">● Disassembly Prohibition Indicates prohibitions when there is a possibility of injury, such as from electric shock, as the result of disassembly.
	<ul style="list-style-type: none">● General Mandatory Caution Indicates non-specific general actions that are required by the user.
	<ul style="list-style-type: none">● Electrical Shock Caution Indicates the possibility of electric shock under specific conditions.

● Safety Precautions

 Caution	
<p>Property damage may occasionally occur due to fire.</p> <p>Tighten terminal screws to the specified tightening torque.</p> <p>Recommended tightening torque for terminal screws: 0.69 to 0.88 .m.</p> <p>Confirm that the screws are straight (i.e., not at an angle) after tightening them.</p>	
<p>Minor or moderate bodily harm or property damage may occasionally occur due to explosion. Do not use the product near inflammable or explosive gas.</p>	
<p>Destruction or rupture may occasionally occur.</p> <p>Make sure that the power supply voltage is within specifications.</p>	
<p>Destruction or rupture may occasionally occur.</p> <p>The voltage input circuit and CT secondary circuit are not isolated. If a Special CT is grounded, incorrect wiring will short circuit the voltage input and the secondary circuit of the CT. To prevent failure, do not ground a Special CT.</p> <p>The Power Monitor uses a Special CT. Correct measurements can be made even if the CT is not grounded.</p>	
<p>Electric shock may occasionally occur.</p> <p>Always turn OFF the power supply before connecting CTs.</p>	
<p>Electric shock may occasionally occur.</p> <p>Do not touch any of the terminals while the power is being supplied.</p>	
<p>Electric shock may occasionally occur.</p> <p>The voltage input circuit and CT secondary circuit are not isolated. Do not touch the secondary side of the Special CT.</p>	
<p>Electrical shock, minor injury, fire, or equipment malfunction may occasionally occur.</p> <p>Do not attempt to disassemble, modify, or repair the product.</p>	

Precautions for Safe Use

The following items must be observed to prevent failure to operate and malfunctions of the product and to prevent adverse effects on performance and functions of the product.

- 1) Do not store, install, or use the product in the following locations.
 - Locations that are greatly affected by vibration or shock
 - Unstable locations
 - Outdoors or locations that are subject to direct sunlight, wind, or rain
 - Locations where the specified range of temperature or humidity would be exceeded
 - Locations that are subject to rapid changes in temperature or humidity where condensation or icing may occur
 - Locations that are affected by static electricity or noise
 - Locations that are subject to corrosive gas (particularly sulfide or ammonia gas)
 - Locations that are subject to dust or iron powder
 - Locations that are subject to flooding or oil
 - Locations that are affected by electric or magnetic fields
 - Locations that are subject to splashing brine
- 2) Install the product in a panel with a panel thickness of 1 to 8 mm.
If a suitable panel thickness is not used or the product is installed incorrectly, the product may come free from the mounting.
- 3) Do not attempt to pull the internal part of the product out of the case.
Pulling out the internal part of the product will increase the contact resistance of the internal terminals, possibly damaging measurement accuracy.
- 4) Read and understand this manual before attempting to install, use, or maintain the product. Electric shock, injury, accidents, failure, or malfunction may occur.
- 5) Always check the wiring and confirm that it is correct before turning ON the power supply. Incorrect or improper wiring may result in electrical shock, injury, accidents, failure, or malfunction.
- 6) Use power supplies and wires with suitable specifications for the control power supply and the power supply for inputs and other parts of the system. Failure, burning, or electrical shock may result.
- 7) Do not install the product near sources of heat, such as devices with coils or windings.
- 8) Check all terminal numbers before wiring.
- 9) Do not connect anything to unused terminals.
- 10) Use crimp terminals that are suitable for M3.5 screws.
- 11) Install the product well separated from devices with strong high-frequency noise (such as high-frequency welders or sewing machines) or devices that generate surge.
- 12) To prevent inductive noise, wire the lines connected to the product separately from power lines carrying high voltages or currents. Do not wire in parallel with or in the same cable as power lines. Other measures for reducing noise include running lines in separate ducts and using shields.
- 13) Do not touch conductive metal parts on the product or the CT terminals while power is being supplied.
- 14) Do not use the product for measurement on the secondary side of an inverter.
- 15) Do not block the ventilation holes in or the areas around the product to ensure proper dissipation of heat.
- 16) Touch grounded metal to discharge any static electricity before touching the product.
- 17) Do not remove the terminal blocks from the product. Doing so may cause failure or malfunction.
- 18) Do not continue to use the product if the front surface peels or becomes cracked. Water may enter the product.
- 19) Install and suitably label a switch or circuit breaker that complies with relevant requirements of IEC 60947-1 and IEC 60947-3 so that the operator can immediately turn OFF the power supply.
- 20) When using the product in an Overvoltage Category III environment, externally install varistors between the power supply and voltage measurement inputs to the product.

- 21) Use only the Special CT and Special CT Cable specified by OMRON.
Special CTs: KM20-CTF-5A, KM20-CTF-50A, KM20-CTF-100A, KM20-CTF-200A, KM20-CTF-400A, and KM20-CTF-600A
Special CT Cable: KM20-CTF-CB3 (3 m)
- 22) The Power Monitor is a Class A product (for use in industrial environments). In residential environment areas it may cause radio interference. If it causes radio interference, the user may be required to take adequate measures to reduce interference.

Installation Precautions

● Maintaining Product Life

Use the KM50-E within the following temperature and humidity ranges.

Temperature: • 10 to 55°C (with no icing or condensation), Humidity: 25% to 85%

When the KM50-E is installed in a control panel, ensure that the temperature around the KM50-E (not the temperature around the panel) does not exceed 55°C.

Some of the electronic components used in the KM50-E have limited service lives. The life of these components depends on the ambient temperature. The service lives will be shorter at higher temperatures and longer at lower temperatures. The life of the KM50-E can thus be extended by lowering the internal temperature. If more than one KM50-E Power Monitor is mounted side by side or top to bottom, the heat generated by the Power Monitors will cause the internal temperatures to increase, shortening the lives of the Power Monitors. To prevent the internal temperature from increasing, forced cooling, such as fans to cool the Power Monitors, must be considered.

● Noise Countermeasures

To prevent inductive noise, wire the lines connected to the terminal block on the KM50-E separately from power lines carrying high voltages or currents. Do not wire in parallel with or in the same cable as power lines. Other measures for reducing noise include running lines in separate ducts and using shields.

Attach surge absorbers or noise filters to nearby equipment that generates noise (particularly equipment with a high inductance component, such as motors, transformers, or magnetic coils). Install the product as far as possible away from devices with strong high-frequency noise (such as high-frequency welders or sewing machines) or devices that generate surge.

● Waterproof Performance

The KM50-E provides the following degree of protection. Any parts for which a degree of protection is not given or for which the degree of protection is given as IP□0 are not waterproof to any degree.

Front panel: IP66 (with enclosed Waterproof Packing), Rear case: IP20, Terminal section: IP00

Precautions for Correct Use

- 1) Make sure that all parameters are set suitably for the measurement target.
- 2) This product is not a Special Measuring Instrument that has passed testing by a specified body under the Measurement Act of Japan. It cannot be used to certify power consumption under Japanese law.
- 3) Do not use solvents, such as paint thinners, to clean the product. Use commercially available alcohol instead.
- 4) Make sure the rated voltage is reached within 2 seconds after the power is turned ON.
Otherwise, the product may not operate correctly.
- 5) When discarding the product, properly dispose of it as industrial waste according to all applicable local ordinances.
- 6) If a water-proof structure is required, install the enclosed Waterproof Packing.
Depending on the application environment, the Waterproof Packing can deteriorate, shrink, or harden. We recommend that you replace it periodically.
Waterproof Packing: Y92S-P5
- 7) Remove the protective film from the front of the product before using the product.
- 8) Provide a separate power supply for the KM50-E from the measurement voltage.
- 9) Reception interference may occur if the KM50-E is installed near radios, televisions, or other wireless devices.

Preoperational Checks

Read the *Instruction Sheet* that is provided with the KM50-E and check the following items.

Process	Item to check	Description
Immediately after purchase	External appearance	After you purchase the KM50-E, make sure there are no dents in the KM50-E or the packaging box. If there is internal damage, correct measurements may not be possible depending on the location of the damage.
	Model number and specifications	Make sure that the specifications of the product you purchased match the required specifications.
Installation	Installation location	Do not block the area around the KM50-E to ensure proper dissipation of heat. Do not block the ventilation holes in the KM50-E. Provide space between the KM50-E Power Monitors when installing them side by side to prevent wiring from coming into contact with adjacent Power Monitors.
Wiring	Terminal wiring	Do not subject the terminals to excessive stress when tightening the screws. Tightening the terminal screws to a torque of 0.69 and 0.88 N-m and then make sure there are no loose screws. Check terminal polarity and wire all terminals correctly.
	Power supply and voltage inputs	Wire the power supply and voltage inputs correctly. Incorrect wiring may damage internal circuits.
Application environment	Ambient temperature	The ambient operating temperature of the KM50-E is • 10 to 55°C (with no condensation or icing). To extend the service life, install the KM50-E to maintain the ambient temperature as low as possible. If higher temperatures are unavoidable, consider using forced cooling with a fan.
	Vibration and shock	Make sure that the vibration and shock in the installation environment do not exceed the specified specifications. (Install the KM50-E as far away from conductors to prevent subjecting the KM50-E to vibration and shock.)
	Foreign matter	Install the KM50-E so that liquids and other foreign matter will not enter it. If sulfuric gas, chloride gas, or other corrosive gases are generated in the installation environment, remove the source of the gas, install exhaust fans, or take other measures to remove the gas.

Revision History

A manual revision code appears as a suffix to the catalog number on the back cover of the manual.

Cat. No. N164-E1-02

Revision code	Date	Revised content
01	March 2010	Original production
02	March 2011	Made revisions for version upgrade.

Upgraded Functions

KM50-E Power Monitors manufactured after February 2011 have been upgraded.

Products manufactured prior to February 2011 are version 1.0, and products manufactured February 2011 or later are version 2.0.

It is possible to distinguish between version 1.0 and version 2.0 startup of the Power Monitor or by displaying the software version in the product information.

There is a parameter called Instantaneous Power in the Basic Level of the Measurement Mode. This parameter has been changed to Active Power to avoid confusion.

The changes are described in the following table. For details on the functions, refer to the description of each function in this manual.

Change	Version 1.0	Version 2.0																																																																																																																																				
Display																																																																																																																																						
		The temperature unit is now displayed.																																																																																																																																				
Terminal name	<table border="1" style="width: 100%; border-collapse: collapse; text-align: center;"> <thead> <tr> <th>Terminal No.</th> <th>Terminal name</th> <th>Terminal No.</th> <th>Terminal name</th> <th>Terminal No.</th> <th>Terminal name</th> </tr> </thead> <tbody> <tr> <td>1</td> <td>P1 Voltage</td> <td>21</td> <td>DO NOT USE</td> <td>11</td> <td>CT1S</td> </tr> <tr> <td></td> <td></td> <td>22</td> <td>Common 1</td> <td>12</td> <td>CT1L</td> </tr> <tr> <td>3</td> <td>P0 Voltage</td> <td>23</td> <td>Three-state HIGH Output</td> <td>13</td> <td>CT2S</td> </tr> <tr> <td></td> <td></td> <td>24</td> <td>Three-state MIDDLE Output</td> <td>14</td> <td>CT2L</td> </tr> <tr> <td>5</td> <td>P2 Voltage</td> <td>25</td> <td>Three-state LOW Output</td> <td>15</td> <td>CT3S</td> </tr> <tr> <td></td> <td></td> <td>26</td> <td>Event Input 2</td> <td>16</td> <td>CT3L</td> </tr> <tr> <td>7</td> <td>P3 Voltage</td> <td>27</td> <td>Common 2</td> <td></td> <td></td> </tr> <tr> <td></td> <td></td> <td>28</td> <td>Event Input 1</td> <td>18</td> <td>Common 3</td> </tr> <tr> <td>9</td> <td>Control Power</td> <td>29</td> <td>RS-485 B (+)</td> <td>19</td> <td>Total Power Consumption Pulse Output</td> </tr> <tr> <td>10</td> <td>Control Power</td> <td>30</td> <td>RS-485 A (-)</td> <td>20</td> <td>Alarm Output</td> </tr> </tbody> </table>	Terminal No.	Terminal name	Terminal No.	Terminal name	Terminal No.	Terminal name	1	P1 Voltage	21	DO NOT USE	11	CT1S			22	Common 1	12	CT1L	3	P0 Voltage	23	Three-state HIGH Output	13	CT2S			24	Three-state MIDDLE Output	14	CT2L	5	P2 Voltage	25	Three-state LOW Output	15	CT3S			26	Event Input 2	16	CT3L	7	P3 Voltage	27	Common 2					28	Event Input 1	18	Common 3	9	Control Power	29	RS-485 B (+)	19	Total Power Consumption Pulse Output	10	Control Power	30	RS-485 A (-)	20	Alarm Output	<table border="1" style="width: 100%; border-collapse: collapse; text-align: center;"> <thead> <tr> <th>Terminal No.</th> <th>Terminal name</th> <th>Terminal No.</th> <th>Terminal name</th> <th>Terminal No.</th> <th>Terminal name</th> </tr> </thead> <tbody> <tr> <td>1</td> <td>P1 Voltage</td> <td>21</td> <td>DO NOT USE</td> <td>11</td> <td>CT1S</td> </tr> <tr> <td></td> <td></td> <td>22</td> <td>Common 1</td> <td>12</td> <td>CT1L</td> </tr> <tr> <td>3</td> <td>P0 Voltage</td> <td>23</td> <td>Three-state HIGH Output</td> <td>13</td> <td>CT2S</td> </tr> <tr> <td></td> <td></td> <td>24</td> <td>Three-state MIDDLE Output</td> <td>14</td> <td>CT2L</td> </tr> <tr> <td>5</td> <td>P2 Voltage</td> <td>25</td> <td>Three-state LOW Output</td> <td>15</td> <td>CT3S</td> </tr> <tr> <td></td> <td></td> <td>26</td> <td>Event Input 2</td> <td>16</td> <td>CT3L</td> </tr> <tr> <td>7</td> <td>P3 Voltage</td> <td>27</td> <td>Common 2</td> <td></td> <td></td> </tr> <tr> <td></td> <td></td> <td>28</td> <td>Event Input 1</td> <td>18</td> <td>Common 3</td> </tr> <tr> <td>9</td> <td>Control Power</td> <td>29</td> <td>RS-485 B (+)</td> <td>19</td> <td>OUT1</td> </tr> <tr> <td>10</td> <td>Control Power</td> <td>30</td> <td>RS-485 A (-)</td> <td>20</td> <td>OUT2</td> </tr> </tbody> </table> <ul style="list-style-type: none"> • Terminal names that have changed with the function upgrade: “ Total Power Consumption Pulse Output” was changed to “OUT1.” “ Alarm Output” was changed to “OUT2.” 	Terminal No.	Terminal name	Terminal No.	Terminal name	Terminal No.	Terminal name	1	P1 Voltage	21	DO NOT USE	11	CT1S			22	Common 1	12	CT1L	3	P0 Voltage	23	Three-state HIGH Output	13	CT2S			24	Three-state MIDDLE Output	14	CT2L	5	P2 Voltage	25	Three-state LOW Output	15	CT3S			26	Event Input 2	16	CT3L	7	P3 Voltage	27	Common 2					28	Event Input 1	18	Common 3	9	Control Power	29	RS-485 B (+)	19	OUT1	10	Control Power	30	RS-485 A (-)	20	OUT2
Terminal No.	Terminal name	Terminal No.	Terminal name	Terminal No.	Terminal name																																																																																																																																	
1	P1 Voltage	21	DO NOT USE	11	CT1S																																																																																																																																	
		22	Common 1	12	CT1L																																																																																																																																	
3	P0 Voltage	23	Three-state HIGH Output	13	CT2S																																																																																																																																	
		24	Three-state MIDDLE Output	14	CT2L																																																																																																																																	
5	P2 Voltage	25	Three-state LOW Output	15	CT3S																																																																																																																																	
		26	Event Input 2	16	CT3L																																																																																																																																	
7	P3 Voltage	27	Common 2																																																																																																																																			
		28	Event Input 1	18	Common 3																																																																																																																																	
9	Control Power	29	RS-485 B (+)	19	Total Power Consumption Pulse Output																																																																																																																																	
10	Control Power	30	RS-485 A (-)	20	Alarm Output																																																																																																																																	
Terminal No.	Terminal name	Terminal No.	Terminal name	Terminal No.	Terminal name																																																																																																																																	
1	P1 Voltage	21	DO NOT USE	11	CT1S																																																																																																																																	
		22	Common 1	12	CT1L																																																																																																																																	
3	P0 Voltage	23	Three-state HIGH Output	13	CT2S																																																																																																																																	
		24	Three-state MIDDLE Output	14	CT2L																																																																																																																																	
5	P2 Voltage	25	Three-state LOW Output	15	CT3S																																																																																																																																	
		26	Event Input 2	16	CT3L																																																																																																																																	
7	P3 Voltage	27	Common 2																																																																																																																																			
		28	Event Input 1	18	Common 3																																																																																																																																	
9	Control Power	29	RS-485 B (+)	19	OUT1																																																																																																																																	
10	Control Power	30	RS-485 A (-)	20	OUT2																																																																																																																																	

Change	Ver. 1.0	Ver. 2.0
Measurement Mode Basic Level Parameters	Instantaneous Power Total Power Consumption Current Voltage Power Factor Reactive Power Frequency Calculated CO ₂ Time	Active Power Total Power Consumption Current Voltage Power Factor Reactive Power Frequency Frequency Calculated CO ₂ Converted Monetary Cost Pulse Converted Value 1 Pulse Converted Value 2 Time
Measurement Mode Professional Level Parameters	Pulse Input Count Specific Power Consumption Pulse Input ON Time HIGH Total Power Consumption MIDDLE Total Power Consumption LOW Total Power Consumption HIGH Total Time MIDDLE Total Time LOW Total Time Product Information	Total Pulse Input Count Specific Power Consumption Pulse Input ON Time HIGH Total Power Consumption MIDDLE Total Power Consumption LOW Total Power Consumption HIGH Total Time MIDDLE Total Time LOW Total Time Total Regenerated Energy Total Leading Reactive Power Consumption Total Lagging Reactive Power Consumption Total Reactive Power Consumption Simple Temperature Product Information
Measurement parameters that can be changed with communications only.	Total Power Consumption Every Five Minutes	Total Power Consumption Every Five Minutes Pulse Input Count 1 Pulse Input Count 2 Total Pulse Input Count Total Pulse Input Count 1 Total Pulse Input Count 2 HIGH Total Power Consumption MIDDLE Total Power Consumption LOW Total Power Consumption HIGH Total Time MIDDLE Total Time LOW Total Time
Communications Setting Mode Basic Level Parameters	Applicable Circuit Special CT Type Rated Primary Current VT Primary Voltage Low-cut Current Pulse Output Unit Display Refresh Period Average Count Simple Measurement Buzzer CO ₂ Coefficient Time Setting Initialize	Applicable Circuit Special CT Type Rated Primary Current VT Primary Voltage and VT Secondary Voltage Low-cut Current Pulse Output Unit Display Refresh Period Average Count Simple Measurement Buzzer CO ₂ Coefficient Conversion to Monetary Cost Setting Pulse Conversion 1 Setting Pulse Conversion 2 Setting Time Setting Initialize

Change	Ver. 1.0	Ver. 2.0
Communications Setting Mode Professional Level Parameters	Event Input Setting Event Input 1 NPN/PNP Input Mode Setting Event Input 2 NPN/PNP Input Mode Setting Event Input 1 NO/NC Input Mode Setting Event Input 2 NO/NC Input Mode Setting Measurement Start Time Measurement End Time Three-state Target Three-state HIGH Threshold Three-state LOW Threshold Three-state Hysteresis Instantaneous Power Alarm Output	Event Input Setting Event Input 1 NPN/PNP Input Mode Setting Event Input 2 NPN/PNP Input Mode Setting Event Input 1 NO/NC Input Mode Setting Event Input 2 NO/NC Input Mode Setting Measurement Start Time Measurement End Time Three-state Target Three-state HIGH Threshold Three-state LOW Threshold Three-state Hysteresis Three-state Color Setting Output Terminal 1 Function Setting Output Terminal 2 Function Setting Active Power Alarm Output Regenerative Power Alarm Output Current Alarm Output Voltage Alarm Output Power Factor Alarm Output Reactive Power Alarm Output Consumed Power Save Selection Automatic Rotation Setting Measurement Parameter Display Selection Display ON Time Temperature Setting

Display Segments

Letters and numbers in parameter abbreviations and settings that appear on the KM50-E display are as follows:

There are two displays, each containing one 7-segment digit and four 11-segment digits.

Eleven-segment Displays

<i>A</i>	<i>b</i>	<i>c</i>	<i>d</i>	<i>E</i>	<i>F</i>	<i>G</i>	<i>H</i>	<i>i</i>	<i>J</i>	<i>K</i>	<i>L</i>	<i>M</i>	<i>N</i>	<i>o</i>	<i>P</i>	<i>Q</i>	<i>R</i>
A	B	C	D	E	F	G	H	I	J	K	L	M	N	O	P	Q	R

<i>S</i>	<i>t</i>	<i>U</i>	<i>v</i>	<i>W</i>	<i>x</i>	<i>y</i>	<i>Z</i>	<i>0</i>	<i>1</i>	<i>2</i>	<i>3</i>	<i>4</i>	<i>5</i>	<i>6</i>	<i>7</i>	<i>8</i>	<i>9</i>
S	T	U	V	W	X	Y	Z	0	1	2	3	4	5	6	7	8	9

Seven-segment Displays

<i>A</i>	<i>b</i>	<i>c</i>	<i>d</i>	<i>E</i>	<i>F</i>	<i>G</i>	<i>H</i>	<i>i</i>	<i>j</i>	<i>K</i>	<i>L</i>	<i>n</i>	<i>n</i>	<i>o</i>	<i>P</i>	<i>q</i>	<i>r</i>
A	B	C	D	E	F	G	H	I	J	K	L	M	N	O	P	Q	R

<i>S</i>	<i>t</i>	<i>U</i>	<i>u</i>	<i>y</i>	<i>o</i>	<i>y</i>	<i>z</i>	<i>0</i>	<i>1</i>	<i>2</i>	<i>3</i>	<i>4</i>	<i>5</i>	<i>6</i>	<i>7</i>	<i>8</i>	<i>9</i>
S	T	U	V	W	X	Y	Z	0	1	2	3	4	5	6	7	8	9

Table of Contents

Introduction	I
Read and Understand this Manual	II
Safety Precautions.....	IV
Precautions for Safe Use	VI
Installation Precautions.....	VII
Precautions for Correct Use.....	VIII
Preoperational Checks.....	IX
Display Segments.....	XIII
Table of Contents	XIV
Section 1 Overview	1-1
1.1 Main Features and Functions.....	1-2
■ Main Features	1-2
■ Main Functions	1-3
1.2 Part Names and Functions.....	1-5
■ Front Panel	1-5
■ Display Functions	1-5
■ LCD Backlight	1-6
1.3 I/O Configuration and Model Number Legend	1-7
■ I/O Configuration.....	1-7
■ Model Number Legend	1-7
1.4 Mode Configuration and Key Operations	1-8
■ Mode Configuration	1-8
■ Measurement Mode.....	1-9
■ Protection Setting Mode	1-14
■ Setting Modes.....	1-15
■ Entering Set Values	1-19
■ Basic Key Operations	1-19
1.5 Insulation Block Diagram.....	1-20
Section 2 Preparations.....	2-1
2.1 Installation.....	2-2
■ Dimensions (Unit: mm)	2-2
■ Panel Cutout Dimensions (Unit: mm))	2-2
■ Installation Method.....	2-3
2.2 Mounting the Special CTs	2-4
2.3 Using the Terminals	2-5
■ Terminal Arrangement.....	2-5
■ Wiring Diagram	2-5

	■ Wiring Methods and CT Mounting Locations	2-6
	■ Wiring Precautions.....	2-7
	■ Wiring.....	2-7
Section 3	Basic Operating Procedures	3-1
3. 1	Icons	3-2
	■ Icon Descriptions	3-2
3. 2	Turning ON the Power	3-3
	■ Turning ON the Power	3-3
3. 3	Basic Settings	3-4
	■ Setting Example.....	3-4
3. 4	Ensuring Correct Measurements.....	3-5
	■ Applicable Circuit.....	3-5
	■ Special CT	3-6
	■ Instantaneous Power	3-7
	■ Total Power Consumption	3-8
	■ Currents	3-9
	■ Voltages.....	3-11
	■ Power Factor	3-13
	■ Reactive Power.....	3-14
	■ Frequency.....	3-14
3. 5	Measuring a High Current	3-15
	■ Rated Primary Current.....	3-15
3. 6	Measuring a High Voltage.....	3-17
	■ VT Primary Voltage.....	3-17
3. 7	Setting a Low-cut Current	3-18
	■ Low-cut Current	3-18
3. 8	Setting the Measurement Pulse	3-19
	■ Pulse Output Unit.....	3-19
3. 9	Changing the Display Refresh Period	3-20
	■ Display Refresh Period.....	3-20
3. 10	Changing the Number of Averaged Measurement Values	3-21
	■ Average Count.....	3-21
3. 11	Easily Measuring Power.....	3-23
	■ Simple Measurement.....	3-23
3. 12	Setting the Buzzer.....	3-25
	■ Buzzer.....	3-25
3. 13	CO ₂ Emission.....	3-26
	■ CO ₂ Coefficient.....	3-26
	■ Calculated CO ₂	3-27
3. 14	Time Setting.....	3-28
	■ Time Setting.....	3-28
	■ Time	3-29
3. 15	Initializing Data.....	3-33

	■ Initialize	3-33
3. 16	Communications Setting Mode	3-35
	■ Protocol Selection	3-35
	■ Unit Number	3-36
	■ Baud Rate	3-37
	■ Data Length	3-38
	■ Stop Bits	3-39
	■ Vertical Parity	3-40
	■ Transmission Wait Time	3-41
Section 4	Advanced Operating Procedures	4-1
4. 1	Event Inputs	4-2
	■ Event Input Setting	4-2
	■ Event Input 1/Event Input 2 NPN/PNP Input Mode Settings	4-4
	■ Event Input 1/Event Input 2 NO/NC Input Mode Settings	4-5
	■ Measurement Start Time/Measurement End Time	4-6
	■ Pulse Input Count	4-8
	■ Specific Power Consumption	4-9
	■ Pulse Input ON Time	4-10
4. 2	Three-state Outputs	4-11
	■ Three-state Target	4-11
	■ Three-state HIGH Threshold/Three-state LOW Threshold	4-13
	■ Three-state Hysteresis	4-15
	■ HIGH Total Power Consumption, MIDDLE Total Power Consumption, and LOW Total Power Consumption	4-16
	■ HIGH Total Time, MIDDLE Total Time, and LOW Total Time	4-17
4. 3	Alarm Output	4-18
	■ Instantaneous Power Alarm Output	4-18
4. 4	Displaying Product Information	4-23
	■ Product Information	4-23
4. 5	Protection Setting Mode	4-24
	■ Protection Setting	4-24
Section 5	Troubleshooting	5-1
5. 1	Error Displays	5-2
5. 2	Troubleshooting	5-3

Appendices..... A-1

- Product Specifications A-2
 - Power Monitor Ratings A-2
 - Power Monitor Performance A-3
 - Option Ratings and Performance A-4
- CTs A-6
 - Specifications..... A-6
 - Dimensions A-6
- Parameter List A-7
 - Measurement Mode, Basic Level A-7
 - Measurement Mode, Professional Level A-9
 - Operation Setting Mode, Basic Level A-10
 - Operation Setting Mode, Professional Level..... A-11
 - Communications Setting Mode..... A-12
 - Protection Setting Mode A-13
- Parameter List A-14
- Index

Section 1 Overview

1. 1	Main Features and Functions	1-2
■	Main Features	1-2
■	Main Functions.....	1-3
●	Outputs.....	1-3
●	Inputs.....	1-4
●	Communications.....	1-4
●	Logging Measurement Data.....	1-4
●	Measurement Data Update Period	1-5
1. 2	Part Names and Functions	1-6
■	Front Panel.....	1-6
■	Display Functions.....	1-6
■	LCD Backlight	1-7
1. 3	I/O Configuration and Model Number Legend.....	1-8
■	I/O Configuration.....	1-8
■	Model Number Legend	1-8
1. 4	Mode Configuration and Key Operations.....	1-9
■	Mode Configuration.....	1-9
■	Measurement Mode	1-10
●	Moving to the Active Power, Current, Voltage, Power Factor, and Reactive Power Displays	1-10
●	Moving between Total Power Consumption Displays.....	1-11
●	Moving between the Pulse Input Count, Specific Power Consumption, and Pulse Input ON Time.....	1-12
●	Moving between the Total Power Consumptions and Total Times for HIGH, MIDDLE, and LOW States.....	1-12
■	Protection Setting Mode	1-16
■	Setting Modes	1-17
●	Operation Setting Mode (State Transitions).....	1-17
●	Communications Setting Mode (State Transitions).....	1-17
●	Incrementing and Decrementing Numbers and Characters	1-18
■	Entering Set Values	1-24
■	Basic Key Operations	1-24
1. 5	Insulation Block Diagram	1-25

1. 1 Main Features and Functions

■ Main Features

- The KM50-E can measure a 480-V input with a three-phase, four-wire circuit.
- A three-state power classification function lets you check the measurement status of the active power, current, or voltage using changes in the backlight color. The total power consumption and total time can also be classified into HIGH, MIDDLE, or LOW power according to the measured values or event inputs.
- The total power consumption can be logged every hour, day, or month.
- The total regenerated energy and reactive power consumption can be found.
- Regenerative power is reverse power, such as power that can be sold to the power company.
- The total power consumption can be converted to the equivalent CO₂ emission or power cost.
- The pulse input count can be converted to find the specific power consumption, pulse input ON time, or pulse converted value.
- The maximum and minimum values of the active power, current, voltage, and power factor can be logged daily for 8 days.
- Measurement values can be automatically moved using the rotation function.
- Incorrect voltage input wiring can be detected.
- The LCD display turns OFF to save energy when the Display ON Time is set.
- A function for measuring simple temperatures is included (with a built-in thermister).
- A buzzer makes key operation easier.
- Parameters are separated into Basic and Professional Levels for easier operation.
 - Basic Level: Provides basic parameters in Measurement Mode or in the Setting Modes. (Refer to pages 1-13 and 1-19.)
 - Professional Level: Provides application parameters in Measurement Mode or in the Setting Modes. (Refer to pages 1-14 and 1-20.)
- Both CompoWay/F and Modbus communications protocols are supported by one Power Monitor.
- The internal clock is backed up for 7 days by a super capacitor.
- IP66 protection is provided for front panel (with enclosed Waterproof Packing).
- The KM50-E complies with IEC safety standards and EMC standards.
- The KM50-E is also certified for the Korean S-Mark and UL standard.
- Application is possible for inverter primary power (2nd, 3rd, 5th, 7th, 9th, 11th, and 13th harmonics).
- An accuracy of $\pm 2.5\%$ FS has been achieved for the rated voltage and rated current for the 2nd, 3rd, 5th, 7th, 9th, 11th, and 13th harmonics. (The measurement accuracy for harmonics is $\pm 0.5\%$ added to the $\pm 2.0\%$ FS normal measurement accuracy.)

■ Main Functions

This section introduces the main functions of the KM50-E.

● Outputs

The following outputs are provided.

Two total power consumption pulse or alarm outputs^{*1}, and three 3-state outputs.

*1. The function of the outputs can be changed in the settings.

● Total Power Consumption Pulse Output

A pulse is output when the total power consumption reaches the number of pulses set by the user in the Pulse Output Unit parameter.

The OUT1 or OUT2 operation indicator (the indicator for the terminal that was set in the output terminal function settings) will light when there is a pulse output.

The pulse ON time is normally 0.5 seconds.

However, if the pulse output frequency is too short, the pulse output frequency is given priority, and the pulse ON time will be shorter to a minimum pulse ON time of 0.1 seconds. The pulse OFF time will also be 0.1 seconds. The pulse OFF time will also be 0.1 seconds.

The pulse output is processed each sampling cycle.

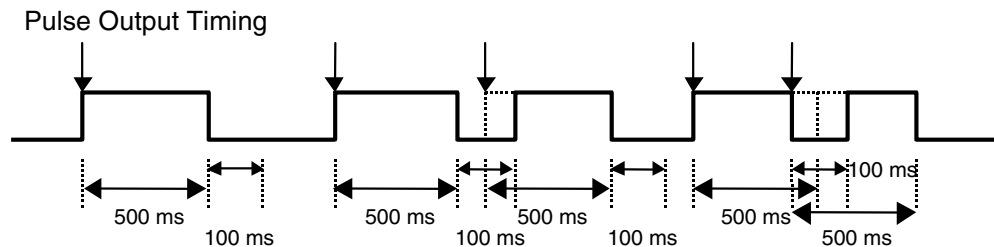

● Three-state Outputs

You can set a HIGH threshold and a LOW threshold to keep separate power consumption totals and total times for HIGH, MIDDLE, and LOW status.

The classification target can be selected from the active power, current, voltage, or none and a HIGH threshold and LOW threshold can be set to separate the measurement status into HIGH, MIDDLE, and LOW states. Any value above the HIGH threshold is classified as the HIGH state, any value below the LOW threshold is classified as the LOW state, and any value between the HIGH and LOW thresholds is classified as the MIDDLE state. The total power consumption, total power ratio, total time, and total time ratio are displayed for each status. It is also possible to classify the measurements into three states according to input status of event inputs 1 and 2.

The applicable three-state output is turned ON according to the current status while the three-state energy classification is being used. In the Setting Modes and Protection Setting Mode, both the measurements and the three-state outputs are stopped.

The backlight color will change according to the status while a three-state output is ON. The backlight color can be changed in the settings.

● Alarm Output

If the measurement value exceeds the Instantaneous Power Alarm Output Threshold, the alarm output will turn ON.

When there is an alarm, the OUT1 or OUT2 operation indicator (the indicator for the terminal that was set in the output terminal function settings) will light, and normal display will alternate with an alarm display. The operating mode can be changed with a mode change procedure even while an alarm is being output. Automatic rotation is not performed while an alarm is output. In the Setting Modes and Protection Setting Mode, both the measurements and the alarm outputs stopped.

The alarm output will be automatically turned OFF when the present measurement value becomes less than the alarm threshold.

● Inputs

The following inputs are provided.

Inputs: Two event inputs

Pulses for inputs from external devices can be counted.

With the event inputs, you can calculate the specific power consumption by dividing the total power consumption by the total pulse count for both inputs (called the pulse input count), calculate the pulse input ON time from an OR condition of the inputs, or use the three-state energy classification function.

The specific power consumption can be used to calculate the takt power for the production line.

The pulse input ON time can be used to calculate the equipment operating time.

Note: Separate I/O common terminals are provided. Wire the terminals correctly according to the information in the wiring diagrams on page 2-5.

● Communications

Communications are possible using either CompoWay/F¹ or Modbus (RTU)².

*1: CompoWay/F is a general-purpose OMRON serial communications protocol. The CompoWay/F protocol supports standard frame formats and FINS-compliant commands, which are widely used by OMRON Programmable Controllers and other devices, for easy communications between computers and components.

*2: This protocol complies with the RTU Mode of the Modbus Protocol. Modbus is a registered trademark of Schneider Electric.

● Logging Measurement Data

The KM50-E provides a data logging function. This function saves the measured values in EEPROM every 5 minutes, every hour, every day, and every month.

Data can be logged as described below.

1) Measurement values can be logged every 5 minutes.

The data is logged every five minutes starting from 00.00 (mm.ss).

The following data can be logged.

- Total power consumption, total regenerated energy, total leading reactive power consumption, total lagging reactive power consumption, and total reactive power consumption

Note: The total regenerated energy, or the total leading reactive power consumption, total lagging reactive power consumption, and total reactive power consumption are saved according to the parameter setting.

- Three-state total power consumptions

2) Measurement values can be logged every hour.

The measurement values that were logged every 5 minutes are totaled every hour and logged.

- Total power consumption

3) Measurement values can be logged every day.

The data is logged every 24 hours starting from 00:00.00 (hh:mm:ss).

The following data can be logged.

- Active power, current, voltage, or maximum/minimum power factors
- Total power consumption
- Pulse input count, pulse input ON time, and specific power consumptions
- Three-state total power consumptions and three-state total times

4) Measurement values can be logged every month.

The data is logged every month starting from day 1, 00:00.00 (hh:mm:ss).

The following data can be logged.

- Total power consumption

● Measurement Data Update Period

The measurement values are updated every five minutes starting from 00.00 (mm.ss).

The following data can be logged.

- Active power, current, voltage, or maximum/minimum power factors
- Pulse input count, pulse input ON time, or specific power consumption.

1.2 Part Names and Functions

■ Front Panel

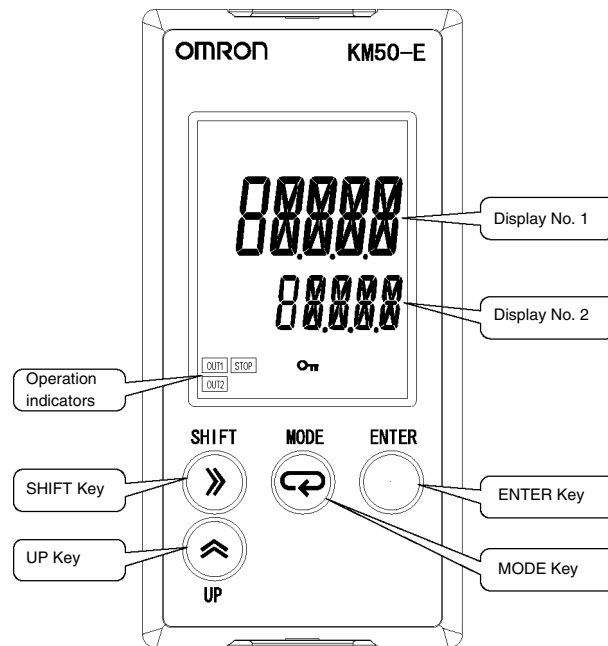

■ Display Functions

1) Display No. 1

The measured value or set data is displayed here.

When three-state power classification is used, the backlight color changes according to the measurement status.

2) Display No. 2

The unit of the measured or set data, or the parameter name is displayed here.

3) Operation Indicators

- OUT1

Lights according to output that is set for terminal OUT1.

- OUT2

Lights according to output that is set for terminal OUT2.

- STOP

Lights if the power supply is turned ON when the backup power supply for the time data has expired while power was interrupted. The time measurement function will be stopped in this state. This indicator will turn OFF when the time data is set. Measurement data cannot be logged while this indicator is lit.

It will light when the Power Monitor is started with the default settings.

- **On** (Key)

Lit while the settings are protected.

4) Temperature Unit

If Celsius is set as the temperature unit, °C will be displayed. If Fahrenheit is set, °F will be displayed.

■ LCD Backlight

The color of the LCD backlight for display No. 1 will be as given in the following table.

Mode	Status	Color
Protection Setting Mode	Any status	Green
Setting Mode	Any status	Green
Measurement Mode	HIGH	Green, orange, or red can be set.
	MIDDLE	
	LOW	
	Three-state Power Classification disabled	Green
	Error message display	Green

1.3 I/O Configuration and Model Number Legend

■ I/O Configuration

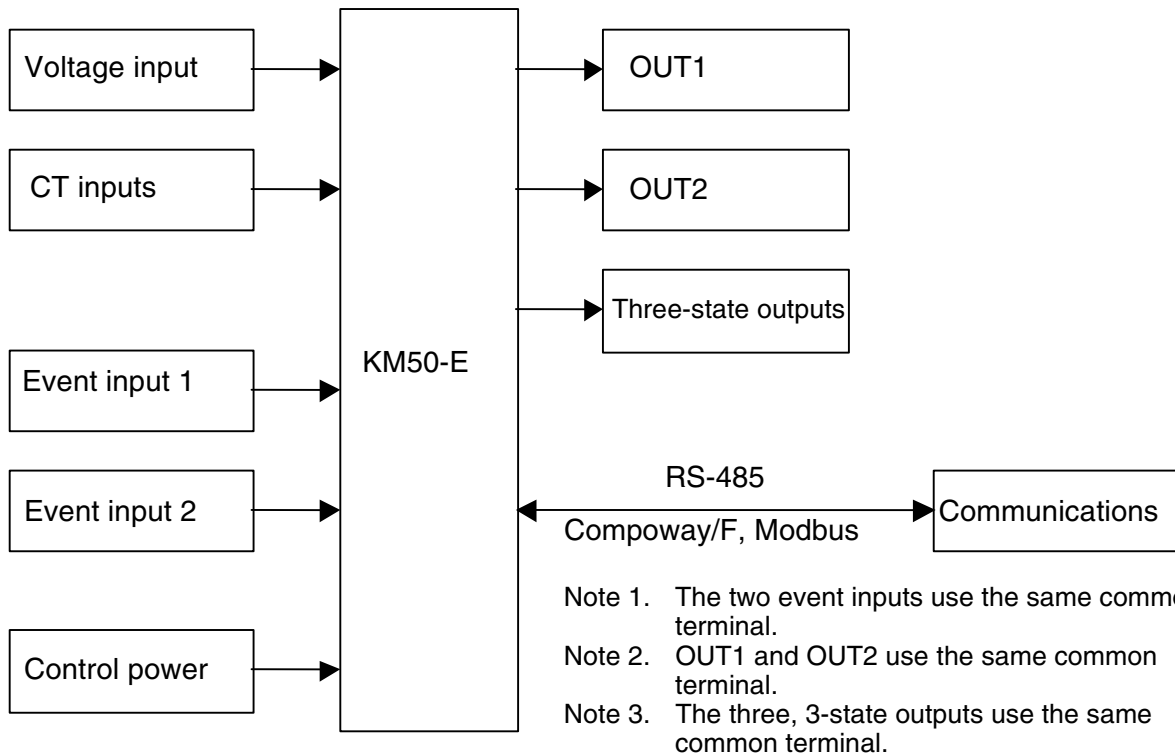

- The following can be measured based on one voltage input and one current input: active power, total power consumption, current, voltage, power factor, reactive power, frequency, total regenerated energy, and total reactive power consumption.
- RS-485 communications can be used to connect to a host system. This enables connecting 31 KM50-E Power Monitors for CompoWay/F or 99 KM50-E Power Monitors for Modbus (not including the master).
 Connect terminating resistance to the nodes at the ends of the transmission path (including the host).
- The power is calculated from the input voltage and current and a pulse signal is output each time the specified power is reached.
 Pulses from external devices can be input and counted.

■ Model Number Legend

KM50 - -
 (1) (2)

Model	(1)	(2)	Description
	Series	Communications	
KM50			
	E1		48x96
		FLK	RS-485 communications

1. 4 Mode Configuration and Key Operations

■ Mode Configuration

Mode		Description	Operation and setting requirements
Measurement Mode	Basic Level	Used to browse measurement data at the basic level.	Operation is required only to browse the data.
	Professional Level	Used to browse measurement data at the professional level.	Operation is required only to browse the data.
Protection Setting Mode		Used to restrict functionality.	The parameter in this mode must be set only when required.
Setting Modes	Operation Setting Mode	Basic Level	Used to set functions at the basic level.
		Professional Level	Used to set functions at the professional level.
	Communications Setting Mode	Used to set communications.	The parameters in this mode must be set only when using communications.

The following figure shows how to move between the modes.

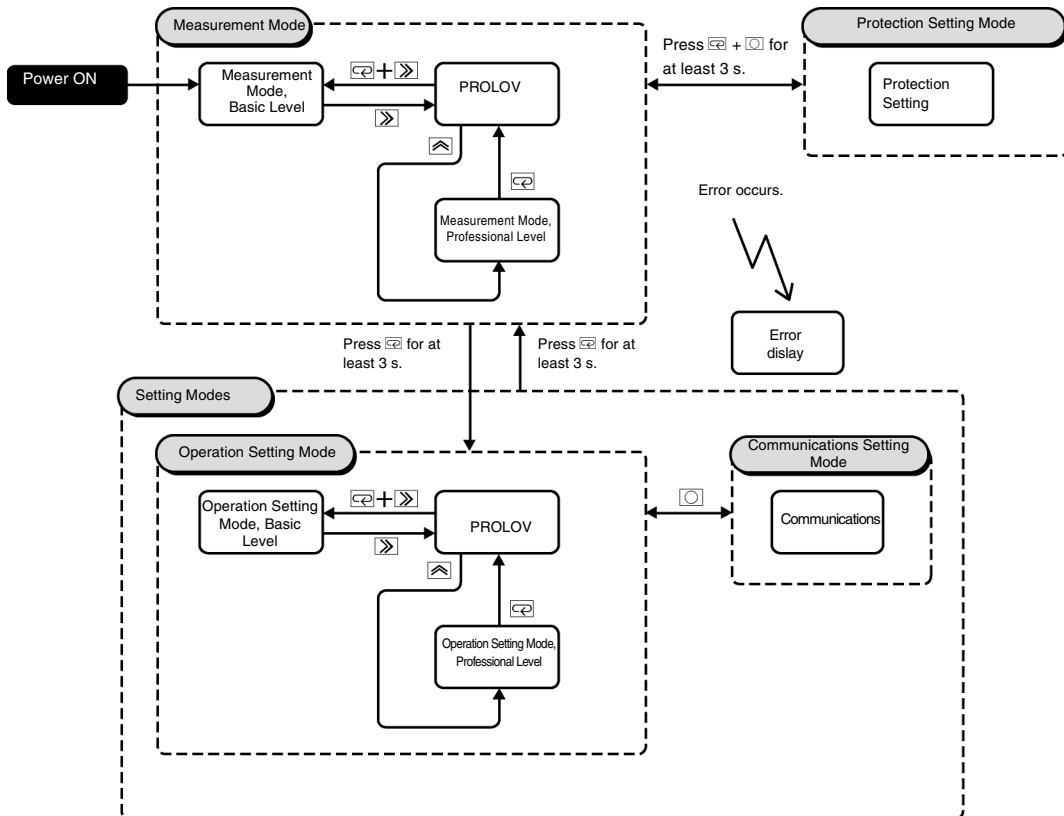

- If you press the **F2** Key for 3 seconds, display No. 1 will start flashing in 1 second, and then Measurement Mode will change to Operation Setting Mode 2 seconds later.
 - If you press the **F2** Key for 3 seconds, *5R/E* will be displayed in 3 seconds, and then the current Setting Mode will change to Measurement Mode.
 - If you press the **F3** Key once, you can switch between Operation Setting Mode and Communications Setting Mode.
- If an error occurs, the error display will appear.
- * For details of the error status and recovery method, refer to page 5-2.
- If you press the **F3** + **F2** Keys for three seconds in Measurement Mode or Protection Setting Mode, you can switch between Measurement Mode and Protection Setting Mode 3 seconds later.
 - Measurements are stopped during Protection Setting Mode and the Setting Modes. The clock will continue.

Measurement Mode

- The following figure shows how to move within Measurement Mode.
- Dotted lines show movements in the measurement log display. The operating mode can be changed with a mode change procedure even during the measurement log display. The measurement values for the current day in the measurement log can be reset by pressing the  Key for 3 seconds when the measurement log data for the maximum or minimum values for the current day is displayed.

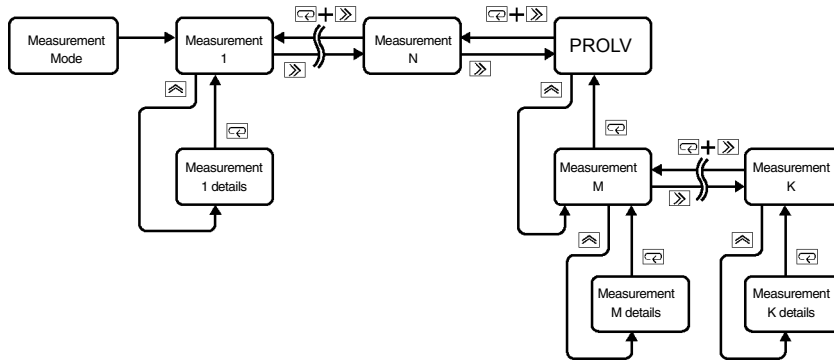

- Moving to the Active Power, Current, Voltage, Power Factor, and Reactive Power Displays

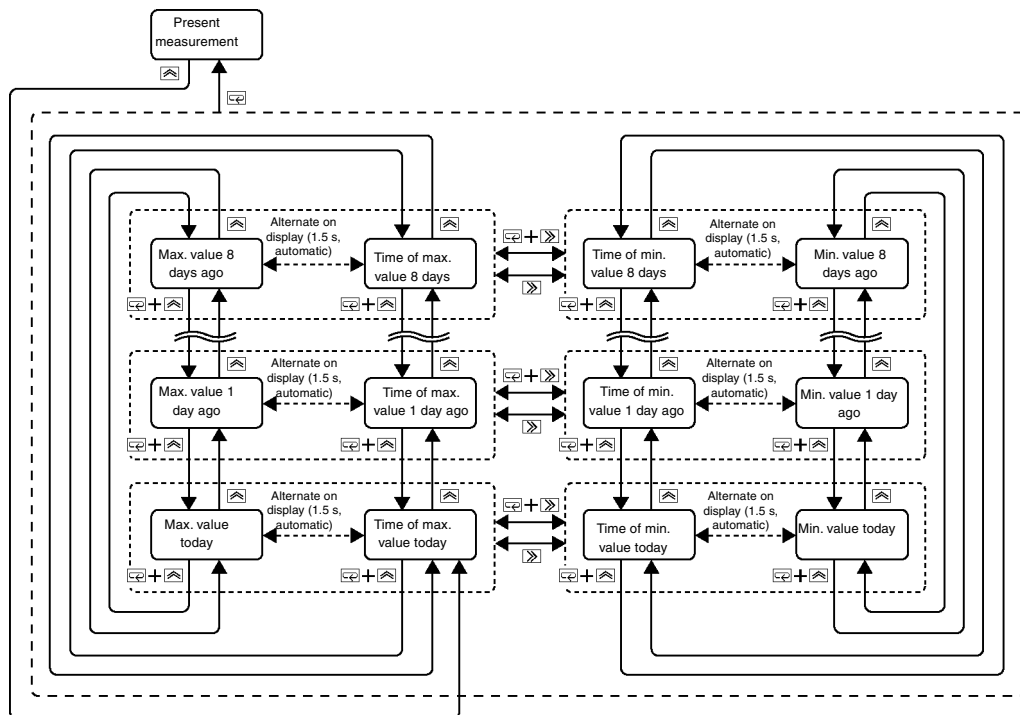

Note: For the reactive power, only the measurement log data for the current day is displayed.

● Moving between Total Power Consumption Displays

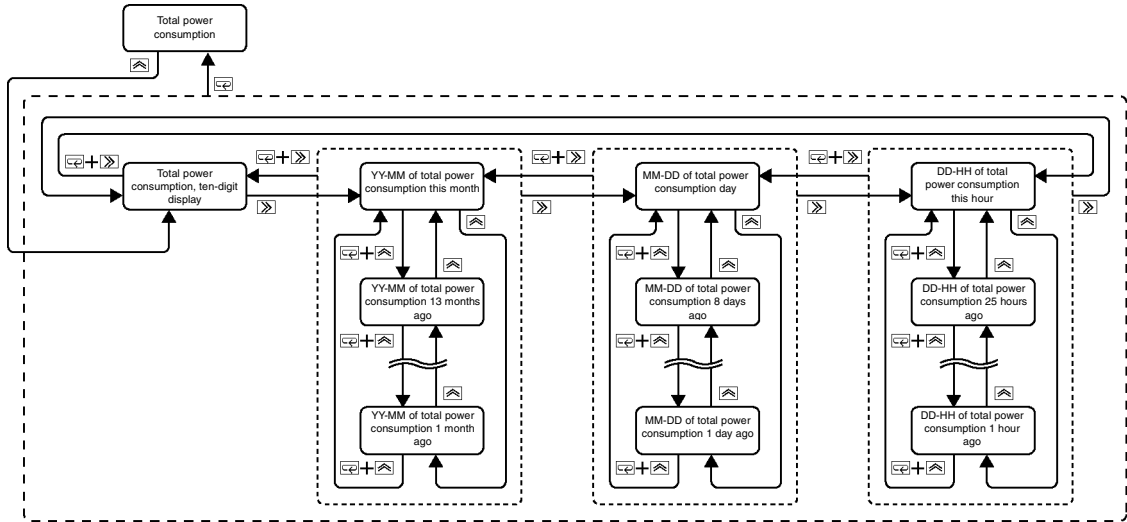

● Moving between Monthly Measurement Log

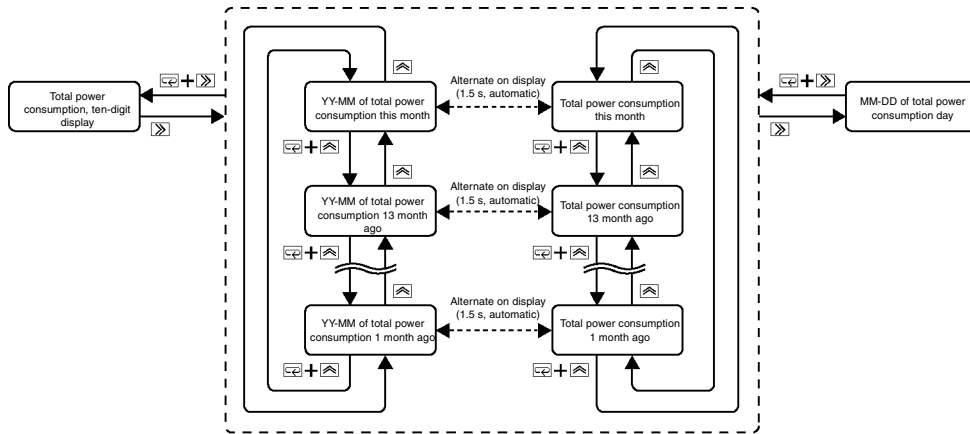

● Moving between Daily Measurement Log

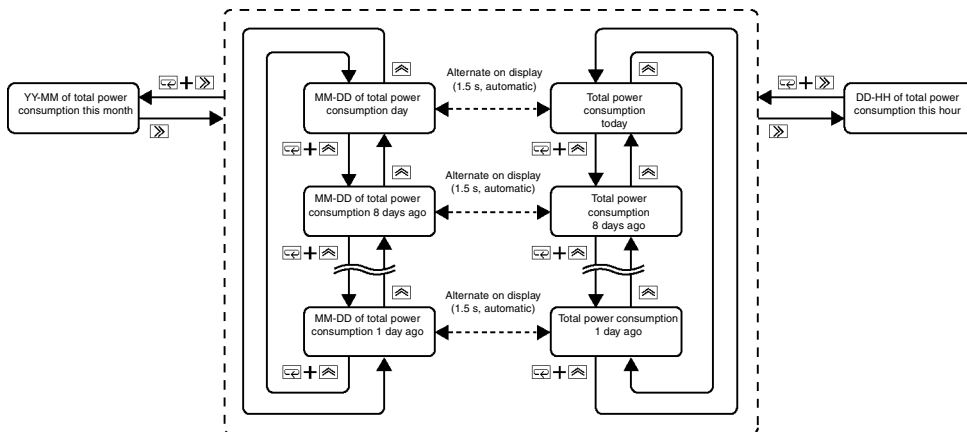

- Moving in Hourly Measurement Log

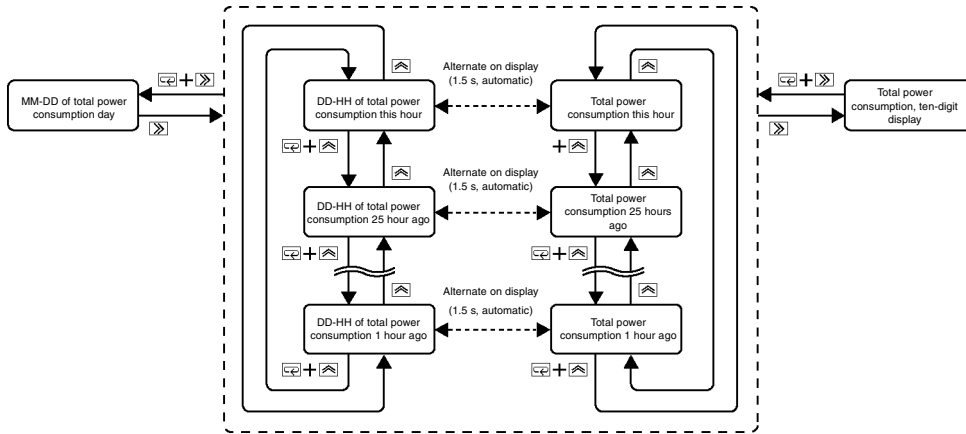

- Moving between the Pulse Input Count, Specific Power Consumption, and Pulse Input ON Time

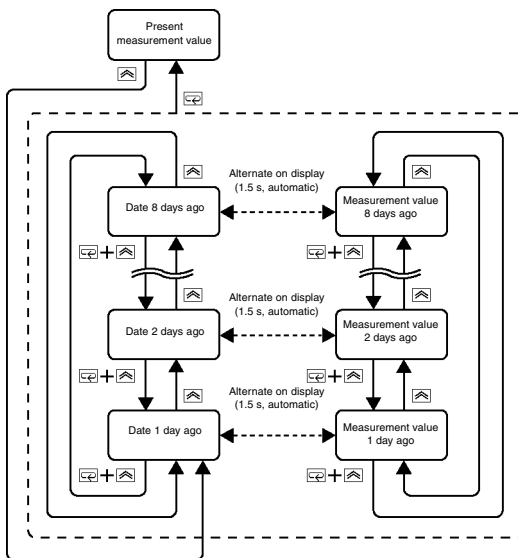

- Moving between the Total Power Consumptions and Total Times for HIGH, MIDDLE, and LOW States

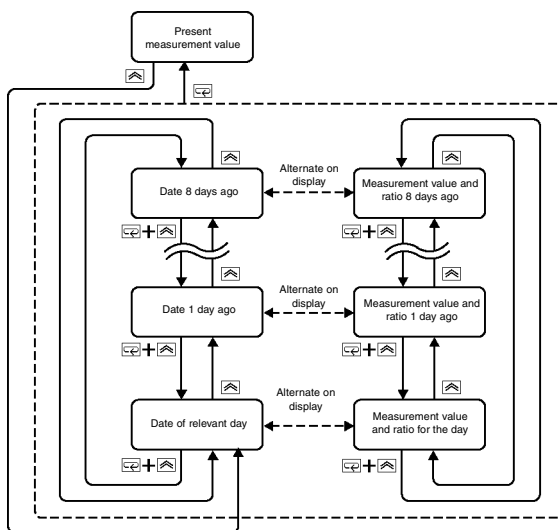

Parameters That Can Be Checked in Measurement Mode

	Parameter	Display No. 1	Display No. 2	Unit	Remarks
Basic Level	Active Power	-9999 to 99999	kWh	kW	The location of the decimal point depends on the measurement value.
	Total Power Consumption	0.0 to 9999.9	kWh MWh	kWh MWh	The unit depends on the measurement value.
	Current 1	0.000 to 99999	A R-R	A	The location of the decimal point depends on the measurement value. Only R is displayed for a single-phase, two-wire circuit. For a single-phase three-wire, three-phase three-wire, or R-R is displayed for a three-phase, four-wire circuit.
	Current 2	0.000 to 99999	R-N R-S	A	The location of the decimal point depends on the measurement value. Not displayed for a single-phase, two-wire circuit. R-N is displayed for a single-phase, three-wire circuit. R-S is displayed for a three-phase, three-wire or three-phase, four-wire circuit.
	Current 3	0.000 to 99999	R-S R-t	A	The location of the decimal point depends on the measurement value. Not displayed for a single-phase, two-wire circuit. R-S is displayed for a single-phase, three-wire circuit. R-t is displayed for a three-phase, three-wire or three-phase, four-wire circuit.
	Voltage 1	0.0 to 99999	V V-RN V-RS V-R	V	Only V is displayed for a single-phase, two-wire circuit. V-RN is displayed for a single-phase, three-wire circuit. V-RS is displayed for a three-phase, three-wire circuit. V-R is displayed for a three-phase, four-wire circuit.
	Voltage 2	0.0 to 99999	V-SN V-SL V-S	V	Not displayed for a single-phase, two-wire circuit. V-SN is displayed for a single-phase, three-wire circuit. V-SL is displayed for a three-phase, three-wire circuit. V-S is displayed for a three-phase, four-wire circuit.
	Voltage 3	0.0 to 99999	V-RS V-tR V-t	V	Not displayed for a single-phase, two-wire circuit. V-RS is displayed for a single-phase, three-wire circuit. V-tR is displayed for a three-phase, three-wire circuit. V-t is displayed for a three-phase, four-wire circuit.
	Power Factor	-1.00 to 1.00	PF	-	
	Reactive Power	-9999 to 99999	kVar	kvar	The location of the decimal point depends on the measurement value.
	Frequency	45.0 to 65.0	Hz	Hz	
	Calculated CO ₂	0.0 to 9999.9	kg-CO ₂	kg-CO ₂	μ or \bar{n} is displayed as the uppermost byte on display No. 2, where μ means 10 ³ and \bar{n} means 10 ⁶ .
	Converted Monetary Cost	0.0 to 9999.9	Any four digits μ + Any four digits \bar{n} + Any four digits	-	Display No. 2 can be set as desired. μ or \bar{n} is displayed as the uppermost byte of display No. 2.
	Pulse Converted Value 1	0.0 to 9999.9	Any four digits μ + Any four digits \bar{n} + Any four digits	-	Display No. 2 can be set as desired. μ or \bar{n} is displayed as the uppermost byte of display No. 2.
	Pulse Converted Value 2	0.0 to 9999.9	Any four digits μ + Any four digits \bar{n} + Any four digits	-	Display No. 2 can be set as desired. μ or \bar{n} is displayed as the uppermost byte of display No. 2.
	Time	00-00 to 23-59	0 1/0 1 to 12/3 1	-	Display No. 1: Hour-Minutes Display No. 2: Month/Day of month

	Parameter	Display No. 1	Display No. 2	Unit	Remarks
Professional Level	Pulse Input Count	0 to 99999	ENE	Pulses	Pulses are counted when counting is enabled.
	Specific Power Consumption	0.000 to 99999	PWH/P	kWh/pulse	Measured when PESP is set. The location of the decimal point depends on the measurement value.
	Pulse Input ON Time	00-00 to 24-00	H-ON	Hour-minutes	Measured when H-ON is set.
	HIGH Total Power Consumption	0.000 to 99999	PWH-H	kWh	The location of the decimal point depends on the measurement value.
	MIDDLE Total Power Consumption	0.000 to 99999	PWH-M	kWh	The location of the decimal point depends on the measurement value.
	LOW Total Power Consumption	0.000 to 99999	PWH-L	kWh	The location of the decimal point depends on the measurement value.
	HIGH Total Time	00-00 to 24-00	ETM-H	Hour-minutes	
	MIDDLE Total Time	00-00 to 24-00	ETM-M	Hour-minutes	
	LOW Total Time	00-00 to 24-00	ETM-L	Hour-minutes	
	Total Regenerated Energy	0.0 to 9999.9	-KWH -MWH	-kWh -MWh	The unit depends on the measurement value. Displayed when the Total Power Consumption Display Setting is ON.
	Total Leading reactive power consumption	0.0 to 9999.9	rVH.d MVH.d	Kvarh Mvarh	The unit depends on the measurement value. Displayed when Total Power Consumption Display Setting is ON.
	Total Lagging reactive power consumption	0.0 to 9999.9	rVH.G MVH.G	Kvarh Mvarh	The unit depends on the measurement value. Displayed when Total Power Consumption Display Setting is ON.
	Total reactive power consumption	0.0 to 9999.9	rVH.R MVH.R	Kvarh Mvarh	The unit depends on the measurement value. Displayed when Total Power Consumption Display Setting is ON.
	Simple Temperature	-15.0 to 140.0	TEMP	°C °F	Either Celsius or Fahrenheit can be selected. Special characters are displayed: °C or °F
	Product Information	E IFLK	Software version	-	

Note 1. E-5 l is displayed if the voltage exceeds 110% of the voltage rating. E-5 2 is displayed if the current exceeds 120% of the current rating. E-5 3 is displayed if the frequency goes below 45 Hz or above 65 Hz. Each of these indicates an error.

Note 2. If a value that is outside the display range is input, the maximum or minimum display value will flash.

Note 3. The log information is not cleared automatically even if the Application Circuit parameter or other parameters are changed. Initialize (I5.L NL) the KM50-E Power Monitor as required.

The following total power consumptions can be checked in the measurement log.

Parameter	Display No. 1	Display No. 2	Remarks
Total Power Consumption, ten-digit display	000000000 to 999999999		The total power consumption is displayed in the 10 digits of displays No. 1 and 2. Unit: Wh
Total Power Consumption	0.0 to 9999.9	KWH MWH	The total power consumptions in the measurement log can be displayed for the following times: Each month from the current month to 13 months ago, each day from the current day to 8 days ago, and each hour from the current hour to 25 hours ago. Display No. 2 will show the following: Monthly log: YY-MM (last two digits of the year and the month), Daily log: MM/DD, Hourly log: DD-HH.

Note: If 9999.99 MWh is exceeded, the total power consumption will restart from 0. The measurement log will also show the value restarted from 0.

Measurement values of the following parameters can be checked using communications only.

Item	Measurement range	Unit	Remarks
Pulse Input Count 1	0 to 99999	Pulses	This is the input pulses on event input 1. It is initialized to 0 every day.
Pulse Input Count 2	0 to 99999	Pulses	This is the input pulses on event input 2. It is initialized to 0 every day.
Total Pulse Input Count	0 to 999999999	Pulses	This is the sum of pulse input counts 1 and 2.
Total Pulse Input Count 1	0 to 999999999	Pulses	This is the input pulses on event input 1. It is not initialized every day.
Total Pulse Input Count 2	0 to 999999999	Pulses	This is the input pulses on event input 2. There is no daily initialization.
HIGH Total Power Consumption	0.0 to 9999999999	Wh	There is no daily initialization.
MIDDLE Total Power Consumption	0.0 to 9999999999	Wh	There is no daily initialization.

Item	Measurement range	Unit	Remarks
LOW Total Power Consumption	0.0 to 9999999999	Wh	There is no daily initialization.
HIGH Total Time	0 to 99999	Minutes	There is no daily initialization.
MIDDLE Total Time	0 to 99999	Minutes	There is no daily initialization.
LOW Total Time	0 to 99999	Minutes	There is no daily initialization.

Note 1. The measurement values return to 0 when the upper limits are exceeded, except for pulse input counts 1 and 2.

Note 2. Pulse input counts 1 and 2 and the total pulse input count are synchronized at the same time.
Pulse input counts 1 and 2 and the total pulse input count are not synchronized at the same time.
Each measurement value is initialized when it reaches the maximum value.

■ Protection Setting Mode

- The operations to change settings can be restricted by setting protection. If protection has been set, the **Key** (Key) indicator will light. (The protection setting can also be changed by using communications.)
- Protection can be set to a protection level in Protection Setting Mode.
- The following figure shows how to move within Protection Setting Mode. You cannot move to other modes while setting protection.
- The following figure shows how to move to Protection Setting Mode.

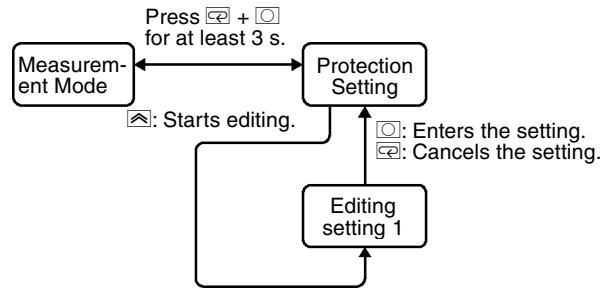

The following figure shows how to move within Protection Setting Mode.

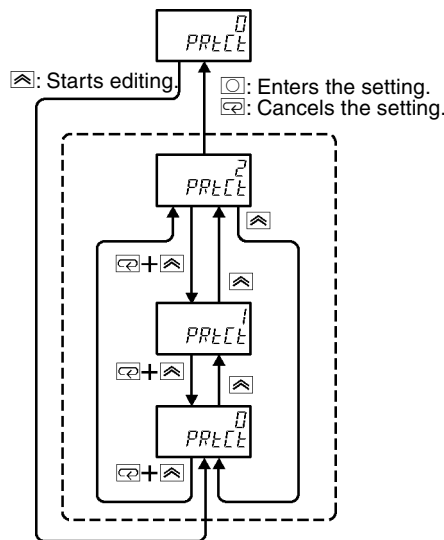

Parameter Settings

Parameter	Display	Set value	Default setting	Remarks
Protection Setting	<i>PRtEt</i>	0: All operations enabled. 1: Changing settings is prohibited (moving to the Setting Modes is possible). 2: Changing settings and moving to Professional Level is prohibited (moving to the Setting Modes is possible).	0	The measurement log cannot be cleared if this parameter is set to 1 and 2. However, any data can be changed or cleared using communications.

■ Setting Modes

- These modes are use to set all parameters other than the Protection Setting parameter.
- There are two Setting Modes: Operation Setting Mode and Communications Setting Mode.
- All measurements will stop in either Setting Mode.

● Operation Setting Mode (State Transitions)

- The following figure shows how to move to and within Measurement Setting Mode.

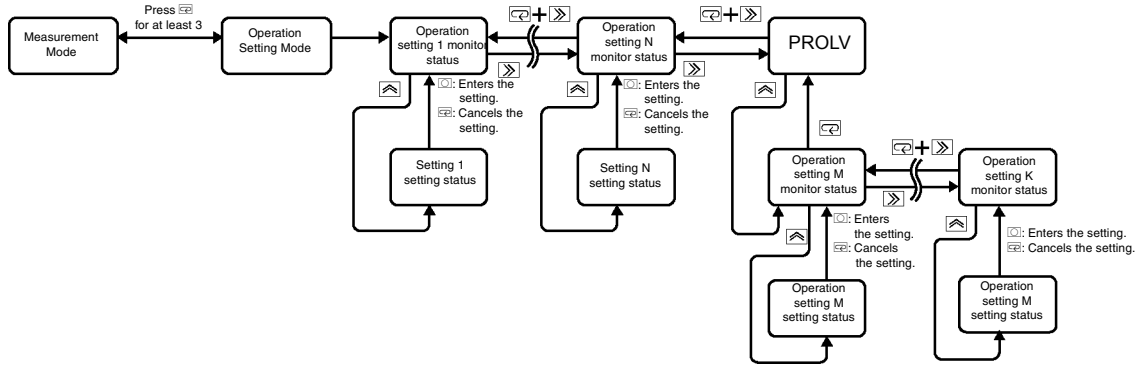



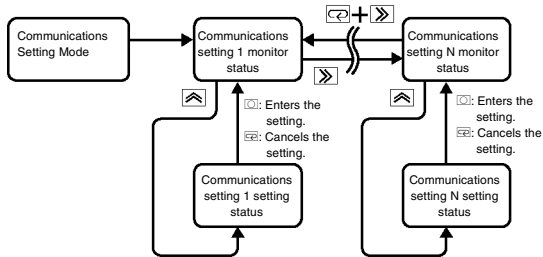

● Communications Setting Mode (State Transitions)



- The following figure shows how to move to and within Communications Setting Mode.

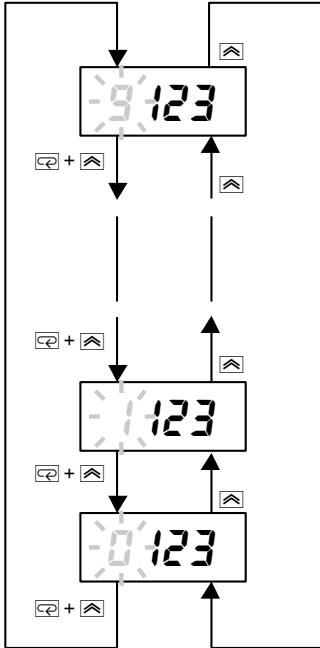

● Incrementing and Decrementing Numbers and Characters

- Use the  and  Keys to change numeric values. (The digit you can change will flash.)
- The value will be incremented by one each time you press the  Key. It will be decremented by one each time you press the + Keys.



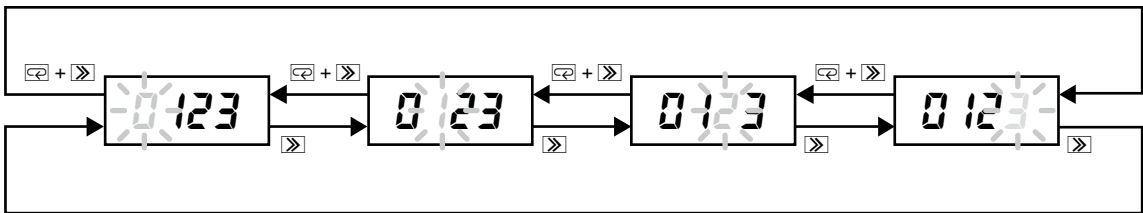

- The digit will move to the right each time you press the  Key. It will move to the left each time you press the + Keys.



Note 1. When digits are incremented, 9 will be incremented to 0. Characters will return to the initial display.

Note 2. The display will not flash during key operations.

Note 3. The  and + Keys are disabled for set values given in text (such as settings described using characters) rather than numerical digits.

The parameters are listed in the following tables.

Operation Setting Mode

	Parameter	Setting range	Display No. 2	Default setting	Remarks	
Basic Level	Applicable Circuit	1P2W, 1P3W, 3P3W, 3P4W	00.LYF	3P3W	1P2W: Single-phase, 2-wire 1P3W: Single-phase, 3-wire 3P3W: 3-phase, 3-wire 3P4W: 3-phase, 4-wire	
	Special CT	5A, 50A, 100A, 200A, 400A, 600A	01.CRG	100A		
	Rated Primary Current	5 to 9999	02.SCE	5	Enabled only when a 5-A CT is used.	
	VT Settings	VT Primary Voltage	NONE, 220, 440, 3300, 6600, 11000, 22000, 33000	03.VRG	NONE	Disabled when Simple Measurement parameter is set to ON. Unit: V
		VT Secondary Voltage	110, 220	V.RG2	110	Set when the VT Primary Voltage is set to something other than NONE. Unit: V
	Low-cut Current	0.1 to 19.9	04.CUE	0.6	Unit: %	
	Pulse Output Unit	1, 10, 100, 1k, 2k, 5k, 10k, 20k, 50k, 100k	05.PLS	100	Unit: Wh	
	Display Refresh Period	OFF, 0.5, 1.0, 2.0, 4.0	06.REF	1.0	OFF: Continuous refreshing Unit: s	
	Average Count	OFF, 2, 4, 8, 16, 32, 64, 128, 256, 512, 1024	07.AVG	8		
	Simple Measurement Settings	Simple Measurement	OFF, ON	08.SMP	OFF	ON: Set the voltage and power factor. The frequency will be 50 Hz.
		Fixed Voltage	0.0 to 9999.9	VLE	110.0	Can be set only when Simple Measurement parameter is set to ON.
		Fixed Power Factor	0.00 to 1.00	PF	1.00	Can be set only when Simple Measurement parameter is set to ON.
	Buzzer	OFF, ON	09.BZ	ON	Enables or disables the buzzer that sounds for key operations.	
	CO ₂ Coefficient	0.000 to 99.999	10.CO2	0.387	Unit: kg-CO ₂ /kWh	
	Conversion to Monetary Cost Setting	Conversion to Monetary Cost Setting	-	11.CHG	-	
		Rate Setting	0.000 to 99.999	RRE	10.00	
		Currency Setting	JPY, USD, EUR, CNY, HKD, R to Z, 0 to 9, /, -, _(Space)	UNCLE	JPY	Up to four digits can be set for the currency unit.
	Pulse Conversion Settings	Pulse Conversion 1 Setting	-	12.CV1	-	
		Pulse Conversion Target 1	C-F.d, C-1.d, C-2.d, C-t.R, C-1.R, C-2.R	tRRG	C-1.d	C-t.d: Total Pulse Input Count C-1.d: Pulse Input Count 1 C-2.d: Pulse Input Count 2 C-t.R: Total Pulse Input Count C-1.R: Total Pulse Input Count 1 C-2.R: Total Pulse Input Count 2
		Coefficient Setting 1	0000 to 9999	SLP	0001	
Decimal Point Position Setting 1		0000, 000.0, 00.00, 0.000	CP	0000		
Display Unit Setting 1		R to Z, 0 to 9, /, -, _(space)	UNCLE	M3-1	Up to four digits can be used to set the display unit.	
Pulse Conversion 2 Setting		-	13.CV2	-		
Pulse Conversion Target 2		C-F.d, C-1.d, C-2.d, C-t.R, C-1.R, C-2.R	tRRG	C-2.d	C-t.d: Total Pulse Input Count C-1.d: Pulse Input Count 1 C-2.d: Pulse Input Count 2 C-t.R: Total Pulse Input Count C-1.R: Total Pulse Input Count 1 C-2.R: Total Pulse Input Count 2	
Coefficient Setting 2		0000 to 9999	SLP	0001		
Decimal Point Position Setting 2		0000, 000.0, 00.00, 0.000	dP	0000		
Display Unit Setting 2		R to Z, 0 to 9, /, -, _(space)	UNCLE	M3-2	Up to four digits can be used to set the display unit.	

	Parameter	Setting range	Display No. 2	Default setting	Remarks
Basic Level	Time Setting (Year, Month/Day, Hour/Minutes)	20 10 to 2099 0 1, 0 1 to 12, 3 1 00-00 to 23-59	14.ELM	20 10 0 1 0 1 00-00	The year, month/day, and hour/minutes are set in order. Any changes are ignored if operation is canceled before completion. The new time is saved when the hour-minutes is set.
	Initialize	SEt, MAX, MIN, LINEG, M.PRo, LOG, RL L	12.LNC	SEt	SEt: Initializes all parameters except for the Time Setting parameter. MAX: Initializes the maximum value for the day. MIN: Initializes the minimum value for the day. LINEG: Initializes the total power consumption. M.PRo: Initializes the measured values for the day in the Professional Level of Measurement Mode. LOG: Initializes the entire measurement log. RL L: Initializes all parameters and measurement logs except for the Time Setting parameter.
Professional Level	Event Input Setting	P.ESP, H-ON, 3-5t	30.EL5	P.ESP	P.ESP: Specific power consumption H-ON: Pulse Input ON Time 3-5t: Three-state classification
	Event Input 1 NPN/PNP Input Mode Setting	NPN, PNP	3 1.PN 1	PNP	NPN: No-voltage input PNP: Voltage input
	Event Input 2 NPN/PNP Input Mode Setting	NPN, PNP	32.PN2	PNP	NPN: No-voltage input PNP: Voltage input
	Event Input 1 NO/NC Input Mode Setting	N-ō, N-C	33.LN 1	N-ō	N-ō: Normally open N-C: Normally closed
	Event Input 2 NO/NC Input Mode Setting	N-ō, N-C	34.LN2	N-ō	N-ō: Normally open N-C: Normally closed
	Measurement Start Time	00-00 to 23-59	35.5tC	00-00	The start time must be before the end time. Applies to all measurement values in the Professional Level of Measurement Mode.
	Measurement End Time	00-0 1 to 24-00	36.5tC	24-00	The end time must be after the start time. Applies to all measurement values in the Professional Level of Measurement Mode.
	Three-state Target	PWR, R, V, NONE	40.tGt	NONE	PWR: Active Power R: Current V: Voltage NONE: No target selected Automatically set to NONE if 3-5t is selected in the Event Input Setting.
	Three-state HIGH Threshold	0. 1 to 150.0	4 1.H.tH 0.00k to 9999M 0.00R to 999kR 0.00V to 999kV 0.00	50.0	The set value must be greater than the LOW threshold. During the setting status, the operation value that is converted from the set value is displayed on display No. 2. The operating value depends on the target. Display No. 2 always shows 0.00 when NONE is set. Unit: %
	Three-state LOW Threshold	0.0 to 149.9	42.L.tH 0.00k to 9999M 0.00R to 999kR 0.00V to 999kV 0.00	10.0	The set value must be less than the HIGH threshold. During the setting status, the operation value that is converted from the set value is displayed on display No. 2. The operating value depends on the criteria. Display No. 2 always shows 0.00 when NONE is set. Unit: %
Three-state Hysteresis	0.0 to 19.9	43.H.tS 0.00k to 9999M 0.00R to 999kR 0.00V to 999kV 0.00	0.0	During the setting status, the operation value that is converted from the set value is displayed on display No. 2. The operating value depends on the criteria. Display No. 2 always shows 0.00 when NONE is set. Unit: %	

	Parameter	Setting range	Display No. 2	Default setting	Remarks		
Professional Level	State Color Settings	Three-state Color Setting	—	44.CdL	—	Set the colors for HIGH, MIDDLE, and LOW.	
		Three-state HIGH Color Setting	GREEN, oRRANG, REd	HcGH	GREEN	GREEN: Green oRRANG: Orange REd: Red	
		Three-state MIDDLE Color Setting	GREEN, oRRANG, REd	Mcd	oRRANG		
		Three-state LOW Color Setting	GREEN, oRRANG, REd	LdW	REd		
	Output Terminal Function Settings	Output Terminal 1 Function Setting	oFF, P.oUt, ALARM	50.o1	P.oUt	oFF: Output terminal function is not used. P.oUt: Total Power Consumption Pulse Output ALARM: Alarm Output This setting is completed if oFF or P.oUt is selected. If ALARM is selected, the display moves to the Alarm Output OFF/ON Setting.	
		Active Power Alarm Output Setting	oFF, oN	P.AL	oFF	This parameter can be set only when ALARM is selected in the Output Terminal 1 Function Setting. oFF: Alarm output is not used. oN: Alarm output is used.	
		Regenerative Power Alarm Output Setting	oFF, oN	P.AL	oFF		
		Current Alarm Output Setting	oFF, oN	R.AL	oFF		
		Voltage Alarm Output Setting	oFF, oN	V.AL	oFF		
		Power Factor Alarm Output Setting	oFF, oN	PF.A	oFF		
		Reactive Power Alarm Output Setting	oFF, oN	Q.AL	oFF		
		Output Terminal 2 Function Setting	oFF, P.oUt, ALARM	51.o2	ALARM	oFF: Output terminal function is not used. P.oUt: Total Power Consumption Pulse Output ALARM: Alarm Output This setting is completed if oFF or P.oUt is selected. If ALARM is selected, the display moves to the Alarm Output OFF/ON Setting.	
		Active Power Alarm Output Setting	oFF, oN	P.AL	oFF	This parameter can be set only when ALARM is selected in the Output Terminal 2 Function Setting. oFF: Alarm output is not used. oN: Alarm output is used.	
		Regenerative Power Alarm Output Setting	oFF, oN	P.AL	oFF		
		Current Alarm Output Setting	oFF, oN	R.AL	oFF		
		Voltage Alarm Output Setting	oFF, oN	V.AL	oFF		
		Power Factor Alarm Output Setting	oFF, oN	PF.A	oFF		
		Reactive Power Alarm Output Setting	oFF, oN	Q.AL	oFF		
		Active Power Alarm Output Setting	Active Power Alarm Output	—	52.P.AL	—	The upper and lower limit thresholds, hysteresis, and OFF/ON delays are set consecutively.
			Upper Limit Threshold	0.0 to 150.0	oV.LH, 0.00k to 9999M	80.0	The operation value that is converted from the set value is displayed on display No. 2. Unit: %
Lower Limit Threshold	0.0 to 150.0		UN.LH, 0.00k to 9999M	0.0	The operation value that is converted from the set value is displayed on display No. 2. Unit: %		
Hysteresis	0.0 to 19.9		AL.HYS, 0.00k to 9999M	5.0	The operation value that is converted from the set value is displayed on display No. 2. Unit: %		
OFF Delay	0.0 to 99.9		oF.dLY	3.0	Unit: s		
ON Delay	0.0 to 99.9		oN.dLY	0.0	Unit: s		

	Parameter	Setting range	Display No. 2	Default setting	Remarks	
Professional Level	Regenerative Power Alarm Output Setting	Regenerative Power Alarm Output	–	52.P.AL	–	The upper and lower limit thresholds, hysteresis, and OFF/ON delays are set consecutively.
		Upper Limit Threshold	0.0 to 150.0	UV.LH, 0.00k to 9999M	80.0	The operation value that is converted from the set value is displayed on display No. 2. Unit: %
		Lower Limit Threshold	0.0 to 150.0	UN.LH, 0.00k to 9999M	0.0	The operation value that is converted from the set value is displayed on display No. 2. Unit: %
		Hysteresis	0.0 to 19.9	RL.HYS, 0.00k to 9999M	5.0	The operation value that is converted from the set value is displayed on display No. 2. Unit: %
		OFF Delay	0.0 to 99.9	OF.dLY	3.0	Unit: s
		ON Delay	0.0 to 99.9	ON.dLY	0.0	Unit: s
	Current Alarm Output Setting	Current Alarm Output	–	54.R.AL	–	The upper and lower limit thresholds, hysteresis, and OFF/ON delays are set consecutively.
		Upper Limit Threshold	0.0 to 120.0	UV.LH, 0.00k to 999kA	110.0	The operation value that is converted from the set value is displayed on display No. 2. Unit: %
		Lower Limit Threshold	0.0 to 120.0	UN.LH, 0.00k to 999kA	0.0	The operation value that is converted from the set value is displayed on display No. 2. Unit: %
		Hysteresis	0.0 to 19.9	RL.HYS, 0.00k to 999kA	5.0	The operation value that is converted from the set value is displayed on display No. 2. Unit: %
		OFF Delay	0.0 to 99.9	OF.dLY	3.0	Unit: s
		ON Delay	0.0 to 99.9	ON.dLY	0.0	Unit: s
	Voltage Alarm Output Setting	Voltage Alarm Output	–	55.V.AL	–	The upper and lower limit thresholds, hysteresis, and OFF/ON delays are set consecutively.
		Upper Limit Threshold	0.0 to 120.0	UV.LH, 0.00V to 999kV	110.0	The operation value that is converted from the set value is displayed on display No. 2. Unit: %
		Lower Limit Threshold	0.0 to 120.0	UN.LH, 0.00V to 999kV	0.0	The operation value that is converted from the set value is displayed on display No. 2. Unit: %
		Hysteresis	0.0 to 19.9	RL.HYS, 0.00V to 999kV	5.0	The operation value that is converted from the set value is displayed on display No. 2. Unit: %
		OFF Delay	0.0 to 99.9	OF.dLY	3.0	Unit: s
		ON Delay	0.0 to 99.9	ON.dLY	0.0	Unit: s
	Power Factor Alarm Output Setting	Power Factor Alarm Output	–	56.PF.A	–	The upper and lower limit thresholds, hysteresis, and OFF/ON delays are set consecutively.
		Upper Limit Threshold	0 to 100	UV.LH, 0.00 to 1.00	100	The operation value that is converted from the set value is displayed on display No. 2. Unit: %
		Lower Limit Threshold	0 to 100	UN.LH, 0.00 to 1.00	0	The operation value that is converted from the set value is displayed on display No. 2. Unit: %
Hysteresis		0 to 19	RL.HYS, 0.00 to 1.00	5	The operation value that is converted from the set value is displayed on display No. 2. Unit: %	
OFF Delay		0.0 to 99.9	OF.dLY	3.0	Unit: s	
ON Delay		0.0 to 99.9	ON.dLY	0.0	Unit: s	
Reactive Power Alarm Output Setting	Reactive Power Alarm Output	–	57.Q.AL	–	The upper and lower limit thresholds, hysteresis, and OFF/ON delays are set consecutively.	
	Upper Limit Threshold	0.0 to 150.0	UV.LH, 0.00k to 9999M	80.0	The operation value that is converted from the set value is displayed on display No. 2. Unit: %	
	Lower Limit Threshold	0.0 to 150.0	UN.LH, 0.00k to 9999M	0.0	The operation value that is converted from the set value is displayed on display No. 2. Unit: %	
	Hysteresis	0.0 to 19.9	RL.HYS, 0.00k to 9999M	5.0	The operation value that is converted from the set value is displayed on display No. 2. Unit: %	
	OFF Delay	0.0 to 99.9	OF.dLY	3.0	Unit: s	
	ON Delay	0.0 to 99.9	ON.dLY	0.0	Unit: s	

	Parameter	Setting range	Display No. 2	Default setting	Remarks	
Professional Level	Consumed Power Save Selection	$-W, VRR.d, VRR.E, VRR.R$	$60.L5L$	$-W$	$-W$: Total Regenerated Energy $VRR.d$: Total Leading reactive power consumption $VRR.E$: Total Lagging reactive power consumption $VRR.R$: Total reactive power consumption For details, refer to page 4-48.	
	Automatic Rotation Setting	Automatic Rotation	OFF, ON	$61.RtL$	OFF	Moves to Transition Time when this parameter is set to ON.
		Transition Time	1 to 99	$61.LM$	3	The transition time can be set only when Automatic Rotation is set to ON. Unit: s
	Measurement Parameter Display Selection	OFF, ON	$62.d5L$	See Remarks.	This setting is made individually for each parameter in the Measurement Mode. The default value is OFF for conversion to monetary cost, pulse conversion 1 and 2, total regenerative energy, total leading reactive power consumption, total lagging reactive power consumption, total reactive power consumption, and simple temperature measurement.	
	Display ON Time	0 to 99	$63.d5P$	0	0 : Always lit. Unit: Minutes	
	Incorrect Voltage Wiring Detection	OFF, ON	$64.V-t$	ON		
	Simple Temperature Settings	Temperature Unit	C, F	$65.d-U$	C	C : Celsius, Unit: °C F : Fahrenheit, Unit: °F
Temperature Compensation		-50.0 to 50.0	$65.Rd$	0.0	The compensation is set according to the set Temperature Unit.	













Communications Setting Mode

Item	Setting range	Display No. 2	Default setting	Remarks
Protocol Selection	$CMPF, Modb$	$80.P5L$	$CMPF$	$CMPF$: CompoWay/F $Modb$: Modbus
Unit Number	CompoWay/F: 0 to 99 Modbus: 1 to 99	$81.U.Nd$	1	
Baud Rate	$1.2k, 2.4k, 4.8k, 9.6k, 19.2k, 38.4k$	$82.bP5$	$9.6k$	Unit: bps
Data Length*1	$7, 8$	$83.LEN$	7	Unit: bits
Stop Bits*2	$1, 2$	$84.5bt$	2	Unit: bits
Vertical Parity	$NONE, odd, EVEN$	$85.PRt$	$EVEN$	
Transmission Wait Time	0 to 99	$86.SdW$	20	Unit: ms

*1. The data length will be 8 bits if Modbus is set as the protocol. It cannot be set to any other value.

*2. The number of stop bits will be set automatically if Modbus is set as the protocol. You do not need to set it. If the Vertical Parity parameter is set to "none" there will be 2 stop bits. If it is set to odd or even parity, there will be 1 stop bit.

■ Entering Set Values

- If the  Key is pressed after the last parameter has been displayed, the first parameter in the same mode will be displayed.
- To change a set value, press then  Key to change to setting status. Then press the  Key or  +  Keys, or the  Key or  +  Keys to change the set value. Finally, press the  Key to enter the setting. To cancel a setting, press the  Key.
- Always press the  Key after changing a setting. The set value will not be changed if only keys such as the  Key and  Key are pressed.
- Changes to the settings are saved when you go from a Setting Mode to Measurement Mode.
- The time setting is saved when *PLM* is set.

■ Basic Key Operations

The basic key operations are given in the following table.

"Monitor status" is when set values are displayed in Protection Setting Mode or one of the Setting Modes. "Setting status" is when the set values can be changed in any of these modes.

Key	Basic usage	Mode	Status	Operating method	Operation
	<ul style="list-style-type: none"> • Switching modes. • Entering settings. 	Measurement Mode	Measurement log for current day	Press for at least 3 s.	Clears the displayed maximum and minimum values for the day.
		Protection Setting Mode or Setting Mode	Setting status	Press	Enters the set value.
		Operation Setting Mode	Monitor status	Press	Moves to Communications Setting Mode.
		Communications Setting Mode	Monitor status	Press	Moves to Operation Setting Mode.
	<ul style="list-style-type: none"> • Switching modes. • Canceling operations. 	Measurement Mode	Present measurement value	Press for at least 3 s.	Moves to Operation Setting Mode.
			Measurement log	Press	Moves to present measurement value.
		Setting Modes	Monitor status	Press for at least 3 s.	Moves to Measurement Mode
			Setting status	Press	Cancel setting status.
Measurement Mode Setting Modes	Professional Level	Press	Moves to <i>PROLV</i> in the Basic Level		
	<ul style="list-style-type: none"> • Moving 	Measurement Mode	Present measurement value	Press	Moves to other parameters.
			Measurement log	Press	Switches the measurement log display.
		Setting Modes	Monitor status	Press	Moves to other parameters.
			Setting status	Press	Moves to another digit.
	<ul style="list-style-type: none"> • Moving to setting status. • Changing a set value. 	Measurement Mode	Present measurement value	Press	Moves to the measurement log.
			Measurement log	Press	Moves through the measurement log.
		Setting Modes	Monitor status	Press	Moves to setting status.
			Setting status	Press	Changes the set value.
Measurement Mode Setting Modes	Basic Level with <i>PROLV</i> displayed	Press	Moves to Professional Level.		
 + 	<ul style="list-style-type: none"> • Moving backward. (Hold down  and press  .)	Measurement Mode	Present measurement value	Press	Moves backward to other parameters.
			Measurement log	Press	Switches the measurement log display.
		Setting Modes	Monitor status	Press	Moves backward to other parameters.
			Setting status	Press	Moves backward to another digit.
 + 	<ul style="list-style-type: none"> • Changing the set value in the reverse direction. (Hold down  and press  .)	Measurement Mode	Measurement log	Press	Moves backward through the measurement log.
		Setting Modes	Setting status	Press	Changes the set value in the reverse direction.
 + 	<ul style="list-style-type: none"> • Switching modes. 	Measurement Mode	Present measurement value	Press for at least 3 s.	Moves to Protection Setting Mode
		Measurement log	Press	Moves to Measurement Mode	
 + 		Protection Setting Mode	Monitor status	Press for at least 3 s.	Moves to Measurement Mode

1.5 Insulation Block Diagram

The insulation block diagram for the KM50-E is provided below.

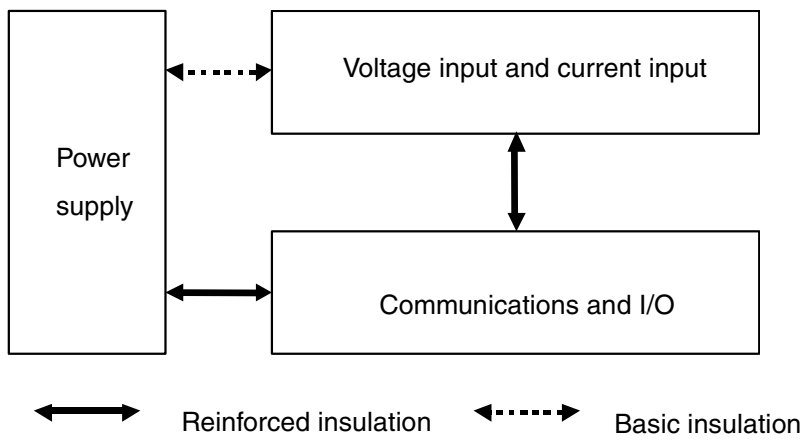

Section 2 Preparations

2.1	Installation	2-2
	■ Dimensions (Unit: mm)	2-2
	■ Panel Cutout Dimensions (Unit: mm).....	2-2
	■ Installation Method.....	2-3
2.2	Mounting the Special CTs.....	2-4
2.3	Using the Terminals.....	2-5
	■ Terminal Arrangement	2-5
	■ Wiring Diagram	2-5
	■ Wiring Methods and Special CT Mounting Locations	2-6
	■ Wiring Precautions.....	2-7
	■ Wiring	2-7
	● Power Supply.....	2-7
	● Measurement Voltage Input	2-7
	● CT Inputs	2-7
	● CT Inputs	2-8
	● Communications.....	2-9
	● Three-state Outputs	2-11
	● Alarm Output	2-13
	● Event Inputs.....	2-14

2.1 Installation

■ Dimensions (Unit: mm)

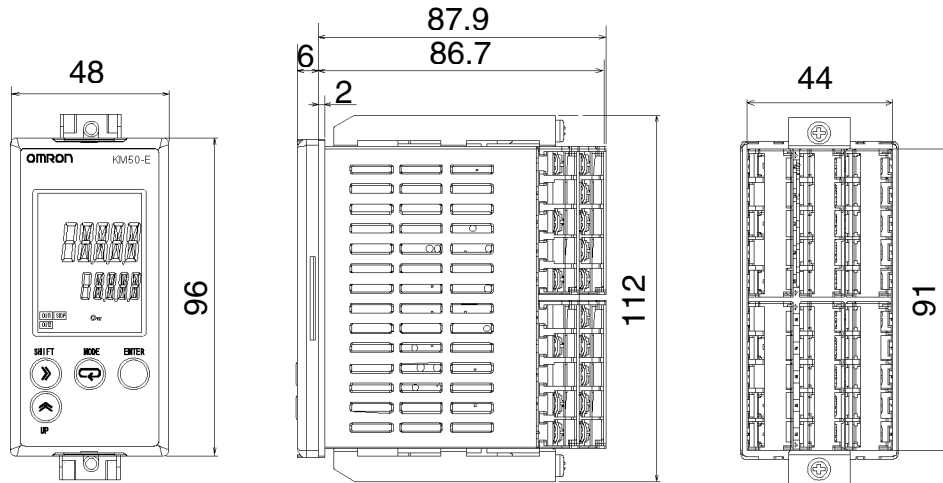

■ Panel Cutout Dimensions (Unit: mm)

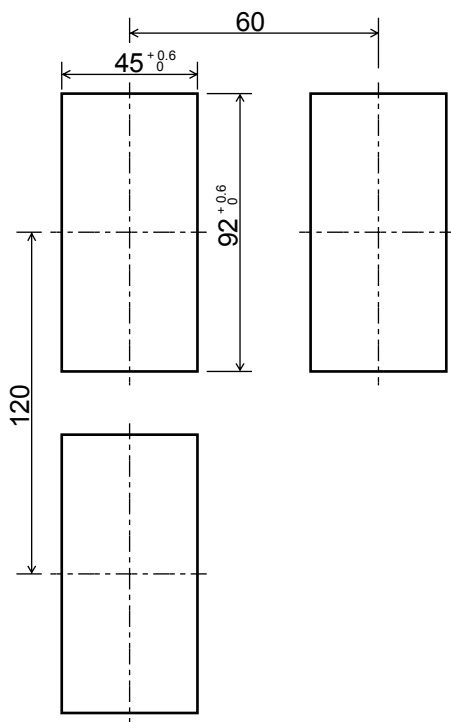

- The mounting panel must be 1 to 8 mm thick.
- When mounting KM50-C Power Monitors side by side, provide sufficient space between them. Reference mounting separation: 120 mm vertically and 60 mm horizontally. Both of these are distances from the centers of the Power Monitors.
- Make sure that the rated ambient temperature of the KM50-E Power Monitor is not exceeded when more than one Power Monitor is mounted.

■ Installation Method

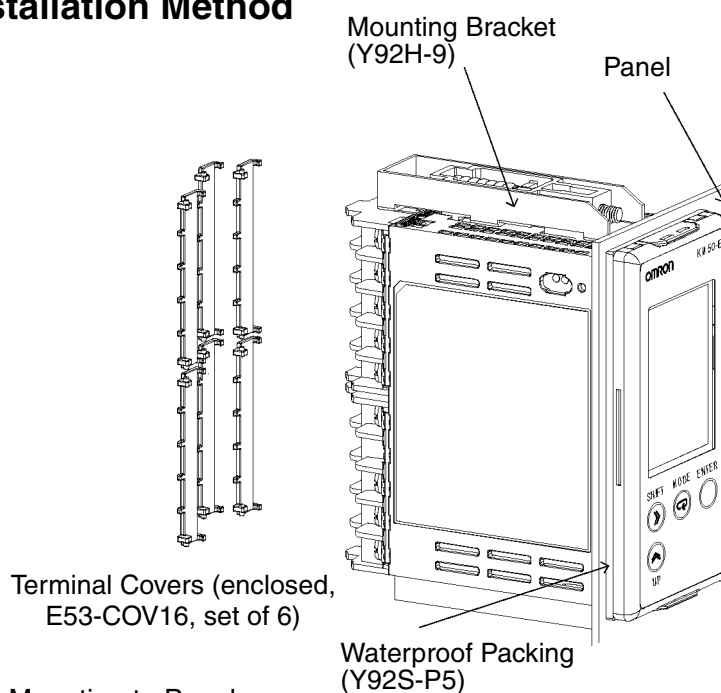

- **Mounting to Panel**
 - (1) If water resistance is required, insert the Waterproof Packing on the KM50-E when mounting it. Attach the Waterproof Packing so that it appears on the front of the mounting panel. Otherwise, the Waterproof Packing is not required.
 - (2) Mount the KM50-E so that the display reads correctly from the front.
 - (3) Insert the KM50-E into a rectangular hole in the panel (panel thickness: 1 to 8 mm).
 - (4) Use the enclosed Mounting Brackets to secure the KM50-E to the panel.
 - (5) Place the enclosed Mounting Brackets in the mounting grooves on the top and bottom surfaces of the rear case. Tighten the screws on the Mounting Brackets evenly on the top and bottom until the ratchets* turn freely.
*A ratchet is a mechanism that prevents overtightening.
- **Mounting the Terminal Covers**
Mount the E53-COV16 Terminal Covers to the terminal block while bending them as shown in the following figure. The Terminal Covers cannot be mounted upside down. The Terminal Covers are provided with the KM50-E.

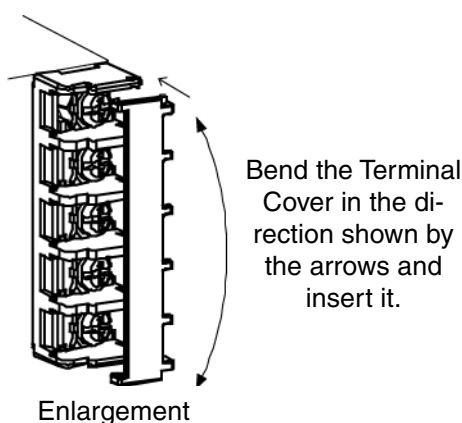

Note: Order the Waterproof Packing or Terminal Covers separately if they are lost or damaged. Depending on the application environment, the Waterproof Packing can deteriorate, shrink, or harden. We recommend that you replace it periodically.

2.2 Mounting the Special CTs

- One Special CT is required to measure a single-phase, two-wire circuit. Two CTs are required to measure a single-phase, three-wire circuit or three-phase, three-wire circuit. Three CTs are required to measure a three-phase, four-wire circuit.
- All the Special CTs connected to one KM50-E Power Monitor must have the same ratings.
- Make sure that the ratings of the Special CTs and the Special CT setting in the KM50-E Power Monitor are the same.
- Check the directions of the power supply (K) and load (L) before making the connections. Correct measurements will not be possible if they are connected in the wrong directions.
- Release the locking hook and clamp the CT on the line. Do this for each phase. Then, press the hook firmly until you hear it lock into place.
- Make sure that the terminal cover on the secondary side of the Special CT is closed securely. Contact with the terminals may result in electric shock.
- Do not ground the Special CTs. Failure may occur.
- The Special CTs have polarity. Connect the Special CT correctly, connecting the 1S, 2S, or 3S terminal on the KM50-E to the k terminal on the CT and the 1L, 2L, or 3L terminal on the KM50-E to the l terminal on the Special CT.

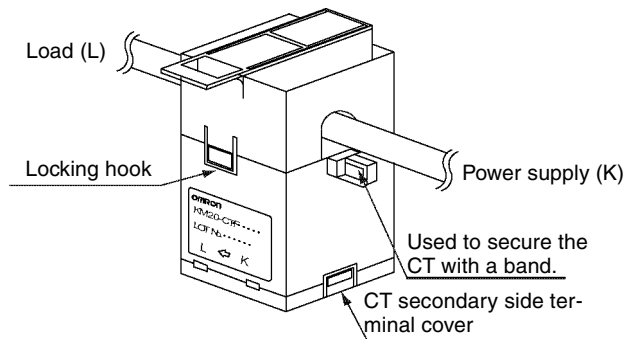

2.3 Using the Terminals

Confirm the terminal arrangement on product labels and printing on the case surface.

Terminal Arrangement

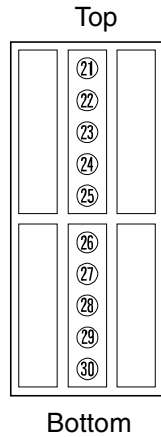

Terminal No.	Terminal name	Terminal No.	Terminal name	Terminal No.	Terminal name
①	P1 voltage	⑪	DO NOT USE	⑪	CT1S
		⑫	Common 1	⑫	CT1L
③	P0 voltage	⑬	Three-state HIGH output	⑬	CT2S
		⑭	Three-state MIDDLE output	⑭	CT2L
⑤	P2 voltage	⑮	Three-state LOW output	⑮	CT3S
		⑯	Event input 2	⑯	CT3L
⑦	P3 voltage	⑰	Common 2		
		⑱	Event input 1	⑱	Common 3
⑨	Control power	⑲	RS-485 B(+)	⑲	OUT1
⑩	Control power	⑳	RS-485 A(-)	⑳	OUT2

Wiring Diagram

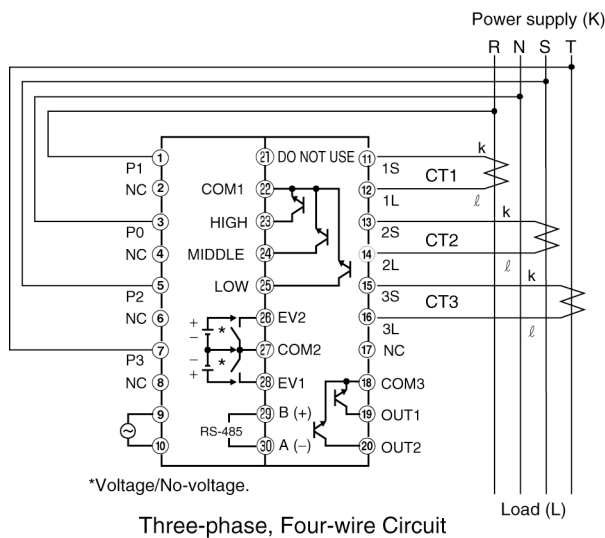
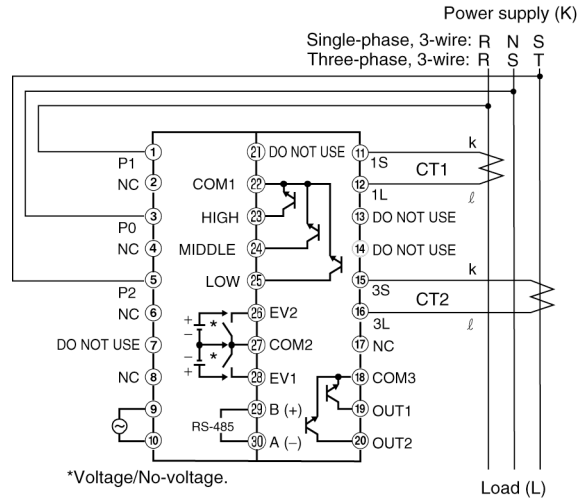
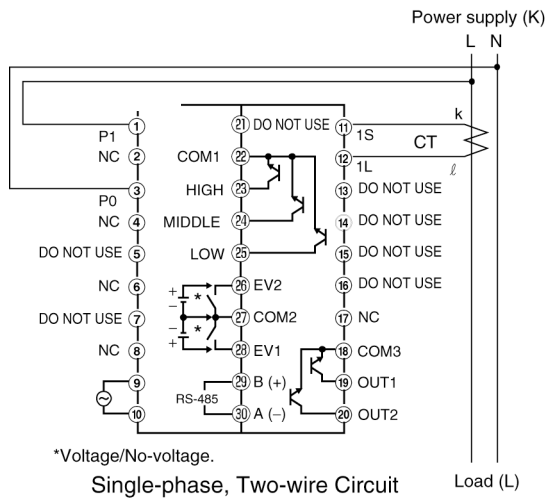

Note 1. Do not ground the Special CTs. Failure may occur.
 Note 2. Use only the Special CTs. Failure may occur.

■ Wiring Methods and Special CT Mounting Locations

The section shows the Special CT mounting locations for various wiring methods and phases.

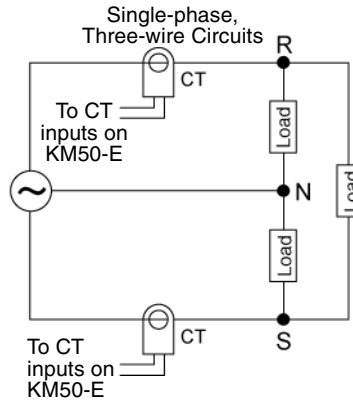
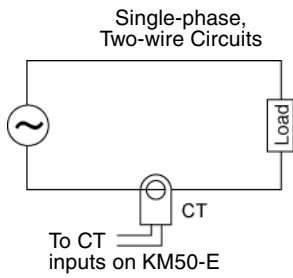

Three-phase, Three-wire Circuits, Star (Y) Wiring

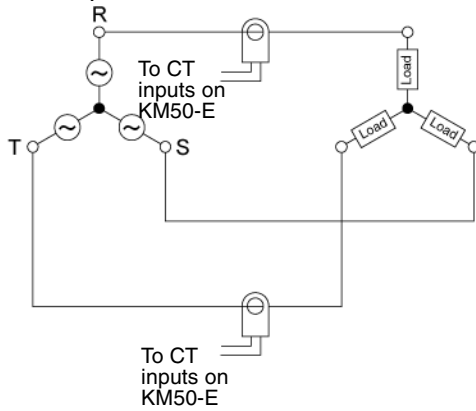

Three-phase, Three-wire Circuits, Delta Wiring

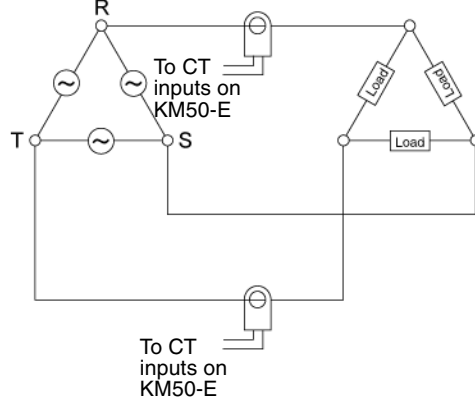

Three-phase, Three-wire Circuits, V Wiring

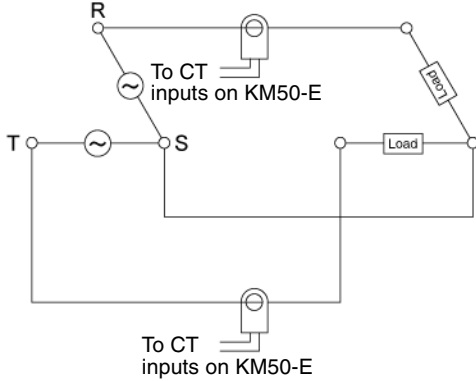

Three-phase, Four-wire Circuits, Star (Y) Wiring

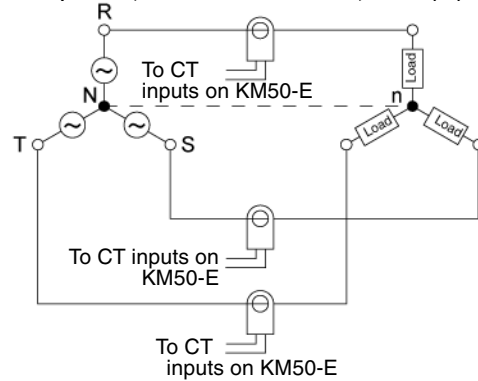

■ Wiring Precautions

- Wire signal lines and power lines separately to prevent the influences of noise.
- Use twisted-pair cables with wires of AWG24 to AWG14 (cross-sectional areas of 0.205 to 2.081 mm²). (Use a stripping length of 5 to 6 mm.)
- Use the Special CT Cable (KM20-CTF-CB3, 3 m) to connect the Special CTs. Connect the Special CT to the end with the shrinking tube.
- The maximum total cable length for RS-485 connections is 500 m.
- Do not ground the Special CTs or the RS-485 signal line. Failure may occur.
- Use crimp terminals to wire the terminals.
- Use wires and crimping tools that are suitable for the crimp terminals.
- If more than one crimp terminal is connected to the same terminal, it may not be possible to tighten the screw sufficiently. To connect more than one wire to the same terminal, connect all of the wires to one crimp terminal.
- Tighten the terminal screws to a torque of 0.69 and 0.88 N·.
- Use the following shape of M3.5 crimp terminals.

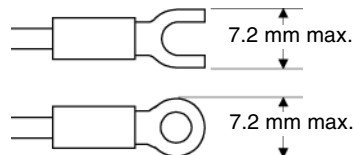

- Do not remove the terminal blocks. Doing so may cause failure or malfunction.

■ Wiring

● Power Supply

Connect the power supply between terminals 9 and 10.

The specifications are given in the following table.

Power Consumption

Power supply voltage	Power consumption
100 to 240 VAC, 50/60 Hz	7 VA max.

Basic insulation is provided between the power supply and current input circuits.

● Measurement Voltage Input

Connect the voltages between terminals 1, 3, 5, and 7 (terminal 1: voltage P1, terminal 3: voltage P0, terminal 5: voltage P2, terminal 7: voltage P3).

Note: Connect the wires in the correct phase sequence. Failure may occur.

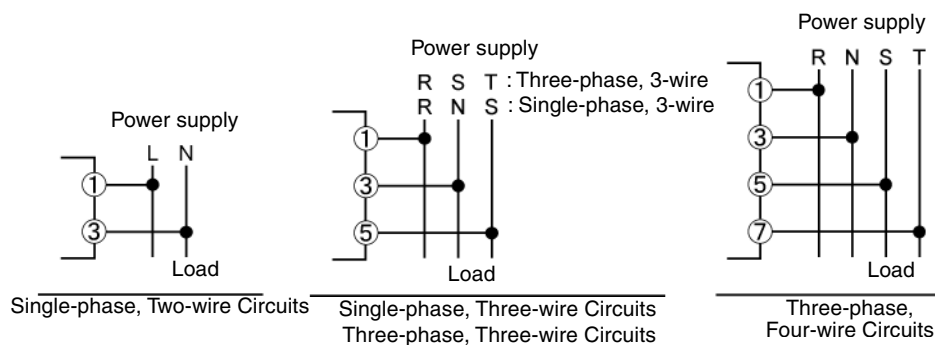

● CT Inputs

For a single-phase, two-wire circuit, connect a Special CT between terminals 11 and 12. For a single-phase, three-wire circuit or three-phase, three-wire circuit, connect a CT for phase R between terminals 11 and 12 and connect a CT for phase S (signal-phase, three-wire) or phase T (three-phase, three-wire) between terminals 15 and 16. For a three-phase, four-wire circuit, connect a CT for phase R between terminals 11 and 12, connect a CT for phase S between terminals 13 and 14, and connect a CT for phase T between terminals 15 and 16. Connect terminals 11, 13, and 15 to the power supply (S) and connect terminals 12, 14, and 16 to the load (L).

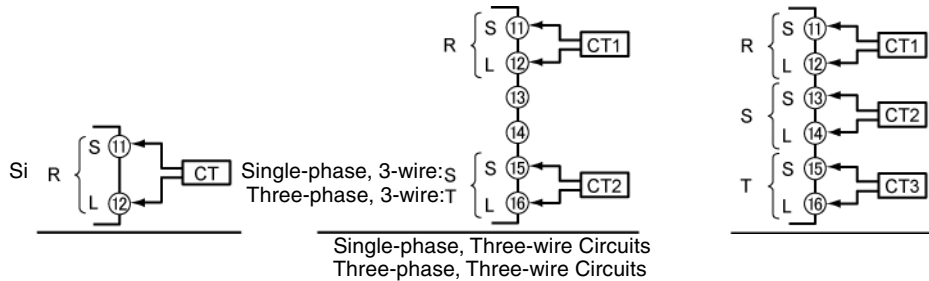

- Note 1. Do not touch conductive metal parts on the CT terminals. Electric shock may occur.
- Note 2. Do not ground the Special CTs. Failure may occur.
- Note 3. When measuring power with a high-harmonic component, such as the current on the primary side of an inverter, select a Special CT with surplus capacity for the rated load. Generally speaking, the current on the primary side of an inverter has a distorted waveform as shown in the following figure. Placing a filter, AC reactor, or similar device between the power supply and the inverter will greatly affect the ratio between the effective value and crest value of the current. The ratio will also change if a capacitor or diode is inserted. If a Special CT is selected for the effective value of the current, it will be saturated and accurate measurements will not be possible. Check the waveform when selecting a Special CT.

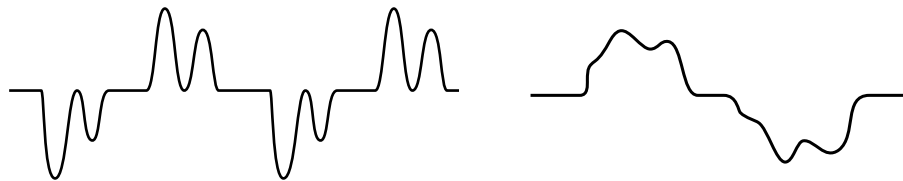

Current Waveform Examples for the Primary Side of an Inverter

● Communications

RS-485

To use communications, connect the communications cable between terminals 29 and 30.

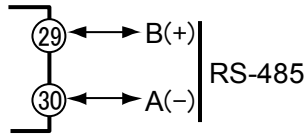

Terminating resistance must be connected to the nodes at the ends of the transmission path (including the host). Use a terminating resistance of $120\ \Omega$ ($1/2\ W$) at each end.

Communications Connections

- The connection configuration is 1:1 or 1:N. Including the host, you can connect 31 KM50 Power Monitors for CompoWay/F or 99 KM50 Power Monitors for Modbus when a 1:N connection configuration is used. For CompoWay/F, the maximum number of devices must include all devices connected on the same communications line, not just the KM50-E. For Modbus, the maximum number of devices assumes that only KM50-E Power Monitors are connected. The maximum total cable length is 500 m. Use shielded twisted-pair cables with wires of AWG24 to AWG14 (cross-sectional areas of 0.205 to 2.081 mm²).

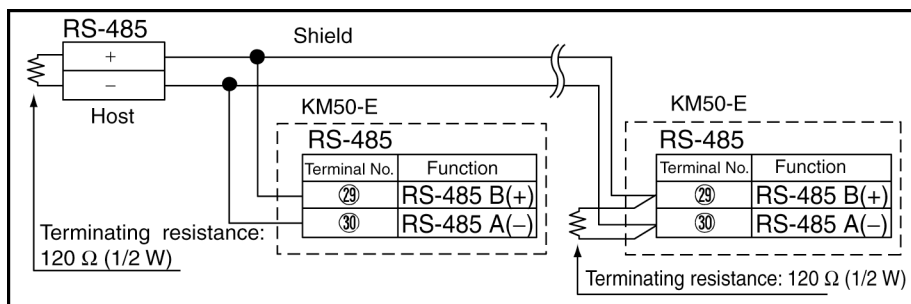

Note: Do not ground the RS-485 signal line. Failure may occur.

- Total Power Consumption Pulse Output

To use total power consumption pulse outputs, connect terminals 18 and 19 and terminals 18 and 20 (the terminals that were set in the output terminal function settings).

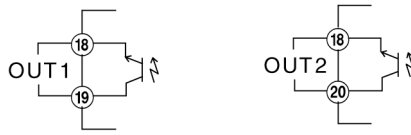

When the total power consumption reaches the pulse output unit set in $U5.PL5$, a pulse will be output from the pulse output terminals.

If the power increases, the total power consumption will increase and the pulse output cycle will become shorter. If the power decreases, the total power consumption will decrease and the pulse output cycle will become longer.

The pulse output cycle can be found with the following formula.

$$\text{Pulse output cycle [s]} = 3,600 \text{ [s]} / \text{Power [W]} / \text{Pulse output unit [Wh]}$$

The following example shows how to find the pulse output cycle.

Example:

If the input power is 200 kW and the pulse output unit is set to 10k [Wh] for a three-phase, three-wire circuit, the output pulse cycle will be $3,600 \text{ [s]} / 200\text{k [W]} / 10\text{k [Wh]} = 180 \text{ [s]}$. If an input power of 10k [W] continues for one hour (3,600 s), the total power consumption will be 10k [Wh]. If the input power is 200k [W] and the pulse output unit is set to 10k [Wh], $200\text{k [W]} / 10\text{k [Wh]}$, or 20 pulses will be output. The cycle will therefore be $3,600 \text{ [s]} / 20 \text{ pulses}$, or 180 [s]. As shown in the following figure, one pulse will be output (i.e., the terminal signal will turn ON) every 180 seconds.

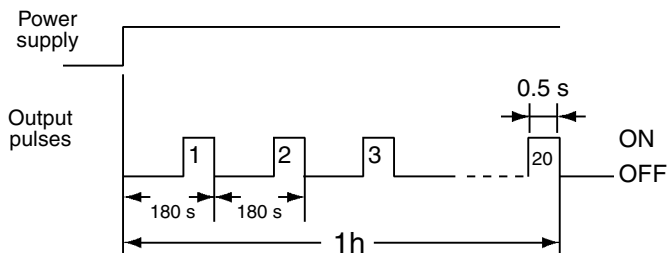

Even if the cycle becomes shorter than the pulse width or even if the output must turn ON immediately after turning OFF, an OFF time of 100 ms will be maintained.

If the OFF time is too short, the PLC or other host may not be able to count the pulses correctly due to the program scan time. Be sure to set a suitable pulse output unit.

● Three-state Outputs

To use the three-state outputs, connect the external devices between terminals 22 and 23, terminals 22 and 24, and terminals 22 and 25.

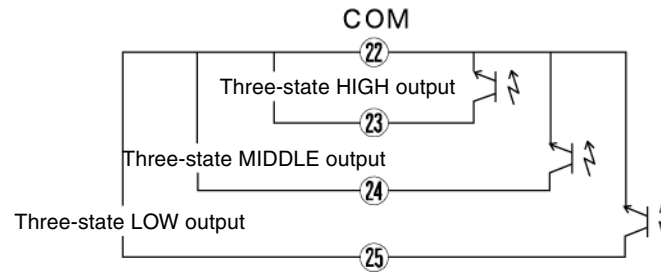

The total power consumption can be divided into three consumptions, HIGH, MIDDLE, and LOW, based on the user-set HIGH threshold (41.H.L.H) and LOW threshold (42.L.L.H). Three-state Energy Classification allows you to visualize the power consumption conditions to help you determine where power is being lost.

The target (40.L.L.L) can be set to PWR , R , or V . Values above the HIGH threshold will be measured as HIGH Total Power Consumption ($H.H.H$), values below the LOW threshold will be measured as LOW Total Power Consumption ($H.H.L$), and values between the thresholds will be measured as MIDDLE Total Power Consumption ($H.H.M$). All of these values are saved in memory.

The three-state output can be used also when the Event Input Setting 30.E.L.S is set to 3-5.L. For details, refer to page 4-3.

In addition to classifying the total power consumption, the time at each status (HIGH/MIDDLE/LOW Total Times (E.L.M-H/E.L.M-M/E.L.M-L)) and the ratios for each status (HIGH/MIDDLE/LOW Total Power Ratios and HIGH/MIDDLE/LOW Total Time Ratios) can also be displayed (in the Profession Level of Measurement Mode).

The Start Time (35.5.L.L) and the End Time (36.E.L.L) can be set for Three-state Energy Classification to save the data for each day. If measurements are performed across days, measurement values will not be saved for the first day. The data will be saved for the next day.

Classification Targets

1) Active Power (PWR)

The active power is used as the classification target and total power consumptions are saved according to the HIGH and LOW thresholds.

When measuring regenerative power, only the LOW status is detected and only the LOW time is totaled.

If the low-cut current function is enabled, the low-cut current will be considered to be instantaneous power of 0.

2) Current (R) or Voltage (V)

The current/voltage* that is measured directly is used as the classification target and total power consumptions are saved according to the HIGH and LOW thresholds.

Note: Phases In and Vrs for a single-phase, three-wire circuit and phases Is and Vtr for a three-phase, three-wire circuit cannot be used as targets.

For a three-phase, three-wire circuit, the HIGH state is determined using an OR of phases Vrs and Vst (i.e., when either value exceeds the threshold), and the LOW state is determined using an AND of phases Vrs and Vst (i.e., when both values go below the threshold). If the low-cut current function is enabled, the low-cut current will be considered to be active power of 0.

3) When the Event Input Setting 30.E.L.S Is Set to 3-5.L

The status of event input 1 and event input 2 are used as the criteria to total the power consumption.

- 4) Select *NONE* to disable Three-state Energy Classification.
 Hysteresis (*43.HYS*) can be set for the HIGH and LOW thresholds. Set the hysteresis as a percentage of the rated input (between 0.0% and 19.9%).
 While the hysteresis is being set, the actual value that corresponds to the setting will be displayed on display No. 2 to make it easier to set the percentage.

The backlight color will change to the color set in the Status Color Setting *44.LCL* according to the status.

Also, there are outputs for the HIGH, MIDDLE, and LOW states to enable linking external devices.

An operation example of Three-state Power Classification is shown below. Here, the status is defined as follows: HIGH = Equipment operating status (green), MIDDLE = Equipment standby status (orange), LOW = Equipment stopped status (red).

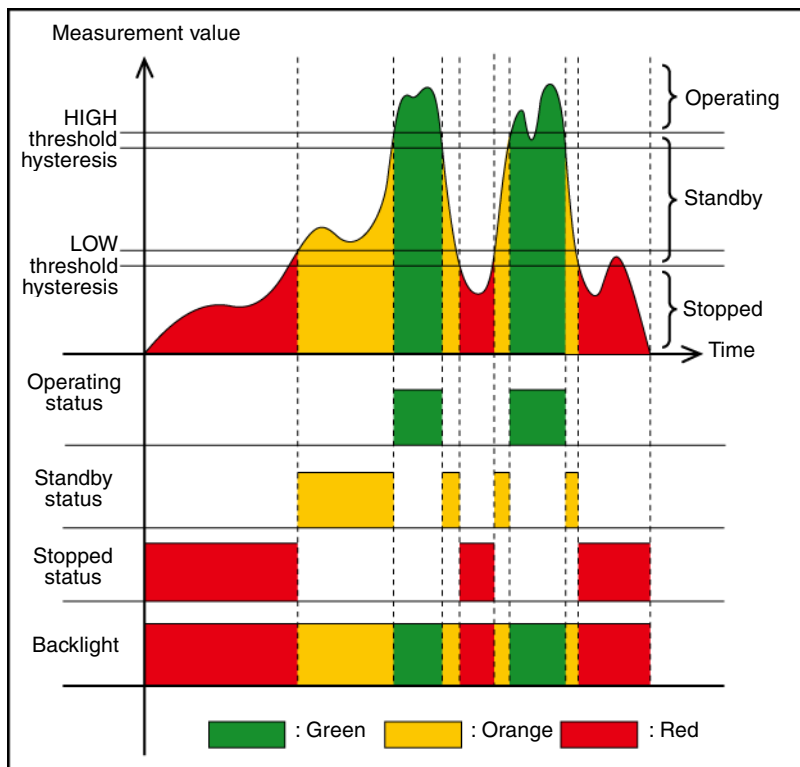

● Alarm Output

Connect terminals 18 and 19 or terminals 18 and 20 (the terminals that were set in the output terminal function settings) to use alarm outputs.

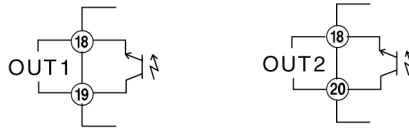

If the measurement value exceeds the upper limit threshold or falls below the lower limit threshold of the alarm output, the alarm will turn ON. If the alarm output is ON, it will remain ON until the measurement value goes below or above the hysteresis range. The OFF delay, which holds the output ON for a set time after the alarm criteria turns OFF, and the ON delay, which holds the output OFF for a set time after the alarm criteria turns ON, can also be set.

When there is an alarm, the OUT 1 or OUT2 operation indicator (the indicator for the terminal that was set in the output terminal function settings) will light, and the present measurement value will alternate with an alarm output display.

However, the error display is given priority if any of errors E-S1 to E-S4 occurs.

Note: Alarms are output when the threshold and hysteresis criteria is met, and the time set for the OFF delay or ON delay has passed.

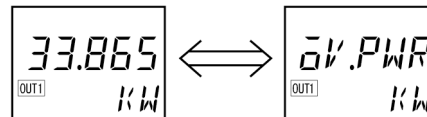

Display Example When Active Power Alarm Output Is Set to OUT1

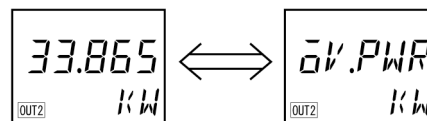

Display Example When Active Power Alarm Output is Set to OUT2

● Event Inputs

To use event inputs, connect terminals 26 and 27 and terminals 27 and 28.

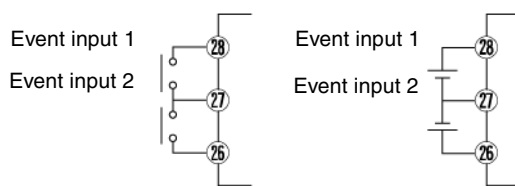

No-voltage (NPN) Input

Voltage (PNP) Input

Note: For details on no-voltage (NPN) and voltage (PNP) inputs, refer to page 4-5.

The ON and OFF criteria can be based on the total count of the two inputs, an OR of the two inputs, or the status of the inputs. The event inputs are used for the following functions.

Input count: Specific power consumption can be managed.

OR: The pulse input ON time is measured.

Input status: Three-state classification of event inputs.

The inputs can be set separately to normally open or normally closed.

The start and stop times for measurement can also be set.

The following values can be measured using the event inputs.

For details, refer to page 4-2.

- Specific Power Consumption

The number of ON signals on the event inputs is counted to find the power consumption for each count. The total number of ON signals for both event input 1 and event input 2 are used as the input to calculate the specific power consumption.

- Pulse Input ON Time

The total time that one or both of the event inputs are ON is calculated for one day and displayed.

The ON time is measured for an OR of the event input 1 and event input 2 signals.

- Three-state Classification of the Event Inputs

Power is classified as HIGH, MIDDLE, and LOW power according to the status of event input 1 and event input 2.

Either of the following input modes can be set.

- Normally open

The event input will be considered valid when it is ON and invalid when it is OFF.

- Normally closed

The event input will be considered invalid when it is ON and valid when it is OFF.

The following timing charts is for event input OR status when the event inputs are set to normally open.

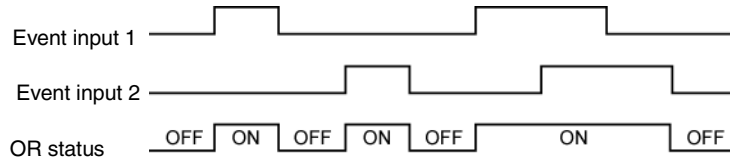

The timing chart for event inputs set to normally closed is given below.

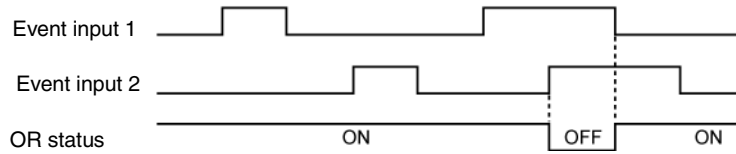

A timing chart for counting pulses when the event inputs are set to normally open is given below.

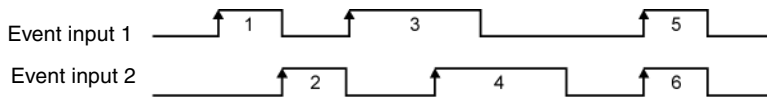

The final pulse count in the above example is 6 pulses. If the event input is set to normally open, pulses are counted on the rising edge. If the event input is set to normally closed, pulses are counted on the falling edge.

The following figure shows the parameters and operation criteria for the event inputs to the KM50-E.

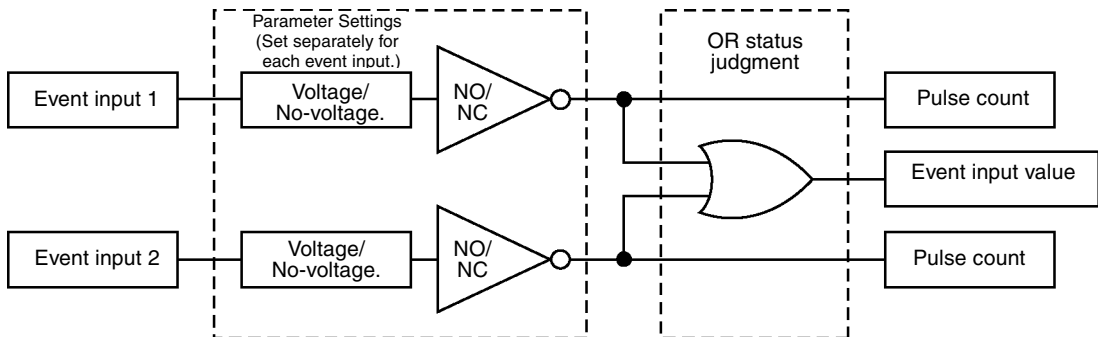

Section 3 Basic Operating Procedures

3. 1 Icons	3-2
■ Icon Descriptions	3-2
3. 2 Turning ON the Power	3-3
■ Turning ON the Power	3-3
3. 3 Basic Settings	3-4
■ Setting Example	3-4
3. 4 Ensuring Correct Measurements	3-5
■ Applicable Circuit	3-5
■ Special CT	3-6
■ Active Power	3-7
■ Total Power Consumption	3-8
■ Currents	3-9
■ Voltages	3-11
■ Power Factor	3-13
■ Reactive Power	3-14
■ Frequency	3-14
3. 5 Measuring a High Current	3-15
■ Rated Primary Current	3-15
3. 6 Measuring a High Voltage	3-17
■ VT Settings	3-17
3. 7 Setting a Low-cut Current	3-19
■ Low-cut Current	3-19
3. 8 Setting the Measurement Pulse	3-20
■ Pulse Output Unit	3-20
3. 9 Changing the Display Refresh Period	3-21
■ Display Refresh Period	3-21
3. 10 Changing the Number of Averaged Measurement Values	3-22
■ Average Count	3-22
● Relation between the Average Count and the Display Refresh Period	3-23
3. 11 Easily Measuring Power	3-24
■ Simple Measurement	3-24
3. 12 Setting the Buzzer	3-26
■ Buzzer	3-26
3. 13 CO ₂ Emission	3-27
■ CO ₂ Coefficient	3-27
■ Calculated CO ₂	3-28
3. 14 Conversion to Monetary Cost	3-29
■ Conversion to Monetary Cost Setting	3-29
■ Converted Monetary Cost	3-31
3. 15 Pulse Conversions	3-32
■ Pulse Conversion Settings	3-32
■ Pulse Converted Values	3-34
3. 16 Time Setting	3-35
■ Time Setting	3-35
■ Time	3-36
● Time Corrections	3-40
3. 17 Initializing Data	3-41
■ Initialize	3-41
3. 18 Communications Setting Mode	3-44
■ Protocol Selection	3-44
■ Unit Number	3-45
■ Baud Rate	3-46
■ Data Length	3-47
■ Stop Bits	3-48
■ Vertical Parity	3-49
■ Transmission Wait Time	3-50

3. 1 Icons

■ Icon Descriptions

The following icons are used in sections 3 and 4 of this manual.

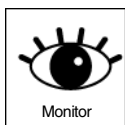

Indicates parameters used only for monitoring.

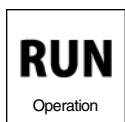

Indicates parameters that are set using key operations.

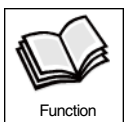

Indicates descriptions of the functions and meanings of parameters.



Indicates parameters used in one of the Setting Modes.

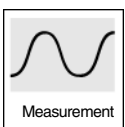

Indicates parameters used in Measurement Mode.

3. 2 Turning ON the Power

■ Turning ON the Power

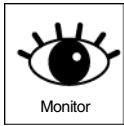

- When the power supply is turned ON, data is loaded from EEPROM. Up to 16 seconds will be required to edit the log data for when the power was interrupted.
- As soon as the power supply is turned ON, the model *PM50E* is displayed on display No. 1 and the software version is displayed on display No. 2. Then, *WRLE* is displayed on display No. 1.
- If power was turned ON for the first time, *E-L I* will be displayed after *WRLE* and the STOP indicator will light.
- The Basic Level of Measurement Mode will be entered and the active power will be displayed.



3. 3 Basic Settings

■ Setting Example



Setting

Applicable circuit: Single-phase, three-wire
Special CT: 5-A CT
Time: 2010/3/5 17:15



Operation



A . Check the wiring and turn ON the power supply.

PMS0E will be displayed and data will be loaded from EEPROM. *WRZE* will be displayed for up to 16 seconds. *E-E1* will be displayed and the STOP indicator will light the first time that the power supply is turned ON or when the backup has expired because the time is not set.

After 3 seconds, the active power will be displayed in Measurement Mode. (The STOP indicator will remain lit.)

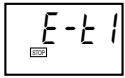

B . Set the applicable circuit to a single-phase, three-wire circuit. (Refer to page 3-5 for details.)

1 . Press the Key for at least 3 seconds to go to the Applicable Circuit parameter (*00.4YP*) in Operation Setting Mode.

2 . Press the Key to enable setting the parameter, press the Key again to change the applicable circuit from *3P3W* to *1P3W*, and then press the Key to enter the setting.



C . Set the Special CT type to a 5-A CT. (Refer to page 3-6 for details.)

1 . Press the Key to move to the CT Type (*0.1CRG*).

2 . Press the Key to enable setting the parameter, press the Key again to change the Special CT type from *100A* to *5A*, and then press the Key to enter the setting.

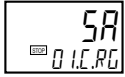

D . Set the time to 2101/3/5 17:15. For details, refer to page 3-35.

The time must be set to enable logging data.

1 . Press the Key to move to the Time Setting (*14.2CM*).

2 . Press the Key to enable setting the parameter, make sure that the year is *20 10*, and then press the Key.

3 . Using the Key to change the digit value and the Key to change to a different digit, change the month/day from *0 1/0 1* to *03/05*, and then press the Key.

4 . Using the Key to change the value of the digit and the Key to change to a different digit, change the hour-minutes from *00-00* to *17-15*, and then press the Key to enter the setting. The time will be saved and the STOP indicator will turn OFF.

5 . Press the Key for at least 3 seconds to go to the Measurement Mode and start measurements. When you move to Measurement Mode, the settings will be saved and *SRVE* will be displayed.

This completes the basic settings.

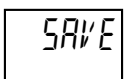
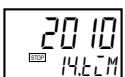
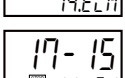
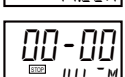

3. 4 Ensuring Correct Measurements

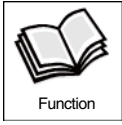

- The applicable circuit and Special CT must be set to ensure correct measurements.
- When the power supply is turned ON, determination of maximum and minimum values is started two seconds after the active power is displayed.

■ Applicable Circuit

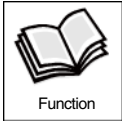

- This parameter sets the number of phases and wires.

Parameter	Displayed characters	Setting range	Default setting	Unit
Applicable Circuit	00.LYP	1P2W, 1P3W, 3P3W, 3P4W	3P3W	

Parameter setting	Meaning	Description
1P2W	Single-phase, two-wire	The measured current and voltage are displayed for Current 1 and Voltage 1.
1P3W	Single-phase, three-wire	The measured currents and voltages are displayed for Currents 1 to 3 and Voltages 1 to 3. Calculated values are displayed for Current 2 and Current 3.
3P3W	Three-phase, three-wire	The measured currents and voltages are displayed for Currents 1 to 3 and Voltages 1 to 3. Calculated values are displayed for Current 2 and Current 3.
3P4W	Three-phase, four-wire	The measured currents and voltages are displayed for Currents 1 to 3 and Voltages 1 to 3. Measured values are displayed for the currents and voltages.



Procedure: The following procedure is used to set the applicable circuit to a single-phase, three-wire.

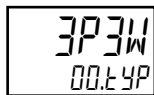

1. Press the Key for at least 3 seconds to go from Measurement Mode to Operation Setting Mode.



2. Press the Key to go to setting status.



3. Press the Key or + Keys to change from 3P3W to 1P3W.

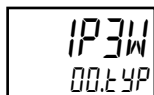

4. Press the Key to enter the setting. To end the setting procedure, press the Key for at least 3 seconds to go from Operation Setting Mode to Measurement Mode.

Special CT

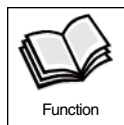

- This parameter sets the type of Special CT to use. Always set this parameter according to the Special CT that is used in the application.



Parameter	Displayed characters	Setting range	Default setting	Unit
Special CT	0 I.C.RG	5A, 50A, 100A, 200A, 400A, 600A	100A	

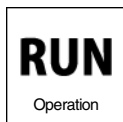

Procedure: The following procedure is used to set the Special CT type to a 5-A CT.

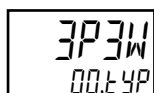

1. Press the Key for at least 3 seconds to go from Measurement Mode to Operation Setting Mode.



2. Press the Key or Keys to change from Applicable Circuit (00.4P) to Special CT (0 I.C.RG).



3. Press the Key to go to setting status.

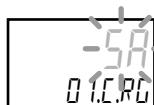

4. Press the Key or Keys to change from 100A to 5A.

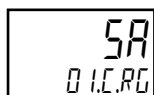

5. Press the Key to enter the setting.
To end the setting procedure, press the Key for at least 3 seconds to go from Operation Setting Mode to Measurement Mode.

Active Power



- The Basic Level of Measurement Mode will be entered and the active power will be displayed when the power supply is turned ON.
The active power will also be displayed if the $\text{PL} \rightarrow \text{LV}$ Key is pressed while $\text{PR} \rightarrow \text{LV}$ is being displayed.
- Press the MAX Key to check the maximum value of the active power. Press the MIN or $\text{MAX} \rightarrow \text{MIN}$ Keys to switch to the minimum value. (You can check the measurement log for the last 8 days.)
The maximum/minimum values and the times they were recorded are displayed alternately while the measurement log is displayed.
- Negative active power is called regenerative power.
The maximum and minimum values are not updated while regenerative power is being measured.
Note: Regenerative power is reverse power, such as power that can be sold to the power company.

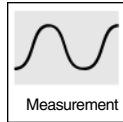

Parameter	Display No. 1	Display No. 2	Unit	Remarks
Active Power	-9999 to 99999	kW	kW	

The decimal point will change depending on the scale of the measurement value.

- 9999 to -1000
- 999.9 to -100.0
- 99.99 to -10.00
- 9.999 to 99.999
- 100.00 to 999.99
- 1000.0 to 9999.9
- 10000 to 99999

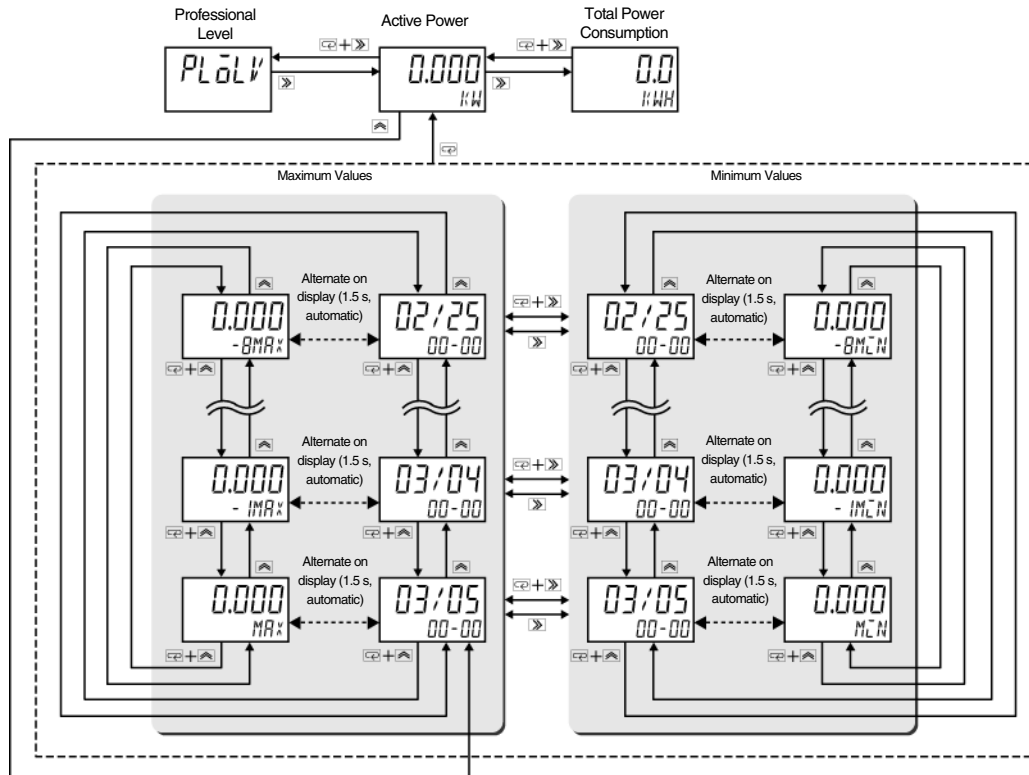

Total Power Consumption

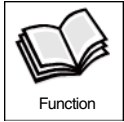

- The total power consumption will be displayed if the Key is pressed while the active power is being displayed in the Basic Level of Measurement Mode.
- Press the Key to display the total power consumption in 10 digits.
- Press the Key or Keys during the 10-digit display to switch to the monthly total power consumption, daily total power consumption, or hourly total power consumption.

- For the display of the monthly consumption, the year and month when the total power consumption was recorded and the total power consumption are displayed alternately on display No. 1 and the number of months before the present month and the unit are displayed alternately on display No. 2.
- For the display of the daily consumption, the month and day when the total power consumption was recorded and the total power consumption are displayed alternately on display No. 1 and the number of days before the present day and the unit are displayed alternately on display No. 2.
- For the display of the hourly consumption, the day and hour when the total power consumption was recorded and the total power consumption are displayed alternately on display No. 1 and the number of hours before the present day and the unit are displayed alternately on display No. 2.

Note 1. The monthly consumption can be displayed for the last 13 months. The daily consumption can be displayed for the last eight days. The hourly consumption can be displayed for the last 25 hours.

Note 2. If the total power consumption exceeds 10,000 MWh, the display will restart from 0. The measurement log will also show the value restarted from 0. The total power consumption for the month, day, and hour will also go to 0.

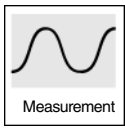

Parameter	Display No. 1	Display No. 2	Unit	Remarks
Total Power Consumption	0.0 to 9999.9	kWh MWh	kWh MWh	If the total power consumption exceeds 9,999.9 kWh, the unit indicator will change to MWh.
Total Power Consumption Ten-digit Display	0000000000 to 9999999999		Wh	The total power consumption is displayed using 10 digits.
Total Power Consumption for Last 13 Months	0.0 to 9999.9	kWh MWh	kWh MWh	The total power consumption can be displayed for the last 13 months from the present time.
Total Power Consumption for Last 8 Days	0.0 to 9999.9	kWh MWh	kWh MWh	The total power consumption can be displayed for the last 8 days from the present time.
Total Power Consumption for Last 25 Hours	0.0 to 9999.9	kWh MWh	kWh MWh	The total power consumption can be displayed for the last 25 hours from the present time.

The displays will be as shown below if the present time is 2010/3/5 17:15.

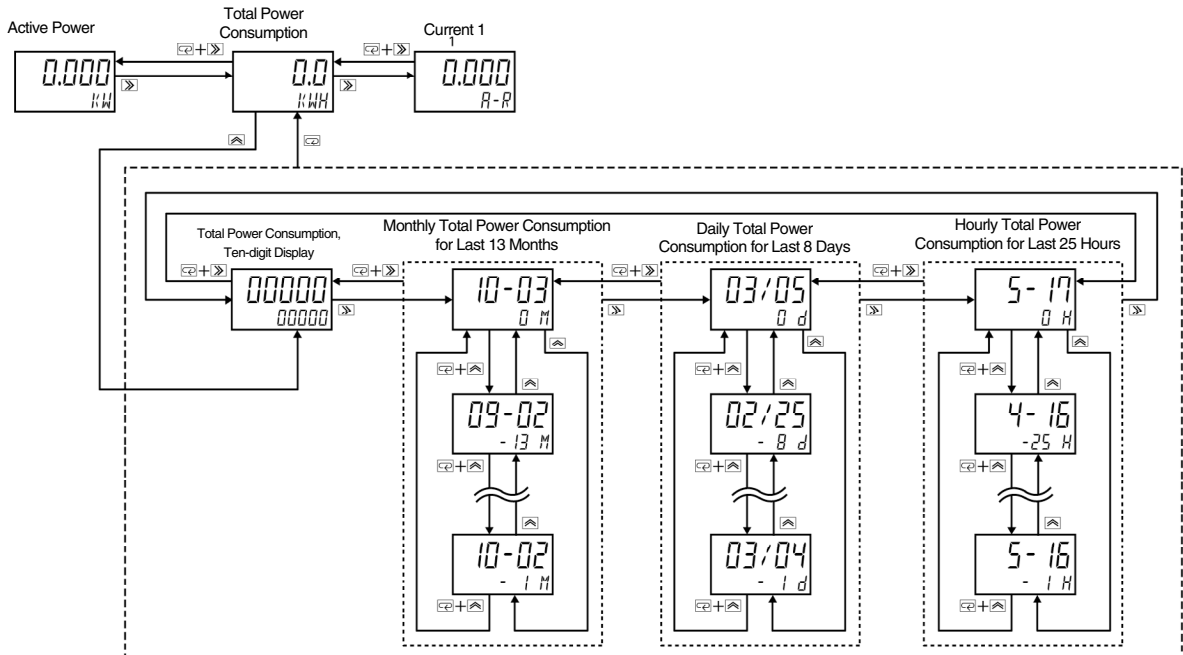

■ Currents



- The currents will be displayed if the F Key is pressed while the total power consumption is being displayed in the Basic Level of Measurement Mode. Press the F Key or $\text{C}+\text{F}$ Keys to switch between Current 1, Current 2, and Current 3.
- Press the M Key to check the maximum values of the currents. Press the F or $\text{C}+\text{F}$ Keys to switch to the minimum values. (You can check the measurement log for the last 8 days.) The maximum/minimum values and the times they were recorded are displayed alternately while the measurement log is displayed.

Note 1. Before starting measurements, set the Applicable Circuit to the numbers of phases and wires in the load that is being measured.

If the setting is not correct, the currents for phases with no load will not be displayed as 0 A, i.e., they will not be displayed correctly.

Note 2. An error will occur if the input exceeds 120% of the rating of the Special CT. If that occurs, $E-5\text{L}^2$ and the present measurement value will be displayed alternately.

Note 3. The measurement values will be reset if the Applicable Circuit is changed from single-phase, three-wire or three-phase, three-wire to single-phase, two-wire.

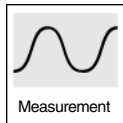

Parameter	Display No. 1	Display No. 2	Unit	Remarks
Current 1	0.000 to 99999	R R-R	A	Only R is displayed for a single-phase, two-wire circuit. R-L is displayed for a single-phase three-wire, three-phase three-wire, or three-phase four-wire circuit.
Current 2	0.000 to 99999	R-N R-S	A	Not displayed for a single-phase, two-wire circuit. R-N is displayed for a single-phase, three-wire circuit. R-S is displayed for a three-phase, three-wire or three-phase, four-wire circuit.
Current 3	0.000 to 99999	R-S R-L	A	Not displayed for a single-phase, two-wire circuit. R-S is displayed for a single-phase, three-wire circuit. R-L is displayed for a three-phase, three-wire or three-phase, four-wire circuit.

The decimal point will change depending on the scale of the measurement value.

- 0.000 to 99.999
- 100.00 to 999.99
- 1000.0 to 9999.9
- 10000 to 99999

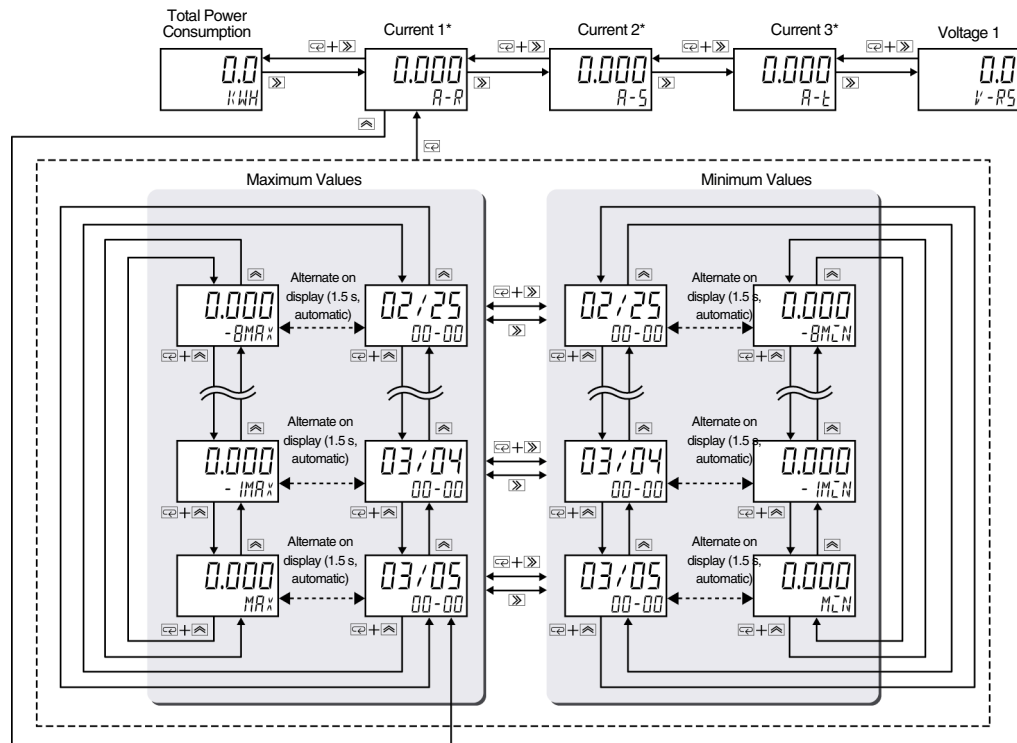

*The displays for Currents 1 to 3 depend on the applicable circuit. Refer to the following table.

Parameter Applicable circuit	Current 1	Current 2	Current 3
Single-phase, two-wire	Measured current (measurement value)	Nothing displayed.	Nothing displayed.
Single-phase, three-wire	Phase-R current (measurement value)	Phase-N current (calculated value)	Phase-S current (measurement value)
Three-phase, three-wire	Phase-R current (measurement value)	Phase-S current (calculated value)	Phase-T current (measurement value)
Three-phase, four-wire	Phase-R current (measurement value)	Phase-S current (measurement value)	Phase-T current (measurement value)

Voltages

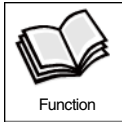

- The voltages will be displayed if the F Key is pressed while Current 3 is being displayed in the Basic Level of Measurement Mode. Press the F Key or $\text{HOLD} + \text{F}$ Keys to switch between Voltage 1, Voltage 2, and Voltage 3.
- Press the MAX Key to check the maximum values of the voltages. Press the F or $\text{HOLD} + \text{F}$ Keys to switch to the minimum values. (You can check the measurement log for the last 8 days.)

The maximum/minimum values and the times they were recorded are displayed alternately while the measurement log is displayed.

- The voltage range changes automatically according to the measurement value.
 - Note 1. Before starting measurements, set the Applicable Circuit to the numbers of phases and wires in the load that is being measured. If the setting is not correct, the residual voltages will be displayed for phases with no load and measurements will not be correct.
 - Note 2. An error will occur if the input exceeds 110% of the rating. If that occurs, $E-5 I$ and the present measurement value will be displayed alternately.
 - Note 3. An error will occur if the phase order is incorrect when the Incorrect Voltage Wiring Detection Setting is set to ON. If that occurs, $E-54$ and the present measurement value will be displayed alternately.
 - Note 4. The measurement values will be reset if the Applicable Circuit is changed from single-phase, three-wire or three-phase, three-wire to single-phase, two-wire.

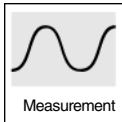

Parameter	Display No. 1	Display No. 2	Unit	Remarks
Voltage 1	0.0 to 99999	V V-RN V-RS V-R	V	Only V is displayed for a single-phase, two-wire circuit. V-RN is displayed for a single-phase, three-wire circuit. V-RS is displayed for a three-phase, three-wire circuit. V-R is displayed for a three-phase four-wire circuit.
Voltage 2	0.0 to 99999	V-5N V-5t V-5	V	Not displayed for a single-phase, two-wire circuit. V-5N is displayed for a single-phase, three-wire circuit. V-5t is displayed for a three-phase, three-wire circuit. V-5 is displayed for a three-phase, four-wire circuit.
Voltage 3	0.0 to 99999	V-RS V-tR V-t	V	Not displayed for a single-phase, two-wire circuit. V-RS is displayed for a single-phase, three-wire circuit. V-tR is displayed for a three-phase, three-wire circuit. V-t is displayed for a three-phase four-wire circuit.

The decimal point will change depending on the scale of the measurement value.

0.0 to 9999.9

10000 to 99999

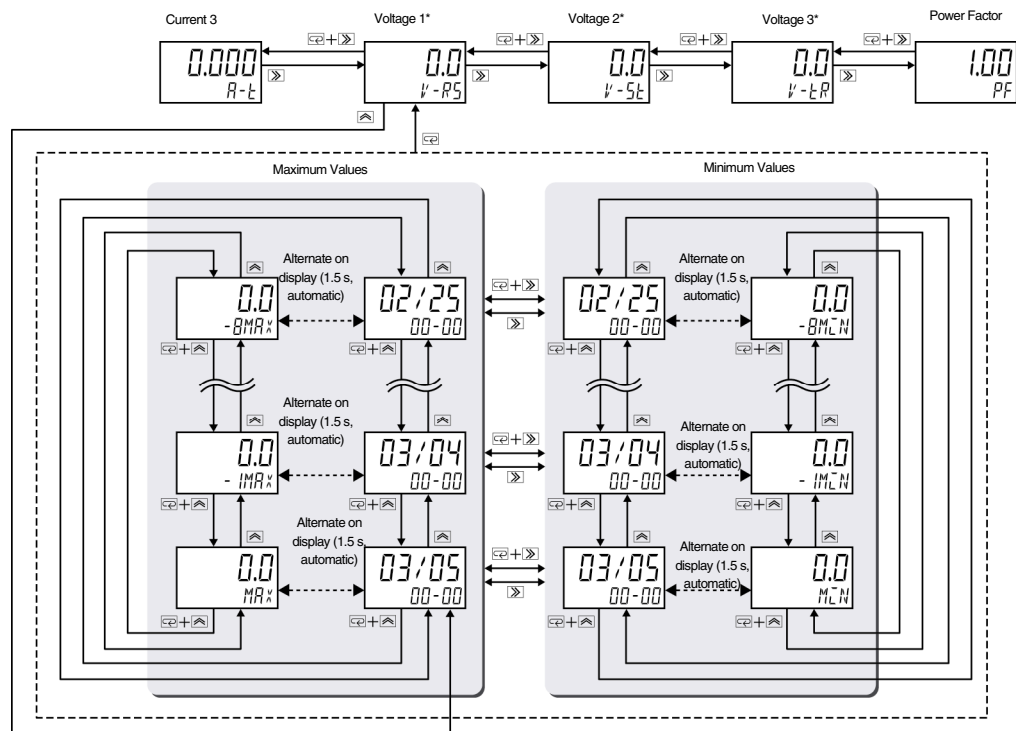

*The displays for Voltages 1 to 3 depend on the applicable circuit. Refer to the following table.

Item Applicable circuit	Voltage 1	Voltage 2	Voltage 3
Single-phase, two-wire	Measured voltage (line voltage measurement value)	Nothing displayed.	Nothing displayed.
Single-phase, three-wire	RN voltage (phase voltage measurement value)	SN voltage (phase voltage measurement value)	RS voltage (line voltage calculated value)
Three-phase, three-wire	RS voltage (line voltage measurement value)	ST voltage (line voltage measurement value)	TR voltage (line voltage calculated value)
Three-phase, four-wire	RN voltage (phase voltage measurement value)	SN voltage (phase voltage measurement value)	TN voltage (phase voltage measurement value)

Power Factor



- The power factors will be displayed if the F Key is pressed while Voltage 3 is being displayed in the Basic Level of Measurement Mode.
- Press the H Key to check the maximum values of the power factor. Press the F or $\text{H}+\text{F}$ Keys to switch to the minimum values. (You can check the measurement log for the last 8 days.) The maximum/minimum values and the times they were recorded are displayed alternately while the measurement log is displayed.
- The maximum and minimum values are not updated while regenerative power is being measured.

Power Factor Calculations

$$\text{Power factor} = \text{Active power} / \text{Apparent power}^*$$

$$* \text{ Apparent power} = \sqrt{(\text{Active power})^2 + (\text{Reactive power})^2}$$

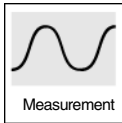

Parameter	Display No. 1	Display No. 2	Unit	Remarks
Power Factor	- 1.00 to 1.00	PF	-	

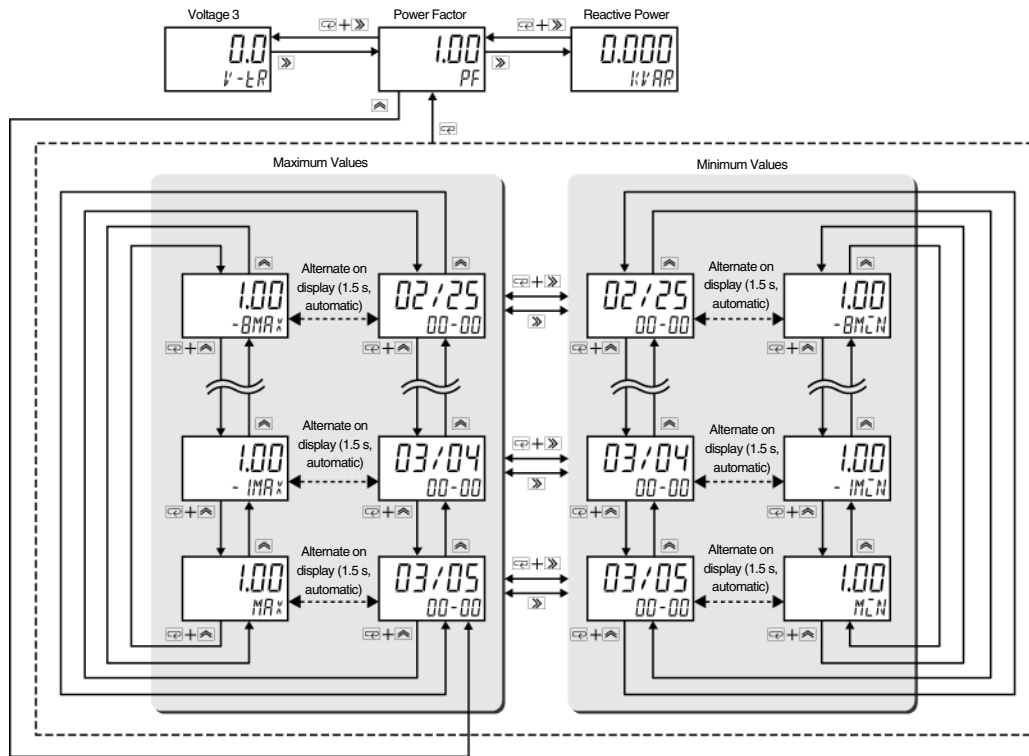

Reactive Power

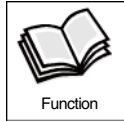

- The reactive power will be displayed if the $\text{F} \gg$ Key is pressed while the power factor is being displayed in the Basic Level of Measurement Mode.
- Press the $\text{F} \wedge$ Key to check the maximum values of the reactive power. Press the $\text{F} \gg$ or $\text{F} \ll$ Keys to switch to the minimum values. (You can check the measurement log for the present day.)
The maximum/minimum values and the times they were recorded are displayed alternately while the measurement log is displayed.
- The maximum and minimum values are not updated while regenerative power is being measured.
Note 1. If the current phase is delayed over the voltage phase, the reactive power will be positive. If the current phase is advanced, the reactive power will be negative.
Note 2. The maximum and minimum values are cleared if you move to the Operation Setting Mode or if the power supply is turned OFF.

Reactive Power Calculation

$$\text{Reactive power} = v \times i \times \sin \theta^*$$

- * "v" is the instantaneous voltage and "i" is the instantaneous current.
 θ is the phase difference between the voltage and current.

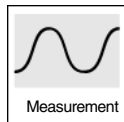

Parameter	Display No. 1	Display No. 2	Unit	Remarks
Reactive Power	-9999 to 99999	kVAR	kvar	

The decimal point will change depending on the scale of the measurement value.

- 9999 to -1000
- 999.9 to -100.0
- 99.99 to -10.00
- 9.999 to 99.999
- 100.00 to 999.99
- 1000.0 to 9999.9
- 10000 to 99999

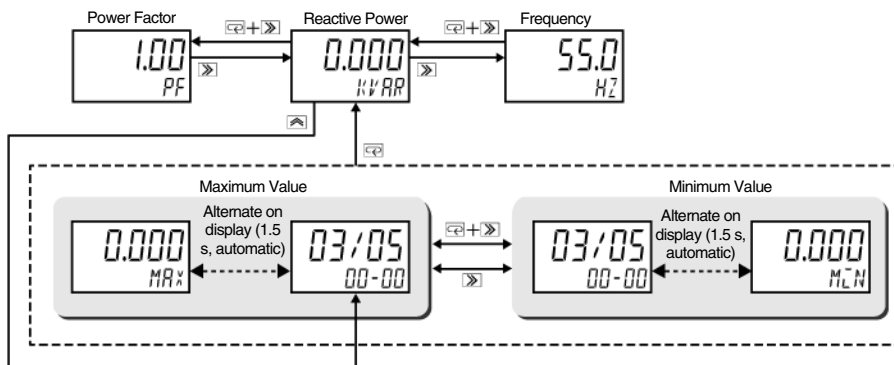

Frequency

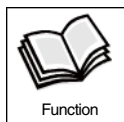

- The voltage frequency will be displayed if the $\text{F} \gg$ Key is pressed while the reactive power is being displayed in the Basic Level of Measurement Mode.
Note: An error will occur if the frequency is not between 45 to 65 Hz. If that occurs, E-53 and the present measurement value will be displayed alternately. If the value is outside of the measurement range, the display will flash.

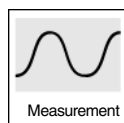

Parameter	Display No. 1	Display No. 2	Unit	Remarks
Frequency	45.0 to 65.0	Hz	Hz	

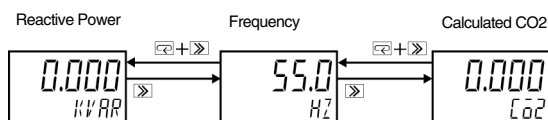

3. 5 Measuring a High Current

■ Rated Primary Current

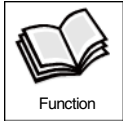

- A maximum current that exceeds the rating of the Special CT can be measured by using the KM20-CTF-5A Special CT and setting the rated primary current. (The KM20-CTF-5A must be used to enable this function.)
- To also use a commercial CT on the secondary 5-A output, set the primary current rating of the commercial CT. (If the commercial CT has a 1-A output, application is possible by using five turns on the Special CT.)

Note: It is best not to use this function and to measure the original current with a Special CT to increase measurement accuracy. Use this function only in applications with the commercial CT error is acceptable.

If this function is not used, set the parameter to 5.

Connecting a 5-A CT

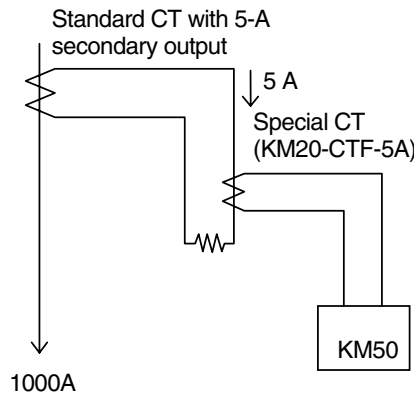

Parameter	Displayed characters	Setting range	Default setting	Unit
Rated Primary Current	02.5CE	5 to 9999	5	A



Procedure: The following procedure is used to set the rated primary current to 1,000 A.

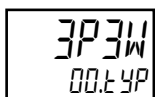

1 . Press the Key for at least 3 seconds to go from Measurement Mode to Operation Setting Mode.

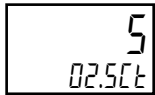

2 . Press the Key or + Keys to change from the Applicable Circuit (00.4P) to the Rated Primary Current (02.5CE).



3 . Press the Key to go to setting status.



4 . Press the Key or + Keys to change from 0 to 1.



5 . Press the \Rightarrow Key or $\leftarrow + \Rightarrow$ Keys to change the digit.



6 . Press the \uparrow Key or $\leftarrow + \uparrow$ Keys to change from 5 to 0.



7 . Press the \square Key to enter the setting.

To end the setting procedure, press the \leftarrow Key for at least 3 seconds to go from Operation Setting Mode to Measurement Mode.

The relation between the primary current, secondary current and KM50 display is shown in the following table.

Primary current	Secondary 5-A output	Rated primary current	KM50 display
1000 A	5 A	1000 A	1000 A (5 A \times (1000 / 5))
500 A	2.5 A	1000 A	500A (2.5 A \times (1000 / 5))

3. 6 Measuring a High Voltage

■ VT Settings

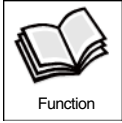

- A parameter is set to indicate whether the voltage will be input to the Power Monitor directly or through a voltage transformer (VT).
- If the voltage that is being measured is 480 V or higher, a VT must be used to convert to the input voltage range of the KM50. Use a commercially available VT with a secondary rating of 110 V.
- Set the primary voltage and secondary voltage according to the voltage transformer that you are using. Set the primary voltage to 220, 440, 3,300, 6,600, 11,000, 22,000, or 33,000 V, and secondary voltage to 110, or 220 V. If a VT is not being used, set the parameter to NONE.
- If the primary voltage is set to 200 to 33,000 V, the voltage on the input voltage terminals will be converted to a transformation ratio, and the active power, total power consumption, voltage, and reactive power will be measured.
- If the parameter is set to NONE, the active power, total power consumption, and reactive power will be measured from the voltage on the voltage input terminals.

Note 1. We recommend inputting the voltage directly when measuring a voltage of 480 V or lower.

Note 2. The VT secondary voltage can be set only if the VT primary voltage is not set to NONE.

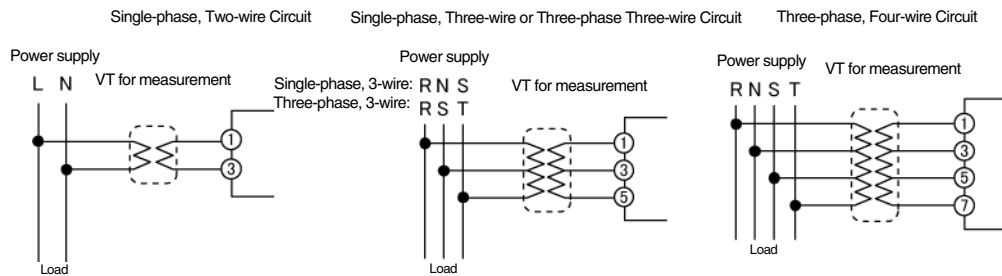

Parameter	Displayed characters	Setting range	Default setting	Unit
VT Primary Voltage	03V.PG	NONE, 220, 440, 3300, 6600, 11000, 22000, 33000	NONE	V
VT Secondary Voltage	V.PG2	110, 220	110	V



Procedure: The following procedure is used to set the VT primary voltage to 6,600 V and VT secondary voltage to 220 V.

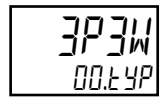

1. Press the Key for at least 3 seconds to go from Measurement Mode to Operation Setting Mode.



2. Press the Key or + Keys to change from the Applicable Circuit (00.tYP) to the VT Primary Voltage (03V.PG).



3. Press the Key to go to the setting status for the VT primary voltage.



4. Press the Key or + Keys to change from NONE to 6600.





5. Press the Key to enter the set value and move to the setting status for the VT secondary voltage.

Basic Operating Procedures

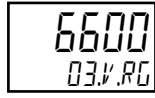

6 . Press the  Key or + Keys to change from 110 to 220.



7 . Press the  Key to enter the set value.
To end the setting procedure, press the  Key for at least 3 seconds to go from Operation Setting Mode to Measurement Mode.

3.7 Setting a Low-cut Current

Low-cut Current

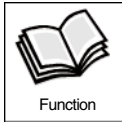

- If the current is below the rated current times the specified percentage, the measurement value of the current will be set to 0.
- This parameter sets the percentage of the load current not to measure.
- By setting the current to 0, you can effectively set the power consumption to 0. This function enables eliminating current and power that would be measured as the result of inductive noise when there is no load. Set the optimum value.

Example: If the KM20-CTF-200A is connected and the Power Monitor measures the current as 10 A even if there is no load current, set 5.0% ($10 / 200 \times 100$) to cut the unnecessary current.

Note 1. The low-cut function will operate when the currents for all phases for which Special CTs are connected are below the specified low-cut currents.

Note 2. The low-cut function judges the effective value of the current. Even if the crest value is above the low-cut current, the low-cut function will operate as long as the effective current is below the low-cut current.



Parameter	Displayed characters	Setting range	Default setting	Unit
Low-cut Current	04.CUT	0.1 to 19.9	0.6	%



Procedure: The following procedure is used to set the low-cut current to 0.1%.



1. Press the Key for at least 3 seconds to go from Measurement Mode to Operation Setting Mode.



2. Press the Key or Keys to change from the Applicable Circuit (00.4YP) to the Low-cut Current (04.CUT).



3. Press the Key to go to setting status.



4. Press the Key or Keys to change the digit.



5. Press the Key or Keys to change from 0 to 1.

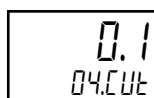

6. Press the Key to enter the setting. To end the setting procedure, press the Key for at least 3 seconds to go from Operation Setting Mode to Measurement Mode.

3. 8 Setting the Measurement Pulse

■ Pulse Output Unit

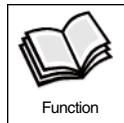

- When the total power consumption reaches the specified pulse output unit, a pulse will be output from the pulse output terminals.
- If the power increases, the total power consumption will increase and the pulse output cycle will become shorter. If the power decreases, the total power consumption will decrease and the pulse output cycle will become longer.
- The OUT1 or OUT2 operation indicator (the indicator for the terminal that was set in the output terminal function settings) light when the pulse is ON.

Note 1. Set the pulse output unit so that the pulse cycle is 600 ms or higher. Pulses may not be output properly if it is less than 600 ms.

Note 2. This function can be used when *P.OUTPUT* is selected in the output terminal function settings. For details, refer to page 4-12.



Parameter	Displayed characters	Setting range	Default setting	Unit
Pulse Output Unit	05.PLS	1, 10, 100, 1k, 2k, 5k, 10k, 20k, 50k, 100k	100	Wh

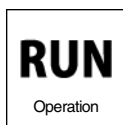

Procedure: The following procedure is used to set the pulse output unit to 10 Wh.

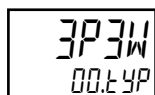

1. Press the Key for at least 3 seconds to go from Measurement Mode to Operation Setting Mode.

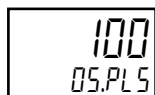

2. Press the Key or + Keys to change from the Applicable Circuit (00.4YP) to the Pulse Output Unit (05.PLS).



3. Press the Key to go to setting status.



4. Press the Key or + Keys to change from 100 to 10.

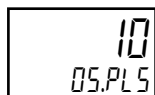

5. Press the Key to enter the setting.
To end the setting procedure, press the Key for at least 3 seconds to go from Operation Setting Mode to Measurement Mode.

3. 9 Changing the Display Refresh Period

■ Display Refresh Period

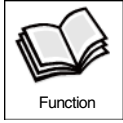

- A suitable display refresh period can be set if the measurement value is difficult to read because the voltage or current changes too quickly.
- If this parameter is set to OFF, the display will be refreshed every 0.1 second.
- If the refresh period is set, the measurement value at the time when the refresh period is set will be displayed.
- The refresh period will be changed only for the display. The present measurement values will be refreshed for all measurement parameters.

Note: If the display refresh period is changed, differences may occur between a displayed value and the value in communications data.



Parameter	Displayed characters	Setting range	Default setting	Unit
Display Refresh Period	06.REF	OFF, 0.5, 1.0, 2.0, 4.0	1.0	s



Procedure: The following procedure is used to set the display refresh period to 4.0 s.

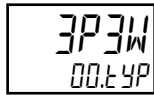

1. Press the Key for at least 3 seconds to go from Measurement Mode to Operation Setting Mode.

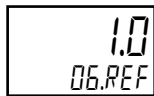

2. Press the Key or + Keys to change from the Applicable Circuit (00.4P) to the Display Refresh Period (06.ref).



3. Press the Key to go to setting status.



4. Press the Key or + Keys to change from 1.0 to 4.0.

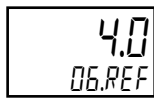

5. Press the Key to enter the setting.
To end the setting procedure, press the Key for at least 3 seconds to go from Operation Setting Mode to Measurement Mode.

Example: If the display refresh period is set to 0.5, the displayed measurement value will be refreshed every 0.5 second as shown below.

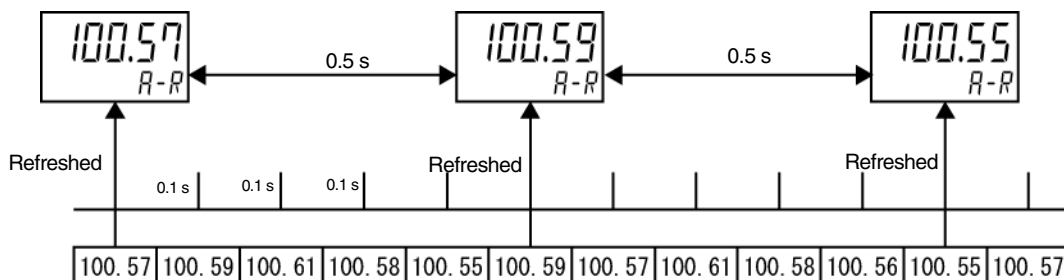

3. 10 Changing the Number of Averaged Measurement Values

■ Average Count



Function

- The present instantaneous value will be displayed without averaging if this parameter is set to OFF.
- The following measurement values are averaged.
Active Power, Current, Voltage, Power Factor, and Reactive Power
Both the display data and communications data for these measurement values are averaged.
- The following processes are affected by the averaging of measurement values.
Maximum/minimum values, three-state classification, and alarm output result
- The following equation is used to calculate the average.

$$\text{Previous value} \times (\text{Number of averaged measurement values} - 1) / \text{Number of averaged measurement values} + \text{Present measurement value} \times 1 / \text{Number of averaged measurement values} = \text{Present value}$$

Note 1. Averaged measurement values are used as thresholds for alarms and three-state classification. Because of this, the classification process may be slow to respond if the number of averaged measurement values is changed greatly.

Note 2. When the number of averaged measurement values becomes large, in the case of high-frequency measurements with inverters, the measurement of maximum and minimum values will become too slow to produce accurate measurements.



Setting

Parameter	Displayed characters	Setting range	Default setting	Unit
Average Count	07.AVG	OFF, 2, 4, 8, 16, 32, 64, 128, 256, 512, 1024	8	Measurements

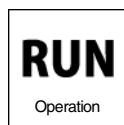

Operation

Procedure: The following procedure is used to set the average count to 4 measurements.

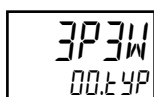

1 . Press the Key for at least 3 seconds to go from Measurement Mode to Operation Setting Mode.



2 . Press the Key or Keys to change from the Applicable Circuit (00.4YP) to the Average Count (07.AVG).



3 . Press the Key to go to setting status.



4 . Press the Key or Keys to change from 8 to 4.

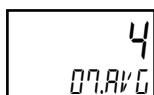

5 . Press the Key to enter the setting.
To end the setting procedure, press the Key for at least 3 seconds to go from Operation Setting Mode to Measurement Mode.

● Relation between the Average Count and the Display Refresh Period

Example: Operation is shown below for an average count of 8 and a display refresh period of 0.5.

The sampling period of the KM50 is 100 ms at 50 Hz and 83.3 ms at 60 Hz. The display refresh period has no affect on the sampling period.

When the average count is set to 8, the measurement values are averaged in order based on the equation on page 3-22. The displayed measurement value changes as shown below according to the display refresh period.

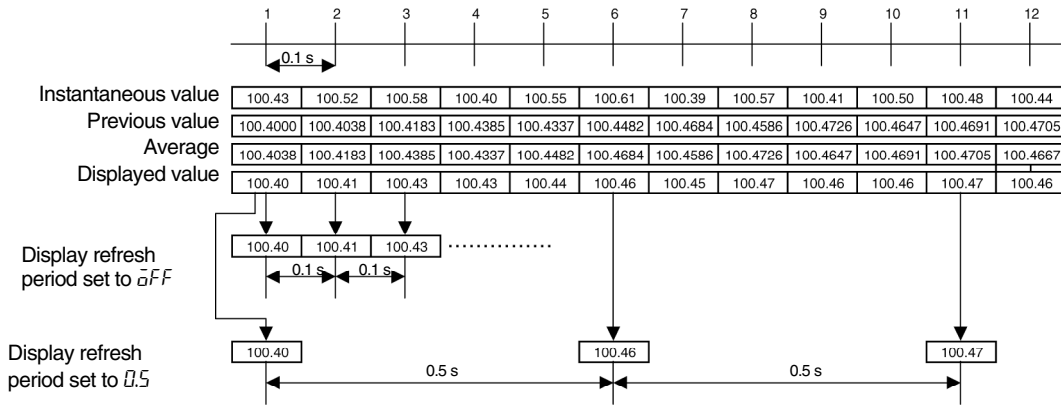

3. 11 Easily Measuring Power

Simple Measurement

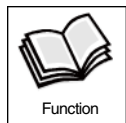

- The simple measurement function can be used to get a general understanding of the power of an installed circuit without wiring and measuring the voltage.
- This function can be used when the voltage cannot be input to the KM50 due to onsite conditions or wiring arrangements.
- If the Simple Measurement parameter is set to ON, the fixed voltage and fixed power factor can be set.
- The simple measurement function can be used to get a general understanding of the power of an installed circuit without wiring and measuring the voltage.
- Set the Applicable Circuit *00.ŁYP* setting according to the wiring when performing simple measurements.
- Fixed values are used for the voltage and power factor, so the accuracy specifications do not apply.
- If the Simple Measurement parameter is set to ON, a frequency of 50 Hz will be used.
 - Note 1. If the Simple Measurement parameter is set to ON, overvoltage errors and frequency errors will not be detected.
 - Note 2. The fixed voltage and fixed power factor can be set only after the Simple Measurement parameter has been set to ON.
 - Note 3. When the Simple Measurement parameter is ON, the VT settings are disabled.
 - Note 4. Fixed values are used for the voltage and power factor, so the voltage alarm and power factor alarm do not apply.
 - Note 5. The current and phase are not actually measured, so they cannot be used for regenerative power measurements. Negative power factors cannot be measured either.

Example: Fixed Voltage of 100.0 V and Fixed Power Factor of 1.00

Applicable Circuit	Single-phase, three-wire	Single-phase, three-wire			Three-phase, three-wire			Three-phase, four-wire		
		V-RN	V-SN	V-RS	V-RS	V-SŁ	V-ŁR	V-RN	V-SN	V-ŁN
Display No. 2	V									
Voltage display	100.0	100.0	100.0	100.0	100.0	100.0	100.0	100.0	100.0	100.0
Power factor display	1.00									



Parameter	Displayed characters	Setting range	Default setting	Unit
Simple Measurement	00.SMP	OFF, ON	OFF	-
Fixed Voltage	VŁŁ	0.0 to 9999.9	110.0	V
Fixed Power Factor	PF	0.00 to 1.00	1.00	-

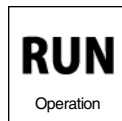

Procedure: The following procedure is used to turn ON the simple measurement function and set the fixed voltage to 200 V and the fixed power factor to 0.95.

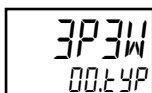

1 . Press the Key for at least 3 seconds to go from Measurement Mode to Operation Setting Mode.

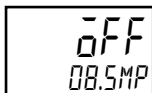

2 . Press the Key or + Keys to change from the Applicable Circuit (00.ŁYP) to the Simple Measurement (00.SMP).



- 3 . Press the Key to go to the setting status for the simple measurement.



- 4 . Press the Key or + Keys to change from OFF to ON.



- 5 . Press the Key to enter the set values and move to the setting status for the fixed voltage.



- 6 . Press the Key or + Keys to change the digit.



- 7 . Press the Key or + Keys to change from 1 to 2.



- 8 . Press the Key or + Keys to change the digit.



- 9 . Press the Key or + Keys to change from 1 to 0.



- 10 . Press the Key to change the set values and move to the setting status for the fixed power factor.



- 11 . Press the Key or + Keys to change from 1 to 0.

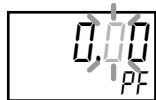

- 12 . Press the Key or + Keys to change the digit.



- 13 . Press the Key or + Keys to change from 0 to 9.

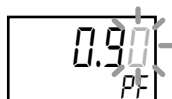

- 14 . Press the Key or + Keys to change the digit.

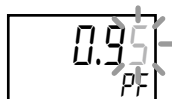

- 15 . Press the Key or + Keys to change from 0 to 5.

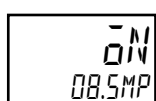

- 16 . Press the Key to enter the setting.
To end the setting procedure, press the Key for at least 3 seconds to go from Operation Setting Mode to Measurement Mode.

3. 12 Setting the Buzzer

■ Buzzer

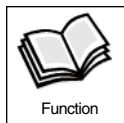

- This parameter turns the buzzer ON and OFF.
- If the buzzer is turned ON, it will sound when keys are pressed.



Parameter	Displayed characters	Setting range	Default setting	Unit
Buzzer	09. bZ	OFF, ON	ON	

Basic Operating Procedures



Procedure: The following procedure is used to turn OFF the buzzer.

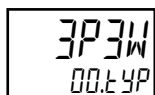

- 1 . Press the Key for at least 3 seconds to go from Measurement Mode to Operation Setting Mode.

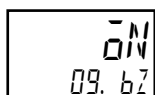

- 2 . Press the Key or + Keys to change from the Applicable Circuit (00.tYP) to the Buzzer (09. bZ).

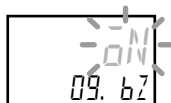

- 3 . Press the Key to go to setting status.



- 4 . Press the Key or + Keys to change from ON to OFF.

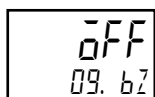

- 5 . Press the Key to enter the setting.
To end the setting procedure, press the Key for at least 3 seconds to go from Operation Setting Mode to Measurement Mode.

3. 13 CO₂ Emission

CO₂ Coefficient

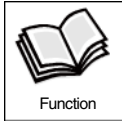

- This parameter is used to set a carbon dioxide conversion coefficient per kWh.
- The following formula is used to calculate the carbon dioxide conversion.

$$\text{CO}_2 = \text{Total power consumption} \times \text{CO}_2 \text{ coefficient}^{*1}$$

*1 The CO₂ coefficient is different for different power generation sites and years. Refer to the website of your power company or contact them directly.



Parameter	Displayed characters	Setting range	Default setting	Unit
CO ₂ Coefficient	10.┆┆┆2	0.0000 to 99.9999	0.387 ^{*2}	kg-CO ₂ / kWh

*2 The default setting is the CO₂ coefficient for Kyushu Electric Power Company for 2009.

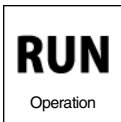

Procedure: The following procedure is used to set the CO₂ coefficient to 0.555 kg-CO₂/kWh.



1. Press the Key for at least 3 seconds to go from Measurement Mode to Operation Setting Mode.

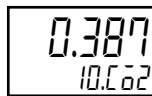

2. Press the Key or + Keys to change from the Applicable Circuit (00.┆┆4P) to the CO₂ Coefficient (10.┆┆2).



3. Press the Key to go to setting status.



4. Press the Key or + Keys to change the digit.



5. Press the Key or + Keys to change from 3 to 5.



6. Press the Key or + Keys to change the digit.



7. Press the Key or + Keys to change from 8 to 5.

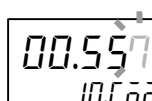

8. Press the Key or + Keys to change the digit.



9. Press the Key or + Keys to change from 7 to 5.



- 10 . Press the Key to enter the setting.
To end the setting procedure, press the Key for at least 3 seconds to go from Operation Setting Mode to Measurement Mode.

■ Calculated CO2

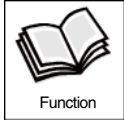

- The calculated CO₂ emission for the total power consumption will be displayed if the Key is pressed while the frequency is being displayed in the Basic Level of Measurement Mode.

Note 1. To reset the calculated CO₂ value, initialize the total power consumption with .

Note 2. μ on display No. 2 means 10³ and \bar{n} means 10⁶.

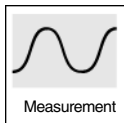

Parameter	Display No. 1	Display No. 2	Unit	Remarks
Calculated CO ₂	0.0 to 99999	\bar{n} \bar{CO}_2 μ \bar{CO}_2 \bar{n} \bar{CO}_2	kg-CO ₂	μ or \bar{n} is displayed on the uppermost digit of display No. 2 according to the measurement value.* There is no daily initialization.

*1 μ and \bar{n} can be checked on the display only. All digits are read out regardless of the unit when communications are used.

The decimal point will change depending on the scale of the measurement value.

- 0.000 to 99.999
- 100.00 to 999.99
- 1000.0 to 9999.9
- 10000 to 99999

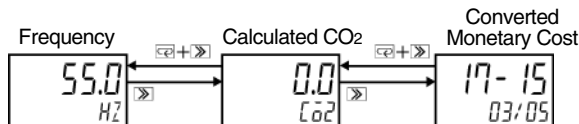

3. 14 Conversion to Monetary Cost

■ Conversion to Monetary Cost Setting

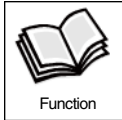

- It is possible to convert measurements to monetary cost in Japanese Yen or US dollars by setting the desired conversion coefficient and unit display.
- The following formula is used to calculate the converted value.

$$\text{Converted value} = \text{Total power consumption} \times \text{Rate setting}$$

Item	Displayed characters	Setting range	Default setting	Unit
Conversion to Monetary Cost Setting	11.CHG	-	-	-
Rate Setting	RALE	00.000 to 999999	10.000	-
Currency Setting	UNLE	JPY, USd, EUR, CNY, KRW ^{*1} R to Z, 0 to 9, /, -, _(space) ^{*2}	JPY	-

Note 1. The following currencies can be set in the currency settings.

JPY: Japanese Yen

USd: US dollars

EUR: Euro

CNY: Chinese Yuan

KRW: Korean Won

Note 2. First, the currency *1 can be set, and then the unit of currency*2 can be set using the setting range with four digits. A space will be displayed as _ while the currency is being set, and will be blank when the setting is finalized.

RUN

Operation

Procedure: The following procedure is used to set the rate setting to 80,000 and the currency setting to Korean Won.



1. Press the Key for at least 3 seconds to go from Measurement Mode to Operation Setting Mode.



2. Press the Key or + Keys to move from Applicable Circuit 00.4YP to Conversion to Monetary Cost Setting 11.CHG.



3. Press the Key to move to the setting status of the Rate Setting.



4. Press the Key or + Keys to change from 1 to 8.









5. Press the Key to enter the set values and move to the setting status for the Currency Setting.





6. Press the Key or + Keys to change from JPY to KRW.



- 7 . Press the  Key to enter the set value and press the  Key or + Keys to move to another digit, or press the  Key or + Keys to change the character string to set the unit to the desired value. In this example, *11RW* is left as it is.



- 8 . Press the  Key to enter the set value.
To end the setting procedure, press the  Key for at least 3 seconds to go from Operation Setting Mode to Measurement Mode.

Converted Monetary Cost

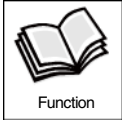

- The calculated cost for the total power consumption will be displayed if the F Key is pressed while the calculated CO₂ is being displayed in the Basic Level of Measurement Mode.
 - Press the H Key to check the calculated cost for the HIGH status. If the H Key is pressed again, or the $\text{C}+\text{H}$ Keys are pressed, you can switch between the calculated cost for the HIGH status, MIDDLE status, and LOW status.
 - The monetary cost of each state is calculated based on the total power consumption of the three states classified by thresholds or the event input status.
- Note: To reset the calculated cost, initialize the total power consumption with CNEEG . To reset the calculated cost of each status, initialize the Measurement Mode Professional Level with M.PRO .

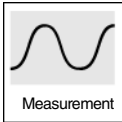

Item	Display No. 1	Display No. 2	Unit	Remarks
Converted Monetary Cost	0.000 to 99999	Display as set in Currency Setting. Display as set in μ + Currency Setting. Display as set in \bar{n} + Currency Setting.	-	μ or \bar{n} is displayed on display No. 2 according to the measurement value.*1 There is no daily initialization.
Calculated HIGH Cost	0.000 to 99999	$\text{H}\bar{c}\text{GH}$ $\mu\text{H}\bar{c}\text{GH}$ $\bar{n}\text{H}\bar{c}\text{GH}$	-	Calculated from the HIGH total power consumption. There is no daily initialization.
Calculated MIDDLE Cost	0.000 to 99999	$\text{M}\bar{c}\text{d}$ $\mu\text{M}\bar{c}\text{d}$ $\bar{n}\text{M}\bar{c}\text{d}$	-	Calculated from the MIDDLE total power consumption. There is no daily initialization.
Calculated LOW Cost	0.000 to 99999	$\text{L}\bar{o}\text{w}$ $\mu\text{L}\bar{o}\text{w}$ $\bar{n}\text{L}\bar{o}\text{w}$	-	Calculated from the LOW total power consumption. There is no daily initialization.

*1 μ and \bar{n} can be checked on the display only. All digits are read out regardless of the unit when communications are used.

The decimal point will change depending on the scale of the measurement value.

- 0.000 to 99.999
- 100.00 to 999.99
- 1000.0 to 9999.9
- 10000 to 99999

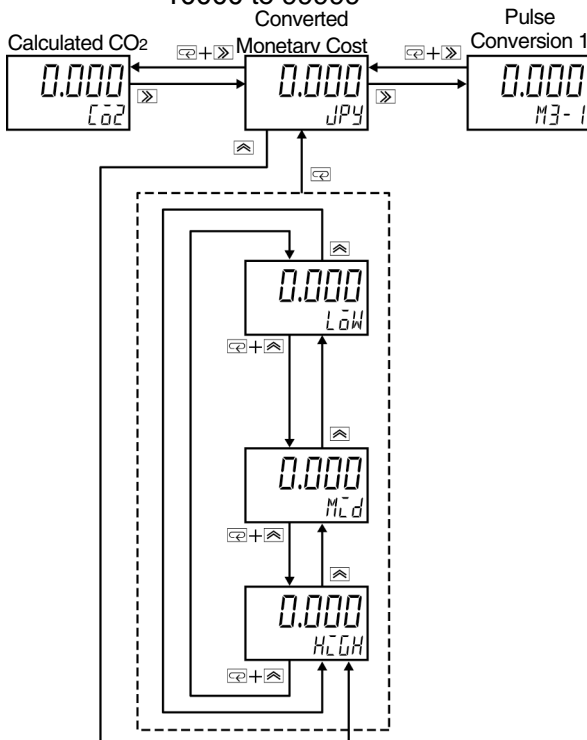

Basic Operating Procedures

3. 15 Pulse Conversions

■ Pulse Conversion Settings

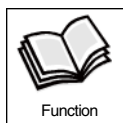

- It is possible to convert measurements to emission levels by setting the desired numerical conversion target, conversion coefficient, and unit display.
- The following formula is used to calculate the converted value.

$$\text{Conversion value} = \text{Pulse input count} \times \text{Conversion coefficient}$$

Item	Displayed characters	Setting range	Default setting	Unit
Pulse Conversion 1 Setting	12.LV 1	-	-	-
Pulse Conversion Target 1	tRRG	[-t.d, [- l.d, [-2.d, [-t.R, [- l.R, [-2.R	[- l.d	-
Coefficient Setting 1	SLP	0000 to 9999	000 1	-
Decimal Point Position Setting 1	dP	0000, 000.0, 00.00, 0.000	0000	-
Display Unit Setting 1	UNt	R to Z, 0 to 9, /, -, _(space) *1	M3- 1	-
Pulse Conversion 2 Setting	13.LV 2	-	-	-
Pulse Conversion Target 2	tRRG	[-t.d, [- l.d, [-2.d, [-t.R, [- l.R, [-2.R	[-2.d	-
Coefficient Setting 2	SLP	0000 to 9999	000 1	-
Decimal Point Position Setting 2	dP	0000, 000.0, 00.00, 0.000	0000	-
Display Unit Setting 2	UNt	R to Z, 0 to 9, /, -, _(space) *1	M3- 2	-

Note 1. The following type of pulse conversions can be made.

- [-t.d: Total Pulse Input Count for the Day
- [- l.d: Sum Pulse Input Count 1 for the Day
- [-2.d: Pulse Input Count 2 for the Day
- [-t.R: Sum Total Pulse Input Count
- [- l.R: Total Pulse Input Count 1
- [-2.R: Total Pulse Input Count 2

The total pulse input count is the sum of pulse input counts 1 and 2.

Pulse input counts 1 and 2 and the total pulse input count are synchronized at the same time.

Total pulse input counts 1 and 2 and the sum total pulse input count are not synchronized at the same time. Each measurement value is initialized when it reaches the maximum value (999999999).

Note 2. In the display unit settings, display unit can be set using the setting range*1 with four digits. A space will be displayed as _ while the currency is being set, and will be blank when the setting is finalized.



Procedure: Set the pulse conversion target of the Pulse Conversion 1 Setting to the total pulse input count for the day, the coefficient to 25.00, and the display unit to L/m.

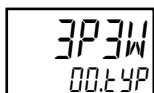

1. Press the Key for at least 3 seconds to go from Measurement Mode to Operation Setting Mode.

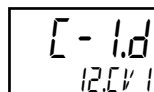

2. Press the or Keys to move from Applicable Circuit 00.t4P to Pulse Conversion 1 Setting 12.LV 1.



3. Press the Key to go to the setting status for the Pulse Conversion Target.



4. Press the Key or + Keys to change from $E-1.d$ to $E-t.d$.



5. Press the Key to enter the set values and move to the setting status for the Coefficient Setting.



6. Press the Key or + Keys to change from 0 to 2.



7. Press the Key or + Keys to change the digit.



8. Press the Key or + Keys to change from 0 to 5.



9. Press the Key or + Keys to change the digit.



10. Press the Key or + Keys to change from 1 to 0.

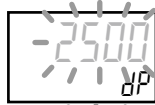

11. Press the Key to enter the set value and move to the setting status for the Decimal Point Position Setting.

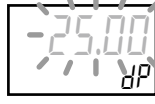

12. Press the Key or + Keys to change from 2500 to 25.00.



13. Press the Key to enter the set values and move to the setting status for the Display Unit Setting.

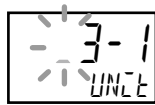

14. Press the Key or + Keys to change from M to _ (space).

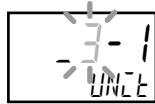

15. Press the Key or + Keys to change the digit.

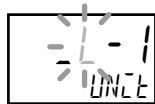

16. Press the Key or + Keys to change from 3 to L.

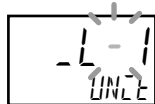

17. Press the Key or + Keys to change the digit.

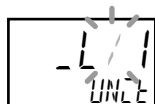

18. Press the Key or + Keys to change from - to /.



19. Press the Key or + Keys to change the digit.



20. Press the \uparrow Key or $\square+\uparrow$ Keys to change from l to M .

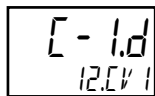

21. Press the \square Key to enter the set value.
To end the setting procedure, press the \square Key for at least 3 seconds to go from Operation Setting Mode to Measurement Mode.

Note: The method for setting for pulse conversion 2 is the same.

Pulse Converted Values

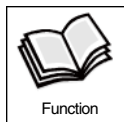

- The converted value for the pulse input count will be displayed if the \rightarrow Key is pressed while the calculated cost is being displayed in the Basic Level of Measurement Mode.

Note: To reset the pulse converted value, initialize the pulse input count.

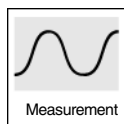

Item	Display No. 1	Display No. 2	Unit	Remarks
Pulse Converted Value 1	0.000 to 99999	Display as set in Display Unit Setting. Display as set in μ + Display Unit Setting. Display as set in \bar{n} + Display Unit Setting.	-	μ or \bar{n} is displayed on the uppermost digit of display No. 2 according to the measurement value.*1
Pulse Converted Value 2	0.000 to 99999	Display as set in Display Unit Setting. Display as set in μ + Display Unit Setting. Display as set in \bar{n} + Display Unit Setting.	-	μ or \bar{n} is displayed on the uppermost digit of display No. 2 according to the measurement value.*1

*1 μ and \bar{n} can be checked on the display only. All digits are read out regardless of the unit when communications are used.

The decimal point will change depending on the scale of the measurement value.

- 0.000 to 99.999
- 100.00 to 999.99
- 1000.0 to 9999.9
- 10000 to 99999

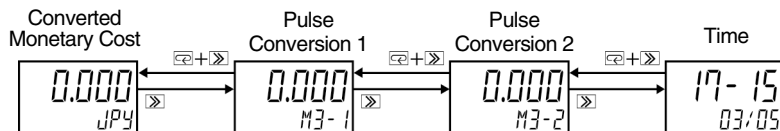

3. 16 Time Setting

■ Time Setting



- The year, month/day, and hour/minutes are set in order.
Any changes are ignored if operation is canceled before completion.

Note: The time setting is saved when the hour/minutes are set.



Parameter	Displayed characters	Setting range	Default setting	Unit
Time (Year, Month/Day, Hour/Minutes)	14.ELM	20 10 to 2099 01/01 to 12/31 00-00 to 23-59	20 10 01/01 00-00	Year Month/day Hour-minutes



Procedure: The following procedure is used to set 2010/3/5 17:15.



- Press the Key for at least 3 seconds to go from Measurement Mode to Operation Setting Mode.

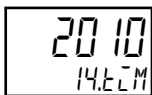

- Press the Key or Keys to change from the Applicable Circuit (00.ELP) to the Time Setting (14.ELM).



- Press the Key to go to setting status for the year.



- Press the Key to enter the year and move to the month/day setting.



- Press the Key or Keys to change the digit.



- Press the Key or Keys to change from 1 to 3.



- Press the Key or Keys to change the digit.



- Press the Key or Keys to change from 1 to 5.



- Press the Key to enter the month/day and move to the hour/minutes setting.



- Press the Key or Keys to change from 0 to 1.

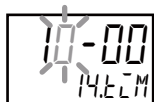

11. Press the Key or + Keys to change the digit.



12. Press the Key or + Keys to change from 0 to 7.



13. Press the Key or + Keys to change the digit.

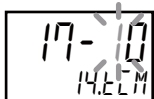

14. Press the Key or + Keys to change from 0 to 1.



15. Press the Key or + Keys to change the digit.

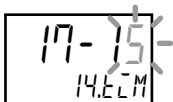

16. Press the Key or + Keys to change from 0 to 5.

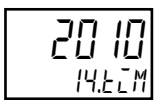

17. Press the Key to enter the setting. The clock will start.
To end the setting procedure, press the Key for at least 3 seconds to go from Operation Setting Mode to Measurement Mode.

■ Time

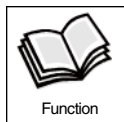

- The time counted from the time that was set will be displayed if the Key is pressed while the Pulse Converted Value 2 is being displayed in the Basic Level of Measurement Mode.
- Display No. 1 will show the hour-minutes and display No. 2 will show the month/day.

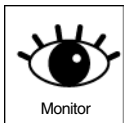

Parameter	Display No. 1	Display No. 2	Unit	Remarks
Time	00-00 to 23-59	01/01 to 12/31	Hour-minutes	

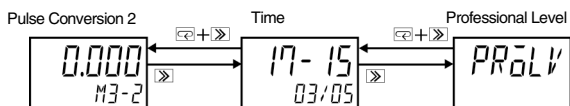

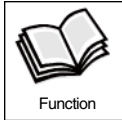

- The KM50 can save the measured values in EEPROM every 5 minutes, every day, or every month.

The following table gives the measurement values and units that are saved.

Measurement value	Logging period	Remarks
Total power consumption	5 min	Two days of measurement values are logged at 5-min intervals.
	1 h	The measurement values that were logged every 5 minutes are totaled every hour and logged for 25 hours.
	1 day	The measurement values from 00:00 to 24:00 are logged for eight days.
	1 month	Measurement values for each month are logged for 13 months.
Active power ^{*2} Current ^{*2} Voltage ^{*2} Power factor ^{*2}	1 day	The measurement values from 00:00 to 24:00 are logged for eight days. (Measurement values are reset after they have been logged.)* ¹
Total three-state power consumption	5 min	Two days of measurement values are logged at 5-min intervals.
	1 day	The measurement values from 00:00 to 24:00 are logged for eight days.
Pulse input count Specific power consumption Pulse input ON time Total Three-state Time	1 day	The measurement values from 00:00 to 24:00 are logged for eight days.
Total Regenerated Energy Total Reactive Power Consumption	5 min	Two days of measurement values are logged at 5-min intervals. Only the items selected in the settings are saved.
Active Power ^{*2} Current ^{*2} Voltage ^{*2} Power Factor ^{*2} Pulse Input Count Specific Power Consumption Pulse Input ON Time	5 min	Measurement values are overwritten every five minutes.

*1 Here, "reset" means that the measurement log is deleted from RAM after the logging period has elapsed.

*2 The maximum and minimum values for each item are logged.

Note 1. Time data is held for 7 days if the power is interrupted.

Note 2. Data that is logged every 5 minutes can be checked only by using communications.

There are three logging periods for measurement values, as described below.

Measurement Values Logged Every Five Minutes

If measurements are started at 0:00.00, the measurement values are logged every 5 minutes (0:05.00, 0:10.00, etc.).

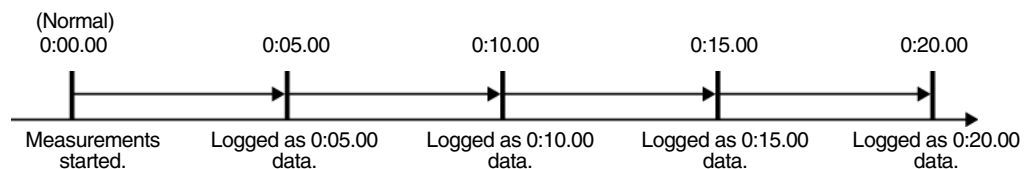

If the time when the power supply is turned ON does not match the measurement interval, the measurement values at the first measurement interval after the power supply is turned ON are logged as the 5-minute data and then the measurement values are logged every 5 minutes.

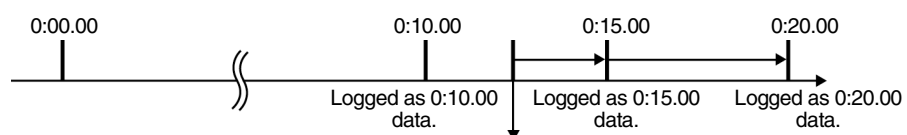

Power turned ON and measurement started at 0:12.30.

If the power supply is interrupted at 0:07.30 and recovered at 0:17.30, data between 0:05.00 and 0:07.30 is not saved.

If time is required to recover power, the data while power was interrupted will be taken as 0.

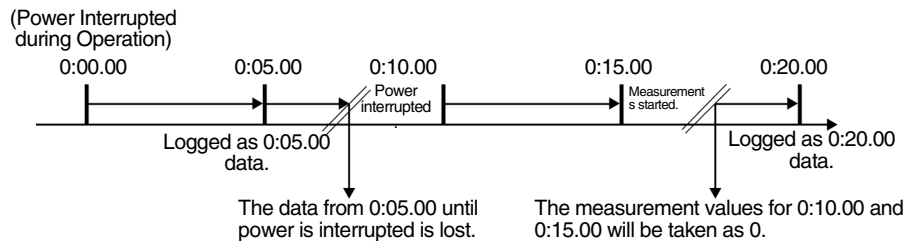

Measurement Values Overwritten Every 5 Minutes

If measurements are started at 0:00.00, the measurement values are overwritten every 5 minutes (0:05.00, 0:10.00, etc.).

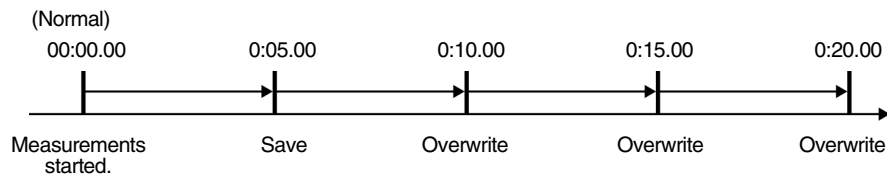

If the time when the power supply is turned ON does not match the measurement interval, the measurement values at the first measurement interval after the power supply is turned ON are overwritten as the 5-minute data and then the measurement values are overwritten every 5 minutes.

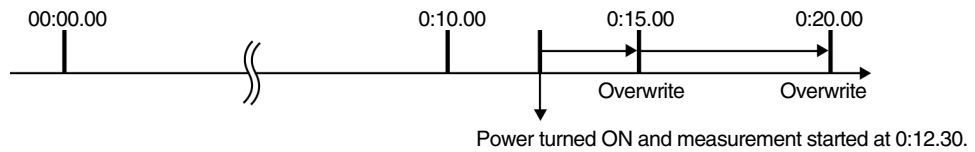

If the power supply is interrupted at 0:07.30 and recovered at 0:17.30, data at 0:07.30 will not be overwritten at 0:17.30. After the power supply has recovered, measurements start from 0:05.00.

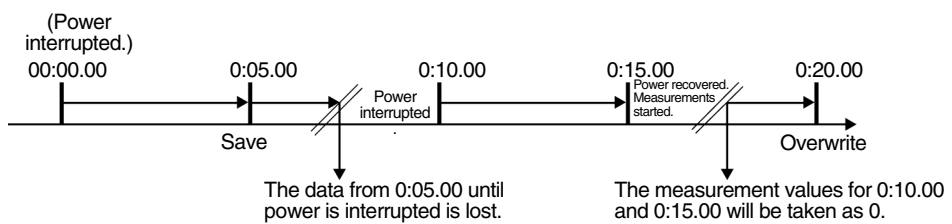

Measurement values can be logged every day.

If measurements are started at Month Day1 0:00.00, the measurement values are logged every day (Month Day2 0:00.00, Month Day3 0:00.00, etc.).

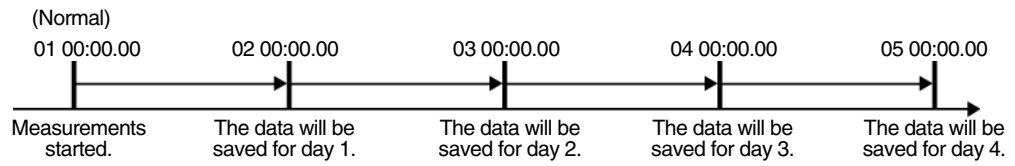

If the time when the power supply is turned ON does not match the measurement interval, the measurement values at the first measurement interval after the power supply is turned ON are saved as the daily data and then the measurement values are saved every day.

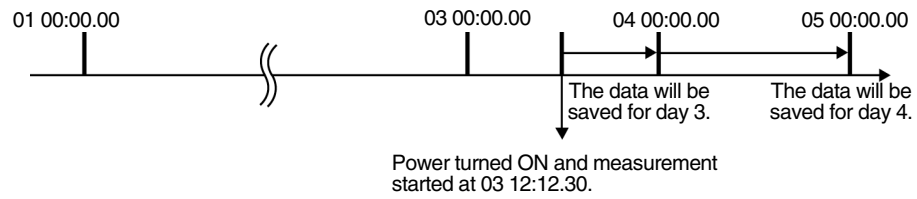

If the power supply is interrupted at Month Day2 12:00.00 and recovered at Month Day4 12:00.00, data between Month Day2 00:00.00 and Month Day2 12:00.00 will not be protected.

If time is required to recover power, the data while power was interrupted will be taken as 0.

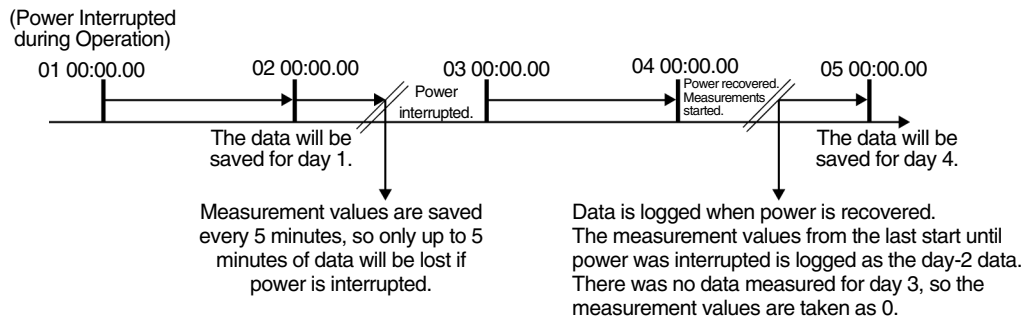

Measurement Values Logged Every Month

If measurements are started at January 1 0:00.00, the measurement values are logged every month (February 1 0:00.00, March 1 0:00.00, etc.).

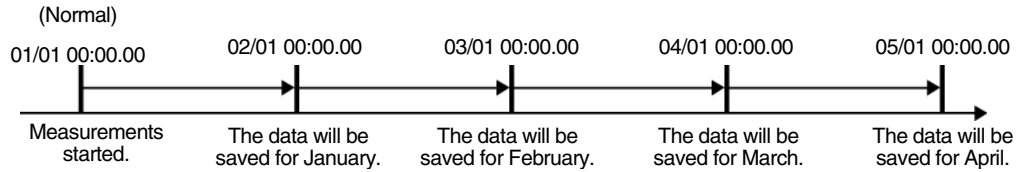

If the time when the power supply is turned ON does not match the measurement interval, the measurement values at the first measurement interval after the power supply is turned ON are logged as the data for the month and then the measurement values are logged every month.

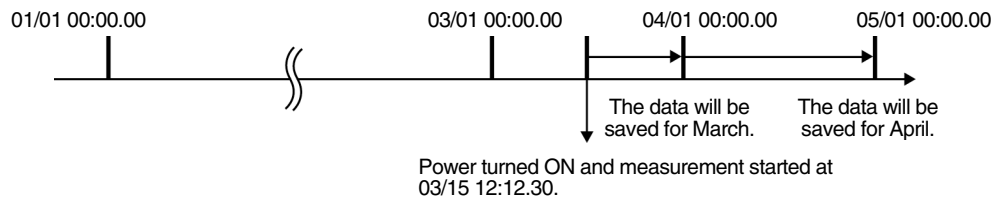

If the power supply is interrupted at February 15 0:00.00 and turned ON at April 15 0:00.00, data between February 1 0:00.00 and February 15 0:00.00 will not be protected.

If time is required to recover power, the data while power was interrupted will be taken as 0.

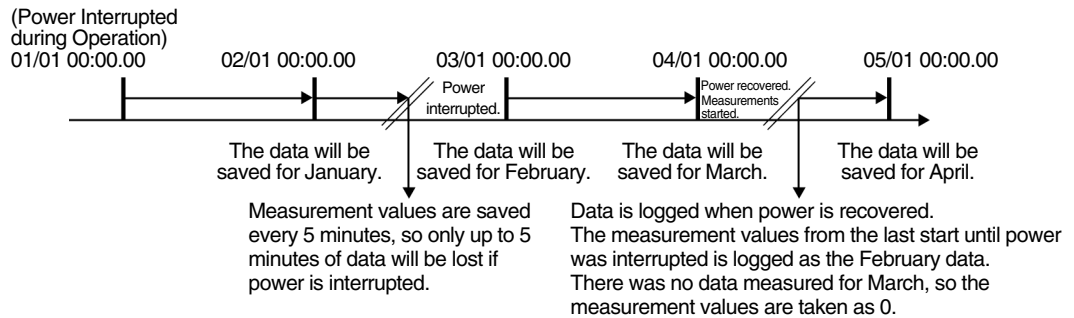

● Time Corrections

The KM50 logs data in sync with the time of the internal clock in the KM50. If the time is corrected, the log data will be compensated as described below.

Setting the Time Forward

The data will be compensated as non-operating data for the time interval that was skipped.

- Total power consumption: The last logged value will be used for the skipped time.
- Maximum values, minimum values, etc.: Data of 0 will be used for the days or months for which measurements were not taken.

Setting the Time Backward

The data for the time that was set back will be lost.

However, the total power consumptions will hold the previous values.

This may mean that the total hourly, daily, and monthly power consumptions for the present hour, day, and month may increase. If you set the time back by a large amount, we recommend that you initialize the total power consumptions.

3. 17 Initializing Data

■ Initialize



Function

- The Initialize parameter can be used with the settings given in the following table.
- If the Key is pressed for the desired setting, the specified data will be initialized.

Setting	Displayed characters	Description
Initialize Settings	SEt	Initializes all parameters except for the Time Setting parameter.
Initialize Maximum Values	MAx	Initializes the maximum values for the day.
Initialize Minimum Values	MIN	Initializes the minimum values for the day.
Initialize Total Power Consumption	ENEg	Initializes the total power consumptions.
Initialize Measurement Values in Professional Level	M,PRo	Initializes the measured values for the day in the Professional Level of Measurement Mode.
Initialize Measurement Log	LoG	Initializes the entire measurement log.
Initialize All	ALL	Initializes all parameters and measurement logs except for the Time Setting parameter.



Setting

Parameter	Displayed characters	Setting range	Default setting	Unit
Initialize	IS.tNt	SEt, MAx, MIN, tNEg, M,PRo, LoG, ALL	SEt	-



Operation

Procedure: The following procedure is used to initialize the measurement log.



1. Press the Key for at least 3 seconds to go from Measurement Mode to Operation Setting Mode.

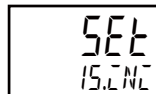

2. Press the Key or + Keys to change from the Applicable Circuit (00.tYP) to Initialize (IS.tNt).

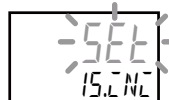

3. Press the Key to go to setting status.

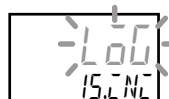

4. Press the Key or + Keys to change from LEt to LoG.

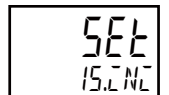

5. Press the Key to enter the setting.
To end the setting procedure, press the Key for at least 3 seconds to go from Operation Setting Mode to Measurement Mode.

Check the following table before initializing data.

Setting Parameter	SET	MAX	MIN	LINEG	MPRO	LOG	ALL
Active Power	Not initialized.	Maximum value for day initialized	Minimum values for day initialized.	Not initialized.	Not initialized.	Entire measurement log initialized.	Entire measurement log initialized.
Total Power Consumption	Not initialized.	Not initialized.	Not initialized.	Total power consumptions initialized.	Not initialized.	Entire measurement log initialized. (Except for total power consumptions.)	Total power consumptions and entire measurement log initialized.
Current	Not initialized.	Maximum value for day initialized	Minimum values for day initialized.	Not initialized.	Not initialized.	Entire measurement log initialized.	Entire measurement log initialized.
Voltage	Not initialized.	Maximum value for day initialized	Minimum values for day initialized.	Not initialized.	Not initialized.	Entire measurement log initialized.	Entire measurement log initialized.
Power Factor	Not initialized.	Maximum value for day initialized	Minimum values for day initialized.	Not initialized.	Not initialized.	Entire measurement log initialized.	Entire measurement log initialized.
Reactive Power	Initialized when switching to Operation Setting Mode.						
Frequency	Not initialized.						
Calculated CO ₂	Not initialized.	Not initialized.	Not initialized.	Initialized (because it depends on the total power consumption).	Not initialized.	Not initialized.	Initialized (because it depends on the total power consumption).
Converted Monetary Cost	Not initialized.	Not initialized.	Not initialized.	Initialized (depends on the Total Power Consumption).	Not initialized.	Not initialized.	Initialized (depends on the Total Power Consumption).
Pulse Converted Value	Not initialized.	Not initialized.	Not initialized.	Not initialized.	Initialized (depends on the Pulse Input Count).	Not initialized.	Initialized (depends on the Pulse Input Count).
Pulse Input Count	Not initialized.	Not initialized.	Not initialized.	Not initialized.	Measurement values for day initialized	Entire measurement log initialized.	Initializes the entire measurement log including the data for today.
Total Pulse Input Count*	Not initialized.	Not initialized.	Not initialized.	Not initialized.	Initialize	Not initialized.	Initialize
Specific Power Consumption	Not initialized.	Not initialized.	Not initialized.	Not initialized.	Measurement values for day initialized	Entire measurement log initialized.	Initializes the entire measurement log including the data for today.
Pulse Input ON Time	Not initialized.	Not initialized.	Not initialized.	Not initialized.	Measurement values for day initialized.	Entire measurement log initialized.	Initializes the entire measurement log including the data for today.
Total three-state power consumption	Not initialized.	Not initialized.	Not initialized.	Not initialized.	Measurement values for day initialized.	Entire measurement log initialized.	Initializes the entire measurement log including the data for today.
Total Three-state Power Consumption*	Not initialized.	Not initialized.	Not initialized.	Not initialized.	Initialize	Not initialized.	Initialize
Total Three-state Time	Not initialized.	Not initialized.	Not initialized.	Not initialized.	Measurement values for day initialized.	Entire measurement log initialized.	Initializes the entire measurement log including the data for today.
Total Three-state Time*	Not initialized.	Not initialized.	Not initialized.	Not initialized.	Initialize	Not initialized.	Initialize
Total Regenerated Energy	Not initialized.	Not initialized.	Not initialized.	Initializes the total regenerative energy.	Initializes the total regenerative power consumption.	Initializes the entire measurement log except for the total regenerated energy.	Initializes the total regenerative energy and entire measurement log.

Setting Parameter	SEt	MAx	MEtN	ENEeG	MPRō	LōG	ALL
Total Leading Reactive Power Total Lagging Reactive Power Total Reactive Power	Not initialized.	Not initialized.	Not initialized.	Initialized the totals for all three reactive power consumptions.	Total reactive power consumptions initialized.	Initializes the entire measurement log except for the totals for all three reactive power consumptions.	Initializes the totals for all three reactive power consumptions and entire measurement log.
Simple Temperature	Not initialized.						
Set Values	All set values initialized.	Not initialized.	Not initialized.	Not initialized.	Not initialized.	Not initialized.	All set values initialized.
Time Setting	Not initialized.						

* Measurement values that can be checked with communications only. The values are not initialized daily.

3. 18 Communications Setting Mode

■ Protocol Selection



- The following communications protocols are supported: CompoWay/F*¹ and Modbus*².
 - *1: CompoWay/F is a general-purpose OMRON serial communications protocol. The CompoWay/F protocol supports standard frame formats and FINS-compliant commands, which are widely used by OMRON Programmable Controllers and other devices, for easy communications between computers and components.
 - *2. This protocol complies with the RTU Mode of the Modbus Protocol.
Modbus is a registered trademark of Schneider Electric.



Parameter	Displayed characters	Setting range	Default setting	Unit
Protocol Selection	80.P5L	COMPF, Modb	COMPF	—

The data length will be 8 bits if Modbus is set as the protocol.

The number of stop bits will be set automatically according to the vertical parity.

If the Vertical Parity parameter is set to "none" there will be 2 stop bits. If it is set to odd or even parity, there will be 1 stop bit.



Procedure: The following procedure is used to set the protocol to Modbus.

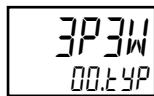

- 1 . Press the Key for at least 3 seconds to go from Measurement Mode to Operation Setting Mode.



- 2 . Press the Key to go from Operation Setting Mode to Communications Setting Mode.



- 3 . Press the Key to go to setting status.



- 4 . Press the Key or + Keys to change from COMPF to Modb.

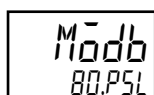

- 5 . Press the Key to enter the setting.
To end the setting procedure, press the Key for at least 3 seconds to go from Operation Setting Mode to Measurement Mode.

■ Unit Number

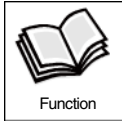

- With RS-485 communications, more than one node can be connected to the same communications line. A unit number must be set for each Power Monitor so that the host can identify them.
- If the same unit number is set for more than one Power Monitor, it will not be possible to communicate with them.



Setting	Displayed characters	Setting range	Default setting	Unit
Unit Number	B I.U.N \bar{a}	CompoWay/F: 0 to 99 Modbus: 1 to 99	CompoWay/F: 1 Modbus: 1	-

It is not necessary for the unit numbers to agree with the number of units that are connected. CompoWay/F: Up to 31 nodes can be connected including nodes not occupied by the KM50. Modbus: Up to 99 nodes can be connected. Only KM50 nodes can be connected to the same communications line.

The numbers of nodes given above do not include the master.

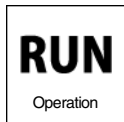

Procedure: The following procedure is used to set the unit number to 5.



1. Press the Key for at least 3 seconds to go from Measurement Mode to Operation Setting Mode.



2. Press the Key to go from Operation Setting Mode to Communications Setting Mode.

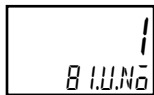

3. Press the Key or + Keys to change from the Protocol Selection (80.PSL) to the Unit Number (8 I.U.N \bar{a}).



4. Press the Key to go to setting status.

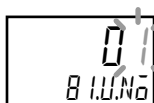

5. Press the Key or + Keys to change the digit.



6. Press the Key or + Keys to change from 1 to 5.

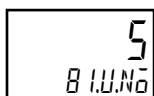

7. Press the Key to enter the setting. To end the setting procedure, press the Key for at least 3 seconds to go from Operation Setting Mode to Measurement Mode.

■ Baud Rate

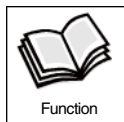

- Use this parameter to set the baud rate.



Setting	Displayed characters	Setting range	Default setting	Unit
Baud Rate	82.bPS	1.2k, 2.4k, 4.8k, 9.6k, 19.2k, 38.4k	9.6k	bps



Procedure: The following procedure is used to set the baud rate to 19.2 kbps.

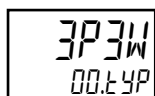

- 1 . Press the Key for at least 3 seconds to go from Measurement Mode to Operation Setting Mode.



- 2 . Press the Key to go from Operation Setting Mode to Communications Setting Mode.

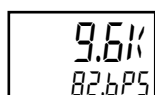

- 3 . Press the Key or + Keys to change from the Protocol Selection (80.PSL) to the Baud Rate (82.bPS).



- 4 . Press the Key to go to setting status.



- 5 . Press the Key or + Keys to change from 9.6k to 19.2k.

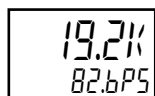

- 6 . Press the Key to enter the setting.
To end the setting procedure, press the Key for at least 3 seconds to go from Operation Setting Mode to Measurement Mode.

■ Data Length

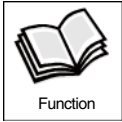

- Use this parameter to set the data length.



Setting	Displayed characters	Setting range	Default setting	Unit
Data Length	B3.LEN	7, 8	7	bit

The data length will be 8 bits if Modbus is set as the protocol.



Procedure: The following procedure is used to set the data length to 8 bits.

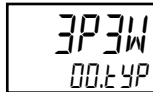

- 1 . Press the Key for at least 3 seconds to go from Measurement Mode to Operation Setting Mode.



- 2 . Press the Key to go from Operation Setting Mode to Communications Setting Mode.

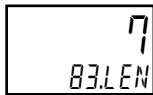

- 3 . Press the Key or + Keys to change from the Protocol Selection (80.PSL) to the Data Length (B3.LEN).

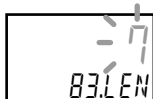

- 4 . Press the Key to go to setting status.

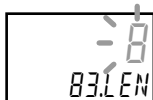

- 5 . Press the Key or + Keys to change from 7 to 8.

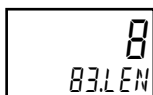

- 6 . Press the Key to enter the setting.
To end the setting procedure, press the Key for at least 3 seconds to go from Operation Setting Mode to Measurement Mode.

■ Stop Bits

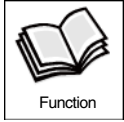

- Use this parameter to set the number of stop bits.



Parameter	Displayed characters	Setting range	Default setting	Unit
Stop Bits	84.5bL	1, 2	2	bit

If Modbus is set as the protocol, the number stop bits will be set automatically according to the vertical parity.

If the Vertical Parity parameter is set to NONE, there will be 2 stop bits. If it is set to ODD or EVEN parity, there will be 1 stop bit.



Procedure: The following procedure is used to set 1 stop bit.



- 1 . Press the Key for at least 3 seconds to go from Measurement Mode to Operation Setting Mode.



- 2 . Press the Key to go from Operation Setting Mode to Communications Setting Mode.

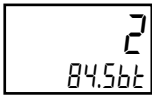

- 3 . Press the Key or + Keys to change from the Protocol Selection (80.P5L) to the Stop Bits (84.5bL).

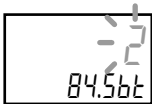

- 4 . Press the Key to go to setting status.



- 5 . Press the Key or + Keys to change from 2 to 1.

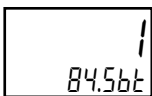

- 6 . Press the Key to enter the setting.
To end the setting procedure, press the Key for at least 3 seconds to go from Operation Setting Mode to Measurement Mode.

Vertical Parity

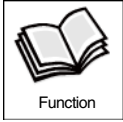

- Use this parameter to set the vertical parity.



Setting	Displayed characters	Setting range	Default setting	Unit
Vertical Parity	<i>BS.PRT</i>	<i>NONE, odd, EVEN</i>	<i>EVEN</i>	—

Select NONE for no parity, EVEN for even parity, and ODD for odd parity.



Procedure: The following procedure is used to set odd vertical parity.

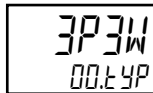

1. Press the Key for at least 3 seconds to go from Measurement Mode to Operation Setting Mode.



2. Press the Key to go from Operation Setting Mode to Communications Setting Mode.



3. Press the Key or + Keys to change from the Protocol Selection (*80.PSL*) to the Vertical Parity (*85.PRT*).

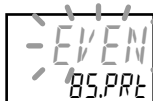

4. Press the Key to go to setting status.



5. Press the Key or + Keys to change from *EVEN* to *odd*.

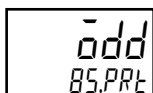

6. Press the Key to enter the setting.
To end the setting procedure, press the Key for at least 3 seconds to go from Operation Setting Mode to Measurement Mode.

■ Transmission Wait Time

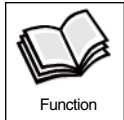

- Use this parameter to set the transmission wait time.
- This parameter is used to set the time from creating a response until the response is sent.
- The time can be set in 1-ms intervals.



Setting	Displayed characters	Setting range	Default setting	Unit
Transmission Wait Time	86.5dW	0 to 99	20	ms



Procedure: The following procedure is used to set the transmission wait time to 10 ms.

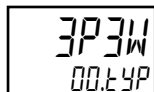

- 1 . Press the Key for at least 3 seconds to go from Measurement Mode to Operation Setting Mode.



- 2 . Press the Key to go from Operation Setting Mode to Communications Setting Mode.

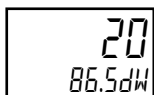

- 3 . Press the Key or + Keys to change from the Protocol Selection (80.P5L) to the Transmission Wait Time (86.5dW).

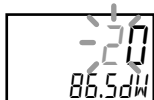

- 4 . Press the Key to go to setting status.

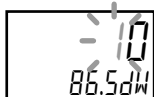

- 5 . Press the Key or + Keys to change from 2 to 1.

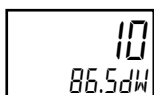

- 6 . Press the Key to enter the setting.
To end the setting procedure, press the Key for at least 3 seconds to go from Operation Setting Mode to Measurement Mode.

Section 4 Advanced Operating Procedures

4.1	Event Inputs	4-2
	■ Event Input Setting.....	4-2
	■ Event Input 1/Event Input 2 NPN/PNP Input Mode Settings	4-5
	■ Event Input 1/Event Input 2 NO/NC Input Mode Settings	4-7
	■ Measurement Start Time/Measurement End Time.....	4-8
	■ Pulse Input Count	4-10
	■ Specific Power Consumption	4-11
	■ Pulse Input ON Time	4-12
	■ Three-state Energy Classification	4-12
4.2	Three-state Outputs.....	4-13
	■ Three-state Target	4-13
	■ Three-state HIGH Threshold/Three-state LOW Threshold	4-15
	■ Three-state Hysteresis	4-17
	■ Three-state Color Setting	4-18
	■ HIGH, MIDDLE, and LOW Total Power Consumptions	4-20
	■ HIGH, MIDDLE, and LOW Total Times.....	4-21
4.3	Output Terminal Function Settings.....	4-22
	■ Output Terminal 1 and Output Terminal 2 Function Settings	4-22
4.4	Alarm Output	4-24
	Alarm Output Time Charts	4-24
	Alarm History	4-26
	■ Active Power Alarm Output	4-27
	■ Current Alarm Output.....	4-33
	■ Voltage Alarm Output	4-36
	■ Power Factor Alarm Output.....	4-39
	■ Reactive Power Alarm Output.....	4-42
4.5	Total Regenerative Energy and Total Reactive Power Consumption .	4-45
	■ Consumed Power Save Selection	4-45
	■ Total Regenerated Energy	4-47
	■ Total Leading Reactive Power Consumption, Total Lagging Reactive Power Consumption, and Total Reactive Power Consumption	4-48
4.6	Measurement Value Displays.....	4-49
	■ Automatic Rotation	4-49
	■ Measurement Parameter Display Selection	4-51
4.7	Energy-saving Mode.....	4-54
	■ Display ON Time.....	4-54
4.8	Incorrect Wiring	4-55
	■ Incorrect Voltage Wiring Detection.....	4-55
4.9	Simple Temperature Measurements	4-56
	■ Temperature Setting	4-56
	■ Simple Temperature	4-57
4.10	Displaying Product Information	4-58
	■ Product Information	4-58
4.11	Protection Setting Mode	4-59
	■ Protection Setting.....	4-59

4.1 Event Inputs



- Pulses for inputs from external devices can be counted.
- The ON and OFF criteria can be based on the total count of the two inputs, an OR of the two inputs, or the status of the inputs. The event inputs are used for the following functions.
 - Total number in input pulses: Specific power consumption management
 - OR: The pulse input ON time is measured.
 - Input status: Three-state classification
- The inputs can be set separately to normally open or normally closed.

Event Input Setting

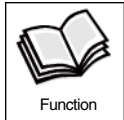

- This parameter is used to set the item that is to be measured with the event inputs.



Parameter	Displayed characters	Setting range	Default setting	Unit
Event Input Setting	30.ECS	P.CSP, H-ON, 3-5t	P.CSP	-

Note: When 3-5t is selected, the Three-state Target parameter is automatically set to NONE.

P.CSP: Specific Power Consumption

The takt power of the production line can be measured in kWh/pulse. If the number of manufactured items is input to the Power Monitor as event input pulses, the takt power consumption can be calculated from the total power consumption and displayed for the specified period (1 day maximum). The count is based on an OR of the two inputs.

The period that is specified in the settings will be used for the total power consumption. (Refer to page 4-8.) The specified period must be 24 hours or less and must be within the same day.

Outside of the specified time period, the final measurement values will continue to be displayed.

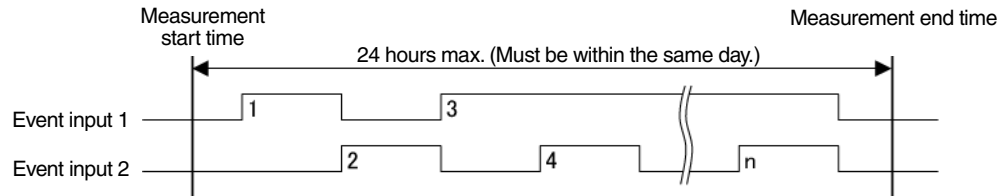

H-ON: Pulse Input ON Time

The total time that one or both of the event inputs are ON is calculated for one day and displayed as the pulse input ON time. The pulse input ON time can be used to monitor the equipment operating time. As long as either of the event inputs is ON, it is assumed that the equipment is operating. The period that is specified in the settings will be used for the total power consumption. (Refer to page 4-8.) The specified period must be 24 hours or less and must be within the same day. Outside of the specified time period, the final measurement values will continue to be displayed.

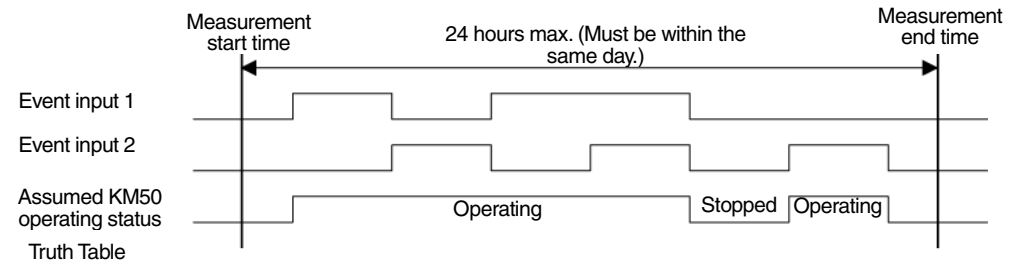

Truth Table

Input 1	Input 2	OR status
0	0	0: Stopped
0	1	1: Operating
1	0	1: Operating
1	1	1: Operating

3-ST: Three-state Energy Classification

The total power consumption is classified according to the two event inputs. Event inputs can be used for the three-state classification when the three-state option is selected in the Event Input Setting. When event input 1 is OFF, the power consumption will be classified as LOW regardless of status of event input 2. The relation between the two inputs is shown in the following truth table.

Input 1	Input 2	Result
0	0	LOW
0	1	LOW
1	0	MIDDLE
1	1	HIGH

0: No input, 1: Input

The combination of the two inputs and relation with the operation criteria are shown in the following timing chart.

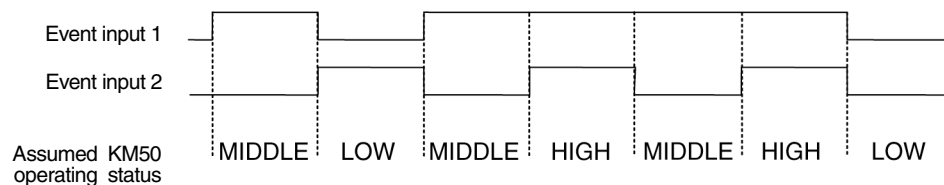

The power consumption is classified into HIGH, MIDDLE, or LOW according to the event inputs as shown above. The backlight color changes according to the status. (The backlight colors can be set as desired.) Also, there are transistor outputs for the HIGH, MIDDLE, and LOW states to enable linking external devices.

For details on three-state classification, refer to page 4-13.

RUN

Operation

Procedure: The following procedure is used to set the event inputs to measure the pulse input ON time.

- 1 . Press the Key for at least 3 seconds to go from Measurement Mode to Operation Setting Mode.

- 2 . Press the Key or + Keys to change from the Applicable Circuit (00.LYP) to the Professional Level (PRoLV).

- 3 . Press the Key to go from Basic Level in the Operation Setting Mode to Professional Level in Operation Setting Mode.

- 4 . Press the Key to go to setting status.

- 5 . Press the Key or + Keys to change from P.CSP to H-oN.

- 6 . Press the Key to enter the setting.
To end the setting procedure, press the Key for at least 3 seconds to go from Operation Setting Mode to Measurement Mode.

■ Event Input 1/Event Input 2 NPN/PNP Input Mode Settings

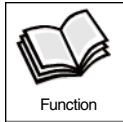

- Event input 1 and event input 2 can be switched between no-voltage and voltage inputs.
- No-voltage (NPN) Inputs
No-voltage input devices are devices such as relays and switches that have no polarity and apply no electrical voltage by themselves.
They are not suitable for applications that require inputs that repeatedly turn ON and OFF at high speeds. Also, chattering must be considered.
ON resistance: 1 kΩ max., OFF resistance: 100 kΩ max.
- Voltage (PNP) Inputs
Voltage inputs either apply a voltage to the event input terminals or turn OFF an applied voltage. They are capable of high-speed signal output and do not have contacts that are subject to wear when they turn ON and OFF.
High level: 4.75 to 30 VDC, Low level: 0 to 2 VDC

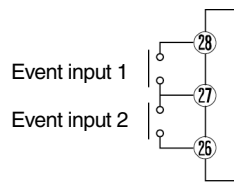

No-voltage (NPN) Input

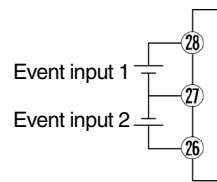

Voltage (PNP) input



Parameter	Displayed characters	Setting range	Default setting	Unit
Event Input 1 NPN/PNP Input Mode Setting	3 1.PN 1	NPN, PNP	PNP	-
Event Input 2 NPN/PNP Input Mode Setting	3 2.PN 2	NPN, PNP	PNP	-



Procedure: The following procedure is used to set event input 1 to a non-voltage input.

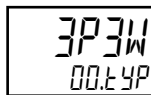

1. Press the Key for at least 3 seconds to go from Measurement Mode to Operation Setting Mode. .

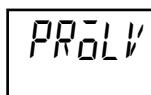

2. Press the Key or + Keys to change from the Applicable Circuit (00.LYP) to the Professional Level (PROLV).

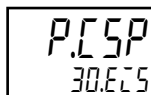

3. Press the Key to go from Basic Level in the Operation Setting Mode to Professional Level in Operation Setting Mode.

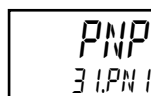

4. Press the Key or + Keys to change from the Event Input Setting (30.ECS) to the Event Input 1 NPN/PNP Input Mode Setting (3 1.PN 1).





5. Press the Key to go to setting status.

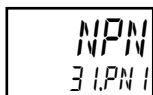

6. Press the Key or + Keys to change from PNP to NPN.



- 7 . Press the  Key to enter the setting.
To end the setting procedure, press the  Key for at least 3 seconds to go from Operation Setting Mode to Measurement Mode.

Note: Essentially the same procedure is used to set the Event Input 2 NPN/PNP Input Mode Setting.

■ Event Input 1/Event Input 2 NO/NC Input Mode Settings

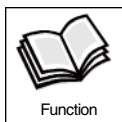

Function

- Event input 1 and event input 2 can be switched between normally open and normally closed operation.
- Normally Open (NO) Operation
When the event input is open, it is in the OFF state and when it is closed, it is in the ON state.
- Normally Closed (NC) Operation
When the event input is closed, it is in the OFF state and when it is open, it is in the ON state.



Setting

Parameter	Displayed characters	Setting range	Default setting	Unit
Event Input 1 NO/NC Input Mode Setting	33.LN1	N- \bar{a} , N-C	N- \bar{a}	-
Event Input 2 NO/NC Input Mode Setting	34.LN2	N- \bar{a} , N-C	N- \bar{a}	-



Operation

Procedure: The following procedure is used to set event input 1 to normally closed operation.

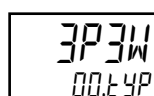

1. Press the Key for at least 3 seconds to go from Measurement Mode to Operation Setting Mode.

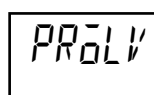

2. Press the Key or + Keys to change from the Applicable Circuit (00.E4P) to the Professional Level (PRoLV).

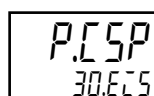

3. Press the Key to go from Basic Level in the Operation Setting Mode to Professional Level in Operation Setting Mode.

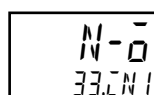

4. Press the Key or + Keys to change from the Event Input Setting (30.ECS) to the Event Input 1 NO/NC Input Mode Setting (33.LN1).

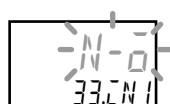

5. Press the Key to go to setting status.

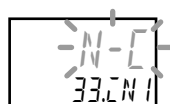

6. Press the Key or + Keys to change from N- \bar{a} to N-C.

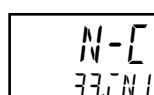

7. Press the Key to enter the setting.
To end the setting procedure, press the Key for at least 3 seconds to go from Operation Setting Mode to Measurement Mode.

Note: Essentially the same procedure is used to set the Event Input 2 NO/NC Input Mode Setting.

Measurement Start Time/Measurement End Time

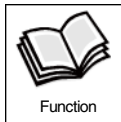

- These parameters are used to set the measurement start and measurement end times for the pulse input count, specific power consumption, pulse input ON time, three-state total power consumptions, and three-state total times.
- The measurement start time must be set to a time that is before the measurement end time.



Parameter	Displayed characters	Setting range	Default setting	Unit
Measurement Start Time	35.5tC	00-00 to 23-59	00-00	Hour-minutes
Measurement End Time	36.EtC	00-01 to 24-00	24-00	Hour-minutes



Procedure: The following procedure is used to set the measurement start time to 8:30 and the measurement end time to 17:15.

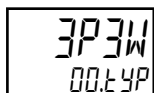

1. Press the Key for at least 3 seconds to go from Measurement Mode to Operation Setting Mode.



2. Press the Key or Keys to change from the Applicable Circuit (00.tYP) to the Professional Level (PRoLV).

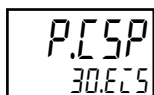

3. Press the Key to go from Basic Level in the Operation Setting Mode to Professional Level in Operation Setting Mode.

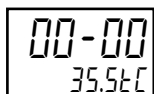

4. Press the Key or Keys to change from the Event Input Setting (30.EtS) to the Measurement Start Time (35.5tC).

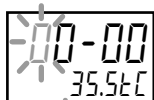

5. Press the Key to go to setting status.



6. Press the Key or Keys to change the digit.



7. Press the Key or Keys to change from 0 to 8.



8. Press the Key or Keys to change the digit.



9. Press the Key or Keys to change from 0 to 3.

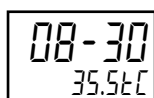

10. Press the Key to enter the setting.

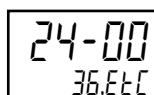

- 11 . Press the Key or + Keys to change from the Measurement Start time (35.5EL) to the Measurement End Time (36.EEL).

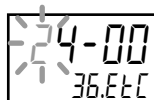

- 12 . Press the Key to go to setting status.



- 13 . Press the Key or + Keys to change from 2 to 1.



- 14 . Press the Key or + Keys to change the digit.



- 15 . Press the Key or + Keys to change from 4 to 7.



- 16 . Press the Key or + Keys to change the digit.

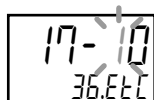

- 17 . Press the Key or + Keys to change from 0 to 1.



- 18 . Press the Key or + Keys to change the digit.

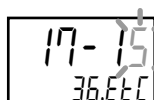

- 19 . Press the Key or + Keys to change from 0 to 5.

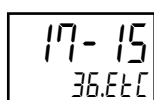

- 20 . Press the Key to enter the setting.
To end the setting procedure, press the Key for at least 3 seconds to go from Operation Setting Mode to Measurement Mode.

Pulse Input Count

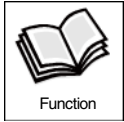

- The pulse input count will be displayed when the Professional Level of Measurement Mode is entered or if the [F] Key is pressed while the product information is being displayed.
- If the [M] Key is pressed, the pulse input count for the previous day can be checked. (You can check the measurement log for the last 8 days.)
- The number of pulses on the event input terminals is counted and the total is displayed. The totals are kept for each day. The number of pulses is reset to 0 when the day changes. Counting will be stopped if the count exceeds 99,999.
- Pulse Input Count 1 and Pulse Input Count 2 count the pulse inputs on event inputs 1 and 2.
- Communications can be used to check pulse input counts 1 and 2, total pulse input counts 1 and 2, and their sum. Up to 999,999,999 counts can be measured for each of the total pulse input counts.

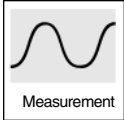

Parameter	Display No. 1	Display No. 2	Unit	Remarks
Pulse Input Count	0 to 99999	[NE]	Pulses	

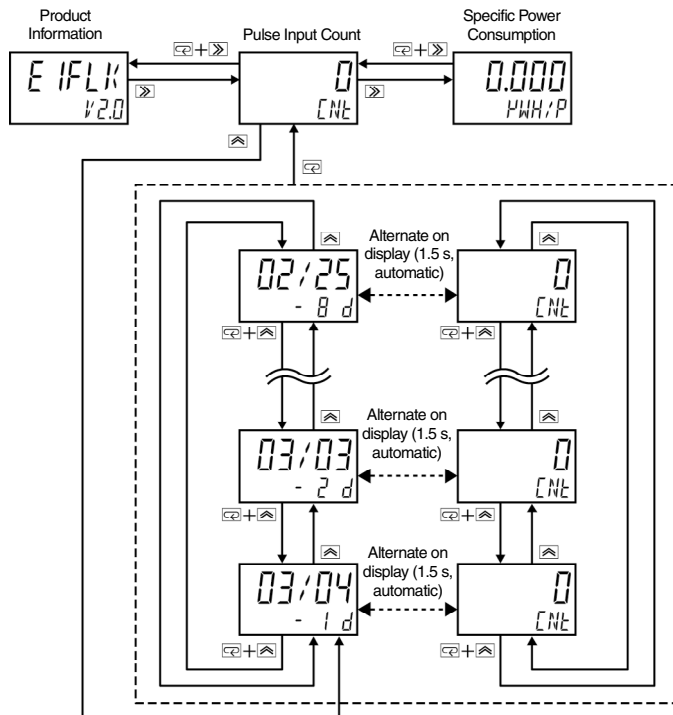

Advanced Operating Procedures

Specific Power Consumption



- The specific power consumption will be displayed if the [>] Key is pressed while the pulse input count is being displayed in the Professional Level of Measurement Mode.
- If the [<] Key is pressed, the specific power consumption for the previous day can be checked. (You can check the measurement log for the last 8 days.)
- The specific power consumption is measured for each day. The specific power consumption is reset to 0 when the day changes.
- The specific power consumption is calculated by dividing the total power consumption for the specified time period by the pulse input count. The total power consumption used here is calculated and saved as a floating-point decimal number. If the total power consumption for a day becomes large, the error in the decimal portion will increase.

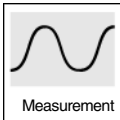

Parameter	Display No. 1	Display No. 2	Unit	Remarks
Specific Power Consumption	0.000 to 99999	PWH/P	kWh/pulse	

The decimal point will change depending on the scale of the measurement value.

- 0.000 to 99.999
- 100.00 to 999.99
- 1000.0 to 9999.9
- 10000 to 99999

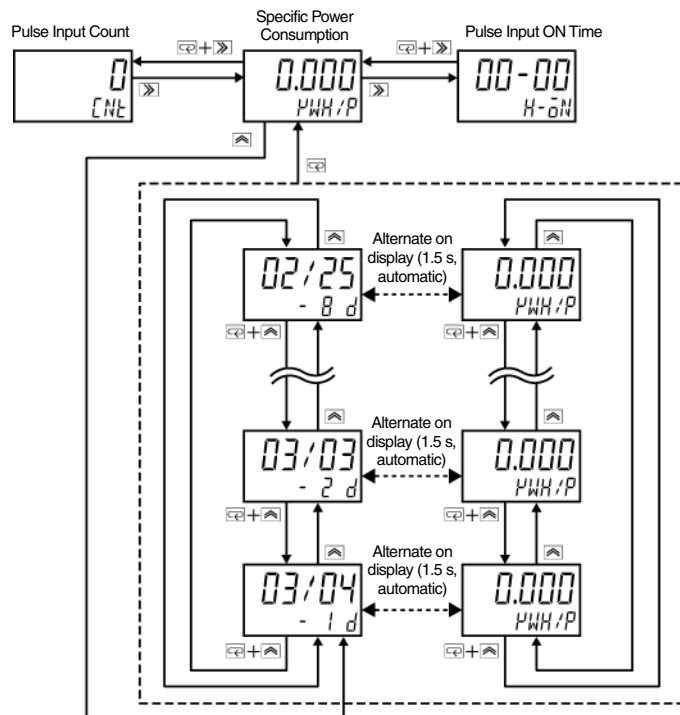

■ Pulse Input ON Time

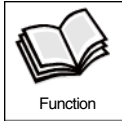

- The pulse input ON time will be displayed if the Key is pressed while the specific power consumption is being displayed in the Professional Level of Measurement Mode.
 - If the Key is pressed, the pulse input ON time for the previous day can be checked. (You can check the measurement log for the last 8 days.)
 - The totals are kept for each day. The pulse input ON time is reset to 0 when the day changes.
- Note: The pulse input ON time is not reset even if the time setting is changed in the same day.

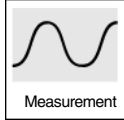

Parameter	Display No. 1	Display No. 2	Unit	Remarks
Pulse Input ON Time	00-00 to 24-00	H-0N	Hour-minutes	The seconds are truncated for all measurement values.

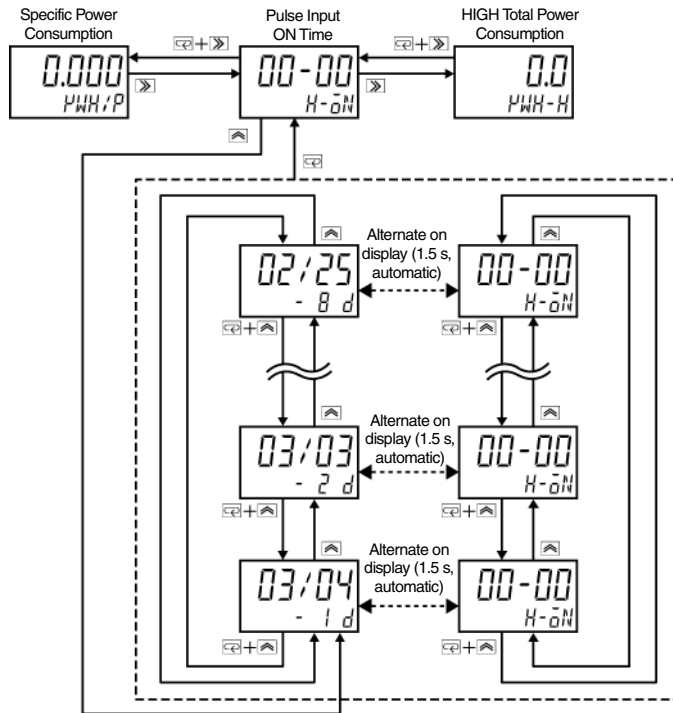

■ Three-state Energy Classification

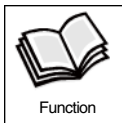

- Three-state energy classification with event inputs can measure the HIGH, MIDDLE, and LOW total power consumptions as well as total times in the same way as the three-state energy classification with thresholds that is described later. For details on three-state energy classification with event inputs, refer to page 4-3, and for details on the three-state energy classification with threshold values, refer to page 4-14.

4.2 Three-state Outputs

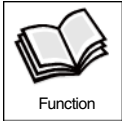

- With this function, the total power consumption and total time is classified according to three states.
- Status signals are output according to the thresholds that are set for the present measurement value (active power, voltage, or current). Status signals are output according to the event input status when $\exists-5t$ is selected in the event input settings.
- The backlight color will change according to the status while a three-state output is ON.
- When the power supply is turned ON, three-state classification is started two seconds after the active power is displayed.
- In the Setting Modes and Protection Setting Mode, both the measurements and the three-state outputs are stopped.

■ Three-state Target



- This parameter is used to set the measurement value for the three-state outputs. The active power, voltage, or current can be set, or None can be set. If you do not want to use three-state energy classification, set the parameter to $NONE$. If $\exists-5t$ is selected as the event input setting, $NONE$ is set automatically as the criteria.
- Classification Criteria
 - 1) Active Power (PWR)

The active power is used as the classification target and total power consumptions are saved according to the HIGH and LOW thresholds. When measuring regenerative power, only the LOW status is detected and only the LOW time is totaled. If the low-cut current function is enabled, the low-cut current will be considered to be an active power of 0.
 - 2) Current (R) or Voltage (V)

The current/voltage* that is measured directly is used as the classification target and total power consumptions are saved according to the HIGH and LOW thresholds.

* Phases I_n and V_{rs} for a single-phase, three-wire circuit and phases I_s and V_{tr} for a three-phase, three-wire circuit cannot be used as targets.

For a three-phase, three-wire circuit, HIGH status is determined using an OR of phases V_{rs} and V_{st} (i.e., when either value exceeds the threshold), and the LOW status is determined using an AND of phases V_{rs} and V_{st} (i.e., when both values go below the threshold).

If the low-cut current function is enabled, the low-cut current will be considered to be instantaneous power of 0.

Parameter	Displayed characters	Setting range	Default setting	Unit
Three-state Target	40.t.t.t	$PWR, R, V, NONE$	$NONE$	-

Setting	Meaning
PWR	Active Power
R	Current
V	Voltage

RUN

Operation

Procedure: The following procedure is used to set the current for three-state power classification.

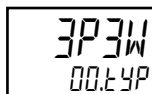

1. Press the \square Key for at least 3 seconds to go from Measurement Mode to Operation Setting Mode.

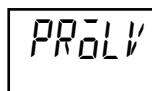

2. Press the \triangleright Key or $\square+\triangleright$ Keys to change from the Applicable Circuit (00.tYP) to the Professional Level (PR0LV).

P.CSP
30.ECS

- 3 . Press the Key to go from Basic Level in the Operation Setting Mode to Professional Level in Operation Setting Mode.

NONE
40.EGT

- 4 . Press the Key or + Keys to change from the Event Input Setting (30.ECS) to the Three-state Target (40.EGT).

NONE
40.EGT

- 5 . Press the Key to go to setting status.

A
40.EGT

- 6 . Press the Key or + Keys to change from NONE to A.

A
40.EGT

- 7 . Press the Key to enter the setting.
To end the setting procedure, press the Key for at least 3 seconds to go from Operation Setting Mode to Measurement Mode.

■ Three-state HIGH Threshold/Three-state LOW Threshold



- These parameters are used to set the thresholds for the measurement status outputs for the three-state target.
- Any measurement value above the item rating times the HIGH threshold is classified as HIGH status, any value below the item rating times the LOW threshold is classified as LOW status, and any value between these values is classified as MIDDLE status
- The HIGH threshold must be larger than the LOW threshold and the LOW threshold must be smaller than the HIGH threshold.

Note 1. If the HIGH threshold is set to 100.0% and the LOW threshold is set to 50.0% and you want to change the HIGH threshold to 40.0% and the LOW threshold to 10.0%, you must first change the LOW threshold to 10.0% before you can change the HIGH threshold to 40.0%.

- The ratings for each item are given in the following tables.

Rated Power

Special CT	Rated power
KM20-CTF-5A	4 kW
KM20-CTF-50A	40 kW
KM20-CTF-100A	80 kW
KM20-CTF-200A	160 kW
KM20-CTF-400A	320 kW
KM20-CTF-600A	480 kW

Rated Current

Special CT	Rated current
KM20-CTF-5A	5 A
KM20-CTF-50A	50 A
KM20-CTF-100A	100 A
KM20-CTF-200A	200 A
KM20-CTF-400A	400 A
KM20-CTF-600A	600 A

Rated Voltage

Applicable circuit	Rated voltage
Single-phase, two-wire	480 V
Single-phase, three-wire	
Three-phase, three-wire	
Three-phase, Four-wire	

- If the rated primary current, the VT primary voltage, or the fixed voltage for simple measurement has been set, the values that were set are used for the rated current or rated voltage. If the VT primary voltage is set to 220 or 440 or the fixed voltage is set to higher than 480 V, a rated voltage of 480 V will be used. The rated power will be calculated with the following formulas.

1) When Rated Primary Current Is Set

$$\text{Rated power} = 4 \text{ [kW]} \times \text{Rated primary current} / 5$$

2) When the VT Primary Voltage Is Set to 3,300, 6,600, 11,000, 22,000, or 33,000

$$\text{Rated power} = \text{CT rated power [kW]} \times \text{VT primary voltage} / 440$$

3) When Rated Primary Current Is Set and VT Primary Voltage Is Set to 3,300, 6,600, 11,000, 22,000, or 33,000

$$\text{Rated power} = 4 \text{ [kW]} \times \text{Rated primary current} / 5 \times \text{VT primary voltage} / 440$$

4) When Fixed Voltage for Simple Measurement Is Set

$$\text{Rated power} = \text{CT rated power [kW]} \times \text{Fixed voltage} / 480$$

5) When Rated Primary Current and Fixed Voltage for Simple Measurement Are Set

$$\text{Rated power} = 4 \text{ [kW]} \times \text{Rated primary current} / 5 \times \text{Fixed voltage} / 480$$



Parameter	Displayed characters	Setting range	Default setting	Unit
Three-state HIGH Threshold	4 I.H.L.H 0.00k to 9999M(PWR) 0.00A to 999kA(A) 0.00V to 999kV(V) 0.00(NONE)	0.1 to 150.0	50.0	% (Percentage of rated input.)
Three-state LOW Threshold	4 L.L.H 0.00k to 9999M(PWR) 0.00A to 999kA(A) 0.00V to 999kV(V) 0.00(NONE)	0.0 to 149.9	10.0	% (Percentage of rated input.)

During the setting status, the parameter abbreviation is shown on display No. 2 for 1.5 seconds and then the rating times the set value is displayed. The unit is watts, amperes, or volts and the display changes depending on the scale of the measurement value. The characters displayed in parenthesis give the target.

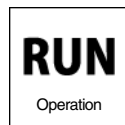

Procedure: The following procedure is used to set the HIGH threshold to 100.0%.

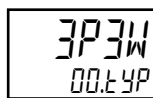

1 . Press the Key for at least 3 seconds to go from Measurement Mode to Operation Setting Mode.



2 . Press the Key or Keys to change from the Applicable Circuit (00.0YP) to the Professional Level (PR0LV).

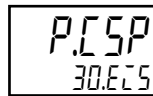

3 . Press the Key to go from Basic Level in the Operation Setting Mode to Professional Level in Operation Setting Mode.

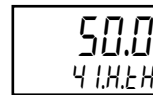

4 . Press the Key or Keys to change from the Event Input Setting (30.0LS) to the HIGH Threshold (4 I.H.L.H).



5 . Press the Key to go to setting status.



6 . Press the Key or Keys to change from 0 to 1.



7 . Press the Key or Keys to change the digit.



8 . Press the Key or Keys to change from 5 to 0.



9 . Press the Key to enter the setting.
To end the setting procedure, press the Key for at least 3 seconds to go from Operation Setting Mode to Measurement Mode.

Note 2. The LOW threshold can be set using essentially the same procedure.

■ Three-state Hysteresis

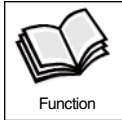

- Hysteresis can be set to prevent the output status from changing frequently when the measurement value is near to a specified threshold.
- If hysteresis is set, it will be used for all judgements, including total power consumption classification, outputs, and the backlight color.
- Hysteresis can be set without considering the settings of the HIGH and LOW thresholds.

Note: If a KM20-CTF-5A is used, HIGH status is to be output for 4 A or higher, and LOW status is to be output for 1 A or lower, the three-state target would be set to the current, the HIGH threshold would be set to 80.0%, and the LOW threshold would be set to 20.0%. If the current fluctuates by ± 0.24 A, frequent changes in the measurement status can be prevented by setting the 3-state hysteresis to 5.0%.



Parameter	Displayed characters	Setting range	Default setting	Unit
Three-state Hysteresis	43.HYS 0.00k to 9999M(PWR) 0.00A to 999kA(A) 0.00V to 999kV(V) 0.00(NONE)	0.0 to 19.9	0.0	% (Percentage of rated input.)

During the setting status, the parameter abbreviation is shown on display No. 2 for 1.5 seconds and then the rating times the set value is displayed. The unit is watts, amperes, or volts and the display changes depending on the scale of the measurement value.

Procedure: The following procedure is used to set the 3-state hysteresis to 3.0%.

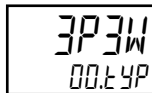
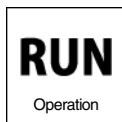

1. Press the Key for at least 3 seconds to go from Measurement Mode to Operation Setting Mode.

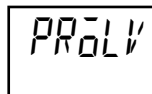

2. Press the Key or + Keys to change from the Applicable Circuit (00.4YP) to the Professional Level (PR0LV).

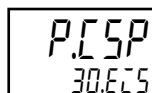

3. Press the Key to go from Basic Level in the Operation Setting Mode to Professional Level in Operation Setting Mode.

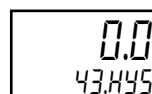

4. Press the Key or + Keys to change from the Event Input Setting (30.E75) to the Three-state Hysteresis (43.HYS).



5. Press the Key to go to setting status.



6. Press the Key or + Keys to change the digit.

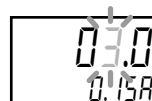

7. Press the Key or + Keys to change from 0 to 3.

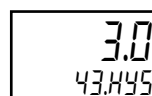

8. Press the Key to enter the setting. To end the setting procedure, press the Key for at least 3 seconds to go from Operation Setting Mode to Measurement Mode.

Three-state Color Setting

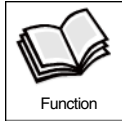

- The backlight color of the three-state output status can be set as desired.
- These settings apply to all targets (active power, current, voltage, or event input).



Item	Displayed characters	Setting range	Default setting	Unit
Three-state Color Setting	44.CōL	-	-	-
Three-state HIGH Color Settings	HcGH	GREEN, oRANG, REd	GREEN	-
Three-state MIDDLE Color Setting	Mcd	GREEN, oRANG, REd	oRANG	-
Three-state LOW Color Setting	LōW	GREEN, oRANG, REd	REd	-



Procedure: The following procedure is used to set the three-state color settings as follows: HIGH: Red, MIDDLE: Green, and LOW: Orange.

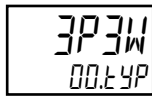

1. Press the Key for at least 3 seconds to go from Measurement Mode to Operation Setting Mode.



2. Press the Key or + Keys to move from Applicable Circuit 00.tYP to Professional Level PRōLV.

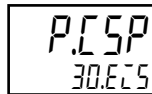

3. Press the Key to go from Basic Level in the Operation Setting Mode to Professional Level in Operation Setting Mode.



4. Press the Key or + Keys to move from Event Input Settings 30.EcS to Three-state Status Color Settings 44.CōL.



5. Press the Key to go to the setting status for the HIGH Color Setting.



6. Press the Key or + Keys to change from GREEN to RED.



7. Press the Key to enter the setting and move to the MIDDLE Color Setting.



8. Press the Key or + Keys to change from oRANG to GREEN.





9. Press the Key to enter the setting and move to the LOW Color Setting.



10 . Press the  Key or + Keys to change from *REd* to *ORANG*.



11 . Press the  Key to enter the set value.
To end the setting procedure, press the  Key for at least 3 seconds to go from Operation Setting Mode to Measurement Mode.

■ HIGH, MIDDLE, and LOW Total Power Consumptions

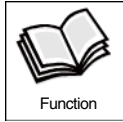

- The HIGH total power consumption will be displayed if the F Key is pressed while the pulse input ON time is being displayed in the Professional Level of Measurement Mode. Press the F Key or $\text{C}+\text{F}$ Keys to switch between the HIGH total power consumption, MIDDLE total power consumption, and LOW total power consumption.
- If the M Key is pressed, the HIGH total power consumption, MIDDLE total power consumption, and LOW total power consumption for the previous day can be checked. (You can check the measurement log for the last 8 days.) The ratio of each total power consumption will be shown on display No. 2. The ratios are calculated as shown below.

$$\text{Total power consumption ratio of a status} = \frac{\text{Individual total power consumption of the status}}{\text{Total power consumption (HIGH + MIDDLE + LOW)}}$$

- The total power consumption is classified as HIGH, MIDDLE, or LOW status according to the HIGH and LOW thresholds and totaled for each individual total power consumption.
- The totals are kept for each day. The power consumptions are reset to 0 when the day changes.
- Communications can be used to check the HIGH, MIDDLE, and LOW total power consumptions. They can each be measured to up to 999,999,999 Wh.
- There may be error between the sum of the three total power consumptions and the overall total power consumption for the day.
- The sum of the total power consumption ratios will not necessarily equal 1.

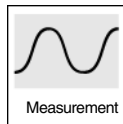

Parameter	Display No. 1	Display No. 2	Unit	Remarks
HIGH Total Power Consumption	0.000 to 99999	PWH-H	kWh	
MIDDLE Total Power Consumption	0.000 to 99999	PWH-M	kWh	
LOW Total Power Consumption	0.000 to 99999	PWH-L	kWh	

The decimal point will change depending on the scale of the measurement value.

- 0.000 to 99.999
- 100.00 to 999.99
- 1000.0 to 9999.9
- 10000 to 99999

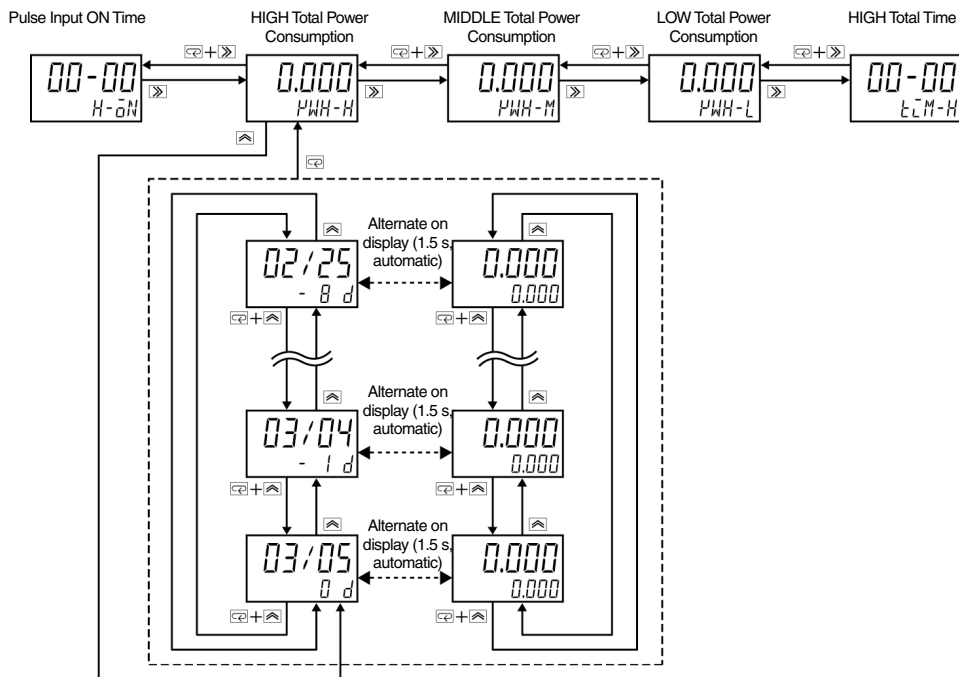

■ HIGH, MIDDLE, and LOW Total Times

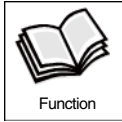

- The HIGH total time will be displayed if the Key is pressed while the LOW total power consumption is being displayed in the Professional Level of Measurement Mode. Press the Key or + Keys to switch between the HIGH total time, MIDDLE total time, and LOW total time.
- If the Key is pressed, the HIGH total time, MIDDLE total time, and LOW total time for the previous day can be checked. (You can check the measurement log for the last 8 days.)The ratio of each total time will be shown on display No. 2. The ratios are calculated as shown below.

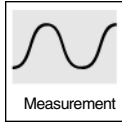

$$\text{Total time ratio of a status} = \frac{\text{Total time of the status}}{\text{Total time (HIGH + MIDDLE + LOW)}}$$

- The total time is classified as HIGH, MIDDLE, or LOW status according to the HIGH and LOW thresholds and totaled for each individual total time.
- The totals are kept for each day. The total times are reset to 0 when the day changes.
- Communications can be used to check the HIGH, MIDDLE, and LOW total times. They can each be measured to up to 99,999 minutes.
- The sum of the individual times will not necessarily equal 24 hours even when the measurement start time is 00:00 and the measurement end time is 24:00.
- The sum of the total time ratios will not necessarily equal 1.

Parameter	Display No. 1	Display No. 2	Unit	Remarks
HIGH Total Time	00-00 to 24-00	h:m-H	Hour-minutes	The seconds are truncated for all measurement values.
MIDDLE Total Time	00-00 to 24-00	h:m-M	Hour-minutes	
LOW Total Time	00-00 to 24-00	h:m-L	Hour-minutes	

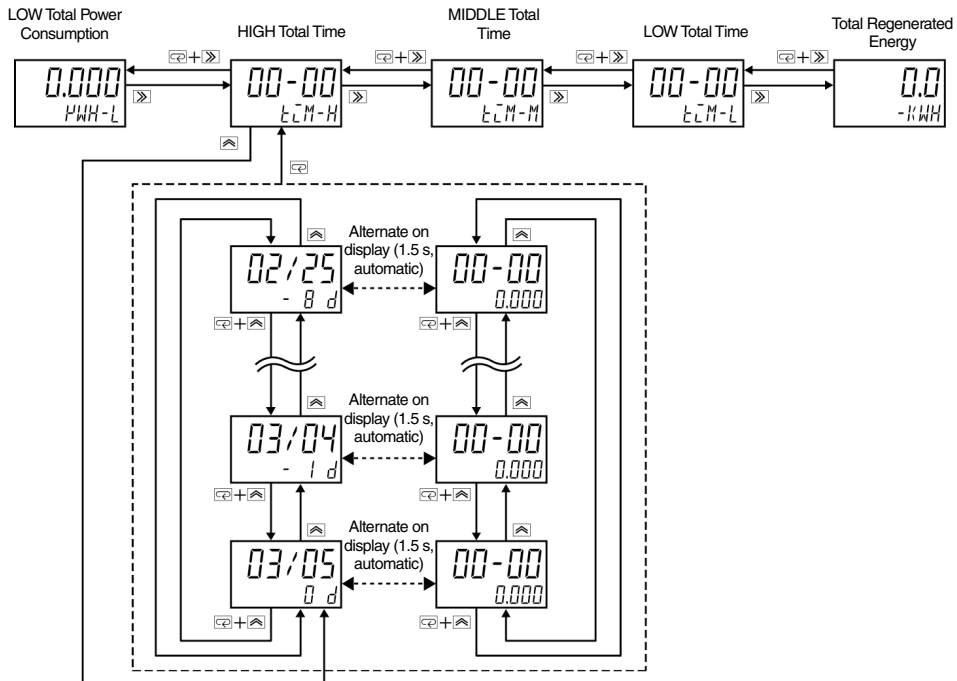

4.3 Output Terminal Function Settings

Output Terminal 1 and Output Terminal 2 Function Settings

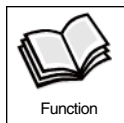

- It is possible to switch between a pulse output and an alarm output for both output terminal 1 and output terminal 2.
- Total Power Consumption Pulse Output**
A pulse is output when the total power consumption reaches the number of pulses set by the user in the Pulse Output Unit parameter.
For details, refer to pages 1-3, 2-10, and 3-20.
- Alarm Output**
An alarm is output when the measurement value exceeds the rated value multiplied by the set value.
For details, refer to pages 1-3, 2-13, and 4-24.



Item	Displayed characters	Setting range	Default setting	Unit
Output Terminal 1 Function Setting	37.01	OFF, P.Outlet, ALARM	P.Outlet	
Active Power Alarm Output	P.AL	OFF, ON	OFF	
Regenerative Power Alarm Output	R.AL	OFF, ON	OFF	
Current Alarm Output	A.AL	OFF, ON	OFF	
Voltage Alarm Output	V.AL	OFF, ON	OFF	
Power Factor Alarm Output	PF.A	OFF, ON	OFF	
Reactive Power Alarm Output	Q.AL	OFF, ON	OFF	
Output Terminal 2 Function Setting	38.02	OFF, P.Outlet, ALARM	ALARM	
Active Power Alarm Output	P.AL	OFF, ON	OFF	
Regenerative Power Alarm Output	R.AL	OFF, ON	OFF	
Current Alarm Output	A.AL	OFF, ON	OFF	
Voltage Alarm Output	V.AL	OFF, ON	OFF	
Power Factor Alarm Output	PF.A	OFF, ON	OFF	
Reactive Power Alarm Output	Q.AL	OFF, ON	OFF	

Note: You can move to the alarm output OFF/ON setting when you set an output terminal function setting to ALARM.



Procedure: Set the Output Terminal 1 Function Setting to an alarm output and set the Active Power Alarm Output to ON.

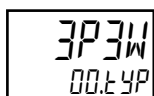

- Press the Key for at least 3 seconds to go from Measurement Mode to Operation Setting Mode.

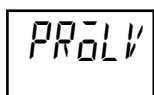

- Press the Key or Keys to move from Applicable Circuit 00.4P to Professional Level PRoLV.

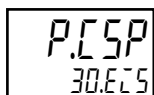

- Press the Key to go from Basic Level in the Operation Setting Mode to Professional Level in Operation Setting Mode.

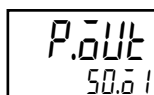

- Press the Key or Keys to move from Event Input Settings 30.ECS to Output Terminal 1 Function Settings 50.01.



5 . Press the  Key to go to setting status.



6 . Press the  Key or + Keys to change from P.OUTPUT to ALARM.



7 . Press the  Key to enter the setting and move to the setting status for the Active Power Alarm Output Setting.





8 . Press the  Key or + Keys to change from OFF to ON.



9 . Press the  Key to enter the setting and move to the setting status for the Regenerative Power Alarm Output Setting.
The other alarm output settings can be set in the same way. Here, alarm outputs other than the active power alarm output are set to OFF.



10 . Press the  Key in the alarm output setting to enter the setting. To end the setting procedure, press the  Key for at least 3 seconds to go from Operation Setting Mode to Measurement Mode.

Note: The method for setting the output terminal 2 function is the same.

4. 4 Alarm Output



- An alarm is output when the present measurement value exceeds the rated value multiplied by the upper limit threshold or falls below the rated value multiplied by the lower limit threshold.
- This function can be used when an alarm output is set for a terminal output function.
- The alarm output upper and lower limit thresholds, hysteresis, and OFF/ON delays are set consecutively.
- Hysteresis can be set to prevent the alarm output from turning ON and OFF frequently when the measurement value is near to the alarm output threshold.
- The hysteresis is set as a percentage of the rated measurement value.
- An OFF delay can be set to keep the alarm output ON for the set time period after the measurement value goes below the hysteresis range. Set the optimum value.
- An ON delay can be set to keep the alarm output OFF for the set time period after the measurement value goes below the hysteresis range. Set the optimum value.
- If the upper limit threshold of the alarm is set to the maximum value, the upper limit alarm function will be disabled. If the lower limit threshold is set to the minimum value, the lower limit alarm function will be disabled. Set the maximum or minimum value to create either only an upper limit alarm or lower limit alarm.
- When the power supply is turned ON, alarm detection is started two seconds after the active power is displayed.
- Operation indicators OUT1 or OUT2 (the indicator for the terminal that was set in the output terminal function settings) will be ON when there is an alarm output.
- In the Setting Modes and Protection Setting Mode, both the measurements and the alarm outputs are stopped.
- Automatic rotation is not performed while an alarm is output. When the alarm is cleared, the automatic rotation starts again.
- The error display is given priority if an alarm criteria is met at the same time as when an error occurs. However, the OUT 1 or OUT2 operation indicator will light.
- Refer to page 4-15 for the parameter settings, rated primary current, VT primary voltage, and the rated power when a fixed voltage is set for simple measurements.
- The alarm priority for different targets is given in the following table.

Alarm target	Alarm display		Priority
	OVER	UNDER	
Active Power	$\overline{\partial V.PWR}$	$UN.PWR$	1
Regenerative power	$\overline{\partial V.REP}$	$UN.REP$	2
Voltage	$\overline{\partial V.VLt}$	$UN.VLt$	3
Current	$\overline{\partial V.AMP}$	$UN.AMP$	4
Power Factor	$\overline{\partial V.PF}$	$UN.PF$	5
Reactive Power	$\overline{\partial V.Q}$	$UN.Q$	6

Note: Alarms are output when the threshold and hysteresis criteria is met, and the time set for the OFF delay or ON delay has passed.

Alarm Output Time Charts

1) No Hysteresis, No OFF Delay, and No ON Delay

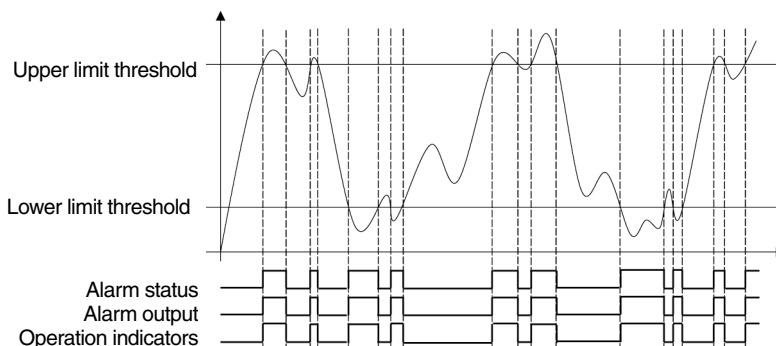

2) Hysteresis, but No OFF Delay and No ON Delay

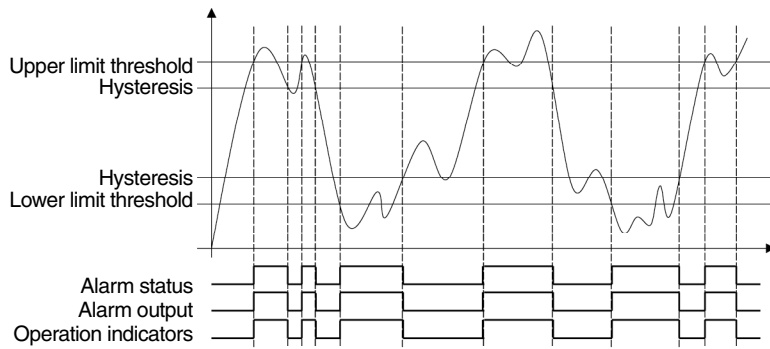

3) OFF Delay, but No Hysteresis and No ON Delay

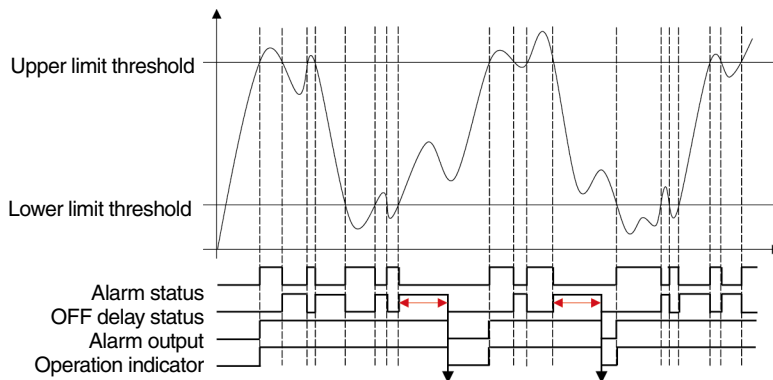

*1. The alarm output is OFF during the OFF delay time (indicated by the arrow in the above diagram) if the alarm status remains OFF.

4) ON Delay, but No Hysteresis and No OFF Delay

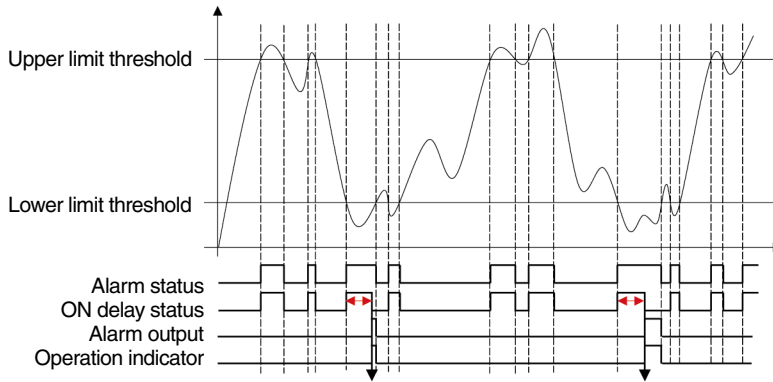

*1. The alarm output is ON during the ON delay time (indicated by the arrow in the diagram above) if the alarm status continues ON.

5) Hysteresis and OFF Delay, but No ON Delay

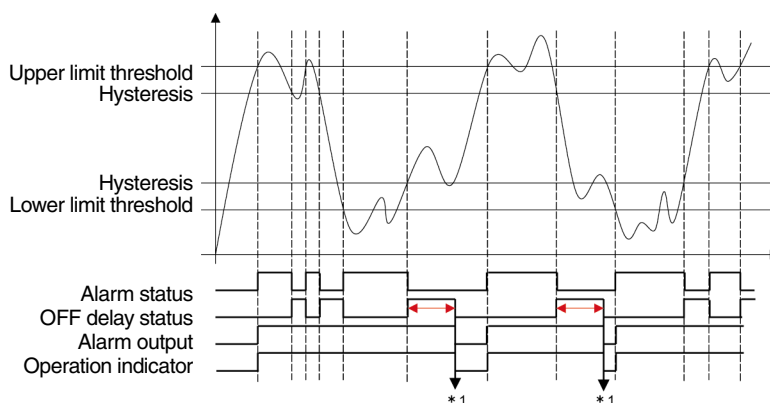

*1. The alarm output is OFF during the OFF delay time (indicated by the arrow in the diagram above) if the alarm status continues OFF.

6) Hysteresis and ON Delay, but No OFF Delay

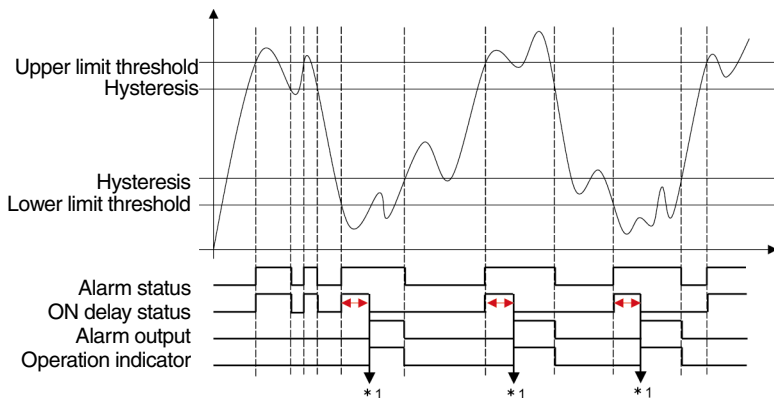

*1. The alarm output is ON during the ON delay time (indicated by the arrow in the diagram above) if the alarm status continues ON.

7) OFF Delay and ON Delay, but No Hysteresis

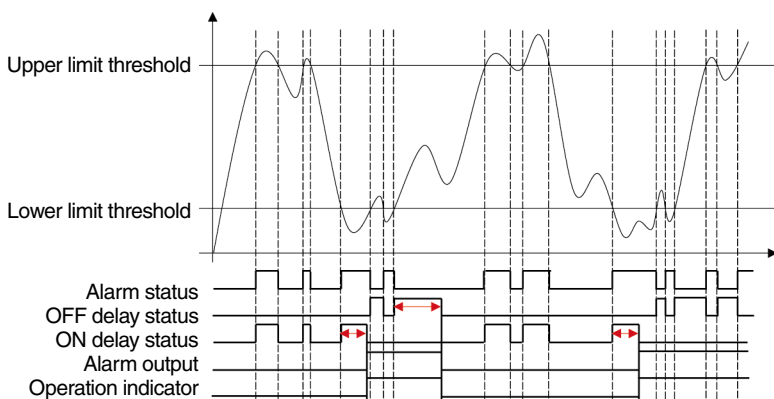

*1. The alarm output is ON during the ON delay time (indicated by the arrow in the diagram above) if the alarm status continues ON.

*2. The alarm output is OFF during the OFF delay time (indicated by the arrow in the diagram above) if the alarm status continues OFF.

8) Hysteresis, OFF Delay, and ON Delay

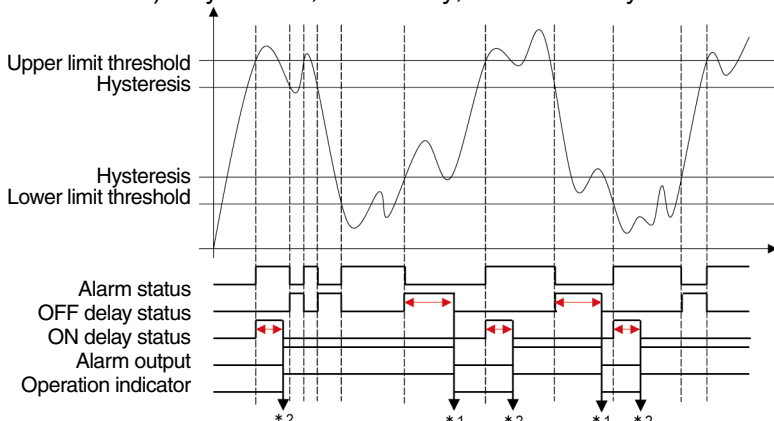

*1. The alarm output is ON during the ON delay time (indicated by the arrow in the diagram above) if the alarm status continues ON.

*2. The alarm output is OFF during the OFF delay time (indicated by the arrow in the diagram above) if the alarm status continues OFF.

Alarm History

Alarms that occurred in the past can be checked using communications. Up to 10 alarms that occurred in the past can be read out. If more than 10 alarms occur, the oldest alarms in the history will be deleted. Data is not saved when there is a power interruption. Only the alarms that occurred while power supply was ON can be read out from the history.

Active Power Alarm Output

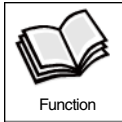

- This function can be used when the Active Power Alarm Output Setting is set to ON in the Output Terminal Function Settings.
- To output an active power alarm when 4.4 kW is exceeded when using a KM20-CTF-5A Special CT (rated power: 4 kW), set the upper limit threshold to 110.0%. If the power fluctuates by ± 0.4 kW, frequent changes in the alarm output can be reduced by setting the alarm output hysteresis to 10.0%.
- For details on the rated power, refer to page 4-15.

Note 1. This function cannot be used when measuring regenerative power.

Note 2. If the alarm output turns ON while active power is being measured and measurement of regenerative power starts before the alarm is cleared, the output will turn OFF after the set OFF delay time.



Item	Displayed characters	Setting range	Default setting	Unit
Active Power Alarm Output	53PRL			
Active Power Alarm Output Upper Limit Threshold	UP.LTH 0.00K to 9999M	0.0 to 150.0	80.0	% (percentage of rated input)
Active Power Alarm Output Lower Limit Threshold	LN.LTH 0.00K to 9999M	0.0 to 150.0	0.0	% (percentage of rated input)
Active Power Alarm Output Hysteresis	RL.HYS 0.00K to 9999M	0.0 to 19.9	5.0	% (percentage of rated input)
Active Power Alarm Output OFF Delay	OFF.DLY	0.0 to 99.9	3.0	s
Active Power Alarm Output ON Delay	ON.DLY	0.0 to 99.9	0.0	s

During the threshold and hysteresis setting status, the parameter abbreviation will be shown on display No. 2 for 1.5 seconds and then the rated power multiplied by the set value will be displayed. The unit is watts and the decimal point will change depending on the scale of the measurement value.



Procedure: The following procedure is used to set the upper limit threshold to 110.0%, lower limit threshold to 50%, hysteresis to 10.0%, OFF delay to 5.0 seconds, and ON delay to 5.0 seconds when a KM20-CTF-5A Special CT is being used.

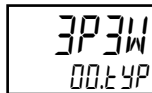

1. Press the Key for at least 3 seconds to go from Measurement Mode to Operation Setting Mode.

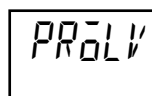

2. Press the Key or + Keys to move from Applicable Circuit 00.4YP to Professional Level PR.LV.

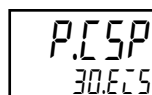

3. Press the Key to go from Basic Level in the Operation Setting Mode to Professional Level in Operation Setting Mode.

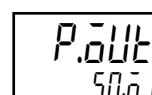

4. Press the Key or + Keys to move from Event Input Settings 30.E.LS to Output Terminal 1 Function Settings 50.0 I.



5. Press the Key to go to setting status.



6. Press the Key or + Keys to change from P.OUT to ALARM.



7 . Press the Key to enter the setting and move to the setting status for the Active Power Alarm Output Setting.



8 . Press the Key or Keys to change from *OFF* to *ON*.



9 . Press the Key to enter the setting and move to the setting status for other Alarm Output Setting.



10 . Press the Key or Keys to move from Output Terminal 1 Function Settings *50.0* to Active Power Alarm Output *52.P.AL*.



11 . Press the Key to go to the setting status for the Upper Limit Threshold.



12 . *OV.LH* will be shown on display No. 2 for 1.5 seconds and then the operation value calculated from the threshold will be displayed. The default setting is 80.0%, so *3.20%* will be shown on display No. 2.



13 . Press the Key or Keys to change from *0* to *1*. The setting is 180.0%, so *7.20%* will be shown on display No. 2.



14 . Press the Key or Keys to change the digit.



15 . Press the Key or Keys to change from *0* to *1*. The setting is 110.0%, so *4.40%* will be shown on display No. 2.



16 . Press the Key to enter the setting and move to the Lower Limit Threshold.



17 . *UN.LH* will be shown on display No. 2 for 1.5 seconds and then the operation value calculated from the threshold will be displayed. The default setting is 0.0%, so *0.00%* will be shown on display No. 2.



18 . Press the Key or Keys to change the digit.



19 . Press the Key or Keys to change from *0* to *5*. The setting is 50.0%, so *2.00%* will be shown on display No. 2.



20 . Press the Key to enter the setting and move to the Hysteresis.



21 . *AL.HYS* will be shown on display No. 2 for 1.5 seconds and then the operation value calculated from the threshold will be displayed. The default setting is 5.0%, so *0.20%* will be shown on display No. 2.



22 . Press the Key or Keys to change from *0* to *1*. The setting is 15.0%, so *0.60%* will be shown on display No. 2.



23 . Press the Key or Keys to change the digit.



24 . Press the Key or Keys to change from *5* to *0*. The setting is 10.0%, so *0.40%* will be shown on display No. 2.



25 . Press the Key to enter the setting and move to the OFF Delay.



26 . Press the Key or Keys to change the digit.



27 . Press the Key or Keys to change from *3* to *5*.



28 . Press the Key to enter the setting and move to the ON Delay.



29 . Press the Key or Keys to change the digit.



30 . Press the Key or Keys to change from *0* to *5*.

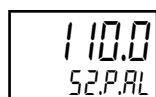

31 . Press the Key to enter the set value. To end the setting procedure, press the Key for at least 3 seconds to go from Operation Setting Mode to Measurement Mode.

Regenerative Power Alarm Output

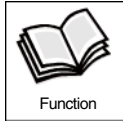

- This function can be used when the Regenerative Power Alarm Output Setting is set to ON in the Output Terminal Function Settings.
- When using a KM20-CTF-5A Special CT, to output an regenerative power alarm when it falls below 1.0 kW (rated power: 4 kW), set the lower limit threshold to 25.0%. If the power fluctuates by ± 0.24 kW, frequent changes in the alarm output can be reduced by setting the alarm output hysteresis to 6.0%.
- For details on the rated power, refer to page 4-15.

Note 1. This function cannot be used when measuring active power.

Note 2. If the alarm output turns ON while regenerative power is being measured and measurement of active power starts before the alarm is cleared, the output will turn OFF after the set OFF delay time.



Item	Displayed characters	Setting range	Default setting	Unit
Regenerative Power Alarm Output	53RAL			
Regenerative Power Alarm Output Upper Limit Threshold	UP.LH 0.000K to 9999M	0.0 to 150.0	80.0	% (percentage of rated input)
Regenerative Power Alarm Output Lower Limit Threshold	UN.LH 0.000K to 9999M	0.0 to 150.0	0.0	% (percentage of rated input)
Regenerative Power Alarm Output Hysteresis	AL.HYS 0.000K to 9999M	0.0 to 19.9	5.0	% (percentage of rated input)
Regenerative Power Alarm Output OFF Delay	oF.dLY	0.0 to 99.9	3.0	s
Regenerative Power Alarm Output ON Delay	oN.dLY	0.0 to 99.9	0.0	s

During the threshold and hysteresis setting status, the parameter abbreviation will be shown on display No. 2 for 1.5 seconds and then the rated power multiplied by the set value will be displayed. The unit is watts and the decimal point will change depending on the scale of the measurement value.



Procedure: The following procedure is used to set the upper limit threshold to 60.0%, lower limit threshold to 25%, hysteresis to 6.0%, OFF delay to 6.0 seconds, and ON delay to 4.0 seconds when a KM20-CTF-5A Special CT is being used.

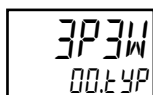

1. Press the Key for at least 3 seconds to go from Measurement Mode to Operation Setting Mode.



2. Press the Key or Keys to move from Applicable Circuit 00.0YP to Professional Level PRoLV.

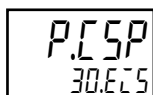

3. Press the Key to go from Basic Level in the Operation Setting Mode to Professional Level in Operation Setting Mode.

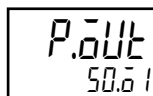























4. Press the Key or Keys to move from Event Input Settings 30.0LS to Output Terminal 1 Function Settings 50.0 l.



5. Press the Key to go to setting status.



6. Press the Key or Keys to change from P.oUt to ALARM.

- 7 . Press the  Key to enter the setting and press the  Key or  Keys to go to the Regenerative Power Alarm Output Settings.
- 8 . Press the  Key or  Keys to change from *OFF* to *ON*.
- 9 . Press the  Key to enter the setting and move to the setting status for other Alarm Output Setting.
- 10 . Press the  Key or  Keys to move from Output Terminal 1 Function Settings *50.01* to Regenerative Power Alarm Output *53.R.AL*.
- 11 . Press the  Key to go to the setting status for the upper limit threshold.
- 12 . *UP.LH* will be shown on display No. 2 for 1.5 seconds and then the operation value calculated from the threshold will be displayed. The default setting is 80.0%, so *3.20%* will be shown on display No. 2.
- 13 . Press the  Key or  Keys to change the digit.
- 14 . Press the  Key or  Keys to change from *8* to *6*. The setting is 60.0%, so *2.40%* will be shown on display No. 2.
- 15 . Press the  Key to enter the setting and move to the Lower Limit Threshold.
- 16 . *LN.LH* will be shown on display No. 2 for 1.5 seconds and then the operation value calculated from the threshold will be displayed. The default setting is 0.0%, so *0.00%* will be shown on display No. 2.
- 17 . Press the  Key or  Keys to change the digit.
- 18 . Press the  Key or  Keys to change from *0* to *2*. The setting is 20.0%, so *0.80%* will be shown on display No. 2.
- 19 . Press the  Key or  Keys to change the digit.
- 20 . Press the  Key or  Keys to change from *0* to *5*. The setting is 25.0%, so *1.00%* will be shown on display No. 2.
- 21 . Press the  Key to enter the setting and move to the Hysteresis.



22 . *RL.HYS* will be shown on display No. 2 for 1.5 seconds and then the operation value calculated from the threshold will be displayed. The default setting is 5.0%, so 0.20% will be shown on display No. 2.



23 . Press the Key or + Keys to change the digit.



24 . Press the Key or + Keys to change from 5 to 6. The setting is 6.0%, so 0.24% will be shown on display No. 2.



25 . Press the Key to enter the setting and move to the OFF Delay.



26 . Press the Key or + Keys to change the digit.



27 . Press the Key or + Keys to change from 3 to 6.



28 . Press the Key to enter the setting and move to the ON Delay.



29 . Press the Key or + Keys to change the digit.



30 . Press the Key or + Keys to change from 0 to 6.

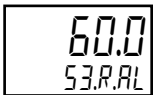

31 . Press the Key to enter the set value. To end the setting procedure, press the Key for at least 3 seconds to go from Operation Setting Mode to Measurement Mode.

Current Alarm Output

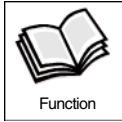

- This function can be used when the Current Alarm Output Setting is set to ON in the Output Terminal Function Settings.
- The alarm criteria is an OR of the status of the phases (if one phase exceeds the threshold). An AND of status of the phases is used to clear the alarm. (All phases exceed the threshold and hysteresis.)
- To output a current alarm when 5.0 A is exceeded (rated current: 5 A) when using a KM20-CTF-5A Special CT, set the upper limit threshold to 100.0%. If the current fluctuates by ± 0.3 A, frequent changes in the alarm output can be reduced by setting the alarm output hysteresis to 6.0%.
- For details on the rated current, refer to page 4-15.



Item	Displayed characters	Setting range	Default setting	Unit
Current Alarm Output	54.RAL			
Current Alarm Output Upper Limit Threshold	0V.LH 0.00 to 999.9A	0.0 to 120.0	110.0	% (percentage of rated input)
Current Alarm Output Lower Limit Threshold	UN.LH 0.00 to 999.9A	0.0 to 120.0	0.0	% (percentage of rated input)
Current Alarm Output Hysteresis	RL.HYS 0.00 to 999.9A	0.0 to 19.9	5.0	% (percentage of rated input)
Current Alarm Output OFF Delay	0F.dLY	0.0 to 99.9	3.0	s
Current Alarm Output ON Delay	0N.dLY	0.0 to 99.9	0.0	s

During the threshold and hysteresis setting status, the parameter abbreviation will be shown on display No. 2 for 1.5 seconds and then the rated current multiplied by the set value will be displayed. The unit is amperes and the decimal point will change depending on the scale of the measurement value.



Procedure: The following procedure is used to set the upper limit threshold to 100.0%, lower limit threshold to 90%, hysteresis to 6.0%, OFF delay to 10.0 seconds, and ON delay to 1.0 seconds when a KM20-CTF-5A Special CT is being used.

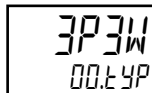

- Press the Key for at least 3 seconds to go from Measurement Mode to Operation Setting Mode.

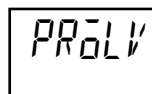

- Press the Key or + Keys to move from Applicable Circuit 00.LYP to Professional Level PR0LV.

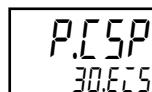

- Press the Key to go from Basic Level in the Operation Setting Mode to Professional Level in Operation Setting Mode.

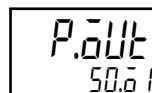

- Press the Key or + Keys to move from Event Input Settings 30.ECS to Output Terminal 1 Function Settings 50.0 I.



- Press the Key to go to setting status.



- Press the Key or + Keys to change from P.0UT to ALARM.



7 . Press the Key to enter the setting and press the Key or + Keys to go to the Current Alarm Output Settings.



8 . Press the Key or + Keys to change from *OFF* to *ON*.



9 . Press the Key to enter the setting and move to the setting status for other Alarm Output Setting.



10 . Press the Key or + Keys to move from Output Terminal 1 Function Settings *50.0 1* to Current Alarm Output *54.R.AL*.



11 . Press the Key to go to the setting status for the upper limit threshold.



12 . *av.LH* will be shown on display No. 2 for 1.5 seconds and then the operation value calculated from the threshold will be displayed. The default setting is 110.0%, so *5.50R* will be shown on display No. 2.



13 . Press the Key or + Keys to change the digit.



14 . Press the Key or + Keys to change from *1* to *0*. The setting is 100.0%, so *5.00R* will be shown on display No. 2.



15 . Press the Key to enter the setting and move to the Lower Limit Threshold.



16 . *UN.LH* will be shown on display No. 2 for 1.5 seconds and then the operation value calculated from the threshold will be displayed. The default setting is 0.0%, so *0.00R* will be shown on display No. 2.



17 . Press the Key or + Keys to change the digit.



18 . Press the Key or + Keys to change from *0* to *9*. The setting is 90.0%, so *4.50R* will be shown on display No. 2.



19 . Press the Key to enter the setting and move to the Hysteresis.



20 . *AL.HYS* will be shown on display No. 2 for 1.5 seconds and then the operation value calculated from the threshold will be displayed. The default setting is 0.0%, so *0.00R* will be shown on display No. 2.



21 . Press the Key or + Keys to change the digit.



22 . Press the Key or + Keys to change from 5 to 6. The setting is 60.0%, so 0.30R will be shown on display No. 2.



23 . Press the Key to enter the setting and move to the OFF Delay.

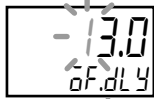

24 . Press the Key or + Keys to change from 0 to 1.



25 . Press the Key or + Keys to change the digit.



26 . Press the Key or + Keys to change from 3 to 0.



27 . Press the Key to enter the setting and move to the ON Delay.



28 . Press the Key or + Keys to change the digit.



29 . Press the Key or + Keys to change from 0 to 1.



30 . Press the Key to enter the set value. To end the setting procedure, press the Key for at least 3 seconds to go from Operation Setting Mode to Measurement Mode.

Voltage Alarm Output

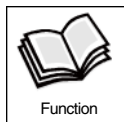

- This function can be used when the Voltage Alarm Output Setting is set to ON in the Output Terminal Function Settings.
- The alarm criteria is an OR of the status of the phases (if one phase exceeds the threshold). An AND of status of the phases is used to clear the alarm. (All phases exceed the threshold and hysteresis.)
- Set the upper limit threshold to 83.3% to output a voltage alarm when it exceeds 400 V. If the voltage fluctuates by ± 10 V, frequent changes in the alarm output can be reduced by setting the alarm output hysteresis to 2.1%.
- For details on the rated voltage, refer to page 4-15.

Note: The voltage alarm cannot be used for simple measurements.



Item	Displayed characters	Setting range	Default setting	Unit
Voltage Alarm Output	55.V.AL			
Voltage Alarm Output Upper Limit Threshold	0.V.LH 0.00 to 999%V	0.0 to 120.0	110.0	% (percentage of rated input)
Voltage Alarm Output Lower Limit Threshold	0.V.LL 0.00 to 999%V	0.0 to 120.0	0.0	% (percentage of rated input)
Voltage Alarm Output Hysteresis	AL.HYS 0.00 to 999%V	0.0 to 19.9	5.0	% (percentage of rated input)
Voltage Alarm Output OFF Delay	0.F.dLY	0.0 to 99.9	3.0	s
Voltage Alarm Output ON Delay	0.N.dLY	0.0 to 99.9	0.0	s

During the threshold and hysteresis setting status, the parameter abbreviation will be shown on display No. 2 for 1.5 seconds and then the rated voltage multiplied by the set value will be displayed. The unit is volts and the decimal point will change depending on the scale of the measurement value.



Procedure: The following procedure is used to set the upper limit threshold to 83.3%, lower limit threshold to 75.0%, hysteresis to 2.1%, OFF delay to 0.0 seconds, and ON delay to 3.0 seconds.

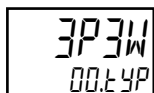

- Press the Key for at least 3 seconds to go from Measurement Mode to Operation Setting Mode.

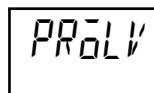

- Press the Key or + Keys to move from Applicable Circuit 00.LYP to Professional Level PRoLV.

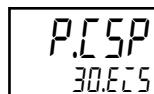

- Press the Key to go from Basic Level in the Operation Setting Mode to Professional Level in Operation Setting Mode.

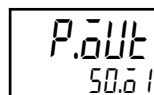

- Press the Key or + Keys to move from Event Input Settings 30.ELS to Output Terminal 1 Function Settings 50.o l.















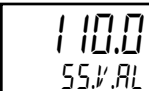

- Press the Key to go to setting status.

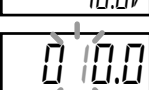
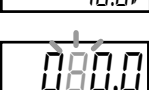
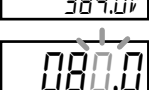
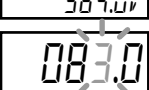
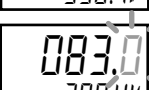
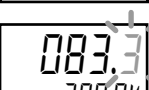

- Press the Key or + Keys to change from P.oUt to ALARM.

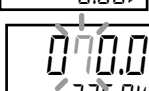

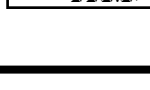
- Press the Key to enter the setting and press the Key or + Keys to go to the Voltage Alarm Output Settings.

- 8 . Press the  Key or  Keys to change from *oFF* to *oN*.
- 9 . Press the  Key to enter the setting and move to the setting status for other Alarm Output Setting.
- 10 . Press the  Key or  Keys to move from Output Terminal 1 Function Settings *50.o 1* to Voltage Alarm Output *55.v AL*.
- 11 . Press the  Key to go to the setting status for the upper limit threshold.
- 12 . *oV.tH* will be shown on display No. 2 for 1.5 seconds and then the operation value calculated from the threshold will be displayed. The default setting is 110.0%, so *528.0v* will be shown on display No. 2.
- 13 . Press the  Key or  Keys to change from *1* to *0*. The setting is 10.0%, so *48.0v* will be shown on display No. 2.
- 14 . Press the  Key or  Keys to change the digit.
- 15 . Press the  Key or  Keys to change from *1* to *8*. The setting is 80%, so *384.0v* will be shown on display No. 2.
- 16 . Press the  Key or  Keys to change the digit.
- 17 . Press the  Key or  Keys to change from *0* to *3*. The setting is 83%, so *398.4v* will be shown on display No. 2.
- 18 . Press the  Key or  Keys to change the digit.
- 19 . Press the  Key or Keys to change from *0* to *3*. The setting is 83.3%, so *399.8v* will be shown on display No. 2.
- 20 . Press the Key to enter the setting and move to the Lower Limit Threshold.
- 21 . *oV.tH* will be shown on display No. 2 for 1.5 seconds and then the operation value calculated from the threshold will be displayed. The default setting is 0.0%, so *0.00v* will be shown on display No. 2.
- 22 . Press the Key or Keys to change the digit.
- 23 . Press the Key or Keys to change from *0* to *7*. The setting is 70%, so *336.0v* will be shown on display No. 2.
- 24 . Press the Key or Keys to change the digit.



25 . Press the \uparrow Key or $\leftarrow+\uparrow$ Keys to change from 0 to 5. The setting is 75%, so 360.0V will be shown on display No. 2.



26 . Press the \square Key to enter the setting and move to the Hysteresis.



27 . ALHYS will be shown on display No. 2 for 1.5 seconds and then the operation value calculated from the threshold will be displayed. The default setting is 5.0%, so 24.0V will be shown on display No. 2.



28 . Press the \rightarrow Key or $\leftarrow+\rightarrow$ Keys to change the digit.



29 . Press the \uparrow Key or $\leftarrow+\uparrow$ Keys to change from 5 to 2. The setting is 2.0%, so 9.60V will be shown on display No. 2.



30 . Press the \rightarrow Key or $\leftarrow+\rightarrow$ Keys to change the digit.



31 . Press the \uparrow Key or $\leftarrow+\uparrow$ Keys to change from 0 to 1. The setting is 2.1%, so 10.08V will be shown on display No. 2.



32 . Press the \square Key to enter the setting and move to the OFF Delay.



33 . Press the \rightarrow Key or $\leftarrow+\rightarrow$ Keys to change the digit.



34 . Press the \uparrow Key or $\leftarrow+\uparrow$ Keys to change from 3 to 0.



35 . Press the \square Key to enter the setting and move to the ON Delay.



36 . Press the \rightarrow Key or $\leftarrow+\rightarrow$ Keys to change the digit.



37 . Press the \uparrow Key or $\leftarrow+\uparrow$ Keys to change from 0 to 3.

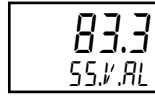

38 . Press the \square Key to enter the set value. To end the setting procedure, press the \leftarrow Key for at least 3 seconds to go from Operation Setting Mode to Measurement Mode.

Power Factor Alarm Output

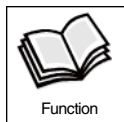

- This function can be used when the Power Factor Alarm Output Setting is set to ON in the Output Terminal Function Settings.
- Set the lower limit threshold to 90% to output a power factor alarm when the power factor falls below 0.9. If the power factor fluctuates by ± 0.08 , frequent changes in the alarm output can be reduced by setting the alarm output hysteresis to 8%.

Note 1. This function cannot be used when measuring regenerative power.

Note 2. If the alarm output turns ON while active power is being measured and measurement of regenerative power starts before the alarm is cleared, the output will turn OFF after the set OFF delay time.

Note 3. The power factor alarm cannot be used for simple measurements.



Item	Displayed characters	Setting range	Default setting	Unit
Power Factor Alarm Output	55.PF.A			
Power Factor Alarm Output Upper Limit Threshold	0V.LH 0.00 to 1.00	0.0 to 100	100	% (percentage of rated input)
Power Factor Alarm Output Lower Limit Threshold	UN.LH 0.00 to 1.00	0.0 to 100	0	% (percentage of rated input)
Power Factor Alarm Output Hysteresis	RL.HYS 0.00 to 1.00	0.0 to 19	5	% (percentage of rated input)
Power Factor Alarm Output OFF Delay	0F.DLY 0.0 to 99.9	0.0 to 99.9	3.0	s
Power Factor Alarm Output ON Delay	0N.DLY 0.0 to 99.9	0.0 to 99.9	0.0	s

During the threshold and hysteresis setting status, the parameter abbreviation will be shown on display No. 2 for 1.5 seconds and then 1.00 multiplied by the set value will be displayed.



Procedure: The following procedure is used to set the upper limit threshold to 100.0% (OFF), lower limit threshold to 90%, hysteresis to 8%, OFF delay to 7.0 seconds, and ON delay to 1.0 second.

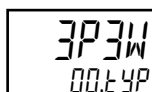

1. Press the Key for at least 3 seconds to go from Measurement Mode to Operation Setting Mode.

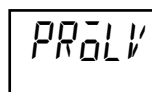

2. Press the Key or Keys to move from Applicable Circuit 00.LYP to Professional Level PR0LV.

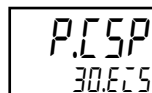

3. Press the Key to go from Basic Level in the Operation Setting Mode to Professional Level in Operation Setting Mode.

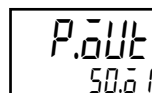

4. Press the Key or Keys to move from Event Input Settings 30.ECS to Output Terminal 1 Function Settings 50.0 I.



5. Press the Key to go to setting status.



6. Press the Key or Keys to change from P.0UT to ALARM.

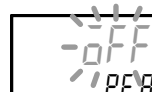

7. Press the Key to enter the setting and press the Key or Keys to go to the Power Factor Alarm Output Settings.



8 . Press the Key or + Keys to change from *OFF* to *ON*.

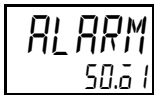

9 . Press the Key to enter the setting and move to the setting status for other Alarm Output Setting.



10 . Press the Key or + Keys to move from Output Terminal 1 Function Settings *50.01* to Power Factor Alarm Output *56.PF.A*.



11 . Press the Key to go to the setting status for the upper limit threshold.



12 . *UV.LH* will be shown on display No. 2 for 1.5 seconds and then the operation value calculated from the threshold will be displayed. The default setting is 100.0%, so *1.00* will be shown on display No. 2. The upper limit threshold does not change, so leave it as it is.



13 . Press the Key to enter the setting and move to the Lower Limit Threshold.



14 . *UN.LH* will be shown on display No. 2 for 1.5 seconds and then the operation value calculated from the threshold will be displayed. The default setting is 0%, so *0.00* will be shown on display No. 2.



15 . Press the Key or + Keys to change the digit.



16 . Press the Key or + Keys to change from *0* to *9*. The setting is 90%, so *0.90* will be shown on display No. 2.



17 . Press the Key to enter the setting and move to the Hysteresis.

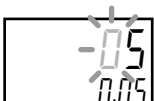

18 . *AL.HYS* will be shown on display No. 2 for 1.5 seconds and then the operation value calculated from the threshold will be displayed. The default setting is 5%, so *0.05* will be shown on display No. 2.



19 . Press the Key or + Keys to change the digit.



20 . Press the Key or + Keys to change from *5* to *8*. The setting is 8%, so *0.08* will be shown on display No. 2.

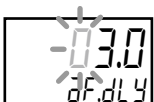

21 . Press the Key to enter the setting and move to the OFF Delay.



22 . Press the Key or + Keys to change the digit.

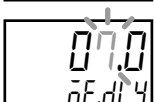



23 . Press the Key or + Keys to change from *3* to *7*.





24 . Press the  Key to enter the setting and move to the ON Delay.





25 . Press the  Key or + Keys to change the digit.



26 . Press the  Key or + Keys to change from 0 to 1.



27 . Press the  Key to enter the set value. To end the setting procedure, press the  Key for at least 3 seconds to go from Operation Setting Mode to Measurement Mode.

Reactive Power Alarm Output

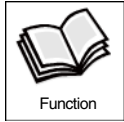

- This function can be used when the Reactive Power Alarm Output Setting is set to ON in the Output Terminal Function Settings.
- To output a reactive power alarm when 0.4 kvar is exceeded when using a KM20-CTF-5A Special CT (rated power: 4 kvar), set the upper limit threshold to 10.0%. If the power fluctuates by ± 0.02 kvar, frequent changes in the alarm output can be reduced by setting the alarm output hysteresis to 0.5%.
- For details on the rated power, refer to page 4-15.

Note 1. This function cannot be used when measuring regenerative power.

Note 2. If the alarm output turns ON while active power is being measured and measurement of regenerative power starts before the alarm is cleared, the output will turn OFF after the set OFF delay time.



Item	Displayed characters	Setting range	Default setting	Unit
Reactive Power Alarm Output	57.0RL			
Reactive Power Alarm Output Upper Limit Threshold	0V.LH 0.000K to 9999M	0.0 to 150.0	80.0	% (percentage of rated input)
Reactive Power Alarm Output Lower Limit Threshold	UN.LH 0.000K to 9999M	0.0 to 150.0	0.0	% (percentage of rated input)
Reactive Power Alarm Output Hysteresis	RL.HYS 0.000K to 9999M	0.0 to 19.9	5.0	% (percentage of rated input)
Reactive Power Alarm Output OFF Delay	oF.dLY	0.0 to 99.9	3.0	s
Reactive Power Alarm Output ON Delay	oN.dLY	0.0 to 99.9	0.0	s

During the threshold and hysteresis setting status, the parameter abbreviation will be shown on display No. 2 for 1.5 seconds and then the rated power multiplied by the set value will be displayed. The unit is volt-amperes and the decimal point will change depending on the scale of the measurement value.



Procedure: The following procedure is used to set the upper limit threshold to 10.0%, lower limit threshold to 0.0%, hysteresis to 0.5%, OFF delay to 15.0 seconds, and ON delay to 7.0 seconds when a KM20-CTF-5A Special CT is being used.

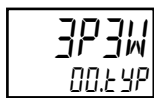

1. Press the Key for at least 3 seconds to go from Measurement Mode to Operation Setting Mode.



2. Press the Key or Keys to move from Applicable Circuit 00.4YP to Professional Level PRoLV.

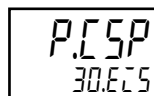

3. Press the Key to go from Basic Level in the Operation Setting Mode to Professional Level in Operation Setting Mode.

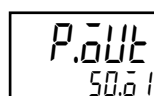

4. Press the Key or Keys to move from Event Input Settings 30.ECS to Output Terminal 1 Function Settings 50.o1.



5. Press the Key to go to setting status.

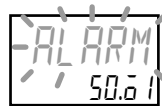

6. Press the \leftarrow Key or \leftarrow + \leftarrow Keys to change from *P.OUTPUT* to *ALARM*.



7. Press the \square Key to enter the setting and press the \leftarrow Key or \leftarrow + \leftarrow Keys to go to the Reactive Power Alarm Output Settings.



8. Press the \leftarrow Key or \leftarrow + \leftarrow Keys to change from *OFF* to *ON*.



9. Press the \square Key to enter the set value.



10. Press the \rightarrow Key or \rightarrow + \rightarrow Keys to move from Output Terminal 1 Function Settings *50.0 I* to Reactive Power Alarm Output *57.0.P.L*.



11. Press the \leftarrow Key to go to the setting status for the upper limit threshold.



12. *0V.L.H* will be shown on display No. 2 for 1.5 seconds and then the operation value calculated from the threshold will be displayed. The default setting is 80.0%, so *3.20%* will be shown on display No. 2.



13. Press the \rightarrow Key or \rightarrow + \rightarrow Keys to change the digit.



14. Press the \leftarrow Key or \leftarrow + \leftarrow Keys to change from *0* to *1*. The setting is 10.0%, so *0.40%* will be shown on display No. 2.



15. Press the \square Key to enter the setting and move to the Lower Limit Threshold.



16. *UN.L.H* will be shown on display No. 2 for 1.5 seconds and then the operation value calculated from the threshold will be displayed. The default setting is 0.0%, so *0.00%* will be shown on display No. 2. The lower limit threshold does not change, so leave it as it is.



17. Press the \square Key to enter the setting and move to the Hysteresis.



18. *AL.HYS* will be shown on display No. 2 for 1.5 seconds and then the operation value calculated from the threshold will be displayed. The default setting is 5.0%, so *0.20%* will be shown on display No. 2.



19. Press the \rightarrow Key or \rightarrow + \rightarrow Keys to change the digit.



20. Press the \leftarrow Key or \leftarrow + \leftarrow Keys to change from *5* to *0*. The setting is 0.0%, so *0.00%* will be shown on display No. 2.



21. Press the \rightarrow Key or \rightarrow + \rightarrow Keys to change the digit.



22 . Press the \uparrow Key or $\square+\uparrow$ Keys to change from 0 to 5. The setting is 0.5%, so 0.02% will be shown on display No. 2.



23 . Press the \square Key to enter the setting and move to the OFF Delay.

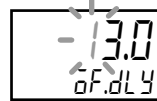

24 . Press the \uparrow Key or $\square+\uparrow$ Keys to change from 0 to 1.

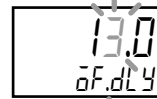

25 . Press the \rightarrow Key or $\square+\rightarrow$ Keys to change the digit.



26 . Press the \uparrow Key or $\square+\uparrow$ Keys to change from 3 to 5.



27 . Press the \square Key to enter the setting and move to the ON Delay.



28 . Press the \rightarrow Key or $\square+\rightarrow$ Keys to change the digit.



29 . Press the \uparrow Key or $\square+\uparrow$ Keys to change from 0 to 7.

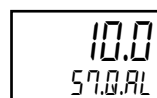

30 . Press the \square Key to enter the set value. To end the setting procedure, press the \square Key for at least 3 seconds to go from Operation Setting Mode to Measurement Mode.

4. 5 Total Regenerative Energy and Total Reactive Power Consumption



- The total regenerated energy and total reactive power consumption are found. Three totals are found for the reactive power consumption: phase leading reactive power consumption, phase lagging reactive power consumption, and the sum of the absolute values of the phase leading and phase lagging reactive power consumptions.

Definition of Phase Leading and Phase Lagging Reactive Power Consumptions

Regardless of whether power is active or regenerative, if the phase is leading, the power consumption is included in the total leading reactive power consumption, and if the phase is lagging, the power consumption is included in the total lagging reactive power consumption. The total reactive power consumption is the sum of the absolute values of the total leading reactive power consumption and the total lagging reactive power consumption. Whether the reactive power is leading or lagging is determined by the current phase in reference to the voltage.

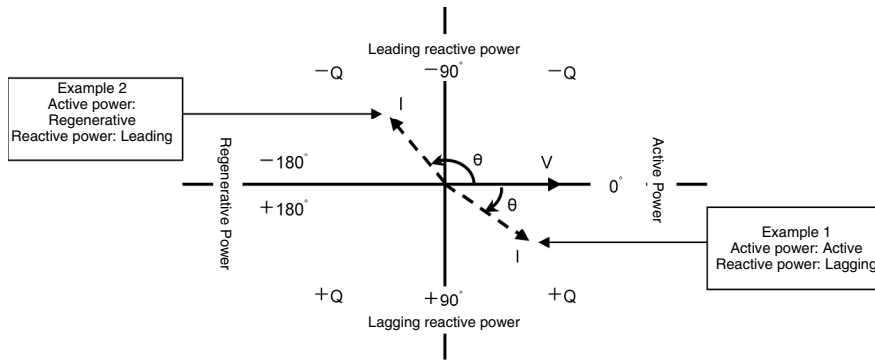

The following totals are calculated regardless of whether the power is active or regenerative.
 Total leading reactive power consumption: -Q is totalled.
 Total lagging reactive power consumption: +Q is totalled.
 Total reactive power consumption: Absolute values of both +Q and -Q are totalled.

Advanced Operating Procedures

Consumed Power Save Selection



- One of the following parameters can be logged every 5 minutes: regenerative power consumption, leading reactive power consumption, lagging reactive power consumption, or total reactive power consumption.



Item	Displayed characters	Setting range	Default setting	Unit
Consumed Power Save Selection	50.L.SL	-W, VRR.d, VRR.L, VRR.R	-W	-

- W: Total Regenerated Energy
- VRR.d: Total leading reactive power consumption
- VRR.L: Total lagging reactive power consumption
- VRR.R: Total reactive power consumption

RUN

Operation

Procedure: The following procedure is used to set the Consumed Power Save Selection to the Total Reactive Power Consumption.

1. Press the Key for at least 3 seconds to go from Measurement Mode to Operation Setting Mode.

2. Press the Key or + Keys to move from Applicable Circuit 00.LYP to Professional Level PR0LV.

3. Press the Key to go from Basic Level in the Operation Setting Mode to Professional Level in Operation Setting Mode.

4. Press the Key or + Keys to move from Event Input Settings 30.ECS to Consumed Power Save Selection 60.LSL.

5. Press the Key to go to setting status.

6. Press the Key or + Keys to change from -W to VARA.

7. Press the Key to enter the set value. To end the setting procedure, press the Key for at least 3 seconds to go from Operation Setting Mode to Measurement Mode.

■ Total Regenerated Energy



- The total regenerated energy will be displayed if the Key is pressed while the LOW total power consumption is being displayed in the Professional Level of Measurement Mode.
 - The totals are kept for each day. The total regenerated energy can be checked in watt-hours. It can be measure to up to -999,999,999 Wh.
- When -999,999,999 Wh is reached, the value is initialized to 0 Wh.

Note: The minus sign is not displayed.

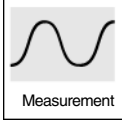

Item	Display No. 1	Display No. 2	Unit	Remarks
Total Regenerated Energy	0.0 to 99999.9	-kWh -MWh	-kWh -MWh	If the total power consumption exceeds -9,999.9 kWh, the unit indicator will change to -MWh.

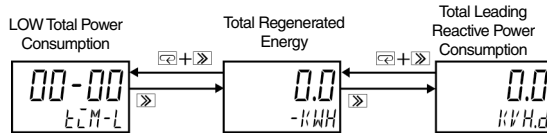

■ Total Leading Reactive Power Consumption

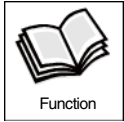

- The total leading reactive power consumption will be displayed if the FWD Key is pressed while the total regenerated energy is being displayed in the Professional Level of Measurement Mode. Press the FWD Key or $\text{CLR}+\text{FWD}$ Keys to switch between the total leading reactive power consumption, total lagging reactive power consumption, and total reactive power consumption.
- The totals are kept for each day.
The total leading power consumption, total lagging power consumption, and total reactive power consumption can be checked in var-hours. They can each be measured to up to 999,999,999 varh.
When 999,999,999 varh is reached, the value is initialized to 0 varh.

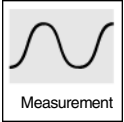

Item	Display No. 1	Display No. 2	Unit	Remarks
Total Leading Reactive Power Consumption	0.0 to 99999.9	kVh.d MvH.d	kvarh Mvarh	If the total leading reactive power consumption exceeds 9,999.9 kvarh, the unit indicator will change to Mvarh.
Total Lagging Reactive Power Consumption	0.0 to 99999.9	kVh.G MvH.G	kvarh Mvarh	If the total leading reactive power consumption exceeds 9,999.9 kvarh, the unit indicator will change to Mvarh.
Total Reactive Power Consumption	0.0 to 99999.9	kVh.R MvH.R	kvarh Mvarh	If the total leading reactive power consumption exceeds 9,999.9 kvarh, the unit indicator will change to Mvarh.

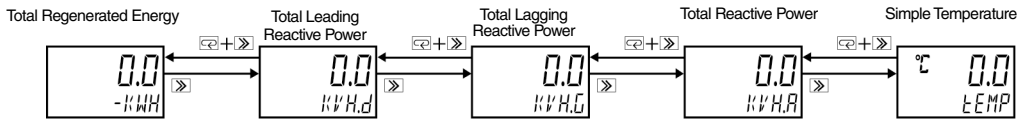

4. 6 Measurement Value Displays

■ Automatic Rotation

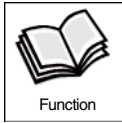

Function

- When automatic rotation is set to ON, the display automatically moves through the parameters in the Measurement Mode at a set interval.
- If a key operation is performed during automatic rotation, the display is momentarily held. Automatic rotation starts 5 seconds after the transition time elapses after the last key operation.
- If automatic rotation is set to ON when the device is started, the $WRLE$ display is cleared and automatic rotation starts 5 seconds after the set time elapses after moving to Measurement Mode.

Note 1. The Professional Level ($PR\bar{O}LV$) is not displayed.

Note 2. When the protection level is set to 2, measurement parameters in the Professional Level will not be displayed.



Setting

Item	Displayed characters	Setting range	Default setting	Unit
Automatic Rotation	$\bar{E} I.RLE$	$\bar{O}FF, \bar{O}N$	$\bar{O}FF$	
Transition Time	$R\bar{E}LM$	1 to 99	3	s



Operation

Procedure: The following procedure is used to set automatic rotation to ON and set the transition time to 5 seconds.

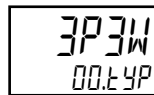

1. Press the \square Key for at least 3 seconds to go from Measurement Mode to Operation Setting Mode.

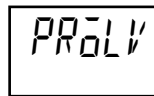

2. Press the \triangleright Key or $\square+\triangleright$ Keys to move from Applicable Circuit $00.4YP$ to Professional Level $PR\bar{O}LV$.

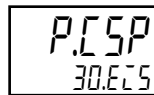

3. Press the \triangleleft Key to go from Basic Level in the Operation Setting Mode to Professional Level in Operation Setting Mode.

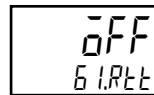

4. Press the \triangleright Key or $\square+\triangleright$ Keys to move from Event Input Settings $30.ECS$ to Automatic Rotation Settings $\bar{E} I.RLE$.



5. Press the \triangleleft Key to go to the setting status for the Automatic Rotation Setting.



6. Press the \triangleleft Key or $\square+\triangleleft$ Keys to change from $\bar{O}FF$ to $\bar{O}N$.

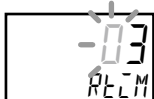

7. Press the \square Key to enter the setting and move to the setting status for the Transition Time.



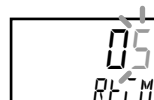

8. Press the \triangleright Key or $\square+\triangleright$ Keys to change the digit.

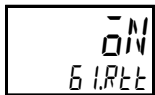

9. Press the \triangleleft Key or $\square+\triangleleft$ Keys to change from 3 to 5.



- 10 . Press the  Key to enter the set value. To end the setting procedure, press the  Key for at least 3 seconds to go from Operation Setting Mode to Measurement Mode.

■ Measurement Parameter Display Selection

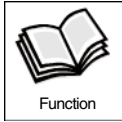

- The display of Measurement Mode parameters can be set to OFF or ON.
 - The display of Professional Level ($PR\bar{a}L\bar{v}$) cannot be set.
- Note 1. If all parameters in the basic level of the Measurement Mode are set to OFF, the display moves directly to Professional Level without displaying $PR\bar{a}L\bar{v}$ when moving to Measurement Mode.
- Note 2. If all parameters in the Measurement Mode Professional Level are set to OFF, Professional Level ($PR\bar{a}L\bar{v}$) is also not displayed.
- Note 3. If all parameters are set to OFF, only the active power is displayed.
- Note 4. When the protection level is set to 2, the Professional Level ($PR\bar{a}L\bar{v}$) will not be displayed.
- Note 5. The current and voltage can be set regardless of the applicable circuit settings.
- Note 6. When there is an alarm output or an error, display of the measurement value that caused the alarm output or error is set to ON regardless of the display setting. This applies to the following measurement values:
Active power, current, voltage, power factor, reactive power, and frequency. The display then operates according to the display settings after the alarm output or error is cleared. However, even if display of the measurement value that was displayed when the alarm output or error was cleared is set to OFF, the measurement value will stay until the display moves to another measurement value.



Item	Displayed characters	Setting range	Default setting	Unit
Measurement Parameter Display Selection	$\bar{b}2.d5L$	$\bar{a}FF, \bar{a}N$	Refer to the following table.	

The measurement parameter display items, display order, and default settings are shown in the following table.

Display order	Parameters	Display No. 2	Default setting
1	Active Power	W	$\bar{a}N$
2	Total Power Consumption	WH	$\bar{a}N$
3	Current 1	$R-1$	$\bar{a}N$
4	Current 2	$R-2$	$\bar{a}N$
5	Current 3	$R-3$	$\bar{a}N$
6	Voltage 1	$V-1$	$\bar{a}N$
7	Voltage 2	$V-2$	$\bar{a}N$
8	Voltage 3	$V-3$	$\bar{a}N$
9	Power Factor	PF	$\bar{a}N$
10	Reactive Power	VRR	$\bar{a}N$
11	Frequency	HZ	$\bar{a}N$
12	Calculated CO ₂	$\bar{C}\bar{a}2$	$\bar{a}N$
13	Converted Monetary Cost	$\bar{C}HG$	$\bar{a}FF$
14	Pulse Converted Value 1	$\bar{C}NV1$	$\bar{a}FF$
15	Pulse Converted Value 2	$\bar{C}NV2$	$\bar{a}FF$
16	Time	$\bar{t}\bar{C}ME$	$\bar{a}N$
17	Total Pulse Input Count	$\bar{C}NE$	$\bar{a}N$
18	Specific Power Consumption	WH/P	$\bar{a}N$
19	Pulse Input ON Time	$H-\bar{a}N$	$\bar{a}N$
20	HIGH Total Power Consumption	$WH-H$	$\bar{a}N$
21	MIDDLE Total Power Consumption	$WH-M$	$\bar{a}N$
22	LOW Total Power Consumption	$WH-L$	$\bar{a}N$
23	HIGH Total Time	$\bar{t}\bar{C}M-H$	$\bar{a}N$
24	MIDDLE Total Time	$\bar{t}\bar{C}M-M$	$\bar{a}N$
25	LOW Total Time	$\bar{t}\bar{C}M-L$	$\bar{a}N$
26	Total Regenerated Energy	$-WH$	$\bar{a}FF$
27	Total Leading Reactive Power	$VH.d$	$\bar{a}FF$
28	Total Lagging Reactive Power	$VH.G$	$\bar{a}FF$
29	Total Reactive Power	$VH.R$	$\bar{a}FF$
30	Simple Temperature	$\bar{t}EMP$	$\bar{a}FF$
31	Product Information	$PRd\bar{C}\bar{t}$	$\bar{a}N$

RUN

Operation

Procedure: The following procedure is used to set all measurement parameter display selections to ON.

1. Press the Key for at least 3 seconds to go from Measurement Mode to Operation Setting Mode.

2. Press the Key or + Keys to move from Applicable Circuit 00.LYP to Professional Level PRoLV.

3. Press the Key to go from Basic Level in the Operation Setting Mode to Professional Level in Operation Setting Mode.

4. Press the Key or + Keys to move from Event Input Settings 30.ECS to Measurement Parameter Display Selections 62.dSL.

5. Press the Key to go to the setting status for the Active Power W.

6. Press the Key to go to the setting status for the Conversion to Monetary Cost CHG.

7. Press the Key or + Keys to change from oFF to oN.

8. Press the Key to change the set value and move to the setting status for the Pulse Conversion Value 1 ENV 1.

9. Press the Key or + Keys to change from oFF to oN.

10. Press the Key to change the set value and move to the setting status for the Pulse Conversion Value 2 ENV 2.

11. Press the Key or + Keys to change from oFF to oN.

12. Press the Key to enter the setting and move to the setting status for the Regenerative Energy -WH.

13. Press the Key or + Keys to change from oFF to oN.

14. Press the Key to enter the setting and move to the setting status for the Total Leading Reactive Power V.H.d.

15. Press the Key or + Keys to change from oFF to oN.



16 . Press the  Key to enter the setting and move to the setting status for the Total Lagging Reactive Power *VH.G*.

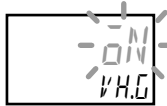

17 . Press the  Key or + Keys to change from *OFF* to *ON*.



18 . Press the  Key to enter the setting and move to the setting status for the Total Reactive Power *VH.R*.



19 . Press the  Key or + Keys to change from *OFF* to *ON*.



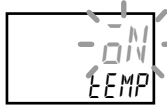

20 . Press the  Key to change the set value and move to the setting status for the Simple Temperature Measurement *TEMP*.

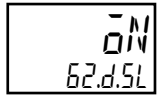

21 . Press the  Key or + Keys to change from *OFF* to *ON*.



22 . Press the  Key to enter the set value.
To end the setting procedure, press the  Key for at least 3 seconds to go from Operation Setting Mode to Measurement Mode.

4.7 Energy-saving Mode

■ Display ON Time

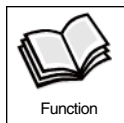

Function

- This function turns the LCD OFF after a set time has passed.
- The energy-saving mode can be deactivated with any key operation and the latest parameters before the LCD turned OFF will be displayed.
- Decimal points on display No.2 will light in order during Energy-saving Mode.

Note: Operation indicators such as OUT1 and OUT2 will operate.



Setting

Item	Displayed characters	Setting range	Default setting	Unit
Display ON Time	63.d5P	0 to 99 ^{min}	0	Minutes

*1. 0: Always ON



Operation

Procedure: The following procedure is used to set the display ON time to 15 minutes.

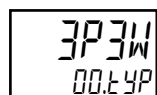

1. Press the Key for at least 3 seconds to go from Measurement Mode to Operation Setting Mode.

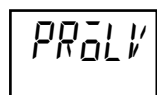

2. Press the Key or Keys to move from Applicable Circuit 00.LYP to Professional Level PRoLV.

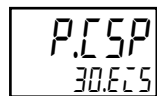

3. Press the Key to go from Basic Level in the Operation Setting Mode to Professional Level in Operation Setting Mode.

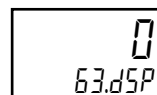

4. Press the Key or Keys to move from Event Input Settings 30.ECS to Display ON Time 63.d5P.

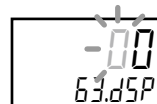

5. Press the Key to go to setting status.

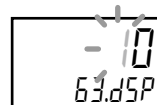

6. Press the Key or Keys to change from 0 to 1.

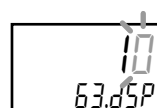

7. Press the Key or Keys to change the digit.

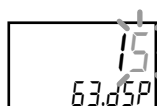

8. Press the Key or Keys to change from 0 to 5.

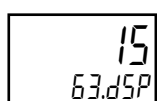

9. Press the Key to enter the set value. To end the setting procedure, press the Key for at least 3 seconds to go from Operation Setting Mode to Measurement Mode.

4. 8 Incorrect Wiring

Incorrect Voltage Wiring Detection

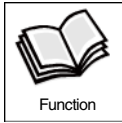

- This function displays an error when incorrect wiring is detected at the voltage input connections.
- An error is displayed when the phase input at the voltage input terminals is incorrect for the Applicable Circuit *DDLYP* while the voltage line is connected.
- When an incorrect wiring is detected, the display of *E-54* will alternate with the present measurement value.

Note 1. Incorrect wiring is not detected while taking simple measurements.

Note 2. If incorrect wiring is detected due to voltage waveform deformity in the secondary side of the inverter, turn OFF the incorrect wiring detection function.



Item	Displayed characters	Setting range	Default setting	Unit
Incorrect Voltage Wiring Detection	<i>64V-E</i>	<i>OFF, ON</i>	<i>ON</i>	

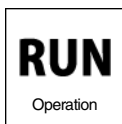

Procedure: The following procedure is used to set the Incorrect Voltage Wiring Detection to OFF.



1. Press the Key for at least 3 seconds to go from Measurement Mode to Operation Setting Mode.



2. Press the Key or + Keys to move from Applicable Circuit *DDLYP* to Professional Level *PROLV*.

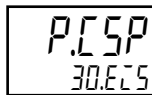

3. Press the Key to go from Basic Level in the Operation Setting Mode to Professional Level in Operation Setting Mode.

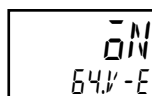

4. Press the Key or + Keys to move from Event Input Settings *30.EL5* to Incorrect Voltage Detection *64V-E*.

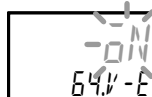

5. Press the Key to go to setting status.



6. Press the Key or + Keys to change from *ON* to *OFF*.

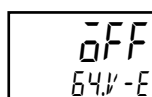

7. Press the Key to enter the set value. To end the setting procedure, press the Key for at least 3 seconds to go from Operation Setting Mode to Measurement Mode.

4.9 Simple Temperature Measurements



- Simple measurements of the ambient temperature can be taken.
- Note 1. This function is a simple function. It is appropriate for checking temperature trends, but do not use it for control purposes.
- Note 2. The temperature will vary according to the load on the internal circuits (i.e., whether indicators are lit) because temperature is measured with the built-in thermister (see following figure). Use this function only for simple measurements.
- Note 3. The measurements will be inaccurate if the temperature between the front and inside the panel is significantly different, or when there is air cooling inside the panel. Use this function when the temperature at the front and inside the panel are the same. Measure the temperature outside and correct the temperature measurement accordingly. The simple temperature measurement can then be used to check temperature trends.

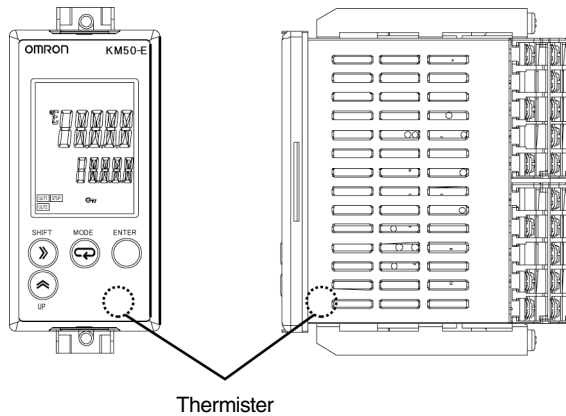

Temperature Setting

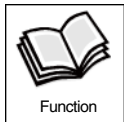

- Celsius or Fahrenheit can be selected.
- The temperature can be corrected by setting a correction.



Item	Displayed characters	Setting range	Default setting	Unit
Temperature Unit	<i>55.d-U</i>	<i>C, F</i>	<i>C</i>	C, F
Temperature Compensation	<i>t.Rd</i>	<i>-50.0 to 50.0</i>	<i>0.0</i>	-

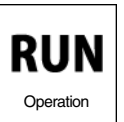

Procedure: The following procedure can be used to set the temperature unit to Celsius and temperature correction to -10.0.

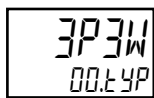

1. Press the Key for at least 3 seconds to go from Measurement Mode to Operation Setting Mode.

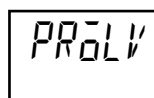

2. Press the Key or + Keys to move from Applicable Circuit *00.tYP* to Professional Level *PRoLV*.

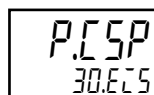

3. Press the Key to go from Basic Level in the Operation Setting Mode to Professional Level in Operation Setting Mode.

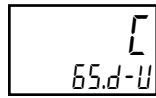

4. Press the \rightarrow Key or $\leftarrow+\rightarrow$ Keys to move from Event Input Settings 30.ECS to Temperature Unit 65.d-U.

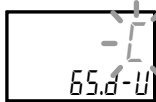

5. Press the \uparrow Key to go to the setting status for the Temperature Unit.

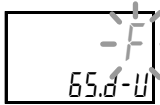

6. Press the \uparrow Key or $\leftarrow+\uparrow$ Keys to change from \square to F.

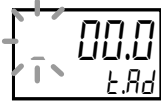

7. Press the \square Key to enter the setting and move to the setting status for the Temperature Correction.



8. Press the \uparrow Key or $\leftarrow+\uparrow$ Keys to change from _ to -.



9. Press the \rightarrow Key or $\leftarrow+\rightarrow$ Keys to change the digit.

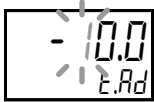

10. Press the \uparrow Key or $\leftarrow+\uparrow$ Keys to change from 0 to 1.

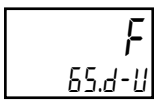

11. Press the \square Key to enter the set value. To end the setting procedure, press the \leftarrow Key for at least 3 seconds to go from Operation Setting Mode to Measurement Mode.

Simple Temperature

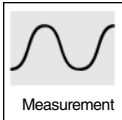

- The simple temperature will be displayed if the \rightarrow Key is pressed while the total reactive power is being displayed in the Professional Level of Measurement Mode.
 - The temperature correction is added to the measurement value and the results is displayed.
- Note: The accuracy is in respect to the error from the temperature saturation point because the temperature is affected by the temperature increase within the KM50.

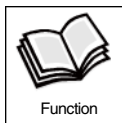

Item	Display No. 1	Display No. 2	Unit	Remarks
Simple Temperature	- 15.0 to 140.0	tEMP	°C, °F	°C or °F is displayed on the top left of display No.1 according to the setting.

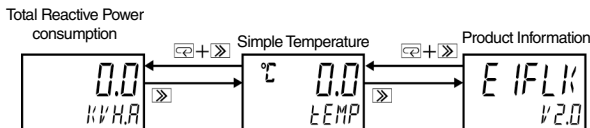

4. 10 Displaying Product Information

■ Product Information

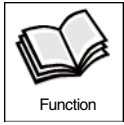

- The model and software version of the Power Monitor will be displayed if the Key is pressed while the simple temperature is being displayed in the Professional Level of Measurement Mode.
- The model *E IFLK* will be displayed on display No. 1 and the present software version will be displayed on display No. 2.

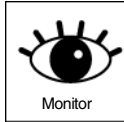

Parameter	Display No. 1	Display No. 2	Unit	Remarks
Product Information	<i>E IFLK</i>	Current software version		

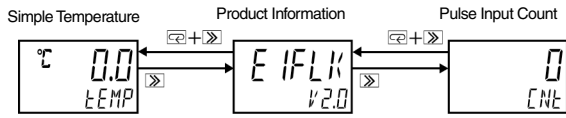

4. 11 Protection Setting Mode

■ Protection Setting

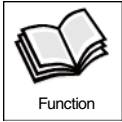

- This parameter can be set to restrict changes to settings. The settings can always be changed using communications.
- Protection can be set to a protection level in Protection Setting Mode.
- The following table shows how to move within Protection Setting Mode.
You cannot move to other modes while setting protection.
- If the protection level is set to 1 or higher, the **On** (Key) indicator will light.

Note: Measurements will stop in Protection Setting Mode.

Set value	Restrictions				
	Changing the display	Moving to the Setting Modes	Moving to Professional Level	Clearing the Measurement Log	Changing the settings (Moving to Setting Statics)
0	○	○	○	○	○
1	○	○	○	×	×
2	○	○	×	×	×

○: Enabled, / ×: Disabled



Parameter	Displayed characters	Setting range	Default setting	Unit
Protection Setting	PRTECT	0, 1, 2	0	-

Advanced Operating Procedures



Procedure: The following procedure is used to set protection level 2.



1 . Press the + Keys for at least 3 seconds to go from Measurement Mode to Protection Setting Mode.



2 . Press the Key to go to setting status.



3 . Press the Key or + Keys to change from 0 to 2.



4 . Press the Key to enter the setting. Protection will be set and the **On** (Key) indicator will light.



Section 5 Troubleshooting

5.1	Error Displays.....	5-2
5.2	Troubleshooting	5-3

5.1 Error Displays

■ Error Displays

Error	Priority	Display	Operation	Recovery method
Time not set in KM50	5	<i>E-t1</i>	The error will be displayed at startup and the STOP indicator will light for 3 seconds. Measurements will stop and operation will not be possible. Measurement Mode will be entered after the error is displayed.	Set the time after the error display turns OFF.
RAM error	1	<i>E-M1</i>	Measurements will stop and operation will not be possible.	Repairs are necessary. Contact your OMRON representative.
EEPROM error	2	<i>E-M2</i>	Measurements will stop and operation will not be possible.	Repairs are necessary. Contact your OMRON representative.
EEPROM data corrupted	3	<i>E-M3</i>	Measurements will stop and operation will not be possible.	Repairs are necessary. Contact your OMRON representative.
Calibration error	4	<i>E-M4</i>	Measurements will stop and operation will not be possible.	Repairs are necessary. Contact your OMRON representative.
Input voltage exceeded allowed range.	6	<i>E-51</i>	The error display and measured value display will alternate and measurements will continue.	Return the input signal to within the rated range.
Input current exceeded allowed range.	7	<i>E-52</i>	The error display and measured value display will alternate and measurements will continue.	Return the input signal to within the rated range.
Incorrect wiring detected.	8	<i>E-53</i>	The error display and measured value display will alternate and measurements will continue.	Correct the phase sequence of the input signal (voltage) wiring.

Note 1. If errors *E-M1* to *E-M4* occur, all outputs will stop and key operations will not be accepted.

Note 2. An error will occur if the voltage exceeds 110% of the rated value, the current exceeds 120% of the rated value, or the frequency is not between 45 and 65 Hz. A frequency error will not be displayed if the input voltage is 20 V or lower.

If the VT is set, the secondary voltage setting will be the rated voltage.

Note 3. Error *E-54* will be displayed only if the Incorrect Voltage Wiring Detection Function is set to ON.

5. 2 Troubleshooting

Check Using the Following Table First

If the KM50 does not operate properly, check any relevant items in the following table before requesting repairs.

If the Power Monitor still does not operate properly, contact your OMRON representative.

When	Problem	Description	Location to check	Reference pages
First time power is turned ON	The OUT1 or OUT2 operation indicator lights.	Does it flash at the same time as the measurement pulse output or alarm output turns ON?	If the OUT1 or OUT2 indicator is lit when the measurement pulse output or alarm output is ON, the Power Monitor is operating properly.	1-3, 1-6
	The operation of the OUT1 or OUT2 operating indicator is not stable. The ON period does not agree with the measurement value.	Is the pulse output unit set to a suitable value?	If the period is 600 ms or less, the ON period is too short and the indicator may not turn ON. Increase the pulse output unit so that the output period is 600 ms or longer.	1-3, 2-10, 3-20
The voltage or current can be measured, but the power is not measured correctly.		The Special CT may be installed in the wrong direction.	Also, if the measured power is negative, the Special CTs may be installed in the wrong direction. Also, if the measured value is close to 0, one of the Special CTs may be installed in the wrong direction.	2-4, 2-5, 2-8
		The voltage phase sequence may not be correct.	The power cannot be measured correctly if the voltage phase sequence is not correct. Error E-54 will be displayed if the Incorrect Voltage Wiring Detection Function is set to ON.	2-5, 2-7, 4-57
The error in the measurement is large.		The wiring may not be correct.	Correct the wiring.	2-5
		The setting of the Special CT type may not be correct.	Check the CT that you are using and make sure the type is set correctly.	2-8, 3-6
		The input may be exceeding the input range of the Special CT.	Check the rating of the Special CT and input a current within the rating.	2-8, A-6
		The applicable circuit setting may not be correct.	Check the circuit type and set the applicable circuit correctly.	3-5
A parameter is not displayed.				
The current is 0.		The input current may be below the low-cut current.	Set the low-cut current so that it is below the input current.	3-18
Communications are not possible.		You may be using a communications adapter other than the recommended one (K3SC-10).	Check the connected device to see if it is normal.	—
		The host system (communications device) may not be normal.		—
	The communications settings may not be correct.	Make sure that the same communications settings are being used by both the KM50 and the communications adapter.	3-43, 3-49	
	The wiring may not be correct.	Correct the wiring.	2-5, 2-9	
	Terminating resistance may not be connected.	Attach terminating resistance of 120 Ω (1/2 W) to the end KM50 and communications adapter.	2-9	
	The system may exceed the maximum transmission distance.	Connect the system so that the maximum transmission distance of 500 m is not exceeded.	2-9	

When	Problem	Description	Location to check	Reference pages
		The maximum number of nodes on the same communications line may be exceeded.	A maximum of 31 KM50-E Power Monitors can be connected for CompoWay/F and a maximum of 99 KM50-E Power Monitors can be connected for Modbus (not including the master).	2-9
During operation	Settings cannot be changed, professional level cannot be entered, or the measurement log cannot be cleared.	Protection may be set.	Go to Protection Setting Mode and clear the protection.	4-61
	The buzzer will not sound.	The buzzer may be set to OFF.	Set the buzzer parameter to ON.	3-26
	A setting is not changed.	You may not be entering the setting after changing it.	Press the <input type="checkbox"/> Key to enter a setting after changing it.	1-23
	The primary current of an inverter is not measured correctly.	The rating of the Special CT may not have enough leeway.	When measuring the primary current of an inverter, the crest value will be several times the effective value. Be sure to use a Special CT with a rating that allows leeway.	2-8
	The temperature error is large.	Are the specifications inside the panel the same as those outside the panel?	When the temperature inside the panel is considerably different to the temperature outside the panel, temperature measurements will not be correct. Set the specifications inside the panel the same as those outside the panel.	4-58

Appendices

Product Specifications	A-2
■ Power Monitor Ratings	A-2
■ Power Monitor Performance	A-3
■ Option Ratings and Performance	A-4
● Default Settings	A-5
● Waterproof Packing	A-5
● Terminal Covers	A-5
● Mounting Bracket	A-5
Special CTs	A-6
■ Specifications	A-6
■ Dimensions (Unit: mm)	A-6
Parameter List	A-7
■ Measurement Mode, Basic Level	A-7
■ Measurement Mode, Professional Level	A-10
■ Operation Setting Mode, Basic Level	A-11
■ Operation Setting Mode, Professional Level	A-13
■ Communications Setting Mode	A-18
■ Protection Setting Mode	A-19
Parameter List	A-20

Product Specifications

■ Power Monitor Ratings

Item \ Model	KM50-E1-FLK	
Rated power supply voltage	100 to 240 VAC, 50/60 Hz	
Allowable supply voltage range	85% to 110% of rated power supply voltage	
Allowable frequency range	45 to 65 Hz	
Power consumption	7 VA max.	
Applicable circuits	Single-phase two-wire, single-phase three-wire, three-phase three-wire, and three-phase four-wire circuits	
Rated input	Rated input voltage	100 to 480 VAC (single-phase, 2-wire): Line voltage 100/200 VAC (single-phase, 3-wire): Phase voltage/line voltage 100 to 480 VAC (3-phase, 3-wire): Line voltage 58 to 277 VAC (3-phase, 4-wire): Phase voltage
	Rated input current	5 A, 50 A, 100 A, 200 A, 400 A, or 600 A (primary current of Special CT)
	Rated frequency	50/60 Hz
	Rated input power	With 5-A CT: 4 kW With 50-A CT: 40 kW With 100-A CT: 80 kW With 200-A CT: 160 kW With 400-A CT: 320 kW With 600-A CT: 480 kW
	Allowable input voltage	110% of rated input voltage (continuous)
	Allowable input current	120% of rated input current (continuous)
	Rated input load	Voltage input: 0.5 VA max. (excluding power supply) Current input: 0.5 VA max. (for each input)
Time	2010 to 2099 (Adjusted for leap year.) Accuracy: ± 1.5 min/month (at 23° C)	
Time backup period	7 days (without power supply, at 23° C)	
Ambient operating temperature	-10 to 55°C (with no condensation or icing)	
Storage temperature	-25 to 65°C (with no condensation or icing)	
Ambient operating humidity	25% to 85%	
Storage humidity	25% to 85%	
Altitude	2,000 m max.	
Installation environment	Overvoltage category and measurement category: II, Pollution level: 2	

■ Power Monitor Performance

Item \ Model	KM50-E1-FLK	
Accuracy*	Voltage*	±1.0% FS ±1 digit (at ambient temperature of 23°C, rated input, and rated frequency) However, the accuracy is ±2.0% FS ±1 digit for the Vtr line voltage for a three-phase, three-wire circuit and the Vrs line voltage for a single-phase, three-wire circuit under the same conditions.
	Current*	±1.0% FS ±1 digit (at ambient temperature of 23°C, rated input, and rated frequency) However, the accuracy is ±2.0% FS ±1 digit for the phase-S current for a three-phase, three-wire circuit and the phase-N current for a single-phase, three-wire circuit under the same conditions.
	Active Power Reactive power*	±2.0% FS ±1 digit (at ambient temperature of 23°C, rated input, rated frequency, and power factor of 1) Reactive power formula: $\text{Reactive power} = v \times i \times \sin \theta$ Note: "v" is the instantaneous voltage and "i" is the instantaneous current. θ is the phase difference between the voltage and current.
	Frequency*	±0.3 Hz ±1 digit (at ambient temperature of 23°C, rated input, and rated frequency)
	Power factor*	±5.0% FS ±1 digit (at ambient temperature of 23°C, rated input, rated frequency, and $\cos\theta = 0.5$ to 1 to 0.5) Power factor formula: $\text{Power factor} = \text{Instantaneous power} / \text{Apparent power}$ Note: $\text{Apparent power} = \sqrt{(\text{Active power})^2 + (\text{Reactive power})^2}$
	Temperature	±5°C two hours after the power is turned ON (after setting the temperature connection according to the ambient environment)
Low-cut current set value	0.1% to 19.9% of rated current input (in 0.1% increments)	
Sampling cycle	100 ms for measurement voltage at 50 Hz and 83.3 ms for measurement voltage at 60 Hz	
Temperature influence*	±1.0% FS ±1 digit (percentage of power within operating temperature range, at ambient temperature of 23°C, rated input, rated frequency, and power factor of 1)	
Frequency influence*	±1.0% FS ±1 digit (percentage of power within ±5 Hz of rated frequency, at ambient temperature of 23°C, rated input, rated frequency, and power factor of 1)	
Influence of harmonics*	±0.5% FS ±1 digit (at ambient temperature of 23°C, error for superimposed 2nd, 3rd, 5th, 7th, 9th, 11th, and 13th harmonics for a content percentage of 30% for current and 5% for voltage of the basic wave)	
Insulation resistance	1) Between all electrical circuits and all of the RS-485 terminals, OUT1, OUT2, event inputs, I/O commons, and transistor outputs: 20 MΩ max. (at 500 VDC) 2) Between all current and voltage inputs and all of the RS-485 terminals, OUT1, OUT2, event inputs, I/O commons, and transistor outputs: 20 MΩ max. (at 500 VDC) 3) Between all current and voltage inputs and the front case: 20 MΩ max. (at 500 VDC) 4) Between all electrical circuits and the front case: 20 MΩ min. (at 500 VDC)	
Dielectric strength	1) Between all electrical circuits and all of the RS-485 terminals, OUT1, OUT2, event inputs, I/O commons, and transistor outputs: 2,800 VAC for 1 min 2) Between all current and voltage inputs and all of the RS-485 terminals, OUT1, OUT2, event inputs, I/O commons, and transistor outputs: 3,600 VAC for 1 min 3) Between all current and voltage inputs and the front case: 3,600 VAC for 1 min 4) Between all electrical circuits and the front case: 2,800 VAC for 1 min	
Vibration resistance	Single-amplitude: 0.35 mm, Acceleration: 50 m/s ² Vibration: 10 to 150 Hz, 10 sweeps for 8 minutes along 3 axes	
Shock resistance	150 m/s ² , 3 times each in 6 directions (up/down, left/right, forward/backward)	
Weight	Approx. 250 g (Power Monitor only)	
Degree of protection	Front panel: IP66, Rear case: IP20, Terminal section: IP00	
Memory backup	EEPROM (non-volatile memory), No. of writes: 1,000,000 times	
Compliant standards	UL 61010-1 and CAN/CSA-C22.2 No. 61010-1 EN61010-1(IEC61010-1), EN61326-1(IEC61326-1)	
EMC (Industrial Applications)	EMI EN61326-1	Radiated RF Electromagnetic Field: CISPR 11 class A Conducted Emission: CISPR 11 class A

Item \ Model	Model
	KM50-E1-FLK
EMS EN61326-1	Electrostatic Discharge Immunity: EN 61000-4-2 Electromagnetic Field Immunity: EN 61000-4-3 Fast Transient/Burst Noise Immunity: EN 61000-4-4 Surge Immunity: EN 61000-4-5 Conducted Disturbance Immunity: EN 61000-4-6 Power Frequency Magnetic Field Immunity: EN 61000-4-8 Voltage Dip and Interruption Immunity: EN 61000-4-11

*The error of the Special CT is not included.

■ Option Ratings and Performance

Item \ Model	Model	
	KM50-E1-FLK	
Event inputs ^{*1}	Number of inputs	Two event inputs The two event inputs use the same common terminal.
	Voltage inputs	High level: 4.75 to 30 VDC Low level: 0 to 2 VDC Input impedance: Approx. 2 kΩ
	No-voltage inputs	ON resistance: 1 kΩ max. OFF resistance: 100 kΩ min. ON residual voltage: 8 V max. ON current (at 0 Ω): 10 mA max.
	Minimum input time	5 ms
Transistor outputs	Number of outputs	5 open-collector outputs Two total power consumption pulse or alarm outputs, and three 3-state outputs. The total power consumption pulse output and alarm output use the same common terminal. The three 3-state outputs use the same common terminal.
	Output capacity	30 VDC, 30 mA max. ON residual voltage: 1.2 V max. OFF leakage current: 100 μA max.
Communications	Communications method	RS-485 (2-wire half-duplex)
	Sync method	Start-stop
	Unit number setting	CompoWay/F : 0 to 99 Modbus : 1 to 99
	Baud rate	1.2、 2.4、 4.8、 9.6、 19.2、 38.4kbps
	Transmission code	CompoWay/F: ASCII, Modbus: Binary
	Data length	7 or 8 bits ^{*2}
	Stop bits	1 or 2 bits ^{*3}
	Parity	Even, odd, or none
	Maximum transmission distance	500 m
Maximum number of nodes ^{*4}	CompoWay/F: 31 Modbus: 99	

*1. Inputs can be changed between voltage and non-voltage inputs using key operations or communications.

*2. The data length will be 8 bits if Modbus is set as the protocol.

*3. If Modbus is set as the protocol, the number stop bits will be set automatically according to the vertical parity. If the Vertical Parity parameter is set to "none" there will be 2 stop bits. If it is set to odd or even parity, there will be 1 stop bit.

*4. You can connect 31 KM50-E Power Monitors for CompoWay/F or 99 KM50-E Power Monitors for Modbus. For CompoWay/F, the maximum number of devices must include all devices connected on the same communications line, not just the KM50-E. For Modbus, the maximum number of devices assumes that only KM50-E Power Monitors are connected. Unit numbers that are higher than the number of connected node may be set.

● Default Settings

Protocol	Unit number	Baud rate	Data length	Stop bits	Vertical parity	Transmission wait time
CompoWay/F	1	9.6 kbps	7	2	Even	20

● Waterproof Packing

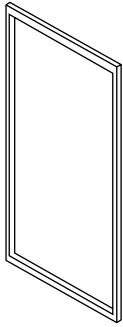

Model: Y92S-P5

● Terminal Covers

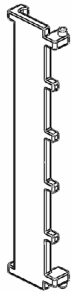

Model: E53-COV16 (includes 6 covers)

● Mounting Bracket

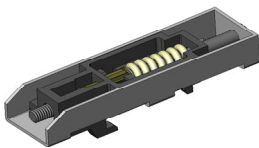

Model: Y92H-9

Special CTs

Specifications

Item \ Model	KM20-CTF-5A	KM20-CTF-50A	KM20-CTF-100A	KM20-CTF-200A	KM20-CTF-400A	KM20-CTF-600A
Rated primary current	5 A	50 A	100 A	200 A	400 A	600 A
Secondary winding	3,000 turns				6,000 turns	9,000 turns
Applicable frequency	10 Hz to 5 kHz					
Insulation resistance	Between output terminals and the front case: 50 MΩ max. (at 500 VDC)					
Dielectric strength	Between output terminals and the front case: 2,000 VAC for 1 minute					
Protective element	7.5 V clamp element					
Allowable number of connections/disconnections	100 times					
Inner diameter	10	16	24	37		
Operating temperature and humidity ranges	-20 to 60°C, 85% max. (with no condensation)					
Storage temperature and humidity ranges	-30 to 65°C, 85% max. (with no condensation)					

Dimensions (Unit: mm)

KM20-CTF-5A

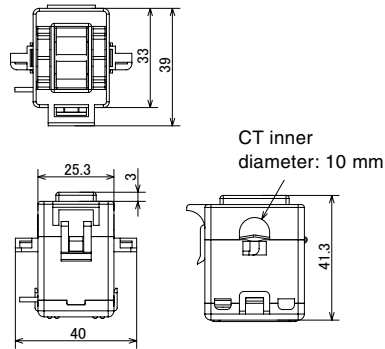

KM20-CTF-50A

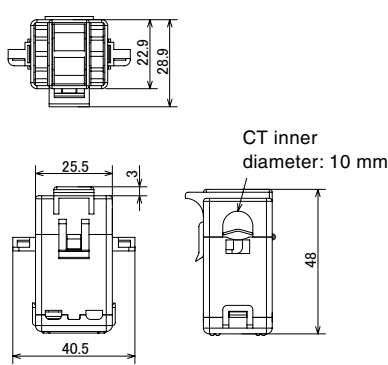

KM20-CTF-100A

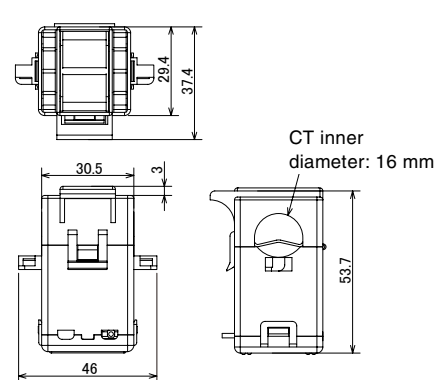

KM20-CTF-200A

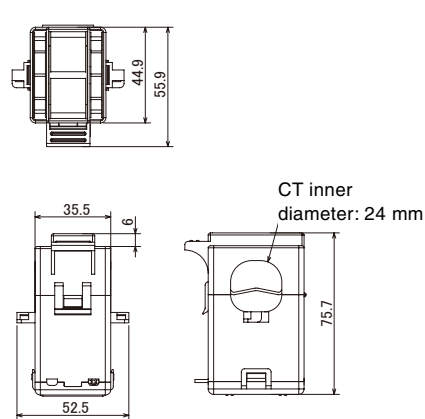

KM20-CTF-400A/KM20-CTF-600A

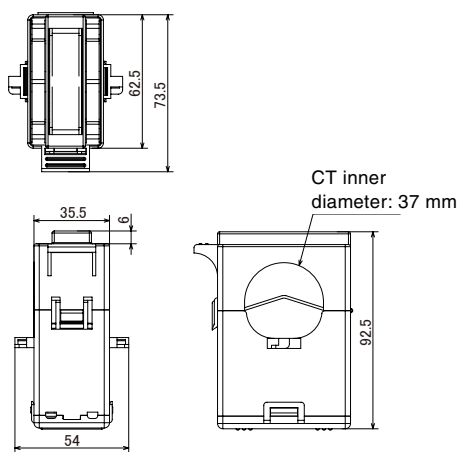

KM20-CTF-CB3 Special CT Cable

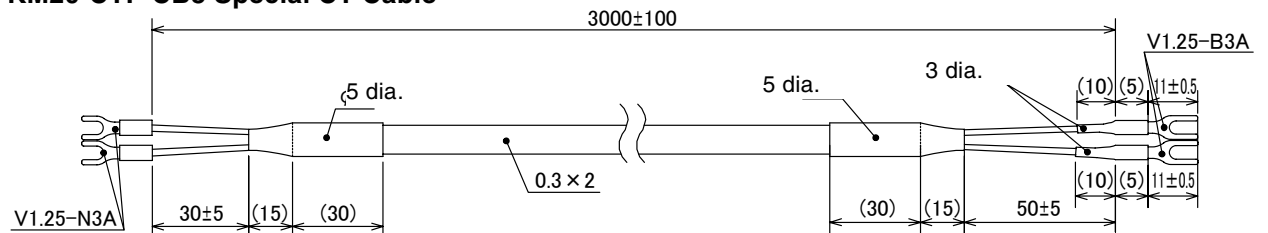

Parameter List

■ Measurement Mode, Basic Level

Parameter	Display No. 1	Display No. 2	Unit
Active Power	-9999 to 99999	kW	kW
Active Power (maximum for the day)	Day of maximum	Hour of maximum	–
Active Power (maximum for the day, flicker)	-9999 to 99999	MA%	kW
Active Power (maximums for 1 to 8 days ago)	Day of maximum	Hour of maximum	–
Active Power (maximums for 1 to 8 days ago, flicker)	-9999 to 99999	-1MA% to -8MA%	kW
Active Power (minimum for the day)	Day of minimum	Hour of minimum	–
Active Power (minimum for the day, flicker)	-9999 to 99999	MEN	kW
Active Power (minimums for 1 to 8 days ago)	Day of minimum	Hour of minimum	–
Active Power (minimums for 1 to 8 days ago, flicker)	-9999 to 99999	-1MEN to -8MEN	kW
Total Power Consumption	0.0 to 9999.9	kWh(MWh)	kWh(MWh)
Total Power Consumption, Ten-digit Display	0000000000 to 9999999999		Wh
Total Power Consumption for Last 13 Months	YY-MM of total power consumption	0M to -13M	–
Total Power Consumption for Last 13 Months (flicker)	0.0 to 9999.9	kWh(MWh)	kWh(MWh)
Total Power Consumption for Last 8 Days	MM/DD of total power consumption	0d to -8d	–
Total Power Consumption for Last 8 Days (Flicker)	0.0 to 9999.9	kWh(MWh)	kWh(MWh)
Total Power Consumption for Last 25 Hours	DD-HH of total power consumption	0H to -25H	–
Total Power Consumption for Last 25 Hours (Flicker)	0.0 to 9999.9	kWh(MWh)	kWh(MWh)
Current 1	0.000 to 99999	A A-R	A
Current 1 (maximum for the day)	Day of maximum	Hour of maximum	–
Current 1 (maximum for the day, flicker)	0.000 to 99999	MA%	A
Current 1 (maximums for 1 to 8 days ago)	Day of maximum	Hour of maximum	–
Current 1 (maximums for 1 to 8 days ago, flicker)	0.000 to 99999	-1MA% to -8MA%	A
Current 1 (minimum for the day)	Day of minimum	Hour of minimum	–
Current 1 (minimum for the day, flicker)	0.000 to 99999	MEN	A
Current 1 (minimums for 1 to 8 days ago)	Day of minimum	Hour of minimum	–
Current 1 (minimums for 1 to 8 days ago, flicker)	0.000 to 99999	-1MEN to -8MEN	A
Current 2	0.000 to 99999	A-N A-S	A
Current 2 (maximum for the day)	Day of maximum	Hour of maximum	–
Current 2 (maximum for the day, flicker)	0.000 to 99999	MA%	A
Current 2 (maximums for 1 to 8 days ago)	Day of maximum	Hour of maximum	–
Current 2 (maximums for 1 to 8 days ago, flicker)	0.000 to 99999	-1MA% to -8MA%	A
Current 2 (minimum for the day)	Day of minimum	Hour of minimum	–
Current 2 (minimum for the day, flicker)	0.000 to 99999	MEN	A
Current 2 (minimums for 1 to 8 days ago)	Day of minimum	Hour of minimum	–
Current 2 (minimums for 1 to 8 days ago, flicker)	0.000 to 99999	-1MEN to -8MEN	A
Current 3	0.000 to 99999	A-S A-t	A
Current 3 (maximum for the day)	Day of maximum	Hour of maximum	–
Current 3 (maximum for the day, flicker)	0.000 to 99999	MA%	A
Current 3 (maximums for 1 to 8 days ago)	Day of maximum	Hour of maximum	–
Current 3 (maximums for 1 to 8 days ago, flicker)	0.000 to 99999	-1MA% to -8MA%	A
Current 3 (minimum for the day)	Day of minimum	Hour of minimum	–
Current 3 (minimum for the day, flicker)	0.000 to 99999	MEN	A
Current 3 (minimums for 1 to 8 days ago)	Day of minimum	Hour of minimum	–
Current 3 (minimums for 1 to 8 days ago, flicker)	0.000 to 99999	-1MEN to -8MEN	A

Parameter	Display No. 1	Display No. 2	Unit
Voltage 1	0.0 to 99999	V V-RN V-R5 V-R	V
Voltage 1 (maximum for the day)	Day of maximum	Hour of maximum	-
Voltage 1 (maximum for the day, flicker)	0.0 to 99999	MA%	V
Voltage 1 (maximums for 1 to 8 days ago)	Day of maximum	Hour of maximum	-
Voltage 1 (maximums for 1 to 8 days ago, flicker)	0.0 to 99999	-1MA% to -8MA%	V
Voltage 1 (minimum for the day)	Day of minimum	Hour of minimum	-
Voltage 1 (minimum for the day, flicker)	0.0 to 99999	M̄CN	V
Voltage 1 (minimums for 1 to 8 days ago)	Day of minimum	Hour of minimum	-
Voltage 1 (minimums for 1 to 8 days ago, flicker)	0.0 to 99999	-1M̄CN to -8M̄CN	V
Voltage 2	0.0 to 99999	V-SN V-SL V-S	V
Voltage 2 (maximum for the day)	Day of maximum	Hour of maximum	-
Voltage 2 (maximum for the day, flicker)	0.0 to 99999	MA%	V
Voltage 2 (maximums for 1 to 8 days ago)	Day of maximum	Hour of maximum	-
Voltage 2 (maximums for 1 to 8 days ago, flicker)	0.0 to 99999	-1MA% to -8MA%	V
Voltage 2 (minimum for the day)	Day of minimum	Hour of minimum	-
Voltage 2 (minimum for the day, flicker)	0.0 to 99999	M̄CN	V
Voltage 2 (minimums for 1 to 8 days ago)	Day of minimum	Hour of minimum	-
Voltage 2 (minimums for 1 to 8 days ago, flicker)	0.0 to 99999	-1M̄CN to -8M̄CN	V
Voltage 3	0.0 to 99999	V-R5 V-ER V-E	V
Voltage 3 (maximum for the day)	Day of maximum	Hour of maximum	-
Voltage 3 (maximum for the day, flicker)	0.0 to 99999	MA%	V
Voltage 3 (maximums for 1 to 8 days ago)	Day of maximum	Hour of maximum	-
Voltage 3 (maximums for 1 to 8 days ago, flicker)	0.0 to 99999	-1MA% to -8MA%	V
Voltage 3 (minimum for the day)	Day of minimum	Hour of minimum	-
Voltage 3 (minimum for the day, flicker)	0.0 to 99999	M̄CN	V
Voltage 3 (minimums for 1 to 8 days ago)	Day of minimum	Hour of minimum	-
Voltage 3 (minimums for 1 to 8 days ago, flicker)	0.0 to 99999	-1M̄CN to -8M̄CN	V
Power Factor	-1.00 to 1.00	PF	-
Power Factor (maximum for the day)	Day of maximum	Hour of maximum	-
Power Factor (maximum for the day, flicker)	-1.00 to 1.00	MA%	-
Power Factor (maximums for 1 to 8 days ago)	Day of maximum	Hour of maximum	-
Power Factor (maximums for 1 to 8 days ago, flicker)	-1.00 to 1.00	-1MA% to -8MA%	-
Power Factor (minimum for the day)	Day of minimum	Hour of minimum	-
Power Factor (minimum for the day, flicker)	-1.00 to 1.00	M̄CN	-
Power Factor (minimums for 1 to 8 days ago)	Day of minimum	Hour of minimum	-
Power Factor (minimums for 1 to 8 days ago, flicker)	-1.00 to 1.00	-1M̄CN to -8M̄CN	-
Reactive Power	-9999 to 99999	kVAR	kvar
Reactive Power (maximum for the day)	Day of maximum	Hour of maximum	-
Reactive Power (maximum for the day, flicker)	-9999 to 99999	MA%	kvar
Reactive Power (minimum for the day)	Day of minimum	Hour of minimum	-
Reactive Power (minimum for the day, flicker)	-9999 to 99999	M̄CN	kvar
Frequency	45.0 to 65.0	Hz	Hz
Calculated CO2	0.0 to 99999	CO ₂ P CO ₂ N̄ CO ₂	kg-CO2
Converted Monetary Cost	0.000 to 99999	Display as set in Currency Setting. Display as set in P+ Currency Setting. Display as set in N̄+ Currency Setting.	-
Calculated HIGH Cost	0.000 to 99999	P.H.C.H N̄.H.C.H	-

Parameter	Display No. 1	Display No. 2	Unit
Calculated MIDDLE Cost	0.000 to 99999	$\mu.M\bar{L}d$ $\bar{n}.M\bar{L}d$	–
Calculated LOW Cost	0.000 to 99999	$\mu.L\bar{o}W$ $\bar{n}.L\bar{o}W$	–
Pulse Converted Value 1	0.000 to 99999	Display as set in Display Unit Setting. Display as set in $\mu+$ Display Unit Setting. Display as set in $\bar{n}+$ Display Unit Setting.	–
Pulse Converted Value 2	0.000 to 99999	Display as set in Display Unit Setting. Display as set in $\mu+$ Display Unit Setting. Display as set in $\bar{n}+$ Display Unit Setting.	–
Time	00-00 to 23-59	01/01 to 12/31	Hour-minutes

■ Measurement Mode, Professional Level

Parameter	Display No. 1	Display No. 2	Unit
Pulse Input Count	0 to 99999	ENL	Pulses
Pulse Input Count (for 1 to 8 days ago)	MM/DD of measurement value	- 1d to -8d	-
Pulse Input Count (for 1 to 8 days ago, flicker)	0 to 99999	ENL	Pulses
Specific Power Consumption	0.000 to 99999	PWH / P	kWh/pulse
Specific Power Consumption (for 1 to 8 days ago)	MM/DD of measurement value	- 1d to -8d	-
Specific Power Consumption (for 1 to 8 days ago, flicker)	0.000 to 99999	PWH / P	kWh/pulse
Pulse Input ON Time	00-00 to 24-00	H-0N	Hour-minutes
Pulse Input ON Time (for 1 to 8 days ago)	MM/DD of measurement value	- 1d to -8d	-
Pulse Input ON Time (for 1 to 8 days ago, flicker)	00-00 to 24-00	H-0N	Hour-minutes
HIGH Total Power Consumption	0.000 to 99999	PWH-H	kWh
HIGH Total Power Consumption (for the day to 8 days ago)	MM/DD of measurement value	0d to -8d	-
HIGH Total Power Consumption (for the day to 8 days ago, flicker)	0.000 to 99999	0.000 to 1.000	kWh
MIDDLE Total Power Consumption	0.000 to 99999	PWH-M	kWh
MIDDLE Total Power Consumption (for the day to 8 days ago)	MM/DD of measurement value	0d to -8d	-
MIDDLE Total Power Consumption (for the day to 8 days ago, flicker)	0.000 to 99999	0.000 to 1.000	kWh
LOW Total Power Consumption	0.000 to 99999	PWH-L	kWh
LOW Total Power Consumption (for the day to 8 days ago)	MM/DD of measurement value	0d to -8d	-
LOW Total Power Consumption (for the day to 8 days ago, flicker)	0.000 to 99999	0.000 to 1.000	kWh
HIGH Total Time	00-00 to 24-00	ETM-H	Hour-minutes
HIGH Total Time (for the day to 8 days ago)	MM/DD of measurement value	0d to -8d	-
HIGH Total Time (for the day to 8 days ago, flicker)	00-00 to 24-00	0.000 to 1.000	Hour-minutes
MIDDLE Total Time	00-00 to 24-00	ETM-M	Hour-minutes
MIDDLE Total Time (for the day to 8 days ago)	MM/DD of measurement value	0d to -8d	-
MIDDLE Total Time (for the day to 8 days ago, flicker)	00-00 to 24-00	0.000 to 1.000	Hour-minutes
LOW Total Time	00-00 to 24-00	ETM-L	Hour-minutes
LOW Total Time (for the day to 8 days ago)	MM/DD of measurement value	0d to -8d	-
LOW Total Time (for the day to 8 days ago, flicker)	00-00 to 24-00	0.000 to 1.000	Hour-minutes
Total Regenerated Energy	0.0 to 9999.9	-kWH -MWH	-kWh -MWh
Total Leading Reactive Power Consumption	0.0 to 9999.9	kVH.d MVH.d	kvar Mvar
Total Lagging Reactive Power Consumption	0.0 to 9999.9	kVH.G MVH.G	kvar Mvar
Total Reactive Power Consumption	0.0 to 9999.9	kVH.R MVH.R	kvar Mvar
Simple Temperature Measurement	- 15.0 to 140.0	TEMP	°C, °F
Product Information	E IFLK	Current software version	-

■ Operation Setting Mode, Basic Level

Parameter	Display No. 1	Display No. 2	Settings	Default setting	Unit
Applicable Circuit	1P2W 1P3W 3P3W 3P4W	00.E4P	1P2W 1P3W 3P3W 3P4W	3P3W	–
Special CT	5A 50A 100A 200A 400A 600A	0 I.C.RG	5 A 50 A 100 A 200 A 400 A 600 A	100A	–
Rated Primary Current	5 to 9999	02.5CL	5 to 9999	5	A
VT Primary Voltage	NONE 220 440 3300 6600 11000 22000 33000	03.V.RG	NONE 220 440 3300 6600 11000 22000 33000	NONE	V
VT Secondary Voltage	110 220	V.RG2	110 220	110	V
Low-cut Current	0.1 to 19.9	04.CUL	0.1 to 19.9	0.5	%
Pulse Output Unit	1 10 100 1k 2k 5k 10k 20k 50k 100k	05.PLS	1 10 100 1 k 2 k 5 k 10 k 20 k 50 k 100 k	100	Wh
Display Refresh Period	OFF 0.5 1.0 2.0 4.0	06.REF	OFF 0.5 1.0 2.0 4.0	1.0	Seconds
Measurement Average Count	OFF 2 4 8 16 32 64 128 256 512 1024	07.AVG	OFF 2 4 8 16 32 64 128 256 512 1024	8	Pulses
Simple Measurement	OFF ON	08.SMP	OFF ON	OFF	–
Fixed Voltage	0.0 to 9999.9	VLE	0.0 to 9999.9	110.0	V
Fixed Power Factor	0.00 to 1.00	PF	0.00 to 1.00	1.00	–
Buzzer	OFF ON	09.bZ	OFF ON	ON	–
CO2 Coefficient	0.000 to 99.999	10.CO2	0.000 to 99.999	0.387	kg-CO ₂ / kWh
Conversion to Monetary Cost Setting	–	11.CHG	–	–	–
Rate Setting	0.000 to 99.999	RRLE	0.000 to 99.999	10.000	–
Currency Setting (Selection)	JPY USD EUR CNY KRW	UNLE	JPY USD EUR CNY KRW	JPY	–

Parameter	Display No. 1	Display No. 2	Settings	Default setting	Unit
Currency Setting (User Specified)	A to Z 0 to 9 / - _(Space)	UNCL	A to Z 0 to 9 / - _(Space)	JPY	-
Pulse Conversion 1 Setting	-	12.EV1	-	-	-
Pulse Conversion Target 1	C-T.D C-1.D C-2.D C-T.A C-1.A C-2.A	LRG	C-T.D C-1.D C-2.D C-T.A C-1.A C-2.A	C-1.D	-
Coefficient Setting 1	0000 to 9999	SLP	0000 to 9999	0001	-
Decimal Point Position Setting 1	0000 000.0 00.00 0.000	dP	0000 000.0 00.00 0.000	0000	-
Display Unit Setting 1	A to Z 0 to 9 / - _(Space)	UNCL	A to Z 0 to 9 / - _(Space)	M3-1	-
Pulse Conversion 2 Setting	-	13.EV2	-	-	-
Pulse Conversion Target 2	C-T.D C-1.D C-2.D C-T.A C-1.A C-2.A	LRG	C-T.D C-1.D C-2.D C-T.A C-1.A C-2.A	C-2.D	-
Coefficient Setting 2	0000 to 9999	SLP	0000 to 9999	0001	-
Decimal Point Position Setting 2	0000 000.0 00.00 0.000	dP	0000 000.0 00.00 0.000	0000	-
Display Unit Setting 2	A to Z 0 to 9 / - _(Space)	UNCL	A to Z 0 to 9 / - _(Space)	M3-2	-
Time Setting: Year	2010 to 2099	14.ECM	2010 to 2099	2010	Year
Time Setting: Month/Day	01, 01 to 2, 31	14.ECM	01, 01 to 12, 31	01/01	Month/day
Time Setting: Hour/Minutes	00-00 to 23-59	14.ECM	00-00 to 23-59	00-00	Hour-minutes
Initialize	SEt MAX MIN INTEG M.PRO LOG ALL	15.ENL	SET MAX MIN INTEG M.PRO LOG ALL	SEt	-

■ Operation Setting Mode, Professional Level

Parameter	Display No. 1	Display No. 2	Settings	Default setting	Unit
Event Input Setting	<i>P.CSP</i> <i>H-ON</i> <i>3-ST</i>	<i>30.ECS</i>	P.CSP H-ON 3-ST	<i>P.CSP</i>	–
Event Input 1 NPN/PNP Input Mode Setting	<i>NPN</i> <i>PNP</i>	<i>31.PN1</i>	NPN PNP	<i>PNP</i>	–
Event Input 2 NPN/PNP Input Mode Setting	<i>NPN</i> <i>PNP</i>	<i>32.PN2</i>	NPN PNP	<i>PNP</i>	–
Event Input 1 NO/NC Input Mode Setting	<i>N-O</i> <i>N-C</i>	<i>33.CN1</i>	N-O N-C	<i>N-O</i>	–
Event Input 2 NO/NC Input Mode Setting	<i>N-O</i> <i>N-C</i>	<i>34.CN2</i>	N-O N-C	<i>N-O</i>	–
Measurement Start Time	<i>00-00</i> to <i>23-59</i>	<i>35.ETC</i>	00-00 to 23-59	<i>00-00</i>	Hour-minutes
Measurement End Time	<i>00-01</i> to <i>24-00</i>	<i>36.ETC</i>	00-01 to 24-00	<i>24-00</i>	Hour-minutes
Three-state Target	<i>PWR</i> <i>A</i> <i>V</i> <i>NONE</i>	<i>40.ETG</i>	PWR A V NONE	<i>NONE</i>	–
Three-state HIGH Threshold (monitor status)	<i>0.1</i> to <i>150.0</i>	<i>41.H.EH</i>	0.1 to 150.0	<i>50.0</i>	%
Three-state HIGH Threshold (setting status)		<i>0.00k</i> to <i>9999M</i> <i>0.00A</i> to <i>999kA</i> <i>0.00V</i> to <i>999kV</i> <i>0.00</i>			
Three-state LOW Threshold (monitor status)	<i>0.0</i> to <i>149.9</i>	<i>42.L.EH</i>	0.0 to 149.9	<i>10.0</i>	%
Three-state LOW Threshold (setting status)		<i>0.00k</i> to <i>9999M</i> <i>0.00A</i> to <i>999kA</i> <i>0.00V</i> to <i>999kV</i> <i>0.00</i>			
Three-state Hysteresis (monitor status)	<i>0.0</i> to <i>19.9</i>	<i>43.HYS</i>	0.0 to 19.9	<i>0.0</i>	%
Three-state Hysteresis (setting status)		<i>0.00k</i> to <i>9999M</i> <i>0.00A</i> to <i>999kA</i> <i>0.00V</i> to <i>999kV</i> <i>0.00</i>			
Three-state Color Setting	–	<i>44.COL</i>	–	–	–
Three-state HIGH Color Settings	<i>GREEN</i> <i>ORANG</i> <i>RED</i>	<i>HIGH</i>	GREEN ORANG RED	<i>GREEN</i>	–
Three-state MIDDLE Color Setting	<i>GREEN</i> <i>ORANG</i> <i>RED</i>	<i>MIDDLE</i>	GREEN ORANG RED	<i>ORANG</i>	–
Three-state LOW Color Setting	<i>GREEN</i> <i>ORANG</i> <i>RED</i>	<i>LOW</i>	GREEN ORANG RED	<i>RED</i>	–
Output Terminal 1 Function Setting	<i>OFF</i> <i>P.OUT</i> <i>ALARM</i>	<i>50.O1</i>	OFF P.OUT ALARM	<i>P.OUT</i>	–
Active Power Alarm Output Setting 1	<i>OFF</i> <i>ON</i>	<i>P.AL</i>	OFF ON	<i>OFF</i>	–
Regenerative Power Alarm Output Setting	<i>OFF</i> <i>ON</i>	<i>R.AL</i>	OFF ON	<i>OFF</i>	–

Parameter	Display No. 1	Display No. 2	Settings	Default setting	Unit
Current Alarm Output Setting 1	OFF ON	R.RL	OFF ON	OFF	–
Voltage Alarm Output Setting 1	OFF ON	V.RL	OFF ON	OFF	–
Power Factor Alarm Output Setting 1	OFF ON	PF.R	OFF ON	OFF	–
Reactive Power Alarm Output Setting 1	OFF ON	Q.RL	OFF ON	OFF	–
Output Terminal 2 Function Setting	OFF P.OUT RLARM	51.02	OFF P.OUT ALARM	RLARM	–
Active Power Alarm Output Setting 2	OFF ON	P.RL	OFF ON	OFF	–
Regenerative Power Alarm Output Setting 2	OFF ON	R.RL	OFF ON	OFF	–
Current Alarm Output Setting 2	OFF ON	R.RL	OFF ON	OFF	–
Voltage Alarm Output Setting 2	OFF ON	V.RL	OFF ON	OFF	–
Power Factor Alarm Output Setting 2	OFF ON	PF.R	OFF ON	OFF	–
Reactive Power Alarm Output Setting 2	OFF ON	Q.RL	OFF ON	OFF	–
Active Power Alarm Output	–	52.P.RL	–	–	–
Active Power Alarm Output Upper Limit Threshold	0.0 to 150.0	AV.LH 0.00k to 9999M	0.0 to 150.0	80.0	%
Active Power Alarm Output Lower Limit Threshold	0.0 to 150.0	UN.LH 0.00k to 9999M	0.0 to 150.0	0.00	%
Active Power Alarm Output Hysteresis	0.0 to 19.9	RL.HYS 0.00k to 9999M	0.0 to 19.9	5.0	%
Active Power Alarm Output OFF Delay	0.0 to 99.9	oF.dLY	0.0 to 99.9	3.0	Seconds
Active Power Alarm Output ON Delay	0.0 to 99.9	oN.dLY	0.0 to 99.9	0.0	Seconds
Regenerative Power Alarm Output	–	53.R.RL	–	–	–
Regenerative Power Alarm Output Upper Limit Threshold	0.0 to 150.0	oV.LH 0.00k to 9999M	0.0 to 150.0	80.0	%
Regenerative Power Alarm Output Lower Limit Threshold	0.0 to 150.0	UN.LH 0.00k to 9999M	0.0 to 150.0	0.00	%
Regenerative Power Alarm Output Hysteresis	0.0 to 19.9	RL.HYS 0.00k to 9999M	0.0 to 19.9	5.0	%
Regenerative Power Alarm Output OFF Delay	0.0 to 99.9	oF.dLY	0.0 to 99.9	3.0	Seconds
Regenerative Power Alarm Output ON Delay	0.0 to 99.9	oN.dLY	0.0 to 99.9	0.0	Seconds
Current Alarm Output	–	54.R.RL	–	–	–
Current Alarm Output Upper Limit Threshold	0.0 to 120.0	oV.LH 0.00k to 999kR	0.0 to 120.0	110.0	%

Parameter	Display No. 1	Display No. 2	Settings	Default setting	Unit
Current Alarm Output Lower Limit Threshold	0.0 to 120.0	UN.LH 0.00A to 999kA	0.0 to 120.0	0.00	%
Current Alarm Output Hysteresis	0.0 to 19.9	RL.HYS 0.00A to 999kA	0.0 to 19.9	5.0	%
Current Alarm Output OFF Delay	0.0 to 99.9	oF.dLY	0.0 to 99.9	3.0	Seconds
Current Alarm Output ON Delay	0.0 to 99.9	oN.dLY	0.0 to 99.9	0.0	Seconds
Voltage Alarm Output	–	55.V.AL	–	–	–
Voltage Alarm Output Upper Limit Threshold	0.0 to 120.0	oV.LH 0.00V to 999kV	0.0 to 120.0	110.0	%
Voltage Alarm Output Lower Limit Threshold	0.0 to 120.0	UN.LH 0.00V to 999kV	0.0 to 120.0	0.00	%
Voltage Alarm Output Hysteresis	0.0 to 19.9	RL.HYS 0.00V to 999kV	0.0 to 19.9	5.0	%
Voltage Alarm Output OFF Delay	0.0 to 99.9	oF.dLY	0.0 to 99.9	3.0	Seconds
Voltage Alarm Output ON Delay	0.0 to 99.9	oN.dLY	0.0 to 99.9	0.0	Seconds
Power Factor Alarm Output	–	56.PF.A	–	–	–
Power Factor Alarm Output Upper Limit Threshold	0 to 100	oV.LH 0.00 to 1.00	0 to 100	100	%
Power Factor Alarm Output Lower Limit Threshold	0 to 100	UN.LH 0.00 to 1.00	0 to 100	0	%
Power Factor Alarm Output Hysteresis	0 to 19	RL.HYS 0.00 to 1.00	0 to 19	5	%
Power Factor Alarm Output OFF Delay	0.0 to 99.9	oF.dLY	0.0 to 99.9	3.0	Seconds
Power Factor Alarm Output ON Delay	0.0 to 99.9	oN.dLY	0.0 to 99.9	0.0	Seconds
Reactive Power Alarm Output	0 to 100	57.Q.AL	–	–	–
Reactive Power Alarm Output Upper Limit Threshold	0.0 to 150.0	oV.LH 0.00k to 9999M	0.0 to 150.0	80.0	%
Reactive Power Alarm Output Lower Limit Threshold	0.0 to 150.0	UN.LH 0.00k to 9999M	0.0 to 150.0	0.00	%
Reactive Power Alarm Output Hysteresis	0.0 to 19.9	RL.HYS 0.00k to 9999M	0.0 to 19.9	5.0	%
Reactive Power Alarm Output OFF Delay	0.0 to 99.9	oF.dLY	0.0 to 99.9	3.0	Seconds
Reactive Power Alarm Output ON Delay	0.0 to 99.9	oN.dLY	0.0 to 99.9	0.0	Seconds
Consumed Power Save Selection	-W VAR.D VAR.G VAR.A	50.C.SL	-W VAR.D VAR.G VAR.A	-W	–
Automatic Rotation	oFF oN	51.R.t.t	OFF ON	oFF	–
Transition Time	1 to 99	R.t.t.M	1 to 99	3	Seconds
Measurement Parameter Display Selection	–	52.d.SL	–	–	–

Parameter	Display No. 1	Display No. 2	Settings	Default setting	Unit
Active Power Display	OFF ON	W	OFF ON	ON	-
Total Power Consumption Display	OFF ON	WH	OFF ON	ON	-
Current 1 Display	OFF ON	R-1	OFF ON	ON	-
Current 2 Display	OFF ON	R-2	OFF ON	ON	-
Current 3 Display	OFF ON	R-3	OFF ON	ON	-
Voltage 1 Display	OFF ON	V-1	OFF ON	ON	-
Voltage 2 Display	OFF ON	V-2	OFF ON	ON	-
Voltage 3 Display	OFF ON	V-3	OFF ON	ON	-
Power Factor Display	OFF ON	PF	OFF ON	ON	-
Reactive Power Display	OFF ON	VAR	OFF ON	ON	-
Frequency Display	OFF ON	Hz	OFF ON	ON	-
Calculated CO ₂ Display	OFF ON	[CO ₂]	OFF ON	ON	-
Converted Monetary Cost Display	OFF ON	[HG]	OFF ON	OFF	-
Pulse Converted Value 1 Display	OFF ON	[NV 1]	OFF ON	OFF	-
Pulse Converted Value 2 Display	OFF ON	[NV 2]	OFF ON	OFF	-
Time Display	OFF ON	[ME]	OFF ON	ON	-
Pulse Input Count Display	OFF ON	[Nt]	OFF ON	ON	-
Specific Power Consumption Display	OFF ON	WH/P	OFF ON	ON	-
Pulse Input ON Time Display	OFF ON	H-ON	OFF ON	ON	-
HIGH Total Power Consumption Display	OFF ON	WH-H	OFF ON	ON	-
MIDDLE Total Power Consumption Display	OFF ON	WH-M	OFF ON	ON	-
LOW Total Power Consumption Display	OFF ON	WH-L	OFF ON	ON	-
HIGH Total Time Display	OFF ON	[M-H]	OFF ON	ON	-
MIDDLE Total Time Display	OFF ON	[M-M]	OFF ON	ON	-
LOW Total Time Display	OFF ON	[M-L]	OFF ON	ON	-
Total Regenerated Energy	OFF ON	-WH	OFF ON	OFF	-

Parameter	Display No. 1	Display No. 2	Settings	Default setting	Unit
Total Leading Reactive Power	OFF ON	VH.d	OFF ON	OFF	-
Total Lagging Reactive Power	OFF ON	VH.G	OFF ON	OFF	-
Total Reactive Power	OFF ON	VH.R	OFF ON	OFF	-
Simple Temperature Display	OFF ON	TEMP	OFF ON	OFF	-
Product Information Display	OFF ON	PRdEt	OFF ON	ON	-
Display ON Time	0 to 99	SDSP	0 to 99	0	Minutes
Incorrect Voltage Wiring Detection	OFF ON	EV-E	OFF ON	ON	-
Temperature Unit	C F	SD-U	C F	C	C F
Temperature Compensation	-50.0 to 50.0	TRd	-50.0 to 50.0	0.0	-

■ Communications Setting Mode

Parameter	Display No. 1	Display No. 2	Settings	Default setting	Unit
Protocol	<i>ComPF</i> <i>Modb</i>	<i>ComPSL</i>	CompoWay/F Modbus	<i>ComPF</i>	–
Unit Number	<i>00 to 99</i> <i>01 to 99</i>	<i>Unit No.</i>	CompoWay/F: 0 to 99 Modbus: 1 to 99	<i>1</i>	–
Baud Rate	<i>1.2k</i> <i>2.4k</i> <i>4.8k</i> <i>9.6k</i> <i>19.2k</i> <i>38.4k</i>	<i>ComBPS</i>	1.2k 2.4k 4.8k 9.6k 19.2k 38.4k	<i>9.6k</i>	bps
Data Length	<i>7</i> <i>8</i>	<i>ComLEN</i>	7 8	<i>7</i> <i>8 (Modbus)*1</i>	bit
Stop Bits*2	<i>1</i> <i>2</i>	<i>ComStBt</i>	1 2	<i>2</i>	bit
Vertical Parity	<i>NONE</i> <i>odd</i> <i>EVEN</i>	<i>ComPRt</i>	NONE ODD EVEN	<i>EVEN</i>	–
Transmission Wait Time	<i>0 to 99</i>	<i>ComStW</i>	0 to 99	<i>20</i>	ms

*1. The data length will be 8 bits if Modbus is set as the protocol.

*2. If Modbus is set as the protocol, the number of stop bits will be set automatically according to the vertical parity. If the Vertical Parity parameter is set to NONE, there will be 2 stop bits. If it is set to ODD or EVEN parity, there will be 1 stop bit.

■ Protection Setting Mode

Parameter	Display No. 1	Display No. 2	Settings	Default setting	Unit
Protection Setting	0 1 2	PRTECT	0: All operations enabled. 1: Changing settings is prohibited (moving to the Setting Modes is possible). 2: Changing settings and moving to Professional Level is prohibited (moving to the Setting Modes is possible).	0	–

Parameter List

State Transitions

Power ON * Example for Three-phase, Three-wire Power
 For single-phase, two-wire power, Current 2, Current 3, Voltage 2, and Voltage 3 are not displayed.
 For single-phase, three-wire power, display No. 2 is different for the current and voltage (e.g., $I-5 \rightarrow R-N$).
 For single-phase, four-wire power, display No. 2 is different for the voltage (e.g., $V-5L \rightarrow V-5$).

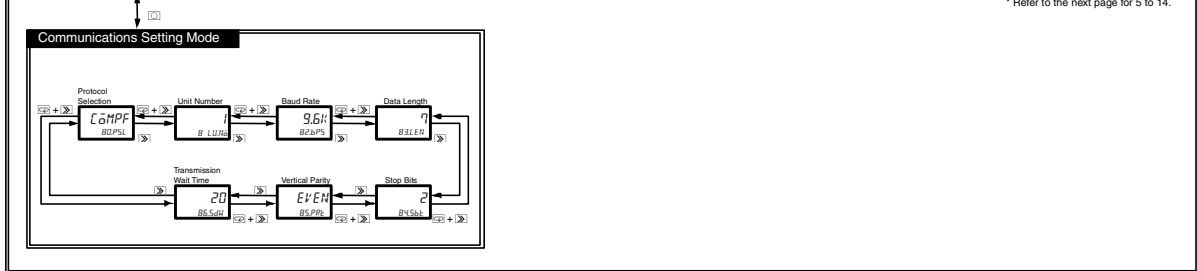
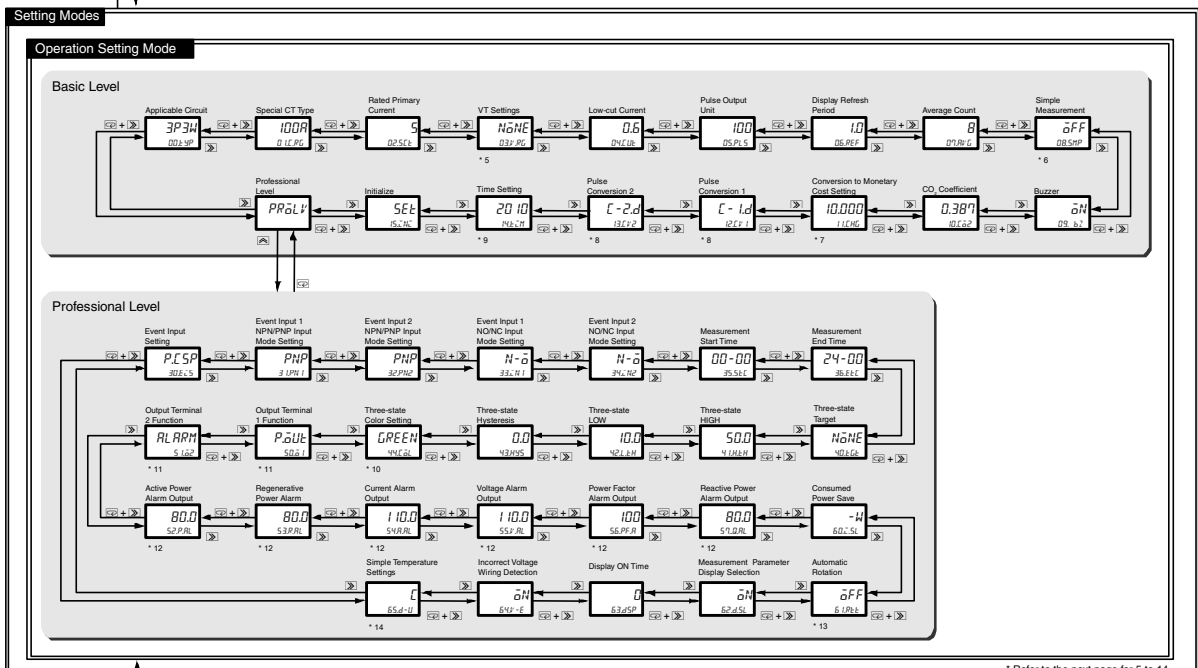
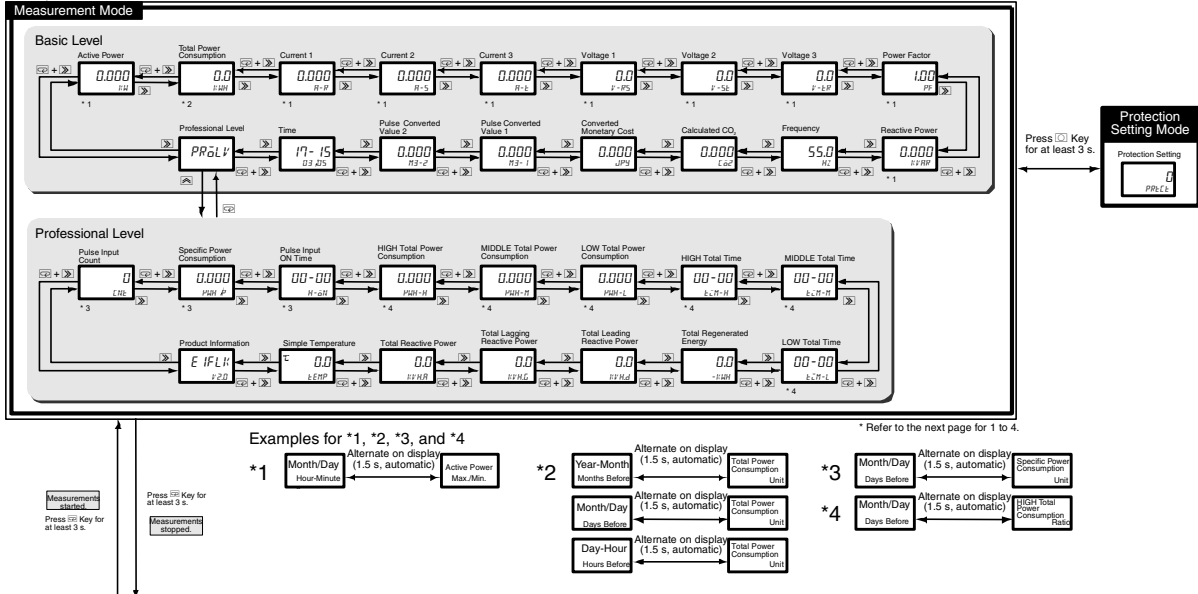

***1 Active Power**

- Example for Active Power
- The maximum/minimum values and the times they were recorded are displayed alternately for each day.
- For the reactive power, only the maximum and minimum values for the day are displayed.

***2 Total Power Consumption**

- For the display of the monthly consumption, the year and month when the total power consumption was recorded and the total power consumption are displayed alternately on display No. 1 and the number of months before the present month and the unit are displayed alternately on display No. 2.
- For the display of the daily consumption, the month and day when the total power consumption was recorded and the total power consumption are displayed alternately on display No. 1 and the number of days before the present day and the unit are displayed alternately on display No. 2.
- For the display of the hourly consumption, the day and hour when the total power consumption was recorded and the total power consumption are displayed alternately on display No. 1 and the number of hours before the present day and the unit are displayed alternately on display No. 2.

***3 Specific Power Consumption**

- Example for Specific Power Consumption
- The month and day when the specific power consumption was recorded and the specific power consumption are displayed alternately on display No. 1 and the number of days before the current day and the unit are displayed alternately on display No. 2.

***4 HIGH Total Power Consumption**

- Example for HIGH Total Power Consumption
- The month and day when the HIGH total power consumption was recorded and the HIGH total power consumption are displayed alternately on display No. 1 and the number of days before the current day and the ratio are displayed alternately on display No. 2.

***5 VT Settings**

- If something other than H5HE is selected, set the primary voltage and secondary voltage of the VT consecutively.

***7 Conversion to Monetary Cost Setting**

- Set the rate and currency consecutively.
- The currency unit can be set to a user-specified value after a currency is selected.

***6 Simple Measurement**

- When the simple measurement function is set to ON, set the fixed voltage and fixed power factor consecutively.

***8 Pulse Conversion 1 Setting**

- Example for Pulse Conversion 1 Setting
- Set the pulse conversion target, coefficient, decimal point position, and display unit consecutively.

***9 Time Setting**

- The year, month/day, and hour/minutes are set in order.

***11 Output Terminal 1 Function Setting**

- Example for Output Terminal 1 Function Settings
- When RL.RPT is selected, set the ON/OFF status of the alarms.

***10 Three-state Color Setting**

- Set the backlight colors for HIGH, MIDDLE, and LOW status consecutively.

***12 Active Power Alarm Output**

- Example for Active Power Alarm Output
- Set the upper and lower limit thresholds, hysteresis, and OFF/ON delays consecutively.
- Display No. 2 changes from the threshold value to the calculated operating value 1.5 seconds after the upper and lower limit thresholds and hysteresis are changed.

***13 Automatic Rotation Setting**

- When automatic rotation is set to ON, set the transition time.

***14 Temperature Setting**

- Set the temperature unit and temperature compensation value

input error	5-2
inputs	
event inputs	1-4
installation method.....	2-3
instantaneous power.....	3-7
instantaneous power alarm output	4-18
instantaneous power alarm output hysteresis	
.....	4-18
instantaneous power alarm output OFF delay	
.....	4-18
instantaneous power alarm output threshold	
.....	4-18
insulation block diagram	1-20

K

Key.....	1-5
key operations.....	1-19
M Key	1-19
M+O Keys.....	1-19
M+S Keys.....	1-19
M+U Keys.....	1-19
O Key	1-19
S Key.....	1-19
U Key.....	1-19

L

LCD backlight	1-6
logging measurement data.....	1-4
LOW total power consumption.....	4-16
LOW total time	4-17
low-cut current	3-18

M

main features	1-2
main functions.....	1-3
measurement end time.....	4-6
measurement mode.....	1-9, 1-12
Basic Level.....	1-12
Professional Level.....	1-12
Professional Level	
specific power consumption	4-9

Measurement Mode

Basic Level

calculated CO2	3-27
currents.....	3-9
frequency	3-14
power factor	3-13
reactive power.....	3-14
time	3-29
total power consumption.....	3-8
voltages.....	3-11

Professional Level

product information	4-23
pulse input count.....	4-8
pulse input ON time	4-10
three-state total power consumption ..	4-16
three-state total time	4-17
measurement start time	4-6
measuring a high current	3-15
measuring a high voltage.....	3-17
MIDDLE total power consumption	4-16
MIDDLE total time	4-17
Modbus	1-4, 2-9, 3-35
mode configuration	1-8
measurement mode	1-9
Protect Setting Mode.....	1-14
Setting Modes	1-15
MODE(M)Key.....	1-19
model number legend	1-7
Mounting Bracket	2-3, A-5

N

NPN/PNP input mode settings.....	4-4
----------------------------------	-----

O

operation indicators.....	1-5
Key.....	1-5
OUT1	1-5
OUT2.....	1-5
STOP	1-5
Operation Mode Setting	
Professional Level	

NO/NC input mode settings	4-5
Operation Setting Level	
Basic Level	
low-cut current.....	3-18
Operation Setting Mode.....	1-15, 1-17
Basic Level.....	1-17
applicable circuit.....	3-5
average count.....	3-21
buzzer.....	3-25
CO2 coefficient.....	3-26
display refresh period.....	3-20
initialize.....	3-34
instantaneous power	3-7
pulse output unit.....	3-19
rated primary current.....	3-15
simple measurement.....	3-23
Special CT type.....	3-6
time setting.....	3-28
VT primary voltage	3-17
Professional Level.....	1-17
event input setting	4-3
instantaneous power alarm output.....	4-19
measurement start time/measurement end time	4-6
NPN/PNP input mode settings	4-4
three-state hysteresis	4-15
three-state LOW threshold	4-14
three-state target.....	4-11
Operation Setting Mode	
Professional Level	
three-state HIGH threshold	4-14
option ratings and performance.....	A-4
OUT1	1-5
OUT2	1-5
output function	
alarm output.....	1-3
three-state output.....	1-3
total power consumption pulse output	1-3
output functions	1-3

P

panel cutout dimensions	2-2
parameter list	A-7, A-14
Communications Setting Mode	A-12
Measurement Mode, Basic Level	A-7
Measurement Mode, Professional Level	A-9
Operation Setting Mode, Basic Level	A-10
Operation Setting Mode, Professional Level	A-11
Protection Setting Mode.....	A-13
part names and functions	1-5
power factor	3-13
Power Monitor performance.....	A-3
Power Monitor ratings	A-2
product information	4-23
product specifications	A-2
option ratings and performance	A-4
Power Monitor performance	A-3
Power Monitor ratings.....	A-2
protection setting.....	1-14, 4-24
Protection Setting Mode	1-14, 4-24
protocol selection.....	3-35
pulse input count.....	4-8
pulse input ON time	4-10
pulse output unit.....	3-19

R

rated primary current	3-15
reactive power.....	3-14
regenerative power	3-7
RS-485.....	1-7, 2-9

S

setting example	3-4
Setting Modes.....	1-15
Communications Setting Mode	1-15
Operation Setting Mode	1-15
SHIFT (S) Key.....	1-19
simple measurement	3-23
single-phase, two-wire	2-6
single-phase, three-wire.....	2-5, 2-6, 2-7, 2-8, 3-17

single-phase, two-wire	2-5, 2-7, 2-8, 3-17
special CT	2-4
Special CT	3-6
specific power consumption	4-9
STOP	1-5
stop bits	3-39

T

terminal arrangement	2-5
Terminal Cover.....	2-3, A-5
three-phase, four-wire...	2-5, 2-6, 2-7, 2-8, 3-17
three-phase, three-wire	2-5, 2-6, 2-7, 2-8, 3-17
three-state HIGH threshold.....	4-13
three-state hysteresis	4-15
three-state LOW threshold	4-13
three-state output	1-3
three-state target	4-11
time	3-29
time corrections	3-32
time setting	3-28
total power consumption.....	3-8
total power consumption pulse output	1-3, 2-10, 3-19
transmission wait time	3-41
troubleshooting	5-3
turning ON the power	3-3

U

unit number.....	3-36
UP (U) Key.....	1-19

using terminals.....	2-5
----------------------	-----

V

vertical parity.....	3-40
voltages.....	3-11
VT primary voltage.....	3-17

W

Waterproof Packing.....	2-3, A-5
wiring.....	2-7
alarm output	2-13
communications	2-9
CT inputs	2-8
event inputs	2-14
measurement voltage input	2-7
power supply	2-7
three-state output	2-11
total power consumption pulse output....	2-10
wiring diagram.....	2-5
wiring methods and CT mounting locations.	2-6
single-phase, three-wire	2-6
three-phase, four-wire, delta wiring.....	2-6
three-phase, four-wire, star (Y) wiring.....	2-6
three-phase, four-wire, V wiring.....	2-6
three-phase, three-wire, delta wiring.....	2-6
three-phase, three-wire, star (Y) wiring....	2-6
three-phase, three-wire, V wiring	2-6
wiring methos and CT mounting locations	
single-phase, two-wire.....	2-6
wiring precautions	2-7

OMRON Corporation Industrial Automation Company
Tokyo, JAPAN

Contact: www.ia.omron.com

Regional Headquarters

OMRON EUROPE B.V.

Wegalaan 67-69-2132 JD Hoofddorp
The Netherlands
Tel: (31)2356-81-300/Fax: (31)2356-81-388

OMRON ELECTRONICS LLC

One Commerce Drive Schaumburg,
IL 60173-5302 U.S.A.
Tel: (1) 847-843-7900/Fax: (1) 847-843-7787

OMRON ASIA PACIFIC PTE. LTD.

No. 438A Alexandra Road # 05-05/08 (Lobby 2),
Alexandra Technopark,
Singapore 119967
Tel: (65) 6835-3011/Fax: (65) 6835-2711

OMRON (CHINA) CO., LTD.

Room 2211, Bank of China Tower,
200 Yin Cheng Zhong Road,
PuDong New Area, Shanghai, 200120, China
Tel: (86) 21-5037-2222/Fax: (86) 21-5037-2200

Authorized Distributor:

© OMRON Corporation 2009 All Rights Reserved.
In the interest of product improvement,
specifications are subject to change without notice.

Cat. No. N164-E1-01

Printed in Japan