

Servo System 1S-series

Startup Guide

R88M-1L[]/-1M[] (AC Servomotors)
R88D-1SN[]-ECT (AC Servo Drives)



Startup
Guide

NOTE

All rights reserved. No part of this publication may be reproduced, stored in a retrieval system, or transmitted, in any form, or by any means, mechanical, photocopying, recording, or otherwise, without the prior written permission of OMRON.

No patent liability is assumed with respect to the use of the information contained herein. Moreover, because OMRON is constantly striving to improve its high-quality products, the information contained in this manual is subject to change without notice. Every precaution has been taken in the preparation of this manual. Nevertheless, OMRON assumes no responsibility for errors or omissions. Neither is any liability assumed for damages resulting from the use of the information contained in this publication.

Introduction

The Servo System 1S-Series Startup Guide (hereinafter, may be referred to as "this Guide") describes the procedures for installation and setup of a 1S Servo Drive, where an NJ/NX-series CPU Unit is used in combination with 1S-series AC Servomotors/Servo Drives and NX-series Safety Unit, by using the Sysmac Studio. A simple installation model is used for the discussion. You can perform the procedures that are presented in this Guide to quickly gain a basic understanding of a 1S-series AC Servomotors/Servo Drives.

This Guide does not contain safety information and other details that are required for actual use. Thoroughly read and understand the manuals for all of the devices that are used in this Guide to ensure that the system is used safely. Review the entire contents of these materials, including all safety precautions, precautions for safe use, and precautions for correct use.

Intended Audience

This Guide is intended for the following personnel.

- Personnel in charge of introducing FA systems
- Personnel in charge of designing FA systems

The personnel must also have the following knowledge.

- Knowledge of electrical systems (an electrical engineer or the equivalent)
- Knowledge of NJ/NX-series CPU Units
- Knowledge of NX-series Safety Units
- Knowledge of Servomotors/Drives
- Knowledge of operation procedure of Sysmac Studio

Applicable Products

This Guide covers the following products.

- CPU Units of NJ/NX-series Machine Automation Controllers
- Automation Software Sysmac Studio
- 1S-series Servomotors/Servo Drives
- NX-series EtherCAT Coupler unit
- NX-series Safety controller

Special Information

The icons that are used in this Guide are described below.



Precautions for Correct Use

Precautions on what to do and what not to do to ensure proper operation and performance.



Additional Information

Additional information to read as required.

This information is provided to increase understanding or make operation easier.

Terms and Conditions Agreement

Warranties

(a) Exclusive Warranty. Omron's exclusive warranty is that the Products will be free from defects in materials and workmanship for a period of twelve months from the date of sale by Omron (or such other period expressed in writing by Omron). Omron disclaims all other warranties, express or implied.

(b) Limitations. OMRON MAKES NO WARRANTY OR REPRESENTATION, EXPRESS OR IMPLIED, ABOUT NON-INFRINGEMENT, MERCHANTABILITY OR FITNESS FOR A PARTICULAR PURPOSE OF THE PRODUCTS. BUYER ACKNOWLEDGES THAT IT ALONE HAS DETERMINED THAT THE PRODUCTS WILL SUITABLY MEET THE REQUIREMENTS OF THEIR INTENDED USE.

Omron further disclaims all warranties and responsibility of any type for claims or expenses based on infringement by the Products or otherwise of any intellectual property right. (c) Buyer Remedy.

Omron's sole obligation hereunder shall be, at Omron's election, to (i) replace (in the form originally shipped with Buyer responsible for labor charges for removal or replacement thereof) the non-complying Product, (ii) repair the non-complying Product, or (iii) repay or credit Buyer an amount equal to the purchase price of the non-complying Product; provided that in no event shall Omron be responsible for warranty, repair, indemnity or any other claims or expenses regarding the Products unless Omron's analysis confirms that the Products were properly handled, stored, installed and maintained and not subject to contamination, abuse, misuse or inappropriate modification. Return of any Products by Buyer must be approved in writing by Omron before shipment. Omron Companies shall not be liable for the suitability or unsuitability or the results from the use of Products in combination with any electrical or electronic components, circuits, system assemblies or any other materials or substances or environments. Any advice, recommendations or information given orally or in writing, are not to be construed as an amendment or addition to the above warranty.

See <http://www.omron.com/global/> or contact your Omron representative for published information.

Limitation on Liability; Etc

OMRON COMPANIES SHALL NOT BE LIABLE FOR SPECIAL, INDIRECT, INCIDENTAL, OR CONSEQUENTIAL DAMAGES, LOSS OF PROFITS OR PRODUCTION OR COMMERCIAL LOSS IN ANY WAY CONNECTED WITH THE PRODUCTS, WHETHER SUCH CLAIM IS BASED IN CONTRACT, WARRANTY, NEGLIGENCE OR STRICT LIABILITY.

Further, in no event shall liability of Omron Companies exceed the individual price of the Product on which liability is asserted.

Suitability of Use

Omron Companies shall not be responsible for conformity with any standards, codes or regulations which apply to the combination of the Product in the Buyer's application or use of the Product. At Buyer's request, Omron will provide applicable third party certification

documents identifying ratings and limitations of use which apply to the Product. This information by itself is not sufficient for a complete determination of the suitability of the Product in combination with the end product, machine, system, or other application or use. Buyer shall be solely responsible for determining appropriateness of the particular Product with respect to Buyer's application, product or system. Buyer shall take application responsibility in all cases. NEVER USE THE PRODUCT FOR AN APPLICATION INVOLVING SERIOUS RISK TO LIFE OR PROPERTY WITHOUT ENSURING THAT THE SYSTEM AS A WHOLE HAS BEEN DESIGNED TO ADDRESS THE RISKS, AND THAT THE OMRON PRODUCT(S) IS PROPERLY RATED AND INSTALLED FOR THE INTENDED USE WITHIN THE OVERALL EQUIPMENT OR SYSTEM.

Programmable Products

Omron Companies shall not be responsible for the user's programming of a programmable Product, or any consequence thereof.

Performance Data

Data presented in Omron Company websites, catalogs and other materials is provided as a guide for the user in determining suitability and does not constitute a warranty. It may represent the result of Omron's test conditions, and the user must correlate it to actual application requirements. Actual performance is subject to the Omron's Warranty and Limitations of Liability

Change in Specifications

Product specifications and accessories may be changed at any time based on improvements and other reasons. It is our practice to change part numbers when published ratings or features are changed, or when significant construction changes are made. However, some specifications of the Product may be changed without any notice. When in doubt, special part numbers may be assigned to fix or establish key specifications for your application. Please consult with your Omron's representative at any time to confirm actual specifications of purchased Product.

Errors and Omissions

Information presented by Omron Companies has been checked and is believed to be accurate; however, no responsibility is assumed for clerical, typographical or proofreading errors or omissions.

Precautions

- When building a system, check the specifications for all devices and equipment that will make up the system and make sure that the OMRON products are used well within their rated specifications and performances. Safety measures, such as safety circuits, must be implemented in order to minimize the risks in the event of a malfunction.
- Thoroughly read and understand the manuals for all devices and equipment that will make up the system to ensure that the system is used safely. Review the entire contents of these manuals, including all safety precautions, precautions for safe use, and precautions for correct use.
- Confirm all regulations, standards, and restrictions that the system must adhere to.
- Check the user program for proper execution before you use it for actual operation.

Trademarks

- Sysmac and SYSMAC are trademarks or registered trademarks of OMRON Corporation in Japan and other countries for OMRON factory automation products.
- Windows is either registered trademarks or trademarks of Microsoft Corporation in the USA and other countries.
- EtherCAT[®] is registered trademark and patented technology, licensed by Beckhoff Automation GmbH, Germany.
- Microsoft product screen shot(s) reprinted with permission from Microsoft Corporation.
- Other company names and product names in this Guide are the trademarks or registered trademarks of their respective companies.

Software Licenses and Copyrights

The NJ-series CPU Units and Sysmac Studio incorporate certain third party software. The license and copyright information associated with this software is available at http://www.fa.omron.co.jp/nj_info_e/.

Related Manuals

The following manuals are related. Use these manuals for reference.

Manual name	Cat. No.	Model	Application	Description
1S-series AC Servomotors/Servo Drives with Built-in EtherCAT Communications User's Manual	I586	R88D-1S□-ECT R88M-1□	Learning detailed specifications of a 1S-series Servo Drive.	Describes how to install and wire the Servo Drive, set parameters needed to operate the Servo Drive, and remedies to be taken and inspection methods to be used in case that problem occur.
Sysmac Studio Version 1 Operation Manual	W504	SYSMAC-SE2□□□	Learning about the operating procedures and functions of the Sysmac Studio.	Describes the operating procedures of the Sysmac Studio.
Sysmac Studio Drive Functions Operation Manual	I589	SYSMAC-SE2□□□	Learning about the operating procedures and functions of the Sysmac Studio for Drives	Describes the operating procedures of the Sysmac Studio to setup Drives
NX-series CPU Unit Hardware User's Manual	W535	NX701-□□□□	Learning the basic specifications of the NX-series CPU Units, including introductory information, designing, installation, and maintenance. Mainly hardware information is provided.	An introduction to the entire NX-series system is provided along with the following information on the CPU Unit. <ul style="list-style-type: none"> • Features and system configuration • Introduction • Part names and functions • General specifications • Installation and wiring • Maintenance and inspection
NX-series NX102 CPU Unit Hardware User's Manual	W593	NX102-□□□□	Learning the basic specifications of the NX102 CPU Units, including introductory information, designing, installation, and maintenance. Mainly hardware information is provided.	An introduction to the entire NX102 system is provided along with the following information on the CPU Unit. <ul style="list-style-type: none"> • Features and system configuration • Introduction • Part names and functions • General specifications • Installation and wiring • Maintenance and inspection
NX-series NX1P2 CPU Unit Hardware User's Manual	W578	NX1P2-□□□□	Learning the basic specifications of the NX1P2 CPU Units, including introductory information, designing, installation, and maintenance. Mainly hardware information is provided.	An introduction to the entire NX1P2 system is provided along with the following information on the CPU Unit. <ul style="list-style-type: none"> • Features and system configuration • Introduction • Part names and functions • General specifications • Installation and wiring • Maintenance and inspection

Manual name	Cat. No.	Model	Application	Description
NJ-series CPU Unit Hardware User's Manual	W500	NJ501-□□□□ NJ301-□□□□ NJ101-□□□□	Learning the basic specifications of the NJ-series CPU Units, including introductory information, designing, installation, and maintenance. Mainly hardware information is provided.	Provides an introduction to the entire NJ-series system along with the following information on the CPU Unit. <ul style="list-style-type: none"> • Features and system configuration • Overview • Part names and functions • General specifications • Installation and wiring • Maintenance and inspection
NJ/NX-series CPU Unit Software User's Manual	W501	NX701-□□□□ NX102-□□□□ NX1P2-□□□□ NJ501-□□□□ NJ301-□□□□ NJ101-□□□□	Learning how to program and set up an NJ/NX-series CPU Unit. Mainly software information is provided.	Provides the following information on a Controller built with an NJ/NX-series CPU Unit. <ul style="list-style-type: none"> • CPU Unit operation • CPU Unit features • Initial settings • Language specifications and programming based on IEC 61131-3
NJ/NX-series CPU Unit Motion Control User's Manual	W507	NX701-□□□□ NX102-□□□□ NX1P2-□□□□ NJ501-□□□□ NJ301-□□□□ NJ101-□□□□	Learning about motion control settings and programming concepts.	Describes the settings and operation of the CPU Unit and programming concepts for motion control.
NJ/NX-series Instructions Reference Manual	W502	NX701-□□□□ NX102-□□□□ NX1P2-□□□□ NJ501-□□□□ NJ301-□□□□ NJ101-□□□□	Learning detailed specifications on the basic instructions of an NJ/NX-series CPU Unit.	Describes the instructions in the instruction set (IEC 61131-3 specifications).
NJ/NX-series Motion Control Instructions Reference Manual	W508	NX701-□□□□ NX102-□□□□ NX1P2-□□□□ NJ501-□□□□ NJ301-□□□□ NJ101-□□□□	Learning about the specifications of the motion control instructions that are provided by OMRON.	Describes the motion control instructions.
NJ/NX-series Troubleshooting Manual	W503	NX701-□□□□ NX102-□□□□ NX1P2-□□□□ NJ501-□□□□ NJ301-□□□□ NJ101-□□□□	Learning about the errors that may be detected in an NJ/NX-series Controller.	Describes concepts on managing errors that may be detected in an NJ/NX-series Controller and information on individual errors.
NX-series Safety Control Units User's Manual	Z930	NX-SL□□□□ NX-SI□□□□ NX-SO□□□□	Learning how to use the NX-series Safety Control Units.	Describe the hardware, setup methods and functions of the NX-series Safety Control Units.

Revision History

A manual revision code appears as a suffix to the catalog number on the front and back covers of the manual.

Cat. No.	I823-E1-01
-----------------	-------------------

↑
Revision code

Revision code	Date	Revised content
01	July 2016	Original production
02	August 2019	Made changes accompanying release of 4 to 15 kW

CONTENTS

Introduction	3
Intended Audience	3
Applicable Products	3
Special Information	3
Terms and Conditions Agreement	4
Precautions	6
Trademarks	6
Software Licenses and Copyrights	6
Related Manuals	7
Revision History	9
1. Servo system configuration and peripheral products	11
1.1. Outline	11
1.2. Servo System constructed in this guide.....	12
1.3. System configuration.....	13
2. Before You Begin	15
3. Performing setup	16
3.1. Installation & Wiring	16
3.2. System configuration with NJ and NX safety controller.....	25
3.3. Sysmac Studio project creation	26
3.4. Motor, ABS Encoder and I/O Setup	30
3.5. Easy tuning for gain adjustment.....	34
3.6. FSoE STO activation.....	38
ANNEX	43
Add a drive and axis OFFLINE	43
Test run and data trace	47
Manual tuning	49
Advanced tuning	53

1. Servo system configuration and peripheral products

1.1. Outline

The 1S-series AC Servo Drives with Built-in EtherCAT communications support 100-Mbps EtherCAT. When you use the 1S-series Servo Drive with a Machine Automation Controller NJ/NX-series CPU Unit or CJ1W-NC□8□ EtherCAT-compatible Position Control Unit, you can construct a high-speed and sophisticated positioning control system.

Also, you need only one communications cable to connect the Servo Drive and the Controller. Therefore, you can realize a position control system easily with reduced wiring effort.

With auto tuning, adaptive filter, notch filter, and damping control, you can set up a system that provides stable operation by suppressing vibration in low-rigidity machines.

The FSoE protocol, the technology for a safe communication layer supported by the 1S-series Servo Drives, allows you to build the safety system that uses the STO function from the safety controller on the EtherCAT network.



Additional Information

For additional information about 1S servo drive, please refer to 1S-series AC Servomotors and Servo Drives User's Manual (with Built-in EtherCAT Communications) (Cat. No. I586)

1.2. Servo System constructed in this guide

This 1S-series Sysmac AC Servo Drives Startup Guide (hereafter referred to as “this Guide”) contains instructions from assembling the hardware that makes up the Servo system to performing debugging on the system. This Guide builds the Servo system in the following steps

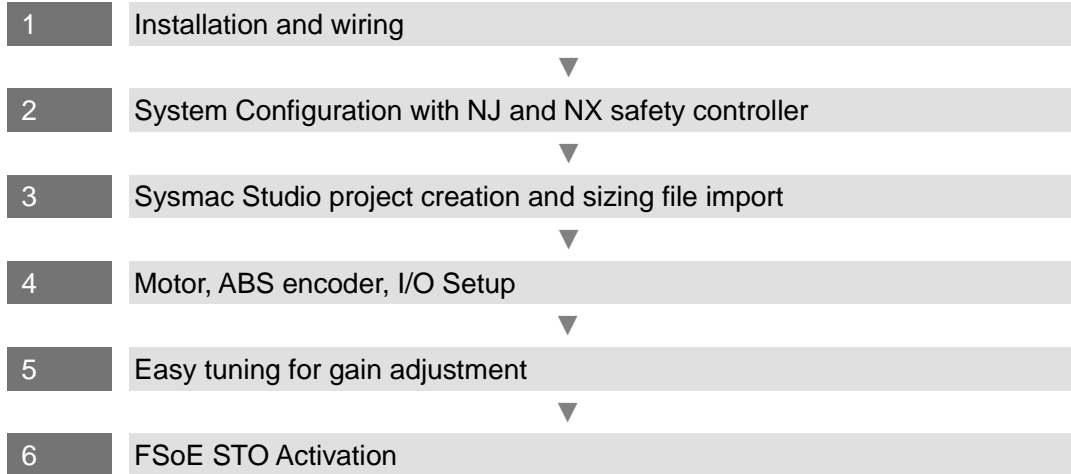

Additional Information

For additional information on how to setup the motion, please refer to the start-up guide for motion control (W514).

1.3. System configuration

The following figure shows the system configuration and devices that are used in this Guide. The system configuration is shown in the following figure.

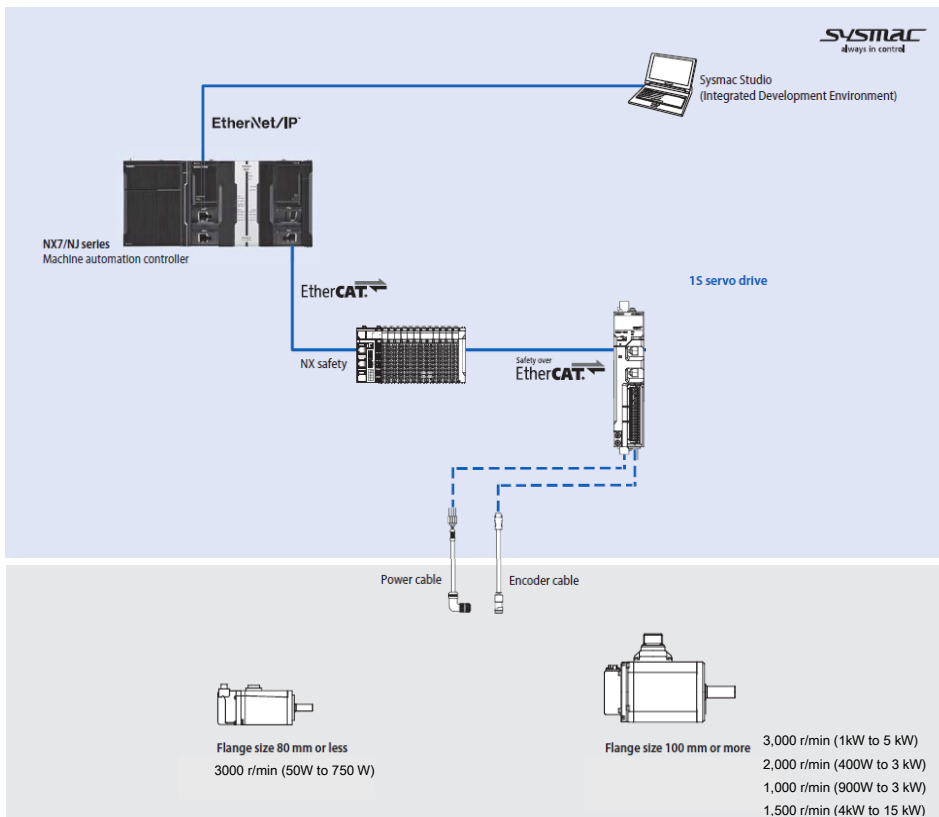

- **Configuration devices**

The models of the devices that are described in this Guide are given in the following table.

When selecting devices for an actual application, refer to the device manuals.

Device name	Model	Manual name
NJ-series CPU Unit	NJ501-[]	NJ-series CPU Unit Hardware User's Manual (Cat. No. W500)
NJ-series Power Supply	NJ-P[]3001	
NX-series EtherCAT Coupler	NX-ECC[]	NX-series EtherCAT Coupler Unit User's Manual (Cat. No. W519)
NX-series Safety control unit	NX-SL3300	NX safety CPU unit Hardware User's Manual (Cat. No. Z930)
NX I/O Series	NX-SID[] NX-SOD[]	
Ethernet/EtherCAT communications cables	XS5W-T[]	-
AC Servo Drives	R88D-1SN[]	1S-series AC Servomotors and Servo Drives User's Manual (with Built-in EtherCAT Communications) (Cat. No. I586)
AC Servo Motors	R88M-1[]	
Power cables	R88A-CA[]	
Encoder Cables	R88A-CR[]	

- **Automation software**

Product	Number of license	Model
Sysmac Studio Standard Edition Version 1.16	None (DVD only)	SYSMAC-SE200D
	From 1 license to site license	SYSMAC-SE[]

2. Before You Begin

■ Unpack Drive/Motor

1. **Unpack motor package.** The package includes only motor and instruction sheet. Cables are provided separately.

2. **Unpack drive package.**
This product comes with the following accessories.
 - **INSTRUCTION MANUAL** × 1 copy
 - **Warning label** × 1 sheet
 - **General Compliance Information and instructions for EU** × 1 copy
 - **Attached connectors**

■ Install the Sysmac Studio Standard Edition

Refer to the *Sysmac Studio Version 1 Operation Manual* (Cat. No. W504) for how to install.



Additional Information

For further details on how to handle drive and motor package, please refer to 1S-series AC Servomotors and Servo Drives User's Manual (with Built-in EtherCAT Communications) (Cat. No. I586)

3. Performing setup

3.1. Installation & Wiring

■ Space Conditions around Servo Drives with its capacity 3 kW or less

Install the Servo Drive according to the following.

● Single-unit Installation

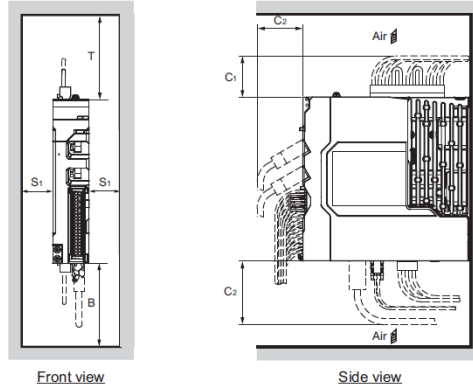

● Side-by-side Installation

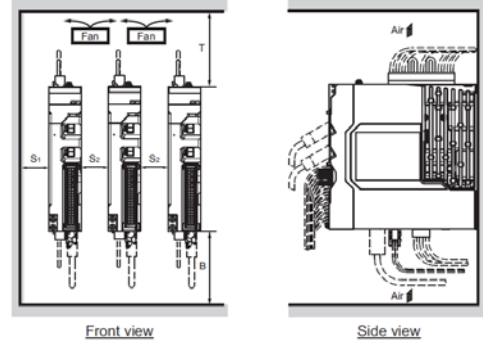

Dimension	Distance	
T	100 mm min.	
B	100 mm min.	
S1	40 mm min.	
S2	10 mm min.*1	
C1	R88D-1SN01L-ECT/-1SN02L-ECT/-1SN04L-ECT/-1SN01H-ECT/ -1SN02H-ECT/-1SN04H-ECT/-1SN08H-ECT/-1SN10H-ECT	45 mm min.
	R88D-1SN15H-ECT/-1SN20H-ECT/-1SN30H-ECT/-1SN06F-ECT/ -1SN10F-ECT/-1SN15F-ECT/-1SN20F-ECT/-1SN30F-ECT	60 mm min.
C2	50 mm min.	
C3	70 mm min.	

*1. Limit the operating ambient temperature of Servo Drive from 0 to 45°C when the distance is less than 10 mm.

- Install the Servo Drive on the vertical metal surface.
- To provide electrical conduction, remove any paint from the surface on which you install the Servo Drives. Also, it is recommended that you apply conductive plating if you make the mounting bracket by yourself.
- The recommended tightening torque for installing the Servo Drive is 1.5 N·m. Make sure that the threaded portion has the sufficient strength to withstand the recommended torque.

■ **Space Conditions around Servo Drives with its capacity 5.5 kW or more**

Install the Servo Drive according to the following.

● **Single-unit Installation**

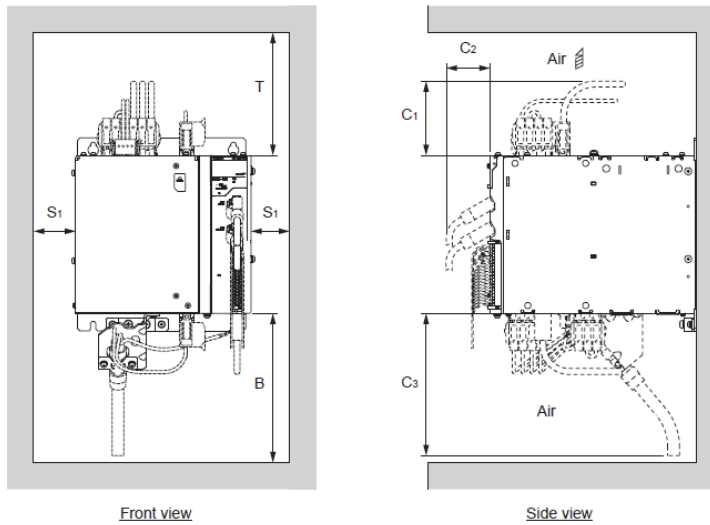

● **Side-by-side Installation**

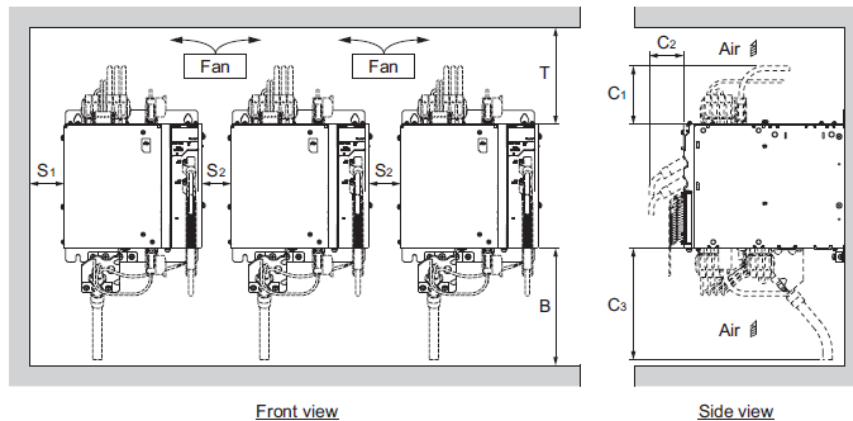

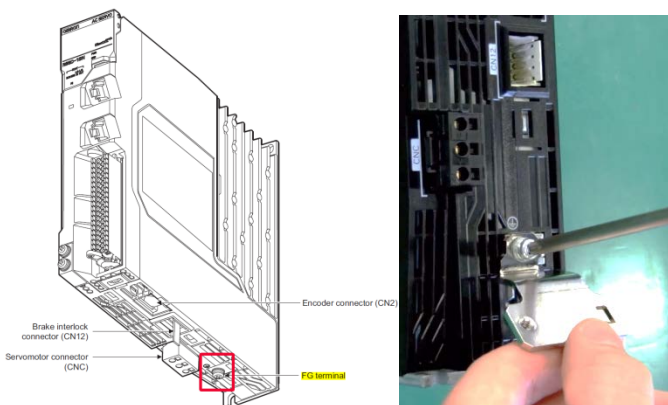
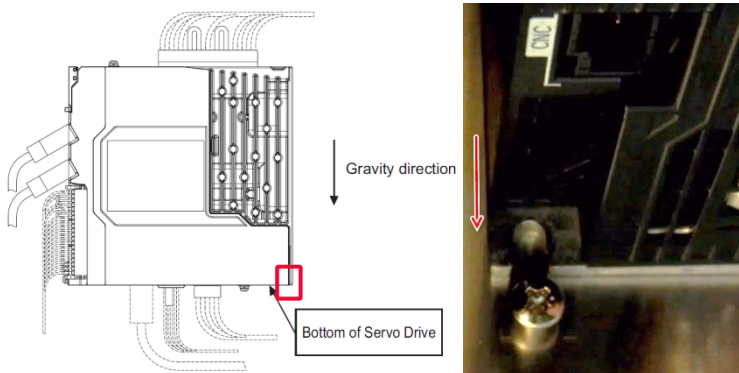
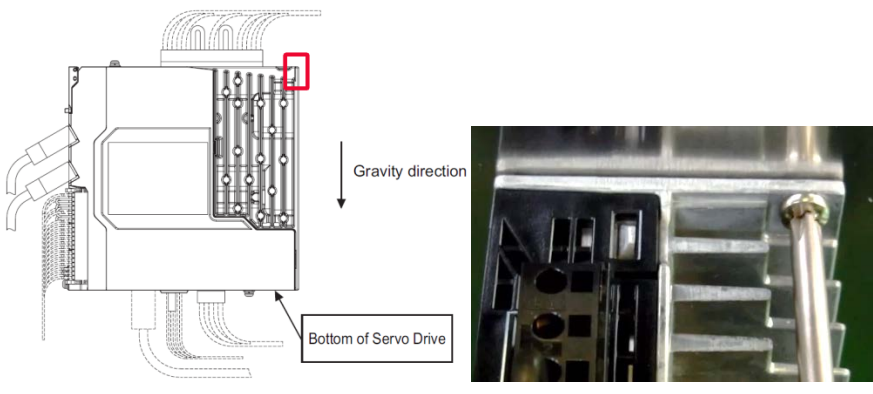
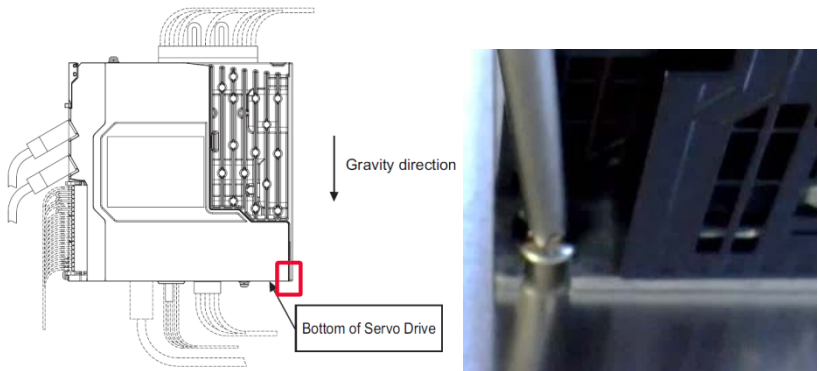

Dimension	Distance	
T	R88D-1SN55H-ECT/-1SN75H-ECT/-1SN55F-ECT/-1SN75F-ECT	200 mm min.
	R88D-1SN150H-ECT/-1SN150F-ECT	280 mm min.
B	500 mm min.	
S1	40 mm min.	
S2	40 mm min.	
C1	R88D-1SN55H-ECT/-1SN75H-ECT/-1SN55F-ECT/-1SN75F-ECT	130 mm min.
	R88D-1SN150H-ECT/-1SN150F-ECT	170 mm min.
C2	50 mm min.	
C3	450 mm min.	

- Install the Servo Drive on the vertical metal surface.
- To provide electrical conduction, remove any paint from the surface on which you install the Servo Drives. Also, it is recommended that you apply conductive plating if you make the mounting bracket by yourself.
- The recommended tightening torques for installing the Servo Drive are the followings. Make sure that the threaded portion has the sufficient strength to withstand the recommended torque.
 R88D-1SN55H-ECT/-1SN75H-ECT/-1SN55F-ECT/-1SN75F-ECT: Tightening torque 3 N·m
 R88D-1SN150H-ECT/-1SN150F-ECT: Tightening torque 5.2 N·m
- Set S₂ distance over a value shown above table to install a Servo Drives.

<p>1.</p>	<p>In case of using the shield clamp, please fix it in advance with the existing screw</p> 
<p>2.</p>	<p>Approach the drive from top to down.</p> 
<p>3.</p>	<p>Tight the upper part.</p> 
<p>4.</p>	<p>Tight the down part.</p> 

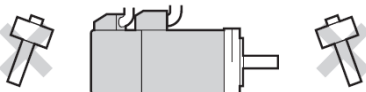
■ **Motor installation** (step 2, 3 order depends on your mechanical implementation)

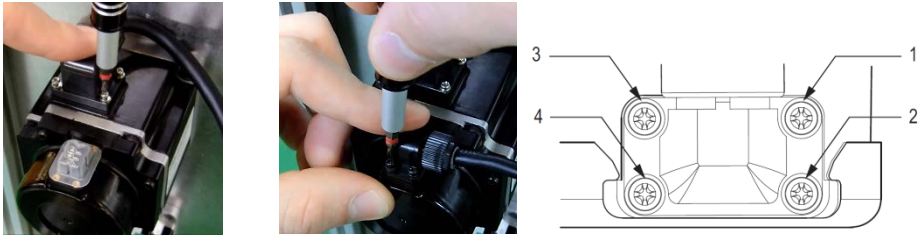
1.	<p>Please handle the motor carefully & do not apply heavy impacts or loads during transport, installation, or removal of the motor.</p> 
2.	<p>Please fixe and connect the motor to the mechanical system</p>  <p>Note: At first, please check motor operation without any load.</p>
3.	<p>Please attached the power and encoder cable</p> <p>Here is an example with 200W motor</p>  <p>Please tight screws in several times in this order :1>4>3>2</p>



Additional Information

For further details about coupling method, please refer to 1S-series AC Servomotors and Servo Drives User's Manual (with Built-in EtherCAT Communications) (Cat. No. I586)

■ **Wiring**

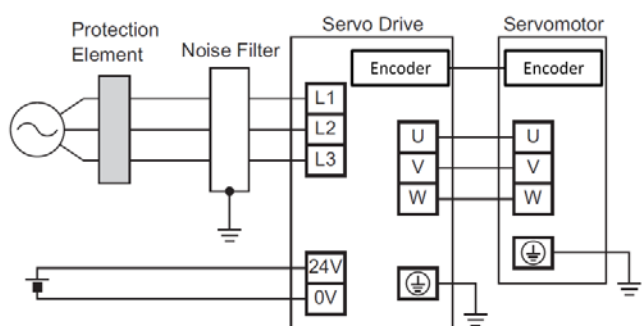
1.	<p>Overview</p> <p>■ Wiring Diagram</p>  <p>Here is an example servo drives with its capacity 3 kW or less. For servo drives with its capacity 4 kW or more, refer to section 4-2 wiring of 1S AC servo drive user's manual (Cat. No. I586)</p>
----	---

2. Remove power connector(s) (CNA) or (CNA)/(CND) from the drive depending on the model:

100V/200V (up to 1kW)

R88D-1SN01L-ECT/-1SN02L-ECT/-1SN04L-ECT/-1SN01H-ECT/
-1SN02H-ECT/-1SN04H-ECT/-1SN08H-ECT/-1SN10H-ECT

200V (1.5kW-3kW) 400V (0.6kW-3kW)

R88D-1SN15H-ECT/-1SN20H-ECT/-1SN30H-ECT/-1SN06F-ECT/
-1SN10F-ECT/-1SN15F-ECT/-1SN20F-ECT/-1SN30F-ECT

3. Please wire the 24V control power supply (stripped wires or ferrules can be used)

24 VDC

Connect wires with the spring opener

Please refer to the corresponding connector depending on your drive and power supply:
 CNA for 100V/200V (up to 1kW) CND for 200V (1.5kW-3kW) 400V (0.6kW-3kW)

L1 L2 L3 B3 B2 P/B1 N1 N2 N3 **+24V** \emptyset

+24V \emptyset NC

4. Please wire the AC power supply

Please refer to the corresponding connector depending on your drive and AC power supply type

1-Phase

100V/200V (up to 1kW)

L1 **L2** **L3** B3 B2 P/B1 N1 N2 N3 +24V \emptyset

200V (1.5kW)

B1 B2 B3 **L3** **L2** **L1**

3-Phase

200V (up to 1kW)

L1 **L2** **L3** B3 B2 P/B1 N1 N2 N3 +24V \emptyset

200V (1.5kW-3kW) 400V (0.6kW-3kW)

B1 B2 B3 **L3** **L2** **L1**

Example: CNA for 100V/200V (up to 1kW)

5. **Please remove the motor connector (CNC) from the drive:**

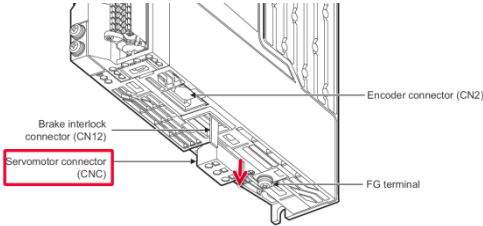

6. **Please wire U, V, W of the motor (stripped wires)**

Pin No.	Name
1	U
2	V
3	W



7. **Please screw the PE wire  of the main power to the drive.**

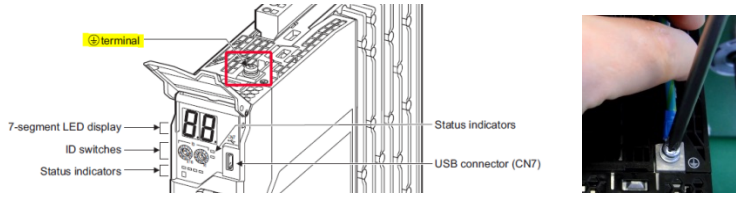

8. **Please plug back above connectors to the drive. (Power and Motor)**

9. **Please fix the FG wire from the motor cable to the drive**

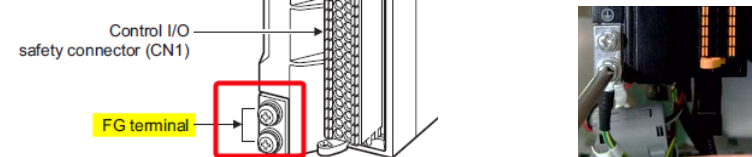

Or
In case of using the shield clamp, please attach the cable to the clamp in order to connect the shielded section.



10. **Please plug the encoder cable to the drive (CN2)**

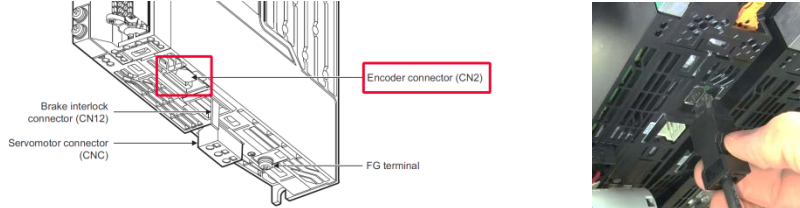

Additional Information

For further details about wiring method, please refer to 1S-series AC Servomotors and Servo Drives User's Manual (with Built-in EtherCAT Communications) (Cat. No. I586)

■ I/O, Safety Wiring

1. By default, STO function is inhibited and bypassed with jumpers



2. In case of using STO by hardwire, Please make the proper wiring between the safety controller and the drive

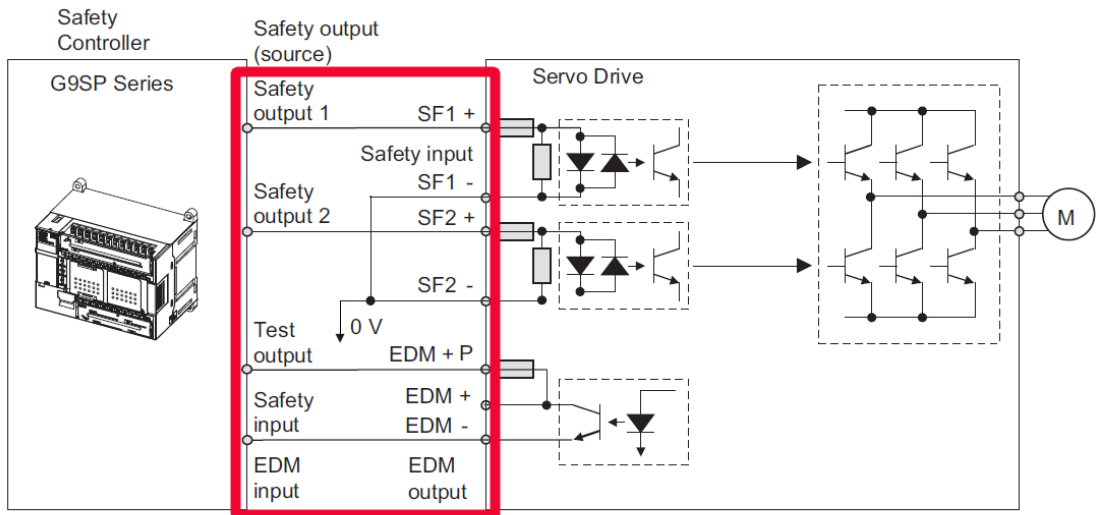

Wire SF1 and SF2 to different safety outputs.

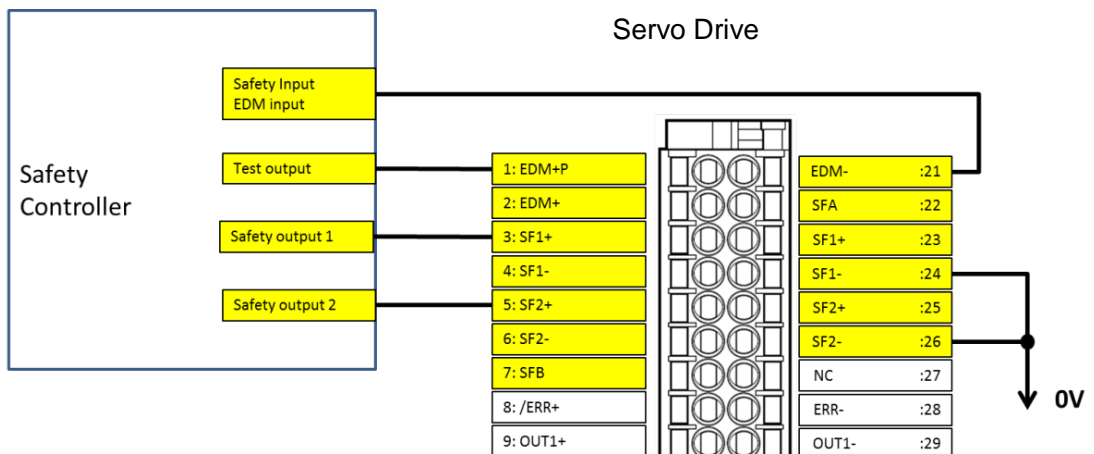

3. In case of using STO by hardware for multiple servo drives, Please make the proper wiring between the safety controller and drives.

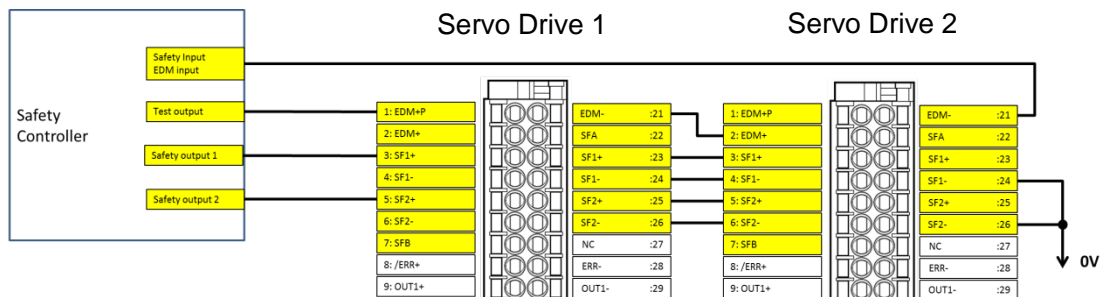
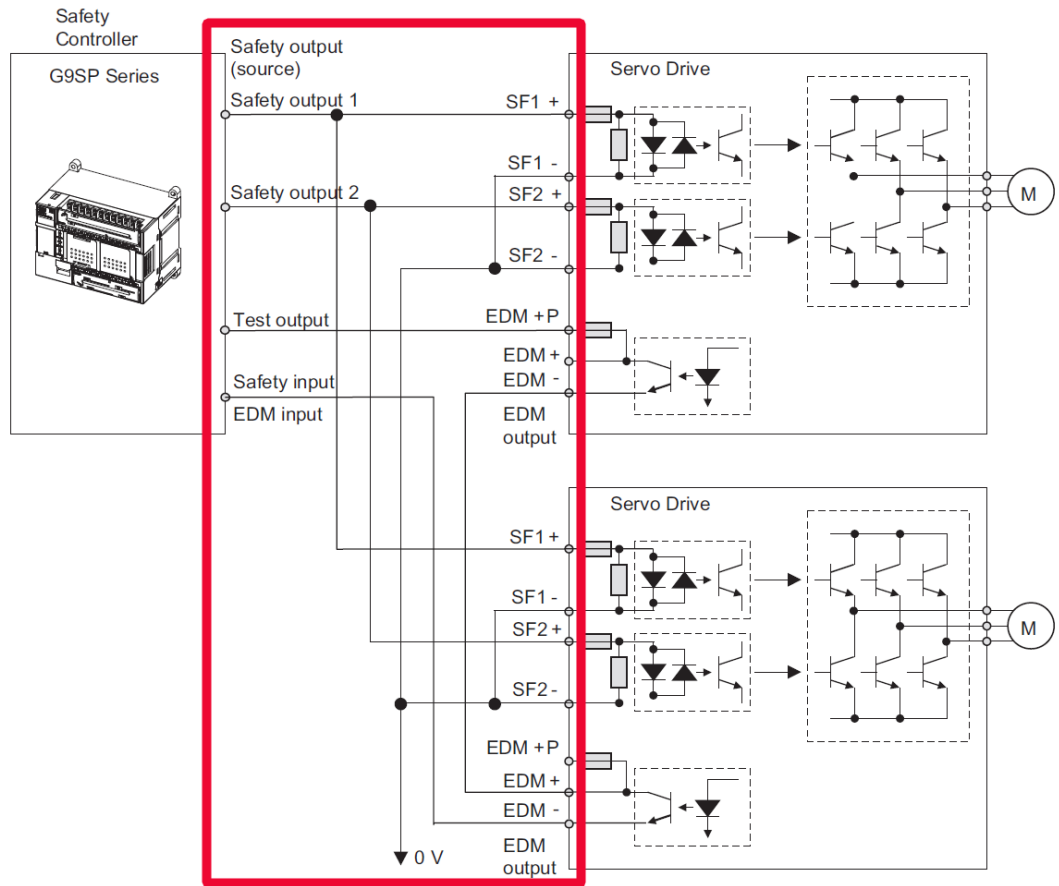

Note: When G9SP-series safety controller is used, you can connect up to four 1S-series Servo Drives

4. When general I/Os are required, please make the proper wiring.

Here is an example of latch input 1:

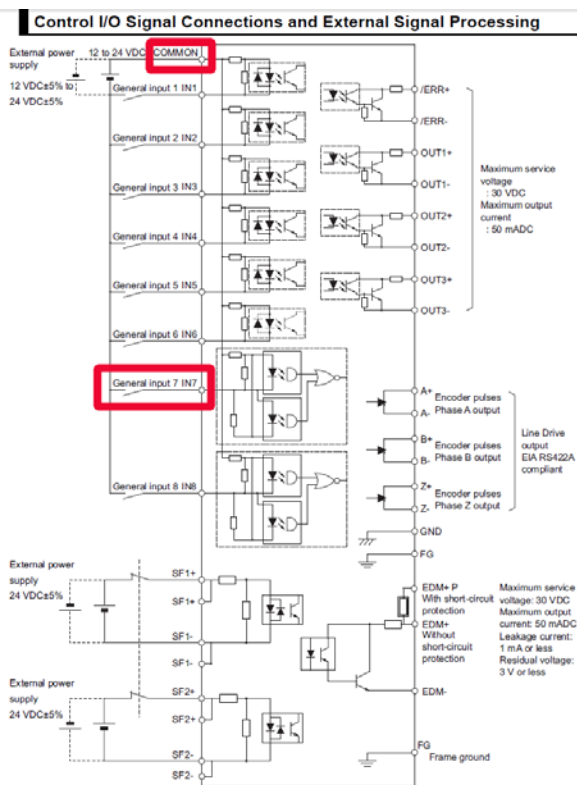

Servo Drive connector view:

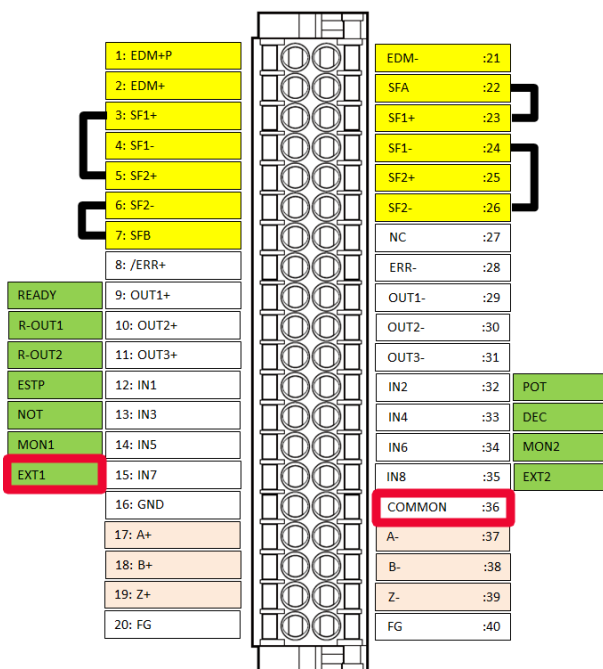



Additional Information

For further details about wiring method, please refer to 1S-series AC Servomotors and Servo Drives User's Manual (with Built-in EtherCAT Communications) (Cat. No. I586)

3.2. System configuration with NJ and NX safety controller

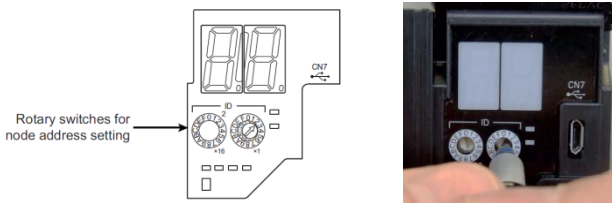
■ Ethercat node address configuration

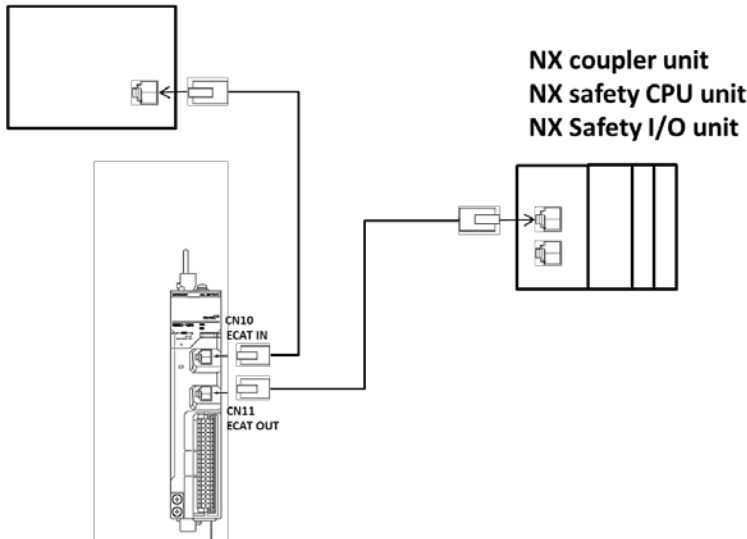
1.	<p>Please configure the Ethercat node address of the drive to 1.</p>  <p>Rotary switches for node address setting</p> <p>Note: You can configure the node address depending on your application</p>
2.	<p>In case of using NX safety, please configure the node address of the NX coupler to 2.</p> <p>Note: You can configure the node address depending on your application</p>
3.	<p>Please connect EtherCAT cables to devices</p>  <p>CN10 Ethercat IN: Ethercat cable from NJ EtherCAT Master CN11 Ethercat OUT: Ethercat cable to NX coupler unit</p> <p>EtherCAT Master</p>  <p>1S-series Servo Drives</p> <p>NX coupler unit NX safety CPU unit NX Safety I/O unit</p>



Additional Information

For further details about safety controller, please refer to the NX-series safety control units user manual Z930

3.3 Sysmac Studio project creation

■ New project

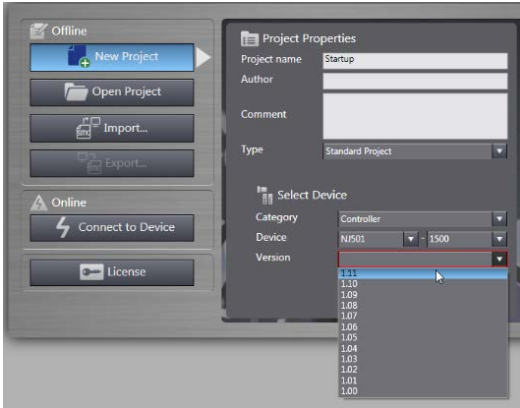
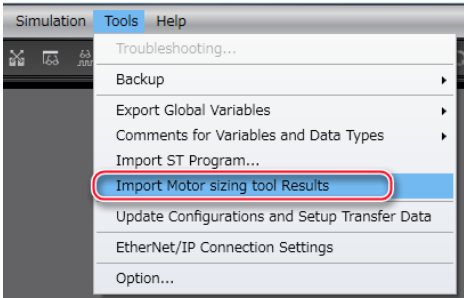
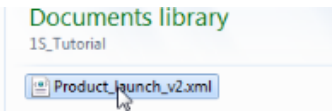
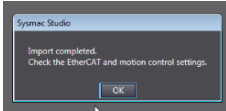
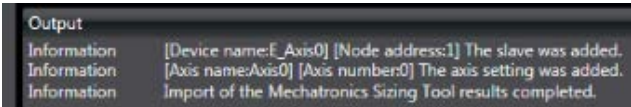
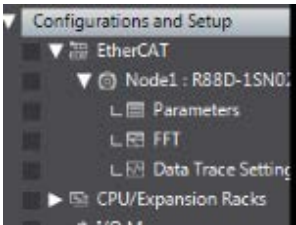
- 1. Create new project**
Select NJ501-1500 from the list.

- 2. Import the sizing file**

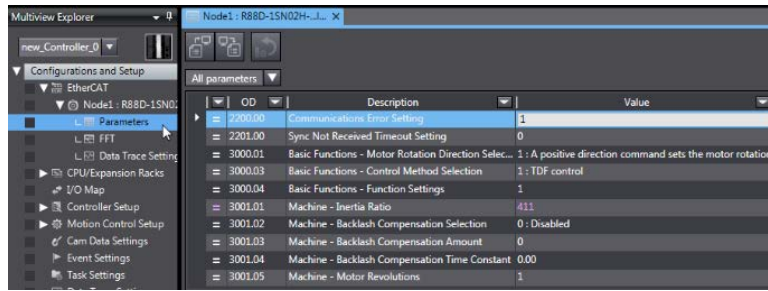
Please select your sizing tool results

Note 1: Please refer to the “motor sizing tool startup guide” for learning how to create the sizing result (I820-E1-01).
Note 2: If you do not use the sizing file import please refer to the annex [“Add drive and axis OFFLINE”](#)
- 3. Device was imported successfully**

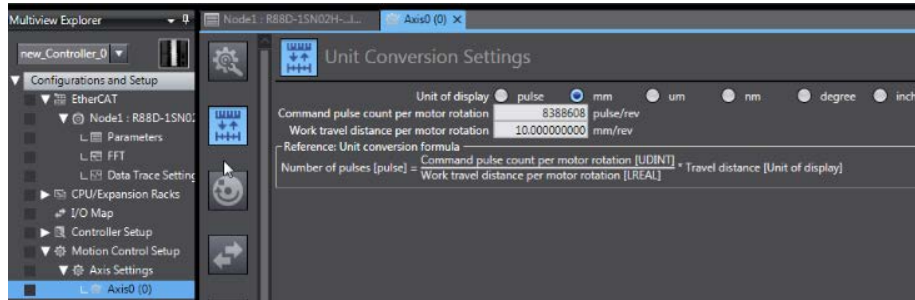
- 4. Ethercat configuration was updated**

5. Drive parameters were updated



6. Axis setting were created and updated



If you do not use NX Safety, please jump to step 10

7. Add a terminal coupler in EtherCAT editor

Double click on Ethercat

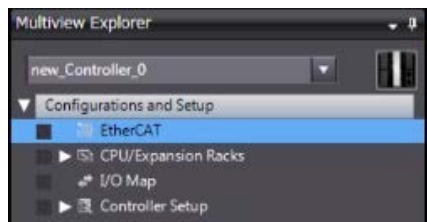

Drag and drop the terminal coupler

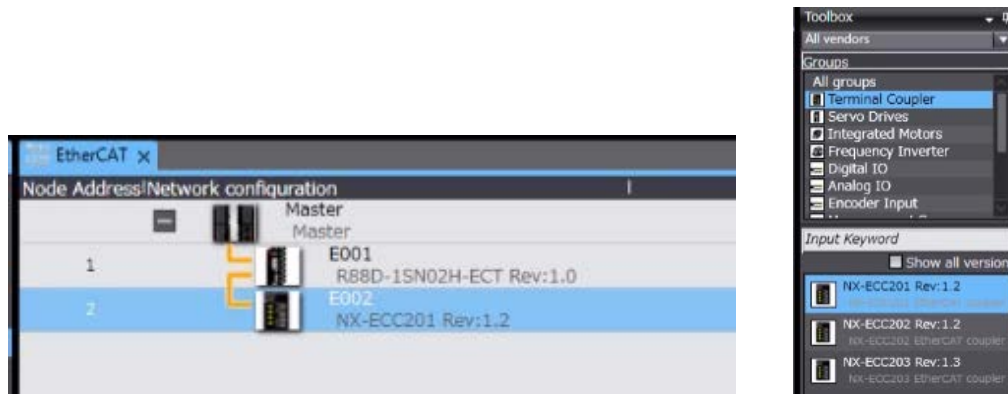

8. **Add NX Safety unit**
 Double click on NX Coupler

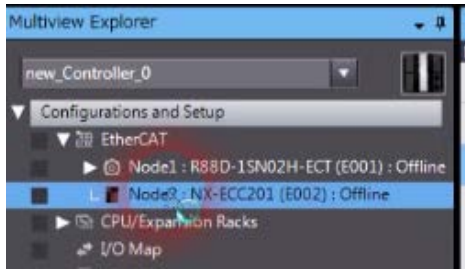

Drag and drop NX safety controller

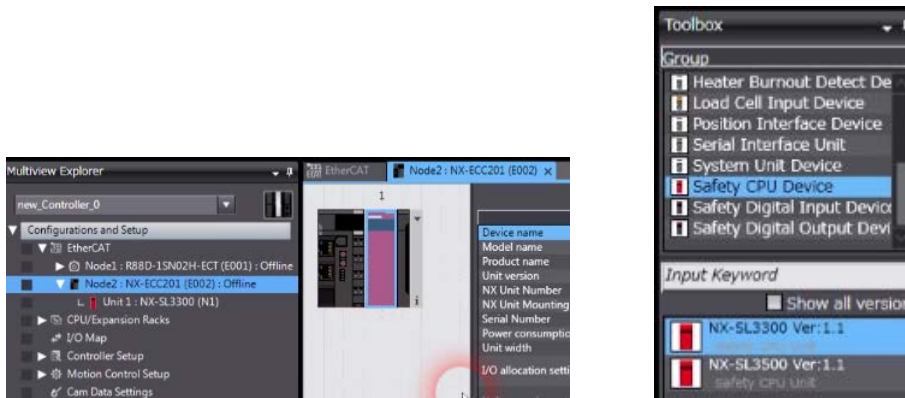

9. **Add NX safety I/O units**
 Drag and drop Safety I/O



10 **Please turn on the power supply of all devices.**

11.

Connect to NJ

Please setup the method of connection

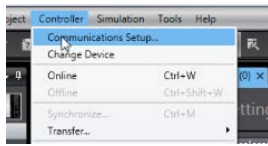

Enter the IP address and test the connection



Push connect button



12.

Send Program to NJ

Push synchronize button



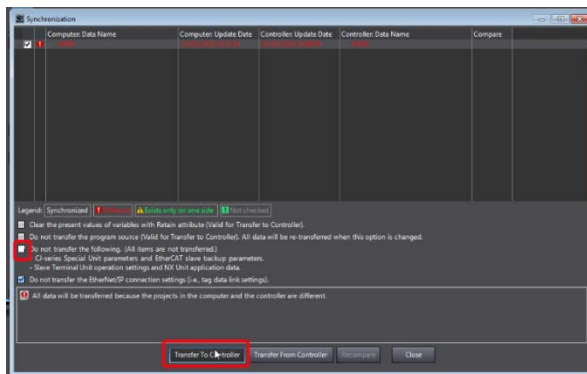

Uncheck the below box in order to send drive parameters and push transfer to controller

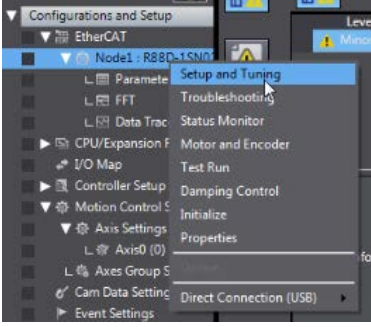
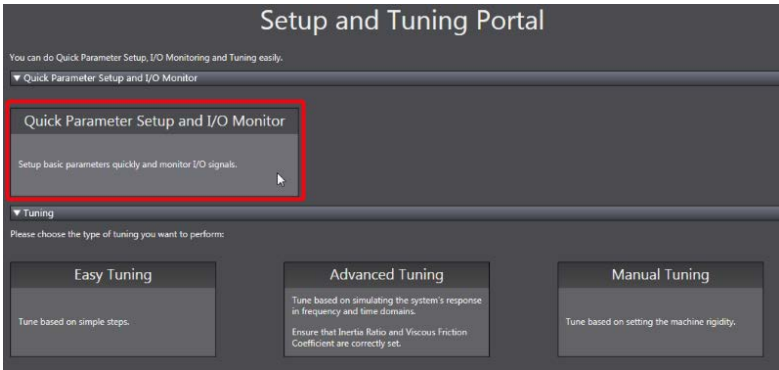

3.4 Motor, ABS Encoder and I/O Setup

■ Quick setup wizard

1.	<p>Please right click to the drive and select “setup and tuning”</p> 
2.	<p>Select quick setup</p> 
3.	<p>This setting is related with Encoder usage and I/O pre-configuration</p>  <p>When using I/O features of the drive in the motion control (MC) function module of Sysmac Controller, recommended settings should be used. (Related inputs: IN2: POT, IN3: NOT, IN4: DEC, IN7: EXT1, IN8: EXT2, Absolute encoder usage: “Use as absolute encoder but ignore multi-rotation counter overflow”).</p>
4.	<p>Absolute encoder usage</p>  <p>1S motor has an absolute encoder for all models. But it can be used as incremental if needed. When using Sysmac Controller, it is recommended to keep the default value. (as described in previous step 3)</p>

5. Setup of the absolute encoder

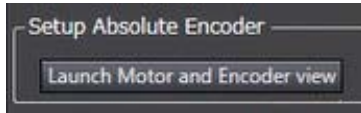

This function can be used for resetting the multi turn data or when replacing a motor in actual machine.

Reset multi-turn data:

Please push "clear system"

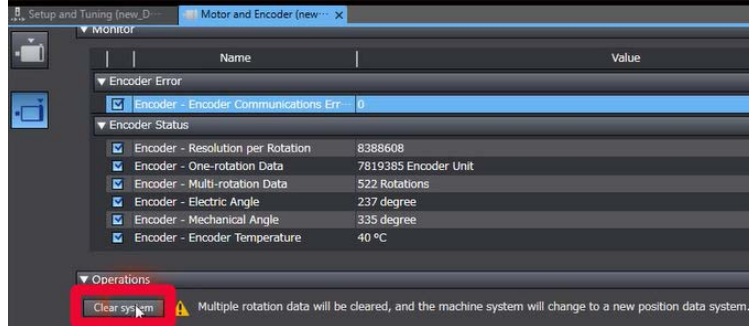

This setting required the drive to be restarted; Sysmac Studio can do it by pressing yes.

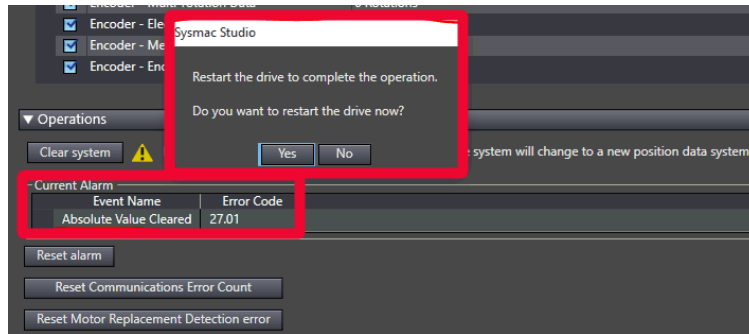

Encoder multi rotation data has been cleared

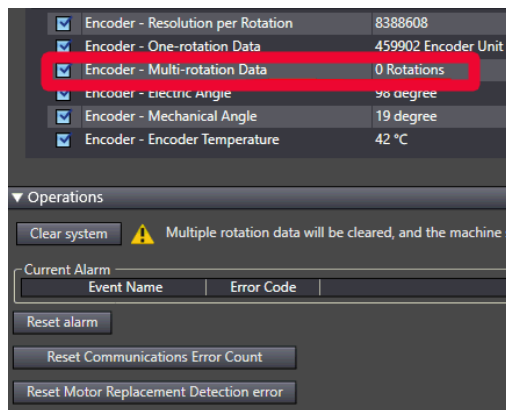

6. **Adjust the motor direction and transfer to the drive**

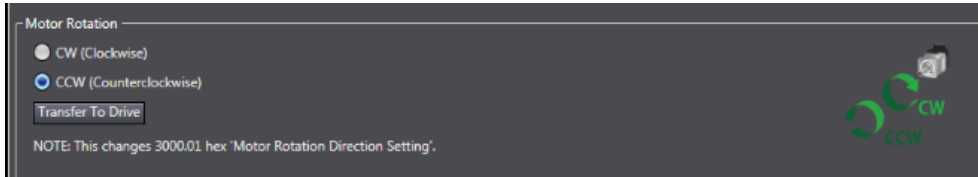

7. **Validate the motor operation**

Apply the test run configuration, activate the Servo ON and initiate the movement

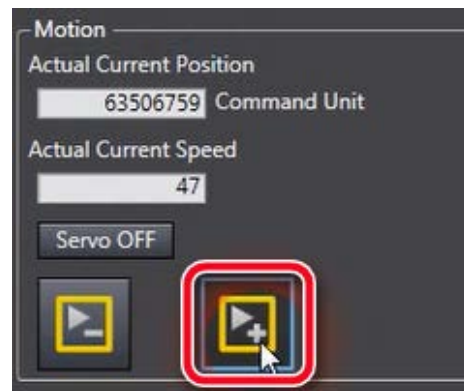
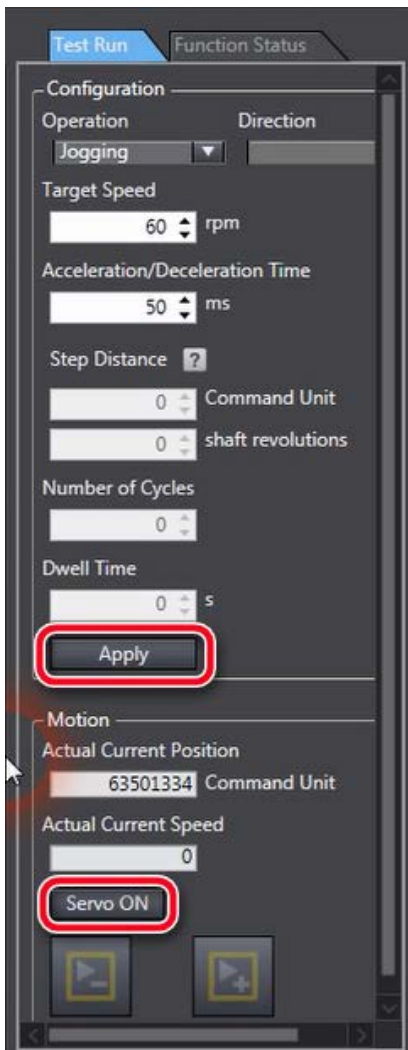

Note: In case of Error 87.00 ESTP input, please check your wiring connection or disable the error stop input (IN1) as explained in the next step.

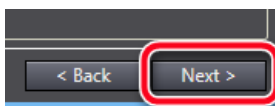

Click next

8. **Adjust Input settings, transfer to the drive and validate with test run**
 By default, ESTOP Input is activated, please deactivated if necessary (as following).
 When ESTP is activated, Error 87.00 is present on the drive.

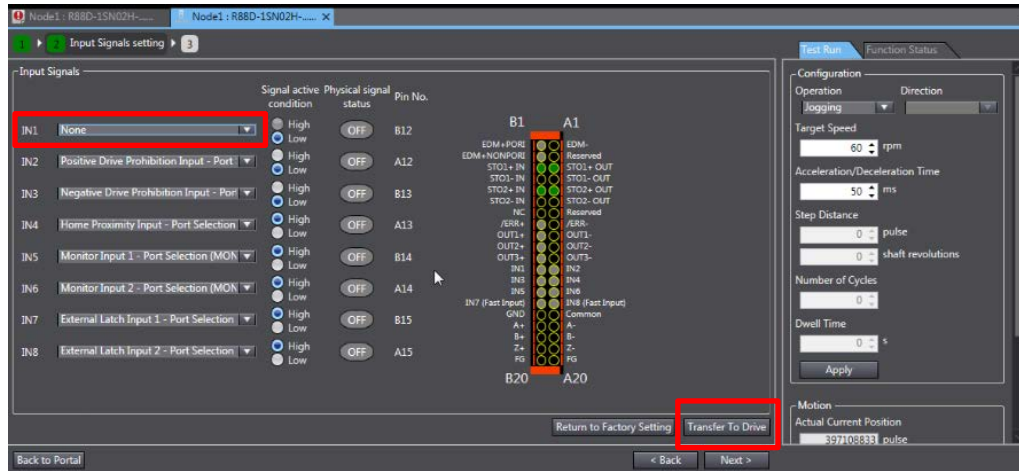

9. **If necessary, Adjust Output settings, transfer to the drive and validate with test run**

10. **Please click finish**



3.5. Easy tuning for gain adjustment

■ Easy tuning

Use the following procedure to perform adjustment. At first, it is recommended to perform easy tuning

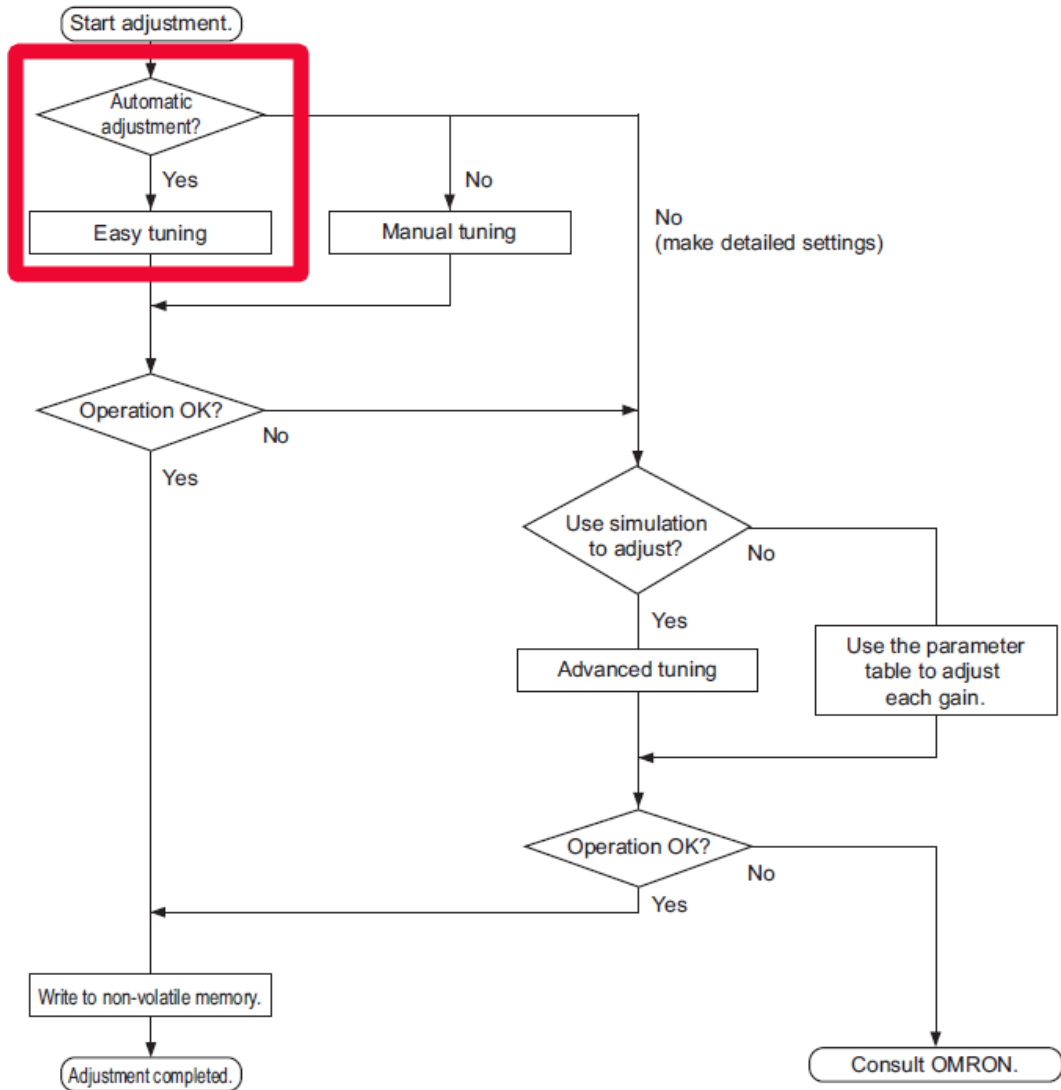

1. Please right click to the drive and select “setup and tuning”

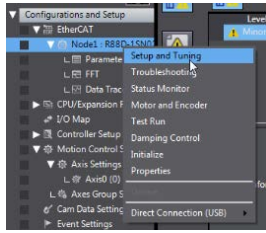

2. Please select Easy tuning

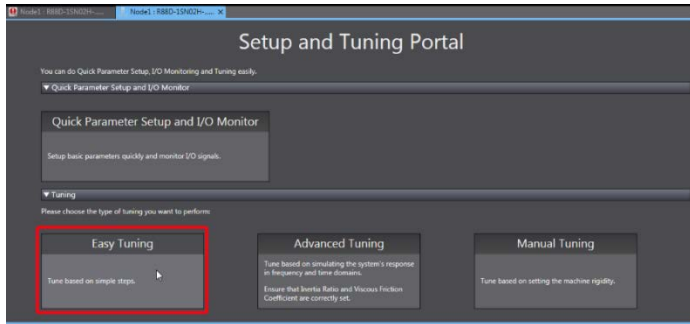

3. Please select simple mode and click next

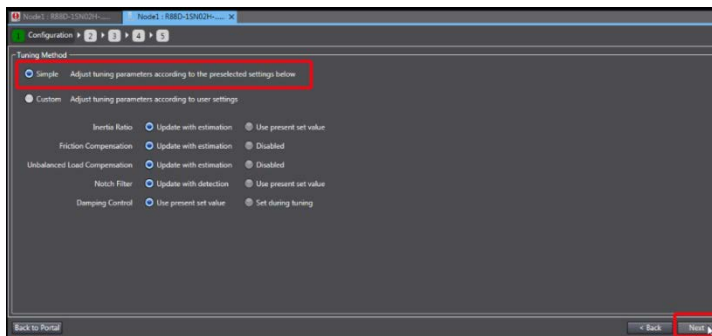

4. Please adjust the motion profile

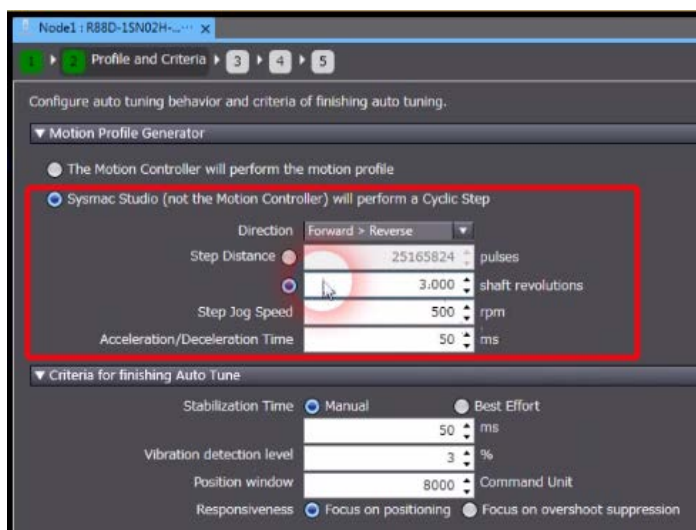

5. **Please adjust criteria and click next**

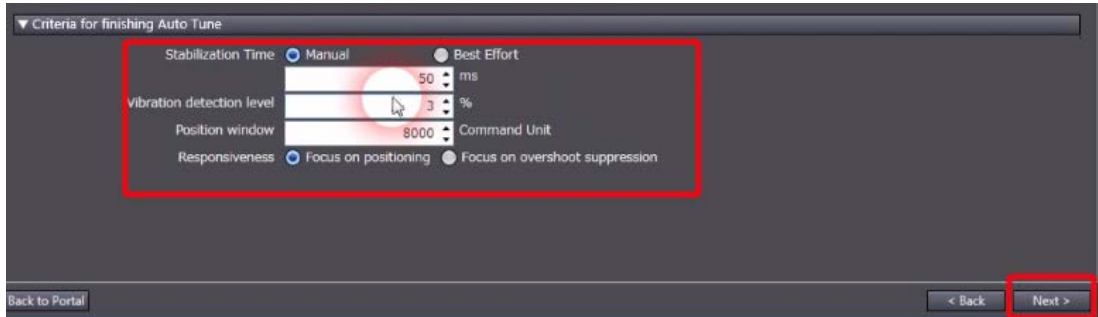

- If you choose the manual setting of settling time, gain will be increased gradually until achieving the specified settling time. The positioning window, specify the position deviation to determine that the positioning is completed. If it detects a vibration above the vibration detection level during tuning, an adjustment failure will occur.
- If you select the best effort mode, gain will be increased gradually until the system does not exceed the vibration detection level.

6. **Please click start, be careful the motor will move**

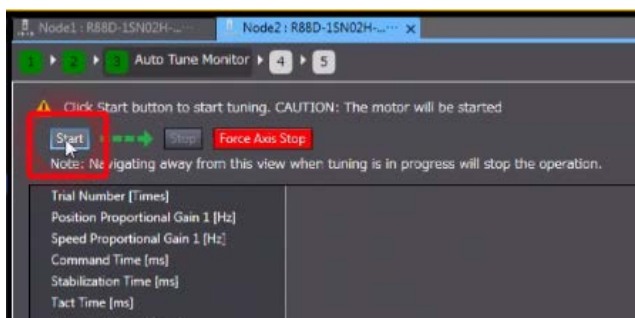

Criteria achieved

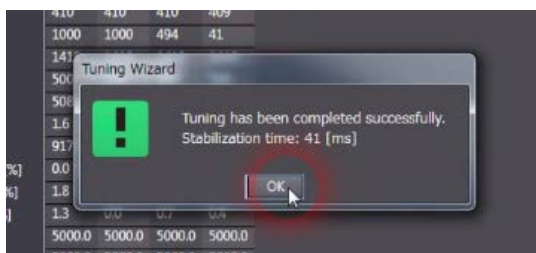

Click next

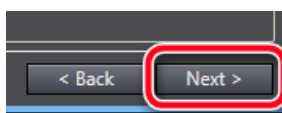

7. Please click the record button, the motor will move and data will be traced and auto scaled

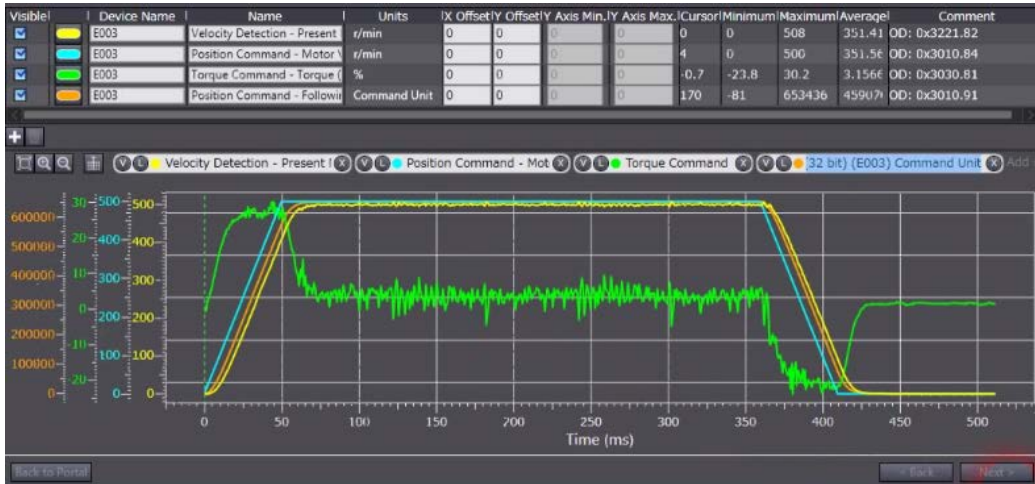
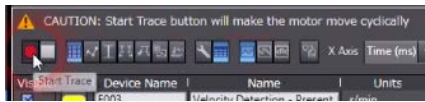

Click next

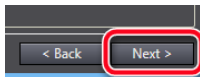

8. Confirm new gain parameters and save to EEPROM

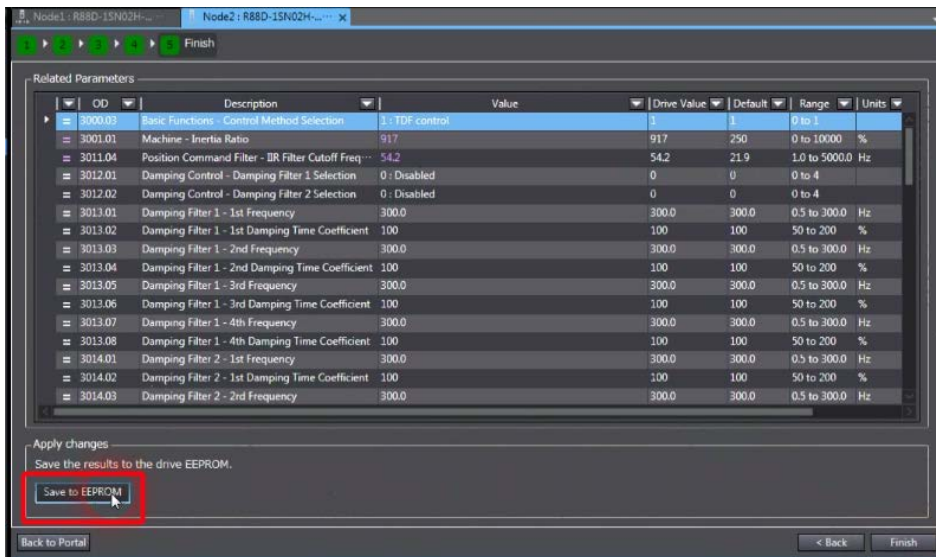



Click Finish

3.6. FSoE STO activation

If you do not use NX Safety and STO via FSoE, please ignore this part (3.6)

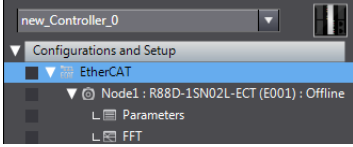
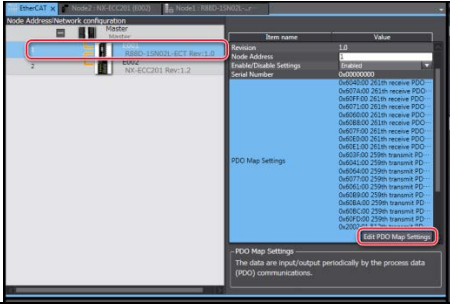
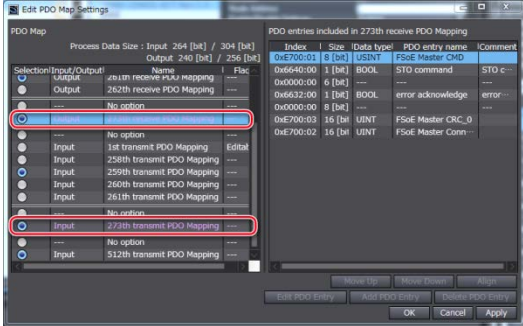
■ Manipulation to activate FSoE STO

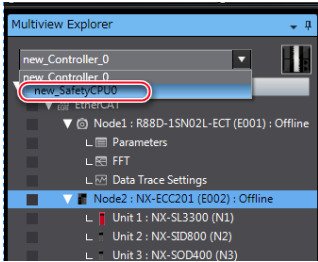
1. **Please double click on Ethercat**

2. **Please select the drive and Edit PDO map settings of the drive**

3. **Select safety input and output (273th)**

It is necessary for setting the information in the safety telegram.
4. **Select the new safety CPU**

5. **Please confirm the FSoE slave addresses**

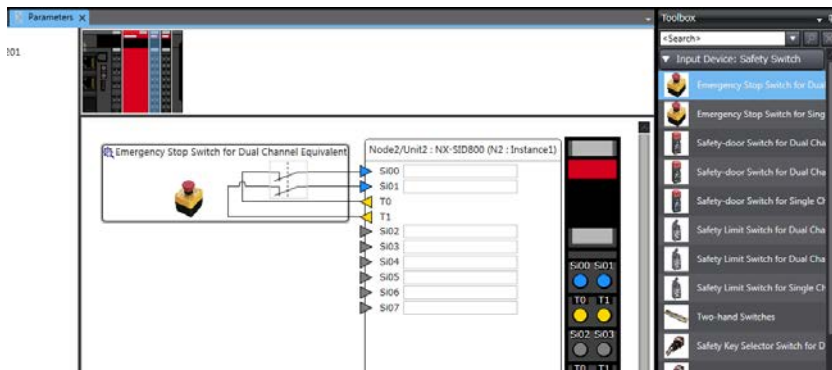
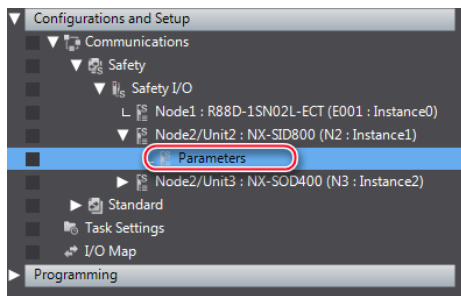
Position	Active	Device name	Product Information	FSoE slave address	StC watchdog timer (WDT) [ms]	WDT auto setting
Node1	<input checked="" type="checkbox"/>	E001	R88D-1SN02L-ECT-1.0	1	43	<input checked="" type="checkbox"/>
Node2/Unit2	<input checked="" type="checkbox"/>	N2	NX-SID800-1.0	2	43	<input checked="" type="checkbox"/>
Node2/Unit3	<input checked="" type="checkbox"/>	N3	NX-SOD400-1.0	3	45	<input checked="" type="checkbox"/>

Safety signals from the servo are shown as Safety I/O

6. Add the Emergency stop button



7. Add the Reset button

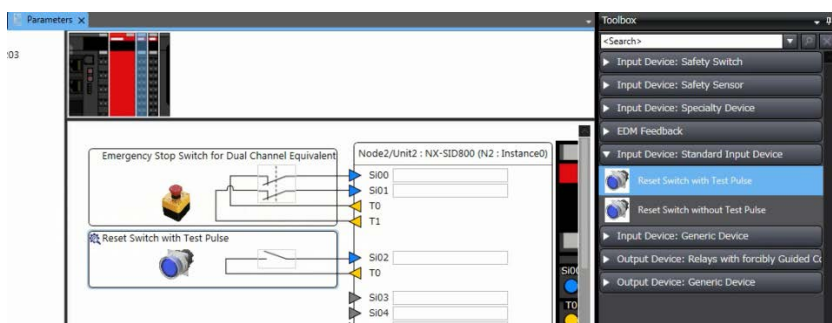

8. Edit I/O Map variables

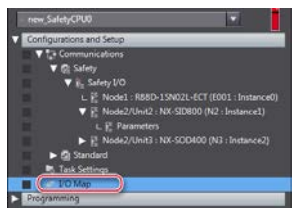

Position	Port	R/W	Data Type	Variable	Variable Comment	Variable Type
EtherCAT Network						
Master						
Node1						
R88D-1SN02L-ECT (E001 : Instance0)						
Safety Inputs						
	STO active	R	SAFEBOOL	SL_EDM		Global Variables
	Error	R	SAFEBOOL	SL_Connection_Status		Global Variables
	Safety Connection Status	R	SAFEBOOL	SL_Connection_Status		Global Variables
Safety Outputs						
	STO	W	SAFEBOOL	SO_STO		Global Variables
	Error Ack	W	SAFEBOOL			
Node2/						
NX-SID800						
Safety Inputs						
	SI00 Logical Value	R	SAFEBOOL	SL_STOP1		Global Variables
	SI01 Logical Value	R	SAFEBOOL			
	SI02 Logical Value	R	SAFEBOOL	SL_RESET		Global Variables
	SI03 Logical Value	R	SAFEBOOL			
	SI04 Logical Value	R	SAFEBOOL			
	SI05 Logical Value	R	SAFEBOOL			
	SI06 Logical Value	R	SAFEBOOL			
	SI07 Logical Value	R	SAFEBOOL			
Status						
	Safety Connection Status	R	SAFEBOOL			
	Safety Input Terminal Status	R	SAFEBOOL			
Node2/						
NX-SOD400						
Status						
	Safety Connection Status	R	SAFEBOOL			
	Safety Output Terminal Status	R	SAFEBOOL			
Safety Outputs						
	SO00 Output Value	W	SAFEBOOL	SO_LAMP		Global Variables
	SO01 Output Value	W	SAFEBOOL			
	SO02 Output Value	W	SAFEBOOL			
	SO03 Output Value	W	SAFEBOOL			

9. Create safety program

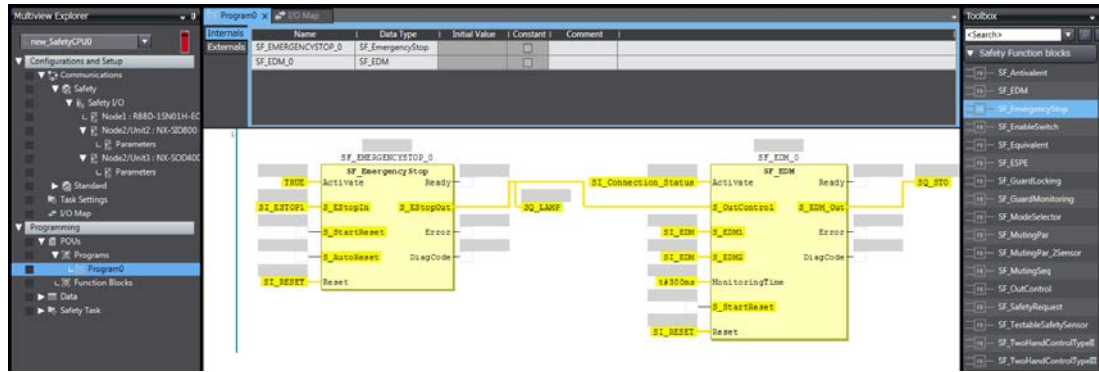

10. Transfer to the controller

Please select the controller area

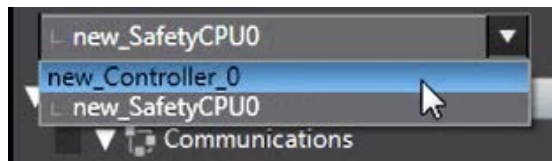

Connect to the controller



Synchronize with the controller



Transfer to the controller

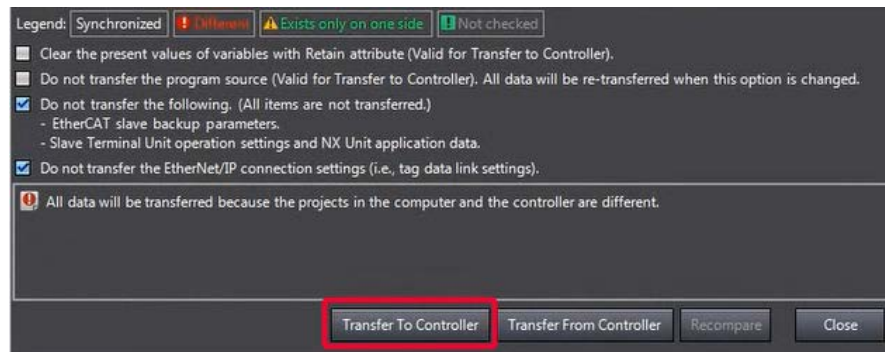

11. **Download the safety application**

Please select the new safety CPU

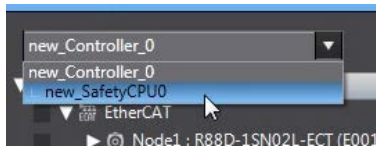

Switch to program mode

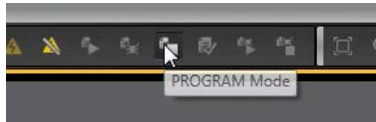

Activate and run the debug mode

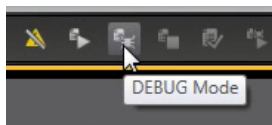

then

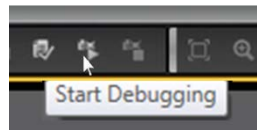

Click on safety validation

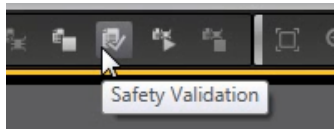

The safety application is now ready to run

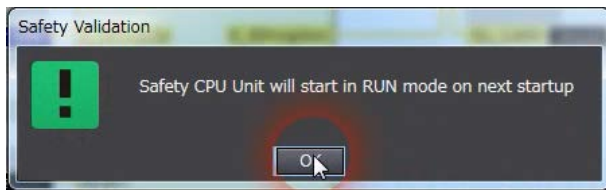

Please click on run



12. **The FSoE communication is now established**

FS LED is green and fixed ON.

STO is activated when Emergency stop button is pushed

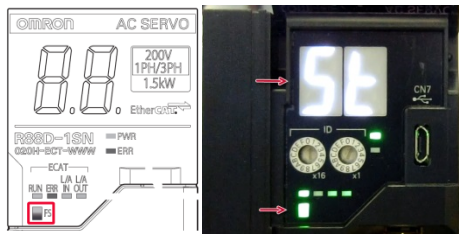

FS	Displays FSoE communications status.	Green	ON	FSoE slave connection established
			Flashing	FSoE slave connection establishment in progress
		Red	Flashing	Safety Parameter Error, Safety Communications Timeout, or other errors
		---	OFF	STO via FSoE is disabled, the power is not supplied, or a fatal error including Self-diagnosis Error

STO is released when Emergency stop button was released and RESET button activated.



ANNEX

Add a drive and axis OFFLINE

■ Creating the EtherCAT Network Configuration

1. Double-click EtherCAT under Configurations and Setups in the Multiview Explorer.

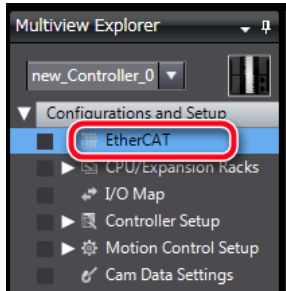

The EtherCAT Tab Page is displayed in the Edit Pane.

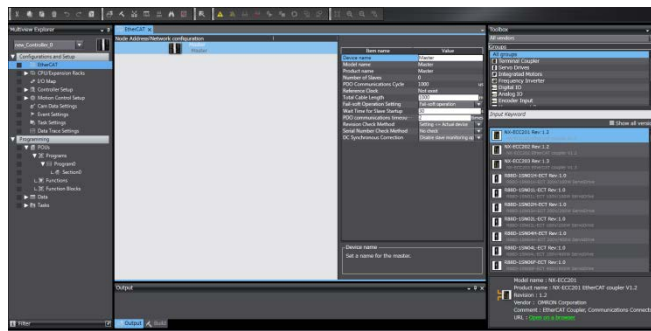

2. Drag the Drive from the Toolbox to the master on the EtherCAT Tab Page

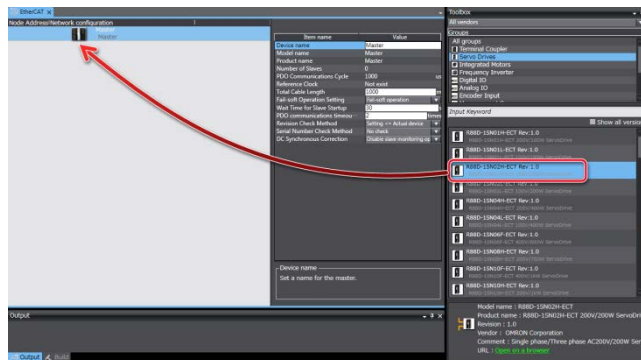

The Servo Drive is added under the master with a node address of 1.

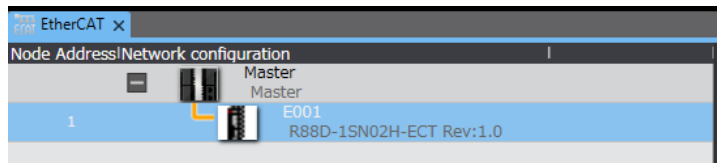

Additional Information

If the physical EtherCAT network configuration is already connected, you can automatically create the virtual network configuration in the Sysmac Studio based on the physical network configuration. Refer to the Sysmac Studio Version 1 Operation Manual (Cat. No. W504) for specific procedures.

■ Setting the axis

This section describes how to add the axis that is used to control the Servo Drive, assign it to the Servo Drive, and set the axis parameters.

1. **Right-click MC_Axis000 (axis 0) in the Multiview Explorer and select Edit from the menu.**

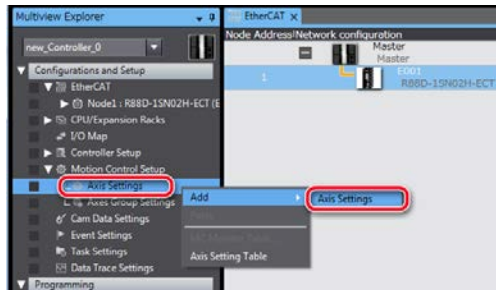

Axis 0 is added to the Multiview Explorer. The axis is added as MC_Axis000.

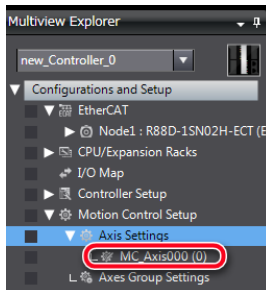

2. **Right-click MC_Axis000 (axis 0) in the Multiview Explorer and select Edit from the menu.**

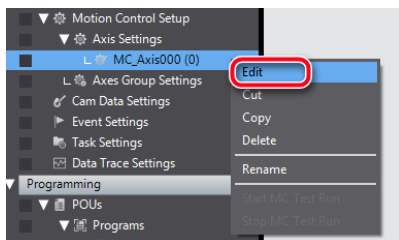

The Axis Basic Settings are displayed on the Axis Parameter Settings Tab Page in the Edit Pane.

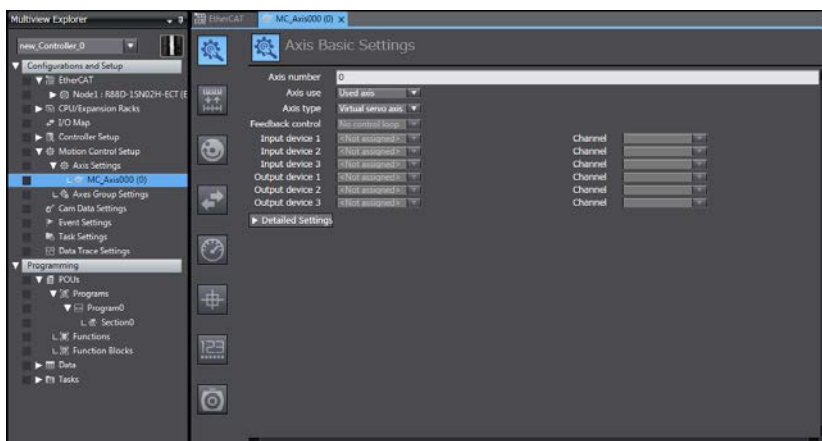

3. **Select Servo axis in the Axis type Box.**

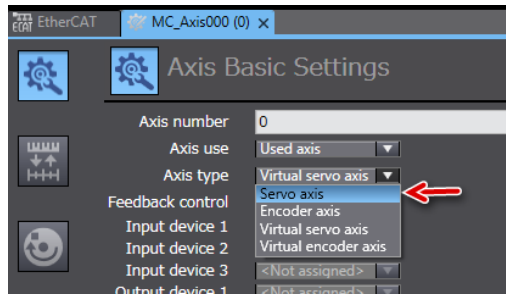

4. **Select the Servo Drive to use in the Input device Box**

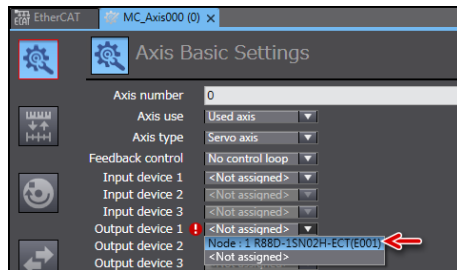

This will assign node 1 and the drive to the input device for axis 0.

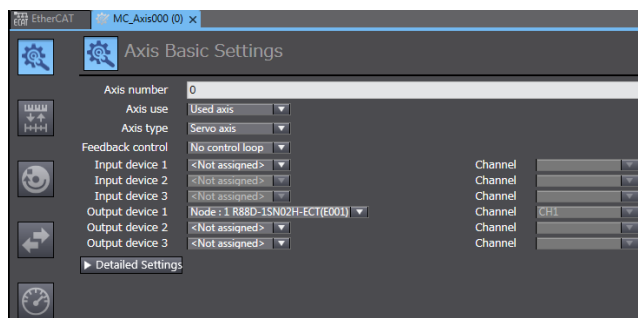

5. **Set the parameters on the Axis Parameter Settings Tab Page**

The following figure shows the axis parameters for the unit conversion settings.

Unit of Display: degree

Command Pulse Count Per Motor rotation: 8388608 (23 bit)

Work travel distance per motor rotation: 360°

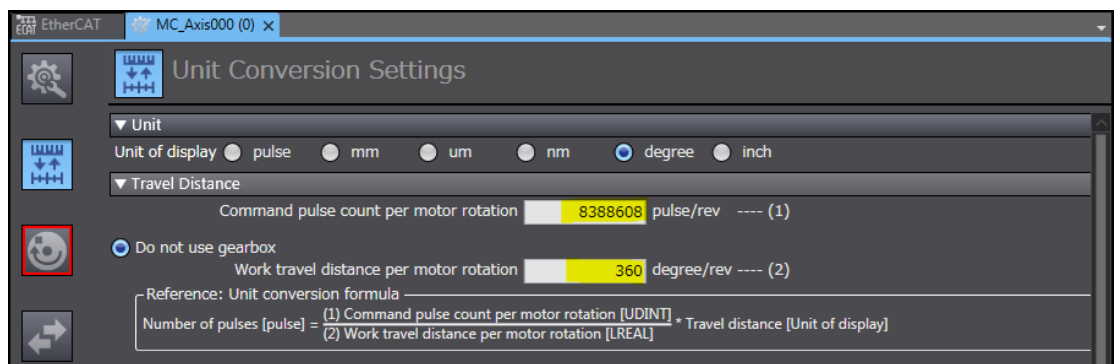

6. **Operation settings**

Maximum Velocity: 18 000 degree/s

Maximum Jog Velocity: 360 degree/s

The screenshot shows the 'Operation Settings' window for MC_Axis000 (0). The settings are organized into several sections:

- Velocity/Acceleration/Deceleration:**
 - Maximum velocity: 18000 degree/s
 - Start velocity: 0 degree/s
 - Maximum jog velocity: 360 degree/s
 - Maximum acceleration: 0 degree/s²
 - Maximum deceleration: 0 degree/s²
 - Acceleration/deceleration over: Use rapid acceleration/deceleration (Blending is changed to Buffered)
 - Operation selection at Reversing: Deceleration stop
- Torque:**
 - Positive torque warning value: 0 %
 - Negative torque warning value: 0 %
- Monitor:**
 - In-position range: 10 degree
 - Actual velocity filter time constant: 0 ms
 - In-position check time: 0 ms
 - Zero position range: 10 degree

7. **Position count settings**

Count mode: Rotary mode

Modulo max: 360

Modulo min: 0

The screenshot shows the 'Position Count Settings' window for MC_Axis000 (0). The settings are as follows:

- Count mode:** Linear mode (unselected), Rotary mode (selected)
- Modulo maximum position setting value:** 360 degree
- Modulo minimum position setting value:** 0 degree
- Encoder type:** Absolute encoder

Test run and data trace

1. Please right click to the drive and select “test run”

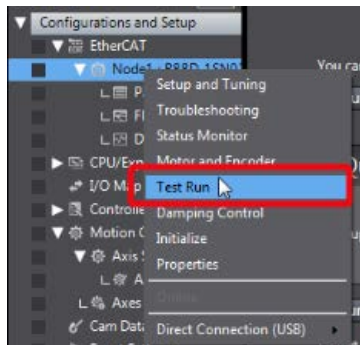

2. Please click “step” tab, adjust motion profile and apply

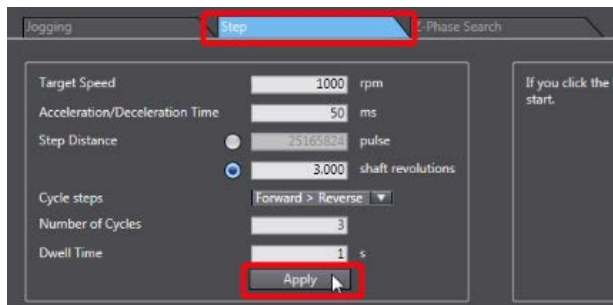

3. Activate the servo ON

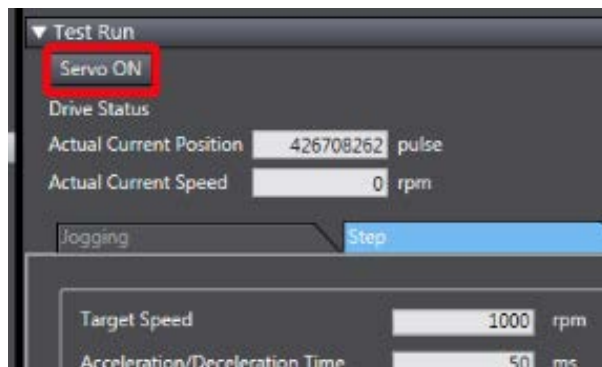

4. Please right click to the “data trace settings” and add a new trace

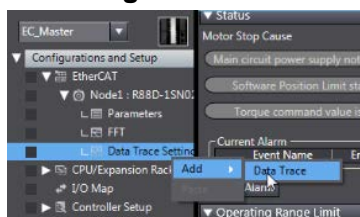

5. Chose cyclic mode

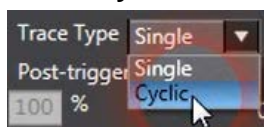

6. Adjust the sampling interval

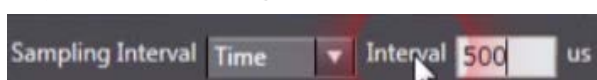

7. Adjust the trigger condition

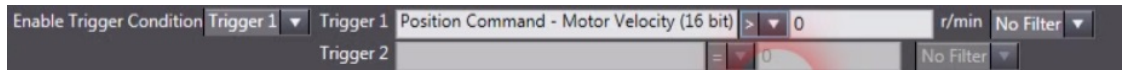

8. Push record button



Sysmac Studio is now waiting for the trigger

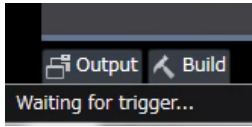

9. Place the Test run and Data trace windows side-by-side with docking window feature

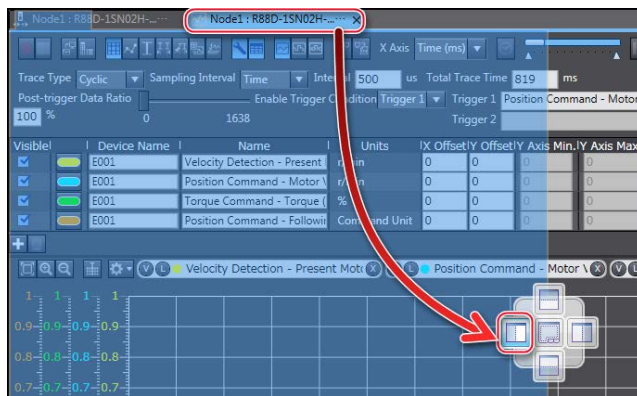

Push start in test run, data traces will appear cyclically

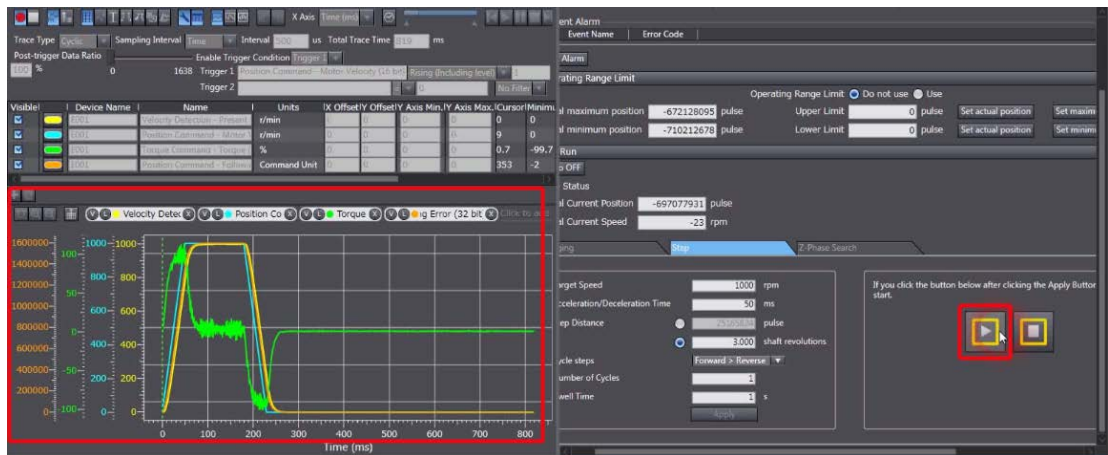

Manual tuning

Manual tuning guide

1. Please right click to the drive and select "setup and tuning"

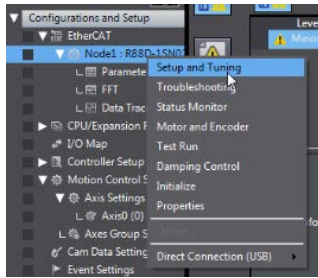



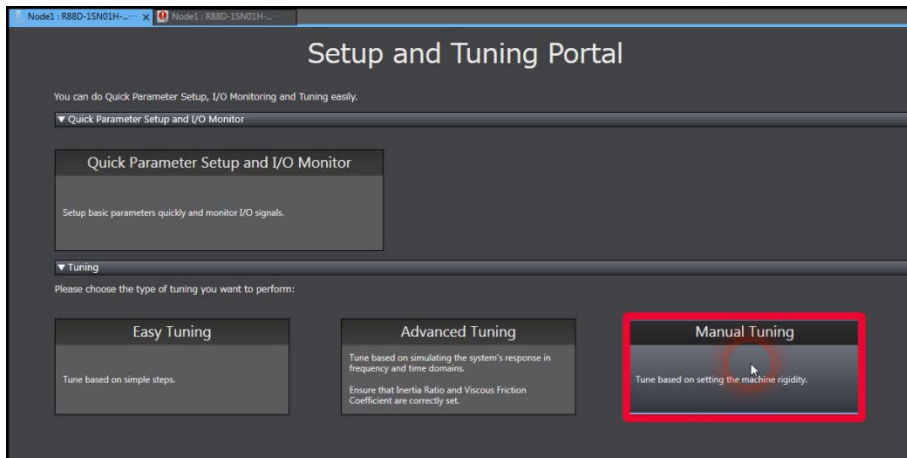

2. Please select Manual Tuning

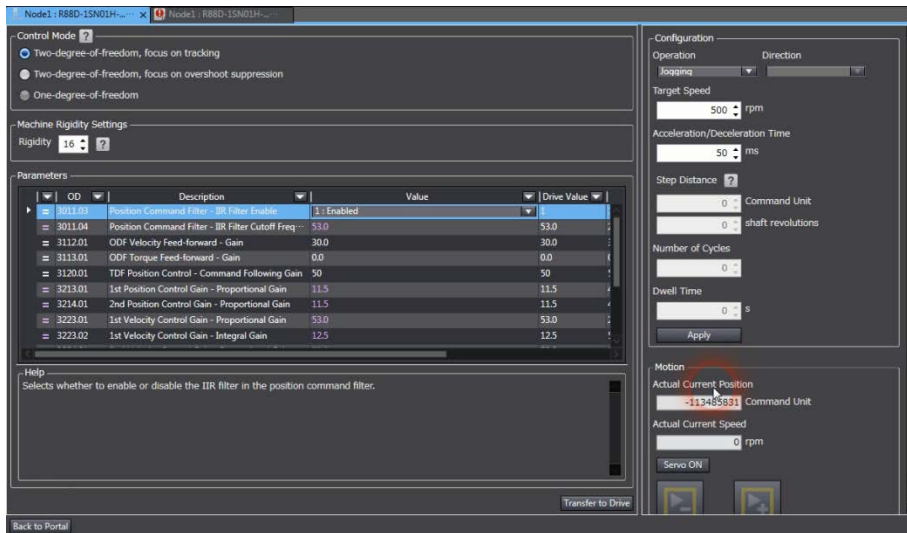

Manual tuning window is displayed

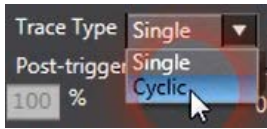
It includes rigidity settings, gain parameters and drive test run



3. In order to check the behavior of the motor, Please right click to the “data trace settings” and add a new trace
 
4. Chose cyclic mode
 
5. Adjust the sampling interval
 
6. Adjust the trigger condition
 
7. Disable parameters reading
 

Push record button

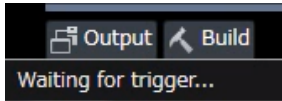
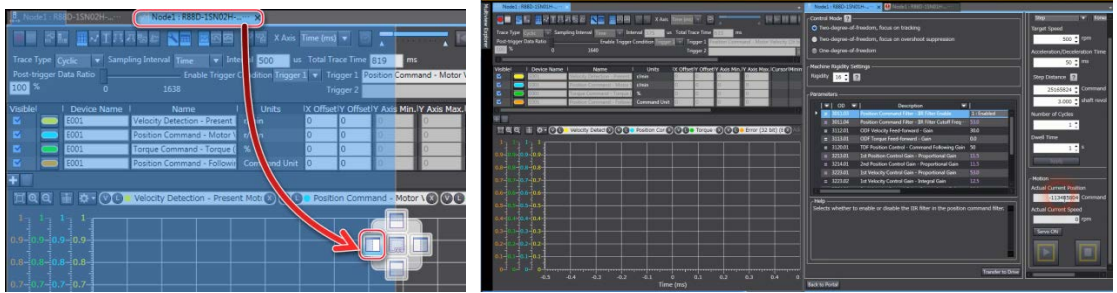

Sysmac Studio is now waiting for the trigger

8. Place the Test run and Manual tuning windows side-by-side with docking window feature
 

9. **Configure the motion profile and click Apply**

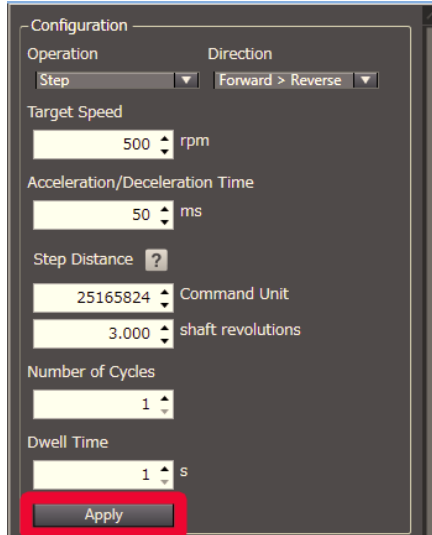

10. **Activate the Servo ON and Push Start**



Be careful, the motor will move in the forward and reverse direction

11. **The data trace is now triggered and result displayed**

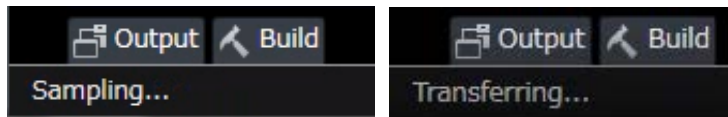

Each time the motor will move, traces will appear cyclically.

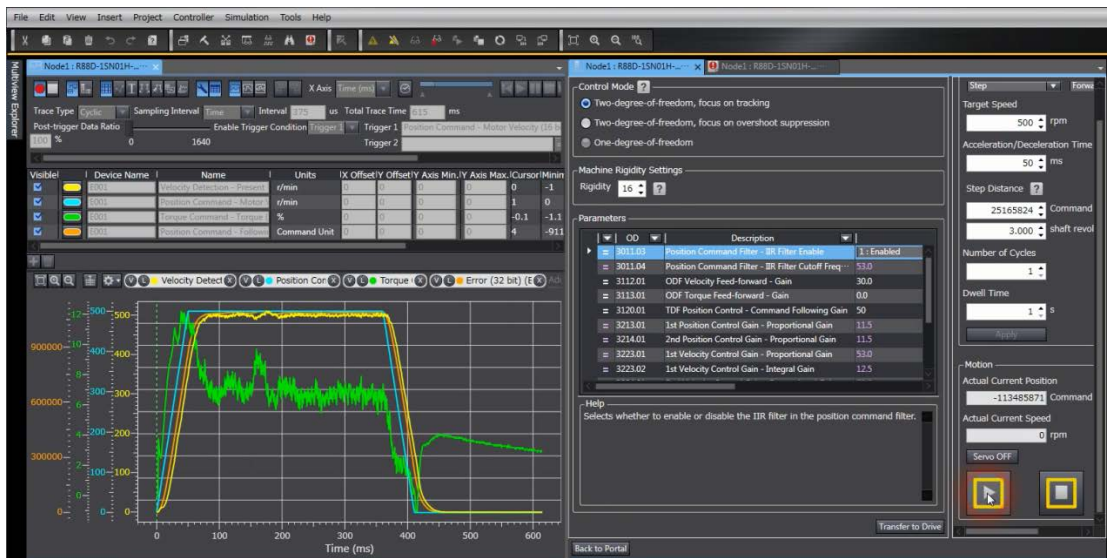

12. **It is possible to increase gain values by changing the rigidity settings**

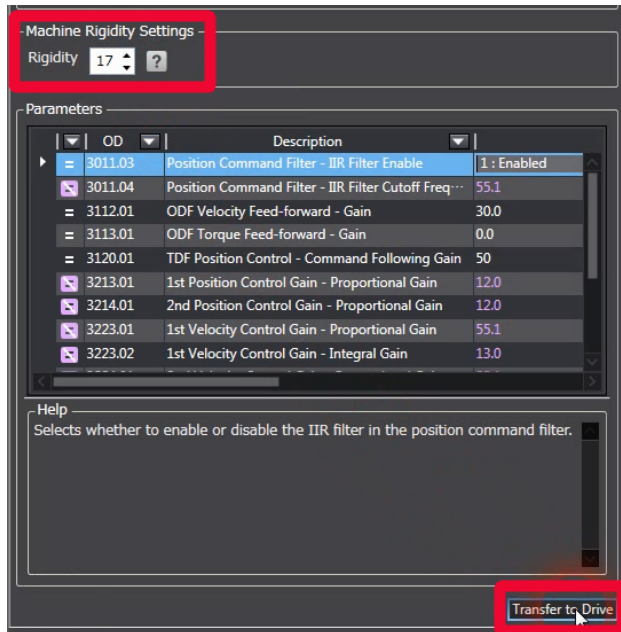

Push transfer to send the gain parameters to the drive.

13. **Please repeat step 10,11 and 12 until achieving the desired performance**

If vibrations appear, please reduce the rigidity settings.

If required, It is possible to increase responsiveness by applying notch filters in advanced tuning mode and adjusting gains. Please refer to Annex "[Advanced tuning](#)".

Advanced tuning

Advanced tuning guide

Overview

Below example explain the way to tune a 1S servo drive and motor with advanced tuning. This method of tuning decrease dramatically the number of tests and trial with actual machine.

1. Please right click to the drive and select “setup and tuning”

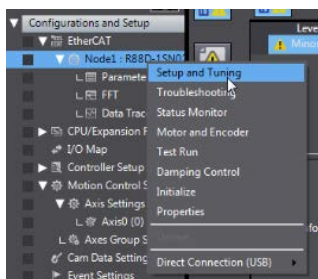

2. Please select Advanced Tuning

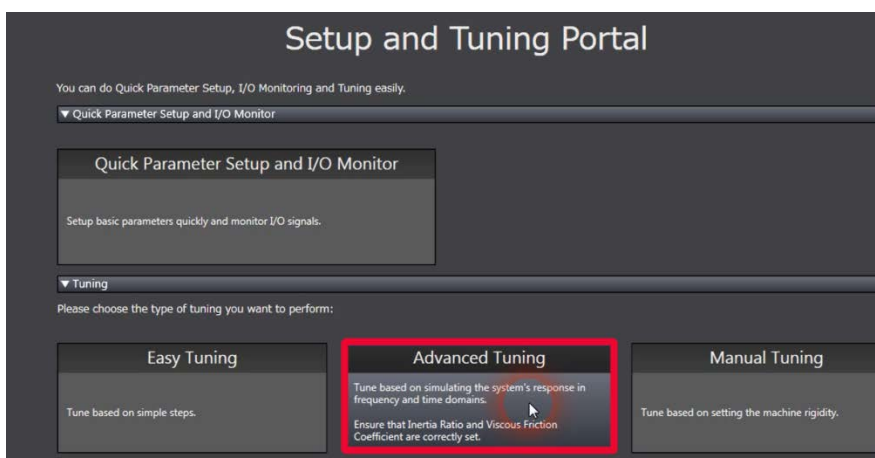

3. Configuration (Wizard Step 1)

Please select your control mode



Please estimate the load characteristics by pushing start (the motor will move)

If easy tuning has been performed already, please select "use present setting"

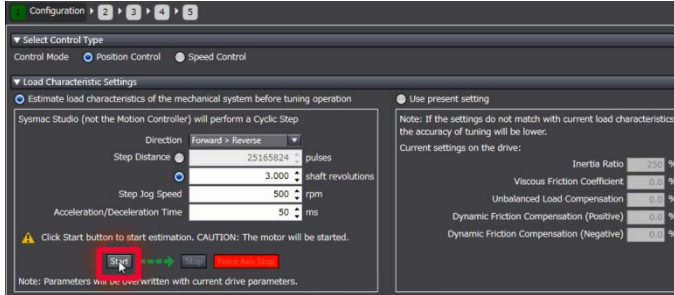

Load characteristics have been updated

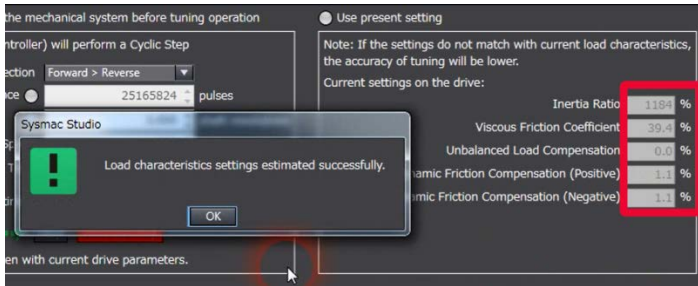

Click Next

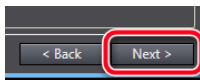

4. Frequency response simulation (Wizard Step 2)

Please start the trace (FFT measurement will be performed, the motor will move slightly)

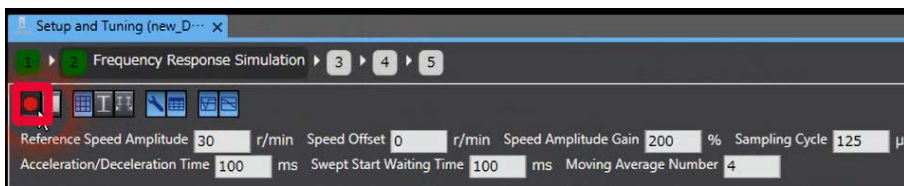

FFT measurement and simulated values are displayed (Gain and Phase)

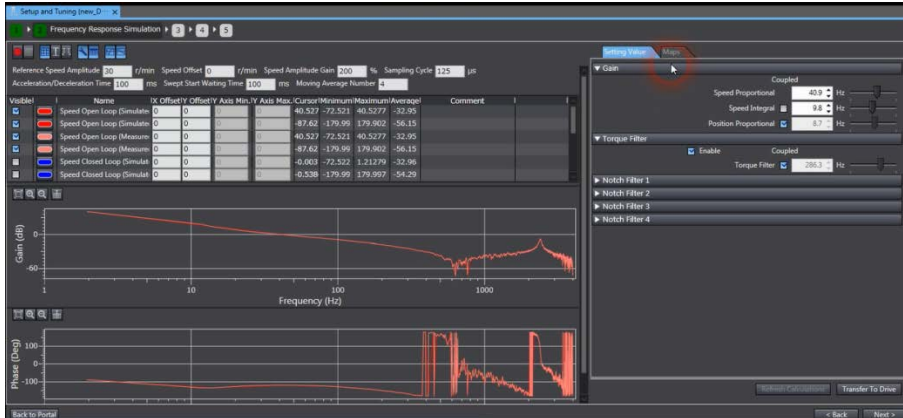

5. **Adjust gain and simulate**
 Please select Maps feature:

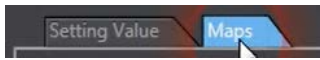

Adjust the gain to a proper value and push “refresh simulation”

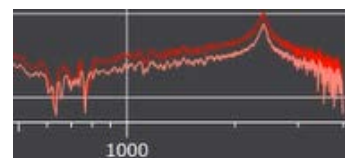
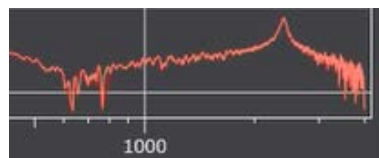
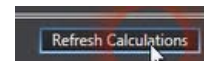
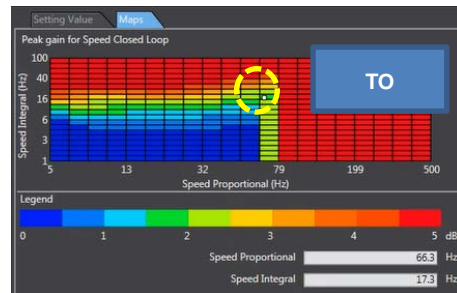
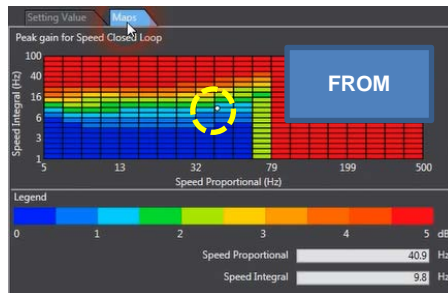
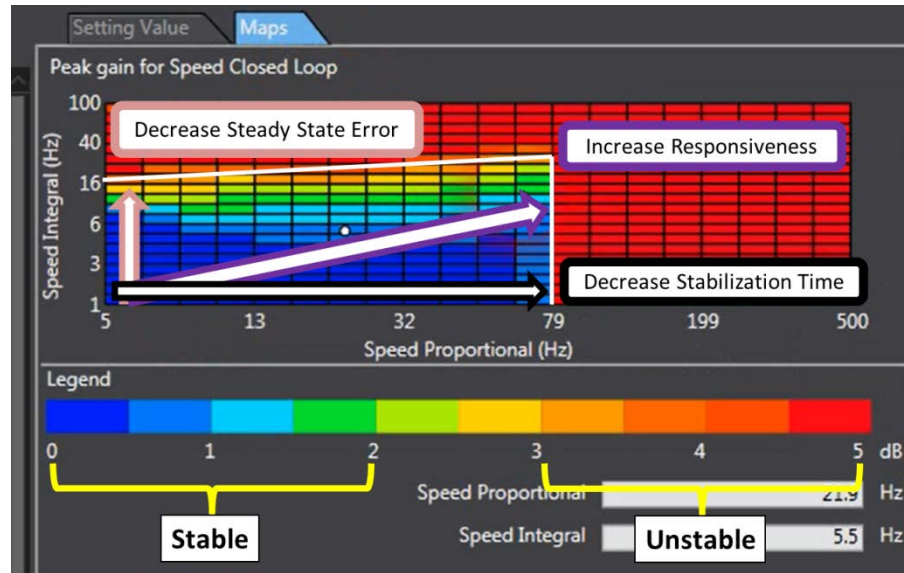

Pink curve is the measured value
 Red curve is the simulated value

6. **Adjust notch filters and simulate**

After increasing gains, the gain simulation shows a peak near 0dB. This peak shows a resonance frequency:

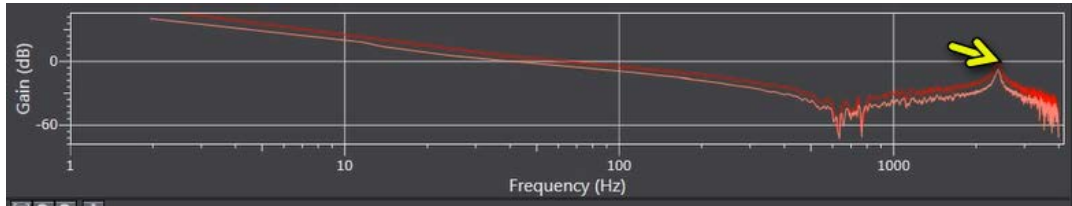

Activate the cursor to measure the frequency

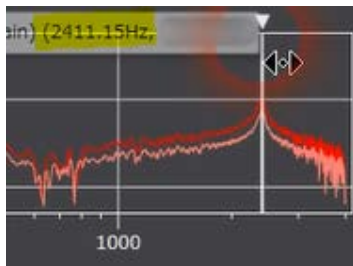

Activate the 1st notch filter to remove this resonance frequency at 2411 Hz:

A screenshot of the 'Notch Filter 1' control panel. The 'Enable' checkbox is checked. The 'Frequency' is set to 2411 Hz, the 'Q value' is 1.40, and the 'Depth' is 60 dB. A 'Refresh Calculations' button is visible. Below the control panel, a Bode plot shows the resonance peak at 2411 Hz being removed, resulting in a flat gain response.

7. **Increase gain with Maps and simulate**

After activating the notch filter, gain can be increased and performance improved

8. **Time response simulation (Wizard step 3)**

In time response simulation, the motion profile can be simulated.

Please push “Simulate Motion Profile”

The chart is updated and shows:

- The speed command, speed detection simulation and following error simulation.

If necessary, please adjust gains:

If your application required a small tracking error, here is an example of position following gain adjustment:



Following error has been reduced.

9. When satisfied with the simulation result, please transfer parameters to the drive

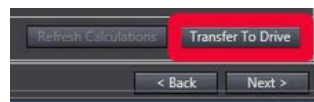

Click Next

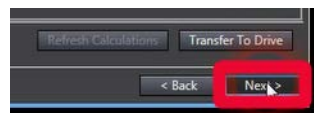

10. Check behavior (Wizard step 4)

Push start trace (the motor will move following the previous configuration in Wizard step 3)



The chart is updated and shows:

- The speed command, speed detection, following error and torque.

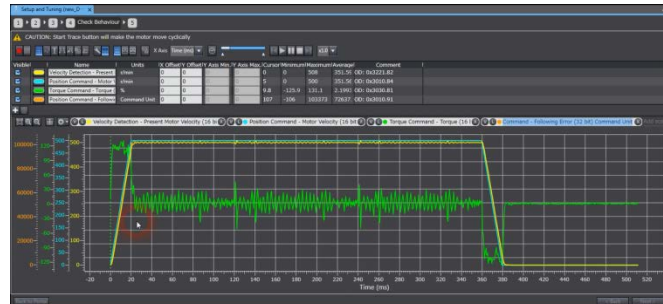

If satisfied, please click next



11. Results (Wizard step 5)

Setup and Tuning (new_D... x)

Results

Related Parameters

OD	Description	Value	Drive Value	Default	Range	Units	Data Attribute
3000.03	Basic Functions - Control Method Selection	1: TDF control	1	1	0 to 1		C
3001.01	Machine - Inertia Ratio	1187	1187	250	0 to 10000	%	A
3011.03	Position Command Filter - BR Filter Enable	1: Enabled	1	1	0 to 1		A
3011.04	Position Command Filter - BR Filter Cutoff Freq...	179.0	179.0	21.9	1.0 to 5000.0	Hz	A
3112.01	ODF Velocity Feed-forward - Gain	30.0	30.0	30.0	0.0 to 100.0	%	A
3112.02	ODF Velocity Feed-forward - LPF Enable	0: Disabled	0	0	0 to 1		A
3112.03	ODF Velocity Feed-forward - LPF Cutoff Freque...	5000.0	5000.0	5000.0	1.0 to 5000.0	Hz	A
3113.01	ODF Torque Feed-forward - Gain	0.0	0.0	0.0	0.0 to 100.0	%	A
3113.02	ODF Torque Feed-forward - LPF Enable	0: Disabled	0	0	0 to 1		A
3113.03	ODF Torque Feed-forward - LPF Cutoff Frequency	5000.0	5000.0	5000.0	1.0 to 5000.0	Hz	A
3120.01	TDF Position Control - Command Following Gain	600	600	50	10 to 5000	%	A
3121.01	TDF Velocity Control - Command Following Gain	100	100	100	10 to 5000	%	A
3213.01	1st Position Control Gain - Proportional Gain	40.7	40.7	4.4	0.0 to 500.0	Hz	A
3223.01	1st Velocity Control Gain - Proportional Gain	179.0	179.0	21.9	0.0 to 3000.0	Hz	A
3223.02	1st Velocity Control Gain - Integral Gain	33.8	33.8	5.5	0.0 to 1600.0	Hz	A
3233.01	1st Torque Command Filter - Enable	1: Enabled	1	1	0 to 1		A
3233.02	1st Torque Command Filter - Cutoff Frequency	1253.0	1253.0	153.6	1.0 to 5000.0	Hz	A
3310.01	Torque Compensation - Viscous Friction Coeffi...	39.3	39.3	0.0	0.0 to 1000.0	%	A
3310.03	Torque Compensation - Positive Dynamic Fricti...	1.1	1.1	0.0	0.0 to 100.0	%	A
3310.04	Torque Compensation - Negative Dynamic Fricti...	1.1	1.1	0.0	0.0 to 100.0	%	A
3321.01	1st Notch Filter - Enable	1: Enabled	1	0	0 to 1		A

Save to EEPROM

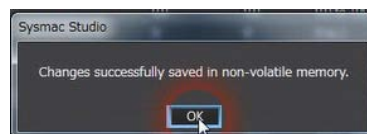
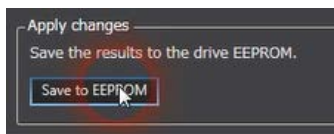

Finish



Note: Do not use this document to operate the Unit.

OMRON Corporation Industrial Automation Company

Tokyo, JAPAN

Contact: www.ia.omron.com

Regional Headquarters

OMRON EUROPE B.V.

Wegalaan 67-69, 2132 JD Hoofddorp
The Netherlands
Tel: (31)2356-81-300/Fax: (31)2356-81-388

OMRON ELECTRONICS LLC

2895 Greenspoint Parkway, Suite 200
Hoffman Estates, IL 60169 U.S.A
Tel: (1) 847-843-7900/Fax: (1) 847-843-7787

OMRON ASIA PACIFIC PTE. LTD.

No. 438A Alexandra Road # 05-05/08 (Lobby 2),
Alexandra Technopark,
Singapore 119967
Tel: (65) 6835-3011/Fax: (65) 6835-2711

OMRON (CHINA) CO., LTD.

Room 2211, Bank of China Tower,
200 Yin Cheng Zhong Road,
PuDong New Area, Shanghai, 200120, China
Tel: (86) 21-5037-2222/Fax: (86) 21-5037-2200

Authorized Distributor:

© OMRON Corporation 2019 All Rights Reserved.
In the interest of product improvement,
specifications are subject to change without notice.

Cat. No. I823-E1-02

0819 (0616)