



Omron TM Collaborative Robot S Series: Safety Manual



Original Instruction

This Manual contains information of the Techman Robot® product series (hereinafter referred to as the TM Robot). The information contained herein is the property of Techman Robot Inc. (hereinafter referred to as the Corporation). No part of this publication may be reproduced or copied in any way, shape or form without prior authorization from the Corporation. No information contained herein shall be considered an offer or commitment. It may be subject to change without notice. This Manual will be reviewed periodically. The Corporation will not be liable for any error or omission.

 and  logo are registered trademark of TECHMAN ROBOT INC. in Taiwan and other countries and the company reserves the ownership of this manual and its copy and its copyrights.

The textual descriptions and images contained in this Manual may differ from the actual product; in the event of any discrepancies, the actual product shall prevail.

 **TECHMAN ROBOT INC.**

Terms and Conditions Agreement

Warranty Limitations of Liability

Warranties

- Exclusive Warranty

Omron's exclusive warranty is that the Products will be free from defects in materials and workmanship for a period of twelve months from the date of sale by Omron (or such other period expressed in writing by Omron). Omron disclaims all other warranties, express or implied.

- Limitations

OMRON MAKES NO WARRANTY OR REPRESENTATION, EXPRESS OR IMPLIED, ABOUT NON-INFRINGEMENT, MERCHANTABILITY OR FITNESS FOR A PARTICULAR PURPOSE OF THE PRODUCTS. BUYER ACKNOWLEDGES THAT IT ALONE HAS DETERMINED THAT THE PRODUCTS WILL SUITABLY MEET THE REQUIREMENTS OF THEIR INTENDED USE.

Omron further disclaims all warranties and responsibility of any type for claims or expenses based on infringement by the Products or otherwise of any intellectual property right.

- Buyer Remedy

Omron's sole obligation hereunder shall be, at Omron's election, to (i) replace (in the form originally shipped with Buyer responsible for labor charges for removal or replacement thereof) the non-complying Product, (ii) repair the non-complying Product, or (iii) repay or credit Buyer an amount equal to the purchase price of the non-complying Product; provided that in no event shall Omron be responsible for warranty, repair, indemnity or any other claims or expenses regarding the Products unless Omron's analysis confirms that the Products were properly handled, stored, installed and maintained and not subject to contamination, abuse, misuse or inappropriate modification. Return of any Products by Buyer must be approved in writing by Omron before shipment. Omron Companies shall not be liable for the suitability or unsuitability or the results from the use of Products in combination with any electrical or electronic components, circuits, system assemblies or any other materials or substances or environments. Any advice, recommendations or information given orally or in writing, are not to be construed as an amendment or addition to the above warranty.

See <http://www.omron.com/global/> or contact your Omron representative for published information.

Limitations of Liability: Etc.

OMRON COMPANIES SHALL NOT BE LIABLE FOR SPECIAL, INDIRECT, INCIDENTAL, OR CONSEQUENTIAL DAMAGES, LOSS OF PROFITS OR PRODUCTION OR COMMERCIAL LOSS IN ANY WAY CONNECTED WITH THE PRODUCTS, WHETHER SUCH CLAIM IS BASED IN CONTRACT, WARRANTY, NEGLIGENCE OR STRICT LIABILITY.

Further, in no event shall liability of Omron Companies exceed the individual price of the Product on which liability is asserted.

Application Considerations

Suitability of Use

Omron Companies shall not be responsible for conformity with any standards, codes or regulations which apply to the combination of the Product in the Buyer's application or use of the Product. At Buyer's request, Omron will provide applicable third party certification documents identifying ratings and limitations of use which apply to the Product. This information by itself is not sufficient for a complete determination of the suitability of the Product in combination with the end product, machine, system, or other application or use. Buyer shall be solely responsible for determining appropriateness of the particular Product with respect to Buyer's application, product or system. Buyer shall take application responsibility in all cases.

NEVER USE THE PRODUCT FOR AN APPLICATION INVOLVING SERIOUS RISK TO LIFE OR PROPERTY WITHOUT ENSURING THAT THE SYSTEM AS A WHOLE HAS BEEN DESIGNED TO ADDRESS THE RISKS, AND THAT THE OMRON PRODUCT(S) IS PROPERLY RATED AND INSTALLED FOR THE INTENDED USE WITHIN THE OVERALL EQUIPMENT OR SYSTEM.

Programmable Products

Omron Companies shall not be responsible for the user's programming of a programmable Product, or any consequence thereof.

Disclaimers

Performance Data

Data presented in Omron Company websites, catalogs and other materials is provided as a guide for the user in determining suitability and does not constitute a warranty. It may represent the result of Omron's test conditions and the user must correlate it to actual application requirements. Actual performance is subject to the Omron's Warranty and Limitations of Liability.

- Change in Specifications

Product specifications and accessories may be changed at any time based on improvements and other reasons. It is our practice to change part numbers when published ratings or features are changed, or when significant construction changes are made. However, some specifications of the Product may be changed without any notice. When in doubt, special part numbers may be assigned to fix or establish key specifications for your application. Please consult with your Omron representative at any time to confirm actual specifications of purchased Product.

Errors and Omissions

Information presented by Omron Companies has been checked and is believed to be accurate; however, no responsibility is assumed for clerical, typographical or proofreading errors or omissions.

Table of Contents

Revision History Table	5
1. Comprehensive Information.....	6
1.1 Overview	6
1.2 Applicable Product Version	6
1.3 Safety Warning Symbols.....	6
1.4 Safety Precautions	7
1.5 Validation and Responsibility	8
1.6 Limitation of Liability	8
1.7 Overall Safety Warning.....	9
1.8 Intended Use	10
1.9 Risk Assessment	11
1.10 Statement of Responsibilities for Cybersecurity Threats	12
2. Safety Function.....	14
2.1 Overview	14
2.2 General Information	14
2.2.1 Safety Function Definitions.....	14
2.2.2 Configuration Tool	15
2.2.3 Performance Safety Settings and Human-Machine Safety Settings	15
2.2.4 Safety End-Points	16
2.2.5 Stopping Time and Stopping Distance in the Safety System	17
2.2.6 Software Safety Setting Permissions.....	17
2.2.7 Safety Checksum	17
2.3 Explanation of Safety Functions	17
2.3.1 Reset Functions – SF21, SF26	17
2.3.2 Emergency Stop Functions – SF0, SF1, SF16	19
2.3.3 Safeguard Functions – SF3.....	21
2.3.4 Enabling Switch Functions – SF15, SF19, SF22	21
2.3.5 Human-Machine Safety Settings Functions – SF9, SF18.....	22
2.3.6 Force and Torque Limit Functions – SF4, SF8	24
2.3.7 Speed Limit Functions – SF6, SF7, SF24	27
2.3.8 Soft Axis Limit Functions – SF5, SF17, SF31	28
2.3.9 Soft Axis Settings Switch Functions – SF27	29
2.3.10 Bumping Sensor Functions – SF23.....	30
2.3.11 MODE Switch Functions – SF25, Robot Stick Mode Switch function.....	30
2.3.12 FreeBot Input Functions – SF32.....	31
2.3.13 Output Functions – SF2, SF10, SF11, SF12, SF13, SF14, SF20, SF28, SF29, SF30	31

2.3.14 Output Signal Switching Device – OSSD.....	39
3. Safety Related Operation	40
3.1 Secure in De-energized Position	40
3.2 Mechanical Stops	40
3.3 Joint Movement without Drive Power.....	40
3.4 Operation Mode and MODE Switch.....	41
3.4.1 AUTO MODE	41
3.4.2 MANUAL MODE	41
3.4.3 Robot Stick MODE Switch Function	43
3.4.4 Recovery Mode.....	43
3.5 Hold-to-Run Function & Play Function.....	45
3.6 Singularity Point.....	45
3.7 Local Control and Robot Stick	49
4. Compliance of Safety Regulations	52
4.1 Compliance	52
4.1.1 Access of Safety Setting.....	52
5. Declaration of Incorporation.....	53
6. Maintenance and Repair.....	56
Appendix A. Certificate of Compliance and Declaration of Incorporation.....	57
Appendix B. Verifications of EMC Compliance.....	61
Appendix C. TM Robot Stopping Time and Distance for All Product Series	63

Tables

Table 1: Safety Warning Symbols.....	7
Table 2: Safety Function Definitions	15
Table 3: The Monitored End-point by the Limit Functions	16
Table 4: Source and Resume Method According to Stop Category	19
Table 5: Force and Torque Limit Functions by Different MODEs and Status	25
Table 6: Speed Limit functions according to Different MODEs and Status.....	28
Table 7: Soft Axis Settings according to Different MODEs and SF27 Input Status.....	30
Table 8: Operation Modes according to SF25 Input Status.....	31
Table 9: Hand guide teaching according to Different MODEs and Input Status	31
Table 10: Output Signal Condition of SF2.....	32
Table 11: The Output Signal Condition of SF10.....	33
Table 12: The Output Signal Condition of SF11.....	34
Table 13: The Output Signal Condition of SF12.....	35
Table 14: Output Signal Condition of SF13 and SF14	36

Table 15: Output Signal Condition of SF28.....	37
Table 16: Output Signal Condition of SF20 and SF29	37
Table 17: Output Signal Condition of SF30.....	38
Table 18: The OSSD Term Definition	39
Table 19: Limit functions according to Recovery Mode.....	44
Table 20: The R_{offset} values of each product series.....	46
Table 21: Robot Stick Status and Operation.....	50
Table 22: Initiate Robot Motion Functions according to Robot Stick Status and MODEs	51
Table 23: Safety Elements according to Robot Stick Status and MODEs	51
Table 24: Declaration of Incorporation.....	55
Table 25: Summary of the Preventive Maintenance Procedures and Guidelines	56
Table 26: Stopping Time and Distance for TM5S Series	63
Table 27: Stopping Time and Distance for TM6S Series	64
Table 28: Stopping Time and Distance for TM7S Series	65
Table 29: Stopping Time and Distance for TM12S Series	66
Table 30: Stopping Time and Distance for TM14S Series	67
Table 31: Stopping Time and Distance for TM20S Series	68
Table 32: Stopping Time and Distance for TM25S Series	69
Table 33: Stopping Time and Distance for TM30S Series	70

Figures

Figure 1: Safety System Version on UI.....	6
Figure 2: Safety End-Point Definition.....	16
Figure 3: X, Y, & Z axes	27
Figure 4: The OSSD Pattern Definition.....	39
Figure 5: The Definition of R_{offset}	46
Figure 6: Extensible Singularity Point in Space.....	47
Figure 7: Wrist Singularity Point in Space.....	48
Figure 8: The Solution when Encountering Singularity Point in Space (1/2).....	48
Figure 9: The Solution when Encountering Singularity Point in Space (2/2).....	49

Revision History Table

Revision	Date	Description
A	June, 2023	Original release
B	March, 2024	Minor revision
C	August, 2024	Minor revision
D	April, 2025	Minor revision
E	August, 2025	Minor revision
F	August, 2025	Minor revision
G	November, 2025	Minor revision

1. Comprehensive Information

1.1 Overview

This chapter describes the comprehensive important safety information of TM Robot. The user and system integrator of TM Robot must read and fully understand this chapter before using this robot.

1.2 Applicable Product Version

This document is only applicable to the corresponding safety system of TM Robot. Users can check the safety system version on UI of **TMflow > Configuration > Safety**.

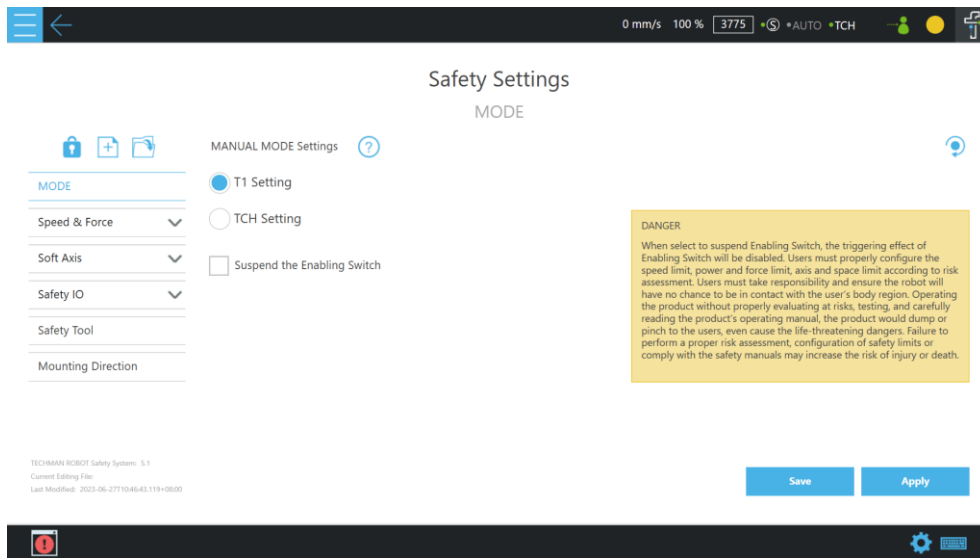



Figure 1: Safety System Version on UI

Users should confirm whether the safety system version of the TM Robot is consistent with the applicable product version of this *Omron TM Collaborative Robot S Series: Safety Manual (Cat. No. I688)*. The Corporation is not responsible for any safety issues caused by referring to the safety instruction of an incorrect version.

1.3 Safety Warning Symbols

The following table defines the levels of the safety warning symbols that are marked in each paragraph in this Manual. Read carefully and comply with each paragraph to avoid harm to people or equipment.

	DANGER: Identifies an imminently hazardous situation which, if not avoided, is likely to result in serious injury, and might result in death or severe property damage.
	WARNING: Identifies a potentially hazardous situation which, if not avoided, will result in minor or moderate injury, and might result in serious injury, death, or significant property damage.



	CAUTION: Identifies a potentially hazardous situation which, if not avoided, might result in minor injury, moderate injury, or property damage.
	WARNING: ELECTROCUTION RISK Identifies a hazardous electrical situation.

Table 1: Safety Warning Symbols

1.4 Safety Precautions



DANGER:

This product may cause serious injuries or even death and bring damages to itself and other equipment without an entire understanding of the following safety precautions.

- All personnel who install, operate, teach, program, or maintain the system must read the *Omron TM Collaborative Robot S Series: TM5S / TM6S / TM7S / TM12S / TM14S / TM20S Hardware Installation Manual (Cat. No. M135)*, *Omron TM Collaborative Robot S Series: TM25S and TM30S Hardware Installation Manual (Cat. No. M104)*, *Omron TM Collaborative Robot: Software Manual TMFlow, Version 2 (Cat. No. I689)*, and *Omron TM Collaborative Robot S Series: Safety Manual (Cat. No. I688)* according to the software and hardware version of this product, and complete a training course for their responsibilities concerning the robot.



Read Manual and Impact Warning labels

- All personnel who design the robot system must read the *Omron TM Collaborative Robot S Series: TM5S / TM6S / TM7S / TM12S / TM14S / TM20S Hardware Installation Manual (Cat. No. M135)*, *Omron TM Collaborative Robot S Series: TM25S and TM30S Hardware Installation Manual (Cat. No. M104)*, *Omron TM Collaborative Robot: Software Manual TMFlow, Version 2 (Cat. No. I689)*, and *Omron TM Collaborative Robot S Series: Safety Manual (Cat. No. I688)* according to the software and hardware version of this product, and must comply with all local and national safety regulations of the location where the robot is installed.
- Read the **Intended Use** section in *Omron TM Collaborative Robot S Series: Safety Manual (Cat. No. I688)* carefully.
- If the installation and application does not observe human-robot collaboration regulations of the safety regulations, user is responsible for providing safety barriers around the robot to prevent anyone from accidentally coming into contact with the robot when it is in motion.
- If any local or national electrical regulation requires, power to the robot and its power supply must

be locked out and tagged out, or have means to control hazardous energy or implement energy isolation before any maintenance is performed.

- Failure to use appropriate power (less than or more than the rated voltage range) can lead to malfunction or failures of the robot or hazardous situations.
-  Dispose of the product in accordance with the relevant rules and regulations of the country or area where the product is used.

1.5 Validation and Responsibility

The information provided in this Manual does not include how to design, install and operate a complete arm application, nor does it include the peripheral devices that will affect the overall system safety. The design and installation of the complete system must comply with local and national standards and regulations for safety requirements. The robot integrator needs to understand safety laws and safety regulations in the local countries, in order to avoid major risks existing in the entire system.

This includes but is not limited to:

- Performing a risk assessment of the whole system
- Adding other machines and additional risk reduction measures based on the results of the risk assessment
- Using appropriate software safety features
- Ensuring no unnecessary modifications to the current safety measures which have already been qualified or confirmed
- Ensuring all systems are correctly designed and installed
- Specifying instructions for use
- Clearly marking the contact information of the integrator that installed the robot
- Making relevant documents accessible, including the risk assessment, and this manual



CAUTION:

This product is only partially completed machinery. The design and installation of the complete system must comply with local and national safety standards and regulations in the country of use. Users and integrators of the robot should understand the safety laws and regulations in their countries to prevent potential hazards from coming into the complete system.

1.6 Limitation of Liability

Even if the safety instructions are followed, any safety-related information in the manual shall not be considered as a guarantee that the product will not cause any personal injury or damage.

1.7 Overall Safety Warning

These safety warnings are relevant for the entire manual.



DANGER:

1. Before transporting, installing, operating, maintaining and repairing this product, make sure to read the product specification and operation manual in detail. Confirm that all the conditions comply with the requirements of the specification and the Manual, to avoid unintended accidents (for example: improper operation or conditions of use that exceed the product specification) that may result in injury to personnel.
2. Before installing and using this product, the integrator must perform a risk assessment and implement risk reduction measures.
3. Users shall create procedures for emergency and abnormal situations.
4. Before using this product, make sure that the emergency stop device functions correctly.



WARNING:

1. Before disassembling or repairing this product, make sure that the power has been turned off and disconnected before proceeding to avoid injury to people or damage to machinery caused by inadvertent short circuit or electric shock.
2. When operating this product, the operator shall avoid wearing loose clothing or wearing other accessories (such as: necklaces, ties, bracelets, etc.) to avoid injury caused by clothing or accessories becoming entangled in the machine during operation.
3. If the product malfunctions, follow the established procedures of your organization to obtain repair of the product. Do not attempt to repair the product yourself to avoid damage to the machinery.
4. Before the robot is in operation, make sure that each part has been completely mounted to avoid any possibility of accidents.
5. Before starting the operation of the robot, confirm that there are no persons or obstacles that may intrude into the operating area during operation. If the operating environment uses human-robot cooperative operation, be sure to complete the due risk assessment before starting the operation.
6. It is forbidden for any unauthorized person to operate this product in order to avoid any possibility of injury to personnel or damage to the machinery.
7. Do not install or operate this product in a hazardous area (for example: strong magnetic field, hazardous gas, fire source, or flammable product) In order to prevent the machinery from causing danger during operation because of external conditions.

**CAUTION:**

1. Before operating the robot, confirm the status of the machinery warning light.
2. After editing the task flow, operate the robot in the MANUAL MODE first, and confirm that all the movements in the task flow are correct before switching the Operation Mode to AUTO MODE.
3. During the operation of machinery, do not turn off the power supply to prevent possible damage to the system.
4. For the robot noise levels and related environmental conditions, refer to the *Omron TM Collaborative Robot S Series: TM5S / TM6S / TM7S / TM12S / TM14S / TM20S Hardware Installation Manual (Cat. No. M135)*, *Omron TM Collaborative Robot S Series: TM25S and TM30S Hardware Installation Manual (Cat. No. M104)* for the corresponding hardware version.

1.8 Intended Use

The TM Robot is designed so the hazards can be reduced to tolerable levels when installed as specified and operated under normal and intended use. TM Robot has been designed and constructed in accordance with relevant safety standards. TM Robot is intended for use in parts assembly and material handling for payloads (including end-effector and workpiece) up to the “Maximum Payload” specification of each model.

The TM Robot focuses on the safety of human-robot cooperative operation by design, but the cooperative operation is only for application procedures that have undergone a risk assessment including robots, related peripheral equipment and working environment.

Any use or application should be subject to risk assessment and ensure no harm. The Corporation disclaims any responsibility for any improper uses or application damages. Improper uses or application damages include but are not limited to:

- Use in a potentially hazardous environment
- Use in any applications that may threaten human lives
- Use in any application that may cause personal injuries
- Use before completion of the risk assessment and implementation of risk reduction measures
- Use for life support
- Use when the rated performance cannot be reached
- Use when the reaction time of safety functions is insufficient
- Use without appropriate parameters in operations

- Use in applications which may cause damage to the robot itself
- Restricted movement of persons
- Failure to comply with applicable safety laws and regulations
- Failure to effectively notify customers, users, or operators of uses and risks
- Use without proper mounting of the robot
- Use involving excessive oscillations when moving
- Use without proper design of earthquake-prevention mounting when installed in earthquake zones
- Use without safe access to (or at/from) the work station
- Use in the presence of exhaust gases/lack of oxygen at the work position
- Use in the presence of flame (flammability of the cabinet, lack of extinguishing means)
- Use with mechanical hazards at the work position: a) rollover; b) fall of objects, penetration by objects; c) break-up of parts moving at high speed; d) contact of persons with machine parts or tools (non-collaborative machines)
- Use with insufficient visibility from the work positions
- Use with inadequate lighting
- Use with inadequate seating
- Use with insufficient means for escape or entrapment avoidance
- Use with inadequate location of manual controls
- Use with inadequate design of manual controls and their mode of operation



IMPORTANT:

The term “collaborative robot” is not used in ISO 10218-1 as only the application can be developed, verified and validated as a collaborative application.

1.9 Risk Assessment

Before installing and using this product, the user must first perform a risk assessments based on the conditions of use. Risk assessments can be in reference to the specifications of ISO 10218-2, ISO 12100 and ISO/TS 15066 documentations. The purpose of a risk assessment is to anticipate any accidents that may occur during the operation process and by means of appropriate protective measures to reduce the occurrence of accidents or to reduce the severity of injury to persons in the event of an accident. Therefore, the risk assessment needs to include any operational actions of the machinery within the scope of the assessment. After the risk assessment is completed, the user can use external related components (i.e. sensing components, emergency stop devices, fences or railings, etc.) as well as the parameter settings of safety functions in the operating system, to reduce possible occurrence of accidents. Additional safety-related components must be installed in accordance with the manufacturer's specifications for the required risk reduction. For operating system safety settings and

other safety components usage, read and understand these manuals, the *Omron TM Collaborative Robot: Software Manual TMFlow, Version 2 (Cat. No. I689)* and the *Omron TM Collaborative Robot S Series: TM5S / TM6S / TM7S / TM12S / TM14S / TM20S Hardware Installation Manual (Cat. No. M135)*, *Omron TM Collaborative Robot S Series: TM25S and TM30S Hardware Installation Manual (Cat. No. M104)* of corresponding versions.

Potential hazards requiring additional risk reduction measures may include but are not limited to:

1. Finger(s) (especially in the case of hand guiding) caught between the rear end of the camera module and the joint module(s).
2. The palm or finger injured by the motion of the robot or the hand guide teaching, if caught between the robot end-effector (including the workpiece) and the robot body.
3. Being hit by a robot and injured.
4. Entrapment between a robot and a fixed surface.
5. Incorrect human-robot collaborative workspace setup, parameter settings or project operation.
6. TCP force may be estimated incorrectly when robot is passing the area near singularity point in space, due to the nature of singularity.



WARNING:

- Ensure compliance with all local and national safety and electrical codes for the installation and operation of the robot system.
- Provide appropriately sized Branch Circuit Protection and Lockout/Tagout Capability in accordance with the National Electrical Code and any local codes.



WARNING: ELECTROCUTION RISK

It is necessary for a skilled and instructed person to perform AC power installation. During installation, it is mandatory to prevent unauthorized third parties from turning on power with the use of lockout/tagout measures. Failure to use appropriate power can lead to malfunction or failures of the robot or hazardous situations.

1.10 Statement of Responsibilities for Cybersecurity Threats

To maintain the security and reliability of the system, a robust cybersecurity defense program should be implemented, which may include some or all of the following:

Anti-virus protection

- Install the latest commercial-quality anti-virus software on the computer connected to the control system and keep the software and virus definitions up-to-date.
- Scan USB drives or other external storage devices before connecting them to control systems and equipment.

Security measures to prevent unauthorized network access

- Install physical controls so that only authorized personnel can access control systems and equipment.

- Reduce connections to control systems and equipment via networks to prevent access from untrusted devices.
- Install firewalls to block unused communications ports and limit communication between systems. Limit access between control systems and systems from the IT network.
- Control remote access and adopt multifactor authentication to devices with remote access to control systems and equipment.
- Set strong password policies and monitor for compliance frequently.

Data input and output protection

- Backup data and keep the data up-to-date periodically to prepare for data loss.
- Validate backups and retention policies to cope with unintentional modification of input/output data to control systems and equipment.
- Validate the scope of data protection regularly to accommodate changes.
- Check validity of backups by scheduling test restores to ensure successful recovery from incidents.
- Safety design, such as emergency shutdown and fail-soft operations in case of data tampering and incidents.

Additional recommendations

- When using an external network environment to connect to an unauthorized terminal such as a SCADA, HMI or to an unauthorized server may result in network security issues such as spoofing and tampering.
- Users themselves should take adequate measures, such as restricting access to the terminal, using a terminal equipped with security features, and securing the installation area.
- When constructing network infrastructure, communication failure may occur due to cable disconnection or the influence of unauthorized network equipment.
- Take adequate measures, such as restricting physical access to network devices, by means such as locking the installation area.
- When using devices equipped with an SD Memory Card, there is a security risk that a third party may acquire, alter, or replace the files and data in the removable media by removing or unmounting the media.

2. Safety Function

2.1 Overview

TM Robot incorporates multiple safety functions and provides interfaces for additional external protective devices.

2.2 General Information

The following describes information of the TM Robot system safety functions. The safety functions and safety input/output are PLd, Category 3 according to ISO 13849-1:2015.

2.2.1 Safety Function Definitions

The table below lists the Safety Function Definitions of the TM Robot System.

SF#	Name	Stop Category	Structure Category	PL
SF0	Robot Stick ESTOP	Category 1 Stop	Cat. 3	d
SF1	User Connected ESTOP Input	Category 1 Stop	Cat. 3	d
SF2	Encoder Standstill Output	-	Cat. 3	d
SF3	User Connected External Safeguard Input	Category 2 Stop	Cat. 3	d
SF4	Additional Joint Torque Monitoring	Category 2 Stop	Cat. 3	d
SF5	Joint position Limit	Category 2 Stop	Cat. 3	d
SF6	Joint Speed Limit	Category 2 Stop	Cat. 3	d
SF7	Speed Limit	Category 2 Stop	Cat. 3	d
SF8	Additional Force Limit	Category 2 Stop	Cat. 3	d
SF9	User Connected External Safeguard Input for Human–Machine Safety Settings	-	Cat. 3	d
SF10	Robot ESTOP Output	-	Cat. 3	d
SF11	User Connected External Safeguard Output	-	Cat. 3	d
SF12	Robot Human–Machine Safety Settings Output	-	Cat. 3	d
SF13	Robot Recovery Mode Output	-	Cat. 3	d
SF14	Robot Moving Output	-	Cat. 3	d
SF15	User Connected Enabling Switch Input	Category 2 Stop	Cat. 3	d
SF16	User Connected ESTOP Input without Robot ESTOP Output	Category 1 Stop	Cat. 3	d
SF17	Cartesian Limit A	Category 2 Stop	Cat. 3	d
SF18	Cartesian Limit B	-	Cat. 3	d
SF19	Robot Stick Enabling Switch	Category 2 Stop	Cat. 3	d
SF20	Reset Output	-	Cat. 3	d
SF21	Robot Stick Reset	-	Cat. 3	d
SF22	Enabling Switch on end-module	Category 2 Stop	Cat. 3	d
SF23	User Connected External Bumping Sensor Input	Category 2 Stop	Cat. 3	d
SF24	End-Point Reduced Speed Limit	Category 2 Stop	Cat. 3	d
SF25	User Connected MODE Switch Input	-	Cat. 3	d
SF26	User Connected Reset Input	-	Cat. 3	d
SF27	User Connected Soft Axis Settings Switch Input	-	Cat. 3	d
SF28	Enabling Switch Output	-	Cat. 3	d
SF29	MODE Switch Output	-	Cat. 3	d
SF30	Safe Home Output	-	Cat. 3	d

SF#	Name	Stop Category	Structure Category	PL
SF31	Tool Orientation Limit	Category 2 Stop	Cat. 3	d
SF32	User Connected FreeBot Input	Category 2 Stop	Cat. 3	d

Table 2: Safety Function Definitions

Note:

1. Emergency stop and protective stop in accordance with ISO 10218-1:2011.
2. Stop categories in accordance with IEC 60204-1.

2.2.2 Configuration Tool

The Configuration Tool in the Safety page of TMflow is available for users to set safety-related parameters (e.g. stop criteria/limitation of safety monitoring functions or range of space/joint limit), suspension (muting) functions, or safety settings (e.g. Manual Reset or Auto Reset). For details of safety settings, refer to the *Software Manual* of corresponding versions.

The default password of the Configuration Tool is **00000000**. Users can change the password by the authority management. For details of password change, refer to the *Software Manual* of corresponding versions.



WARNING:

Users should consider the strength and the complexity of the password to prevent unauthorized decryption. It is the users' responsibility to ensure the password security and the correctness of safety configuration in advance.

2.2.3 Performance Safety Settings and Human-Machine Safety Settings

While a person is inside the collaborative workspace, the system should trigger the Human-Machine Safety Settings according to the risk assessment to ensure safety. The Configuration Tool provides the different speed and force limit settings in Performance Safety Settings and Human-Machine Safety Settings for different scenarios. The speed and force limit settings include these categories:

1. Joint Speed Limit
2. Speed Limit
3. Additional Joint Torque Monitoring
4. Additional Force Limiting

When in any Operation Modes, by the providing safety functions provided switching between Performance Safety Settings and a Human-Machine Safety Settings triggered, one setting is enabled, and the other is disabled.

For summarizing the Human-Machine Safety Settings triggering condition and the output status, the Human-Machine Safety Settings triggering condition from SF9, SF18, and Recovery mode

and output status, refer to 2.3.13 Output Functions – SF2, SF10, SF11, SF12, SF13, SF14, SF20, SF28, SF29, SF30.

2.2.4 Safety End-Points

The safety end-points are the point or points being used in safety functions. The safety end-points include two categories:

1. The fixed points on robot body: Robot end-point
2. The additional points required for monitoring: Safety tool point.

For fixed points on robot body, in the figure, end-point 1~5 denote the cross point positions of joint rotational axes and joint covers, and end-point 6, the robot end flange frame center.

For the safety tool point, users can set one primary safety tool point and up to eight additional points. The safety tool point is the X, Y, Z axis position offset from the robot end flange frame aiming for covering the various tools used in the project. For the setting of safety tool points, refer to the relevant contents in the *Software Manual*.

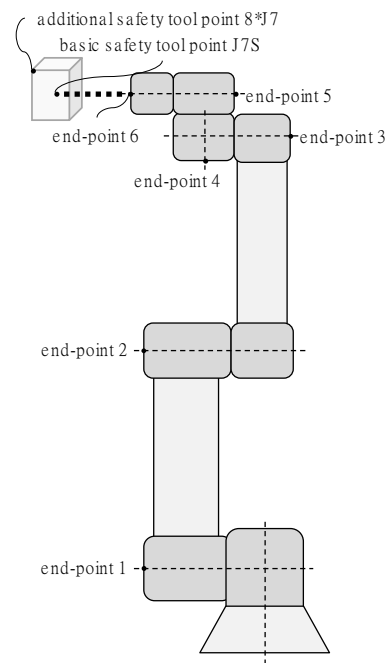

Figure 2: Safety End-Point Definition

- The Motion TCP is the parameters set in **TMflow > Configuration > TCP Setting**.
- The elbow is defined as end-point 2.
- The one primary safety tool point is defined as J7S.
- The up to eight additional safety tool points are defined as 8*J7, and the number of the additional safety tool point goes by users' configuration.

The table below lists the monitored safety end-points by the different limit functions.

Limit Functions	SF#	Monitored Safety End-Points
Force	SF8	Motion TCP + end-point 2
Soft Axis	SF17, SF18	8*J7 + J7S + end-point 2
Speed	SF7	8*J7 + J7S + end-point 2
Reduced Speed	SF24	8*J7 + J7S + end-point 1~6

Table 3: The Monitored End-point by the Limit Functions

2.2.5 Stopping Time and Stopping Distance in the Safety System

Stopping time is the time required from when an Emergency Stop function or a protective function (i.e. internal or external) activates and motion stops. In this system, activating the Emergency Stop button will issue a Category 1 Stop. Activation of a safety function or external safety protective device will issue a Category 2 Stop. While implementing risk reduction measures, it may be necessary for users or system integrators to take these stopping times into considerations. The robot continues moving during this time, which can transmit energy and present additional risks. Refer to Appendix C. TM Robot Stopping Time and Distance for All Product Series

2.2.6 Software Safety Setting Permissions

Changing safety settings may bring the risk of hazards, and therefore, requires permission control before the change implements. Upon the Safety page, the permissions management function would list all known acceptable settings and potential hazards. Authorized users must log in with the administrator's privilege to set all levels of permissions appropriately. Cybersecurity measures should take place when using a network connection. The Corporation is not liable for the possible harm caused by malicious attacks or intrusion of the users' network to modify the permissions management system or safety setup.

2.2.7 Safety Checksum

This function intends to generate a checksum from the safety settings showing on the UI for users to quickly check the safety settings after modified or typed-in safety parameters to other robots. Reading from left to right such as 36B9, the Safety Checksum indication displayed on the upper bar shows the applied safety settings. Different indication, including text or numbers, denotes different safety setting configuration.



WARNING:

The Safety Checksum changes only when the limits or settings in safety setting been changed and saved.

2.3 Explanation of Safety Functions

2.3.1 Reset Functions – SF21, SF26

There are two Reset functions: SF21 Robot Stick Reset and SF26 User Connected Reset Input. The effectiveness of the Reset function refers to 3.7 Local Control and Robot Stick. With this function, users could recover the robot from latching safety statuses, such as Safeguard functions triggered, Recovery mode, or certain power-off status.

The valid trigger of the Reset function requires a long press, longer than 1 second, of the Reset button on either the Robot Stick or the user connected external input. The source of different stop categories and the resume methods are listed below:

Stop category	Source	Resume method
0	1. Violation of standstill monitoring function	The leaving methods should be <ul style="list-style-type: none"> • Reboot the system.
	2. Encoder related fault	
1	1. From Input IO port discrepancy	Fix the wiring of IO port, dual-channel LOW then dual-channel HIGH for more than 1 second then LOW, and the leaving methods should be either <ul style="list-style-type: none"> • Long press the Reset button on Robot Stick for more than 1 second and then release. Or • Close the User Connected Reset Input for more than 1 second and then open. to power on the robot.
	2. From Emergency Stop function of SF0, SF1 or SF16	Restore the ESTOP button, and the leaving methods should be either <ul style="list-style-type: none"> • Long press the Reset button on Robot Stick for more than 1 second and then release. Or • Close the User Connected Reset Input for more than 1 second and then open. to power on the robot.
	3. From faults other than encoder related fault	The leaving methods should be <ul style="list-style-type: none"> • Reboot the system.
	4. From fault in Safety Communication	
2	1. From SF3 set to Manual Reset	The resume method should be <ol style="list-style-type: none"> Un-trigger the corresponding SF3 input port. Long press the Reset button on Robot Stick for more than 1 second and then release or close the User Connected Reset Input for more than 1 second and then open. Press the Play button on Robot Stick, or close the user defined IO of stick Play button then open to resume the project.
	2. From SF3 set to Auto Reset	The resume method should be <ul style="list-style-type: none"> • Un-trigger the corresponding SF3 input port and the project will resume automatically.

Stop category	Source	Resume method
	3. From SF4, SF5, SF6, SF7, SF8, SF17, SF23, SF24 or SF31	Robot enters Recovery mode, users can jog or hand guide the robot to get back to the limited space manually, and the leaving methods should be either <ul style="list-style-type: none"> • Long press the Reset button on Robot Stick for more than 1 second and then release. Or • Close User Connected Reset Input for more than 1 second and then open to get back to the normal operation.
	4. From SF15, SF19, SF22 or SF32	The resume method should be <ol style="list-style-type: none"> I. Un-trigger the corresponding input ports. II. Press the Play button on Robot Stick or close the user-defined IO of the stick Play button and then open it to resume the project.
	5. From software error	The resume method should be <ul style="list-style-type: none"> • Long the press Reset button on Robot Stick for more than 1 second and then release. Or • Close the User Connected Reset Input for more than 1 second and then open to get back to the normal operation.
	6. From entering the safety configuration status	While logging into the Configuration Tool, the robot enters the safety configuration status, the leaving methods should be <ul style="list-style-type: none"> • Log out the Configuration Tool.

Table 4: Source and Resume Method According to Stop Category



DANGER:

Users should pause the robot and check the device's wiring, payload, and tool weight in use, environmental setup, safety settings, and the robot's condition in case the system consistently signals a safe stop. It is crucial not to exceed the specified weight limit, as doing so may result in continuous errors and potential damage to the robot joints. Failure to maintain the health of the robot joints can increase the risk of injury or death.

2.3.2 Emergency Stop Functions – SF0, SF1, SF16

There are three Emergency Stop functions: SF0 Robot Stick ESTOP, SF1 User Connected ESTOP Input and SF16 User Connected ESTOP Input without Robot ESTOP Output. The effectiveness of the Emergency Stop function refers to 3.7 Local Control and Robot Stick.

Activation (input status: LOW) of an Emergency Stop function initiates a Category 1 Stop. The Indication Light Ring of the robot will not display light. The resume method refers to Table 4: Source and Resume Method According to Stop Category. SF16 User Connected ESTOP Input without Robot ESTOP Output provides an Emergency Stop function without triggering SF10 Robot ESTOP Output. This safety function helps to avoid the deadlock of the Emergency Stop function between the robot and other devices/machines in different system integration design.

Users can stop the robot by pressing the Emergency Stop button. After the robot movement has ceased, users must confirm that no hazardous conditions are present before manually releasing the Emergency Stop button to allow reactivation of the robot. The Emergency Stop should be applied only when a critical condition occurs. To stop the robot movement under routine operation, use the Stop button on the Robot Stick.

If the risk assessment requires additional Emergency Stop devices, the selected device must comply with the requirements of the IEC 60204-1. Connect supplementary Emergency Stop devices directly to the SF1 User Connected ESTOP Input, so they do not diminish the overall performance level of the emergency stop. One Emergency Stop function input is present on the robot control box. For the related connection and usage, refer to the *Hardware Installation Manual*.



WARNING:

If the Emergency Stop function is triggered, the power of the robot arm will go off, and the joint brake will be activated. The Indication Light Ring of robot's end module will not show light. In this case, even though it locks each of the joints automatically with the brakes, the robot body will still drop slightly before it completely stops. Pay attention to the risk that the end part of the robot may pinch the operator or collide with other objects.



WARNING:

During an emergency stop, the power to the end effector will go off. If the system integrates with a power I/O enabled end effector, the emergency stop condition may cause the workpiece to drop.

Take this into considerations when users integrate the system to perform appropriate design in compliance with risk assessment. To prevent the unexpected dropping of workpiece, users can choose an end-effector with the self-maintaining function, using the pneumatic logic configuration of reverse logic, using the power supply I/O of the control box, or connecting the extra power supply. Users should be responsible for the correct integration.



CAUTION:

Personnel should be outside the robot's operational space (areas that the robot can reach) when recovering from the emergency stop. Clear off the loading at the tool end before recovering from the emergency stop.



CAUTION:

During the Joint Position Calibration period, each joint of the robot will perform a calibration motion. Make sure the robot pose is in a clear space of at least 1.5 degrees per joint to perform the calibration motion before starting the calibration. At the same time, make sure the TCP, which may have a long distance to the robot flange, will not cause harm during the calibration motion.

2.3.3 Safeguard Functions – SF3

There is one Safeguard function: SF3 User Connected External Safeguard Input.

Activation (input status: LOW) of a Safeguard function initiates a Category 2 Stop. The Indication Light Ring of the robot will start blinking. The resume method refers to Table 4: Source and Resume Method According to Stop Category.

One Safeguard function input is present on the robot control box. For the related connection and usage, refer to the *Omron TM Collaborative Robot S Series: TM5S / TM6S / TM7S / TM12S / TM14S / TM20S Hardware Installation Manual (Cat. No. M135)*, *Omron TM Collaborative Robot S Series: TM25S and TM30S Hardware Installation Manual (Cat. No. M104)*. Reset from the Safeguard functions can be manual or auto. If configured Manual Reset, it requires a Reset function and an additional Play button to resume the project. For the setting for Manual Reset or Auto Reset, refer to the relevant contents in the *Omron TM Collaborative Robot: Software Manual TMFlow, Version 2 (Cat. No. I689)*.

The Safeguard function is designed to suspend by configuration during teaching (e.g. MANUAL MODE), to avoid continuously being blocked by Category 2 Stop and can't fulfill teaching intention. For the setting of suspending the Safeguard function, refer to the relevant contents in the *Omron TM Collaborative Robot: Software Manual TMFlow, Version 2 (Cat. No. I689)*.

2.3.4 Enabling Switch Functions – SF15, SF19, SF22

There are three Enabling Switch functions: SF15 User Connected Enabling Switch Input, SF19 Robot Stick Enabling Switch, and SF22 Enabling Switch on end-module. The effectiveness of the Enabling Switch function refers to 3.7 Local Control and Robot Stick.

Activation (input status: LOW, released or fully compressed) of an Enabling Switch function initiates a Category 2 Stop. The Indication Light Ring of the robot will start blinking. For the three-position Enabling Switch, the center position is the enabled position (the ON position), indicating the ON Status as OFF is the released and fully compressed position (the OFF position) for the OFF Status. Note that the ON or OFF Status of Enabling Switch function will not affect the operation in AUTO MODE. Once in MANUAL MODE, all manual control operations are enabled only when users continuously hold the three-position Enabling Switch at ON Status.

SF15 User Connected Enabling Switch Input and SF19 Robot Stick Enabling Switch are designed to permit manual control operation while the Enabling Switch is at ON Status under MANUAL MODE. SF22 Enabling Switch on end-module is designed to grant robot hand guide

teaching while the Enabling Switch on end-module at ON Status under MANUAL MODE.

If the risk assessment requires additional Enabling Switch, connect only SF15 User Connected Enabling Switch Input to the three-position Enabling Switch compliant with IEC60204-1. Note that the input of this safety function has two input statuses only, so the Enabling Switch should not have an ON Status during the procedure from the fully pressed status to the fully released status.

If there is more than one Enabling Switch at ON Status, it takes the Enabling Switch function as at OFF status, and the robot will not be able to move. The Enabling Switch function will be at ON Status if and only if all Enabling Switches are released (OFF Status) at first, and only one of them turns to ON Status, which will permit motion of the robot.



DANGER:

Enabling Switch stops the robot only under MANUAL MODE and not under AUTO MODE.

2.3.5 Human-Machine Safety Settings Functions – SF9, SF18

There are two Human-Machine Safety Settings functions: SF9 User Connected External Safeguard Input for Human–Machine Safety Settings and SF18 Cartesian Limit B.

Activation of a Human-Machine Safety Settings function will change the speed and force limit settings to another set of those limit settings according to users' risk assessment. It comes with a deceleration time parameter that users can configure to prevent force/torque-related safety functions from triggering by the dramatic slowdown from high speed. The upper limit of the deceleration time is 1000 ms. For the setting of the deceleration time, refer to the relevant contents in the *Omron TM Collaborative Robot: Software Manual TMFlow, Version 2 (Cat. No. I689)*. Note that the **Monitored Criteria Switching Time** is a configurable time delay after triggering the Human-Machine Safety Settings function to begin to monitor the speed and the force limit settings to have the robot decrease the speed to the Human-Machine Safety Settings. Users should consider these timings regarding the risk assessment of applications and setting the distance of the safeguard devices properly. Reset from the SF9 can be manual or auto. If configured Manual Reset, it requires a Reset function to leave Human-Machine Safety Settings. For the setting for Manual Reset or Auto Reset, refer to the relevant contents in the *Omron TM Collaborative Robot: Software Manual TMFlow, Version 2 (Cat. No. I689)*.

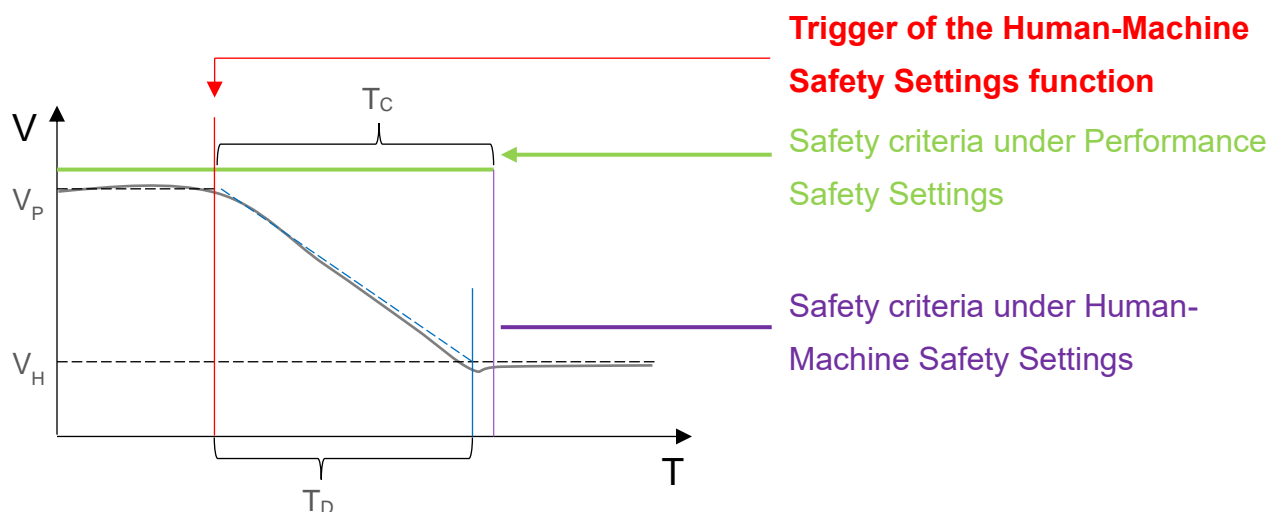

Legends:

V_P: The speed robot executing under Performance Settings.

V_H: The speed robot executing under Human-Machine Safety Settings.

T_C: Monitored Criteria Switching Time. The time where safety module switches to monitor the safety criteria under Human-Machine Safety Settings.

T_D: Deceleration Time. The time it takes to decrease the speed from **V_P** to **V_H**.

SF18 provides a safety function for users to set the Cartesian limit on the robot. Users can set cubical and cylindrical limits as the limited spaces to monitor both the safety tool point and the elbow. The monitored safety end-point of limit functions refers to 2.2.4 Safety End-Points. When any safety tool point or elbow exceeds the limited space, the robot changes the speed and the force limit settings to decrease to the speed setting in the Human-Machine Safety Settings. For the Cartesian limit setting, refer to the relevant contents in the *Omron TM Collaborative Robot: Software Manual TMFlow, Version 2 (Cat. No. I689)*.

For the resume method of SF18, follow the steps below:

1. Switch to MANUAL MODE,
 - (1) Press and hold the Enabling Switch on end-module to hand guide the robot to leave limited space. Or,
 - (2) Press and hold the Robot Stick Enabling Switch or the User Connected Enabling Switch Input to permit manual control operation and jog the robot to leave limited space.
2. Under any other MODE, let the robot leave limited space by programming.



NOTE:

The default Human-Machine Safety Settings (HMSS) only ensure compliance with ISO/TS 15066 when there is no payload applied. For applications that require large payloads and extended reach, there is a possibility that the robot could run into joint torque limit errors with

HMSS Mode activated. It is the end user's responsibility to adjust the safety settings as needed to mitigate these errors, but also to ensure that the adjusted setting does not violate the limit settings for human contact according to the ISO/TS 15066 standard. The end user must then conduct a safety risk assessment with these new settings in mind.



DANGER:

The Cartesian Limit cannot be the only safety measure of collision prevention between the human and the robot. Even with this safety function in use, it should still provide other means to keep the human or the limb from entering the limited space or detect the entering of the limited space with a protective measure.

2.3.6 Force and Torque Limit Functions – SF4, SF8

There are two Force and Torque Limit functions: SF4 Additional Joint torque monitoring and SF8 Additional Force Limit.

Activation of a Force and Torque Limit function initiates a Category 2 Stop. The Indication Light Ring of the robot will start blinking. The resume method refers to Table 4: Source and Resume Method According to Stop Category.

SF4 provides a safety function to monitor the additional torque that the joint received after compensating the tool weight in TCP setting, the workpiece weight in payload setting in the project, and the weight of the robot body. When any joint exceeds the set limit, it will initiate a Category 2 Stop. The torque of each joint is the external torque at the joint estimated through the model by the robot system but not the protection limit of the applicable external torque at the joints by the robot system. For the setting of joint torque limits, refer to the relevant contents in the *Omron TM Collaborative Robot: Software Manual TMFlow, Version 2 (Cat. No. I689)*.

SF8 provides a safety function to monitor the additional force acting on the TCP after compensating the tool weight in the TCP setting and the workpiece weight in the payload setting in the project. Users can set the force limit of the TCP and the elbow. When TCP or elbow exceeds the set limit, it will initiate a Category 2 Stop. The force of the TCP is the external force at the TCP estimated through the model by the robot system. It is not the protection limit of the applying external force at the TCP by the robot system. The monitored safety end-point of limit functions refers to 2.2.4 Safety End-Points. For the setting of force limits, refer to the relevant contents in the *Omron TM Collaborative Robot: Software Manual TMFlow, Version 2 (Cat. No. I689)*.

While triggering the Human-Machine Safety Settings (HMSS) function of SF9 or SF18, the limit settings of which users configured in Human-Machine Safety Settings will be active. The options below are available for Force and Torque Limit function configuration for different applications:

- A. Active at all times: for the robot in the fence-less workspace.
- B. Active only when receiving safety input LOW: only activated when the assigned input port receives signal LOW.

Different MODEs, statuses, and monitor types summarize the Force and Torque Limit functions as the table below.

				Force and Torque Limit Functions' Follow
MODEs	Monitor type	Trigger HMSS	SF4/SF8 Configuration input status	SF4 and SF8
MANUAL (T1, TCH) AUTO	Active at all times	Y	L/H (ignore)	Human-Machine Safety Settings
		N	L/H (ignore)	Performance Safety Settings
	Active only when receiving safety input LOW	Y	L	Human-Machine Safety Settings
			H	No Effect
		N	L	Performance Safety Settings
			H	No Effect

Table 5: Force and Torque Limit Functions by Different MODEs and Status



WARNING:

When triggering the Force and Torque limit function or the Bumping Sensor functions, the robot performs a softening action and moves itself away in the direction of the applied force within a period of 750ms. This action aims to reduce the quasi-static collision force and prevent an operator from being pinned against a surface. Paying attention to the moving direction of the robot is essential to prevent pinching or other hazards.



DANGER:

The Force and Torque limit function comes with two exception spaces in the internal singularity point and external singularity point space. Due to the physical characteristics of a robot, high force can occur at low speeds when the robot extends fully or moves close to the base. Pinching hazards may arise under these conditions. To prevent hazards, use the Soft Axis limit function and the Speed limit or ensure the robot does not enter the exception spaces.

**DANGER:**

Users can configure the Force & Torque Limit function through risk assessments and application scenarios, and users must take responsibility and ensure the robot will have no chance of contacting the body regions of users. Operating the robot without proper evaluation of risks, testing, and carefully reading its operating manual as it pertains to the configurable safety limits can result in danger. Failure to perform a proper risk assessment configuration of safety limits or to comply with the safety manuals may increase the risk of injury or death.

- Robot in fenceless workspace: the safety module will monitor the Force & Torque Limits at all times.
- Only activate while receiving safety input "LOW": Force & Torque Limits are active while the assigned Safety Input channel is "LOW."

**DANGER:**

If the system continuously reports errors related to the Force & Torque Limit function, users should inspect the payload, the weight of the tool used in the program, and the condition of the robot's joints. It is forbidden to use a weight higher than the specified value. Otherwise, the system may continuously report errors, and the robot joints may result in damage. Failure to maintain the health condition of the robot joint may increase the risk of injury or death.

**DANGER:**

Pay attention that the "TCP Force" (Tool Center Point Force) is the external force at the tool center point estimated through the model by the robot system, but not the external force protection value at the tool center point on the robot system. When the robot system exceeds the external force value at the tool center point, the robot will perform a Category 2 stop. In this condition, applied forces will exceed this value. Therefore, clearly understand the amount of the external force applied before the robot comes to a complete stop. The extent to this value exceeds as the robot speed increases, which cannot be the primary risk mitigation for human-robot collision.

**DANGER:**

When the motion of TM Robot is passing the area near the singular space, due to the nature of singularity, it may estimate the TCP force wrong. Users can set the robot's motion properly to avoid this situation by not getting the motion close to the singularity point in the space. It is a residual risk, and users should apply the risk assessment for the SF8 Additional Force Limit near the singularity detection case. SF8 Additional Force Limit should not be applied solely as the only safety protection measure in human-robot collision case. It's always recommended that SF4 Additional Joint torque monitoring including in the human-robot collision safety protection measure.

**DANGER:**

The speed, the power, and the force limiting by different body region in the Human-Machine Safety Settings are designed for users to quickly set up an initial robot application in the collaborative workspace following the biomechanical limits of each body region listed in ISO/TS 15066. The initial parameters are tested* based on the conditions stated in the same UI. For details, please refer to the Software Manual. Users should still perform the risk assessment on real applications before deployment. Users should take responsibility for the

human body region not listed in this graph and ensure the robot does not have any chance to contact any vulnerable body region such as the spine and the hindbrain.

*The default speed limit on each body region is derived from the test based on the following criteria:

- 100 mm long and 0.67 kg weight tool for X and Y axes impact test installs on the robot TCP. The tool weight compensates in the TCP setting.
- 100 mm long and 0.12 kg weight tool for Z axes impact test installs on the robot TCP. The tool weight compensates in the TCP setting.
- The impact force of the robot at the half reach collided with the sensor matches the biomechanical limits of each body region defined in ISO/TS 15066.
- Default setting parameters of Speed Suppression and Deceleration Time in Motion Setting.
- The sensor used in the impact test selects from what describes in the document of DGUV: FB HM 080 (August 2017).

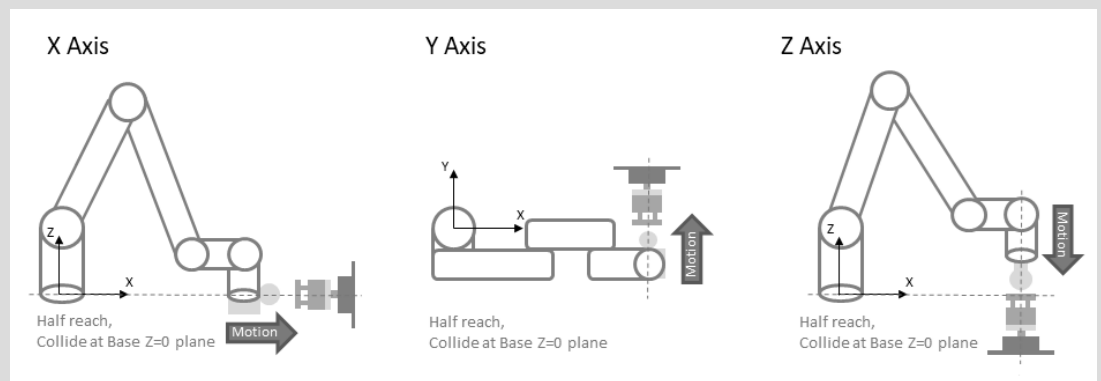

Figure 3: X, Y, & Z axes

2.3.7 Speed Limit Functions – SF6, SF7, SF24

There are three Speed Limit functions: SF6 Joint Speed Limit, SF7 Speed Limit, and SF24 End-Point Reduced Speed Limit.

Activation of a Speed Limit function initiates a Category 2 Stop. The Indication Light Ring of the robot will start blinking. The resume method refers to Table 4: Source and Resume Method According to Stop Category.

SF6 provides a safety function for each joint's speed limit to set. When any joint exceeds the set limit, it will initiate a Category 2 Stop. For the speed limit setting the joint, refer to the relevant contents in the *Omron TM Collaborative Robot: Software Manual TMFlow, Version 2 (Cat. No. 1689)*.

SF7 provides a safety function to set the safety tool speed limit. When any safety tool speed exceeds the set limit, it will initiate a Category 2 Stop. The monitored safety end-point of limit functions refers to 2.2.4 Safety End-Points. For the speed limit setting of the safety tool, refer to

the relevant contents in the *Omron TM Collaborative Robot: Software Manual TMFlow, Version 2 (Cat. No. I689)*.

SF24 provides a safety function to set the robot end-point reduced speed limit. When any robot end-point exceeds the set limit under T1 MODE, it will initiate a Category 2 Stop. The monitored safety end-point of limit functions refers to 2.2.4 Safety End-Points. For the setting of robot end-point reduced speed limit, refer to the relevant contents in the *Omron TM Collaborative Robot: Software Manual TMFlow, Version 2 (Cat. No. I689)*.

Users can separate the Speed Limit functions by monitoring parts as safety tool points, end-points, and joints. The SF6 Joint Speed Limit of joint and SF7 Speed Limit of safety tool point come with different limit settings in Performance Settings and Human-Machine Safety Settings (HMSS) symbolized as SF6-P, SF6-H, SF7-P, and SF7-H below. On the other hand, the SF24 End-Point Reduced Speed Limit is enabled under T1 MODE and jogging under TCH MODE. The Hand-Guide Speed Limit in SF7 comes with different limitations in different MODEs of both T1 MODE and TCH MODE symboling SF7HG-T1 and SF7HG-TCH below. It is not affected by the triggering of Human-Machine Safety Settings. The Speed Limit functions according to different MODEs and statuses can be summarized as the table below:

MODEs	Trigger HMSS	Input Status		Speed Limit Functions' Follow		
		SF15/ SF19 Status	SF22/ SF32 Status	SF7	SF24	SF6
MANUAL (T1)	Y	ON	OFF	SF7-H	Enable	SF6-H
		OFF	ON	SF7HG-T1		
	N	ON	OFF	SF7-P		SF6-P
		OFF	ON	SF7HG-T1		
MANUAL (TCH)	Y	ON	OFF	SF7-H	Disable	SF6-H
		OFF	ON	SF7HG-TCH		
	N	ON	OFF	SF7-P		SF6-P
		OFF	ON	SF7HG-TCH		
AUTO	Y	Disable	Disable	SF7-H	Disable	SF6-H
	N	Disable	Disable	SF7-P		SF6-P

Table 6: Speed Limit functions according to Different MODEs and Status

2.3.8 Soft Axis Limit Functions – SF5, SF17, SF31

There are two Soft Axis Limit functions: SF5 Joint position limit and SF17 Cartesian Limit A

Activation of a Soft Axis Limit function initiates a Category 2 Stop. The Indication Light Ring of the robot will start blinking. The resume method refers to Table 4: Source and Resume Method According to Stop Category.

SF5 provides a safety function to set each joint's motion angle limit. When any joint exceeds the set limit, it will initiate a Category 2 Stop. For the joint angle setting limit, refer to the relevant contents in the *Omron TM Collaborative Robot: Software Manual TMFlow, Version 2 (Cat. No. I689)*. SF17 provides a safety function for users to set the Cartesian limit on the robot. Users can set cubical and cylindrical limits as the limited spaces to monitor both the safety tool point and the elbow. When any safety tool point or elbow exceeds the limited space, it will initiate a Category 2 Stop. The monitored safety end-point of limit functions refers to 2.2.4 Safety End-Points. For the setting of the Cartesian limit, refer to the relevant contents in the *Omron TM Collaborative Robot: Software Manual TMFlow, Version 2 (Cat. No. I689)*.

SF31 provides a safety function for users to set the orientation limit to restrict a specified safety tool vector within a specified restriction cone. Users can set a safety tool vector by the RobotEndFlange frame and a restriction cone vector as well as its deviation angle by the RobotBase frame. When the safety tool vector exceeds the restriction cone space, it will initiate a Category 2 Stop. For settings of the orientation limit, refer to the associated contents in the *Omron TM Collaborative Robot: Software Manual TMFlow, Version 2 (Cat. No. I689)*.



WARNING:

SF17 Cartesian Limit A and SF31 Tool Orientation Limit are designed to monitor the position of safety points on the robot arm and cause a protective stop once one of those points goes beyond specified positional limits. This means that the robot will stop somewhere outside of the monitored positional limits, so users must take the robot's stopping time and the stopping distance into consideration when using this safety function to set the restricted space and the safeguarded space during system integration.



DANGER:

The Cartesian Limit and the Orientation Limit cannot be the only safety measure of collision prevention between the human and the robot. Even with this safety function in use, there must still be other means to keep the humans from entering the limited space or safety sensors that detect when humans enter the limited space to trigger protective measures.

2.3.9 Soft Axis Settings Switch Functions – SF27

SF27 User Connected Soft Axis Settings Switch Input provides a safety function for users to switch between different pre-defined Soft Axis Settings of SF5 Joint Position Limit, SF17 Cartesian Limit A, SF18 Cartesian Limit B, and SF31 Tool Orientation Limit. For the setting of Soft Axis Settings, refer to the relevant contents in the *Omron TM Collaborative Robot: Software Manual TMFlow, Version 2 (Cat. No. I689)*. The Soft Axis Settings according to different MODEs and SF27 input status can be summarized as the table below:

		Soft Axis Settings Follow	
MODEs	SF27 Input Status	SF5, SF17, SF18 and SF31	
MANUAL (T1)	L	Default Settings	
	H	Additional Settings	
MANUAL (TCH)	L	Default Settings	
	H	Additional Settings	
AUTO	L	Default Settings	
	H	Additional Settings	

Table 7: Soft Axis Settings according to Different MODEs and SF27 Input Status

2.3.10 Bumping Sensor Functions – SF23

SF23 User Connected External Bumping Sensor Input comes with a safety function for users to attach safety skin or bumping sensor on robot body while users in the collaborative workspace. It will initiate a Category 2 Stop when triggering (input status: LOW) the safety skin or bumping sensors connected to SF23 as the robot bumps into users. The Indication Light Ring of the robot will start blinking. The resume method refers to Table 4: Source and Resume Method According to Stop Category.



WARNING:

When triggering the Force and Torque limit function or the Bumping Sensor functions, the robot performs a softening action and moves itself away in the direction of the applied force within a period of 750ms. This action aims to reduce the quasi-static collision force and prevent an operator from being pinned against a surface. Paying attention to the moving direction of the robot is essential to prevent pinching or other hazards.

2.3.11 MODE Switch Functions – SF25, Robot Stick Mode Switch function

There are two MODE Switch functions: SF25 User Connected MODE Switch Input and Robot Stick MODE Switch function. The effectiveness of the Mode Switch function refers to 3.7 Local Control and Robot Stick. The Robot Stick MODE Switch function refers to 3.4.3 Robot Stick MODE Switch Function.

SF25 provides a safety function for users to switch MODEs between Operation Modes of AUTO or MANUAL MODE from user connected external input such as a key switch. The Operation Modes will be set to AUTO MODE when input LOW, while the Operation Modes will be MANUAL MODE when input HIGH. The detail Operation Modes and Robot Stick MODE Switch function refer to 3.4 Operation Mode and MODE Switch. The Operation Modes according to SF25 input status can be summarized as the table below:

SF25 Input Status	Operation Modes
L	AUTO MODE
H	MANUAL MODE (T1 MODE or TCH MODE)

Table 8: Operation Modes according to SF25 Input Status

2.3.12 FreeBot Input Functions – SF32

SF32 User Connected FreeBot Input comes with a safety function for users to grant robot hand guide teaching while the input receives signal HIGH under MANUAL MODE. It will initiate a Category 2 Stop when receiving the input signal LOW. The Indication Light Ring of the robot will start blinking. The resume method refers to Table 4: Source and Resume Method According to Stop Category.

This function enhances usability when a unique tool design obstructs the Enabling Switch on the end module or when accessing the end module for hand-guided teaching is difficult. This function is mutually exclusive with SF22. The table below summarizes hand-guided teaching according to different modes and input statuses:

MODEs	SF22 Status	SF32 Status	Hand Guide Teaching
MANUAL (T1, TCH)	H	L	Allow
	H	H	Not Allow
	L	L	Not Allow
	L	H	Allow
AUTO	Disable	Disable	Not Allow
	Disable	Disable	Not Allow

Table 9: Hand guide teaching according to Different MODEs and Input Status

2.3.13 Output Functions – SF2, SF10, SF11, SF12, SF13, SF14, SF20, SF28, SF29, SF30

Output functions provide digital output signals according to different safety functions triggered, which users can use during system integration. Refer to the tables below for the respective Output functions and output signal HIGH/LOW condition. When detected any fault other than the discrepancy in safety functions, the system will perform a Category 0. Stop, and the corresponding output signal will switch to LOW. The resume method refers to Table 4: Source and Resume Method According to Stop Category. These Output functions will output signal LOW when triggered. The definition of triggered status is that the connected device stops or enters the safety status.

For integration with safety output functions, it is necessary to add the corresponded safety input functions' PFHd values for calculation. For example, when using SF10 Robot ESTOP Output to stop other machines in an emergency, it is necessary to put SF0 Robot Stick ESTOP into the

calculation or to put both the external Emergency Stop button PFHd value and SF1 User Connected ESTOP Input into the calculation. For those outputs to stop other machines when triggered internal safety functions like SF13 Robot Recovery Mode Output, it is needed to consider the corresponded input function, for example, SF7 Speed Limit's PFHd value into the calculation.

SF2 Encoder Standstill Output comes with a safety output function to monitor the movement of each robot actuator through the joint encoder after triggered Category 2 Stop within a fixed time. If the joint encoder movement exceeds the acceptable range, the robot will perform a Category 0 Stop. The termination of this function is further decided by the system while resuming from the Category 2 Stop. This function is designed to provide the output signal for users to connect with their own devices to ensure the robot is indeed under standstill monitoring status, and users can achieve interlock mechanism with their own devices then. The table below summarizes the output signal condition.

SF#	Name	Output Signal HIGH Condition	Output Signal LOW Condition	Action when Fault Detection
SF2	Encoder Standstill Output	While Category 2 Stop is triggered and under standstill monitoring status.	While resuming from standstill monitoring status.	Category 0 Stop and output signal LOW.

Table 10: Output Signal Condition of SF2

SF10 Robot ESTOP Output, SF11 User Connected External Safeguard Output and SF12 Robot Human–Machine Safety Settings Output provide configuration of output behavior as “follow Robot Status” or “follow Input Status” for different cases.

For the machine without its resuming function, in this case, the output should configure “follow Robot Status” to resume only when the robot has been resumed from its safety status, e.g. after users trigger the Reset function to exit the power off status from SF1.

For the machine with its resuming function, in this case, the output should configure to “follow Input Status” to resume once the input signal is resumed, e.g. after the SF1 resume signal HIGH.

According to different cases, users can configure either "follow Robot Status" or "follow Input Status" as the output behavior. For the setting of output behavior, refer to the relevant contents in the *Omron TM Collaborative Robot: Software Manual TMFlow, Version 2 (Cat. No. I689)*.

SF10 Robot ESTOP Output provides the dual-channel output signal IO connection port for users to connect with their own devices. When users push the intrinsic Emergency Stop button (from SF0) or the control system connected external Emergency Stop button (from SF1), users can use these provided output signals to put other devices in their safe state at the same time.

Note that SF10 only reflects the Emergency Stop function resulting from SF0 and SF1. The Emergency Stop function resulting from SF16 User Connected ESTOP Input without Robot ESTOP Output will not reflect on SF10. The table below summarizes the output signal condition:

		SF0, SF1			SF16		
		Manual reset ONLY					
		SF0 or SF1 input status			SF16 input status		
		L	L→H	H	L	L→H	H
SF10 Output follow	robot status	L	L*	H	H	H	H
	input status	L	H	H	H	H	H
Robot Status		Power off status	Power off status**	Normal	Power off status	Power off status**	Normal

Table 11: The Output Signal Condition of SF10

Note:

* Denotes when SF1 input status L→H, the output keeps LOW before Reset function trigger.

** Denotes robot keeps in power off status before Reset function trigger.

SF11 User Connected External Safeguard Output provides the dual-channel output signal IO connection port for users to connect with their own devices. When the external safeguard device (from SF3) is triggered, users can use these provided output signals to put other devices in their safe state at the same time. The table below summarizes the output signal condition:

		Suspend Safeguard function / Operation Modes									
		<ul style="list-style-type: none"> Safeguard function NO suspended, OR AUTO MODE. 					<ul style="list-style-type: none"> Safeguard function suspended, AND MANUAL MODE (T1 or TCH) 				
		SF3 set to					SF3 set to				
		Manual Reset		Auto Reset			Manual Reset		Auto Reset		
		SF3 input status					SF3 input status				
		L	L→H	H	L	H	L	L→H	H	L	H
SF11 Output follow	robot status	L	L*	H	L	H	H	H	H	H	H
	input status	L	H	H	L	H	L	H	H	L	H
Robot Status		Standstill monitoring status	Standstill monitoring status**	Normal	Standstill monitoring status	Normal	Normal	Normal	Normal	Normal	Normal

Table 12: The Output Signal Condition of SF11

Note:

* Denotes when SF3 input status L→H, the output keeps LOW before Reset function trigger.

** Denotes robot keeps in standstill monitoring status before Reset function trigger.

SF12 Robot Human–Machine Safety Settings Output provides the dual-channel output signal IO connection port for users to connect with their own devices. After triggered the control system connected external safeguard device (from SF9), the robot end-point out of the Cartesian Limit B (SF18), or the robot in Recovery mode, users can use these provided output signals to put other devices in their safe state at the same time. The table below summarizes the output signal condition:

		SF9 set to					SF18		Trigger Recovery mode
		Manual Reset			Auto Reset		Auto Reset		Disable SF9 Disable SF18
		SF9 input status					Robot end-points		
		L	L→H	H	L	H	Inside limit	Outside limit	
SF12 Output follow	robot status	L	L*	H	L	H	H	L	L
	input status	L	H	H	L	H			
Robot Parameter Settings		Human-Machine Safety Settings	Human-Machine Safety Settings**	Performance Safety Settings	Human-Machine Safety Settings	Performance Safety Settings	Performance Safety Settings	Human-Machine Safety Settings	Human-Machine Safety Settings

Table 13: The Output Signal Condition of SF12

Note:

* Denotes when SF9 input status L→H, the output keeps LOW before Reset function trigger.

** Denotes robot keeps in Human-Machine Safety Settings before Reset function trigger.

SF13 Robot Recovery Mode Output provides the dual-channel output signal IO connection port for users to connect with their own devices. With any Category 2 Stop caused by SF4, SF5, SF6, SF7, SF8, SF17, SF23, SF24 or SF31, users can use these provided output signals to put other devices in their safe state at the same time.

SF14 Robot Moving Output provides the dual-channel output signal IO connection port for users to put other devices in their safe state or not, to achieve a system motion latching scenario, which means “One move, the other should STOP” scenario.

The table below summarizes the output signal condition:

SF#	Name	Output Signal HIGH Condition	Output Signal LOW Condition	Action when Fault Detection
SF13	Robot Recovery Mode Output	While robot is not in Recovery mode.	While robot is in Recovery mode.	Category 0 Stop and output signal LOW.
SF14	Robot Moving Output	While all of robot joint speeds are found to be lower than the configured value.	While any robot joint speed is found to be higher than the configured value.	Category 0 Stop and output signal LOW.

Table 14: Output Signal Condition of SF13 and SF14



WARNING:

SF14 Robot Moving Output is designed for stopping the other machine when the robot is moving. When the robot is not moving, the output is HIGH, and this signal allows the other machine's movement but not stops the other machine. To stop the other machine while the robot is standstill, use other measures such as the safeguard output of the robot or use the safety device to stop both the robot and the other machine at the same time.

SF28 Enabling Switch Output provides the dual-channel output signal IO connection port for users to connect with their own devices. When activation (released or fully compressed) of an Enabling Switch function of SF15 or SF19, users can use these provided output signals to put other devices in their safe state at the same time.



DANGER:

While integrating an Enabling Switch in a robot cell, make sure to connect the Enabling Switch Output to the other devices' Emergency Stop or Protective Stop function to prevent motion from the device while moving the robot.

Note that SF28 only reflects the Enabling Switch function resulting from SF15 or SF19. The Enabling Switch function resulting from SF22 Enabling Switch on end-module will not reflect on SF28. The table below summarizes the output signal condition:

MODEs	Enabling Switch Status		Robot Status	SF28 Output
	SF15/ SF19 Status	SF22/ SF32 Status		
MANUAL (T1)	ON	OFF	Normal (permit jogging)	H
	ON	ON	Standstill monitoring status	L
	OFF	OFF	Standstill monitoring status	L
	OFF	ON	Normal (permit hand guide)	L
MANUAL (TCH)	ON	OFF	Normal (permit jogging)	H
	ON	ON	Standstill monitoring status	L
	OFF	OFF	Standstill monitoring status	L
	OFF	ON	Normal (permit hand guide)	L
AUTO	Disable	Disable	Normal	H

Table 15: Output Signal Condition of SF28

SF20 Reset Output provides the dual-channel output signal IO connection port for users to connect with their own devices. When any Reset functions by SF21 or SF26, users can use these provided output signals to let other devices leave the latching safety status at the same time.

SF29 MODE Switch Output provides the dual-channel output signal IO connection port for users to connect with their own devices. When any Mode Switch functions by SF25 or Robot Stick MODE Switch function, user can use these provided output signals to put other devices to the same Operation Mode at the same time.

The table below summarizes the output signal condition:

SF#	Name	Output Signal HIGH Condition	Output Signal LOW Condition	Action when Input Discrepancy	Action when Fault Detection
SF20	Reset Output	While SF21 or SF26 input signal HIGH.	While SF21 or SF26 input signal LOW.	Category 1 Stop and output signal LOW.	Category 0 Stop and output signal LOW.
SF29	MODE Switch Output	While under MANUAL MODE.	While under AUTO MODE.	Category 1 Stop and output signal LOW.	Category 0 Stop and output signal LOW.

Table 16: Output Signal Condition of SF20 and SF29

**DANGER:**

When integrating a MODE Switch in a robot cell, make sure to connect the MODE Switch Output to the other devices' mode switching function for the device and the robot in the same operation mode.

When the robot integrates on a mobile device such as an autonomous guided vehicle, AGV, it is necessary to make sure the robot is within a relatively safe pose to ensure the robot will not cause any risk during the mobile device moving. For example, the AGV may carry the robot moving with a non-desired pose as the robot extended outside the AGV area sweeping and crushing to a human.

SF30 Safe Home Output provides the dual-channel output signal IO connection port for users to connect with their own devices. It benefits the system integration with mobile devices to prevent the risk mentioned above. Use the custom application cases to configure the safe home pose and its tolerance. For the custom safe home pose and tolerance, refer to the relevant contents in the *Omron TM Collaborative Robot: Software Manual TMFlow, Version 2 (Cat. No. I689)*. The table below summarizes the output signal condition:

SF#	Name	Output Signal HIGH Condition	Output Signal LOW Condition	Action when Fault Detection
SF30	Safe Home Output	While all of robot joint positions are within the tolerance of the user self-configurable pose, the robot is in the safe home pose.	While any of robot joint position is over the tolerance of the user self-configurable pose, the robot is not in the safe home pose.	Category 0 Stop and output signal LOW.

Table 17: Output Signal Condition of SF30

**DANGER:**

When integrating a robot onto an AGV or other moving device, make sure to configure the safe home pose and connect the Safe Home Output to the other device's Emergency Stop or Protective Stop function to prevent motion from the device while not configuring the robot in the safe home pose. The user risk assessment should define the robot's safe home pose.

2.3.14 Output Signal Switching Device – OSSD

The output signal switching device (OSSD) works as a diagnosis signal for other devices to check the LOW pulse in the corresponded output HIGH pulse. When configured the diagnosis signal, a 1-millisecond LOW pulse will generate in the corresponded output signal every fixed period. For the configuration of the diagnosis signal, refer to the relevant contents in the *Omron TM Collaborative Robot: Software Manual TMFlow, Version 2 (Cat. No. I689)*.

The figure and the table below summarize the terms of output signal definition and the values:

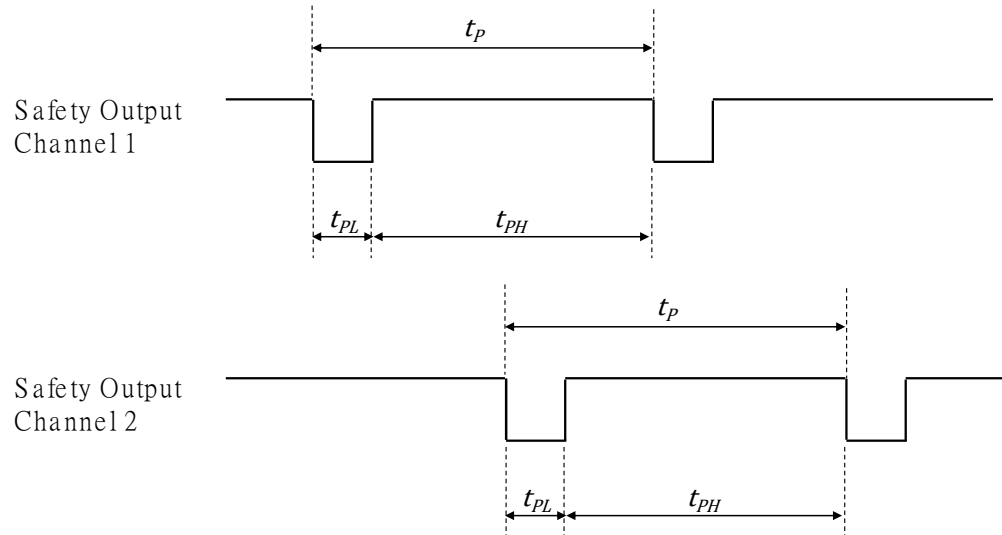

Figure 4: The OSSD Pattern Definition

Term	Definition	Values (ms)	
		Channel 1	Channel 2
t_p	Periodic time of the output pulses	1000	990
t_{PL}	Low time of the output pulses	1	1
t_{PH}	HIGH time of the output pulses	999	989

Table 18: The OSSD Term Definition

3. Safety-Related Operation

The followings are the operating instructions for safety-related robot functions and designs.

3.1 Secure in De-energized Position

The control box comes with a pair of keyholes for users to lock and isolate any hazardous energy source to the robot, which can lock or otherwise secure the robot in the de-energized position. Users should prepare a proper secure lock if a de-energized situation is required.

3.2 Mechanical Stops

For the design and the installation of adjustable mechanical stops, please approach your TM Robot distributor. Users can also set proper Soft Axis Limit functions to limit robot motion within the defined space. Refer to 2.3.8 Soft Axis Limit Functions – SF5, SF17, SF31 for details.

3.3 Joint Movement without Drive Power

When the robot is shut down or loses external power, there will be no drive power to the motors to move the robot normally. This is also true when an ESTOP or error that results in a Cat. 0 stop occurs. If it is necessary to move the robot arm or joint manually, users can do so by manually releasing the brake of each individual joint.

If it is necessary to move the robot arm or joint manually, users can manually release the brake of each joint. Refer to the *Omron TM Collaborative Robot S Series: TM5S / TM6S / TM7S / TM12S / TM14S / TM20S Hardware Installation Manual (Cat. No. M135)*, *Omron TM Collaborative Robot S Series: TM25S and TM30S Hardware Installation Manual (Cat. No. M104)* for more information about the specific release procedures.



DANGER:

There is no force compensation during joint movement without drive power, which means more force is required to move each joint directly against the motor drive.



WARNING:

- Due to gravity, additional supports are recommended when manually releasing the brake.
- When manually moving each robot joint, the movement angle must be within a range of +/- 45 °
- Users should be well trained and pay attention to moving the robot without drive power during any emergency and abnormal situations.

3.4 Operation Mode and MODE Switch

TM Robot comes with two Operation Modes: AUTO MODE and MANUAL MODE. There are two settings in the MANUAL MODE, T1 and the Teaching setting. Users can configure to either T1 or the Teaching setting with the Configuration Tool to have the MANUAL MODE map to either T1 MODE or TCH MODE (Teaching MODE).

The AUTO MODE and MANUAL MODE are visually distinguishable by the MODE indicator of Robot Stick and the color of the Indication Light Ring on the robot's end-module. While under Local Control (the Robot Stick is at ON Status), the robot is in AUTO MODE by default after booting up. While Robot Stick is at OFF Status, the robot is in the MODE of which SF25 User Connected MODE Switch Input is when finishing booting up. The effectiveness of the Mode Switch function refers to 3.7 Local Control and Robot Stick.

3.4.1 AUTO MODE

In AUTO MODE, the Indication Light Ring on the end module lights in white, and the Mode Indicator on the Robot Stick is in the **A** position. Users can press the Play button to execute the robot project, and the project will perform with the Project Override Speed defined in the project Start node. Users can adjust the Project Override Speed with the **+ / -** buttons during project execution.

Users should take the additional separate confirmation action before the project execution. The control box comes with an **AUT.P** port for AUTO MODE confirmation. User can only carry out the project while **AUT.P** is in the Close state. For the connection of this port, refer to the relevant contents in the *Omron TM Collaborative Robot S Series: TM5S / TM6S / TM7S / TM12S / TM14S / TM20S Hardware Installation Manual (Cat. No. M135)*, *Omron TM Collaborative Robot S Series: TM25S and TM30S Hardware Installation Manual (Cat. No. M104)*.



WARNING:

The additional separate confirmation action of AUTO MODE play confirm port should locate outside the safeguarded space to ensure users will not execute the project near the robot. Users are still required to ensure all persons are outside the safeguarded space before activating the automatic mode.

3.4.2 MANUAL MODE

In MANUAL MODE, the Indication Light Ring on the end module lights in green and the Mode Indicator on Robot Stick is in the **M** position. There are two settings in the MANUAL MODE, T1 and the Teaching setting. Users can configure to either T1 or the Teaching setting with the Configuration Tool to have the MANUAL MODE map to either T1 MODE or TCH MODE

(Teaching MODE). Motions are allowed only with Enabling Switch function continuously holding at ON Status and a hold-to-run function or a Play function. Users can press the Play button and hold Enabling Switch function at ON Status to verify the robot project, and the project will perform with the Project Override Speed at the lowest speed. Users can adjust the Project Override Speed with the + / - buttons during the project verification.



WARNING:

Wherever possible, all persons should perform the MANUAL MODE operations outside the safeguarded space.

3.4.2.1 T1 MODE

In T1 MODE, users can:

- Jog the robot with Enabling Switch on Robot Stick (or User Connected Enabling Switch Input) continuously holding at ON Status and a hold-to-run function. The maximum jogging speed is not beyond 250 mm/s.
- Hand guide the robot with Enabling Switch on end-module continuously holding at ON Status and drag. The maximum hand guide TCP speed is not beyond 250 mm/s.
- Verify the project with the Enabling Switch on Robot Stick (or User Connected Enabling Switch Input) continuously holding at ON Status and a Play function. The maximum executing speed is not available to set beyond 250 mm/s.
- When any speed exceeds the set limit, it will initiate a Category 2 Stop. The Speed Limit function refers to 2.3.7 Speed Limit Functions – SF6, SF7, SF24.

3.4.2.2 TCH MODE

In TCH MODE, users can:

- Jog the robot with Enabling Switch on Robot Stick (or User Connected Enabling Switch Input) continuously holding at ON Status and a hold-to-run function. The maximum jogging speed is not beyond 250 mm/s.
- Hand guide the robot with Enabling Switch on end-module continuously holding at ON Status and drag. The maximum hand guide TCP speed is available to set beyond 250 mm/s.
- Verify the project with the Enabling Switch on Robot Stick (or User Connected Enabling Switch Input) continuously holding at ON Status and a Play function. The maximum executing speed is available to set beyond 250 mm/s.
- When any speed exceeds the set limit, it will initiate a Category 2 Stop. The Speed Limit function refers to 2.3.7 Speed Limit Functions – SF6, SF7, SF24.

3.4.3 Robot Stick MODE Switch Function

While under Local Control (Robot Stick is at ON Status), the robot is in AUTO MODE by default after booting up. The MODE switch functions follow the Robot Stick MODE switch function result. The method to switch MODE is:

1. Press and hold the **M/A** button on Robot Stick.
2. Type in a valid password.
3. Press the **M/A** button to send out the password, and the system will wait 30 seconds for the confirmation.
4. Press the **M/A** button again to confirm or press the STOP button to cancel.

The default password of the Robot Stick is + - + + - . Users are able to change password by authorization. For details to change the password, refer to the respective version of the *Omron TM Collaborative Robot: Software Manual TMFlow, Version 2 (Cat. No. I689)*.



WARNING:

Users should consider the strength and the complexity of password to prevent unauthorized decryption. It is the users' responsibility to ensure the password security and the correctness of safety configuration in advance.

Under Robot Stick at OFF Status, the robot is in the MODE whose SF25 User Connected MODE Switch Input is after booting up. The MODE switch functions follow the SF25 User Connected MODE Switch Input result. The robot is in the MODE of which User Connected MODE Switch Input selection is. For the Operation Modes by the SF25 input status, refer to 2.3.11 MODE Switch Functions – SF25, Robot Stick Mode Switch function.

While it triggers the MODE Switch function during robot motion, the system will issue a stop signal to stop robot motion.



DANGER:

Any suspended safeguards shall be set back to full functionality before selecting automatic operation.

3.4.4 Recovery Mode

This mode is provided for users to recover the robot after a safety-triggered error and return to ordinary operation. The robot will enter Recovery mode according to the conditions listed in Table 4: Source and Resume Method According to Stop Category, the robot will enter Recovery mode. This is an auxiliary status where the Space-Limiting functions SF5, SF17, and SF31 are disabled so users can jog or hand guide the robot to return within the positional limits manually.

During jogging or hand guiding in this mode, Human-Machine Safety Settings for force and torque limits are applied as a means of risk reduction to protect users during the recovery procedure.

The defined strict safety limiting parameters are the user-configurable parameters in "Human-Machine Safety Settings". Triggering in Recovery mode, the safety limiting parameters shall always be the limits in "Human-Machine Safety Settings", and no other safety functions that trigger or de-trigger the limits criteria of "Human-Machine Safety Settings" can affect the limits. The safety functions that trigger or de-trigger the limits criteria of "Human-Machine Safety Settings" with SF9 and SF18 included will be disabled in this mode.

The table below summarizes the safety limiting parameters by different functions.

				Force and Torque Limit Functions ¹
Recovery Mode	Monitor Type	Trigger HMSS	SF4/SF8 Configuration Input Status	SF4 and SF8
	Active at all times	Disable	L/H (ignore)	Human-Machine Safety Settings
	Active only when receiving safety input LOW	Disable	L	Human-Machine Safety Settings
H			No Effect	

		Input Status		Speed Limit Functions Follow		
Recovery Mode	SF15/ SF19 Status	SF22/SF32 Status	SF7	SF24	SF6	
	ON	OFF	SF7-H	Enable	SF6-H	
	OFF	ON	SF7HG-T1			

		Soft Axis Settings Follow
Recovery Mode	SF27 Input Status	SF5, SF17, SF18 and SF31
	L	Disable
	H	Disable

Table 19: Limit functions according to Recovery Mode

3.5 Hold-to-Run Function & Play Function

When the TM Robot is in MANUAL MODE, the functions include:

- joint angle movement
- robot base end movement
- tool base end movement
- self-defined base end movement
- move to visual initial position
- visual servo action
- step run
- move to point
- hand guiding
- project verification
- others

Hold-to-run function comes with two categories:

- Jog the robot by continuously pressing the + / - button.
- Jog the robot by continuously pressing the Play button.

Play function comes with:

- Verify the robot project by single pressing the Play button.

Once the + / - , Play button is released, the robot will stop operation immediately and will continue the operation when pressed again. If TMflow connects to the robot through Ethernet or Wi-Fi, the robot will automatically issue a stop when releasing the + / - , Play Button or the connection is interrupted.

Depending on the connection quality, there may be a maximum detection delay of 800 ms for the communication loss. Using the physical button to perform hold-to-run function, the detection time of releasing the button is up to 30 ms.

3.6 Singularity Point

The motion of an articulated robot is often limited by the kinematic design, and cannot perform Cartesian motion control under all joint positions. The joint position that will cause the robot to be unable to perform Cartesian control is a singularity point. When the robot encounters a singularity point, it will stop motion and initiate a warning.

**DANGER:**

The Force and Torque limit function comes with two exception spaces in the internal singularity point and external singularity point space. Due to the physical characteristics of a robot, high force can occur at low speeds when the robot extends fully or moves close to the base. Pinching hazards may arise under these conditions. To prevent hazards, use the Soft Axis limit function and the Speed limit or ensure the robot does not enter the exception spaces.

Three types of singularity point for TM Robot:

- Internal Singularity Point in Space
- Extensible Singularity Point in Space.
- Wrist Singularity Point in Space.

Internal Singularity Point in Space:

The distance from the intersection of the rotational axes of the fifth joint and the sixth joint to the extended line of the rotational axis of the first joint is defined as R_{offset} . The cylindrical space that is formed by R_{offset} as the radius and centered on the extended line of the rotational axis of the first joint is the Internal Singularity Point in Space. As soon as the robotic arm approaches the Internal Singularity Point in Space, the arm will stop and issue a warning. The R_{offset} values of each product series are shown in the following table:

Main model	R_{offset}
TM7S/TM5S Series	147.8 mm
TM12S/TM14S Series	181.8 mm
TM25S/TM30S Series	70.0 mm

Table 20: The R_{offset} values of each product series

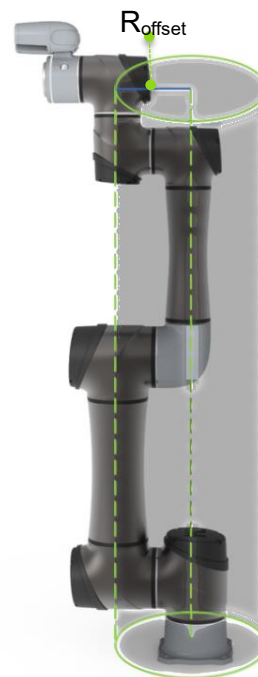

Figure 5: The Definition of R_{offset} .

Extensible Singularity Point in Space:

When the third joint is nearing zero degrees, it indicates that the robot has reached over 80% of its maximum working radius. The space exceeding this radius is the Extensible Singularity Point in Space. In this space, the robot will stop and report a warning due to exceeding the motion range of the robot.

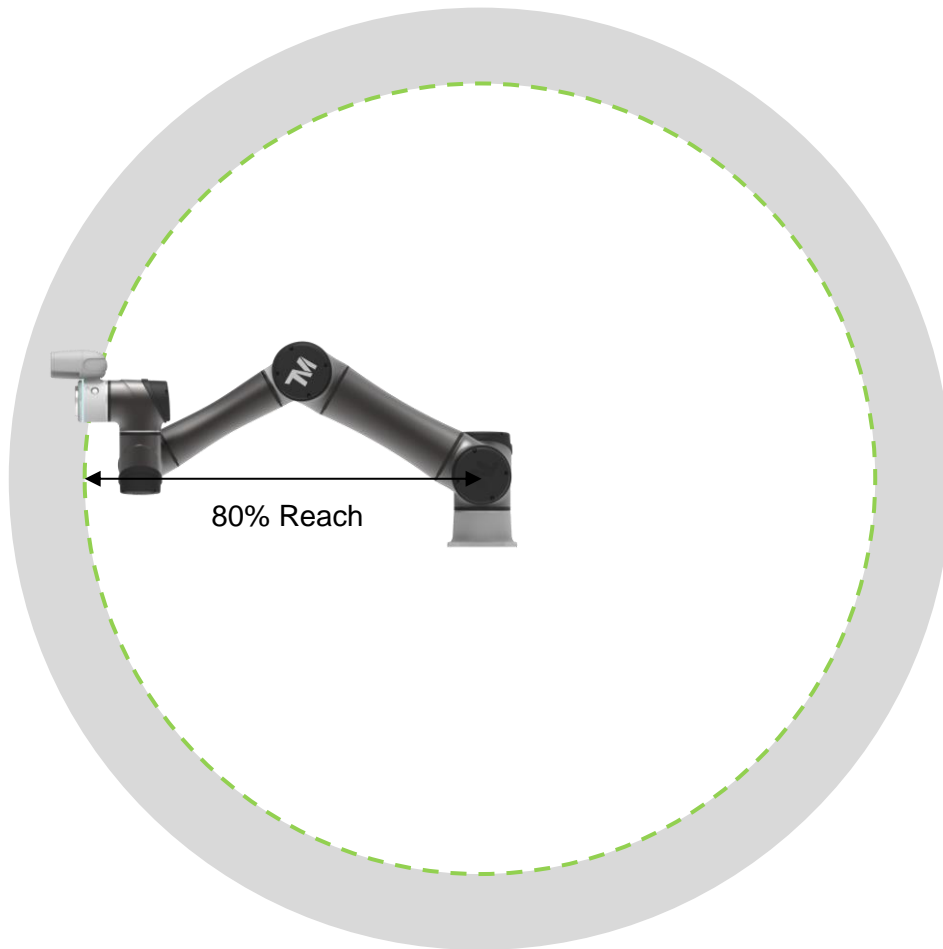

Figure 6: Extensible Singularity Point in Space

Wrist Singularity Point in Space:

When the rotational axes of the fourth and the sixth joints are nearly parallel, which means the fifth joint closes to 0 degrees, the robot will enter the Wrist Singularity Point in Space. At this time, the motion of the arm will cause a large-angle displacement of the fourth joint, but it will be stopped due to stop criteria of motion speed. Once the robot enters the Wrist Singularity Point in Space, it will stop and report an error.

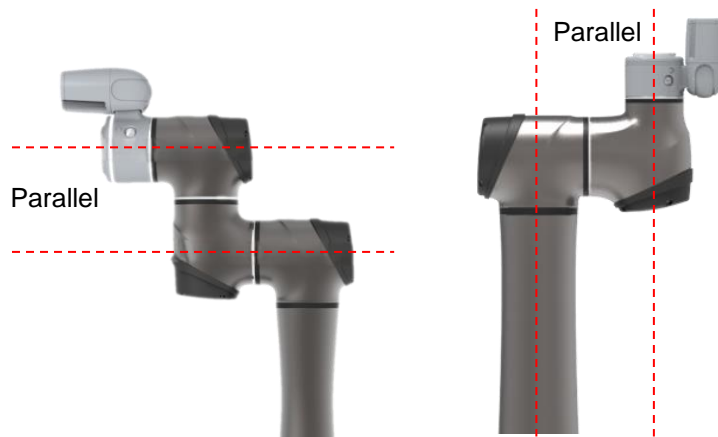

Figure 7: Wrist Singularity Point in Space

The Solution when Encountering Singularity Point in Space:

When the robot reports singularity, confirm the posture of the robot. If the tool end path crosses the internal cylinder as shown in the figure below, check the first point description. If the rotational axes of the fourth and sixth joints of the robot are parallel, check the second point description below.

1. When the robot reports a warning due to the Internal Singularity Point in Space, press the FreeBot button to release it from the posture. Change the point position or change the motion type to PTP between the points to avoid the arm path between the points crossing the Internal Singularity Point in Space, as shown in the figure below.

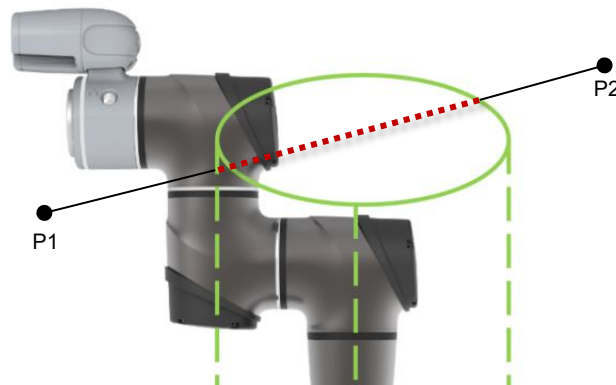

Figure 8: The Solution when Encountering Singularity Point in Space (1/2)

When the path crosses the Internal Singularity Point in Space, singularity will be triggered. Adjust the path and confirm that it will not cross the Internal Singularity Point in Space.

2. When the robot reports a warning because of entering the Wrist Singularity Point in Space, press the FreeBot button to release it. When the rotational axes of the fourth and the sixth joint are in parallel, if users still try to perform Cartesian motion, the Wrist Singularity Point in Space will be encountered. At this time, the method in the following figure can be used to avoid the rotational axes of the fourth and the sixth joints being parallel.

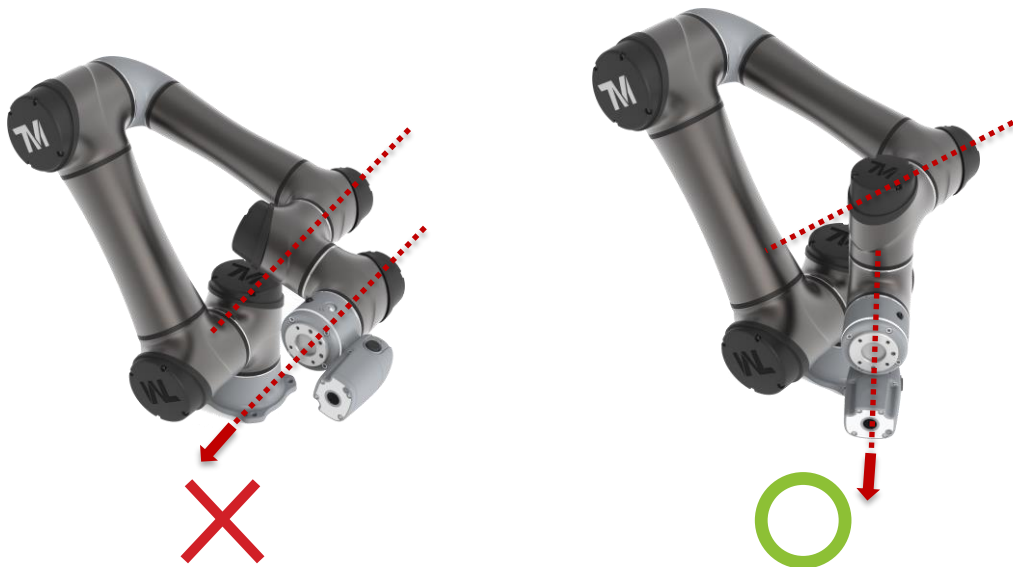



Figure 9: The Solution when Encountering Singularity Point in Space (2/2)

This example demonstrates how to avoid the rotational axes of the fourth and sixth joint being parallel, when the user needs to move the robot according to tool Z-axis.

3.7 Local Control and Robot Stick

The robot will totally under Local Control while user is controlling the robot using the Robot Stick, which ensures the robot will not allow motion by receiving peripheral commands. Here defines the Local Control is the operation using the Robot Stick, or the operation of optionally adding a display module into TM Teach Pendant. The Robot Stick Enable Indicator  will be lights on while under Local Control.

The method of switching off Local Control is using the Enable/Disable of Robot Stick function. The method to set Enable/Disable of Robot Stick function is:

1. Long press the **Pause** button on Robot Stick.
2. Type in valid password.
3. Press the **Pause** button to send out the password, and the system will wait 30 seconds for the confirmation.
4. Press the **Pause** button again to confirm, or press the STOP button to cancel.

The default password of the Robot Stick is + - + + - . For details of password change, refer to the *Omron TM Collaborative Robot: Software Manual TMFlow, Version 2 (Cat. No. I689)* of corresponding versions.

After switching off Local Control, the only method to switch back to Local Control is using the Enable/Disable of Robot Stick function from Robot Stick.



WARNING:

Users should consider the strength and the complexity of password to prevent unauthorized decryption. It is the users' responsibility to ensure the password security and the correctness of safety configuration in advance.

The Robot Stick status and operation are summarized in the table below:

Enable/Disable status of Robot Stick function	Operation Using
Enable, ON	<ul style="list-style-type: none"> Robot Stick TM Teach Pendant
Disable, OFF	<ul style="list-style-type: none"> External IO connection Fieldbus command

Table 21: Robot Stick Status and Operation



DANGER:

When using the TM Teach Pendant, it is forbidden to integrate the robot with Screen/Keyboard/Mouse resulting in the multi-control of the robot. The system integrator is responsible for ensuring that the robot is under only one control source.

Below are the initiate robot motion functions of Play, + / - function by the Robot Stick status. The peripheral functions include external IO connection and fieldbus command.

MODEs	Enable/Disable status of Robot Stick	Jog and Hold-to-run function		Project Verification	
		Robot Stick + / -	Peripheral + / -	Robot Stick Play	Peripheral Play
MANUAL (T1)	ON	Allow	Not Allow	Allow	Not Allow
	OFF	Not Allow	Allow	Not Allow	Allow
MANUAL (TCH)	ON	Allow	Not Allow	Allow	Not Allow
	OFF	Not Allow	Allow	Not Allow	Allow
AUTO	ON	Not Allow	Not Allow	Not Allow	Not Allow
	OFF	Not Allow	Not Allow	Not Allow	Not Allow

MODEs	Enable/Disable status of Robot Stick	Project Execution		Project Override Speed Adjustment	
		Robot Stick Play	Peripheral Play	Robot Stick + / -	Peripheral + / -
MANUAL (T1)	ON	Not Allow	Not Allow	Allow	Not Allow
	OFF	Not Allow	Not Allow	Not Allow	Allow
MANUAL (TCH)	ON	Not Allow	Not Allow	Allow	Not Allow
	OFF	Not Allow	Not Allow	Not Allow	Allow
AUTO	ON	Allow	Not Allow	Allow	Not Allow
	OFF	Not Allow	Allow	Not Allow	Allow

Table 22: Initiate Robot Motion Functions according to Robot Stick Status and MODEs

The functions of safety elements on the Robot Stick, includes Emergency Stop function, Enabling Switch function, MODE Switch function and Reset function, according to different MODEs and the Robot Stick status can be summarized as the table below.

MODEs	Enable/Disable status of Robot Stick	Emergency Stop function		Enabling Switch function	
		On Robot Stick	User Connected	On Robot Stick	User Connected
MANUAL (T1)	ON	Effective	Effective	Effective	No Effect
	OFF	Effective	Effective	No Effect	Effective
MANUAL (TCH)	ON	Effective	Effective	Effective	No Effect
	OFF	Effective	Effective	No Effect	Effective
AUTO	ON	Effective	Effective	No Effect	No Effect
	OFF	Effective	Effective	No Effect	No Effect

MODEs	Enable/Disable status of Robot Stick	MODE Switch function		Reset function	
		On Robot Stick	User Connected	On Robot Stick	User Connected
MANUAL (T1)	ON	Effective	No Effect	Effective	No Effect
	OFF	No Effect	Effective	No Effect	Effective
MANUAL (TCH)	ON	Effective	No Effect	Effective	No Effect
	OFF	No Effect	Effective	No Effect	Effective
AUTO	ON	Effective	No Effect	Effective	No Effect
	OFF	No Effect	Effective	No Effect	Effective

Table 23: Safety Elements according to Robot Stick Status and MODEs

4. Compliance of Safety Regulations

This section describes the compliance and certification of this product to international safety regulations.

This product complies with to the following international safety regulations:

ISO 10218-1:2011

ISO/TS 15066

ISO 13849-1:2015

Certification: Third-party certification (refer to the certificate in Appendix A)

4.1 Compliance

This product complies with the combined scope of ISO 10218-1:2011 and ISO/TS-15066.

The relevant design and corresponding provisions in safety regulations of this part are listed in the following sections.

4.1.1 Access of Safety Setting

TM Robot's safety setting has been integrated with the user's permission system of the entire product.

5. Declaration of Incorporation

The following is based on the Declaration of Incorporation in application of 2006/42/EG, Annex II, No. 1 B

The robot product of the Corporation is a partly completed machinery. When it is put into automation applications, it needs to be integrated with other equipment, and appropriately installed with the safety related measures and design before it can be used. When the semi-finished products are to put on the market, the following requirements according to 2006/42/EC Annex I need to be achieved. It must be noted that since the TM Robot product is easy to use, the “system integrator” here refers to the end user who uses the product directly through simple installation.

A: Not related

B: Satisfied by machinery equipment provider

C: Responsibility of the system integrator

Attention: in the following tables:

- Items marked as A: The scope of use of this product has been exceeded, and is not included into the consideration, or it is not directly related to this product.

- Items marked as B solely: The items that are to be satisfied by the machinery equipment provider, meaning the machinery provider has satisfied or has specified in each of the Software and Hardware / Safety Manual. In the latter case, the system integrator is still responsible for the full compliance with specification of machinery equipment provider. In addition, in the entire system, the satisfaction of machinery equipment belonging to the system but not belonging to this product is not included here, and the system integrator must be responsible for it.

- Items marked as C solely: The item cannot be satisfied by this product. The system integrator must implement additional measures.

- Items marked as both B and C:
 1. When the item can be satisfied in using this product itself, the machinery equipment provider of this product shall satisfy it.
 2. When the system integrator replaces the related functions of this product through system integration, the system integrator shall satisfy it. For example:
 - Replacing the Emergency Stop button of the Robot Stick with an external Emergency Stop button connected to the User Connected ESTOP Input.
 - Replacing the Play/Stop Button of the Robot Stick with user-defined IO or the functions of

equivalent functions.

When this type of design replaces the original function of this product, the system integrator shall be responsible for the equivalence of the replacement.

3. The machinery equipment provider satisfies this item in normal conditions, but in extraordinary conditions, the satisfying of this item is the responsibility of the system integrator. For example:
 - The product will not break in normal operation, without a collision. However, the product can break in the event of a strong collision due to incorrect programming setup and safety setting during operation.

* A – Scope Exceeded, B – Manufacturer Provided, C – May Require Additional Risk Reduction Measures

Number	Original Language Items	A*	B*	C*
1.1	Essential Requirements			
1.1.1	Definitions		X	X
1.1.2	Principles of safety integration		X	X
1.1.3	Materials and products		X	
1.1.4	Lighting			X
1.1.5	Design of machinery to facilitate its handling		X	
1.1.6	Ergonomics		X	X
1.1.7	Operating positions			X
1.1.8	Seating			X
1.2	Control Systems			
1.2.1	Safety and reliability of control systems		X	X
1.2.2	Control devices		X	X
1.2.3	Starting		X	X
1.2.4	Stopping		X	X
1.2.4.1	Normal stop		X	X
1.2.4.2	Operational stop		X	X
1.2.4.3	Emergency stop		X	X
1.2.4.4	Assembly of machinery			X
1.2.5	Selection of control or operating modes		X	X
1.2.6	Failure of the power supply			X
1.3	Protection against mechanical hazards			
1.3.1	Risk of loss of stability			X
1.3.2	Risk of break-up during operation		X	X
1.3.3	Risks due to falling or ejected objects		X	X
1.3.4	Risks due to surfaces, edges or angles		X	X
1.3.5	Risks related to combined machinery			X
1.3.6	Risks related to variations in operating conditions			X
1.3.7	Risks related to moving parts		X	X
1.3.8	Choice of protection against risks arising from moving parts			X
1.3.8.1	Moving transmission parts		X	X
1.3.8.2	Moving parts involved in the process		X	X
1.3.9	Risks of uncontrolled movements			X
1.4	Required characteristics of guards and protective devices			
1.4.1	General requirements			X

Number	Original Language Items	A*	B*	C*
1.4.2	Special requirements for guards			X
1.4.2.1	Fixed guards			X
1.4.2.2	Interlocking movable guards			X
1.4.2.3	Adjustable guards restricting access			X
1.4.3	Special requirements for protective devices			X
1.5	Risks due to other hazards			
1.5.1	Electricity supply			X
1.5.2	Static electricity			X
1.5.3	Energy supply other than electricity			X
1.5.4	Errors of fitting			X
1.5.5	Extreme temperatures	X		
1.5.6	Fire	X		
1.5.7	Explosion	X		
1.5.8	Noise		X	X
1.5.9	Vibrations			X
1.5.10	Radiation	X		
1.5.11	External radiation			X
1.5.12	Laser radiation	X		
1.5.13	Emissions of hazardous materials and substances		X	X
1.5.14	Risk of being trapped in a machine			X
1.5.15	Risk of slipping, tripping or falling			X
1.5.16	Lightning			X
1.6	Maintenance			
1.6.1	Machinery maintenance			X
1.6.2	Access to operating positions and servicing points			X
1.6.3	Isolation of energy sources			X
1.6.4	Operator intervention			X
1.6.5	Cleaning of internal parts	X		
1.7	Information			
1.7.1	Information and warnings on the machinery		X	
1.7.1.1	Information and information devices		X	X
1.7.1.2	Warning devices		X	X
1.7.2	Warning of residual risks		X	
1.7.3	Marking of machinery		X	
1.7.4	Instructions		X	
1.7.4.1	General principles for the drafting of instructions		X	
1.7.4.2	Contents of the instructions		X	
1.7.4.3	Sales collateral	X		

Table 24: Declaration of Incorporation

6. Maintenance and Repair

The following table gives a summary of the preventive maintenance procedures and guidelines:

Items	Period	Guideline
Check Warning, Safety labels	1 week	Ensure labels are present and legible. Replace them if necessary.
Check Emergency Stop Functions	1 month	Activation (input status: LOW) of an Emergency Stop function initiates a Category 1 Stop. The Indication Light Ring of the robot will not display light.
Check Enabling Switch Functions	1 month	Activation (input status: LOW, released or fully compressed) of an Enabling Switch function initiates a Category 2 Stop. The Indication Light Ring of the robot will start blinking.
Check Reset Functions	1 month	Activation of a Reset function will let robot leave latching safety status of Safeguard functions, Recovery mode or certain power off status.
Check Safeguard Functions	1 month	Activation (input status: LOW) of a Safeguard function initiates a Category 2 Stop. The Indication Light Ring of the robot will start blinking.
Check Input Functions	1 month	Activation (input status: LOW) of any Input function should initiate corresponded status.
Check Output Functions	1 month	Activation (input status: LOW) of any Output function should initiate corresponded status.

Table 25: Summary of the Preventive Maintenance Procedures and Guidelines

Only the legal distributor or authorized service center should repair the TM Robot. Users should not repair it by themselves.



DANGER:

Before performing maintenance or service, record the details of each setting for the normal operations of robot and ensure each of them satisfies the original conditions before resuming the operations, including but not limited to:

- Safety Settings
- Safety I/O
- Preset operation project
- TCP Settings
- I/O Settings
- I/O Wirings

Appendix A. Certificate of Compliance and Declaration of Incorporation



ZERTIFIKAT CERTIFICATE

Hiermit wird bescheinigt, dass die Firma / This certifies that the company

Techman Robot Inc.
5F No. 58-2, Huaya 2nd Rd
Guishan Dist., Taoyuan City, 33383
Taiwan

berechtigt ist, das unten genannte Produkt mit dem abgebildeten Zeichen zu kennzeichnen
is authorized to provide the product mentioned below with the mark as illustrated

Fertigungsstätte:
Manufacturing plant: Techman Robot Inc.
7F No. 58-2, Huaya 2nd Rd
Guishan Dist., Taoyuan City, 33383
Taiwan

Beschreibung des Produktes:
(Details s. Anlage 1)
Description of product
(Details see Annex 1) Industrial Robots

Typenbezeichnung:
Type designation: TM5S; TM5S-X; TM5S SEMI; TM5S-X SEMI; TM5S SHL; TM5S-X SHL
TM6S; TM6S-X; TM6S SEMI; TM6S-X SEMI; TM6S SHL; TM6S-X SHL
TM7S; TM7S-X; TM7S SEMI; TM7S-X SEMI; TM7S SHL; TM7S-X SHL
TM12S; TM12S-X; TM12S SEMI; TM12S-X SEMI; TM12S SHL; TM12S-X SHL
TM14S; TM14S-X; TM14S SEMI; TM14S-X SEMI; TM14S SHL; TM14S-X SHL
TM16S; TM16S-X; TM16S SEMI; TM16S-X SEMI; TM16S SHL; TM16S-X SHL
TM20S; TM20S-X; TM20S SEMI; TM20S-X SEMI; TM20S SHL; TM20S-X SHL
TM25S; TM25S-X; TM25S SEMI; TM25S-X SEMI; TM25S SHL; TM25S-X SHL
TM30S; TM30S-X; TM30S SEMI; TM30S-X SEMI; TM30S SHL; TM30S-X SHL
TM30SC; TM30SC-X; TM30SC SEMI; TM30SC-X SEMI; TM30SC SHL; TM30SC-X SHL

TM5S-M; TM5S-MX; TM5S-M SEMI; TM5S-MX SEMI; TM5S-M SHL; TM5S-MX SHL
TM6S-M; TM6S-MX; TM6S-M SEMI; TM6S-MX SEMI; TM6S-M SHL; TM6S-MX SHL
TM7S-M; TM7S-MX; TM7S-M SEMI; TM7S-MX SEMI; TM7S-M SHL; TM7S-MX SHL
TM12S-M; TM12S-MX; TM12S-M SEMI; TM12S-MX SEMI; TM12S-M SHL; TM12S-MX SHL
TM14S-M; TM14S-MX; TM14S-M SEMI; TM14S-MX SEMI; TM14S-M SHL; TM14S-MX SHL
TM16S-M; TM16S-MX; TM16S-M SEMI; TM16S-MX SEMI; TM16S-M SHL; TM16S-MX SHL
TM20S-M; TM20S-MX; TM20S-M SEMI; TM20S-MX SEMI; TM20S-M SHL; TM20S-MX SHL
TM25S-M; TM25S-MX; TM25S-M SEMI; TM25S-MX SEMI; TM25S-M SHL; TM25S-MX SHL
TM30S-M; TM30S-MX; TM30S-M SEMI; TM30S-MX SEMI; TM30S-M SHL; TM30S-MX SHL
TM30SC-M; TM30SC-MX; TM30SC-M SEMI; TM30SC-MX SEMI; TM30SC-M SHL; TM30SC-MX SHL



Geprüft nach:
Tested in accordance with: EN ISO 10218-1:2011
EN ISO 13849-1:2023 Cat. 3, PL d
ISO/TS 15066:2016

Zertifizierungsprogramm:
Certification program: P 14.1VA001

Registrier-Nr. / Registered No. 44 780 21246101
Prüfbericht Nr. / Test Report No. 35386366/35386367
Aktenzeichen / File reference 8003078815

Gültigkeit / Validity
von / from 2025-06-23
bis / until 2030-06-22

Zertifizierungsstelle der
TÜV NORD CERT GmbH

Essen, 2025-06-23

TÜV NORD CERT GmbH Am TÜV 1 45307 Essen www.tuev-nord-cert.de technology@tuev-nord.de

Bitte beachten Sie auch die umseitigen Hinweise
Please also pay attention to the information stated overleaf

The "manufacturer" in the article above should be deemed to be "original equipment manufacturer."



ZERTIFIKAT CERTIFICATE

Hiermit wird bescheinigt, dass die Firma / *This certifies, that the company*

Techman Robot Inc.
5F No. 58-2, Huaya 2nd Rd
Guishan Dist., Taoyuan City, 33383
Taiwan

berechtigt ist, das unten genannte Produkt mit dem abgebildeten Zeichen zu kennzeichnen.
is authorized to provide the product mentioned below with the mark as illustrated.

Fertigungsstätte: Techman Robot Inc.
Manufacturing plant: 7F No. 58-2, Huaya 2nd Rd
Guishan Dist., Taoyuan City, 33383
Taiwan

Beschreibung des Produktes: Industrial Robots
(Details s. Anlage 1)
Description of product
(Details see Annex 1)

Typenbezeichnung: TM5S; TM5S-X; TM5S SEMI; TM5S-X SEMI; TM5S SHL; TM5S-X SHL
Type designation: TM6S; TM6S-X; TM6S SEMI; TM6S-X SEMI; TM6S SHL; TM6S-X SHL
TM7S; TM7S-X; TM7S SEMI; TM7S-X SEMI; TM7S SHL; TM7S-X SHL
TM12S; TM12S-X; TM12S SEMI; TM12S-X SEMI; TM12S SHL; TM12S-X SHL
TM14S; TM14S-X; TM14S SEMI; TM14S-X SEMI; TM14S SHL; TM14S-X SHL
TM16S; TM16S-X; TM16S SEMI; TM16S-X SEMI; TM16S SHL; TM16S-X SHL
TM20S; TM20S-X; TM20S SEMI; TM20S-X SEMI; TM20S SHL; TM20S-X SHL
TM25S; TM25S-X; TM25S SEMI; TM25S-X SEMI; TM25S SHL; TM25S-X SHL
TM30S; TM30S-X; TM30S SEMI; TM30S-X SEMI; TM30S SHL; TM30S-X SHL
TM30SC; TM30SC-X; TM30SC SEMI; TM30SC-X SEMI; TM30SC SHL; TM30SC-X SHL

Geprüft nach: EN ISO 13849-1:2023 Cat. 3, PL d
Tested in accordance with:
Zertifizierungsprogramm: P14.2VA001
Certification program:

Registrier-Nr. / *Registered No.* 44 207 21246101
Prüfbericht Nr. / *Test Report No.* 35386366/35386367
Aktenzeichen / *File reference* 8003078815
Gültigkeit / *Validity*
von / *from* 2025-06-23
bis / *until* 2030-06-22

Zertifizierungsstelle der
TÜV NORD CERT GmbH

Essen, 2025-06-23

TÜV NORD CERT GmbH Am TÜV 1 45307 Essen www.tuev-nord-cert.de technology@tuev-nord.de

Bitte beachten Sie auch die umseitigen Hinweise
Please also pay attention to the information stated overleaf



The "manufacturer" in the article above should be deemed to be "original equipment manufacturer."



CERTIFICATE OF COMPLIANCE

Certificate Number: SGSNA/23/SH/00150X

Contract Number: 801820
Certificate Project Number: SH-CERT220704766

Certified Product: Industrial Robot
Trademarks:



Model(s): TMX1-X2 and TM X1-X2SEMI, TMX3-X4 and TM X3-X4SEMI
(X1=5S, 7S, 12S, 14S, 16S and X2=M or MX or X or blank
X3=25S, 30S and X4=M or MX or X or blank)

Technical Data: X2=X or blank are 100-240Vac
X3=X or blank are 200-240Vac
X2=M or MX are 24-60Vdc
X4=M or MX are 48-60Vdc
X means Robot has no embedded camera and no X (blank) means Robot has embedded camera.
SEMI or blank means there is SEMI certified or not.

Certificate Holder: Techman Robot Inc.
5F., No. 58-2, Huaya 2nd Rd, Guishan Dist, Taoyuan City, 333411, Taiwan

This certificate supercedes previous certificates issued with the same certificate number. Certification is valid when products are indicated on the SGS directory of certified products at www.sgs.com or using the QR code below. The product is certified according to ISO/IEC Guide 17067, Conformity assessment - Fundamentals of product certification, System 3, and in accordance with:

UL 1740, 4th Edition, Revised November 17, 2020
NFPA 79 2021 Edition, Dated Oct. 25, 2020
CAN/CSA Z434-14 (R2019), Reaffirmed 2019

Certification Condition

End user should provide suitable power to robots

Authorized by:

Effective date: 16 May 2024



Jason Wei
Certifier

Page 1 of 1



SGS operates certification programs under the authority of several accreditation or recognition bodies including A2LA, ANAB, OSHA, NRTL, and Standards Council of Canada. This certificate is issued by the company under its General Conditions for Certification Services accessible at <https://www.sgs.com/en/ems-and-conditions>. Attention is drawn to the limitations of liability defined therein and in the Test Report here above mentioned which findings are reflected in this Certificate. Any unauthorized alteration, forgery or falsification of the content or appearance of this document is unlawful and offenders may be prosecuted to the fullest extent of the law.

Certification Body

Connectivity & Products, a division of SGS North America Inc.
620 Old Peachtree Road, Ste. 100, Suwanee, GA 30024, USA
t +1 770 570 1800 f +1 770 277 1240 www.sgs.com



DECLARATION OF INCORPORATION

We **TECHMAN ROBOT Inc.**
5F., No. 58-2, Huaya 2nd Rd., Guishan Dist., Taoyuan City, 333411, Taiwan (R.O.C.)

Declare that the

Product name: Industrial Robot

Series Model Number:

AC Type:

TM5S; TM5S-X; TM5S SEMI; TM5S-X SEMI; TM6S; TM6S-X; TM6S SEMI; TM6S-X SEMI;
TM7S; TM7S-X; TM7S SEMI; TM7S-X SEMI; TM12S; TM12S-X; TM12S SEMI; TM12S-X SEMI;
TM14S; TM14S-X; TM14S SEMI; TM14S-X SEMI; TM16S; TM16S SEMI; TM16S-X; TM16S-X SEMI;
TM20S; TM20S-X; TM20S SEMI; TM20S-X SEMI; TM25S; TM25S-X; TM25S SEMI; TM25S-X SEMI;
TM30S; TM30S-X; TM30S SEMI; TM30S-X SEMI;

DC Type:

TM5S-M; TM5S-MX; TM5S-M SEMI; TM5S-MX SEMI; TM6S-M; TM6S-MX; TM6S-M SEMI; TM6S-MX SEMI;
TM7S-M; TM7S-MX; TM7S-M SEMI; TM7S-MX SEMI; TM12S-M; TM12S-MX; TM12S-M SEMI; TM12S-MX SEMI;
TM14S-M; TM14S-MX; TM14S-M SEMI; TM14S-MX SEMI; TM16S-M; TM16S-M SEMI; TM16S-MX; TM16S-MX SEMI;
TM20S-M; TM20S-MX; TM20S-M SEMI; TM20S-MX SEMI; TM25S-M; TM25S-MX; TM25S-M SEMI; TM25S-MX SEMI;
TM30S-M; TM30S-MX; TM30S-M SEMI; TM30S-MX SEMI;

Robot Arm Serial Number: CAXXXXXXXX

Control Box Serial Number: CCXXXXXXX

Conform to the essential safety requirements of the relevant European Directive:

- Machinery Directive 2006/42/EC
- EMC Directive 2014/30/EU

The following essential requirements of EC Machinery Directive 2006/42/EC have been applied:

Clause 1.1.2, 1.1.3, 1.1.5, 1.1.6, 1.1.7, 1.2.1, 1.2.2, 1.2.3, 1.2.4.1, 1.2.4.2, 1.2.4.3, 1.2.4.4, 1.2.5, 1.2.6, 1.3.1, 1.3.2,
1.3.4, 1.3.6, 1.3.7, 1.3.8.1, 1.3.8.2, 1.3.9, 1.4.1, 1.4.2.1, 1.4.3, 1.5.1, 1.5.2, 1.5.3, 1.5.4, 1.5.13, 1.5.14, 1.6.1,
1.6.2, 1.6.3, 1.6.4, 1.6.5, 1.7.1.1, 1.7.1.2, 1.7.2, 1.7.3, 1.7.4, 1.7.4.1, 1.7.4.2, 1.7.4.3

The person who compile technical file established within the EU:

Name: TECHMAN ROBOT Inc.

Address: Staalindustrieweg 21 NL-2952 AT Alblasserdam, Netherlands

Mounting and connecting instructions defined in catalogues and technical construction files must be respected by the user.

They are based on the following standards :

- EN ISO 12100:2010 / Safety of Machinery - General principles for design / Risk Assessment and Risk reduction.
- EN 60204-1:2018 / Safety of machinery - Electrical equipment of machines - Part 1: General requirements
- EN ISO 13849-1:2023 / Safety of machinery - Safety-related parts of control systems Part 1: General principles for design
- EN ISO 10218-1:2011 / Robots and robotic devices - Safety requirements for industrial robots - Part 1: Robots
- ISO TS 15066-2016 / Robots and robotic devices — Collaborative robots
- EN IEC 61000-6-2:2019 / Electromagnetic compatibility (EMC) - Part 6-2: Generic standards - Immunity for industrial environments
- EN 61000-6-4:2019(Class A) / Electromagnetic compatibility (EMC) - Part 6-4: Generic standards - Emission standard for industrial environments

The relevant technical documentation has been compiled in accordance with Annex VII, Part B of EC Machinery Directive 2006/42/EC. We undertake, in response to a reasoned request, to supply it to the market surveillance authorities within a reasonable period.

The partly completed machinery must not be put into service until the final machinery into which it is to be incorporated has been declared in conformity with the provisions of the Machinery Directive.

Authorized Signature :

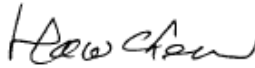
Name : Haw Chen 
Responsibility : CEO
Date : October 13th, 2025
Place : Taiwan

Appendix B. Verifications of EMC Compliance

SGS

SGS Reference No. : VTMHY2409001651YEA/2024

Page: 1 of 1

VERIFICATION OF COMPLIANCE

Issue Date: Dec. 24, 2024
Applicant: Techman Robot Inc.
Address: 5F., No. 58-2, Huaya 2nd Rd., Guishan Dist., Taoyuan City, 333411, Taiwan (R.O.C.)
Manufacturer: Techman Robot Inc.
Address: 5F., No. 58-2, Huaya 2nd Rd., Guishan Dist., Taoyuan City, 333411, Taiwan (R.O.C.)
Product: Industrial Robot
Brand Name/Trade Mark:  Techman Robot Inc.
Model/Type: TM12S-M SEMI
Added Model(s): TM5S-M, TM5S-MX, TM5S-M SEMI, TM5S-MX SEMI, TM6S-M, TM6S-MX, TM6S-M SEMI, TM6S-MX SEMI, TM7S-M, TM7S-MX, TM7S-M SEMI, TM7S-MX SEMI, TM12S-M, TM12S-MX, TM12S-M SEMI, TM12S-MX SEMI, TM14S-M, TM14S-MX, TM14S-M SEMI, TM14S-MX SEMI, TM16S-M, TM16S-MX, TM16S-M SEMI, TM16S-MX SEMI, TM20S-M, TM20S-MX, TM20S-M SEMI, TM20S-MX SEMI, TM5S-M SHL, TM5S-MX SHL, TM6S-M SHL, TM6S-MX SHL, TM7S-M SHL, TM7S-MX SHL, TM12S-M SHL, TM12S-MX SHL, TM14S-M SHL, TM14S-MX SHL, TM16S-M SHL, TM16S-MX SHL, TM20S-M SHL, TM20S-MX SHL
Applicable Standards: EN IEC 61000-6-4 : 2019 (Class A)
EN IEC 61000-6-2 : 2019
IEC 61000-4-2 : 2008
IEC 61000-4-3 : 2020
IEC 61000-4-4 : 2012
IEC 61000-4-5 : 2014+A1:2017
IEC 61000-4-6 : 2013+COR1:2015
IEC 61000-4-8 : 2009
Test Laboratory: SGS Taiwan Ltd.
Electromagnetic Compatibility Laboratory
No.2, Keji 1st Rd., Guishan District, Taoyuan City, Taiwan
Test Report No.: TMHY2409001651YE, dated on Dec. 24, 2024

Conclusion: Based upon a review of the Test Report(s), the tested sample of the product mentioned above is deemed to comply with the requirements of the above standards.

Note: This verification is only valid for the product and configuration described and in conjunction with the test report as detailed above.

Authorised Signatory:



SGS Taiwan Ltd.
Bill Cheng
Supervisor

Unless otherwise stated the results shown in this test report refer only to the sample(s) tested and such sample(s) are retained for 90 days only.

除非另有說明，此報告結果僅對測試之樣品負責，同時此樣品僅保留90天。本報告未經本公司書面許可，不可部份複製。

This document is issued by the Company subject to its General Conditions of Service printed overleaf, available on request or accessible at <http://www.sgs.com.tw/Terms-and-Conditions> and for electronic format documents, subject to Terms and Conditions for Electronic Documents at <http://www.sgs.com.tw/Terms-and-Conditions>. Attention is drawn to the limitation of liability, indemnification and jurisdiction issues defined therein. Any holder of this document is advised that information contained hereon reflects the Company's findings at the time of its intervention only and within the limits of Client's instructions, if any. The Company's sole responsibility is to its Client and this document does not exonerate parties to a transaction from exercising all their rights and obligations under the transaction documents. This document cannot be reproduced except in full, without prior written approval of the Company. Any unauthorized alteration, forgery or falsification of the content or appearance of this document is unlawful and offenders may be prosecuted to the fullest extent of the law.

SGS Taiwan Ltd. No.2, Keji 1st Rd., Guishan District, Taoyuan City, Taiwan / 桃園市龜山區科技一路2號

台灣檢驗科技股份有限公司 t (886-2) 2299-3279

f (886-3) 327-7559

www.sgs.com.tw

Form-LAMP-EMC-020-01(1.1)

Member of SGS Group

VERIFICATION OF COMPLIANCE

Issue Date: Mar. 11, 2025

Applicant: Techman Robot Inc.

Address: 5F., No. 58-2, Huaya 2nd Rd., Guishan Dist., Taoyuan City, 333411, Taiwan (R.O.C.)

Manufacturer: Techman Robot Inc.

Address: 5F., No. 58-2, Huaya 2nd Rd., Guishan Dist., Taoyuan City, 333411, Taiwan (R.O.C.)

Product: Industrial Robot

Brand Name/Trade Mark: Techman Robot Inc.

Model/Type: TM12S

Added Model(s): TM5S, TM5S-X, TM5S SEMI, TM5S-X SEMI, TM6S, TM6S-X, TM6S SEMI, TM6S-X SEMI, TM7S, TM7S-X, TM7S SEMI, TM7S-X SEMI, TM12S, TM12S-X, TM12S SEMI, TM12S-X SEMI, TM14S, TM14S-X, TM14S SEMI, TM14S-X SEMI, TM16S, TM16S-X, TM16S SEMI, TM16S-X SEMI, TM20S, TM20S-X, TM20S SEMI, TM20S-X SEMI, TM5S SHL, TM5S-X SHL, TM6S SHL, TM6S-X SHL, TM7S SHL, TM7S-X SHL, TM12S SHL, TM12S-X SHL, TM14S SHL, TM14S-X SHL, TM16S SHL, TM16S-X SHL, TM20S SHL, TM20S-X SHL

Applicable Standards: EN IEC 61000-6-4 : 2019 (Class A)
EN IEC 61000-6-2 : 2019
EN IEC 61000-3-2 : 2019+A1:2021
EN 61000-3-3 : 2013+A1:2019+A2:2021+AC:2022-01
IEC 61000-4-2 : 2008
IEC 61000-4-3 : 2020
IEC 61000-4-4 : 2012
IEC 61000-4-5 : 2014+A1:2017
IEC 61000-4-6 : 2013+COR1:2015
IEC 61000-4-8 : 2009
IEC 61000-4-11 : 2020+COR1:2020

Test Laboratory: SGS Taiwan Ltd.
Electromagnetic Compatibility Laboratory
No.2, Keji 1st Rd., Guishan District, Taoyuan City, Taiwan

Test Report No.: TMHY2409001650YE, dated on Mar. 11, 2025

Conclusion: Based upon a review of the Test Report(s), the tested sample of the product mentioned above is deemed to comply with the requirements of the above standards.

Note: This verification is only valid for the product and configuration described and in conjunction with the test report as detailed above.

Authorised Signatory:

SGS Taiwan Ltd.
Bill Cheng
Supervisor

Unless otherwise stated the results shown in this test report refer only to the sample(s) tested and such sample(s) are retained for 90 days only.
除非另有說明，此報告結果僅對測試之樣品負責，同時樣品僅保留90天。本報告未經本公司書面許可，不可部份複製。
This document is issued by the Company subject to its General Conditions of Service printed overleaf, available on request or accessible at <http://www.sgs.com.tw/Terms-and-Conditions> and for electronic format documents, subject to Terms and Conditions for Electronic Documents at <http://www.sgs.com.tw/Terms-and-Conditions>. Attention is drawn to the limitation of liability, indemnification and jurisdiction issues defined therein. Any holder of this document is advised that information contained hereon reflects the Company's findings at the time of its intervention only and within the limits of Client's instructions, if any. The Company's sole responsibility is to its Client and this document does not exonerate parties to a transaction from exercising all their rights and obligations under the transaction documents. This document cannot be reproduced except in full, without prior written approval of the Company. Any unauthorized alteration, forgery or falsification of the content or appearance of this document is unlawful and offenders may be prosecuted to the fullest extent of the law.

SGS Taiwan Ltd. No.2, Keji 1st Rd., Guishan District, Taoyuan City, Taiwan / 桃園市龜山區科技一路2號
台灣檢驗科技股份有限公司 t (886-2) 2299-3279 f (886-3) 327-7559 www.sgs.com.tw
Form-LAMP-EMC-020-01(1.1) Member of SGS Group

Appendix C. TM Robot Stopping Time and Distance for All Product Series

The stopping time and stopping distance of the Category 1 Stop functions of this product at different speeds and with different payloads are shown below.



WARNING:

Any moving robot requires some distance to stop. When stopping a robot, make sure that there is no interference with other equipment. This requires more distance at high operating speeds or with heavier payloads.

TM5S Series

Stopping Time and Distance Table								
Percentage of the Max. Payload (%)	Extension(%)	Speed(%)	First joint		Second joint		Third joint	
			Stop Time (ms)	Stop Distance (deg)	Stop Time (ms)	Stop Distance (deg)	Stop Time (ms)	Stop Distance (deg)
33	33	33	264	11	262	11	262	11
		66	272	21	268	21	268	22
		100	274	31	270	31	269	31
	66	33	264	11	262	11	262	11
		66	267	21	264	19	267	22
		100	270	32	267	32	269	32
	100	33	262	11	260	11	261	11
		66	265	22	264	22	266	22
		100	267	32	265	31	268	32
66	33	33	263	11	261	11	263	11
		66	271	21	268	22	267	22
		100	275	32	270	31	269	32
	66	33	263	11	261	11	262	11
		66	268	21	265	20	267	22
		100	270	32	267	32	268	32
	100	33	262	11	260	11	260	11
		66	265	22	263	22	266	22
		100	265	31	264	31	267	31
100	33	33	262	11	261	11	260	11
		66	269	21	267	21	267	22
		100	273	32	271	32	268	31
	66	33	262	11	262	11	261	11
		66	268	21	265	20	267	22
		100	269	32	267	32	269	32
	100	33	260	11	260	11	262	11
		66	264	22	262	21	265	22
		100	265	32	263	32	267	32

Table 26: Stopping Time and Distance for TM5S Series

TM6S Series

Stopping Time and Distance Table								
Percentage of the Max. Payload (%)	Extension(%)	Speed(%)	First joint		Second joint		Third joint	
			Stop Time (ms)	Stop Distance (deg)	Stop Time (ms)	Stop Distance (deg)	Stop Time (ms)	Stop Distance (deg)
33	33	33	312	9.08	307	8.80	357	14.15
		66	323	17.99	323	17.88	389	29.20
		100	328	26.98	330	27.50	408	42.40
	66	33	316	8.99	319	9.02	358	14.62
		66	328	18.25	328	18.15	379	28.62
		100	329	27.12	334	27.57	405	43.06
	100	33	320	8.95	321	8.94	354	14.55
		66	325	17.62	333	17.89	364	27.98
		100	334	25.50	341	25.71	390	43.06
66	33	33	310	9.05	308	8.70	352	14.54
		66	320	18.11	326	18.02	361	29.16
		100	323	27.37	329	27.16	407	44.22
	66	33	313	9.05	314	8.75	343	14.28
		66	317	17.84	330	17.93	357	28.59
		100	323	27.41	324	9.07	355	43.36
	100	33	315	9.01	331	18.03	348	14.54
		66	322	17.93	308	25.47	360	28.93
		100	325	25.71	327	17.59	372	42.93
100	33	33	309	8.76	310	8.93	330	14.31
		66	329	17.96	317	17.79	333	28.84
		100	331	27.06	320	26.82	337	48.17
	66	33	317	9.03	314	8.98	326	14.57
		66	322	17.68	320	17.78	331	29.15
		100	324	26.78	323	27.24	334	49.04
	100	33	316	8.95	312	8.90	320	13.97
		66	323	17.87	311	17.36	335	28.93
		100	324	25.03	316	26.46	333	42.55

Table 27: Stopping Time and Distance for TM6S Series

TM7S Series

Stopping Time and Distance Table								
Percentage of the Max. Payload (%)	Extension(%)	Speed(%)	First joint		Second joint		Third joint	
			Stop Time (ms)	Stop Distance (deg)	Stop Time (ms)	Stop Distance (deg)	Stop Time (ms)	Stop Distance (deg)
33	33	33	264	11	264	11	264	11
		66	271	21	270	21	270	21
		100	272	32	274	32	273	32
	66	33	264	11	261	11	264	11
		66	269	21	267	21	269	21
		100	270	32	269	30	271	32
	100	33	263	11	261	11	263	11
		66	265	22	265	22	269	21
		100	267	32	267	32	270	32
66	33	33	263	11	264	11	263	11
		66	270	21	268	21	269	21
		100	273	31	271	32	272	32
	66	33	262	11	262	11	264	11
		66	268	21	267	21	268	21
		100	270	32	269	30	271	32
	100	33	261	11	260	11	263	11
		66	266	22	264	22	268	21
		100	266	31	266	32	271	32
100	33	33	263	11	263	11	264	11
		66	270	21	271	22	269	21
		100	273	32	272	32	272	32
	66	33	263	11	263	11	265	11
		66	267	22	267	22	269	21
		100	270	32	269	30	272	32
	100	33	261	11	261	11	264	11
		66	265	22	267	22	269	21
		100	267	32	266	32	271	32

Table 28: Stopping Time and Distance for TM7S Series

TM12S Series

Stopping Time and Distance Table								
Percentage of the Max. Payload (%)	Extension(%)	Speed(%)	First joint		Second joint		Third joint	
			Stop Time (ms)	Stop Distance (deg)	Stop Time (ms)	Stop Distance (deg)	Stop Time (ms)	Stop Distance (deg)
33	33	33	258	6.61	259	6.65	265	10.77
		66	268	13.32	270	13.41	269	21.56
		100	275	20.19	274	20.09	271	32.87
	66	33	260	6.65	260	6.66	263	10.77
		66	269	13.31	270	13.32	267	21.55
		100	274	20.08	275	20.32	269	32.98
	100	33	262	6.65	262	6.65	262	10.75
		66	268	13.32	269	13.23	264	21.54
		100	272	20.25	274	20.37	267	33.10
66	33	33	259	6.66	259	6.66	263	10.70
		66	268	13.33	270	13.32	266	21.55
		100	274	20.19	274	20.19	268	32.68
	66	33	260	6.66	258	6.61	263	10.77
		66	266	13.24	267	13.24	267	21.54
		100	272	20.19	272	20.08	268	32.78
	100	33	260	6.66	261	6.66	260	10.75
		66	268	13.32	268	13.32	263	21.40
		100	271	20.21	272	20.12	266	32.62
100	33	33	258	6.66	259	6.66	261	10.78
		66	268	13.33	268	13.23	264	21.56
		100	273	20.19	272	20.20	269	34.66
	66	33	259	6.66	260	6.66	261	10.77
		66	267	13.32	267	13.33	264	21.56
		100	272	20.19	271	20.06	274	35.29
	100	33	258	6.67	259	6.61	258	10.77
		66	265	13.34	266	13.33	264	21.53
		100	266	20.22	251	20.82	253	33.46

Table 29: Stopping Time and Distance for TM12S Series

TM14S Series

Stopping Time and Distance Table								
Percentage of the Max. Payload (%)	Extension(%)	Speed(%)	First joint		Second joint		Third joint	
			Stop Time (ms)	Stop Distance (deg)	Stop Time (ms)	Stop Distance (deg)	Stop Time (ms)	Stop Distance (deg)
33	33	33	256	7	256	7	258	11
		66	258	13	258	13	260	22
		100	257	20	258	20	260	32
	66	33	256	7	255	7	258	11
		66	257	13	257	13	260	22
		100	258	20	258	20	260	32
	100	33	256	7	256	7	256	11
		66	257	13	257	13	258	21
		100	257	20	258	20	260	32
66	33	33	256	7	256	7	257	11
		66	258	13	258	13	259	22
		100	258	20	258	20	259	32
	66	33	256	7	255	7	257	11
		66	257	13	257	13	259	22
		100	258	20	258	20	260	32
	100	33	255	7	256	7	257	11
		66	257	13	257	13	259	21
		100	257	20	258	20	260	32
100	33	33	256	6.66	256	7	257	11
		66	258	13.31	257	13	259	22
		100	258	20.17	258	20	254	32
	66	33	256	6.66	257	7	257	11
		66	257	13.31	257	13	259	22
		100	258	20.18	258	20	250	32
	100	33	255	6.67	255	7	257	11
		66	257	13.34	257	13	259	21
		100	256	20.07	258	20	259	32

Table 30: Stopping Time and Distance for TM14S Series

TM20S Series

Stopping Time and Distance Table								
Percentage of the Max. Payload (%)	Extension(%)	Speed(%)	First joint		Second joint		Third joint	
			Stop Time (ms)	Stop Distance (deg)	Stop Time (ms)	Stop Distance (deg)	Stop Time (ms)	Stop Distance (deg)
33	33	33	364	9.71	372	7.27	367	9.82
		66	375	19.43	396	14.55	375	19.64
		100	382	29.45	418	22.08	378	29.80
	66	33	364	9.71	369	7.27	366	9.79
		66	376	19.43	398	14.56	375	19.61
		100	380	29.45	414	22.08	378	29.78
	100	33	363	9.71	370	7.27	366	9.79
		66	375	19.43	399	14.55	375	19.61
		100	382	29.43	383	21.99	387	29.74
66	33	33	364	9.71	364	7.29	371	9.81
		66	375	19.42	376	14.58	383	19.62
		100	384	29.44	389	22.09	386	29.71
	66	33	365	9.71	364	7.29	370	9.79
		66	379	19.43	377	14.58	382	19.60
		100	383	29.43	385	22.09	387	29.71
	100	33	365	9.71	365	7.28	369	9.79
		66	377	19.43	0	0.00	383	19.60
		100	377	29.43	379	22.09	384	28.51
100	33	33	363	9.70	364	7.29	371	9.81
		66	375	19.41	374	14.58	382	19.61
		100	385	29.43	390	22.08	383	28.47
	66	33	364	9.71	365	7.28	368	9.76
		66	380	19.42	380	14.57	379	19.56
		100	384	29.41	386	22.06	384	28.47
	100	33	364	9.71	364	7.28	370	9.78
		66	377	19.42	379	14.56	380	19.56
		100	378	29.48	406	22.15	377	29.79

Table 31: Stopping Time and Distance for TM20S Series

TM25S Series

Stopping Time and Distance Table								
Percentage of the Max. Payload (%)	Extension(%)	Speed(%)	First joint		Second joint		Third joint	
			Stop Time (ms)	Stop Distance (deg)	Stop Time (ms)	Stop Distance (deg)	Stop Time (ms)	Stop Distance (deg)
33	33	33	338	6.84	339	6.86	347	8.91
		66	349	13.71	351	13.74	356	17.84
		100	355	20.77	357	20.99	357	27.31
	66	33	339	6.85	341	6.86	347	8.90
		66	352	13.73	354	13.76	356	17.84
		100	357	20.81	361	21.16	357	27.36
	100	33	340	6.85	346	6.87	345	8.90
		66	356	13.76	360	13.79	355	17.73
		100	363	20.92	366	21.22	356	27.22
66	33	33	338	6.85	339	6.87	346	8.90
		66	348	13.65	350	13.68	356	17.83
		100	354	20.79	356	20.94	357	27.16
	66	33	338	6.81	338	6.87	345	8.90
		66	350	13.73	354	13.76	356	17.83
		100	355	20.80	358	21.02	357	27.19
	100	33	335	6.85	342	6.88	345	8.90
		66	352	13.75	356	13.79	356	17.82
		100	359	20.85	360	20.96	356	27.12
100	33	33	337	6.85	339	6.83	345	8.85
		66	347	13.65	349	13.68	356	17.82
		100	352	20.68	356	20.83	357	27.01
	66	33	338	6.85	339	6.87	345	8.86
		66	350	13.71	352	13.76	356	17.82
		100	351	20.66	357	20.87	357	27.02
	100	33	331	6.87	337	6.88	345	8.90
		66	343	13.72	351	13.78	356	17.82
		100	348	20.77	354	20.98	357	27.03

Table 32: Stopping Time and Distance for TM25S Series

TM30S Series

Stopping Time and Distance Table								
Percentage of the Max. Payload (%)	Extension(%)	Speed(%)	First joint		Second joint		Third joint	
			Stop Time (ms)	Stop Distance (deg)	Stop Time (ms)	Stop Distance (deg)	Stop Time (ms)	Stop Distance (deg)
33	33	33	339	6.83	340	6.84	348	8.86
		66	353	13.68	352	13.67	363	17.75
		100	360	20.70	361	20.79	369	27.06
	66	33	340	6.84	342	6.85	348	8.86
		66	357	13.70	356	13.69	361	17.75
		100	365	20.77	366	20.93	368	27.12
	100	33	343	6.85	351	6.85	347	8.85
		66	363	13.73	365	13.71	360	17.73
		100	367	20.95	369	21.06	364	27.02
66	33	33	338	6.82	340	6.83	347	8.86
		66	352	13.66	349	13.66	361	17.74
		100	358	20.82	357	20.72	367	26.94
	66	33	339	6.83	341	6.84	348	8.86
		66	358	13.67	351	13.68	361	17.74
		100	362	20.73	361	20.78	365	26.98
	100	33	337	6.83	343	6.84	347	8.85
		66	361	13.76	359	13.69	358	17.73
		100	366	20.78	366	20.89	364	26.95
100	33	33	338	6.80	342	6.84	347	8.86
		66	352	13.60	351	13.65	361	17.73
		100	360	20.56	360	20.67	365	26.87
	66	33	339	6.81	342	6.84	347	8.86
		66	353	13.61	353	13.66	361	17.73
		100	362	20.61	359	20.70	366	26.87
	100	33	335	6.82	339	6.84	347	8.85
		66	359	13.65	356	13.67	360	17.73
		100	368	20.67	359	20.70	362	26.89

Table 33: Stopping Time and Distance for TM30S Series

OMRON Corporation Industrial Automation Company

Kyoto, JAPAN

Contact : www.ia.omron.com

Regional Headquarters

OMRON EUROPE B.V.

Wegalaan 67-69, 2132 JD Hoofddorp
The Netherlands
Tel: (31) 2356-81-300 Fax: (31) 2356-81-388

OMRON ASIA PACIFIC PTE. LTD.

438B Alexandra Road, #08-01/02 Alexandra
Technopark, Singapore 119968
Tel: (65) 6835-3011 Fax: (65) 6835-3011

OMRON ELECTRONICS LLC

2895 Greenspoint Parkway, Suite 200
Hoffman Estates, IL 60169 U.S.A.
Tel: (1) 847-843-7900 Fax: (1) 847-843-7787

OMRON ROBOTICS AND SAFETY TECHNOLOGIES, INC.

4225 Hacienda Drive, Pleasanton, CA 94588 U.S.A.
Tel: (1) 925-245-3400 Fax: (1) 925-960-0590

OMRON (CHINA) CO., LTD.

Room 2211, Bank of China Tower, 200 Yin Cheng Zhong Road,
PuDong New Area, Shanghai, 200120, China
Tel: (86) 21-6023-0333 Fax: (86) 21-5037-2388

Authorized Distributor:

©OMRON Corporation 2023-2025 All Rights Reserved.
In the interest of product improvement,
specifications are subject to change without notice.

Cat. No. I688-E-07 1125 (1123)

29888-300 G