



AMR (Autonomous Mobile Robot)

MD-series Platform

Safety and Unpacking Guide

MD-650

MD-900



I682-E-02

NOTE

All rights reserved. No part of this publication may be reproduced, stored in a retrieval system, or transmitted, in any form, or by any means, mechanical, electronic, photocopying, recording, or otherwise, without the prior written permission of OMRON.

No patent liability is assumed with respect to the use of the information contained herein. Moreover, because OMRON is constantly striving to improve its high-quality products, the information contained in this manual is subject to change without notice. Every precaution has been taken in the preparation of this manual. Nevertheless, OMRON assumes no responsibility for errors or omissions. Neither is any liability assumed for damages resulting from the use of the information contained in this publication.

Trademarks

Company names and product names in this document are the trademarks or registered trademarks of their respective companies.

Copyrights

Microsoft product screen shots reprinted with permission from Microsoft Corporation.

Introduction

Thank you for purchasing the MD-series Autonomous Mobile Robot (referred to as AMR in this document).

This guide is OMRON's original instructions describing the unpacking and safety considerations of the AMR.

This guide does not provide all AMR details, specifications, installation, operation, troubleshooting, or maintenance information. This guide is not a substitute for the *AMR (Autonomous Mobile Robot) MD-series Platform User's Manual (Cat. No. I681)*. All personnel that work with the AMR must read and understand the *AMR (Autonomous Mobile Robot) MD-series Platform User's Manual (Cat. No. I681)*. Please read this guide and make sure you understand the unpacking and safety considerations of the AMR before attempting to unpack or use it.

Keep this guide in a safe place where it will be available for reference for repacking purposes.

Intended Audience

This guide is intended for the following personnel, who must also have knowledge of factory automation (FA) systems and robotic control methods.

- Personnel in charge of introducing FA systems.
- Personnel in charge of designing FA systems.
- Personnel in charge of installing and maintaining FA systems.
- Personnel in charge of managing FA systems and facilities.

It is the end-user's responsibility to ensure that all personnel who will work with or around AMRs have attended an appropriate training and have a working knowledge of the system. The user must provide the necessary additional training for all personnel who will be working with the system.

As described in this document, you should allow only skilled persons or instructed persons to do certain procedures. Skilled persons have technical knowledge or sufficient experience to enable them to avoid either electrical or mechanical dangers. Instructed persons are adequately advised or supervised by skilled persons to enable them to avoid either electrical or mechanical dangers.

All personnel must observe industry-prescribed safety practices during the installation, operation, and testing of all electrically-powered equipment.

Before working with the AMR, every person must confirm that they:

- Have the necessary qualifications and training.
- Have access to this document and other safety documentation.
- Have read and understand the related documentation.
- Have agreed work in the manner specified by the documentation.

Units

All units are metric unless otherwise noted.

Distances are provided in mm unless otherwise noted.

Manual Information

Page Structure

The following page structure is used in this manual.

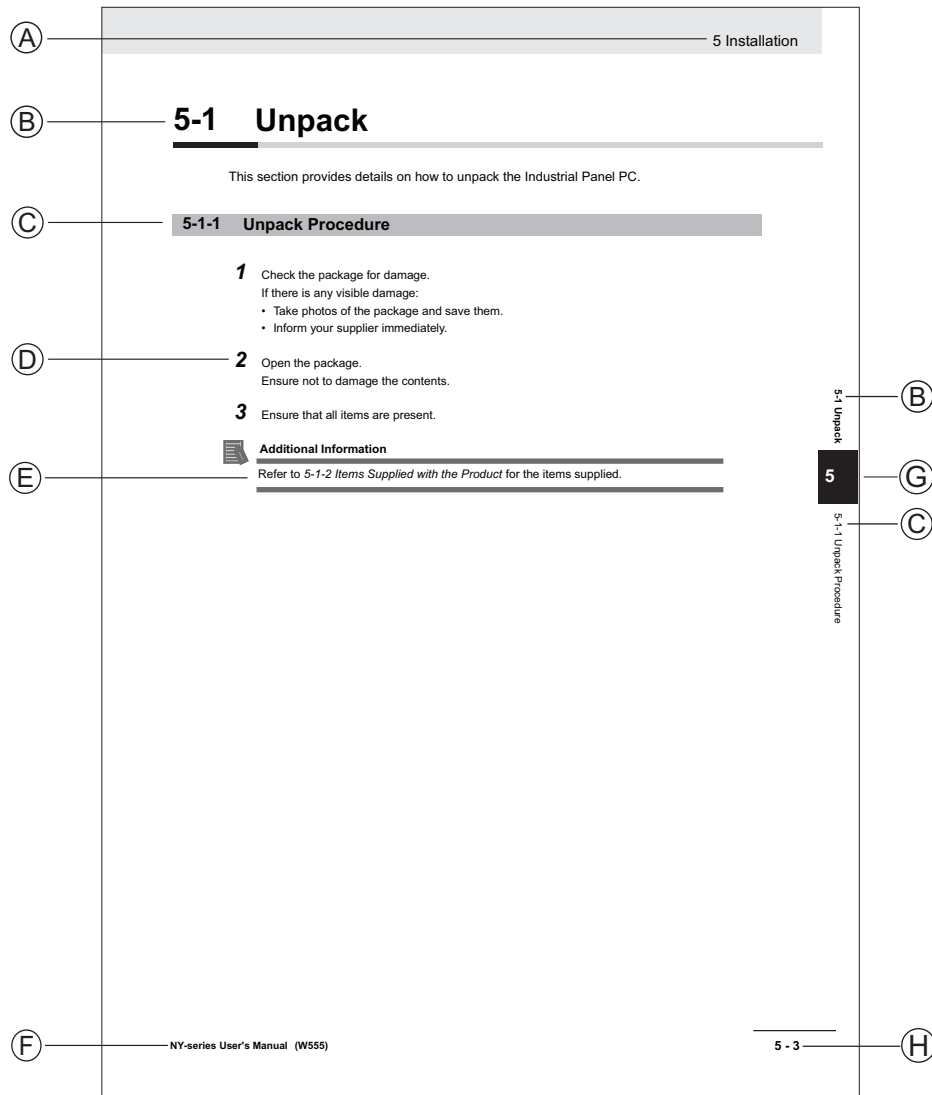

Note: This illustration is provided as a sample. It will not literally appear in this manual.

Item	Explanation	Item	Explanation
A	Level 1 heading	E	Special Information
B	Level 2 heading	F	Manual name
C	Level 3 heading	G	Page tab with the number of the main section
D	Step in a procedure	H	Page number

Special Information

Special information in this manual is classified as follows:

**Precautions for Safe Use**

Precautions on what to do and what not to do to ensure safe usage of the product.

**Precautions for Correct Use**

Precautions on what to do and what not to do to ensure proper operation and performance.

**Additional Information**

Additional information to read as required.

This information is provided to increase understanding or make operation easier.

**Version Information**

Information on differences in specifications and functionality between different versions.

Sections in this Manual

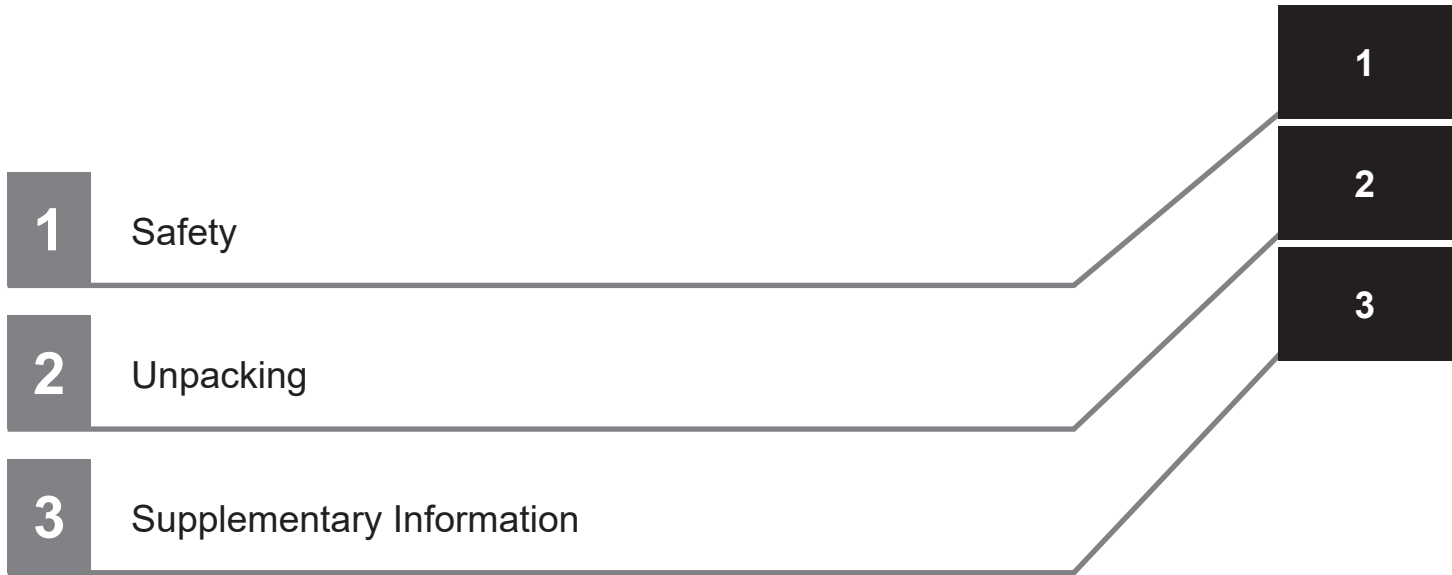

CONTENTS

Introduction	1
Intended Audience	1
Units	1
Manual Information	2
Page Structure	2
Special Information	2
Sections in this Manual	5
Terms and Conditions Agreement.....	8
Warranty and Limitations of Liability	8
Application Considerations	9
Disclaimers	9
Related Manuals.....	11
Revision History.....	12

Section 1 Safety

1-1 Safety Precautions.....	1-2
1-1-1 Definition of Precautionary Information	1-2
1-1-2 Symbols	1-2
1-1-3 Dangers.....	1-3
1-1-4 Warnings	1-3
1-1-5 Cautions	1-9
1-2 Precautions for Safe Use	1-11
1-3 Precautions for Correct Use	1-14

Section 2 Unpacking

2-1 Unpacking Introduction.....	2-2
2-2 Unpacking the AMR.....	2-3

Section 3 Supplementary Information

3-1 Removing and Replacing Skins	3-2
3-2 Battery Removal and Installation	3-3
3-2-1 Battery Removal Procedure	3-4
3-2-2 Battery Installation Procedure	3-5
3-3 Charging the Battery	3-7
3-3-1 Charging a Battery Outside of the AMR.....	3-7
3-4 Circuit Breakers and Fuses	3-8
3-5 Lifting the AMR	3-9
3-6 Main Disconnect Switch.....	3-11
3-7 Operator Panel	3-12
3-7-1 Brake Release Button	3-12

3-7-2	Emergency Stop Button	3-12
3-7-3	Main Screen	3-12
3-7-4	ON Button	3-13
3-7-5	OFF Button.....	3-13
3-7-6	Mode Selection Switch.....	3-13
3-7-7	Pendant Port	3-14
3-8	AMR Start-up	3-15
3-9	Pendant Operation.....	3-16
3-9-1	Driving with the Pendant	3-17
3-10	Emergency Stop Recovery Procedure.....	3-18
3-11	AMR Shut-down	3-19
3-12	Releasing the Brakes.....	3-20
3-12-1	Electronic Brake Release.....	3-20
3-12-2	Mechanical Brake Release	3-20
3-13	Manually Pushing the AMR.....	3-22

Terms and Conditions Agreement

Warranty and Limitations of Liability

Warranty

● Exclusive Warranty

Omron's exclusive warranty is that the Products will be free from defects in materials and workmanship for a period of twelve months from the date of sale by Omron (or such other period expressed in writing by Omron). Omron disclaims all other warranties, expressed or implied.

● Limitations

OMRON MAKES NO WARRANTY OR REPRESENTATION, EXPRESS OR IMPLIED, ABOUT NON-INFRINGEMENT, MERCHANTABILITY OR FITNESS FOR A PARTICULAR PURPOSE OF THE PRODUCTS. BUYER ACKNOWLEDGES THAT IT ALONE HAS DETERMINED THAT THE PRODUCTS WILL SUITABLY MEET THE REQUIREMENTS OF THEIR INTENDED USE.

Omron further disclaims all warranties and responsibility of any type for claims or expenses based on infringement by the Products or otherwise of any intellectual property right.

● Buyer Remedy

Omron's sole obligation hereunder shall be, at Omron's election, to (i) replace (in the form originally shipped with Buyer responsible for labor charges for removal or replacement thereof) the non-complying Product, (ii) repair the non-complying Product, or (iii) repay or credit Buyer an amount equal to the purchase price of the non-complying Product; provided that in no event shall Omron be responsible for warranty, repair, indemnity or any other claims or expenses regarding the Products unless Omron's analysis confirms that the Products were properly handled, stored, installed and maintained and not subject to contamination, abuse, misuse or inappropriate modification. Return of any Products by Buyer must be approved in writing by Omron before shipment. Omron Companies shall not be liable for the suitability or unsuitability or the results from the use of Products in combination with any electrical or electronic components, circuits, system assemblies or any other materials or substances or environments. Any advice, recommendations or information given orally or in writing, are not to be construed as an amendment or addition to the above warranty.

See <http://www.omron.com/global/> or contact your Omron representative for published information.

Limitations of Liability

OMRON COMPANIES SHALL NOT BE LIABLE FOR SPECIAL, INDIRECT, INCIDENTAL, OR CONSEQUENTIAL DAMAGES, LOSS OF PROFITS OR PRODUCTION OR COMMERCIAL LOSS IN ANY WAY CONNECTED WITH THE PRODUCTS, WHETHER SUCH CLAIM IS BASED IN CONTRACT, WARRANTY, NEGLIGENCE OR STRICT LIABILITY. Further, in no event shall liability of Omron Companies exceed the individual price of the Product on which liability is asserted.

Application Considerations

Suitability for Use

Omron Companies shall not be responsible for conformity with any standards, codes or regulations which apply to the combination of the Product in the Buyer's application or use of the Product. At Buyer's request, Omron will provide applicable third party certification documents identifying ratings and limitations of use which apply to the Product. This information by itself is not sufficient for a complete determination of the suitability of the Product in combination with the end product, machine, system, or other application or use. Buyer shall be solely responsible for determining appropriateness of the particular Product with respect to Buyer's application, product or system. Buyer shall take application responsibility in all cases.

NEVER USE THE PRODUCT FOR AN APPLICATION INVOLVING SERIOUS RISK TO LIFE OR PROPERTY WITHOUT ENSURING THAT THE SYSTEM AS A WHOLE HAS BEEN DESIGNED TO ADDRESS THE RISKS, AND THAT THE OMRON PRODUCT(S) IS PROPERLY RATED AND INSTALLED FOR THE INTENDED USE WITHIN THE OVERALL EQUIPMENT OR SYSTEM.

Programmable Products

- Omron Companies shall not be responsible for the user's programming of a programmable Product, or any consequence thereof.
- Omron Companies shall not be responsible for the operation of the user accessible operating system (e.g. Windows, Linux), or any consequence thereof.

Disclaimers

Performance Data

Data presented in Omron Company websites, catalogs and other materials is provided as a guide for the user in determining suitability and does not constitute a warranty. It may represent the result of Omron's test conditions, and the user must correlate it to actual application requirements. Actual performance is subject to the Omron's Warranty and Limitations of Liability.

Change in Specifications

Product specifications and accessories may be changed at any time based on improvements and other reasons. It is our practice to change part numbers when published ratings or features are changed, or when significant construction changes are made. However, some specifications of the Product may be changed without any notice. When in doubt, special part numbers may be assigned to fix or establish key specifications for your application. Please consult with your Omron's representative at any time to confirm actual specifications of purchased Product.

Errors and Omissions

Information presented by Omron Companies has been checked and is believed to be accurate; however, no responsibility is assumed for clerical, typographical or proofreading errors or omissions.

Related Manuals

Use the following related manuals for reference.

Manual Title	Description
Advanced Robotics Command Language Enterprise Manager Integration Guide (Cat. No. I618)	Describes how to use the Advanced Robotics Command Language (ARCL) a text-based, command line operating language Use ARCL to integrate a fleet of AMRs with an external automation system.
Enterprise Manager 2100 User's Guide (Cat. No. I631)	Describes the installation of an EM2100 appliance, which runs the Fleet Operations Workspace software to manage a fleet of AMRs.
Fleet Operations Workspace Core User's Manual (Cat. No. I635)	Describes Fleet management, MobilePlanner software, the SetNetGo OS, and most of the configuration procedures for an AMR.
Fleet Operation Workspace Core Integration Toolkit User's Manual (Cat. No. I637)	Contains information that is necessary to use the Integration Toolkit facilitating integration between the Fleet Manager and the end user's client application.
Fleet Simulator User's Manual (Cat. No. I649)	Describes the configuration and use of the Fleet Simulator software on an EM2100 appliance.
AMR Controller User's Guide (Cat. No. I650)	Describes the information necessary to use the AMR Controller.
Fleet Operations Workspace iQ User's Manual (Cat. No. I665)	Describes functionality and operation of the Fleet Operations Workspace iQ application.
Autonomous Mobile Robot (AMR) MD-series Platform Safety and Unpacking Guide (Cat. No. I682)	Describes safety and unpacking of the MD-series AMR.
AMR (Autonomous Mobile Robot) Charging Station Safety, Unpacking, and Installation Guide (Cat. No. I683)	Describes safety and unpacking of the Charging Station.
Sysmac Studio Version 1 Operation Manual (Cat. No. W504)	Describes the operating procedures of the Sysmac Studio.
NX-series Digital I/O Unit User's Manual (Cat. No. W521)	Describes the information necessary to use NX-series Digital I/O Units.
NX-series NX102 CPU Unit Hardware User's Manual (Cat. No. W593)	Describes the information necessary to use the NX102 CPU Unit.

Revision History

A manual revision code appears as a suffix to the catalog number on the front and back covers of the manual.

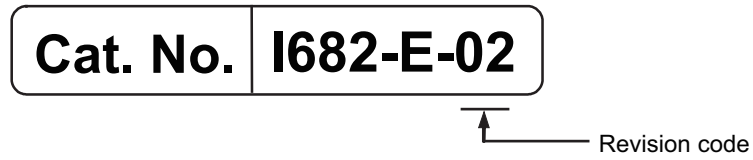

Revision code	Date	Revised content
02	October 2023	Corrections and improvements.
01	June 2023	Original production

1

Safety

This section provides safety information for the AMR system.

1-1	Safety Precautions	1-2
1-1-1	Definition of Precautionary Information	1-2
1-1-2	Symbols.....	1-2
1-1-3	Dangers.....	1-3
1-1-4	Warnings	1-3
1-1-5	Cautions	1-9
1-2	Precautions for Safe Use.....	1-11
1-3	Precautions for Correct Use	1-14



1-1 Safety Precautions

1-1-1 Definition of Precautionary Information







The following notation is used in this manual to provide precautions required to ensure safe usage of the AMR. The safety precautions that are provided are extremely important to safety.

Always read and heed the information provided in all safety precautions.

The following notation is used.

 DANGER	Identifies an imminently hazardous situation which, if not avoided, is likely to result in serious injury, and might result in fatality or severe property damage.
 WARNING	Indicates a potentially hazardous situation which, if not avoided, could result in death or serious injury. Additionally, there may be severe property damage.
 CAUTION	Indicates a potentially hazardous situation which, if not avoided, may result in minor or moderate injury, or property damage.

1-1-2 Symbols

	The circle and slash symbol indicates operations that you must not do. The specific operation is shown in the circle and explained in text. This example indicates prohibiting disassembly.
	The triangle symbol indicates precautions (including warnings). The specific operation is shown in the triangle and explained in text. This example indicates a precaution for electric shock.
	The triangle symbol indicates precautions (including warnings). The specific operation is shown in the triangle and explained in text. This example indicates a general precaution.
	The filled circle symbol indicates operations that you must do. The specific operation is shown in the circle and explained in text. This example shows a general precaution for something that you must do.
	The triangle symbol indicates precautions (including warnings). The specific operation is shown in the triangle and explained in text. This example indicates a precaution for high temperatures.
	The triangle symbol indicates precautions (including warnings). The specific operation is shown in the triangle and explained in text. This example indicates a precaution for laser radiation.

1-1-3 Dangers

DANGER

The AMR can cause serious injury to personnel or damage to itself or other equipment if it drives off of a ledge, such as a loading dock, or down stairs.



Improper operation of the AMR on inclined floors that do not comply with the applicable operating specifications can result in the AMR tipping over, and consequently a serious personal injury.



The end-user of the AMR must perform a risk assessment to identify and mitigate any additional personal and property damage hazards caused by the payload.



1-1-4 Warnings

WARNING

General

Implementing methods to circumvent the need for a person to enable the AMR's motor power at start-up is prohibited.



Equipment used to lift the AMR must be adequately rated. It is the end user's responsibility to review lifting equipment and apply appropriate safety factors before lifting. Do not attempt to lift the AMR from the bottom with a forklift or similar devices. Doing so could damage the AMR.



When working near the encoder cables, take care not to disconnect or damage them. Improper connection or disconnection of encoder cables may result in erratic motion of the AMR during operation. Operating the AMR with damaged, disconnected, or improperly connected encoder signals can cause potentially hazardous uncommanded rotation.



The following actions are strictly prohibited and could result in injury or damage to the equipment.

- Riding on the AMR.
- Towing applications.
- Exceeding the maximum payload limit.
- Operating in environments with life support systems.
- Operating in residential areas.
- Operating on non-stationary areas, including moving floors or any type of land vehicle, watercraft, or aircraft.
- Exceeding the maximum recommended speed, acceleration, deceleration, or rotation limits. Rotational speed becomes more significant when the payload's center of gravity is increasingly offset from the AMR's center of gravity.
- Dropping, driving off a ledge, or operating irresponsibly.
- Allowing the AMR to drive through an opening that has an automatic gate or door, unless the door and AMR are configured correctly with the Call / Door Box option.
- Throwing an object in front of the AMR or suddenly stepping into the path of the AMR. The AMR braking system cannot be expected to function as designed and specified in such instances.
- Exposing the AMR to rain or moisture.
- Using unauthorized parts to repair the AMR.
- Powering ON the AMR without its wireless antennas in place.
- Operating the AMR in hazardous environments where there is explosive gas, an oil mist, or a corrosive atmosphere.
- Operating the AMR in an environment that contains ionizing radiation.
- Using non-approved batteries or charging systems.



The Charging Station, battery, and AMR transfer high electric power and contain hazardous voltages. You must take necessary precautions to avoid electric shock. Follow appropriate Lock-Out, Tag-Out (LOTO) instructions prior to any installation and maintenance work performed on or near these items.



No modification is allowed that may affect functionality unless a complete risk assessment is performed. Any modifications made to the AMR can lead to loss of safety or functionality of the AMR therefore it is the end-user's responsibility to perform complete risk assessment after making any modifications to the AMR, and to confirm that all safety features of the AMR are fully functional.



The AMR as a partly-completed machine is intended to be incorporated into other machinery and must not be put into service until the final machinery into which it is to be incorporated has been declared in conformity with the provisions of EC Machinery Directive 2006/42/EC, where appropriate.



The assembly instructions shall then form part of the technical file for the final machine.

Use only the specified tools, equipment, and OMRON-supplied spare parts to service and maintain the AMR according to the specified service intervals. Failure to do so could result in an unsafe operating state that might result in personal injury or damage to property.



It is the end-user's responsibility to perform a task-based risk assessment and to implement appropriate safety measures at the point of use of the AMR in accordance with local regulations.







If you are using a user-supplied E-STOP, you must perform commissioning to verify the emergency stop functionality before putting the AMR into service.













It is the end-user's responsibility to make sure that the AMR design and implementation complies with all local standards and legal requirements.





It is the end-user's responsibility to make sure that the AMR is operated within its specifications, intended use, and intended environments.	
The user is responsible for the safety of the AMR, which includes confirming that the system is stable with any payload, payload structure, or other attachments while functioning in the specified operating environment.	
Although the AMR is commissioned at the factory, the user must perform commissioning as part of the initial setup upon receipt.	
If the AMR transports containers of liquid or other non-solid material, consider the effect on the AMR's stability if their contents can shift. It is the end user's responsibility to ensure that the payload is properly secured to the AMR, and that payload shifting does not create AMR instability.	
The motor and motor assemblies will be exposed when the side skins are removed, exposing potential pinch points. Take necessary precautions when moving an AMR without its skins attached. The rear and top of the AMR also pose pinch hazards when the rear skin and the top plate are removed.	
You need to modify the safety zones if your payload overhangs the AMR's default dimensions and if operating on a floor surface that has poor traction to the extent that the AMR cannot stop reliably within the default zones. OMRON is not responsible for any risks incurred by modifying safety zone sizes or other Safety Laser Scanner settings.	
While it is possible to generally reduce AMR deceleration settings for normal operation, the maximum deceleration used in the case of emergency stops, or stops due to Safety Laser Scanner intrusions cannot be lowered below 1300 mm/s ² . It is your responsibility to ensure that the AMR and its load will remain stable in your operating environment at all times, including during an emergency stop.	
Lifting straps must be fastened with consideration to even weight distribution to ensure that the AMR is level and stable when lifted. Uneven weight distribution while lifting may cause the AMR to shift or become unstable which may result in injury or damage to equipment.	
Do not use organic solvents to clean any part of the AMR unless directed in the cleaning instructions. Organic solvents might damage electronics resulting in an unsafe operating state that could cause injury or damage to equipment.	
Follow all unpacking safety instructions and use appropriate tools and equipment. Failure to do so could result in personal injury or property damage.	
Use safe lifting practices when moving the heavy objects such as the Power Supply Box, Battery, Docking Target, and AMR.	
The rare-earth magnet embedded in the AMR charging contacts creates a strong magnetic field. Magnetic fields can be hazardous if you have a medical implant. Keep a minimum of 30 cm away from the AMR charging contacts.	
Do not attempt to lift the AMR from the bottom with a forklift or similar devices. Doing so could damage the AMR.	
When operating the AMR with the pendant, it is the operator's responsibility to make sure that no people or objects are in the immediate vicinity of the moving AMR.	





You must comply with the latest version of the applicable laser safety regulations.	
Do not walk or run in the travel path of the AMR or directly toward the AMR.	
Do not approach the AMR from the side or the direction opposing travel.	
Removing side skins exposes the AMR drive wheel motors, which can become extremely hot during operation. You must allow sufficient time for the drive wheel motors to cool down prior to coming into contact with them.	
The accessible laser of the laser devices on the AMR are not hazardous as long as the beam cross section is not reduced by optical instruments, such as magnifying glasses, lenses, or telescopes.	

Battery and Charging Station





Improper installation of the Power Supply Box could result in a tipping hazard. You must make sure that the Power Supply Box is safely and properly installed.	
Do not damage the battery by subjecting it to impacts or shocks. Using a damaged battery can result in fire or other dangerous conditions.	
Charging Station strain reliefs and the power cords must be installed by a licensed or appropriately certified electrician.	
You must wear proper Personal Protective Equipment (PPE) for removing, installing, and lifting the battery or when working around a leaking battery.	
The AMR battery and the Charging Station outputs have high current. You must take appropriate precautions to avoid potential short circuit.	
Replace the battery only with an OMRON factory-supplied battery intended for use in the AMR. Do not use batteries intended for use in other OMRON AMR models.	
At least 2 people are required to lift the battery. Always use safe lifting practices when removing or installing the battery.	
At least 2 people are required to lift the Docking Target. Always use safe lifting practices when removing or installing the Docking Target.	
If power cords lie on the ground, you must make sure that they are highly visible to prevent tripping hazards and must be protected from physical damage with barriers or covers.	
Improper installation or wiring misconfiguration of the Power Supply Box could result in electrical shock hazard. You must ensure the safe and proper installation of the Power Supply Box in accordance with the applicable rules and regulations, and by qualified personnel.	

The Power Supply Box, charging contacts on both the Docking Target and the AMR, and the drive wheel motors can get hot during operation. Allow these items to cool down prior to servicing.	
There are no user-serviceable parts inside the Charging Station and high voltage may be present in this area. Do not remove the covers of the Charging Station.	
(Battery) Risk of Fire - No User Serviceable Parts AVERTISSEMENT: Risque d'incendie - Aucune des pièces ne peut être.	

Payload

The payload must be kept higher than the top of the AMR. If the payload or associated structure blocks any of the AMR's sensors, the AMR cannot function correctly.	
The total weight of your payload structure plus any objects carried by the structure must not exceed the maximum payload capacity of the AMR.	
Tipping hazards are more likely if the payload center of gravity is outside the recommended specifications.	
If a payload or payload structure projects or overhangs the outer dimensions of the AMR, make the following considerations. <ul style="list-style-type: none"> • Contact your OMRON representative to change the size of the Safety Laser Scanners' zones. • Modify parameters to change the AMR's <i>Width</i>, <i>LengthFront</i>, <i>LengthRear</i>, and potentially its <i>Radius</i>. When making these modifications, ensure that the modified parameters are used during path planning and obstacle avoidance. 	

Operating Environment

Abrupt appearance of objects or persons in the path of the AMR could result in personal injury or property damage. You must make sure that the operating environment of the AMR is adequately controlled.	
Using the brake release button while the AMR is positioned on a slope of greater than 3% will cause the AMR to roll down. You must not use the brake release button to move the AMR manually when it is positioned on a slope of greater than 3%, unless necessary precautions have been taken to prevent uncontrolled rolling of the AMR.	
Use caution when stopping the AMR on a ramp. The use of the brake release will cause direct rolling of AMR down the ramp. Powering OFF the AMR on a ramp should be avoided if possible to minimize the use of brake release on a ramp.	
Do not expose the AMR to rain or moisture.	
If the AMR is in an operational hazard or restricted zone, these areas must be properly marked or restricted according to applicable standards.	

The AMR can cause serious injury to personnel or damage to itself if a dangerous area is not properly configured in the map and blocked with a physical barrier.



An AMR can be unsafe if operated under environmental conditions other than those specified in this manual.



Objects in the environment protruding out, above, or below the AMR lasers' scanning planes shall be configured as Forbidden Areas during workspace map creation. This will minimize possible collision risk during operation.



Dust, dirt, grease, and water (or other liquids) can affect wheel traction, as well as operation of the drive wheels. If the drive wheels slip, it can potentially affect operating duration, stopping distance, and navigation accuracy.



Do not expose the AMR to an ingress above IP22 or a high-humidity environment.



Cybersecurity

To maintain the security and reliability of the system, a robust cybersecurity defense program should be implemented, which may include some or all of the following:

Anti-virus protection

- Install the latest commercial-quality anti-virus software on the computer connected to the control system and keep the software and virus definitions up-to-date.
- Scan USB drives or other external storage devices before connecting them to control systems and equipment.

Security measures to prevent unauthorized network access

- Install physical controls so that only authorized personnel can access control systems and equipment.
- Reduce connections to control systems and equipment via networks to prevent access from untrusted devices.
- Install firewalls to block unused communications ports and limit communication between systems. Limit access between control systems and systems from the IT network.
- Control remote access and adopt multifactor authentication to devices with remote access to control systems and equipment.
- Set strong password policies and monitor for compliance frequently.

Data input and output protection

- Backup data and keep the data up-to-date periodically to prepare for data loss.
- Validate backups and retention policies to cope with unintentional modification of input/output data to control systems and equipment.
- Validate the scope of data protection regularly to accommodate changes.
- Check validity of backups by scheduling test restores to ensure successful recovery from incidents.
- Safety design, such as emergency shutdown and fail-soft operations in case of data tampering and incidents.













Additional recommendations

- When using an external network environment to connect to an unauthorized terminal such as a SCADA, HMI or to an unauthorized server may result in network security issues such as spoofing and tampering.
- You must take sufficient measures such as restricting access to the terminal, using a terminal equipped with a secure function, and locking the installation area by yourself.
- When constructing network infrastructure, communication failure may occur due to cable disconnection or the influence of unauthorized network equipment.
- Take adequate measures, such as restricting physical access to network devices, by means such as locking the installation area.
- When using devices equipped with an SD Memory Card, there is a security risk that a third party may acquire, alter, or replace the files and data in the removable media by removing or unmounting the media.
- Please take sufficient measures, such as restricting physical access to the Controller or taking appropriate management measures for removable media, by means of locking and controlling access to the installation area.
- Educate employees to help them identify phishing scams received via email on systems that will connect to the control network.



1-1-5 Cautions



<p>Any electrical charge that accumulates on the AMR skins does not have a path to ground, and therefore cannot discharge. This can be hazardous to electrostatic sensitive devices. Always keep electrostatic sensitive devices at least 30 cm away from the AMR skins.</p>	
<p>All E-STOP buttons must be located in areas that are easy to reach and within 600 mm of personnel. It is the end user's responsibility to ensure that any additional E-STOP buttons are placed in a location where the operator can easily access them in an emergency situation.</p>	
<p>An AMR must have a readily visible warning device such as a user-supplied flashing light, to indicate when it is either ready to move or is moving.</p>	
<p>Pushing an AMR requires significant effort and might cause personal injury or property damage. Take appropriate care and follow all safety instructions.</p>	
<p>The pushing points of the AMR are low to the ground. You must use safe pushing practices when manually moving the AMR.</p>	
<p>When manually moving the AMR, do not push it from a high position on its payload or payload structure. This might cause the AMR to topple.</p>	
<p>Manually moving the AMR while the brakes are released is not recommended. If you must manually move the AMR, make sure to do this safely as this could result in personal injury or property damage.</p>	
<p>Although the Safety Laser Scanners are integrated with the emergency stop circuit at all times, the operator must maintain full control of the pendant functions and the AMR when the pendant is in use.</p>	
<p>Changing warning buzzer parameter values might make the AMR unsafe and affect its compliance to safety standards. Refer to the applicable safety standards for your locale before you change any parameter values.</p>	
<p>If you change <i>AbsoluteMaxTransVel</i> parameter, you should commission the AMR before putting it into service.</p>	
<p>Follow all appropriate local safety regulations for working with isopropyl alcohol, including fire safety, toxicity, and protective clothing and gear requirements.</p>	
<p>Although the AMR's software provides the option of using the map features to keep the AMR within its designated workspace, poor or improper localization may result in incorrect path planning. To ensure safety, you must always install physical barriers where there is a risk of property damage or personal hazard.</p>	

1-2 Precautions for Safe Use

- The following actions are required for safe use of the AMR.
 - Review and understand the safety protections associated with your specific application and environment.
 - Make sure that the environment is suitable for safe operation of the AMR.
 - Make use of the Fleet Manager when two or more AMRs are used in the same environment and are not confined to separate workspaces. Refer to the *Fleet Operations Workspace Core User's Manual (Cat. No. I635)* for more information.
 - Make sure that any person working with or near an AMR is trained and has read and understands this document and the *Autonomous Mobile Robot (AMR) MD-series Platform Safety and Unpacking Guide (Cat. No. I682)*.
 - Mechanically maintain and service AMRs for proper operation of all control and safety functions.
- All equipment must be shipped and stored in a temperature-controlled environment, within specified temperature and humidity range. It should be shipped and stored in the supplied packaging, which is designed to prevent damage from normal shock and vibration.
- OMRON recommends storing and securing the Pendant when not in use to prevent an unauthorized person from operating the AMR.
- Prior to cleaning the Charging Station, you must ensure that the AMR is not engaged with the Docking Target.
- Use a rated forklift, pallet jack, or similar devices to move the shipping crates.
- To prevent damage to the lifting points, AMR chassis, or lifting rings, do not exceed a 30° angle from vertical when attaching the lifting straps to the lifting device.
- Do not exceed the maximum allowable tension force of 10 kN for designated M16 x 2.0 lifting points. Lifting points are rated for the AMR weight without a payload.
- Inspect lifting straps for signs of wear and tear or any damages before attaching to the lifting rings and lifting the AMR.
- When placing the AMR back on the floor after lifting, you must make sure that all safety precautions have been taken to prevent personal injury or property damage.
- Do not power ON the AMR until you have read the appropriate sections of this document.
- Do not tamper with any AMR control devices.
- It is the end user's responsibility to provide the necessary training to personnel to properly mark the floors around the payload transfer locations.
- It is the end user's responsibility to ensure that the person operating the lifting device has successfully completed the required training, and is certified to operate these machines.
- The operator must take necessary precautions to ensure that the operator's hands or other body parts do not get stuck in between the charging pad and the AMR when docking.
- Do not operate the AMR in areas where environmental conditions are beyond what is specified in this document.
- You must have floor markings to prevent people from entering the operating hazard zone for pick-up / dropoff locations with inadequate clearance.
- You can contribute to resource conservation and protecting the environment by the proper disposal of Waste Electronics and Electrical Equipment (WEEE). All electrical and electronic products should be disposed of separately from the municipal waste system according to local ordinances using designated collection facilities.



- Do not dispose of the battery in a waste stream that might result in incineration or crushing. Safely dispose of the battery through a designated facility according to all local and national environmental regulations regarding lithium battery disposal.



- Bright, direct, or high-intensity light can interfere with the AMR's laser operation. Do not operate the AMR in areas where it may be exposed to these conditions.
- Operating the AMR at high ambient temperatures (particularly when carrying a full payload at high speeds) can cause the battery to exceed its operating temperature limits. If this happens, do not try to access the battery. You must allow several hours for an overheated battery to cool sufficiently before trying to remove or replace it.
- Avoid liquid near the Charging Station and the AMR.
- If you suspect that liquid has penetrated the skins or contaminated the AMR's interior, do not attempt to power ON the system and contact your OMRON representative.
- In case of fire, use a type ABC or type BC dry chemical fire extinguisher.
- Although the lasers used are Class 1/1M (eye-safe), OMRON recommends that you not look into the laser light. The maximum permissible exposure cannot be exceeded when viewing lasers with the naked eye.
- Lasers cannot reliably detect glass, mirrors, and other highly-reflective objects. Use caution when operating the AMR in areas that have these types of objects. If the AMR will need to drive close to these objects, we recommend that you use a combination of markings on the objects (e.g., tape or painted strips), and also use Forbidden Areas in the map, so that the AMR can plan paths safely around these objects.
- Consider all safety factors related to the location of the integrated E-STOP button when relocating the Operator Panel.
- The emergency stop or protective stop devices you install on the AMR must have a dual channel circuit to ensure the same performance level as the other safety devices of the AMR.
- Any E-STOP buttons installed on the payload structure must be within 600 mm of reach. They must not be installed in a location that affects operator's safety in order to reach them in an emergency situation.
- You must ensure that the payload structure is properly secured to the AMR.
- The payload or payload structure shall not be positioned in such a way that would put the operator in danger while trying to reach an E-STOP button.
- You must perform a complete risk assessment for your payload design and the intended use of the AMR prior to its operation.
- No modifications shall be made that affect the AMR payload capacity.
- Intentional movement of the payload structure (such as conveyor or arm) during the AMR movement is prohibited. It is the end-user's responsibility to design an appropriate interlock to prevent this.
- For payload applications where you cannot easily reduce the size and weight of the payload, or if the AMR's center of gravity is not within the recommended limits, contact your local OMRON representative for support.
- The tilt detection feature will not prevent an improperly loaded AMR from toppling.

- Damaged or worn casters and drive wheels can degrade the AMR stability. You must regularly inspect the casters and drive wheels for signs of damage, excessive wear, or uneven spots.
- The Power Supply Box must be installed according to the local regulations or codes, and by authorized personnel or licensed electricians.
- The Power Supply Box and the Docking Target must be properly secured to the wall or floor prior to operation.
- Never access the interior of the AMR while it is connected to the Docking Target.
- Only use charging equipment and batteries supplied by OMRON. The charger shall only be used to charge an HD-1500 or MD-series AMR battery.
- Avoid shorting the battery terminals or connectors.
- It is the end user's responsibility to make sure that the speed is appropriate for the payload that the AMR carries, and that the speed does not cause the AMR to move uncontrollably.
- After you remove or replace the skins, you must make sure that the light strips and discs are operational once the AMR is powered back ON.
- Physical immobilization might cause motors in the AMR to overheat.
- The NX102 contains factory-installed programs and configurations that control the safety functions in the AMR. Do not attempt to modify the safety program or configuration.
- A minimum of 8 mm of thread engagement must be present for each lifting ring (11 mm if a Top Plate is present).
- It is the end user's responsibility to ensure that the person operating the overhead hoist or forklift has successfully completed the required training, and is certified to operate these machines.

1-3 Precautions for Correct Use

- Always observe the proper disassembly and handling of components for disposal.
- Never remove the battery while the AMR is powered ON. Always power OFF the AMR and then place the Main Disconnect Switch in the OFF position before removing the battery.
- Never expose the battery to water.
- Rough or uneven floors can degrade the drive wheels, and shorten their life span.
- Replacement of the differential drive train, casters, and wheels require an OMRON service engineer. Contact your local OMRON representative for more information.
- When speakers are used as a means of notifying personnel of an approaching AMR, you must routinely verify that they are still functioning normally. Verify that the speakers are audible, and the sound level is at the same level as needed during the operation.
- Using the Fleet Manager or map features is not a substitute for physical methods of preventing collisions, such as interlocked gateways or barriers. It is the user's responsibility to provide a physical method of preventing collisions where necessary.
- Do not leave an AMR that is not localized, not connected to the Fleet Manager, or not powered ON in a location that can be accessed by other AMRs.
- If it is not possible to prevent some interference between the payload and the Side Lasers' sensing plane, contact your local OMRON representative for advanced configuration settings.
- Laser lenses can easily get scratched and damaged. Care must be taken to prevent scratching the laser lens during any maintenance or installation procedures.
- Map creation is required before an AMR can be used for normal operation.
- For optimal performance of an MD-series AMR in a fleet, use a map created by an MD-series AMR for the area in which it operates.
- The Integration Toolkit only runs on a Fleet Manager device.
- Minimize payload power consumption whenever possible to prevent excessive battery drain.
- Vertical orientation of the Power Supply Box allows for heat dissipation, which prevents overheating and possible fire danger. Horizontal installation of the Power Supply Box is not allowed.
- The Docking Target will move during the docking attempts and cause docking and charging failures if appropriate fasteners are not used.
- Do not over-torque the charging paddle adjustment screws if they reach their limits.
- When making adjustments to the charging paddle adjustment screws, always begin by turning in the clockwise direction until the screw stops. Then, turn in the counter-clockwise direction to adjust for correct position, but do not exceed seven turns in the counter-clockwise direction. If the screw is turned beyond seven full rotations, correct charging paddle adjustment may not be possible and OMRON support may be necessary.
- After making adjustments to the charging paddle, carefully observe the AMR as it approaches the Docking Target and be prepared to press an E-STOP button if alignment is not correct.
- The Power Supply Box has cooling vents at the top and bottom of the unit. Do not block these areas.
- The Main Disconnect Switch located on the electrical access panel controls current flow into the Power Supply Box. When the switch is in the horizontal position, it is OFF and when it is in the vertical position, it is ON.
- Consult your network systems administrator before using SetNetGo to change any default settings. Refer to the *Fleet Operations Workspace Core User's Manual (Cat. No. I635)* for information about modifying network settings.

- Before you configure wireless Ethernet on your AMR, contact your network administrator to confirm the IP, radio, and security settings.
- It is the end user's responsibility to ensure that the payload does not attenuate the wireless antennas' signal.
- You must attach either a jumper or some other safety-rated devices (typically E-STOP buttons) to the SCPU connector in order for the AMR to function.
- Do not exceed the maximum allowable tension force of 10 kN for M16 x 2.0 mounting points.
- Do not exceed the maximum allowable tension force of 4 kN for M6 x 1.0 mounting points.
- Do not use the M6 x 1.0 mounting points to lift the AMR.
- Insert screws provided in the Top Plate Seal Kit (part number 24861-000) into any unused M16 x 2.0 mounting point holes to maintain IP22 protection.
- OMRON does not provide the protective coverings with the HAPS option. A protective covering needs to be installed when applying the magnetic tape to the floor to prevent damage from the AMR traffic. The protective covering must be supplied by the user.
- You cannot use the same marker tape configuration for different AMRs in hybrid fleets because of their different sizes and turn radiuses. To determine the distance between the AMR and its final alignment goal (such as a machine with which it interfaces), refer to the AMR User's Manual to obtain the exact dimensions of the platform.
- There may be future updates for the Safety Controller. Safety Controller updates cause the Safety Laser Scanner to decommission because the safety zone check will fail. After a Safety Controller update is complete, you must recommission the Safety Laser Scanner.
- Do not operate the AMR on soft surfaces such as carpet.
- The AMR is designed and intended to operate on smooth floors. While it is capable of driving over a step or gap, frequent or high-speed driving over steps or gaps will shorten the lifespan of the drive-train components.
- A physical barrier must be easily detectable by the AMR and also strong enough to stop a fully-loaded AMR traveling at its maximum speed.
- Always ship and store the AMR, Power Supply Box, and the Docking Target in an upright position in a clean and dry area. Do not lay the shipping crates on their sides or any other non-upright position. This could damage the Power Supply Box and the Docking Target.
- You must route and secure the power cords properly. They must be secured in such a way that prevents straining of the connection points.
- It is safe to connect or disconnect the power cord from the Docking Target or battery without powering OFF the Power Supply Box.
- Always wait until the green OPERATION LED indicator on the Power Supply Box is ON solid before attempting to charge a battery.
- Do not press the Service button on the Power Supply Box if the yellow DC POWER LED indicator is flashing when there is no battery connected. Contact your OMRON representative if this condition is present.
- The AMR must be powered ON in order to charge the battery while at the Docking Target.
- Avoid moving the AMR while it is powered OFF. If you manually move the AMR while it is powered OFF, it may not be able to determine its current location when it is powered ON again. Use the localization feature in MobilePlanner to localize the AMR if this occurs.
- You should move the AMR manually only when absolutely necessary during an emergency, for safety, or if it is lost or stuck. If you find that you must frequently move the AMR, use MobilePlanner to reconfigure its route to avoid problematic areas.

- If the loaded AMR is too heavy to move manually, it is recommended that you seek additional help or remove the payload.
- OMRON recommends that you train personnel on the safe use of the brake release operations and procedures for safely pushing an AMR.
- IATA regulations (UN 3480, PI 965) require that air freight shipped lithium ion batteries not installed in the AMR must be transported at a state of charge not exceeding 30%. To avoid total discharge, fully charge the battery immediately upon receipt. The battery might arrive fully charged if it is not shipped by air freight.
- The Power Supply Box can only be connected directly to the Docking Target or to one battery. Simultaneous charging configurations are not possible.
- The Main Disconnect Switch should not be used as a frequent means of turning OFF the AMR. Use the OFF button to turn OFF the AMR with a controlled shut-down method.
- Only qualified personnel who have read and understood this manual and the *Autonomous Mobile Robot (AMR) MD-series Platform Safety and Unpacking Guide (Cat. No. I682)* should manually move the AMR.
- Maintenance of the payload structure is not covered in this document and is the responsibility of the end-user.
- The frequency of cleaning intervals depends on your particular system, its operating environment, and the amount of use. Cleaning intervals may need to be shortened for certain environments.
- Do not use solvents or chemicals other than isopropyl alcohol on the AMR charging contacts, as this could damage the AMR surfaces near the contacts. Do not expose any of the surfaces surrounding the charging contacts to isopropyl alcohol.
- Do not reduce the charging surface area of the charging contacts while cleaning. A smaller charging surface will reduce the charging speed and affect charging operations.
- The operation of the lasers may be affected by substances in the AMR operating environment, such as fog, smoke, steam, and other small particulate. You must clean the lenses of all lasers periodically and as guided in this document to avoid operational failures.
- After removing the skin panels, place them inner-side down so that the outer surfaces do not get scratched.
- The AMR's internal clock must be set correctly to ensure that accurate timestamps are present in the Debug Info file. Refer to the *Fleet Operations Workspace Core User's Manual (Cat. No. I635)* for more information.
- Do not place additional components in the User Connections area.
- When the battery is turned OFF, all internal calibration data about the charge level is lost. Turning the battery ON will activate the battery LED indicators, but the charge level may not be represented accurately. Charge the battery completely to recalibrate and display the charge level accurately.
- Always place the AMR in manual mode before connecting a Pendant. The Pendant cannot be used to control the AMR while in Automatic mode.
- The mechanical brake release can be used if battery power is not available.
- The electronic brake release will timeout after two minutes of operation to prevent bypassing. Re-depressing the button will resume the brake release function after a two minute timeout occurs.
- If alternate Safety Laser Scanner Zones are used for varying payload sizes, an alternate AMR footprint should also toggle for navigation purposes. Refer to the *Fleet Operations Workspace Core User's Manual (Cat. No. I635)* for more information about configuring the AMR footprint clearances.



Unpacking

This chapter describes how to unpack the AMR equipment.

2-1	Unpacking Introduction	2-2
2-2	Unpacking the AMR	2-3

2-1 Unpacking Introduction

A fully assembled AMR is packed in the shipping crate. The general AMR unpacking steps are provided below.

Make the following considerations before unpacking.

- The battery must be charged immediately upon receipt. This may require an installed and commissioned Power Supply Box at the facility. Refer to the *AMR (Autonomous Mobile Robot) MD-series Platform User's Manual (Cat. No. I681)* or the *AMR (Autonomous Mobile Robot) Charging Station Safety, Unpacking, and Installation Guide (Cat. No. I683)* for more information.
- The battery must be fully charged before turning ON the AMR for the first time.

WARNING

- Use safe lifting practices when moving the heavy objects such as the Power Supply Box, Battery, Docking Target, and AMR.
- At least 2 people are required to lift the battery. Always use safe lifting practices when removing or installing the battery.
- The Charging Station, battery, and AMR transfer high electric power and contain hazardous voltages. You must take necessary precautions to avoid electric shock. Follow appropriate Lock-Out, Tag-Out (LOTO) instructions prior to any installation and maintenance work performed on or near these items.
- Follow all unpacking safety instructions and use appropriate tools and equipment. Failure to do so could result in personal injury or property damage.



WARNING

Equipment used to lift the AMR and Power Supply Box shipping crates must be adequately rated. It is the end user's responsibility to review lifting equipment and apply appropriate safety factors before lifting.



Precautions for Correct Use

IATA regulations (UN 3480, PI 965) require that air freight shipped lithium ion batteries must be transported at a state of charge not exceeding 30%. To avoid total discharge, fully charge the battery immediately upon receipt. The battery might arrive fully charged if it is not shipped by air freight.



Additional Information

- Keep the original packaging materials for future transportation.
- Unpack all equipment before attempting to configure the AMR.

- 1** Access the battery and charge it.
- 2** Prepare the shipping crate for offloading the AMR.
- 3** Offload the AMR.

2-2 Unpacking the AMR

Use the following procedure to unpack the AMR.

Make the following considerations before unpacking the AMR.

- The AMR may be lifted from the shipping crate or driven down the provided ramp.
- Select a suitable unpacking area that is clean, well lit, and has at least 3 m of clearance around the crate.
- If driving the AMR out of the crate, the front side is used for attaching the included ramp. Orient the crate accordingly before unpacking.
- A pendant is needed if driving the AMR out of the crate.
- At least two people are required to unpack the AMR.
- Handle all crate and packing materials with care and store them in a safe place for reuse if the AMR may be repackaged for shipping later.

The following items are required for the unpacking procedure.

- Lifting kit (supplied with AMR).
- 13 mm wrench or driver.
- Lever / pry bar

Use the following illustration to understand the AMR crate components.

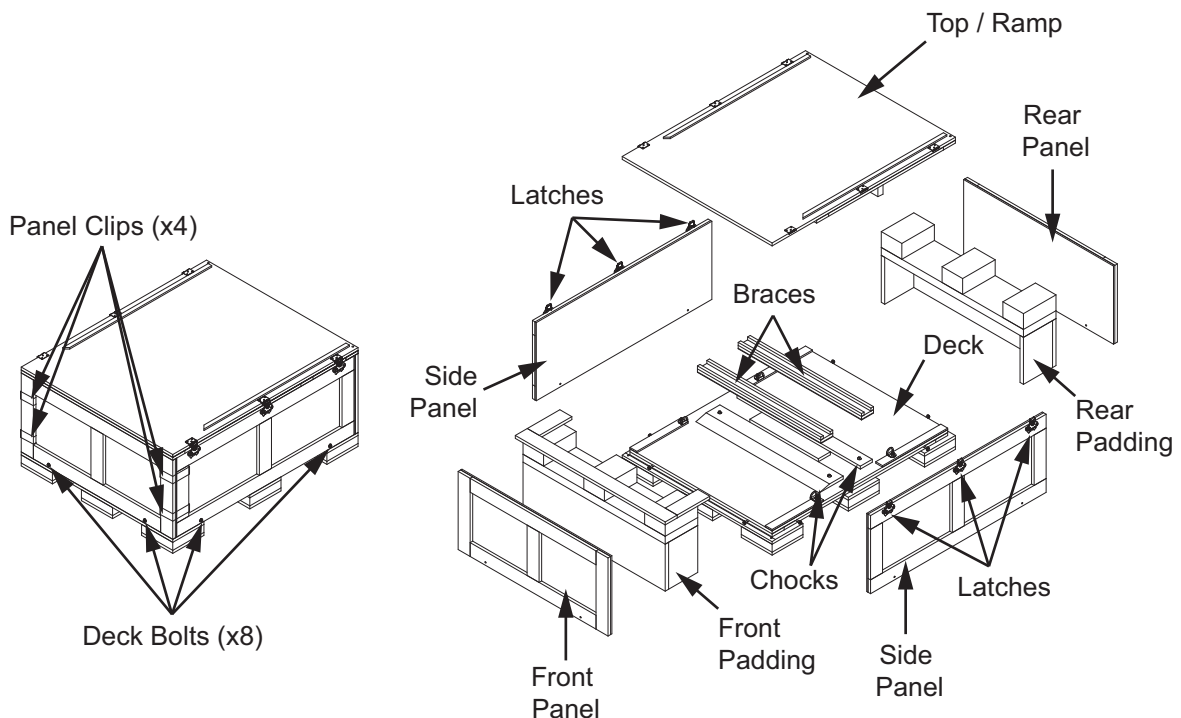

- 1** Remove the four panel clips from the front panel using a prybar.
- 2** Remove eight deck bolts using a 13 mm wrench or driver.
- 3** Remove the front panel and set it aside.
- 4** Slide the side and rear panel assembly away from the deck, towards the rear of the crate. Place the side and rear panel assembly on the floor, away from the AMR.

- 5** Remove all padding items and set them aside.
- 6** Perform a visual inspection of the AMR exterior.
Check the exterior of the AMR for damage that may have occurred during transport. Inspect for scratches, loose or displaced items, impacts, or other signs of damage.
If any signs of damage are present, stop this procedure and contact the shipping company immediately to report the damage.
- 7** Remove the adhesive tape from the front and rear of the AMR skins.
- 8** If the battery was shipped pre-installed in the AMR, access and remove the battery from the AMR and charge it immediately. Proceed to the next step when a fully charged battery is available.
Refer to the following sections for more information.
 - *3-1 Removing and Replacing Skins* on page 3-2
 - *3-2-1 Battery Removal Procedure* on page 3-4
 - *3-3-1 Charging a Battery Outside of the AMR* on page 3-7
- 9** Check the Circuit Breaker Panel and ensure all breakers are in the ON position.
Refer to the following sections for more information.
 - *3-1 Removing and Replacing Skins* on page 3-2
 - *3-4 Circuit Breakers and Fuses* on page 3-8
- 10** Install a fully charged battery.
Refer to *3-2-2 Battery Installation Procedure* on page 3-5 for more information.
- 11** Remove the ratchet straps and braces that secure the AMR to the deck.
- 12** If lifting the AMR from the crate is your chosen method, use the included lifting hardware to lift the AMR from the crate. Proceed to step 16 when the AMR is lifted and placed on the ground in the desired location. If driving the AMR from the crate is your chosen method, proceed to the next step.
Refer to *3-5 Lifting the AMR* on page 3-9 for more information.
- 13** Remove both chocks using a 13 mm wrench or driver and then slide them out from under the AMR and set them aside for use later.
- 14** Place the top / ramp at the front edge of the crate.
Align the holes on the top / ramp with the holes at the front corners of the deck and then insert the supplied screws to secure it. Two screws are supplied in the bag with this document.
Ensure the orientation of the top / ramp is correct as shown below.

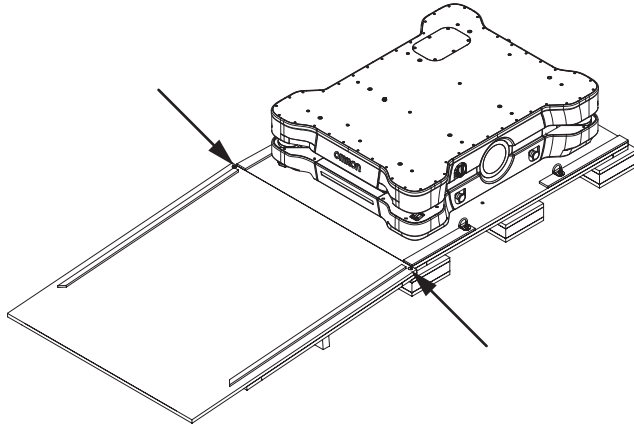

- 15** Place the large chock removed in the previous step at the base of the ramp. This provides a smooth transition from the ramp to the floor.

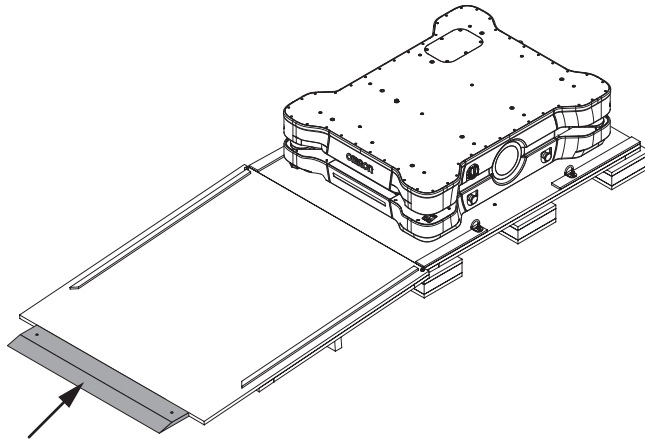

- 16** Make the following preparations before turning the AMR ON.
- Remove the AMR Mode Selection Switch keys from the Main Disconnect Switch lockout hole and set them aside.
 - Place the Main Disconnect Switch in the ON (horizontal) position. Refer to *3-6 Main Disconnect Switch* on page 3-11 for more information.
 - Place the mode selection switch in the Manual position using the key. Refer to *3-7-6 Mode Selection Switch* on page 3-13 for more information.
 - Connect the Pendant to the pendant port.
 - Ensure the Pendant speed control rotary dial is set to the lowest setting (turn counterclockwise).
 - Release all E-STOP buttons on the AMR sides, Operator Panel, and the Pendant.

- 17** Turn the AMR ON by pressing the ON button for half a second. Refer to *3-8 AMR Start-up* on page 3-15 for more information.

It takes about one minute for all the systems to start-up and make their various interconnections.

Refer to the *AMR (Autonomous Mobile Robot) MD-series Platform User's Manual (Cat. No. I681)* for more information about AMR start-up problems if necessary.

- 18** Use the Pendant to drive the AMR straight down the ramp and on to the floor. Do not exceed a linear speed of 300 mm/s.

Do not turn or rotate while driving on the ramp.

Ensure that there are no objects near the AMR Safety Laser Scanners.

Avoid stopping on the ramp. Drive the AMR completely off the ramp. If the AMR must be stopped on the ramp, avoid releasing the brakes.

Refer to *3-9 Pendant Operation* on page 3-16 for more information.

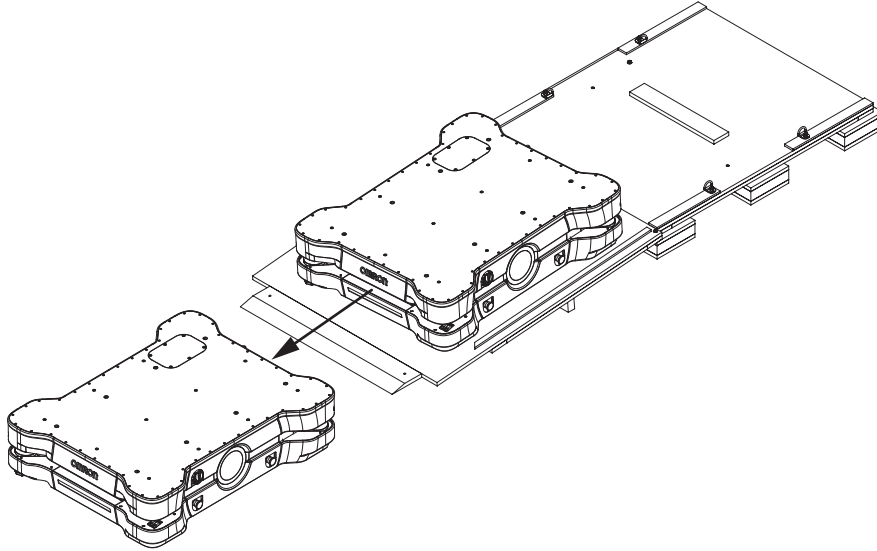

19 Turn the AMR OFF to complete this procedure.

Refer to *3-11 AMR Shut-down* on page 3-19 for more information.

3

Supplementary Information

This section contains supplementary information to support the unpacking details.

3-1	Removing and Replacing Skins	3-2
3-2	Battery Removal and Installation	3-3
3-2-1	Battery Removal Procedure	3-4
3-2-2	Battery Installation Procedure	3-5
3-3	Charging the Battery	3-7
3-3-1	Charging a Battery Outside of the AMR	3-7
3-4	Circuit Breakers and Fuses	3-8
3-5	Lifting the AMR	3-9
3-6	Main Disconnect Switch	3-11
3-7	Operator Panel	3-12
3-7-1	Brake Release Button	3-12
3-7-2	Emergency Stop Button	3-12
3-7-3	Main Screen	3-12
3-7-4	ON Button.....	3-13
3-7-5	OFF Button.....	3-13
3-7-6	Mode Selection Switch	3-13
3-7-7	Pendant Port	3-14
3-8	AMR Start-up	3-15
3-9	Pendant Operation	3-16
3-9-1	Driving with the Pendant	3-17
3-10	Emergency Stop Recovery Procedure	3-18
3-11	AMR Shut-down	3-19
3-12	Releasing the Brakes	3-20
3-12-1	Electronic Brake Release	3-20
3-12-2	Mechanical Brake Release.....	3-20
3-13	Manually Pushing the AMR	3-22

3-1 Removing and Replacing Skins

Skins need to be removed or replaced during various maintenance and installation procedures.

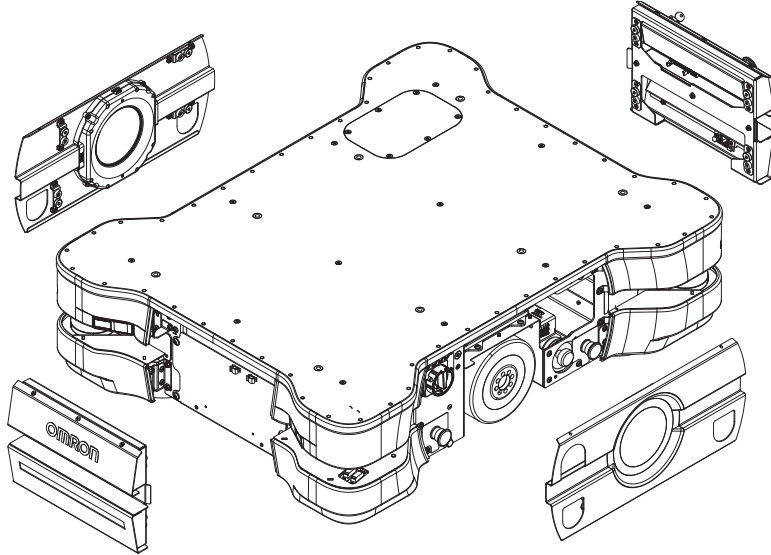

Make the following considerations when removing or replacing skins.

- No tools are required for skin removal. Skins are fastened to the AMR chassis with magnets.
- Right-side and left-side skins are not symmetrical.
- All skins have cables that need to be disconnected when removing. Preserve cable routing and connections replacing skins.
- Pull skins from the bottom when removing.
- Ensure skins are aligned and straight after fastening them.

WARNING

The motor and motor assemblies will be exposed when the side skins are removed, exposing potential pinch points. Take necessary precautions when moving an AMR without its skins attached. The rear and top of the AMR also pose pinch hazards when the rear skin and the top plate are removed.



Precautions for Safe Use

After you remove or replace the skins, you must make sure that the light strips and discs are operational once the AMR is powered back ON.



Precautions for Correct Use

After removing the skin panels, place them inner-side down so that the outer surfaces do not get scratched.

3-2 Battery Removal and Installation

Removal or installation of the battery must be performed by persons who have read and understood this manual.

Before you begin, press an E-STOP button, turn the AMR OFF, and then place the Main Disconnect Switch in the OFF position.

WARNING

- If removal or replacement of the battery is not handled with care or in accordance with instructions provided in this manual, it can cause serious injury to personnel or damage to itself or other equipment.
- Do not damage the battery by subjecting it to impacts or shocks. Using a damaged battery can result in fire or other dangerous conditions.
- You must wear proper Personal Protective Equipment (PPE) for removing, installing, and lifting the battery or when working around a leaking battery.
- At least 2 people are required to lift the battery. Always use safe lifting practices when removing or installing the battery.



Precautions for Safe Use

Operating the AMR at high ambient temperatures (particularly when carrying a full payload at high speeds) can cause the battery to exceed its operating temperature limits. If this happens, do not try to access the battery. You must allow several hours for an overheated battery to cool sufficiently before trying to remove or replace it.



Precautions for Correct Use

Never remove the battery while the AMR is ON. Always power OFF the AMR and then place the Main Disconnect Switch in the OFF position before removing the battery.



Additional Information

Inspect the empty battery compartment and remove any foreign objects before attempting to install a battery.

Use the following figure to understand the lifting points for the battery.

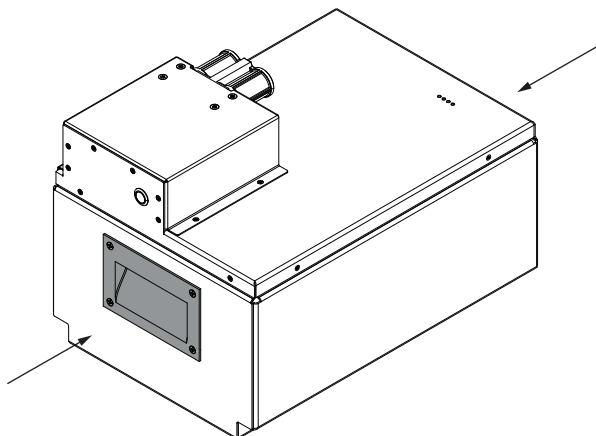

3-2-1 Battery Removal Procedure

Use the following procedure to remove the battery from the AMR.

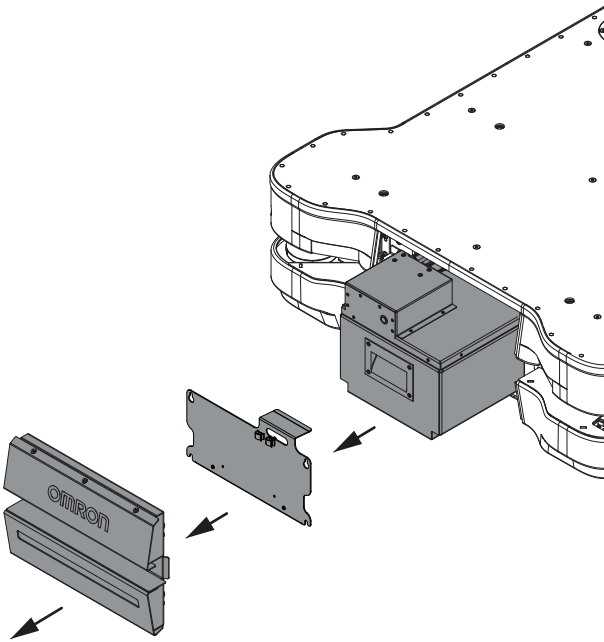

The following tools are required for this procedure.

- T30 star bit
- Torque wrench

- 1** Turn the AMR OFF.
- 2** Place the Main Disconnect Switch in the OFF position.
- 3** Remove the Front Skin and then disconnect all cables.
Refer to *3-1 Removing and Replacing Skins* on page 3-2 for more information.
- 4** Use a T30 star bit to loosen the four captive M6 screws.

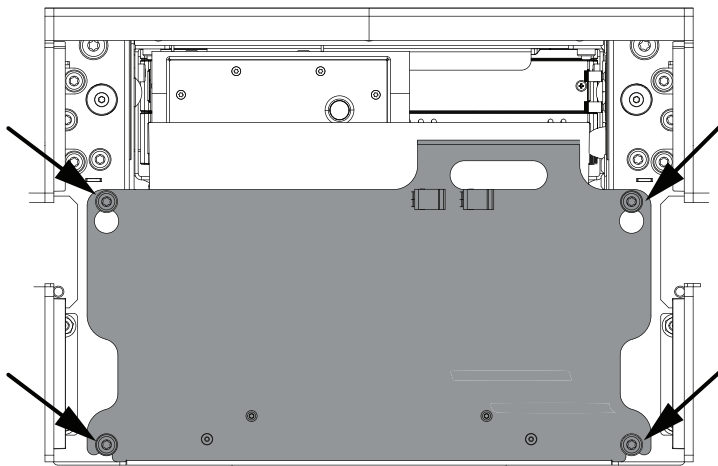

- 5** Slide up the battery compartment cover and remove it from the AMR.

- 6** Use the handle to pull the battery out of the battery compartment. Do not drop the battery while removing it.
- 7** Align the battery compartment cover over the screws and slide it down to fit it in place.
- 8** Tighten the four M6 screws to a torque of 9 N-m.
- 9** Replace the Front Skin to complete this procedure.

3-2-2 Battery Installation Procedure

Use the following procedure to install a battery into the AMR.

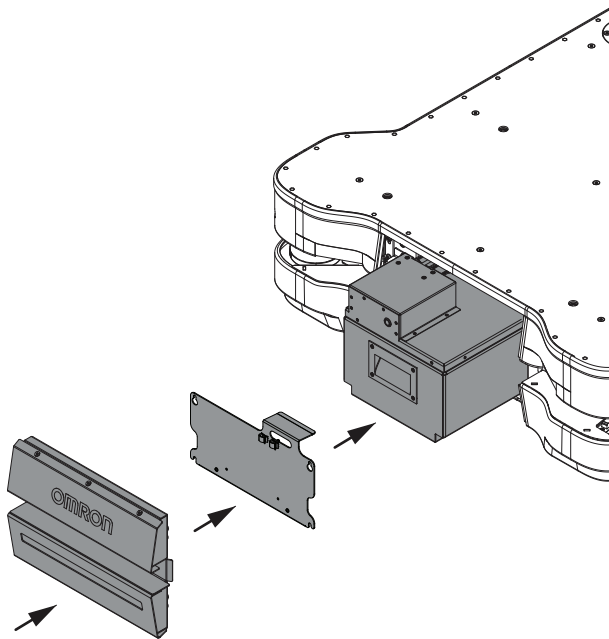

The following tools are required for this procedure.

- T30 star bit
- Torque wrench

- 1** Turn the AMR OFF.
- 2** Place the Main Disconnect Switch in the OFF position.
- 3** Remove the Front Skin and then disconnect all cables.
Refer to *3-1 Removing and Replacing Skins* on page 3-2 for more information.
- 4** Use a T30 star bit to loosen the four captive M6 screws.

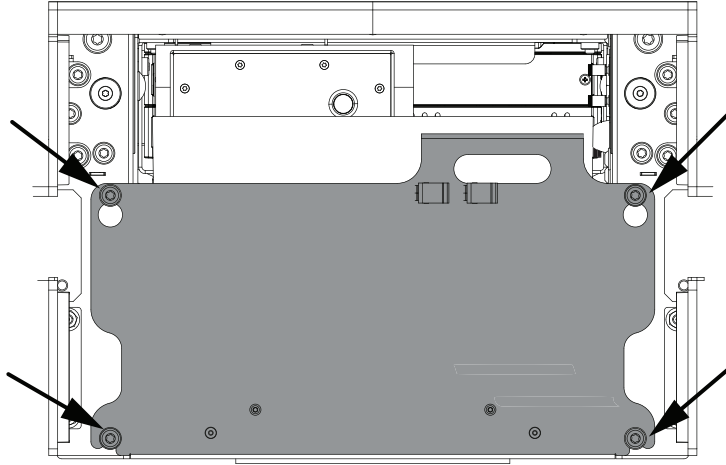

- 5** Slide up the battery compartment cover and remove it from the AMR.
- 6** Align the battery in the battery compartment and then slide it towards the rear of the AMR. Push the battery back until it stops. Alignment tabs keep the battery in position as it mates with the internal power connector.
- 7** Align the battery compartment cover over the screws and slide it down to fit it in place.
- 8** Tighten the four M6 screws to a torque of 9 N-m.
- 9** Replace the Front Skin to complete this procedure.

3-3 Charging the Battery

A battery can be charged while inside the AMR or outside (removed from) the AMR.

Charging automatically begins when the Power Supply Box detects a connected battery, either inside the AMR when it is engaged with the Docking Target or when a battery is removed from the AMR and directly connected to the Power Supply Box.

Ensure the battery pushbutton is in the retracted position (depressed) before attempting to charge.

WARNING

The Power Supply Box, charging contacts on both the Docking Target and the AMR, and the drive wheel motors can get hot during operation. Allow these items to cool down prior to servicing.



Precautions for Safe Use

Avoid shorting the battery terminals or connectors.



Precautions for Correct Use

IATA regulations (UN 3480, PI 965) require that air freight shipped lithium ion batteries not installed in the AMR must be transported at a state of charge not exceeding 30%. To avoid total discharge, fully charge the battery immediately upon receipt. The battery might arrive fully charged if it is not shipped by air freight.

3-3-1 Charging a Battery Outside of the AMR

Charging a battery outside the AMR is typically used for spare batteries. This method is also required if the AMR becomes immobilized due to a low battery.

Charging a battery outside the AMR is accomplished by removing the cable from the Docking Target and connecting it directly to the battery. When the battery is connected to the Power Supply Box, a 10 second delay occurs during an automatic check sequence and then charging begins when the yellow DC POWER LED is ON solid. If the yellow DC POWER LED begins flashing, this indicates that the connected battery is absolutely depleted. You must press and release the Service button on the Power Supply Box to acknowledge this state, and then charging will begin.



Precautions for Correct Use

- The Power Supply Box can only be connected directly to the Docking Target or to one battery. Simultaneous charging configurations are not possible.
- Do not press the Service button on the Power Supply Box if the yellow DC POWER LED indicator is flashing when there is no battery connected. Contact your local OMRON representative if this condition is present.

3-4 Circuit Breakers and Fuses

Use the following information to understand circuit breaker and fuse location and functionality. Circuit breakers and fuses are found in the following locations.

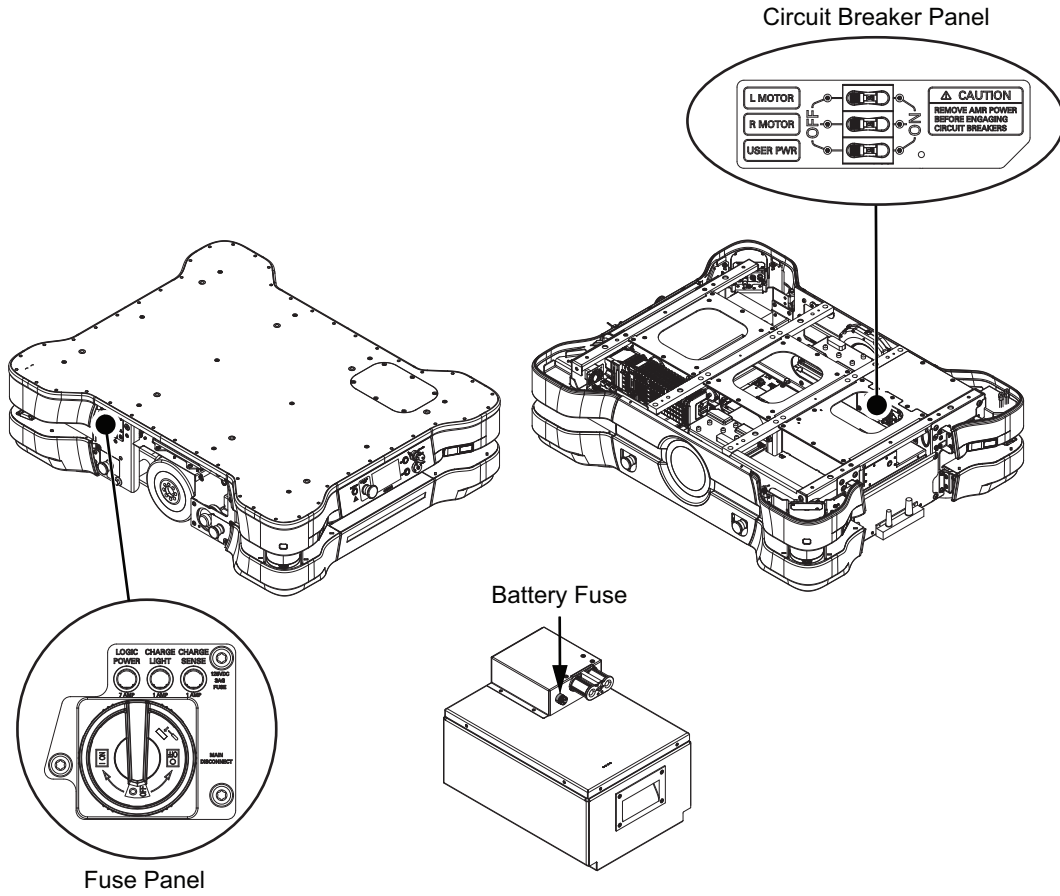

3-5 Lifting the AMR

Use the following procedure to lift the AMR. A lifting kit is supplied with the AMR that includes four lifting rings and four straps.

WARNING

- Lifting straps must be fastened with consideration to even weight distribution to ensure that the AMR is level and stable when lifted. Uneven weight distribution while lifting may cause the AMR to shift or become unstable which may result in injury or damage to equipment.
- Equipment used to lift the AMR must be adequately rated. It is the end user's responsibility to review lifting equipment and apply appropriate safety factors before lifting.
- Do not attempt to lift the AMR from the bottom with a forklift or similar devices. Doing so could damage the AMR.



Precautions for Safe Use

- Do not exceed the maximum allowable tension force of 10 kN for designated M16 x 2.0 lifting points. Lifting points are rated for the AMR weight without a payload.
- A minimum of 8 mm of thread engagement must be present for each lifting ring (11 mm if a Top Plate is present).
- To prevent damage to the lifting points, AMR chassis, or lifting rings, do not exceed a 30° angle from vertical when attaching the lifting straps to the lifting device.
- Inspect lifting straps for signs of wear and tear or any damages before attaching to the lifting rings and lifting the AMR.
- It is the end user's responsibility to ensure that the person operating the overhead hoist or forklift has successfully completed the required training, and is certified to operate these machines.
- When placing the AMR back on the floor after lifting, you must make sure that all safety precautions have been taken to prevent personal injury or property damage.

The following equipment is required for this procedure.

- 4 lifting rings (supplied with AMR)
- 4 safety slings (supplied with AMR)
- Personal Protective Equipment (eye protection, toe protection, gloves).
- Overhead hoist or forklift rated for a minimum of 600 kg.

- 1** Perform the appropriate Lock-out Tag-out procedures.
- 2** Attach the OMRON-supplied lifting rings using to the locations shown in the figure below.

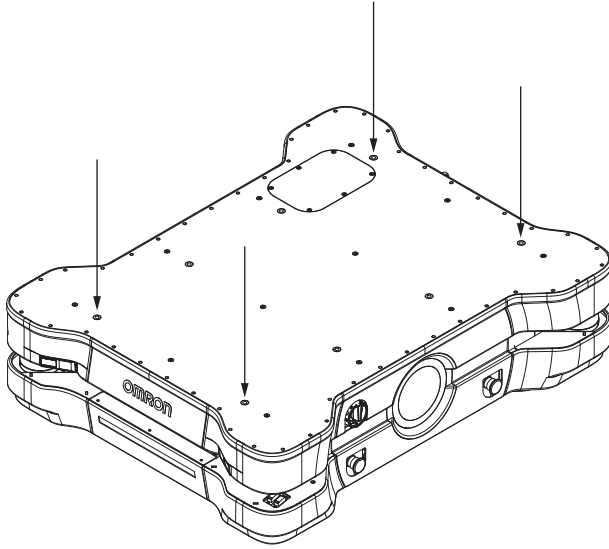

- 3** Using an overhead hoist or a forklift, lift the AMR.
- 4** After the AMR is no longer lifted, remove the lifting rings and straps from the AMR to complete this procedure.

3-6 Main Disconnect Switch

When the Main Disconnect Switch is in OFF (vertical) position, power is completely disconnected from the internal battery. All systems in the AMR will not be energized in this position. Rotating the Main Disconnect Switch to the ON (horizontal) position will establish a connection between the internal battery and all AMR systems.



Precautions for Correct Use

The Main Disconnect Switch should not be used as a frequent means of turning OFF the AMR. Use the OFF button to turn OFF the AMR as a controlled shut-down method.

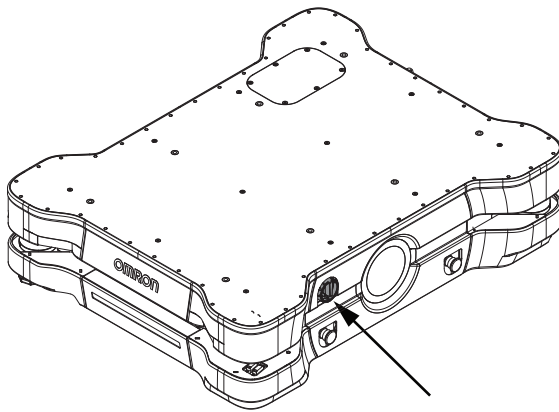

3-7 Operator Panel

The information below describes the operator panel components and functions.

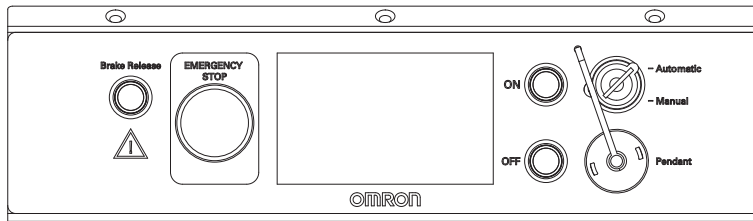

Precautions for Correct Use

Do not tamper with any AMR control devices.

3-7-1 Brake Release Button

The brake release button is used when the AMR needs to be moved manually.

To release the brakes using this button, you must first press the E-STOP button on the Operator Panel and then press and hold the brake release button. The brakes remain released while pressing this button. When the button is released, the brakes are automatically enabled.

Releasing the brakes with the brake release button requires a small amount of battery power while the AMR is ON. If the AMR is OFF or there is insufficient battery power, the brakes remain engaged when using this method. Refer to *3-12 Releasing the Brakes* on page 3-20 for more information.

3-7-2 Emergency Stop Button

The Emergency Stop button will activate an emergency stop when depressed.

3-7-3 Main Screen

Information displayed on the main screen during AMR operation is described below.

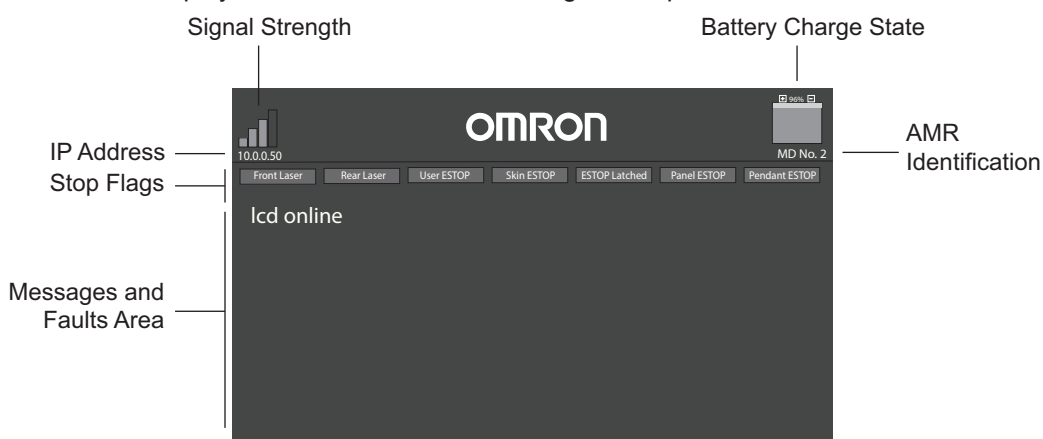

Boot-up Screen

The following image shows the first screen that appears during boot-up when the AMR is turned ON.



3-7-4 ON Button

The ON button has the following functions.

- Turns the AMR ON. If the AMR is in the process of shutting down, the ON button is ignored until shut down is completed.
- Enable motors after an emergency stop has occurred.
- An LED ring around the button illuminates solid green when the AMR is ON while the brake is not engaged, and also during power-up, power-down operations.



Additional Information

There is a 2.5 second delay between when the ON button is pressed and the AMR resumes its activity. During this time, the AMR scans its path for potential obstacles and will resume its commanded motion if there is adequate space to maneuver. Refer to *3-8 AMR Start-up* on page 3-15 for more information.

3-7-5 OFF Button

The OFF button shuts down the AMR in a controlled manner. During shut-down after the OFF button is pressed, the system saves the AMR's last known location so it automatically localizes when it is powered ON again. An LED ring around the button flashes red during the shut-down procedure. Refer to *3-11 AMR Shut-down* on page 3-19 for more information.

When the AMR is shut down using the OFF button, it enters a standby state. In this state, some systems remain active and consume low power. For prolonged periods of AMR shut-down, use the OFF button and then turn OFF the Main Disconnect Switch to prevent battery drain.



Precautions for Correct Use

- The Main Disconnect Switch should not be used as a frequent means of turning OFF the AMR. Use the OFF button to turn OFF the AMR with a controlled shut-down method.
- Avoid moving the AMR while it is powered OFF. If you manually move the AMR while it is powered OFF, it may not be able to determine its current location when it is powered ON again. Use the localization feature in MobilePlanner to localize the AMR if this occurs.

3-7-6 Mode Selection Switch

The AMR mode is controlled with a key switch on the Operator Panel.

Automatic mode is used for typical operation under normal circumstances. Manual mode must be selected to drive the AMR manually with a Pendant. The AMR will enter an emergency stop state when the mode is changed. Pressing the ON button will return the AMR to a normal state.



Precautions for Correct Use

Always place the AMR in manual mode before connecting a Pendant. The Pendant cannot be used to control the AMR while in Automatic mode.

3-7-7 Pendant Port

The pendant port is used to connect a handheld pendant to the AMR. This is typically used when driving the AMR manually. Disconnect the pendant from the pendant port during normal operation.

3-8 AMR Start-up

Ensure the following conditions are present before attempting to start-up the AMR.

- The battery is sufficiently charged.
- The battery pushbutton is in the retracted (depressed) position.
- The Main Disconnect Switch is in the ON position.

Press and hold the power ON button for half a second, then release. It takes about one minute for all the systems to start-up and make their various interconnections. The AMR Controller, navigation lasers, and auxiliary power systems automatically start when you press the ON button.

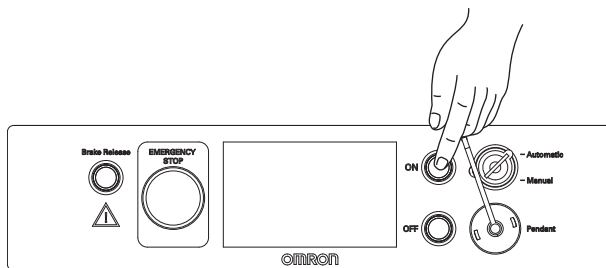

During normal start-up, the AMR powers all of its systems, including all factory and user configurations. It then automatically runs its on-board software and customer integrated processes to provide an application-ready AMR. If a map has been created and stored, and the AMR is localized, you need to press the ON button a second time to enable motor power, for autonomous operation start-up. Absent localization, you need to plug in a pendant in order to move the unit. After the initial, localized start-up is complete, the AMR will be capable of operating autonomously. Refer to *Fleet Operations Workspace Core User's Manual (Cat. No. I635)* for information on map creation, start-up procedures, and localization.





WARNING

Implementing methods to circumvent the need for a person to enable the AMR's motor power at start-up is prohibited.



3-9 Pendant Operation

The Pendant is used to drive the AMR manually and to make a map. Use the information below to understand the Pendant operation and functions.

 WARNING	
When operating the AMR with the pendant, it is the operator's responsibility to make sure that no people or objects are in the immediate vicinity of the moving AMR.	
 CAUTION	
Although the Safety Laser Scanners are integrated with the emergency stop circuit at all times, the operator must maintain full control of the pendant functions and the AMR when the pendant is in use.	



Precautions for Safe Use

- It is the end user's responsibility to make sure that the speed is appropriate for the payload that the AMR carries, and that the speed does not cause the AMR to move uncontrollably.
- OMRON recommends storing and securing the pendant when not in use to prevent an unauthorized person from operating the AMR.



Precautions for Correct Use

Always place the AMR in manual mode before connecting a Pendant. The Pendant cannot be used to control the AMR while in Automatic mode.

The pendant is intended for single-handed operation. While gripping the handle and applying pressure to the three-position enabling device so that it is in the middle position, use your thumb to move the directional control stick to drive the AMR. If the three-position device is not depressed or completely depressed, or the E-STOP button is pressed, the drive motors are disabled and the AMR cannot move. The three-position device must be in the middle position with the emergency stop button released to enable the drive motors and allow the AMR to move. If the pendant E-STOP button or enabling switch is triggered, the AMR will activate an emergency stop. Refer to *3-10 Emergency Stop Recovery Procedure* on page 3-18 for more information.

The pendant is equipped with speed control rotary dial that is used to set the speed of the AMR when moving forward or reverse.

The pendant's goal button is used for marking positions while making a map scan.

The AMR's ON button must be pressed after connecting or disconnecting the pendant.

While the pendant is connected, it is the only method by which the AMR can be controlled.

The pendant has a Power Enabled indicator LED to provide a visual indication of the following AMR operating states.

LED State	Description
Solid Red	AMR is in an emergency stop state.
Solid Yellow	AMR transitioning from an emergency stop state to a normal operational state.
Solid Green	The AMR motors are enabled.
Flashing Green	The AMR is in motion.

3-9-1 Driving with the Pendant

Use the following procedure to drive the AMR with the Pendant.

- 1** Press one of the E-STOP buttons on the AMR.
- 2** Place the AMR in manual mode using the mode selection switch on the Operator Panel.
- 3** Connect the pendant to the Operator Panel Pendant port.
- 4** Turn the speed dial counterclockwise to the lower speed limit.
- 5** Release the E-STOP button(s).
- 6** Press the AMR ON button.
- 7** Squeeze and hold the three-position enabling device with medium pressure so it is in the middle position.
Check the E-STOP button on the Pendant and make sure it is released.
- 8** Move the directional control stick to drive the AMR in that direction.
Push the directional control stick forward or back to make the AMR move in that direction.
Push the directional control button to the left side to make the AMR rotate in place counterclockwise. Push the directional control button to the right side to make the AMR rotate in place clockwise. Diagonal positions of the directional control button move the AMR in an arc.
Use the speed control dial to control the speed of the AMR.
- 9** To stop the AMR, you can release the three-position enabling device or depress it completely. This will trigger an emergency stop and disable the drive motors. Refer to *3-10 Emergency Stop Recovery Procedure* on page 3-18 for more information. You can also release the directional control stick which will bring the AMR to a full stop (this does not disable power to the motors).

3-10 Emergency Stop Recovery Procedure

Recovery from an emergency stop requires additional manual actions only after the operator has confirmed that it is safe to return the AMR to operation. The AMR's drive motors remain disabled until the procedure below is executed. This procedure cannot be used if the AMR is engaged with the Docking Target or has a critical driving fault present.

Use the following procedure to recover from an emergency stop event.

- 1** Reset the device that triggered the emergency stop.
This could be an E-STOP button, the enabling device on the pendant, or additional safety devices that may be connected to the emergency stop circuit.
- 2** Make sure that all surrounding areas are clear so the AMR has room to maneuver.
- 3** Press the ON button on the Operator Panel.



Additional Information

- Pressing the ON button is not required if only the E-STOP button on the pendant was pressed to trigger the emergency stop. In this condition, use the three-position enabling device to recover.
 - Pressing the ON button is not required if only the enabling device on the pendant was activated to trigger the emergency stop. In this condition, place the three-position enabling device in the middle position to recover.
 - There is a 2.5 second delay between when the ON button is pressed and the AMR resumes its activity. During this time, the AMR scans its path for potential obstacles and will resume its commanded motion if there is adequate space to maneuver.
-

3-11 AMR Shut-down

Pressing the OFF button will shut down the AMR in a controlled manner. The system will save the AMR's last known location so it can automatically localize when it is powered ON later.

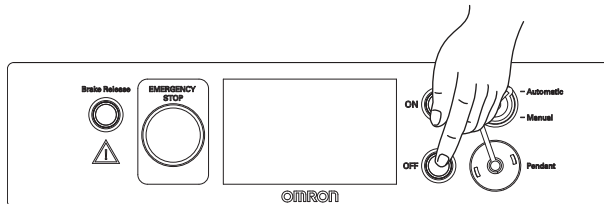

An LED ring around the button flashes red during the shut-down procedure.

When the AMR is shut down using the OFF button, it enters a standby state. In this state, some systems remain active and consume low power. For prolonged periods of AMR shut-down, use the OFF button and then turn OFF the Main Disconnect Switch to prevent battery drain.







Precautions for Correct Use

- The Main Disconnect Switch should not be used as a frequent means of turning OFF the AMR. Use the OFF button to turn OFF the AMR with a controlled shut-down method.
- Avoid moving the AMR while it is powered OFF. If you manually move the AMR while it is powered OFF, it may not be able to determine its current location when it is powered ON again. Use the localization feature in MobilePlanner to localize the AMR if this occurs.

3-12 Releasing the Brakes

The brakes on the drive wheels can be released in case of an emergency or abnormal situation. This may be required to manually move the AMR. Refer to *3-13 Manually Pushing the AMR* on page 3-22 for more information.

 WARNING	
<ul style="list-style-type: none"> Using the brake release button while the AMR is positioned on a slope of greater than 3% will cause the AMR to roll down. You must not use the brake release button to move the AMR manually when it is positioned on a slope of greater than 3%, unless necessary precautions have been taken to prevent uncontrolled rolling of the AMR. Use caution when stopping the AMR on a ramp. The use of the brake release will cause direct rolling of AMR down the ramp. Powering OFF the AMR on a ramp should be avoided if possible to minimize the use of brake release on a ramp. 	
 CAUTION	
<p>Manually moving the AMR while the brakes are released is not recommended. If you must manually move the AMR, make sure to do this safely as this could result in personal injury or property damage.</p>	

3-12-1 Electronic Brake Release

Use the Brake Release button on the Operator Panel to release the brakes electronically. Refer to *3-7-1 Brake Release Button* on page 3-12 for more information.

Make the following considerations when using the electronic brake release.

- The brake button on the Operator Panel must be pressed continuously. Releasing the brake button will activate the brakes.
- The AMR must be powered ON.
- The E-STOP button on the Operator Panel must be depressed before attempting to use the electronic brake release.



Precautions for Correct Use

- The mechanical brake release can be used if battery power is not available.
- The electronic brake release will timeout after two minutes of operation to prevent bypassing. Re-depressing the button will resume the brake release function after a two minute timeout occurs.

3-12-2 Mechanical Brake Release

A mechanical brake release is provided as an alternative to the electronic brake release. The mechanical brake release is typically used in the following situations.

- Releasing the brakes when the battery is removed or completely exhausted.
- Releasing the brakes when the AMR needs to be pulled backwards.

The mechanical brake release does not have a time limit like the electronic brake release. Refer to *3-12-1 Electronic Brake Release* on page 3-20 for more information.

The mechanical brake release lever is located behind the rear skin. Squeezing the lever shown below will mechanically release the brakes.

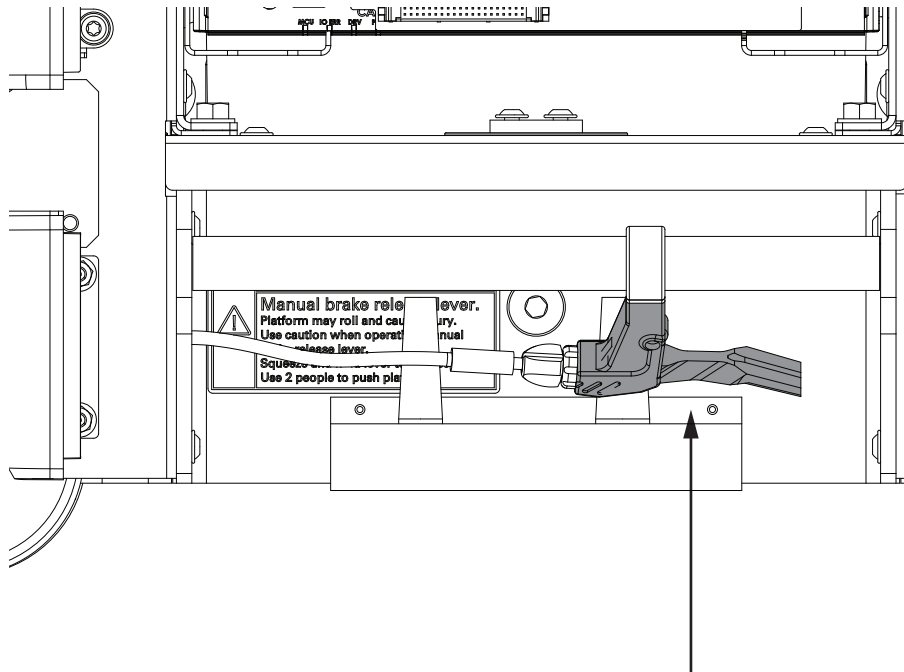

Ensure brake lever returns to original position after releasing.

3-13 Manually Pushing the AMR

If the AMR becomes immobilized, it may need to be manually pushed to a new location. Payloads and other user-supplied equipment can affect an AMR's stability. All operators should know the locations on the AMR (or its payload) where they can push safely without toppling the AMR over or damaging its components. Push points should be as low as possible and near the center of gravity. Make the following considerations when manually pushing the AMR.

- Do not push the AMR by pressing on the skins.
- There is no appropriate point at which to pull the AMR. Only push the AMR when attempting to manually move it.
- Do not push the AMR with another motorized device.
- Only push from the top of the AMR or the bar near the mechanical brake release.
- Use at least 2 people to manually push the AMR. One person is required to operate the brake release during the pushing process. Refer to *3-12 Releasing the Brakes* on page 3-20 for more information.

WARNING

Use caution when stopping the AMR on a ramp. The use of the brake release will cause direct rolling of AMR down the ramp. Powering OFF the AMR on a ramp should be avoided if possible to minimize the use of brake release on a ramp.



CAUTION

- Pushing an AMR requires significant effort and might cause personal injury or property damage. Take appropriate care and follow all safety instructions.
- The pushing points of the AMR are low to the ground. You must use safe pushing practices when manually moving the AMR.
- When manually moving the AMR, do not push it from a high position on its payload or payload structure. This might cause the AMR to topple.
- Manually moving the AMR while the brakes are released is not recommended. If you must manually move the AMR, make sure to do this safely as this could result in personal injury or property damage.



Precautions for Correct Use

- You should move the AMR manually only when absolutely necessary during an emergency, for safety, or if it is lost or stuck. If you find that you must frequently move the AMR, use MobilePlanner to reconfigure its route to avoid problematic areas.
- Avoid moving the AMR while it is powered OFF. If you manually move the AMR while it is powered OFF, it may not be able to determine its current location when it is powered ON again. Use the localization feature in MobilePlanner to localize the AMR if this occurs.
- If the loaded AMR is too heavy to move manually, it is recommended that you seek additional help or remove the payload.
- Only qualified personnel who have read and understood this manual and the *Autonomous Mobile Robot (AMR) MD-series Platform Safety and Unpacking Guide (Cat. No. I682)* should manually move the AMR.
- OMRON recommends that you train personnel on the safe use of the brake release operations and procedures for safely pushing an AMR.

OMRON Corporation Industrial Automation Company

Kyoto, JAPAN

Contact : www.ia.omron.com

Regional Headquarters

OMRON EUROPE B.V.

Wegalaan 67-69, 2132 JD Hoofddorp
The Netherlands
Tel: (31) 2356-81-300 Fax: (31) 2356-81-388

OMRON ASIA PACIFIC PTE. LTD.

438B Alexandra Road, #08-01/02 Alexandra
Technopark, Singapore 119968
Tel: (65) 6835-3011 Fax: (65) 6835-3011

OMRON ELECTRONICS LLC

2895 Greenspoint Parkway, Suite 200
Hoffman Estates, IL 60169 U.S.A.
Tel: (1) 847-843-7900 Fax: (1) 847-843-7787

OMRON ROBOTICS AND SAFETY TECHNOLOGIES, INC.

4225 Hacienda Drive, Pleasanton, CA 94588 U.S.A.
Tel: (1) 925-245-3400 Fax: (1) 925-960-0590

OMRON (CHINA) CO., LTD.

Room 2211, Bank of China Tower, 200 Yin Cheng Zhong Road,
PuDong New Area, Shanghai, 200120, China
Tel: (86) 21-6023-0333 Fax: (86) 21-5037-2388

Authorized Distributor:

©OMRON Corporation 2023 All Rights Reserved.
In the interest of product improvement,
specifications are subject to change without notice.

Cat. No. I682-E-02 1023 (0623)

73000-530 B