

**SCARA Robots
YRCX Series**

PROFINET

USER'S MANUAL

OMRON

Important information before reading this manual	1
Introduction	1
Safety Precautions (Always read before starting use)	2
Warranty	4
1. Overview of functions	5
2. Controller status transitions	6
3. Input/output assignments	7
4. Part names and functions	9
5. Flow until operation begins	10
6. Connection	11
6.1 Network structure	11
6.2 Cabling	13
6.3 Noise countermeasures	13
7. GSD files	14
8. Settings	15
8.1 Communication parameter settings	15
9. Monitoring communication data	16
9.1 Using the programming box	16
9.1.1 Switching the port number	17
9.1.2 Input/output list display	18
9.1.3 Input/output details display	18
9.1.4 Switching the output status	19
9.2 Using SCARA-YRCX Studio support software	20

10. Disabling an option unit	23
10.1 Making settings	24
10.1.1 Using the programming box	24
10.1.2 Using SCARA-YRCX Studio support software	25

11. Actions to take if communication is not established	27
11.1 Reconsider the startup steps	27

11.2 Viewing the alarm codes in the 7-segment LED	28
---	----

11.3 Diagnostics by alarm message	28
11.3.1 Alarms related to network unit connections and settings	28
11.3.2 Alarms related to I/O on/off status	29
11.3.3 Alarms that the customer cannot resolve	29
11.3.4 Checking alarm codes in the programming box	30
11.3.5 Checking alarm codes in SCARA-YRCX Studio support software	30

11.4 Detailed diagnostics using the indicators	31
11.4.1 Common situations and LED illumination patterns	32

12. Specifications	33
12.1 Network specifications	33

12.2 Input/output specifications	34
----------------------------------	----

13. Reserved word list	35
-------------------------------	-----------

Important information before reading this manual

Introduction

The OMRON network interface unit documentation consists of a User's Manual that is specific to each network unit that describes the specifications and communication settings of that unit, and a Remote I/O Manual describing the remote I/O specifications that are common to all network units.

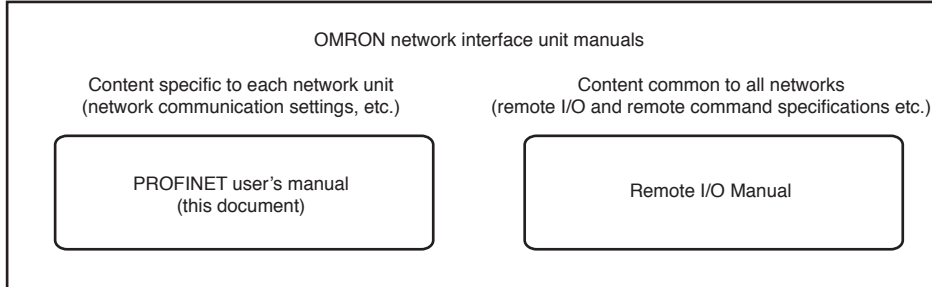

For details on network unit specifications and communication settings, refer to this User's Manual.
For details on communication functions between the controller and the host control device, such as remote I/O and remote commands, refer to the Remote I/O Manual.

For details on the functions of the robot controller unit, refer to the following manuals.
YRCX Operator's Manual for operation of the controller unit
YRCX User's Manual..... for specifications and settings of the controller unit
YRCX Programming Manual for the programming language used by OMRON robot controllers

Safety Precautions (Always read before starting use)

Before using this product, be sure to read this manual carefully as well as the robot controller user's manual and programming manual. Take sufficient precautions to ensure safety and handle the product correctly. The cautions given in this manual are related to this product. Refer to the robot controller user's manual for details on the cautions to be taken with the robot controller system using this product. The safety precautions are ranked as "WARNING" and "CAUTION" in this manual.



WARNING

FAILURE TO FOLLOW WARNING INSTRUCTIONS COULD RESULT IN SERIOUS INJURY OR DEATH TO THE OPERATOR OR PERSON SERVICING THE PRODUCT.



CAUTION

Failure to follow CAUTION instructions may result in injury to the operator or person servicing product, or damage to the product or peripheral equipment.



NOTE

The key points in the operation are explained simply and clearly.

Note that some items described as "CAUTION" may lead to serious results depending on the situation. In any case, important information that must be observed is explained.

Store this manual where it can be easily referred to, and make sure that it is delivered to the end user.

■ Precautions for design



WARNING

- FOR INFORMATION ABOUT THE STATUS OF THE NETWORK SYSTEM AND ROBOT CONTROLLER IN THE EVENT THAT A COMMUNICATION PROBLEM OCCURS IN THE NETWORK SYSTEM, REFER TO THE MANUAL OF THE HOST CONTROL DEVICE AS WELL AS TO THIS DOCUMENT. CONFIGURE AN INTERLOCK CIRCUIT IN THE SEQUENCE PROGRAM SO THAT THE SYSTEM, INCLUDING THE ROBOT CONTROLLER, WILL WORK SAFELY WITH USING THE COMMUNICATION STATUS INFORMATION.
- THE SAFETY CONNECTOR HAS AN EMERGENCY STOP TERMINAL TO TRIGGER EMERGENCY STOP OF THE ROBOT CONTROLLER. BY USING THIS TERMINAL, PREPARE A PHYSICAL INTERLOCK CIRCUIT SO THAT THE SYSTEM INCLUDING THE ROBOT CONTROLLER WILL WORK SAFELY.



CAUTION

The control line and communication cable must not be bound with or placed near the main circuit or power line. Separate these by at least 100mm. Failure to observe this could lead to communication error or declining throughput caused by noise.

■ Precautions for installation



WARNING

- ALWAYS CRIMP, PRESS-FIT OR SOLDER THE CONNECTOR WIRING WITH THE MAKER-DESIGNATED TOOL, AND SECURELY FIX THE CONNECTOR TO THE MODULE.
- ALWAYS SHUT OFF ALL PHASES OF THE POWER SUPPLY EXTERNALLY BEFORE STARTING INSTALLATION OR WIRING WORK.
FAILURE TO SHUT OFF ALL PHASES COULD LEAD TO ELECTRIC SHOCKS OR PRODUCT DAMAGE.



CAUTION

- Use the robot controller in the environmental conditions specified in this manual. Operation outside the specified environmental range may cause electric shocks, fire, malfunction or product damage or deterioration.
- Do not directly touch the conductive portions or electronic components of a network module.
- Never directly touch the controller's interior areas.
- Accurately connect each cable connector to the mounting section.
Failure to observe this could lead to malfunctions caused by a connection fault.



WARNING

ALWAYS SHUT OFF ALL PHASES OF THE POWER SUPPLY EXTERNALLY BEFORE STARTING INSTALLATION OR WIRING WORK. FAILURE TO SHUT OFF ALL PHASES COULD LEAD TO ELECTRIC SHOCKS OR PRODUCT DAMAGE.



CAUTION

- Make sure that foreign matter, such as cutting chips or wire scraps, does not enter the robot controller.
- Communication cables that contact network modules must be kept inside a duct or secured by clamps. Failure to place the cable in a duct or secure it by a clamp could damage the cable or module by shifting, movement or unintentional pulling the cable, or cause malfunction by poor contact condition.
- When disconnecting a connector from the network module, grasp the connector rather than pulling on the cable. Pulling on the cable could damage the cable and module, possibly causing a poor contact condition which could result in malfunctions.

■ Precautions for starting and maintenance



WARNING

- DO NOT TOUCH THE TERMINALS WHILE THE POWER IS ON. FAILURE TO OBSERVE THIS COULD LEAD TO MALFUNCTIONS.
- ALWAYS SHUT OFF ALL PHASES OF THE POWER SUPPLY EXTERNALLY BEFORE PERFORMING CLEANING OR WIRING WORK. FAILURE TO SHUT OFF ALL PHASES COULD LEAD TO ELECTRIC SHOCKS, PRODUCT DAMAGE OR MALFUNCTIONS.
- NEVER DISASSEMBLE OR MODIFY ANY OF THE ROBOT CONTROLLER MODULES.
FAILURE TO OBSERVE THIS COULD LEAD TO TROUBLE, MALFUNCTIONS, INJURIES OR FIRES.



CAUTION

Power must be supplied to the robot controller only after supplying power to the host control device. The robot controller will enter an error state if communication is not established within a certain length of time after the controller starts.

■ Precautions for disposal



CAUTION

Dispose of this product as industrial waste.

Warranty

The OMRON robot and/or related product you have purchased are warranted against the defects or malfunctions as described below.

■ Warranty description

If a failure or breakdown occurs due to defects in materials or workmanship in the genuine parts constituting this OMRON robot and/or related product within the warranty period, then OMRON shall supply free of charge the necessary replacement/repair parts.

■ Warranty period

The warranty period ends 24 months after the date of manufacturing as shown on the products.

■ Exceptions to the warranty

This warranty will not apply in the following cases:

1. Fatigue arising due to the passage of time, natural wear and tear occurring during operation (natural fading of painted or plated surfaces, deterioration of parts subject to wear, etc.)
2. Minor natural phenomena that do not affect the capabilities of the robot and/or related product (noise from computers, motors, etc.)
3. Programs, point data and other internal data were changed or created by the user.

Failures resulting from the following causes are not covered by warranty.

1. Damage due to earthquakes, storms, floods, thunderbolt, fire or any other natural or man-made disaster.
2. Troubles caused by procedures prohibited in this manual.
3. Modifications to the robot and/or related product not approved by OMRON or OMRON sales representative.
4. Use of any other than genuine parts and specified grease and lubricant.
5. Incorrect or inadequate maintenance and inspection.
6. Repairs by other than authorized dealers.

WARRANTY

OMRON's exclusive warranty is that the products are free from defects in materials and workmanship for a period of one year (or other period if specified) from date of sale by OMRON.

OMRON MAKES NO WARRANTY OR REPRESENTATION, EXPRESS OR IMPLIED, REGARDING NONINFRINGEMENT, MERCHANTABILITY, OR FITNESS FOR PARTICULAR PURPOSE OF THE PRODUCTS. ANY BUYER OR USER ACKNOWLEDGES THAT THE BUYER OR USER ALONE HAS DETERMINED THAT THE PRODUCTS WILL SUITABLY MEET THE REQUIREMENTS OF THEIR INTENDED USE. OMRON DISCLAIMS ALL OTHER WARRANTIES, EXPRESS OR IMPLIED.

LIMITATIONS OF LIABILITY

OMRON SHALL NOT BE RESPONSIBLE FOR SPECIAL, INDIRECT OR CONSEQUENTIAL DAMAGES, LOSS OF PROFITS OR COMERCIAL LOSS IN ANY WAY CONNECTED WITH THE PRODUCTS, WETHER SUCH CLAIM IS BASED ON CONTRACT, WARRANTY, NEGLIGENCE OR STRICT LIABILITY.

In no event shall the responsibility of OMRON for any act exceed the individual price of the product on which liability is asserted.

IN NO EVENT SHALL OMRON BE RESPONSIBLE FOR WARRANTY, REPAIR OR OTHER CLAIMS REGARDING THE PRODUCTS UNLESS OMRON'S ANALYSIS CONFIRMS THAT THE PRODUCTS WERE PROPERLY HANDLED, STORED, INSTALLED AND MAINTAINED AND NOT SUBJECT TO CONTAMINATION, ABUSE, MISUSE OR INAPPROPRIATE MODIFICATION OR REPAIR.

1. Overview of functions

A network interface unit is a device that transmits and receives I/O information via a communication protocol between a controller and a host control device.

We provide a lineup of products that support fieldbus (DeviceNet, PROFIBUS, etc.) or industrial Ethernet (EtherNet/IP, PROFINET, etc.).

In any of these networks, the robot controller (slave device) operates in accordance with commands via I/O control from a host (master device).

While acting as distributed I/O for the host control device, the network interface unit simultaneously shares I/O information with the controller. The I/O update cycle time between the controller and the network interface unit is 5 ms.

The I/O update cycle time between the network interface unit and the host control device will vary depending on the structure of the applicable network.

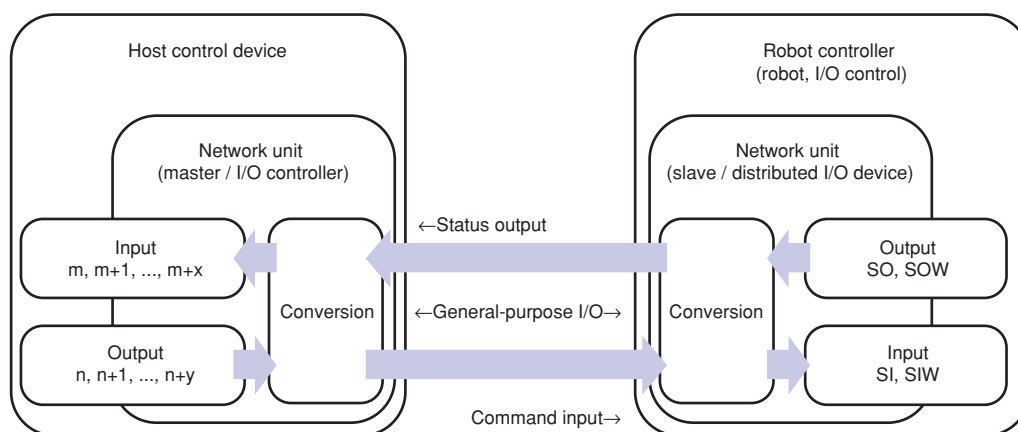

I/O consists of a general-purpose input/output area, and a dedicated input/output area that has specific significance such as command input and status output that is optimized for control of robot controllers. Using these, the robot controller can be controlled from the host control device.

The following methods can be used for control via I/O. Combining these methods makes it possible to control the robot.

1. Controlling the robot controller directly using simple commands and status queries via remote I/O's dedicated input/output.

Example) Dedicated input: cancel emergency stop, servo on, reset, start program execution, etc.

Dedicated output: CPU_OK, return-to-origin complete, etc.

2. Using remote commands to programlessly control the robot controller directly with advanced instructions and status queries.

Example) < Transmission >

SIW0 = 0x1031 (absolute reset command for robot no.1)

SIW2 = 0x0015 (axis designation: axis 1 through axis 4)

< Reception >

SOW = 0x0100 (executing command)

↓

SOW = 0x0200 (normal end)

3. Using remote I/O's general-purpose input/output to exchange desired information with an external peripheral device, and load it into a robot program or sequence program for execution.

Example) WAIT SI(20)=1, 1000 ; Wait until SI(20) turns on; stop command if it does not turn on after 1 second

OUT SO2(), 200 ; SO(27--20) turns on, and turns off after 200 ms

* For details on remote I/O and remote commands, refer to the Remote I/O Manual. For details on robot programs, refer to the YRCX Programming Manual.

2. Controller status transitions

Here we explain the status transitions of a robot controller equipped with a network interface unit. A controller equipped with a network interface unit will initially start up in the emergency stop state. In order for robot operation to be possible, communication must be established with the host control device, and a sign that cancels the emergency stop state must be input.

If communication with the host control device is interrupted for any reason, the controller will again transition to the emergency stop state regardless of the I/O status. In order to resume operation, I/O processing is required, such as reestablishing communication, cancelling the emergency stop state, and resetting any error.

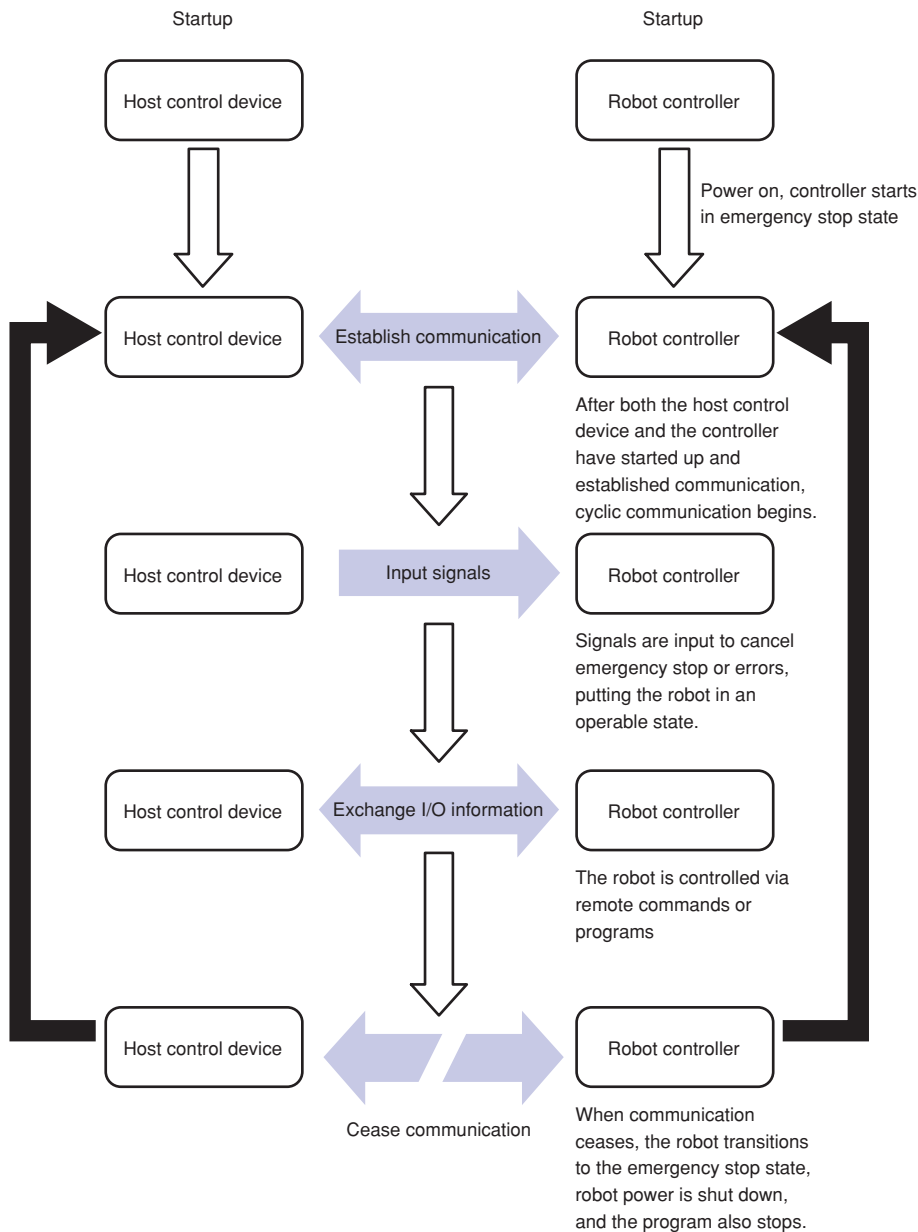

3. Input/output assignments

Here we show the correspondence between the robot controller's serial input/output data and the input/output data on the network.

■ Output from the controller, input to the host device

Host control device Address (READ)	Controller		
	Address (WRITE)	Input/output type	Use
I (n)	SOW(0)	-	Word output
I (n+1)			
I (n+2)	SOW(1)	-	Remote command error code area
I (n+3)			
I (n+4)	SOW(2)	SOD(2)	Command response area / General-purpose output area
I (n+5)			
I (n+6)	SOW(3)	SOD(2)	
I (n+7)			
I (n+8)	SOW(4)	SOD(4)	
I (n+9)			
I (n+10)	SOW(5)	SOD(4)	
I (n+11)			
I (n+12)	SOW(6)	SOD(6)	
I (n+13)			
I (n+14)	SOW(7)	SOD(6)	
I (n+15)			
I (n+16)	SOW(8)	SOD(8)	
I (n+17)			
I (n+18)	SOW(9)	SOD(8)	
I (n+19)			
I (n+20)	SOW(10)	SOD(10)	
I (n+21)			
I (n+22)	SOW(11)	SOD(10)	
I (n+23)			
I (n+24)	SOW(12)	SOD(12)	
I (n+25)			
I (n+26)	SOW(13)	SOD(12)	
I (n+27)			
I (n+28)	SOW(14)	SOD(14)	
I (n+29)			
I (n+30)	SOW(15)	SOD(14)	
I (n+31)			
I (n+32)	SO07 - SO00		Status output area
I (n+33)	SO17 - SO10		
I (n+34)	SO27 - SO20		General-purpose output area
I (n+35)	SO37 - SO30		
I (n+36)	SO47 - SO40		
I (n+37)	SO57 - SO50		
I (n+38)	SO67 - SO60		
I (n+39)	SO77 - SO70		
I (n+40)	SO107 - SO100		
I (n+41)	SO117 - SO110		
I (n+42)	SO127 - SO120		
I (n+43)	SO137 - SO130		
I (n+44)	SO147 - SO140		
I (n+45)	SO157 - SO150		
I (n+46)	(Reserve)		Use is prohibited
I (n+47)	(Reserve)		

I(n) : Starting address of the input data area for the target controller

- I(n), I(n+1), ..., (n+47) assume data memory that is divided at each byte (8-bits).
- SOx() is handled as unsigned 8-bit integer data. (x=2-7, 10-17)
- SOW(y) is handled as unsigned 16-bit integer data. (y=0 - 15)
- The upper byte and lower byte of SOW(y) correspond to I(2y+1) and I(2y) respectively.
- SOD(z) is handled as signed 32-bit integer data. (z=2, 4, ..., 14)
- The upper word and lower word of SOD(z) correspond to SIW(z+1) and SIW(n), respectively.

■ Output from the host control device, input to the controller

Host control device		Controller		
Address (WRITE)	Address (READ)		Input/output type	Use
Q m	SIW(0)	-	Word input	Remote command area
Q m+1				
Q m+2	SIW(1)	-	Word input	Command data area
Q m+3				
Q m+4	SIW(2)	SID(2)	Word input / Double word input	Command data area / General-purpose input area
Q m+5				
Q m+6	SIW(3)	SID(2)	Word input / Double word input	
Q m+7				
Q m+8	SIW(4)	SID(4)	Word input / Double word input	
Q m+9				
Q m+10	SIW(5)	SID(4)	Word input / Double word input	
Q m+11				
Q m+12	SIW(6)	SID(6)	Word input / Double word input	
Q m+13				
Q m+14	SIW(7)	SID(6)	Word input / Double word input	
Q m+15				
Q m+16	SIW(8)	SID(8)	Word input / Double word input	
Q m+17				
Q m+18	SIW(9)	SID(8)	Word input / Double word input	
Q m+19				
Q m+20	SIW(10)	SID(10)	Word input / Double word input	
Q m+21				
Q m+22	SIW(11)	SID(10)	Word input / Double word input	
Q m+23				
Q m+24	SIW(12)	SID(12)	Word input / Double word input	
Q m+25				
Q m+26	SIW(13)	SID(12)	Word input / Double word input	
Q m+27				
Q m+28	SIW(14)	SID(14)	Word input / Double word input	
Q m+29				
Q m+30	SIW(15)	SID(14)	Word input / Double word input	
Q m+31				
Q m+32	SI07 - SI00		Bit input	Command input area
Q m+33	SI17 - SI10			
Q m+34	SI27 - SI20		But input / Byte input	General-purpose input area
Q m+35	SI37 - SI30			
Q m+36	SI47 - SI40			
Q m+37	SI57 - SI50			
Q m+38	SI67 - SI60			
Q m+39	SI77 - SI70			
Q m+40	SI107 - SI100			
Q m+41	SI117 - SI110			
Q m+42	SI127 - SI120			
Q m+43	SI137 - SI130			
Q m+44	SI147 - SI140			
Q m+45	SI157 - SI150			
Q m+46	(Reserve)		Reserved area	Use is prohibited
Q m+47	(Reserve)			

Q(m) : Starting address of the output data area for the target controller

- Q(m), Q(m+1), ..., Q(m+47) assume data memory that is divided at each byte (8-bits).
- SIx() is handled as unsigned 8-bit integer data. (x=2-7, 10-17)
- SIW(y) is handled as unsigned 16-bit integer data. (y=0 - 15)
- The upper byte and lower byte of SIW(y) correspond to Q(2y+1) and Q(2y) respectively.
- SID(z) is handled as signed 32-bit integer data. (z=2, 4, ..., 14)
- The upper word and lower word of SID(z) correspond to SIW(z+1) and SIW(n), respectively.

* For details on the functions that are assigned to each serial input/output data, refer to the separate Remote I/O Manual.

* The reserved area cannot be used.

4. Part names and functions

Here we explain the part names and functions of the network interface unit.

Part names

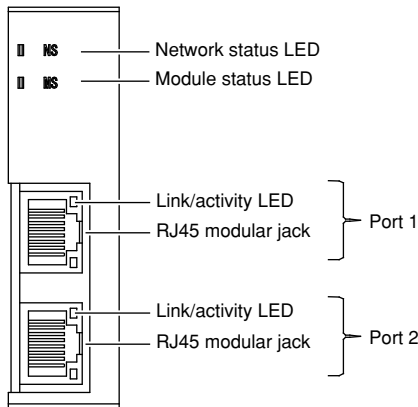

Connector: RJ45 modular jack

Pin configuration and connector specifications

Number	Name
1	TXD+
2	TXD-
3	RXD+
4	-
5	-
6	RXD-
7	-
8	-

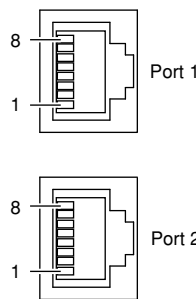

* An RJ45 modular plug is not included.

Connect a CAT 5e or higher STP (Shielded Twisted Pair) cable to the connector. From the standpoint of durability and noise rejection, double-shielded LAN cable for industrial use is recommended.

Network status (NS) LED

LED status	Explanation	Comment
OFF	Offline	Power is off IO controller is not connected
Green	Online (RUN)	Connection with IO controller is not established IO controller is in RUN state
Flashing green	Online (STOP)	Connection with IO controller is not established IO controller is in STOP state

Module status (MS) LED

LED status	Explanation	Comment
OFF	Not initialized	Power is off, or module is in SETUP or "NW_INIT" state
Green	Normal operation	Module has transitioned from "NW_INIT" state
Flash green once	Diagnostic event	Diagnostic event is occurring
Flash green at 1 Hz	DCP flashing	An engineering tool is being used to identify a node on the network
Red	Exception error	Module is in the "EXCEPTION" state
Flash red once	Setting error	Expected ID differs from actual ID
Flash red twice	IP address error	IP address is not set
Flash red three times	Station name error	Station name is not set
Flash red four times	Internal error	A serious error occurred inside the module

Link/activity LED: Port 1 / Port 2

LED status	Explanation	Comment
OFF	No link	A link is not established, and communication is not occurring
Green	Link detected	An Ethernet link is established, but communication is not occurring
Flashing green	Activity	An Ethernet link is established, and communication is occurring

5. Flow until operation begins

Here we explain the flow from startup until operation begins. Proceed with the flow shown in the illustration below, and consult the appropriate manuals as necessary for each step.

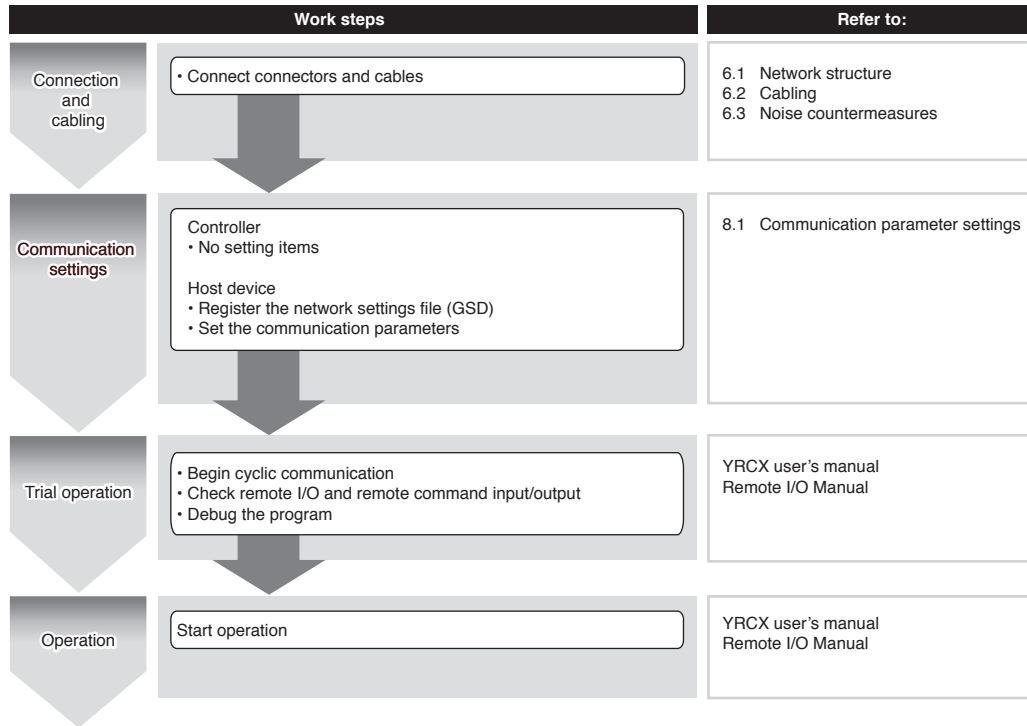

6. Connection

Here we provide an overview of the steps for connecting the robot controller to the network. Network structure and cable specifications should be designed according to the materials provided by the network interest group (PI: PROFIBUS & PROFINET International).

6.1 Network structure

PROFINET is an industrial multi-vendor network system based on Ethernet technology that is open and promoted by PI (PROFIBUS & PROFINET International).

Since it uses standard Ethernet as its lower-level protocol, the network can coexist with general-purpose Ethernet equipment.

A PROFINET network is typically constructed in a star topology via a switch, but since the robot controller's PROFINET unit contains a two-port switch, a cable-saving linear network can also be constructed by daisy-chained connection.



CAUTION

The two Ethernet ports of a PROFINET unit are for the purpose of allowing a versatile network topology within a single subnet without using a switch. It is not possible for the two ports to be connected to different subnets.

■ Example of a cable-saving linear network using daisy-chaining

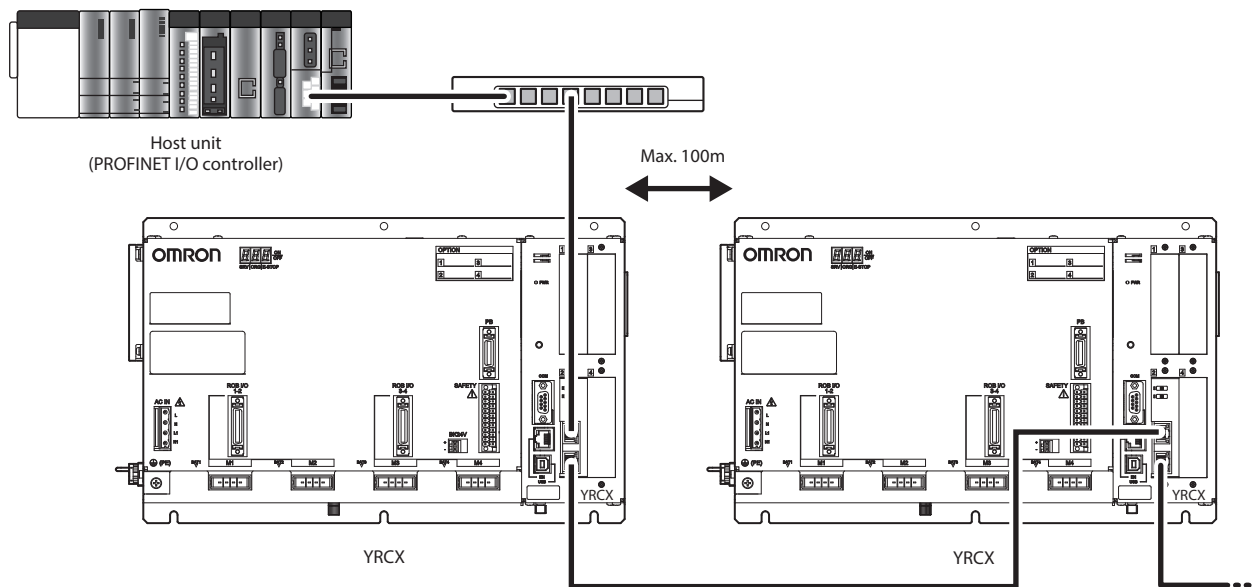

CAUTION

Network equipment such as switches can be used if it satisfies the requirements of the PROFINET network. However if the equipment is to be used in an environment where noise is a concern, such as a factory, equipment that meets EMC industrial standards should be selected.

■ Example of a cable-saving layout that combines PROFINET with a general-purpose Ethernet network

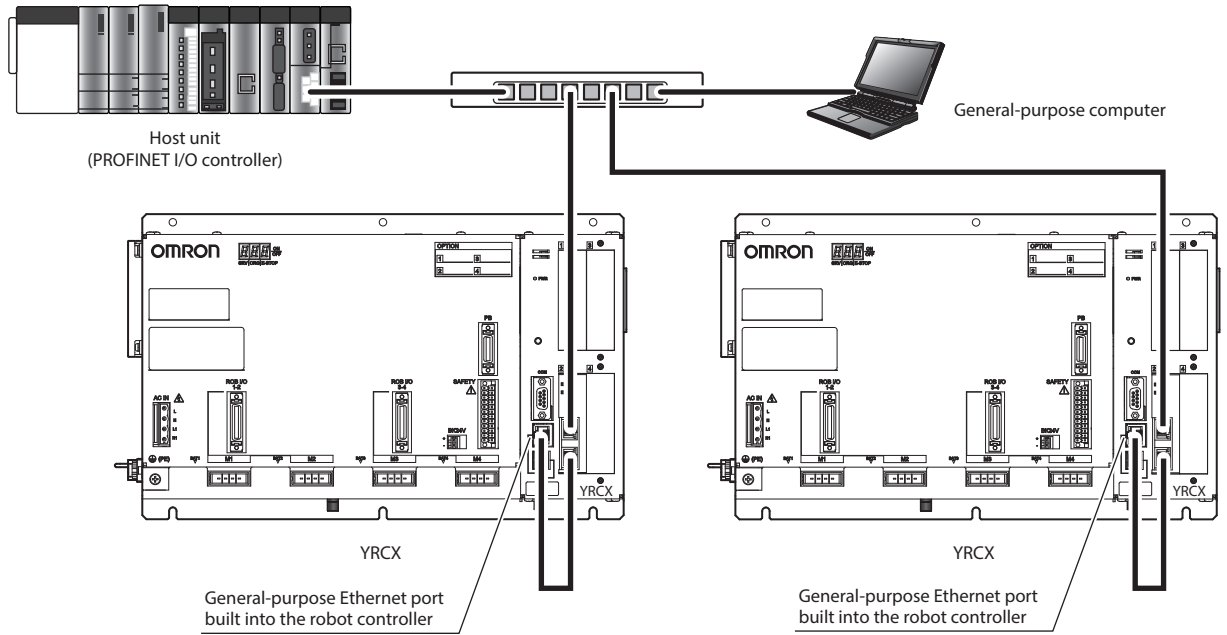

CAUTION

The general-purpose Ethernet ports built into the controller unit do not support the PROFINET communication protocol. Also, communication settings are made separately from the PROFINET unit. For details on settings for the general-purpose Ethernet ports, refer to the user's manual of the controller unit.

When cabling via option boards as shown above, do not set the option board setting parameter to "disable." As setting the option board setting parameter to "disable" causes the option board's internal switch to stop functioning, the general-purpose Ethernet communication pathway to the controller will be shut off.

6.2 Cabling



WARNING

SHUT OFF THE POWER SUPPLY INPUT TO THE ROBOT CONTROLLER BEFORE PERFORMING THIS WORK.

Insert the LAN cable's modular plug into the controller's modular jack until you hear it click into place.

■ Cable specifications

Use LAN cables that meet the following specifications.

Category 5e (CAT 5e) or higher

Shielded Twisted Pair (STP: Shielded Twist Pair)

Double-shielded

100 m or shorter (solid-core cable is recommended if it is over 10 m)

(Example selections) SIEMENS AG

Connector plug IE FC RJ45 Plug 180 6GK1 901-1BB10-2A00

Cable material IE FC TP standard cable 6XV1 840-2AH10

Tool Stripping tool for IE FC cable 6GK1 901-1GA00

* OO indicates the number of metal housings (A0: 1 / B0: 10 / E0: 50).

* The cable length can be specified in 1-meter units from a minimum of 20 m to a maximum of 1,000 m.

6.3 Noise countermeasures

Although the robot controller unit complies with EMC standards and has a certain amount of resistance to external noise, there may be cases in which communication is affected by noise depending on the environment in which the equipment and cable are located.

If communication is affected by noise, a communication error occurs, possibly causing the robot to enter an emergency stop state, or causing throughput to decline. If there is a source of noise, and this noise is suspected of affecting communication, please take the following countermeasures.

1. Equipment and cable selection

As the equipment to be connected to the network, select units that conform to EMC directives. Be sure to use cable of the prescribed specifications.

2. Equipment and cable placement and grounding

If the noise source is nearby, create an appropriate distance between the noise source and the network environment including the cable. For the robot controller unit and equipment connected to it, be sure to attach an appropriate ground as directed by the manual of each unit.

3. Adding anti-noise components

Apply the following measures to the robot controller.

- Install a ferrite core on both ends of the cable immediately adjacent to the connector of the device.
- Install a ferrite core or noise filter on the power supply input of the controller.

7. GSD files

GSD (General Station Description) is a type of network setting file. It contains settings for a device that supports PROFIBUS or PROFINET.

The network settings file contains information necessary for connecting to a host device, such as I/O size and communication settings, in a prescribed format. When constructing a network, the settings information of all connected network devices must be loaded into the host control device.

The appropriate engineering or configuration tool is used to make settings for and write to the host control device, and during this process it will be necessary to load each device's network settings file into the tool.

The steps for loading the file will depend on the host device used, and on the tool that supports it. Refer to the manual for the device and tool.

8. Settings

Here we explain the parameters that must be set and the settings files that are required in order to begin communication between the host control device and the robot controller.

8.1 Communication parameter settings

The robot controller does not have parameters related to PROFINET unit communication.

Communication with the host control device (IO controller) requires network parameter settings such as IP address, subnet mask, and station name.

All of these are set by the corresponding engineering tool (IO Supervisor).

Tasks such as viewing the network parameters and performing "Reset to factory setting" are also all performed from the engineering tool. For details on how to use the engineering tool, refer to the manual of the device and software you're using.

■ Network settings flow

If there is no topology setting for the host control device (IO controller), such as when the facility is being started up:

With the robot controller and the engineering tool in a state where they can communicate with each other, specify the IP address, subnet mask, gateway, and station name individually.

Also make the same settings for the host control device.

If you are replacing only one device within the network, such as when replacing a controller, and topology settings have been made for the host control device (IO controller):

The network parameters that had been specified for the device before replacement can be automatically assigned by PROFINET to the replacement device based on the address information of the peripheral device.

This means that in this case, there is no need to make communication settings.



CAUTION

Data of the robot controller other than network parameters is not passed on automatically.

Be sure to back up from the controller before replacing it, download this data to the controller following replacement, and then connect the controller to the network.

9. Monitoring communication data

On/off data for the host controller device and controller I/O can be monitored via the programming box or the SCARA-YRCX Studio support software. This can be used to check the input/output addresses during setup or for debugging.



CAUTION

Since the display update interval of the programming box and of SCARA-YRCX Studio is longer than the data update interval of I/O information, there may be cases in which accurate information is not shown if the on/off interval of the I/O information is short.

9.1 Using the programming box

At the initial screen, select [Monitor]-[I/O] to access the monitor screen.

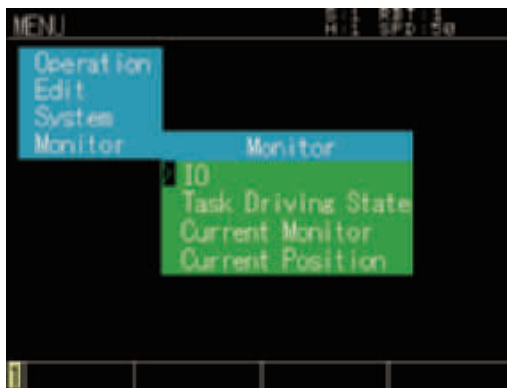

Valid keys and submenu descriptions in the MANUAL mode are shown below.

Valid keys	Menu	Function
F1	DETAIL	Switches between the input/output list and detail displays.
F2	DI	Displays the DI monitor.
F3	DO	Displays the DO monitor.
F4	MO	Displays the MO monitor.
F5	LO	Displays the LO monitor.
F6	TO	Displays the TO monitor.
F7	SI	Displays the SI monitor.
F7	SO	Displays the SO monitor.
F9	SIW	Displays the SIW monitor.
F10	SOW	Displays the SOW monitor.
MONITOR		Switches the monitor number. It is possible to change the port number display by switching the monitor number. For details on the monitor number, refer to "9.1.1 Switching the port number."



NOTE

Four types of I/O data can be transmitted and received via the network: SI, SO, SIW, and SOW.

9.1.1 Switching the port number

■ Monitor screen

By switching the monitor number the displayed port number can be changed.
The following table shows the correspondence between monitor number and port number.

Port name	Monitor number	Display range	Display format
SI,SO	1	<input type="checkbox"/> 00-77	● : ON ○ : OFF
	2	<input type="checkbox"/> 100-177	
	3	<input type="checkbox"/> 200-277	
SIW SOW	1	<input type="checkbox"/> 0-7	4-digit hexadecimal
	2	<input type="checkbox"/> 8-15	

* The port name is shown in □. For example if "DO monitor 2" (monitor number 2 of the DO port) is shown, DO100-DO177 is shown.

The monitor number is shown in the upper left of the screen.
Press the MONITOR key to switch the monitor number.

■ Monitor number

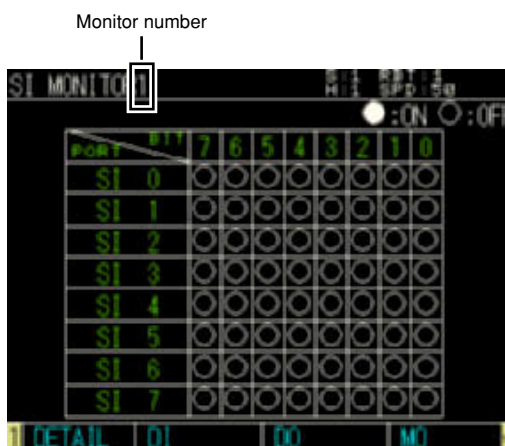

■ Monitor Detail screen

By switching the monitor number it is possible to change the tens digit in the order of 0 → 10 → 20. The ones digit can be changed by using the cursor keys to select [Δ] or [▽] and pressing the enter key.

■ Changing the ones digit of the port number

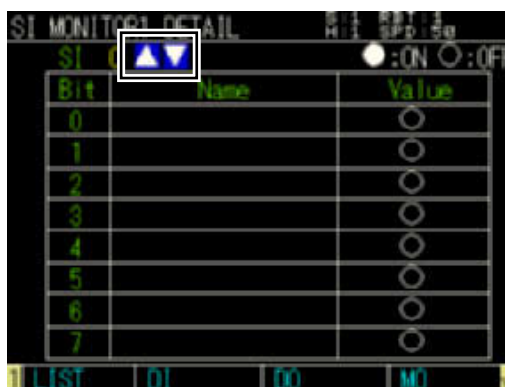

For details on operation, refer to "9.1.3 Input/output detail view."

9.1.2 Input/output list display

Step1 At the initial screen, select [MONITOR] → [I/O].
The "DI Monitor 1" screen then displays.

Step2 Select the input/output monitor to be displayed.
Pressing the F2 key (DI)--F10 key (SOW) displays the input/output monitor corresponding to the key.
Pressing the MONITOR key changes the port number.

Key	Input/output
F2	DI
F3	DO
F4	MO
F5	LO
F6	TO
F7	SI
F8	SO
F9	SIW
F10	SOW

Press the [ESC] key to end the monitor display.

"SI MONITOR 1" screen

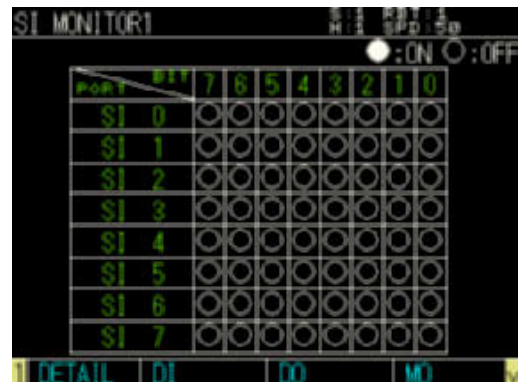

9.1.3 Input/output details display

Step1 Open the Input/Output Monitor screen.

Step2 Press the [F1] (Details) key.
The "Input/Output Details" screen then displays.

Step3 Changing the port number.

- Changing the tens digit of port number
Pressing the MONITOR key changes the tens digit of the port number in the order of 0 → 10 → 20.
- Changing the ones digit of port number
Use the cursor key to select (Δ) or (∇), then press the (enter) key. The port number can then be changed.

Press the [ESC] key to end the monitor display.

* There are no displays for SIW and SOW details.

"SI MONITOR 1 DETAIL" screen



9.1.4 Switching the output status

In the "Input/output detail view" screen, DO, MO, LO, TO, and SO output can be switched on/off by individual bits.



CAUTION

- In order to switch the output on/off, the programming box must have control authority.
- SO00-07, SO10-17, and DO00-07 and DO10-17 cannot be changed, since they are dedicated bit outputs that indicate the status of the controller.

Step1 Display the output port "Monitor" screen.

Press the F3 key (DO)--F6 key (TO) or F8 key (SO) to display the "Monitor" screen.

Step2 Display the "Detail" screen.

Press the F1 key (Detail) to display the "Detail" screen.

Step3 Specify the port number.

- Changing the tens digit of port number
Pressing the MONITOR key changes the tens digit of the port number in the order of 0 → 10 → 20.
- Changing the ones digit of port number
Use the cursor key to select (Δ) or (▽) , then press the (enter) key. The port number can then be changed.

Step4 Switch the output status.

Use the cursor keys to select the ON or OFF setting for the bit number which changes the output status, then press the [enter] key to switch that output status.

Press the [ESC] key to end the monitor display.

Example of the output monitor detail screen: "SO MONITOR1 DETAIL"

Bit	Name	Value
0		<input checked="" type="radio"/> ON <input type="radio"/> OFF
1		<input checked="" type="radio"/> ON <input type="radio"/> OFF
2		<input checked="" type="radio"/> ON <input type="radio"/> OFF
3		<input checked="" type="radio"/> ON <input type="radio"/> OFF
4		<input checked="" type="radio"/> ON <input type="radio"/> OFF
5		<input checked="" type="radio"/> ON <input type="radio"/> OFF
6		<input checked="" type="radio"/> ON <input type="radio"/> OFF
7		<input checked="" type="radio"/> ON <input type="radio"/> OFF

9.2 Using SCARA-YRCX Studio support software

From the window tree, choose [Monitor] and then double-click a port name DI through SOW to monitor. The monitor screen appears.

The monitor screen contains a list screen and a detail screen. When starting SCARA-YRCX Studio, the monitor screen that appears first will always be the "Detail screen."

The explanation here uses the example of SI, SO, SIW, and SOW.

Tip

Once you open a monitor screen, it is shown as a tab at the bottom of the screen. The monitor screen can be displayed by switching tabs.

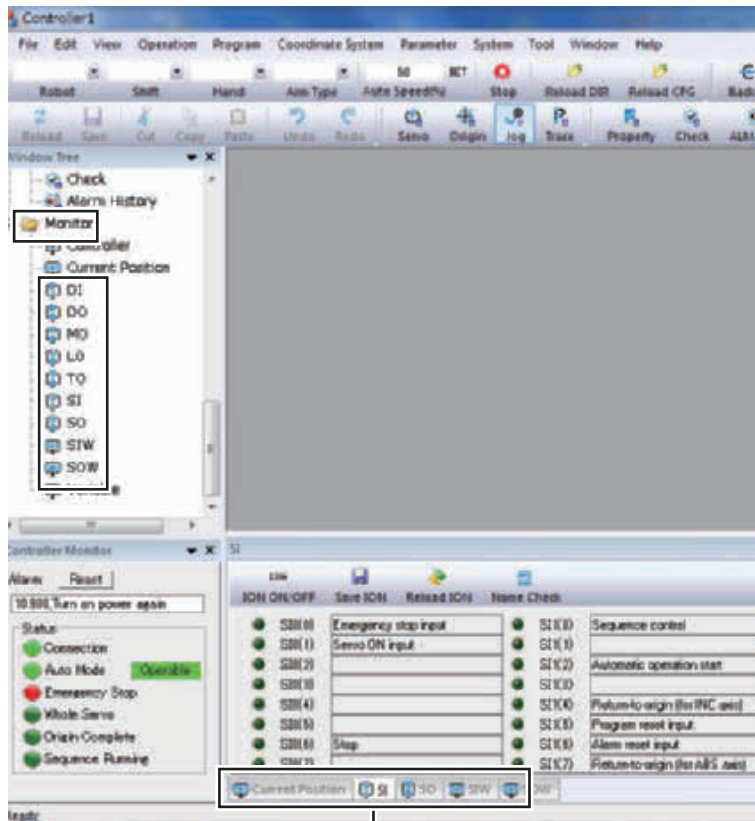

Tab display

■ SI monitor

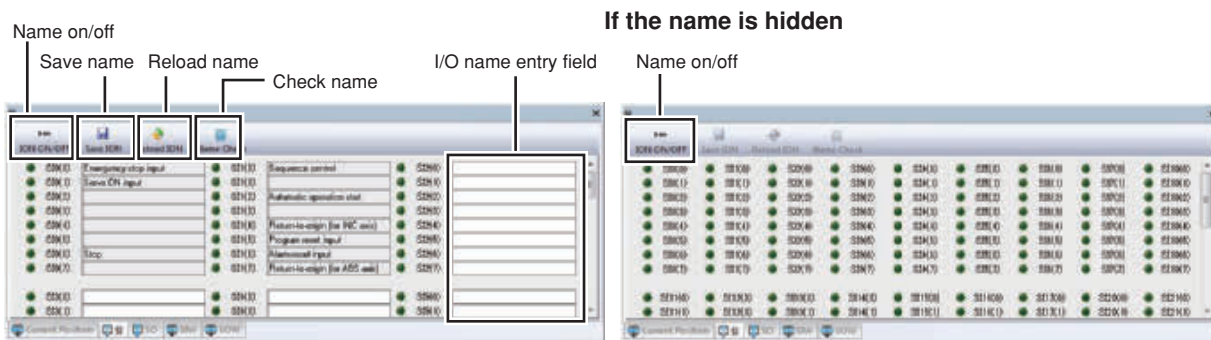

	Function
Name on/off	Shows/hides the name.
Save name	Sends the name that is entered in the name entry field to the controller.
Reload name	Loads the name from the controller, updating the indication of the name entry field.
Check name	Checks whether the entered I/O name conforms to the prescribed rules. For details on the naming rules for an I/O name, see "I/O name entry field" below.
I/O name entry field	<p>Enters the I/O name. Observe the following naming rules when entering the name.</p> <ul style="list-style-type: none"> • The maximum is 16 characters. • Single-byte alphanumeric characters and "_" (underscore) can be used. • Uppercase and lowercase alphabetical characters are distinguished. • A numeral cannot be used as the first character. • It is not possible to assign an I/O name that is identical to a reserved word, or that starts with a system variable name. • It is not possible to assign the same I/O name to more than one I/O. • Since SI00-07 and SI10-17 are dedicated bit inputs, the I/O name cannot be input. Similarly, I/O name input is not possible for DI inputs (DI00-07 and DI10-17).

* For a list of reserved words and system variables, and for usage examples of variable names, refer to "13. Reserved word list."

■ SIW monitor

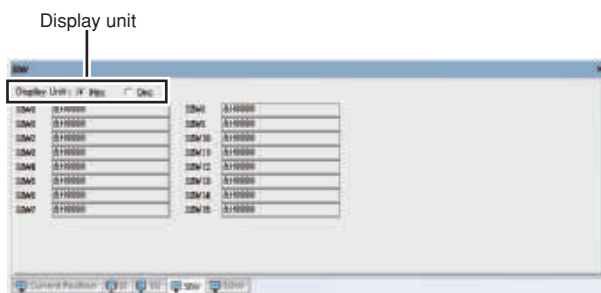

	Function
Display unit	Displays port values in hexadecimal or decimal.

■ SO monitor

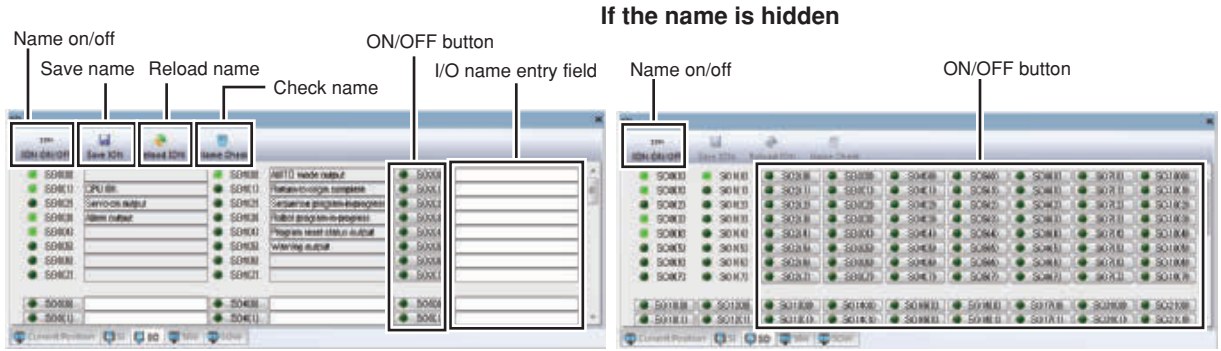

	Function
Name on/off	Shows/hides the name.
Save name	Sends the name that is entered in the name entry field to the controller.
Reload name	Loads the name from the controller, updating the indication of the name entry field.
Check name	Checks whether the entered I/O name conforms to the prescribed rules.
ON/OFF button	Switches the bit output on/off. However since SO00-07 and SO10-17 are dedicated bit outputs that indicate the status of the controller, they cannot be switched on/off. Similarly, DO output (DO00-07 and DO10-17) cannot be switched on/off.
Name entry field	Enters the I/O name. However since SO00-07 and SO10-17 are dedicated bit outputs that indicate the status of the controller, name entry is not possible. Similarly, DO output (DO00-07 and DO10-17) does not allow name entry. For details on the rules for I/O names, refer to "I/O name entry field" in the preceding "n SI monitor (Detail screen)."



CAUTION

- In order to switch SO or DO on/off, the programming box must release control authority, and the controller must be in auto mode.
- SO00-07, SO10-17, DO00-07, and DO10-17 are dedicated bit outputs that indicate the status of the controller, and therefore cannot be changed.

■ SOW monitor

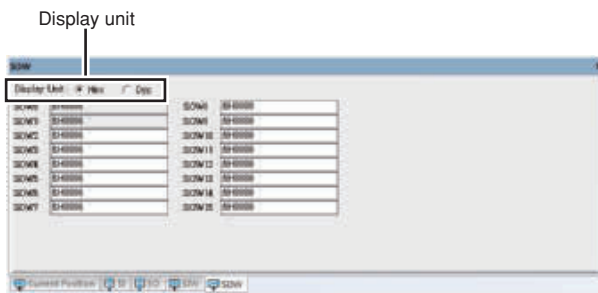

	Function
Display unit	Displays port values in hexadecimal or decimal.

Tip

The SOW2-15 output values can be updated to desired values by rewriting the numerical value in the text box during communication with the controller.

As SOW0 and 1 are dedicated outputs, their values cannot be changed.

As SIW is an external input value, it cannot be changed to an arbitrary value.

10. Disabling an option unit

If the controller is equipped with a field network option unit, it normally communicates with the host control device and controls the robot in accordance with the communicated content, so a ladder program is required for the host device.

When performing teaching or trial operation of the robot by itself in a state in which the host device's ladder program has not been provided, the robot can be operated without communicating with the host device by setting the option board to "disabled".



CAUTION

When shipped from the factory, all functions of the option unit are set to "enabled." In the "enabled" state, the robot first becomes operable when an emergency stop or stop signal is input from the host control device. For details on I/O functionality, refer to the separate "Remote I/O Manual".

Option board setting parameters

Item		Values	Default value
Option board enabled	Slot 1	0 : INVALID, 1 : VALID	1 : VALID
	Slot 2		
	Slot 3		
	Slot 4		



CAUTION

The "Option board enable" parameter is set individually for option slots 1 through 4. When changing the settings of an option board, be sure to verify the location in which the target option board is installed, and change the setting only for the target slot number.

The illustration below shows the correspondence between the location of each option slot and the actual installation location.

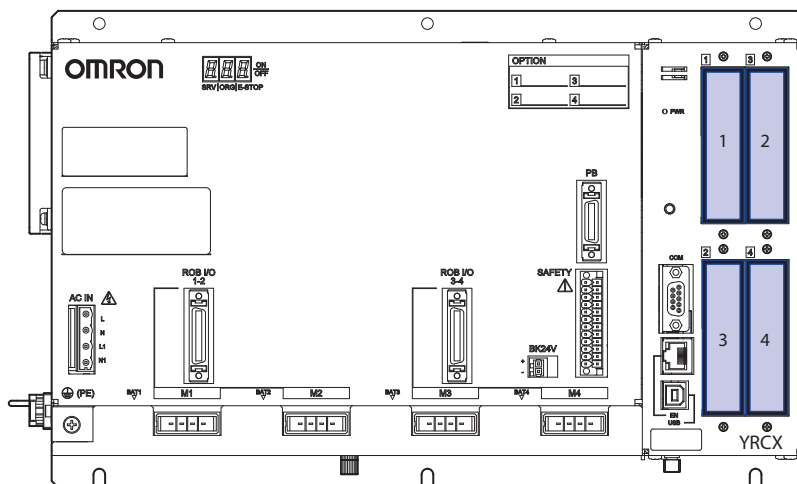

10.1 Making settings

An option board can be disabled either from the programming box or from SCARA-YRCX Studio support software.

10.1.1 Using the programming box

Step 1 *Open the Parameter Edit screen.*

At the initial screen, select [Edit], press [Enter], then select [Parameter].

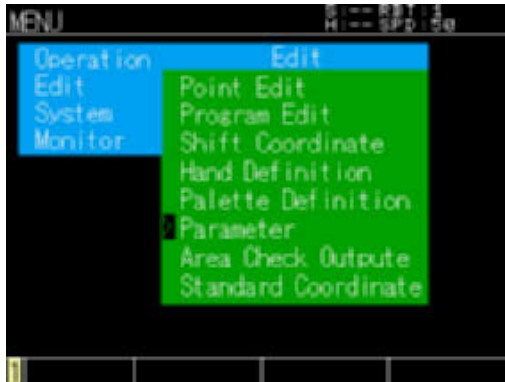

Step 2 *Press the [F6] (OPTION) key to display the Option Parameters screen.*

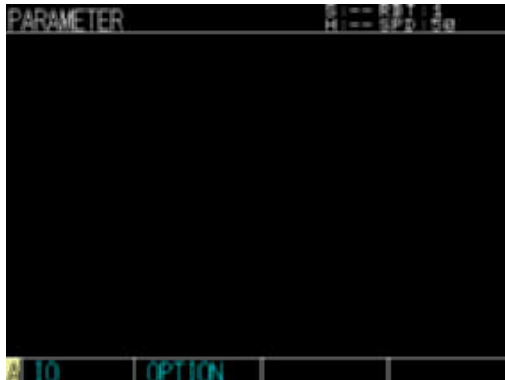

Step 3 *Select the desired parameter.*

Use the cursor up/down keys to select the parameter to be edited, then press the [F1] (EDIT) key.

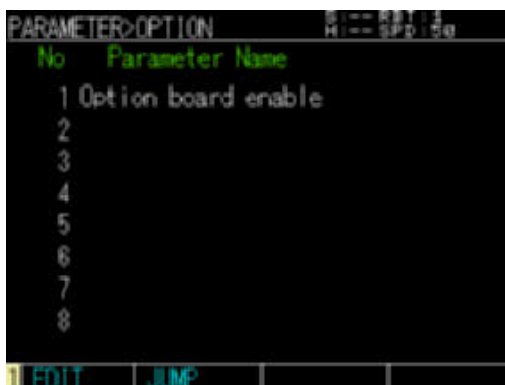

Step4 Edit the parameter.

Change the setting for the target slot, and press the enter key.

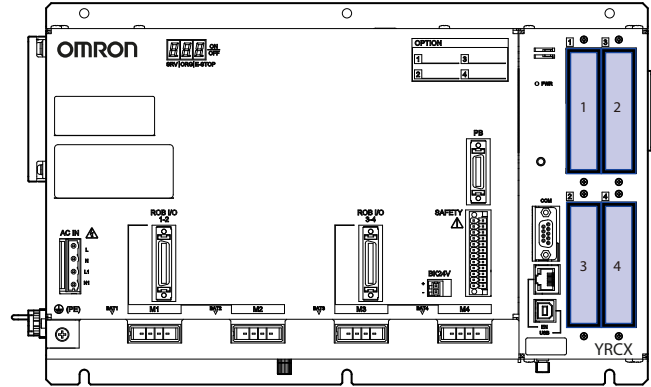

NOTE

The values of the option board enable parameter correspond to slots 1 through 4 starting from the left. Verify the slot in which the network unit is installed, and change the value only for the target slot number.

Step5 Press the [ESC] key to end the editing operation.

The specified content is applied after the controller is restarted.

10.1.2 Using SCARA-YRCX Studio support software

Step1 In the window tree, select the board parameters.

In the window tree, select [Parameter]-[Option], and double-click [Board Enable].

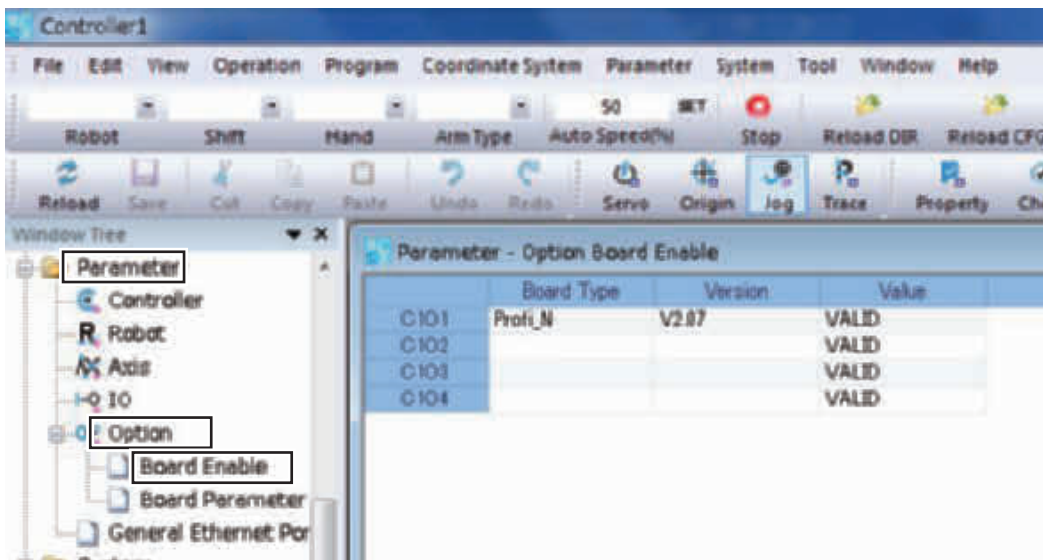

- * C101-C104 correspond to slots 1--4.
Verify the slot in which the network unit is installed, and change the value only for the target slot number.

Step2 Select the option slot "Value" column, and choose either "VALID" or "INVALID."

C101 through C104 in the chart correspond to option slots 1 through 4 of controller 1.
 If controllers are linked to each other in a YC-Link/E network, the option slots of controller 2 and following are shown in C201 through C204.

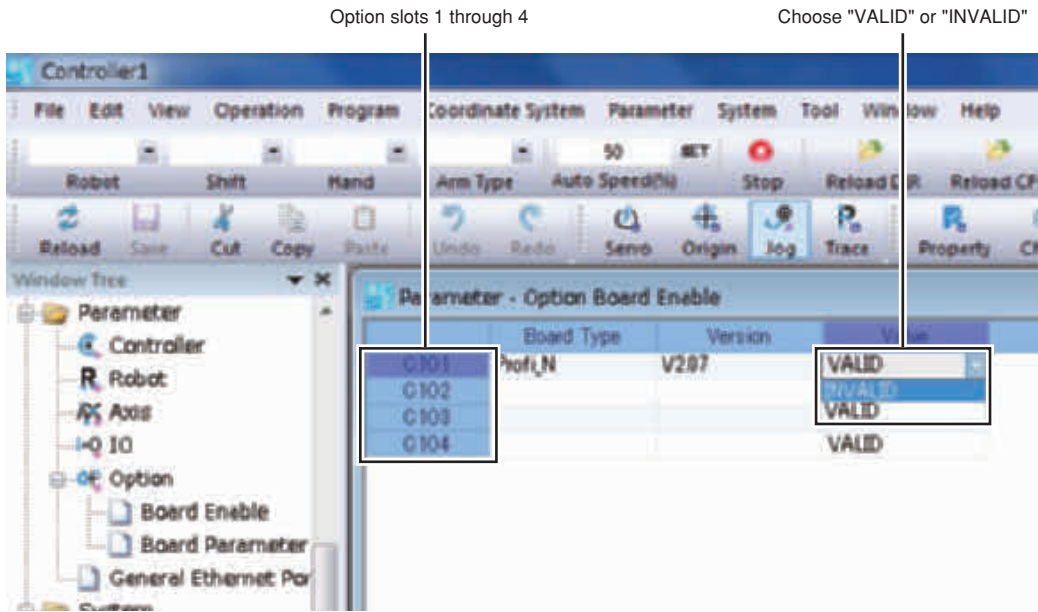

Tip
 If a cell's value is changed, its background color turns red.

Step3 Click the [Save] button to save the settings.

When saving is complete, the cell color changes from red to white.
 The specified content is applied after the controller is restarted.

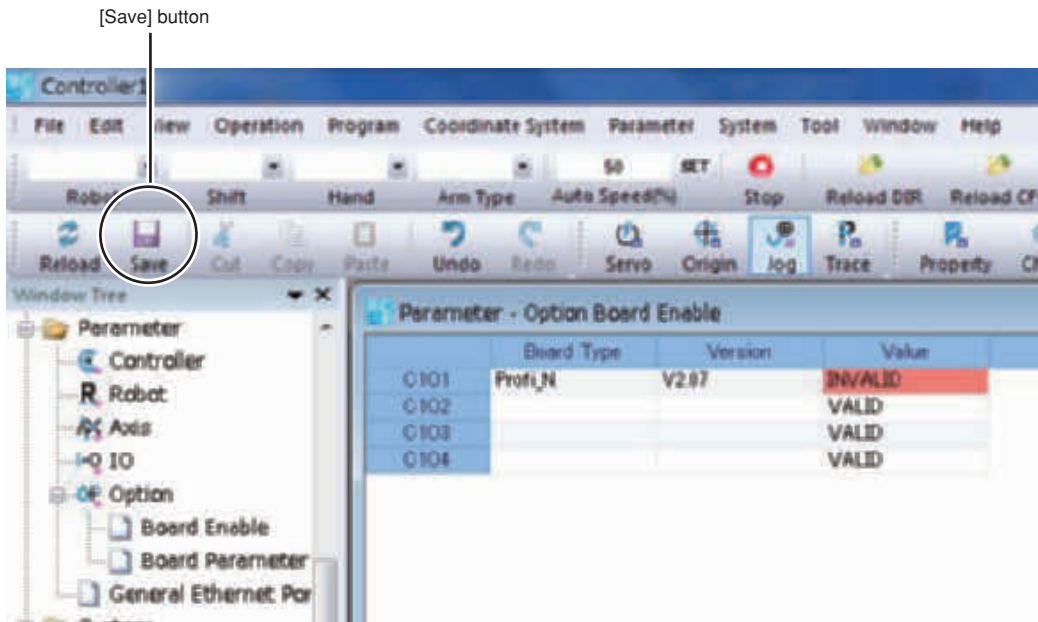

11. Actions to take if communication is not established

If communication is not established, diagnose the situation by referring to the alarm codes or alarm messages of the controller unit and to the network unit's LED illumination pattern, and take the appropriate actions.

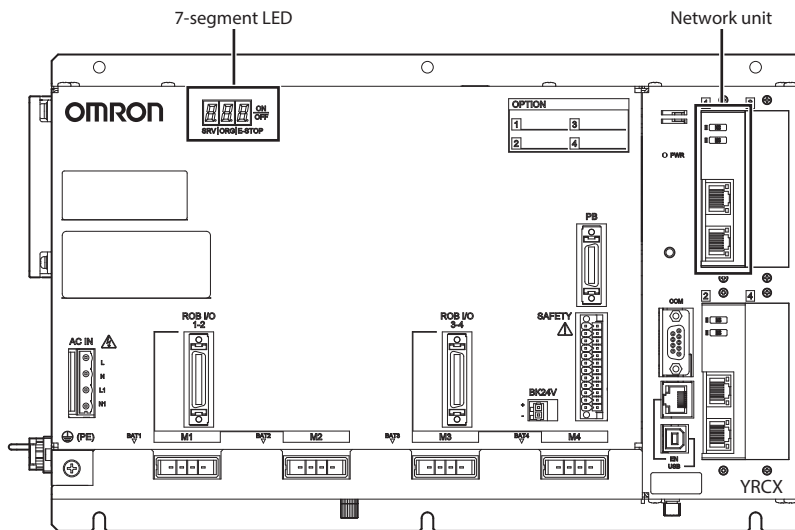

11.1 Reconsider the startup steps

The following steps must be taken when starting up the network system.

If communication cannot be established after the cabling and settings have been completed, it is possible that one of the steps was not performed correctly.

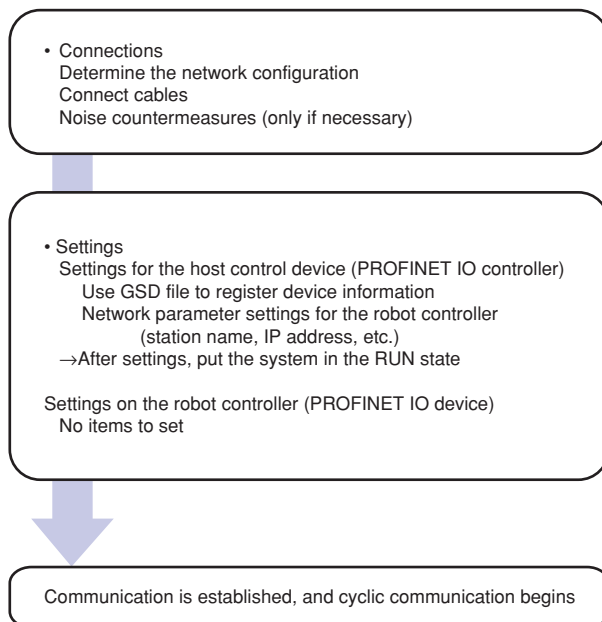

If communication is not established, check the following points.

- Connections: Do the cables meet the network specifications, and are they securely connected?
- Parameter settings: Are parameters such as station name and IP address specified from the host control device (IO controller)?
Is the topology specified?
- GSD file: Is the correct GSD file registered on the host control device (IO controller)?

11.2 Viewing the alarm codes in the 7-segment LED

Normal state

- The "PWR" LED on the front of the controller is lit, and the 7-segment LED shows the following.
(Servo off, return-to-origin incomplete, emergency stop cancelled)



Abnormal state

- The "PWR" LED on the front of the controller is lit, and the 7-segment LED shows an alarm code.
- Note the alarm message on the programming box, and take the actions prescribed by the troubleshooting guidelines.

(Example) Display when an alarm occurs

"E + alarm group number" and "alarm type number" are displayed alternately.

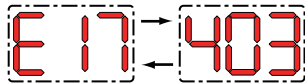

- * In the example above, alarm code "17.403" is indicated.
- * For details on the alarm messages and content corresponding to each alarm code, refer to "11.3 Diagnostics by alarm message," or the troubleshooting section of the YRCX controller user's manual.

11.3 Diagnostics by alarm message

Alarm messages related to the network unit are shown below.

Alarm messages not listed in this document may be alarms resulting from the robot controller unit.

Refer to the troubleshooting section of the robot controller user's manual.

11.3.1 Alarms related to network unit connections and settings

These errors occur if communication is not established, or if communication is unstable.

12.571 : PROFINET link error

Code : &H000C &H023B

Meaning/Cause	<ul style="list-style-type: none"> a. Error occurred in cable for PROFINET system. b. The communication setting of the PROFINET system incorrect. c. The master module power is turned off, or the PLC has stopped operating, or is broken. d. The PROFINET compatible module is breakdown.
Action	<ul style="list-style-type: none"> a. Check for a break disconnection, wiring error, short circuit on the PROFINET cable or the specifications (cable length, etc.). b. Check the communication setting. c. Check that the master module operates correctly. d. Replace the PROFINET compatible module.

12.572 : PROFINET overtime error

Code : &H000C &H023C

Meaning/Cause	<ul style="list-style-type: none"> a. Communication error occurred by noise, etc. in the PROFINET system. b. Master module power is turned off or has stopped operating. c. The cable is broken or unconnected.
Action	<ul style="list-style-type: none"> a. Take the noise preventive actions for the cable and controller of the PROFINET system. b. Check that the master module operates correctly. c. Check the PROFINET cable connection.

11.3.2 Alarms related to I/O on/off status

These errors occur depending on the state of the dedicated input/output.

If the robot controller is equipped with a network unit, the robot cannot be operated unless an emergency stop or STOP signal is input from the host device, even if the robot is being controlled from somewhere other than the host control device.

For details on I/O functions, refer to "Remote I/O Manual."

12.400 : Stop input on

Code : &H000C &H0190

Meaning/Cause	<ul style="list-style-type: none"> a. Program execution or axis movement was attempted in the stop status. b. The robot was put in the stop status during program execution or axis movement. c. 24V-power for I/O is not supplied to the DIO connector. d. The DIO connector is not connected.
Action	<ul style="list-style-type: none"> a, b. Cancel the stop status, and then execute the program or move the axis. c. Supply 24V-power for I/O. d. Connect the DIO connector. <p>* Set the "Option board enable" parameter INVALID when DIO is not used.</p>

12.600 : Emergency stop on

Code : &H000C &H0258

Meaning/Cause	<ul style="list-style-type: none"> a. The programming box emergency stop button was pressed. b. The emergency stop terminal on the SAFETY connector is open (emergency stop status). c. The programming box or terminator is not connected to the PB connector. d. The SAFETY connector is not connected.
Action	<ul style="list-style-type: none"> a. Release the emergency stop button on the programming box. b. Close the emergency stop terminal on SAFETY connector. c. Connect the programming box or terminator to the PB connector. d. Attach the SAFETY connector.

11.3.3 Alarms that the customer cannot resolve

These are error messages that are not expected to occur in the field.

If one of these errors occurs, please contact your distributor with details of the situation.

12.765 : PROFINET initialize error

Code : &H000C &H02FD

Meaning/Cause	Initializing the PROFINET option board failed.
Action	Contact your distributor.

12.900 : Incorrect option setting

Code : &H000C &H0384

Meaning/Cause	<ul style="list-style-type: none"> a. Error occurred in ID setting on the option module. b. Option modules that cannot be mixed were installed. c. The installed option module cannot be identified.
Action	<ul style="list-style-type: none"> a. Check the ID setting of the option module. b. Install the correct option modules. c. Replace the option module. <ul style="list-style-type: none"> • Replace the controller.

12.904 : SIO option board initialize error

Code : &H000C &H0338

Meaning/Cause	Initializing the SIO option board failed.
Action	Contact your distributor.

11.3.4 Checking alarm codes in the programming box

Step1 *Open the Parameter Edit screen.*

At the initial screen, select [Edit], press [Enter], then select [Parameter].



Step2 *Check the alarm code that is occurring.*

Press the F1 key (RELOAD) to update the display to the current state.

In the illustration, alarm code 10.900 is occurring.

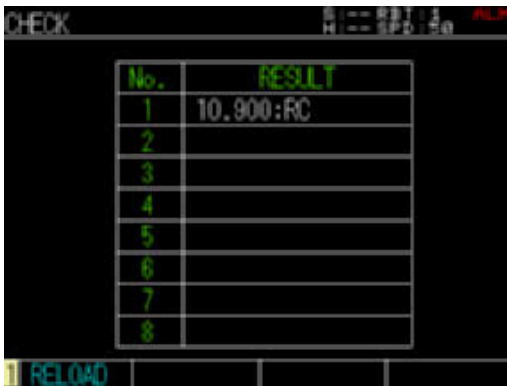

11.3.5 Checking alarm codes in SCARA-YRCX Studio support software

Alarm codes and alarm messages are shown in the "Controller Monitor" located in the lower left of the screen.

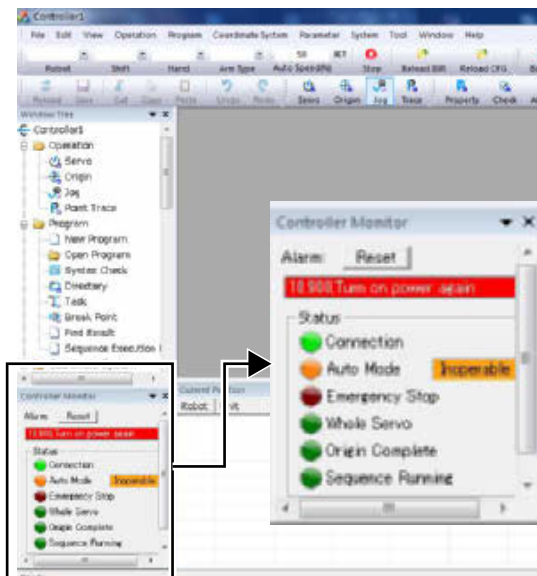

11.4 Detailed diagnostics using the indicators

Details of the situation can be obtained from the illumination pattern of the network unit indicators.

■ Network unit indicators and illumination patterns

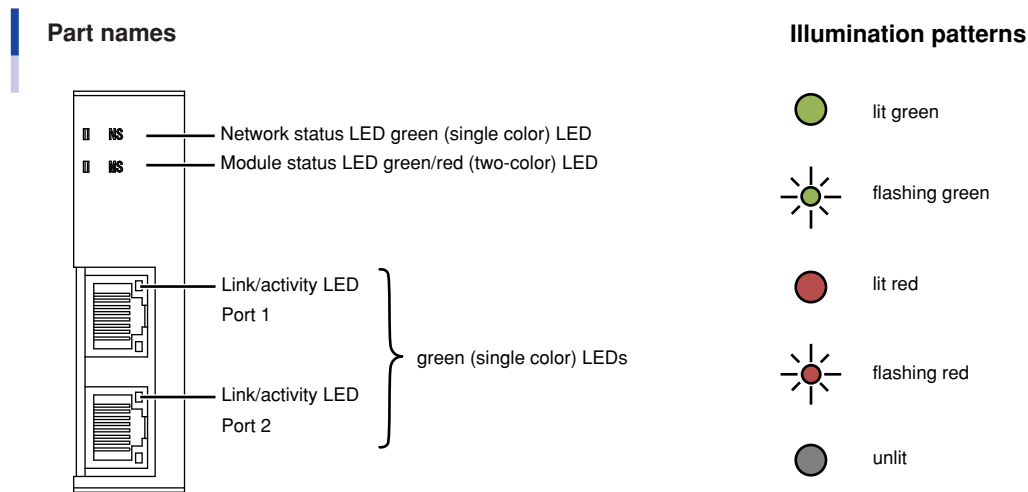

Network status (NS) LED

LED status	Explanation	Comment
OFF	Offline	Power is off IO controller is not connected
Green	Online (RUN)	Connection with IO controller is not established IO controller is in RUN state
Flashing green	Online (STOP)	Connection with IO controller is not established IO controller is in STOP state

Module status (MS) LED

LED status	Explanation	Comment
OFF	Not initialized	Power is off, or module is in SETUP or "NW_INIT" state
Green	Normal operation	Module has transitioned from "NW_INIT" state
Flash green once	Diagnostic event	Diagnostic event is occurring
Flash green at 1 Hz	DCP flashing	An engineering tool is being used to identify a node on the network
Red	Exception error	Module is in the "EXCEPTION" state
Flash red once	Setting error	Expected ID differs from actual ID
Flash red twice	IP address error	IP address is not set
Flash red three times	Station name error	Station name is not set
Flash red four times	Internal error	A serious error is occurring inside the module



Link/activity LED: Port 1 / Port 2

LED status	Explanation	Comment
OFF	No link	A link is not established, and communication is not occurring
Green	Link detected	An Ethernet link is established, but communication is not occurring
Flashing green	Activity	An Ethernet link is established, and communication is occurring

11.4.1 Common situations and LED illumination patterns

■ Illumination patterns when connection exists

1. PROFINET IO controller in RUN state, I/O control possible

Network Status	
Module Status	
Link/Activity	



■ Presumed state

Connection with the host control device (IO controller) is established, and I/O control via cyclic communication is possible.

■ Action to take

None. Settings have completed normally, and communication has begun.

2. PROFINET IO controller in idling state, I/O control not possible

Network Status	
Module Status	
Link/Activity	

■ Presumed state



Connection with the host control device (IO controller) is established, but cyclic communication has not begun.

■ Action to take

Use the host control device to switch the control mode to START.

■ Illumination patterns when connection does not exist

3. Unset parameters

Network Status	
Module Status	
Link/Activity	

MS flashing red twice: IP address is not set.
MS flashing red three times: Station name is not set.



■ Presumed state

Parameters such as the IP address or station name have not been set from the IO supervisor (e.g., engineering tool for the host control device).
Network topology has not been specified, and neighbor detection via LLDP is not functioning.

■ Action to take

From the IO supervisor, manually specify the IP address and station name.
Make topology settings for the IO controller.

4. LAN cable unconnected

Network Status	
Module Status	
Link/Activity	



■ Presumed state

The cable between the host control device and robot controller is unconnected.

■ Action to take

Check the cabling. Check the connection state of the peripheral devices.

5. Option invalid setting

Network Status	
Module Status	
Link/Activity	

■ Presumed state

The option board setting parameter is set to "invalid."
Alternatively, the controller power is shut off.

■ Action to take

Set the option board setting parameter to "valid," and restart the robot controller. Alternatively, check the power supply input to the controller.

12. Specifications

12.1 Network specifications

Spec. Item	Contents	
Supported software versions	YRCX	: V1.21 or later
	PBEX	: V1.08 or later
	SCARA-YRCX Studio	: V1.0.1 or later
Network specification conformance	PROFINET IO V2.2	
Conformance class	Conformance Class B / IO Device	
Product revision	1.00	
GSD file name	GSDML-V2.3-YMC-RCX3-20150203.xml	
Transmission speed	100Mbps (Auto-negotiation)	
Connector specifications	RJ-45 connector (8-pole modular connector) 2 ports	
Conforming cable specifications	CAT 5e or higher STP cable (double shield)	
Max. cable length	100m	
Monitor LEDs	Module Status(MS), Network Status(NS), Link/Activity:Port1-2	
Input/output data size	Input : 48bytes	Dedicated word input 2 words (4 bytes)
		General-purpose word input 14 words (28 bytes)
		Dedicated bit input 16 bits (2 bytes)
		General-purpose bit input 96 bits (12 bytes)
		Reserved area 2 bytes
	Output : 48bytes	Dedicated word output 2 words (4 bytes)
		General-purpose word output 14 words (28 bytes)
		Dedicated bit output 16 bits (2 bytes)
		General-purpose bit output 96 bits (12 bytes)
		Reserved area 2 bytes

12.2 Input/output specifications

Controller ⇒ Host control device			Host control device ⇒ Controller			
Address (WRITE)		I/O function	Address (READ)		I/O function	
SOW(0)	-	Command status area	SIW(0)	-	Remote command area	
SOW(1)	-	Command response area	SIW(1)	-	Command data area	
SOW(2)	SOD(2)	Command response area / General-purpose output area	SIW(2)	SID(2)	Command data area / General-purpose input area	
SOW(3)			SIW(3)			
SOW(4)	SOD(4)		SIW(4)	SID(4)		
SOW(5)			SIW(5)			
SOW(6)	SOD(6)		SIW(6)	SID(6)		
SOW(7)			SIW(7)			
SOW(8)	SOD(8)		SIW(8)	SID(8)		
SOW(9)			SIW(9)			
SOW(10)	SOD(10)		SIW(10)	SID(10)		
SOW(11)			SIW(11)			
SOW(12)	SOD(12)		SIW(12)	SID(12)		
SOW(13)			SIW(13)			
SOW(14)	SOD(14)		SIW(14)	SID(14)		
SOW(15)			SIW(15)			
SO07 - SO00	SO00		Emergency stop status output	SI07 - SI00		SI00
	SO01	CPU_OK status output	SI01		Servo on input	
	SO02	Servo on status output	SI02		Reserved area (do not use)	
	SO03	Alarm status output	SI03			
	SO04	MPRDY status output	SI04			
	SO05	Reserved area (do not use)	SI05		SI05	Stop input
	SO06		SI06		SI06	Reserved area (do not use)
SO07	SI07		SI07	Reserved area (do not use)		
SO17 - SO10	SO10	Auto mode status output	SI17 - SI10	SI10	Sequence control input	
	SO11	Return-to-origin complete status output		SI11	Reserved area (do not use)	
	SO12	Sequence program execution status output		SI12	Automatic operation start	
	SO13	Robot program operating output		SI13	Reserved area (do not use)	
	SO14	Program reset status output		SI14	Return-to-origin input (incremental type axis)	
	SO15	Warning output		SI15	Program reset input	
	SO16	Reserved area (do not use)		SI16	SI16	Alarm reset input
SO17	SI17		SI17	Return-to-origin input (absolute type axis)		
SO27 - SO20	General-purpose output area	General-purpose input area	SI27 - SI20	General-purpose input area		
SO37 - SO30			SI37 - SI30			
SO47 - SO40			SI47 - SI40			
SO57 - SO50			SI57 - SI50			
SO67 - SO60			SI67 - SI60			
SO77 - SO70			SI77 - SI70			
SO107 - SO100			SI107 - SI100			
SO117 - SO110			SI117 - SI110			
SO127 - SO120			SI127 - SI120			
SO137 - SO130			SI137 - SI130			
SO147 - SO140			SI147 - SI140			
SO157 - SO150	SI157 - SI150					
(Reserve)	Reserved area (do not use)	(Reserve)	Reserved area (do not use)			
(Reserve)		(Reserve)				

For details on each I/O function, refer to the separate "Remote I/O Manual".

13. Reserved word list

Because the following names are reserved for the robot language, they cannot be used as I/O names.

A	DEF	IDIST	N
ABS	DEGRAD	IF	NAME
ABSADJ	DELAY	IMP	NEXT
ABSRPOS	DI	INCH	NOT
ACC	DIM	INCHT	O
ACCEL	DIR	INCHXY	OFF
ACCESS	DIST	INIT	OFFLINE
ACO	DO	INPUT	ON
ALL	DPM	INT	ONLINE
ALM	DRIVE	ION	OPEN
ALMRST	DRIVEI	J	OPT
AND	DRV	JL	OR
ARCHP1	DS	JOG	ORD
ARCHP2	DSPEED	JOGT	ORGORD
ARM	E	JOGXY	ORGRTN
ARMCND	ELSE	JTOXY	ORIGIN
ARMSEL	ELSEIF	L	OUT
ARMTYP	EMG	LEFT	OUTPOS
ARP	END	LEFTY	P
ARY	ENDIF	LEN	P
ASPEED	EOF	LET	PATH
ATN	EQV	LINEMODE	PC
ATN2	ERA	LOAD	PCM
ATTR	ERL	LOC1	PDEF
AXWGHT	ERR	LOC2	PGM
B	ERROR	LOC3	PGMTSK
BIN	ETH	LOC4	PGN
BREAK	ETHSTS	LOC5	PLS
C	EXIT	LOC6	PLT
CALL	EXITTASK	LOCF	PMOVE
CASE	F	LOG	PNM
CFG	FN	LSHIFT	PNT
CHANGE	FOR	M	PPNT
CHGPRI	FREE	MAINPG	PRINT
CHR	G	MCHREF	PRM
CLOSE	GEP	MEM	PSHFRC
CMU	GEPSTS	MID	PSHJGSP
CNT	GO	MNS	PSHMTD
CONT	GOSUB	MOD	PSHRSLT
COPY	GOTO	MODE	PSHSPD
COS	H	MOTOR	PSHTIME
CURTQST	HALT	MOVE	PUSH
CURTRQ	HALTALL	MOVEI	PWR
CUT	HAND	MOVET	R
D	HEX	MRF	RADDEG
DATE	HND	MRKSET	RBT
DBP	HOLD	MSG	READ
DEC	HOLDALL	MSGCLR	REF
DECEL	I	MSPEED	REM

REN	SGI	SWI	VEL
RESET	SGR	SYNCHK	VER
RESTART	SHARED	T	W
RESUME	SHIFT	TAG	WAIT
RETURN	SI	TAN	WEIGHT
RIGHT	SID	TASKS	WEIGHTG
RIGHTY	SIN	TCHXY	WEND
RSHIFT	SIW	TCOUNTER	WHERE
RUN	SKIP	TEACH	WHILE
RUNTO	SKIPTO	THEN	WHRXY
S	SO	TIM	WHRXYEX
S	SOD	TIME	WRITE
SCK	SOW	TIMER	X
SELECT	SPEED	TO	XOR
SEND	SQR	TOLE	XY
SEQCML	START	TORQUE	XYTOJ
SEQUENCE	STEP	TSKECD	Y
SERVO	STOP	TSKMON	YZ
SET	STOPON	TSKPGM	Z
SETGEP	STR	V	ZX
SETPW	SUB	VAL	
SFT	SUSPEND	VAR	

List of system variables

Because the following names are used as system variable names, they cannot be used at the beginning of other variable names (n: numeric value).

A	FN	MO _n	S _n
Ac _n	G	P	So _n
D	GP _n	PC _n	SONM _n
Dl _n	H	P _n	T
DlNM _n	H _n	PN _n	TO _n
DO _n	L	S	
DONM _n	LO _n	S _n	
F	M	SINM _n	

Variable name usage examples

- Although keywords which are reserved as robot language words cannot be used as they are, **they can be used as variable names if alphanumeric characters are added to them.**

Example: "ABS" cannot be used, but "ABS1" or "ABSX" can be used.

- Keywords reserved as system variables **cannot be used at the beginning of other variable names**, even if alphanumeric characters are added to them.

Example: "FN" cannot be used. "FNA" and "FN123" also cannot be used.

Revision history

A manual revision code appears as a suffix to the catalog number on the front cover manual.

Cat. No. I247E-EN-01A

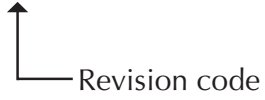

The following table outlines the changes made to the manual during each revision.

Revision code	Date	Description
01	July 2016	Original production
01A	April 2020	The WEIGHTG command was added to the 'Reserved word list' section. The section 'Diagnostics by alarm message' was updated.

OMRON

Authorized Distributor: