

**SCARA Robots
YRCX Series**

YRCX Robot Controller

OPERATION MANUAL

OMRON

Warranty

Important information before reading this manual

Introduction	i
About this manual	i
Safety precautions	ii
Signal symbols	ii
Overview of the YRCX	iii
Before using the robot controller (Be sure to read the following notes)	iv

Chapter 1 Using the robot safely

1. Emergency action when a person is caught by robot	1-1
2. Emergency stop	1-3
2.1 Emergency stop release and alarm reset	1-3
3. Power-ON procedures	1-5
4. Usage environments	1-6

Chapter 2 System overview

1. Operation overview	2-1
2. The YRCX robot controller	2-2
2.1 External device connectors	2-2
2.2 7-segment LED display function	2-3
3. Programming box	2-4
3.1 Part names and functions	2-4
3.2 Connection to the robot controller	2-5
3.3 Programming box screen	2-5
4. Operation key	2-6
4.1 Operation key layout	2-6
4.2 Basic key operation	2-6
4.3 Function keys	2-7
4.4 Control keys	2-8
4.5 Data keys	2-9
4.6 Other keys	2-9

5. Hierarchy structure	2-9
5.1 Basic hierarchies	2-9
5.2 Quick menu	2-10
5.3 Selecting hierarchy and menu	2-14

Chapter 3 Operation

1. Servo operation	3-1
1.1 Emergency stop release and alarm reset	3-1
1.2 Motor power and servo on/off	3-1
1.2.1 Servo operation (all axes)	3-1
1.2.2 Servo operation (each axis)	3-2

2. Jog	3-3
2.1 Jog movement	3-4
2.1.1 Jog movement in return-to-origin complete status	3-5
2.1.2 Jog movement in return-to-origin complete status (When hand definition is set)	3-6
2.1.3 Jog movement in return-to-origin incomplete status	3-6
2.2 Changing the display units	3-7
2.3 Changing the Jog movement speed	3-7
2.4 Changing the inch distance	3-8
2.5 Inputting point data by teaching	3-8
2.6 Jumping the point display	3-9

3. Point trace	3-9
3.1 PTP motion	3-10
3.2 Linear interpolation motion	3-11
3.3 Arch motion	3-13
3.4 Setting the speed	3-14
3.5 Changing the display unit	3-14
3.6 Jumping the point display	3-15

4. Automatic operation	3-15
4.1 Executing automatic operation	3-17
4.2 Stopping a program	3-18
4.3 Resetting a program	3-18
4.3.1 Resetting a program	3-18
4.3.2 Resetting all programs	3-19
4.4 Registering and releasing task	3-19
4.5 Task priority	3-20
4.6 Switching task display	3-20
4.7 Changing the automatic movement speed	3-20
4.8 Sequence program execution flag	3-21
4.9 Restarting the program	3-21

4.10	Input function	3-22
4.10.1	Inputting message	3-22
4.10.2	Canceling INPUT command	3-23
4.11	Debug function	3-23
4.11.1	Executing a step	3-24
4.11.2	Skipping a step	3-24
4.11.3	Executing the next step	3-24
4.11.4	Break points	3-24
4.11.5	RUNTO	3-25
<hr/>		
5.	Origin return	3-26
5.1	Return-to-origin operation	3-27
5.2	Return-to-origin procedure	3-29
5.3	Absolute reset (mark method) procedure	3-30
5.4	Return-to-origin for all robots	3-33
<hr/>		
6.	Dual offset	3-34
6.1	Dual offset settings	3-34
6.1.1	Automatic dual offset setting	3-35
6.1.2	Adjusting dual offset	3-36
<hr/>		
Chapter 4 Edit		
1.	Point editing	4-1
1.1	Inputting/editing point data	4-3
1.2	Point data input by teaching	4-4
1.3	Point data input by direct teaching	4-6
1.4	Jumping point display	4-6
1.5	Copying point data	4-6
1.6	Deleting point data	4-7
1.7	Executing point trace	4-7
1.8	Deleting point name	4-7
<hr/>		
2.	Program editing	4-8
2.1	Selecting the program	4-9
2.2	Creating a new program	4-10
2.3	Editing the program	4-10
2.3.1	Cursor movement	4-11
2.3.2	Quitting program editing	4-11
2.3.3	Switching between the "insert" and "overwrite" modes	4-11
2.3.4	Inserting a line	4-12
2.3.5	Deleting one character	4-12
2.3.6	Backspace	4-12
2.3.7	Copying/cutting a program	4-12

2.3.8	Searching a character string	4-12
2.3.9	Jumping step	4-13
2.3.10	Checking entry data	4-13
2.4	Compiling sequence program	4-13
2.5	Setting a main program	4-14
2.6	Changing a program attribute	4-14
2.7	Deleting a program	4-15
2.8	Changing a program name	4-15
2.9	Copying a program	4-16
2.10	Resetting an alarm	4-16
3. Shift coordinates		4-17
3.1	Creating new shift coordinates	4-20
3.2	Editing shift coordinates	4-21
3.3	Setting shift coordinate 1	4-21
3.4	Setting shift coordinate 2	4-23
3.5	Selecting shift coordinates	4-24
4. Hand definitions		4-25
4.1	Data format of hand definition	4-26
4.1.1	SCARA type robots	4-27
4.2	"HAND EDIT"/"CREATING NEW HAND" screen	4-28
4.3	Creating new hand definitions	4-30
4.4	Editing hand definitions	4-31
4.5	Setting hand definitions	4-31
4.6	Selecting hand definitions	4-32
5. Work definitions		4-33
5.1	Data format of work definition	4-34
5.2	Creating new work definitions	4-34
5.3	Editing work definitions	4-35
5.4	Selecting work definitions	4-36
6. Pallet definitions		4-37
6.1	Creating new pallet definitions	4-39
6.2	Editing pallet definitions	4-40
6.3	Setting pallet definitions	4-40
6.4	Setting point of pallet definitions	4-41
7. Parameters		4-42
7.1	Parameter setting conditions	4-42
7.2	Setting the parameters	4-42
7.3	Parameter list	4-44

7.4	Parameter descriptions	4-47
7.4.1	Controller parameters	4-47
7.4.2	Robot parameters	4-49
7.4.3	Axis parameters	4-52
7.4.4	I/O parameters	4-58
7.4.5	Option board related parameters	4-60
7.5	PRM skip	4-64
<hr/>		
8.	Area check output	4-65
8.1	Setting area check output	4-65
8.2	Initializing area check output	4-66
8.3	Parameter list	4-67
<hr/>		
9.	Standard coordinates	4-68
9.1	Setting the standard coordinates by simple teaching	4-70
9.2	Setting the standard coordinate by 3-point teaching	4-72
9.3	Setting the standard coordinate by 4-point teaching	4-73
9.4	Setting the standard coordinate by both handed system teaching	4-75
<hr/>		
10.	General Ethernet port (GEP) setting	4-77
<hr/>		
Chapter 5 Controller system settings		
1.	Overview	5-1
<hr/>		
2.	History	5-1
<hr/>		
3.	Check	5-2
<hr/>		
4.	Property	5-2
4.1	Robot information	5-2
4.2	Option information	5-3
4.3	Clock	5-3
4.4	Version	5-3
4.5	Configuration	5-4
<hr/>		
5.	USB memory operation	5-4
5.1	Saving the data	5-4
5.2	Loading the data	5-5
<hr/>		
6.	Execution level	5-6
6.1	Changing access level	5-6
<hr/>		
7.	Safety setting	5-7

8. Initialize	5-8
8.1 Initializing data	5-8
8.2 Setting the clock	5-9

9. Generation	5-10
----------------------	-------------

Chapter 6 Monitor

1. Overview of function	6-1
--------------------------------	------------

2. Current position display	6-1
------------------------------------	------------

3. I/O status display	6-2
3.1 I/O monitor list	6-3
3.2 I/O monitor detail	6-4
3.3 Changing output status	6-4

4. Task driving state	6-5
------------------------------	------------

5. Current monitor	6-6
---------------------------	------------

Troubleshooting

1. When trouble occurs	A-1
<hr/>	
2. Acquiring the alarm information	A-2
2.1 Checking the alarm occurrence status	A-2
2.2 Checking the alarm history	A-2
<hr/>	
3. Troubleshooting checkpoints	A-3
3.1 Installation and power supply	A-3
3.2 Robot operation	A-4
3.3 I/O	A-5
<hr/>	
4. Alarm messages	A-6
[0] Operation messages	A-9
[1] System events	A-10
[2] Alarm related to the robot operation	A-12
[3] Alarm related to the program file operation	A-19
[4] Alarm related to the data input	A-21
[5] Alarm related to the syntax of the robot language (compile)	A-23
[6] Alarm related to the robot language execution	A-30
[9] Alarm related to the memory	A-39
[10] Alarm related to the environment and general hardware	A-43
[12] Alarm related to the option board	A-45
[14] Alarm related to the communication	A-53
[17] Alarm related to the motor control	A-55
[19] Alarm related to the YC-Link/E	A-62
[21] Serious alarm related to software	A-65
[22] Serious alarm related to hardware	A-66
[26] Alarm related to the gripper	A-68
[28] Alarm related to the driver I/F	A-72
<hr/>	
5. Warning number	A-74
[c] Warning	A-74
<hr/>	
6. Alarm messages related to the programming box	A-76

Warranty

The OMRON robot and/or related product you have purchased are warranted against the defects or malfunctions as described below.

■ Warranty description

If a failure or breakdown occurs due to defects in materials or workmanship in the genuine parts constituting this OMRON robot and/or related product within the warranty period, then OMRON shall supply free of charge the necessary replacement/ repair parts.

■ Warranty period

The warranty period ends 24 months after the date of manufacturing as shown on the products.

■ Exceptions to the warranty

This warranty will not apply in the following cases:

1. Fatigue arising due to the passage of time, natural wear and tear occurring during operation (natural fading of painted or plated surfaces, deterioration of parts subject to wear, etc.)
2. Minor natural phenomena that do not affect the capabilities of the robot and/or related product (noise from computers, motors, etc.)
3. Programs, point data and other internal data were changed or created by the user.

Failures resulting from the following causes are not covered by warranty.

1. Damage due to earthquakes, storms, floods, thunderbolt, fire or any other natural or man-made disaster.
2. Troubles caused by procedures prohibited in this manual.
3. Modifications to the robot and/or related product not approved by OMRON or OMRON sales representative.
4. Use of any other than genuine parts and specified grease and lubricant.
5. Incorrect or inadequate maintenance and inspection.
6. Repairs by other than authorized dealers.

WARRANTY

OMRON's exclusive warranty is that the products are free from defects in materials and workmanship for a period of one year (or other period if specified) from date of sale by OMRON. OMRON MAKES NO WARRANTY OR REPRESENTATION, EXPRESS OR IMPLIED, REGARDING NONINFRINGEMENT, MERCHANTABILITY, OR FITNESS FOR PARTICULAR PURPOSE OF THE PRODUCTS. ANY BUYER OR USER ACKNOWLEDGES THAT THE BUYER OR USER ALONE HAS DETERMINED THAT THE PRODUCTS WILL SUITABLY MEET THE REQUIREMENTS OF THEIR INTENDED USE. OMRON DISCLAIMS ALL OTHER WARRANTIES, EXPRESS OR IMPLIED.

LIMITATIONS OF LIABILITY

OMRON SHALL NOT BE RESPONSIBLE FOR SPECIAL, INDIRECT OR CONSEQUENTIAL DAMAGES, LOSS OF PROFITS OR COMMERCIAL LOSS IN ANY WAY CONNECTED WITH THE PRODUCTS, WHETHER SUCH CLAIM IS BASED ON CONTRACT, WARRANTY, NEGLIGENCE OR STRICT LIABILITY.

In no event shall the responsibility of OMRON for any act exceed the individual price of the product on which liability is asserted.

IN NO EVENT SHALL OMRON BE RESPONSIBLE FOR WARRANTY, REPAIR OR OTHER CLAIMS REGARDING THE PRODUCTS UNLESS OMRON'S ANALYSIS CONFIRMS THAT THE PRODUCTS WERE PROPERLY HANDLED, STORED, INSTALLED AND MAINTAINED AND NOT SUBJECT TO CONTAMINATION, ABUSE, MISUSE OR INAPPROPRIATE MODIFICATION OR REPAIR.

Important information before reading this manual

Introduction	i
About this manual	i

Safety precautions	ii
Signal symbols	ii

Overview of the YRCX	iii
-----------------------------	------------

Before using the robot controller (Be sure to read the following notes)	iv
--	-----------

Introduction

Our sincere thanks for your purchase of this OMRON robot controller.

Be sure to read this manual carefully as well as related manuals and comply with their instructions for using the OMRON robot controller safely and correctly.

About this manual

Warnings and cautions listed in this manual relate to OMRON robot controllers. To ensure safety of the user's final system that includes OMRON robots and controllers, please take appropriate safety measures as required by the user's individual system.

Industrial robots are highly programmable machines that provide a large degree of freedom in movement. To use OMRON robots and controllers safely and correctly, be sure to comply with the safety instructions and precautions described in this manual.

Failure to take necessary safety measures or incorrect handling may result not only in trouble or damage to the robot and controller, but also in serious accidents involving injury or death to personnel (robot installer, operator, or service personnel). Observe the precautions given in each Chapter.

To use OMRON robots and controllers safely and correctly, **first read "Safety Instructions" in this manual** and always comply with the safety rules and instructions.

Please note, however, this manual cannot cover all items regarding safety.

So it is extremely important that the operator or user have knowledge of safety and make correct decisions regarding safety.

Safety precautions

Warnings and cautions listed in this manual relate to OMRON robot controllers. To ensure safety of the user's final system that includes OMRON robots and controllers, please take appropriate safety measures as required by the user's individual system.

Industrial robots are highly programmable machines that provide a large degree of freedom in movement. To use OMRON robots and controllers safely and correctly, be sure to comply with the safety instructions and precautions described in this manual.

Failure to take necessary safety measures or incorrect handling may result not only in trouble or damage to the robot and controller, but also in serious accidents involving injury or death to personnel (robot installer, operator, or service personnel). Observe the precautions given in each Chapter.

To use OMRON robots and controllers safely and correctly, first read the separate volume "Safety Instructions" and always follow the safety rules and instructions.

Please note, however, this manual cannot cover all items regarding safety.

So it is extremely important that the operator or user have knowledge of safety and make correct decisions regarding safety.

Signal symbols

The following safety alert symbols and signal words are used to provide safety instructions that must be observed and to describe handling precautions, prohibited actions, and compulsory actions. Make sure to understand the meaning of each symbol and signal word and then read this manual.



DANGER

This indicates an immediately hazardous situation which, if not avoided, will result in death or serious injury.



WARNING

This indicates a potentially hazardous situation which, if not avoided, could result in death or serious injury.



CAUTION

This indicates a potentially hazardous situation which, if not avoided, could result in minor or moderate injury, or damage to the equipment.



NOTE

This indicates a supplementary explanation in the operation.

Overview of the YRCX

The OMRON YRCX robot controllers were developed based on years of OMRON experience and proven achievements in robotics and electronics. These controllers are specifically designed to operate OMRON industrial robots efficiently and accurately.

Despite their compact size, the YRCX controllers operate efficiently as multi-axis controllers with a variety of functions. Major features and functions are:

1. Multi-task function

Up to 16 tasks* can be executed simultaneously by specifying the priority. However, low priority tasks are halted while high priority tasks are running.

Programs are processed in parallel to efficiently perform various operations. Additionally, the operation efficiency of the total robot system including peripheral units is greatly improved.

*Refer to "Multi-tasking" in the YRCX programming manual for more details on tasks.

2. Robot language

The YRCX series controller comes with a BASIC-like high-level robot language that conforms to the industrial robot programming language SLIM*. This robot language allows easy programming even of complex movements such as multi-task operations.

*Standard Language for Industrial Manipulators

3. Robot control

Up to four robots can be controlled.

Versatile motion functions are incorporated and these functions can be executed by multiple robots.

4. Applicable robots

Software servo control provides unit standardization.

The YRCX can be connected to almost all OMRON SCARA robots.

5. CE marking

The YRCX series robot controller is designed to conform to machinery directives and EMC (Electromagnetic compatibility) directives as a OMRON robot series product.

For details about CE marking compliance, refer to the "Safety standards application guide". Additionally, to make the system applicable to the CE marking, select the YRCX CE specifications.

This manual explains how to handle and operate the OMRON robot controllers correctly and effectively, as well as I/O interface connections.

Read this manual carefully before installing and using the robot controller.

Also refer to the separate YRCX programming manual and robot user's manual as needed.

Before using the robot controller (Be sure to read the following notes)

Please be sure to perform the following tasks before using the robot controller. Failing to perform these tasks will require the return-to-origin for setting the origin position each time the power is turned on or may cause abnormal operation (vibration, noise).

[1] When connecting the power supply to the robot controller

Always make a secure connection to the ground terminal on the robot controller to ensure safety and prevent malfunctions due to noise.

TIP

Refer to the user's manual for detailed information.

[2] When connecting the battery cable to the robot controller

The absolute battery connector has not been connected to the controller at shipment to prevent discharge. After installing the controller, be sure to connect the absolute battery connector while referring to the relevant section in the YRCX user's manual before connecting the robot connection cable.

An error is always issued and the origin position cannot be detected if the robot controller power is turned on without connecting the absolute batteries. This means the robot connected to this controller cannot be used with absolute specifications.

[3] When connecting robot cables to the robot controller

Be sure to keep robot cables separate from the robot controller power connection lines and other equipment power lines. Using in close contact with lines carrying power may cause malfunctions or abnormal operation.

TIP

Performing return-to-origin is always required when the robot controller power is first turned on after connecting the robot cable to the robot controller. Refer to "5. Origin return" in Chapter 3.

Additionally, when the robot connection cable is disconnected from the controller and connected again, it is also required to perform return-to-origin.

[4] Setting the maximum speed

When operating a ball screw driven robot, the ball screw's free length will increase as the movement stroke increases, and the resonant frequency will drop. This may cause the ball screw to resonate and vibrate severely depending on the motor rotation speed. (The speed at which resonance occurs is called the critical speed.)

To prevent this resonance, the maximum speed must be reduced depending on the robot model when the movement stroke increases.



CAUTION

Continuous operation while the ball screw is resonating may cause the ball screw to wear out prematurely.

[5] Duty

To lengthen the service life of robots, the robots must be operated within the allowable duty (50%).

The duty is calculated as follows:

$$\text{Duty (\%)} = \frac{\text{Operation time}}{\text{Operation time} + \text{Non-operation time}} \times 100$$

If the robot duty is too high, an error such as "overload" or "overheat" occurs. In this case, increase the non-operation time to reduce the duty.

Chapter 1 Using the robot safely

1. Emergency action when a person is caught by robot	1-1
2. Emergency stop	1-3
2.1 Emergency stop release and alarm reset	1-3
3. Power-ON procedures	1-5
4. Usage environments	1-6

1. Emergency action when a person is caught by robot

If a person should get caught between the robot and mechanical part such as the installation base, or get captured by the robot, free the person by following the instructions below.

1. For axis not equipped with a brake

Put the robot into the emergency stop status to shut off the motor power to the robot. Then move the axis by pushing it with hands.

2. For axis equipped with a brake

Although the power to the robot can be shut off by putting the controller into the emergency stop status, the axis cannot be moved due to the action of the brake. Release the brake by following the procedure below, then move the axis by pushing it with hands.



WARNING

The vertical axis of the vertical use robot will slide down when the brake is released, causing a hazardous situation.

- Prop up the vertical axis with a support stand before releasing the brake.
- Be careful not to let your body get caught between the vertical axis and the support stand when releasing the brake.

Step 1 Press on the programming box to display the "QUICK MENU" screen.

▶ **Step 1** "QUICK MENU" screen



Step 2 Use the cursor keys (⬅️/➡️) to select [Servo Operation], and then press .

The screen will change to the "SERVO OPERATION (ALL)" screen.

▶ **Step 2** "SERVO OPERATION (ALL)" screen



Step 3 Press (SEP) on the "SERVO OPERATION (ALL)" screen.

The screen will change to the "SERVO OPERATION (SEP)" screen.

▶ **Step 4** "SERVO OPERATION (SEP)" screen



Step 4 On the "SERVO OPERATION (SEP)" screen, select the axis to release the brake or select [FREE] for all axes with the cursor keys (⬅️/➡️/⬆️/⬇️), and then press .

The brake release confirmation screen will appear.

Step 5 Use the cursor keys (◀/▶) to select [OK] and press  to release the brake.

For the vertical axis, when the brake is released, the vertical axis may drop. Therefore, check that the vertical axis is supported by the table, etc., and then release the brake. To apply the brake again, select (OFF) on the "SERVO OPERATION" screen.

▶ **Step 5** Brake release confirmation screen



2. Emergency stop

To stop the robot immediately in case of emergency during operation, press the emergency stop button on the programming box.

Pressing the emergency stop button cuts off power to the robot.



CAUTION

In addition to the emergency stop button on the programming box, the SAFETY connector has terminals for external dedicated input (emergency stop). Refer to "SAFETY I/O interface" in the YRCX user's manual for details.

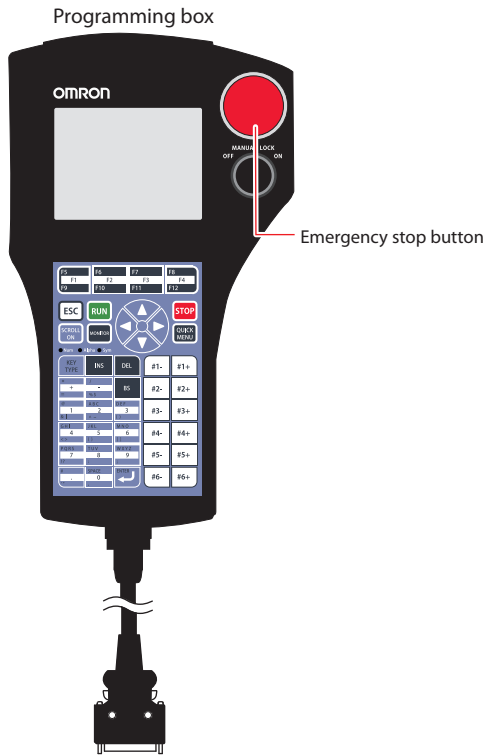

2.1 Emergency stop release and alarm reset

To return to normal operation after emergency stop, release the emergency stop button and reset the alarm.



NOTE

- Emergency stop can also be triggered by an emergency stop input from the SAFETY I/O interface. To release the emergency stop, refer to "SAFETY I/O interface" in the YRCX user's manual.
- Origin positions are retained even when emergency stop is triggered, therefore the robot can be restarted by releasing emergency stop without absolute reset or return-to-origin operation.

Step 1 Turn the emergency stop button clockwise to release the emergency stop status.

Step 2 Reset the alarm.

Press **QUICK MENU** on the programming box. The "QUICK MENU" screen will appear. Use the cursor keys (▲/▼) to select (Alarm Reset), and then press **ENTER**. The confirmation pop-up screen will appear. Use the cursor keys (▲/▼) to select (YES), and then press **ENTER**. The alarm status is then reset.

NOTE
The serious alarm cannot be reset. In this case, it is necessary to turn off the controller power, and then turn it on again.

To turn on the motor power, follow the Steps below.

Step 3 Display the "SERVO OPERATION (ALL)" screen.

Press **QUICK MENU** on the programming box. The "QUICK MENU" screen will appear. Use the cursor keys (▲/▼) to select (Servo Operation), and then press **ENTER**.

Step 4 Turn on the motor power and servo.

Use the cursor keys (▲/▼) to select (ON), and then press **ENTER** to turn on the servo.

NOTE
Select (ON) on the "SERVO OPERATION (ALL)" screen using the cursor keys and press the ENTER key to turn on the servo of all the robot axes connected to the controller. To avoid turning the servo on of all axes, select "POWER" using the cursor keys and press the ENTER key to turn on the motor. Press the F1 key (SEP) to display "SERVO OPERATION (SEP)" screen. Select (ON) of the axis to turn the servo on or all axes and press the ENTER key to turn the servo on. Refer to "1. Servo operation" in Chapter 3 for details about servo on operation.

Step 5 Press **ESC** to return to the initial screen.

Step 2 "QUICK MENU" screen



Step 2 Alarm reset confirmation screen



Step 3 "QUICK MENU" screen



Step 4 "SERVO OPERATION (ALL)" screen



3. Power-ON procedures

This section describes the procedures from turning on the controller power to performing return-to-origin of the robot.



CAUTION

To connect the programming box to the controller, always use the dedicated cable and connector that come supplied with the programming box. Do not modify the cable and do not connect a relay to the cable.



NOTE

- After turning off the robot controller, wait at least 5 seconds until turning the power back on again. If power is turned on again too quickly after the power was turned off, the controller might not start up correctly.
- Do not turn off the robot controller during program execution. Doing so may cause errors in the internal system data and the program may not restart correctly when the power is again turned on. Always quit or stop the program before turning off the robot controller.
- When the "Servo on when power on" parameter is set to "INVALID", the controller always starts with the robot servo turned off when power is turned on, regardless of serial I/O settings. Refer to the YRCX user's manual for details.

Step 1 Check the setup and connections.

Make sure that the necessary setup and connections are correctly completed according to the instructions in the YRCX user's manual.

Step 2 Activate emergency stop.

Press the emergency stop button on the programming box to activate emergency stop.

Step 3 Turn on the power.

The power is supplied to the power terminal on the front panel of the controller. The "PWR" LED and 7-segment LED are lit and the initial screen appears on the programming box. (It takes maximum 7 seconds to start the controller correctly after the "PWR" LED has been lit.)

Step 4 Release emergency stop status.

Turn the emergency stop button on the programming box clockwise to release emergency stop status.

Step 5 Turn on the servo.

Refer to "1. Servo operation" in Chapter 3 for details about servo on operation.

Step 6 Perform return-to-origin.

Refer to "5. Origin return" in Chapter 3 for details on return-to-origin.



NOTE

If the warning message "c50: Memory backup battery low" appears when turning on the power, replace the lithium battery (service life is about 4 years) inside the controller. Refer to the YRCX user's manual for details about replacing the memory battery.

4. Usage environments

Operating temperature

Operating temperature	0°C to 40°C
-----------------------	-------------

The ambient temperature should be maintained within a range of 0 to 40°C during operation.

This is the range in which continuous operation of the robot controller is guaranteed according to the initial specifications. If the robot controller is installed in a narrow space, then heat generated from the controller itself and from peripheral equipment may drive the temperature above the allowable operating temperature range.

This may result in thermal runaway or malfunctions and may lower component performance along with shortening their useful service life. So be sure to install the controller in locations with a vent having a natural air flow. If this proves insufficient, provide forced air-cooling.

Storage temperature

Storage temperature	-10°C to 65°C
---------------------	---------------

The controller should be stored in a location at an ambient temperature between -10 and +65°C when not being used. If the robot controller is stored in a location at high temperatures for extended periods, deterioration of the electronic components may occur and the memory backup time may decrease.

Operating humidity

Operating humidity	35% to 85% RH (no condensation)
--------------------	---------------------------------

The ambient humidity of the robot controller should be 35% to 85% RH (no condensation) in order to guarantee continuous operation within the initial specifications. Installing the robot controller inside an air-conditioned or cooling unit is recommended when the ambient humidity is higher than 85% or when condensation occurs.

Storage humidity

Storage humidity	Below 95% RH (no condensation)
------------------	--------------------------------

The controller should be stored in a location at an ambient humidity below 95% RH (no condensation) when not being used. If the robot controller is stored in a location at high humidity for an extended period of time, rust may form on the electronic components.

Vibration and shock

Do not apply strong shocks to the controller. Do not install the controller in locations subject to large vibrations or shocks. The controller may malfunction or break down if subjected to large vibrations or shocks.

Environments

The controller is not designed to meet explosion-proof, dust-proof, and drip-proof specifications, and so do not use it in the following locations. If used in these locations, component corrosion, improper installation, or fire may result.

- 1) Environments containing combustible gases or dust particles, or flammable liquids, etc.
- 2) Environments where conductive substances such as metal cutting chips are present.
- 3) Environments where water, cutting water, oils, dust, metal particles, or organic solvents are present.
- 4) Environments containing corrosive gases or substances such as acid or alkali.
- 5) Environments containing mist such as cutting fluids or grinding fluids.
- 6) Environment containing silicon gas that leads to contact failure of the electrical contact point.

If using the controller in locations where dust particles of gases may generate, it is recommended to install the controller in a box with a cooling unit.

Installation location

Always install the robot controller indoors, at a height of less than 2000 meters above sea level.

Install the controller in a control panel with a structure that does not allow water, oil, carbon or dust particles to penetrate it. Do not install the controller in the following locations:

- 1) Near devices which may be a source of electrical noise, such as large inverters, high output high-frequency generators, large contactors, and welding machines.
- 2) Locations where electrostatic noise is generated.
- 3) Locations subject to radio frequency interference.
- 4) Locations where there is a possibility of exposure to radioactivity.
- 5) Locations where dangerous items such as ignitable, flammable or explosive materials are present.
- 6) Near combustible materials.
- 7) Environments exposed to direct sunlight.
- 8) Narrow space where tasks (teaching, inspections, etc.) cannot be performed safely.

Chapter 2 System overview

1. Operation overview	2-1
<hr/>	
2. The YRCX robot controller	2-2
2.1 External device connectors	2-2
2.2 7-segment LED display function	2-3
<hr/>	
3. Programming box	2-4
3.1 Part names and functions	2-4
3.2 Connection to the robot controller	2-5
3.3 Programming box screen	2-5
<hr/>	
4. Operation key	2-6
4.1 Operation key layout	2-6
4.2 Basic key operation	2-6
4.3 Function keys	2-7
4.4 Control keys	2-8
4.5 Data keys	2-9
4.6 Other keys	2-9
<hr/>	
5. Hierarchy structure	2-9
5.1 Basic hierarchies	2-9
5.2 Quick menu	2-10
5.3 Selecting hierarchy and menu	2-14

1. Operation overview

The controller configuration and main functions are shown below.
Set up the equipment as needed according to the operation to be performed.



NOTE
The external circuit connected to the robot controller should be prepared by the user.

■ Operation overview

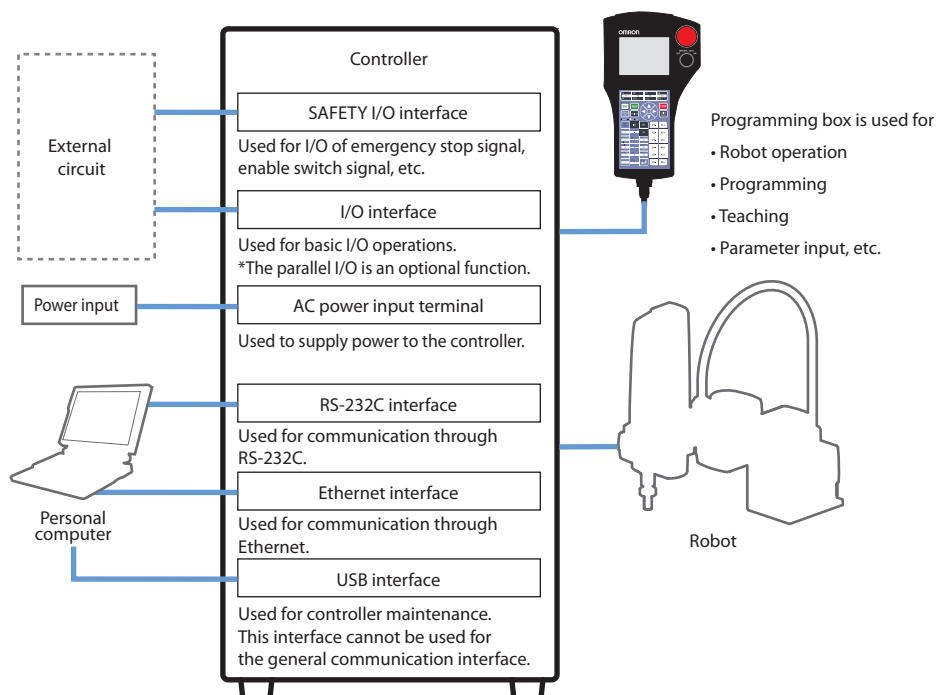

This manual mainly explains how to operate the programming box.
For other functions such as the SAFETY I/O interface, refer to the YRCX user's manual.

2. The YRCX robot controller

The illustration below shows the controller's main display functions and connectors to external devices.

■ Controller front panel

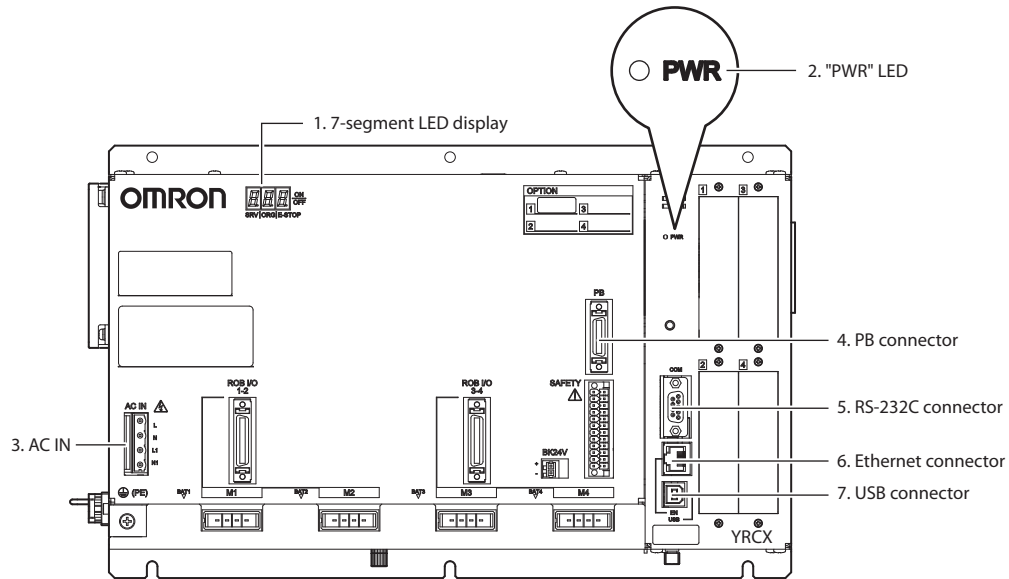

2.1 External device connectors

	Name	Function
1	7-segment LED display	Displays the controller status. For details, refer to "2.2 7-segment LED display function" in this Chapter.
2	"PWR" LED	Lights up when the power is turned on.
3	AC IN	Supplies the AC power to the controller.
4	PB connector	Connects the programming box.
5	RS-232C connector	Connects an external device through the RS-232C interface. The terminal is D-SUB 9P (female).
6	Ethernet connector	Connects an external device through the Ethernet interface.
7	USB connector for maintenance	Used for controller maintenance. *This interface cannot be used for the general communication interface.

2.2 7-segment LED display function

• In normal status

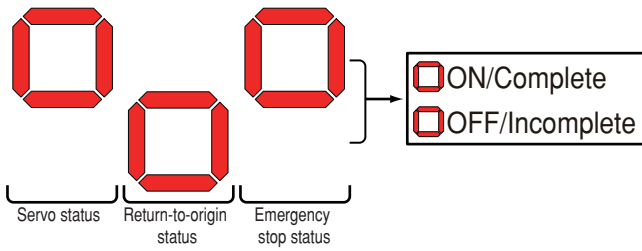

• When alarm/warning occurs.

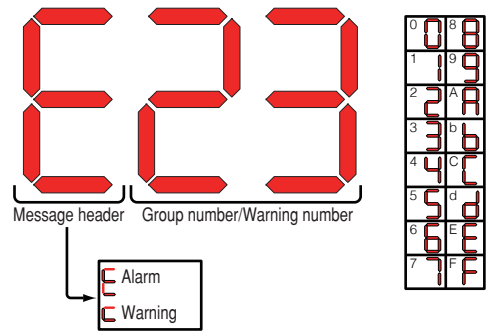

Normally, the servo status, return-to-origin status, and emergency stop status are displayed. If an alarm or warning occurs, the alarm number or warning number is displayed.

• Servo on, return-to-origin complete, emergency stop released	
• Servo off, return-to-origin incomplete, emergency stop	
• Servo off, return-to-origin incomplete, emergency stop released	
• Servo off, return-to-origin complete, emergency stop	
• Alarm occurs. "E+ alarm group number" and "alarm classification number" are displayed alternately.	
• Warning occurs. If a warning occurs, "C+ warning number" is displayed for 2 seconds. After that, the warning number and normal status are displayed alternately at intervals of 1 second.	
• Display during program operation	
• HELLO display scrolls at startup.	
• bYE is displayed at power shutdown.	

3. Programming box

The programming box connects to the controller and is used to edit and execute robot programs.

3.1 Part names and functions

■ Programming box

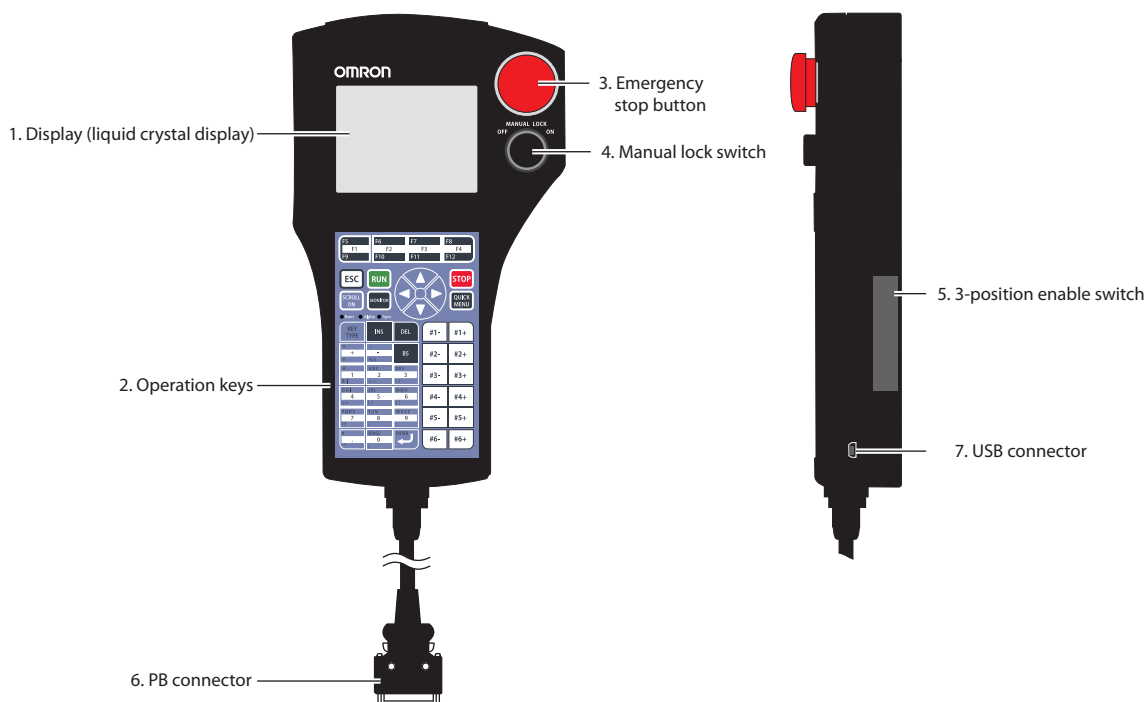

	Name	Function
1	Display	This is a liquid crystal display (LCD), showing various types of information.
2	Operation keys	Use these keys to operate the robot or edit any data. These are grouped into three types: function/ control/ data
3	Emergency stop button	Pressing this button during operation immediately stops robot operation. This is a normally closed, self-lock switch. • PB emergency stop button Manufacturer: IDEC Corporation Type number: XA 1E-BV302R
4	Manual lock switch	Switches the controller operation mode between AUTO and MANUAL. To execute the automatic operation (AUTO), it is necessary to set the manual lock switch at "OFF". To operate the robot manually during teaching work, it is necessary to set the manual lock switch at "ON". (For details about executable operations in each mode, refer to "5.2 Quick menu" in this Chapter.)
5	3-position enable switch	This switch is provided for safety. Pressing it to mid-position only allows robot operation. To use this switch function, the safety circuit must be connected to the SAFETY connector. For the connection to the safety circuit, refer to the YRCX user's manual. Switch is released : Emergency stop Switch is pressed to mid position : Operation possible Switch is fully pressed : Emergency stop Manufacturer: OMRON Type number: A4E-B200HS
6	PB connector	Use this connector to connect the programming box to the robot controller.
7	USB connector	Connects the USB memory and programming box. This connector is used for saving of various controller data and the maintenance of the programming box.

3.2 Connection to the robot controller

Connect the programming box to the PB connector on the front panel of the controller. Make sure that the cable is securely connected since poor connections may cause malfunction or breakdown.

CAUTION Emergency stop is triggered and the servo turns off when the programming box is disconnected from the controller while the controller power is on.

■ Connection to controller

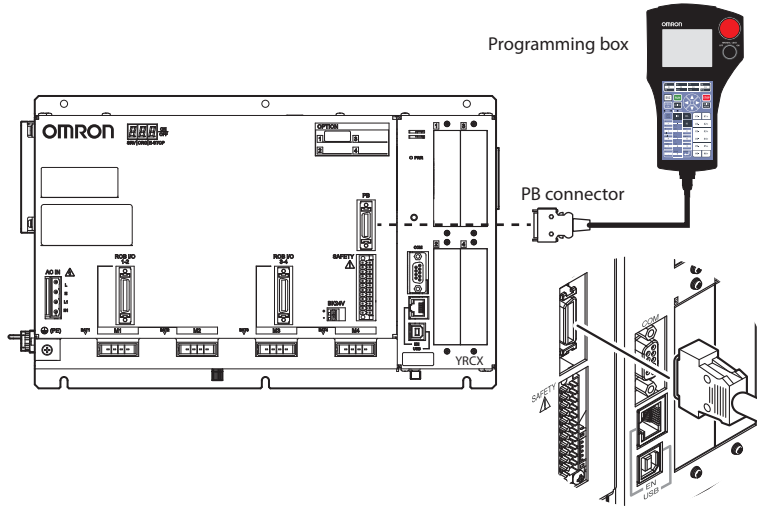

3.3 Programming box screen

The screen of the programming box is composed of three areas as shown below

■ Example of programming box screen



1. System line (top line)

The current hierarchy is displayed on the left. The figure above shows the "SERVO OPERATION" screen. Additionally, the set robot or hand, and controller status are displayed on the right.

S : 1 . . . Specified "shift coordinate" number

H : 1 . . . Specified "hand definition" number

RBT : 1 . . . Specified "robot number"

SPD : 30 . . . Specified speed

ALM . . . Displayed when any alarm occurs.

SRV . . . Displayed when the servo is on.

AUTO . . . Displayed when the control setting is "RELEASE".

(This is not displayed when the setting is "GET" or the operation is in MANUAL mode.)

SEQ . . . Displayed when the sequence program is executed.

2. Data area

This area shows various data or edit contents. Scrolling the area left or right will display up to 255 characters/line.

3. Guide line (bottom line)

The bottom line mainly shows the contents assigned to the programming box function keys.

4. Operation key

4.1 Operation key layout

The operation keys are covered with a plastic sheet to prevent dust. There are 3 types of keys: function keys, control keys, and data keys. LED displays show selected key types.

■ Operation key layout

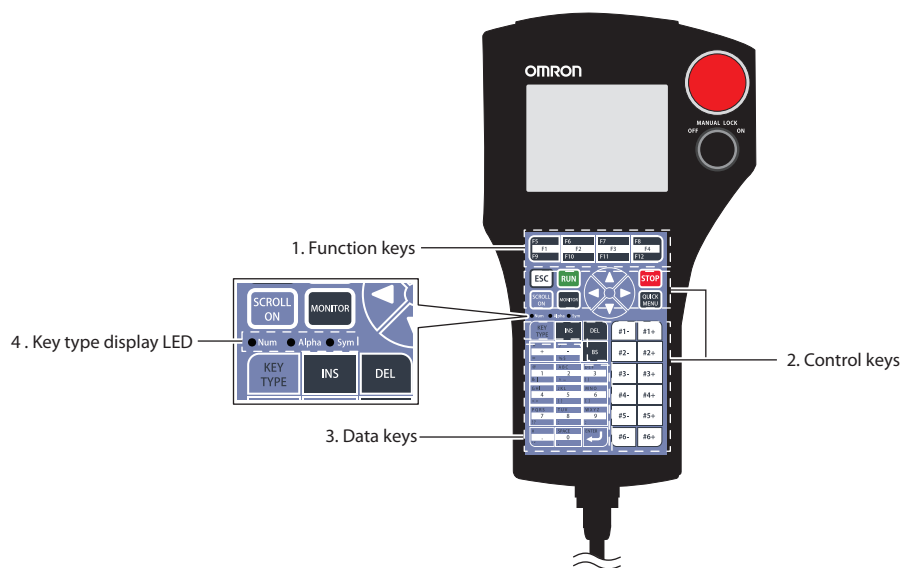

4.2 Basic key operation

Each key can perform three different inputs according to the key type setting as shown in the figure below.

Key type configuration

Alpha	JKL	Alpha	F5	Alpha: Alphabet entry
Num	5	Num	F1	Num: Number entry
Sym	{ }	Sym	F9	Sym: Symbol entry

How to select the key type

When pressing this key, key types switch over in turn.

KEY TYPE Num (Number) → Alpha (Alphabet) → Sym (Symbol)

Additionally, the LED for the selected key type is lit.

Example of key input

Input key	Character type	Description	Input data
ABC	Alpha (Alphabet)	Shift 1: When pressing the key in the key type Alpha status, the display at the upper portion of the key is input.	"A", "B", "C" *1
2	Num (Number)	Shift 2: When pressing the key in the key type Num status, the display at the middle portion of the key is input.	"2"
^ ~	Sym (Symbol)	Shift 3: When pressing the key in the key type Sym status, the display at the lower portion of the key is input.	"^", "to" *2

*1 Every time the input key is pressed, the data changes like "A" → "B" → "C".

*2 Every time the input key is pressed, the data changes like "^" → "to".

4.3 Function keys

To operate the programming box, select the submenus by pressing the function keys. If there are five or more submenus, change the key type. When changing the key type, the submenu display will change.

For example, the relationship between the key type and submenu display on the "DI MONITOR 1" screen is as follows.

■ Example of key type and submenu correspondence

- Key type is "Num".

PORT	BIT	7	6	5	4	3	2	1	0
DI 0		○	○	○	○	○	○	○	○
DI 1		○	○	○	○	○	○	○	○
DI 2		○	○	○	○	○	○	○	○
DI 3		○	○	○	○	○	○	○	○
DI 4		○	○	○	○	○	○	○	○
DI 5		○	○	○	○	○	○	○	○
DI 6		○	○	○	○	○	○	○	○
DI 7		○	○	○	○	○	○	○	○

1 | DETAIL | DI | DO | MO |

- Key type is "Alpha".

LO	TO	SI	SO
----	----	----	----

- Key type is "Sym".

SIW	SOW		
-----	-----	--	--



NOTE

In the subsequent descriptions;



Describing "F5 to F8" means that the key type is set at "Alpha" and "F1 to F4" is pressed.

Describing "F9 to F12" means that the key type is set at "Sym" and "F1 to F4" is pressed.





4.4 Control keys

There are four kinds of control keys; Hierarchy move keys, Cursor keys, Edit keys, and Jog keys. The functions of each key are explained below.



1. Hierarchy move keys

-  : Displays the "QUICK MENU" screen.
-  : Displays the next port while the "MONITOR" screen is displayed.
-  : Returns to the previous screen or initial screen.















2. Cursor keys

-  : Switches the scroll function between valid and invalid.
-  : Moves up the cursor.
Moves up the white frame when the cursor is not displayed.
Data area display scrolls one screen up when the scroll function is on.
-  : Moves down the cursor.
Moves down the white frame when the cursor is not displayed.
Data area display scrolls one screen down when the scroll function is on.
-  : Moves the cursor left.
Moves the white frame left when the cursor is not displayed.
Data area display scrolls one screen left when the scroll function is on.
-  : Moves the cursor right.
Moves the white frame right when the cursor is not displayed.
Data area display scrolls one screen right when the scroll function is on.

3. Edit keys

-  : Toggles between "Insert" and "Overwrite" modes.
The cursor "█" appears in "Overwrite" mode and " | " appears in "Insert" mode.
-  : Deletes one character left of the cursor position.
-  : Deletes one character at the cursor position or clears the numeric value before setting.

4. Jog keys

-  : Starts automatic operation.
This key is valid only during AUTO mode, point trace or performing return-to-origin.
-  : Stops automatic operation.
This key is valid during program execution, point trace execution, or return-to-origin operation.
-  : Moves axis 1 in the + direction or the SCARA type robot in the +X direction on the XY coordinates.
-  : Moves axis 1 in the - direction or the SCARA type robot in the -X direction on the XY coordinates.
-  : Moves axis 2 in the + direction or the SCARA type robot in the +Y direction on the XY coordinates.
-  : Moves axis 2 in the - direction or the SCARA type robot in the -Y direction on the XY coordinates.
-  : Moves axis 3 in the + direction.
-  : Moves axis 3 in the - direction.
-  : Moves axis 4 in the + direction.
-  : Moves axis 4 in the - direction.
-  : Moves axis 5 in the + direction
-  : Moves axis 5 in the - direction.
-  : Moves axis 6 in the + direction.
-  : Moves axis 6 in the - direction.

**NOTE**

The #1+ to #6- keys are hereafter called the "Jog keys". They are enabled when Jog movement can be operated.

**CAUTION**

Axis 1 of the robot may not match to the X-axis on the XY coordinates depending on the robot setting.

4.5 Data keys

The data keys are used for input data, creating programs, and editing data.

They can input numbers, alphabetic characters, and symbols according to the key type setting.

*	/	
+	-	
=	% S	
@	ABC	DEF
1	2	3
&	^ ~	()
GHI	JKL	MNO
4	5	6
<>	{ }	[]
PQRS	TUV	WXYZ
7	8	9
!?	:	;
#	SPACE	
.	0	
"/	,	

4.6 Other keys

ENTER key

: When the cursor is displayed, pressing this key completes the data input on the cursor line. When the item is selected on the screen, pressing this key will make the setting.

5. Hierarchy structure

The hierarchy structure is shown below.

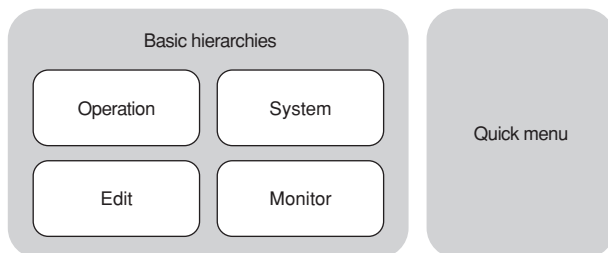

The controller functions are mainly classified into four hierarchies.

1. Operation
2. Edit
3. System
4. Monitor

In addition to the four hierarchies shown above, you can directly move to a specific screen from the "QUICK MENU" screen.

5.1 Basic hierarchies

1. Operation

The robot operations, such as program operation execution, Jog operation, and return-to-origin can be operated.

2. Edit

Various data, such as point data, program, and parameter can be edited.

3. System

The robot setting or data can be initialized or data can be saved into an external memory. Additionally, the robot system information or alarm log can also be checked in this hierarchy.

4. Monitor

The current position information or I/O status is displayed.

5.2 Quick menu

When pressing , the "QUICK MENU" screen will appear.

The "QUICK MENU" screen is shown below. Use the cursor keys to select a menu, and then press the ENTER key. The screen for the selected menu will appear.

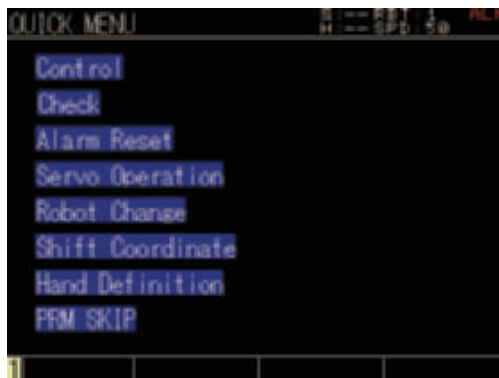

1. Control

When the manual lock switch is set at OFF, the control setting is changed to the programming box or external device.

To give the control authority to the programming box, select [GET] and press the ENTER key. To give the control authority to an external device, select [RELEASE] and press the ENTER key.

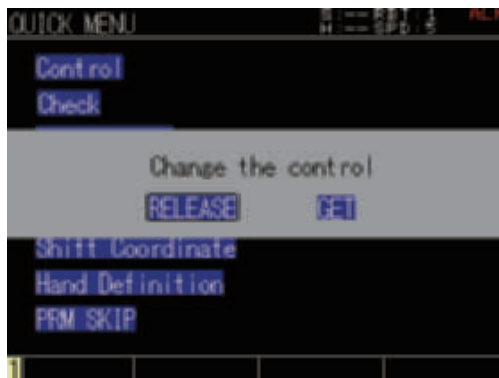

The following shows the operations that can be performed according to the manual lock switch and control setting status.

			CE Specifications				Normal specifications			
SAFETY connector AUTO mode input			OFF		ON		-			
Manual lock switch			ON	OFF	ON	OFF		ON	OFF	
Control setting			-	-	-	PBEX (GET)	External device (RELEASE)	-	PBEX (GET)	External device (RELEASE)
Mode			Manual	-	Automatic		Manual	Automatic		
PBEX Operation	Operation	Jog	✓	WARNING	-	-	✓	-	-	
		Point Trace	✓		-	-	✓	-	-	
		Automatic Operation	✓		✓	-	✓	✓	-	
		Origin Return	✓		✓	-	✓	✓	-	
		Robot Change	✓		✓	✓	✓	✓	✓	
		Servo Operation	✓		✓	-	✓	✓	-	
	Edit	Point Edit	✓	WARNING	*	-	✓	*	-	
		Program Edit	✓		✓	-	✓	-		
		Shift Coordinate	✓		✓	-	✓	-		
		Hand Definition	✓		✓	-	✓	-		
		Pallet Definition	✓		✓	-	✓	-		
		Parameter	✓		✓	-	✓	-		
		Area Check Output	✓		✓	-	✓	-		
		Standard Coordinate	✓		✓	-	✓	-		
		GEP Setting	✓		✓	-	✓	-		
		Calibration	✓		✓	-	✓	-		
	System	History	✓	WARNING	✓	✓	✓	✓	✓	
		Check	✓		✓	✓	✓	✓		
		Property	✓		✓	✓	✓	✓		
		USB Memory Operation	✓		✓	*	✓	✓	*	
		Execution Level	✓		✓	-	✓	✓	-	
		Safety Setting	✓		✓	-	✓	✓	-	
		Communication Setting	✓		✓	-	✓	✓	-	
		Initialize	✓		✓	-	✓	✓	-	
	Generation	✓	✓	-	✓	✓	-			
	Monitor	IO	✓	WARNING	✓	✓	✓	✓	✓	
		Task Driving State	✓		✓	✓	✓	✓		
		Current Monitor	✓		✓	✓	✓	✓		
Current Position		✓	✓		✓	✓	✓			
Gripper State		✓	✓		✓	✓	✓			
Tracking Monitor		✓	✓		✓	✓	✓			
External Device Operation	Operation	Jog	-	WARNING	-	✓	✓	-	✓	
		Point Trace	-		-	✓	✓	-	✓	
		Automatic Operation	-		-	✓	✓	-	✓	
		Origin Return	-		-	✓	✓	-	✓	
		Robot Change	✓		✓	✓	✓	✓	✓	
		Servo Operation	-		-	✓	✓	-	✓	
	Edit	Program Edit	-	WARNING	-	✓	✓	-	✓	
		Point Edit	-		-	✓	✓	-	✓	
		Shift Coordinate	-		-	✓	✓	-	✓	
		Hand Definition	-		-	✓	✓	-	✓	
		Pallet Definition	-		-	✓	✓	-	✓	
		Parameter	-		-	✓	✓	✓	✓	
		Area Check Output	-		-	✓	✓	-	✓	
		Standard Coordinate	-		-	✓	✓	-	✓	
GEP Setting	-	-	✓	✓	-	✓				
Calibration	-	-	✓	✓	-	✓				

			CE Specifications				Normal specifications			
SAFETY connector AUTO mode input			OFF		ON		-			
Manual lock switch			ON	OFF	ON	OFF		ON	OFF	
Control setting			-	-	-	PBEX (GET)	External device (RELEASE)	-	PBEX (GET)	External device (RELEASE)
Mode			Manual	-	Automatic		Manual	Automatic		
External Device Operation	System	History	✓	WARNING	✓	✓	✓	✓	✓	
		Check	✓		✓	✓	✓	✓		
		Property	✓		✓	✓	✓	✓		
		USB Memory Operation	-		-	✓	-	✓		
		Execution Level	-		-	✓	-	✓		
		Safety Setting	-		-	✓	-	✓		
		Communication Setting	-		-	✓	-	✓		
		Initialize	-		-	✓	-	✓		
		Generation	-		-	✓	-	✓		
	Monitor	IO	✓	WARNING	✓	✓	✓	✓	✓	
		Task driving state	✓		✓	✓	✓	✓		
		Current Monitor	✓		✓	✓	✓	✓		
		Current Position	✓		✓	✓	✓	✓		
		Gripper State	✓		✓	✓	✓	✓		
Tracking Monitor		✓	✓		✓	✓	✓			

(NOTE) Each notation in the tables means;

✓: The operation can be performed. *: The function is partly limited.

-: The operation cannot be performed. In this case, even though the parameters or points can be checked, the parameter editing or setting change cannot be made when the access level is set at "1: Operator level".

2. Check

The controller is diagnosed and if an error is detected, the alarm number and occurrence location will appear. For details, refer to "3. Check" in Chapter 5.

"Check" screen

No.	RESULT
1	20.500:C10V
2	
3	
4	
5	
6	
7	
8	

3. Alarm Reset

Select [YES] and press the ENTER key to execute alarm reset.

Confirming the alarm reset execution

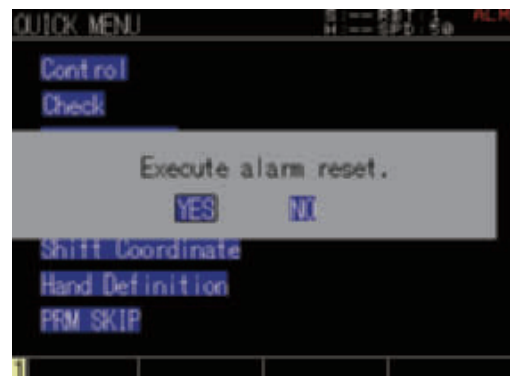

4. Servo Operation

Operates the servo status.

For details, refer to "1. Servo operation" in Chapter 3.

"SERVO OPERATION (ALL)" screen

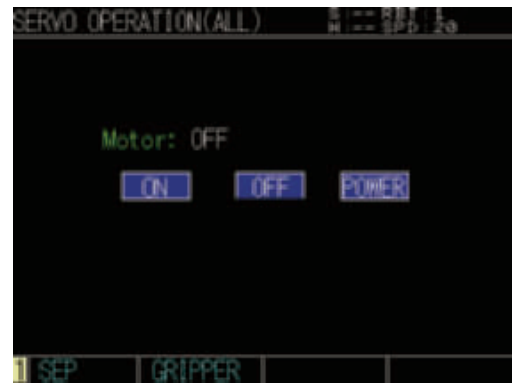

5. Robot Change

Input the robot number to select and press the ENTER key.

Press the F1 key (ARM TYPE) to change the hand system.

"ROBOT CHANGE" screen

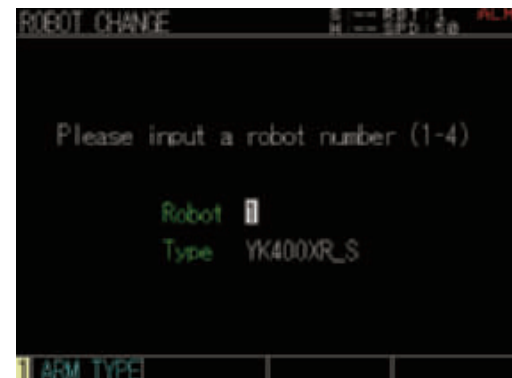

6. Shift Coordinate

Sets the shift coordinates.

For details, refer to "3. Shift coordinates" in Chapter 4.

"SHIFT COORDINATE" screen



7. Hand Definition

Sets the hand definitions.

For details, refer to "4. Hand definitions" in Chapter 4.

"HAND DEFINITION" screen



8. PRM SKIP

Input "0: INVALID" or "1: VALID" and press the ENTER key.

"PRM SKIP" screen

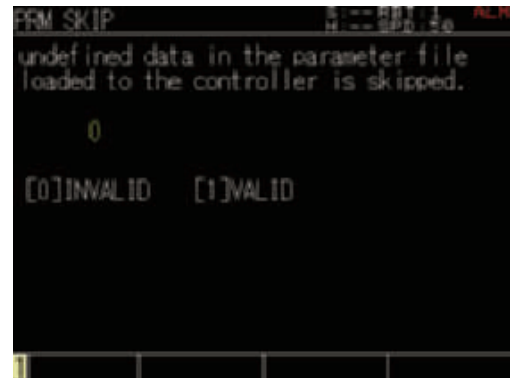

5.3 Selecting hierarchy and menu

The robot operation is mainly performed by selecting an objective hierarchy from the hierarchy menu. (Refer to the "Hierarchy diagram" described later.) To select the menu, use the cursor keys.

When turning on the controller power, the initial screen (menu screen) will appear. The menu screen located at the uppermost position of the hierarchy menu.

■ Initial screen (MENU)

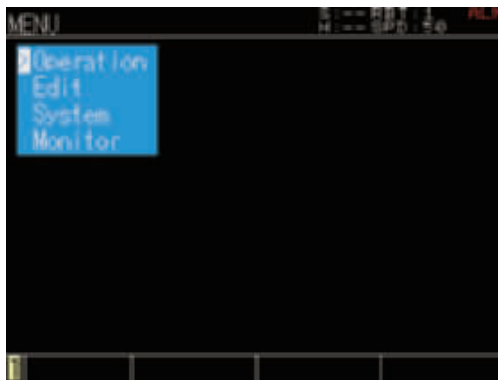

Use the cursor keys to select a hierarchy and press the ENTER key. Relevant hierarchy menu will appear. For example, when selecting [Edit] on the initial screen, the Edit menu will appear.

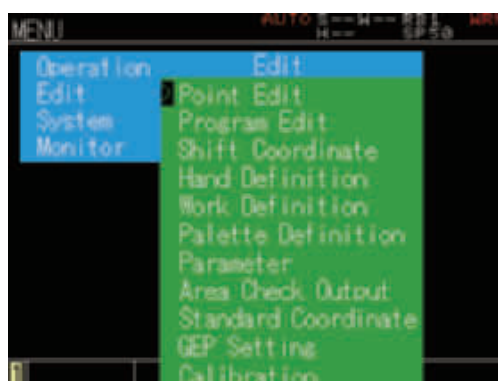

To move to the lower hierarchy, select the menu with the cursor keys in the same manner as described above. Press the ESC key to return to the initial screen.



NOTE

In the subsequent descriptions, the hierarchy status is expressed as follows.
First (top) hierarchy → Second hierarchy → Third hierarchy → Fourth hierarchy
Example): Edit → Point Edit

The example above means that (Edit) is selected on the first hierarchy (initial menu) screen and (Point Edit) is selected on the second hierarchy screen.

For details about overall hierarchy, refer to the "Hierarchy diagram" on the next page.

Hierarchy diagram

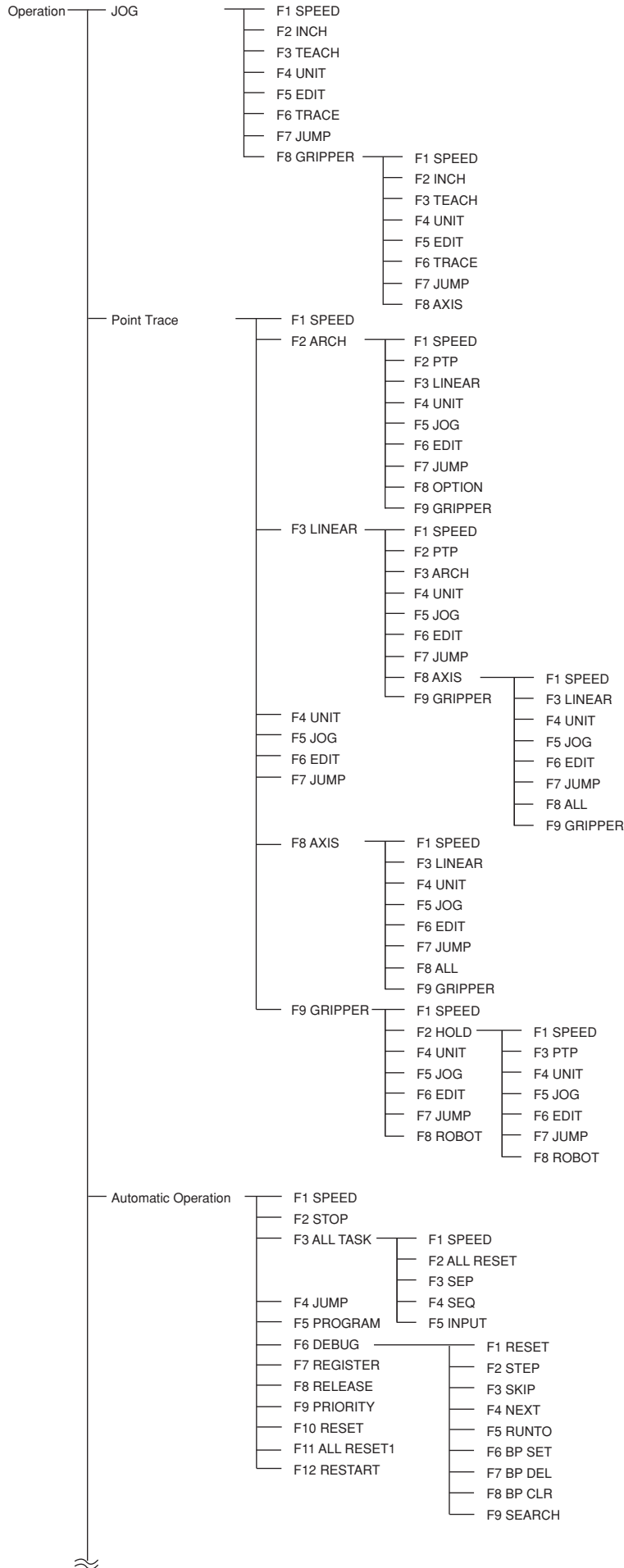

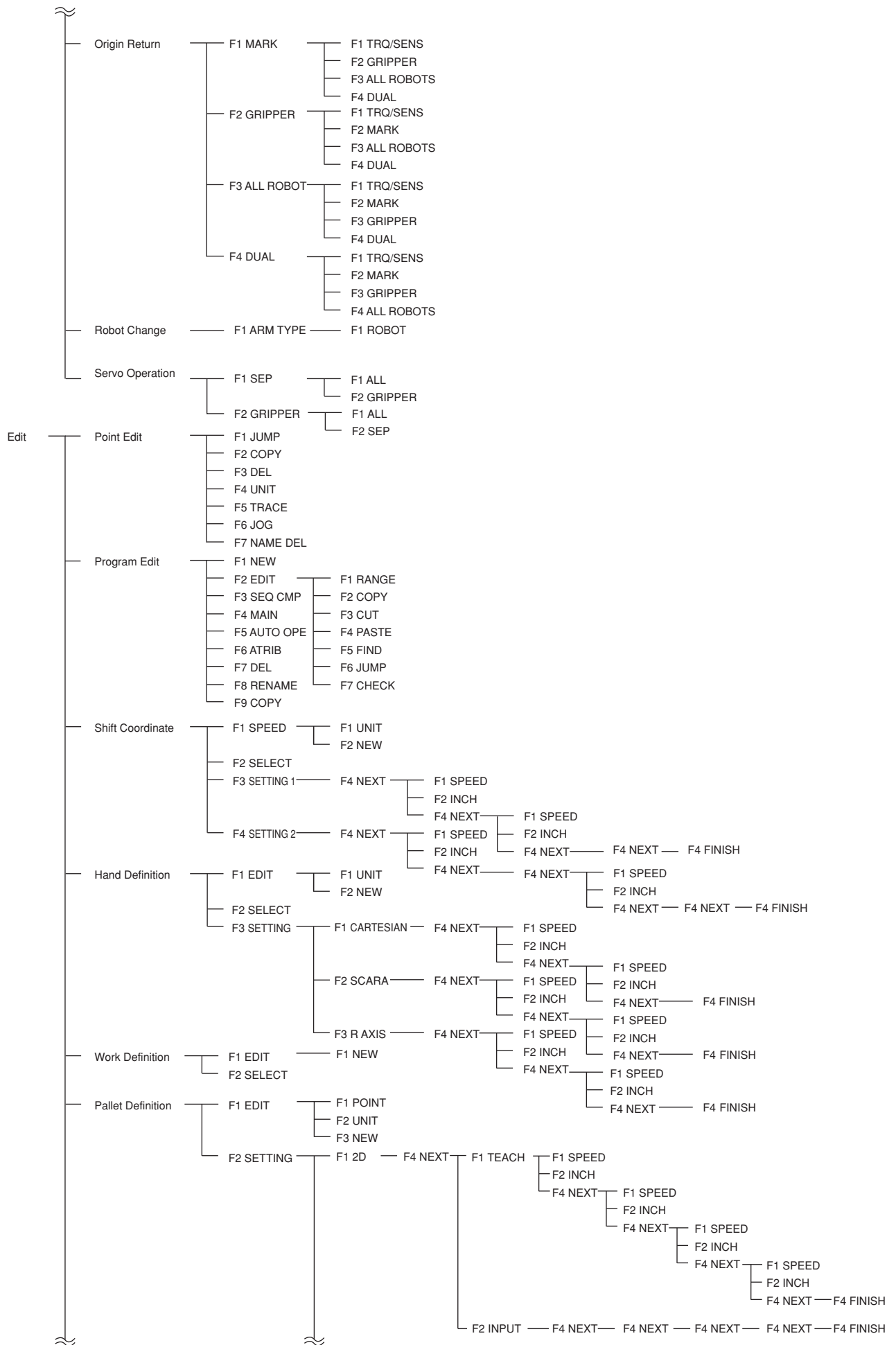

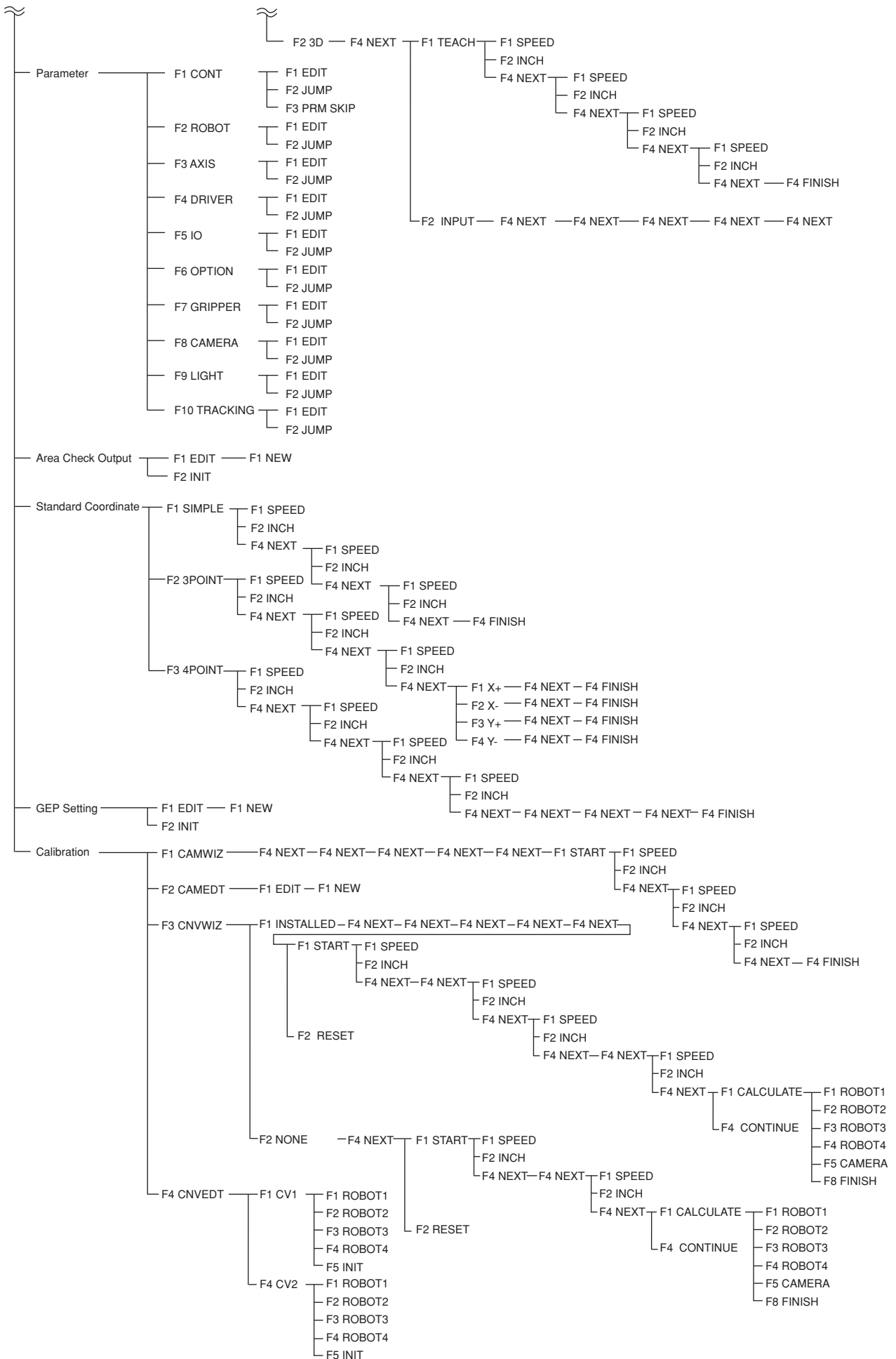

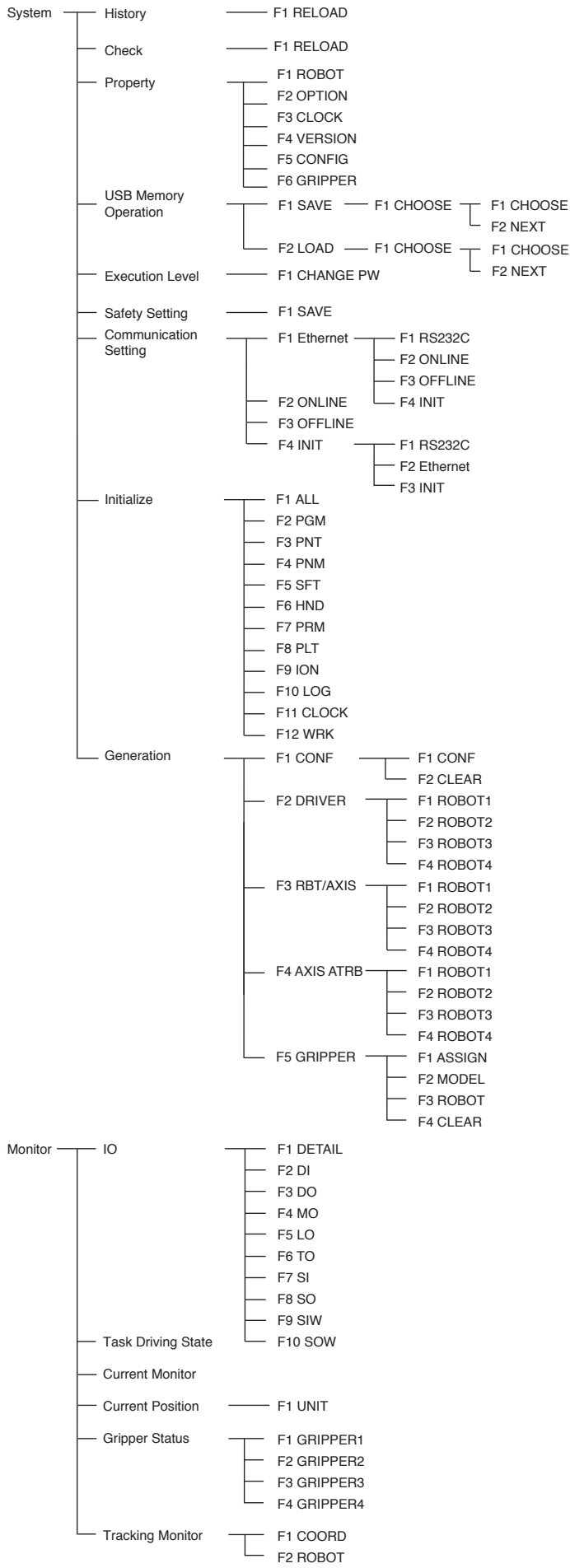

Chapter 3 Operation

1. Servo operation	3-1
1.1 Emergency stop release and alarm reset	3-1
1.2 Motor power and servo on/off	3-1
1.2.1 Servo operation (all axes)	3-1
1.2.2 Servo operation (each axis)	3-2

2. Jog 3-3	
2.1 Jog movement	3-4
2.1.1 Jog movement in return-to-origin complete status	3-5
2.1.2 Jog movement in return-to-origin complete status (When hand definition is set)	3-6
2.1.3 Jog movement in return-to-origin incomplete status	3-6
2.2 Changing the display units	3-7
2.3 Changing the Jog movement speed	3-7
2.4 Changing the inch distance	3-8
2.5 Inputting point data by teaching	3-8
2.6 Jumping the point display	3-9

3. Point trace	3-9
3.1 PTP motion	3-10
3.2 Linear interpolation motion	3-11
3.3 Arch motion	3-13
3.4 Setting the speed	3-14
3.5 Changing the display unit	3-14
3.6 Jumping the point display	3-15

4. Automatic operation	3-15
4.1 Executing automatic operation	3-17
4.2 Stopping a program	3-18
4.3 Resetting a program	3-18
4.3.1 Resetting a program	3-18
4.3.2 Resetting all programs	3-19
4.4 Registering and releasing task	3-19
4.5 Task priority	3-20
4.6 Switching task display	3-20
4.7 Changing the automatic movement speed	3-20
4.8 Sequence program execution flag	3-21
4.9 Restarting the program	3-21

Chapter 3 Operation

4.10	Input function	3-22
4.10.1	Inputting message	3-22
4.10.2	Canceling INPUT command	3-23
4.11	Debug function	3-23
4.11.1	Executing a step	3-24
4.11.2	Skipping a step	3-24
4.11.3	Executing the next step	3-24
4.11.4	Break points	3-24
4.11.5	RUNTO	3-25
<hr/>		
5.	Origin return	3-26
5.1	Return-to-origin operation	3-27
5.2	Return-to-origin procedure	3-29
5.3	Absolute reset (mark method) procedure	3-30
5.4	Return-to-origin for all robots	3-33
<hr/>		
6.	Dual offset	3-34
6.1	Dual offset settings	3-34
6.1.1	Automatic dual offset setting	3-35
6.1.2	Adjusting dual offset	3-36

1. Servo operation

1.1 Emergency stop release and alarm reset

Step 1 Turn the emergency stop button clockwise to release the emergency stop.

Step 2 Reset the alarm.

Press the (QUICK MENU) key on the programming box. The "QUICK MENU" screen will appear. Use the cursor keys to select (Alarm Reset), and then press the ENTER key. The confirmation screen will appear. Use the cursor keys to select (YES), and then press the ENTER key. The alarm status is then reset.



NOTE
The serious alarm cannot be reset. In this case, it is necessary to turn off the controller power, and then turn it on again.

Step 2 "QUICK MENU" screen



Step 2 Confirming the alarm reset execution

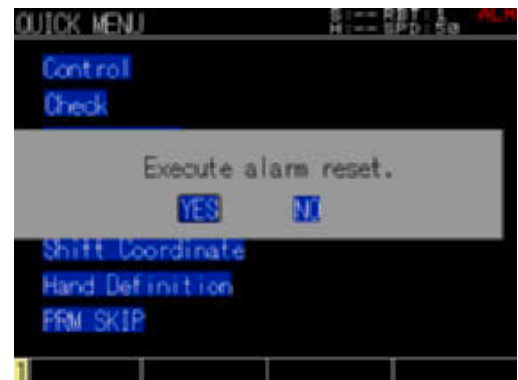

1.2 Motor power and servo on/off

This is usually used with the motor power turned on. This operation is performed to temporarily turn on or off the servo so as to perform the direct teaching.



WARNING

- When the brake is provided, selecting (FREE) will release the brake. However, when releasing the brake of the robot with the vertical specifications, the vertical axis may drop, causing a serious accident.
- After pressing the emergency stop button, prop up the vertical axis with a support stand before releasing the brake.
- Be careful not to let your body get caught between the vertical axis and installation base when releasing the brake to perform direct teaching.

1.2.1 Servo operation (all axes)

The operations on the "SERVO OPERATION (ALL)" screen apply to all axes.

Step 1 Display the "SERVO OPERATION (ALL)" screen.

Press the (QUICK MENU) key on the programming box. Use the cursor keys to select (Servo Operation), and then press the ENTER key. *The "SERVO OPERATION (ALL)" screen can also be displayed by selecting (Operation) - (Servo Operation) from the initial screen.

Step 2 Turn on/off the motor power and servo.

Use the cursor keys to any of the following items, and then press the ENTER key.

ON: Turn on the servo.

OFF: Turn off the servo.

POWER: Turn on only the motor power.

**NOTE**

- Select (ON) of motor power and press the ENTER key, then all the axes specified to the controller will become servo on status.
- Select (OFF) of motor power and press the ENTER key, then all the axes specified to the controller will become servo off status.

Step 2 "SERVO OPERATION (ALL)" screen**1.2.2 Servo operation (each axis)**

The servo status can be set in "robot" units or "axis" units on the "SERVO OPERATION (SEP)" screen.

Step 1 Display the "SERVO OPERATION (SEP)" screen.

Press the (QUICK MENU) key on the programming box.

Use the cursor keys to select (Servo Operation), and then press the ENTER key.

Step 4 "SERVO OPERATION (SEP)" screen**Step 2 Turn on the motor power.**

Use the cursor keys to select (POWER), and then press the ENTER key.

Step 3 Press the F1 key (SEP) to display the "SERVO OPERATION (SEP)" screen.**Step 4 Select each axis or all axes to set.**

Use the cursor keys to select (ON), (OFF), or (FREE) of each axis or all axes, and then press the ENTER key to set the servo status.

*When selecting (FREE), the confirmation screen will appear. Use the cursor keys to select (OK), and then press the ENTER key.

Confirming the servo free change

2. Jog

The "JOG" screen is shown below.



1. Hierarchy

Displays the current hierarchy.

2. Robot setting status

Displays the currently selected robot, shift and so on.

S : 1 . . . Specified "shift coordinate" number

H : 1 . . . Specified "hand definition" number

RBT : 1 . . . Specified "robot number"

SPD : 30 . . . Specified speed

ALM . . . Displayed when any alarm occurs.

SRV . . . Displayed when the servo is on.

AUTO . . . Displayed when the control setting is "RELEASE".
(This is not displayed when the setting is "GET" or the operation is in MANUAL mode.)

SEQ . . . Displayed when the sequence program is executed.

When using multiple robots, the robot number display is changed by changing the target robot on the "QUICK MENU".

3. Current position

Displays the current position of the robot. The current position is displayed by an integer when using "pulse" units. When using "mm" units, the position is displayed by a value with the decimal point.

4. Coordinate unit system

Displays the coordinate unit system. The unit shows [pulse], [mm], or [mm](tool).

5. Hand system

Displays the hand system of the current robot. This information is displayed only when the unit system of the hand system is "mm" units.

- 0 : No hand system setting (Standard coordinates are not set.)
- 1 : Right-handed system
- 2 : Left-handed system

6. Point information

Displays the point name when the number and point name of the displayed point data are registered.

7. Guide line

Displays the contents assigned to the function keys.

Valid keys and submenu descriptions in the Jog operation are shown below.

Valid keys	Menu	Function
#1+ to #6-		Moves the robot manually (Jog movement).
F1	SPEED	Sets the manual movement speed.
F2	INCH	Sets the inching movement amount.
F3	TEACH	Performs the teaching of the point currently displayed.
F4	UNIT	Changes the display unit of the current position to [pulse], [mm], and [mm] (tool) in order.
F5	EDIT	Moves to the "POINT EDIT" screen.
F6	TRACE	Moves to the "PTP (ALL)" screen.
F7	JUMP	Displays the point data of the specified point number.

2.1 Jog movement

The robot can be moved with the Jog keys.



WARNING

The robot starts to move when a Jog key is pressed. To avoid danger, do not enter the robot movement range.



NOTE

- When using multiple robots, check the name of the robot to be operated, and then perform the Jog movement. If the robot to be operated is different, change to the target robot. To change the robot, use the "QUICK MENU". For details, refer to "5.2 Quick menu" in Chapter 2.
- For details on the soft limits, refer to the YRCX user's manual.
- When the current position is displayed in "pulse" units, the robot can be moved manually along the axes whose servos are on, even if the servos of the other axes are off.
- When the current position is displayed in "mm" units, the robot can be moved manually only when the servos of all axes are on.
- The maximum jog movement time for one movement command is 300 seconds. Therefore, if the movement time exceeds 300 seconds at the specified speed, the robot movement will stop in 300 seconds. To move the robot further, use jog movement once again.

2.1.1 Jog movement in return-to-origin complete status

1. When the current position is displayed in "pulse" units.

"[pulse]" is displayed on the right of "CURRENT" on the programming box screen.

Each time a Jog key is pressed, the robot moves a specified distance (inching distance) along the corresponding axis. When the Jog key is held down, the robot keeps moving towards the soft limit of the axis. The robot stops when the Jog key is released or it reaches the soft limit.

The distance to be moved using the inching operation equals the number of pulses that are set using "INCH".

■ Display shown in "pulse" units



Example): When the INCH movement amount is "1000",

the inching distance in "pulse" units becomes 1000 pulses.

When it is attempted to move to a position exceeding +/- soft limit of each axis by pressing the Jog key, the message "2.334: Over soft limit" appears and the robot does not move.

2. When the current position is displayed in "mm" units.

"[mm]" is displayed on the right of "CURRENT" on the programming box screen. When the tool coordinate is selected, "[mm](tool)" is displayed.

1) Tool coordinate is not selected ([mm])

When pressing the Jog key, the robot arm tip moves on the Cartesian coordinates in the direction corresponding to this key.

For the axis with the auxiliary axis setting, only the corresponding axis moves.

2) Tool coordinate is selected ([mm](tool))

The tool coordinates can be used when selecting the hand data fixed to the R-axis of the SCARA type robots (hand definitions are set).

■ Display shown in "mm" units



When pressing the Jog key on the programming box, the hand will move.

Pressing the or key moves the hand forwards or backwards.

Pressing the or key moves the hand to the left or right.

Pressing the or key rotates the end of the hand around its center.

When the other Jog keys are pressed, the robot moves the same way as when tool coordinates are not selected.

2.1.2 Jog movement in return-to-origin complete status (When hand definition is set)

■ Robot movement in "Tool coordinate" mode (example)

■ Hand definition

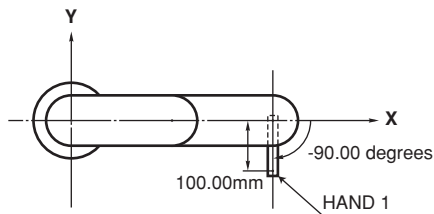

HAND DEFINITION				
H00	1	0.000	Robot 1	
	2	0.000		
	3	0.000		
	4	R		
H01	1	8.207	Robot 1	
	2	0.000		
	3	57.766		
	4	R		
H02	1		Robot	
	2			
	3			
	4			

■ Jog key operation

Robot movement with #1+ to #2- keys

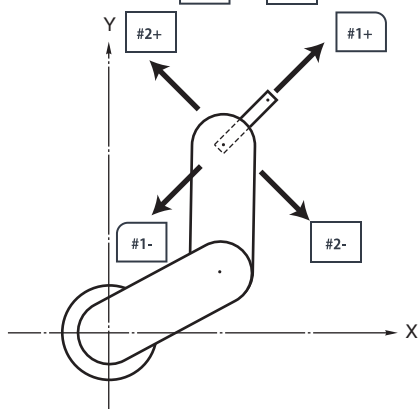

Robot movement with #4+ to and #4- keys

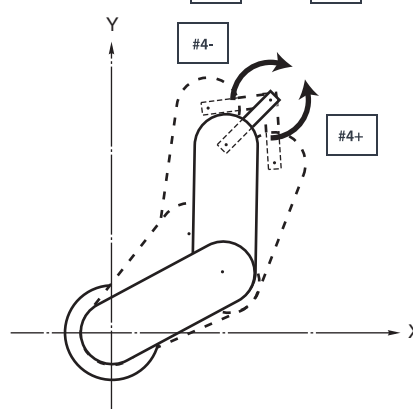

Each time a Jog key is pressed, the robot moves a specified distance (inching movement). When the Jog key is held down, the robot keeps moving. The robot stops when the Jog key is released or either of the soft limit or shift coordinate range is reached. The robot stops when the Jog key is released or the soft limit is reached.

The distance to be moved using the inching operation equals the number of millimeters set using "INCH".

* When using "mm" units, the inch amount is set in "μm" units.

Example): When the INCH movement amount is 5000,
the inching distance in "mm" units is 5mm.

If robot movement beyond the +/- soft limits is attempted with the Jog keys, the error message "2.334: Over soft limit" appears and the robot does not move. If robot movement beyond the shift coordinate range is attempted, the error message "2.308 to 2.311: Exceeded shift coord. range" appears and the robot does not move.

If the current position is outside the soft limits, the error message "2.334: Over soft limit" also appears and the robot does not move.

2.1.3 Jog movement in return-to-origin incomplete status

When the display unit of the current position is "[pulse]", it is possible to operate the robot by the jog key so as to be in the return-to-origin completed status. "6.302: Origin incomplete" alarm occurs by pressing the jog key when the display unit of the current position is "[mm]" or "[mm] (tool)". "Org. Incomplete", which means origin incomplete status, is displayed on the "JOG" screen.

■ "JOG" screen (return-to-origin incomplete status)

JOG					
CURRENT [pulse]		Org. Incomplete			
1:	-20348	3:	262369	5:	22504
4:	9857	6:	0	8:	0
FLD:		FG1:		FG2:	
P 10000 ▲ ▼					
1:	0	2:	0	3:	0
4:	0	5:	0	6:	0
FLD:		FG1:		FG2:	



CAUTION

When return-to-origin is incomplete, the robot does not stop even if soft limits are exceeded.

2.2 Changing the display units

The current position on the programming box screen can be changed in "pulse" units, "mm" units, or "tool coordinate ("mm" units)".

The tool coordinates are used when the hand data fixed to the R-axis is selected (hand definitions are set).

- When pressing the F4 (UNIT) on the "JOG" screen, the display unit of the current position is changed.
- Every time the key is pressed, the display unit is changed.

"[pulse]", "[mm]", or "[mm] (tool)" corresponding to the selected display unit is displayed on the right of "CURRENT" on the programming box screen.

■ Switching the display units

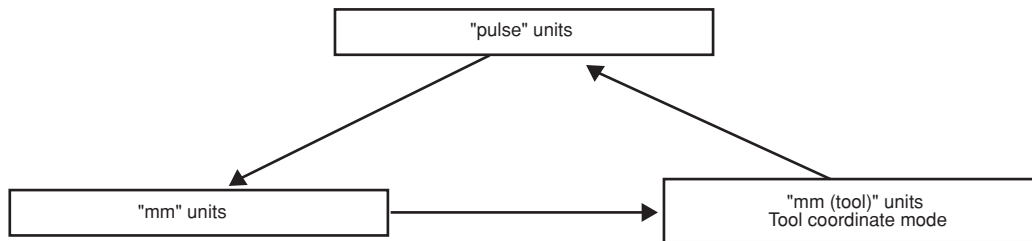

- "pulse" units (joint coordinates)
Displays the current position with an integer.
 - "mm" units (Cartesian coordinates, tool coordinates *1)
Displays the current position with a number consisting of an integer and a decimal fraction.
- *1 This is used only when the hand data fixed to the R-axis is selected.

Robot Jog movement with Jog keys varies depending on the currently selected display units. For more details, refer to "2.1 Jog movement" in this Chapter.

2.3 Changing the Jog movement speed

The Jog movement speed of the target robot can be set in a range of 1 to 100%.

The movement speed in the MANUAL mode differs from that in the AUTO mode.

Additionally, the maximum movement speed is 3% in the MANUAL mode.

The following describes how to change the speed.

Step 1 Press the F1 key (SPEED) on the "JOG" screen.

The "SPEED" setting screen will appear.

Step 2 Input a numeric value and press the ENTER key.

Step 3 Set the value you have input.

Use the cursor keys to select (OK), and then press the ENTER key.

■ "SPEED" setting screen



2.4 Changing the inch distance

When the inching movement amount of the target robot uses "pulse" units, you can set 1 to 10000 [pulse]. When using "mm" units, you can set the inching movement amount in a range of 0.001 to 10 [mm].

The following describes how to set the inching movement amount.

Step 1 Press the F2 key (INCH) on the "JOG" screen.

The "INCH" setting screen will appear.

■ Inputting the inch distance



Step 2 Input a numeric value and press the ENTER key.



NOTE

When using "pulse" units, the inching movement amount is set in "pulse" units.

When using "mm" units, the inching movement amount is set in "µm" units.

Example)

When the "INCH DISTANCE" is 1000, the inching movement amount is:

1000 (pulse) in "pulse" units

1.000 (mm) in "mm" units

Step 3 Set the value you have input.

Use the cursor keys to select (OK), and then press the ENTER key.

2.5 Inputting point data by teaching

The current position of the robot can be obtained as point data by teaching.



WARNING

The robot moves during teaching. To avoid danger, do not enter the robot movement range.



CAUTION

- When using multiple robots, be sure to check the current robot number.
- The robot is changed by selecting "Robot Change" on the "QUICK MENU" screen.



NOTE

• In the return-to-origin incomplete status, the teaching of the point data cannot be performed. Be sure to perform the teaching after absolute reset or return-to-origin has been performed.

• When performing the teaching of the point data in "mm" units, the hand system data during teaching is input to the hand system information of the point data. "0" is set to the first and second arm rotation information.

Step 1 Select the point.

Input a numeric value on the "JOG" screen or use the cursor keys to select (Δ) or (▽), then press the ENTER key to select the point. Select the point using the jump function otherwise.

* For details on the jump function, refer to "2.6 Jumping the point display" in this Chapter.

■ "JOG" screen



Step 2 Move the robot axis.

Move the axis with the Jog keys.
The current position display will change as the axis moves.

Step 3 Perform teaching.

When the axis reaches the target position, press the F3 key (TEACH).
The confirmation screen appears. Select (OK) and press the ENTER key.
When selecting (CANCEL), the teaching is canceled.

The input format of the point data to be taught is the same as that of the current position display.

■ Confirming the teaching execution

**CAUTION**

The robot will not move to the same position if moving with a hand system different from that used for teaching. When changing the hand system that was used for registering the point data, re-teach the position using the hand system that you have changed to.

2.6 Jumping the point display

The point data of the specified point number is displayed.

Step 1 Press the F7 key (JUMP) on the "JOG" screen.

The point number entry screen will appear.

Step 2 Input the point number.

Input a numeric value and press the ENTER key.

Step 3 Set the value you have input.

Use the cursor keys to select (OK), and then press the ENTER key.

■ Inputting the point number

**NOTE**

Valid point numbers are from 0 to 29999.

3. Point trace

Point data positions can be checked by actually moving the robot.

The robot can be moved by PTP motion, linear interpolation motion and arch motion.

To display the "PTP (ALL)" screen where the point trace is executed, select [Operation] - [Point Trace] from the initial screen.

The "PTP (ALL)" screen will appear as shown below.

■ "PTP (ALL)" screen

**CAUTION**

- When using multiple robots, be sure to check the current robot number.
To change the robot, use the "QUICK MENU". For details, refer to "5.2 Quick menu" in Chapter 2.
- Point trace cannot be performed unless return-to-origin is complete.

The contents displayed on the screen are the same as the "JOG" screen. For descriptions about display contents, refer to "2. Jog operation" in this Chapter.

3.1 PTP motion

Valid keys and submenu descriptions on the "PTP (ALL)" and "PTP (SEP)" screens are shown below.

Valid keys	Menu	Function
		Moves the cursor.
		Executes the point trace.
		Stops the point trace.
	SPEED	Sets the movement speed for the point trace.
	ARCH	Changes the trace type to arch motion.
	LINEAR	Changes the trace type to the linear interpolation motion.
	UNIT	Changes the display units of the current position to [pulse], [mm], and [mm](tool) in this order.
	JOG	Moves to the "JOG" screen.
	EDIT	Moves to the "POINT EDIT" screen.
	JUMP	Displays the point data of the specified point number.
	SEP / ALL	Changes the point trace target axis to individual axis or all axes.
		Returns to the previous screen.



WARNING

The robot moves when point trace starts. To avoid danger, do not enter the robot movement range.

■ All axes point trace

Step 1 Display the "PTP (ALL)" screen.

To display the screen, select (Operation) from the initial screen and then (Point Trace), or press the F2 key (PTP) on the (LINEAR) or (ARCH) screen.

Step 2 Select the point number to check.

Use the cursor keys to select (Δ) or (▽) on the screen and press the ENTER key to change the point number.
Or, select (P00000) to input the point number directly, and then press the ENTER key. The point number can also be selected with the F7 key (JUMP).
For details, refer to "3.6 Jumping the point display" in this Chapter.

▶ Step 2 "PTP (ALL)" screen

PTP(ALL)					
CURRENT [pulse]					
1:	0	2:	0	3:	0
4:	0	5:	0	6:	0
FLG:		FG1:		FG2:	
P 00000 ▲ ▼					
1:	251.735	2:	235.721	3:	0.000
4:	-0.013	5:	0.000	6:	0.000
FLG:	0	FG1:	0	FG2:	0
SPEED ARCH LINEAR UNIT					



NOTE

When a SCARA type robot is used and a hand system flag is set for the point data, the hand system will have priority over the current arm type.

Step 3 Execute point trace.

Press the RUN key and the robot moves by PTP motion to the position of the selected point. The trace speed is 1/10 of the AUTO movement speed.

To stop point trace, press the STOP key.

*For details about how to set the speed, refer to "3.4 Setting the speed" in this Chapter.

■ Each axis point trace

Step 1 Display the "PTP (SEP)" screen.

Press the F8 key (SEP) on the "PTP (ALL)" screen (Operation → Point Trace).

Step 2 Select the point number to check.

Use the cursor keys to select (Δ) or (▽) on the screen and press the ENTER key to change the point number.
 Or, select (P00000) to input the point number directly, and then press the ENTER key.
 The point number can also be selected with the F7 key (JUMP).
 For details, refer to "3.6 Jumping the point display" in this Chapter.

▶ **Step 2,3 "PTP (SEP)" screen**



Step 3 Select the axis number to check.

Use the cursor keys to select (Δ) or (▽) on the screen and press the ENTER key to change the axis number.
 Select (Axis1) to input the axis number directly, and then press the ENTER key otherwise.



NOTE

When a SCARA type robot is used and a hand system flag is set for the point data, the hand system will have priority over the current arm type.

Step 4 Execute point trace.

Press the RUN key and the robot moves by PTP motion to the position of the selected point. The trace speed is 1/10 of the AUTO movement speed.
 To stop point trace, press the STOP key
 * For details about how to set the speed, refer to "3.4 Setting the speed" in this Chapter.

3.2 Linear interpolation motion

Valid keys and submenu descriptions on the "LINEAR (ALL)" and "LINEAR (SEP)" screen are shown below.

Valid keys	Menu	Function
		Moves the cursor.
		Executes the point trace.
		Stops the point trace.
	SPEED	Sets the movement speed for the point trace.
	PTP	Changes the trace type to PTP motion.
	ARCH	Changes the trace type to the arch motion.
	UNIT	Changes the display units of the current position to [pulse], [mm], and [mm](tool) in this order.
	JOG	Moves to the "JOG" screen.
	EDIT	Moves to the "POINT EDIT" screen.
	JUMP	Displays the point data of the specified point number.
	SEP / ALL	Changes the point trace target axis to individual axis or all axes.
		Returns to the previous screen.



WARNING

The robot moves when point trace starts. To avoid danger, do not enter the robot movement range.

■ All axes point trace

Step 1 Display the "LINEAR (ALL)" screen.

Press the F3 key (LINEAR) on the "PTP (ALL)" or "Arch motion" screen.

Step 2 Select the point number to check.

Use the cursor keys to select (Δ) or (∇) on the screen and press the ENTER key to change the point number.

Or, select (P00000) to input the point number directly, and then press the ENTER key.

The point number can also be selected with the F7 key (JUMP).

For details, refer to "3.6 Jumping the point display" in this Chapter.

▶ Step 2 "LINEAR (ALL)" screen



NOTE

When a SCARA type robot is used and a hand system flag is set for the point data, the hand system will have priority over the current arm type.

Step 3 Execute point trace.

Press the RUN key and the robot moves by linear interpolation motion to the position of the selected point. The trace speed is 1/10 of the AUTO movement speed.

To stop point trace, press the STOP key.

* For details about how to set the speed, refer to "3.4 Setting the speed" in this Chapter.

■ Each axis point trace

Step 1 Display the "LINEAR (SEP)" screen.

Press the F3 key (LINEAR) on the "PTP (ALL)" screen (Operation → Point Trace), and then press the F8 key (EACH).

Step 2 Select the point number to check.

Use the cursor keys to select (Δ) or (∇) on the screen and press the ENTER key to change the point number.

Or, select (P00000) to input the point number directly, and then press the ENTER key.

The point number can also be selected with the F7 key (JUMP).

For details, refer to "3.6 Jumping the point display" in this Chapter.

▶ Step 2 "LINEAR (SEP)" screen



NOTE

When a SCARA type robot is used and a hand system flag is set for the point data, the hand system will have priority over the current arm type.

Step 4 Execute point trace.

Press the RUN key and the robot moves by PTP motion to the position of the selected point. The trace speed is 1/10 of the AUTO movement speed.

To stop point trace, press STOP key.

* For details about how to set the speed, refer to "3.4 Setting the speed" in this Chapter.

3.3 Arch motion

Valid keys and submenu descriptions on the "ARCH (ALL)" and "ARCH (SEP)" screens are shown below.

Valid keys	Menu	Function
		Moves the cursor.
		Executes the point trace.
		Stops the point trace.
	SPEED	Sets the movement speed for the point trace.
	PTP	Changes the trace type to PTP motion.
	LINEAR	Changes the trace type to the linear interpolation motion.
	UNIT	Changes the display units of the current position to [pulse], [mm], and [mm](tool) in this order.
	JOG	Moves to the "JOG" screen.
	EDIT	Moves to the "POINT EDIT" screen.
	JUMP	Displays the point data of the specified point number.
	SEP / ALL	Changes the point trace target axis to individual axis or all axes.
		Returns to the previous screen.

Input	Function
AXIS	Sets the axis number to perform arch motion.
POS	Sets the arch movement position.
Dist 1	Sets the arch position 1.*
Dist 2	Sets the arch position 2.*

* Dist 1 (arch position 1) and Dist 2 (arch position 2) are arch options.



WARNING

The robot moves when point trace starts. To avoid danger, do not enter the robot movement range.

Step 1 Display the "ARCH (ALL)" screen.

Press the F2 key (ARCH) on the "PTP" screen or F3 key (ARCH) on the "LINEAR" screen.

Step 2 Select the point number to check.

Use the cursor keys to select (Δ) or (▽) on the screen and press the ENTER key to change the point number.

Select (P00000) to input the point number directly, and then press the ENTER key otherwise.

The point number can also be selected with the F7 key (JUMP).

For details, refer to "3.6 Jumping the point display" in this Chapter.

Step 2 "ARCH (ALL)" screen



NOTE

When a SCARA type robot is used and a hand system flag is set for the point data, the hand system will have priority over the current arm type.

Step 3 Set the axis number and arch motion position to perform arch motion.

For details about the arch motion position, refer to "Arch pulse 1/2" parameter of "6.4.3 Axis parameters" in Chapter 4.

Step 4 Input the arch option as necessary.

Press the F8 key (OPTION) to display the pop-up screen of arch option.

Use the cursor keys to select (ON) and then press the ENTER key to display "Dist 1" and "Dist 2" of the arch option. Refer to the figure below for inputting in (mm) units.

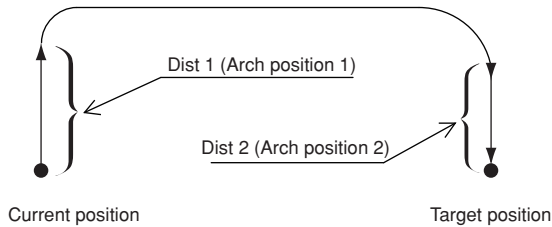
**Step 4 Arch option****Arch option is ON****Step 5 Execute point trace.**

Press the RUN key and the robot moves by arch motion to the position of the selected point. The trace speed is 1/10 of the AUTO movement speed.

To stop point trace, press the STOP key.

* For details about how to set the speed, refer to "3.4 Setting the speed" in this Chapter.

3.4 Setting the speed

The trace speed is changed on the point trace screen.

The speed setting procedure is common to the PTP motion, linear interpolation motion and arch motion.

Step 1 Input the set speed.

Press the F1 key (SPEED) on the PTP screen to display the "SPEED" setting screen.

Input a numeric value and press the ENTER key.

Step 1,2 Setting the speed**Step 2 Set the value you have input.**

Use the cursor keys to select (OK), and then press the ENTER key.

**NOTE**

The operation speed is a product of the trace speed and automatic movement speed.
For example; Point trace speed is 100%, automatic movement speed is 2%
Operation speed = 100% × 2% = 2%

3.5 Changing the display unit

Press the F4 key (UNIT) on the "JOG" screen to change the unit of the current position to be displayed on the programming box is changed to "pulses", "mm", or "tool coordinate (mm)".

For details, refer to "2.2 Changing the display units" in this Chapter.

3.6 Jumping the point display

Point data can be displayed from the specified point number.

Step 1 Display the jump destination point number entry screen.

Press the F7 key (JUMP) on the PTP screen.
The number designation screen will appear.

Step 2 Input the point number and press the ENTER key.

Step 3 Use the cursor keys to select [OK], and then press the ENTER key.



NOTE
Valid point numbers are from 0 to 29999.

Step 2,3 Inputting the point number



4. Automatic operation

Operations related to the robot language program execution are performed during automatic operation. The automatic operation provides the "AUTO OPE (SEP)" screen where only one task is displayed and operated and the "AUTO OPE (ALL TASK)" screen where the execution status of multiple tasks is checked. The following shows the "AUTO OPE" screens.

"AUTO OPE" screen

"AUTO OPE (SEP)" screen

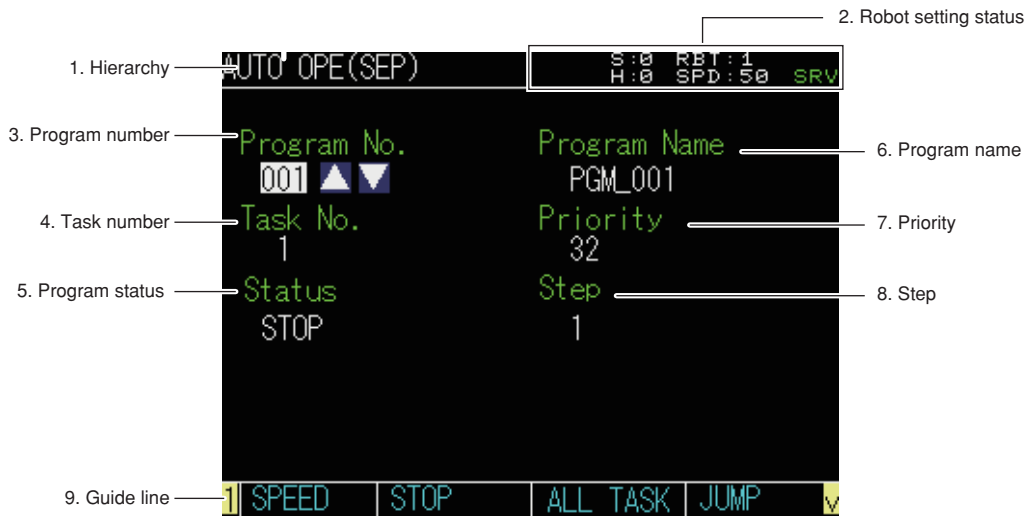

"AUTO OPE (ALL TASK)" screen

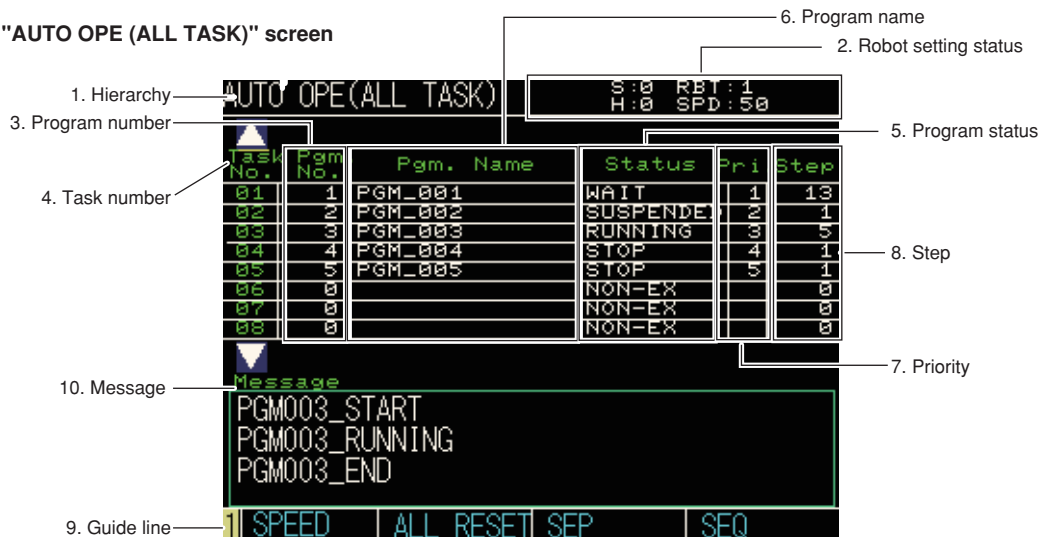

1. Hierarchy

Displays the current hierarchy.

2. Robot setting status

Displays the currently selected robot, shift and so on.

S : 1 . . . Specified "shift coordinate" number

H : 1 . . . Specified "hand definition" number

RBT : 1 . . . Specified "robot number"

SPD : 30 . . . Specified speed

ALM . . . Displayed when any alarm occurs.

SRV . . . Displayed when the servo is on.

AUTO . . . Displayed when the control setting is "RELEASE".
(This is not displayed when the setting is "GET" or the operation is in MANUAL mode.)

SEQ . . . Displayed when the sequence program is executed.

When using multiple robots, the robot number display is changed by changing the target robot on the "QUICK MENU".

3. Program number

Displays the selected program number.

4. Task number

Displays the selected program task number.

5. Program status

Displays the selected program status.

STOP	Stop status
RUNNING	Execution status
WAIT	Wait status
SUSPENDED	Forced suspended status
NON-EX	Unregistered status

For details about each task status, refer to the YRCX programming manual.

6. Program name

Displays the selected program name.

7. Priority

Displays the priority of the selected program.

8. Step

Displays the line number at which the program stops.

9. Guide line

Displays the contents assigned to the function keys.

10. Message (on "AUTO OPE (ALL TASK)" screen only)

Displays the output of the PRINT command in the program.



NOTE

When executing the automatic operation, it is necessary to put in the return-to-origin complete status beforehand. The automatic operation cannot be executed when the return-to-origin is not completed. In this case, refer to "5. Origin return" in Chapter 3.

Valid keys and submenu descriptions on the "AUTO OPE (SEP)" screen are shown below.

Valid keys	Menu	Function
		Moves the cursor.
		Executes the automatic operation.
		Stops the automatic operation.
	SPEED	Sets the automatic movement speed.
	STOP	Stops the automatic operation.

Valid keys	Menu	Function
F3	ALL TASK	Changes to the all task display.
F4	JUMP	Specifies the program number.
F5	PROGRAM	Moves to the "PROGRAM SELECTION" screen. Used to edit the program.
F6	DEBUG	Changes to the "DEBUG" screen.
F7	REGISTER	Registers the program to the task.
F8	RELEASE	Cancels the task registration of the task.
F9	PRIORITY	Sets the priority of the program.
F10	RESET	Resets the program currently selected.
F11	ALL RESET	Resets all programs registered as task.
F12	RESTART	Restarts the program that is being paused.

4.1 Executing automatic operation

Program commands are executed continuously. Before starting the automatic operation, make sure that the return-to-origin, program debug, I/O signal connection, and point data teaching have already been completed. The robot program is executed in the format called "task". Therefore, the program needs to be registered as task before starting the execution. The following shows how to execute the program.

Step 1 Display the "AUTO OPE (SEP)" screen.

Use the cursor keys to select (Operation) from the initial screen, and then press the ENTER key. Next, select (Automatic Operation), and then press the ENTER key. The "AUTO OPE (SEP)" screen will appear.

▶ Step 1 "AUTO OPE (SEP)" screen



Step 2 Select the program.

Use the cursor keys to select (Δ) or (▽) on the screen and press the ENTER key to change the program number. Select (001) to input the program number directly, and then press the ENTER key otherwise. The program number can also be selected with the F4 key (JUMP).

▶ Step 3 Registering the task

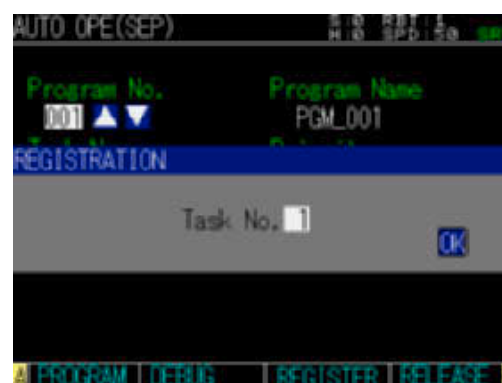

Step 3 Register the program as task.

Press the F7 key (REGISTER) on the "AUTO OPE (SEP)" screen to display the task registration screen. Input the task number and press the ENTER key. Use the cursor keys to select (OK), and then press the ENTER key.

Step 4 Execute the program.

When pressing the RUN key, the program is executed from the line number displayed in the "Step" area.



WARNING

- The robot moves when automatic operation starts. To avoid danger, do not enter the robot movement range.
- When changing the automatic movement speed during automatic operation, check safety for surrounding areas.

The programming box can be operated even during automatic operation.



NOTE

Auto movement speed change during robot operation will be reflected at the next movement.

4.2 Stopping a program

■ Stopping a program

The program execution is interrupted or stopped. When pressing the F2 key (STOP), the program stop confirmation screen will appear. Use the cursor keys to select [OK], and then press the ENTER key. The program currently executed will stop. The command is not canceled. After the command is completed, the program stops. Press the RUN key to restart the program execution.

■ Confirming the program stop



■ Interrupting the command and stopping the program

Press the STOP key to cancel the command being executed and stop the program execution. Press the RUN key to restart the program execution.



CAUTION

Do not turn off the robot controller during program execution. If turned off, the internal system data may be corrupted and the program may not restart when the power is again turned on. Always be sure to terminate or stop the program before turning the power off.

4.3 Resetting a program

The program being selected is reset and all programs that are registered as task are reset.

4.3.1 Resetting a program

When restarting the program that is paused from the first line, the program must be reset.



NOTE

When resetting the program, the output is also reset. However, the output is not reset in the following case.

- The DO output of the parameter is set at "HOLD" when performing the program reset. (For details, refer to the YRCX user's manual.)

To reset the program selected on the "AUTO OPE (SEP)" screen, press the F10 key (RESET) to display the program reset confirmation screen. Use the cursor keys to select [OK], and then press the ENTER key.

■ Confirming the program reset



4.3.2 Resetting all programs

All programs registered as task are reset, and then the program set in the main program or current program is registered as task.

Press the F11 key (ALL RESET) on the "AUTO OPE (SEP)" to display the program all reset pop-up screen. Use the cursor keys to select [OK], and then press the ENTER key.

■ Confirming the program reset

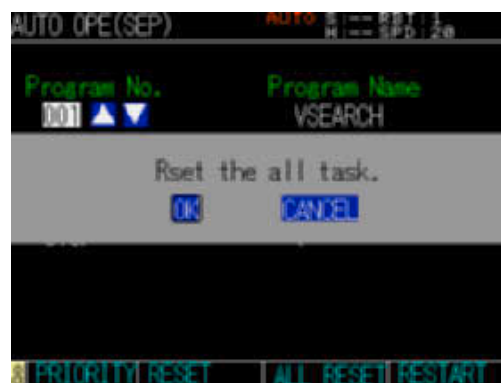

■ Program to be selected after program reset

The main program is selected when it is set. When the main program is not set, the current program is selected. When both programs are not set, the program registration is not performed at program reset. The following describes the main program and current program.

- Main program
This program can be specified freely by the parameter. When there is the main program at program reset, it is selected automatically.
- Current program
The program that is executed last in the task 1 or the program that is assigned last to the task 1 is selected.

4.4 Registering and releasing task

The program needs to be registered as a task in order to execute it.

When registering other program into the task, into which the program has already been registered, the program registered as task needs to be released.

The following shows how to register or release the program task.

■ Registering program as task

Press the F7 key (REGISTER) on the "AUTO OPE (SEP)" screen to display the task registration pop-up screen.

Input the task number and press the ENTER key. Use the cursor keys to select [OK], and then press the ENTER key.

■ Registering the task

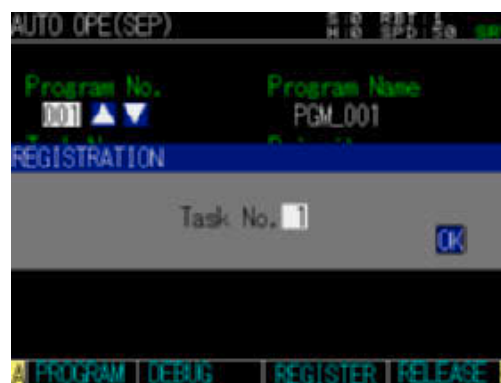

■ Releasing program task

Press the F8 key (RELEASE) on the "AUTO OPE (SEP)" screen to display the task release pop-up screen. Input the task number and press the ENTER key. Use the cursor keys to select [OK], and then press the ENTER key.

■ Releasing the task

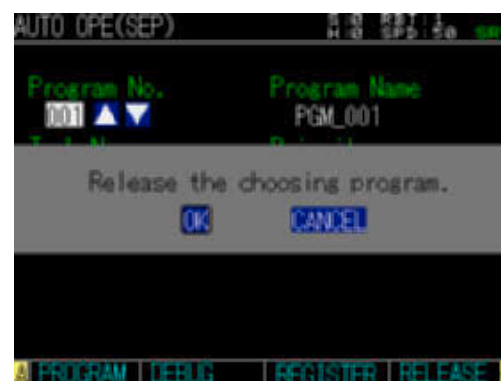

4.5 Task priority

The priority of each task can be specified in a range of 1 to 64. The smaller priority value, the higher priority. The larger priority value, the lower priority. (High: 1 ⇔ 64: Low)

When the program is registered as task, "32" is set as initial value.

* For details about priority, refer to "Multi-task" in the YRCX programming manual.

The following shows how to set the task priority.

■ Setting the task priority

Press the F9 key (PRIORITY) on the "AUTO OPE (SEP)" screen to display the priority setting pop-up screen.

Input the priority and press the ENTER key.

Use the cursor keys to select [OK], and then press the ENTER key.



NOTE

The priority setting range is 1 to 64.
(High: 1 ⇔ 64: Low)

4.6 Switching task display

Multiple-task execution status can be checked by changing the "AUTO OPE" screen.

Press the F3 key (ALL TASK) on the "AUTO OPE (SEP)" screen. The "AUTO OPE (ALL TASK)" screen will appear.

When pressing the F3 key (SEP), the "AUTO OPE (SEP)" screen will appear.

■ "AUTO OPE (ALL TASK)" screen



4.7 Changing the automatic movement speed

The automatic movement speed is set in a range of 1 to 100%.

Press the F1 key (SPEED) on the "AUTO OPE (SEP)" screen or "AUTO OPE (ALL TASK)" screen to display the speed setting pop-up screen.

Input a numeric value and press the ENTER key.

Use the cursor keys to select [OK], and then press the ENTER key.

■ Setting the automatic movement speed

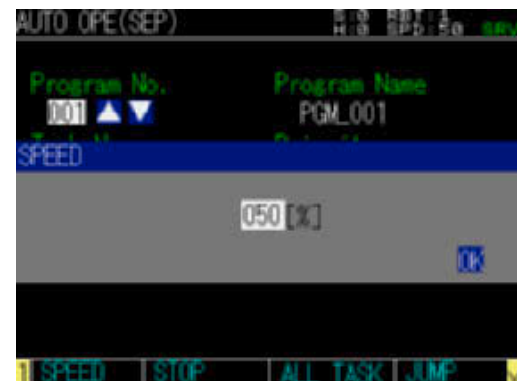

NOTE

Since the AUTO movement speed you have set here is saved into the internal memory, the set value is retained even when the power is turned off. Additionally, when the speed is specified by the command (SPEED statement) of the program, the operation speed is a product of this speed and AUTO movement speed.
For example; Automatic movement speed is 50%, Speed by the SPEED statement is 2%
Operation speed = 80% × 50% = 40%

4.8 Sequence program execution flag

The sequence program execution is switched between "disable" and "enable".
For details about sequence program, refer to the YRCX programming manual.

Press the F4 key (SEQ) on the "AUTO OPE (ALL TASK)" screen to display the confirmation screen.
To enable the sequence program, use the cursor keys to select [RUN], and then press the ENTER key.
To disable the sequence program, use the cursor keys to select [STOP], and then press the ENTER key.

■ Sequence program run/stop confirmation screen

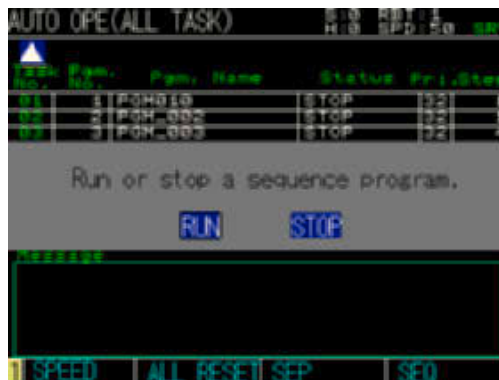

4.9 Restarting the program

The program in the "SUSPENDED" status is restarted.
To restart the program in the "STOP" status, press the RUN key.

Select the program in the "SUSPENDED" status on the "AUTO OPE (SEP)" screen and press the F12 key (RESTART) to display the execution confirmation screen.
Use the cursor keys to select [OK], and then press the ENTER key.
The program in the "SUSPENDED" status is then restarted.

■ Task restart confirmation screen



* For details about "SUSPENDED" status, refer to the YRCX programming manual.

4.10 Input function

It is possible to input some data into "INPUT" command in the program using the input function. Press the F5 key (INPUT) on the "AUTO OPE (ALL)", and then "AUTO OPE (INPUT)" screen will appear.

■ "INPUT" screen

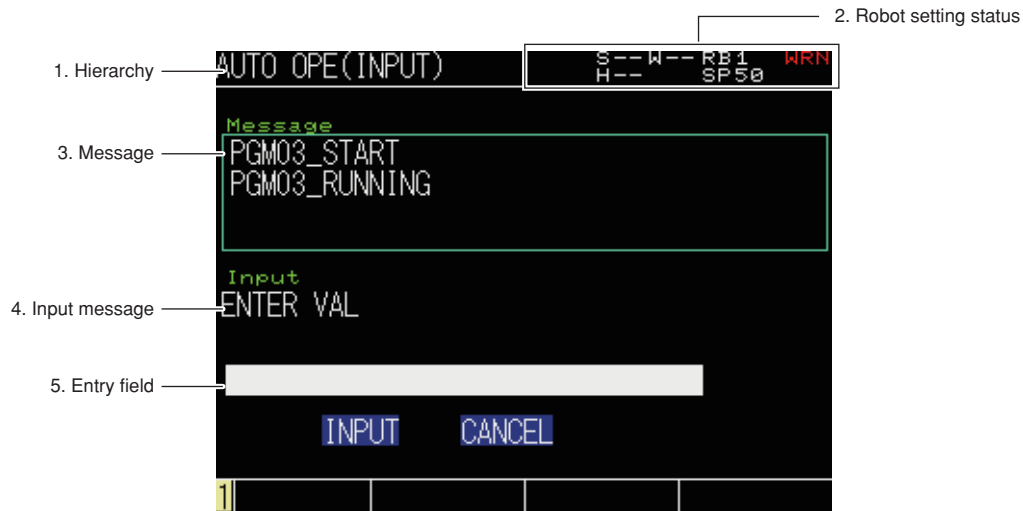

1. Hierarchy

Displays the current hierarchy.

2. Robot setting status

Displays the currently selected robot, shift and so on.

S: 1 . . . Specified "shift coordinate" number

H: 1 . . . Specified "hand definition" number

RBT: 1 . . . Specified "robot number"

SPD: 30 . . . Specified speed

ALM . . . Displayed when any alarm occurs.

SRV . . . Displayed when the servo is on.

AUTO . . . Displayed when the control setting is "RELEASE".

(This is not displayed when the setting is "GET" or the operation is in MANUAL mode.)

SEQ . . . Displayed when the sequence program is executed.

When using multiple robots, the robot number display is changed by changing the target robot on the "QUICK MENU".

3. Message

Displays the output of the PRINT command in the program.

4. Input message

Displays the output of the INPUT command in the program.

5. Entry field

Displays values or character string to the INPUT command in the program.

Valid keys and sub-menu descriptions in the MANUAL mode are shown below.

Valid keys	Menu	Function
		Moves the cursor.
		Executes automatic operation.
		Stops automatic operation.

4.10.1 Inputting message

Input the data into INPUT command in the program.

Input the data into the entry field using the operation keys and press the ENTER key to define.

Select "INPUT" using the cursor keys and press the ENTER key to send the data.

4.10.2 Canceling INPUT command

Select "CANCEL" using the cursor keys and press the ENTER key to cancel "INPUT" command in execution. The program execution line will move to the next line after canceling the command.

4.11 Debug function

The program step execution or break point setting is performed with the debug function. Select the program to debug on the "AUTO OPE (SEP)" screen and press the F6 key (DEBUG). The "DEBUG" screen will appear.

■ "DEBUG" screen



1. Hierarchy

Displays the current hierarchy.

2. Robot setting status

Displays the currently selected robot, shift and so on.

S: 1 . . . Specified "shift coordinate" number

H: 1 . . . Specified "hand definition" number

RBT: 1 . . . Specified "robot number"

SPD: 30 . . . Specified speed

ALM . . . Displayed when any alarm occurs.

SRV . . . Displayed when the servo is on.

AUTO . . . Displayed when the control setting is "RELEASE".

(This is not displayed when the setting is "GET" or the operation is in MANUAL mode.)

SEQ . . . Displayed when the sequence program is executed.

3. Program

Displays the program.

4. Execution line













Displays the line on which the program stops.

When performing the step execution, the step displayed on the execution line is executed.

5. Guide line

Displays the contents assigned to the function keys.

Valid keys and submenu descriptions on the "DEBUG" screen are shown below.

Valid keys	Menu	Function
		Moves the cursor.
		Executes the automatic operation.
		Stops the automatic operation.
	RESET	Resets the program currently selected.
	STEP	Executes one line displayed in the execution line display and moves the execution line display to the next line.
	SKIP	Skips to the next line without executing one line displayed in the execution line display.
	NEXT	Executes one line displayed in the execution line display and moves the execution line display to the next line.
	RUNTO	Executes from the line on the execution line to the line at the cursor position.
	BP SET	Sets the break points.
	BP DEL	Deletes the break points.
	BP CLR	Deletes all set break points.
	SEARCH	Searches for the break point.

4.11.1 Executing a step



WARNING

The robot may begin to move when step is executed. To avoid danger, do not enter the robot movement range.

Press the F2 key (STEP) to execute the command at the line number displayed in the execution line display and move the execution line display to the next line. When the command is a sub-routine or sub-procedure, its first line is executed.

4.11.2 Skipping a step

When pressing the F3 key (SKIP), the program operation skips to the next line without executing the command at the line number displayed in the execution line display.

4.11.3 Executing the next step



WARNING

The robot may begin to move when step is executed. To avoid danger, do not enter the robot movement range.

When pressing the F4 key (NEXT), the command at the line number displayed in the execution line display is executed and the execution line display moves to the next line. When the command is a sub-routine or sub-procedure, it is executed in the batch mode.

4.11.4 Break points

An ongoing program can be stopped if a break point is set in the program.

The program execution pauses on the line just prior to a break point.

The program execution will restart from the break point when the RUN key is pressed.



NOTE

- Up to 32 break points can be set for one program.
- Break points are omitted during step execution or next execution.
However, when performing the next execution of the sub-routine with break points set, the break points are valid.

■ Setting break points

Step 1 Select the line where to set a break point.

Move the cursor to a line to set the break point on the "DEBUG" screen (Operation → Automatic Operation → Debug).

▶ Step 1 "DEBUG" screen

```

DEBUG
0001 *L:1
0002 DRIVE(3,0,0)↓
0003 WAIT ARM!
0004 DRIVE(3,P10)↓
0005 WAIT ARM!
0006 DRIVE(3,0,0)↓
0007 WAIT ARM!
0008 PUSH(3,P10),DS=20↓
0009 WAIT ARM!
0010 GOTO *L1
RESET STEP SKIP NEXT
  
```

Step 2 Set the break point.

When pressing the F6 key (BP SET), the break point is set on the selected line and "*" is shown on the right of the line number.

▶ Step 2 "DEBUG" screen (break point)

```

DEBUG
0001 *SEARCH 1,3,10↓
0002 *P33=VGETPIX(0)↓
0003 *HALT!
0004 ↓
0005 ↓
0006 ↓
0007 ↓
0008 ↓
0009 ↓
0010 ↓
RUNTO BP SET BP DEL BP CLR
  
```

■ Searching break points

To search the line number where a break point is set.

When pressing the F9 key (SEARCH) on the "DEBUG" screen (Operation → Automatic Operation → Debug), the operation jumps to the line number with the break point set.

■ Canceling break points

Step 1 Select the break point to cancel.

Move the cursor to a line to cancel the break point on the "DEBUG" screen (Operation → Automatic Operation → Debug).

Step 2 Cancel the break point.

When pressing the F7 key (BP DEL), the break point of the selected line is canceled and "*" shown on the right of the line number disappears. To cancel all the set break points, press the F8 key (BP CLR).

TIP

To find the line number on which another break point was set, press F9 key (SEARCH). This function makes it easier to find a break point that you want to cancel.

4.11.5 RUNTO

The program can be executed from the line displayed in the execution line to the line at the cursor position.

Step 1 Select the execution line area.

Use the cursor keys to move the cursor to a line to stop the program execution on the "DEBUG" screen (Operation → Automatic Operation → Debug).

Step 2 Execute the program until the line at the cursor position.

When pressing the F5 key (RUNTO), the program is executed from the line displayed in the execution line display to the line at the cursor position.



NOTE

To return the execution line display to its top, press the F1 key (RESET).

5. Origin return

Before turning on the power to start the robot operation, it is necessary to set the origin point that becomes the reference for the robot operation.

For absolute type axes, it is necessary to set the origin position only when the robot is put in the return-to-origin incomplete status.

The origin position setting procedure is classified as follows according to the return-to-origin methods and robot axis specifications.

Return-to-origin method	Axis specifications	Return-to-origin type	Return-to-origin when the power is turned on again.
Torque (stroke end) / sensor	Absolute specifications	Return-to-origin	Unnecessary
	Incremental specifications		Necessary
Mark	Absolute specifications	Absolute Reset	Unnecessary
	Incremental specifications		Necessary

*Regardless of the return-to-origin method, the status, in which the origin point that becomes the reference for the robot operation is set, is called "return-to-origin complete status". The status, in which the origin point is not set, is called "return-to-origin incomplete status".

Parameters related to the return-to-origin are available as shown below. For details about each parameter, refer to the YRCX user's manual.

Category	Parameter name	Description
Robot parameter	Origin sequence	Sets the order in which to perform return-to-origin or absolute search on each axis.
Axis parameter	Origin speed	Sets the speed at which to perform return-to-origin or absolute search.
	Origin shift	Sets the offset of origin position data.
	Origin method	Sets the method for performing return-to-origin or absolute search.
	Origin direction	Sets the direction for performing return-to-origin or absolute search.

The return-to-origin incomplete status occurs in the following cases.

- a. An absolute related alarm occurs in the axis.
 - 17.403 Position reset malposition
 - 17.905 Resolver wire breakage
- b. The controller detects the faulty wiring or voltage drop of the absolute battery.
- c. The cable that connects the controller and robot main unit is disconnected.
(The robot is in this status at controller shipment.)
- d. The robot generation is changed.
- e. The parameters are initialized.
- f. The origin shift of the axis parameter, return-to-origin method, return-to-origin direction, and axis polarity are changed.
(The robot enters this status when a part of the parameters are changed.)
- g. The motor is replaced.
- h. All data file (extension is ALL data) or parameter file (extension is PRM data) is written into the controller.

The return-to-origin incomplete status occurs if any of the following alarms occurs. These alarms occur when turning on the controller.

- | | |
|--------|--|
| 17.410 | ABS. battery error during power off |
| 17.411 | Resolver disconnected during power off |
| 17.413 | ABS. overflow error |
| etc. | |

■ Checking the return-to-origin complete status

To check the return-to-origin complete status of each controller axis, select [Operation] - [Origin Return] from

the initial screen.

The "ORIGIN RTN (TRQ/SENS)" screen will appear. Check the return-to-origin status.

■ "ORIGIN RTN (TRQ/SENS)" screen

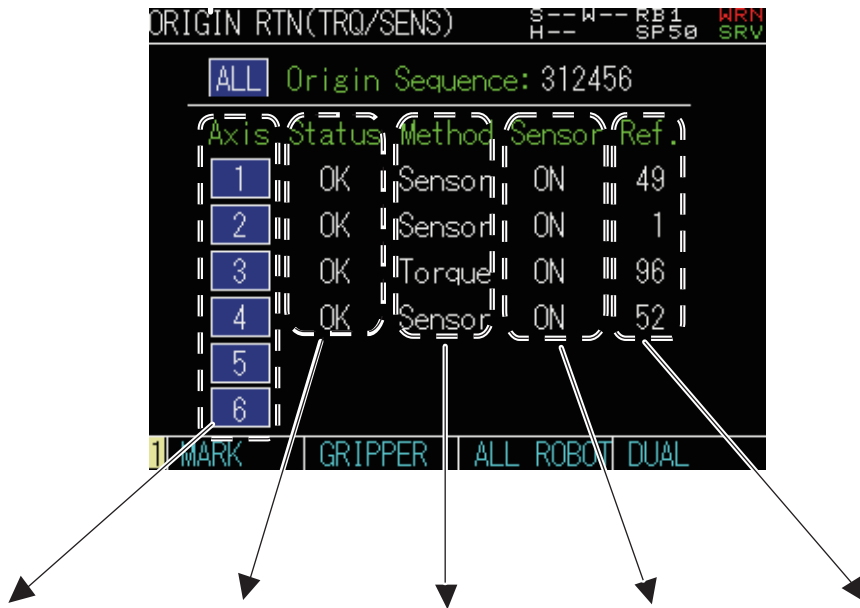

Axis	Return-to-origin complete status	Return-to-origin method	Sensor	Machine reference
Axis 1	Complete	Sensor method	ON	0
Axis 2	Complete	Sensor method	ON	0
Axis 3	Complete	Torque (stroke end) method	ON	0
Axis 4	Complete	Sensor method	ON	0

Subsequently, there are no axes.

5.1 Return-to-origin operation

Return-to-origin methods include the sensor method and torque (stroke end) detection method.

Each return-to-origin method is described below.

Refer to "5.3 Return-to-origin procedure" for instructions on how to perform return-to-origin.

1. Return-to-origin operation using the sensor method

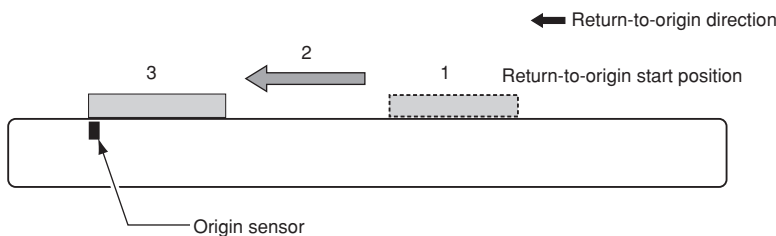

1. Before performing return-to-origin, check that all axes are in positions that allow return-to-origin.

Return-to-origin direction	Position allowing return-to-origin
Minus (-) direction	Plus (+) side from origin sensor position
Plus (+) direction	Minus (-) side from origin sensor position

2. When a return-to-origin operation is started, each axis of the robot moves in the return-to-origin direction.

However, if the origin sensor was on when return-to-origin was started, then the robot first moves in a direction opposite the return-to-origin direction. Then, when the origin sensor turns off, the robot stops and restarts return-to-

origin from that position.

3. After the origin sensor turns on, the robot stops and the origin position is then found. At this point, the current position of each axis is set as an origin shift parameter value.



NOTE

For the sensor method, the return-to-origin starts in the origin sensor on status. When the return-to-origin operation continues without turning off the origin sensor, "17.500: Origin sensor failure" alarm occurs.

2. Return-to-origin operation using the torque (stroke end) detection method

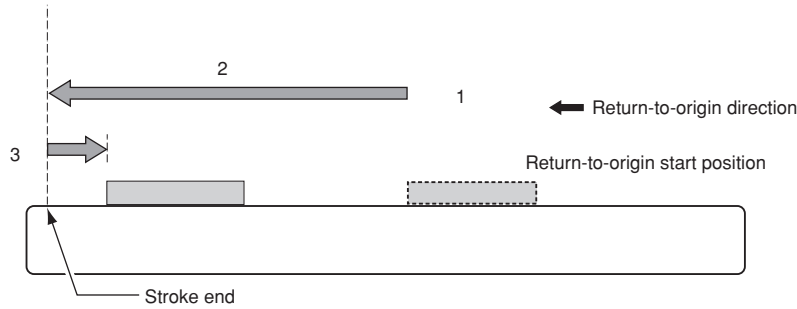

1. In the stroke end detection method, return-to-origin can start from any position.
2. Upon starting return-to-origin, the robot starts moving in the return-to-origin direction.
3. When the robot axis strikes and detects the stroke end, it moves back slightly and stops, and the origin position is then determined. At this point, the current position of the axis is set as an origin shift parameter value.



CAUTION

For the stroke end method, if the robot arm interferes with an obstacle or a load is applied to the motor during return-to-origin, the return-to-origin may complete at an incorrect position. Additionally, if the return-to-origin is stopped during contacting the stroke end, "17.800: Motor overload" alarm may occur.



NOTE

When using "ZR stroke-end method" for return-to-origin, stroke-end method will be performed on both Z and R-axis at the same time.

5.2 Return-to-origin procedure

The robot must be at servo-on status to perform return-to-origin operation.

The return-to-origin procedure is shown below. The absolute search procedure is the same as the return-to-origin procedure.



WARNING

The robot starts moving as soon as return-to-origin is performed. To avoid hazardous situations, do not enter the robot movement range.



CAUTION

Before performing return-to-origin, check that axes are in positions that allow return-to-origin operation. Emergency stop might be triggered if return-to-origin or absolute search is simultaneously performed on three or more axes whose return-to-origin method is the stroke end detection method. In this case, change the setting so that stroke end return-to-origin or absolute search is simultaneously performed on two axes or is performed separately on each axis.



NOTE

When using multiple robots, the return-to-origin is performed one robot by one robot.

Step 1 Move to the "ORIGIN RTN (TRQ/SENS)" screen.

Use the cursor keys to select (Operation) from the initial screen, and then press the ENTER key. Next, use the cursor keys to select (Origin Return), and then press the ENTER key.

Step 1 "ORIGIN RTN (TRQ/SENS)" screen



Step 2 Perform the return-to-origin.

Use the cursor keys to select the axis number for the return-to-origin or (ALL) (all axes), and then press the ENTER key.

The return-to-origin execution confirmation screen will appear.

Step 2 Confirming the return-to-origin execution



NOTE

If there are mark method axes when performing the return-to-origin of all axes, absolute reset of all mark method axes is performed, and then the return-to-origin of the axes other than the mark method axes is performed.

When pressing the RUN key on the confirmation screen, the return-to-origin is then started. After the return-to-origin has been completed, press the ENTER key to return to the "ORIGIN RTN (TRQ/SENS)" screen.

To stop the return-to-origin, press the STOP key. At this time, after the return-to-origin has been completed, press the ENTER key to return to the "ORIGIN RTN (TRQ/SENS)" screen.

The message, "1.8 Stop executed", will appear.

Step 3 Check the machine reference.

After the return-to-origin operation has been completed, "Ref." (machine reference) and "Status" are displayed on the "ORIGIN RTN (TRQ/SENS)" screen.
 Check that the machine reference is within the tolerable value and that the status is "OK".
 Press the ESC key to return to the initial screen.

Step 3 "ORIGIN RTN (TRQ/SENS)" screen



NOTE

- Refer to "5.1 Return-to-origin operation" in this Chapter for details on return-to-origin operation and "5.2 Semi-absolute" in this Chapter for details on absolute search operation.
- The machine reference is expressed as a percentage of the number of position detection pulses showing the difference between the origin sensor signal and position detector reference signal (encoder zero signal, etc.). This is also called the "grid position" or "grid pulse".
- When the return-to-origin has been completed, the return-to-origin does not need to be performed again even when pressing the emergency stop button.
 For increment type axes, the return-to-origin needs to be performed again when turning off the controller.

5.3 Absolute reset (mark method) procedure

For axes with mark method, the return-to-origin is not performed.

For the mark method, absolute reset is performed from the programming box. Therefore, when the robot is in the servo on status, use the Jog keys to move the robot to a position where absolute reset is possible. When the robot is in the servo off status, use the direct movement to do so.

For absolute reset, the robot origin position can be set at a desired position.



WARNING

During absolute reset in the servo on status, pressing the jog keys will operate the robot. Therefore, do not enter the robot movement range to prevent any hazard.

Key operation to move the robot to a position where absolute reset is possible.

The current position of axis 1 is "1" (machine reference: 82%).

When pressing , the axis moves to "2", and then it moves to a position where the machine reference is about 50%.

When pressing , the axis moves to "3", and then it moves to a position where the machine reference is about 50%.

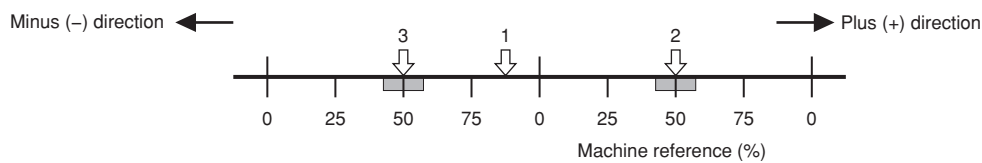

█ : Range in which absolute reset can be made (44 to 56%).

Position where absolute reset can be performed and "0" pulse position

When performing absolute reset at position A, position B (machine reference 38%) is reset as "0" pulse position. The axis moves to the "0" pulse position after resetting when performing absolute reset in the servo on status.



WARNING

When performing absolute reset in the servo on status, the robot operates slightly. Therefore, do not enter the robot movement range to prevent any hazard.

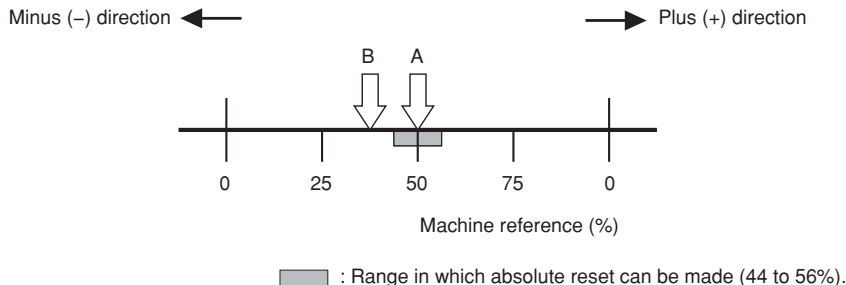

Absolute reset procedure in servo on status

Step 1 Move to the "ORIGIN RTN (MARK)" screen.

Select (Operation) - (Origin Return) from the initial screen. The "ORIGIN RTN (TRQ/SENS)" screen will appear. Press the F1 key (MARK) on it.

Step 1 "ORIGIN RTN (MARK)" screen



Step 2 Select the axis to perform absolute reset.

Use the cursor keys to select the axis number for absolute reset, and then press the ENTER key. Absolute reset execution confirmation screen will appear.

Step 2 Confirming the absolute reset execution



Step 3 Move the axis to a position where absolute reset is possible.

Press the Jog key to move the specified axis to a position where absolute reset is possible.



WARNING

The robot starts to move when a Jog key or movement key is pressed. To avoid danger, do not enter the robot movement range.



NOTE

If the robot controller is in origin incomplete due to some kind of problem, perform absolute reset on the axis which was unable to return-to-origin. After absolute reset, always check if the axis can move to the same position as before origin incomplete.

Step 4 Perform absolute reset.



WARNING

The robot starts to move slightly when absolute reset is performed while the servo is on. To avoid danger, do not enter the robot movement range.

Press the ENTER key on the "ORIGIN RTN (MARK)" screen to complete absolute reset.
After absolute reset has been completed, the axis moves to the "0" pulse position.
When absolute reset is not executed, press the ESC key.

Step 5 Check the status.

"Status" is displayed on the "ORIGIN RTN (MARK)" screen.
Check that the machine reference is within the tolerable value and that the status is "OK". Press the ESC key to return to the initial screen.

▶ Step 5 Checking the status

Axis	Status	Method	Sensor	Ref.
1	OK	Sensor	ON	38
2	OK	Sensor	ON	38
3	OK	Torque	ON	38
4	OK	Sensor	ON	38
5				
6				

■ Absolute reset procedure in servo off status

Step 1 Move to the "ORIGIN RTN (MARK)" screen.

Use the cursor keys to select (Operation) from the initial screen, and then press the ENTER key.
Next, select (Origin Return), and then press the ENTER key.

▶ Step 1 "ORIGIN RTN (MARK)" screen

Axis	Status	Method	Sensor	Ref.
1	NG	Sensor	OFF	41
2	NG	Sensor	OFF	44
3	NG	ZR-Torque	ON	88
4	NG	ZR-Torque	ON	79
5				
6				

Step 2 Move the axis to a position where absolute reset is possible.

Press the emergency stop button on the programming box to put the robot in the emergency stop status. Move the target axis by hand to a position where absolute reset is performed. At this time, take appropriate measures so that the "Ref." (machine reference) display is within a range of 44 to 56.



NOTE

When the machine reference display is not within a range of 44 to 56, "17.403: Position rest malposition" alarm appears and absolute reset ends abnormally.
If a failure occurs and the controller enters the return-to-origin incomplete status, perform absolute reset for the axis in the return-to-origin incomplete status. After absolute reset has been completed, be sure to check that the axis moves to the same position as the position before the axis enters the return-to-origin incomplete status.



WARNING

Be sure to press the emergency stop button and move the robot in the status where the servo on cannot be operated from the outside.

Step 3 Select the axis to perform absolute reset.

Use the cursor keys to select the axis number for absolute reset, and then press the ENTER key.
Absolute reset execution confirmation screen will appear.

Step 4 Perform absolute reset.

Press the ENTER key on the confirmation screen to complete absolute reset.
When absolute reset is not executed, press the ESC key.

Step 5 Check the status.

"Status" is displayed on the "ORIGIN RTN (MARK)" screen.
Check that the machine reference is within the tolerable value and that the status is "OK". Press the ESC key to return to the initial screen.

Step 3 Confirming the absolute reset execution**Step 5 "ORIGIN RTN (MARK)" screen**

5.4 Return-to-origin for all robots

Step 1 Move to the "ORIGIN RTN (ALL ROBOT)" screen.

Use the cursor keys to select (Operation) from the initial screen, and then press the ENTER key. Next, press the F3 key (ALL ROBOT), and then press the ENTER key.

Step 1 "ORIGIN RTN (ALL ROBOT)" screen**Step 2 Select [ALL ROBOT & GRIPPER] and press the ENTER key.**

Confirmation message will appear.
Press the RUN key to start return-to-origin and then the ENTER key to return to the "ORIGIN RTN (TRQ/SENS)" screen.
To halt the operation, press the STOP key.

Step 2 Confirming the return-to-origin execution

Step 3 Check the display turns "OK".

As the return-to-origin conditions of each axis and gripper are displayed, confirm now they are "OK".

Press the ESC key to return to the initial screen.

Step 3 "ORIGIN RTN (ALL ROBOT)" screen



6. Dual offset

When two drive axes are the completely same, they can be controlled as one drive axis, which is called "Dual axis". The first one is "main axis" and the second one is "sub axis".

"Dual offset" function is adjusting of the sub axis origin position for that of the main axis, and used mainly in the following cases:

1. On the dual axis with Rigid dual setting;

Lack of connective rigidity between the main and sub axes makes the origin position of sub axis uneven.

2. On the dual axis with Flexible dual setting; How to adjust the sub-axis origin position.

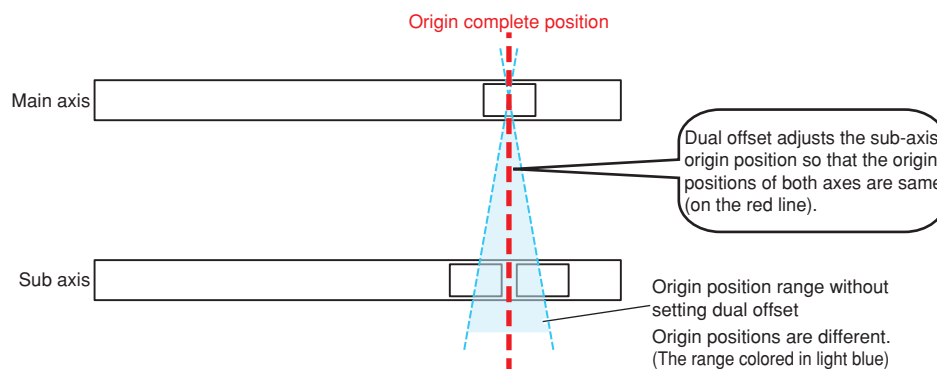

■ Software version

Host CPU software	Ver.1.30, R0255 or later
Driver CPU software	Ver.1.11, R0017 or later
PBEX (Programming box) main software	Ver.1.10 or later

6.1 Dual offset settings

Set the dual offset with the programming box. Follow the procedure below.



CAUTION

- By changing positions influencing dual offset, such as changing installation position of the main and sub axes, changing connection assembly and changing origin sensor position for each axis, dual offset function that has already been set may malfunction. Therefore, make sure to dual offset automatic setting after changing such positions.
- It is required to set dual offset even if the same model is purchased.

6.1.1 Automatic dual offset setting

Step 1 Turn the servo on of the axis to set dual offset.

Step 2 Select [Operation] from the initial screen and then [Origin Return] to display the "ORIGIN RTN" screen.

Step 3 Press the F3 key (DUAL) to display the "ORIGIN RTN (DUAL)" screen.

Step 3 "ORIGIN RTN (DUAL)" screen

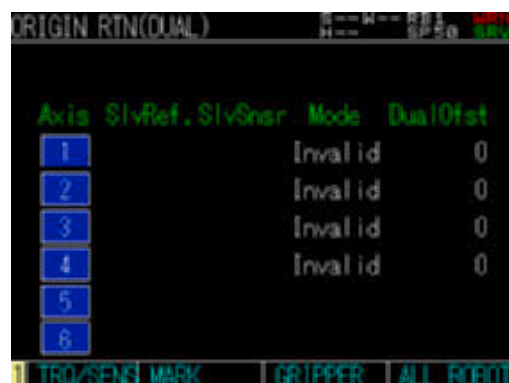

Step 4 Select the axis to set dual offset and display the execution pop-up screen.

Step 4 Execution pop-up screen



Step 5 Input "2" to set "Mode" and press the ENTER key.

Step 5 Changing the setting

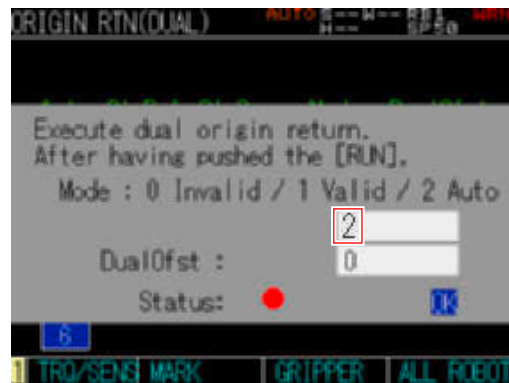

Step 6 Press the RUN key to perform dual return-to-origin.

When it is complete, the "Status" turns green.

Step 7 Press [OK]. Confirm the "Mode" on the screen is now "Valid" and the "DualOfst" value is set.

Step 7 "ORIGIN RTN (DUAL)" screen



If the sub-axis origin position is acceptable, automatic setting of the dual offset is complete. Follow the next procedure when adjusting the sub-axis origin position furthermore.

6.1.2 Adjusting dual offset

Step 1 Display the pop-up screen for executing in the same procedure of "6.1.1 Automatic dual offset setting".

Step 2 Confirm the "Mode" value is set to "1".

Step 3 The setting value of "DualOfst" is the value set by automatic setting. Input value that is added to/reduced from the distance (pulse) to offset the sub-axis origin position, and then press the ENTER key. Refer to the illustrations below.

Step 1,2 Execution screen

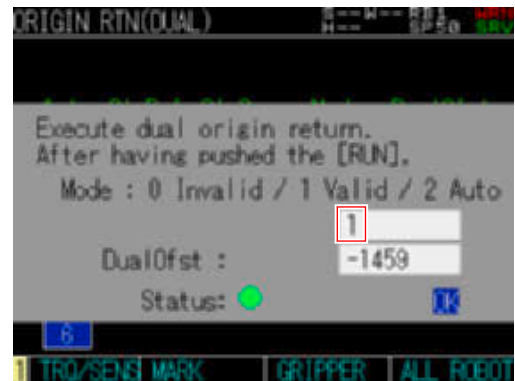

Make dual offset the plus (+) direction

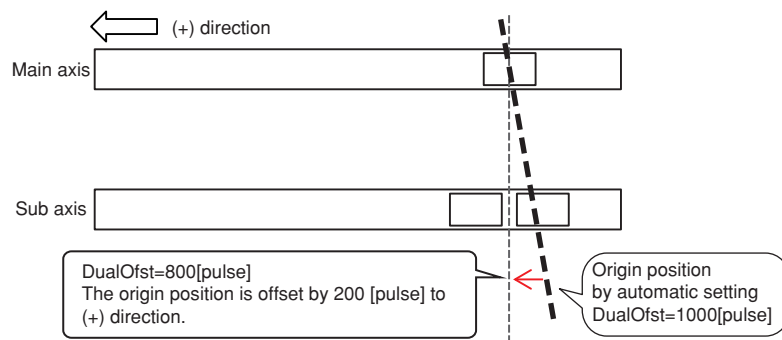

Make dual offset the minus (-) direction

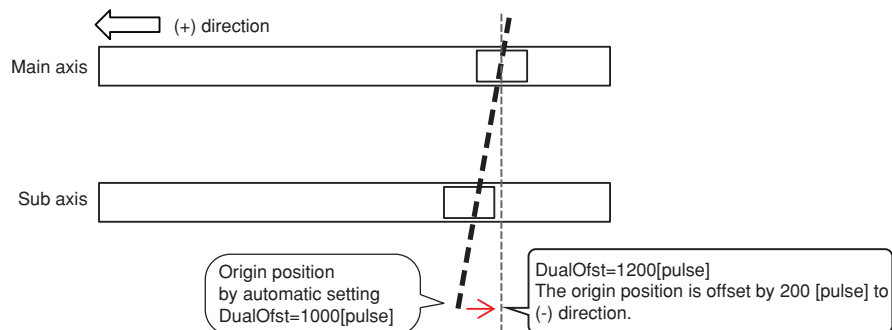

NOTE

- For ball screw type robots;
Slider movement distance (mm/pulse) = Ball screw lead*¹ (mm) / 16384*² (pulse)
 - For Linear type robots;
Slider movement distance (mm/pulse) = 0.001 mm/pulse
- *1 Refer to the robot specification for ball screw lead.
*2 Pulse number per motor rotation (depends on the model)

Step 4 Perform dual return-to-origin with pressing the RUN key.

When return-to-origin is complete, the "Status" turns green.

Step 5 Confirm the sub-axis origin position.

When the adjusting is not enough with the sub-axis origin position, repeat Step 3 to 5.

Chapter 4 Edit

1. Point editing	4-1
1.1 Inputting/editing point data	4-3
1.2 Point data input by teaching	4-4
1.3 Point data input by direct teaching	4-6
1.4 Jumping point display	4-6
1.5 Copying point data	4-6
1.6 Deleting point data	4-7
1.7 Executing point trace	4-7
1.8 Deleting point name	4-7

2. Program editing	4-8
2.1 Selecting the program	4-9
2.2 Creating a new program	4-10
2.3 Editing the program	4-10
2.3.1 Cursor movement	4-11
2.3.2 Quitting program editing	4-11
2.3.3 Switching between the "insert" and "overwrite" modes	4-11
2.3.4 Inserting a line	4-12
2.3.5 Deleting one character	4-12
2.3.6 Backspace	4-12
2.3.7 Copying/cutting a program	4-12
2.3.8 Searching a character string	4-12
2.3.9 Jumping step	4-13
2.3.10 Checking entry data	4-13
2.4 Compiling sequence program	4-13
2.5 Setting a main program	4-14
2.6 Changing a program attribute	4-14
2.7 Deleting a program	4-15
2.8 Changing a program name	4-15
2.9 Copying a program	4-16
2.10 Resetting an alarm	4-16

3. Shift coordinates	4-17
3.1 Creating new shift coordinates	4-20
3.2 Editing shift coordinates	4-21
3.3 Setting shift coordinate 1	4-21
3.4 Setting shift coordinate 2	4-23
3.5 Selecting shift coordinates	4-24

Chapter 4 Edit

4. Hand definitions	4-25
4.1 Data format of hand definition	4-26
4.1.1 SCARA type robots	4-27
4.2 "HAND EDIT"/"CREATING NEW HAND" screen	4-28
4.3 Creating new hand definitions	4-30
4.4 Editing hand definitions	4-31
4.5 Setting hand definitions	4-31
4.6 Selecting hand definitions	4-32

5. Work definitions	4-33
5.1 Data format of work definition	4-34
5.2 Creating new work definitions	4-34
5.3 Editing work definitions	4-35
5.4 Selecting work definitions	4-36

6. Pallet definitions	4-37
6.1 Creating new pallet definitions	4-39
6.2 Editing pallet definitions	4-40
6.3 Setting pallet definitions	4-40
6.4 Setting point of pallet definitions	4-41

7. Parameters	4-42
7.1 Parameter setting conditions	4-42
7.2 Setting the parameters	4-42
7.3 Parameter list	4-44
7.4 Parameter descriptions	4-47
7.4.1 Controller parameters	4-47
7.4.2 Robot parameters	4-49
7.4.3 Axis parameters	4-52
7.4.4 I/O parameters	4-58
7.4.5 Option board related parameters	4-60
7.5 PRM skip	4-64

8. Area check output	4-65
8.1 Setting area check output	4-65
8.2 Initializing area check output	4-66
8.3 Parameter list	4-67

9. Standard coordinates	4-68
9.1 Setting the standard coordinates by simple teaching	4-70
9.2 Setting the standard coordinate by 3-point teaching	4-72
9.3 Setting the standard coordinate by 4-point teaching	4-73
9.4 Setting the standard coordinate by both handed system teaching	4-75

10. General Ethernet port (GEP) setting	4-77
--	-------------

1. Point editing

When selecting [Edit] - [Point Edit] from the initial screen, the "POINT EDIT" screen will appear. One point consists of 6 axes data (axis 1, axis 2, axis 3, axis 4, axis 5, and axis 6). For the point data that is set in the Cartesian coordinate system ("mm" units), the hand system flag, first arm rotation information, and second arm rotation information can be set as expansion settings.

Point data format

Axis 1	Axis 2	Axis 3	Axis 4	Axis 5	Axis 6	Hand system (FLG)
fxxxxxx	fyyyyyy	fzzzzzz	frrrrrr	faaaaaa	fbbbbbbb	t

f.....Coordinate sign: + / - / space
 xxxxxx././bbbbbbNumeric value of up to 8 digits. When the numeric value includes a dot, the coordinate system becomes that in "mm" units.
 t.....Hand system flag of the expansion settings of SCARA type robots
 0 : No setting (Conforms to the selected arm type setting.)
 1 : Right-handed system
 2 : Left-handed system

- The hand system flag is valid only when the coordinate system in "mm" units is specified.
- When a numeric value other than "1" and "2" is specified for the hand system flag or when no numeric value is specified, the hand system flag setting becomes none (0).
- When a numeric value other than "0", "1", and "-1" is specified for the first arm rotation information and second arm rotation information or when no numeric value is specified, the setting becomes "0".

The point number can be specified in a range of 0 to 29999.



NOTE
 When using multiple robots, the point data is used commonly.

The current position (upper portion) and axis data to two points are displayed on the screen. To see other data, use the cursor keys to scroll the screen.

Press the cursor up or down key to scroll up or down one line.

When the scroll function is ON (this function is changed every time the SCROLL ON key is pressed), press the cursor up or down key to scroll up or down one screen (two points).



CAUTION
 Repetitive positioning accuracy in the robot specifications does not apply to the stop position of a different hand system if it is used to move to a point data on the Cartesian coordinates (units: mm).

■ "POINT EDIT" screen

The screenshot shows the "POINT EDIT" screen with the following data and callouts:

- 1. Hierarchy: POINT EDIT
- 2. Robot setting status: S:0 RBT:1 H:0 SPD:20
- 3. Current position: CURRENT [pulse] 1: 2 2: 5 3: 0 4: 0 5: 0 6: 0
- 4. Coordinate unit system: [pulse]
- 5. Point number: P0
- 6. Point name: PNTNAME001
- 7. Hand system: FLG: FG1: FG2:
- 8. First arm and second arm rotation information: 1: 100 2: 200 3: 300 4: 400 5: 500 6: 600
- 8. Guide line: JUMP COPY DEL UNIT

1. Hierarchy

Displays the current hierarchy.

2. Robot setting status

Displays the currently selected robot, shift and so on.

S : 1 ' ' ' Specified "shift coordinate" number

H : 1 ' ' ' Specified "hand definition" number

RBT : 1 ' ' ' Specified "robot number"

SPD : 30 ' ' ' Specified speed

ALM ' ' ' Displayed when any alarm occurs.

SRV ' ' ' Displayed when the servo is on.

AUTO ' ' ' Displayed when the control setting is "RELEASE".
(This is not displayed when the setting is "GET" or the operation is in MANUAL mode.)

SEQ ' ' ' Displayed when the sequence program is executed.

When using multiple robots, the robot number display is changed by changing the target robot on the "QUICK MENU".

3. Current position

Displays the current position of the robot. The current position is displayed by an integer when using "pulse" units. When using "mm" units, the position is displayed by a value with the decimal point.

4. Coordinate unit system

Displays the coordinate unit system. The unit shows [pulse], [mm], or [mm](tool).

5. Point number

Displays the selected point number.

The selected point data is displayed in yellow.

6. Point name

Displays the point name when the point name is registered into the displayed point.

The selected point data is displayed in yellow.

7. Hand system

0: No hand system setting (Standard coordinates are not set.)

1: Right-handed system

2: Left-handed system

8. Guide line

Displays the contents assigned to the function keys.

Valid keys and submenu descriptions on the "POINT EDIT" screen (Edit → Point Edit) are shown below.

Valid keys	Menu	Function
		Moves the cursor or scrolls the screen.
		Switches between the "insert" and "overwrite" modes alternately.
		Deletes one character on the left of the cursor position.
		Deletes one character at the cursor position.
		Returns the edit contents before setting to its original status. Returns to the initial screen when the data is not edited.
	JUMP	Displays the pop-up screen, allowing you to input the jump destination point number.
	COPY	Copies the point data.
	DEL	Deletes the point data.
	UNIT	Changes the display unit of the current position to [pulse], [mm], and [mm] (tool) in order.
	TRACE	Moves to the "PTP (ALL)" screen.
	JOG	Moves to the "JOG" screen.
	NAME DEL	Deletes the point name.

1.1 Inputting/editing point data

Step 1 Select the point data to input/edit.

Use the cursor keys on the "POINT EDIT" screen (Edit → Point Edit) to select the point data to input/edit.
The selected point data is displayed in yellow.

Step 2 Input the point data or point name.

Input the point data or point name, and then press the ENTER key to set the data you have input.
The cursor moves to the point data of the next axis.

Step 1 "POINT EDIT" screen



Data entry format is shown below.

When registering new point data, input the point data for all axes, axis 1 to axis 6. When the registration is completed even if there is an axis without inputting data, "4.202: input format error" occurs. If the data format is incorrect, the alarm message, such as "5.206 Digit number error", etc. appears. Input the data in the correct format.

- To input the data in joint coordinates ("pulse" units)
Input an integer of up to 8 digits. : ±#####
When the number of display digits is set to 8 in SYSTEM>PARAM mode, data is displayed in 8 digits as in ±#####.
- To input the data in Cartesian coordinates ("mm" units)
Input a number consisting of an integer portion of up to 5 digits and having 3 or less places below the decimal point. : ±###.##,±####.#,±#####.
When the number of display digits is set to 8 in SYSTEM>PARAM mode, data is displayed in 8 digits as in ±#####.##, ±#####.#, and ±#####.
- Setting the hand system flag in SCARA type robots
Set "1" or "2" for FLG. When a numeric value other than "1" and "2" is specified or when no numeric value is specified, "0" is set as non-hand system flag setting.
 - 1 : Shows that the point is set in the right-handed system.
 - 2 : Shows that the point is set in the left-handed system.
 - 0 : The range of the angle data x (*1) after converted from "mm" to "pulse" is -180.00 degrees < x <= 180.00 degrees.
 - 1 : The range of the angle data x (*1) after converted from "mm" to "pulse" is 180.00 degrees < x <= 540.00 degrees.
 - 1 : The range of the angle data x (*1) after converted from "mm" to "pulse" is -540.00 degrees < x <= -180.00 degrees.(*1) This angle data is that the pulse data after converted into the joint coordinates is converted into the angle from the mechanical origin of each arm.
- Setting the point name
Characters used for the name data are only alphanumeric characters and "_" (underscore). Up to 16 characters are used.
If characters exceeding 16 characters are input, characters after the 17th character are deleted.
Only alphabetic character or underscore is used for the first character of the point name.



NOTE

The maximum point data capacity is approximately 2100 KB.
Since the point data area is shared with the program, the capacity may decrease depends on the amount of program.
Example: In the case of 6 100-KB programs, the capacity decrease 1500 KB and approximately 250000 points can be used.

Step 3 Set the point data registration.

To complete the point data registration, press the ENTER key or right cursor key until the cursor moves to the point name area.

To cancel the point data registration, press the ESC key.

■ Restoring the point data

When pressing the ESC key while the point data is being edited, the data you have input is canceled and it returns to the data before inputting. This function is valid only for the point data before the registration is completed.

1.2 Point data input by teaching

The current position of the robot can be registered as point data by teaching.
To directly load the current position of the point data, use the "JOG" screen.



WARNING

The robot moves during teaching. To avoid danger, do not enter the robot movement range.

**CAUTION**

- When using multiple robots, be sure to check the current target robot.
- The robot is changed from the "QUICK MENU". For details, refer to "5.2 Quick menu" in Chapter 2.

**NOTE**

- In the return-to-origin incomplete status, the teaching of the point data cannot be performed. Be sure to perform the teaching after the return-to-origin has been performed.
- When performing the teaching of the point data in "mm" units, the hand system information during teaching is input for the hand system information of the point data.
- "0" is set for the first arm rotation information and second arm rotation information.

Step 1 Select the point.

Use the cursor keys or the jump function on the "POINT EDIT" screen (Edit → Point Edit) to select the point number to input.

* For details about jump function, refer to "1.4 Jumping point display" in this Chapter.

Step 1 "POINT EDIT" screen**Step 2 Display the "JOG" screen.**

Press the F6 key (JOG) to display the "JOG" screen.

Step 2 "JOG" screen**Step 3 Move the robot axis.**

Move the robot axis using the Jog keys. The current position values change as the axis moves.

Step 4 Teaching confirmation pop-up screen**Step 4 Execute the teaching.**

When the axis reaches the target position, press the F3 key (TEACH). The confirmation pop-up screen appears. Select (OK) and press the ENTER key. When selecting (CANCEL), the teaching is canceled.

The input format of point data for teaching is the same as the current position display.

**CAUTION**

- The robot will not move to the same position if moving with a hand system different from that used for teaching. When changing the hand system that was used for registering the point data, re-teach the position using the hand system that you have changed to.

1.3 Point data input by direct teaching

Point data can also be registered by direct teaching (moving the robot by hand to the target point while the robot servo is off). To directly load the current position of the point data, use the "JOG" screen.



WARNING

Before starting direct teaching, press the emergency stop button on the programming box so that the servo will not turn on by external operation.

Step 1 Activate emergency stop.

Press the emergency stop button on the programming box

Step 2 Execute point teaching.

For point data teaching methods, refer to "1.2 Point data input by teaching" in this Chapter. In this procedure, move the robot by hand since the Jog keys cannot be used.



NOTE

When the robot is in the servo off status, the automatic operation or Jog operation cannot be performed. To put the robot in the servo on status, use the programming box or dedicated input. For details, refer to "1. Servo operation" in Chapter 3 or the YRCX user's manual.

1.4 Jumping point display

Point data can be displayed from the point numbers you have specified.

When pressing the F1 key (JUMP) on the "POINT EDIT" screen (Edit → Point Edit), the pop-up screen will appear, allowing you to specify the point number. Input the jump destination point number, and then press the ENTER key.

Next, use the cursor keys to select [OK], and then press the ENTER key.

The point data is displayed from the specified point number.



NOTE

Valid point numbers are from 0 to 29999.



Point number designation pop-up screen



1.5 Copying point data

Point data can be copied under another point number.



NOTE

When the hand system flag is set for the point data, the hand system flag is also copied.

Step 1 Display the "POINT DATA COPY" pop-up screen.

When pressing the F2 key (COPY) on the "POINT EDIT" screen (Edit → Point Edit), the "POINT DATA COPY" pop-up screen will appear.

Step 2 Input the point number range to copy.

Input the point numbers for the copy range and destination, then press the ENTER key.



NOTE

Valid point numbers are from 0 to 29999.



Step 1,2 Copying the point data



Step 3 Copy the point data

Use the cursor keys to select (OK), and then press the ENTER key.
The point data in the specified range is copied to the start number of the copy destination.
When pressing the ESC key before executing the copy, the copy process is then canceled.

1.6 Deleting point data

Step 1 Display the "POINT DATA DELETE" pop-up screen.

When pressing the F3 key (DEL) on the "POINT EDIT" screen (Edit → Point Edit), the "POINT DATA DELETE" pop-up screen will appear.

Step 2 Input the point number range to delete.

Input the point numbers for the delete range, and then press the ENTER key.



NOTE
Valid point numbers are from 0 to 29999.

Step 1,2 Deleting point data



Step 3 Delete the point data.

Use the cursor keys to select (OK), and then press the ENTER key.
The point data in the specified range is deleted.
When pressing the ESC key before executing the data delete, the delete process is then canceled.

1.7 Executing point trace

Positions of point data you have input can be checked by actually moving the robot.
To execute the point trace, press the F5 key (TRACE) on the "POINT EDIT" screen (Edit → Point Edit) to display the "PTP (All)" screen.
After that, use the point trace function to execute the point trace. For details, refer to "3. Point trace" in Chapter 3.



WARNING
The robot starts to move when point trace is executed. To avoid danger, do not enter the robot movement range.

1.8 Deleting point name

The point name can be deleted.

Step 1 Display the "POINT NAME DELETE" pop-up screen.

When pressing the F7 key (NAME DEL) on the "POINT EDIT" screen (Edit → Point Edit), the "POINT NAME DELETE" pop-up screen will appear.

Step 2 Input the point number range to delete.

Input the point numbers for the delete range, and then press the ENTER key.



NOTE
Valid point numbers are from 0 to 29999.

Step 1,2 Deleting point name



Step 3 Delete the point name.

Use the cursor keys to select (OK), and then press the ENTER key.
The point name in the specified range is deleted.
When pressing the ESC key before executing the copy process, the delete process is then canceled.

2. Program editing

In the program editing, you can edit or delete the robot language program.

When inputting the program edit initial screen (Edit → Program Edit) by selecting [Program Edit] on the "Edit" pop-up screen that is displayed from the Menu screen, the "PROGRAM SELECTION" screen will appear as shown in the figure below. The "PROGRAM SELECTION" screen displays the information on the program currently selected.

■ "PROGRAM SELECTION" screen

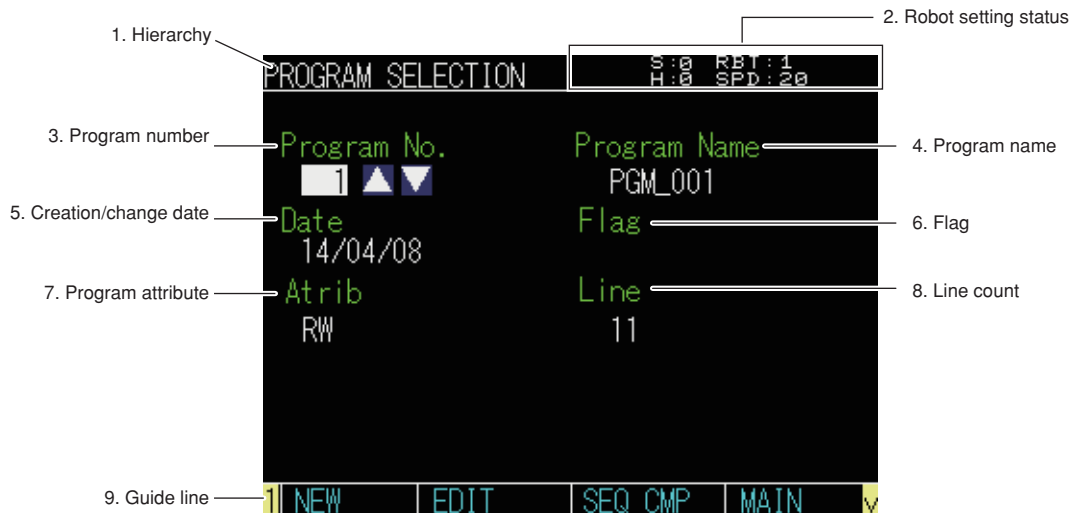

1. Hierarchy

Displays the current hierarchy.

2. Robot setting status

Displays the currently selected robot, shift and so on.

S: 1 . . . Specified "shift coordinate" number

H: 1 . . . Specified "hand definition" number

RBT: 1 . . . Specified "robot number"

SPD: 30 . . . Specified speed

ALM . . . Displayed when any alarm occurs.

SRV . . . Displayed when the servo is on.

AUTO . . . Displayed when the control setting is "RELEASE".

(This is not displayed when the setting is "GET" or the operation is in MANUAL mode.)

SEQ . . . Displayed when the sequence program is executed.

When using multiple robots, the robot number display is changed by changing the target robot on the "QUICK MENU".

3. Program number

Displays the selected program number.

4. Program name

Displays the program name (name attached to the program).

5. Creation/change date

Displays the program creation or update date.

6. Flag

Displays "m" when the main program is specified, "c" when the current program exists, "s" when the object for the sequence program is shared, and nothing in other cases.

7. Program attribute

Displays the program attribute.

8. Line count

Displays the number of program lines.

9. Guide line

Displays the contents assigned to the function keys.

Valid keys and submenu descriptions on the "PROGRAM SELECTION" screen are shown below.

Valid keys	Menu	Function
		Moves the cursor.
	NEW	Creates a new program.
	EDIT	Moves to the "PROGRAM EDIT" screen.
	SEQ CMP	Moves to the screen that allows you to compile the sequence program.
	MAIN	Moves to the screen that allows you to set the program currently selected to the main program.
	AUTO OPE	Moves to the "AUTO OPE" screen for the selected program.
	ATRIB	Moves to the screen that allows you to change the program attribute.
	DEL	Deletes the program.
		Returns to the previous screen.



NOTE

- Refer to the separate YRCX programming manual for details on the programming language.
- For details automatic operation, refer to "4. Automatic operation" in Chapter 3.

2.1 Selecting the program

The "PROGRAM SELECTION" screen displays the program configuration (overview).

The program to be displayed can be selected by changing the program number.

■ "PROGRAM SELECTION" screen

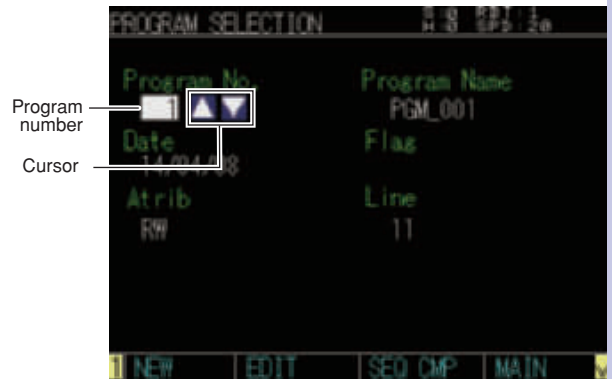

■ Selecting the program number with the cursor keys

Use the cursor keys on the programming box to select [Δ] or [▽] on the screen, and then press the ENTER key to increase or decrease the program number so as to display the program configuration of the specified program number.

■ Inputting the program number directly

Use the cursor keys on the programming box to select the program number.

Input the program number and press the ENTER key. The program configuration of the specified program number appears.

2.2 Creating a new program

To create a new program, register the program name at first.

Step 1 Create a new program.

Press the F1 key (NEW) on the "PROGRAM SELECTION" screen (Edit → Program Edit).
The program name entry screen will appear.

Step 2 Input the program name.

On the program name entry screen, input the program name using the operation keys.

▶ Step 2 Inputting the program name

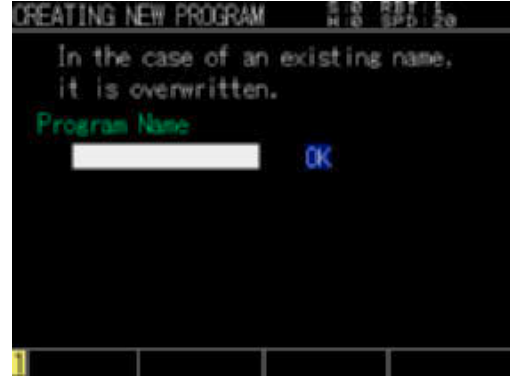

NOTE

Characters 0 to 9, A to Z, and "_" (underscore) are valid for the program name.
Up to 32 characters can be used.
Additionally, since the controller recognizes the program names shown below as special programs, do not use these names for normal program names.
"SEQUENCE" "COMMON"
(For details, refer to the separate YRCX programming manual.)

Step 3 Register the program name.

Press the (OK) button to register the program name.



NOTE

The numbers except for those into which the programs have already been registered are automatically assigned to the program numbers from "1" in order.

Press the ESC key to cancel the new program creation and return to the previous screen.
Be aware that the existing program is overwritten when registering the same program name as that already registered in the program.

Step 4 Check the new program you have registered.

Select the newly registered program name on the "PROGRAM SELECTION" screen, and then press the F2 key (EDIT).

"3.220: Program step doesn't exit" alarm appears when creating a new program.

When pressing the ESC key, the alarm display disappears and you can start editing.













NOTE

When creating a new program, the alarm occurs since no program is written. This alarm does not occur when editing the created program.

2.3 Editing the program

Valid keys and submenu descriptions on the "PROGRAM EDIT" screen (Edit → Program Edit → Edit) are shown below.

Valid keys	Menu	Function
 /  /  / 		Moves the cursor.
		Returns to the previous screen.
		Switches between the "insert" and "overwrite" modes alternately.
		Deletes one character at the cursor position.
		Deletes one character immediately before the cursor position.
	RANGE	Specify the range of copy or cut.
	COPY	Sets the copy contents and saves the data into the buffer temporarily.

Valid keys	Menu	Function
F3	CUT	Sets the cut contents, deletes the selected contents, and saves the data into the buffer temporarily.
F4	PASTE	Inserts the data saved in the buffer to a portion immediately before the cursor line.
F5	FIND	Specifies the character string you want to find.
F6	JUMP	Displays the program from the specified line.
F7	CHECK	Checks the program entry error, etc.

Step 1 Put the program in the editable status.

When pressing the F2 key (EDIT) on the "PROGRAM SELECTION" screen (Edit → Program Edit), the program is displayed and it can be edited.

Step 2 Input the program.

Use the cursor keys to move the cursor to the position where to edit the program, and then input the program with the programming box.

Up to 255 characters can be input for one line. Input the program for one line, and then press the ENTER key at the end. The program entry is completed and the cursor then moves to the top of the next line.

Step 2 Inputting the program

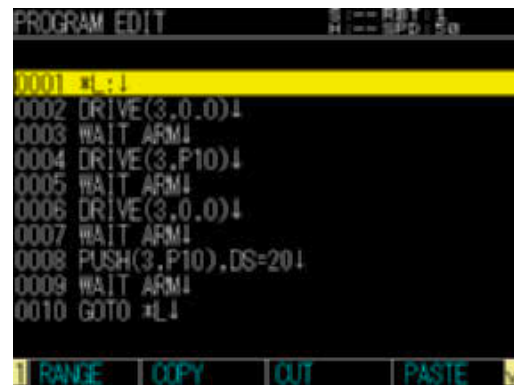

NOTE

One program consists of up to 9999 lines and the maximum program capacity is approximately 2100 KB. Since the program area is shared with the point data, the capacity may decrease depends on the amount of point data. Example) When the amount of point data is 10000, the capacity decrease 600 KB and approximately 1500 KB can be used for the program.

Step 3 Exit the program editing.

After the program entry has been completed, press the ESC key to exit the program editing.

2.3.1 Cursor movement

- When pressing the cursor key, the cursor moves up or down one line. Additionally, when changing the scroll function to the ON status with the SCROLL ON key, pressing the cursor key will move up or down the cursor ten lines.
- When pressing the cursor key, the cursor moves left or right one line.

2.3.2 Quitting program editing

Press the ESC key to quit editing program.

2.3.3 Switching between the "insert" and "overwrite" modes

When pressing the INS key, the insert and overwrite modes are changed alternately.

When changing the overwrite mode to the insert mode, the cursor shape changes from "■" to "▏" and the character to be input is inserted to a portion immediately before the cursor position.

When changing the insert mode to the overwrite mode, the cursor shape changes from "▏" to "■" and the character to be input is overwritten on the character at the cursor position.

2.3.4 Inserting a line

A blank line is inserted into the program. Move the cursor to the top of the line where you want to insert a line, and then press the ENTER key.

A blank line is then inserted to a portion immediately before the cursor line.

When the cursor is located at a position other than the top of the line, a new line is inserted into the cursor position.

2.3.5 Deleting one character

Move the cursor to the character you want to delete, and then press the DEL key to delete one character at the cursor position.

2.3.6 Backspace

When pressing the BS key, one character immediately before the cursor position is then deleted.

2.3.7 Copying/cutting a program

The program can be copied or cut.

Step 1 Use the cursor keys to move to the position where you start the copy or cut.

Step 2 Specify the copy or cut range.

Press the F1 key (RANGE) and specify the copy or cut range with the cursor keys.

Pressing the up/down cursor key will cancel the range designation.

Step 2 Specifying the range



NOTE

A range including multiple lines cannot be specified.

Step 3 Copy or cut the specified range.

When pressing the F2 key (COPY) or F3 key (CUT), the data in the specified range is copied into the buffer. When cutting the specified range, the program in the specified range is deleted after the data has been copied into the buffer.

Step 4 Paste the program.

Press the F4 key (PASTE) to paste the program in the specified range.

The data saved in the buffer is inserted to a portion immediately before the cursor line.



NOTE

The data stored in the buffer can be pasted repeatedly until you exit PROGRAM mode. However, if another copy/cut operation is performed, then the data within the buffer is rewritten.

2.3.8 Searching a character string

Step 1 Display the character string search pop-up screen.

Press the F5 key (FIND) on the "PROGRAM EDIT" screen (Edit → Program Edit → Edit) to display the pop-up screen.

Step 2 *Input the character string to search.*

Input the character string to find, and then press the ENTER key. Up to 24 characters can be input.

Step 3 *Specify the search direction.*

The search starts toward the top from the cursor position by pressing the F1 key (Previous) and the cursor jumps to the character string that is found first. The searching starts toward the end from the cursor position by pressing the F2 key (Next) and the cursor jumps to the character string that is found first. When executing the finding subsequently, press the F1 key (Previous) or F2 key (Next) to specify the direction and perform searching in relevant direction.

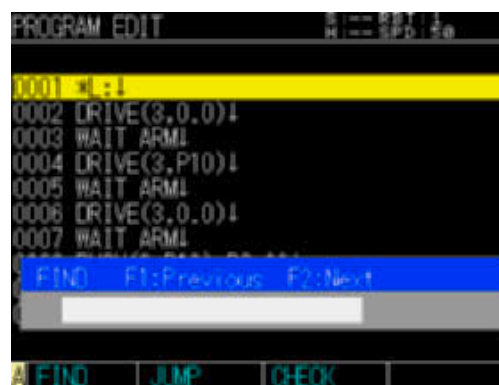
Step 2,3 Searching a character string**2.3.9** Jumping step

The currently selected program can be displayed from a specified step.

Step 1 *Display the "JUMP" pop-up screen.*

Press the F6 key (JUMP) on the "PROGRAM EDIT" screen (Edit → Program Edit → Edit) to display the pop-up screen.

Step 1 Jumping step (step number entry)**Step 2** *Input the step number.*

Input the step number, and then press the ENTER key. The program is displayed from the specified step.

**2.3.10** Checking entry data

The entry error, etc. can be checked after editing the program.

Step 1 *Press the F7 key (CHECK) on the "PROGRAM EDIT" screen (Edit → Program Edit → Edit).***Step 2** *Check the results.*

If any command statement you have input has an error, the cursor moves to the program including incorrect line.

**CAUTION**

Only one error location of the program including errors is displayed. If there are multiple error locations, it is necessary to correct the errors line-by-line from the top, and then repeat the check work.

When there are no errors, the cursor does not move from its current position and the display does not change.

2.4 Compiling sequence program

The sequence program is compiled.

**NOTE**

The sequence program can be executed when all of the following items are satisfied.

1. The object program for the sequence is created.
2. The execution of the sequence program is enabled.
3. The DI10 (sequence control) contact is closed.

Step 1 Display the sequence compile pop-up screen.

Press the F3 key (SEQ CMP) on the "PROGRAM EDIT" screen (Edit → Program Edit → Edit) to display the pop-up screen.

Step 2 Execute the sequence compile.

Select (OK) and press the ENTER key. The sequence compile is executed and "s" is shown in FLAG on the "PROGRAM SELECTION" screen.

Select (CANCEL) and press the ENTER key or press the ESC key to cancel the sequence compile and return to the "PROGRAM SELECTION" screen.

Step 2 Executing the sequence compile



CAUTION

The program name of the sequence program needs to be "SEQUENCE". If the program name is not "SEQUENCE", the sequence compile cannot be executed.

2.5 Setting a main program

The program you have selected is set for the main program.

Step 1 Display the main program setting pop-up screen.

Press the F4 key (MAIN) on the "PROGRAM SELECTION" screen (Edit → Program Edit) to display the pop-up screen.

Step 2 Set the program for the main program.

Select (OK) and press the ENTER key. The selected program is set for the main program and "m" is shown in FLAG on the "PROGRAM SELECTION" screen. Select (CANCEL) and press the ENTER key or press the ESC key to cancel setting the program for the main program and return to the "PROGRAM SELECTION" screen.

Step 2 Setting for the main program

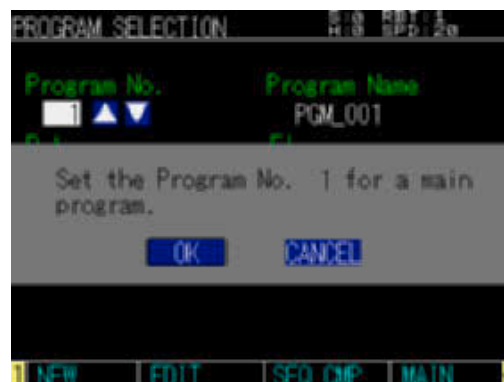

2.6 Changing a program attribute

It can be prohibited to edit or delete the registered program by specifying the program attribute on the "PROGRAM SELECTION" screen (Edit → Program Edit).

There are three kinds of program attributes as described below.

1. RW (read or write)

The program can be edited or deleted.

This attribute is automatically specified when the program name is registered.

2. RO (read only)

The program cannot be edited or deleted.

3. H (hide)

The program cannot be edited or deleted. Program contents cannot also be seen.

To change the program attribute, follow the Steps below. Note that the program attribute can be changed only when the access level is the "maintainer level".

Step 1 *Select the program to change the attribute.*

Select the program to change the attribute. For details about how to select the program, refer to "2.1 Selecting the program" in this Chapter.

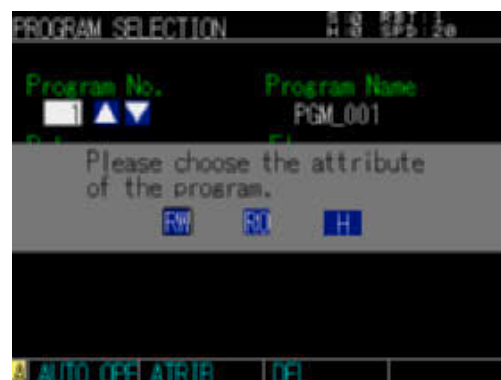
Step 2 **Changing the program attribute****Step 2** *Change the program attribute.*

Press the F6 key (ATRB) to display the attribute change pop-up screen. Select (RW), (RO), or (H), and press the ENTER key to change the program attribute. Press the ESC key to return to the previous screen.

2.7 Deleting a program

The program you have selected on the "PROGRAM SELECTION" screen (Edit → Program Edit) can be deleted.

Step 1 *Select the program to delete.*

Use the cursor keys to select the program to delete. For details about how to select the program, refer to "2.1 Selecting the program" in this Chapter.

Step 2 *Delete the program.*

Press the F7 key (DEL) to display the delete confirmation pop-up screen. Select (OK) and press the ENTER key to delete the program. Select (CANCEL) or press the ESC key to return to the previous screen.

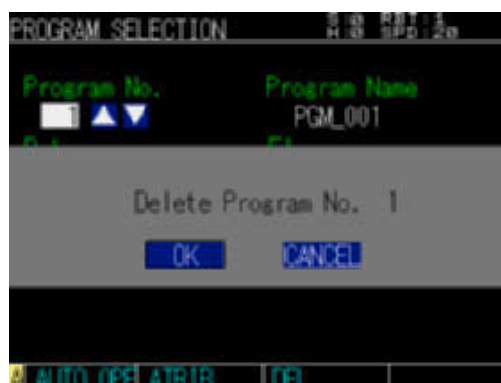
Step 2 **Deleting a program****NOTE**

- When the attribute of the program is RO (read only) or H (hide), this program cannot be deleted. To delete such programs, change the program attribute.
- For details about how to change the program attribute, refer to "2.6 Changing a program attribute" in this Chapter.

2.8 Changing a program name

The program name can be changed on the "PROGRAM SELECTION" screen (Edit → Program Edit).

Step 1 *Select the program.*

Select the program to change the name using cursor keys. For details on selection operating, refer to "2.1 Selecting the program" in this Chapter.

Step 2 **Changing a program name****Step 2** *Change the program name.*

Display the "CHANGE THE PROGRAM NAME" pop-up screen by pressing the F8 key (RENAME). Input the program name to "New program name" using the operation keys, select "OK" and press the ENTER key to change the name. To return to the previous screen without changing, select "CANCEL" or press the ESC key.

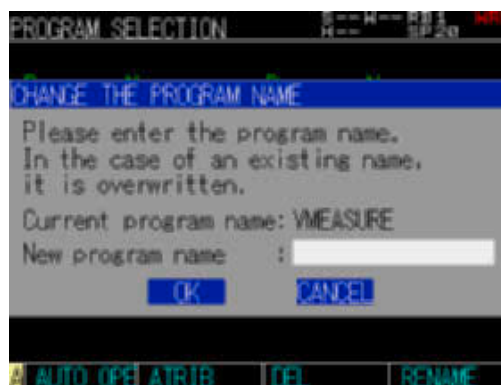



NOTE

- Characters 0 to 9, A to Z, and "_" (underscore) are valid for the program name.
- Up to 16 characters can be used.
- Program names that are already used for other programs cannot be used.
- Since the controller recognizes the program names shown below as special programs, do not use these names for normal ones.

"SEQUENCE" "COMMON"

(For details, refer to the separate YRCX programming manual.)

2.9 Copying a program

The programs can be copied on the "PROGRAM SELECTION" screen (Edit → Program Edit).

Step 1 Select the program.

Select the program to copy using the cursor keys.

For details on selecting operation, refer to "2.1 Selecting a program" in this Chapter.



Step 2 Copying a program

Step 2 Copy the program.

Display the "PROGRAM COPY" pop-up screen by pressing the F9 key (COPY). Input the destination program number to "Program number" and the program name to "Program name" using the operation keys, select "OK" and press the ENTER key to copy the program.

To return to the previous screen without changing, select "CANCEL" or press the ESC key.

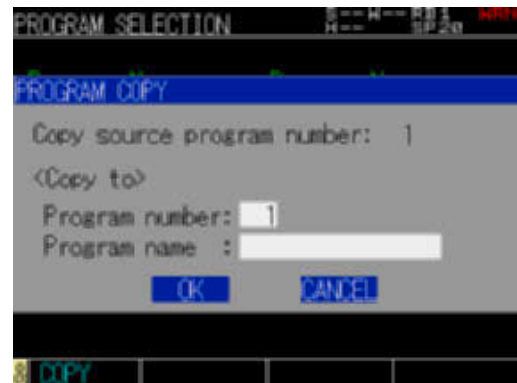

NOTE

- Valid program numbers are between 1 and 100.
- Characters 0 to 9, A to Z, and "_" (underscore) are valid for the program name.
- Up to 16 characters can be used.
- Program names that are already used for other programs cannot be used.
- Program numbers that are already used for other programs cannot be used.
- Since the controller recognizes the program names shown below as special programs, do not use these names for normal ones.

"SEQUENCE" "COMMON"

(For details, refer to the separate YRCX programming manual.)

2.10 Resetting an alarm

If "9.701: Program destroyed" occurs in the program, reset the alarm. After resetting the alarm, the program can then be edited.



CAUTION

If the checksum error occurs, a failure may occur in the program. Although this operation resets the alarm, it does not restore the program data. Be sure to check and change the program on the "PROGRAM EDIT" screen.

To reset the alarm, move to the "QUICK MENU" screen with the QUICK MENU key and select [Alarm Reset]. For details, refer to "5.2 Quick menu" in Chapter 2.

3. Shift coordinates

Use the cursor keys to select [Edit] on the initial screen, and press the ENTER key. Next, select [Shift Coordinate], and then press the ENTER key to display the "SHIFT COORDINATE" screen.

In this hierarchy, you can display, edit, or set the shift coordinates and shift coordinate range.

However, when using SCARA type robots, the standard coordinates need to be set.

For details about how to set the standard coordinates, refer to "8. Standard coordinates" in this Chapter.

The robot work position specified by point data on the Cartesian coordinates ("mm" units) can be shifted by setting the shift coordinates. The movement range can also be limited in each direction.

40 shift coordinates, the shift coordinate number is between 0 and 39, can be set. Shift coordinates are set by shifting the standard coordinates in the X-direction, Y-direction, Z-direction, and R-direction (rotation of XY plane).

Data format of shift coordinates

Sn:

- 1 [dX] : ± #####.###(mm)
- 2 [dY] : ± #####.###(mm)
- 3 [dZ] : ± #####.###(mm)
- 4 [dR] : ± #####.###(degree)
- (n = 0 to 39)



NOTE

- "n" corresponds to the shift coordinate number. Up to 40 shift coordinates can be set. Example): S1...Shows the shift coordinate S1.
- When the shift amounts are "dX = 0.00", "dY = 0.00", "dZ = 0.00", and "dR = 0.00", the shift coordinates equal the standard coordinates.
- When using multiple robots, the shift data is used commonly. The shift number can also be set individually for each robot.

Standard coordinates and shift coordinates

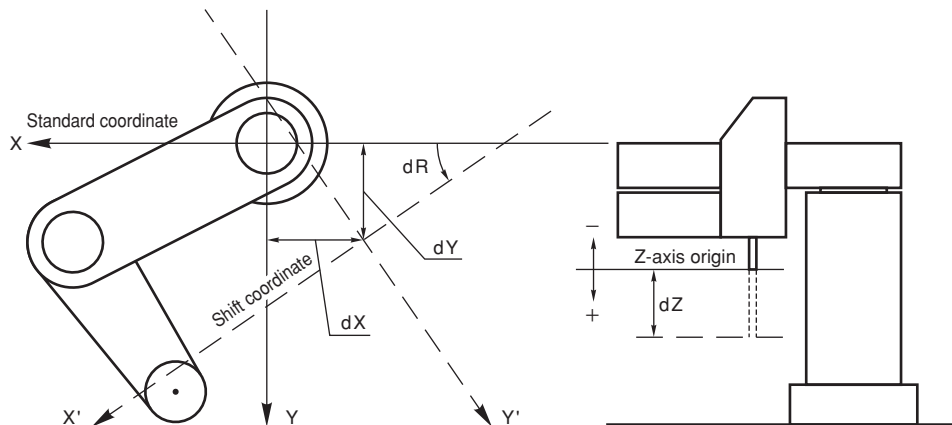

Additionally, as the shift coordinate range is set, the robot movement range is limited by each shift coordinate. Furthermore, as the soft limit parameter is set, the robot movement range can be specified more accurately.

Data format of shift coordinate range

- Shift coordinate range (plus) side SHIFT+
 - 1 [dPX] : ± #####.###(mm)
 - 2 [dPY] : ± #####.###(mm)
 - 3 [dPZ] : ± #####.###(mm)
 - 4 [dPR] : ± #####.###(degree)
 - (n = 0 to 39)
- Shift coordinate range (minus) side SHIFT-
 - 1 dMX : ± #####.###(mm)
 - 2 dMY : ± #####.###(mm)
 - 3 dMZ : ± #####.###(mm)
 - 4 dMR : ± #####.###(degree)



NOTE

- "n" is a shift coordinate number. Up to 40 shift coordinates can be set.
- When both the plus side and minus side are "0.00", the movement range is not limited by each axis (x, y, z, r).

Shift coordinate range

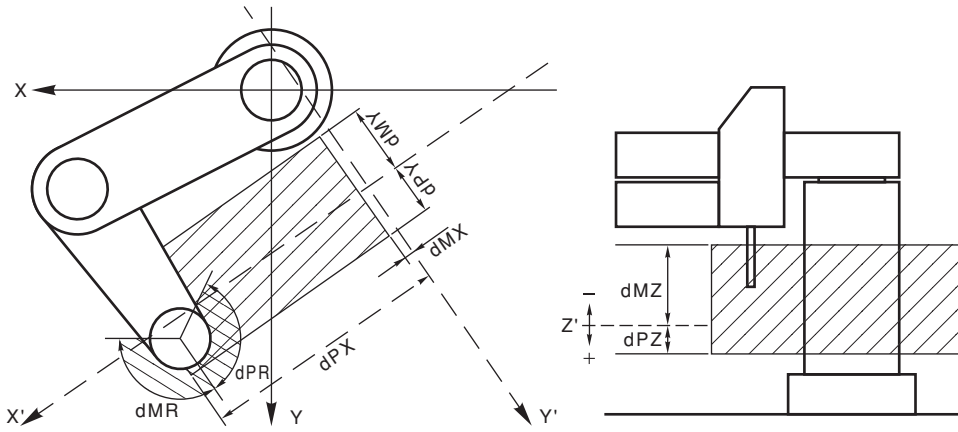

When moving to the "SHIFT COORDINATE" screen (Edit → Shift Coordinate), the screen shown below will appear.

"SHIFT COORDINATE" screen

1. Hierarchy

2. Robot setting status

6. Shift coordinates

7. Shift coordinate range

8. Guide line

Press the F1 key (EDIT) to show the screen below.

"SHIFT EDIT" screen

1. Hierarchy

2. Robot setting status

3. Current position

4. Coordinate unit system

5. Shift number

6. Shift coordinates

7. Shift coordinate range

8. Guide line

1. Hierarchy

Displays the current hierarchy.

2. Robot setting status

Displays the currently selected robot, shift and so on.

S : 1 . . . Specified "shift coordinate" number

H : 1 . . . Specified "hand definition" number

RBT : 1 . . . Specified "robot number"

SPD : 30 . . . Specified speed

ALM . . . Displayed when any alarm occurs.

SRV . . . Displayed when the servo is on.

AUTO . . . Displayed when the control setting is "RELEASE".
(This is not displayed when the setting is "GET" or the operation is in MANUAL mode.)

SEQ . . . Displayed when the sequence program is executed.

When using multiple robots, the robot number display is changed by changing the target robot on the "QUICK MENU".

3. Current position

Displays the current position of the robot. The current position is displayed by an integer when using "pulse" units. When using "mm" units, the position is displayed by a value with the decimal point.

4. Coordinate unit system

Displays the coordinate unit system. The unit shows [pulse] or [mm].

5. Shift number

Displays the shift number selected on the "SHIFT EDIT" screen.

6. Shift coordinates

Displays the shift coordinates of the shift number selected on the "SHIFT EDIT" screen. When there is any input data in the shift coordinates to use, this means that the data is already defined.





7. Shift coordinate range

Displays the shift coordinate range of each shift coordinates. The robot movement range of each shift coordinates can be limited by setting the shift coordinate range.

8. Guide line

Displays the contents assigned to the function keys.





Valid keys and submenu descriptions on the "SHIFT COORDINATE" screen (Edit → Shift Coordinate) are shown below.

Valid keys	Menu	Function
		Selects the operation system that specifies the shift number.
	EDIT	Edits the shift data currently selected.
	SELECT	Selects the shift coordinates For details, refer to "3.5 Selecting shift coordinates" in this Chapter.
		Returns to the previous screen.

3.1 Creating new shift coordinates

Shift coordinates are created newly.

Valid keys and submenu descriptions on the "CREATING NEW SHIFT" screen (Edit → Shift Coordinate → New) are shown below.

Valid keys	Menu	Function
		Specifies the shift coordinates and shift coordinate range (+/-).
		Switches between the "insert" and "overwrite" modes alternately.
		Deletes one character immediately before the cursor position.
		Deletes one character at the cursor position.
		Returns to the previous screen.



NOTE

The shift coordinates cannot be edited without creating them newly.
Be sure to create new shift coordinates before setting.

Step 1 Select the shift coordinate number using the cursor keys.

The shift number scrolls up or down to display the set contents of this shift number by three when the scroll function is ON.

Step 2 Press the F1 key (EDIT) to display the "SHIFT EDIT" screen.

Step 3 Press the F2 key (NEW).



NOTE

The values input before pressing the F1 key (NEW) will be cleared.

Step 4 Input the shift coordinates.

Use the cursor keys to move the cursor to the shift coordinate and shift coordinate range + and - setting items. Use 0 to 9 keys, "+" key, "-" key, and "." key to input a numeric value consisting of an integer portion of up to 4 digits and having 3 or less places below the decimal point.



NOTE

Input the data for all shift coordinates, axis 1 to axis 4 (dX, dY, dZ, dR), shift coordinate range (plus) side (dPX, dPY, dPZ, dPR), shift coordinate range (minus) side (dMX, dMY, dMZ, dMR).

For the data without entry, "0" (zero) is input automatically.

Input the data in the Cartesian coordinate system ("mm" units).

Step 5 Set the entry values.

After inputting the values, press the ENTER key to set them.

Press the ESC key to cancel the data you have input and return to the previous screen.

Step 6 Return to the "SHIFT COORDINATE" screen.

After inputting the data, press the ESC key to return to the "SHIFT COORDINATE" screen (Edit → Shift Coordinate).

Step 1 Selecting the shift number











Step 2-5 Creating new shift coordinates



3.2 Editing shift coordinates

Shift coordinates are edited.

Valid keys and submenu descriptions on "SHIFT EDIT" screen (Edit → Shift Coordinate → Edit) are shown below.

Valid keys	Menu	Function
 / 		Specifies the shift coordinates and shift coordinate range (+/-).
	UNIT	Switches the units of the current position "mm" and "pulse".
	NEW	Moves to the "CREATING NEW SHIFT" screen.
		Switches between the "insert" and "overwrite" modes alternately.
		Deletes one character immediately before the cursor position.
		Deletes one character at the cursor position.
		Returns to the previous screen.

Step 1 Select the shift coordinate number using the cursor keys.

The shift number scrolls up or down to display the set contents of this shift number by three when the scroll function is ON.

Step 2 Press the F1 key (EDIT) to display the "SHIFT EDIT" screen.

Step 3 Input the shift coordinates.

For details on how to input values, refer to Step 4 through Step 6 of "3.1 Creating new shift coordinates" in this Chapter.



NOTE

All the values input before pressing the F1 key (NEW) will be cleared. Take care as the values cannot be returned after creating new shift coordinates.

▶ Step 1 Selecting the shift number



■ Restoring the shift coordinates and shift coordinate range

When pressing the ESC key while the shift coordinate data is edited, the data you have input is canceled and it returns to the data before inputting.

This function is valid only for the cursor line before the data entry is completed.

3.3 Setting shift coordinate 1

This sets the shift coordinate data by inputting the coordinate direction after teaching two points.

The point 1 (1st P) taught first is the coordinate origin, and the Z-axis value of point 1 is that of the shift coordinates.



WARNING

The robot moves during teaching. To avoid danger, do not enter the robot movement range.

■ Shift coordinate setting 1

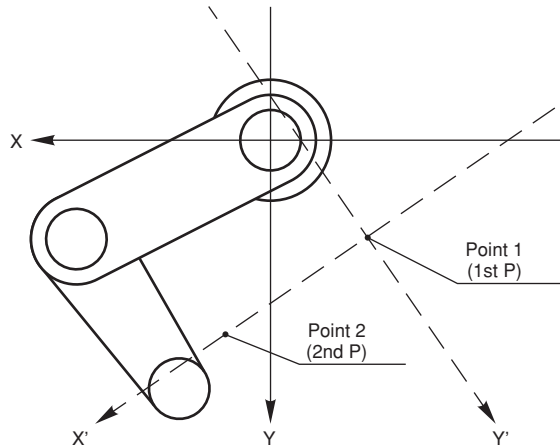

Step 1 Display "SHIFT SETTING 1" screen.

Press the F3 key (SETTING1) to display "Edit > Shift coordinate > Shift setting 1".

Step 2 Input shift coordinate number.

Use 0 to 9 keys to input the shift number and press the F4 key (NEXT).

▶ Step 2 Inputting the shift coordinate number

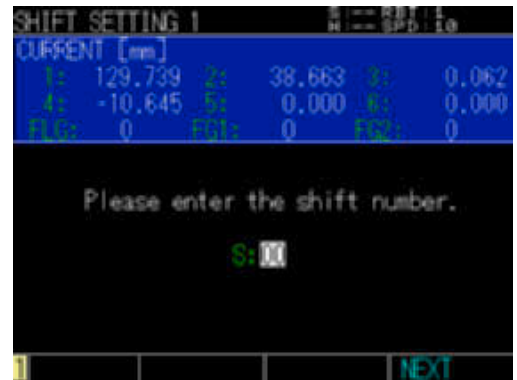

Step 3 Determine point P [1].

Move the robot tip to the Point P (1) with the jog key, press the F4 key (NEXT) to decide the position.



NOTE

Determine the points to teach accurately, otherwise the shift coordinates cannot be set correctly.

Press the F1 key (SPEED) to display pop-up screen for speed settings. Refer to "2.3 Changing the Jog movement speed" in Chapter 3 for details of speed adjustment. Press the F2 key (INCH) to display pop-up screen. Use 0 to 9 keys to input the value in "mm" units.

▶ Step 3 Setting inch distance



Step 4 Determine point P [2].

Repeat the Step3 operation.

Step 5 Determine direction from P [1] to P [2].

Determine the direction from P (1) to P (2) using 0 to 3 key.

▶ Step 5 Inputting direction from P [1] to P [2]

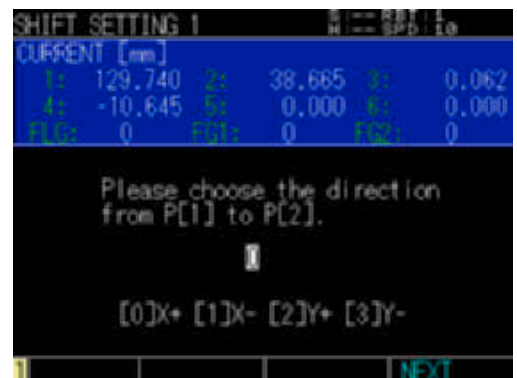

Step 6 Set the shift coordinate.

Check the shift coordinate to be displayed. Select "SET" and press the ENTER key to save the settings. Press the F4 key (FINISH) to finish setting.

When pressing the F4 key (FINISH) or ESC key in the status that the settings are not saved, the setting finishes without saving the data. If the calculation cannot be performed, a corresponded alarm occurs.

Step 6 Checking the setting



3.4 Setting shift coordinate 2

This sets the shift coordinate data by inputting the coordinate direction after teaching two points. The Z-axis value of point 1 is that of the shift coordinate.



WARNING

The robot moves during teaching. To avoid danger, do not enter the robot movement range.



CAUTION

Input the point coordinate value to teach correctly, otherwise wrong calculation results will be registered. Therefore, determine the points to teach accurately

Shift coordinate setting 2

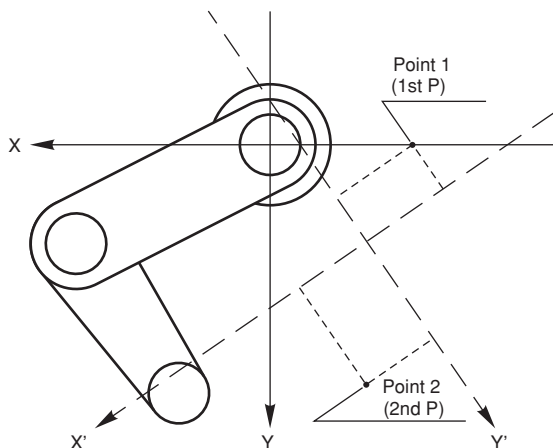

Step 1 Display "SHIFT SETTING 2" screen.

Press the F4 key (SETTING2) to display "Edit > Shift coordinate > Shift setting 2".

Step 2 Input shift coordinate number.

Use 0 to 9 keys to input the shift number and press the F4 key (NEXT).

Step 2 Inputting the shift coordinate number

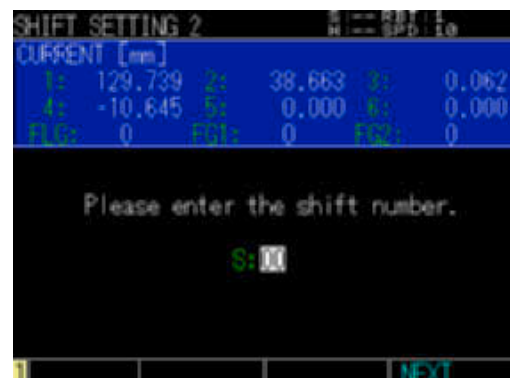

Step 3 Determine the point P [1].

Move the robot tip to the Point P (1) with the jog key, press the F4 key (NEXT) to decide the position.

**NOTE**

Determine the points to teach accurately, otherwise the shift coordinates cannot be set correctly.

Step 4 Input the point P [1].

Input the point data of X, Y, and Z with 0 to 9, "+", "-", and "." keys, then press the F4 key (NEXT).

Step 5 Determine point P [2].

Determine the point P (2) according to the same procedure as the point P (1).

**NOTE**

The shift value of the Z-direction will be defined by the Z-axis coordinate value of point 1. On the other hand, that of point 2 will not be reflected to the shift coordinates.

Step 6 Set the shift coordinate.

Check the shift coordinate to be displayed. Select "SET" and press the ENTER key to save the settings. Press the F4 key (FINISH) to finish setting. When pressing the F4 key (FINISH) or ESC key in the status that the settings are not saved, the setting is completed without saving. If the calculation cannot be performed, a corresponded alarm occurs.

Step 3 Inputting the inch distance**Step 4 Inputting point P [1] value****Step 6 Checking the setting**

3.5 Selecting shift coordinates

When using the shift coordinates, select the shift coordinates that have been created.

**NOTE**

The shift coordinates cannot be used only when creating or editing them. Be sure to select the shift coordinates.

Step 1 Select [SELECT].

Press the F6 key (SELECT) on the "SHIFT COORDINATE" screen (Edit → Shift Coordinate) to open the shift number selection pop-up screen.

Step 2 Input the shift number.

Use 0 to 9 keys to input the shift number. Select (CLR) and press the ENTER key. The shift number currently selected at the upper right portion of the screen changes from (S) to "—" showing that the shift number is not selected.

Step 3 Set the shift number.

Select (OK), and then press the ENTER key. Press the ESC key to return to the previous screen.

Step 2 Inputting the shift number



4. Hand definitions

Use the cursor keys to select [Edit] on the initial screen and press the ENTER key. Next, select [Hand Definition] and press the ENTER key to display the "HAND DEFINITION" screen.

In this hierarchy, you can display, edit, or set the hand definitions.

However, when using SCARA type robots, the standard coordinates need to be set. For details about how to set the standard coordinates, refer to "8. Standard coordinates" in this Chapter.



NOTE

When using multiple robots, the hand data cannot be used commonly.

The tip position of the tool attached to the second arm (Y-axis) or the R-axis can be specified as the robot coordinate position by hand definition.

There are 4 kinds of hand definitions depending on the combination of the robot type and tool attachment position.

Using hand definitions allows moving the tips of different tools to positions on the same Cartesian coordinates.

"HAND DEFINITION" screen (Edit → Hand Definition) a screen like that shown below appears.

■ "HAND DEFINITION" screen

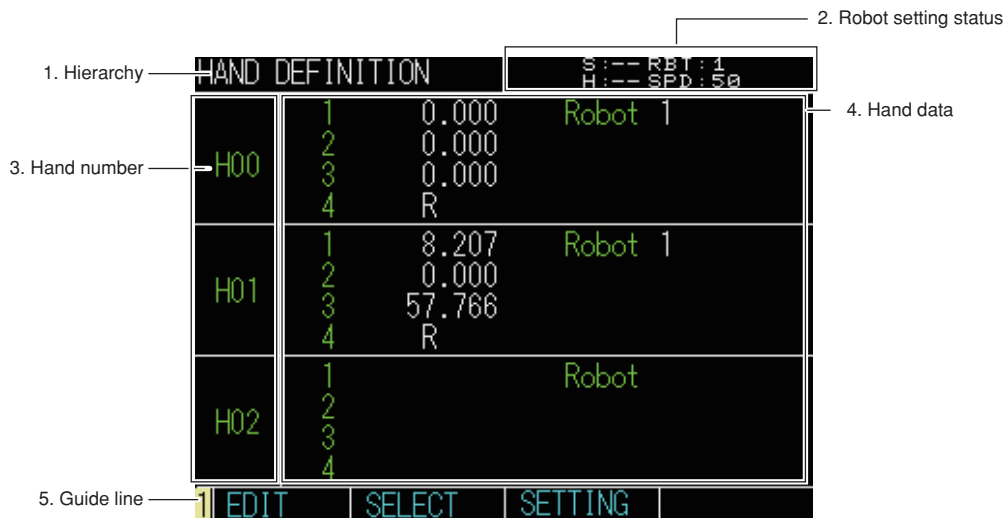

1. Hierarchy

Displays the current hierarchy.

2. Robot setting status

Displays the currently selected robot, shift and so on.

S: 1 ' ' ' Specified "shift coordinate" number

H: 1 ' ' ' Specified "hand definition" number

RBT: 1 ' ' ' Specified "robot number"

SPD: 30 ' ' ' Specified speed

ALM . . . Displayed when any alarm occurs.

SRV . . . Displayed when the servo is on.

AUTO . . . Displayed when the control setting is "RELEASE".

(This is not displayed when the setting is "GET" or the operation is in MANUAL mode.)

SEQ . . . Displayed when the sequence program is executed.

When using multiple robots, the robot number display is changed by changing the target robot on the "QUICK MENU".

3. Hand number

Displays the hand number selected on the "HAND EDIT" screen.

The selected hand number is highlighted.

4. Hand data

Displays the hand data of the hand number selected on the "HAND EDIT" screen.

When the hand definition you want to use has any input data, this means that the hand is already defined.

5. Guide line

Displays the contents assigned to the function keys.

4.1 Data format of hand definition

Hn:

Robot : m

1 : ± #####.###

2 : ± #####.###

3 : ± #####.###

4 : [R]

Item	Input range
Hand definition number (n)	Input 0 to 31.
Robot number (m)	Input 1 to 4.
First parameter	Input a numeric value consisting of an integer portion of up to 4 digits and having 3 or less places below the decimal point or an integer value of up to 8 digits. (The numeric value format is determined according to the robot model setting or hand definition type.)
Second and third parameters	Input a numeric value consisting of an integer portion of up to 4 digits and having 3 or less places below the decimal point.
Fourth parameter (R)	Input one character or nothing. (This is determined by the hand definition type.)

* Setting all hand definition values to "0" means that no hand definition is set.

The parameter setting and movement of each robot type are shown below.

4.1.1 SCARA type robots

1. Hand attached to 2nd arm

- a. Robot movement
 - Imaginary 2nd arm of hand "n" moves to a specified point as if it were the actual 2nd arm.
 - Imaginary 2nd arm of hand "n" determines whether the robot is in a right-handed system or left-handed system.
- b. Parameter descriptions
 - <1st parameter>: Specify with an integer, the difference between the number of offset pulses of the standard 2nd arm and the number of offset pulses of the imaginary 2nd arm of hand "n". If counterclockwise, input a "+" value. (unit: pulses)
 - <2nd parameter>: Specify with a real number, the difference between the imaginary 2nd arm length of hand "n" and the standard 2nd arm length. (unit: mm)
 - <3rd parameter>: Specify the Z-axis offset amount of hand "n" with a real number. (unit: mm)
 - <4th parameter>: No setting for "R".

■ Hands attached to 2nd arm (SCARA type)

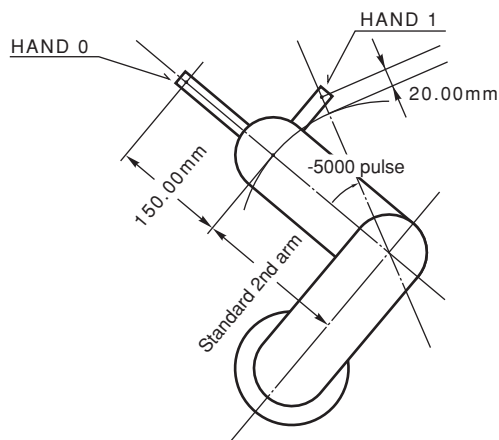

HAND DEFINITION			
CURRENT [pulse]			
1:	0	2:	0
4:	0	5:	0
FLG:		FG1:	FG2:

H01	
Robot	1
1	-5000.000
2	20.000
3	0.000
4	

■ Input example

H0:		H1:	
ROBOT : 1	(Robot number)	ROBOT : 1	(Robot number)
1 : 0	(Pulse)	1 : -5000	(Pulse)
2 : 150.00	(mm)	2 : 20.00	(mm)
3 : 0.00	(mm)	3 : 0.00	(mm)
4 : No input		4 : No input	

2. Hand attached to R-axis

- a. Robot movement

The tip of hand "n" moves to a specified point. The direction of hand "n" changes according to the R coordinate of the point.

Even if hand "n" is between obstacles, it can move while avoiding the obstacles. Hand "n" moves in parallel to or perpendicular to its direction.
- b. Parameter descriptions
 - <1st parameter> : When the current R-axis position is 0.00, specify with a real number the angle between the +X direction of Cartesian coordinates and hand "n". If counterclockwise, input a "+" value. (unit: degrees)
 - <2nd parameter> : Specify the length of hand "n" with a positive real number. (unit: mm)
 - <3rd parameter> : Specify the Z-axis offset amount of hand "n" with a real number. (unit: mm)
 - <4th parameter> : Specify "R".

■ Hands attached to R-axis (SCARA type)

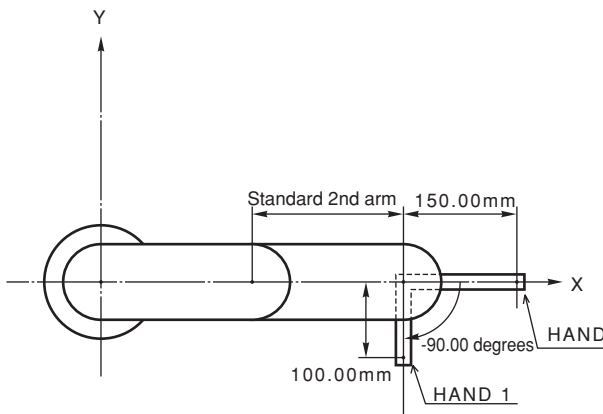

Input example

H0:
 ROBOT : 1 (Robot number)
 1 : 0.00 (degree)
 2 : 150.00 (mm)
 3 : 0.00 (mm)
 4 : R

H1:
 ROBOT : 1 (Robot number)
 1 : -90.00 (degree)
 2 : 100.00 (mm)
 3 : 0.00 (mm)
 4 : R

4.2 "HAND EDIT"/"CREATING NEW HAND" screen

Valid keys and submenu descriptions on the "HAND DEFINITION" screen (Edit → Hand Definition) are shown below.

Valid keys	Menu	Function
		Selects the operation system that specifies the hand definition number. The hand definition scrolls up or down to display the set contents of this shift number by three when the scroll function is ON.
	EDIT	Edits the hand data currently selected.
	SELECT	Selects the hand definition. For details, refer to "4.6 Selecting hand definitions" in this Chapter.
		Switches the scroll function on/off.
		Returns to the previous screen.

The screen shown below will appear when moving to the "HAND EDIT" (Edit → Hand Definition → HAND EDIT) or "CREATING NEW HAND" (Edit → Hand Definition → HAND EDIT → CREATING NEW HAND).

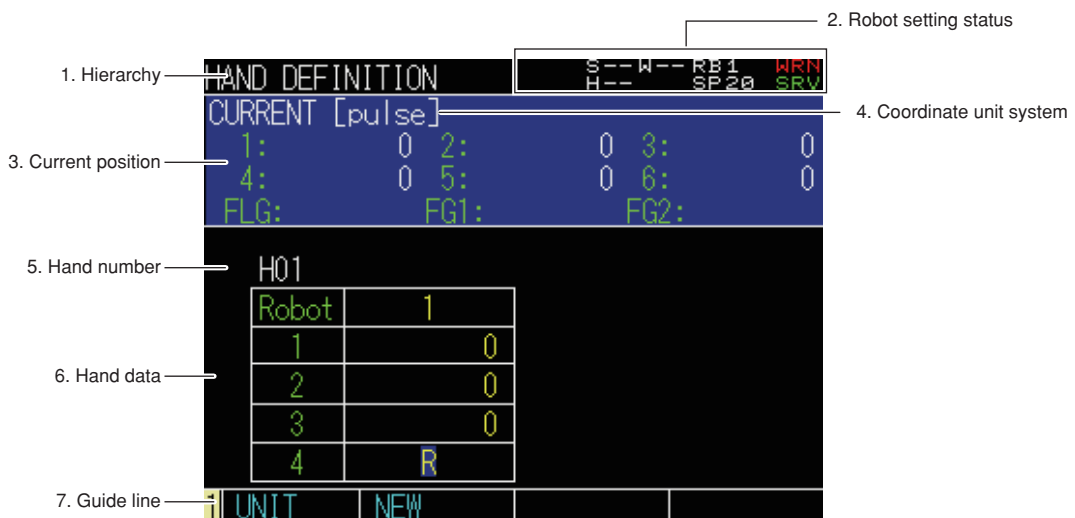

* The "CREATING NEW HAND" screen is the same as above except for the guide line display.

1. Hierarchy

Displays the current hierarchy.

2. Robot setting status

Displays the currently selected robot, shift and so on.

S : 1 ' ' ' Specified "shift coordinate" number

H : 1 ' ' ' Specified "hand definition" number

RBT : 1 ' ' ' Specified "robot number"

SPD : 30 ' ' ' Specified speed

ALM ' ' ' Displayed when any alarm occurs.

SRV ' ' ' Displayed when the servo is on.

AUTO ' ' ' Displayed when the control setting is "RELEASE".
(This is not displayed when the setting is "GET" or the operation is in MANUAL mode.)

SEQ ' ' ' Displayed when the sequence program is executed.

When using multiple robots, the robot number display is changed by changing the target robot on the "QUICK MENU".

3. Current position

Displays the current position of the robot. The current position is displayed by an integer when using "pulse" units. When using "mm" units, the position is displayed by a value with the decimal point.

4. Coordinate unit system

Displays the coordinate unit system. The unit shows [pulse] or [mm].

5. Hand number

Displays the hand number selected on the "HAND EDIT" screen.
The selected hand number is highlighted.

6. Hand data

Displays the hand data of the hand number selected on the "HAND EDIT" screen.
When the hand definition you want to use has any input data, this means that the hand is already defined.

7. Guide line

Displays the contents assigned to the function keys.

■ Data format of hand definition

Hn:

Robot : m

1 : ± #####.###

2 : ± #####.###

3 : ± #####.###

4 : [R]







Item	Input range
Hand definition number (n)	Input 0 to 31.
Robot number (m)	Input 1 to 4.
First parameter	Input a numeric value consisting of an integer portion of up to 4 digits and having 3 or less places below the decimal point or an integer value of up to 8 digits. (The numeric value format is determined according to the robot model setting or hand definition type.)
Second to third parameters	Input a numeric value consisting of an integer portion of up to 4 digits and having 3 or less places below the decimal point.
Fourth parameter (R)	Input one character or nothing. (This is determined by the hand definition type.)

* Setting all hand definition values to "0" means that no hand definition is set.

4.3 Creating new hand definitions

New hand definitions are created.

Valid keys and submenu descriptions on the "CREATING NEW HAND" screen (Edit → Hand Definition → New) are shown below.

Valid keys	Menu	Function
 / 		Specifies the hand data.
		Switches between the "insert" and "overwrite" modes alternately.
		Deletes one character immediately before the cursor position.
		Deletes one character at the cursor position.
		Returns to the previous screen.

Step 1 Select the hand definition number with the cursor keys.

The hand definition scrolls up or down to display the set contents of this shift number by three when the scroll function is ON.

Step 2 Press the F1 key (EDIT) to display the "HAND EDIT" screen.

Step 3 Press the F2 key (NEW).



NOTE

The values input before pressing the F1 key (NEW) will be cleared.

Step 4 Input the hand data

Use the cursor keys to move the cursor to the item to set (robot number, parameters 1 to 4). Use 0 to 9 keys, "+" key, "-" key, and "." key to input a value.

For the fourth parameter, input "R" or nothing.

Step 5 Set the values you have input.

After inputting the values, press the ENTER key to set them.

Press the ESC key to cancel the data you have input and return to the previous screen.

Step 6 Return to the "HAND DEFINITION" screen.

After inputting the data, press the ESC key to return to the "HAND DEFINITION" screen (Edit → Hand Definition).

Step 1 Selecting the hand definition number

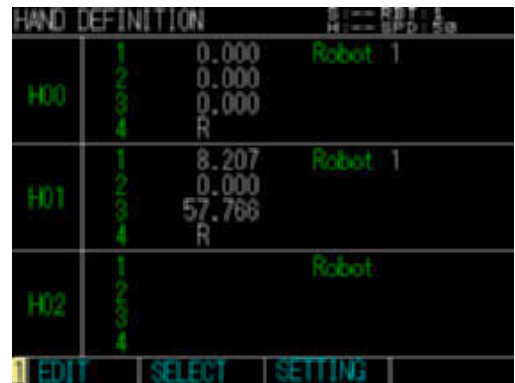







Step 2-5 Creating new hand definitions



4.4 Editing hand definitions

Hand definitions are edited.

Valid keys and submenu descriptions on the "HAND EDIT" screen (Edit → Hand Definition → Edit) are shown below.

Valid keys	Menu	Function
		Specifies the hand data.
	UNIT	Switches the units of the current position "mm" and "pulse".
	NEW	Moves to the "CREATING NEW HAND" screen.
		Switches between the "insert" and "overwrite" modes alternately.
		Deletes one character immediately before the cursor position.
		Deletes one character at the cursor position.
		Returns to the previous screen.

Step 1 Select the hand definition number with the cursor keys.

The hand definition scrolls up or down to display the set contents of this shift number by three when the scroll function is ON.

Step 2 Press the F1 key (EDIT) to display the "HAND EDIT" screen.

Step 3 Press the F2 key (NEW).

Refer to Step 4 through Step 6 of "4.1 Creating new hand definitions" in this Chapter for details on how to input values.



NOTE

All the values input before pressing the F2 key (NEW) will be cleared. Take care as the values cannot be returned after newly creating.

Step 1 Selecting the hand definition number



Hand Definition	X	Y	Z	Robot
H00	1	0.000	0.000	Robot 1
	2	0.000	0.000	
	3	0.000	0.000	
	4	R		
H01	1	8.207	0.000	Robot 1
	2	0.000	57.766	
	3	0.000	0.000	
	4	R		
H02	1			Robot
	2			
	3			
	4			

Restoring hand definitions

When pressing the ESC key while the hand definition data is edited, the data you have input is canceled and it returns to the data before inputting.

This function is valid only for the cursor line before the data entry is completed.

4.5 Setting hand definitions

Specify the hand definition by teaching.



WARNING

The robot starts to move when a jog key is pressed. Do not enter the robot movement range to avoid danger.



NOTE

Teach the same point with right-handed and left-handed system at the tool tip to set the hand definition data. Make sure to move the robot with a right-handed system to teach the point 1, for point 2, move with a left-handed system.

Step 1 Input the hand definition number.

Input the hand definition number using 0 to 9 keys and press the F4 key (NEXT).

Step 2 Teach working point at the point P [1].

Move the robot tip to the point P (1) with the jog keys and press the F4 key (NEXT).



NOTE
Make sure to teach the point precisely, otherwise the hand definition cannot be set correctly.

Step 3 Teach working point at the point P [2].

Move the tool tip to the point P (2) with the jog keys and press the F4 key (NEXT).

Step 4 Set the hand definition.

Check the hand coordinates to be displayed. Select (SET) and press the ENTER key to save the setting. After saving, press the F4 key (FINISH) to end the setting. Pressing the F4 key (FINISH) without saving, it ends before saving.

Step 2 Teaching



Step 4 Setting hand definition



4.6 Selecting hand definitions

To use the hand definition, select the hand definition you have created.



NOTE
The hand definition cannot be edited only when creating or editing hand definitions. Be sure to select the hand definition.
When using multiple robots, the hand data cannot be used commonly.
Select the hand number by robot that corresponds to the robot number set in the hand definitions.

Step 1 Select [SELECT].

Press the F5 key (SELECT) on the "HAND DEFINITION" screen (Edit → Hand Definition) to display the "HAND DEFINITION SELECT" pop-up screen.

Step 2 Input the hand number.

Use 0 to 9 keys to input the hand number. Select (CLR) and press the ENTER key. The hand number currently selected at the upper right portion of the screen changes from (H) to "—" showing that the hand number is not selected.

Step 3 Set the hand number.

Select (OK), and then press the ENTER key. Press the ESC key to return to the previous screen.

Step 2,3 Setting the hand number



5. Work definitions

A workpiece that is held at the tip of the robot or the tool specified by hand definition will be regarded as the robot coordinate position by work definition. Using work definition enables the tip of a different workpiece to move to the same Cartesian coordinate position.

■ "WORK DEFINITION" screen



1. Hierarchy

Displays the current hierarchy.

2. Robot setting status

Displays the currently selected robot, shift and so on.

- S1** . . . Specified "shift coordinate" number
- H1** . . . Specified "hand definition" number
- W1** . . . Specified "work definition" number
- RB1** . . . Specified "robot number"
- SP30** . . . Specified speed

ALM . . . Displayed when any alarm occurs.

SRV . . . Displayed when the servo is on.

AUTO . . . Displayed when the control setting is "RELEASE".

(This is not displayed when the setting is "GET" or the operation is in MANUAL mode.)

SEQ . . . Displayed when the sequence program is executed.

When using multiple robots, the robot number display is changed by changing the target robot on the "QUICK MENU".

3. Work number

Displays the work number selected on the "WORK EDIT" screen.

The selected work number is highlighted.

4. Work data

Displays the work data of the work number selected on the "WORK EDIT" screen.

When the work definition you want to use has any input data, this means that the work is already defined.

5. Guide line

Displays the contents assigned to the function keys.

5.1 Data format of work definition

Wn:

X : ± #####.###
 Y : ± #####.###
 Z : ± #####.###
 R : ± #####.###

Item	Input range	Description	Unit
Work definition number (n)	0 to 39		mm
X-coordinate Offset	Numeric value consisting of an integer portion of up to 4 digits and having 3 or less places below the decimal point	Specifies X-coordinate Offset amount from the tip of the robot (the tip of the tool with hand definition) of the work "n" with real number.	mm
Y-coordinate Offset		Specifies Y-coordinate Offset amount from the tip of the robot (the tip of the tool with hand definition) of the work "n" with real number.	mm
Z-coordinate Offset		Specifies Z-coordinate Offset amount from the tip of the robot (the tip of the tool with hand definition) of the work "n" with real number.	mm
R-coordinate Offset		Specifies the angle of + X-direction of the Cartesian coordinate and work "n" when R-coordinate current position of the tip of the robot (the tip of the tool with hand definition) is "0.00". Input positive value for counterclockwise value.	degree

* Setting all work definition values to "0" means that no work definition is set.

Robot Movement

The robot moves the tip of the work "n" to the specified point. The direction of the work "n" changes depending on R-coordinate value of the point, which enables the tip to move the target position (i.e. installation position) with the position and angle based on the work "n". The robot moves in parallel / vertical direction to the work "n".

Example

Moving the robot with Point A as the operating point along Plane B

X	115.000mm
Y	-50.000mm
Z	0.000mm
R	30.000°

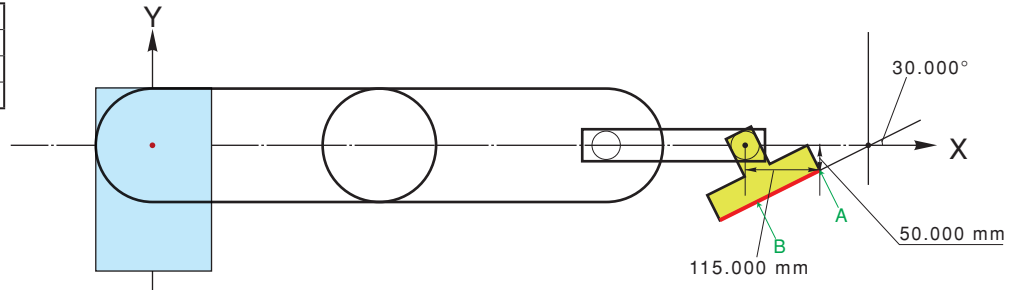

5.2 Creating new work definitions

New work definitions are created.

Valid keys and submenu descriptions on the "CREATING NEW WORK" screen (Edit → Work Definition → New) are shown below.

Valid keys	Menu	Function
		Specifies the work data.
INS		Switches between the "insert" and "overwrite" modes alternately.
BS		Deletes one character immediately before the cursor position.
DEL		Deletes one character at the cursor position.
ESC		Returns to the previous screen.



NOTE

The hand definition cannot be edited without creating it newly. Set the hand definition after creating it newly.

Step 1 Select the work definition number with the cursor keys.

The work definition scrolls up or down to display the set contents of this shift number by three when the scroll function is ON.

Step 2 Press the F1 key (EDIT) to display the "WORK EDIT" screen.

Step 3 Press the F1 key (NEW).



NOTE
The values input before pressing the F1 key (NEW) will be cleared.

Step 4 Input the work data

Use the cursor keys to move the cursor to the item to set (parameters X to R). Use 0 to 9 keys, "+" key, "-" key, and "." key to input a value.

Step 5 Set the values you have input.

After inputting the values, press the ENTER key to set them.
Press the ESC key to cancel the data you have input and return to the previous screen.

Step 6 Return to the "WORK DEFINITION" screen.

After inputting the data, press the ESC key to return to the "WORK DEFINITION" screen (Edit → Work Definition → Edit → Work Definition).

Step 1 Selecting the work definition number

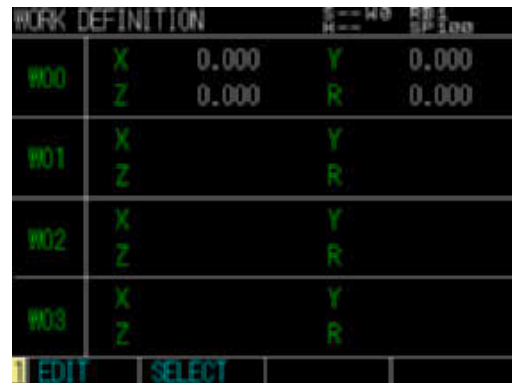

Step 2-5 Creating new work definitions



5.3 Editing work definitions

Work definitions are edited.

Valid keys and submenu descriptions on the "WORK EDIT" screen (Edit → Work Definition → Edit) are shown below.

Valid keys	Menu	Function
		Specifies the work data.
	NEW	Moves to the "CREATING NEW WORK" screen.
		Switches between the "insert" and "overwrite" modes alternately.
		Deletes one character immediately before the cursor position.
		Deletes one character at the cursor position.
		Returns to the previous screen.

Step 1 Select the work definition number with the cursor keys.

The work definition scrolls up or down to display the set contents of this shift number by three when the scroll function is ON.

Step 2 Press the F1 key (EDIT) to display the "WORK DEFINITION" screen.

Step 3 Input the work definition.

Refer to 4 through 6 of "5.2 Creating new work definitions" in this Chapter for details on how to input values.



NOTE

All the values input before pressing the F1 key (NEW) will be cleared. Take care as the values cannot be returned after newly creating.

Step 1 Selecting the work definition number

WORK DEFINITION	X	Z	Y	R
W00	X	0.000	Y	0.000
	Z	0.000	R	0.000
W01	X		Y	
	Z		R	
W02	X		Y	
	Z		R	
W03	X		Y	
	Z		R	

Restoring work definitions

When pressing the ESC key while the work definition data is edited, the data you have input is canceled and it returns to the data before inputting.

This function is valid only for the cursor line before the data entry is completed.

5.4 Selecting work definitions

To use the work definition, select the work definition you have created.



NOTE

The work definition cannot be edited only when creating or editing work definitions. Be sure to select the work definition.

When using multiple robots, the work data cannot be used commonly.

Select the work number by robot that corresponds to the robot number set in the work definitions.

Step 1 Select [SELECT].

Press the F5 key (SELECT) on the "WORK DEFINITION" screen (Edit → Work Definition) to display the "WORK DEFINITION SELECT" pop-up screen.

Step 2 Input the work number.

Use 0 to 9 keys to input the work number. Select (CLR) and press the ENTER key. The work number currently selected at the upper right portion of the screen changes from (H) to "—" showing that the work number is not selected.

Step 3 Set the work number.

Select (OK), and then press the ENTER key. Press the ESC key to return to the previous screen.

Step 2,3 Setting the work number

WORK DEFINITION	X	Z	Y	R
W00	X	0.000	Y	0.000
	Z	0.000	R	0.000
W01	X		Y	
	Z		R	
W02	X		Y	
	Z		R	
W03	X		Y	
	Z		R	

6. Pallet definitions

Use the cursor keys to select [Edit] on the initial screen and press the ENTER key. Next, select [Pallet Definition] and press the ENTER key to display the "PALLET DEFINITION" screen.

In this hierarchy, you can display, edit, or set the pallet definitions.

However, when using SCARA type robots, the standard coordinates need to be set.

For details about how to set the standard coordinates, refer to "8. Standard coordinates" in this Chapter.

A total of 40 pallets (definition numbers 0 to 39) can be defined then assign five consecutive point data from point data areas (P0 to P2999). Five points are used for each pallet. The maximum number of points that can be defined in one pallet is 32767 (=NX*NY*NZ).



NOTE

- A total of 40 (PL0 to PL39) pallets can be defined.
- The maximum number of points that can be defined as the positions on one pallet is 32767.
- Data in the point data area is used point data on the for pallet definitions.



NOTE

- When using multiple robots, the pallet definitions are used commonly.

■ Pallet definition

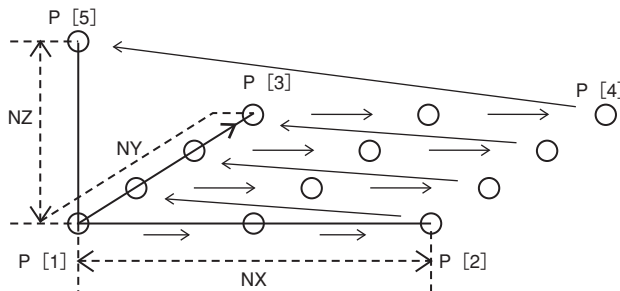

■ Data format of pallet definition

PLm : Pallet number (m = 0 to 39)

PLN : XY or YZ or ZX (Reference plane. The figure above shows that the XY plane is the reference.)

NX : ### (Number of points in the X-axis direction)

NY : ### (Number of points in the Y-axis direction)

NZ : ### (Number of points in the Z-axis direction)

POINT : P #### - P #### (Start point number to be used - Start point number to be used + 4)

- Conditions "NX*NY*NZ < 32768" need to be satisfied.
- For points to be used, five consecutive points need to be allocated from P0 to P2995.
Example): Pallet number PL0 Points to be used, P2900 to P2904

When moving to the "PALLET DEFINITION" screen (Edit → Pallet Definition), the screen shown below will appear.

■ "PALLET DEFINITION" screen

PL	PLN	NX	NY	NZ	Head Point	P
PL00						
PL01	XY	5	5	1	P	0
PL02						

Robot setting status: S:-- RBT: 1, H:-- SPD: 20

Navigation: [EDIT] [SETTING]

Press the F1 key (EDIT) to move to the "PALLET EDIT" screen.

■ "PALLET EDIT" screen

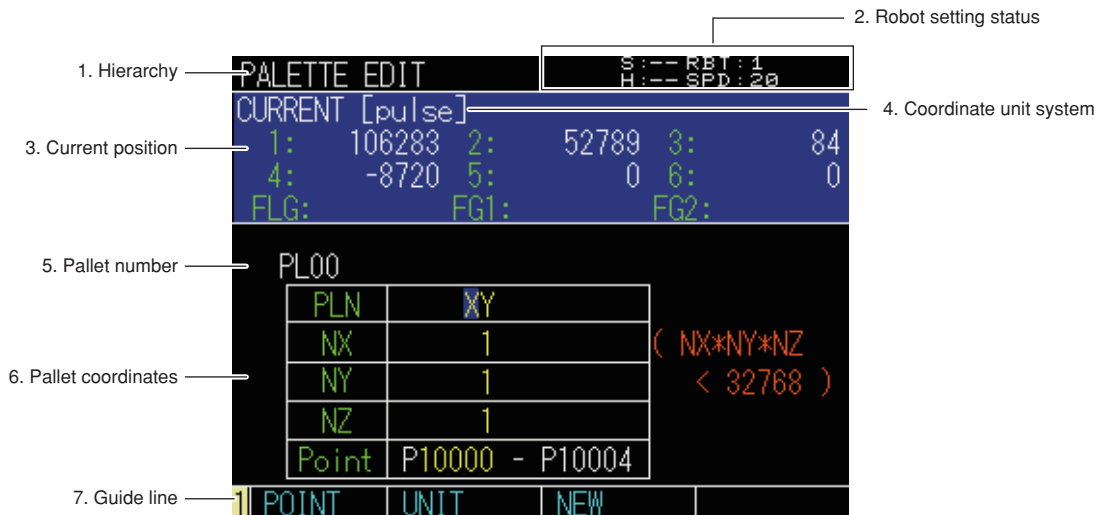

1. Hierarchy

Displays the current hierarchy.

2. Robot setting status

Displays the currently selected robot, shift and so on.

- S: 1 . . . Specified "shift coordinate" number
- H: 1 . . . Specified "hand definition" number
- RBT: 1 . . . Specified "robot number"
- SPD: 30 . . . Specified speed

- ALM . . . Displayed when any alarm occurs.
- SRV . . . Displayed when the servo is on.
- AUTO . . . Displayed when the control setting is "RELEASE".
(This is not displayed when the setting is "GET" or the operation is in MANUAL mode.)
- SEQ . . . Displayed when the sequence program is executed.

When using multiple robots, the robot number display is changed by changing the target robot on the "QUICK MENU".

3. Current position

Displays the current position of the robot. The current position is displayed by an integer when using "pulse" units. When using "mm" units, the position is displayed by a value with the decimal point.

4. Coordinate unit system

Displays the coordinate unit system. The unit shows [pulse] or [mm].

5. Pallet number

Displays the pallet number selected on the "PALLET EDIT" screen.





6. Pallet data

Displays the pallet data of the pallet number selected on the "PALLET EDIT" screen. When the pallet definition to be used has any input data, this means that the data is already defined.

7. Guide line

Displays the contents assigned to the function keys.







Valid keys and submenu descriptions on the "PALLET DEFINITION" screen (Edit → Pallet Definition) are shown below.

Valid keys	Menu	Function
 / 		Selects the operation system that specifies the pallet number.
	EDIT	Edits the pallet data currently selected.
		Switches the scroll function on/off.
		Returns to the previous screen.

6.1 Creating new pallet definitions

New pallet definitions are created.

Valid keys and submenu descriptions on the "PALLET EDIT (NEW)" screen (Edit → Hand Definition → New) are shown below.

Valid keys	Menu	Function
 / 		Specifies the pallet number.
	POINT	Moves to the "POINT EDIT" screen in the pallet definition.
		Switches between the "insert" and "overwrite" modes alternately.
		Deletes one character immediately before the cursor position.
		Deletes one character at the cursor position.
		Returns to the previous screen.



NOTE

The pallet definition cannot be edited without creating it newly. Set the pallet definition after creating it newly.

Step 1 Select the pallet definition number with the cursor keys.

The pallet definition number scrolls up or down to display the set contents of this shift number by three when the scroll function is ON.

Step 2 Press the F1 key (EDIT) to display the "PALLET EDIT" screen.

Step 3 Press the F3 key (NEW).



NOTE

Make sure to teach the point precisely, otherwise the hand definition cannot be set correctly.

Step 4 Input the pallet data.

Use the cursor keys to move the cursor to the setting item (PLN, NX, NY, NZ, POINT). Input "XY", "YZ", or "ZX" for PLN. For other items, use 0 to 9 keys to input a value. If data other than "XY", "YZ", and "ZX" is input for PLN, relevant alarm occurs.



NOTE

- For PLN, specify the plane that becomes the reference for the pallet definition. For details, refer to "5. Pallet definitions" in this Chapter.
- Conditions "NX*NY*NZ < 32768" need to be satisfied.
- The points to be used are five consecutive point data in the point data area (P0 to P29995).

Step 1 Selecting the pallet definition number

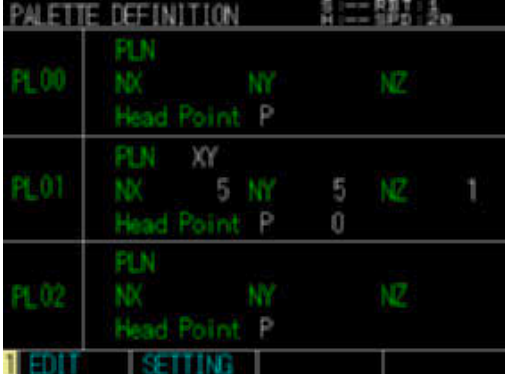

Pallet	PLN	NX	NY	NZ	Head Point P
PL00					P
PL01	XY	5	5	1	0
PL02					P

Step 2-5 Creating new pallet definitions



Item	Value
X	106283
Y	-8720
Z	52789
F1	84
F2	0
F3	0

PLN	XY	(NX*NY*NZ < 32768)
NX	1	
NY	1	
NZ	1	
Point	P10000 - P10004	

Step 5 Set the data you have input.

After inputting the data, press the ENTER key to set it.
Press the ESC key to cancel the data you have input and return to the previous screen.









Step 6 Return to the "PALLET DEFINITION" screen.

After the data has been set, press the ESC key to return to the "PALLET DEFINITION" screen (Edit → Pallet Definition).

6.2 Editing pallet definitions

Pallet definitions are edited.

Valid keys and submenu descriptions on the "PALLET EDIT" screen (Edit → Pallet Definition → Edit) are shown below.

Valid keys	Menu	Function
		Selects among PLN, NX, NY, NZ.
	POINT	Moves to the "POINT EDIT" screen.
	UNIT	Changes the display unit of the current position. ([mm] ⇔ [pulse])
	NEW	Moves to the "CREATING NEW PALLET" screen.
		Switches between the "insert" and "overwrite" modes alternately.
		Deletes one character immediately before the cursor position.
		Deletes one character at the cursor position.
		Returns to the previous screen.

Step 1 Select the pallet definition number with the cursor keys.

The pallet definition number scrolls up or down to display the set contents of this shift number by three when the scroll function is ON.

Step 2 Press the F1 key (EDIT) to display the "PALLET EDIT" screen.

Step 3 Input the pallet data.

For details on how to input values, refer to Step 4 through Step 6 of "5.1 Creating new pallet definitions" in this Chapter.

▶ Step 1 Selecting the pallet definition number

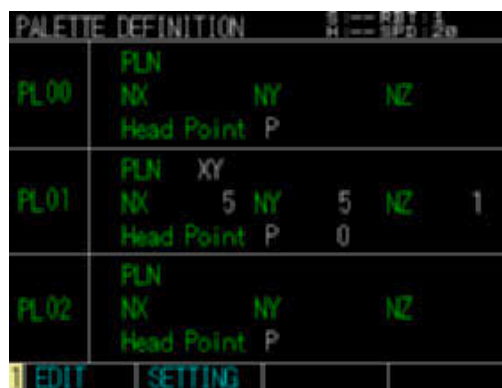

NOTE

All the values input before pressing the F3 key (NEW) will be cleared. Take care as the values cannot be returned after newly creating.

6.3 Setting pallet definitions



WARNING

The robot starts to move when a jog key is pressed. Do not enter the robot movement range to avoid danger.



NOTE

The pallet definition cannot be input by teaching in the return-to-origin incomplete status. Make sure to perform absolute reset or return-to-origin before teaching.

Step 1 Display the "PALLET SETTING" screen.

Press the F2 key (SETTING), <Edit> and <Pallet definition> to open the "PALLET SETTING" screen.

Step 2 Select the pallet to define.

Input the pallet number using 0 to 9 keys and press the F1 key (2D) or F2 key (3D) to select the dimension.

Step 3 Input the number of points between points.

Input a positive integer as the number of points, NX, between P (1) and P (2). In the case of NY and NZ (when specifying 3D), input the same way as NX. Press the F4 key (NEXT) after inputting.

Step 4 Input the start point number to be used.

Input the pallet numbers using 0 to 9 keys and press the F1 key (TEACH).

Step 5 Teach the point P [1].

Move the robot tip to the point P (1) which is used for the pallet definition and press the F4 key (NEXT).



WARNING

When moving the robot, do not enter the robot movement range to avoid danger.

Step 6 Teach other points.

Teach P (2), P (3), P (4), and P (5) (only when specifying 3D) in the same way as teaching P (1).

Step 7 Specify the pallet definition.

Check the pallet definition to be displayed. Select (SET) and press the ENTER key to save the setting. After saving, press the F4 key (FINISH) to finish the setting. Pressing the F4 key (FINISH) without saving, it ends before saving. When the calculation failed, an corresponded alarm occurs.

Step 2 Inputting the pallet definition number

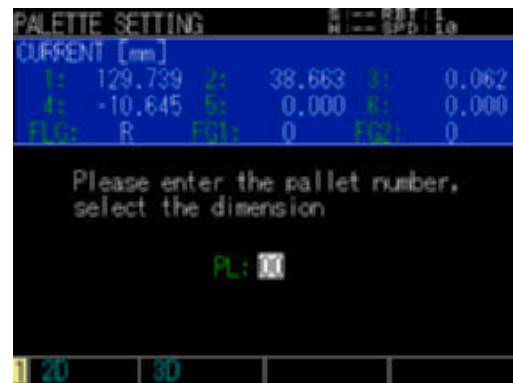

Step 3 Inputting the point number

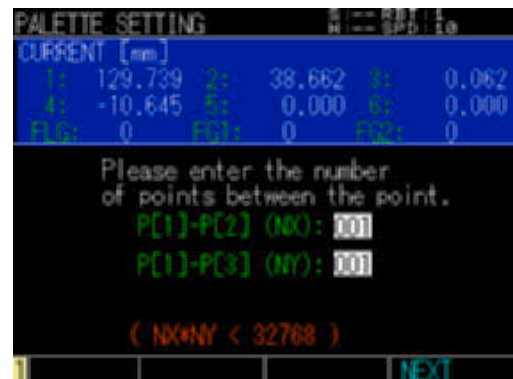

Step 6 Teaching other points



6.4 Setting point of pallet definitions

When pressing the F1 key (POINT) on the "PALLET EDIT (NEW)" screen (Edit → Pallet Definition → New) described in "5.1 Creating pallet definitions newly" of this Chapter or "PALLET EDIT" screen (Edit → Pallet Definition → Edit) described in "5.2 Editing pallet definitions" of this Chapter, you can set the point of the pallet definition.

To set the point, move to the "POINT EDIT" screen described in "2. Point editing" in this Chapter.

Point setting



Move to relevant point number in the pallet definition and edit the point data. For details about how to edit the point data, refer to "1. Point editing" in this Chapter.

**WARNING**

The robot starts to move when point trace or manual operation is executed. To avoid danger, do not enter the robot movement range.

**NOTE**

- There are five point data in the pallet definition. Set all of the point data.
- Input the point data in the pallet definition in "mm" units.
- The point order in the pallet definition has the meaning. For details, refer to "5. Pallet definitions" in this Chapter.

7. Parameters

There are six kinds of parameters available; controller setting related parameters, robot operation related parameters, axis related parameters, control related parameters, I/O related parameters, and option board related parameters.

When selecting [Edit] - [Parameter] from the initial screen, the "PARAMETER" screen will appear.

7.1 Parameter setting conditions

Set the parameters in the following cases.

- The system generation is performed.
- The robot in the factory shipment status is installed and operated.
- The robot or axis movement range is changed.
- The robot or axis transfer conditions are changed.

**CAUTION**

- The parameters are important data to match the robot specifications to the controller specifications. If the parameters are set incorrectly, this may cause alarm or malfunction. So, be sure to set the parameters correctly.
- Save the data files (program, point, point comment, parameter, shift, hand, and pallet, etc.) saved inside the YRCX to an external storage device, such as personal computer before and after setting the parameters.
- If incorrect parameter setting is changed, this may adversely affect the robot operation or cause serious hazard to the operator. Before changing the parameters, contact your distributor.
- Absolute reset or return-to-origin may be required as the parameters are changed.
- Some parameters require turning off and on the power to be valid.

7.2 Setting the parameters

The robot operation and controller setting related parameters are set.

Step 1 Press the F1 key (CONT) to F10 key (TRACKING) to select the category. ▶ **Step 1** "PARAMETER" screen

The "PARAMETER" screen for the selected category will appear.



Valid keys and submenu descriptions on the "PARAMETER" category screen are shown below.

Valid keys	Menu	Function
F1	CONT	Sets the controller setting related parameters.
F2	ROBOT	Sets the robot operation related parameters.
F3	AXIS	Sets the axis related parameters.
F4	DRIVER	Sets the driver related parameters.(Contact your distributor for changing this parameter.)
F5	IO	Sets the I/O related parameters.
F6	OPTION	Sets the option board related parameters.
F7	GRIPPER	Sets the gripper related parameters.*

Valid keys	Menu	Function
	TRACKING	Sets the tracking system related parameters.*
		Returns to the previous screen.

* Refer to the each manual for details.

Step 2 Select the parameter.

Use the cursor keys to select the parameter. Input the parameter number on the pop-up screen that is displayed by pressing the F2 key (JUMP) to select the parameter otherwise. Press the F1 key (EDIT) to select.

"PARAMETER>CONT" screen	"PARAMETER>ROBOT" screen	"PARAMETER>AXIS" screen
"PARAMETER>DRIVER" screen	"PARAMETER>IO" screen	"PARAMETER>OPTION" screen

* The screen setting depends on the robots and options to use.



NOTE

Changing the driver parameters might influence to robot control even though they can be selected. Contact your distributor for changing them.

Valid keys and submenu descriptions on each parameter setting screen are shown below.

Valid keys	Menu	Function
		Moves up or down the cursor.
	EDIT	Edits the parameter.
	JUMP	Moves the cursor to the specified number.
		Switches ON/OFF of the scroll function.
		Returns to the previous screen.

Step 3 Press the ESC key to exit the parameter editing.

7.3 Parameter list

■ Controller parameters

For details about parameters, refer to "10.4 Controller parameters" in this Chapter.

Name	Identifier	Setting range	Initial value	Unit
Incremental Mode control	INCMOD	0: INVALID, 1: VALID	0	—
MOVEI/DRIVEI start pos.	MOVIMD	0: KEEP, 1: RESET	0	—
MOVET start pos.	MOVMTD	0: KEEP, 1: RESET	0	—
Servo on when power on	SRVOON	0: INVALID, 1: VALID	0	—
Sequence flag*1	SEQFLG	0: INVALID, 1: VALID 3: VALID & EMG-Reset	0	—
Safe mode flag*1	SAFEMODE	-2147483648 to 2147483647	-1	—
Permission to start program in origin non-completion	RUNINOIC	0: INVALID, 1: VALID	0	—
Permission to reset at controller boot	RSTATBOT	0: INVALID, 1: VALID	0	—
Permission to reset at program start	RSTATRUN	0: INVALID, 1: VALID	0	—
Current program no.	CRNTPG	0 to 100	0	—
Main program no.	MAINPG	0 to 100	0	—
INPUT/PRINT using channel	STDPRN	1: PB, 2: CMU, 3: ETH	1	—
Emergency time*1*2	EMGTIM	0 to 2000	1000	ms
Emergency time 2*1*2	EMGTIM2	0 to 2000	300	ms
Debug start mode	DBGSTAMD	0: LOAD, 1: START	0	—
Break point stop mode	BRKSTPMD	0: HOLD, 1: HALDALL	1	—
Shift on area check out	SFTONACO	0: INVALID, 1: VALID	1	—

*1 Contact your distributor for changing these parameters as editing them may influence the robot control.

*2 New setting values will be valid after turning off and on the power.



NOTE

This manual describes the controller parameters shown above.

Others are normally write-protected. When such parameters need to be changed, contact your distributor.

■ Robot parameters

For details about parameters, refer to "10.5 Robot parameters" in this Chapter.

Name	Identifier	Setting range	Initial value	Unit
Tip weight (kg)	WEIGHT	0 to 500	Depends on the model.	kg
Tip weight (g)	WEIGHTG	0 to 500000	Depends on the model.	g
Origin sequence	ORGORD	0 to 654321	312456	—
R axis orientation	RORIEN	0: KEEP, 1: FREE	0	—
Arm type at reset	ARMTYP	0: NONE, 1: RIGHT, 2: LEFT	0	—
MOVE L coef.	CPACRAT	1 to 100	100	%
R axis inertia	SCRINR	0 to 32767	0	10 ⁻⁴ kgm ²
R axis inertia offset	INROFST	0 to 32767	0	0.001 mm
MOVE L max speed	CPVMAX	1 to 32767	750	mm/s
MOVE L accel.	CPACCL	1 to 32767	500	mm/s ²
MOVE L comp. curve	CPCMPCRV	0 to 255	0	—
MOVE L comp. velocity	CPCMPVL	1 to 32767	500	mm/s
Zone control	ZONCTRL	0: INVALID, 1: VALID	0	—

Name	Identifier	Setting range	Initial value	Unit
XY axis accel. rate	SCRACC	1 to 500	100	%
XY axis accel. velocity rate	SCRVEL	1 to 500	100	%
R axis velocity rate	SCRRVEL	1 to 500	Depends on the model.	%
Inner side circle minimum radius	MINRAD	10 to 100000	5000	0.001mm
Speed limit radius 1	CERAD1	10 to 100000	30000	0.001mm
Speed limit radius 2	CERAD2	10 to 100000	5000	0.001mm
Speed limit 1	SPLMT1	1 to 100	10	%
Speed limit 2	SPLMT2	1 to 100	1	%
Outer CP prohibited range	SCROPHR	0 to 9999999	Depends on the model.	0.001mm
Outer Jogging CP velocity limited range	SCROVLR	0 to 9999999	Depends on the model.	0.001mm
Outer Jogging CP velocity limit	SCROVL	1 to 100	5	%
Custom robot ^{*1}	CSTMRBT	0: INVALID, 1: VALID	0	—

*1 Contact your distributor for changing these parameters as editing them may influence the robot control.

Axis parameters

For details about parameters, refer to "10.6 Axis parameters" in this Chapter.

Name	Identifier	Setting range	Initial value	Unit
+ Soft limit	PLMT+	-9999999 to 9999999	Depends on the model.	pulse
- Soft limit	PLMT-	-9999999 to 9999999	Depends on the model.	pulse
Accel. coefficient	ACCEL	1 to 100	100	%
Decel. rate	DECRAT	1 to 100	100	%
Tolerance	TOLE	1 to value depending on the model	80	pulse
OUT position	OUTPOS	1 to 9999999	2000	pulse
CONT pulse	CONTPLS	0 to 9999999	0	pulse
Arch pulse 1	ARCHP1	0 to 9999999	9999999	pulse
Arch pulse 2	ARCHP2	0 to 9999999	9999999	pulse
Push speed	PSHSPD	1 to 100	10	%
Push force	PSHFRC	-1000 to 1000	100	ms
Push time	PSHTIME	1 to 32767	1000	ms
Push judge speed	PSHJGSP	0 to 100	0	%
Push method	PSHMTD	0: NORMAL, 1: RESET	0	—
Manual accel	MANACC	1 to 100	100	%
Origin speed 1	ORGVEL1	1 to 1000	200	pulse/10ms
Origin speed 2	ORGVEL2	1 to 100	50	pulse/10ms
Speed after origin	ORGMVS	1 to 100	20	%
Move position	ORGMVP	-9999999 to 9999999	0	pulse
Origin shift	ORGSFT	-9999999 to 9999999	0	pulse
Dual offset	DOFSET	-9999999 to 9999999	0	pulse
Origin method	ORGMTD	0: MARK, 1: SENSOR, 2: TORQUE, 3: ZR_TORQUE	Depends on the model.	—
Origin direction	ORGDIR	0: MINUS, 1: PLUS	0	—
Motor direction	MOTDIR	0: CW, 1: CCW	Depends on the model.	—
Arm length	ARMLEN	0 to 9999999	0	0.001mm, 0.001 deg.
Offset pulse	OFFSET	-9999999 to 9999999	0	pulse

- Set the workpiece weight held at the robot tip for the tip weight of the robot parameters.
- The value of the arm length parameter may affect the acceleration. The effective stroke value of each axis needs to be input for the arm length.

■ I/O parameters

For details about parameters, refer to "10.7 I/O parameters" in this Chapter.

Name	Identifier	Setting range	Initial value
DO output at emergency stop	EMGCDO	0: IO_RESET, 1: IO_HOLD	1
Error output (DO & SO)*	ERPORT	0 to 0277 (Octal)	0
Battery warning output (DO & SO)*	BTALRM	0 to 0277 (Octal)	0
DIO Noise Cancel Num.	DIOCAN	0 to 7	1
DO output at program reset	RESCDO	0: IO_RESET, 1: IO_HOLD	0
Remote command	RMTCMD	0: INVALID, 1: VALID	1
DI17 mode	DI17MD	0: ABS, 1: ABS_ORG	0
Indiv. Origin	IOORGMD	0: INVALID, 1: VALID	0
Axes sel. port (DI & SI)	IOORGIN	2 to 027 (Octal)	2
Done output port (DO & SO)*	IOORGOUT	0 to 027 (Octal)	0
Servo output port (DO & SO)*	IOSRVOUT	0 to 027 (Octal)	0
Gripper origin axes select port (DI & SI)*	GRPORGIN	0 to 027 (Octal)	0
Real time output	RTOENBL	0: INVALID, 1: VALID	0

* New setting values will be valid after turning off and on the power.

■ Option parameters

For details about parameters, refer to "10.8 Option board related parameters" in this Chapter.

Name	Identifier	Setting range	Initial value	Separate manual
Option board enable*	OPTENBL	0: INVALID, 1: VALID	1	—
Parallel IO ID*	DIOID	1234 to 4321	1234	—
PROFIBUS station address*	PBUSADD	1 to 125	125	✓
Gripper servo when emergency stop	GEMGMD	0: OFF, 1: ON	1	✓
Include Gripper in Origin	GORGMD	0: NO, 1: YES	1	✓
Manual Holding of Gripper	GMHLMD	0: INVALID, 1: VALID	1	✓
Gripper origin sequence	GORGORD	1234 to 4321	1234	✓
Gripper origin priority	GORGPRI	0: AFTER, 1: BEFORE	0	✓
DeviceNet address ID	DEVADD	0 to 63	0	✓
DeviceNet baudrate	DEVCOM	0:125K, 1:250K, 2: 500K, 3: AUTO	0	✓
DeviceNet I/O type	DEVTYP	0: NORMAL, 1: COMPACT	0	✓
EtherNet/IP IP address	EIPADD	0.0.0.0 to 255.255.255.255	0.0.0.0	✓
EtherNet/IP subnet mask	EIPSUB	0.0.0.0 to 255.255.255.255	0.0.0.0	✓
EtherNet/IP default gateway	EIPDEF	0.0.0.0 to 255.255.255.255	0.0.0.0	✓
EtherNet/IP DHCP enable	EIPDHCP	0: INVALID, 1: VALID	0	✓
SIOW extension*	SIOWEXT	0: INVALID, 1: VALID	0	✓

* New setting values will be valid after turning off and on the power.

7.4 Parameter descriptions

7.4.1 Controller parameters

■ Incremental mode control <INCMOD>

This parameter sets whether or not the robot is always put in the return-to-origin incomplete status when starting up this controller. Set "0: INVALID" in the case that there are axes whose return-to-origin method are set to "Mark". When this parameter is initialized, "0: INVALID" is set.

Setting	Meaning
0: INVALID	Holds the origin position information on absolute type axes even when the power is shut down.
1: VALID	Puts all axes in the return-to-origin incomplete status when turning on the power.



NOTE

- When this parameter is set to "VALID", all axes are always put in the return-to-origin incomplete status when turning on the controller.
- When using the absolute type axes without installing the absolute battery, set this parameter to "VALID".

■ MOVEI/DRIVEI start pos. <MOVIMD>

This parameter sets the operation when executing the relative motion command again after it has been stopped by the interlock or emergency stop. When this parameter is initialized, "0: KEEP" is set.

Setting	Meaning
0: KEEP	The previous motion continues. The target position before executing again does not change. When executing return-to-origin or absolute reset, the target position after the relative motion stop is reset.
1: RESET	The relative motion is newly performed from the current position. The target position before executing again will change.

■ MOVET start pos. <MOVMTD>

This parameter sets the operation when executing the MOVET command again after it has been stopped by the interlock or emergency stop. When this parameter is initialized, "0: KEEP" is set.

Setting	Meaning
0: KEEP	The previous motion continues. The target position before executing again does not change. When executing return-to-origin or absolute reset, the target position after the relative motion stop is reset.
1: RESET	The relative motion is newly performed from the current position. The target position before executing again will change.

■ Servo on when power on <SRVOON>

This parameter sets whether the controller starts in the servo on status or servo off status when starting up the controller. When this parameter is initialized, "0: INVALID" is set.

Setting	Meaning
0: INVALID	The controller always starts in the servo on status.
1: VALID	The controller starts in the servo on status. However, when the control authority is not released or the serial I/O setting is enabled, the controller starts in the servo on status.

■ Sequence flag <SEQFLG>

This parameter sets whether the controller executes the sequence program. When this parameter is initialized, "0: INVALID" is set.

Setting	Meaning
0: INVALID	The sequence program execution is not allowed.
1: VALID	The sequence program execution is allowed.
3: VALID & EMG-Reset	The sequence program execution, program reset and emergency stop release are allowed.

■ Safe mode flag <SAFEMODE>

The setting value saved in "7. Safety setting" in this Chapter will be stored into this parameter. As editing this may influence the robot setting, do not attempt to edit.

■ Permission to start program in origin non-completion <RUNINOIC>

This parameter sets whether the controller allows to execute the program in origin incomplete status. When this parameter is initialized, "0: INVALID" is set.

Setting	Meaning
0: INVALID	The program cannot be executed.
1: VALID	The program can be executed.

■ Permission to reset at controller boot <RSTATBOT>

This parameter sets whether the controller performs program reset when it starts. When this parameter is initialized, "0: INVALID" is set.

Setting	Meaning
0: INVALID	The program reset is not performed.
1: VALID	The program reset is performed.

■ Permission to reset at program start <RSTATRUN>

This parameter sets whether the controller performs program reset when the program starts. When this parameter is initialized, "0: INVALID" is set.

Setting	Meaning
0: INVALID	The program reset is not performed.
1: VALID	The program reset is performed.

■ Current program no. <CRNTPG>

This parameter sets the program number last executed to the task 1. When this parameter is initialized, "0" is set.



NOTE

Current program is the one that was executed last at task 1. Setting this number allows to register any programs. Furthermore, it is registered to task 1 at program resetting when the main program number is "0".

■ Main program no. <MAINPG>

This parameter sets the program number that is registered to the task 1 first at program resetting. When this parameter is initialized, "0" is set.



NOTE

Main program is the one that is registered to task 1 first at program resetting. When the main program number is "0", the current program number is registered to the task 1 at program resetting.

■ INPUT/PRINT using channel <STDPRN>

This parameter sets the PRINT statement output destination channel and INPUT statement input origin channel. When this parameter is initialized, "1: PB" is set.

Setting	Meaning
1: PB	Programming box
2: CMU	RS232C port
3: ETH	Ethernet port

■ Emergency time <EMGTIM>

This parameter sets the longest servo control time at emergency stop. As editing this may influence the robot setting, do not attempt to edit.

■ Emergency time2 <EMGTIM2>

This parameter sets the longest servo control time when the power is shut off. As editing this may influence the robot setting, do not attempt to edit.

■ Debug start mode <DBGSTAMD>

This parameter sets whether the started program should be executed or stopped when the START statement is executed on the program step execution (debug). When this parameter is initialized, "0: LOAD" is set.

Setting	Meaning
0: LOAD	The started program is in stop status on the first line.
1: START	The started program is in executed status.

■ Break point stop mode <BRKSTPMD>

This parameter sets whether the break point stops only the relevant program or all the programs. When this parameter is initialized, "1: HOLD ALL" is set.

Setting	Meaning
0: HOLD	The program with the break point stops.
1: HOLD ALL	All the programs stop.

7.4.2 Robot parameters

■ Tip weight <WEIGHT>

The tip weight (workpiece weight + tool weight) of the robot is set in "kg" units. However, when the robots for which the tip weight is set are R6YXG120, R6YXG150, R6YXG180 or R6YXG220, the tip weight is set in "0.1kg" units. The maximum value is determined by the robot model that has been set. When this parameter is initialized, the maximum value is set.

The acceleration value, etc., is set to the optimal value according to the value of this parameter.



CAUTION

When a value lower than the actual tip weight is set, this may adversely affect the robot main body. Therefore, be sure to input a correct value.



NOTE

- The tip weight of the axes specified as auxiliary axis are set on the axis tip weight of the axis parameter.
- If both of Tip weight parameters; <WEIGHT> and <WEIGHTG> are set, a total value will be set.
Example: WEIGHT = 2, WEIGHTG = 500; Tip weight = 2.5 kg (2500 g)

■ Tip weight (g) <WEIGHTG>

The tip weight (workpiece weight + tool weight) of the robot is set in "g" units.

When this parameter is initialized, the value of the tip weight will be set depending on the robot model. The maximum value is determined by the robot model that has been set.



CAUTION

When a value lower than the actual tip weight is set, this may adversely affect the robot main body. Therefore, be sure to input a correct value.



NOTE

- The tip weight of the axes specified as auxiliary axis are set on the axis tip weight of the axis parameter.
- If both of Tip weight parameters; <WEIGHT> and <WEIGHTG> are set, a total value will be set.
Example: WEIGHT = 2, WEIGHTG = 500; Tip weight = 2.5 kg (2500 g)

■ Origin sequence <ORGORD>

This parameter sets the order of return-to-origin operation using the axis number (1 to 6).

Axes perform return-to-origin operation in order from the left end. Axes that are not set finally perform return-to-origin operation at the same time. When this parameter is initialized, "312456" is set.



CAUTION

**When performing return-to-origin of three or more axes with the return-to-origin method set at the stroke end method, the emergency stop may be activated.
At this time, change the stroke end return-to-origin method to simultaneous two axes or return-to-origin of each axis.**



NOTE

- Perform return-to-origin operation from an axis that may interfere with a peripheral device.
- This order includes the robot axis and auxiliary axis.

When different position detection methods (absolute specifications or incremental specifications) are mixed in one robot, the order of return-to-origin operations may vary depending on the return-to-origin method.

Example:

Robot axis configuration: Axis 1, axis 2, axis 3, axis 4

Return-to-origin order setting: 312456

Position detection method of each axis: Axis 1, axis 2 ⇒ Incremental specifications
Axis 3, axis 4 ⇒ Absolute specifications

1. Return-to-origin operations of only the absolute type axes are performed.

Return-to-origin operations of only the absolute type axes are performed from the left end of the return-to-origin order setting in order.

3 → 1 → 2 → 4 → 5 → 6
Axis 3 operation Axis 1 cancel Axis 2 cancel 4 operation Axis 5 cancel Axis 6 cancel

2. Return-to-origin operations of only the incremental type axes are performed.

Return-to-origin operations of only the incremental type axes are performed from the left end of the return-to-origin order setting in order.

3 → 1 → 2 → 4 → 5 → 6
Axis 3 cancel Axis 1 operation Axis 2 operation Axis 4 cancel Axis 5 cancel Axis 6 cancel

3. Return-to-origin operations of both the absolute type and incremental type axes are performed.

First, return-to-origin operations of the absolute type axes are performed from the left end of the return-to-origin order setting in order.

Subsequently, return-to-origin operations of the incremental type axes are performed in the same manner.

3 → 1 → 2 → 4 → 5 → 6
Axis 3 operation Axis 1 cancel Axis 2 cancel Axis 4 operation Axis 5 cancel Axis 6 cancel

3 → 1 → 2 → 4 → 5 → 6
Axis 3 cancel Axis 1 operation Axis 2 operation Axis 4 cancel Axis 5 cancel Axis 6 cancel

The actual example of return-to-origin operation is shown below.

	Programming box operation	PGM execution	IO operation	
	Key operation	Command *1	Input port	DI17 mode *2
Absolute specifications only	Impossible (possible by-axis)	ORIGIN 0, 2	DI17	ABS
Incremental specifications only	Impossible (possible by-axis)	ORIGIN 0, 1	DI14	ABS
Both specifications at the same time	"ALL"	ORIGIN 0, 0	DI17	ABS/ORG

*1 For details about ORIGIN command, refer to the YRCX programming manual.

*2 This is the DI17 mode setting of the control parameters.

■ R-axis orientation <RORIEN>

This parameter sets whether or not the R-axis orientation (posture) is held when performing jog operation on the Cartesian coordinates in the SCARA robot. When this parameter is initialized, "0: KEEP" is set.

When the orientation set at "KEEP", the R-axis automatically rotates to hold the current orientation if jog movement is performed on the Cartesian coordinates.

Setting	Meaning
0: KEEP	Keeps the R-axis orientation (posture).
1: FREE	Does not keep the R-axis orientation (posture).



NOTE

This parameter is invalid when the R-axis is set at the auxiliary axis.

■ Arm type at reset <ARMTYP>

This parameter sets the hand system that is selected at program reset. When this parameter is initialized, "0: NONE" is set. When moving on the Cartesian coordinates in the SCARA robot or when performing coordinate conversion (pulse coordinates ↔ Cartesian coordinates), the hand system setting becomes important.

Setting	Meaning
0: NONE	Keeps the hand system that was set before performing program reset.
1: RIGHT	Sets the hand system to the right-handed.
2: LEFT	Sets the hand system to the left-handed.

■ MOVE L coef. <CPACRAT>

This parameter sets the acceleration/ deceleration at linear interpolation, circular interpolation and PATH movement of the SCARA robots between 1 to 100%. When this parameter is initialized, "100" is set.

This coefficient obtains optimum efficiency when set to "100%" to the tip weight and SCARA R-axis moment of inertia.



CAUTION

If decreasing the acceleration coefficient, a period of stop time in response to the stop command by the STOP key or stop signal may become long.



NOTE

When the tip swings during robot movement acceleration/ deceleration, decrease this value to suppress the swing.

■ R axis inertia <SCRINR>

This parameter sets the moment of inertia for the R-axis of the SCARA robot. The unit is "kgm² × 10⁻⁴".

When this parameter is initialized, "0" is set.

■ R axis inertia offset for SCARA <INROFST>

This parameter sets the distance that is offset from the rotation center of the R-axis to the gravity center of the tip weight. The unit is "0.001 mm".

This parameter is invalid for robots other than the SCARA robot R6YXE.

When this parameter is initialized, "0" is set.

7.4.3 Axis parameters

■ Plus (+) soft limit <PLMT+> Minus (-) soft limit <PLMT->

This parameter sets the axis movement range using the upper limit value [plus (+) soft limit] and lower limit value [minus (-) soft limit]. When this parameter is initialized, the value unique to the model is set. When performing point teaching or automatic operation, check that the specified point data is within the soft limit range.



WARNING

Be sure to set the soft limit inside the mechanical movement range (mechanical stopper) of the axis.



CAUTION

- Since this parameter is important to determine the operating range, be sure to set the correct value.
- For the X-axis and Y-axis of the SCARA robot, make the setting so that the total of the plus (+) and minus (-) soft limit absolute values does not exceed 360 degrees. Otherwise, an error may occur in the coordinate conversion results.
- When return-to-origin is incomplete, the soft limits become invalid. Therefore, take great care when performing jog movement.



NOTE

Input the soft limit value with the 0 to 9 keys, "." key, and "-" key. When the value that is input with the keys is a real number (numeric value including a period), the unit is automatically converted into the pulse value.

■ Acceleration coefficient <ACCEL>

This parameter sets the acceleration/ deceleration during robot movement in a range of 1 to 100%. When this parameter is initialized, "100" is set.



CAUTION

When decreasing the acceleration coefficient, a period of stop time in response to the stop command by the STOP key or stop signal may become long. Take great care when using the robot with the acceleration coefficient decreased extremely.



NOTE

When the tip swings during robot movement acceleration/ deceleration, decrease this value to suppress the swing.

■ Deceleration rate <DECRAT>

This parameter sets the deceleration rate during robot movement in a range of 1 to 100% and sets the deceleration as the rate to acceleration. When this parameter is initialized, the value unique to the model is set.



CAUTION

When decreasing the deceleration rate, a period of stop time in response to the stop command by the STOP key or stop signal may become long. Take great care when using the robot with the deceleration rate decreased extremely.



NOTE

- Set this parameter for changing only deceleration without decreasing acceleration.
- When the tip swings during robot movement deceleration, decrease this value to suppress the swing.

■ Tolerance <TOLE>

This parameter sets the positioning completion range to the target position when the robot moves. When this parameter is initialized, the value unique to the model is set.

When the current position of the robot enters the specified range, this is judged to the positioning completion.



NOTE

Input the tolerance value with the 0 to 9 keys, "." key, and "-" key.

When the value that is input with the keys is a real number (numeric value including a period), the unit is automatically converted into the pulse value.

Tolerance range

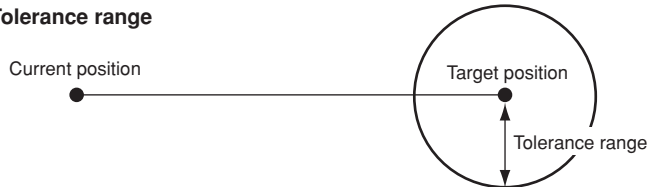

CAUTION

If the tolerance value is made small, a variation in robot positioning time may occur.

■ OUT position <OUTPOS>

This parameter sets the execution completion range to the target position when a movement command is executed. However, it applies to only the PTP motion.

When the current position of the robot enters the specified range, this is judged to the movement command execution completion. However, the movement to the target position continues. The larger the value is, the shorter the time until the next command executed is.

When executing the movement command continuously, the next movement command cannot be executed until the positioning is completed even when the previous movement command line has been completed.

When this parameter is initialized, the value unique to the model is set.



NOTE

Input the OUT valid position with the 0 to 9 keys, "." key, and "-" key. When the value input with the keys is a real number (numeric value including a period), the unit is converted into the pulse value.

OUT valid position range

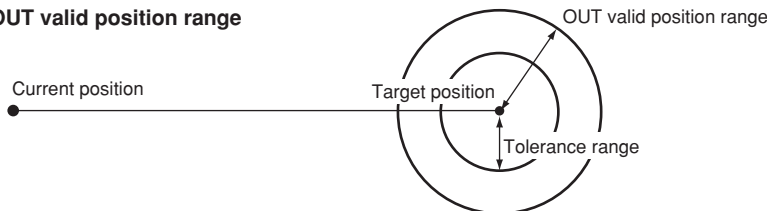

CAUTION

If the tolerance value is larger than the OUT valid position value, both the command execution and positioning are completed when it enters the OUT valid position range.

■ CONT pulse <CONTPLS>

This parameter sets the execution completion range to the target position when the movement command specified as CONT option is executed in the program. However, this parameter applies to only the PTP motion. When this parameter is initialized, the value unique to the model is set.

When the current position of the robot enters the specified range, this is judged to the movement command execution completion. However, the movement to the target position continues. The larger the value is, the shorter the time until the next command execution is.

When executing the movement command continuously, the next movement command cannot be executed until the positioning is completed even when the previous movement command line has been completed.



CAUTION

The movement command is judged by the OUT valid position value when the CONT pulse value is "0". If the tolerance value is larger than the OUT valid position value, both the command execution and positioning are completed when it enters the OUT valid position range.

**NOTE**

Input the OUT valid position with the 0 to 9 keys, "." key, and "-" key. When the value input with the keys is a real number (numeric value including a period), the unit is converted into the pulse value.

■ Arch pulse 1 <ARCHP1> Arch pulse 2 <ARCHP2>

This parameter sets the overlap area of the arch-specified axis and other axis movement when executing the arch motion that is an option of the PTP motion. When this parameter is initialized, "9999999" is set.

The smaller the value, the larger the overlap area during axis movement. As a result, the movement execution time can be reduced.

The value whose unit of the selected axis setting value was converted is shown.

**NOTE**

Input the arch pulse 1 and arch pulse 2 with the 0 to 9 keys, "." key, and "-" key. When the value input with the keys is a real number (numeric value including a period), the unit is converted into the pulse value.

Arch pulse

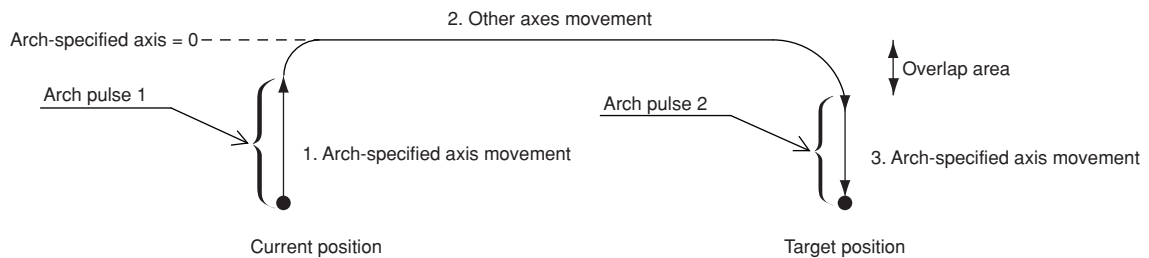

1. The arch-specified axis starts moving to the position specified by the option. ("1" shown in the figure above)
2. When the arch-specified axis moves arch pulse 1 value or more, other axes move to their target positions. ("2" shown in the figure above)
3. The arch-specified axis moves to the target position so that the remaining distance becomes arch pulse 2 when the movement of other axes is completed. ("3" shown in the figure above)
4. When all axes enter the OUT valid position range, the command is completed.

**CAUTION**

The tracking of the arch motion may vary depending on the movement speed. Check the interference check at actual robot operation speed.

■ Push speed <PSHSPD>

This parameter sets the movement speed rate in 1 to 100 [%] at executing PUSH statement.

- Neither "S" nor "DS" is set as an option in the PUSH statement:
Max. speed of a robot (mm/s or deg./s) x Pushing movement speed (%) x Auto. movement speed (%)
- "S" is set as an option in the PUSH statement:
Max. speed of a robot (mm/s or deg./s) x Pushing movement speed (%) x Auto. movement speed (%) x Program movement speed (%)
- "DS" is set as an option in the PUSH statement:
Max. speed of a robot (mm/s or deg./s) x Pushing movement speed (%) x Movement speed of an axis (%)

* Refer to the YRCX programming manual for details regarding the option settings of the PUSH statement.

When this parameter is initialized, "10" is set.

■ Push force <PSHFRC>

This parameter sets the pushing thrust in -1000 to 1000 [%] at executing PSHFRC statement.

Actual pushing thrust is as follows:

- Rated thrust x <pushing thrust> / 100

When this parameter is initialized, "100" is set.

■ Push time <PSHTIME>

This parameter sets the pushing time within 0 to 32767 [ms] at executing PSHTIME statement. Pushing time is counted in conditions as follows:

- The pushing time reaches the specified value.
- The axis movement speed lowers the pushing detection speed threshold.

When this parameter is initialized, "1000" is set.

■ Push judge speed <PSHJGSP>

The pushing time counting starts when the current axis movement speed lowers the rate specified in this parameter against command movement speed. When "0" is set, the judgement is invalid.
When this parameter is initialized, "0" is set.

■ Push method <PSHMTD>

This parameter sets the pushing control end detection at executing PUSH statement as follows:

0: The time for the pushing thrust to reach the specified value is totalized to execute the pushing control end detection.

1: The pushing control end detection is executed only when the pushing thrust continuously reaches the specified value. If the pushing thrust is lower than the specified value, the elapsed time is reset to "0".

When this parameter is initialized, "0: NORMAL" is set.

■ Manual acceleration <MANACC>

This parameter sets the acceleration coefficient during robot movement with the manual operation in a range of 1 to 100 [%]. When this parameter is initialized, "100" is set.



CAUTION

When decreasing the acceleration coefficient, a period of stop time in response to the stop command by the STOP key or stop signal may become long. Take great care when using the robot with the acceleration coefficient decreased extremely.



NOTE

When the tip swings during acceleration of the manual movement, decrease this value to suppress the swing.

■ Origin speed 1 <ORGVEL1>

This parameter sets the movement speed when performing return-to-origin. When this parameter is initialized, the value unique to the model is set for the incremental type axis and absolute type axis.

■ Origin speed 2 <ORGVEL2>

This parameter sets the stop speed in performing return-to-origin. When this parameter is initialized, the value unique to the model is set.

■ Speed after origin <ORGMVS>

This parameter sets the movement speed when moving to the return-to-origin position in a range of 1 to 100 [%]. When this parameter is initialized, the value unique to the model is set.



CAUTION

Actual movement speed is:

Maximum speed command (rpm) x Automatic operation speed (%) x Speed after origin (%)

■ Move position <ORGMVP>

This parameter sets the movement position after performing return-to-origin. When this parameter is initialized, the value unique to the model is set.



CAUTION

The axes that are set as mark method move to the "move position" after performing absolute reset in servo on status. After performing absolute reset in servo off status, they do not move to the "move position".

■ Origin shift <ORGSFT>

This parameter is used to correct the deviation amount of each axis if the work position deviates after the motor has been replaced and an impact has been applied. When this parameter is initialized, "0" is set.

Set the electrical deviation origin position amount to the mechanical origin position of the robot. The value of this parameter becomes the current motor position immediately after return-to-origin operation.

Example:

When the current position after moved to the work position before positional deviation is expressed by "A" pulse and the current position after moved to the work position after positional deviation is expressed by "B" pulse, input the value (A - B).



CAUTION

- This parameter is important to determine the robot position.
- When this parameter is changed, the robot is put in the origin return incomplete status.
- This parameter is valid after performing absolute reset or return-to-origin.
- Setting incorrect values may cause of robot collision.

■ Dual offset <DOFSET>

The dual offset is the function that controls two motor axes of the same models with one motor axis and adjusts the origin position of the sub axis to the main one. Refer to the YRCX operator's manual for details. When this parameter is initialized, "0" is set.



CAUTION

This parameter is used only for the robots which are prepared to use dual offset function.

■ Origin method <ORGMTD>

This parameter sets the return-to-origin method of the robot. When this parameter is initialized, the value unique to the model is set.

0: Mark method Method to set the origin position, such as match mark by the user

1: Sensor method Origin position detection method by inputting sensor

2: TORQUE (Stroke end method) ... Origin position detection method by the robot stroke end

3: ZR_TORQUE (ZR-stroke end method) ...

Origin position detection method by the specific robot stroke end

The origin position is detected by combining the Z and R-axis return-to-origin methods.



CAUTION

- If the setting is changed without consulting, your distributor shall not be held responsible for any trouble arising from this setting change.
- When this parameter is changed, the robot is put in the origin return incomplete status.

■ Origin direction <ORGDIR>

This parameter sets the movement direction when the robot performs return-to-origin. When this parameter is initialized, the value unique to the model is set.

0: Minus ... The minus (-) direction of the motor position is the return-to-origin direction.

1: Plus ... The plus (+) direction of the motor position is the return-to-origin direction.



CAUTION

- When any of the conditions shown below is satisfied, do not change the factory setting.

Conditions	Problem at setting change
The model is the F14H lead 5 mm.	When performing stroke end return-to-origin on the non-motor side, the origin position becomes unstable.

When the setting needs to be changed, contact your distributor.

- If the setting is changed without consulting, your distributor shall not be held responsible for any trouble arising from this setting change.
- When this parameter is changed, the robot is put in the origin return incomplete status.

Motor direction <MOTDIR>

This parameter sets the direction, in which the robot moves. When this parameter is initialized, the value unique to the model is set.

0: CW ... The motor CW direction is the minus (-) direction of the axis.

1: CCW ... The motor CCW direction is the minus (-) direction of the axis.

This parameter cannot be changed in the servo on status. To change the parameter, turn the servo off.

For details on the movement direction when the robot is operated to the minus direction by jog movement and the motor axis polarity is set to "0", refer to "Robot operation direction list" mentioned later in this Chapter.



CAUTION

- When any of the conditions shown below is satisfied, do not change the factory setting.

Conditions	Problem at setting change
The model is the F14H lead 5 mm.	When performing stroke end return-to-origin on the non-motor side, the origin position becomes unstable.

When the setting needs to be changed, contact your distributor.

- If the setting is changed without consulting, your distributor shall not be held responsible for any trouble arising from this setting change.
- When this parameter is changed, the robot is put in the origin return incomplete status.

Arm length <ARMLEN>

For SCARA type robots, this parameter sets the X and Y-arm lengths.

When this parameter is initialized, the unique value to the model is set. Additionally, this parameter is set automatically when setting the standard coordinates.

Offset pulse <OFFSET>

This parameter sets the angle to the arm posture or standard coordinate axis in the status where the X, Y, and R-axis motor positions of the SCARA robots are located at their "0"-pulse positions.

- X-axis offset pulse
... Angle formed by the plus (+) X-axis direction of the standard coordinates and the X-arm. (Unit: pulse)
- Y-axis offset pulse
... Angle formed by the X-arm and Y-arm. (Unit: pulse)
- R-axis offset pulse
... Angle formed by the plus (+) X-axis direction of the standard coordinates and the R-axis tip tool. (Unit: pulse)

When this parameter is initialized, "0" is set. Additionally, this parameter is set automatically when setting the standard coordinates.

"Offset pulse" setting

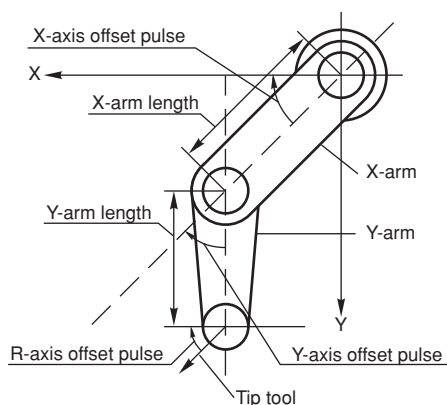

CAUTION

- For SCARA type robots, coordinate conversion to the Cartesian coordinates is performed using the arm length and offset pulse. Therefore, be sure to set the correct offset pulse.
- When the data is input using this parameter (press in the input cursor display status), the standard coordinates are set.

7.4.4 I/O parameters

■ DO at emergency stop <EMGCDO>

This parameter sets the DO/MO/LO/TO/SO port outputs to RESET/HOLD when the emergency stop is input. When this parameter is initialized, "1: IO_HOLD" is set.

Setting	Meaning
0: IO_RESET	Turns the DO/MO/LO/TO/SO port outputs OFF when the emergency stop is input to the controller.
1: IO_HOLD	Holds the DO/MO/LO/TO/SO port outputs when the emergency stop is input to the controller.

■ Error output (DO & SO) <ERPORT>

This parameter sets error outputs to the general-purpose output ports when an error occurred on the controller. The port number between 0 and 0277 (octal) can be used as an error output port. When this parameter is initialized, "0" is set. New setting value will be valid after turning off and on the power.



NOTE

- The alarms with category of message (alarm classification number is between 0 and 199) are excluded.
- The alarms that occur in online command or remote command with category of operation error (alarm classification number is between 200 and 399) are excluded.
- SO with the same number as DO is output when serial boards such as DeviceNet is added to the option board.

Setting	Meaning
0	Outputs no error.
1 to 0277 (Octal)	Outputs an error from the port specified by DO or SO.

The general-purpose output used in error output is OFF in any case of follows:

1. Servo was turned on.
2. Program reset was executed.
3. Step execution, skip or next execution started.
4. Return-to-origin started.
5. Remote command was send.
6. Jog movement started with the programming box in MANUAL mode.
7. Online command was executed.

■ Battery warning output (DO & SO) <BTALRM>

This parameter sets alarm outputs to the general-purpose output ports when an alarm related to memory battery or absolute battery occurs on the controller. The port number between 0 and 0277 (octal) can be used as an alarm output port. When this parameter is initialized, "0" is set.

New setting value will be valid after turning off and on the power.

Setting	Meaning
0	Outputs no battery alarm.
1 to 0277 (Octal)	Outputs a battery alarm from the port specified by DO or SO.

■ DIO noise cancel Num. <DIOCAN>

This parameter cancels the short pulse shape external input signals (dedicated input signals and general-purpose input signals). Unintended input signals, such as noise are prevented. Signals with length that does not satisfy the conditions (specified cycle x 0.25 ms) are determined to noise to be canceled. When this parameter is initialized, "1" is set.

* For input signals, input signals with 6 ms or longer on or off signal.

■ DO output at program reset <RESCDO>

This parameter sets the DO/MO/LO/TO/SO port outputs to RESET/HOLD when all programs are reset or the HALT ALL statement is executed. When this parameter is initialized, "0: IO_RESET" is set.

Setting	Meaning
0: IO_RESET	The DO/MO/LO/TO/SO port outputs are reset when executing any of the following operations. <ul style="list-style-type: none"> • All reset (RESETALL) is performed during automatic operation. • Dedicated input signal DI15 or SI15 (program reset) is turned on during program stop. • Any of the following data is initialized by selecting [System] → [Initialize]. <ul style="list-style-type: none"> ALL: All data PGM: Program data • Online command @RESET, @INIT PGM, @INIT ALL, @INIT MEM, or @SWI is executed. • HALTALL is executed in the program.
1: IO_HOLD	Even when any of the operations shown above is executed, the DO/MO/LO/TO/SO port outputs are not reset.

■ Remote command <RMTCMD>

This parameter sets VALID/INVALID of the remote command. When the option parameter "DeviceNet I/O type" is set to "COMPACT", the remote command cannot be used even when this parameter is set to "VALID". When this parameter is initialized, "1: VALID" is set.

Setting	Meaning
0: INVALID	Remote command cannot be used.
1: VALID	Remote command can be used.

■ DI17 mode <DI17MD>

This parameter sets the operation of the dedicated input DI17/SI17. When this parameter is initialized, "0: ABS" is set.

Setting	Meaning
0: ABS	When the DI17/SI17 signal is input, return-to-origin of the absolute type motor axis is performed For the incremental specifications, return-to-origin is performed by the DI14/SI14 input.
1: ABS_ORG	When the DI17/SI17 signal is input, return-to-origin of the absolute and incremental type axes is performed.

■ Indiv. Origin <IOORGMD>

This parameter sets axes to perform return-to-origin; all axes with return-to-origin input DI14 (for incremental axes) / DI17 (for absolute axes), or only specified axes. When this parameter is initialized, "0: INVALID" is set.

Setting	Meaning
0: INVALID	Performs return-to-origin on all axes.
1: VALID	Performs return-to-origin on the axes specified by "Axes sel. port (DI & SI)" or "Gripper origin axes select port (DI & SI)" parameter and the gripper only.

■ Axes sel. port (DI & SI) <IOORGIN>

This parameter sets ports which specify axes to perform return-to-origin when the "Indiv. Origin" parameter is set to "VALID". Axis 1 of robot 1 is "0" pit of specified port, then axes are allocated subsequently. When the number of axes exceeds 8, the next port is used to specify 16 axes maximum. When this parameter is initialized, "2" is set.

■ Done output port (DO & SO) <IOORGOUT>

This parameter sets ports to output the return-to-origin status of each axis. When the number of axes exceeds 8, the next port is used to specify 16 axes maximum. When this parameter is initialized, "0" is set. The return-to-origin status is not output when "0" is set.

New setting value will be valid after turning off and on the power.

■ Servo output port (DO & SO) <IOSRVOUT>

This parameter sets ports to output the servo status of each axis. When the number of axes exceeds 8, the next port is used to specify 16 axes maximum. When this parameter is initialized, "0" is set. The servo status is not output when "0" is set.

New setting value will be valid after turning off and on the power.

■ Gripper origin axes select port (DI & SI) <GRPORGIN>

This parameter sets ports which specify grippers to perform return-to-origin when the "Indiv. Origin" parameter is set to "VALID". When this parameter is initialized, "0" is set. Individual gripper return-to-origin is not performed when "0" is set.

New setting value will be valid after turning off and on the power.

■ Real time output <RTOENBL>

This parameter sets the real time output function enabled or disabled.

When this parameter is enabled, items registered in the real time output file are output into the word output area SOW(24) to (127). Update cycle is 10 ms.

Only EtherNet/IP and PROFINET support this function.

To use this parameter, the word IO area should be extended beforehand; set the option board parameter "SLOW extension" to "1: VALID".

Note that the real time output setting (the registration in the real time output file) is performed on the editor of SCARA-YRCX Studio or via the remote commands.

When this parameter is initialized, "0: INVALID" is set.



NOTE

For details about the real time output function, refer to the remote I/O manual.

Setting	Meaning
0: INVALID	Disables the real time output function.
1: VALID	Enables the real time output function.

7.4.5 Option board related parameters

■ Option board enable <OPTENBL>

This parameter sets the option DIO (PNP specifications and NPN specifications) enabled or disabled. When this parameter is initialized, "1: VALID" is set.

New setting value will be valid after turning off and on the power.

Setting	Meaning
0: INVALID	Disables the option DIO.
1: VALID	Enables the option DIO.

■ Parallel IO ID <DIOID>

This parameter sets allocate order to DIO in numeric value when several parallel I/O boards are inserted. When this parameter is initialized, "1234" is set.

The numbers 1 to 4 correspond to the inserted parallel I/O board ID in the option board number order. The board corresponded the number allocates ID to DIO in order from the left. In the case of normal I/O board, the ID is always "1" no matter what is set.

Example:

Option board configuration	1: Dedicated parallel I/O board 2: General-purpose parallel I/O board 1 4: General-purpose parallel I/O board 2
Parallel I/O ID setting	3214
DI0 to DI3, DO0 to DO2	Dedicated parallel I/O board
DI4 to DI7, DO3 to DO5	General-purpose parallel I/O board 2
DI8 to DI11, DO6 to DO8	General-purpose parallel I/O board 1

■ PROFIBUS station address <PBUSADD>

This parameter sets the station number (the identifier to each node of the PROFIBUS) of the PROFIBUS-corresponding unit. The setting range is between 1 and 125. When this parameter is initialized, "125" is set.

New setting value will be valid after turning off and on the power.

■ Gripper servo when emergency stop <GEMGMD>

This parameter sets the gripper servo status when the emergency stop button is pressed. When this parameter is initialized, "1: ON" is set.

Setting	Meaning
0: OFF	The remote command cannot be used.
1: ON	The gripper servo is not turned off when the emergency button is pressed. Therefore, the gripper keeps to grip the workpiece.

■ Include Gripper in Origin <GORGMD>

This parameter sets whether the gripper is added to the axes when return-to-origin operation of the entire robot. When this parameter is initialized, "1: YES" is set.

The following operations enable this parameter:

- Return-to-origin by DI14 or DI17
- Return-to-origin by the programming language (ORIGIN)
- Return-to-origin by remote command

Setting	Meaning
0: NO	The gripper is not added to the axes to be performed return-to-origin. * Executes the online command @GORIGIN to perform return-to-origin of the gripper.
1: YES	The gripper is added to the axes to be performed return-to-origin.

■ Manual Holding of Gripper <GMHLMD>

This parameter sets whether the gripper holds the workpiece by the jog movement online command (@GJOG, @GJOGXY). When this parameter is initialized, "1: VALID" is set.

Setting	Meaning
0: INVALID	The jog movement online command (@GJOG, @GJOGXY) is INVALID. If the gripper holds the workpiece, "26.801: Gripper over load" alarm occurs.
1: VALID	The jog movement online command (@GJOG, @GJOGXY) is VALID.

■ Gripper origin sequence <GORGORD>

This parameter sets the order of return-to-origin for the gripper to decide the motor position. When this parameter is initialized, "1234" is set, and each number is corresponding to the gripper numbers. Return-to-origin operations of the grippers are performed from the left end of the return-to-origin order setting in order. The grippers without setting perform return-to-origin simultaneously at last.

■ Gripper origin priority <GORGPRI>

This parameter sets the timing of performing return-to-origin of the gripper. When this parameter is initialized, "0: AFTER" is set.

Setting	Meaning
0: AFTER	Return-to-origin of the gripper is performed after all the robots return-to-origin.
1: BEFORE	Return-to-origin of the gripper is performed before all the robots return-to-origin.

■ DeviceNet address ID <DEVADD>

This parameter sets the DeviceNet station number. When this parameter is initialized, "0" is set.

■ DeviceNet baudrate <DEVCOM>

This parameter sets the DeviceNet baud rate. When this parameter is initialized, "0: 125kbps" is set.

Setting	Meaning
0	125kbps
1	250kbps
2	500kbps
3	Auto

■ DeviceNet I/O type <DEVTYP>

This parameter selects the number of channels shared by the DeviceNet applicable unit from "Normal" or "Compact". When "Normal" is selected, each of the input and output shares 24CH (I/O including word data). When "Compact" is selected, each of the input and output shares 2CH (dedicated/ general-purpose I/O). When this parameter is initialized, "0: DEV_NORMAL" is set.

Setting	Meaning
0	DEV_NORMAL
1	DEV_COMPACT

■ EtherNet/IP IP address <EIPADD>

This parameter sets the IP address. When this parameter is initialized, "0.0.0.0" is set.

■ EtherNet/IP subnet mask <EIPSUB>

This parameter sets the subnet mask. When this parameter is initialized, "0.0.0.0" is set.

■ EtherNet/IP default gateway <EIPDEF>

This parameter sets the gateway. When this parameter is initialized, "0.0.0.0" is set.

■ EtherNet/IP DHCP enable <EIPDHCP>

This parameter sets the DHCP function VALID or INVALID.

Set this parameter to "VALID" when assigning the IP address, etc. from the host unit. When this parameter is initialized, "0: INVALID" is set.

Setting	Meaning
0	INVALID
1	VALID

* When the DHCP function is valid, the setting value of IP address, subnet mask and gateway is "0.0.0.0".

■ SLOW extension <SIOWEXT>

This parameter sets the SLOW extension enabled or disabled.

When this parameter is enabled, the word IO area in the field network is extended to use SIW(24)-(127) and SOW(24)-(127) as the general IO ports.

Only EtherNet/IP and PROFINET support this function.

When this parameter is initialized, "0: INVALID" is set.



NOTE

- To use the real time output function, enable this parameter and extend the word IO area.
- For details about the SLOW extension function, refer to the relevant field network manual.



CAUTION

- When using the unsupported field network, this parameter is not shown on SCARA-YRCX Studio.
- Even if you use the field network that supports the SLOW extension, the communication cannot be established unless you use the setting file that supports SLOW extension and set PLC correctly.

Setting	Meaning
0	INVALID
1	VALID

7.5 PRM skip

This function sets skipping the undefined data of parameter files to load the controller (parameters that the controller is not corresponded) or not.

Undefined data in the file will be skipped when the parameter files are loaded with this function "VALID". This function is not included in the parameter file.



CAUTION

Spelling mistakes in the parameter file are not detected when this function is "VALID". Do not set this to "VALID" except the case that it is necessary to load the parameters from later version controller into the earlier one.



NOTE

New parameters may added as the controller software upgrading. "10.214: Undefined parameter found" alarm will occur when the later version parameter file including such new parameters is load to the controller with earlier version.

Step 1 Press the F3 key (PRM SKIP) on the "PAREMETER>CONT" screen.

Step 1 "PARAMETER>CONT" screen

```
PARAMETER>CONT          H==M==R15  0.0
                        H==SP50  0.0
No  Parameter Name
 1 Incremental Mode control
 2 MOVEI/DRIVEI start pos.
 3 MOVET start pos.
 4 Servo on when power on
 5 Sequence flag
 6 Safe mode flag
 7 Permission to start program in o
 8 Permission to reset at program s
[1]EDIT  [2]JMP  [3]PRM SKIP
```

Step 2 Input the value.

Input "1" and press the ENTER key to enable "Do not load undefined parameters". To disable, input "0" and press the ENTER key.

Step 2 "PRM SKIP" screen

```
PRM SKIP          H==M==R15  0.0  0.0
undefined data in the parameter file
loaded to the controller is skipped.
0
[0]INVALID  [1]VALID
```

8. Area check output

This performs the area check of the current robot position by defining the point data to the area check output parameter, then the result will be output to the specified port.

When the comparison point is set shown as ● below, if the robot tip moves between ○, output is off in ⇔ and on in ⇔. (When the check condition of the area check output is on within the area.)

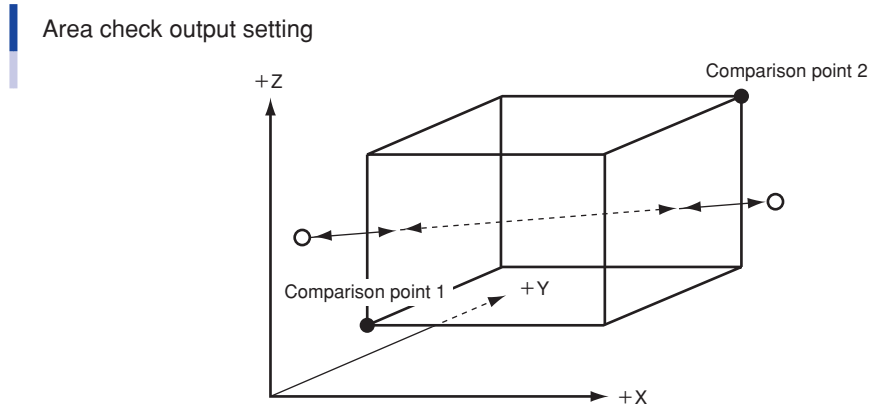

NOTE

- The maximum number of areas that can be checked is 32.
- The output state may change unexpectedly when the output ports overlap used in the program and area check output. Therefore, make sure to set the output port so as not to overlap.
- Make sure that the comparison point number does not overlap with that for another use.
Example: Point number used for move command, pallet definition, etc.
- This will be OR output when the same ports are specified to different area check output.
- An error occurs if the comparison point does not exist or comparison points are different in the unit system, and the area check output cannot be performed.
If it is in such a state during automatic operation, the operation will be stopped and an error occurs. The area check output where an error occurred will be off and automatic operation stops while an error occurring.
- The area check output does not operate in return-to-origin incomplete stated.
- All the specified axes are target of the area check. Give special attention to settings when there is a rotation axis.
- The area check does not output outside when a number that does not exist in the hardware was specified as an area check output port number.

Select "Edit" – "Area check output" on the initial screen, "AREA CHECK OUTPUT" screen appears.

8.1 Setting area check output

Set the parameters on area check output.

Valid keys and sub menu descriptions on the "AREA CHECK OUTPUT" screen (Edit → Area check output) are shown below.

Valid keys	Menu	Function
		Moves the cursor.
	EDIT	Moves to the edit screen for area check output.
	INIT	Initializes the selected area check output parameters.
		Switches ON/OFF of the scroll function.
		Returns to the previous screen.

Valid keys and submenu descriptions on "AREA CHECK OUTPUT" screen (Edit → Area check output → Edit → New) are shown below.

Valid keys	Menu	Function
		Moves the cursor.
F1 (Only on EDIT screen)	NEW	Creates new area check output.
INS		Switches between the "insert" and "overwrite" modes alternately.
BS		Deletes one character immediately before the cursor position.
DEL		Deletes one character at the cursor position.
ESC		Returns to the previous screen.

Step 1 Select the area check output using the cursor keys.

Turn the scroll function on to scroll the shift numbers up and down by three.
 Press the F1 key (EDIT), then the "Edit" screen appears.
 Pressing the F2 key (INIT) initializes the selected area check output parameter.
 Refer to "7.2 Initializing area check output" in this Chapter.

Step 1 Selecting the area check output



Step 2 Edit or create area check output.

Select the setting value to edit with the cursor keys, then input values and press the ENTER key.
 * Pressing the ESC key halfway cancels editing.
 Press F1 key (NEW) to create new area check output.

Step 2 Editing the area check output



Step 3 Press the ESC key to exit the editing.

8.2 Initializing area check output

Select the area check output number to initialize the parameter on the "Area check output" screen, press the F2 key (INIT) to display the pop-up screen. Select [OK] with the cursor keys and press the ENTER key to initialize the selected area check output. To return to the previous screen without initialization, press the ESC key or [CANCEL] and the ENTER key.

Area check output initialization

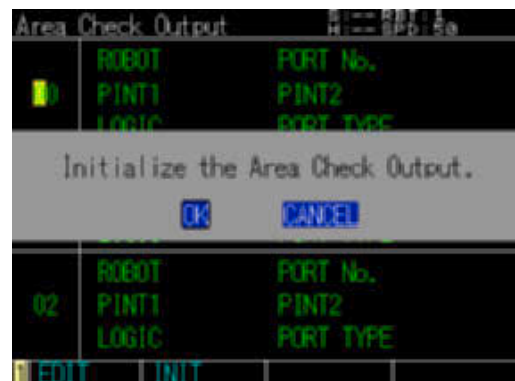

8.3 Parameter list

There are six parameters for the area check output.

■ ROBOT

Select the robot to perform the area check.

Setting	Meaning
0	INVALID: The area check output is not performed.
1 to 4	Perform the area check output for the robot 1 to 4.

■ PORT TYPE

Select the port type to output the result of the area check.

Setting	Port type
0	DO/SO
1	DO
2	SO
3	MO

■ PORT NUMBER

Select the port number to output the result of the area check. Available port numbers are shown below.

Port type	Setting range
0: DO/SO	20 to 277
1: DO	20 to 277
2: SO	20 to 277
3: MO	0 to 277



NOTE

The output state may change unexpectedly when the output ports overlap used in the program and area check output. Therefore, make sure to set the output port so as not to overlap.

■ Check conditions <LOGIC>

Select the condition where the area check output turns ON from within/outside the area.

Setting	Meaning
0	ON within the area
1	ON outside the area



NOTE

- The position just on the border line is within the area.
- Despite the condition settings, the area check output turns OFF when normal area check cannot be performed such as in return-to-origin incomplete status, except manual/automatic mode, during a memory error.
- Initial setting is (0: ON within the area).

■ Comparison number 1 <PINT1>

■ Comparison number 2 <PINT2>

Sets the points to define the area.

Setting range
0 to 29999

Possible point number range to use is P0 to P29999. All the specified axes are the target of the area. When the R-axis is specified, make sure that the R-axis data of comparison point is specified.



NOTE

- Use the same unit system for comparison point 1 and 2.
- An error occurs when no comparison points exist, or the comparison points are different in the unit system and area check cannot be performed.
- If it is in such a state during automatic operation, the operation will be stopped and an error occurs. The area check output where an error occurred will be off and automatic operation stops while an error occurring.
- All the specified axes are target of the area check. Give special attention to settings when there is a rotation axis.
- Make sure that the comparison point data ranges to a certain extent. If the two of comparison point data is specified nearly equal, the area check may be unstable.

9. Standard coordinates

When selecting [Edit] - [Standard Coordinate] from the initial screen, the "STD COORD" screen will appear. In this hierarchy, the standard coordinates can be set.

The standard coordinates for SCARA type robots are treated as Cartesian coordinates using the X-arm rotating center as the coordinate origin.

The following operations and functions are enabled on SCARA type robots by setting the standard coordinates.

- Moving the robot arm tip in the direction of the Cartesian coordinates.
- Using PALLET definitions, SHIFT coordinates, and HAND definitions.
- Using commands requiring coordinate conversion, such as linear/circular interpolation and pallet movement commands.

To set the standard coordinates, two methods shown below are available.

- Simple teaching
Align the first arm and second arm of the SCARA type robot on the straight line, and then input the lengths of the first arm and second arm to set the standard coordinates.
- 3-point teaching
Perform the teaching of three points arranged on the line at equal intervals, and input the direction and length from the start point to the end point so as to set the standard coordinates.
- 4-point teaching
Perform the teaching of four points that form a rectangle. The first point is specified as the teaching origin and the positions of other 3 points are input relative to the first point.
* This method is different from that described in YRC operator's manual.
- Both handed system teaching
To set the standard coordinates, prepare two points that is separated 100 mm in parallel from the X-axis or Y-axis of the new standard coordinates.
Set the two points to the values three times; the teaching points, the arm length, and the direction from the start point to the end point.
For the start point, set twice the values above in the both handed system; the right- and left-handed system.
For the end point, set the values once.



NOTE

The both handed teaching is the most recommended method, for this method is more easy to realize the high precision than the other methods.
Available version (REF) "9.4 Setting the standard coordinates by both handed system teaching"

■ Setting the standard coordinates

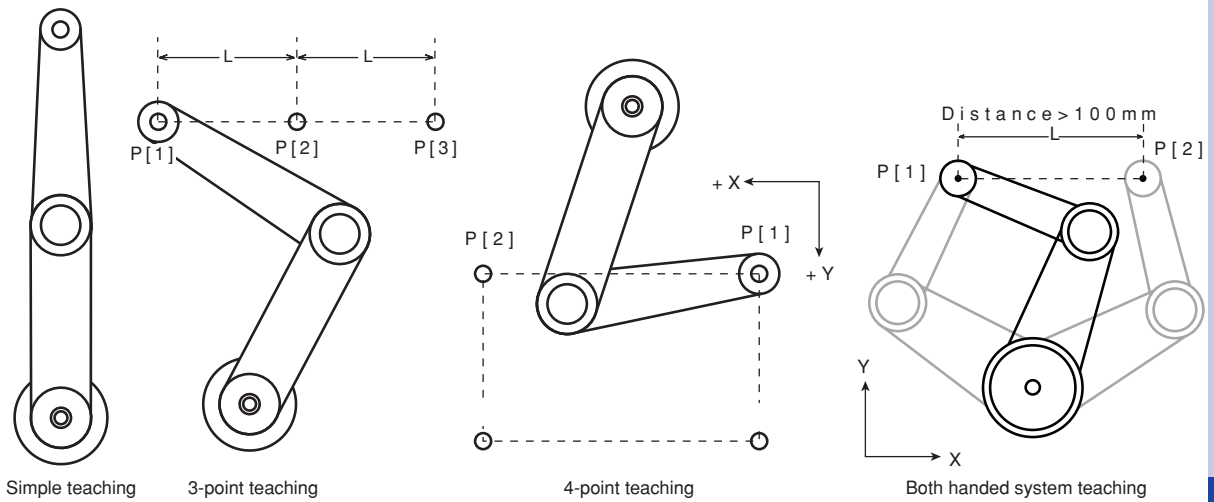

CAUTION

When setting the standard coordinates, note the following points.

- Always perform teaching with the same hand system carefully and accurately.
- Set the teach points as near as possible to the center of actual work area and also separate them from each other as much as possible.
- The plane formed by the robot X and Y-axis movement must be parallel to the actual working plane.
- Perform point teaching at the rotation center of the R-axis.
- The standard coordinate setting accuracy greatly affects the Cartesian coordinate accuracy.

The following parameters are automatically set when the standard coordinates are input.

1) Arm length (mm)

M1 = ###.###

First arm length (distance between the first arm and second arm rotation centers)

M2 = ###.###

Second arm length (distance between the second arm and R-axis rotation centers)

2) Offset pulse

M1 = #####

X-axis offset pulse (angle formed by the first arm when the axis 1 motor is located at the "0" pulse position and the X-axis of the standard coordinates)

M2 = #####

Y-axis offset pulse (angle formed by the first arm and second arm when the axis 2 motor is located at the "0" pulse position)

M4 = #####

R-axis offset pulse (angle formed by the R-axis direction when the R-axis motor is located at the "0" pulse position and the X-axis of the standard coordinates)

When using multiple robots, set the standard coordinates for each robot.

However, the offset pulse of the R-axis is not set automatically. Set it by editing the parameters directly.



CAUTION

When using multiple robots, be sure to check the current target robot. The robot is changed from the "QUICK MENU" screen. For details, refer to "5.2 Quick menu" in Chapter 2.



NOTE

- The standard coordinates have been set at shipment.
- The offset pulse value equals the pulse value that axis 1, axis 2, and R-axis move on the X-axis of the standard coordinates.

■ Setting the standard coordinates

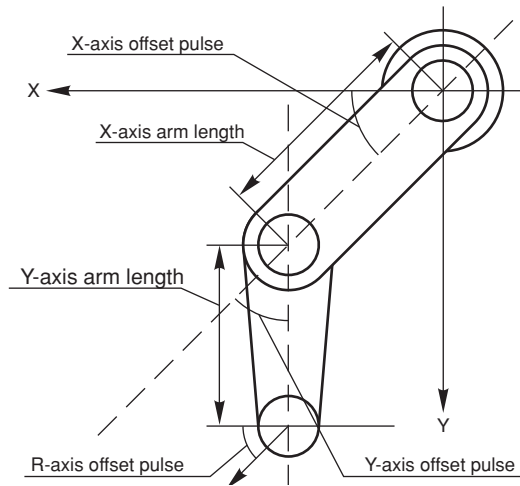

■ Selecting standard coordinate setting method



Valid keys	Menu	Function
F1	SIMPLE	Moves to the screen that allows you to set the standard coordinates by simple teaching.
F2	3POINT	Moves to the screen that allows you to set the standard coordinates by 3-point teaching.
F3	4POINT	Moves to the screen that allows you to set the standard coordinates by 4-point teaching.
F4	BOTH HND	Moves to the screen that allows you to set the standard coordinates by both handed system teaching.
ESC		Returns to the previous screen.

9.1 Setting the standard coordinates by simple teaching



NOTE

Align the rotation centers of the first arm, second arm, and R-axis on the line as much as possible.

■ Setting the standard coordinates by simple teaching

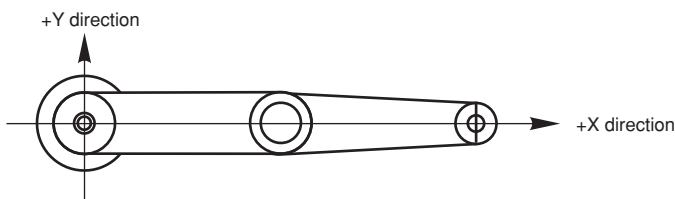

Step 1 Press the F1 key (SIMPLE) on the "STD COORD" setting screen (Edit → Standard Coordinate).

Step 1 Setting the standard coordinates by simple teaching



Step 2 Align the first arm and second arm on the line.

Move the first arm and second arm using the Jog key operation or Jog operation in the servo off status to the position where they are aligned, and then press the F4 key (NEXT). At this time, the direction shown in the figure above becomes the +X direction.



WARNING

When performing the operation with the Jog key, the robot is in operation. Therefore, do not enter the robot movement range to prevent any hazard.

During the operation with the Jog key, the operation can be performed by adjusting the speed and inch distance.

To adjust the speed, select the F1 key (SPEED) to display the speed setting pop-up screen. Adjust the speed on this screen.

For details about speed adjustment, refer to "2.3 Changing the Jog movement speed" in Chapter 3.

To adjust the inch amount, select the F2 key (INCH) to display the inch amount adjustment pop-up screen. Use 0 to 9 keys to input the pulse value.

* The first arm and second arm of the robot described in this manual are equivalent to the X-arm and Y-arm of the YRC controller.

Step 2 Setting the inch amount



Step 3 Input the arm lengths.

Use 0 to 9 keys to input the first arm length, and then press the F4 (NEXT).

Next, input the second arm length, and then press the F4 key (NEXT).

Step 4 Set the standard coordinates.

Check the arm length and offset pulse value. Select (SET), and then press the ENTER key to save the settings. After the settings have been saved, press the F4 key (FINISH) or ESC key to exit the setting.

When pressing the F4 key (FINISH) or ESC key in the status that the settings are not saved, the setting is completed without saving.

If the calculation cannot be performed, corresponding alarms occur.

Step 3 Inputting the first arm and second arm lengths

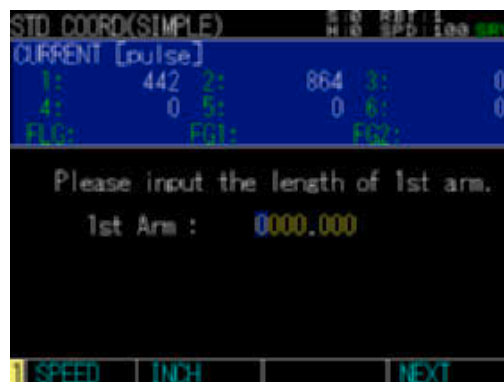

Step 4 Checking the settings



9.2 Setting the standard coordinate by 3-point teaching



NOTE

Separate the teach points from each other as much as possible.

■ Setting the standard coordinate by 3-point teaching

Precondition: All 3 points P[1], P[2] and P[3] must be aligned, with P[2] set at the midpoint between P[1] and P[3].

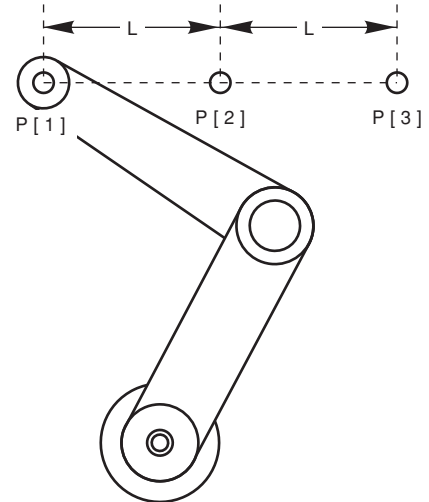

Step 1 Press the F2 key (3POINT) on the "STD COORD" screen (Edit → Standard Coordinate).

Step

▶ **Step 1** Setting the standard coordinate by 3-point teaching

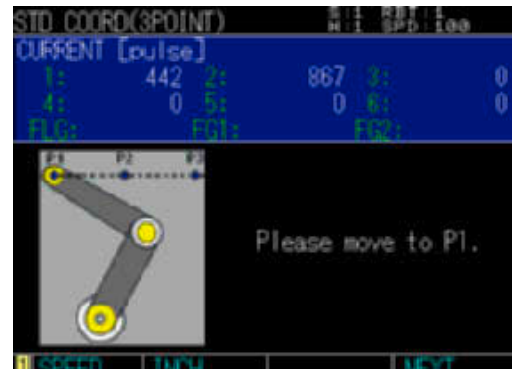

Step 2 Determine the point P1.

Use the Jog key to move the robot tip to the point P1 and press the F4 key (NEXT) to set the position.



WARNING

When performing the operation with the Jog key, the robot operates. Therefore, do not enter the robot movement range to prevent any hazard.



NOTE

Perform teaching carefully to obtain accurate points. Precise standard coordinates cannot be set if a point is inaccurate.

▶ **Step 2** Setting the inch distance



To adjust the speed, select the F1 key (SPEED) to display the speed setting pop-up screen. Adjust the speed on this screen.

For details about speed adjustment, refer to "2.3 Changing the Jog movement speed" in Chapter 3.

To adjust the inch amount, select the F2 key (INCH) to display the inch amount adjustment pop-up screen. Use 0 to 9 keys to input the pulse value.

Step 3 Determine the points P2 and P3.

Perform the same operation stated in Step 2.

Step 4 Determine the direction from P1 to P3.

Use the F1 key (+X) to F4 key (-Y) to determine the direction from P1 to P3.

Step 4 Inputting the direction from P1 to P3

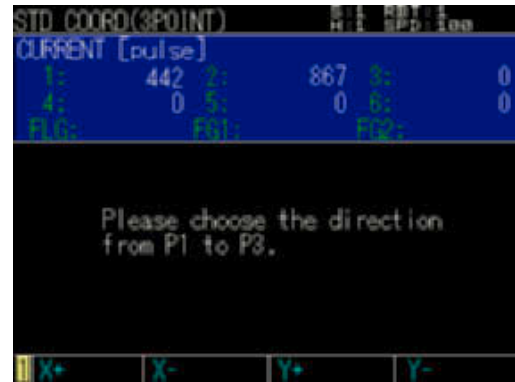

Step 5 Input the length from P1 to P3.

Use 0 to 9 keys and "." key to input the length from P1 to P3, and then press the F4 key (NEXT). The upper limit of the input value is "1000".

Step 5 Inputting the length from P1 to P3

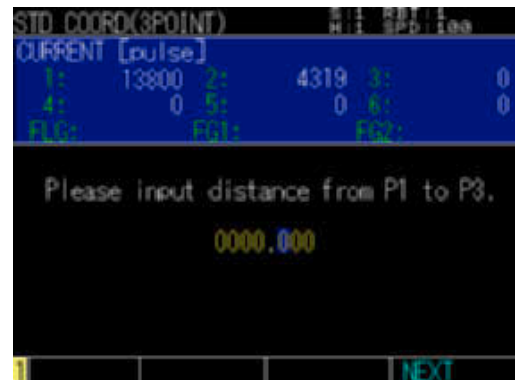

Step 6 Set the standard coordinates.

Check the arm length and offset pulse value. Select (SET), and then press the ENTER key to save the settings. After the settings have been saved, press the F4 key (FINISH) or ESC key to exit the setting.

When pressing the F4 key (FINISH) or ESC key in the status that the settings are not saved, the setting is then completed without saving. If the calculation cannot be performed, corresponding alarms occur.



9.3 Setting the standard coordinate by 4-point teaching



NOTE

- Separate the teach points from each other as much as possible.
- If one side length is inadequate, an error may occur and the point cannot be set.

■ Setting the standard coordinate by 4-point teaching

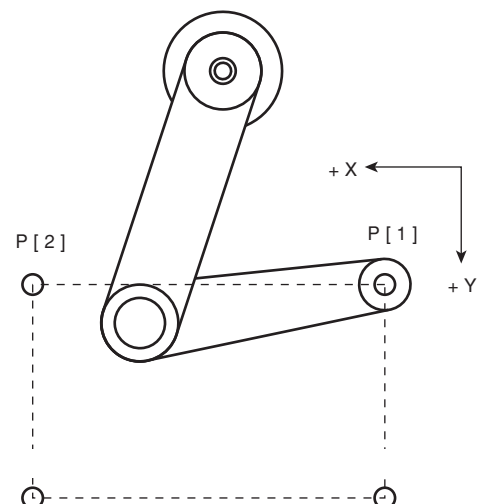

Step 1 Press the F3 key (4POINT) on the "STD COORD" screen (Edit → Standard Coordinates).

▶ **Step 1** Setting the standard coordinate by 4-point teaching

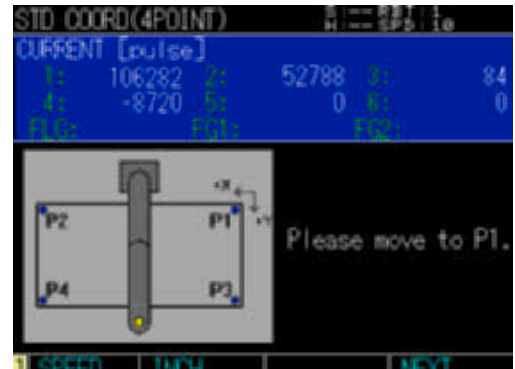

Step 2 Determine the point P1.

Use the Jog key to move the robot tip to the point P1 and press the F4 key (NEXT) to set the position.

▶ **Step 2** Setting the inch distance



WARNING

When performing the operation with the Jog key, the robot operates. Therefore, do not enter the robot movement range to prevent any hazard.



NOTE

Perform teaching carefully to obtain accurate points. Precise standard coordinates cannot be set if a point is inaccurate.

To adjust the speed, select the F1 key (SPEED) to display the speed setting pop-up screen. Adjust the speed on this screen.

For details about speed adjustment, refer to "2.3 Changing the Jog movement speed" in Chapter 3. To adjust the inch amount, select the F2 key (INCH) to display the inch amount adjustment pop-up screen. Use 0 to 9 keys to input the pulse value.

Step 3 Determine the points P2 and P3.

Perform the same operation stated in Step 2.

▶ **Step 4** Inputting each point coordinate with P1 as the origin

Step 4 Input coordinate values of each point from the P1 as the origin point.

Use 0 to 9 and "." keys to input the coordinates of each point from P1. The upper limit of input value is 9999.999.



Step 5 Set the standard coordinates.

Check the arm length and offset pulse value. Select (SET), and then press the Input key to save the settings. After the settings have been saved, press the F4 key (FINISH) or ESC key to exit the setting.

When pressing the F4 key (FINISH) or ESC key in the status that the settings are not saved, the setting is then completed without saving the settings.

If the calculation cannot be performed, the alarm occurs.

▶ **Step 5** Confirming the setting



9.4 Setting the standard coordinate by both handed system teaching



NOTE

The both handed system teaching is available in the version below.

- Host controller (indispensable) : V1.71 or later
- Programming box (required for the standard coordinates setting with operating the pendant; PBEX) : V1.16 or later
- SCARA-YRCX Studio (required for the standard coordinates setting with operating the support software) : V1.4.2 or later

■ Setting the standard coordinates by both handed system teaching.

The both handed system teaching is the method for setting the standard coordinates that is based on the two points that is separated 100 mm in parallel from the X-axis or Y-axis of the new standard coordinates.

For the start point, the teaching is required twice by the both handed system; the right- and the left-handed system.

The standard coordinates can be set by teaching three times and by entering the arm length and the direction from the start point to the end point.

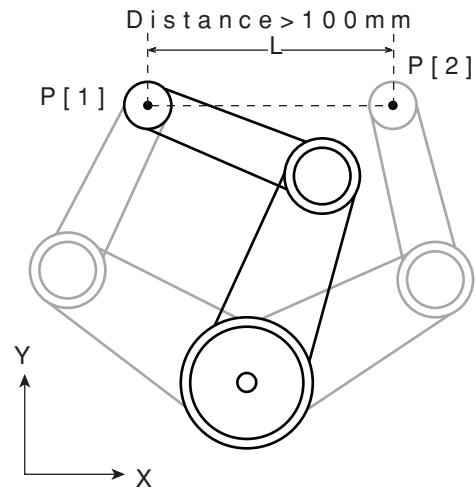

Step 1 Press the F4 key (Both handed) on the "STD COORD" screen (EditStandard Coordinate).

Step 2 Confirm (change) the arm length.

The value firstly shown in the entering form is the default value of the arm length of the currently set robot model.

Check the arm length value and press the F4 key (NEXT) if it is not necessary to change.

If the change of the arm length is needed, use 0 to 9 keys to input the first arm length, and then press the F4 (NEXT).

▶ Step 2 Confirm (change) the arm length.

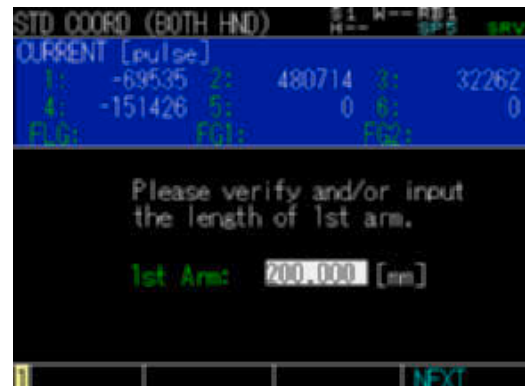

Step 3 Teach the point P1.

Use the Jog key to move the robot tip to the point P1 and press the F4 key (NEXT) to set the position.

▶ Step 3 Teach the point P1.



WARNING

When performing the operation with the Jog key, the robot operates. Therefore, do not enter the robot movement range to prevent any hazard.



NOTE

Perform teaching carefully to obtain accurate points. Precise standard coordinates cannot be set if a point is inaccurate.

To adjust the speed, select the F1 key (SPEED) to display the speed setting pop-up screen. Adjust the speed on this screen.

For details about speed adjustment, refer to "2.3 Changing the Jog movement speed" in Chapter 3. To adjust the inch amount, select the F2 key (INCH) to display the inch amount adjustment pop-up screen. Use 0 to 9 keys to input the pulse value.

Step 4 Teach the point P1 in the opposite hand system.

In the opposite hand system (left <--> right) of the one at Step3, move the robot tip to the point P1' (the same position at Step3), and then press the F4 key (NEXT) to teach the position.

Step 5 Determine the point P2.

Move the robot tip to the point P2 and press the F4 key (NEXT) to set the position.

It doesn't matter whether the hand system is left or right.

Set the position of P1 and P2 so that they are parallel to the X- or Y-axis in the new standard coordinates.

Step 6 Determine the direction from P1 to P2.

Using the F1 key (+X) to the F4 key (-Y), set the direction from P1 to P2.

Step 7 Set the standard coordinates.

Check the arm length and offset pulse value. Select (SET), and then press the Input key to save the settings. After the settings have been saved, press the F4 key (FINISH) or ESC key to exit the setting.

When pressing the F4 key (FINISH) or ESC key in the status that the settings are not saved, the setting is then completed without saving the settings.

If the calculation cannot be performed, the alarm occurs.

Step 4 Teach the point P1 in the opposite hand system



Step 5 Determine the point P2



Step 6 Determine the direction from P1 to P2.



Step 7 Set the standard coordinates





NOTE

To optimize the precision, be sure to fulfill the following conditions.

- The distance between P1 and P2 should be more than 100 mm.
- P1 and P2 should not be within a 50 mm radius from rotation center of the first axis of SCARA robot.
- Keep 20 mm or more (10 mm or more for the tiny SCARA) between P1/P2 and the working envelope of robot.
- To set P1 and P1', surely use both of the left- and right- handed system. if each point is set in the same handed system, an incorrect value will be estimated.

TIP how to optimize the precision:

- Concerning the teaching of P1, the more an angle made of the first and the second axis get close to 90-degrees, the more the precision will be increased.

10. General Ethernet port (GEP) setting

Press the F5 key (GEP) on the "Ethernet" screen to display the "GEP SETTING" screen. The general Ethernet port parameters are set on this screen.

■ "GEP SETTING" screen

GEP SETTING		S:-- RBT:1	H:-- SPD:50
0	MODE 0	PORT 40	
	TYPE 0	EOL 0	
	IPADRS 192.168.0.2		
01	MODE	PORT	
	TYPE	EOL	
	IPADRS		
02	MODE	PORT	
	TYPE	EOL	
	IPADRS		
1	EDIT	INIT	

Refer to the YRCX user's manual for details on GEP and setting.

Chapter 5 Controller system settings

1. Overview	5-1
2. History	5-1
3. Check	5-2
4. Property	5-2
4.1 Robot information	5-2
4.2 Option information	5-3
4.3 Clock	5-3
4.4 Version	5-3
4.5 Configuration	5-4
5. USB memory operation	5-4
5.1 Saving the data	5-4
5.2 Loading the data	5-5
6. Execution level	5-6
6.1 Changing access level	5-6
7. Safety setting	5-7
8. Initialize	5-8
8.1 Initializing data	5-8
8.2 Setting the clock	5-9
9. Generation	5-10

1. Overview

To operate the robot, various settings corresponding to the customer's operation are needed. This Chapter describes how to make the various controller settings and display the information. Additionally, system settings other than the robot operation settings are also described.

	Item	Description
2	History	Displays the alarm history data.
3	Check	Checks if an alarm occurs in the controller.
4	Property	Displays the information of the controller.
5	USB Memory Operation	Saves or restores various data using the USB memory.
6	Execution Level	Sets the operating level (operable range).
7	Safety Setting	Sets the safety parameters.
8	Initialize	Initializes various data.
9	Generation	Makes the settings corresponding to specifications of the axis and the robot to be connected.

2. History

When selecting [System] - [History] from the initial screen, the "HISTORY" screen will appear. The "HISTORY" screen displays five past alarm history records from the latest. Up to 500 records are saved.

The alarm display format is shown below.

Number	Alarm occurrence date and time
	Alarm number: Alarm occurrence location

The display is scrolled one line with the cursor keys. When pressing the "SCROLL ON" key to set the scroll function ON, the display is scrolled one screen with the cursor keys.

■ "HISTORY" screen



CAUTION

The alarm history data is very important information when taking the robot troubleshooting measures. Therefore, do not initialize the alarm history data carelessly.



NOTE

- When the number of alarm history records exceeds 500, the oldest history record is deleted.
- The same alarm as the previous alarm in the same occurrence place occurs is not recorded.
- When the alarm classification is between 0 and 99, such alarms are not recorded.
- Alarms with the classification number between 200 and 399 on the online or remote commands are not recorded.

3. Check

When selecting [System] - [Check] from the initial screen, the "CHECK" screen will appear.
The controller is diagnosed. If an error is detected, relevant message will appear.

■ "CHECK" screen

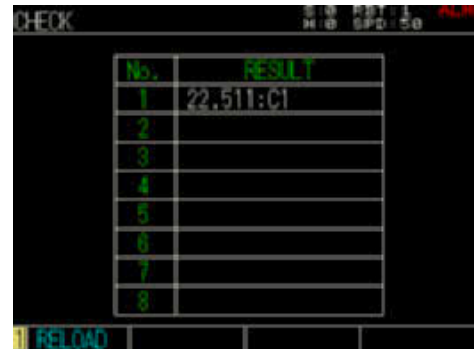

No.	RESULT
1	22.511:Cl
2	
3	
4	
5	
6	
7	
8	



NOTE

Even when the 24 V DC power is not supplied to the option DIO, the alarm always occurs.

4. Property

When selecting [System] - [Property] from the initial screen, the property screen will appear.
The property screen displays the robot information, option information, clock, and version.

4.1 Robot information

The robot names connected to the controller are displayed.

To display the "ROBOT" screen, select [Menu] → [System] → [Property] or press the F1 key (ROBOT) on other information screen.

Select the robot (Robot 1 to Robot 4) using the cursor keys and press the ENTER key to switch to the screen displaying the axis name connected to the robot.

■ ROBOT name



Robot No.	Robot Name
Robot1	MULTI
Robot2	
Robot3	
Robot4	

■ ROBOT axis name



Axis No.	Robot Name
A1	TSMOTOR
A2	TSMOTOR

4.2 Option information

When pressing the F2 key (OPTION), the "OPTION" screen displays the type and version of the option boards connected to the option slot of the controller.

Display	Unit name
DIO_Nm*	Displays that the option DIO with the NPN specifications is installed. (S: Standard DIO, 1 to 4: Expanded DIO2)
DIO_Pm*	Displays that the option DIO with the PNP specifications is installed. (S: Standard DIO, 1 to 4: Expanded DIO2)
D_Net	DeviceNet unit
ENet_IP	EtherNet/IP unit
Profi_B	PROFIBUS unit
Profi_N	PROFINET unit
YCLnkE_M	YC-Link/E master unit
YCLnkE_S	YC-Link/E slave unit
Tracking	Tracking System unit

*"m" shows the specifications.

■ "OPTION" screen



4.3 Clock

When pressing the F3 key (CLOCK), the controller built-in clock will appear.

■ "CLOCK" screen



4.4 Version

When pressing the F4 key (VERSION), various versions inside the controller and the version of the programming box are displayed.

■ "VERSION" screen

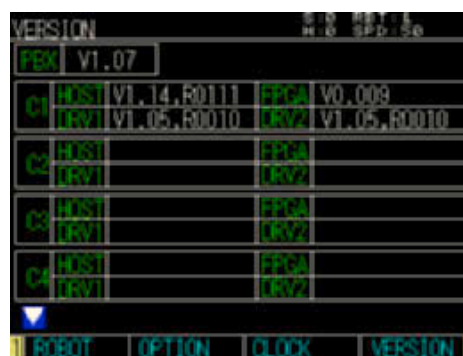

4.5 Configuration

When pressing the F5 (CONFIG) key to display each controller setting.

* The F5 is shown by switching the KEYSYTYPE.

Display	Meaning
Type	Displays the controller type. YRCX is displayed.
Method	Displays controller specification. Global: CE specification, Local: Normal specification
Node	Displays YC-Link/E settings. Blank: Master, 1 to 99: Slave station number
Memory	Displays controller memory size.
Brake	Displays the brake power settings. Internal (power supply) / External (power supply)
MAC	Displays the MAC address of the Ethernet port.

"CONFIG" screen



5. USB memory operation

Various data in the memory inside the controller can be saved into the USB memory. Additionally, the saved data can be reloaded to the controller.

Select [System] - [USB Memory] from the initial screen, to display the "USB MEMORY" screen.

"USB MEMORY" screen

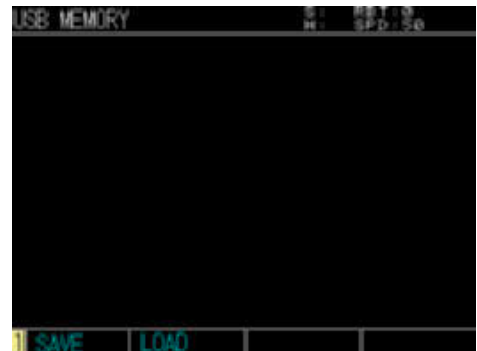

NOTE
It is recommended to save the internal data when robot controller setting is completed.



CAUTION

- If a trouble (data corruption, error, etc.) occurs in the USB memory or saved data, the data cannot be loaded. Be sure to save the data into an external storage device, such as personal computer.
- If an abnormal process, such as power shutdown occurs while the data is being saved or loaded, the data is not guaranteed.

5.1 Saving the data

The internal data of the controller is saved into the USB memory. The data will be saved into the "OMRON" folder immediately beneath the USB memory.

Step 1 Select [System] - [USB Memory] - [SAVE] from the initial screen.

Use the cursor keys to select the type of the data to save, then press the F1 key (CHOOSE) to show the list of the data files to be saved.

Step 1 Selecting the data to save



Step 2 Select the file to save.

To save the file newly:

Press the F1 key (CHOOSE) and input the file name in the next Step.

To save the file in the overwrite mode:

Use the cursor keys to select the file to save, and then press the F1 key (CHOOSE) or ENTER key.

When many files are saved:

Press the F2 key (NEXT) to scroll the file list.

Step 3 Save the file.

Input the file name of the data to save.

To save into a new file, input a new file name.

Input a new file name or input an existing file name to overwrite.

Press the ESC key to cancel the data saving.

"Now Saving" message will appear during data saving.

5.2 Loading the data

The data saved in the USB memory is restored to the internal memory of the controller.

It is required to the data to have been saved into the "OMRON" folder immediately beneath the USB memory.

Step 1 Select [System] - [USB Memory] - [LOAD] from the initial screen.

Use the cursor keys to select the type of the data to load, then press the F1 key (CHOOSE) to show the list of the data files which can be loaded.

▶ Step 1 Selecting the data to save**Step 2 Select the file to load.**

Use the cursor keys to select the data file to load, then press the F1 key (CHOOSE). The confirmation message will appear.

When many files are saved, press the F2 key (NEXT) to scroll the file list.

Step 3 Load the data.

Press the ENTER key to load the data from the file.

Press the ESC key to cancel the data loading. The message, "Now Loading", will appear during data loading.

**CAUTION**

When loading the data as ALL file or parameter file, the controller must be put in the servo off status. Additionally, after the data has been loaded, the robot is put in the origin return incomplete status.

6. Execution level

The controller can be set to operating levels that permit or prohibit changing programs and point data.

Access level	Description
Level 0: Maintainer level	All operations can be performed. To move to this level, a password is required.
Level 1: Operator level	Only the manual operation and automatic operation can be performed. Programs with hidden attribute cannot be loaded.



NOTE

When any of the following conditions arises, the access level is forcibly set to "Level 0".

1. All of the data are initialized. (Refer to "8. Initialize" in this Chapter.)
2. The alarm message "9.723: Controller status data destroyed" appears.

6.1 Changing access level

To change the access level, follow the procedure below.

Step 1 Display the "ACCESS LEVEL" screen.

Use the cursor keys to select (System) on the initial screen, and then press the ENTER key. Next, select (Execution Level), and then press the ENTER key. The "ACCESS LEVEL" screen will appear.

Step 2 Input the access level to set.

Input the access level and press the ENTER key. Select (SET) and press the ENTER key.

To set "0 (Maintainer level)":

Perform the operation stated in Step 3.

To set "1 (Operator level)":

Press the ENTER key again to determine the setting you have input.

Step 3 Input the password.

Input the password in the password entry field, and then press the ENTER key.

* If an incorrect password is input, "6.235: Password error" alarm occurs.

▶ Step 2 Setting the ACCESS LEVEL



Input the password.

■ Changing the password

Step 1 Press the F1 key (CHANGE PW) on the "ACCESS LEVEL" screen.

The "CHANGE PW" screen will appear.

Step 2 Set a new password.

Input the current password in (Pass), and then press the ENTER key. Next, input a new password in (New Pass) at two locations, and then press the ENTER key.

▶ Step 2 Changing the password



Input the current password.
Input a new password (two locations).

7. Safety setting

The safety parameters are set to safely perform the work with the programming box within the movement range (the safety enclosure) of the system using the robot.



WARNING

- In "Safety setting", changing the settings from their default values is likely to increase hazards to the robot operator during maintenance or operation. Although customers can change these settings based on their own responsibility, adequate consideration should first be given to safety.
- Set the control setting "GET" to enable the SAFETY SETTING.

On the "SAFETY SETTING" screen, you can set five items described below.

	Item name	Setting	Remarks
1	Hold to Run For Auto	VALID/INVALID	The robot operation (including the program execution) is executed while holding down the key on the programming box.
2	Deceleration Control	VALID/INVALID	When set VALID, the maximum robot movement speed is limited to its 3%.
3	Exclusive IO	VALID/INVALID	Sets the dedicated input of the I/O interface VALID or INVALID. * Even when set INVALID, the general-purpose inputs and outputs can be used.
4	RS-232C	VALID/INVALID	Sets the RS-232C interface VALID or INVALID.
5	Ethernet	VALID/INVALID	Sets the Ethernet interface VALID or INVALID.

■ Setting procedure

Step 1 Select [System] - [Safety Setting] from the initial screen.

When the warning screen appears, agree to the contents and press the ENTER key.

▶ Step 1 Warning message

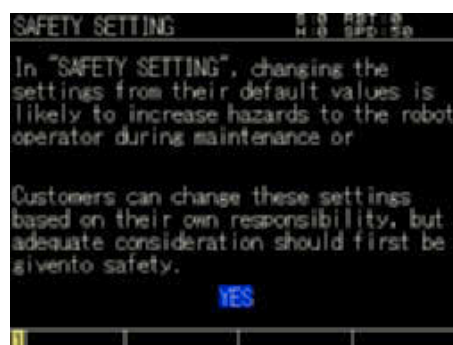

Step 2 Set [VALID] or [INVALID].

Use the cursor keys to select (VALID) or (INVALID) of the item to set, and then press the ENTER key.

To set the setting valid even after the power shut-down, perform the operation stated in Step 3.

▶ Step 2 Setting the safety parameters



Step 3 Save the settings.

When pressing the F1 key (SAVE) on the "SAFETY SETTING" screen, the setting save confirmation screen will appear.

Select (OK), and then press the ENTER key to save the settings.

When selecting (Cancel), the settings are not saved.

This setting will be valid after turning on the power again.

▶ Step 3 Saving the safety parameters



8. Initialize

When selecting [System] - [Initialize] from the initial screen, the "Initialize" screen will appear.

On this screen, you can initialize the data managed by the controller. Use the F1 key (ALL DATA) to F11 (CLOCK) to select the item to initialize.

■ "INITIALIZE" screen



Valid keys and submenu descriptions on the "INITIALIZE" screen are shown below.

Valid keys	Menu	Function
F1	ALL	Initializes all data.
F2	PGM	Deletes the program data.
F3	PNT	Deletes the point data.
F4	PNM	Deletes the point name data.
F5	SFT	Deletes the shift coordinate data.
F6	HND	Deletes the hand definition data.
F7	PRM	Initializes the parameter data.
F8	PLT	Deletes the pallet definition data.
F9	ION	Deletes the I/O name data.
F10	LOG	Deletes the alarm history data.
F11	CLOCK	Sets the clock.

8.1 Initializing data

Programs, point data, point names, shift coordinates, hand definitions, parameters, pallet definitions, IO names, and alarm history data are initialized or deleted.

Before executing the initialization process, carefully check that the currently input data is unnecessary.



NOTE

- Once the memory is initialized, the external data needs to be input to restore the data.
- If the memory is corrupted for some reason, the memory needs to be initialized.

Valid keys and submenu descriptions on the "INITIALIZE" screen are shown below.

Valid keys	Menu	Function
F1	ALL	Initializes all data.
F2	PGM	Deletes the program data.
F3	PNT	Deletes the point data.
F4	PNM	Deletes the point name data.
F5	SFT	Deletes the shift coordinate data.
F6	HND	Deletes the hand definition data.
F7	PRM	Initializes the parameter data.
F8	PLT	Deletes the pallet definition data.
F9	ION	Deletes the I/O name data.
F10	LOG	Deletes the alarm history data.

Step 1 Use the function keys to select the item to initialize.

Use the F1 key (ALL) to F10 key (LOG) to select items to initialize. The initialization execution confirmation screen will appear.

Step 1 Confirming the initialization execution



Step 2 Execute the initialization process.

Select the (OK) button and press the ENTER key to execute the initialization process. Select the (CANCEL) button, and then press the ENTER key to cancel the initialization process.

8.2 Setting the clock

The controller is equipped with the clock function, allowing you to set the date and time.



CAUTION

The clock used inside the controller has an error when compared to the actual time. If an error occurs, make the setting again.

Step 1 Press the F11 key (CLOCK) on the "INITIALIZE" screen.

The current date and time will appear.

Step 2 Input the date.

Select the date (year/month/day) using the cursor keys, input a value using the 0 to 9 keys, and then press the ENTER key. Subsequently, use the cursor keys to select (SET), and then press the ENTER key. The date is then set in the controller.



Step 3 Input the time.

Select the date (hour: minute: second) using the cursor keys, input a value using the 0 to 9 keys, and then press the ENTER key. Subsequently, use the cursor keys to select (SET), and then press the ENTER key. The time is then set in the controller.

9. Generation

The system generation of the controller has been set at shipment corresponding to the specification of robot to be connected and axis. So, the system generation setting by the customer is not needed.

If the system generation related memory is corrupted by serious trouble or if the robot or axis to be connected to the controller is changed, the system generation setting is needed.

For details about how to operate the system generation, contact your distributor.



CAUTION

- If the system generation is changed by mistake, this may adversely affect the robot operation or cause serious hazard to the operator. When the system generation needs to be changed, contact your distributor.
 - If the system generation is changed without consulting your distributor, OMRON shall not be held responsible for any trouble arising from this change.
-

Chapter 6 Monitor

1. Overview of function	6-1
2. Current position display	6-1
3. I/O status display	6-2
3.1 I/O monitor list	6-3
3.2 I/O monitor detail	6-4
3.3 Changing output status	6-4
4. Task driving state	6-5
5. Current monitor	6-6

1. Overview of function

This monitor function allows you to display or check the robot current position information, controller I/O status, and task driving state.

Use the cursor keys to select [Monitor] from the initial screen, and then press the ENTER key. The monitor hierarchy menu will appear.

2. Current position display

The current position of the robot is displayed.

In the monitor hierarchy, select [Current Position], and then press the ENTER key to display the current position information.

■ "CURRENT POSITION" screen



1. Current position

Displays the current position of the robot.

The current position in "pulse" units is displayed by an integer. The current position in "mm" units is displayed by a value with the decimal point.

When pressing the F1 key (UNIT), the display unit can be changed to [mm] or [pulse].

2. Coordinate unit system

Displays the coordinate unit system. The unit shows [pulse] or [mm].

3. Hand system

Displays the hand system of the current robot. This information is displayed only when the unit of the hand system information is "mm".

0 : No hand system setting (Standard coordinates are not set.)

1 : Right-handed system

2 : Left-handed system

* The hand system information is valid only when the SCARA type robot and the coordinate system in "mm" units are specified.

3. I/O status display

The I/O status of the controller is displayed.



NOTE Input and output ports that do not exist as hardware are also displayed.

- I/O status display examples are shown below.

Example of bit I/O list display

PORT	BIT	7	6	5	4	3	2	1	0
DI 0		○	○	○	○	○	○	○	○
DI 1		○	○	○	○	○	○	○	○
DI 2		○	○	○	○	○	○	○	○
DI 3		○	○	○	○	○	○	○	○
DI 4		○	○	○	○	○	○	○	○
DI 5		○	○	○	○	○	○	○	○
DI 6		○	○	○	○	○	○	○	○
DI 7		○	○	○	○	○	○	○	○

Example of bit I/O detail display

Bit	Name	Value
0		○
1		○
2		○
3		○
4		○
5		○
6		○
7		○

Example of word data display

PORT	VALUE
SIW(00)	&H0000
SIW(01)	&H0000
SIW(02)	&H0000
SIW(03)	&H0000
SIW(04)	&H0000
SIW(05)	&H0000
SIW(06)	&H0000
SIW(07)	&H0000

* Values are displayed in hexadecimal notation.

Valid keys and submenu descriptions on the I/O status display are shown below.

Valid keys	Menu	Function
F1	LIST/DETAIL	Switches between the I/O list and detail displays.
F2	DI	Displays the DI motor.
F3	DO	Displays the DO motor.
F4	MO	Displays the MO motor.
F5	LO	Displays the LO motor.
F6	TO	Displays the TO motor.
F7	SI	Displays the SI motor.
F8	SO	Displays the SO motor.
F9	SIW	Displays the SIW motor.
F10	SOW	Displays the SOW motor.

3.1 I/O monitor list

In the monitor hierarchy, select [IO], and then press the ENTER key. The I/O monitor list will appear. The I/O monitor list provides the input status list and output status list. The input status list is displayed first.

■ Input status list display

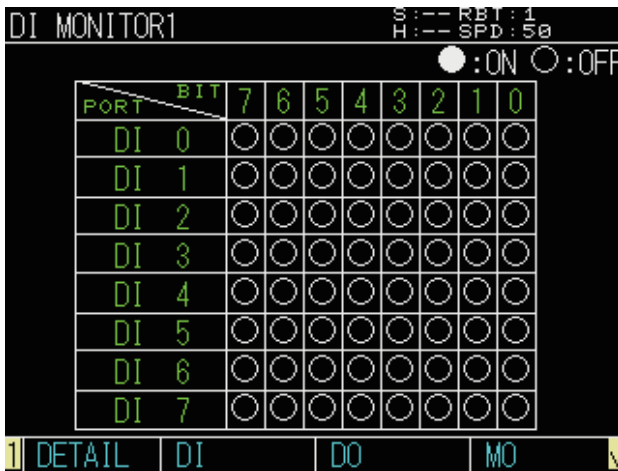

When pressing the MONITOR key on this screen, the next DI port is displayed. When there is no next DI port, the I/O status is displayed in the order shown below.

DI → DO → MO → LO → TO → SI → SO → SIW → SOW

Additionally, the input or output can be selected with the function key.



NOTE _____
The screen display is updated at constant intervals.

Press the ESC key to exit the monitor display and return to the initial screen.

3.2 I/O monitor detail

When pressing the F1 key (DETAIL), the details of the displayed I/O are displayed. The "DETAIL" screen displays the point names registered by the support software. * SIW and SOW detail displays are not available.

■ Input status detail

Bit	Name	Value
0		<input type="radio"/>
1		<input type="radio"/>
2		<input type="radio"/>
3		<input type="radio"/>
4		<input type="radio"/>
5		<input type="radio"/>
6		<input type="radio"/>
7		<input type="radio"/>

■ Changing the ten's place of the port number

When pressing the MONITOR key, the ten's place of the DI port changes "0 → 10 → 20" to display the monitor detail. When there is no next DI port, the I/O is displayed in the order shown below.

DI → DO → MO → LO → TO → SI → SO → SIW → SOW

■ Changing the one's place of the port number

Use the cursor keys to select [Δ] or [▽] on the screen, and then press the ENTER key to change the port number.



NOTE
The screen display is updated at constant intervals.

Press the ESC key to exit the monitor display and return to the initial screen.

3.3 Changing output status

ON/OFF of the DO, MO, LO, TO, or SO output can be changed in "bit" units.

Step 1 Display the output monitor detail.

Display the output list of the port whose output ON/OFF you want to change, and then press the F1 (DETAIL) key. The "DO MONITOR DETAIL" screen will appear.

Step 2 Specify the port number of the port whose ON/OFF to change.

Use the cursor keys to select (Δ) or (▽) on the output monitor detail screen, and then press the ENTER key to change the port.

Step 3 Change the output status.

Use the cursor keys to select (ON) or (OFF) of the bit number whose output status to change, and then press the ENTER key. The output status is then changed.

▶ Step 2,3 Changing the output status

Bit	Name	Value
0	DONAME-2-0	<input type="radio"/> ON <input type="radio"/> OFF
1	DONAME-2-1	<input type="radio"/> ON <input type="radio"/> OFF
2	DONAME-2-2	<input type="radio"/> ON <input type="radio"/> OFF
3	DONAME-2-3	<input type="radio"/> ON <input type="radio"/> OFF
4	DONAME-2-4	<input type="radio"/> ON <input type="radio"/> OFF
5	DONAME-2-5	<input type="radio"/> ON <input type="radio"/> OFF
6	DONAME-2-6	<input type="radio"/> ON <input type="radio"/> OFF
7	DONAME-2-7	<input type="radio"/> ON <input type="radio"/> OFF

This figure shows the "DO MONITOR1 DETAIL" screen as an example.

4. Task driving state

The task driving state can be checked.

In the monitor hierarchy, select [Task Driving State] and press the ENTER key to display the task driving state.

■ "TASK STATE" screen

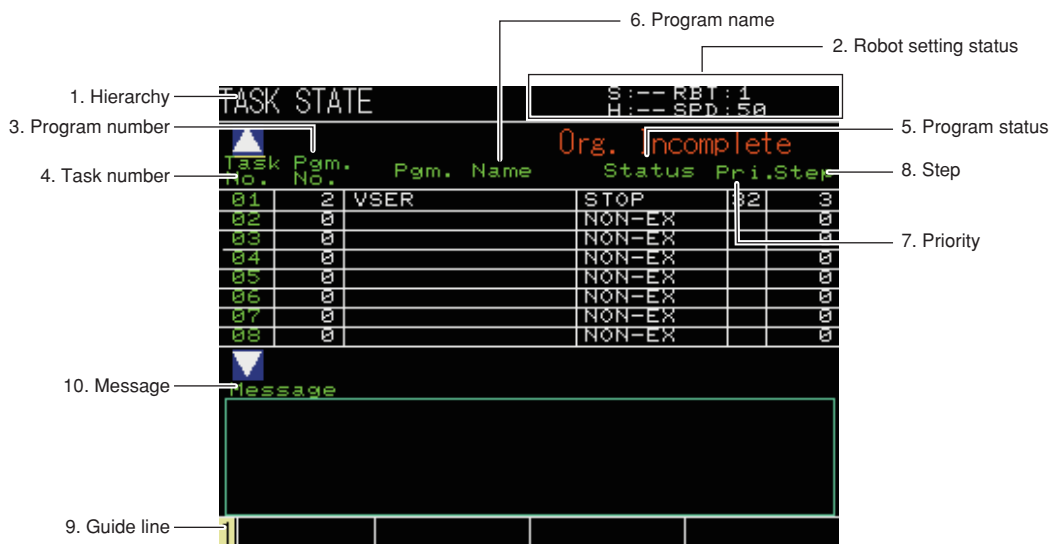

1. Hierarchy

Displays the current hierarchy.

2. Robot setting status

Displays the currently selected robot, shift and so on.

S : 1 . . . Specified shift number
H : 1 . . . Specified hand number
RBT : 1 . . . Specified robot number
SPD : 30 . . . Specified speed

ALM . . . Alarm occurrence status (This is not displayed when no alarm occurs.)

SRV . . . Servo on status (This is not displayed when the servo is off.)

AUTO . . . Control setting is set "RELEASE". (This is not displayed when the control setting is "GET" and the operation is in the MANUAL mode.)

SEQ . . . Sequence program execution status (This is not displayed when the sequence program is not executed.)

When using multiple robots, the robot number display is changed by changing the target robot on the "QUICK MENU".

3. Program number

Displays the selected program number.

4. Task number

Displays the task number of the selected program.

5. Program status

Displays the status of the selected program.

STOP Stop status
 RUNNING Execution status
 WAIT Wait status
 SUSPENDED Forced suspended status
 NON-EX Unregistered status

For details about each task status, refer to the YRCX programming manual.

6. Program name

Displays the selected program name.

7. Priority

Displays the priority of the selected program.

8. Step

Displays the line number at which the program stops.

9. Guide line

Displays the contents assigned to the function keys.

10. Message

Displays the output of "PRINT" command in the program.

5. Current monitor

The current torque to each axis rated torque of the selected robot is displayed.

Press the ESC key to return to the previous screen.



NOTE

The robot is changed from the "QUICK MENU" screen. For details, refer to "5.2 Quick menu" in Chapter 2.

■ "CURRENT MONITOR" screen

The screenshot shows a terminal window with the following content:

```
CURRENT MONITOR          S:-- RBT:1
                          H:-- SPD:50

Robot 1

  A1      0    A2      0
  A3      5    A4      0
  A5              A6

1|
```

Axis	Value	Axis	Value
A1	0	A2	0
A3	5	A4	0
A5		A6	

Troubleshooting

1. When trouble occurs	A-1
2. Acquiring the alarm information	A-2
2.1 Checking the alarm occurrence status	A-2
2.2 Checking the alarm history	A-2
3. Troubleshooting checkpoints	A-3
3.1 Installation and power supply	A-3
3.2 Robot operation	A-4
3.3 I/O	A-5
4. Alarm messages	A-6
[0] Operation messages	A-9
[1] System events	A-10
[2] Alarm related to the robot operation	A-12
[3] Alarm related to the program file operation	A-19
[4] Alarm related to the data input	A-21
[5] Alarm related to the syntax of the robot language (compile)	A-23
[6] Alarm related to the robot language execution	A-30
[9] Alarm related to the memory	A-39
[10] Alarm related to the environment and general hardware	A-43
[12] Alarm related to the option board	A-45
[14] Alarm related to the communication	A-53
[17] Alarm related to the motor control	A-55
[19] Alarm related to the YC-Link/E	A-62
[21] Serious alarm related to software	A-65
[22] Serious alarm related to hardware	A-66
[26] Alarm related to the gripper	A-68
[28] Alarm related to the driver I/F	A-72
5. Warning number	A-74
[c] Warning	A-74
6. Alarm messages related to the programming box	A-76

1. When trouble occurs

Please contact your distributor and report the following items in as much detail as possible.

Item	Description
What happened	<ul style="list-style-type: none"> • Controller model name and serial number example: YRCX • Robot model name and serial number example: R6YXG500 • Controller version No. example: V1.46
When	<ul style="list-style-type: none"> • Date of purchase example: January 2020 • Period of use example: Since delivery, about 1 year
Under what conditions	<ul style="list-style-type: none"> • Usage conditions example: when power is turned on when creating program during jog movement when robot is moved to particular location during program operation
Current status is	<ul style="list-style-type: none"> • Programming box screen status example: Nothing is displayed on screen Error message appears on screen • Robot servo status example: Servo won't turn on. Abnormal sound occurs when robot is moved. Return-to-origin is incomplete. • Programming box operating status example: Keys won't function. Response after pressing key is slow. Only the emergency stop button functions. etc.
How often it happens	<ul style="list-style-type: none"> • How often above problem occurs example: Always occurs when power is turned on. Occurs at particular line during program operation. Only occurs once, then does not occur again.



NOTE When the programming box is connected, the error message appearing on the screen is a valuable source of information for troubleshooting.

2. Acquiring the alarm information

The controller stores the alarm information in its inside. You can check the current controller error status and past alarm history data.

2.1 Checking the alarm occurrence status

■ Checking the alarm with the programming box

Select [System] - [Check] from the initial screen.
If an alarm occurs, relevant alarm code will appear.

Checking the alarm occurrence status

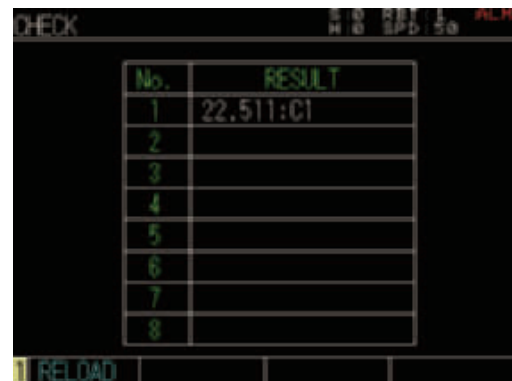

No.	RESULT
1	22.511:CI
2	
3	
4	
5	
6	
7	
8	

■ Checking the alarm through the RS-232C or Ethernet

Step 1 Connect the controller and personal computer.

Connect the controller and personal computer with the RS-232C cable or Ethernet cable (category 5 or higher) and set the communication conditions so that the online command can be set.

Step 2 Check the alarm status.

Send the command "@READ SCK" from the personal computer.
The alarm code is received when an alarm occurs. No alarm code is received when any alarm does not occur.

2.2 Checking the alarm history

■ Checking the alarm history with the programming box

Select [System] - [History] from the initial screen.

Checking the alarm history

The alarms that occurred past will appear.
Up to 500 alarm records can be checked.

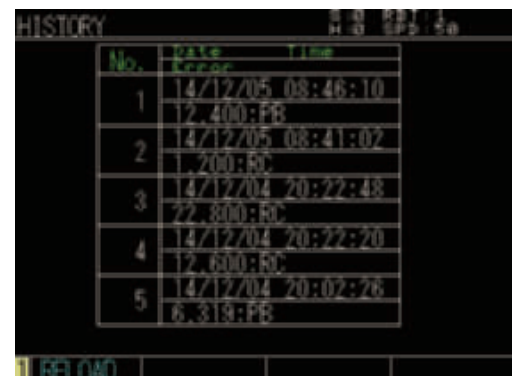

No.	Date	Time	Result
1	14/12/05	08:48:10	12.400:FB
2	14/12/05	08:41:02	1.200:FO
3	14/12/04	20:22:48	22.800:FO
4	14/12/04	20:22:20	12.600:FO
5	14/12/04	20:02:28	6.319:FE

■ Checking the alarm through the RS-232C or Ethernet

Step 1 Connect the controller and personal computer.

Connect the controller and personal computer with the RS-232C cable or Ethernet cable (category 5 or higher) and set the communication conditions so that the online command can be set.

Step 2 Check the alarm status.

Send the command "@READ LOG" from the personal computer, and the alarm status is received when an alarm occurs.
Up to 500 alarm records can be checked.

3. Troubleshooting checkpoints

3.1 Installation and power supply

	Symptom	Possible cause	Check items	Corrective action
1	The controller was not turned on even though the power was supplied.	<ul style="list-style-type: none"> Power is not supplied. Problem occurred in the controller internal power supply. 	<ul style="list-style-type: none"> Check power input terminal connection (L/N/L1/N1). Check power input terminal voltage (L/N/L1/N1). Check if "PWR" LED on front panel is lit. 	<ul style="list-style-type: none"> Connect the power input terminal correctly. Supply the specified power voltage. Replace the controller.
2	The programming box is not displayed even though the controller is turned on.	<ul style="list-style-type: none"> The programming box is not connected. The programming box connection is incorrect. Malfunction occurred in the programming box. Problem occurred in controller internal power supply. 	<ul style="list-style-type: none"> Check the PB connector. Check how the PB connector is inserted. Replace the programming box and check operation. 	<ul style="list-style-type: none"> Plug in the PB connector correctly. Replace the programming box. Replace the controller.
3	Although the controller turns on, the alarm number is displayed on the 7-segment LED on the front.	<ul style="list-style-type: none"> The controller is now in emergency stop status. 	<ul style="list-style-type: none"> Connect the programming box and check the alarm using self-diagnosis. Check the DO00 (Output of emergency stop input status) on the "MONITOR" screen displayed on the programming box. 	<ul style="list-style-type: none"> Release the emergency stop button on the programming box. Connect the PB connector. Connect the emergency stop terminal of the SAFETY connector.
		<ul style="list-style-type: none"> An alarm with alarm group number 17 occurred. 	<ul style="list-style-type: none"> Connect the programming box and check the alarm using self-diagnosis. 	<ul style="list-style-type: none"> Check the axis from the alarm information. Check the cause from the alarm information. Take the corrective action.
		<ul style="list-style-type: none"> An alarm with alarm group number 21 or 22 occurred. 	<ul style="list-style-type: none"> Connect the programming box and check the alarm using self-diagnosis. 	<ul style="list-style-type: none"> Check the cause from the alarm information. Take the corrective action.

3.2 Robot operation

	Symptom	Possible cause	Check items	Corrective action
1	Although the controller turns on, program and jog movement cannot be executed.	• Stop signal is in the open status.	<ul style="list-style-type: none"> • Check the I/O interface connector stop signal and 24V-power supply connections. • Check DI06 (stop) on the "MONITOR" screen displayed on the programming box. 	<ul style="list-style-type: none"> • Connect the power input terminal correctly. • Supply the specified power voltage. • Replace the controller.
		• The controller is now in emergency stop status.	<ul style="list-style-type: none"> • Connect the programming box and check the alarm using self-diagnosis. • Check DO00 (Output of emergency stop input status) on the "MONITOR" screen displayed on the programming box. 	<ul style="list-style-type: none"> • Release the emergency stop button on the programming box. • Connect the PB connector. • Connect the emergency stop terminal of the SAFETY connector.
		• An alarm occurred.	<ul style="list-style-type: none"> • Connect the programming box and check the alarm using self-diagnosis. • Check the 7-segment LED display on the front of the controller. 	<ul style="list-style-type: none"> • Check the cause from the alarm information. • Take the corrective action.
2	An abnormal sound or vibration occurred.	• The robot or axis type setting is incorrect.	<ul style="list-style-type: none"> • Connect the programming box and check the robot settings in SYSTEM mode. • Check if the robot and controller are compatible. 	<ul style="list-style-type: none"> • Correct the robot or axis type setting. • Make sure the robot and controller are compatible.
		• The tip weight or acceleration settings is incorrect.	<ul style="list-style-type: none"> • Check the tip weight parameter setting in EDIT. • Check the acceleration parameter setting in SYSTEM. • Check the command setting of changing the tip weight or acceleration in program language. 	<ul style="list-style-type: none"> • Set a correct tip weight parameter. • Set a correct acceleration parameter. • Make a correct setting in the program language.
		• A mechanical problem occurred.	<ul style="list-style-type: none"> • Check for resonance in the robot frame. • Check for the loose screws on robot cover. • Check for warping or damage on guides or ball screws. 	<ul style="list-style-type: none"> • Reinforce the robot frame. • Tighten the robot cover screws. • Remove foreign matter if found. • Replace guides or ball screws if warping or damage is found.
		• The controller is defective.	<ul style="list-style-type: none"> • Replace with another controller and check operation. 	<ul style="list-style-type: none"> • Replace the controller if operation is normal.
3	A position deviation occurred.*	<ul style="list-style-type: none"> • The position sensor device is defective. • The cable is defective. 	<ul style="list-style-type: none"> • Move the axis in emergency stop and check the pulse count. 	<ul style="list-style-type: none"> • Replace the motor if count is incorrect. • Replace the cable if found to be defective.
		• A position detection error due to noise.	<ul style="list-style-type: none"> • Check grounding of the robot and controller. • Check the robot periphery for noise. • Check for noise sources around ROB I/O cable. 	<ul style="list-style-type: none"> • Ground the robot and controller. • Isolate from the noise sources around the robot. • Isolate from the noise sources around ROB I/O cable.
		• A mechanical error occurred.	<ul style="list-style-type: none"> • Check the belt tension. • Check for warping or damage on the guides or ball screws. 	<ul style="list-style-type: none"> • Adjust to correct tension if necessary. • Remove the foreign matter if found. • Replace the guides or ball screws if warping or damage is found.
		• The controller is defective.	<ul style="list-style-type: none"> • Replace the controller and check operation. 	<ul style="list-style-type: none"> • Replace the controller if operation is normal.

* There are two main types of position deviation.

1. Electrical position deviation 2. Mechanical position deviation

In the case of 1, the robot can move back to the original position by return-to-origin operation after position deviation, which does not correspond in the case of 2.

3.3 I/O

	Symptom	Possible cause	Check items	Corrective action
1	The command does not work even when the dedicated input signal is supplied.	• No 24 V DC is supplied.	<ul style="list-style-type: none"> • Check the I/O interface connector stop signal and 24V-power supply connections. • Check DI06 (stop) on the "MONITOR" screen displayed on the programming box. 	• Supply 24 V DC.
		• A problem in signal connection occurred.	• Check the I/O interface connector wiring.	• Correct the I/O interface connector wiring.
		• An alarm occurred.	<ul style="list-style-type: none"> • Connect the programming box and check the alarm by using self-diagnosis. • Check the 7-segment LED display on the front of the controller. 	<ul style="list-style-type: none"> • Check the cause from the alarm information. • Take the corrective action.
2	The dedicated output signal is not output.	• No 24 V DC is supplied.	<ul style="list-style-type: none"> • Check the I/O interface connector 24V-power supply connections. • Check DI04 on the "MONITOR" screen displayed on the programming box. 	• Supply 24 V DC.
		• A problem in signal connection occurred.	• Check the I/O interface connector wiring.	• Correct the I/O interface connector wiring.
		• An alarm occurred.	<ul style="list-style-type: none"> • Connect the programming box and check the alarm by using self-diagnosis. • Check the 7-segment LED display on the front of the controller. 	<ul style="list-style-type: none"> • Check the cause from the alarm information. • Take the corrective action.
3	The general-purpose I/O signal is not output.	• No 24 V DC is supplied.	<ul style="list-style-type: none"> • Check the I/O interface connector 24V-power supply connections. • Check DI04 on the "MONITOR" screen displayed on the programming box. • Check the I/O interface 24V-power supply connection. 	• Supply 24 V DC.
		• A problem in signal connection occurred.	• Check the I/O interface connector wiring.	• Correct the I/O interface connector wiring.
		• A problem in I/O interface setting occurred.	• Check the ID setting of the I/O interface.	• Correct the ID setting of the I/O interface.
		• An alarm occurred.	<ul style="list-style-type: none"> • Connect the programming box and check the alarm by using self-diagnosis. • Check the 7-segment LED display on the front of the controller. 	<ul style="list-style-type: none"> • Check the cause from the alarm information. • Take the corrective action.

4. Alarm messages

When an alarm occurs, an alarm code (alarm group number, alarm classification number and occurrence location) and an alarm message) is displayed on the programming box screen.

The 7-segment LED on the front of the controller alternately displays "E+ alarm group number" and "alarm classification number"

The alarm code consists of two elements, "group" and "classification". Each code is classified as follows.

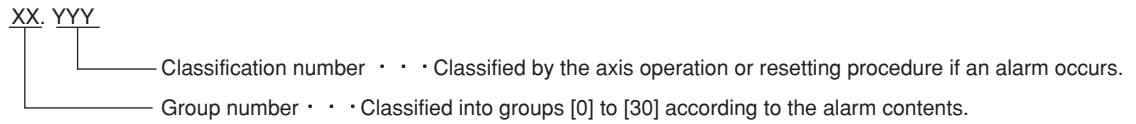

■ Checking the alarm occurrence status

No.	RESULT
1	22.511:C1
2	
3	
4	
5	
6	
7	
8	

1 RELOAD

1. Alarm group number list

The alarm message is classified into groups [0] to [30] according to the alarm contents. The contents of each group are shown below.

Group number	Contents
[0]	Operation messages
[1]	System events
[2]	Alarm related to the robot movement range
[3]	Alarm related to the program file operation
[4]	Alarm related to the data input
[5]	Operation alarm related to the syntax of the robot language (compile)
[6]	Alarm related to the robot language execution
[7]	(Not used.)
[8]	(Not used.)
[9]	Alarm related to the memory
[10]	Alarm related to the environment and general hardware
[11]	(Not used.)
[12]	Alarm related to the option board
[13]	(Not used.)
[14]	Alarm related to the communication
[15]	(Not used.)
[16]	(Not used.)
[17]	Alarm related to the motor control
[18]	(Not used.)
[19]	Alarm related to the YC-Link/E
[20]	(Not used.)
[21]	Serious software alarm
[22]	Serious hardware alarm
[23]	(Not used.)
[24]	(Not used.)
[25]	(Not used.)
[26]	Alarm related to the gripper
[27]	(Not used.)
[28]	Alarm related to the driver I/F
[29]	(Not used.)
[30]	(Not used.)

2. Alarm classification number list

Alarm code	Type	Axis operation in case of error	History	LED display	Reset method	Example					
0	Correct	-	-	Not displayed	-	-					
1 to 99	Message				-	-	Restart operation	HALT, HOLD, Break point, Key release			
100 to 199								CPU start			
200 to 399	Operation error	Individual operation stop	Save	Display	Restart corresponding operation	No point					
400 to 499		Operation stop				Interlock					
500 to 599	External error	Servo brake			-	-	Reset command	PIO24V off, SIO link error			
600 to 699								Emergency stop, Main power off			
700 to 799	Internal error	Operation stop						-	-	-	Fan error
800 to 899		Servo brake									Overload
900 to 999		Immediate servo off									Over-current, Driver communication failure
										Restart system	

3. Alarm occurrence location list

T*	Task *... Task number
SYS	Startup, memory check, generation
ONL	Online command
RMT	Remote command
SEQ	Sequence program
SIN	Standard input
C*	Controller *... Controller number
C*O*	Option board *... Controller number, option slot number
R*/R*A*	Robot, axis *... Robot number, axis number
M*/C*M*	Physical motor *... Controller number, motor number

For example, when "17.403:M1" is displayed, this shows that the position reset position error occurs in motor 1. In the same manner, when "14.400:T02" is displayed, this shows that the communication shutdown error occurs in task 2.

[Display format]

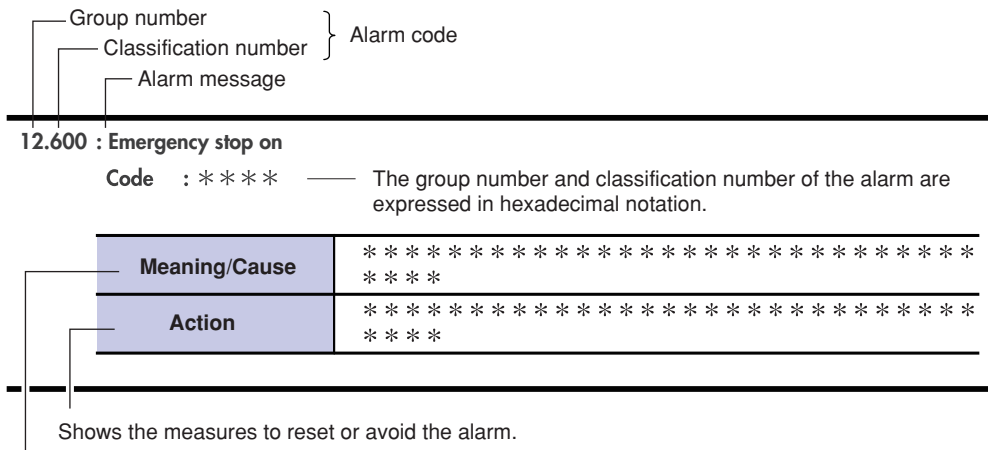

Shows the alarm meaning and the cause of the alarm occurrence.

* The alarm occurrence status and alarm history can be checked from the programming box. Information on the alarm occurrence location (axis, option unit, and so on) may be added.

[0] Operation messages

0.0 : OK

Code : &H0000 &H0000

Meaning/Cause	Correct status. No alarm occurs.
Action	—

0.2 : Running

Code : &H0000 &H0002

Meaning/Cause	A program or command is running.
Action	—

0.5 : Busy

Code : &H0000 &H0005

Meaning/Cause	The data is being saved.
Action	—

0.8 : Try again

Code : &H0000 &H0008

Meaning/Cause	The operation failed.
Action	Try again.

0.19 : Can't edit

Code : &H0000 &H0013

Meaning/Cause	The read-only file is being edited.
Action	Change the file attribute.

0.20 : Illegal command in this mode

Code : &H0000 &H0014

Meaning/Cause	The specified online command cannot be executed in the current mode.
Action	Change the mode.

0.21 : No control right

Code : &H0000 &H0015

Meaning/Cause	The operation cannot be executed because of the control setting.
Action	Change the control setting properly with the programming box.

0.22 : Not be execute by the safety setting

Code : &H0000 &H0016

Meaning/Cause	The command cannot be executed since the SAFETY setting is "INVALID".
Action	Set the target item in the SAFETY setting to "VALID".

0.23 : No right of PRINT/INPUT

Code : &H0000 &H0017

Meaning/Cause	The "PRINT/INPUT" statement was executed without setting.
Action	Change the setting of "PRINT/INPUT using channel" of the controller parameter.

[1] System events**1.1 : Program terminated by "CUT"**

Code : &H0001 &H0001

Meaning/Cause	The program execution was terminated by the "CUT" command.
Action	—

1.2 : Program terminated by "EXIT TASK"

Code : &H0001 &H0002

Meaning/Cause	The program execution was terminated by the "EXIT TASK" command.
Action	—

1.3 : Program terminated by "HALTALL"

Code : &H0001 &H0003

Meaning/Cause	The program execution was terminated by the "HALTALL" command.
Action	—

1.4 : Program ended by "HALTALL"

Code : &H0001 &H0004

Meaning/Cause	The program execution was terminated by the "HALTALL" command.
Action	—

1.5 : Program ended by "HALT"

Code : &H0001 &H0005

Meaning/Cause	The program execution was terminated by the "HALT" command.
Action	—

1.6 : Program stopped by "HOLDALL"

Code : &H0001 &H0006

Meaning/Cause	The program execution was stopped by the "HOLDALL" command.
Action	The stop status is canceled by pressing the RUN key and the program execution restarts from the next command.

1.7 : Program stopped by "HOLD"

Code : &H0001 &H0007

Meaning/Cause	The program execution was stopped by the "HOLD" command.
Action	The stop status is canceled by pressing the RUN key and the program execution restarts from the next command.

1.8 : Stop executed

Code : &H0001 &H0008

Meaning/Cause	The program/command execution was stopped by external stop command.
Action	—

1.9 : Arrived at debug

Code : &H0001 &H0009

Meaning/Cause	<ul style="list-style-type: none"> • The program in execution reached the break point and stopped. • The program executed by the "RUNTO" command reached the specified line and stopped. • One line of the program was executed and stopped by the "STEP/NEXT" command.
Action	—

1.10 : Changed control right

Code : &H0001 &H000A

Meaning/Cause	The operation stopped since the control setting was changed.
Action	Change the control setting to "RELEASE" with the programming box.

1.12 : Program stopped by key release

Code : &H0001 &H000C

Meaning/Cause	The RUN key was released in the "Hold To Run" enable status.
Action	—

1.13 : Changed PRINT/INPUT right

Code : &H0001 &H000D

Meaning/Cause	The operation stopped since the "PRINT/INPUT using channel" was changed.
Action	Change the setting of "PRINT/INPUT channel in use" of the controller parameter.

1.100 : CPU normal start

Code : &H0001 &H0064

Meaning/Cause	Start-up checks and initialization ended and controller operation started normally.
Action	—

1.101 : First Boot

Code : &H0001 &H0065

Meaning/Cause	SRAM has been initialized during the first boot of controller.
Action	—

[2] Alarm related to the robot operation**2.300 : Std. coord. doesn't exist**

Code : &H0002 &H012C

Meaning/Cause	The standard coordinates are not set.
Action	<ul style="list-style-type: none"> • Set the standard coordinates. • Set the "Arm length" and "Offset pulse" of the axis parameter.

2.301 : Coordinate cal. failed

Code : &H0002 &H012D

Meaning/Cause	<ul style="list-style-type: none"> a. The standard coordinate setting is not correct. b. The operating position is out of the movement range.
Action	<ul style="list-style-type: none"> a. Set the standard coordinates correctly. b. Change the operating position within the movement range.

2.303 : Shift cal. failed

Code : &H0002 &H012F

Meaning/Cause	Preset calculation for the shift setting is not functioning.
Action	Set the shift coordinates correctly.

2.304 : Hand cal. failed

Code : &H0002 &H0130

Meaning/Cause	<ul style="list-style-type: none"> a. Preset calculation for the hand definition setting is not functioning. b. Multiple axes with the same coordinate attribute were operated simultaneously when specifying the hand R.
Action	<ul style="list-style-type: none"> a. Set the hand definitions correctly. b. Set the specified axis of the movement command correctly when specifying the hand R.

2.305 : Illegal Pallet parameter

Code : &H0002 &H0131

Meaning/Cause	Preset calculation for the pallet setting is not functioning.
Action	Set the pallet definition correctly.

2.306 : Movable range cal. failed

Code : &H0002 &H0132

Meaning/Cause	a. Preset calculation for the movement path setting is not functioning. b. The current position is not within the movement range.
Action	a. Change to the correct movement point. b. Change the current position to within the movement range.

2.307 : Overlap soft limit

Code : &H0002 &H0133

Meaning/Cause	On SCARA type robots, the total of the absolute values of the X or Y-axis plus soft limit and minus soft limit becomes the value to move the arm one or more rotation.
Action	Set the soft limit values so that the arm movement range becomes one rotation or less.

2.308 : X exceeded shift coord. range

Code : &H0002 &H0134

Meaning/Cause	X-axis exceeded the shift coordinate range.
Action	<ul style="list-style-type: none"> • Change the operation position to the inside of the shift coordinate range. • Change the shift coordinate range.

2.309 : Y exceeded shift coord. range

Code : &H0002 &H0135

Meaning/Cause	Y-axis exceeded the shift coordinate range.
Action	<ul style="list-style-type: none"> • Change the operation position to the inside of the shift coordinate range. • Change the shift coordinate range.

2.310 : Z exceeded shift coord. range

Code : &H0002 &H0136

Meaning/Cause	Z-axis exceeded the shift coordinate range.
Action	<ul style="list-style-type: none"> • Change the operation position to the inside of the shift coordinate range. • Change the shift coordinate range.

2.311 : R exceeded shift coord. range

Code : &H0002 &H0137

Meaning/Cause	R-axis exceeded the shift coordinate range.
Action	<ul style="list-style-type: none"> • Change the operation position to the inside of the shift coordinate range. • Change the shift coordinate range.

2.314 : Arch condition bad

Code : &H0002 &H013A

Meaning/Cause	The arch position and arch distance of the arch option are set in "mm" units on the arch motion command for X and Y-axis on SCARA type robots.
Action	Set the arch position and arch distance of the arch option in "pulse" units.

2.318 : Arm length is 0

Code : &H0002 &H013E

Meaning/Cause	The arm length is set is "0" on SCARA type robots.
Action	<ul style="list-style-type: none"> • Set the standard coordinates. • Set the "Arm length" of the axis parameter.

2.319 : Cannot move (RIGHTY to LEFTY)

Code : &H0002 &H013F

Meaning/Cause	The interpolation movement to the target point whose hand system is set to "LEFT" was attempted when the hand system is set to "RIGHT" on the SCARA type robots.
Action	Check the current hand system and hand system flag of the point data.

2.320 : Cannot move (LEFTY to RIGHTY)

Code : &H0002 &H0140

Meaning/Cause	The interpolation movement to the target point whose hand system is set to "RIGHT" was attempted when the hand system is set to "LEFT" on the SCARA type robots.
Action	Check the current hand system and hand system flag of the point data.

2.321 : Cannot use TOOL coord.

Code : &H0002 &H0141

Meaning/Cause	The hand data is not set.
Action	Set the hand data.

2.326 : Exceeded velocity

Code : &H0002 &H0146

Meaning/Cause	The interpolation operation speed exceeded the specified level.
Action	Change the specified speed.

2.327 : Circular arc cal. failed

Code : &H0002 &H0147

Meaning/Cause	The circular interpolation operation point is incorrect.
Action	<ul style="list-style-type: none"> • Set the correct point data. • Specify the correct circular arc plane option of the circular interpolation movement. • Set the correct specified axis of the circular interpolation movement.

2.328 : Circular arc restart failed

Code : &H0002 &H0148

Meaning/Cause	Stop position of the "MOVE C" command was different from the restart position.
Action	Set the stop position same as the restart position.

2.329 : Same point exists

Code : &H0002 &H0149

Meaning/Cause	<ul style="list-style-type: none"> • Two or three points of the "MOVE C" command three points are same. • Same points are consecutive on the path of PATH motion.
Action	Set the correct points.

2.330 : 3 points on line

Code : &H0002 &H014A

Meaning/Cause	Three points of one "MOVE C" command were placed on a straight line.
Action	Change the three points of the "MOVE C" command so that they are not on the same straight line.

2.331 : Circular arc radius too small

Code : &H0002 &H014B

Meaning/Cause	The "MOVE C" command radius is less than 0.1 mm.
Action	Change the "MOVE C" command to 0.1 mm or more for circular arc radius.

2.332 : Circular arc radius too large

Code : &H0002 &H014C

Meaning/Cause	The "MOVE C" command radius exceeded 5000 mm (5 meters).
Action	Change the "MOVE C" command to within 5000 mm (5 meters) for circular arc radius.

2.333 : Too low speed

Code : &H0002 &H014D

Meaning/Cause	The movement time exceeded 60 minutes since the specified speed was too low.
Action	Increase the specified speed or shorten the distance so that the movement time becomes within 60 minutes.

2.334 : Over soft limit

Code : &H0002 &H014E

Meaning/Cause	The value of the target position exceeded the soft limit specified in the parameter.
Action	<ul style="list-style-type: none"> • Change the operating position to within the soft limits. • Change the soft limit value.

2.335 : Over movable range

Code : &H0002 &H014F

Meaning/Cause	There is a point outside the movement range on the movement path.
Action	Specify the movement path to be within the movement range.

2.336 : ZR Torque origin failed

Code : &H0002 &H0150

Meaning/Cause	Return-to-origin with ZR-stroke end method failed.
Action	Change the R-axis dog length.

2.337 : Illegal DRIVE XY axes

Code : &H0002 &H0151

Meaning/Cause	X or Y-axis point is not specified when using the XY designation option of the "DRIVE" command.
Action	Specify the X or Y-axis point when using the XY designation option of the "DRIVE" command.

2.338 : PATH execute error

Code : &H0002 &H0152

Meaning/Cause	<ol style="list-style-type: none"> a. The PATH motion cannot be executed. b. The acceleration/deceleration zone distance is too short. c. The speed is too high at the position where the direction changes.
Action	<ol style="list-style-type: none"> a. Reduce the speed setting. b. Lengthen the straight line or circular arc distance containing acceleration/deceleration. c. Set the speed so that the direction at the connection point of straight lines does not change greatly.

2.339 : Start position changed by other task

Code : &H0002 &H0153

Meaning/Cause	The start position was changed by other tasks.
Action	Check the start position of the target task and change the position as needed.

2.340 : Target position changed by other task

Code : &H0002 &H0154

Meaning/Cause	The target position was changed by other tasks.
Action	Check the target position of the target task and change the position as needed.

2.341 : Illegal axes (R axis shift exist)

Code : &H0002 &H0155

Meaning/Cause	The operation was executed with specifying either X or Y-axis while selecting the shift coordinates for the R-axis rotation.
Action	Change the program so that the operation is executed with specifying both X and Y-axis.

2.342 : Illegal hand type

Code : &H0002 &H0156

Meaning/Cause	The hand definition of R-axis attachment was used to the robot without R-axis attachment.
Action	<ul style="list-style-type: none"> • Change to the hand definition of Y-axis attachment. • Quit to use the hand definition.

2.343 : Illegal axes (R selected hand)

Code : &H0002 &H0157

Meaning/Cause	<ul style="list-style-type: none"> a. Tool coordinate jog operation was executed for the auxiliary axis. b. Tool coordinate jog operation was executed while "R-axis orientation hold" is invalid.
Action	<ul style="list-style-type: none"> a. The auxiliary axis cannot be jog-operated on tool coordinate. b. Set "R-axis orientation hold" of the robot parameter to "VALID".

2.346 : Illegal axes (tracking)

Code : &H0002 &H015A

Meaning/Cause	<ul style="list-style-type: none"> a. Tracking cannot be executed with this axis configuration. b. "CTDRIVE" or "CTMOVE" command with specifying the Z-axis operation command was executed for the robot without Z-axis.
Action	<ul style="list-style-type: none"> a. Check the robot axis configuration. b. Change the program so that "CTDRIVE" or "CTMOVE" command with specifying the Z-axis operation command cannot be executed for the robot without Z-axis.

2.347 : Not tracking status

Code : &H0002 &H015B

Meaning/Cause	"CTDRIVE" command was executed for the robot without following the conveyor.
Action	Change the program so that "CTDRIVE" command is executed after following the conveyor by "CTMOVE" command.

2.348 : Over tracking area

Code : &H0002 &H015C

Meaning/Cause	<ul style="list-style-type: none"> • The robot cannot be operated since the elements of position monitoring queue specified by "CTMOVE" command was out of the work area. • The elements of position monitoring queue in following moved out of the work area.
Action	<ul style="list-style-type: none"> • Review the robot program so that the elements of position monitoring queue specified by "CTMOVE" command is in the work area. • Reduce the setting value of the tracking end margin of the tracking parameter. • Change the program so that the next command or "CTSTOP" command execute before moving out of the work area.

2.349 : Can't execute CTMOVE

Code : &H0002 &H015D

Meaning/Cause	"CTMOVE" command was not executed since it was in deceleration control.
Action	"CTMOVE" command cannot be executed in MANUAL mode.

2.352 : SCARA outer CP prohibited range

Code : &H0002 &H0160

Meaning/Cause	The CP (Continuous Path) motion of SCARA robot has been executed within the prohibited range of the outer CP motion.
Action	<ul style="list-style-type: none"> • The CP motion cannot be executed within the range. • Move the robot to outside of the range with the servo-off status or with the PTP motion.

2.353 : Over W.carrier limit

Code : &H0002 &H0161

Meaning/Cause	The target position exceeds the working envelope restricted by the double-carrier parameter.
Action	Operate so that the starting position and the target position of the operation do not collide with Double-carrier.

2.354 : Illegal coordinates for pos. correction

Code : &H0002 &H0162

Meaning/Cause	The position correction can not be executed in this robot configuration
Action	Use the robot involving each XYR axis.

2.700 : System error (EXCEPTION)

Code : &H0002&H02BC

Meaning/Cause	Error occurred in software.
Action	Contact your distributor.

2.701 : System error (Robot Type)

Code : &H0002&H02BD

Meaning/Cause	Error occurred in software.
Action	Contact your distributor.

2.702 : System error (Robot No)

Code : &H0002&H02BE

Meaning/Cause	Error occurred in software.
Action	Contact your distributor.

2.703 : System error (Axis No)

Code : &H0002&H02BF

Meaning/Cause	Error occurred in software.
Action	Contact your distributor.

2.704 : System error (Arm Type)

Code : &H0002&H02C0

Meaning/Cause	Error occurred in software.
Action	Contact your distributor.

2.705 : System error (OPTION)

Code : &H0002&H02C1

Meaning/Cause	Error occurred in software.
Action	Contact your distributor.

2.706 : System error (PATH)

Code : &H0002&H02C2

Meaning/Cause	Error occurred in software.
Action	Contact your distributor.

2.707 : AXSWEI over

Code : &H0002&H02C3

Meaning/Cause	The axis weight exceeds the input range.
Action	Set the axis weight within the input range.

2.708 : System error (Tracking)

Code : &H0002&H02C4

Meaning/Cause	Error occurred in software.
Action	Contact your distributor.

2.709 : System error (W.carrier)

Code : &H0002&H02C5

Meaning/Cause	Error occurred in software.
Action	Contact your distributor.

2.710 : W.carrier collision prevention

Code : &H0002&H02C6

Meaning/Cause	The operation was stopped because Double-carrier attempted to move to a colliding position.
Action	<ol style="list-style-type: none"> a. Change the target position of the motion command to the position where Double-carrier does not collide. b. Check if W.carrier control mode is set correctly. c. When W.carrier control mode is STOP, Execute the movement command after the partner carrier has moved to the position where it does not collide.

2.711 : W.carrier collision deadlock

Code : &H0002&H02C7

Meaning/Cause	Double-carrier became a deadlock state.
Action	Change the program so that carriers do not wait the partner's movement each other.

2.712 : W.carrier overstroke

Code : &H0002&H02C8

Meaning/Cause	The target position of Double-carrier exceeds the range of Double-carrier stroke.
Action	Change the target position of each carrier so that the target position is smaller than Doublecarrier stroke.

2.713 : Illegal W.carrier parameter

Code : &H0002&H02C9

Meaning/Cause	Parameter setting of Double-carrier is incorrect.
Action	Change the parameter setting not to correspond to the following condition. a. Robot/axis set at Double-carrier parameter does not exist. b. Robot/axis set at Double-carrier parameter is SCARA robot or YP-X. c. Robot/axis set at Double-carrier parameter is the same setting for each carrier.

2.714 : W.carrier can't excute CTMOVE

Code : &H0002&H02CA

Meaning/Cause	CTMOVE cannot be executed while Double-carrier collision prevention function is enabled.
Action	Set W.carrier control mode to OFF when executing CTMOVE.

2.715 : W.carrier servo off

Code : &H0002&H02CB

Meaning/Cause	Axis set at Double-carrier collision prevention is servo off status.
Action	a. Prevent the other carrier from becoming servo-powered OFF when one carrier is waiting. b. Change the target position of one carrier so as not to collide the other carrier.

[3] Alarm related to the program file operation**3.201 : Too many programs**

Code : &H0003 &H00C9

Meaning/Cause	A new program was created over 100 programs.
Action	Create a new program after deleting an unnecessary program. (Make a backup if necessary.)

3.202 : Program already exists

Code : &H0003 &H00CA

Meaning/Cause	A program with the same name of a registered program was created, copied, or renamed.
Action	Use a different program name to create, copy, or rename.

3.203 : Program doesn't exist

Code : &H0003 &H00CB

Meaning/Cause	A registered program of the specified name does not exist.
Action	Input a program name that is registered.

3.204 : Writing prohibited

Code : &H0003 &H00CC

Meaning/Cause	The specified program is write-protected.
Action	Make the program not write-protected.

3.206 : Too many breakpoints

Code : &H0003 &H00CE

Meaning/Cause	More than 32 break points were set.
Action	Delete unnecessary programs and then set new ones. (32 or less break points can be set per program.)

3.207 : Breakpoint doesn't exist

Code : &H0003 &H00CF

Meaning/Cause	The break point was not found during search.
Action	Set break points if necessary.

3.208 : Current program doesn't exist

Code : &H0003 &H00D0

Meaning/Cause	As the current program does not exist, Reset can not be executed.
Action	LOAD the program once or set MAINPG once, then reset again.

3.218 : Duplicated Breakpoint

Code : &H0003 &H00DA

Meaning/Cause	Break points were already set on the line.
Action	To set the break point, specify the line on which break point has not been set yet.

3.219 : Illegal program no

Code : &H0003 &H00DB

Meaning/Cause	A program number exceeding 1 to 100 was set.
Action	Specify a program number between 1 and 100.

3.220 : Program step doesn't exist

Code : &H0003 &H00DC

Meaning/Cause	The number of lines exceeding the number registered in the program was specified.
Action	Specify lines registered in the program.

3.221 : Reading prohibited

Code : &H0003 &H00DD

Meaning/Cause	The program with the hidden attribute was browsed.
Action	Make the relevant program readable.

3.237 : Program has been already loaded

Code : &H0003 &H00ED

Meaning/Cause	The program that is already in the executable status was loaded.
Action	—

3.238 : Program is already running

Code : &H0003 &H00EE

Meaning/Cause	The program is already running.
Action	—

3.239 : Sequence program is already running

Code : &H0003 &H00EF

Meaning/Cause	The sequence program to revise or delete is running.
Action	Stop the sequence program.

[4] Alarm related to the data input**4.201 : Point number error**

Code : &H0004 &H00C9

Meaning/Cause	A point number exceeding P29999 was input.
Action	Input a correct point number.

4.202 : Input format error

Code : &H0004 &H00CA

Meaning/Cause	The format used to input the data is incorrect.
Action	Input the data in correct format.

4.204 : Undefined robot number

Code : &H0004 &H00CC

Meaning/Cause	The specified robot number does not exist.
Action	Input a correct robot number.

4.205 : Undefined axis number

Code : &H0004 &H00CD

Meaning/Cause	The specified axis number does not exist.
Action	Input a correct axis number.

4.206 : Invalid input number

Code : &H0004 &H00CE

Meaning/Cause	a. Invalid data was input. b. Invalid data was input in the area check output port number.
Action	Input a port number that can be used

4.208 : Parameter range error

Code : &H0004 &H00D0

Meaning/Cause	The parameter to set exceeds the range that can be input.
Action	Set the parameter within the range that can be input.

4.209 : Point name doesn't exist

Code : &H0004 &H00D1

Meaning/Cause	The specified point name does not exist.
Action	<ul style="list-style-type: none"> • Input a point name that can be used. • Register a new point name.

4.210 : Illegal point name

Code : &H0004 &H00D2

Meaning/Cause	The specified point name is incorrect.
Action	<ul style="list-style-type: none"> • Input a point name that can be used. • Save a new point name.

4.211 : Illegal I/O port

Code : &H0004 &H00D3

Meaning/Cause	The specified port number is incorrect.
Action	Input a correct port number.

4.212 : Data not enough

Code : &H0004 &H00D4

Meaning/Cause	The specified data does not exist.
Action	<ul style="list-style-type: none"> • Input a point name that can be used. • Create and save new data.

4.213 : Undefined controller number

Code : &H0004 &H00D5

Meaning/Cause	The specified controller number does not exist.
Action	Input a correct controller number.

4.214 : Undefined motor number

Code : &H0004 &H00D6

Meaning/Cause	The specified motor number does not exist.
Action	Input a correct motor number.

4.215 : Real time output number error

Code : &H0004 &H00D7

Meaning/Cause	Specified real time output number is out of range.
Action	Input a correct real time output number.

[5] Alarm related to the syntax of the robot language (compile)**5.201 : Syntax error**

Code : &H0005 &H00C9

Meaning/Cause	The syntax error was found in program.
Action	Input a correct syntax.

5.202 : Data error

Code : &H0005 &H00CA

Meaning/Cause	The input data format is incorrect.
Action	Use a correct data format.

5.203 : Number error

Code : &H0005 &H00CB

Meaning/Cause	a. The input number is incorrect. b. The input expression value is incorrect.
Action	a. Input a correct number. b. Input a correct expression value.

5.204 : Bit number error

Code : &H0005 &H00CC

Meaning/Cause	The specified bit number is not within 0 to 7.
Action	Specify a correct bit number.

5.206 : Digit number error

Code : &H0005 &H00CE

Meaning/Cause	a. Binary number has exceeded 8 digits (places). b. Octal number has exceeded 6 digits (places). c. Decimal number has exceeded the specified range. d. Hexadecimal number has exceeded 8 digits (places). e. Cartesian coordinate point data has more than 3 decimal places.
Action	• Change to the correct number of digits (places). • Specify the Cartesian coordinate point data of up to 3 decimal places.

5.207 : Illegal axis name

Code : &H0005 &H00CF

Meaning/Cause	The input robot axis name is incorrect.
Action	Input a correct axis name.

5.208 : Illegal order

Code : &H0005 &H00D0

Meaning/Cause	The bit order specified for I/O port is incorrect.
Action	Input in descending order starting from left.

5.212 : Stack overflow

Code : &H0005 &H00D4

Meaning/Cause	The stack area for execution overflowed.
Action	<ul style="list-style-type: none"> • Shorten the expression (for example, by dividing). • Reduce nesting of "GOSUB", "CALL" and "FOR to NEXT" statement. • Reduce argument of "CALL" statement.

5.213 : Illegal variable

Code : &H0005 &H00D5

Meaning/Cause	A variable other than a global variable was used in "SEND/@READ/@WRITE" commands.
Action	Input a global variable.

5.214 : Type mismatch

Code : &H0005 &H00D6

Meaning/Cause	<ul style="list-style-type: none"> a. Expression types are not equal on both sides. b. An incorrect type constant/variable/expression is used.
Action	<ul style="list-style-type: none"> a. Use the same expression type on both sides. b. Use a correct type constant/variable/expression.

5.215 : FOR variable error

Code : &H0005 &H00D7

Meaning/Cause	The variable name for "NEXT" statement differs from that for the corresponding "FOR" statement.
Action	Use the corresponding variable names.

5.216 : WEND without WHILE

Code : &H0005 &H00D8

Meaning/Cause	There is no "WHILE" statement corresponding to the "WEND" statement.
Action	<ul style="list-style-type: none"> • Delete the "WEND" statement. • Add a "WHILE" statement corresponding to the "WEND" statement.

5.217 : WHILE without WEND

Code : &H0005 &H00D9

Meaning/Cause	There is no "WEND" statement corresponding to the "WHILE" statement.
Action	<ul style="list-style-type: none"> • Delete the "WHILE" statement. • Add a "WEND" statement corresponding to the "WHILE" statement.

5.218 : NEXT without FOR

Code : &H0005 &H00DA

Meaning/Cause	<ul style="list-style-type: none"> a. There is no "FOR" statement corresponding to the "NEXT" statement. b. "NEXT" command was executed without executing "FOR" command.
Action	<ul style="list-style-type: none"> a-1. Delete the "NEXT" statement. a-2. Add "FOR" statement corresponding to the "NEXT" statement. b. Confirm execution of "FOR" command.

5.219 : FOR without NEXT

Code : &H0005 &H00DB

Meaning/Cause	There is no "NEXT" statement corresponding to the "FOR" statement.
Action	<ul style="list-style-type: none"> • Delete the "FOR" statement. • Add "NEXT" statement corresponding to the "FOR" statement.

5.220 : ENDF without IF

Code : &H0005 &H00DC

Meaning/Cause	There is no "IF" statement corresponding to the "ENDIF" statement.
Action	<ul style="list-style-type: none"> • Delete the "ENDIF" statement. • Add IF statement corresponding to the "ENDIF" statement.

5.221 : ELSE without IF

Code : &H0005 &H00DD

Meaning/Cause	There is no "IF" statement corresponding to the "ELSE" statement.
Action	<ul style="list-style-type: none"> • Delete the "ELSE" statement. • Add IF statement corresponding to the "ELSE" statement.

5.222 : IF without ENDF

Code : &H0005 &H00DE

Meaning/Cause	There is no "ENDIF" statement corresponding to the "IF" statement.
Action	<ul style="list-style-type: none"> • Delete the "IF" statement. • Add "ENDIF" statement corresponding to the "IF" statement.

5.223 : ELSE without ENDF

Code : &H0005 &H00DF

Meaning/Cause	There is no "ENDIF" statement corresponding to the "ELSE" statement.
Action	<ul style="list-style-type: none"> • Delete the "ELSE" statement. • Add "ENDIF" statement corresponding to the "ELSE" statement.

5.224 : END SUB without SUB

Code : &H0005 &H00E0

Meaning/Cause	<ol style="list-style-type: none"> There is no "SUB" statement corresponding to the "END SUB" statement. "END SUB" command was executed without "SUB" command.
Action	<ol style="list-style-type: none"> 1. Delete the END SUB statement. 2. b-1. Add SUB statement corresponding to the END SUB statement. 2. Confirm execution of "SUB" command.

5.225 : SUB without END SUB

Code : &H0005 &H00E1

Meaning/Cause	There is no "END SUB" statement corresponding to the "SUB" statement.
Action	<ul style="list-style-type: none"> • Delete the "SUB" statement. • Add "END SUB" statement corresponding to the "SUB" statement.

5.226 : Duplicated variable

Code : &H0005 &H00E2

Meaning/Cause	Two or more array variables were defined with the same name.
Action	Delete the definition statement for the array variables with the same name or define other array variables.

5.227 : Duplicated identifier

Code : &H0005 &H00E3

Meaning/Cause	Two or more identifiers were defined with the same name.
Action	Define identifiers with the different name.

5.228 : Duplicated label

Code : &H0005 &H00E4

Meaning/Cause	The labels were defined with the same name.
Action	Define the labels with different name.

5.229 : Undefined array

Code : &H0005 &H00E5

Meaning/Cause	Assignment/reference was made for an undeclared array.
Action	Declare the array.

5.230 : Undefined identifier

Code : &H0005 &H00E6

Meaning/Cause	An undefined identifier was used.
Action	Define the undefined identifier.

5.231 : Undefined label

Code : &H0005 &H00E7

Meaning/Cause	An undefined label was used.
Action	Define the undefined label.

5.232 : Undefined user function

Code : &H0005 &H00E8

Meaning/Cause	Undefined function was called.
Action	Define the undefined function.

5.233 : Undefined HAND

Code : &H0005 &H00E9

Meaning/Cause	The specified hand is not defined.
Action	<ul style="list-style-type: none"> • Specify a correct hand. • Define the hand.

5.234 : Too many dimensions

Code : &H0005 &H00EA

Meaning/Cause	An array exceeding 3 dimensions was declared.
Action	Change array to within 3 dimensions.

5.235 : Dimension mismatch

Code : &H0005 &H00EB

Meaning/Cause	The array dimension number does not correspond to that declared.
Action	Make the array dimension numbers correspond to each other.

5.236 : Argument mismatch

Code : &H0005 &H00EC

Meaning/Cause	The number of "SUB" statement arguments does not correspond to that of "CALL" statement arguments.
Action	Make the number of "SUB" statements correspond to that of "CALL" statements.

5.238 : Illegal option

Code : &H0005 &H00EE

Meaning/Cause	The command option is incorrect.
Action	Input a correct option.

5.239 : Illegal identifier

Code : &H0005 &H00EF

Meaning/Cause	A reserved word was used as an identifier.
Action	Use an identifier name other than a reserved word. Refer to the programming manual.

5.240 : Illegal command in procedure

Code : &H0005 &H00F0

Meaning/Cause	The command cannot be executed inside the procedure (between "SUB to END SUB" statements).
Action	Delete the target command.

5.241 : Illegal command outside procedure

Code : &H0005 &H00F1

Meaning/Cause	The command cannot be executed outside the procedure (between "SUB to END SUB" statements).
Action	Delete the target command.

5.242 : Illegal command inside IF

Code : &H0005 &H00F2

Meaning/Cause	The command cannot be executed in simple "IF" statement.
Action	<ul style="list-style-type: none"> • Input a command that can be executed in simple "IF" statement. • Input a block "IF" statement.

5.243 : Illegal direct

Code : &H0005 &H00F3

Meaning/Cause	The command cannot be executed independently.
Action	<ul style="list-style-type: none"> • Change the execution according to program. • Change it to a command that can be executed independently.

5.244 : Cannot use external label

Code : &H0005 &H00F4

Meaning/Cause	The command cannot use an external label.
Action	<ul style="list-style-type: none"> • Change to an internal label. • Change the execution command.

5.245 : Illegal program name

Code : &H0005 &H00F5

Meaning/Cause	a. When transmitting a program file by "SEND" command, the "NAME" statement was not defined on beginning line of the program data. b. Characters other than alphanumeric and "_" (underscore) were used in the program name. c. Program name has more than 32 characters.
Action	a. Define the "NAME" statement on beginning line of program data. b. Use only alphanumeric and "_" (underscore) characters in the program name. c. Use 32 characters or less in the program name.

5.246 : Too many identifiers

Code : &H0005 &H00F6

Meaning/Cause	There are too many identifiers.
Action	Reduce the number of identifiers. (An array variable or character string consume more memory than a numeric variable.)

5.247 : CASE without SELECT

Code : &H0005 &H00F7

Meaning/Cause	There is no "SELECT" statement corresponding to the "CASE" statement.
Action	• Delete the "CASE" statement. • Add a SELECT statement corresponding to the "CASE" statement.

5.248 : END SELECT without SELECT

Code : &H0005 &H00F8

Meaning/Cause	There is no "SELECT" statement corresponding to the "END SELECT" statement.
Action	• Delete the "END SELECT" statement. • Add a "SELECT" statement corresponding to the "END SELECT" statement.

5.249 : SELECT without END SELECT

Code : &H0005 &H00F9

Meaning/Cause	There is no "END SELECT" statement corresponding to the "SELECT" statement.
Action	• Delete the "SELECT" statement. • Add an "END SELECT" statement corresponding to the "SELECT" statement.

5.250 : CASE without END SELECT

Code : &H0005 &H00FA

Meaning/Cause	There is no "END SELECT" statement corresponding to the "CASE" statement.
Action	• Delete the "CASE" statement. • Add an "END SELECT" statement corresponding to the "CASE" statement.

5.251 : Illegal command line

Code : &H0005 &H00FB

Meaning/Cause	The command cannot be executed since it is between "SELECT" and "CASE" statements.
Action	Delete the command between "SELECT" and "CASE" statements.

5.252 : Command doesn't exist

Code : &H0005 &H00FC

Meaning/Cause	There is a line which does not have a command.
Action	• Add a command. • Delete the line.

5.253 : Compile failure

Code : &H0005 &H00FD

Meaning/Cause	An error occurred in software.
Action	Contact your distributor.

5.254 : ELSEIF without IF

Code : &H0005 &H00FE

Meaning/Cause	There is no "IF" statement corresponding to the "ELSEIF" statement.
Action	<ul style="list-style-type: none"> • Delete the "ELSEIF" statement. • Add an "IF" statement corresponding to the "ELSEIF" statement.

5.255 : ELSEIF without ENDIF

Code : &H0005 &H00FF

Meaning/Cause	There is no "ENDIF" statement corresponding to the "ELSEIF" statement.
Action	<ul style="list-style-type: none"> • Delete the "ELSEIF" statement. • Add an "ENDIF" statement corresponding to the "ELSEIF" statement.

5.256 : Subscript mismatch

Code : &H0005 &H0100

Meaning/Cause	The numbers of the array declared by DIM and the subscript do not correspond.
Action	<ul style="list-style-type: none"> • Make the number of the subscript correspond to that of declared array. • Change the number of the subscript specified by the array declaration. • Check if there is an array with the same name and different subscript in other program.

5.300 : Identifier already exists

Code : &H0005 &H012C

Meaning/Cause	The specified identifier already exists.
Action	Specify an identifier that does not exist.

5.301 : EXIT FOR without FOR

Code : &H0005 &H012D

Meaning/Cause	There is no "FOR" statement corresponding to the "EXIT FOR" statement.
Action	<ul style="list-style-type: none"> • Delete the "EXIT FOR" statement. • Add a "FOR" statement corresponding to the "EXIT FOR" statement.

5.302 : EXIT SUB without SUB

Code : &H0005 &H012E

Meaning/Cause	There is no "SUB" statement corresponding to the "EXIT SUB" statement.
Action	<ul style="list-style-type: none"> • Delete the "EXIT SUB" statement. • Add a "SUB" statement corresponding to the "EXIT SUB" statement.

5.303 : Can't open communicate file

Code : &H0005 &H012F

Meaning/Cause	The communication file was specified in the "READ/WRITE" command.
Action	Use the "SEND" command.

[6] Alarm related to the robot language execution

6.201 : Illegal command

Code : &H0006 &H00C9

Meaning/Cause	Non-supported or non-executable command was executed.
Action	Change to a command that can be executed.

6.202 : Illegal function call

Code : &H0006 &H00CA

Meaning/Cause	The <expression> of "ON <expression> GOTO" or "ON <expression> GOSUB" command was a negative value.
Action	Change the <expression> to a positive value.

6.203 : Division by 0

Code : &H0006 &H00CB

Meaning/Cause	A command to divide by 0 was executed.
Action	Change the command to divide by 0.

6.204 : Point doesn't exist

Code : &H0006 &H00CC

Meaning/Cause	Assignment, movement or reference to an undefined point was attempted.
Action	Define the point.

6.205 : Coordinate type error

Code : &H0006 &H00CD

Meaning/Cause	a. Arithmetic operations of joint coordinate point data and Cartesian coordinate point data were attempted. b. Joint coordinate system exists in the "MOVE C" command point data. c. Joint coordinate system exists in the "PMOVE" command point data.
Action	a. Change to the same coordinate system. b, c. Change to the Cartesian coordinate system.

6.206 : Subscript out of range

Code : &H0006 &H00CE

Meaning/Cause	A subscript of an array variable has exceeded the declared range.
Action	Change the subscript of array variable to within the defined range.

6.207 : RETURN without GOSUB

Code : &H0006 &H00CF

Meaning/Cause	The "RETURN" command was executed without executing the "GOSUB" command.
Action	Confirm the execution of "GOSUB" command.

6.208 : END SUB without CALL

Code : &H0006 &H00D0

Meaning/Cause	The "END SUB" command was executed without executing the "CALL" command.
Action	Confirm the execution of "SUB" command.

6.209 : EXIT SUB without CALL

Code : &H0006 &H00D1

Meaning/Cause	The "EXIT SUB" command was executed without executing the "CALL" command.
Action	Confirm the execution of "SUB" command.

6.210 : SUSPEND without START

Code : &H0006 &H00D2

Meaning/Cause	The "SUSPEND" command was executed for a task not executed by the "START" command.
Action	Confirm the execution of "START" command.

6.211 : CUT without START

Code : &H0006 &H00D3

Meaning/Cause	The "CUT" command was executed for a task not executed by the "START" command.
Action	Confirm the execution of "START" command.

6.212 : RESTART without START

Code : &H0006 &H00D4

Meaning/Cause	The "RESTART" command was executed for a task not executed by the "START" command.
Action	Confirm the execution of "START" command.

6.213 : RESTART without SUSPEND

Code : &H0006 &H00D5

Meaning/Cause	The "RESTART" command was executed for a task not executed by the "SUSPEND" command.
Action	Confirm the execution of "SUSPEND" command.

6.214 : Task number error

Code : &H0006 &H00D6

Meaning/Cause	a. Task number is outside the range from 1 to 16. b. "START", "CUT", "SUSPEND" or "RESTART" command was executed for task 1 (main task). c. "START", "CUT", "SUSPEND" or "RESTART" command was executed for its own task.
Action	a. Specify a correct task number. b. Delete the task command for task 1. c. Delete the command for its own task.

6.215 : Task running

Code : &H0006 &H00D7

Meaning/Cause	The "START" command was executed for a task currently in operation.
Action	Delete or correct the "START" command.

6.216 : Task suspending

Code : &H0006 &H00D8

Meaning/Cause	The "START" or "SUSPEND" command was executed for a task in pause (suspend) condition.
Action	Delete or correct the "START" or "SUSPEND" command.

6.217 : Illegal command in error routine

Code : &H0006 &H00D9

Meaning/Cause	The command could not be executed within an error processing routine.
Action	Delete the command.

6.218 : EXIT FOR without FOR

Code : &H0006 &H00DA

Meaning/Cause	The "EXIT FOR" command was executed without executing the "FOR" command.
Action	Confirm the execution of "FOR" command.

6.219 : SUB without CALL

Code : &H0006 &H00DB

Meaning/Cause	The "SUB" command was executed without executing the "CALL" command.
Action	Confirm the execution of "CALL" command.

6.220 : Not execute CALL

Code : &H0006 &H00DC

Meaning/Cause	The "CALL" command was not executed.
Action	Confirm the execution of "CALL" command.

6.225 : No sufficient memory for OUT

Code : &H0006 &H00E1

Meaning/Cause	Since 17 or more the "OUT" commands were executed in parallel, the command cannot be executed because of insufficient memory.
Action	The maximum number of "OUT" commands that can be run in parallel is 16.

6.226 : PATH without SET

Code : &H0006 H00E2

Meaning/Cause	Either of the "PATH L", "PATH C" or "PATH END" command was executed without executing the "PATH SET" command.
Action	First execute the "PATH SET" command when setting a path.

6.227 : PATH without END

Code : &H0006 &H00E3

Meaning/Cause	The "PATH START" command was executed without executing the "PATH END" command.
Action	Execute the "PATH END" command to end the path setting and then execute the "PATH START" command.

6.228 : No PATH data

Code : &H0006 &H00E4

Meaning/Cause	<p>a. No path is set for PATH motion.</p> <p>b. The previously set path was lost for the following reasons:</p> <ul style="list-style-type: none"> • When "PATH SET" command is executed. • When the program is changed. • When the program is reset. • When the controller power is turned off.
Action	Set a path with the "PATH L" and "PATH C" commands.

6.229 : Too many PATH data

Code : &H0006 &H00E5

Meaning/Cause	The number of PATH motion paths exceeded 1000.
Action	Reduce the number of PATH motion paths to 1000 or less in total of the "PATH L" and "PATH C" commands.

6.230 : Not PATH start position

Code : &H0006 &H00E6

Meaning/Cause	The robot's current position is not the start position of PATH motion.
Action	Move the robot to the start position specified with the "PATH SET" command and then execute the "PATH START" command.

6.232 : ABS of MARK incomplete

Code : &H0006 &H00E8

Meaning/Cause	Absolute reset was performed with the "ORIGIN" statement or dedicated input while axes of "Mark" method are in the origin-incomplete status.
Action	Perform the absolute reset of the axis with the "Mark" method first.

6.233 : MARK method is not allowed

Code : &H0006 &H00E9

Meaning/Cause	Return-to-origin was performed by "ORIGIN" statement or dedicated input while the return-to-origin method for incremental type axes or semi-absolute type axes are set to "Mark".
Action	Change the return-to-origin method.

6.234 : Port number error

Code : &H0006 &H00EA

Meaning/Cause	<ul style="list-style-type: none"> • The port numbers for the DO, DI, MO, SI, and SO ports were not specified within the range of 0 to 7, 10 to 17, and 20 to 27. • The port numbers specified for the LO and TO ports were other than 0. • The output to port 0 or port 1 was specified for the DO, MO, and SO ports.
Action	Specify the correct port numbers.

6.235 : Password error

Code : &H0006 &H00EB

Meaning/Cause	The password is not correct.
Action	Input the correct password.

6.236 : Undefined pallet

Code : &H0006 &H00EC

Meaning/Cause	Data is not defined in the specified pallet number.
Action	<ul style="list-style-type: none"> • Specify another pallet number. • Define the pallet.

6.237 : Specification mismatch

Code : &H0006 &H00ED

Meaning/Cause	The command is non-executable in the current robot specifications.
Action	Change the execution command.

6.238 : Too many point data

Code : &H0006 &H00EE

Meaning/Cause	More than 32 values of point data are specified for movement command.
Action	Specify 32 or less values of point data for one movement command line.

6.239 : Illegal PATH task no

Code : &H0006 &H00EF

Meaning/Cause	The "PATH L", "PATH C", or "PATH END" command was executed in different task from that executed the "PATH SET" command.
Action	Execute commands from the "PATH SET" to the "PATH END" in the same task.

6.251 : Stack underflow

Code : &H0006 &H00FB

Meaning/Cause	a. The "RESUME" statement was executed outside the alarm routine. b. Error occurred in software.
Action	a. Use the "RESUME" statement within the alarm routine declared in "ON ERROR GOTO". b. Contact your distributor.

6.252 : Data out of range

Code : &H0006 &H00FC

Meaning/Cause	The specified value is out of the input range.
Action	Specify the value within the input range.

6.253 : Illegal point no

Code : &H0006 &H00FD

Meaning/Cause	The specified point number is out of the range; between 0 and 29999.
Action	Specify a point number between 0 and 29999.

6.254 : Illegal shift no

Code : &H0006 &H00FE

Meaning/Cause	The specified shift number is out of the range; between 0 and 39.
Action	Specify a shift number between 0 and 39.

6.255 : Illegal hand no

Code : &H0006 &H00FF

Meaning/Cause	The specified hand number is out of the range; between 0 and 31.
Action	Specify a hand number between 0 and 31.

6.256 : Illegal pallet no

Code : &H0006 &H0100

Meaning/Cause	The specified pallet number is out of the range; between 0 and 39.
Action	Specify a pallet number between 0 and 39.

6.257 : Illegal axis no

Code : &H0006 &H0101

Meaning/Cause	The specified axis number is out of the range; between 1 and 6.
Action	Specify an axis number between 1 and 6.

6.258 : Illegal robot no

Code : &H0006 &H0102

Meaning/Cause	The specified robot number is out of the range; between 1 and 4.
Action	Specify a robot number between 1 and 4.

6.259 : Illegal task no

Code : &H0006 &H0103

Meaning/Cause	The specified task number is out of the range; between 1 and 16.
Action	Specify a task number between 1 and 16.

6.260 : Too many characters

Code : &H0006 &H0104

Meaning/Cause	a. The number of defined character constants exceeds 255. b. The number of addition characters exceeds 255.
Action	a. Define the number of character constants within 255. b. Set the number of additional characters within 255.

6.261 : Task stopped

Code : &H0006 &H0105

Meaning/Cause	The task is in stop status.
Action	Restart the task by "RESTART" statement.

6.262 : Task doesn't exist

Code : &H0006 &H0106

Meaning/Cause	The task is not executed.
Action	Start the task by "START" statement.

6.263 : Too many Tasks

Code : &H0006 &H0107

Meaning/Cause	The number of programs has exceeded the upper limit (16).
Action	Release the task by "EXIT TASK" statement or "CUT" statement, then register a task.

6.264 : Type mismatch

Code : &H0006 &H0108

Meaning/Cause	a. Expression types are not equal on both sides. b. Prohibited type constant/variable/expression was used.
Action	a. Use the same expression type on both sides. b. Use a correct type of constant/variable/expression.

6.265 : Timeout

Code : &H0006 &H0109

Meaning/Cause	a. Servo off/free of the axis has not completed. b. Mark setting has not completed. c. Servo on/off of the gripper has not completed.
Action	a. Check the axis connection. b. Check the mark axis connection. c. Check the gripper connection.

6.266 : All axes completed

Code : &H0006 &H010A

Meaning/Cause	Return-to-origin has completed on all axes.
Action	It is not necessary to perform return-to-origin.

6.267 : Access level error

Code : &H0006 &H010B

Meaning/Cause	The operation cannot be executed at the present access level.
Action	Change the access level so that the operation can be executed.

6.270 : Can't calculate

Code : &H0006 &H010E

Meaning/Cause	The position that cannot be calculated is taught during wizard.
Action	Teach again at the correct position.

6.271 : Can't be in hand use

Code : &H0006 &H010F

Meaning/Cause	The hand data to change is in use.
Action	Release the setting of the robot and specify the correct hand setting.

6.272 : Can't be in shift use

Code : &H0006 &H0110

Meaning/Cause	The shift data to change is in use.
Action	Release the setting of the robot and specify the correct shift setting.

6.280 : Illegal command Operating

Code : &H0006 &H0118

Meaning/Cause	The online command was executed during data editing.
Action	After completing data editing, execute the online command.

6.281 : Illegal command Running

Code : &H0006 &H0119

Meaning/Cause	The non-executable online command was executed during program running.
Action	After stopping the program, execute the online system command.

6.282 : Illegal command Moving

Code : &H0006 &H011A

Meaning/Cause	The non-executable online command was executed during axis operation.
Action	After stopping the axis operation, execute the online system command.

6.283 : Illegal work no

Code : &H0006 &H011B

Meaning/Cause	The specified work number is out of the range; between 0 and 39.
Action	Specify a work number between 0 and 39.

6.300 : Motor power off

Code : &H0006 &H012C

Meaning/Cause	The movement command was executed in the motor power off status.
Action	Put the robot in the motor and servo on status.

6.301 : Servo off

Code : &H0006 &H012D

Meaning/Cause	The movement command was executed in the servo off status.
Action	Put the robot in the servo on status.

6.302 : Origin incomplete

Code : &H0006 &H012E

Meaning/Cause	<ul style="list-style-type: none"> ● Without performing return-to-origin, operations shown below were performed in the origin incomplete status. <ul style="list-style-type: none"> • Program or command execution • Point teaching • Cartesian coordinate movement ● The robot puts into the origin-incomplete status by the following reasons. <ul style="list-style-type: none"> • The absolute batteries were removed from the controller or retained position became unstable by absolute battery voltage drop. • ROB I/O cable was disconnected. • Return-to-origin operation was stopped halfway. • System generation was changed, parameters were initialized or parameters to determine the origin return direction, axis polarity, or origin position were changed. (Writing ALL and PRM files into the controller is also included.)
Action	Perform absolute reset or return-to-origin operation to put the robot in the return-to-origin complete status.

6.309 : INC. motor disconnected

Code : &H0006 &H0135

Meaning/Cause	Return-to-origin command was executed without incremental type or absolute type axes.
Action	Refer to "DI14 Return-to-origin (for INC axis)" of "1.9 Dedicated input signal description" in Chapter 4.

6.310 : ABS. motor disconnected

Code : &H0006 &H0136

Meaning/Cause	Return-to-origin command was executed without absolute type axes.
Action	Refer to "DI14 Return-to-origin (for INC axis)" of "1.9 Dedicated input signal description" in Chapter 4.

6.312 : ABS. reset position incomplete

Code : &H0006 &H0138

Meaning/Cause	Absolute reset was executed at a position where the absolute reset cannot be performed.
Action	Move to a position where the absolute reset can be performed.

6.313 : MRK. motor disconnected

Code : &H0006 &H0139

Meaning/Cause	Return-to-origin was executed without mark-specified axes.
Action	Check the system generation data.

6.314 : Can't execute while servo on

Code : &H0006 &H013A

Meaning/Cause	Writing in "ALL" or "PRM" files was attempted in servo on status.
Action	Turn off the servo before writing files.

6.315 : ZR torque origin incorrect setting

Code : &H0006 &H013B

Meaning/Cause	<ul style="list-style-type: none"> a. Simultaneous return-to-origin was performed while the ZR-stroke end method was set. b. R-axis stack was not set for the Z-axis. c. Either Z or R-axis return-to-origin method was not set to the ZR-stroke end method. d. Multiple Z-axis (or R-axis) return-to-origin methods were set to the ZR-stroke end method.
Action	<ul style="list-style-type: none"> a. Set the return-to-origin order correctly. (Simultaneous return-to-origin cannot be performed.) b. Set the R-axis stack correctly. c. Set both Z and R-axis return-to-origin methods to the ZR-stroke end method. d. Set Z and R-axis one each for the ZR-stroke end method.

6.316 : Can't execute while motor power on

Code : &H0006 &H013C

Meaning/Cause	The parameter that cannot be written in motor power off status was saved.
Action	Turn off the motor, and then save the parameter.

6.317 : Illegal origin method

Code : &H0006 &H013D

Meaning/Cause	<ul style="list-style-type: none"> a. Performing return-to-origin (mark method) was attempted. b. Only one of Z or R-axis is set to ZR-stroke end method.
Action	<ul style="list-style-type: none"> a. Perform absolute reset for axes of "Mark" method using the programming box or support software. b. Set both Z and R-axis at "ZR-stroke end method".

6.319 : Can't change hand data

Code : &H0006 &H013F

Meaning/Cause	<ul style="list-style-type: none"> a. Changing the hand setting that another robot is using was attempted. b. Specifying the hand R for the robot without R-axis was attempted.
Action	<ul style="list-style-type: none"> a. Release the hand setting of the other robot. b. Set blank for the fourth parameter of the target parameter.

6.321 : Illegal option slot no

Code : &H0006 &H0141

Meaning/Cause	The specified option slot number is out of the range; between 1 and 4.
Action	Specify an option slot number between 1 and 4.

6.322 : Illegal calibration no

Code : &H0006 &H0142

Meaning/Cause	The specified calibration number is out of the range; between 0 and 31.
Action	Specify a calibration number between 0 and 31.

6.323 : Illegal real time output no

Code : &H0006 &H0143

Meaning/Cause	The specified calibration number is out of the range; between 24 and 127.
Action	The specified calibration number is out of the range; between 24 and 127.

6.399 : Can't execute while alarm

Code : &H0006 &H018F

Meaning/Cause	The program cannot be executed while an alarm is occurring.
Action	Clear the alarm cause and reset alarm or restart the controller as necessary.

6.999 : Interpreter runtime system error

Code : &H0006 &H03E7

Meaning/Cause	Error occurred in software.
Action	Contact your distributor.

[9] Alarm related to the memory**9.300 : Memory full**

Code : &H0009 &H012C

Meaning/Cause	There is no available space in the program or point data area.
Action	Delete unnecessary programs or points.

9.301 : Program too big

Code : &H0009 &H012D

Meaning/Cause	The program size exceeded the permissible size.
Action	Compress the program size.

9.400 : Gripper origin data destroyed

Code : &H0009 &H0190

Meaning/Cause	Part or all of the data that saved after performing return-to-origin of gripper has been destroyed.
Action	Perform return-to-origin of the gripper.

9.701 : Program destroyed

Code : &H0009 &H02BD

Meaning/Cause	a. Part or all of the program data has been destroyed. b. This error message is sometimes issued due to a major error or the power being turned off during rewrite of program data.
Action	a. Delete that program during selection. b. Initialize the program data.

9.702 : Point data destroyed

Code : &H0009 &H02BE

Meaning/Cause	<ul style="list-style-type: none"> Part or all of the point data has been destroyed. This error message is sometimes issued due to a major error or the power being turned off during rewriting point data.
Action	Initialize the point data.

9.704 : Parameter destroyed

Code : &H0009 &H02C0

Meaning/Cause	Part or all of the parameter data has been destroyed.
Action	Initialize the parameter data.

9.706 : Shift data destroyed

Code : &H0009 &H02C2

Meaning/Cause	Part or all of the shift data has been destroyed.
Action	Initialize the shift data.

9.707 : Hand data destroyed

Code : &H0009 &H02C3

Meaning/Cause	Part or all of the hand data has been destroyed.
Action	Initialize the hand data.

9.709 : Pallet data destroyed

Code : &H0009 &H02C5

Meaning/Cause	Part or all of the pallet definition data was destroyed.
Action	Initialize the pallet definition data.

9.710 : Break point data destroyed

Code : &H0009 &H02C6

Meaning/Cause	Part or all of the break point has been destroyed.
Action	Initialize the break point.

9.711 : IO name data destroyed

Code : &H0009 &H02C7

Meaning/Cause	Part or all of the name of I/O has been destroyed.
Action	Initialize the name of I/O

9.712 : Area checkout data destroyed

Code : &H0009 &H02C8

Meaning/Cause	Part or all of the area check output has been destroyed.
Action	Initialize the area check output.

9.713 : Calibration data destroyed

Code : &H0009 &H02C9

Meaning/Cause	Part or all of the calibration output has been destroyed.
Action	Initialize the calibration.

9.714 : Conveyor data destroyed

Code : &H0009 &H02CA

Meaning/Cause	Error occurred in the conveyor calibration data.
Action	Initialize the conveyor calibration data.

9.715 : Alarm log destroyed

Code : &H0009 &H02CB

Meaning/Cause	Part or all of the alarm history has been destroyed.
Action	Initialize the alarm history.

9.716 : Variable data destroyed

Code : &H0009 &H02CC

Meaning/Cause	Part or all of the variable data has been destroyed.
Action	Initialize the controller.

9.717 : Program register data destroyed

Code : &H0009 &H02CD

Meaning/Cause	Part or all of the program register has been destroyed.
Action	Initialize the program.

9.718 : Communicate setting destroyed

Code : &H0009 &H02CE

Meaning/Cause	Part or all of the controller status data has been destroyed.
Action	Initialize the communication setting.

9.722 : Global EtherNet Port setting destroyed

Code : &H0009 &H02D2

Meaning/Cause	Part or all of the communication setting of general-purpose Ethernet has been destroyed.
Action	Initialize the communication setting of general-purpose Ethernet.

9.723 : Controller status data destroyed

Code : &H0009 &H02D3

Meaning/Cause	Part or all of the controller status data has been destroyed.
Action	Initialize the controller status.

9.724 : Robot status data destroyed

Code : &H0009 &H02D4

Meaning/Cause	Part or all of the robot status data has been destroyed.
Action	<ul style="list-style-type: none"> • Initialize the robot status. • Reset the standard coordinates in the case of SCARA type robots.

9.725 : Axis status data destroyed

Code : &H0009 &H02D5

Meaning/Cause	Part or all of the axis status data has been destroyed.
Action	Initialize the axis status.

9.726 : Motor status data destroyed

Code : &H0009 &H02D6

Meaning/Cause	Part or all of the motor status data has been destroyed.
Action	<ul style="list-style-type: none"> • Initialize the motor status. • Re-perform return-to-origin.

9.727 : Out status data destroyed

Code : &H0009 &H02D7

Meaning/Cause	Part or all of the out status data has been destroyed.
Action	Reset the output port.

9.729 : Sequence object destroyed

Code : &H0009 &H02D9

Meaning/Cause	Part or all of the sequence object program has been destroyed.
Action	Re-compile the sequence program.

9.730 : Gripper status data destroyed

Code : &H0009 &H02DA

Meaning/Cause	Part or all of the data for the gripper operation has been destroyed. Data for the gripper operation was initialized.
Action	Re-perform the gripper generation.

9.731 : Trace setting destroyed

Code : &H0009 &H02DB

Meaning/Cause	Part or all of the trace setting was destroyed.
Action	Initialize the trace setting.

9.732 : Counter status data destroyed

Code : &H0009 &H02DC

Meaning/Cause	Error occurred in the tracking counter status data. Status specified on "CCOND" and "CTVISION" commands will be initialized.
Action	Re-execute "CCOND" and "CTVISION" commands.

9.733 : Real time output setting destroyed

Code : &H0009 &H02DD

Meaning/Cause	Part or all of the real time output setting has been destroyed.
Action	Initialize the real time output setting.

9.734 : Sys. accumulated data destroyed

Code : &H0009 &H02DE

Meaning/Cause	Part or all of the system accumulated data has been destroyed
Action	–

9.735 : Motor accumulated data destroyed

Code : &H0009 &H02DF

Meaning/Cause	Part or all of the motor accumulated data has been destroyed.
Action	–

9.900 : Sys. generation destroyed

Code : &H0009 &H0384

Meaning/Cause	Part or all of the system generation data has been destroyed.
Action	Back up the current data, then send/load the data that is proper for the target robot and controller.

9.901 : Sys. generation mismatch

Code : &H0009 &H0385

Meaning/Cause	The robot type or axis number designation in the system generation data is incorrect.
Action	Back up the current data, then send/load the data that is proper for the target robot and controller.

[10] Alarm related to the environment and general hardware**10.201 : Robot disconnected**

Code : &H000A &H00C9

Meaning/Cause	The system generation is not set.
Action	<ul style="list-style-type: none"> • Back up the current data, then send/load the data that is proper for the target robot and controller. • Contact your distributor.

10.205 : Illegal robot type

Code : &H000A &H00CD

Meaning/Cause	The specified robot type is incorrect.
Action	<ul style="list-style-type: none"> • Check the robot type data. • Back up the current data, then send/load the data that is proper for the target robot and controller. • Contact your distributor.

10.208 : Cannot set auxiliary axis

Code : &H000A &H00D0

Meaning/Cause	An auxiliary axis was set on an axis that cannot be set as so.
Action	<ul style="list-style-type: none"> • Do not set an auxiliary axis. • Contact your distributor.

10.209 : Cannot set no axis
Code : &H000A &H00D1

Meaning/Cause	"No axis" was set on an axis which cannot accept "no axis" setting.
Action	<ul style="list-style-type: none"> • Do not set "no-axis" on the axis. • Contact your distributor.

10.213 : Cannot set Dualdrive
Code : &H000A &H00D5

Meaning/Cause	"Dual drive" was set on an axis that cannot be set to "Dual drive".
Action	<ul style="list-style-type: none"> • Do not set "Dual drive" on the axis. • Contact your distributor.

10.214 : Undefined parameter found
Code : &H000A &H00D6

Meaning/Cause	<ol style="list-style-type: none"> The parameter name is incorrect. Undefined and non-corresponded parameter data was written because the controller data of different controller version was used.
Action	<ol style="list-style-type: none"> Input the parameter name correctly. Write the correct parameter data. <ol style="list-style-type: none"> Set the "PRM SKIP" parameter to "VALID".

10.219 : Illegal axis type
Code : &H000A &H00DB

Meaning/Cause	This axis type cannot be set.
Action	<ul style="list-style-type: none"> • Check the axis setting. • Back up the current data, then send/load the data that is proper for the target robot and controller. • Contact your distributor.

10.223 : Axis disconnected
Code : &H000A &H00DF

Meaning/Cause	No axis is set.
Action	<ul style="list-style-type: none"> • Check the axis setting. • Back up the current data, then send/load the data that is proper for the target robot and controller. • Contact your distributor.

10.225 : Controller disconnected
Code : &H000A &H00E1

Meaning/Cause	No controller is connected.
Action	<ul style="list-style-type: none"> • Check the system generation data. • Re-perform the system generation.

10.226 : Motor disconnected
Code : &H000A &H00E2

Meaning/Cause	No motor is connected.
Action	<ul style="list-style-type: none"> • Check the system generation data. • Re-perform the system generation.

10.231 : Driver overlap assign
Code : &H000A &H00E7

Meaning/Cause	The driver assignments are overlapping.
Action	Assign the drivers not to overlap.

10.232 : Can't release driver-assign by using

Code : &H000A &H00E8

Meaning/Cause	The driver registration to release is in use.
Action	Release the driver registration after deleting the robot setting.

10.233 : Illegal robot configuration

Code : &H000A &H00E9

Meaning/Cause	The robot configuration is specified incorrect.
Action	<ul style="list-style-type: none"> • Check the system generation data. • Re-perform the system generation.

10.700 : Illegal safe mode

Code : &H000A &H02BC

Meaning/Cause	The safe mode setting is incorrect.
Action	Reset the safe mode.

10.701 : Real time clock data failed

Code : &H000A &H02BD

Meaning/Cause	Gaining real time clock data failed.
Action	Reset the real time clock.

10.900 : Turn on power again

Code : &H000A &H0384

Meaning/Cause	<ul style="list-style-type: none"> • System generation was performed because of changing robot and so on. • Parameters were changed through the communication. • System generation data was destroyed. • The controller is abnormal.
Action	Turn the power off and then on again.

10.901 : Illegal driver setting

Code : &H000A &H0385

Meaning/Cause	The driver configuration cannot be specified.
Action	<ul style="list-style-type: none"> • Check the system generation data. • Re-perform the system generation.

[12] Alarm related to the option board**12.75 : Illegal remote command**

Code : &H000C &H004B

Meaning/Cause	The remote command or command data is incorrect.
Action	Check the remote command or command data.

12.76 : Disable remote command

Code : &H000C &H004C

Meaning/Cause	The "Remote command" of the I/O parameter is set to "INVALID".
Action	Set the "Remote command" parameter to "VALID".

12.100 : EtherNet/IP DHCP enabled

Code : &H000C &H0064

Meaning/Cause	The DHCP setting of the communication parameter was changed from "INVALID" to "VALID".
Action	—

12.200 : Tracking disabled

Code : &H000C &H00C8

Meaning/Cause	a. No tracking board is connected to the option slot. b. The tracking board is set to "INVALID".
Action	a. Check that the tracking board is connected. b. Set the tracking board to "VALID".

12.201 : Tracking counter not enabled

Code : &H000C &H00C9

Meaning/Cause	a. The tracking counter status is set "INVALID". b. The value of counter pulse did not change during calibration.
Action	a. Check the counter status and set "VALID". b. Check if the counter value can be read.

12.202 : Tracking vision not enabled

Code : &H000C &H00CA

Meaning/Cause	Tasks or counters which did not execute the "CTVISION" command were specified when executing the "CADDQUEV" command.
Action	Execute the "CTVISION" command on the tasks or counters beforehand.

12.203 : Tracking calibration incomplete

Code : &H000C &H00CB

Meaning/Cause	Tracking function was executed with the robot or counter on which calibration was not executed.
Action	<ul style="list-style-type: none"> • Execute calibration. • Write the calibration data. • Set the different calibration data at upstream and downstream positions.

12.204 : Tracking counter number error

Code : &H000C &H00CC

Meaning/Cause	The specified counter number was neither 1 nor 2.
Action	Specify the correct value.

12.205 : Tracking queue element number error

Code : &H000C &H00CD

Meaning/Cause	The position monitor queue element number that is out of specifiable range was specified. Between 0 and 79 can be specified.
Action	Specify the value within the range.

12.206 : Tracking queue element doesn't exist

Code : &H000C &H00CE

Meaning/Cause	The queue element specified by the position monitoring queue does not exist.
Action	<ul style="list-style-type: none"> • Add the queue element to the position monitoring queue. • Check the specified queue element.

12.207 : Tracking queue element being used

Code : &H000C &H00CF

Meaning/Cause	The "CRMVQUE" command was executed during tracking operation.
Action	Execute the command after tracking operation has completed.

12.208 : Tracking queue element over run

Code : &H000C &H00D0

Meaning/Cause	The queue element registered on the position monitoring queue exceeded the monitoring range.
Action	<ul style="list-style-type: none"> • Delete the queue elements that are not used by the "CRMVQUE" command. • Check the queue elements to register.

12.300 : Incorrect Individ. Origin setting

Code : &H000C &H012C

Meaning/Cause	<ul style="list-style-type: none"> • Multiple axes were specified for the "Axes sel. port (DI & SI)" parameter. • No axis was specified for the "Axes sel. port (DI & SI)" parameter. • Axis which is not present was specified for the "Axes sel. port (DI & SI)" parameter.
Action	Specify one axis each.

12.301 : SIO board does not support real time output

Code : &H000C &H012D

Meaning/Cause	Using SIO board does not support real time output function.
Action	Real time output function is compatible only with the board for EtherNet/IP, EtherCAT, PROFINET.

12.400 : Standard in stop on

Code : &H000C &H0190

Meaning/Cause	<ul style="list-style-type: none"> a. Program execution or axis movement was attempted in the stop status. b. The robot was put in the stop status during program execution or axis movement. c. 24V-power for I/O is not supplied to the DIO connector. d. The DIO connector is not connected.
Action	<ul style="list-style-type: none"> a, b. Cancel the stop status, and then execute the program or move the axis. c. Supply 24V-power for I/O. d. Connect the DIO connector. * Set the "Option board enable" parameter INVALID when DIO is not used.

12.401 : Arm locked

Code : &H000C &H0191

Meaning/Cause	The arm was moved while the arm lock variable LO was ON.
Action	Set the arm lock variable LO off.

12.500 : Changed operation mode input

Code : &H000C &H01F4

Meaning/Cause	The robot in operation stopped since the operation mode was changed.
Action	Check the status, reset the alarm, and restart operating the robot.

12.520 : PIO DC24V low voltage

Code : &H000C &H0208

Meaning/Cause	a. 24V power is not supplied to the PIO board. b. The power voltage supplying to the PIO board has dropped.
Action	a. Supply 24V power. b. Check if any device with over voltage source capacity is connected or how power supply state is.

12.521 : PIO DC24V over voltage

Code : &H000C &H0209

Meaning/Cause	Exceeding 24V power is supplied to the PIO board.
Action	Supply power at 24V.

12.522 : PIO STD DC24V low voltage

Code : &H000C &H020A

Meaning/Cause	a. 24V power is not supplied to the PIO STD board. b. The power supply voltage supplying to the PIO STD board has dropped.
Action	a. Supply 24V power. b. Check if any device with over voltage source capacity is connected or how power supply state is.

12.541 : DeviceNet link error

Code : &H000C &H021D

Meaning/Cause	a. Error occurred on the cable for DeviceNet system. b. The communication setting of the DeviceNet system is incorrect. c. Power for communication is not supplied. d. The master module power is turned off, has stopped operating or is damaged. e. The DeviceNet compatible module is damaged.
Action	a. Check for a break disconnection, wiring error, short circuit on the DeviceNet cable or the specifications (cable length, etc.). b. Check the communication settings. c. Check that the communication power is supplied. d. Check that the master module operates correctly. e. Replace the DeviceNet compatible module.

12.542 : DeviceNet overtime error

Code : &H000C &H021E

Meaning/Cause	a. Communication error occurred by noise, etc. in the DeviceNet system. b. The master module power is turned off or has stopped operating. c. The cable is broken or unconnected.
Action	a. Take the noise preventive actions for the cable of the DeviceNet system and the controller. b. Check that the master module operates correctly. c. Check the DeviceNet cable connection.

12.551 : EtherNet/IP link error

Code : &H000C &H0227

Meaning/Cause	a. Error occurred on the cable for EtherNet/IP system. b. The communication setting of the EtherNet/IP system is incorrect. c. The master module power is turned off, has stopped operating or is damaged. d. The EtherNet/IP compatible module is damaged.
Action	a. Check for a break disconnection, wiring error, short circuit on the EtherNet/IP cable or the specifications (cable length, etc.). b. Check the communication setting. c. Check that the master module operates correctly. d. Replace the EtherNet/IP compatible module.

12.552 : EtherNet/IP overtime error

Code : &H000C &H0228

Meaning/Cause	a. Communication error occurred by noise, etc. in the EtherNet/IP system. b. The master module power is turned off or has stopped operating. c. The cable is broken or unconnected.
Action	a. Take the noise preventive actions for the cable of the EtherNet/IP system and the controller. b. Check that the master module operates correctly. c. Check the EtherNet/IP cable connection.

12.561 : PROFIBUS link error

Code : &H000C &H0231

Meaning/Cause	a. Error occurred in cable for PROFIBUS system. b. The communication setting of the PROFIBUS system was incorrect. c. The master module power is turned off, has stopped operating or is damaged. d. The PROFIBUS compatible module is damaged.
Action	a. Check for a break disconnection, wiring error, short circuit on the PROFIBUS cable or the specifications (cable length, etc.). b. Check the communication setting. c. Check that the master module operates correctly. d. Replace the PROFIBUS compatible module.

12.562 : PROFIBUS overtime error

Code : &H000C &H0232

Meaning/Cause	a. Communication error occurred by noise, etc. in the PROFIBUS system. b. Master module power is turned off or has stopped operating. c. The cable is broken or unconnected.
Action	a. Take the noise preventive actions for the cable of the PROFIBUS system and the controller. b. Check that the master module operates correctly. c. Check the PROFIBUS cable connection.

12.571 : PROFINET link error

Code : &H000C &H023B

Meaning/Cause	a. Error occurred in cable for PROFINET system. b. The communication setting of the PROFINET system incorrect. c. The master module power is turned off, or the PLC has stopped operating, or is broken. d. The PROFINET compatible module is breakdown.
Action	a. Check for a break disconnection, wiring error, short circuit on the PROFINET cable or the specifications (cable length, etc.). b. Check the communication setting. c. Check that the master module operates correctly. d. Replace the PROFINET compatible module.

12.572 : PROFINET overtime error

Code : &H000C &H0232

Meaning/Cause	a. Communication error occurred by noise, etc. in the PROFINET system. b. Master module power is turned off or has stopped operating. c. The cable is broken or unconnected.
Action	a. Take the noise preventive actions for the cable and controller of the PROFINET system. b. Check that the master module operates correctly. c. Check the PROFINET cable connection.

12.581 : Counter1 wire breakage

Code : &H000C &H0245

Meaning/Cause	The encoder cable connected to the counter 1 is broken. The break detection is available when the counter 1 is set to "VALID".
Action	<ul style="list-style-type: none"> • Set the counter status to "INVALID" if the encoder is not connected to the counter 1. • Check the encoder cable of the counter 1. • Check if the encoder works normally.

12.582 : Counter2 wire breakage

Code : &H000C &H0246

Meaning/Cause	The encoder cable connected to the counter 2 is broken. The break detection is available when the counter 2 is set to "VALID".
Action	<ul style="list-style-type: none"> • Set the counter status to "INVALID" if the encoder is not connected to the counter 2. • Check the encoder cable of the counter 2. • Check if the encoder works normally.

12.583 : Tracking watchdog error

Code : &H000C &H0247

Meaning/Cause	There is no response from the tracking board for a certain time.
Action	<ul style="list-style-type: none"> • Check the tracking board connection status. • Check if the tracking board is recognized on the programming box. • Turn the power off and on again.

12.600 : Emergency stop on

Code : &H000C &H0258

Meaning/Cause	<ul style="list-style-type: none"> a. The programming box emergency stop button was pressed. b. The emergency stop terminal on the SAFETY connector is open (emergency stop status). c. The programming box or terminator is not connected to the PB connector. d. The SAFETY connector is not connected.
Action	<ul style="list-style-type: none"> a. Release the emergency stop button on the programming box. b. Close the emergency stop terminal on SAFETY connector. c. Connect the programming box or terminator to the PB connector. d. Attach the SAFETY connector.

12.601 : Illegal operation mode input

Code : &H000C &H0259

Meaning/Cause	<ul style="list-style-type: none"> a. The programming box or terminator is not connected to the PB connector, b. Settings of the MANUAL LOCK of the programming box and AUTO MODE of the SAFETY connector are incorrect in the case of a CE specification controller.
Action	<ul style="list-style-type: none"> a. Connect the programming box or terminator to the PB connector. b. Check the AUTO MODE connection of the SAFETY connector in the case of a CE specification controller.

12.700 : Option board changed

Code : &H000C &H02BC

Meaning/Cause	The option board configuration was changed.
Action	Initialize the option board setting.

12.705 : Parallel I/O board assign changed

Code : &H000C &H02C1

Meaning/Cause	<ul style="list-style-type: none"> a. The PIO board was pulled out, or new one was inserted. b. "Option board enable" parameter was changed. c. "Parallel IO ID" parameter was changed. d. PIO board is damaged.
Action	<ul style="list-style-type: none"> a. Check if the PIO board configuration is correct. b. Check if the option board configuration is correct. c. Check the PIO board IDs are correct. d. Check unrecognizable PIO boards and replace them.

12.706 : PIO board I/O stop

Code : &H000C &H02C2

Meaning/Cause	a. PIO board power is turned off or has stopped operation. b. The PIO board is broken.
Action	a. Check if power for the PIO board is supplied normally. b. Replace the PIO board.

12.734 : POS.OUT Point not exist

Code : &H000C &H02DE

Meaning/Cause	Comparison point data does not exist.
Action	Set the comparison point data correctly.

12.735 : POS.OUT Point unit error

Code : &H000C &H02DF

Meaning/Cause	Comparison points 1 and 2 do not use the same unit system.
Action	Change them to the same unit system.

12.750 : PIO board Flash error

Code : &H000C &H02EE

Meaning/Cause	The PIO board is breakdown.
Action	Replace the PIO board.

12.751 : PIO STD. board connector error

Code : &H000C &H02EF

Meaning/Cause	a. The standard PIO board cable is not connected. b. The standard PIO board connector is half-plugged. c. The standard PIO board wiring is incorrect.
Action	a. Connect the standard PIO board cable. b. Re-insert the standard PIO board connector. c. Check the wiring of the standard PIO board.

12.761 : DeviceNet initialize error

Code : &H000C &H02F9

Meaning/Cause	Initializing the DeviceNet option board failed.
Action	Contact your distributor.

12.762 : EtherNet/IP initialize error

Code : &H000C &H02FA

Meaning/Cause	Initializing the EtherNet/IP option board failed
Action	Contact your distributor.

12.763 : EtherNet/IP parameter mismatch

Code : &H000C &H02FB

Meaning/Cause	Parameters set in the controller do not correspond to those set in the option board.
Action	Initialize the EtherNet/IP option parameters.

12.764 : PROFIBUS initialize error

Code : &H000C &H02FC

Meaning/Cause	Initializing the PROFIBUS option board failed.
Action	Contact your distributor.

12.765 : PROFINET initialize error

Code : &H000C &H02FD

Meaning/Cause	Initializing the PROFINET option board failed.
Action	Contact your distributor.

12.900 : Incorrect option setting

Code : &H000C &H0384

Meaning/Cause	<ul style="list-style-type: none"> a. Error occurred in ID setting on the option module. b. Option modules that cannot be mixed were installed. c. The installed option module cannot be identified.
Action	<ul style="list-style-type: none"> a. Check the ID setting of the option module. b. Install the correct option modules. c. Replace the option module. <ul style="list-style-type: none"> • Replace the controller.

12.901 : PIO internal error

Code : &H000C &H0385

Meaning/Cause	<ul style="list-style-type: none"> a. The PIO board cable is abnormal. b. The PIO board power is turned off, or has stopped operation. c. The PIO board is breakdown.
Action	<ul style="list-style-type: none"> a. Check for a break disconnection, wiring error, short circuit on the PIO cable or the specifications (cable length, etc.). b. Check if power for the PIO board is supplied normally. c. Replace the PIO board.

12.903 : PIO option setting error

Code : &H000C &H0387

Meaning/Cause	The PIO board installed incorrectly.
Action	<ul style="list-style-type: none"> • Remove the PIO board for correct configuration. • Set the PIO board INVALID for correct configuration.

12.904 : SIO option board initialize error

Code : &H000C &H0388

Meaning/Cause	Initializing the SIO option board failed.
Action	Contact your distributor.

12.905 : Option board overlapped

Code : &H000C &H0389

Meaning/Cause	The installed option board cannot be overlapped.
Action	Remove the option board that cannot be overlapped.

12.906 : Undefined option board

Code : &H000C &H038A

Meaning/Cause	The installed option board inapplicable.
Action	Contact your distributor.

[14] Alarm related to the communication**14.201 : Communication error**

Code : &H000E &H00C9

Meaning/Cause	a. Error occurred in the external communication. b. The external device was turned on or off with connecting to the communication cable.
Action	<ul style="list-style-type: none"> • Prevent putting noise generation source close to the robot so as to improve the communication environment. • Replace the communication cable. • Check the communication parameter settings.

14.211 : Receive buffer overflow

Code : &H000E &H00D3

Meaning/Cause	The communication receive buffer exceeded permissible capacity.
Action	<ul style="list-style-type: none"> • Decrease the communication parameter speed (baud rate). • Change communication parameter so that the flow control is enabled.

14.212 : CMU is not ready

Code : &H000E &H00D4

Meaning/Cause	Sending the data from controller failed because the receiving prohibition status of the external device continued for 10 or more seconds.
Action	<ul style="list-style-type: none"> • Replace the communications cable. • Check that the flow control is normal in software processing for the external device.

14.220 : Too many Command characters

Code : &H000E &H00DC

Meaning/Cause	a. The online command character string in 1 line exceeded 255 characters. b. The command statement created with a remote command exceeded 255 characters.
Action	a. Limit the number of characters in 1 line for an online command to 255 or less. b. Check the command data of the remote command.

14.221 : No return code(C/R)

Code : &H000E &H00DD

Meaning/Cause	a. The character string in 1 line exceeded 255 characters. b. C/R code (0Dh) was not added at the end of a single line.
Action	a. Limit the number of characters in 1 line to 255. b. Add a C/R code (0Dh) at the end of a single line.

14.222 : No start code (@)

Code : &H000E &H00DE

Meaning/Cause	Starting code "@" is not added at beginning of a single line in the online command.
Action	Add starting code "@" at the beginning of the online command.

14.228 : Illegal port type

Code : &H000E &H00E4

Meaning/Cause	The communication port is not specified.
Action	Contact your distributor.

14.229 : Command stop timeout

Code : &H000E &H00E5

Meaning/Cause	Timeout occurred during sending/receiving through the communication port.
Action	<ul style="list-style-type: none"> • Check the communication port settings. • Check the communication cable connection.

14.230 : Port is already open

Code : &H000E &H00E6

Meaning/Cause	The communication port is open.
Action	Check if the communication port has already been opened.

14.231 : Port open failed

Code : &H000E &H00E7

Meaning/Cause	Opening the communication port failed.
Action	<ul style="list-style-type: none"> • Check the communication port settings. • Check the communication cable. • Check if the communication port has already been opened.

14.233 : Parameter error

Code : &H000E &H00E9

Meaning/Cause	The parameter exceeded the range that can be input.
Action	Set the parameters within the range.

14.400 : Communicate disconnected

Code : &H000E &H0190

Meaning/Cause	<ul style="list-style-type: none"> a. Error occurred on the external communication. b. Overrun error or framing error occurred. c. External device power was turned on/off with connecting to the external device by the communication cable.
Action	<ul style="list-style-type: none"> • Prevent putting noise generation source close to the robot so as to improve the communication environment. • Check the connection of the communication cable. • Replace the communication cable. • Check the communication parameter settings.

14.441 : EtherNet link error

Code : &H000C &H01B9

Meaning/Cause	Error occurred on the EtherNet option board.
Action	Contact your distributor.

14.500 : Data send error

Code : &H000E &H0190

Meaning/Cause	Error occurred on the external communication by RS-232C during sending.
Action	Check the communication parameter settings.

14.501 : Data receive error

Code : &H000E &H01F5

Meaning/Cause	Error occurred on the external communication by RS-232C during receiving.
Action	Check the communication parameter settings.

14.502 : Framing error

Code : &H000E &H01F6

Meaning/Cause	Error occurred on the external communication by RS-232C.
Action	Check the communication parameter settings.

14.503 : Parity error

Code : &H000E &H01F7

Meaning/Cause	Error occurred on the external communication by RS-232C.
Action	Check the communication parameter settings.

14.504 : Over run error

Code : &H000E &H01F8

Meaning/Cause	Error occurred on the external communication by RS-232C.
Action	Check the communication parameter settings.

14.505 : Break

Code : &H000E &H01F9

Meaning/Cause	Error occurred in external communication by RS-232C.
Action	Check the communication parameter settings.

14.700 : Can't be initialized

Code : &H000E &H02BC

Meaning/Cause	Initializing the communication port failed.
Action	Check the communication port settings.

[17] Alarm related to the motor control**17.400 : PZ failure**

Code : &H0011 &H0190

Meaning/Cause	a. The motor is defective. b. The resolver signal wire is broken.
Action	a. Replace the motor. b. Replace the ROB I/O cable.

17.401 : Pole search error

Code : &H0011 &H0191

Meaning/Cause	The motor magnetic pole was not detected when the servo was turned on. a. The servo wire is broken or incorrectly connected. b. The position sensor cable is incorrectly wired. c. Axis parameter settings related to motor control is incorrect.
Action	a. Check the connection of the servo wire. b. Check the connection of the position sensor cable. c. Set the parameter setting correctly.

17.402 : ABS. data error

Code : &H0011 &H0192

Meaning/Cause	a. The linear scale length setting is incorrect. b. Z-phase was detected incorrectly.
Action	a. Set the correct value for the linear scale length. b-1. Replace the ROB/IO cable. b-2. Replace the robot.

17.403 : Position reset malposition

Code : &H0011 &H0193

Meaning/Cause	a. "ABSINIT" statement was executed at a position where the current position cannot be reset. b. Absolute reset was executed at a position where it cannot be executed.
Action	a. Move to a position where the current position can be reset, and then execute the "ABSINIT" statement. b. Move the axis to a position (machine reference is 44 to 56%) where the absolute reset can be executed.

17.404 : Moving distance error

Code : &H0011 &H0194

Meaning/Cause	The movement distance exceeded the specified value by return-to-origin.
Action	Re-perform the system generation.

17.410 : ABS. battery error

Code : &H0011 &H019A

Meaning/Cause	During the controller power-off... a. The absolute battery cable is breakdown. b. The absolute battery cable is not connected. c. The absolute battery voltage has dropped.
Action	This alarm occurs every time the power is turned on until the absolute reset is completed. a. Replace the absolute battery. b. Connect the absolute battery. c. Set the "Incremental mode control" parameter to "VALID" for use in incremental mode.

17.411 : ABS. encoder error

Code : &H0011 &H019B

Meaning/Cause	<ul style="list-style-type: none"> • Resolver signal line was disconnected or breakdown during the controller power-off. (Same as when ROB I/O connector is removed.) • The controller was restarted after the resolver signal line had been disconnected during power-on. (Same as when ROB I/O connector is removed.) Even after turning off the power, the controller still memorizes the disconnection and this is displayed as an error when the controller is restarted.
Action	Perform absolute reset.

17.412 : ABS. count error

Code : &H0011 &H019C

Meaning/Cause	The movement speed is too high during the controller power-off.
Action	Perform absolute reset.

17.413 : ABS. overflow error

Code : &H0011 &H019D

Meaning/Cause	The number of motor rotation exceeded 4096 during the controller power-off.
Action	<ul style="list-style-type: none"> • Do not rotate motor more than necessary during the controller power-off. • Perform absolute reset.

17.414 : ABS. mixing error 1

Code : &H0011 &H019E

Meaning/Cause	The position data count is inconsistent. (The electrical resolver position data deviated from the mechanical during the controller power-off.)
Action	Perform absolute reset.

17.500 : Origin sensor failure

Code : &H0011 &H01F4

Meaning/Cause	<ul style="list-style-type: none"> a. The origin sensor is defective. b. The origin sensor wiring is breakdown.
Action	<ul style="list-style-type: none"> a. Replace the origin sensor. b. Replace the ROB I/O cable.

17.800 : Motor overload

Code : &H0011 &H0320

Meaning/Cause	<ul style="list-style-type: none"> a. The robot drive section mechanically locked. b. The motor current exceeded its rated value due to a motor overload. c. The motor acceleration is excessive. d. The system generation setting is incorrect. e. The motor cable wiring is broken or wiring is incorrect. f. The vertical axes electromagnetic brake is defective. g. Wiring is incorrect or disconnected on the vertical axes electromagnetic brake. h. The SAFETY connector is not used correctly.
Action	<ul style="list-style-type: none"> a. Perform robot service and maintenance. b. Decrease the load on motor. c. Lower the motor acceleration. d. Redo the system generation. e-1. Wire the motor cable correctly. e-2. Replace the motor cable. f. Replace the vertical axes electromagnetic brake. g. Replace the ROB I/O cable. h. Do not use 24 V DC from the SAFETY connector as power source for external loads.

17.801 : Driver overload

Code : &H0011 &H0321

Meaning/Cause	<ul style="list-style-type: none"> a. The robot drive section mechanically locked. b. The motor current exceeded its rated value due to a motor overload. c. The motor acceleration is excessive. d. The system generation setting is incorrect. e. The motor cable wiring is broken or wiring is incorrect. f. The vertical axes electromagnetic brake is defective. g. Wiring is incorrect or disconnected on the vertical axes electromagnetic brake. h. The SAFETY connector is not used correctly.
Action	<ul style="list-style-type: none"> a. Perform robot service and maintenance. b. Decrease the load on motor. c. Lower the motor acceleration. d. Redo the system generation. e-1. Wire the motor cable correctly. e-2. Replace the motor cable. f. Replace the vertical axes electromagnetic brake. g. Replace the ROB I/O cable. h. Do not use 24 V DC from the SAFETY connector as power source for external loads.

17.802 : Current limit error

Code : &H0011 &H0322

Meaning/Cause	<ul style="list-style-type: none"> a. The robot drive section mechanically locked. b. The system generation setting is wrong. c. The motor cable wiring is broken or wiring is incorrect. d. The vertical axes electromagnetic brake is defective. e. Wiring is incorrect or disconnected on the vertical axes electromagnetic brake. f. The SAFETY connector is not used correctly.
Action	<ul style="list-style-type: none"> a. Perform robot service and maintenance. b. Redo the system generation. c-1. Wire the motor cable correctly. c-2. Replace the motor cable. d. Replace the vertical axes electromagnetic brake. e. Replace the ROB I/O cable. f. Do not use 24 V DC from the SAFETY connector as power source for external loads.

17.900 : AC power down

Code : &H0011 &H0384

Meaning/Cause	<ul style="list-style-type: none"> a. AC supply voltage of control power supply dropped below 85% of rated voltage. b. The power source has insufficient capacity.
Action	<ul style="list-style-type: none"> a-1. Check the AC supply voltage. a-2, b-1. Check if the supply voltage drops during robot operation. b-2. Lower the robot duty cycle.

17.901 : Over voltage

Code : &H0011 &H0385

Meaning/Cause	<ul style="list-style-type: none"> a. Output voltage for motor power supply exceeded 420 V. b. The regenerative unit safety device was triggered due to temperature rise (120 °C or more) in regeneration damping resistor. c. The regenerative unit is defective. d. The SAFETY connector is used incorrectly.
Action	<ul style="list-style-type: none"> a, b-1. Check the power supply voltage. b-2, c. Lower the robot duty cycle. d. Do not supply 24 V DC to the SAFETY connector from external source.

17.902 : IPM error

Code : &H0011 &H0386

Meaning/Cause	<ul style="list-style-type: none"> • The power module overheated. • The power module or motor drew excessive current.
Action	Lighten the load on the robot.

17.905 : Resolver wire breakage

Code : &H0011 &H0389

Meaning/Cause	a. The resolver signal wire is broken. b. The motor malfunction occurred. c. The controller malfunction occurred.
Action	a. Replace the ROB I/O cable. b. Replace the motor. c. Replace the controller.

17.906 : ABS. mixing error 2

Code : &H0011 &H038A

Meaning/Cause	The position data count is not consistent while the controller power is on.
Action	• Replace the ROB/IO cable. • Replace the controller.

17.910 : Position deviation error

Code : &H0011 &H038E

Meaning/Cause	a. The robot drive section mechanically locked. b. The motor acceleration is excessive. c. The system generation setting is incorrect. d. The motor cable wiring is broken or wiring is incorrect. e. The vertical axes electromagnetic brake is defective. f. Wiring is incorrect or disconnected on the vertical axes electromagnetic brake. g. The SAFETY connector is not used correctly.
Action	a. Perform robot service and maintenance. b. Lower the motor acceleration. c. Redo the system generation. d-1. Wire the motor cable correctly. d-2. Replace the motor cable. e. Replace the vertical axes electromagnetic brake. f. Replace the ROB I/O cable. g. Do not use 24 V DC from the SAFETY connector as power source for external loads.

17.911 : Velocity deviation error

Code : &H0011 &H038F

Meaning/Cause	a. The robot drive section mechanically locked. b. The motor acceleration is excessive. c. The system generation setting is incorrect. d. The motor cable wiring is broken or wiring is incorrect. e. The vertical axes electromagnetic brake is defective. f. Wiring is incorrect or disconnected on the vertical axes electromagnetic brake.
Action	a. Perform robot service and maintenance. b. Lower the motor acceleration. c. Redo the system generation. d-1. Wire the motor cable correctly. d-2. Replace the motor cable. e. Replace the vertical axes electromagnetic brake. f. Replace the ROB I/O cable.

17.912 : Current deviation error

Code : &H0011 &H0390

Meaning/Cause	a. The motor cable wiring was broken. b. The controller was defective.
Action	a. Replace the motor cable. b. Replace the controller.

17.913 : Dual position deviation error

Code : &H0011 &H0391

Meaning/Cause	On a dual-drive axis, the position differential between the main axis and sub axis is too large. a. Friction in the robot drive section is too large. b. The motor brake wiring is broken.
Action	a. Check the drive sections for assembled condition and lubrication to ensure smooth movement. b. Check that the motor brake works properly.

17.914 : Overspeed

Code : &H0011 &H0392

Meaning/Cause	a. The robot drive unit was pushed by external force and its speed exceeded the specified value. b. The system generation setting is incorrect.
Action	a. Remove the external force. b. Re-perform the system generation.

17.915 : Motor over current

Code : &H0011 &H0393

Meaning/Cause	a. The robot drive section mechanically locked. b. The motor current exceeded its rated value due to a motor overload. c. The motor acceleration is excessive. d. The system generation setting is incorrect. e. The motor cable wiring is broken or wiring is incorrect. f. The vertical axes electromagnetic brake is defective. g. Wiring is incorrect or disconnected on the vertical axes electromagnetic brake. h. The SAFETY connector is not used correctly.
Action	a. Perform robot service and maintenance. b. Decrease load on motor. c. Lower the motor acceleration. d. Redo the system generation. e-1. Wire the motor cable correctly. e-2. Replace the motor cable. f. Replace the vertical axes electromagnetic brake. g. Replace the ROB I/O cable. h. Do not use 24 V DC from the SAFETY connector as power source for external loads.

17.916 : Feedback error1

Code : &H0011 &H0394

Meaning/Cause	Wiring of the motor cable or ROB I/O cable is incorrect.
Action	• Rewire the motor cable or ROB I/O cable correctly. • Replace the motor cable or ROB I/O cable.

17.920 : EMG. stop Input error

Code : &H0011 &H0398

Meaning/Cause	a. The driver unit malfunctioned by external noise. b. The controller is defective.
Action	a. Turn the power off and then on again. b. Contact your distributor.

17.921 : Reference velocity error

Code : &H0011 &H0399

Meaning/Cause	a. The driver unit malfunctioned by external noise. b. The controller is defective.
Action	a. Turn the power off and then on again. b. Contact your distributor.

17.922 : Command error

Code : &H0011 &H039A

Meaning/Cause	a. The driver unit malfunctioned by external noise. b. The controller is defective.
Action	a. Turn the power off and then on again. b. Contact your distributor.

17.923 : Parameter data error

Code : &H0011 &H039B

Meaning/Cause	a. The driver unit malfunctioned by external noise. b. The controller is defective.
Action	a. Turn the power off and then on again. b. Contact your distributor.

17.990 : Watchdog error 1

Code : &H0011 &H03DE

Meaning/Cause	a. The driver unit malfunctioned by external noise. b. The controller is defective.
Action	a. Turn the power off and then on again. b. Contact your distributor.

17.991 : Watchdog error 2

Code : &H0011 &H03DF

Meaning/Cause	a. The driver unit malfunctioned by external noise. b. The controller is defective.
Action	a. Turn the power off and then on again. b. Contact your distributor.

17.992 : System error 1

Code : &H0011 &H03E0

Meaning/Cause	Error occurred in software for driver unit.
Action	Contact your distributor.

17.993 : System error 2

Code : &H0011 &H03E1

Meaning/Cause	Error occurred in software for driver unit.
Action	Contact your distributor.

17.994 : System error 3

Code : &H0011 &H03E2

Meaning/Cause	Error occurred in software for driver unit.
Action	Contact your distributor.

17.995 : System error 4

Code : &H0011 &H03E3

Meaning/Cause	Error occurred in software for driver unit.
Action	Contact your distributor.

17.996 : Mode error 1

Code : &H0011 &H03E4

Meaning/Cause	Error occurred in software for driver unit.
Action	Contact your distributor.

17.997 : Mode error 2

Code : &H0011 &H03E5

Meaning/Cause	Error occurred in software for driver unit.
Action	Contact your distributor.

17.999 : Undefined

Code : &H0011 &H03E7

Meaning/Cause	Undefined system error.
Action	Contact your distributor.

[19] Alarm related to the YC-Link/E**19.400 : YC/E slave connecting retry**

Code : &H0013 &H0190

Meaning/Cause	The YC-Link/E slave is retrying the connection establishment with the master.
Action	Please wait while retrying the connection.

19.500 : YC/E master port open fail

Code : &H0013 &H01F4

Meaning/Cause	The communication port of the YC-Link/E master board does not open within a certain period of time (about 20 seconds).
Action	<ul style="list-style-type: none"> • Check that the master and slave are connected with the cables. • Check the slave power is turned on.

19.501 : YC/E communicate initialize fail

Code : &H0013 &H01F5

Meaning/Cause	The communication failed in the initialization process of the YC-Link/E connection.
Action	<ul style="list-style-type: none"> • Restart the controller. • Take noise preventive measures. • Replace the slave option board.

19.502 : YC/E slave port wrong

Code : &H0013 &H01F6

Meaning/Cause	The IN port and OUT port of the YC-Link/E slave are used incorrectly.
Action	<ul style="list-style-type: none"> • Check the connection. • Reconnect the cable into the correct port.

19.800 : YC/E send data checksum error

Code : &H0013 &H0320

Meaning/Cause	The checksum error occurred in the data sent from the YC-Link/E master.
Action	<ul style="list-style-type: none"> • Check the cable connection. • Replace the cable. • Take noise preventive measures. • Replace the controller.

19.801 : YC/E receive data checksum error

Code : &H0013 &H0321

Meaning/Cause	The checksum error occurred in the data received by the YC-Link/E master (Host check).
Action	<ul style="list-style-type: none"> • Check the cable connection. • Replace the cable. • Take noise preventive measures. • Replace the controller.

19.802 : YC/E working counter error

Code : &H0013 &H0322

Meaning/Cause	<ul style="list-style-type: none"> a. The YC-Link/E master could not send the data correctly. b. The slave could not receive the data correctly.
Action	<ul style="list-style-type: none"> • Check the cable connection. • Replace the cable. • Replace the master board and slave board.

19.805 : YC/E master receive checksum error

Code : &H0013 &H0325

Meaning/Cause	The checksum error occurred in the data received by the YC-Link/E master. (Master check)
Action	<ul style="list-style-type: none"> • Check the cable connection. • Replace the cable. • Take noise preventive measures. • Replace the controller.

19.900 : YC/E master board watchdog error

Code : &H0013 &H0384

Meaning/Cause	The data was not sent from the master board of the YC-Link/E for a certain period of time.
Action	<ul style="list-style-type: none"> • Check the LAN cable for disconnection. • Take noise preventive measures. • Replace the master board.

19.901 : YC/E master interrupt fail

Code : &H0013 &H0385

Meaning/Cause	The master board of the YC-Link/E could not receive the data from the HOST CPU for a certain period of time.
Action	<ul style="list-style-type: none"> • Check the LAN cable for disconnection. • Take noise preventive measures. • Replace the master board.

19.902 : YC/E master data send fail

Code : &H0013 &H0386

Meaning/Cause	The master board of the YC-Link/E could not send the data for a certain period of time.
Action	<ul style="list-style-type: none"> • Check the LAN cable for disconnection. • Take noise preventive measures. • Replace the master board.

19.903 : YC/E master data receive fail

Code : &H0013 &H0387

Meaning/Cause	The return of the data packet sent from the master board of the YC-Link/E could not be received for a certain period of time.
Action	<ul style="list-style-type: none"> • Check the LAN cable for disconnection. • Take noise preventive measures. • Replace the master board.

19.904 : YC/E master send data destroy

Code : &H0013 &H0388

Meaning/Cause	The return of the data packet sent from the master board of the YC-Link/E was different from its sent status.
Action	<ul style="list-style-type: none"> • Take noise preventive measures. • Replace the master board.

19.905 : YC/E master receive data destroy

Code : &H0013 &H0389

Meaning/Cause	The format of the data received by the master board of the YC-Link/E was faulty.
Action	<ul style="list-style-type: none"> • Take noise preventive measures. • Replace the master board.

19.906 : YC/E invalid slave exist

Code : &H0013 &H038A

Meaning/Cause	Slave that cannot be used exists in the slaves of the YC-Link/E.
Action	Remove the inapplicable slave.

19.907 : YC/E slave unconformity

Code : &H0013 &H038B

Meaning/Cause	The controller mode setting on the master controller of the YC-Link/E is different from that on the slave controller.
Action	Replace the controller.

19.908 : YC/E slave config mismatch

Code : &H0013 &H038C

Meaning/Cause	The number of controllers set in the master of the YC-Link/E is different from the number of actually connected controllers.
Action	Change the parameter setting or turn off the power, and turn it on again after matching the number of slaves to the setting.

19.909 : YC/E slave power low

Code : &H0013 &H038D

Meaning/Cause	The control power voltage of the YC-Link/E slave dropped.
Action	Check the power supply of the slave, and turn off both the master and slave, and turn them on again.

19.910 : YC/E system power turn on again

Code : &H0013 &H038E

Meaning/Cause	The slave of the YC-Link/E does not communicate. Only the master might be turned off, and then it might be turned on again.
Action	Turn off all the controllers that are connected with the YC-Link/E, and turn them on again.

19.920 : YC/E master slave loose connection

Code : &H0013 &H0398

Meaning/Cause	The connection between the master and slave of the YC-Link/E has broken.
Action	<ul style="list-style-type: none"> • Check the cable connection. • Replace the cable. • Take noise preventive measures. • Replace the controller.

19.993 : YC/E master fatal error

Code : &H0013 &H03E1

Meaning/Cause	An unknown error occurred in the YC-Link/E.
Action	Contact your distributor.

[21] Serious alarm related to software**21.900 : System error (EXCEPTION)**

Code : &H0015 &H0384

Meaning/Cause	Software error occurred.
Action	Contact your distributor.

21.903 : System error (TaskID)

Code : &H0015 &H0387

Meaning/Cause	Software error occurred.
Action	Contact your distributor.

21.912 : System error (RTOS)

Code : &H0015 &H0390

Meaning/Cause	Software error occurred.
Action	Contact your distributor.

21.915 : System error (NULL access)

Code : &H0015 &H0393

Meaning/Cause	Software error occurred.
Action	Contact your distributor.

21.999 : System error (UNDEFINED)

Code : &H0015 &H03E7

Meaning/Cause	Software error occurred.
Action	Contact your distributor.

[22] Serious alarm related to hardware

22.504 : Abnormal drop in voltage

Code : &H0016 &H01F8

Meaning/Cause	a. Output voltage for motor power supply dropped below 140V. b. Power supply has insufficient capacity. c. The vertical axes electromagnetic brake is defective. d. The SAFETY connector is used incorrectly.
Action	a. Check the power supply voltage. b-1. Check if supply voltage drops during robot operation. b-2. Lower the robot duty cycle. c. Replace the vertical axes electromagnetic brake. d-1. Do not supply 24 V DC to the SAFETY connector from external source. d-2. Do not use 24 V DC from the SAFETY connector as power source for driving external loads.

22.507 : Driver over heat

Code : &H0016 &H01FB

Meaning/Cause	The driver unit temperature increased to approximately 60 °C or more.
Action	<ul style="list-style-type: none">• Improve the installation environment.• Check that the cooling fan operates correctly.• Replace or clean the cooling fan filter.• Decrease the robot duty cycle to reduce the amount of heat generated.• Replace the controller.

22.508 : Regen. over heat

Code : &H0016 &H01FC

Meaning/Cause	The regenerative unit heated up abnormally.
Action	<ul style="list-style-type: none">• Improve the installation environment.• Check that the cooling fan operates correctly.• Replace or clean the cooling fan filter.• Decrease the robot duty cycle to reduce the amount of heat generated.• Replace the controller.

22.509 : Internal 24V power abnormal

Code : &H0016 &H01FD

Meaning/Cause	Internal 24V-power voltage dropped. a. The SAFETY connector wiring was incorrect. b. The brake cable was short-circuited. c. The controller malfunctioned.
Action	a. Perform the wiring of the SAFETY connector correctly. b. Replace the robot cable. c. Replace the controller.

22.511 : Fan stop error

Code : &H0016 &H01FF

Meaning/Cause	Power was not supplied to the controller cooling fan. a. The controller cooling fan cable wiring was broken. b. ROB I/O cable was short-circuited. c. The controller malfunctioned. d. Error occurred in the controller cooling fan. e. The controller cooling fan malfunctioned.
Action	a. Replace the controller cooling fan cable. b. Replace the ROB/IO cable. c. Replace the controller. d, e. Replace the controller cooling fan.

22.516 : Controller over heat

Code : &H0016 &H0204

Meaning/Cause	The environmental temperature inside the controller increased to approximately 60 °C or more.
Action	<ul style="list-style-type: none"> • Improve the installation environment. • Check that the cooling fan operates correctly. • Replace the controller.

22.600 : Motor power off

Code : &H0016 &H0258

Meaning/Cause	The main power voltage dropped in the servo on or servo off status.
Action	Check that the main power is input.

22.800 : Control power off

Code : &H0016 &H0320

Meaning/Cause	<ol style="list-style-type: none"> a. The AC supply voltage of control power supply dropped below 85% of rated voltage. b. The power source has insufficient capacity.
Action	<ol style="list-style-type: none"> a-1. Check the AC supply voltage. a-2. Check if supply voltage drops during robot operation. b. Lower the robot duty cycle.

**CAUTION**

This error always occurs when the power is cut off.

22.807 : Driver over heat

Code : &H0016 &H0327

Meaning/Cause	The driver unit temperature increased to approximately 60 °C or more.
Action	<ul style="list-style-type: none"> • Improve the installation environment. • Check that the cooling fan operates correctly. • Replace or clean the cooling fan filter. • Decrease the robot duty cycle to reduce the amount of heat generated. • Replace the controller.

22.808 : Regen. over heat

Code : &H0016 &H0328

Meaning/Cause	The regenerative unit heated up abnormally.
Action	<ul style="list-style-type: none"> • Improve the installation environment. • Check that the cooling fan operates correctly. • Replace or clean the cooling fan filter. • Decrease the robot duty cycle to reduce the amount of heat generated. • Replace the controller.

22.816 : Controller over heat

Code : &H0016 &H0330

Meaning/Cause	The environmental temperature inside the controller increased to approximately 60 °C or more.
Action	<ul style="list-style-type: none"> • Improve the installation environment. • Check that the cooling fan operates correctly. • Replace the controller.

22.901 : CT type mismatch

Code : &H0016 &H0385

Meaning/Cause	The correct current sensor controller is not used for the set robot.
Action	Replace the current sensor controller with a correct one.

22.902 : Position sensor type mismatch

Code : &H0016 &H0386

Meaning/Cause	The correct position sensor is not set for the set robot correctly.
Action	Contact your distributor.

22.903 : Driver unit disconnected

Code : &H0016 &H0387

Meaning/Cause	The CPU unit did not recognize the driver unit.
Action	Replace the controller.

22.904 : Driver2 board disconnected

Code : &H0016 &H0388

Meaning/Cause	The CPU unit did not recognize the driver 2 board.
Action	Replace the controller.

22.905 : Abnormal over voltage

Code : &H0016 &H0389

Meaning/Cause	<ul style="list-style-type: none"> a. Output voltage for motor power supply exceeded 420 V. b. The regenerative unit safety device triggered due to temperature rise in regeneration damping resistor. c. The regenerative unit is defective. d. The SAFETY connector is used incorrectly.
Action	<ul style="list-style-type: none"> • Check the power supply voltage. • Lower the robot duty cycle. • Do not supply 24 V DC to the SAFETY connector from external source.

22.906 : Break 24V power abnormal

Code : &H0016 &H038A

Meaning/Cause	<ul style="list-style-type: none"> The brake power voltage dropped. a. Power was not supplied to BK 24 V. b. Brake cable was short-circuited. c. Controller malfunctioned.
Action	<ul style="list-style-type: none"> a. Supply the brake power. b. Replace the robot cable. c. Replace the controller.

[26] Alarm related to the gripper**26.97 : Undefined gripper type number**

Code : &H001A &H0061

Meaning/Cause	The specified type number gripper does not exist.
Action	Input the correct gripper number.

26.98 : Gripper overlap assign

Code : &H001A &H0062

Meaning/Cause	a. A different gripper in an option slot for which generation settings were already made was registered. b. A different option slot to a gripper for which generation settings were already made was assigned.
Action	a. Change the option slot number. b. Stop making gripper settings.

26.99 : Gripper undefined error

Code : &H001A &H0063

Meaning/Cause	Undefined error was detected on the gripper control board.
Action	Contact your distributor.

26.332 : Gripper soft limit over

Code : &H001A &H014C

Meaning/Cause	The operating position exceeds the software limit value specified by the parameter.
Action	<ul style="list-style-type: none"> • Change the operating position to be within the software limit. • Change the software limit value. • Change the limit width.

26.336 : Gripper servo off

Code : &H001A &H0150

Meaning/Cause	A movement command was executed in the servo OFF status.
Action	Turn the servo ON.

26.337 : Gripper stop signal on

Code : &H001A &H0151

Meaning/Cause	It was attempted to execute the program or move the gripper while the gripper's stop signal was ON.
Action	Contact your distributor.

26.350 : Gripper data error

Code : &H001A &H015E

Meaning/Cause	Option data such as a movement command sent to the gripper control board exceeds the input range.
Action	Contact your distributor.

26.351 : Gripper type error

Code : &H001A &H015F

Meaning/Cause	The gripper generation is set using an undefined type number.
Action	Contact your distributor.

26.395 : Gripper type isn't assigned

Code : &H001A &H018B

Meaning/Cause	The gripper type number is not assigned.
Action	Use system generation settings to assign the gripper type number.

26.396 : Gripper cannot get error

Code : &H001A &H018C

Meaning/Cause	Obtaining an error generated by the gripper itself failed.
Action	Contact your distributor.

26.397 : Gripper disconnected

Code : &H001A &H018D

Meaning/Cause	a. The specified gripper is not connected. b. Generation is incomplete for the specified gripper.
Action	a. Connect the gripper. b. Make gripper settings.

26.398 : Illegal gripper no

Code : &H001A &H018E

Meaning/Cause	A gripper number outside the range from 1 to 4 was specified.
Action	Specify a gripper number between 1 and 4.

26.399 : Gripper timeout error

Code : &H001A &H018F

Meaning/Cause	Execution of a command sent to the gripper control board ended in timeout.
Action	Contact your distributor.

26.435 : Gripper origin incomplete

Code : &H001A &H01B3

Meaning/Cause	Return-to-origin has not been performed.
Action	Perform return-to-origin so that the gripper is in the return-to-origin complete status.

26.604 : Gripper 24V power supply voltage low

Code : &H001A &H025C

Meaning/Cause	The 24 V DC power supply voltage is less than 80% of the rated value.
Action	Check the power supply capacity, and if it is insufficient, adjust the power supply voltage to be within the rated range.

26.608 : Gripper 24V power off

Code : &H001A &H0260

Meaning/Cause	a. The 24 V DC power supply is not wired. b. The 24 V DC power supply is not being provided. c. The 24 V DC power supply cable is disconnected.
Action	a. Check the wiring of the 24 V DC power supply. b. Check the 24 V DC power supply. c. Check the 24 V DC power supply cable.

26.612 : Gripper over voltage

Code : &H001A &H0264

Meaning/Cause	The 24 V DC power supply voltage is greater than 130% of the rated value. a. Power supply voltage increased due to regeneration b. The DC24V power supply voltage is incorrect.
Action	a. Decrease the duty of the mechanism. b. Check the 24 V DC power supply voltage and adjust it to be within the rated range.

26.801 : Gripper over load

Code : &H001A &H0321

Meaning/Cause	Motor overload a. Motor is defective. b. Parameters are incorrect. c. Power supply line capacity is insufficient. d. Excessive friction within the mechanism itself.
Action	a. If there are problems such as excessively heavy motion when moving the motor manually, replace the motor. b. Initialize the parameters. c. Check the power supply capacity, and if it is insufficient, adjust the power supply voltage to be within the rated range. d. Check the moving parts of the mechanism for heavy motion. If motion is excessively heavy, make readjustments.

26.802 : Gripper over current

Code : &H001A &H0322

Meaning/Cause	Motor over current a. Motor wiring is shorted. b. Gripper control board is defective. c. Parameters are incorrect.
Action	a. Test the conductivity of the motor wiring, and if a fault is found, replace the motor. b. Replace the gripper control board. c. Initialize the parameters.

26.803 : Gripper machine reference over

Code : &H001A &H0323

Meaning/Cause	The encoder Z-phase position deviated from the initial value stored in the controller. • The gripper main body was replaced. • A finger was replaced with the origin set to the close side. • The CPU board of the controller was replaced. • The CPU software version of the controller was changed. • An obstacle was struck while returning to the origin point. • The encoder Z-phase has broken or has malfunctioned. • The gripper drive section or transmission section has malfunctioned.
Action	• Perform return-to-origin again. • Remove the obstacle and perform return-to-origin again. • Replace the gripper main body.

26.806 : Gripper position deviation error

Code : &H001A &H0326

Meaning/Cause	a. Mechanical lock occurred in the gripper drive section. b. Motor cable is broken or wired incorrectly. c. Parameters are incorrect.
Action	a. Check the gripper drive section for mechanical lock. b. Check the motor cable and encoder cable connections. c. Initialize the parameters.

26.807 : Gripper internal fault

Code : &H001A &H0327

Meaning/Cause	Error occurred within the gripper control board.
Action	Contact your distributor.

26.809 : Gripper watchdog error

Code : &H001A &H0329

Meaning/Cause	The software input a runaway state due to external noise.
Action	Contact your distributor.

26.810 : Gripper feedback error 1

Code : &H001A &H032A

Meaning/Cause	a. External force caused the finger to overrun the software limit. b. External noise caused the encoder to miscount.
Action	a. Turn on the power and check that no external force is applied to the finger, and perform return-to-origin. b. Contact your distributor.

26.811 : Gripper encoder wire breakage

Code : &H001A &H032B

Meaning/Cause	a. The encoder cable is disconnected. b. The guide block is locked.
Action	a. Check the encoder cable connection. b. Unlock the guide block.

26.814 : Gripper current deviation error

Code : &H001A &H032E

Meaning/Cause	The motor cable is broken or wired incorrectly.
Action	Check the motor cable connection.

26.899 : Gripper parameter send fail

Code : &H001A &H0383

Meaning/Cause	Sending the gripper parameter to the gripper control board failed.
Action	Contact your distributor.

[28] Alarm related to the driver I/F**28.900 : Driver version mismatch**

Code : &H001C &H0384

Meaning/Cause	The software version of the driver unit was not appropriate.
Action	Update the software version of the driver unit.

28.902 : DMA transfer timeout

Code : &H001C &H0386

Meaning/Cause	Time-out occurred in the communication process between the CPU unit and driver unit.
Action	Contact your distributor.

28.903 : Driver interrupt timeout

Code : &H001C &H0387

Meaning/Cause	Time-out occurred in the communication process between the CPU unit and driver unit.
Action	Contact your distributor.

28.904 : RTOS fail

Code : &H001C &H0388

Meaning/Cause	Software error occurred.
Action	Contact your distributor.

28.905 : Send checksum fail

Code : &H001C &H0389

Meaning/Cause	The driver unit received abnormal data.
Action	Contact your distributor.

28.906 : Receive checksum fail

Code : &H001C &H038A

Meaning/Cause	The CPU unit received abnormal data.
Action	Contact your distributor.

28.999 : Driver I/F undefined error

Code : &H001C &H03E7

Meaning/Cause	Undefined errors were detected in the communication process between the CPU unit and driver unit.
Action	Contact your distributor.

5. Warning number

The 7-segment LED on the front of the controller displays “C+ warning number” for 2 seconds when a warning occurs. After that, warning numbers and normal display are displayed alternately at 1-second intervals.

Warning number	Type	Axis operation in case of error	History	LED display	Reset method	Example
c1 to c99	General warning	-	-	Warning ↔ Status	Remove the warning cause.	Overload warning

[Warning meaning display format]

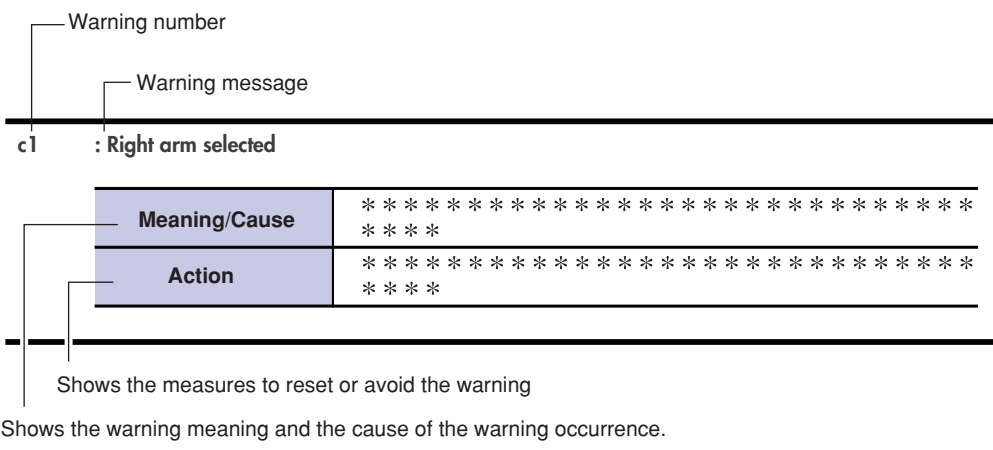

[c] Warning

c1 : Right arm selected

Meaning/Cause	On SCARA type robots, the arm uses the right-handed system for starting interpolation movement.
Action	<ul style="list-style-type: none"> • Stop the axis immediately when the robot moves unexpectedly. • Operate carefully when the robot moves as expected.

c2 : Left arm selected

Meaning/Cause	On SCARA type robots, the arm uses the left-handed system for starting interpolation movement.
Action	<ul style="list-style-type: none"> • Stop the axis immediately when the robot moves unexpectedly. • Operate carefully when the robot moves as expected.

c3 : Jogging speed limited

Meaning/Cause	The speed is limited since the robot is within the jogging speed limited range.
Action	The speed limit is released if the robot goes out the range.

c50 : Memory backup battery low

Meaning/Cause	The memory battery voltage dropped.
Action	Replace the memory battery.

c70 : Motor overload

Meaning/Cause	The motor was overloaded. Alarm might occur.
Action	Reduce the load to the motor.

c71 : Driver overload

Meaning/Cause	The driver was overloaded. Alarm might occur.
Action	Reduce the load to the driver.

c72 : Motor over current

Meaning/Cause	The motor drew excessive current. Alarm might occur.
Action	Reduce the load to the motor.

c73 : Absolute battery low voltage

Meaning/Cause	The ABS battery voltage was 3.1 V or less.
Action	Replace the ABS battery.

6. Alarm messages related to the programming box

If a hardware or software error occurs in the programming box, relevant message appears on the screen.

NO PANEL DATA

Meaning/Cause: Screen data could not be downloaded during upgrading.

Action: Perform the upgrading again.

Receiving Error.

Meaning/Cause: Error occurred during data receiving.

Specified communication was not performed within the specified period of time.

Action: Check the communication cable for abnormality.

Check that the connector is inserted correctly.

Sending Error.

Meaning/Cause: Error occurred during data sending.

CTS signal did not turn on for 5 seconds during data sending.

Action: Check the communication cable for abnormality.

Check that the connector is inserted correctly.

Receiving timeout.

Meaning/Cause: Error occurred during data receiving.

Specified communication was not performed within the specified period of time.

Action: Check the communication cable for abnormality.

Check that the connector is inserted correctly.

NG=xx.xxx

Meaning/Cause: Alarm occurred in the controller.

Action: Check the alarm contents and perform the alarm reset.

No breakpoint set.

Meaning/Cause: Break point was not set in the program debug.

Action: Set a break point.

USB IO ERROR

Meaning/Cause: USB memory device was not supported.

Action: Replace the USB memory device with a correct one.

USB Not Connect

Meaning/Cause: USB memory device was not connected or a device other than the USB memory device was connected.

Action: Connect the USB memory device correctly.

Bad Format

Meaning/Cause: Format of the USB memory device was incorrect.

Action: Change the format of the USB memory device to FAT16 or FAT32.

Not FAT16 Format

Meaning/Cause: Format of the USB memory device was NTFS.

Action: Change the format of the USB memory device to FAT16 or FAT32.

Revision history

A manual revision code appears as a suffix to the catalog number on the front cover manual.

Cat. No. I233E-EN-03

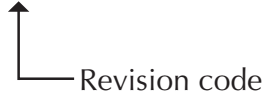

The following table outlines the changes made to the manual during each revision.

Revision code	Date	Description
01	June 2016	Original production
01A	February 2018	Small corrections
02	April 2018	A new section "5. Work definitions" has been included to the "Chapter 4. Edit".
03	April 2020	The section "9.4 Setting the standard coordinates by both handed system teaching" has been included to the "Chapter 4. Edit". The "Troubleshooting" section was updated. Information related to new WEIGHTG, INROFST, RTOENBL and SLOWEXT commands were added.

OMRON

Authorized Distributor: