



# Lifting Crane Application Software

Model: 3G3RX

CX-Drive Version: 2.7.0.20

## USER'S MANUAL



**OMRON**

## ***Notice:***

OMRON products are manufactured for use according to proper procedures by a qualified operator and only for the purposes described in this manual.

The following conventions are used to indicate and classify precautions in this manual. Always heed the information provided with them. Failure to heed precautions can result in injury to people or damage to property.

## ***OMRON Product References***

All OMRON products are capitalized in this manual. The word "Unit" is also capitalized when it refers to an OMRON product, regardless of whether or not it appears in the proper name of the product.

## **© OMRON, 2013**

All rights reserved. No part of this publication may be reproduced, stored in a retrieval system, or transmitted, in any form, or by any means, mechanical, electronic, photocopying, recording, or otherwise, without the prior written permission of OMRON.

No patent liability is assumed with respect to the use of the information contained herein. Moreover, because OMRON is constantly striving to improve its high-quality products, the information contained in this manual is subject to change without notice. Every precaution has been taken in the preparation of this manual. Nevertheless, OMRON assumes no responsibility for errors or omissions. Neither is any liability assumed for damages resulting from the use of the information contained in this publication.

# *Lifting Crane Application Software*

## *Read and Understand this Manual*

Please read and understand this manual before using the product. Please consult your OMRON representative if you have any questions or comments.

### **Warranty and Limitations of Liability**

#### **WARRANTY**

OMRON's exclusive warranty is that the products are free from defects in materials and workmanship for a period of one year (or other period if specified) from date of sale by OMRON.

OMRON MAKES NO WARRANTY OR REPRESENTATION, EXPRESS OR IMPLIED, REGARDING NON-INFRINGEMENT, MERCHANTABILITY, OR FITNESS FOR PARTICULAR PURPOSE OF THE PRODUCTS. ANY BUYER OR USER ACKNOWLEDGES THAT THE BUYER OR USER ALONE HAS DETERMINED THAT THE PRODUCTS WILL SUITABLY MEET THE REQUIREMENTS OF THEIR INTENDED USE. OMRON DISCLAIMS ALL OTHER WARRANTIES, EXPRESS OR IMPLIED.

#### **LIMITATIONS OF LIABILITY**

OMRON SHALL NOT BE RESPONSIBLE FOR SPECIAL, INDIRECT, OR CONSEQUENTIAL DAMAGES, LOSS OF PROFITS OR COMMERCIAL LOSS IN ANY WAY CONNECTED WITH THE PRODUCTS, WHETHER SUCH CLAIM IS BASED ON CONTRACT, WARRANTY, NEGLIGENCE, OR STRICT LIABILITY.

In no event shall the responsibility of OMRON for any act exceed the individual price of the product on which liability is asserted.

IN NO EVENT SHALL OMRON BE RESPONSIBLE FOR WARRANTY, REPAIR, OR OTHER CLAIMS REGARDING THE PRODUCTS UNLESS OMRON'S ANALYSIS CONFIRMS THAT THE PRODUCTS WERE PROPERLY HANDLED, STORED, INSTALLED, AND MAINTAINED AND NOT SUBJECT TO CONTAMINATION, ABUSE, MISUSE, OR INAPPROPRIATE MODIFICATION OR REPAIR.

## Application Considerations

<b>SUITABILITY FOR USE</b>
<p>OMRON shall not be responsible for conformity with any standards, codes, or regulations that apply to the combination of products in the customer's application or use of the products.</p> <p>At the customer's request, OMRON will provide applicable third party certification documents identifying ratings and limitations of use that apply to the products. This information by itself is not sufficient for a complete determination of the suitability of the products in combination with the end product, machine, system, or other application or use.</p> <p>The following are some examples of applications for which particular attention must be given. This is not intended to be an exhaustive list of all possible uses of the products, nor is it intended to imply that the uses listed may be suitable for the products:</p> <ul style="list-style-type: none"><li>• Outdoor use, uses involving potential chemical contamination or electrical interference, or conditions or uses not described in this manual.</li><li>• Nuclear energy control systems, combustion systems, railroad systems, aviation systems, medical equipment, amusement machines, vehicles, safety equipment, and installations subject to separate industry or government regulations.</li><li>• Systems, machines, and equipment that could present a risk to life or property.</li></ul> <p>Please know and observe all prohibitions of use applicable to the products.</p> <p><b>NEVER USE THE PRODUCTS FOR AN APPLICATION INVOLVING SERIOUS RISK TO LIFE OR PROPERTY WITHOUT ENSURING THAT THE SYSTEM AS A WHOLE HAS BEEN DESIGNED TO ADDRESS THE RISKS, AND THAT THE OMRON PRODUCTS ARE PROPERLY RATED AND INSTALLED FOR THE INTENDED USE WITHIN THE OVERALL EQUIPMENT OR SYSTEM.</b></p>



<b>PROGRAMMABLE PRODUCTS</b>
<p>OMRON shall not be responsible for the user's programming of a programmable product, or any consequence thereof.</p>

## Disclaimers

### CHANGE IN SPECIFICATIONS

Product specifications and accessories may be changed at any time based on improvements and other reasons.

It is our practice to change model numbers when published ratings or features are changed, or when significant construction changes are made. However, some specifications of the products may be changed without any notice. When in doubt, special model numbers may be assigned to fix or establish key specifications for your application on your request. Please consult with your OMRON representative at any time to confirm actual specifications of purchased products.

### DIMENSIONS AND WEIGHTS

Dimensions and weights are nominal and are not to be used for manufacturing purposes, even when tolerances are shown.

### PERFORMANCE DATA

Performance data given in this manual is provided as a guide for the user in determining suitability and does not constitute a warranty. It may represent the result of OMRON's test conditions, and the users must correlate it to actual application requirements. Actual performance is subject to the OMRON Warranty and Limitations of Liability.

### ERRORS AND OMISSIONS



The information in this manual has been carefully checked and is believed to be accurate; however, no responsibility is assumed for clerical, typographical, or proofreading errors, or omissions.

# Safety Precautions









- **Indications and meanings of safety information**

In this user's manual, the following precautions and signal words are used to provide information to ensure the safe use of the RX Inverter. The information provided here is vital to safety. Strictly observe the precautions provided.







- **Meanings of signal words**

 <span style="font-size: 2em; font-weight: bold; margin-left: 10px;">DANGER</span>	<p>Indicates an imminently hazardous situation which, if not avoided, is likely to result in serious injury or may result in death. Additionally there may be severe property damage.</p>
 <span style="font-size: 2em; font-weight: bold; margin-left: 10px;">CAUTION</span>	<p>Indicates a potentially hazardous situation which, if not avoided, may result in minor or moderate injury or in property damage.</p>

- **Alert symbols in this document**

 <span style="font-size: 2em; font-weight: bold; margin-left: 10px;">DANGER</span>	
	<p>Turn off the power supply and implement wiring correctly. Not doing so may result in a serious injury due to an electric shock.</p>
	<p>Wiring work must be carried out only by qualified personnel. Not doing so may result in a serious injury due to an electric shock.</p>
	<p>Do not change wiring and slide switches (SW1), put on or take off Digital Operator and optional devices, replace cooling fans while the input power is being supplied. Doing so may result in a serious injury due to an electric shock.</p>
	<p>Be sure to ground the unit. Not doing so may result in a serious injury due to an electric shock or fire. (200-V class: type-D grounding, 400-V class: type-C grounding)</p>
	<p>Do not remove the terminal block cover during the power supply and 10 minutes after the power shutoff. Doing so may result in a serious injury due to an electric shock.</p>
	<p>Do not operate the Digital Operator or switches with wet hands. Doing so may result in a serious injury due to an electric shock.</p>
	<p>Inspection of the Inverter must be conducted after the power supply has been turned off. Not doing so may result in a serious injury due to an electric shock. The main power supply is not necessarily shut off even if the emergency shutoff function is activated.</p>

# CAUTION

	Do not connect resistors to the terminals (PD/+1, P/+, N/-) directly. Doing so might result in a small-scale fire, heat generation or damage to the unit.
	Install a stop motion device to ensure safety. Not doing so might result in a minor injury. (A holding brake is not a stop motion device designed to ensure safety.)
	Be sure to use a specified type of braking resistor/regenerative braking unit. In case of a braking resistor, install a thermal relay that monitors the temperature of the resistor. Not doing so might result in a moderate burn due to the heat generated in the braking resistor/regenerative braking unit. Configure a sequence that enables the Inverter power to turn off when unusual overheating is detected in the braking resistor/regenerative braking unit.
	The Inverter has high voltage parts inside which, if short-circuited, might cause damage to itself or other property. Place covers on the openings or take other precautions to make sure that no metal objects such as cutting bits or lead wire scraps go inside when installing and wiring.
	Do not touch the Inverter fins, braking resistors and the motor, which become too hot during the power supply and for some time after the power shutoff. Doing so may result in a burn.
	Take safety precautions such as setting up a molded-case circuit breaker (MCCB) that matches the Inverter capacity on the power supply side. Not doing so might result in damage to property due to the short circuit of the load.
	Do not dismantle, repair or modify this product. Doing so may result in an injury.

# Precautions for Safe Use

## • Installation and storage

Do not store or use the product in the following places.

- Locations subject to direct sunlight.
- Locations subject to ambient temperature exceeding the specifications.
- Locations subject to relative humidity exceeding the specifications.
- Locations subject to condensation due to severe temperature fluctuations.
- Locations subject to corrosive or flammable gases.
- Locations subject to exposure to combustibles.
- Locations subject to dust (especially iron dust) or salts.
- Locations subject to exposure to water, oil, or chemicals.
- Locations subject to shock or vibration.

## • Transporting, installation and wiring

- Do not drop or apply strong impact on the product. Doing so may result in damaged parts or malfunction.
- Do not hold by the front cover and terminal block cover, but hold by the fins during transportation.
- Do not connect an AC power supply voltage to the control input/output terminals. Doing so may result in damage to the product.
- Be sure to tighten the screws on the terminal block securely.  
Wiring work must be done after installing the unit body.
- Do not connect any load other than a three-phase inductive motor to the U, V, and W output terminals.
- Take sufficient shielding measures when using the product in the following locations. Not doing so may result in damage to the product.
  - Locations subject to static electricity or other forms of noise.
  - Locations subject to strong magnetic fields.
  - Locations close to power lines.

## • Operation and adjustment

- Be sure to confirm the permissible range of motors and machines before operation because the inverter speed can be changed easily from low to high.
- Provide a separate holding brake if necessary.
- If the Drive Programming stops during multi-function output, the output status is held. Take safety precautions such as stopping peripheral devices.
- If the clock command is used in Drive Programming, an unexpected operation may occur due to weak battery. Take measures such as detecting a weak battery by a check that the clock data returns to the initial setting and stopping the inverter or programs. When the LCD Digital Operator is removed or disconnected, Drive Programming is in a waiting status by the clock command.

## • Maintenance and Inspection

- Be sure to confirm safety before conducting maintenance, inspection or parts replacement.
- The capacitor service life is influenced by the ambient temperature. Refer to “Smoothing Capacitor Life Curve” described in the manual. When a capacitor reaches the end of its service life and does not work as the product, you need to replace the capacitor.
- When disposing of LCD digital operators and wasted batteries, follow the applicable ordinances of your local government. When disposing of the battery, insulate it using tape.



The following display must be indicated when products using lithium primary batteries (with more than 6 ppb of perchlorate) are transport to or through the State of California, USA.

Perchlorate Material - special handling may apply.  
See [www.dtsc.ca.gov/hazardouswaste/perchlorate](http://www.dtsc.ca.gov/hazardouswaste/perchlorate)

The 3G3AX-OP05 has the lithium primary battery (with more than 6 ppb of perchlorate).  
Label or mark the above display on the exterior of all outer shipping packages of your products when exporting your products which the 3G3AX-OP05 are installed to the State of California, USA.



- 
- Do not short + and –, charge, disassemble, heat, put into the fire, or apply strong impact on the battery. The battery may leak, explode, produce heat or fire. Never use the battery which was applied strong impact due to such as fall on the floor, it may leak.
  - UL standards establish that the battery shall be replaced by an expert engineer. The expert engineer must be in charge of the replacement and also replace the battery according to the method described in this manual.
  - When the display of LCD Digital Operator can not be recognized due to the service life, replace the LCD Digital Operator.

## *Precautions for Correct Use*

- **Installation**

- Mount the product vertically on a wall with the product's longer sides upright.  
The material of the wall has to be noninflammable such as a metal plate.

- **Main circuit power supply**

- Confirm that the rated input voltage of the Inverter is the same as AC power supply voltage.

- **Error Retry Function**

- Do not come close to the machine when using the error retry function because the machine may abruptly start when stopped by an alarm.
- Be sure to confirm the RUN signal is turned off before resetting the alarm because the machine may abruptly start.

- **Non-stop function at momentary power interruption**

- Do not come close to the machine when selecting restart in the non-stop function at momentary power interruption selection (b050) because the machine may abruptly start after the power is turned on.

- **Operation stop command**

- Provide a separate emergency stop switch because the STOP key on the Digital Operator is valid only when function settings are performed.
- When checking a signal during the power supply and the voltage is erroneously applied to the control input terminals, the motor may start abruptly. Be sure to confirm safety before checking a signal.

- **Product Disposal**

- Comply with the local ordinance and regulations when disposing of the product.

### Warning labels

Warning labels are located on the inverter as shown in the following illustration. Be sure to follow the instructions.

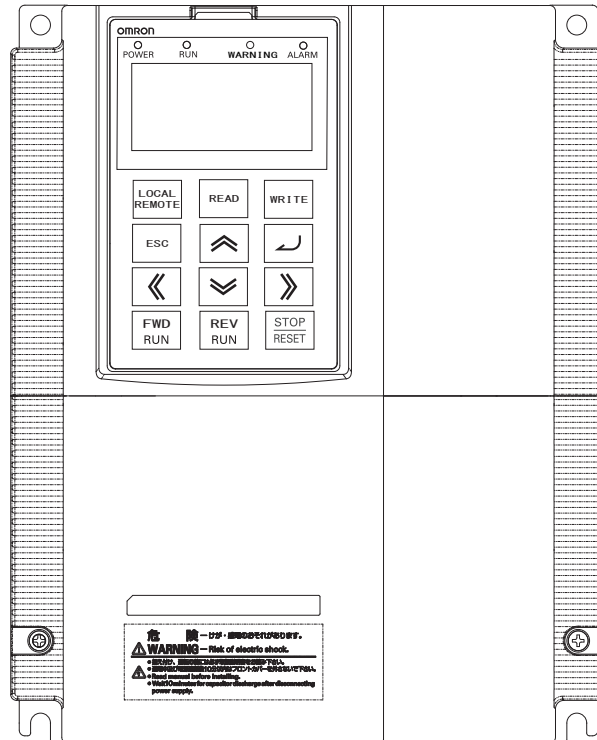

### Warning description

**危険** — けが・感電のおそれがあります。

**WARNING** — Risk of electric shock.

- 据え付け、運転の前には必ず取扱説明書をお読み下さい。
- 通電中及び電源遮断後10分以内はフロントカバーを外さないで下さい。
- Read manual before installing.
- Wait 10 minutes for capacitor discharge after disconnecting power supply.

# Checking Before Unpacking

- **Checking the product**

- On delivery, be sure to check that the delivered product is the Inverter RX model that you ordered. Should you find any problems with the product, immediately contact your nearest local sales representative or OMRON sales office.

- **Checking the nameplate**

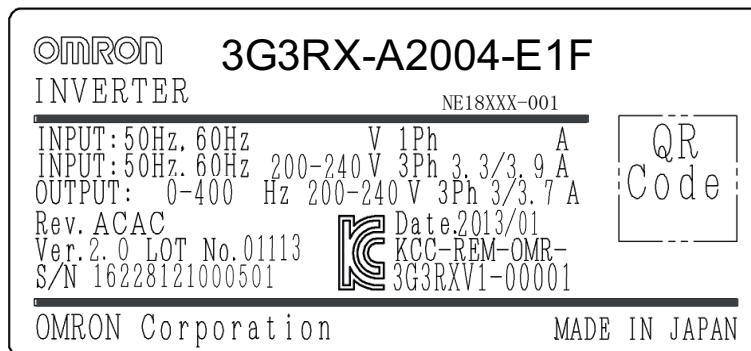

- **Checking the model**

3 G 3 R X - A 2 0 5 5 - E F

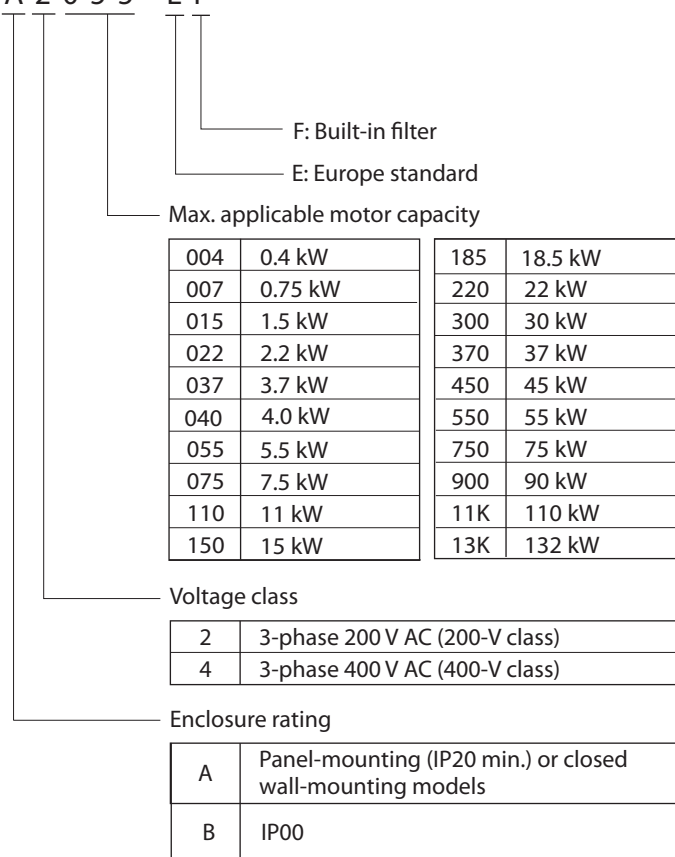

# Revision History

- A manual revision code appears as a suffix to the catalogue number located at the lower left of the front and back covers.

Cat. No. I210E-EN-01

↑ Revision code

Revision code	Revision date	Description
01	October 2013	Original production

## Related Manuals

Cat. No.	Description
I560-E2	RX User's Manual
I130E-EN	RX Quick Start Guide
I579-E2	LCD Digital Operator User's Manual
I580-E2	MX2/RX/LX Drive Programming User's Manual

# Lifting Crane Application Software

<b>1 OVERVIEW .....</b>	<b>13</b>
1.1 Introduction .....	13
1.2 Handling of this user's manual .....	13
1.3 Safety instruction .....	13
1.4 Advantages using the application software .....	13
1.5 Features of the application software .....	13
<b>2 PREPARATION AND SYSTEM CONFIGURATION .....</b>	<b>14</b>
2.1 Installation and power circuits .....	14
2.2 3G3RX DIP-SWITCH .....	14
2.3 3G3RX connection diagram .....	15
2.4 Encoder connection (3G3AX-PG Board) .....	16
<b>3 APPLICATION CONFIGURATION STEPS .....</b>	<b>17</b>
3.1 Motor autotuning .....	17
3.2 Parameter settings and Drive Programming application .....	19
<b>4 DRIVE PROGRAMMING PARAMETERS .....</b>	<b>26</b>
4.1 Application software parameters .....	26
4.2 Inputs/outputs .....	27
4.3 Monitor parameters .....	27
4.4 Error codes .....	27
4.5 Other relevant parameters .....	28
<b>5 OPERATION DIAGRAMS .....</b>	<b>30</b>



# Lifting Crane Application Software

## 1 OVERVIEW

---

### 1.1 Introduction

This software allows speed control on a hoisting application optimizing running speed depending on load. With programmable current parameters the application will limit the final speed at which the crane works in up direction, taking it always to the maximum speed inside motor protection limits.

The software can also get direct control of the brake contactor of the system.

New specific alarms for hoisting are added.

### 1.2 Handling of this user's manual

The contents of this user's manual are subject to change without prior notice. No part of this user's manual may be reproduced in any form without the publisher's permission.

If you find any incorrect description, missing description or have questions concerning the contents of this user's manual, please contact the publisher.

### 1.3 Safety instruction

Be sure to read this user's manual, inverter user's manual, and appended documents thoroughly before using Lifting Crane Application program and the inverter. Ensure you to understand and follow all safety information, precautions, and operating and handling instructions for the correct use of the inverter. Always use the inverter strictly within the range of specifications described in the inverter user's manual and correctly implement maintenance and inspection to prevent fault from occurring. When using the inverter together with optional products, also read the manual of those products. Note that this user's manual and the manual for each optional product to be used should be delivered to the end user of the inverter. In this user's manual you can find WARNING along the instruction WARNINGS: indicates that incorrect handling may cause hazardous situation, which may result in serious personal injury or death.

3G3AX-EIO21-ROE (extra input/output option board) cannot be used with this Drive Programming case software.

### 1.4 Advantages using the application software

- The speed control is transparent to the user. He just asks for maximum speed when going up, and the speed ends up in a value where motor current is maximum.
- Brake control is fully integrated in the drive, with enough adjustment parameters to achieve very smooth start and stop. Brake release feedback alarm has been added.
- New alarms specific for elevation malfunctions are added to the standard alarms.
- The algorithm is not predictive, it uses a continuous control that allows to cover the case where winding the rope in multiple layers generates changes in the current.

### 1.5 Features of the application software

#### Speed references and ramp generator

The customer will set in the inverter 3 or 4 speeds, and will change the different speeds of the inverter by digital inputs. Analog input is also available for analog joystick use in the future. High priority jog input is also available.

A new multi-function analog input has been added to scale the final output frequency, with this analog input it will be possible to adjust the output frequency based on the analog input value and the maximum speed.

#### Motor current limiter

When a digital input is on, the inverter will limit the output current to the motor controlling final running reference speed but only if a minimum limiting speed has been surpassed.

The value of this limit will be set in the inverter in % of motor nominal current.

Normally, we will have this digital input signal ON, when the Inverter is going in forward direction, that usually means up (selectable). The program will apply internally the limitation only in one selectable direction, the input can be permanently closed if we want it to operate in this way in all conditions. The speed will never be limited under a specific **Limiting Speed parameter**.

### Encoder faults

For control and safety reasons is recommended to mount a line driver encoder in the shaft of the AC motor connected to the 3G3AX-PG01 option board.

The Inverter detects the following items as errors, and the digital output fault contact will open:

- With standard encoder errors (**PGO open error**, **Deviation** and **Overspeed**).
- An special error called **Brake Slip error** has been added. It triggers when a little movement of the load is detected while the inverter is stopped. Margin is quite narrow to ensure the detection in cases like a brake not strong enough to hold the load.

### Brake sequence

This special software controls a brake output with the following characteristics:

- **Motor current condition**, is necessary to exceed the current level (on new parameter in % of motor nominal) for the brake to open. This is to make sure the motor is magnetized before opening.
- For open loop applications. **Brake open minimum frequency** and **Brake close minimum frequency** are available. To provide maximum flexibility, as going up and going down is different in hoisting, independent values are available in each direction.
- **Brake open delay** will delay the brake output a certain time. Usually this should be set to zero but it could be useful with motors that requires long magnetizing time.
- **Brake close delay** holds the internal run command with zero speed to make sure that mechanical brake is closed (see time diagrams).
- **Brake release check** provides the possibility of an external signal to confirm the brake status. A fault will be generated when the brake is open and a confirmation from this input is not received on the time set on brake check time.

## 2 PREPARATION AND SYSTEM CONFIGURATION

To prepare the inverters for operation, the configuration tool CX-Drive is used for setting parameters and to download the Lifting Crane Application program. In the following chapters we will show the necessary steps to set up the inverter for a lifting crane application. We will use 3G3RX inverter.

### 2.1 Installation and power circuits

This manual does not cover how to install the inverters in cabinets, how to wire power supply or how to satisfy other application specific requirements. Please, refer to the RX User's Manual (I560-E2).

### 2.2 3G3RX DIP-SWITCH

There is only one switch in 3G3RX. If the switch is ON, digital input 1 and 3 are configured as emergency shutoff inputs.

Factory setting is OFF, so just check that the switch is really OFF.

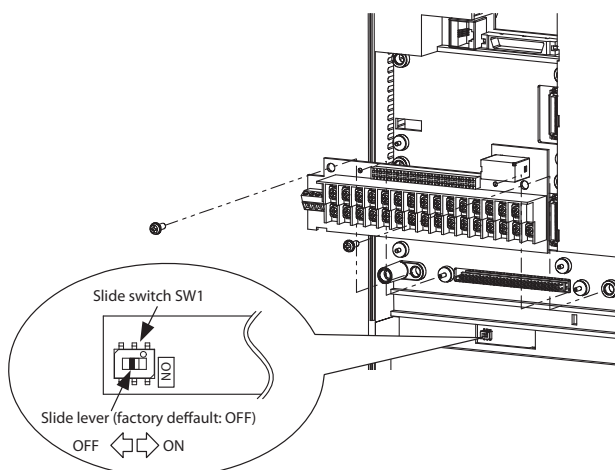



2.3 3G3RX connection diagram

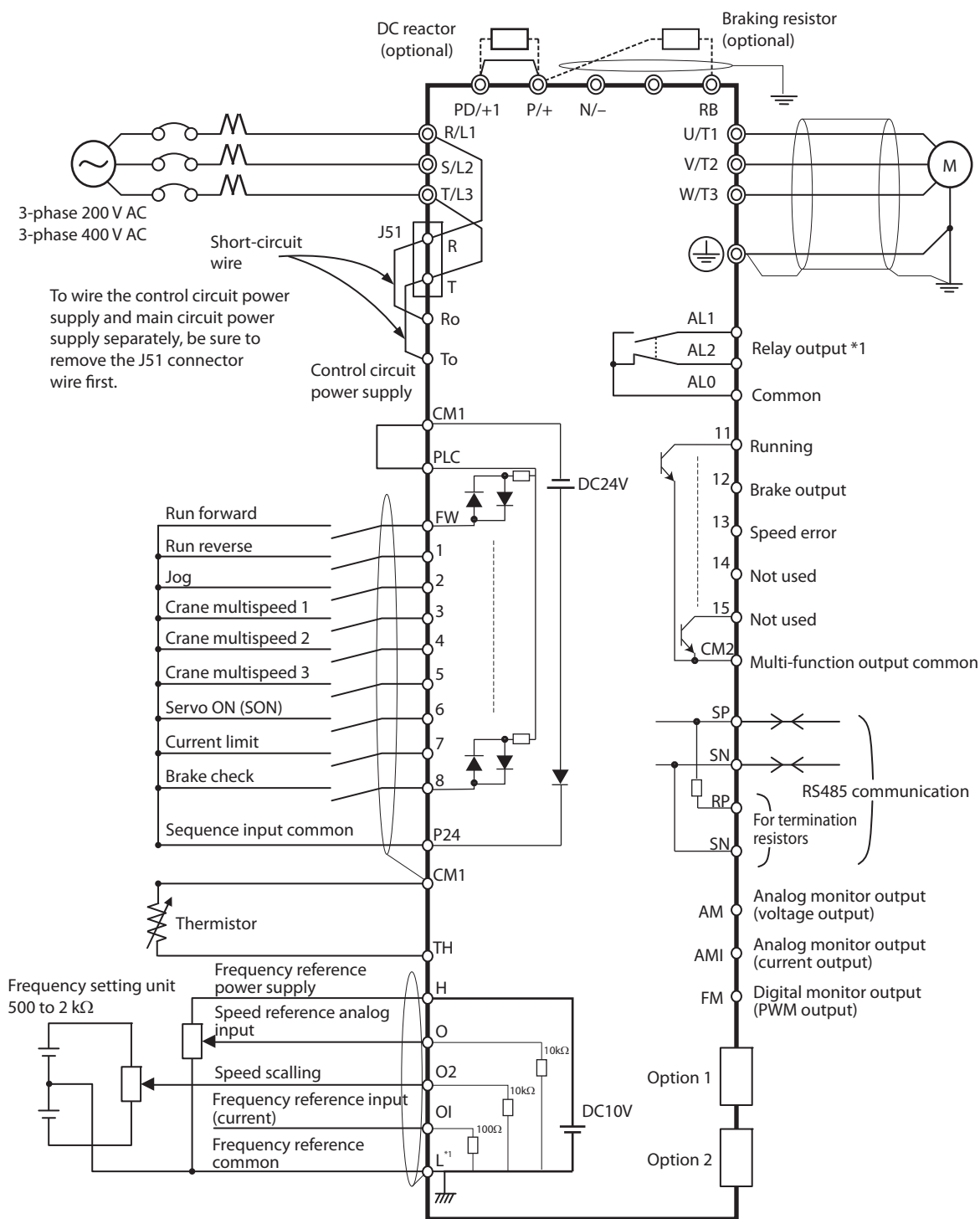

\*1 L is the common reference for analog input and also for analog output.

2.4 Encoder connection (3G3AX-PG Board)

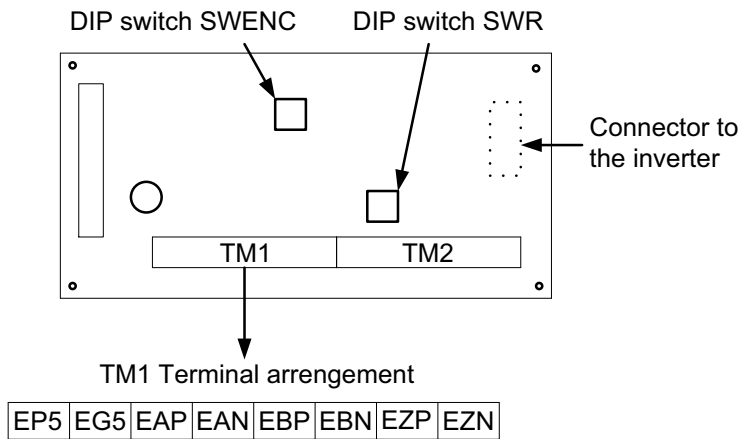

TM1	
Input terminal	Encoder signal
EP5	+5 VDC
EG5	0 V (common)
EAP	A
EAN	A/
EBP	B
EBN	B/
EZP	Z
EZN	Z/

Switch arrangement

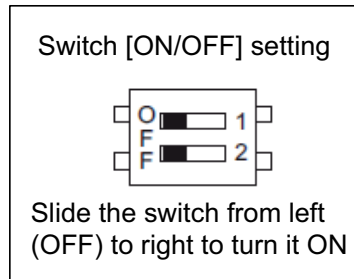

Default settings

The default settings (factory settings) are shown below:

DIP switch name	Switch No.	Settings		Default settings
SWENC	1	ON	Disconnection detection enabled when encoder A and B phases are not connected.	OFF
		OFF	Disconnection detection disabled when encoder A and B phases are not connected.	
	2	ON	Disconnection detection enabled when encoder Z phase is not connected.	OFF
		OFF	Disconnection detection disabled when encoder Z phase is not connected.	
SWR <sup>*1</sup>	1	ON	Built-in termination resistor between SAP and SAN (150 Ω) enabled	OFF
		OFF	Built-in termination resistor between SAP and SAN disabled	
	2	ON	Built-in termination resistor between SBP and SBN (150 Ω) enabled	OFF
		OFF	Built-in termination resistor between SBP and SBN disabled	

\*1. When connecting to multiple units in parallel for pulse train position command inputs, turn ON the SWR1 and SWR2 of the only one unit located farthest from the master unit.

### 3 APPLICATION CONFIGURATION STEPS

#### 3.1 Motor autotuning

1. Introduce motor settings:

Par. No.	Name	Value
A003	Base frequency	Motor base frequency (Hz)
A044	V/f characteristics selection	05: V2 (Sensor vector control)
b012	Electronic thermal level	Motor rated current
H002	Motor parameter selection	01: Auto-tuning parameter
H003	Motor capacity selection	Introduce motor capacity (kW)
H004	Motor pole number selection	Introduce motor pole number
P011	Encoder pulses	Introduce number of encoder pulses per revolution (ppr)
P012	V2 control mode selection	00: ASR (speed control mode)

Before starting the auto-tuning set parameter A051 (DC injection braking selection) to disable.

2. After introducing motor parameter settings, set H001 = 01: Static or 02: Rotate and turn on the run command. It will start the motor auto-tuning.



**Note:** It is recommended to use option 02: rotate autotuning. Please, be sure that the shaft is free (no gear/run connected).

Once the auto-tuning process is finished it will appear a message indicating if the auto-tuning is ok or not.

(1) Auto-tuning OK: Change A051 (DC injection braking selection) again to enable.

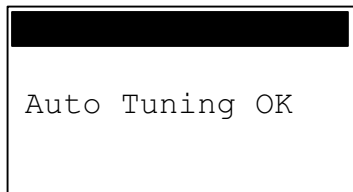

(2) Auto-tuning NOK: Verify introduced motor settings. For further information, please refer to the RX user's manual.

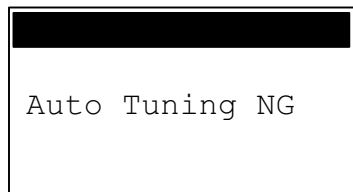

**Note:** After complete the auto-tuning process, be sure that with Run FW signal the motor shaft is going in CW (clock wise) up direction:

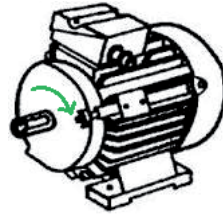

If motor is rotating CCW (Counter clock wise), change channel A by B in the encoder wiring and two output phases.

APPLICATION CONFIGURATION STEPS

### 3.2 Parameter settings and Drive Programming application

After finishing the autotuning process, follow next steps in order to upload inverter parameter settings with CX-Drive tool, download the lifting crane application case software and save the project:

1. Open CX-Drive.  CX-Drive
2. Connect your computer USB port to the RJ-45 3G3RX inverter port with 3G3AX-PCACN2 cable or USB-CONVERTERCABLE. Remove the LCD Digital Operator to access RJ-45 port:

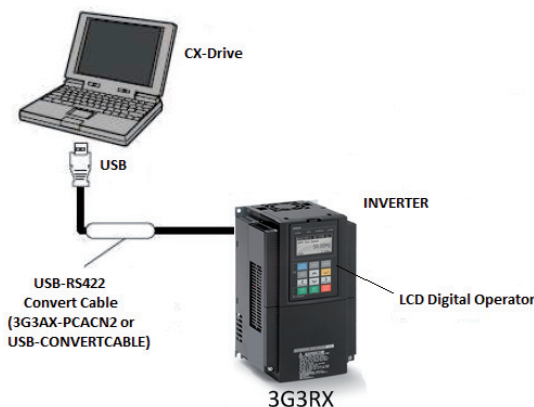

3. Use the CX-Drive autodetect  function in order to go online with the 3G3RX inverter:

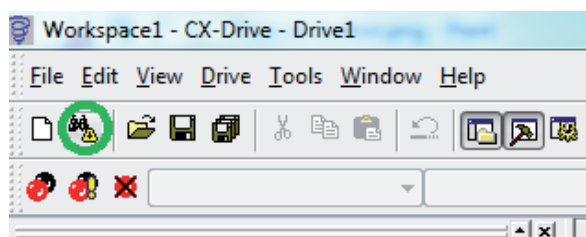

4. A new dialog will appear for autodetect function, trying to connect with 3G3RX inverter:

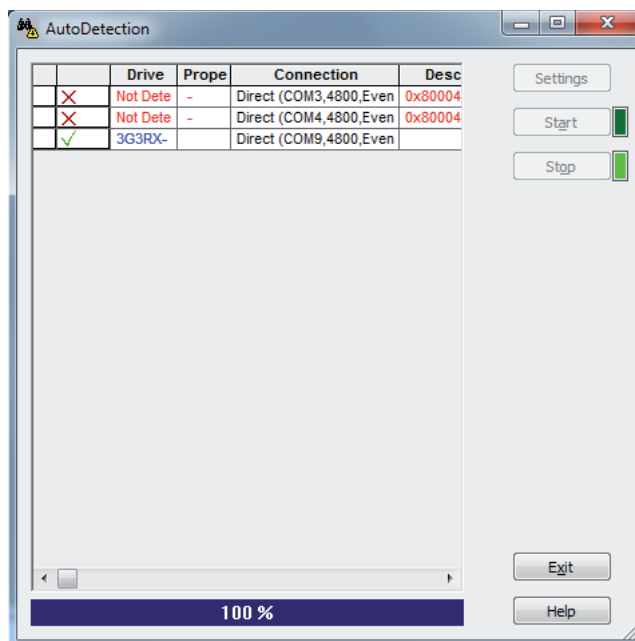

5. After detecting the inverter, automatically a new project will be created (in online mode) in the CX-Drive:

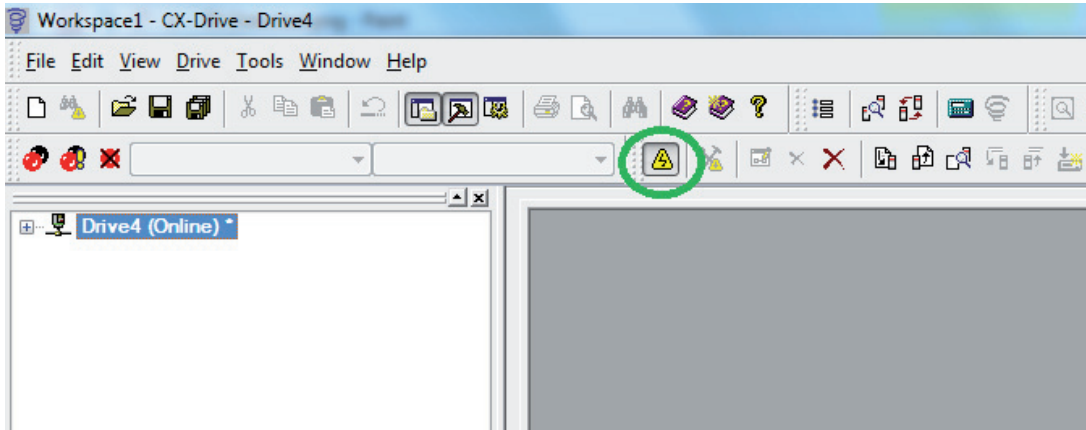

6. Press mouse right button if you want to change the Drive name. A new dialog will appear:

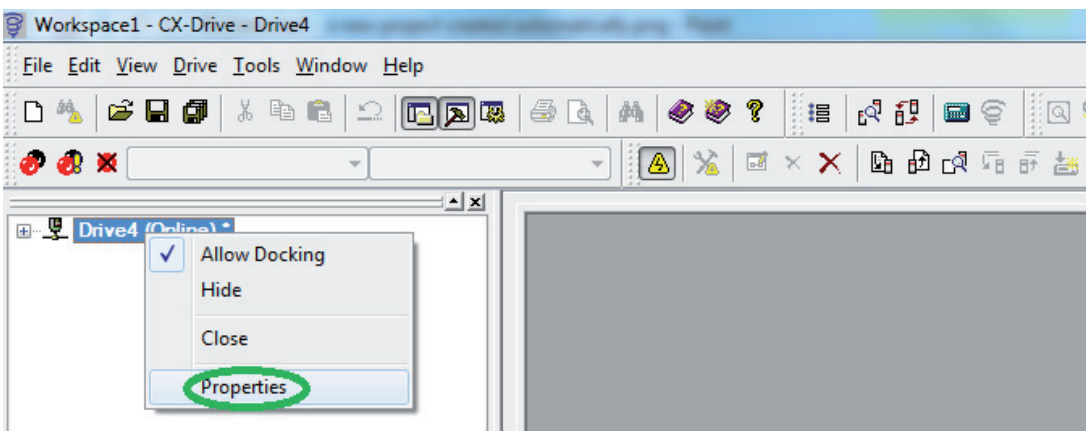

7. Introduce the Drive name and press OK button:

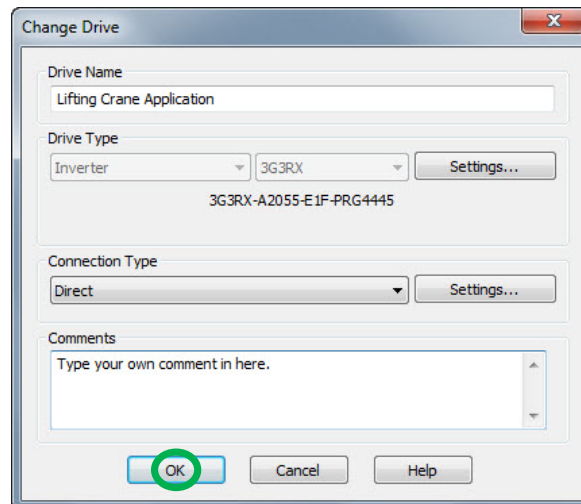

8. The new name will be updated in the project tree:

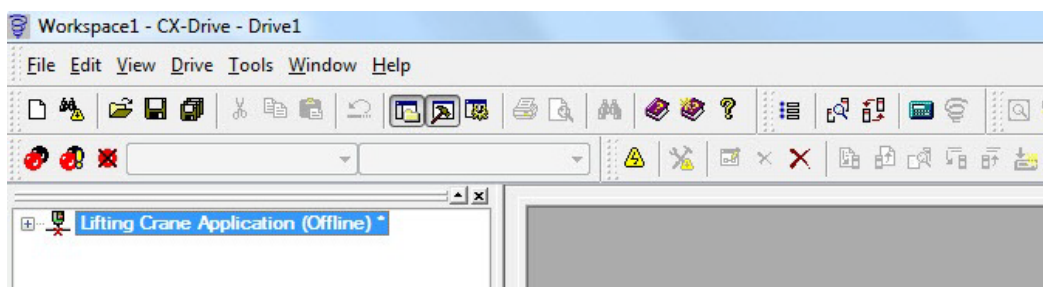

APPLICATION CONFIGURATION STEPS

9. Upload inverter parameters clicking the  icon.

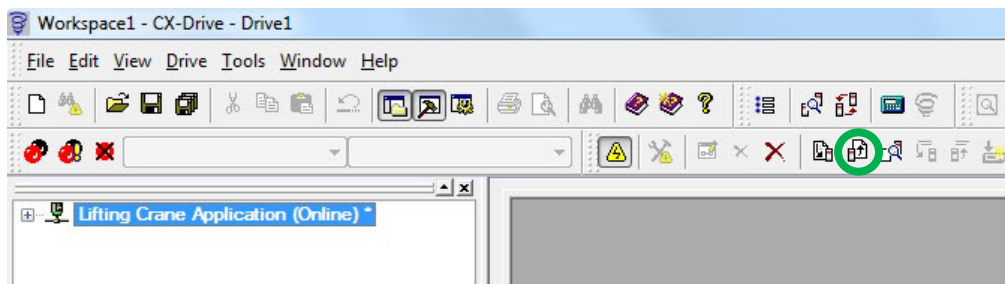

A new dialog will appear. Select only Drive Parameter and press ok:

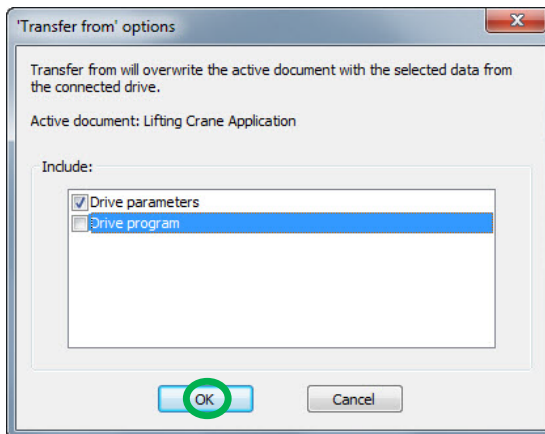

After pressing ok, the parameters will start to be transferred:

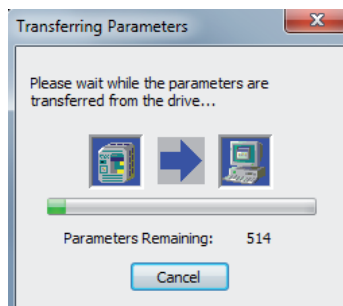

Once the parameters have been downloaded, a new message window will appear indicating that parameter have been transferred successfully:

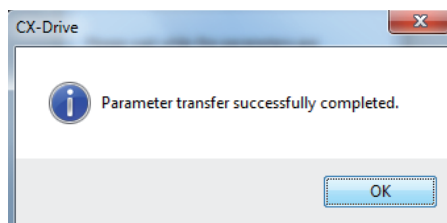

10. Import the Drive Programming case application software. Go to *File -> Import*:

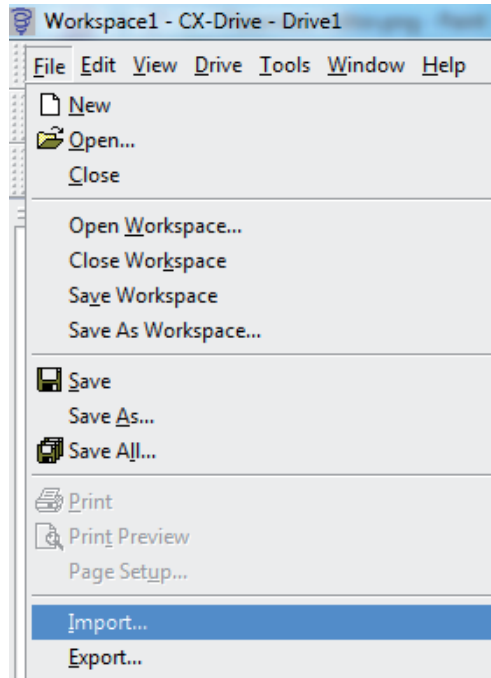

Go to the folder where you have the “driveprogram” file. Select the file and press Open button:

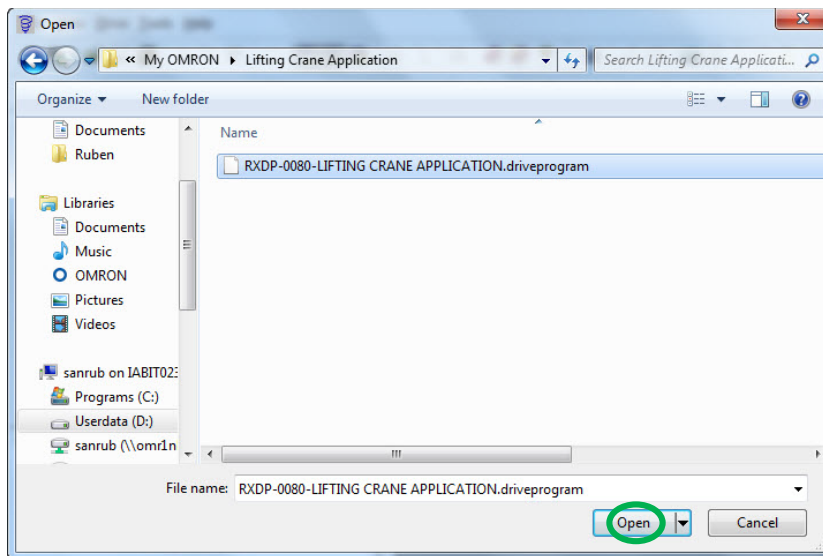

11. In the project tree go to the section Drive Programming with double-click:





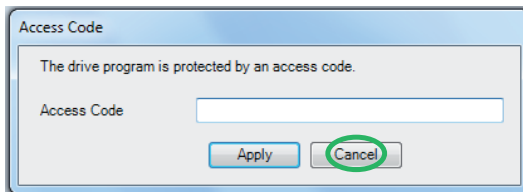

APPLICATION CONFIGURATION STEPS

12. A message will appear requesting an access code. Press cancel button:

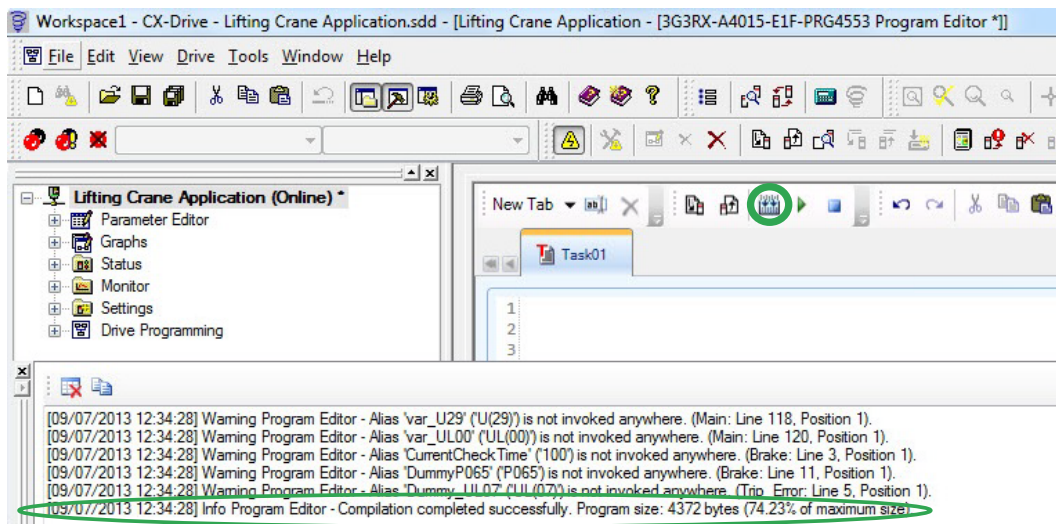

13. Compile the program and verify in the output window that the program size is not 0 bytes:



14. Download Drive Programming program by pressing the download icon  in the Drive Programming section:

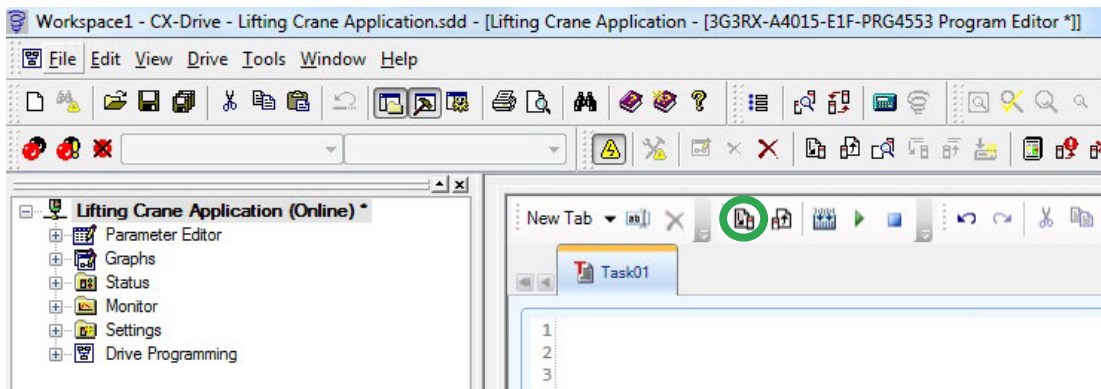

A new dialog will appear showing the status of the downloading process:

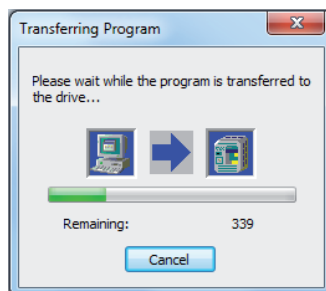

After downloading a new message box will appear indicating that the program has been down loaded with success. Press ok button:

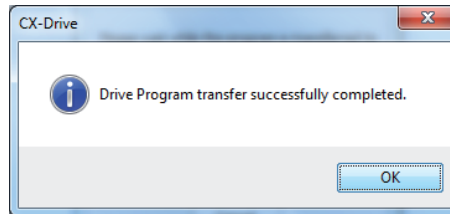

15. After downloading the DP program, press the Start  program button, or set parameter A017 (Drive programming (EzSQ) selection) to 02: Always ON.

16. Go to the *Status -> Drive Programming* section and verify that Tasks are running:

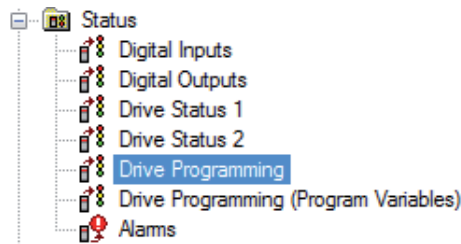

Double-click in the *Status -> Drive Programming* section:

<input checked="" type="checkbox"/>	T1S	Status of task #1	1: Running
<input checked="" type="checkbox"/>	T2L	Current execution step of task #2	2
<input checked="" type="checkbox"/>	T2S	Status of task #2	1: Running
<input checked="" type="checkbox"/>	T3L	Current execution step of task #3	0
<input checked="" type="checkbox"/>	T3S	Status of task #3	1: Running
<input checked="" type="checkbox"/>	T4L	Current execution step of task #4	0
<input checked="" type="checkbox"/>	T4S	Status of task #4	1: Running
<input checked="" type="checkbox"/>	T5L	Current execution step of task #5	0
<input checked="" type="checkbox"/>	T5S	Status of task #5	1: Running
<input checked="" type="checkbox"/>	TNUM	Number of tasks	2

**Note:** This Lifting Crane Application software version is using all tasks. So, verify if all tasks are running.

17. Save your project. Go to *File -> Save As...* option:

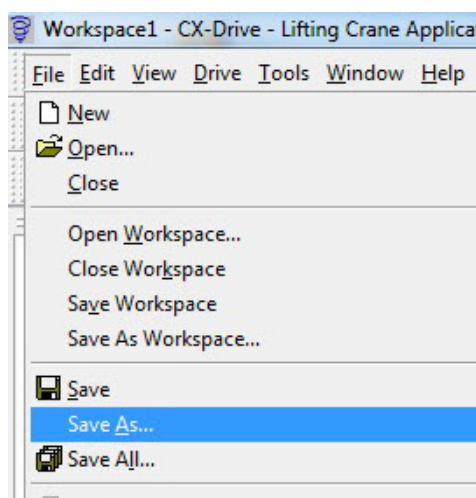

## APPLICATION CONFIGURATION STEPS

A new dialog will appear. Put the file name that you want for the project and press the “Save” button:

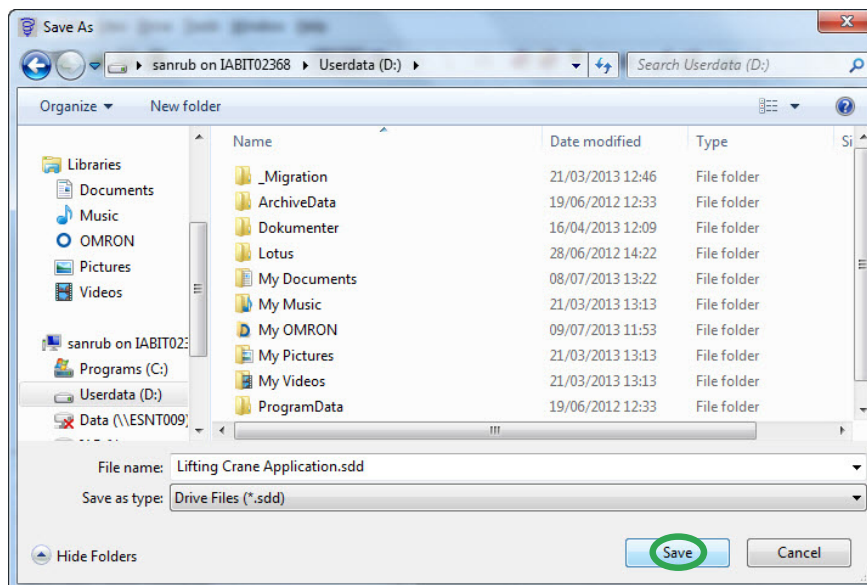

18. Start with the application configuration and inverter parameter settings.

## 4 DRIVE PROGRAMMING PARAMETERS

### 4.1 Application software parameters

Parameter No.	Name	Setting range	Unit	Default setting	Description
P101	Low current limit	3000 to 15000 [30.00% to 150.00%]	%	3000 [30.00%]	Current level where compensation begins
P102	High current limit	3000 to 15000 [30.00% to 150.00%]	%	10000 [100.00%]	Max. current level allowed
P103	Filter constant	0 to 9000	-	0	Response time
P104	Limiting speed	0 to 10000 [0Hz to 100.00Hz]	Hz	5000 [50.00Hz]	Below this speed no compensation done
P106	Ref. 1 is analog	0 to 1	-	0	With this ON, select preset 1 for analog in
P107	Limit direction	0 to 1	-	0	0: Forward is up 1: Reverse is up
P108	Current limiting accel time	10 to 200 [0.1sec to 20.0sec]	sec	20 [2.0sec]	Accel time for current limit function
P109	Current limiting decel time	10 to 200 [0.1sec to 20.0sec]	sec	10 [1.0sec]	Decel time for current limit function
P110	Brk open current	0 to 10000 [0% to 100.00%]	% Imot	5000 [50.00%]	Motor current for release of brake
P111	Brk open UP freq.	0 to 2000 [0Hz to 20.00Hz]	Hz	0 [0Hz]	Min. frequency to open brake during up
P112	Brk open DOWN freq.	0 to 2000 [0Hz to 20.00Hz]	Hz	0 [0Hz]	Min. frequency to open brake during down
P113	Brk open delay	0 to 200 [0.00sec to 2.00sec]	sec	0.00 [0sec]	Brake open delay both directions
P114	Brk close freq. UP	0 to 2000 [0Hz to 20.00Hz]	Hz	0 [0Hz]	Freq. where brake will close when UP
P115	Brk close freq. DOWN	0 to 2000 [0Hz to 20.00Hz]	Hz	0 [0Hz]	Freq. where brake will close when DOWN
P116	Brk close delay	0 to 200 [0.0sec to 20.0sec]	sec	0 [0.0sec]	Stop delay after brake when closing
P117	Brk check time	0 to 500 [0.00sec to 5.00sec]	sec	50 [0.5sec]	Set the time for brake release check D.I
P120	Brake slip margin	0 to 500 [0.0Hz to 5.0Hz]	Hz	100 [1.0Hz]	Margin for static (in STOP) movement
P121	Spd alarm delay	0 to 100 [0.00sec to 1.00sec]	sec	50 [0.5sec]	Delay to avoid spurious & peak error. Set P121 to 0 to disable this brake slip margin error
P122	Brake open delay error	0 to 1000 [0.00sec to 10.00sec]	sec	200 [2.00 sec]	If after run command and P122 time the brake output is not activated a trip will be thrown. Set P122 to 0 to disable this error
P130	Internal trip error	1 to 5	-	0	Trip error number generated by the program
P131	Set default settings	0 to 1	-	1	Setting this variable to 0 and making power off/ power on on the RX inverter, the program will load default settings on the parameters

**Note:** If during hoisting operation it is appreciated some roll back, increase H005 (Speed response) value through the LCD digital operator.

DRIVE PROGRAMMING PARAMETERS

4.2 Inputs/outputs

Digital inputs

Terminal input	Value	Description
1	C001 = 01: RV - Run reverse	Run reverse (Reverse is DOWN)
2	C002 = 61: X(05) DP - Jog mode	Higher priority than the others for JOG reference (standard parameter A038)
3	C003 = 56: X(00) DP - Crane multispeed 1	These inputs select a preset speed (preset values in standard parameters A020-A027)
4	C004 = 57: X(01) DP - Crane multispeed 2	
5	C005 = 58: X(02) DP - Crane multispeed 3	
6	C006 = 54: Servo ON (SON)	--- (internal use)
7	C007 = 59: X(03) DP - Enable Current limit function	If this input is closed, current limitation happens in the sense defined by parameter P107 [0: Disabled, 1: Enabled]
8	C008 = 60: X(04) DP - Brake check	When the brake is open, the inverter will wait for the time set on P117
FW	Run forward	Run forward (Forward is up)

Digital outputs

Terminal output	Value	Description
11	C021 = 00: RUN (during RUN)	Indicates inverter run status
12	C022 = 44: Y(00) DP - Brake output	Controls the brake contactor
13	C023 = 45: Y(01) DP - Speed error	Digital output to indicate speed error output
14	C024 = 46: Y(02) DP - Not used	Not used
15	C025 = 47: Y(03) DP - Not used	Not used
AL2, AL1	C026 = 05: AL (alarm output)	Alarm output

Analog inputs

Terminal input	Value	Description
O	Analog speed reference input	Crane speed reference. It will work when parameter P106 is set to 01
O2	Analog freq. adjust	The value of the analog input scales the final output frequency based on the maximum frequency. For example, if analog input is set to 50%, all the output frequency will be reduced to half of the calculated value. The exception is Jog speed on parameter A038

4.3 Monitor parameters

Parameter No.	Name	Unit	Description
d001	Output frequency monitor	Hz	Output frequency monitor
d002	Output current monitor	A	Instantaneous current
d008	Real frequency monitor	Hz	Real frequency monitor
d025	Crane filtered current	%	Filtered current

4.4 Error codes

Error	Name	Description
E53	Brake open delay error	Detects if the brake is not opened before the time specified in parameter P122 after run command
E54	Brake slip error	Detects movement only in stop condition, higher sensitivity than normal error (limit in P120)
E55	Brake check error	After brake command has been issued, the confirmation brake input doesn't come active in P117 time
E60.x	Encoder disconnection (3G3AX-PG board)	Detects the encoder disconnection and connection failure
E70.x		
E61.x	Overspeed (3G3AX-PG board)	Detects if the motor rotation has been exceeded
E71.x		
E69.x	3G3AX-PG connection error	Detects PG board connection failure
E79.x		

### 4.5 Other relevant parameters

Parameter No.	Name	Value	Description
F002	Acceleration time 1	4 sec	Acceleration time 1
F003	Deceleration time 1	3 sec	Deceleration time 1
A001	Frequency reference selection	07: EzSQ (Drive Programming)	Crane freq. reference selection by Drive Programming
A002	RUN command selection	01: Terminal	Run command selection
A003	Base frequency	-	Base frequency
A004	Maximum frequency	100.0 Hz	Maximum frequency for Crane
A017	Drive Programming (EzSQ) selection	2: Always ON	Run Crane program
A020	Multi-step speed reference 0	10.00 Hz	Speed ref. 0
A021	Multi-step speed reference 1	25.00 Hz	Speed ref. 1
A022	Multi-step speed reference 2	50.00 Hz	Speed ref. 2
A024	Multi-step speed reference 3	100.00 Hz	Speed ref. 3 (High speed)
A038	Jogging frequency	6.00 Hz	JOG speed
A039	Jogging stop selection	04: DEC (RUN) (Deceleration stop on jogging stop/enabled in operation)	Deceleration stop on jogging
A044	V/f characteristics selection	05: V2 (Sensor vector control)	Control method
A051	DC injection braking selection	00: OFF (Disabled)	DC injection activation (please disable)
A069	Acceleration stop frequency	0.00 Hz	Initial frequency at start in 0.01 Hz. 0.00 Hz means disabled
A070	Acceleration stop time	0.0 sec	Initial frequency at start time in 0.1 sec
A081	AVR selection	01: Always OFF	AVR selection
A085	RUN mode selection	00: Normal operation	RUN mode selection
A097	Acceleration pattern selection	00: Line	Accel s-ramp pattern selection
A098	Deceleration pattern selection	00: Line	Decel s-ramp pattern selection
A131	Acceleration curve parameter	01: Small curve	Accel curve parameter
A132	Deceleration curve parameter	01: Small curve	Decel curve parameter
A150 to A153	EL-S-curve ratios	0 %	EL-S-curve ratios
b001	Retry selection	00: TRIP (Alarm)	Retry selection
b008	Trip retry selection	00: TRIP (Alarm)	Trip retry function
b013	Electronic thermal characteristics selection	00: Reduced TRQ (Reduced torque characteristics)	Motor constant torque
b021	Overload limit selection	00: OFF (Disabled)	Overload limit selection
b024	Overload limit selection 2	00: OFF (Disabled)	Overload limit selection 2
b027	Overcurrent suppression function	00: OFF (Disabled)	Overcurrent suppression function
b031	Soft lock selection	01: Only FQ (SFT)	Soft lock protection
b040	Torque limit selection	00: 4-quadrant (Four-quadrant separate setting)	Torque limit selection
b041 to b044	Torque limit 1 to 4	150 %	Torque limits 1 to 4
b045	Torque LADSTOP selection	00: OFF (Disabled)	Torque LAD Stop selection
b046	Reverse rotation prevention selection	00: OFF (Disabled)	Reverse rotation prevention function
b050	Selection of non-stop function at momentary power interruption	00: OFF (Disabled)	Non-stop function at momentary power interruption
b082	Starting frequency	0.10 Hz	Starting frequency
b083	Carrier frequency	5.0 kHz	Carrier frequency
b088	Free-run stop selection	00: 0 Hz start	Free RUN stop selection
b089	Automatic carrier reduction	00: OFF (Disabled)	Automatic carrier reduction
b090	Usage rate of regenerative braking function	100.0 %	% duty for brake unit. Please set to 100 % for brake to work. If set to 0 %, transistor disabled
b091	Stop selection	00: Decel-Stop (Deceleration → Stop)	Stop selection
b092	Cooling fan control	00: Alws-ON (Always ON)	Fan control
b095	Regenerative braking function operation selection	01: RUN-ON (Enabled (Disabled during stop))	Regenerative braking function operation selection
b096	Regenerative braking function ON level	720 V	Regenerative braking function ON level

DRIVE PROGRAMMING PARAMETERS

Parameter No.	Name	Value	Description
b130	Overvoltage protection function selection during deceleration	00: OFF (Disabled)	Overvoltage protection function
C102	Reset selection	02: On in Trip (Enabled only during trip (Reset when the power is ON))	Reset selection
C103	Reset frequency matching selection	00: 0 Hz start	Reset frequency matching selection
H002	Motor parameter selection	01: Auto-tuning parameter	Select final motor data
H003	Motor capacity selection	-	Motor power (kW). Don't touch after the motor parameters changed
H004	Motor pole number selection	-	Motor poles. Please don't touch after autotuning is done or motor parameters changed
H005	Speed response	-	Motor speed constant
H020 / H030	Motor parameter R1	-	Motor R1 (offset)
H021 / H031	Motor parameter R2	-	Motor R2 (slip)
H022 / H032	Motor parameter L	-	Motor L (inductance)
H023 / H033	Motor parameter IO	-	Motor no load current
H024 / H034	Motor parameter J	-	Motor inertia
H050	PI proportional gain	-	ASR P
H051	PI integral gain	-	ASR I
P011	Encoder pulses	1024	Number of actual encoder pulses
P012	V2 control mode selection	00: ASR (speed control mode)	Speed control mode
P025	Secondary resistance compensation enable/disable selection	00: OFF (Disabled)	Secondary resistance compensation (temperature) enable/disable only for vector control
P026	Overspeed error detection level	135.0	Sets the overspeed error detection level
P027	Speed deviation error detection level	7.50	When the deviation between real frequency exceeds this value, the DSE signal turns on
P031	Acceleration/deceleration time input time	00: OPE (Digital Operator)	Select the acceleration and deceleration from the digital operator

 **Warning:** Minimum value for parameters F002 (Acceleration time 1) and F003 (Deceleration time 1) is 0.10 seconds. If the value is lower than 0.10 a PRG syntax error will appear.

## 5 OPERATION DIAGRAMS

The following block diagram tries to explain how the limitation function works, which is the priority of the speed selection inputs and the ramp generator.

The brake control output is also described.

### Brake output sequence timing diagrams

Values are unreal (too big) values in order to make the meaning of parameters more evident

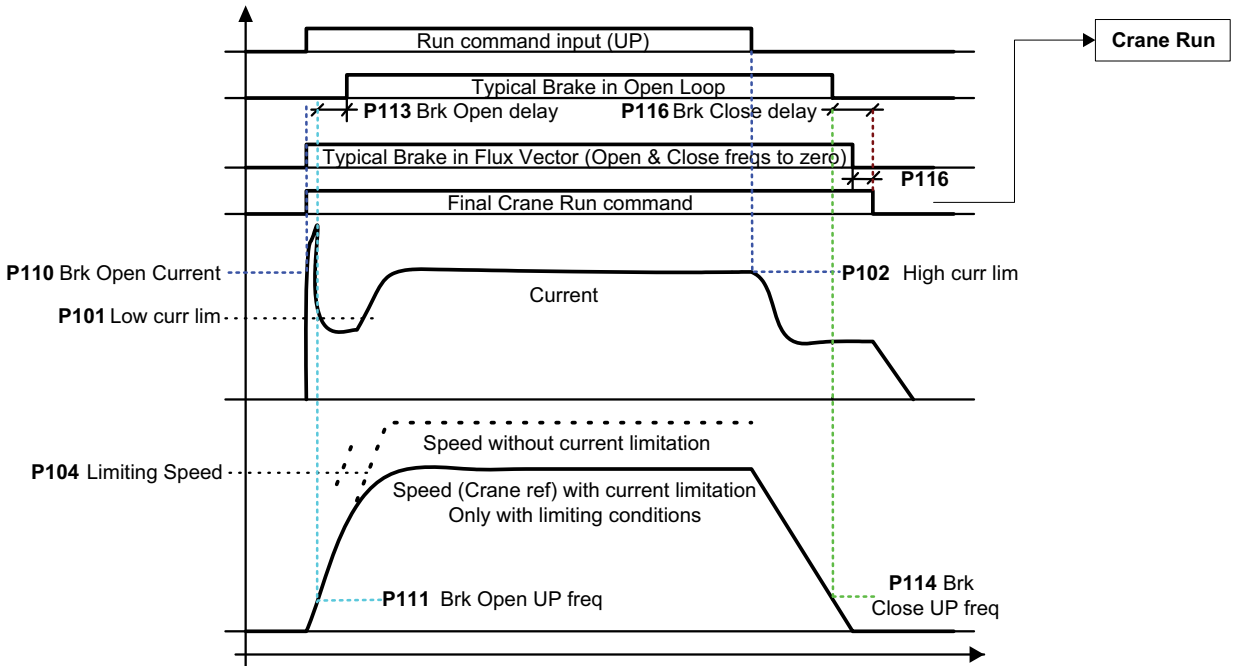

### SPEED SELECTION & CURRENT LIMITING SECTION

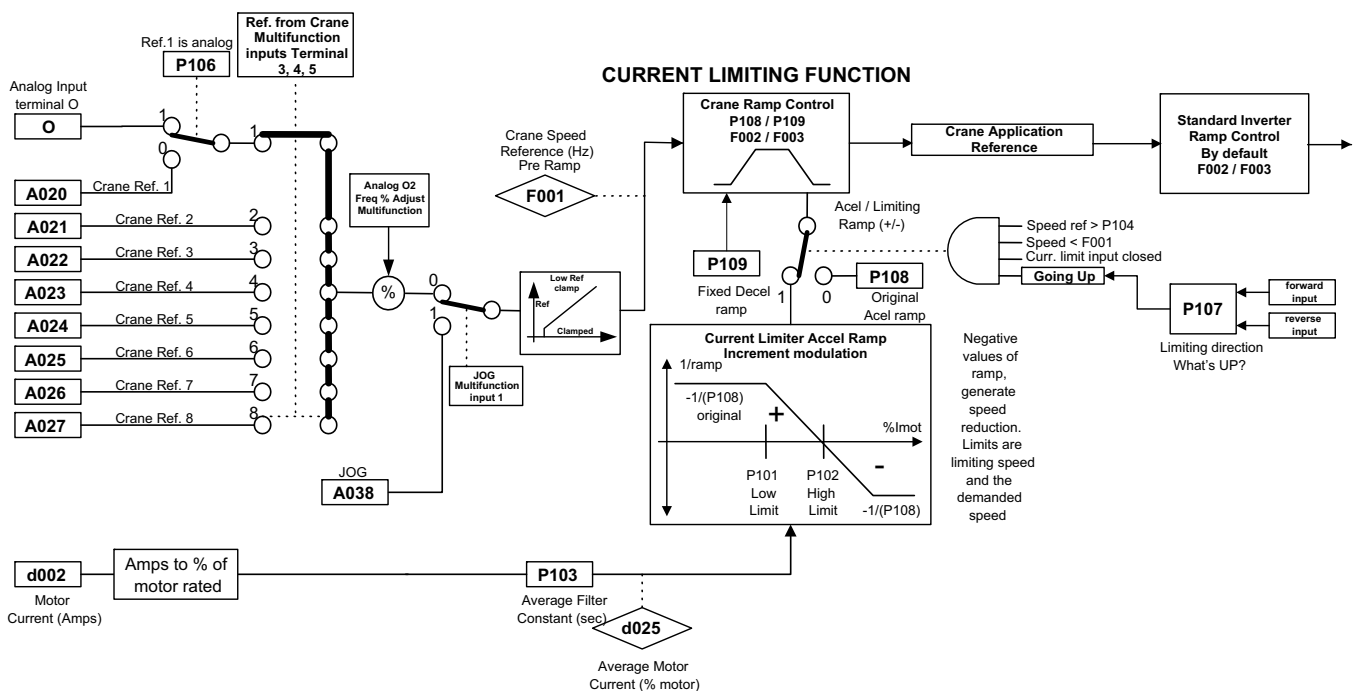





# OMRON

**Authorized Distributor:**