

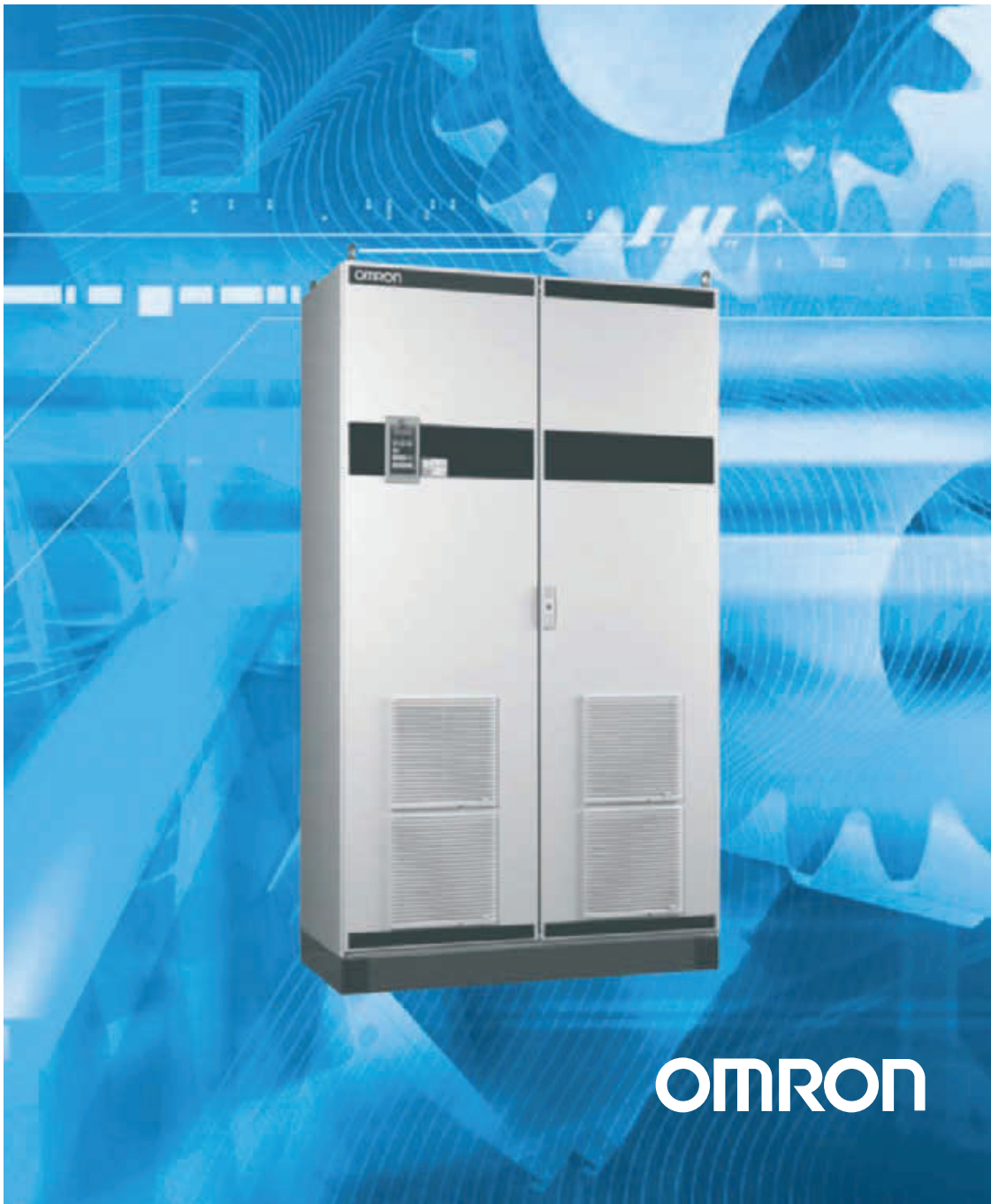

SX-AFE

Instruction Manual



OMRON

OMRON

SX AFE (Active Frond End Option)

Instruction manual – English

Document number: I123E-EN-01

Date of release: May '15

© OMRON, 2015

All rights reserved. No part of this publication may be reproduced, stored in a retrieval system, or transmitted, in any form, or by any means, mechanical, electronic, photocopying, recording, or otherwise, without the prior written permission of OMRON.

No patent liability is assumed with respect to the use of the information contained herein. Moreover, because OMRON is constantly striving to improve its high-quality products, the information contained in this manual is subject to change without notice. Every precaution has been taken in the preparation of this manual. Nevertheless, OMRON assumes no responsibility for errors or omissions. Neither is any liability assumed for damages resulting from the use of the information contained in this publication.

Safety Instructions

Instruction manual

Read this instruction manual before using the system.

The following symbols can appear in this manual. Always read these first before continuing:

NOTE: Additional information as an aid to avoid problems.



CAUTION!
Failure to follow these instructions can result in malfunction or damage to the active front end or motor inverter.



WARNING!
Failure to follow these instructions can result in serious injury to the user in addition to serious damage to the active front end or motor inverter.



HOT SURFACE!
Failure to follow these instructions can result in injury to the user.

Handling the Active front end unit

Installation, commissioning, demounting, taking measurements, etc, of or on the active front end may only be carried out by personnel technically qualified for the task. The installation must be carried out in accordance with local standards.

Opening the Active front end unit



WARNING!
Always switch off the mains voltage before opening the drive unit and wait at least 7 minutes to allow the buffer capacitors to discharge.

Always take adequate precautions before opening the active front end. Although the connections for the control signals and the switches are isolated from the main voltage, do not touch the control board when the active front end is switched on.

Precautions to be taken with a connected motor

If work must be carried out on a connected motor or on the driven machine, the mains voltage must always be disconnected from the active front end first. Wait at least 7 minutes before starting work.

Earthing

The active front end must always be earthed via the mains safety earth connection.

Earth leakage current



CAUTION!
This active front end has an earth leakage current which does exceed 3.5 mA AC. Therefore the minimum size of the protective earth conductor must comply with the local safety regulations for high leakage current equipment which means that according the standard IEC61800-5-1 the protective earth connection must be assured by one of following conditions:

1. Use a protective conductor with a cable cross-section of at least 10 mm² for copper (Cu) or 16 mm² for aluminium (Al).
 2. Use an additional PE wire, with the same cable cross-section as the used original PE and mains supply wiring.
-

Residual current device (RCD) compatibility

This product cause a DC current in the protective conductor. Where a residual current device (RCD) is used for protection in case of direct or indirect contact, only a Type B RCD is allowed on the supply side of this product. Use RCD of 300 mA minimum.

EMC Regulations

In order to comply with the EMC Directive, it is absolutely necessary to follow the installation instructions. All installation descriptions in this manual follow the EMC Directive.

Mains voltage selection

The active front end may be ordered for use with the mains voltage range listed below.

SX-FR/VL/AFR 400V models: 380-460 V

SX-FR/VL/AFR 690V models: 480-690 V

Voltage tests (Megger)

Do not carry out voltage tests (Megger) on the motor, before all the motor cables have been disconnected from the active front end and variable speed drive.

Condensation

If the active front end or motor inverter is moved from a cold (storage) room to a room where it will be installed, condensation can occur. This can result in sensitive components becoming damp. Do not connect the mains voltage until all visible dampness has evaporated.

Incorrect connection

The Active front end or motor inverter drive is not protected against incorrect connection of the mains voltage, and in particular against connection of the mains voltage to the motor outputs U, V and W. The Active front end or motor inverter can be damaged in this way.

Power factor capacitors for improving $\cos\phi$

Remove all capacitors from the motor and the motor outputs.

Precautions during Autoreset

When the automatic reset is active, the motor will restart automatically provided that the cause of the trip has been removed. If necessary take the appropriate precautions.

Transport

To avoid damage, keep the active front end and motor inverter in its original packaging during transport. This packaging is specially designed to absorb shocks during transport.

IT Mains supply

The Active front end can be modified for an IT mains supply, (non-earthed neutral), please contact your supplier for details.

Heat warning



Be aware of specific parts on the Active front end and motor inverter having high temperature.

DC-link residual voltage



WARNING: After switching off the mains supply, dangerous voltage can still be present in the Active front end-AFR or motor inverter-AC drive. When opening the equipment for installing and/or commissioning activities wait at least 5 minutes. In case of malfunction a qualified technician should check the DC-link or wait for one hour before dismantling the AFR or AC drive for repair.

Contents

	<i>SAFETY INSTRUCTIONS.....</i>	<i>III</i>
<i>1</i>	<i>INTRODUCTION</i>	<i>3</i>
	1.1 Delivery and unpacking	3
	1.2 Using of the instruction manual.....	3
	1.3 Type code number.....	3
	1.4 Standards.....	4
	1.5 Dismantling and scrapping	5
	1.6 Glossary.....	5
<i>2</i>	<i>GENERAL DESCRIPTION.....</i>	<i>7</i>
	2.1 AC drive types	7
	2.2 OMRON AFR cabinet concept.....	8
	2.3 OMRON AFR features.....	9
<i>3</i>	<i>MOUNTING</i>	<i>11</i>
	3.1 Lifting instructions	11
	3.2 Cabinet mounting.....	12
<i>4</i>	<i>INSTALLATION</i>	<i>15</i>
	4.1 Before installation.....	15
	4.2 Connect motor and mains.....	15
	4.3 Cable specifications	16
<i>5</i>	<i>CONTROL CONNECTIONS FOR OMRON SX-FR AND SX-VL.....</i>	<i>17</i>
	5.1 Terminal connections for AFR.....	18
	5.2 Connecting the Control Signals.....	18
	5.3 Connecting options	20
<i>6</i>	<i>GETTING STARTED</i>	<i>21</i>
	6.1 Connect the mains and motor cables.....	21
	6.2 Using the function keys	21
	6.3 Remote control.....	21
<i>7</i>	<i>EMC AND MACHINE DIRECTIVE</i>	<i>25</i>
	7.1 EMC standards.....	25
	7.2 Stop categories and emergency stop	25
<i>8</i>	<i>OPERATION VIA THE CONTROL PANEL</i>	<i>27</i>
	8.1 Control panels	27
	8.2 General	27
	8.3 The control panel.....	28
	8.4 The menu structure	31
	8.5 Programming during operation	31
	8.6 Editing values in a menu.....	32
	8.7 Copy current parameter to all sets	32
	8.8 Programming example.....	32

9	FUNCTIONAL DESCRIPTION FOR AFR UNIT	33
9.1	Preferred View [100].....	33
9.2	Main Setup [200]	33
9.3	Process and Application Parameters [300].....	35
9.4	I/Os and Virtual Connections [500].....	35
9.5	Logical Functions and Timers [600].....	35
9.6	View Operation/Status [700].....	36
9.7	View Trip Log [800].....	37
9.8	System Data [900]	37
9.9	AFR Option [O00]	38
10	TROUBLESHOOTING, DIAGNOSES AND MAINTENANCE	43
10.1	Trips, warnings and limits	43
10.2	Trip conditions, causes and remedial action.....	43
10.3	Maintenance.....	46
11	TECHNICAL DATA	47
11.1	Electrical and mechanical specifications related to model.....	47
11.2	General electrical specifications	49
11.3	Operation at higher temperatures.....	50
11.4	Environmental conditions	50
11.5	Control signals.....	50
12	MENU LIST	53
12.1	Communication information list.....	56

Chapter 1 Introduction

Note: Read this instruction manual carefully before starting installation, connection or working with the active front end or motor inverter.

Users

This instruction manual is intended for:

- Installation engineers
- Maintenance engineers
- Operators
- Service engineers

Motors

The active front end and motor inverter are suitable for use with standard 3-phase asynchronous motors. Under certain conditions it is possible to use other types of motors. Contact your supplier for details.

1.1 DELIVERY AND UNPACKING

Check for any visible signs of damage. Inform your supplier immediately of any damage found. Do not install the active front end or motor inverter if damage is found.

1.2 USING OF THE INSTRUCTION MANUAL

Within this instruction manual the abbreviation “AFR” is used to indicate the complete active front end as a single unit.

Check that the software version number on the first page of this manual matches the software version in the active front end. See chapter chapter 9.8 page 37 for more information

With help of the Index and the Table of contents in this manual, it is easy to track individual functions and to find out how to use and set them.

1.3 TYPE CODE NUMBER

Fig. 1 gives an example of the type code numbering used on all active front ends. With this code number the exact type of the drive can be determined. This identification will be required for type specific information when mounting and installing. The code number is located on the product label, on the front of the unit.

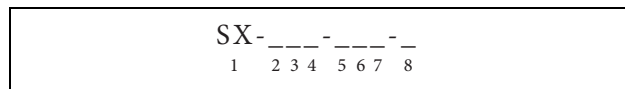

Fig. 1 Type code number

Position	Code	Description
1	SX	SX series inverter
2	D	IP54 protection class
3	4 = 400 V	Voltage
	6 = 690 V	
4	055 (55 kW) to 1K1 (1100 kW)	Rated power
5	E1	Europe IP54 cabinet with front door fan
6	V = V/Hz	Control type
	F = Direct torque control	
7	L = Low harmonic drive	AFE type
	R = Regenerative drive	
	AR= DC Bus supply	
8 (Options)	A = Blank control panel (Blank PPU)	Control panel
	B = IT-Net (filter disconnected from ground)	Built-in EMC filter
	E = Standby power supply included	Standby power supply
	G = Coated boards	Coated boards
	H = Crane I/O	Option board position 1/2/3
	I = Encoder	
	J = PTC/PT100	
	K = Extended I/O	
	L = DeviceNet	
	M = PROFIBUS-DP	Option board Fieldbus position 4
	M1= PROFINET	
N = RS232/485		
O = Ethernet Modbus TCP		
O1= EtherCAT		
P = Liquid cooling	Liquid cooling	

1.4 STANDARDS

The active front ends and variable speed drives described in this instruction manual comply with the standards listed in table 1. For the declarations of conformity and manufacturer's certificate, contact your OMRON representative for more information or visit industrial.omron.eu.

1.4.1 Product standard for EMC

Product standard EN(IEC)61800-3, second edition of 2004 defines the:

First Environment (Extended EMC) as environment that includes domestic premises. It also includes establishments directly connected without intermediate transformers to a low voltage power supply network that supplies buildings used for domestic purposes.

Category C2: Power Drive System (PDS) of rated voltage <1.000 V, which is neither a plug in device nor a movable device and, when used in the first environment, is intended to be installed and commissioned only by a professional.

Second environment (Standard EMC) includes all other establishments.

Category C3: PDS of rated voltage <1.000 V, intended for use in the second environment and not intended for use in the first environment.

Category C4: PDS or rated voltage equal or above 1.000 V, or rated current equal to or above 400 A, or intended for use in complex systems in the second environment.

The active front end and motor inverter complies with the product standard EN(IEC) 61800-3:2004 (Any kind of metal screened cable may be used). The standard active front end is designed to meet the requirements according to category C3.

By using the optional "Extended EMC" filter the VSI fulfils requirements according to category C2,



WARNING!

In a domestic environment this product may cause radio interference, in which case it may be necessary to take adequate additional measures.



WARNING!

The standard AFR or VSI, complying with category C3, is not intended to be used on a low-voltage public network which supplies domestic premises; radio interference is expected if used in such a network. Contact your supplier if you need additional measures.

Market	Standard	Description
European	Low Voltage Directive	2006/95/EC
	WEEE Directive	2002/96/EC
All	EN 60204-1	Safety of machinery - Electrical equipment of machines Part 1: General requirements.
	EN(IEC)61800-3:2004	Adjustable speed electrical power drive systems Part 3: EMC requirements and specific test methods. EMC Directive: Declaration of Conformity and CE marking
	EN(IEC)61800-5-1 Ed. 2.0	Adjustable speed electrical power drive systems Part 5-1. Safety requirements - Electrical, thermal and energy. Low Voltage Directive: Declaration of Conformity and CE marking
	IEC 60721-3-3	Classification of environmental conditions. Air quality chemical vapours, unit in operation. Chemical gases 3C2, Solid particles 3S2. Optional with coated boards Unit in operation. Chemical gases Class 3C3, Solid particles 3S2.

Table 1 Standards

1.5 DISMANTLING AND SCRAPPING

The enclosures of the drives are made from recyclable material as aluminium, iron and plastic. Each drive contains a number of components demanding special treatment, for example electrolytic capacitors. The circuit boards contain small amounts of tin and lead. Any local or national regulations in force for the disposal and recycling of these materials must be complied with.

1.5.1 Disposal of old electrical and electronic equipment

This information is applicable in the European Union and other European countries with separate collection systems.

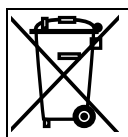

This symbol on the product or on its packaging indicates that this product shall be taken to the applicable collection point for the recycling of electrical and electronic equipment. By ensuring this product is disposed of correctly, you will help prevent potentially negative consequences for the environment and human health, which could otherwise be caused by inappropriate waste handling of this product. The recycling of materials will help to conserve natural resources. For more detailed information about recycling this product, please contact the local distributor of the product.

1.6 GLOSSARY

1.6.1 Abbreviations and symbols

In this manual the following abbreviations are used:

Abbreviation/symbol	Description
AFE	Active front end
AFR	Regenerative active front end
DFE	Diode front end
SX-FR	Regenerative drive
SX-VL	Low harmonic drive
AC drive	Frequency converter
VSI	Voltage source inverter (motor inverter)
LCL-filter	Induction - Capacitance - Induction filter
THD	Total harmonic distortion
CP	Control panel, the programming and presentation unit on the unit
EInt	Communication format
UInt	Communication format (Unsigned integer)
Int	Communication format (Integer)
Long	Communication format (4 byte integer)
	The function cannot be changed in run mode

Table 2 Abbreviations

1.6.2 Definitions

In this manual the following definitions for current, torque and frequency are used:

Name	Description	Quantity
I_{IN}	Nominal input current of AFR	A_{RMS}
I_{NOM}	Nominal output current of VSI	A_{RMS}
I_{MOT}	Nominal motor current	A_{RMS}
P_{NOM}	Nominal power of VSI	kW
P_{MOT}	Motor power	kW
T_{NOM}	Nominal torque of motor	Nm
T_{MOT}	Motor torque	Nm
f_{OUT}	Output frequency of VSI	Hz
f_{MOT}	Nominal frequency of motor	Hz
n_{MOT}	Nominal speed of motor	rpm
I_{CL}	Maximum output current	A_{RMS}
Speed	Actual motor speed	rpm
Torque	Actual motor torque	Nm

Table 3 Definitions

Chapter 2 General description

The OMRON AFR is a regenerative active front end (AFE) unit designed to be used together with motor inverters (VSIs), to comprise a complete VSI. The OMRON AFR consists of an active rectifier module and a LCL-filter. The main objective of the OMRON AFR is to rectify the supply AC voltage into DC voltage to be fed to or regenerated from the VSIs. This is achieved with minimal impact on the supply by the control of the active rectifier module which provides sinusoidal input currents with a very low harmonic content, typically a THD(I) below 5%.



CAUTION!
Always consult OMRON before connecting an AFR to a standard VSI.

2.1 AC DRIVE TYPES

2.1.1 Standard AC drive (as comparison)

A standard AC drive consists of a rectifier module and an inverter module. The rectifier module (front-end) consists of a 6-pulse diode bridge, i.e. diode front-end (DFE) while the inverter module (VSI) consists of IGBTs with anti-parallel free wheeling diodes, see Fig. 2. The main advantages of DFEs are the simple and robust design together with their high efficiency, i.e. low losses. The main disadvantages are unidirectional power flow and the high harmonic content in the line current, typically THD 30- 40%.

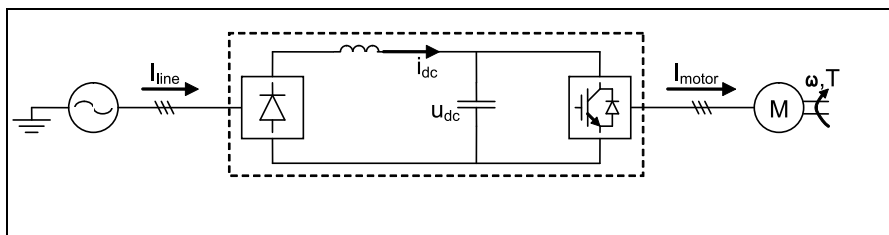

Fig. 2 Standard AC drive.

2.1.2 AC drive with AFR (as this delivery)

An AFR unit is basically a VSI towards the supply (via a filter) where the IGBTs are used as an active rectifier, see Fig. 3. The main advantages are inherent 4Q-operation, i.e. bi-directional power flow, and sinusoidal supply currents, i.e. low harmonics.

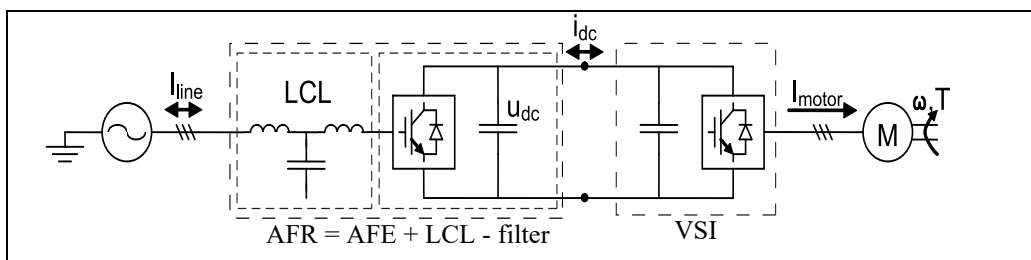

Fig. 3 VSI with AFR.

The AFR unit is controlled in such a way to keep the energy between motor and supply in balance. This is achieved by controlling the DC-link voltage (U_{dc}). Other features are the possibility for reactive power compensation and boosted DC-link voltage.

2.2 OMRON AFR CABINET CONCEPT

2.2.1 Single drive applications

The OMRON regenerative AC drive, i.e. SX-FR, is comprised by an AFR unit, i.e. AFE and filters, and a VSI, i.e. a standard SX inverter. The concept is designed as a cabinet solution, see Fig. 4 ,

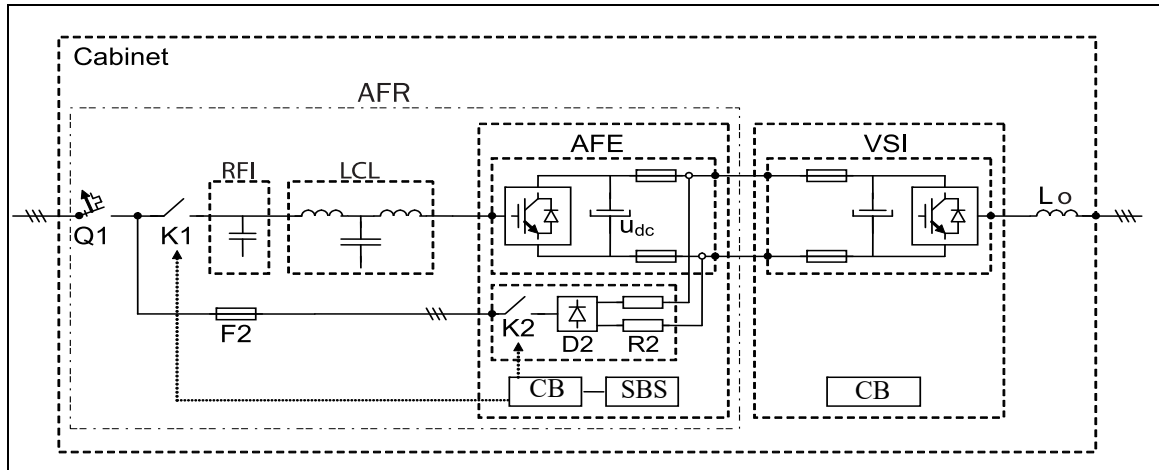

Fig. 4 Single drive in cabinet

where

- Cabinet - IP54 cabinet with door fans
- Q1 - Main switch *
- K1 - Main contactor *
- RFI - EMC filter
- LCL - LCL filter
- F2 - MCB (Miniature circuit breaker) for pre-charge circuit
- AFE - OMRON AFE module with 24V standby supply board and integrated pre-charge circuit (K2,D2,R2)
- AFR - OMRON AFE and filters
- VSI - DC-voltage fed VSI module, i.e. OMRON standard SX
- CB - Control board
- SBS - Standby supply board
- Lo - Output coil

*) For larger units, Q1 Main switch and K1 Main contact are replaced by Q1 Motorized circuit breaker.

2.2.2 Common DC-bus applications

For common DC-bus applications, the cabinet will contain only the AFR part of Fig. 4, i.e. all except the VSI & Lo.

2.3 OMRON AFR FEATURES

2.3.1 Power-up and DC-link charging

Power up and charge control of the OMRON AFR and DC-link (U_{dc}) is handled via the dedicated control board (CB) relays 1 and 3, where Charge contactor (K2) control is fixed to CB Relay1 and Main contactor (K1) is fixed to CB Relay3.

Typical charge time is 3-5 s and an additional delay after K1 activation of 1s is added before Run (or Auto ID) command is acknowledged.

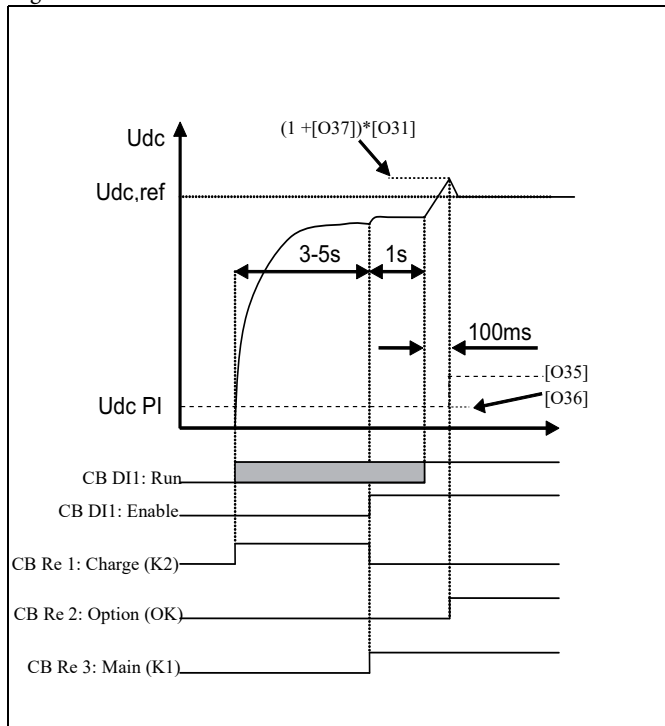

Fig. 5 DC-link voltage (U_{dc}) charge control.

Optional signal Running OK, i.e. U_{dc} under control, is signaled via default CB Relay2 selection 'Option' and is preferably used to enable the VSIs in order to interlock the AFR and VSIs. Typical time delay is <100ms after acknowledged run command. If Auto ID mode [O16] is used an additional delay of 1s is inserted before Run command is acknowledged.

AFR I/O	Contactor K1/K2	Comment
Re1='Charge contactor' {NC/NO}	K2.A1 (coil/ctrl)	
Re3='Main contactor' {NO}	K1.A1 (coil/ctrl)	
DI3='Enable'	K1.NO (aux)	Enable AFR only if K1 OK. Preferably used also for "Emergency Stop" input.

Table 4 I/O connection for AFR charge operation

2.3.2 Automatic power supply parameter detection

The AFR can automatically detect power supply parameters voltage [O11], frequency [O12] and phase sequence [O14] by separately activated function either manually [O15] or automatically at every power up [O16].

The power supply parameters are detected by running a network measurement routine. See chapter 9.9 page 38 for detailed information about AFR parameters.

2.3.3 Power supply synchronisation

The AFR synchronises to the power supply when starting by making test measurement. Synchronisation during operation is handled via the U_{dc} [O30], Q [O40] and frequency [O50] controllers. See chapter 9.9 page 38 for detailed information about AFR parameters.

Synchronisation methods

- Standard sync (Default), extended sync routine. This routine also verifies supply network. Takes approx. 50 ms.
- Voltage sync, i.e. via supply voltage measurement.
- Fast sync (fast measurement).

Fast sync method can be enabled via a service menu. Voltage sync requires supply voltage measurement option and is enabled via [O17].

2.3.4 Start command

The AFR can be started from digital I/O, control panel (CP) or via serial communication options. Typically the AFR is started via digital I/O either automatically at power up or by the VSI when the VSI has a run command.

In order to avoid unnecessary losses it is preferred only to run the AFR when needed, i.e. when the VSI has a run command. Fig. 14, page 17

2.3.5 Start on regeneration demand

The AFR can be started on regeneration demand [O22], i.e. when the DC-link voltage increases due to generated power from the VSIs. In motoring operation the AFR modulation is deactivated and the free wheeling diodes operates as a DFE and in regenerating operation the AFR is activated and regenerates the energy back to the supply.

Regeneration start/stop operation

- The AFR will start (DFE stop) when DC-link voltage rises due to energy flow from load towards DC-link.
- The AFR will stop (DFE start) when energy flow from supply is positive (into the AFR) during stop delay time [O23].

Note: Requires supply voltage measurement.

2.3.6 PWM modulation

The AFR uses carrier wave based PWM modulation for controlling the IGBTs. The switching (carrier) frequency and PWM mode can be setup in [O60].

2.3.7 Active power (Energy) control

The energy control is utilized by the DC-link voltage controller [O30] which balances the active power flow from supply to load, see Fig. 6

It is possible to set/change

- U_{DC} reference value - limited by the requirement of operation, i.e. voltage amplitude control.
- U_{DC} ramp time
- U_{DC} margin value
- U_{DC} controller parameters.

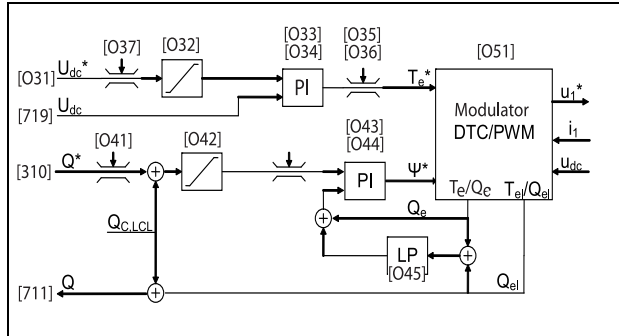

Fig. 6 U_{dc} and Q controllers.

PI - PI regulator

LP - Low pass filter

Te - Active power

Qe - Reactive power

*) Reference

2.3.8 Reactive power (Q or $\cos \varphi$) control (normally not used)

The reactive power (Q or $\cos \varphi$) control can be used for reactive power compensation of other loads, i.e. motors. The amount of reactive power compensation possible is dependent on the unused capacity of the AFR, i.e. over capacity not used for active power control. The reactive power control is utilised via the Q controller [O40], see Fig. 6.

It is possible to set/change

- Q reference value via standard reference source (Remote, CP or COM)
- Q max limit
- Q ramp time
- Q controller parameters

2.3.9 Frequency (f) control

The AFR handles frequency variations via the supply frequency observer [O50].

2.3.10 Energy actual value signals

The AFR provides separate signals for: consumed, generated and total energy in group [O80] of the AFR.

2.3.11 Fault signals

The AFR provides separate fault signals for specific AFR related trips:

- Supply error - Synchronization failure due to supply error problems
- Phase error - Synchronization failure due to frequency or phase sequence problems
- Sync error - Synchronization failure due to overcurrent
- AutoID error - Failure during Auto Identification Run, i.e. supply not correctly identified.
- Sensor error - Failure in supply voltage measurement option
- Frequency error - Supply frequency out of range
- Voltage error - Supply voltage out of range

2.3.12 Supply voltage measurement option

Supply voltage measurement can add the following improved functions

- AFR as Regenerative unit, i.e. DFE mode used in motor operation and AFR active in generator operation.
- Faster power supply synchronization.

Chapter 3 Mounting

This chapter describes how to mount the AC drive.

Before mounting it is recommended that the installation is planned first.

- Be sure that the AC drive suits the mounting location.
- The mounting site must support the weight of the AC drive.
- Will the AC drive continuously withstand vibrations and/or shocks?
- Check ambient conditions, ratings, required cooling air flow, compatibility of the motor, etc.
- Know how the AC drive will be lifted and transported.

3.1 LIFTING INSTRUCTIONS

The easiest way to move or lift the equipment is to use the lifting eyes on top of the cabinet, see Fig. 7.

When lifting, be careful not to damage the air outlets.

Note: To prevent personal risks and any damage to the unit during lifting, it is advised to use the lifting eyes on top of the equipment.

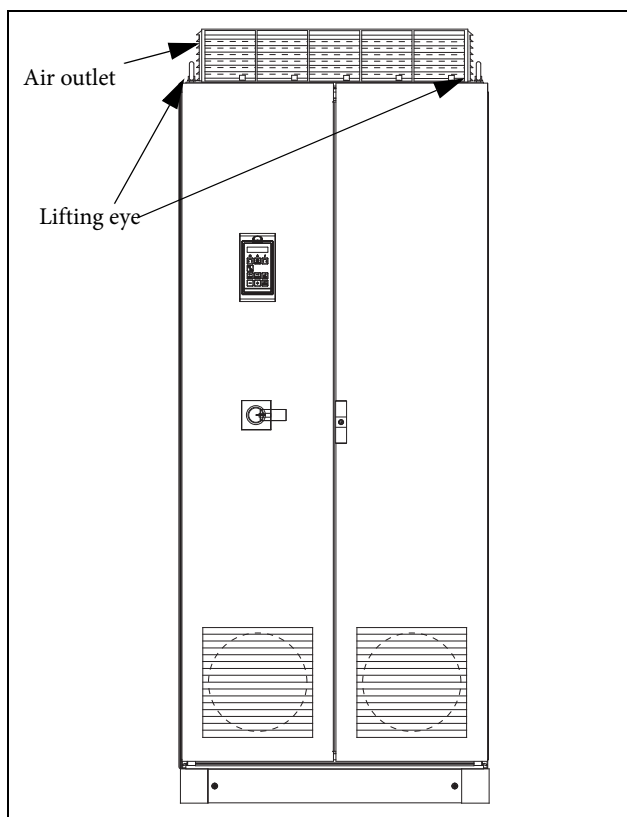

Fig. 7 Use the lifting eyes.

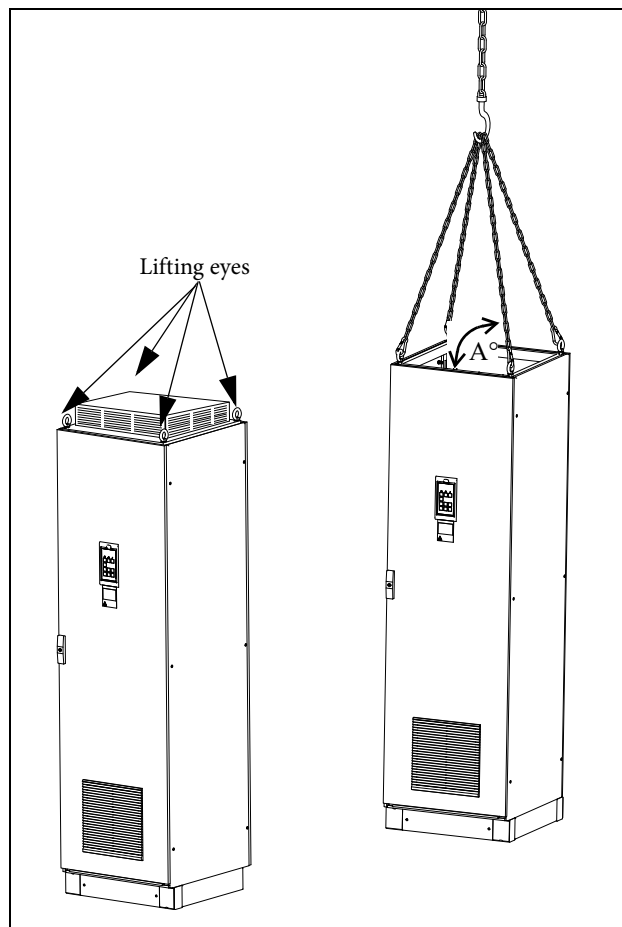

Fig. 8 Remove the roof unit and use the lifting eyes to lift single unit 600mm and 900mm.

Single cabinet drives can be lifted/transported safely using the eye-bolts supplied and lifting cables/chains as in illustration Fig. 8 above. Depending on the cable/chain angle A (in Fig. 8), following loads are permitted:

Cable/chain angle A	Permitted load
45 °	4 800 N
60 °	6 400 N
90 °	13 600N

Regarding lifting instructions for other cabinet sizes, please contact your OMRON representative.

3.1.1 Cooling

Fig. 9 below shows the minimum free space required above the AFR and/or VSI cabinets in order to guarantee adequate cooling. Normally the cabinet can be placed close to a wall or another cabinet, however 65° mm space to the wall is required in order to open the cabinet door with main switch handle at least 90 for maintenance.

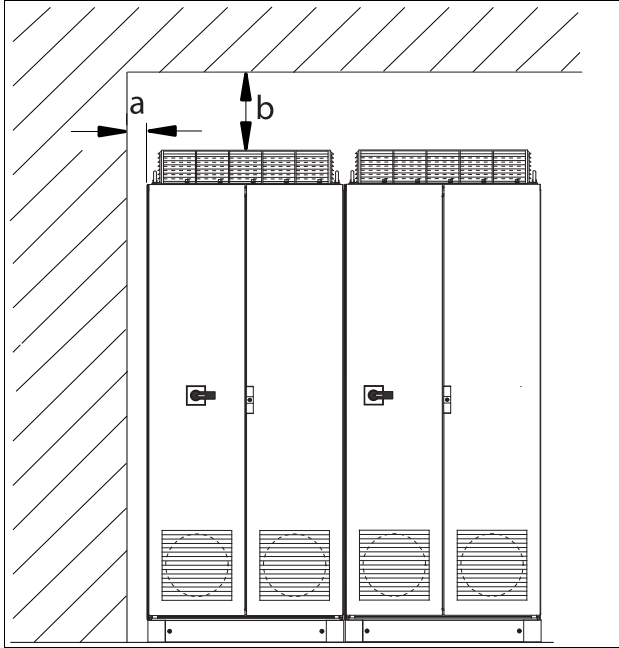

Fig. 9 Required free space around cabinet

Position	Free space
a	65 mm
b	200 mm

Note: When a cabinet is placed between two walls, a minimum distance at each side of 200 mm must be maintained.

3.2 CABINET MOUNTING

3.2.1 Cooling

If the AFR or VSI is installed in a cabinet, the rate of airflow supplied by the cooling fans must be taken into consideration.

Frame	AFR Model [A]	Flow rate [m ³ /hour]
E46	175	510
F46	250	800
F69	175	
G46	375	1020
H46	500	1600
H69	355	
I46	750	2400
I69	525	
J46	1K0	3200
J69	700	
K46	1K5	4800
K69	1K05	

Table 5 Flow rates cooling fans

Frame sizes are listed in chapter 11.1 page 47.

Note: For the models SX-D4560 to SX-D4800 the mentioned amount of air flow should be divided equally over the two cabinets.

3.2.2 Mounting schemes

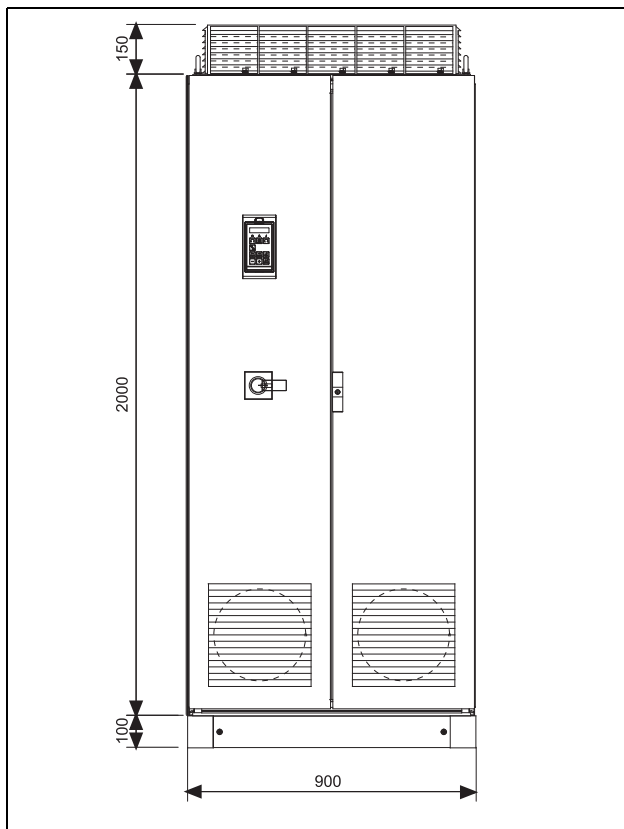

Fig. 10 SX-FR/SX-VL: 4090 to 4132 models

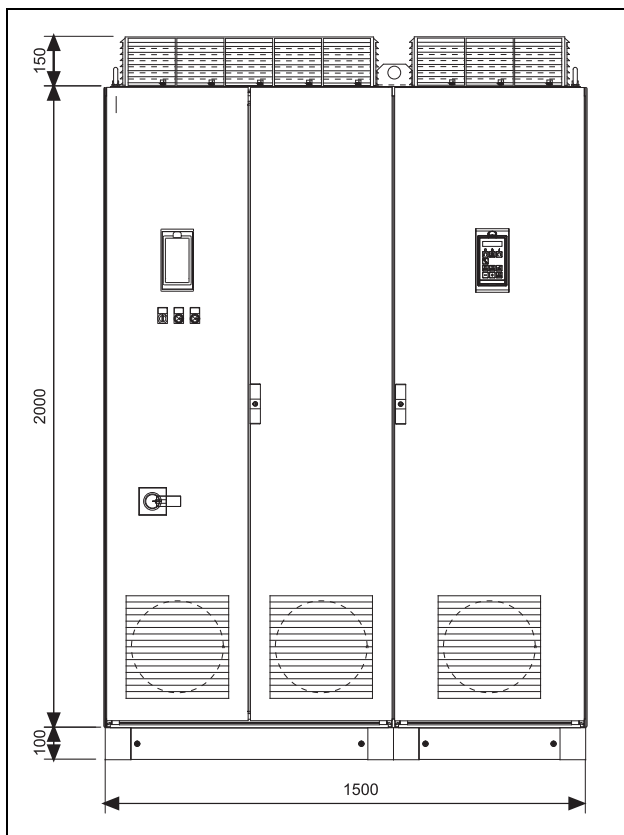

Fig. 11 SX-FR/SX-VL: 4200 to 4250 models

Chapter 4 Installation

The description of installation in this chapter complies with the EMC standards and the Machine Directive.

Select cable type and screening according to the EMC requirements valid for the environment where the AFR and VSI is installed.



CAUTION!
Always consult OMRON before connecting an AFR to a standard AC drive.

4.1 BEFORE INSTALLATION

Read the following checklist and prepare for your application before installation.

- Local or remote control.
- Functions used.
- Suitable AFR and VSI size in proportion to the motor/application.
- Mount separately supplied option boards according to the instructions in the appropriate option manual.

If the AFR and AC drive is temporarily stored before being connected, please check the technical data for environmental conditions. If the AFR and VSI is moved from a cold storage room to the room where it is to be installed, condensation can occur on it. Allow the AFR and VSI to become fully acclimatised and wait until any visible condensation has evaporated before connecting the mains voltage.

4.2 CONNECT MOTOR AND MAINS

4.2.1 Single drives

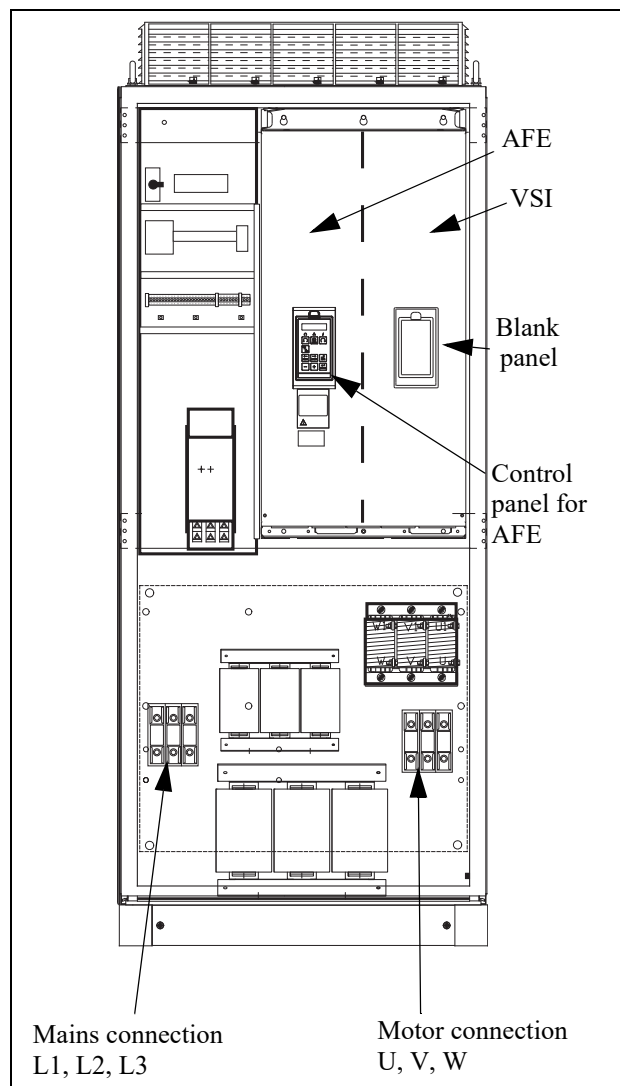

Fig. 12 Connecting motor and mains cables for SX-FR/SX-VL: 4055 to 4132 models

L1,L2,L3	Mains supply, 3 -phase
PE	Safety earth (protective earth)
 U, V, W	Motor earth Motor output, 3-phase
DC-,DC+	DC-link connections (optional)

Table 6 Mains and motor connection

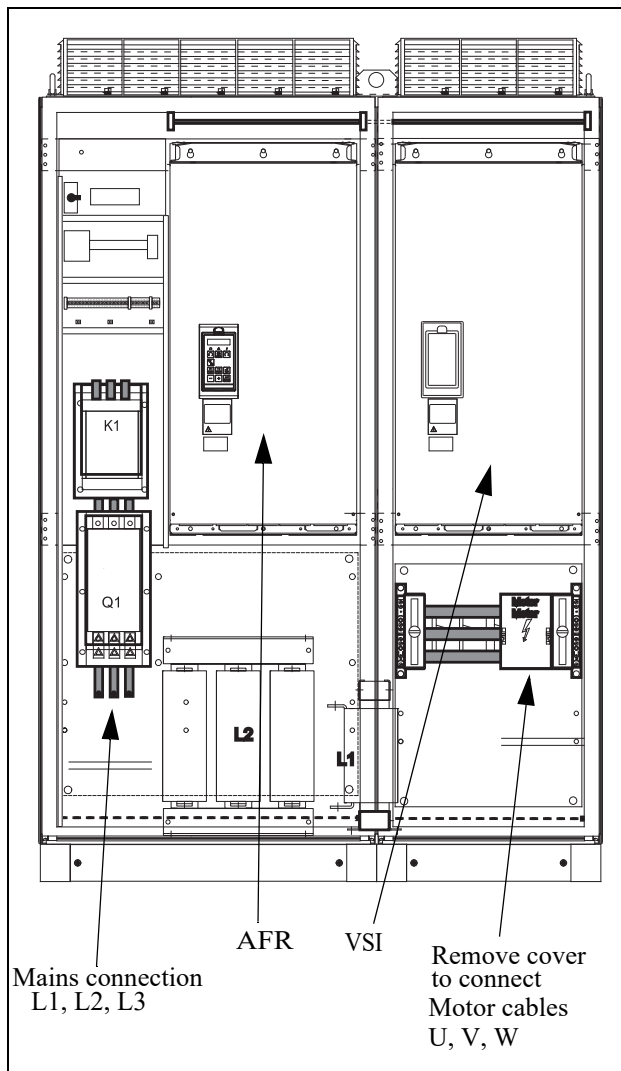

Fig. 13 Connecting motor and mains cables for SX-FR/SX-VL: 4200 to 4250 models

4.2.2 Common DC-bus

For common DC-bus applications, the cabinet will contain only the AFR part.

4.3 CABLE SPECIFICATIONS

Cable	Cable specification
Mains	Power cable suitable for fixed installation for the voltage used.
Motor	Symmetrical three conductor cable with concentric protection (PE) wire or a four conductor cable with compact low-impedance concentric shield for the voltage used.
Control	Control cable with low-impedance shield, screened.

Table 7 Cable specifications

Chapter 5 Control Connections for OMRON SX-FR and SX-VL

Fig. 14 shows typical control signal connections required for basic functionality. For more detailed information, see drawings in cabinet and in the standard SX instruction manuals (I126E/I127E).



WARNING!

Always switch off the mains voltage and wait at least 7 minutes to allow the DC capacitors to discharge before connecting the control signals or changing position of any switches. If the option External supply is used, switch of the mains to the option. This is done to prevent damage on the control board.

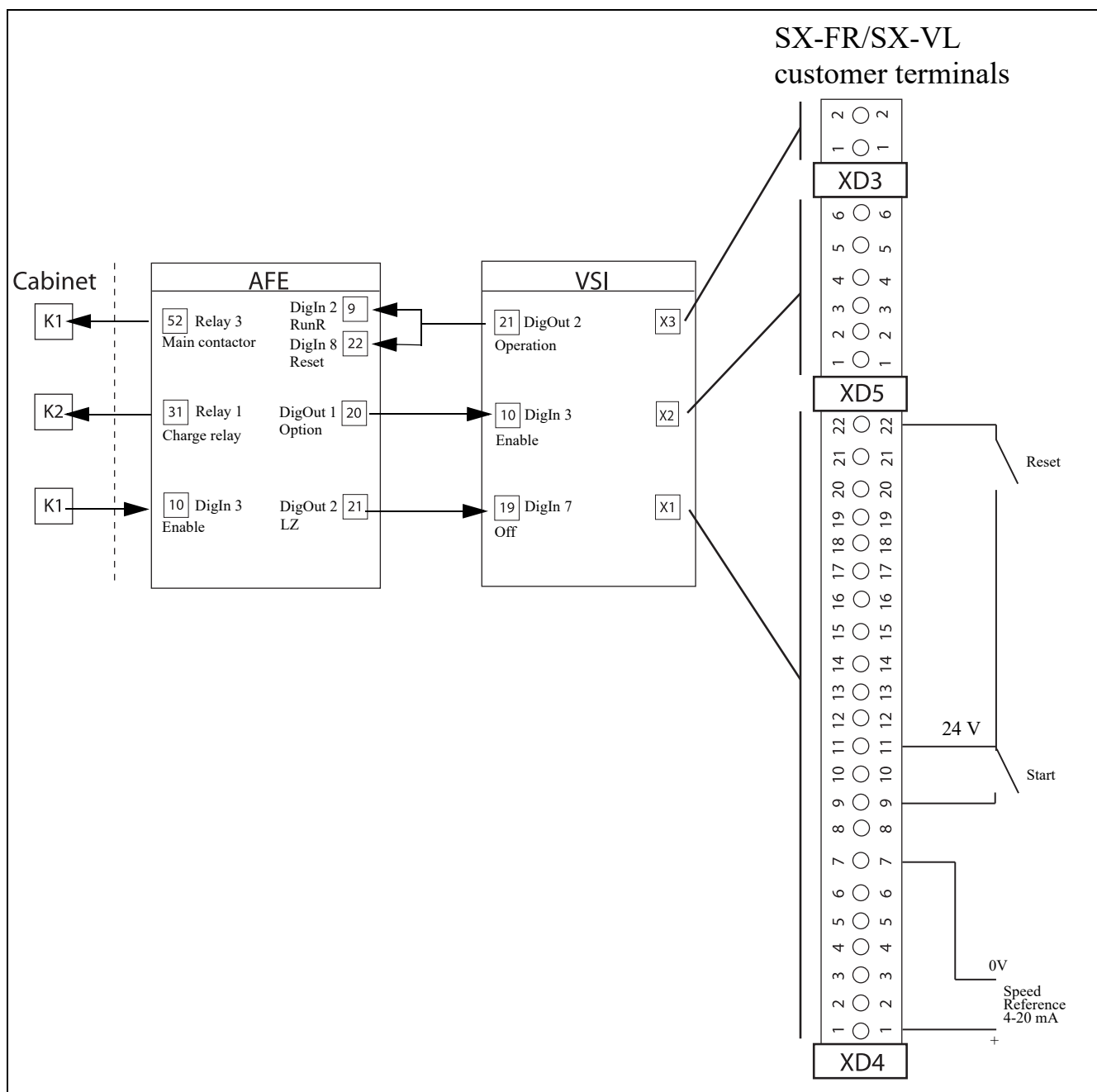

Fig. 14 Recommended control signals

5.1 TERMINAL CONNECTIONS FOR AFR

The terminal strip for connecting the control signals is accessible after opening the front door

The table describes the default functions for the signals. The inputs and outputs are programmable for other functions as described in chapter Chapter 9 page 33. For signal specifications refer to chapter Chapter 11 page 47.

For VSI, refer to standard SX instruction manuals (I126E/I127E).

Note: The maximum total combined current for outputs 11, 20 and 21 is 100mA.

Terminal	Name	Function (Default)
Outputs		
1	+10 V	+10 VDC supply voltage
6	-10 V	-10 VDC supply voltage
7	Common	Signal ground
11	+24 V	+24 VDC supply voltage
12	Common	Signal ground
15	Common	Signal ground
Digital inputs		
8	DigIn 1	RunL (reverse)
9	DigIn 2	RunR (forward)
10	DigIn 3	Enable
16	DigIn 4	Off
17	DigIn 5	Off
18	DigIn 6	Off
19	DigIn 7	Off
22	DigIn 8	RESET
Digital outputs		
20	DigOut 1	Option (Active when AFR is running)
21	DigOut 2	LZ (Trip pulse of 1s)
Analogue inputs		
2	AnIn 1	Process Ref
3	AnIn 2	Off
4	AnIn 3	Dedicated for supply voltage measurement option.
5	AnIn 4	Dedicated for supply voltage measurement option.
Analogue outputs		
13	AnOut 1	0 to nominal current
14	AnOut 2	0 to max torque
Relay outputs		
31	N/C 1	Relay 1 output
32	COM 1	Dedicated for Charge contactor K2.
33	N/O 1	
41	N/C 2	Relay 2 output
42	COM 2	Option (Active when the AFR is running).
43	N/O 2	
51	COM 3	Relay 3 output
52	N/O 3	Dedicated for Main contactor K1

Table 8 Control signals for AFR

Note: N/C is opened when the relay is active and N/O is closed when the relay is active.

5.2 CONNECTING THE CONTROL SIGNALS

5.2.1 Cables

The standard control signal connections are suitable for stranded flexible wire up to 1.5 mm² and for solid wire up to 2.5 mm².

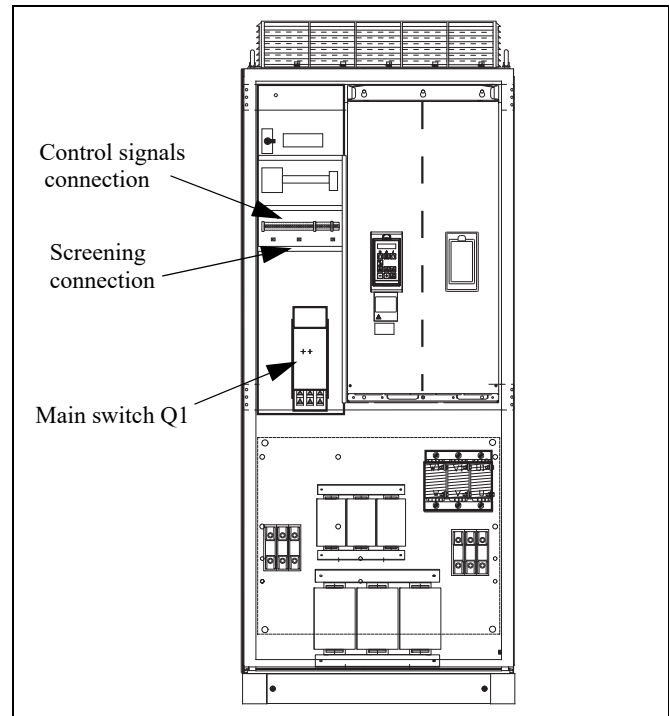

Fig. 15 Connecting the control signals SX-FR/SX-VL: 4055 to 4132 models

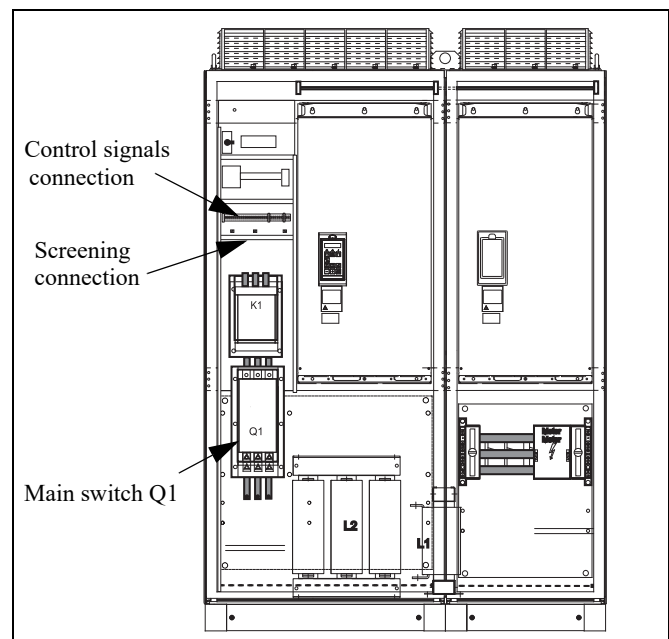

Fig. 16 Connecting the control signal SX-FR/SX-VL: 4200 to 4250 models

Connecting the Control Signals

Note: The screening of control signal cables is necessary to comply with the immunity levels given in the EMC Directive (it reduces the noise level).

Note: Control cables must be separated from motor and mains cables.

5.2.2 Types of control signals

Always make a distinction between the different types of signals. Because the different types of signals can adversely affect each other, use a separate cable for each type. This is often more practical because, for example, the cable from a pressure sensor may be connected directly to the motor inverter.

We can distinguish between the following types of control signals:

Analogue inputs

Voltage or current signals, (0-10 V, 0/4-20 mA) normally used as control signals for speed, torque and PID feedback signals.

Analogue outputs

Voltage or current signals, (0-10 V, 0/4-20 mA) which change slowly or only occasionally in value. In general, these are control or measurement signals.

Digital

Voltage or current signals (0-10 V, 0-24 V, 0/4-20 mA) which can have only two values (high or low) and only occasionally change in value.

Data

Usually voltage signals (0-5 V, 0-10 V) which change rapidly and at a high frequency, generally data signals such as RS232, RS485, Profibus, etc.

Relay

Relay contacts (0-250 VAC) can switch highly inductive loads (auxiliary relay, lamp, valve, brake, etc.).

Signal type	Maximum wire size	Tightening torque	Cable type
Analogue	Rigid cable: 0.14-2.5 mm ²	0.5 Nm	Screened
Digital			Screened
Data	Flexible cable: 0.14-1.5 mm ²		Screened
Relay			Not screened
	Cable with ferrule: 0.25-1.5 mm ²		

Example:

The relay output from a motor inverter which controls an auxiliary relay can, at the moment of switching, form a source of interference (emission) for a measurement signal from, for example, a pressure sensor. Therefore it is advised to separate wiring and screening to reduce disturbances.

5.2.3 Screening

For all signal cables the best results are obtained if the screening is connected to both ends: the VSI side and at the source (e.g. PLC, or computer). See Fig. 17.

It is strongly recommended that the signal cables be allowed to cross mains and motor cables at a 90° angle. Do not let the signal cable go in parallel with the mains and motor cable.

5.2.4 Single-ended or double-ended connection?

In principle, the same measures applied to motor cables must be applied to all control signal cables, in accordance with the EMC-Directives.

For all signal cables as mentioned in § 5.2.2 the best results are obtained if the screening is connected to both ends. See Fig. 17.

Note: Each installation must be examined carefully before applying the proper EMC measurements.

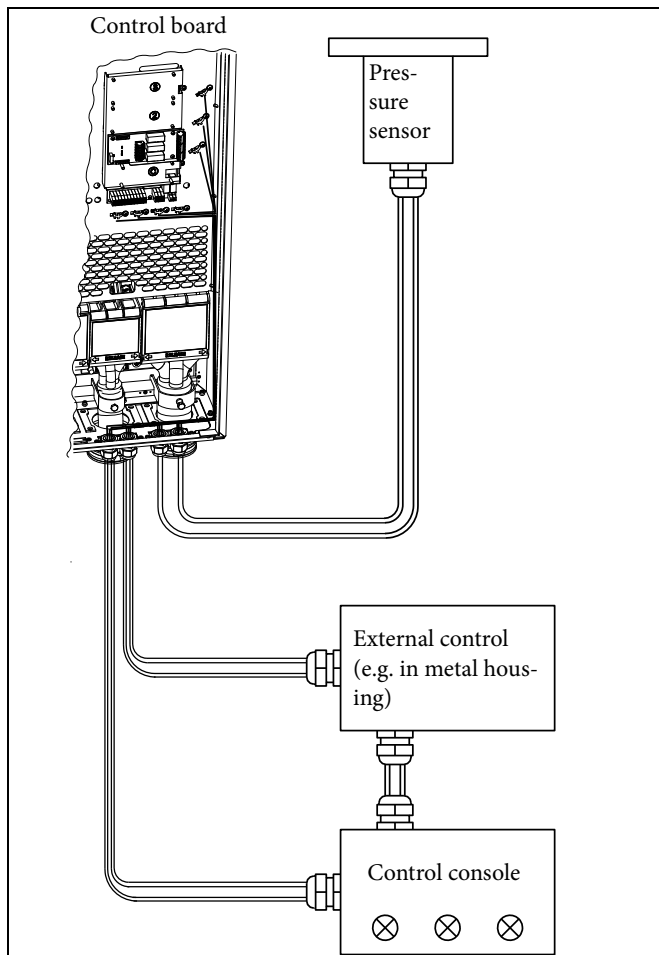

Fig. 17 Electro Magnetic (EM) screening of control signal cables.

5.2.5 Current signals ((0)4-20 mA)

A current signal like (0)4-20 mA is less sensitive to disturbances than a 0-10 V signal, because it is connected to an input which has a lower impedance (250Ω) than a voltage signal ($20 \text{ k}\Omega$). It is therefore strongly advised to use current control signals if the cables are longer than a few metres.

5.2.6 Twisted cables

Analogue and digital signals are less sensitive to interference if the cables carrying them are "twisted". This is certainly to be recommended if screening cannot be used. By twisting the wires the exposed areas are minimised. This means that in the current circuit for any possible High Frequency (HF) interference fields, no voltage can be induced. For a PLC it is therefore important that the return wire remains in proximity to the signal wire. It is important that the pair of wires is fully twisted over 360° .

5.3 CONNECTING OPTIONS

See standard SX instruction manuals (I126E/I127E) for how to connect option cards.

Chapter 6 Getting Started

This chapter is a step by step guide that will show you the quickest way to get the motor shaft turning. We will show you setup with remote control.

We assume that the AFR and VSI is mounted in a cabinet as in the chapter Chapter 3 page 11.

First there is general information of how to connect mains, motor and control cables. The next section describes how to use the function keys on the control panel. The subsequent remote control examples describe how to program/set the motor data and run the AFR, the VSI and motor.

6.1 CONNECT THE MAINS AND MOTOR CABLES

Dimension the mains and motor cables according to local regulations. The cables must be able to carry the AFR and VSI load current. Connect mains cables and motor cables according to chapter 4.2 page 15.

6.2 USING THE FUNCTION KEYS

For more information regarding the control panel and menu system, see chapter Chapter 8 page 27

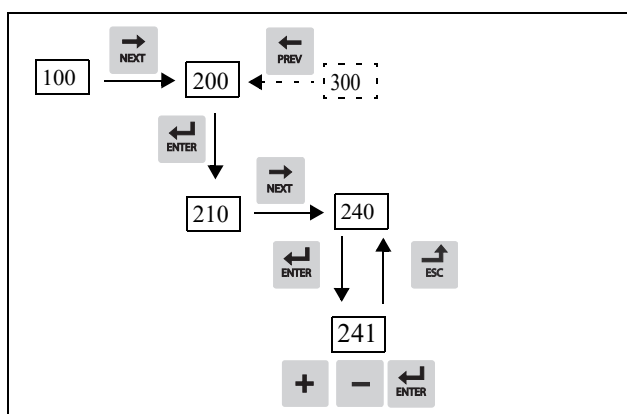







Fig. 18 Example of menu navigation when entering motor voltage

-  step to lower menu level or confirm changed setting
-  step to higher menu level or ignore changed setting
-  step to next menu on the same level
-  step to previous menu on the same level
-  increase value or change selection
-  decrease value or change selection

6.3 REMOTE CONTROL

In this example external signals, an external start button and an analogue reference, are used to control the VSI and motor. The AFR is controlled from the VSI.

In order to perform the setup examples, you will use the control panels for the AFR (inside cabinet) and VSI (cabinet door), see Fig. 21, page 27. For further information about the control panel (CP) and menu structure, see chapter Chapter 8 page 27.

6.3.1 Set up AFR



WARNING!
Always switch off the mains voltage before opening the drive unit and wait at least 7 minutes to allow the buffer capacitors to discharge.

Make sure that the main supply is switched off and open the SX-FR/SX-VL door. Check wiring according to Fig. 14, page 17.

Note: Wiring is pre-made from factory. In this case, wiring is made for Charge method [O21] "Supply-NC" via NC terminal (31) on CB Relay 1.

1. If other Charge method [O21] than default "Supply-NC" = Charge at power supply via NC terminal on Relay 1 is to be used then
 - a) Connect Charge Relay control signal to NO terminal (33)
 - b) Connect external 24V supply. Required for all charge methods [O21] using NO terminal (33).
 - c) Setup required Charge method [O21].

- Switch on the power supply. Once the mains is switched on, the internal fans of the AFR and VSI will run for 5 seconds. Menu [100] Preferred view is displayed in CP after power up.



WARNING!

While power is supplied to the inverter, do not touch any terminal or internal part of the inverter. Do not connect or disconnect any wire or connector. Otherwise, you run the risk of electric shock resulting in serious injury!

In addition this could cause serious damage to the active front end or motor inverter.

- Perform a supply ID-run [O15]
 - [Set [O15] Supply ID run to On, confirm with
 - Give start command
 - The AFE will now measure and setup supply parameters
 - * [O11] Supply voltage
 - * [O13] Supply frequency
 - * [O14] Supply phase sequence
 - After successful ID-run ("Test Run OK" is displayed), press to continue.
 - Verify the new settings for [O11]-[O14].
 - Mains supply voltage [O11] can preferably be manually set back to the average mains supply voltage value after ID-run. This is recommended if the mains supply voltage fluctuates much over time.
- For 1st run, setup AFE to start from CP.
 - Set Reference control [214] to "Keyboard"
 - Set Run/Stop control [215] to "Keyboard"
 - Set Reset control [216] to "Keyboard"
 - Set Process Ref [310] to 0%.
 - Disable reactive power compensation by setting Q max [O41] to 0%.
 - Start AFR by pressing or . Note that the both run directions, i.e. RunR and RunL, are accepted independent of the actual phase sequence.
 - Verify operation via menus [710].
 - Stop AFR by pressing Stop/Reset.
- Setup AFR to start from VSI command via I/O.
 - Change Ref control [214] to "Remote"
 - Change Run/Stop control [215] to "Remote"
 - Change Reset control [216] to "Remote" or "Remote+Keyb"
 - Verify default parameter setup according to table 9 on page 22 below.

Parameter	Setup	Comment
[551] Relay 1	Charge K2	Cabinet hardware control/feedback
[552] Relay 2	Option	
[553] Relay 3	Main K1	
[523] DigIn 3	Enable	AFE command setup Q (cos φ) reference
[214] Ref Control	Remote	
[215] Run/Stp Ctrl	Remote	
[216] Reset Ctrl	Remote	
[310] Set/View ref	0%	
[522] DigIn 2	RunR	AFE/VSI command/feed-back
[528] DigIn 8	Reset	
[541] DigOut 1	Option	
[542] DigOut 2	LZ	

Table 9 Default parameter setup for AFR

Parameter	Setup	Comment
[651] Timer2 Trig	Trip	AFE 1s trip pulse
[652] Timer2 Mode	Delay	
[653] Timer2 Delay	00:00:01	
[6151] CD1	Trip	
[6151] CD2	T2Q	
[630] Logic Z	CD1 & !D2	

Table 9 Default parameter setup for AFR

- Now the AFR is set to be controlled from the VSI
- Close the AFR cabinet door.

6.3.2 Set up VSI

Menu [100], Preferred View is displayed when started.

- Enter correct motor data for the connected motor. The motor data is used in the calculation of complete operational data in the VSI.
 - Set motor voltage [221]
 - Set motor frequency [222]
 - Set motor power [223]
 - Set motor current [224]
 - Set motor speed [225]
 - Set motor power factor (cos φ) [227]
 - Select supply voltage level used [21B]
 - [229] Motor ID run: Choose Short, confirm with and give start command . The VSI will now measure some motor parameters. The motor makes some beeping sounds but the shaft does not rotate. When the ID run is finished after about one minute ("Test Run OK!" is displayed), press to continue.
- Use AnIn1 as input for the reference value. The default range is 4-20 mA. If you need a 0-10 V reference value, change switch (S1) on control board and set [512] AnIn 1 Set-up to 0-10V.
- Setup VSI to control the AFR via I/O, see Table 10.
 - Set digital output 2 [542] to "Operation". Gives start command to AFR from VSI.
 - Set digital input 3 [523] to "Enable". Feedback to VSI that AFR is running.
 - Adapt AFR trip pulse polarity for VSI Extern Trip polarity
 - * Set digital input 7 [527] to "Off". Feedback to VSI that AFE is tripped (pulse if 1s).
 - * Set digital comparator 1 [6151] to "DigIn7".
 - * Set virtual I/O 1 Source [562] to "!D1".
 - * Set virtual I/O 1 Destination [561] to "Ext Trip". see Table 10.

Parameter	Setup	Comment
[542] DigOut 2	Operation	Command AFE run
[523] DigIn 2	Enable	Feedback AFE running
[527] DigIn 7	Off	Feedback AFE trip via Ext Trip
[6151] CD 1	DigIn 7	
[561] VIO 1 Dest	External trip	

Table 10 Default parameter setup for VSI (Standard SX)

Remote control

4. Switch off power supply.



WARNING!
 Always switch off the mains voltage before opening the drive unit and wait at least 7 minutes to allow the buffer capacitors to discharge.

5. Connect digital and analogue inputs/outputs as in Fig. 19.
 - a) Connect a reference value between terminals 7 (Common) and 2 (AnIn 1).
 - b) Connect an external start button between terminal 11(+24 VDC) and 9 (DigIn2, RUNR).
 - c) Connect a reset signal between terminal 11 (+24 VDC) and 22 Reset.

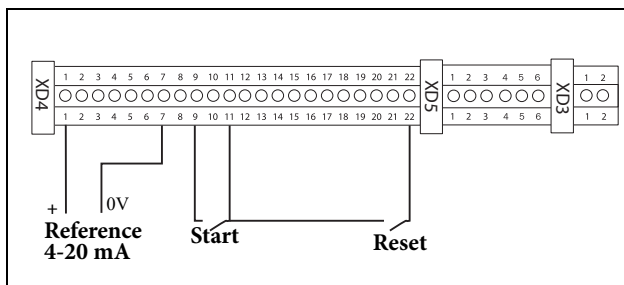

Fig. 19 Wiring

6. Close the door and switch on the power supply. Once the mains is switched on, the internal fans of the AFR and VSI will run for 5 seconds. Menu [100] Preferred view, is displayed in the Control panel after power up.

6.3.3 Run the VSI

Now the installation is finished, and you can press the external start button to start the motor.

When the AFR, VSI and motor are running the main connections are OK.

Chapter 7 EMC and Machine Directive

7.1 EMC STANDARDS

The active front end and variable speed drive complies with the following standards:

EN(IEC)61800-3:2004 Adjustable speed electronic power drive systems, part 3, EMC product standards:

Standard: Category C3, for systems of rated supply voltage < 1000 VAC, intended for use in the second environment.

Optional: Category C2, for systems of rated supply voltage < 1000 V, which is neither a plug in device nor a movable device and, when used in the first environment, is intended to be installed and commissioned only by experienced person with the necessary skills in installing and/or commissioning variable speed drives including their EMC aspects.

7.2 STOP CATEGORIES AND EMERGENCY STOP

The following information is important if emergency stop circuits are used or needed in the installation where a variable speed drive is used. EN 60204-1 defines 3 stop categories:

Category 0: Uncontrolled STOP:

Stopping by switching off the supply voltage. A mechanical stop must be activated. This STOP may not be implemented with the help of a variable speed drive or its input/output signals.

Category 1: Controlled STOP:

Stopping until the motor has come to rest, after which the mains supply is switched off. This STOP may not be implemented with the help of a variable speed drive or its input/output signals.

Category 2: Controlled STOP:

Stopping while the supply voltage is still present. This STOP can be implemented with each of the variable speed drives STOP command.



WARNING!

EN 60204-1 specifies that every machine must be provided with a category 0 stop. If the application prevents this from being implemented, this must be explicitly stated. Furthermore, every machine must be provided with an Emergency Stop function. This emergency stop must ensure that the voltage at the machine contacts, which could be dangerous, is removed as quickly as possible, without resulting in any other danger. In such an Emergency Stop situation, a category 0 or 1 stop may be used. The choice will be decided on the basis of the possible risks to the machine.

Note: With option Safe Stop, a stop according EN-IEC 62061:2005 SIL 2 & EN-ISO 13849-1:2006, can be achieved. See standard SX instruction manuals (I126E/I127E).

Chapter 8 Operation via the Control Panel

This chapter describes how to use the control panel. If nothing else is mentioned, this information is valid for both AFR and VSI.

8.1 CONTROL PANELS

There are two control panels, one main panel in the Cabinet door controlling the complete OMRON SX-FR/SX-VL and one internal AFR panel designated for service engineers.

8.1.1 Main control panel for OMRON SX-FR/SX-VL

The OMRON SX-FR/SX-VL is equipped with one main control panel on the cabinet door see Fig. 20. When we further in this chapter describe how to use the control panel this is the one we are referring to.

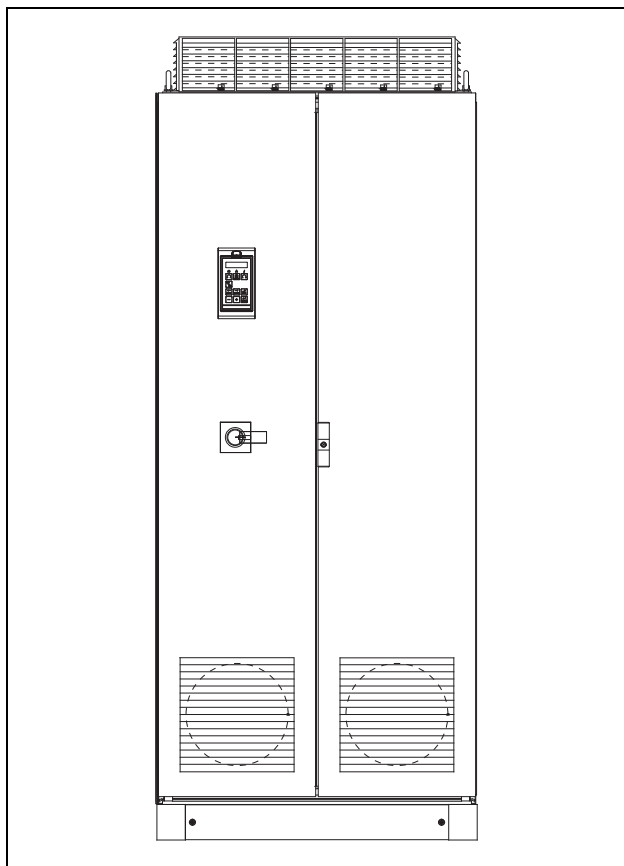

Fig. 20 SX-FR with control panel in front door.

8.1.2 Control panel for AFR

Inside the cabinet door you will find a second control panel for the AFR unit, see Fig. 21. In this display you can observe status, trips and set parameters. Normally you do not need to do any changes in this panel. This panel is designated for use by service engineers.

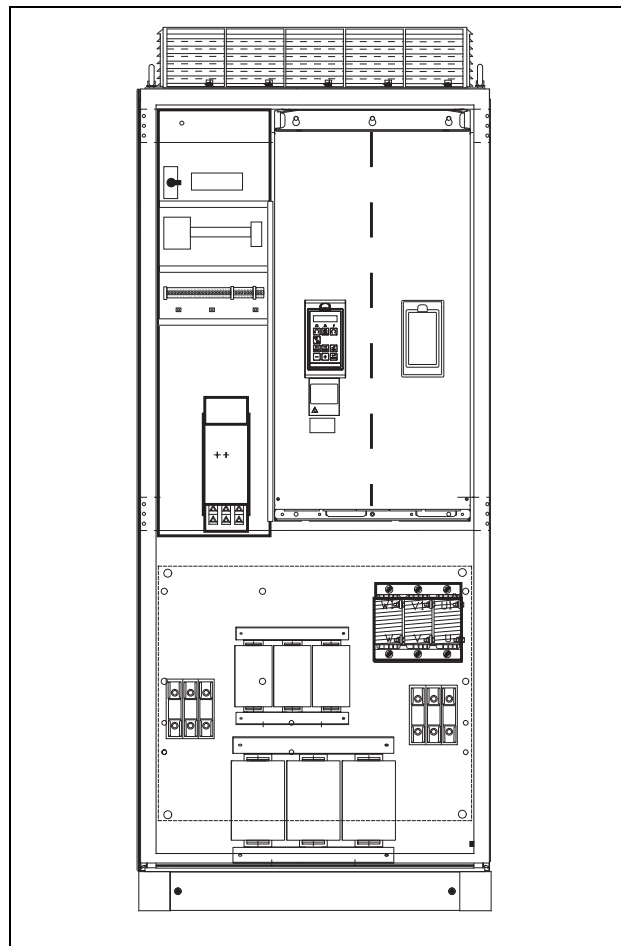

Fig. 21 Open the cabinet door to expose the AFR control panel

8.2 GENERAL

The control panel in the front door displays the status of the OMRON SX-FR and is used to set all the user parameters. It is also possible to control the motor directly from the control panel. The control panel can be built-in or located externally via serial communication.

Note: The VSI can run without the control panel being connected. However the settings must be such that all control signals are set for external use.

8.3 THE CONTROL PANEL

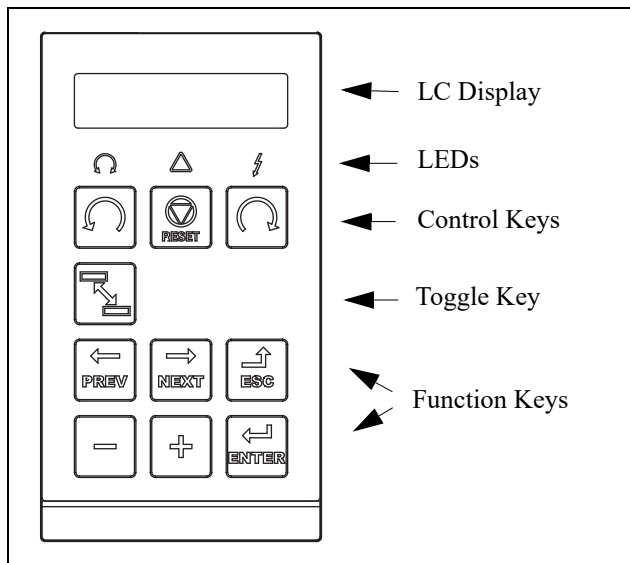

Fig. 22 Control panel

8.3.1 The display

The display is back lit and consists of 2 rows, each with space for 16 characters. The display is divided into six areas.

The different areas in the display are described below:

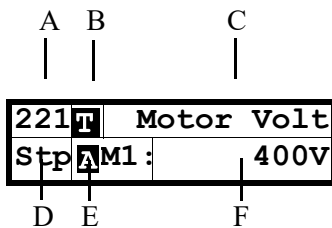

Fig. 23 The display

Area A: Shows the actual menu number (3 or 4 digits).

Area B Shows if the menu is in the toggle loop or the VSI is set for Local operation.

Area C: Shows the heading of the active menu.

Area D: Shows the status of the VSI (3 digits).
The following status indications are possible:

- Acc : Acceleration
- Dec : Deceleration
- I²t : Active I²t protection
- Run : Motor runs
- Trp : Tripped
- Stp : Motor is stopped
- VL : Operating at Voltage limit
- SL : Operating at Speed limit
- CL : Operating at Current limit
- TL : Operating at Torque limit
- OT : Operating at Temperature Limit
- LV : Operating at Low Voltage
- Sby : Operating from Standby power supply
- SST : Operating Safe Stop, is flashing when activated
- LCL : Operating with low cooling liquid level

Area E: Shows active parameter set and if it is a motor parameter.

Area F: Shows the setting or selection in the active menu. This area is empty at the 1st level and 2nd level menu. This area also shows warnings and alarm messages. In some situations this area could indicate +++ or --- please see further information in chapter 8.3.2 page 28



Fig. 24 Example 1st level menu



Fig. 25 Example 2nd level menu

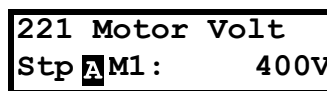

Fig. 26 Example 3d level menu

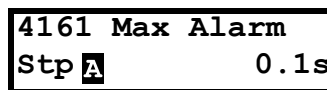

Fig. 27 Example 4th level menu

8.3.2 Indications on the display

The display can indicate +++ or --- if a parameter is out of range. In the VSI there are parameters which are dependent on other parameters. For example, if the speed reference is 500 and the maximum speed value is set to a value below 500, this will be indicated with +++ on the display. If the minimum speed value is set over 500, --- is displayed.

The control panel

8.3.3 LED indicators

The symbols on the control panel have the following functions:

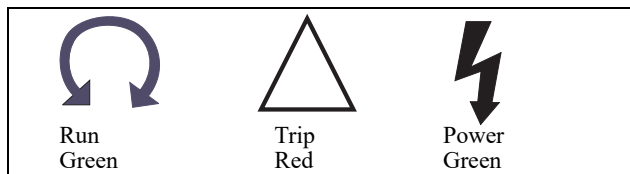

Fig. 28 LED indications

Symbol	Function		
	ON	flashing	OFF
POWER (green)	Power on	-----	Power off
TRIP (red)	Tripped	Warning/Limit	No trip
RUN (green)	Running	AC drive speed increase/ decrease (VSI only)	AFR/VSI stopped

Table 11 LED indication

Note: If the control panel is built in, the back light of the display has the same function as the Power LED in Table 11 (Blank panel LEDs).

8.3.4 Control keys

The control keys are used to give the Run, Stop or Reset commands directly. As default these keys are disabled, set for remote control. Activate the control keys by selecting Keyboard in the menus Ref Control [214] and Reset Ctrl [216].

If the Enable function is programmed on one of the digital inputs, this input must be active to allow Run/Stop commands from the control panel.

	RUN L:	gives a start with left rotation
	STOP/RESET:	stops or resets
	RUN R:	gives a start with right rotation

Table 12 Control keys

Note: It is not possible to simultaneously activate the Run/Stop commands from the keyboard and remotely from the terminal strip (terminals 1-22).

8.3.5 The Toggle and Loc/Rem Key

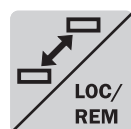

This key has two functions: Toggle and switching between Loc/Rem function.

Press one second to use the toggle function

Press and hold the toggle key for more than five seconds to switch between Local and Remote function, depending on the settings in [2171] and [2172].

When editing values, the toggle key can be used to change the sign of the value, see § 8.6, page 32.

Toggle function

Using the toggle function makes it possible to easily step through selected menus in a loop. The toggle loop can contain a maximum of ten menus. As default the toggle loop contains the menus needed for Quick Setup. You can use the toggle loop to create a quick-menu for the parameters that are most importance to your specific application.

Note: Do not keep the Toggle key pressed for more than five seconds without pressing either the +, - or Esc key, as this may activate the Loc/Rem function of this key instead. See menu [217].

Add a menu to the toggle loop

1. Go to the menu you want to add to the loop.
2. Press the Toggle key and keep it pressed while pressing the + key.

Delete a menu from the toggle loop

1. Go to the menu you want to delete using the toggle key.
2. Press the Toggle key and keep it pressed while pressing the - key.

Delete all menus from the toggle loop

1. Press the Toggle key and keep it pressed while pressing the Esc key.
2. Confirm with Enter. The menu Preferred view [100] is displayed.

Default toggle loop

Fig. 29 shows the default toggle loop. This loop contains the necessary menus that need to be set before starting. Press Toggle to enter menu [211] then use the Next key to enter the sub menus [212] to [21A] and enter the parameters. When you press the Toggle key again, menu [221] is displayed.

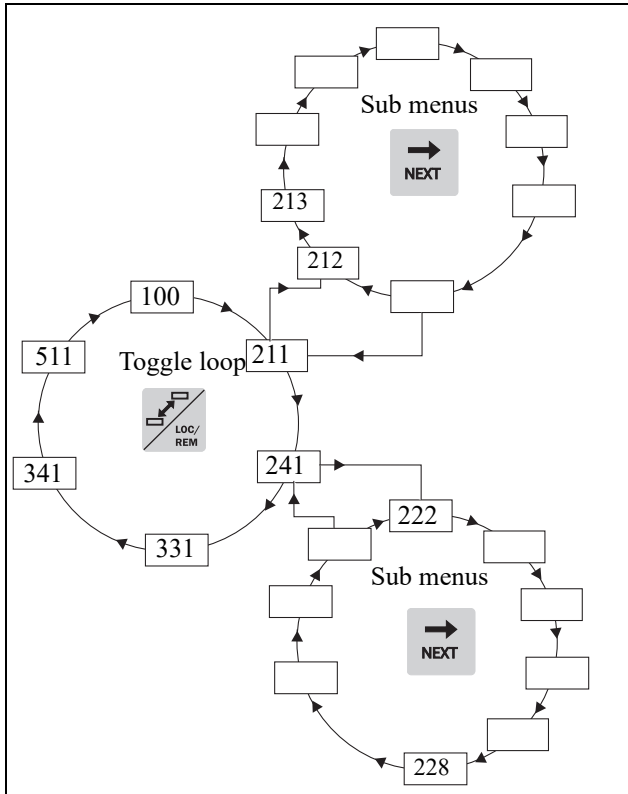

Fig. 29 Default toggle loop

Indication of menus in toggle loop

Menus included in the toggle loop are indicated with a **T** in area B in the display.

Loc/Rem function

The Loc/Rem function of this key is disabled as default. Enable the function in menu [2171] and/or [2172].

With the function Loc/Rem you can change between local and remote control of the VSI from the control panel. The function Loc/Rem can also be changed via the DigIn, see menu Digital inputs [520]

Change control mode

1. Press the Loc/Rem key for five seconds, until Local? or Remote? is displayed.
2. Confirm with Enter.
3. Cancel with Esc.

Local mode

Local mode is used for temporary operation. When switched to LOCAL operation, the VSI is controlled via the defined Local operation mode, i.e. [2171] and [2172]. The actual status of the VSI will not change, e.g. Run/Stop conditions and the actual speed will remain exactly the same. When the VSI is set to Local operation, the display will show **T** in area B in the display.

The VSI will be started and stopped using the keys on the control panel. The reference signal can be controlled using the + and - keys

on the keyboard, when in the menu [310] according to the selection in Keyboard Reference menu [369].

Remote mode

When the VSI is switched to REMOTE operation, the VSI will be controlled according to selected control methods in the menu's Reference Control [214], Run/Stop Control [215] and Reset Control [216]. The actual operation status of the VSI will reflect the status and settings of the programmed control selections, e.g. Start/Stop status and settings of the programmed control selections, acceleration or deceleration speed according to the selected reference value in the menu Acceleration Time [331] / Deceleration Time [332].

To monitor the actual Local or Remote status of the VSI control, a "Loc/Rem" function is available on the Digital Outputs or Relays. When the VSI is set to Local, the signal on the DigOut or Relay will be active high, in Remote the signal will be inactive low. See menu Digital Outputs [540] and Relays [550].

8.3.6 Function keys

The function keys operate the menus and are also used for programming and read-outs of all the menu settings.

	ENTER key:	- step to a lower menu level - confirm a changed setting
	ESCAPE key:	- step to a higher menu level - ignore a changed setting, without confirming
	PREVIOUS key:	- step to a previous menu within the same level - go to more significant digit in edit mode
	NEXT key:	- step to a next menu within the same level - go to less significant digit in edit mode
	- key:	- decrease a value - change a selection
	+ key:	- increase a value - change a selection

Table 13 Function keys

8.4 THE MENU STRUCTURE

The menu structure consists of 4 levels:

Main Menu 1st level	The first character in the menu number.
2nd level	The second character in the menu number.
3rd level	The third character in the menu number.
4th level	The fourth character in the menu number.

This structure is consequently independent of the number of menus per level.

For instance, a menu can have one selectable menu (Set/View Reference Value [310]), or it can have 17 selectable menus (menu Speeds [340]).

Note: If there are more than 10 menus within one level, the numbering continues in alphabetic order.

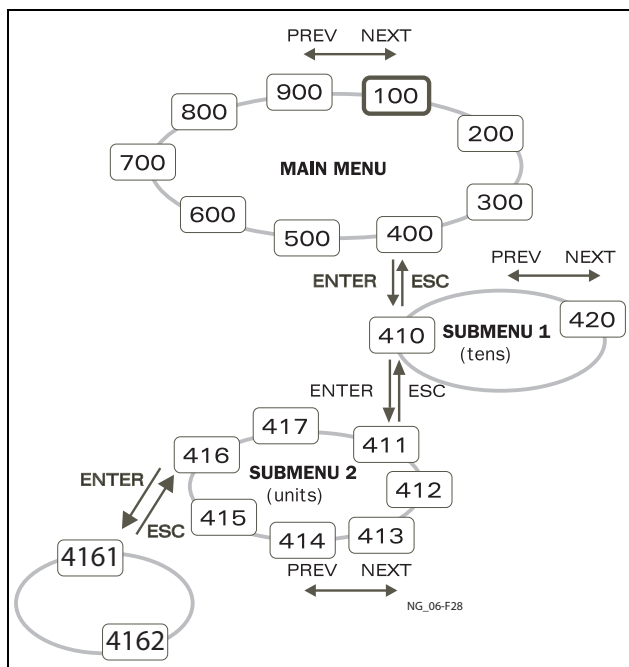

Fig. 30 Menu structure (general principle)

8.4.1 The main menu for AFR

This section gives you a short description of the functions in the Main menu for AFR.

For OMRON SX inverter, see standard SX instruction manuals (I126E/I127E).

100 Preferred View

Displayed at power-up. It displays the actual process value as default. Programmable for many other read-outs.

200 Main Setup

Main settings to get the AFR operable. The supply data settings are the most important. Also option utility and settings.

300 Process and Application Parameters

Settings more relevant to the application such as Reactive power, Reference etc.

500 Inputs/Outputs and Virtual Connections

All settings for inputs and outputs are entered here.

600 Logical Functions and Timers

All settings for conditional signal are entered here.

700 View Operation and Status

Viewing all the operational data like frequency, load, power, current, etc.

800 View Trip Log

Viewing the last 10 trips in the trip memory.

900 Service Information and AFR Data

Electronic type label for viewing the software version and AFR type.

000 AFR Option

Main setup for AFR dedicated features

8.5 PROGRAMMING DURING OPERATION

Most of the parameters can be changed during operation without stopping the AFR or VSI. Parameters that can not be changed are marked with a lock symbol in the display.

Note: If you try to change a function during operation that only can be changed when the AFR is stopped, the message “Stop First” is displayed.

8.6 EDITING VALUES IN A MENU

Most values in the second row in a menu can be changed in two different ways. Enumerated values like the baud rate can only be changed with alternative 1.



Alternative 1

When you press the + or - keys to change a value, the cursor is flashing to the left in the display and the value is increased or decreased when you press the appropriate key. If you keep the + or - keys pressed, the value will increase or decrease continuously. When you keep the key pressed the change speed will increase. The Toggle key is used to change the sign of the entered value. The sign of the value will also change when zero is passed. Press Enter to confirm the value.

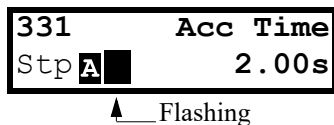

Alternative 2

Press the + or - key to enter edit mode. Then press the Prev or Next key to move the cursor to the right most position of the value that should be changed. The cursor will make the selected character blink. Move the cursor using the Prev or Next keys. When you press the + or - keys, the character at the cursor position will increase or decrease. This alternative is suitable when you want to make large changes, i.e. from 2 s to 400 s.

To change the sign of the value, press the toggle key. This makes it possible to enter negative values.

Example: When you press Next the 4 will blink.

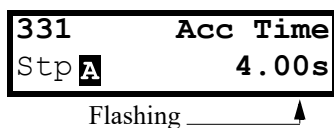

Press Enter to save the setting and Esc to leave the edit mode.

8.7 COPY CURRENT PARAMETER TO ALL SETS

When a parameter is displayed, press the Enter key for 5 seconds. Now the text To all sets? is displayed. Press Enter to copy the setting for current parameter to all sets.

8.8 PROGRAMMING EXAMPLE

This example shows how to program a change of Language from English (default) to Nederlands.

The flashing cursor indicates that a change has taken place but is not saved yet. If at this moment, the power fails, the change will not be saved.

Use the ESC, Prev, Next or the Toggle keys to proceed and to go to other menus.

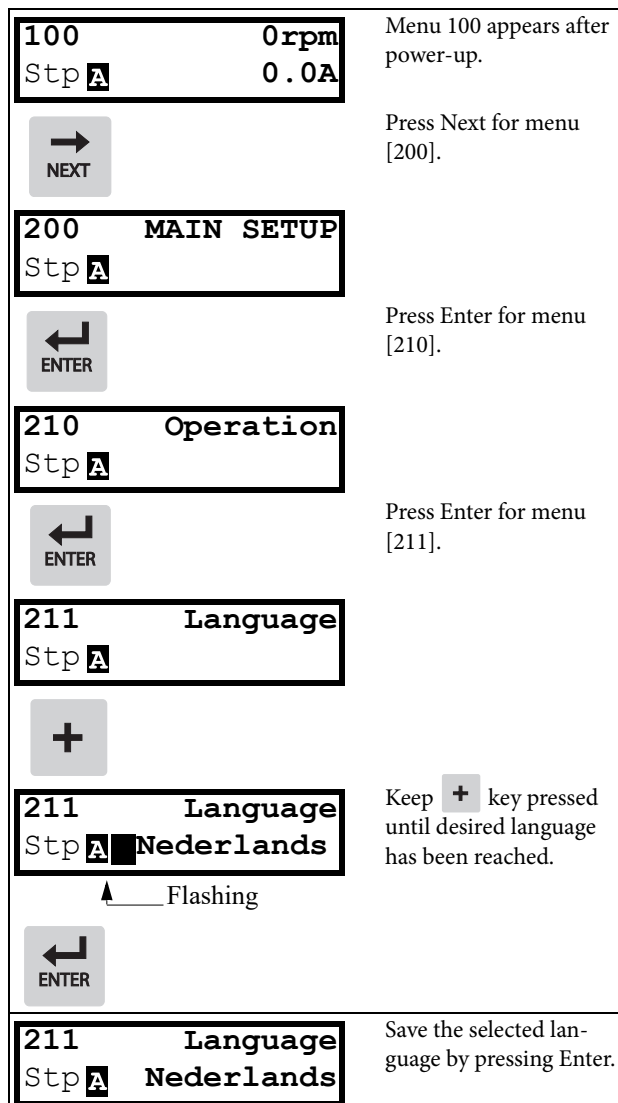



Fig. 31 Programming example

Chapter 9 Functional Description for AFR unit

This chapter describes the menus and parameters in the AFR software. You will find a short description of each function and information about default values, ranges, etc.

Regarding the functional description for SX-FR/SX-VL refer to standard SX instruction manuals (I126E/I127E), chapter “Functional description”.

Note: For communication information refer to standard SX instruction manuals (I126E/I127E).

Note: Functions marked with the sign  cannot be changed during Run Mode.

Description of table layout

Menu no. Menu name		
Status Selected		
Default:		
Selection or range	Integer value of selection	Description

Resolution of settings

The resolution for all range settings described in this chapter is 3 significant digits. Table 14 shows the resolutions for 3 significant digits.

3 Digit	Resolution
0.01-9.99	0.01
10.0-99.9	0.1
100-999	1
1000-9990	10
10000-99900	100

Table 14

9.1 Preferred View [100]

This menu is displayed at every power-up. During operation, the menu [100] will automatically be displayed when the keyboard is not operated for 5 minutes. The automatic return function will be switched off when the Toggle and Stop key is pressed simultaneously. As default it displays the actual current and torque.



Menu [100], Preferred View displays the settings made in menu [110], 1st line, and [120], 2nd line. See Fig. 32.

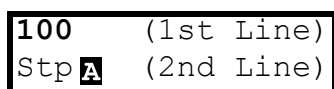



Fig. 32 Display functions

9.1.1 1st Line [110]

Sets the content of the upper row in the menu [100] Preferred View.

110 1st Line		
Stp  Current		
Default:		Current
Dependent on menu		
Process Val	0	Process value (Q)
Torque	2	Torque
Process Ref	3	Process reference
React Power	4	Reactive power
El Power	5	Electrical power
Current	6	Current
Output volt	7	Output voltage
Frequency	8	Frequency
DC Voltage	9	DC voltage
Heatsink Tmp	10	Heatsink temperature
AFR Status	12	AFR status
Run Time	13	Run Time
Energy	14	Energy
Mains Time	15	Mains time

9.1.2 2nd Line [120]

Sets the content of the lower row in the menu [100] Preferred View. Same selection as in menu [110].

120 2nd Line	
Stp  Torque	
Default:	Torque

9.2 Main Setup [200]

The Main Setup menu contains the most important settings to get the AFR operational and set up for the application. It includes different sub menus concerning the control of the unit, protection, utilities and automatic resetting of faults. This menu will instantaneously be adapted to build in options and show the required settings.

9.2.1 Operation [210]

Selections concerning the control signals and serial communication are described in this submenu and is used to set the AFE up for the application.

Language [211]

Select the language used on the LC Display. Once the language is set, this selection will not be affected by the Load Default command.

211 Language Stp A English		
Default:		English
English	0	English selected
Svenska	1	Swedish selected
Nederlands	2	Dutch selected
Deutsch	3	German selected
Français	4	French selected
Español	5	Spanish selected
Русский	6	Russian selected
Italiano	7	Italian selected
Česky	8	Czech selected
Turkish	9	Turkish selected

Reference control [214]

To control the reactive power of the AFE needs a reference signal. This reference signal can be controlled by a remote source from the installation, the keyboard of the AFR, or by serial or fieldbus communication. Select the required reference control for the application in this menu.

214 Ref Control Stp A Keyboard		
Default:		Keyboard
Remote	0	The reference signal comes from the analogue inputs of the terminal strip (terminals 1-22).
Keyboard	1	Reference is set with the + and - keys on the Control Panel. Can only be done in menu Set/View reference [310].
Com	2	The reference is set via the serial communication (RS 485, Fieldbus.) See Fieldbus or RS232/485 option manual for details.

Note: If the reference is switched from Remote to Keyboard, the last remote reference value will be the default value for the control panel.

Run/Stop Control [215]

This function is used to select the source for run and stop commands.

215 Run/Stp Ctrl Stp A Keyboard		
Default:		Keyboard
Remote	0	The start/stop signal comes from the digital inputs of the terminal strip (terminals 1-22).
Keyboard	1	Start and stop is set on the Control Panel.
Com	2	The start/stop is set via the serial communication (RS 485, Fieldbus.) See Fieldbus or RS232/485 option manual for details.

Reset Control [216]

When the AFR is stopped due to a failure, a reset command is required to make it possible to restart the AFR. Use this function to select the source of the reset signal.

216 Reset Ctrl Stp A Keyboard		
Default:		Keyboard
Remote	0	The command comes from the inputs of the terminal strip (terminals 1-22).
Keyboard	1	The command comes from the command keys of the Control Panel.
Com	2	The command comes from the serial communication (RS 485, Fieldbus).
Remote + Keyb	3	The command comes from the inputs of the terminal strip (terminals 1-22) or the keyboard.
Com + Keyb	4	The command comes from the serial communication (RS485, Fieldbus) or the keyboard.
Rem+Keyb +Com	5	The command comes from the inputs of the terminal strip (terminals 1-22), the keyboard or the serial communication (RS485, Fieldbus).

Local/Remote key function [217]

Please, refer to standard SX instruction manuals (I126E/I127E) for further information.

Lock Code [218]

Please, refer to standard SX instruction manuals (I126E/I127E) for further information.

Remote signal Level/Edge [21A]

Please, refer to standard SX instruction manuals (I126E/I127E) for further information.

9.2.2 Motor Protection [230]

Please, refer to standard SX instruction manuals (I126E/I127E) for further information.

9.2.3 Parameter Set Handling [240]

Select Set [241]

Here you select the parameter set.

Note: The active front end unit only supports one parameter set.

241 Select Set		
Stp A A		
Default:		A
Selection:		A
A	0	Fixed selection to parameter set A

The active set can be viewed with function [721] FI status.

Load Default Values Into Set [243]

With this function the factory setting can be selected for the parameter set. When loading the default settings, all changes made in the software are set to factory settings.

243 Default>Set		
Stp A A		
Default:		A
A	0	Only the selected parameter set will revert to its default settings.
Factory	5	All settings, except [211], [261] and [923], will revert to the default settings.

Note: Trip log hour counter and other VIEW ONLY menus are not regarded as settings and will be unaffected.

Note: If “Factory” is selected, the message “Sure?” is displayed. Press the + key to display “Yes” and then Enter to confirm.

9.2.4 Trip Autoreset/Trip Conditions [250]

Please, refer to standard SX instruction manuals (I126E/I127E) for further information.

9.2.5 Serial Communication [260]

Please, refer to standard SX instruction manuals (I126E/I127E) for further information.

9.3 Process and Application Parameters [300]

These parameters are mainly adjusted to obtain optimum process or machine performance.

9.3.1 Set/View Reference Value [310]

Set/view reference value for reactive power in % of AFR unit nominal power.

Note: Positive value - Capacitive or leading.
Negative value - Inductive or lagging.

View reference value

As default the menu [310] is in view operation. The value of the active reference signal is displayed.

Set reference value

If the function Reference Control [214] is set to: Ref Control = Keyboard, the reference value can be set in menu Set/View Reference [310] as a normal parameter or as a motor potentiometer with the + and - keys on the control panel.

310 Set/View ref	
Stp 0%	
Default:	0%
Range	+/- Qmax [O41]

Note: Write access to this parameter is only allowed when menu “Ref Control [214] is set to Keyboard. When Reference control is used, see section 10.5 Reference signal in standard SX instruction manuals (I126E/I127E).

9.4 I/Os and Virtual Connections [500]

For settings of the standard inputs and outputs of the AFE refer to standard SX instruction manuals (I126E/I127E).

Note: Relay 1 is dedicated to Charge relay K2.
Relay 3 is dedicated for main Contactor K1.

Note: Default values can differ in comparison to standard manual.

9.5 Logical Functions and Timers [600]

For programming of Comparators, Logic Functions and Timers see standard SX instruction manuals (I126E/I127E).

Note: Default values can differ in comparison to standard manual.

9.6 View Operation/Status [700]

Menu with parameters for viewing all actual operational data, such as speed, torque, power, etc.

9.6.1 Operation [710]

Process Value (Reactive power) [711]

The process value is a display function which can be programmed according to several quantities and units related to the reference value in % of nominal power.

Note: Positive value - Capacitive or leading.
Negative value - Inductive or lagging.

711 Process Val Stp 0%	
Unit:	%
Resolution:	1%

Torque [713]

Displays the virtual torque in % of nominal power and in W.

Note: Positive value - Generating.
Negative value - Motoring.

713 Torque Stp 0%0W	
Unit:	W
Resolution:	1 W

Reactive power [714]

Displays the actual reactive power.

Note: Positive value - Capacitive or leading.
Negative value - Inductive or lagging.

714 ReactPower Stp W	
Unit:	W
Resolution:	1W

Electrical Power [715]

Displays the actual electrical output power.

Note: Positive value - Generating.
Negative value - Motoring.

715 El Power Stp kW	
Unit:	kW
Resolution:	1 W

Current [716]

Displays the actual output current.

716 Current Stp A	
Unit:	A
Resolution:	0.1 A

Output Voltage [717]

Displays the actual output voltage, i.e. AFR terminal voltage.

717 Output Volt Stp V	
Unit:	V
Resolution:	1 V

Frequency [718]

Displays the actual output frequency.

Note: Positive value = Positive phase sequence, i.e. L1 - L2 - L3.
Negative value = Negative phase sequence, i.e. L3 - L2 - L1.

718 Frequency Stp Hz	
Unit:	Hz
Resolution:	0.1 Hz

DC Link Voltage [719]

Displays the actual DC link voltage.

719 DC Voltage Stp V	
Unit:	V
Resolution:	1 V

Heatsink Temperature [71A]

Displays the actual heatsink temperature.

71A Heatsink Tmp Stp °C	
Unit:	°C
Resolution:	0.1°C

9.6.2 Status [720]

For viewing the overall status of the VSI refer to standard SX instruction manuals (I126E/I127E).

9.6.3 Stored values [730]

For viewing the stored values of the VSI refer to standard SX instruction manuals (I126E/I127E).

9.7 View Trip Log [800]

Main menu with parameters for viewing all the logged trip data. In total the AFR saves the last 9 trips in the trip memory. The trip memory refreshes on the FIFO principle (First In, First Out). Every trip in the memory is logged on the time of the Run Time [731] counter. At every trip, the actual values of several parameter are stored and available for troubleshooting.

9.7.1 Trip Message log [810]

Display the cause of the trip and what time that it occurred. When a trip occurs the status menus are copied to the trip message log. There are nine trip message logs [810]–[890]. When the tenth trip occurs the oldest trip will disappear.

8x0 Trip message	
Stp h:mm:ss	
Unit:	h: m (hours: minutes)
Range:	0h: 0m–65355h: 59m
810 Ext Trip	
Stp 132:12:14	

For fieldbus integer value of trip message, see message table for warnings, [722].

Note: Bits 0–5 used for trip message value. Bits 6–15 for internal use.

Trip message [811]–[81N]

The information from the status menus are copied to the trip message log when a trip occurs.

Trip menu	Copied from	Description
811	711	Process Value
813	713	Torque
814	714	Reactive Power
815	715	Electrical Power
816	716	Current
817	717	Output voltage
818	718	Frequency
819	719	DC Link voltage
81A	71A	Heatsink Temperature
81C	721	VSI Status
81D	723	Digital input status
81E	724	Digital output status
81F	725	Analogue input status 1-2
81G	726	Analogue input status 3-4
81H	727	Analogue output status 1-2
81L	731	Run Time
81M	732	Mains Time
81N	733	Energy
81O	310	Process reference

Example:

Fig. 33 shows the third trip memory menu [830]: Over temperature trip occurred after 1396 hours and 13 minutes in Run time.

830 Over temp	
Stp 1396h:13m	

Fig. 33 Trip 3

9.7.2 Trip Messages [820] - [890]

Same information as for menu [810].

9.7.3 Reset Trip Log [8A0]

Resets the content of the 10 trip memories.

8A0 Reset Trip	
Stp No	
Default:	No
No	0
Yes	1

Note: After the reset the setting goes automatically back to “NO”. The message “OK” is displayed for 2 sec.

9.8 System Data [900]

Main menu for viewing all the AFR system data.

9.8.1 AFR Data [920]

AFR Type [921]

Shows the AFR type according to the type number.

The options are indicated on the type plate of the AFR.

921 AFR2.0	
Stp SX-D4115-E1AR	

Fig. 34 Example of type

Examples:

SX-D4115-E1AR suited for 380-460 V mains supply and a rated input current of 175 A.

Software [922]

Shows the software version number of the AFR.

Fig. 35 gives an example of the version number.

922 Software	
Stp	V4.30-97.03

Fig. 35 Example of software version

Bit	Description
7-0	minor
13-8	major
15-14	release 00: V, release version 01: P, pre-release version 10: β, Beta version 11: α, Alpha version

Table 15 Information for Modbus and Profibus number, software version

Bit	Description
7-0	minor
15-8	major

Table 16 Information for Modbus and Profibus number, option version

V 4.30 = Version of the Software

Note: It is important that the software version displayed in menu [920] is the same software version number as the software version number written on the title page of this instruction manual. If not, the functionality as described in this manual may differ from the functionality of the AFR.

9.9 AFR Option [O00]

Main menu for AFR dedicated settings.

9.9.1 Supply parameters [O10]

Main menu for power supply parameters.

Supply Volts [O11]

Nominal supply voltage.

O11 Supply Volts	
Stp	400 V
Default:	400 V
Range:	380 - 460 V

Supply Frequency [O12]

Nominal supply frequency.

O12 Supply Freq	
Stp	50 Hz
Default:	50Hz
Range:	50 - 60Hz

Supply Current [O13]

Nominal supply current. Only used for mains supply synchronisation and overcurrent protection.

O13 Supply Curr	
Stp	AFR. Inom
Default:	AFR. Inom
Range:	0 - AFR. Inom

Supply Sequence [O14]

Nominal phase sequence of supply. Supply ID run [O15]

O14 Supply Seq		
Stp	Pos	
Default:	Pos	
Pos	0	Positive phase sequence, i.e. L1-L2-L3
Neg	1	Negative phase sequence, i.e. L3-L2-L1

Identification run to measure and set up supply parameters.

O15 Supply IDrun		
Stp	Off	
Default:	Off	
Off	0	
On	1	Activate the supply ID-run

Supply Auto [O16]

Automatic activation of supply parameter identification after every power-up.

O16 Supply Auto		
Stp	Off	
Default:	Off	
Off	0	
On	1	Activate automatic ID-run

AFR Option [O00]

Volt sensor [O17]

Supply voltage sensor option.

		O17 Volt sensor Stp Pos
Default:	Off	
Off	0	
On	1	Activate supply voltage measurement.

Note: Requires supply voltage measurement hardware option.

9.9.2 Charge/Start parameters [O20]

Main menu for charge control and start/stop parameters.

Charge control [O21]

DC-link Charge relay control function.

		O21 Charge Ctrl Stp Supply-NC
Default:	Supply - NC	
Supply - NC	0	Charge at power supply via NC terminal on Relay 1.
Supply - NO	1	Charge at power supply via NO terminal on Relay 1.
Run-NO	2	Charge at run command via NO terminal on Relay 1.
Enable - NO	3	Charge at Enable command via NO terminal on Relay 1.

Note: Normally open (NO) alternatives requires 24 V Standby supply option.

Start Mode [O22]

Start/Stop mode. If set to "Regen" AFR starts on regenerative demand.

		O22 Run/Stop Mode Stp Standard
Default:	Standard	
Standard	0	AFR active via Run command
Regen	1	AFR active only if regeneration required and valid run command.

Note: Regeneration mode requires supply voltage measurement hardware option.

Regeneration stop delay time [O23]

Regeneration stop delay time after AFR in motoring mode.

		O23 Reg Stp Mode Stp 1s
Default:	1s	
Range	0.0 - 10.0s	

Note: Regeneration mode requires supply voltage measurement.

9.9.3 Udc controller oparameters [O30]

Main menu for DC-link voltage (Udc) parameters.

Udc reference [O31]

DC-link voltage reference value..

		O31 Udc ref Stp 1.05*Upeak
Default:	1.05*Upeak	
Range	Upeak to Umax	

Note: Actual DC - link voltage reference value is limited via actual supply voltage and [O37 Udc margin].

Udc ramp time [O32]

Udc ramp time, defined as time from 0 ->1000V.

		O32 Udc ramp Stp 1s
Default:	1s	
Range	0.0 - 10.0s	

Udc PI Gain controller [O33]

Proportional gain of Udc PI controller..

		O33 Udc PI Gain Stp 5.0
Default:	5.0	
Range	0.0 - 10.0	

Udc PI Time controller [O34]

Integral time constant of Udc PI controller.

		O34 Udc PI Time Stp 0.2s
Default:	0.2s	
Range	0.0 - 10.0s	

Udc PI Max limit [O35]

Udc PI controller max limit, i.e. active power limit.

O35 Udc PI Max	
Stp 200%	
Default:	200%
Range	0 - 400%

Udc PI Charge limit [O36]

Udc PI controller max charge limit during synchronization, i.e. during Udc charging.

O36 Udc PI Charg	
Stp 20%	
Default:	20%
Range	0 - 100%

Udc margin [O37]

Udc reference control margin from actual output voltage.

O37 Udc margin	
Stp 5%	
Default:	5%
Range	0.0 - 20.0%

Note: Actual internal DC - link voltage reference value is limited via actual supply voltage and [O37 Udc margin], i.e.

$$\sqrt{3} \times U_{ac} \times (1 + [O37])$$

where U_{ac} is actual supply voltage.

9.9.4 Reactive power (Q) controller parameters [O40]

Q Max limit [O41]

Reactive power max. limit value, i.e. amount of unused overcapacity that is allowed for Q - compensation.

O41 Q Max	
Stp 0%	
Default:	0%
Range	0 to 100%

Note: Reactive power limited internally by the actual active power.

Q ramp time [O42]

Q ramp time, defined as time from 0->100%.

O42 Q ramp	
Stp 1s	
Default:	1s
Range	0.0 - 10.0s

Q PI Gain [O43]

Q PI controller P gain.

O43 Q PI Gain	
Stp 0.10	
Default:	0.10
Range	0.00 - 1.00

Q PI Time [O44]

Q PI controller I time.

O44 Q PI Time	
Stp 0.1s	
Default:	0.1s
Range	0.0 - 10.0s

Q Filter time [O45]

Q filter time in dynamic/static feedback loop.

O45 Q Filter	
Stp 1s	
Default:	1s
Range	0.0 - 10.0s

9.9.5 Frequency controller parameters [O50]

Frequency type [O51]

Use frequency observer to handle variations in supply frequency.

O51 Freq Type		
Stp Observer		
Default:	Observer	
Observer	0	Use observer
Fixed	1	Use fixed frequency

9.9.6 View energy status [O80]

Energy from Supply [O81]

Energy from Supply (Total = Motoring - Generating).

O81 Energy Suppl	
Stp 1Wh	
Unit:	Wh
Resolution:	1Wh

AFR Option [O00]

Energy to Motor [O82]

Energy delivered to Motor (Motoring mode).

O82 Energy Motor	
Stp	1Wh
Unit:	Wh
Resolution:	1Wh

Psi Reference and actual value [O94]

Internal Psi reference (Q PI output) and actual value.

O94 Psi Ref/Val	
Stp	100%/100%
Unit:	%
Resolution:	1 %

Energy to Supply [O83]

Energy delivered to Supply (Generating mode).

O83 Energy Gen	
Stp	1Wh
Unit:	Wh
Resolution:	1Wh

Reset energy [O84]

Clear all energy Wh counters [O81] - [O83]

O84 Reset Energy	
Stp	No
Default:	No
No	0
Yes	1
Clear Wh counters.	

9.9.7 View control status [O90]

Udc Reference and actual value [O91]

Internal Udc reference (after ramp) and actual value..

O91 Udc Ref/Val	
Stp	110%/100%
Unit:	%
Resolution:	1 %

T Reference and actual value [O92]

Internal R reference (Udc PI output) and actual value..

O92 T Ref/Val	
Stp	20%/0%
Unit:	%
Resolution:	1 %

Q Reference and actual value [O93]

Internal Q reference (after ramp) and actual value..

O93 Q Ref/Val	
Stp	-5%/0%
Unit:	%
Resolution:	1 %

Chapter 10 Troubleshooting, Diagnoses and Maintenance

10.1 TRIPS, WARNINGS AND LIMITS

In order to protect the AFR or VSI the principal operating variables are continuously monitored by the system. If one of these variables exceeds the safety limit an error/warning message is displayed. In order to avoid any possibly dangerous situations, the inverter sets itself into a stop Mode called Trip and the cause of the trip is shown in the display.

“Trip”

- The AFR/VSI stops immediately.
- The Trip relay or output is active (if selected).
- The Trip LED is on.
- The accompanying trip message is displayed.
- The “TRP” status indication is displayed (area D of the display).

Apart from the TRIP indicators there are two more indicators to show that the inverter is in an “abnormal” situation.

“Warning”

- The AFR/VSI is close to a trip limit.
- The Warning relay or output is active (if selected).
- The Trip LED is flashing.
- The accompanying warning message is displayed in window [722] Warning.
- One of the warning indications is displayed (area F of the display).

“Limits”

- The AFR/VSI is limiting torque and/or frequency to avoid a trip.
- The Limit relay or output is active (if selected).
- The Trip LED is flashing.
- One of the Limit status indications is displayed (area D of the display).

Trip/Warning messages	Selections	Warning indicators (Area D)
Ext trip	Via DigIn	
Comm error	Trip/Off/Warn	
Over temp	On	OT
Over curr F	On	
Over volt G	On	
Over volt	On	
Under voltage	On	LV
Power Fault PF #### *	On	
Desat ### *	On	
Dclink error	On	
Ovolt m cut	On	

Table 17 List of trips and warnings

Trip/Warning messages	Selections	Warning indicators (Area D)
Over voltage	Warning	VL
Safe stop	Warning	SST
Supply error	On	
Phase error	On	
Sync error	On	
AutoID error	On	
Sensor error	On	
Freq Error	On	
Volt Error	On	

Table 17 List of trips and warnings

* Refer to Table 18 regarding which Desat or Power Fault is triggered.

Note: For VSI refer to standard SX instruction manuals (I126E/ I127E).

10.2 TRIP CONDITIONS, CAUSES AND REMEDIAL ACTION

The table later on in this section must be seen as a basic aid to find the cause of a system failure and to how to solve any problems that arise. An active front end and variable speed drive are mostly just a small part of a complete VSI system. Sometimes it is difficult to determine the cause of the failure, although the motor inverter gives a certain trip message it is not always easy to find the right cause of the failure. Good knowledge of the complete drive system is therefore necessary. Contact your supplier if you have any questions.

The AFR/VSI is designed in such a way that it tries to avoid trips by limiting torque, overvolt etc.

Failures occurring during commissioning or shortly after commissioning are most likely to be caused by incorrect settings or even bad connections.

Failures or problems occurring after a reasonable period of failure-free operation can be caused by changes in the system or in its environment (e.g. wear).

Failures that occur regularly for no obvious reasons are generally caused by Electro-Magnetic Interference. Be sure that the installation fulfils the demands for installation stipulated in the EMC directives. See chapter Chapter 7 page 25.

Sometimes the so-called “Trial and error” method is a quicker way to determine the cause of the failure. This can be done at any level, from changing settings and functions to disconnecting single control cables or replacing entire drives.

The Trip Log can be useful for determining whether certain trips occur at certain moments. The Trip Log also records the time of the trip in relation to the run time counter.



WARNING!

If it is necessary to open the AFR or VSI or any part of the system (motor cable housing, conduits, electrical panels, cabinets, etc.) to inspect or take measurements as suggested in this instruction manual, it is absolutely necessary to read and follow the safety instructions in the manual.

10.2.1 Technically qualified personnel

Installation, commissioning, demounting, making measurements, etc., of or at the motor inverter may only be carried out by personnel technically qualified for the task.

10.2.2 Opening the variable speed drive



WARNING!

Always switch the mains voltage off if it is necessary to open the AFR or VSI and wait at least 7 minutes to allow the capacitors to discharge.



WARNING!

In case of malfunctioning always check the DC-link voltage, or wait one hour after the mains voltage has been switched off, before dismantling the AFR or VSI for repair.

The connections for the control signals and the switches are isolated from the mains voltage. Always take adequate precautions before opening the AFR or VSI.

10.2.3 Precautions to take with a connected motor

If work must be carried out on a connected motor or on the driven machine, the mains voltage must always first be disconnected from the AFR and VSI. Wait at least 5 minutes before continuing.

10.2.4 Autoreset Trip

If the maximum number of Trips during Autoreset has been reached, the trip message hour counter is marked with an "A".

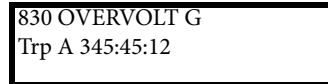

Fig. 36 Autoreset trip

Fig. 36 shows the 3rd trip memory menu [830]: Overvoltage G trip after the maximum Autoreset attempts took place after 345 hours, 45 minutes and 12 seconds of run time.

Trip condition	Possible Cause	Remedy
Ext trip	External input (DigIn 1-8) active: - active low function on the input.	- Check the equipment that initiates the external input - Check the programming of the digital inputs DigIn 1-8
Comm error	Error on serial communication (option)	- Check cables and connection of the serial communication. - Check all settings with regard to the serial communication - Restart the equipment including the VSI
Over temp	Heatsink temperature too high: - Too high ambient temperature of the VSI - Insufficient cooling - Too high current - Blocked or stuffed fans	- Check the cooling of the VSI cabinet. - Check the functionality of the built-in fans. The fans must switch on automatically if the heatsink temperature gets too high. At power up the fans are briefly switched on. - Check VSI and motor rating - Clean fans
Over curr F	Current exceeds the peak VSI current: - Too high load - Excessive load change - Soft short-circuit between phases or phase to earth - Poor or loose cable connections	- Check the main supply voltage. - Check on bad line cable connections - Check on bad earth cable connection - Check on water or moisture in the motor housing and cable connections.
Over volt (Generator)	Too high DC Link voltage	- Check the main supply voltage - Try to take away the interference cause or use other main supply lines.

Table 18 Trip condition, their possible causes and remedial action

Trip conditions, causes and remedial action

Trip condition	Possible Cause	Remedy
Over volt (Mains)	Too high DC Link voltage, due to too high mains voltage	<ul style="list-style-type: none"> - Check the main supply voltage - Try to take away the interference cause or use other main supply lines.
Over volt (Mains cut)		
Under voltage	Too low DC Link voltage: <ul style="list-style-type: none"> - Too low or no supply voltage - Mains voltage dip due to starting other major power consuming machines on the same line. 	<ul style="list-style-type: none"> - Make sure all three phases are properly connected and that the terminal screws are tightened. - Check that the mains supply voltage is within the limits of the VSI. - Try to use other mains supply lines if dip is caused by other machinery
Desat	Failure in output stage, desaturation of IGBTs	<ul style="list-style-type: none"> - Check on bad line cable connections - Check on bad earth cable connections - Check on water and moisture in the cabinet and cable connections
Desat U+ *		
Desat U- *		
Desat V+ *		
Desat V- *		
Desat W+ *		
Desat W- *		
Desat BCC *		
DC link error	DC link voltage ripple exceeds maximum level	<ul style="list-style-type: none"> - Make sure all three phases are properly connected and that the terminal screws are tightened. - Check that the mains supply voltage is within the limits of the VSI. - Try to use other mains supply lines if dip is caused by other machinery.
Power Fault	One of the PF(Power Fault) trips below has occurred, but could not be determined.	<ul style="list-style-type: none"> - Check the PF errors and try to determine the cause. The trip history can be helpful.
PF Fan Err *	Error in fan module	<ul style="list-style-type: none"> - Check for clogged air inlet filters in panel door and blocking material in fan module.
PF Curr Err	Error in current balancing: <ul style="list-style-type: none"> - between different modules. - between two phases within one module. 	<ul style="list-style-type: none"> - Check LCL - filter - Check fuses and line connections
PF Overvolt *	Error in DC - link	<ul style="list-style-type: none"> - Check LCL - filter. - Check fuses and line connections.
PF Comm Err *	Internal communication error	Contact service
PF Int Temp *	Internal temperature too high	Check internal fans
PF Temp Err *	Malfunction in temperature sensor	Contact service
Supply error	No synchronisation current pulse detected	<ul style="list-style-type: none"> - Check mains supply voltage - Check LCL-filter and cables - Check Circuit breaker and main contactor
Phase Error	Failed to verify setup phase sequence during synchronisation	
Sync Error	Overcurrent during synchronisation to supply	<ul style="list-style-type: none"> - Check mains supply voltage - Check LCL-filter and cables - Check Circuit breaker and main contactor - Check supply parameters [O11]-[O14]
AutoID Error	Failure during ID run -Supply could not be identified	
Sensor Error *	Error in voltage measurement	<ul style="list-style-type: none"> - Check mains supply voltage - Check wiring of voltage sensor
Freq. Error	Supply frequency out of range	<ul style="list-style-type: none"> - Check mains supply voltage and frequency - Check LCL-filter and cables - Check Circuit breaker and main contactor - Check supply parameters [O11] - [O14]
Volt Error	Supply voltage out of range	

Table 18 Trip condition, their possible causes and remedial action

* = 2...6 Module number if parallel power units (size 300-1500 A)

Note: For VSI refer to standard SX instruction manuals (I126E/I127E).

10.3 MAINTENANCE

The variable speed drive is designed not to require any servicing or maintenance. There are however some things which must be checked regularly.

All variable speed drives have built-in fan which is speed controlled using heatsink temperature feedback. This means that the fans are only running if the VSI is running and loaded. The design of the heatsinks is such that the fan does not blow the cooling air through the interior of the VSI, but only across the outer surface of the heat-sink. However, running fans will always attract dust. Depending on the environment the fan and the heatsink will collect dust. Check this and clean the heatsink and the fans when necessary.

If variable speed drives are built into cabinets, also check and clean the dust filters of the cabinets regularly.

Check external wiring, connections and control signals. Tighten terminal screws if necessary.

Chapter 11 Technical Data

11.1 ELECTRICAL AND MECHANICAL SPECIFICATIONS RELATED TO MODEL

11.1.1 OMRON SX-FR/SX-VL

SX-FR/ SX-VL Model	Max output current I _{max} [A] ^{*1}	Normal duty 120%, 1 min every 10 min		Heavy duty 150%, 1 min every 10 min		Frame	Dimensions Height=2,250 mm Depth=600 mm Width [mm]	Weight [kg]	SX-AFR model
		Rated current I _{nom} [A]	Power @400 V [kW]	Rated current I _{nom} [A]	Power @400 V [kW]				
SX-D4055-E1_L/R	131	109	55	87	45	E46+E=G	800	380	SX-D4115-E1AR
SX-D4075-E1_L/R	175	146	75	117	55	E46+E=G	800	400	SX-D4115-E1AR
SX-D4090-E1_L/R	210	175	90	140	75	E46+E=G	900	480	SX-D4115-E1AR
SX-D4110-E1_L/R	252	210	110	168	90	F46+F=H	900	500	SX-D4165-E1AR
SX-D4132-E1_L/R	300	250	132	200	110	F46+F=H	900	500	SX-D4165-E1AR
SX-D4160-E1_L/R	360	300	160	240	132	F46+H=I	1,300	700	SX-D4165-E1AR
SX-D4200-E1_L/R	450	375	200	300	160	G46 +G	1,500	750	SX-D4250-E1AR
SX-D4220-E1_L/R	516	430	220	344	200	G46+H	1,500	830	SX-D4250-E1AR
SX-D4250-E1_L/R	600	500	250	400	220	H46+H	1,500	880	SX-D4330-E1AR
SX-D4315-E1_L/R	720	600	315	480	250	H46+I	1,900	1,040	SX-D4330-E1AR
SX-D4355-E1_L/R	780	650	355	520	315	I46+I	2,200	1,210	SX-D4500-E1AR
SX-D4400-E1_L/R	900	750	400	600	355	I46+I	2,200	1,210	SX-D4500-E1AR
SX-D4450-E1_L/R	1,032	860	450	688	400	I46+J	2,500	1,370	SX-D4500-E1AR
SX-D4560-E1_L/R	1,200	1,000	560	800	450	J46+J	3,000	1,600	SX-D4660-E1AR
SX-D4630-E1_L/R	1,440	1,200	630	960	500	J46+KA	3,300	1,700	SX-D4660-E1AR
SX-D4800-E1_L/R	1,800	1,500	800	1,200	630	K46+K	4,500	2,250	SX-D41K0-E1AR
SX-D4900-E1_L/R	2,100	1,750	900	1,400	800	K46+L	On request		SX-D41K0-E1AR

Table 19 SX-FR/SX-VL typical motor power at mains voltage 400 V (refer also to the standard SX instruction manuals (I126E/I127E))

*1 Available for a limited time and as long as drive temperature permits

Note: Assembled in IP54 cabinet including main switch, main contactor and output choke.

SX-FR/SX-VL Model	Max output current I _{max} [A] ^{*1}	Normal duty 120%, 1 min every 10 min		Heavy duty 150%, 1 min every 10 min		Frame	Dimensions Height=2250 mm Depth=600 mm Width [mm]	Weight [kg]	SX-AFR model
		Rated current I _{nom} [A]	Power @690 V [kW]	Rated current I _{nom} [A]	Power @690 V [kW]				
SX-D6110-E1_L/R	131	109	110	87	90	F69+F69=H69	800	410	SX-D6200-E1AR
SX-D6132-E1_L/R	175	146	132	117	110	F69+F69=H69	800	430	SX-D6200-E1AR
SX-D6160-E1_L/R	222	185	160	148	132	F69+F69=H69	900	540	SX-D6200-E1AR
SX-D6250-E1_L/R	300	250	250	200	200	H69+H69	1,800	870	SX-D6400-E1AR
SX-D6315-E1_L/R	360	300	315	240	250	H69+H69	1,800	870	SX-D6400-E1AR
SX-D6355-E1_L/R	450	375	355	300	315	H69+H69	1,800	910	SX-D6400-E1AR
SX-D6450-E1_L/R	516	430	450	344	355	I69+I69	2,800	1,350	SX-D6600-E1AR
SX-D6560-E1_L/R	672	560	560	448	450	I69+I69	2,800	1,390	SX-D6600-E1AR
SX-D6710-E1_L/R	900	750	710	600	600	J69+J69	On request		SX-D6800-E1AR
SX-D61K0-E1_L/R	1,200	1,000	1,000	800	800	K69+KA69	On request		SX-D61K2-E1AR
SX-D61K1-E1_L/R	1,344	1,120	1,100	896	900	K69+K69	On request		SX-D61K2-E1AR

Table 20 SX-FR/SX-VL typical motor power at mains voltage 690 V

*1 Available for a limited time and as long as drive temperature permits

Note: Assembled in IP54 cabinet including main switch, main contactor or motor driven circuit breaker and output choke.

11.1.2 OMRON SX-AFR

Model	Max input current I _{max} [A] ^{*1}	Normal duty 120%, 1 min every 10 min		Frame	Dimensions Height=2250mm Depth=600mm Width [mm]	Weight [kg]
		Rated input current I _{nom} [A]	Output DC power @400 V AC [kW]			
SX-D4115-E1AR	210	175	115	E46	600	290
SX-D4165-E1AR	300	250	165	F46	800	400
SX-D4250-E1AR	450	375	250	G46	1,000	560
SX-D4330-E1AR	600	500	330	H46	1,200	660
SX-D4500-E1AR	900	750	500	I46	1,500	830
SX-D4660-E1AR	1,200	1,000	660	J46	1,800	1,100
SX-D41K0-E1AR	1,800	1,500	1,000	K46	2,700	1,600

Table 21 SX-AFR Typical output DC power at mains voltage 400 V

^{*1}Available for a limited time and as long as drive temperature permits

Note: Assembled in IP54 cabinet including main switch and main contactor.

Model	Max input current I _{max} [A] ^{*1}	Normal duty 120%, 1 min every 10 min		Frame	Dimensions Height=2250mm Depth=600mm Width [mm]	Weight [kg]
		Rated input current I _{nom} [A]	Output DC power @690 V AC [kW]			
SX-D6200-E1AR	210	175	200	F69	800	320
SX-D6400-E1AR	420	350	400	H69	1,200	590
SX-D6600-E1AR	630	525	600	I69	1,700	860
SX-D6800-E1AR	840	700	800	J69	On request	
SX-D61K2-E1AR	1,260	1,050	1,200	K69	On request	

Table 22 SX-AFR typical output DC power at mains voltage 690 V

^{*1}Available for a limited time and as long as drive temperature permits.

Note: Assembled in IP54 cabinet including main switch and main contactor or motor driven circuit breaker.

General electrical specifications

11.2 GENERAL ELECTRICAL SPECIFICATIONS

General

Mains voltage:	SX-FR/VL/AFR 400V models SX-FR/VL/AFR 690V models	380 - 460 V +10%/-15% 480 - 690 V +10%/-15%
Mains frequency:		48 to 52Hz and 58 to 62Hz
Input total power factor:		1.0
Output voltage	SX-FR/VL	(0 - 1.2) * Mains supply voltage (V AC)
Output voltage	SX-AFR	(1.0 - 1.2) * $\sqrt{2}$ * Mains supply voltage (V DC)
Switching frequency:	SX-FR/VL SX-AFR	3 kHz (adjustable 1.5 - 6 kHz, SX-VL only) 3 kHz
Efficiency at nominal load	SX-FR/VL SX-AFR	97% 98%
Harmonics to supply, THDI		< 5 %

Control signal inputs:

Analogue (differential)

Analogue Voltage/current:	0-±10 V/0-20 mA via switch
Max. input voltage:	+30 V/30 mA
Input impedance:	20 kΩ (voltage) 250 Ω (current)
Resolution:	11 bits + sign
Hardware accuracy:	1% type + 1½ LSB fsd
Non-linearity	1½ LSB

Digital:

Input voltage:	High: >9 V DC, Low: <4 V DC
Max. input voltage:	+30 V DC
Input impedance:	<3.3 V _{DC} : 4.7 kΩ ≥3.3 V _{DC} : 3.6 kΩ
Signal delay:	≤8 ms

Control signal outputs

Analogue

Output voltage/current:	0-10 V/0-20 mA via software setting
Max. output voltage:	+15 V @5 mA cont.
Short-circuit current (∞):	+15 mA (voltage), +140 mA (current)
Output impedance:	10 Ω (voltage)
Resolution:	10 bit
Maximum load impedance for current	500 Ω
Hardware accuracy:	1.9% type fsd (voltage), 2.4% type fsd (current)
Offset:	3 LSB
Non-linearity:	2 LSB

Digital

Output voltage:	High: >20 V DC @50 mA, >23 V DC open Low: <1 V DC @50 mA
Shortcircuit current(∞):	100 mA max (together with +24 V DC)

Relays

Contacts	0.1 - 2 A/U _{max} 250 VAC or 42 V _{DC}
----------	--

References

+10 V DC	+10 V DC @10 mA Short-circuit current +30 mA max
-10 V DC	-10 V DC @10 mA
+24 V DC	+24 V DC Short-circuit current +100 mA max (together with Digital Outputs)

Table 23 General electrical specifications

11.3 OPERATION AT HIGHER TEMPERATURES

All OMRON AFE units are made for operation at maximum of 40 °C ambient temperature. However it is possible to use the AFE units at higher temperatures with some loss in performance, using derating.

Derating, - 2,5% per degree Celsius is possible. Maximum is +5 °C (45 °C).

11.4 ENVIRONMENTAL CONDITIONS

Parameter	Normal operation
Nominal ambient temperature	0°C–40°C See Chapter 11.3, for different conditions
Atmospheric pressure	86–106 kPa
Relative humidity, non-condensing	0–90%
Contamination, according to IEC 60721-3-3	No electrically conductive dust allowed. Cooling air must be clean and free from corrosive materials. Chemical gases, class 3C2 (Coated boards 3C3). Solid particles, class 3S2.
Vibrations	According to IEC 600068-2-6, Sinusoidal vibrations: 10<f<57 Hz, 0.075 mm 57<f<150 Hz, 1g
Altitude	0–1,000 m, 400 V AFE units, with derating 1%/100m of rated current up to 4,000 m. Coated boards recommended > 2,000m 690 V AFE units, with derating 1%/100m of rated current up to 2,000 m.

Table 24 Operation

Parameter	Storage condition
Temperature	-20 to +60 °C
Atmospheric pressure	86–106 kPa
Relative humidity, non-condensing	0– 90%

Table 25 Storage

11.5 CONTROL SIGNALS

Terminal X1	Name:	Function (Default):	Signal:	Type:
1	+10 V	+10 VDC Supply voltage	+10 V DC, max 10 mA	output
2	AnIn1	Process reference	0 -10 V DC or 0/4–20 mA bipolar: -10 - +10 V DC or -20 - +20 mA	analogue input
3	AnIn2	Off	0 -10 V DC or 0/4–20 mA bipolar: -10 - +10 V DC or -20 - +20 mA	analogue input
4	AnIn3	Dedicated for supply voltage measurement option	0 -10 V DC or 0/4–20 mA bipolar: -10 - +10 V DC or -20 - +20 mA	analogue input
5	AnIn4	Dedicated for supply voltage measurement option	0 -10V DC or 0/4–20 mA bipolar: -10 - +10 V DC or -20 - +20 mA	analogue input
6	-10 V	-10VDC Supply voltage	-10 V DC, max 10 mA	output
7	Common	Signal ground	0V	output
8	DigIn 1	RunL	0-8/24 V DC	digital input
9	DigIn 2	RunR	0-8/24 V DC	digital input
10	DigIn 3	Enable	0-8/24 V DC	digital input
11	+24 V	+24VDC Supply voltage	+24 V DC, 100 mA	output
12	Common	Signal ground	0 V	output
13	AnOut 1		0 ±10 V DC or 0/4– +20 mA	analogue output
14	AnOut 2	0 to max torque	0 ±10 V DC or 0/4– +20 mA	analogue output
15	Common	Signal ground	0 V	output
16	DigIn 4	Off	0-8/24 V DC	digital input

Table 26

Control signals

Terminal X1	Name:	Function (Default):	Signal:	Type:
17	DigIn 5	Off	0-8/24 V DC	digital input
18	DigIn 6	Off	0-8/24 V DC	digital input
19	DigIn 7	Off	0-8/24 V DC	digital input
20	DigOut 1	Option (Active when AFR is running)	24 V _{DC} , 100 mA	digital output
21	DigOut 2	LZ (trip pulse of 1s)	24 V _{DC} , 100 mA	digital output
22	DigIn 8	RESET	0-8/24 VDC	digital input

Table 26

Terminal X2	Name:	Function (Default):	Signal:	Type:
31	N/C 1	Relay 1 output N/C is opened when the relay is active (valid for all relays) N/O is closed when the relay is active (valid for all relays)	potential free change over 0.1 – 2 A/U _{max} 250 V AC or 42 V DC	relay output
32	COM 1			
33	N/O 1			
41	N/C 2	Relay 2 Output Option (active when the AFR is running)	potential free change over 0.1 – 2 A/U _{max} 250 V AC or 42 V DC	relay output
42	COM 2			
43	N/O 2			

Table 27

Terminal X3	Name:	Function (Default):	Signal:	Type:
51	COM 3	Relay 3 Output, Dedicated for Main Contactor K1	potential free change over 0.1 – 2 A/U _{max} 250 V AC or 42 V DC	relay output
52	N/O 3			

Table 28

Chapter 12 Menu List

		DEFAULT	CUSTOM
100	Preferred View		
110	1st Line	Current	
120	2nd Line	Torque	
200	Main Setup		
210	Operation		
211	Language	English	
214	Ref Control	Remote	
215	Run/Stp Ctrl	Remote	
216	Reset Ctrl	Remote	
217	Local/Rem		
2171	LocRefCtrl	Standard	
2172	LocRunCtrl	Standard	
218	Lock Code?	0	
21A	Level / Edge	Level	
21B	Supply Volts	Not defined	
240	Set Handling		
241	Select Set	A	
243	Default>Set	A	
300	Process		
310	Set/View ref	0%	
500	I/Os		
510	An Inputs		
511	AnIn1 Fc	Process Ref	
512	AnIn1 Setup	User Bipol V	
513	AnIn1 Advn		
514	AnIn2 Fc	Off	
515	AnIn2 Setup	0 - 10 V	
516	AnIn2 Advn		
517	AnIn3 Fc	Off	
518	AnIn3 Setup	User Bipol V	
519	AnIn3 Advn		
51A	AnIn4 Fc	Off	
51B	AnIn4 Setup	User Bipol V	
51C	AnIn4 Advn		
520	Dig Inputs		
521	DigIn 1	RunL	
522	DigIn 2	RunR	
523	DigIn 3	Enable	
524	DigIn 4	Off	
525	DigIn 5	Off	
526	DigIn 6	Off	
527	DigIn 7	Off	
528	DigIn 8	Reset	
530	An Outputs		
531	AnOut1 Fc	Current	
532	AnOut1 Setup	4-20mA	
533	AnOut1 Adv		

		DEFAULT	CUSTOM
534	AnOut2 FC	Torque	
535	AnOut2 Setup	4-20mA	
536	AnOut2 Advn		
540	Dig Outputs		
541	DigOut 1	Option	
542	DigOut 2	LZ	
550	Relays		
551	Relay 1	Charge K2	
552	Relay 2	Option	
553	Relay 3	Main K1	
55D	Relay Adv		
55D1	Relay 1 Mode	N.O	
55D2	Relay 2 Mode	N.O	
55D3	Relay 3 Mode	N.O	
560	Virtual I/Os		
561	VIO 1 Dest	Off	
562	VIO 1 Source	Off	
563	VIO 2 Dest	Off	
564	VIO 2 Source	Off	
565	VIO 3 Dest	Off	
566	VIO 3 Source	Off	
567	VIO 4 Dest	Off	
568	VIO 4 Source	Off	
569	VIO 5 Dest	Off	
56A	VIO 5 Source	Off	
56B	VIO 6 Dest	Run R	
56C	VIO 6 Source	DigIn 1	
56D	VIO 7 Dest	Run L	
56E	VIO 7 Source	DigIn 2	
56F	VIO 8 Dest	Off	
56G	VIO 8 Source	Operation	
600	Logical&Timers		
610	Comparators		
611	CA1 Setup		
6111	CA1 Value	Current	
6112	CA1 Level HI	30	
6113	CA1 Level LO	20	
6114	CA1 Type	Hysteresis	
6115	CA1 Bipolar	Unipolar	
612	CA2 Setup		
6121	CA2 Value	Torque	
6122	CA2 Level HI	20	
6123	CA2 Level LO	10	
6124	CA2 Type	Hysteresis	
6125	CA2 Bipolar	Unipolar	
613	CA3 Setup		
6131	CA3 Value	Process Val	
6132	CA3 Level HI	300	
6133	CA3 Level LO	200	
6134	CA3 Type	Hysteresis	
6135	CA3 Bipolar	Unipolar	

		DEFAULT	CUSTOM
614	CA4 Setup		
6141	CA4 Value	Process Err	
6142	CA4 Level HI	100	
6143	CA4 Level LO	- 100	
6144	CA4 Type	Window	
6145	CA4 Bipolar	Bipolar	
615	CD Setup		
6151	CD1	Trip	
6152	CD2	T2Q	
6153	CD3	Trip	
6154	CD4	Ready	
620	Logic Y		
621	Y Comp 1	CA1	
622	Y Operator 1	&	
623	Y Comp 2	!A2	
624	Y Operator 2	&	
625	Y Comp 3	CD1	
630	Logic Z		
631	Z Comp 1	CD1	
632	Z Operator 1	&	
633	Z Comp2	!D2	
634	Z Operator 2	.	
635	Z Comp 3	CD1	
640	Timer1		
641	Timer1 Trig	Off	
642	Timer1 Mode	Off	
643	Timer1 Delay	0:00:00	
644	Timer 1 T1	0:00:00	
645	Timer1 T2	0:00:00	
649	Timer1 Value	0:00:00	
650	Timer2		
651	Timer2 Trig	Trip	
652	Timer2 Mode	Delay	
653	Timer2 Delay	0:00:01	
654	Timer2 T1	0:00:01	
655	Timer2 T2	0:00:00	
659	Timer2 Value	0:00:00	
700	Oper/Status		
710	Operation		
711	Process Val		
713	Torque		
714	React Power		
715	El Power		
716	Current		
717	Output volt		
718	Frequency		
719	DC Voltage		
71A	Heatsink Tmp		
720	Status		
721	VSD Status		
722	Warning		
723	DigIn Status		
724	DigOut Status		
725	AnIn 1 - 2		
726	AnIn 3 - 4		

		DEFAULT	CUSTOM
	727	AnOut 1 - 2	
730	Stored Val		
	731	Run Time	00:00:00
	7311	Reset RunTm	No
	732	Mains Time	00:00:00
	733	Energy	...kWh
	7331	Rst Energy	No
800	View TripLog		
810	Trip Message (811 - 81o)		
	811	Process Val	
	813	Torque	
	814	Shaft Power	
	815	El Power	
	816	Current	
	817	Output volt	
	818	Frequency	
	819	DC Voltage	
	81A	Heatsink Tmp	
	81B	VSD Status	
	81C	FI Status	
	81D	DigIn status	
	81E	DigOut status	
	81F	AnIn 1 - 2	
	81G	AnIn 3 - 4	
	81H	AnOut 1 - 2	
	81L	Run Time	00:00:00
	81M	Mains Time	00:00:00
	81N	Energy	...kWh
	81o	Set/View ref	
820	Trip Message (821 - 82o)		
830	Trip Message (831 - 83o)		
840	Trip Message (841 - 84o)		
850	Trip Message (851 - 85o)		
860	Trip Message (861 - 86o)		
870	Trip Message (871 - 87o)		
880	Trip Message (881 - 88o)		
890	Trip Message (891 - 89o)		
8A0	Reset Trip l	No	
900	System Data		
920	VSD Data		
	921	AFR 2.0	
	922	Software	
	9221	Build Info	
	923	Unit name	0
000	AFR Option		
010	Supply		
	011	Supply Volts	AFR. Unom
	012	Supply Freq	50Hz
	013	Supply Curr	AFR. Inom
	014	Supply Seq	Pos
	015	Supply ID run	Off
	016	Supply Auto	Off
	017	Volt sensor	Off
020	Start/Stop		
	021	Charge ctrl	Supply-NC

		DEFAULT	CUSTOM
	O22	Run/Stop Mode	Standard
	O23	Reg Stp Time	1s
O30	Udc control		
	O31	Udc ref	1.05*Upeak
	O32	Udc ramp	1s
	O33	Udc PI Gain	5
	O34	Udc PI Time	0.2s
	O35	Udc PI max	200%
	O36	Udc PI Charg	20%
	O37	Udc margin	5%
O40	Q control		
	O41	Q max	0%
	O42	Q ramp	1s
	O43	Q PI Gain	0.1
	O44	Q PI Time	0.1s
	O45	Q Filter	1s
O50	Frequency control		
	O51	Frequency mode	Observer
O80	View energy		
	O81	Energy suppl	...kWh
	O82	Energy Motor	...kWh
	O83	Energy Gen	...kWh
	O84	Reset energy	No
O90	View control		
	O91	Udc Ref / Val	105% / 100%
	O92	T Ref / Val	20% / 0%
	O93	Q Ref / Val	-5% / 0%
	O94	Psi Ref / Val	100% / 100%

12.1 COMMUNICATION INFORMATION LIST

For communication information regarding menu numbers not included in the list below, please refer to the standard SX instruction manuals (I126E/I127E).

AFE Option Parameters		Modbus instance / DeviceNet number	Profibus slot / index	EtherCAT index (HEX)	Fieldbus format	Modbus format
700	View Operation/Status					
710	Operation					
711	Process value	31001	121/145	23e9	Long, 1 = 0.001	EInt
713	Torque	31003 Nm, 31004 %	121/147,121/ 148	23eb, 23ec	Long, 1 = 0.1 Nm Long, 1 = 1%	EInt
714	Reactive power	31005	121/149	23ed	Long, 1 = 1W	EInt
715	Electrical Power	31006	121/150	23ee	Long, 1=1W	EInt
716	Current	31007	121/151	23ef	Long, 1=0.1A	EInt
717	Output voltage	31008	121/152	23f0	Long, 1=0.1 V	EInt
718	Frequency	31009	121/153	23f1	Long, 1= 0.1 Hz	EInt
719	DC-link Voltage	31010	121/154	23f2	Long, 1=0.1 V	EInt
71A	Heat Sink Temperature	31011	121/155	23f3	Long, 1 = 0.1 C	EInt
O00	AFE option					
O10	Supply					
O11	Supply Volts	48001	188/60		Long, 1=1V	EInt
O12	Supply Freq	48002	188/61		Long, 1=1Hz	EInt
O13	Supply Curr	48003	188/62		Long, 1=0.1A	EInt
O14	Supply Seq	48004	188/63		UInt, 1=1	UInt
O15	Supply Idrun	48005	188/64		UInt, 1=1	UInt
O16	Supply Auto	48006	188/65		UInt, 1=1	UInt
O17	Volt Sensor	48007	188/66		UInt, 1=1	UInt
O20	Start/Stop					
O21	Charge Ctrl	48011	188/70		UInt, 1=1	UInt
O22	Run/Stop Mode	48012	188/71		UInt, 1=1	UInt
O23	Reg Stop Time	48013	188/72		Long, 1=0.01s	EInt
O30	Udc Control					
O31	Udc ref	48021	188/80		Long, 1=0.1V	EInt
O32	Udc ramp	48022	188/81		Long, 1=0.01s	EInt
O33	Udc PI Gain	48023	188/82		Long, 1=0.1	EInt
O34	Udc PI Time	48024	188/83		Long, 1=0.01s	EInt
O35	Udc PI Max	48025	188/84		Long, 1=1%	EInt
O36	Udc PI Chrg	48026	188/85		Long, 1=1%	EInt
O37	Udc Margin	48027	188/86		Long, 1=0.1%	EInt
O40	Q Control					
O41	Q max	48031	188/90		Long, 1=1%	EInt
O42	Q ramp	48032	188/91		Long, 1=0.01s	EInt
O43	Q PI Gain	48033	188/92		Long, 1=0.01	EInt
O44	Q PI Time	48034	188/93		Long, 1=0.01s	EInt
O45	Q Filter	48035	188/94		Long, 1=0.01s	EInt
O50	Freq Control					
O51	Freq Type	48041	188/100		UInt, 1=1	UInt
O80	View Energy					
O81	Energy Suppl	31034	121/178		Long, 1=1Wh	EInt
O82	Energy Motor	48071	188/130		Long, 1=1Wh	EInt
O83	Energy Gen	48075	188/134		Long, 1=1Wh	EInt

AFE Option Parameters		Modbus instance / DeviceNet number	Profibus slot / index	EtherCAT index (HEX)	Fieldbus format	Modbus format
O84	Reset Energy	48079	188/138			
O90	View Control					
O91	UdcRef Val	48081	188/140		Long, 1=0.1	EInt
O92	T Ref Val	48083	188/142		Long, 1=0.1	EInt
O93	Q Ref Val	48085	188/144		Long, 1=0.1	EInt
O94	PsiRef Val	48087	188/146		Long, 1=0.1	EInt

OMRON

Authorized Distributor: