

# HS-360X Handheld DPM Scanner User Manual



---

## *Copyright and Disclaimers*

Copyright ©2018  
Omron Microscan Systems, Inc.  
Tel: +1.425.226.5700 / 800.762.1149  
Fax: +1.425.226.8250

All rights reserved. The information contained herein is proprietary and is provided solely for the purpose of allowing customers to operate and/or service Omron Microscan-manufactured equipment and is not to be released, reproduced, or used for any other purpose without written permission of Omron Microscan.

Throughout this manual, trademarked names might be used. We state herein that we are using the names to the benefit of the trademark owner, with no intention of infringement.

### ***Disclaimer***

The information and specifications described in this manual are subject to change without notice.

### ***Latest Manual Version***

For the latest version of this manual, see the Download Center on our web site at:

[www.microscan.com/downloadcenter](http://www.microscan.com/downloadcenter).

### ***Technical Support***

For technical support, e-mail: [helpdesk@microscan.com](mailto:helpdesk@microscan.com).

### ***Warranty***

For current warranty information, see: [www.microscan.com/warranty](http://www.microscan.com/warranty).

## **Omron Microscan Systems, Inc.**

### **United States Corporate Headquarters**

+1.425.226.5700 / 800.762.1149

### **United States Northeast Technology Center**

+1.603.598.8400 / 800.468.9503

### **European Headquarters**

+31.172.423360

### **Asia Pacific Headquarters**

+65.6846.1214

No part of this publication may be reproduced or used in any form, or by any electrical or mechanical means, without permission in writing from Omron Microscan. This includes electronic or mechanical means, such as photocopying, recording, or information storage and retrieval systems. The material in this manual is subject to change without notice.

The software is provided strictly on an "as is" basis. All software, including firmware, furnished to the user is on a licensed basis. Omron Microscan grants to the user a non-transferable and non-exclusive license to use each software or firmware program delivered hereunder (licensed program). Except as noted below, such license may not be assigned, sublicensed, or otherwise transferred by the user without prior written consent of Omron Microscan. No right to copy a licensed program in whole or in part is granted, except as permitted under copyright law. The user shall not modify, merge, or incorporate any form or portion of a licensed program with other program material, create a derivative work from a licensed program, or use a licensed program in a network without written permission from Omron Microscan. The user agrees to maintain Omron Microscan's copyright notice on the licensed programs delivered hereunder, and to include the same on any authorized copies it makes, in whole or in part. The user agrees not to decompile, disassemble, decode, or reverse engineer any licensed program delivered to the user or any portion thereof.

Omron Microscan reserves the right to make changes to any product to improve reliability, function, or design.

Omron Microscan does not assume any product liability arising out of, or in connection with, the application or use of any product, circuit, or application described herein. No license is granted, either expressly or by implication, estoppel, or otherwise under any patent right or patent, covering or relating to any combination, system, apparatus, machine, material, method, or process in which Omron Microscan products might be used. An implied license exists only for equipment, circuits, and subsystems contained in Omron Microscan products.

This product may include Seller Software, Third Party Software, and/or Publicly Available Software.

Use of any Software is subject to the applicable licenses, terms and conditions of the agreement in force between you and the Seller unless a separate License is included, in which case, use of the Software will be governed by the separate License.

Copies of the licenses for the following Publicly Available Software, and all attributions, acknowledgments, and software information details, are included below. Seller is required to reproduce the software licenses, acknowledgments and copyright notices as provided by the Authors and Owners. The information is provided in its native language form, without modification or translation.

Publicly available software list:

Name: Regular Expression Evaluator

Version: 8.3

Description: Compiles and executes regular expressions.

Software Site: <http://www.freebsd.org/cgi/cvsweb.cgi/src/lib/libc/regex/>

Source Code: No Source Distribution Obligations. Seller will not provide nor distribute the Source Code for the Regular Expression Evaluator.

License: BSD Style License

©1992 Henry Spencer.

©1992, 1993 The Regents of the University of California. All rights reserved.

This code is derived from software contributed to Berkeley by Henry Spencer of the University of Toronto.

Redistribution and use in source and binary forms, with or without modification, are permitted provided that the following conditions are met:

1. Redistributions of source code must retain the above copyright notice, this list of conditions and the following disclaimer.
2. Redistributions in binary form must reproduce the above copyright notice, this list of conditions and the following disclaimer in the documentation and/or other materials provided with the distribution.
3. All advertising materials mentioning features or use of this software must display the following acknowledgment:  
This product includes software developed by the University of California, Berkeley and its contributors.
4. Neither the name of the University nor the names of its contributors may be used to endorse or promote products derived from this software without specific prior written permission.

THIS SOFTWARE IS PROVIDED BY THE REGENTS AND CONTRIBUTORS "AS IS" AND ANY EXPRESS OR IMPLIED WARRANTIES, INCLUDING, BUT NOT LIMITED TO, THE IMPLIED WARRANTIES OF MERCHANTABILITY AND FITNESS FOR A PARTICULAR PURPOSE ARE DISCLAIMED. IN NO EVENT SHALL THE REGENTS OR CONTRIBUTORS BE LIABLE FOR ANY DIRECT, INDIRECT, INCIDENTAL, SPECIAL, EXEMPLARY, OR CONSEQUENTIAL DAMAGES (INCLUDING, BUT NOT LIMITED TO, PROCUREMENT OF SUBSTITUTE GOODS OR SERVICES; LOSS OF USE, DATA, OR PROFITS; OR BUSINESS INTERRUPTION) HOWEVER CAUSED AND ON ANY THEORY OF LIABILITY, WHETHER IN CONTRACT, STRICT LIABILITY, OR TORT (INCLUDING NEGLIGENCE OR OTHERWISE) ARISING IN ANY WAY OUT OF THE USE OF THIS SOFTWARE, EVEN IF ADVISED OF THE POSSIBILITY OF SUCH DAMAGE.

# Table of Contents

Introduction	
Table of Contents .....	iv
About This Manual .....	viii
HS-360X Configurations .....	ix
Service Information .....	x
Chapter 1 Quick Start	
HS-360X Handheld DPM Scanner .....	1-2
HS-360X Wireless Handheld DPM Scanner .....	1-4
HS-360X Wired Handheld DPM Scanner .....	1-14
Chapter 2 Data Capture	
HS-360X Wireless Scanner Beeper and LED .....	2-2
HS-360X Beeper and LED Definitions .....	2-7
HS-360X Scanning .....	2-8
Chapter 3 Maintenance and Technical Specifications	
Maintenance .....	3-2
Troubleshooting .....	3-4
Technical Specifications .....	3-7
HS-360X Wired Scanner Signal Descriptions .....	3-10
Chapter 4 Radio Communications	
HS-360X Wireless Scanner Radio Communications .....	4-2
Radio Communications Parameter Defaults .....	4-3
Wireless Beeper Definitions .....	4-5
Radio Communications Host Types .....	4-5
Bluetooth-Friendly Name .....	4-9
Wi-Fi Friendly Mode .....	4-11
Radio Output Power .....	4-14
Bluetooth Radio State .....	4-16
HID Host Parameters .....	4-17
Reconnect Attempt Beep Feedback .....	4-29
Out-of-Range Indicator .....	4-34
Beep on <BEL> .....	4-36
Scanner(s)-to-Cradle Support .....	4-37
Batch Mode .....	4-46
Persistent Batch Storage .....	4-50
Page Button .....	4-51
Page Options .....	4-52
Classic Bluetooth and/or Low Energy (Cradle Host Only) .....	4-54
Bluetooth Security .....	4-55
Bluetooth Radio, Linking, and Batch Operation .....	4-59

<b>Chapter 5</b>	<b>User Preferences and Miscellaneous Options</b>	
	Introduction.....	5-2
	Scanning Sequence Examples.....	5-2
	Errors While Scanning.....	5-2
	Parameter Defaults.....	5-3
	User Preferences.....	5-5
<b>Chapter 6</b>	<b>Imaging Preferences</b>	
	Introduction.....	6-2
	Scanning Sequence Examples.....	6-3
	Errors While Scanning.....	6-3
	Imaging Preferences Parameter Defaults .....	6-3
<b>Chapter 7</b>	<b>USB Interface</b>	
	Connecting a USB Interface .....	7-2
	USB Parameter Defaults .....	7-5
	USB Host Parameters .....	7-6
	Optional USB Parameters .....	7-20
	ASCII Character Set for USB .....	7-26
<b>Chapter 8</b>	<b>RS-232 Interface</b>	
	Introduction.....	8-2
	Connecting an RS-232 Interface .....	8-3
	RS-232 Parameter Defaults .....	8-5
	ASCII Character Set for RS-232.....	8-23
<b>Chapter 9</b>	<b>Symbologies</b>	
	Introduction.....	9-2
	Scanning Sequence Examples.....	9-2
	Errors While Scanning.....	9-2
	Symbology Parameter Defaults.....	9-3
	Enable/Disable All Code Types .....	9-8
	UPC/EAN.....	9-9
	Code 128.....	9-36
	Code 39.....	9-48
	Code 93.....	9-60
	Code 11.....	9-63
	Interleaved 2 of 5 (ITF).....	9-68
	Discrete 2 of 5 (DTF).....	9-77
	Codabar (NW - 7).....	9-80
	MSI.....	9-86
	Chinese 2 of 5.....	9-92
	Matrix 2 of 5.....	9-93
	Korean 3 of 5.....	9-98
	Inverse 1D.....	9-99
	GS1 DataBar.....	9-100

---

## Table of Contents

BC412 .....	9-105
Composite .....	9-106
PDF417 .....	9-112
MicroPDF417 .....	9-113
Code 128 Emulation .....	9-114
Data Matrix .....	9-115
GS1 Data Matrix .....	9-115
Data Matrix Inverse .....	9-116
Maxicode .....	9-117
QR Code .....	9-118
GS1 QR .....	9-119
Micro QR Code .....	9-120
Aztec .....	9-121
Aztec Inverse .....	9-122
Han Xin .....	9-123
Han Xin Inverse .....	9-124
DotCode .....	9-125
U.S. Postnet .....	9-126
U.S. Planet .....	9-127
UK Postal .....	9-129
Japan Postal .....	9-131
Australia Post .....	9-132
Netherlands KIX Code .....	9-135
USPS 4CB/One Code/Intelligent Mail .....	9-136
UPU FICS Postal .....	9-137
Mailmark .....	9-138
Symbology-Specific Security Levels .....	9-139
Report Version .....	9-145
Macro PDF Features .....	9-146
<b>Chapter 10      WebLink<sub>PC</sub></b>	
Set Up HS-360X Host Interface .....	10-2
Install WebLink <sub>PC</sub> .....	10-3
Connect to WebLink <sub>PC</sub> .....	10-4
Explore the Start View .....	10-5
Create a New Setup or Load an Existing Setup .....	10-6
Explore the Setup View .....	10-7
Configure Cycle Settings .....	10-8
Configure Performance Settings .....	10-9
Configure Symbology and Decode Settings .....	10-12
Configure Output Formatting .....	10-14
Run the Application .....	10-16

Appendices

Appendix A — Standard Default Parameters .....A-2  
Appendix B — Country Codes .....A-11  
Appendix C — Country Code Pages .....A-31  
Appendix D — Chinese, Japanese, and Korean (CJK) Decode Control .....A-44  
Appendix E — Programming Reference .....A-53  
Appendix F — Sample Symbols .....A-59  
Appendix G — Alphanumeric Keyboard .....A-62  
Appendix H — Numeric Keyboard .....A-77  
Appendix I — ASCII Character Sets .....A-79  
Appendix J — Non-Parameter Attributes .....A-90

## About This Manual

The *HS-360X Handheld DPM Scanner User Manual* provides general instructions for setting up, operating, maintaining, and troubleshooting wireless and wired HS-360X scanners.

### ***Notational Conventions***

The following conventions are used in this document:

*Italics* are used to highlight the following:

- Chapters and sections in this and related documents;
- Dialog box, window and screen names;
- Drop-down list and list box names;
- Check box and radio button names.

**Bold** text is used to highlight the following:

- Key names on a keypad;
- Button names on a screen.

Bullets (•) indicate:

- Action items;
- Lists of alternatives.

Lists of required steps that are not necessarily sequential:

- Sequential lists (e.g., those that describe step-by-step procedures) appear as numbered lists.
- Throughout the programming barcode menus, asterisks (\*) are used to denote default parameter settings.



\* Indicates Default — \* **HID Keyboard Emulation** — Feature/Option

### ***Related Documents***

- *HS-360X Wired Scanner Quick Start Guide*, P/N 83-9310013-02, provides general information about how to get started with the wired version of the HS-360X Handheld DPM Scanner, and includes basic instructions for setup and operation.
- *HS-360X Wireless Scanner Quick Start Guide*, P/N 83-9310014-02, provides general information about how to get started with the wireless version of the HS-360X Handheld DPM Scanner, and includes basic instructions for setup and operation.
- *HS-360X Four-Slot Spare Battery Charger Quick Start Guide*, P/N 83-93100017-02, provides general information about how to mount, configure, and use the HS-360X Four-Slot Spare Battery Charger.
- *HS-360X Cradle Quick Start Guide*, P/N 83-93100018-02, provides general information about how to mount, connect, configure, and use the HS-360X Cradle.

For the latest version of all guides, visit the Download Center at: [www.microscan.com](http://www.microscan.com).



# HS-360X Configurations

This guide includes the following HS-360X configurations:

<b>Part Number</b>	<b>Description</b>
HDS-3608-0001	HS-360X Handheld DPM Scanner, Wired
HDS-3678-0001	HS-360X Handheld DPM Scanner, Wireless

## HS-360X Accessories, Cables, and Power Supplies

**Caution:** Use only cables designed for the HS-360X Handheld DPM Scanner.

<b>Part Number</b>	<b>Description</b>
<b>Accessories</b>	
12-9000937-01	Cradle / Charger, HS-360X Wireless
98-9000185-01	4-Slot Battery Charger, HS-360X Wireless, Power Supply Required
98-9000186-01	Stand, HS-360X
98-9000224-01	Battery, Spare, HS-360X Wireless
<b>USB Cables</b>	
12-9000942-01	Cable, USB, Shielded, 2 M, Ext. 12V, HS-360X, Power Supply Required
12-9000943-01	Cable, USB, Shielded, 4.6 M, Ext. 12V, HS-360X, Power Supply Required
12-9000946-01	Cable, USB, Shielded, 2 M, HS-360X
12-9000947-01	Cable, USB, Shielded, 4.6 M, HS-360X
<b>RS-232 Cables</b>	
12-9000953-01	Cable, RS-232, DB9 Socket, 2 M, Straight, HS-360X, 98-9000181-01 and A/C Power Cord Required
<b>Power Supplies</b>	
12-9000959-01	AC Power Cord, 2.5 M, U.S., C13 Conn.
12-9000960-01	AC Power Cord, 2.5 M, EU, C13 Conn.
12-9000961-01	AC Power Cord, 2.5 M, UK, C13 Conn.
12-9000962-01	AC Power Cord, 2.5 M, China, C13 Conn.
12-9001046-01	AC Power Cord, 1.8 M, Japan, C13 Conn.
98-9000181-01	Kit, Power Supply for Cradle / Charger, HS-360X Wireless / RS-232 Cable, A/C Power Cord Required
98-9000182-01	Kit, Power Supply for 4-Slot Battery Charger, HS-360X, A/C Power Cord Required

## **Service Information**

If you have a problem using the equipment, contact your facility's technical or systems support. If there is a problem with the equipment, you can contact customer service at: [www.microscan.com](http://www.microscan.com).

When contacting support, please have the following information available:

- Serial number of the unit
- Model number or product name
- Software type and version number

Omron Microscan responds to calls by e-mail, telephone or fax within the time limits set forth in service agreements.

If your problem cannot be solved by support, you may need to return your equipment for servicing and will be given specific directions. Omron Microscan is not responsible for any damages incurred during shipment if the approved shipping container is not used. Shipping the units improperly can possibly void the warranty.

If you purchased your product from an Omron Microscan business partner, please contact that partner for support.

# **1 Quick Start**

This section provides a product overview, unpacking instructions, and configuration information.

## **HS-360X Handheld DPM Scanner**

The wireless HS-360X combines superior 1D and 2D omnidirectional barcode scanning performance and advanced ergonomics in a lightweight design. The scanner design ensures comfort and ease of use over extended periods of time.

**Important:** A PowerPrecision+ 3100 mAh Li-Ion rechargeable battery is included with wireless versions of the HS-360X.

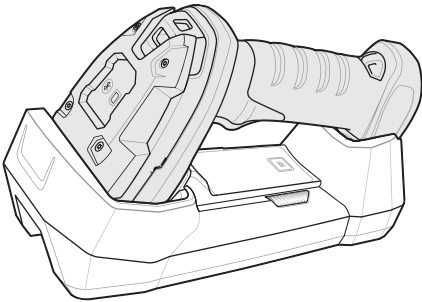

***HS-360X Wireless Handheld DPM Scanner***

The wired HS-360X combines superior 1D and 2D omnidirectional barcode scanning performance and advanced ergonomics in a lightweight, hands-free / handheld design. The HS-360X Stand seamlessly accommodates both countertop and handheld use.

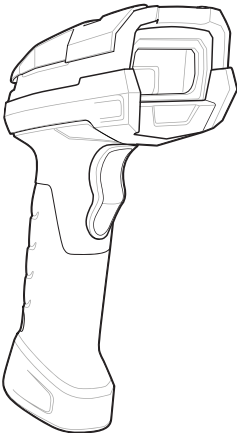

***HS-360X Wired Handheld DPM Scanner***

## ***The HS-360X Handheld DPM Scanner Supports:***

- USB connection to a host. The scanner autodetects a USB host and defaults to HID keyboard. Select other USB interface types by scanning programming symbol menus. The USB interface supports the following international keyboards for a Windows® environment: North American English, Japanese, German, French, French Canadian, Spanish, Italian, Swedish, UK English, and Brazilian Portuguese.
- Standard RS-232 connection to a host. Scan programming symbol menus to set up communication between the scanner with the host.  
**Important:** An RS-232 connection is not compatible with WebLink<sub>PC</sub> configuration software, and offers only limited programming options.
- Configuration via WebLink<sub>PC</sub>.

## ***Unpacking***

Remove the scanner from its packaging and inspect it for damage. If the scanner was damaged during shipping, contact Omron Microscan support. **KEEP THE PACKING MATERIALS.** They comprise the approved shipping container, which you can use to return the scanner for servicing.

# HS-360X Wireless Handheld DPM Scanner

## Parts

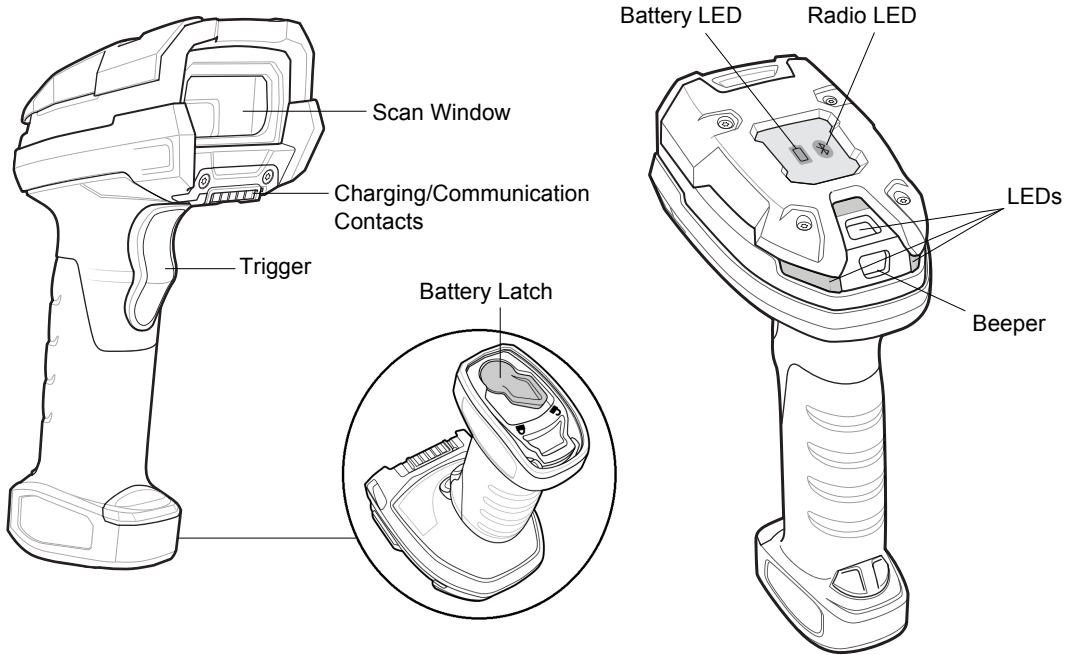

## The HS-360X Cradle

The HS-360X Cradle is a charger, radio communication interface, and host communication interface for the HS-360X Wireless Scanner.

The wireless cradle charges the scanner and provides host communication by receiving scanner data via a Bluetooth radio, and sending that data to the host through an attached cable. An external power supply or a powered host cable provides power to the cradle.

For more mounting options, refer to the *HS-360X Cradle Quick Start Guide*, P/N 83-9310018-02, included with the cradle.

### Cradle – Front View

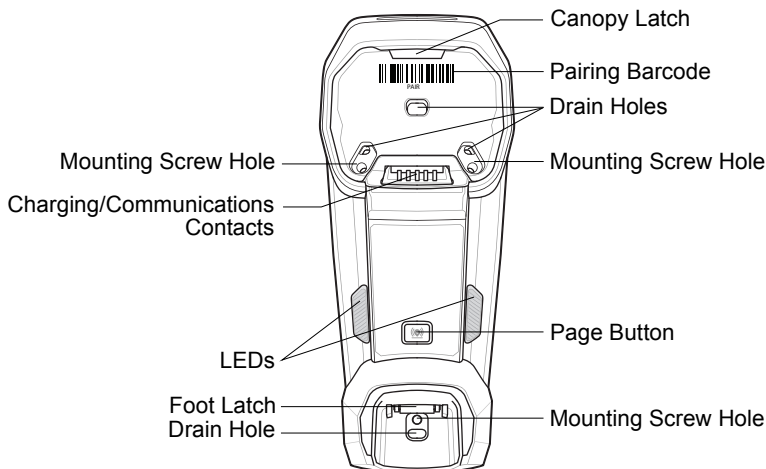

### Cradle – Back View

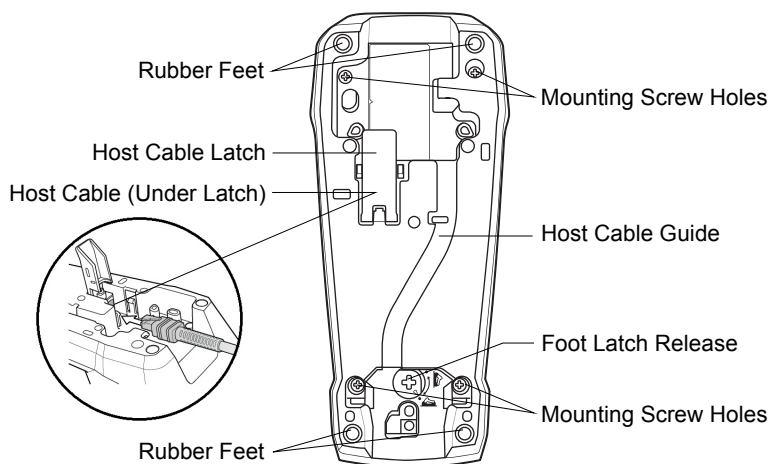

## Connecting the Cradle

**Note:** The interface cable and power supply (if necessary) in the following order to ensure proper operation of the scanner and cradle.

To connect the HS-360X Cradle:

1. Connect the appropriate cable to the power supply and an AC power source, if necessary.
2. Insert the interface cable into the host port.
3. Lift the latch and connect the interface cable into the cradle's host port and then close the latch.
4. If applicable, thread the interface cable over the cable support hook and run the host cable into the cable groove.
5. Pair the scanner to the cradle either by inserting it in the cradle (if pair on contacts is enabled), or by scanning the pairing symbol.
6. If necessary, scan the appropriate host symbol (for non-autodetected interfaces). See the specific host chapter.

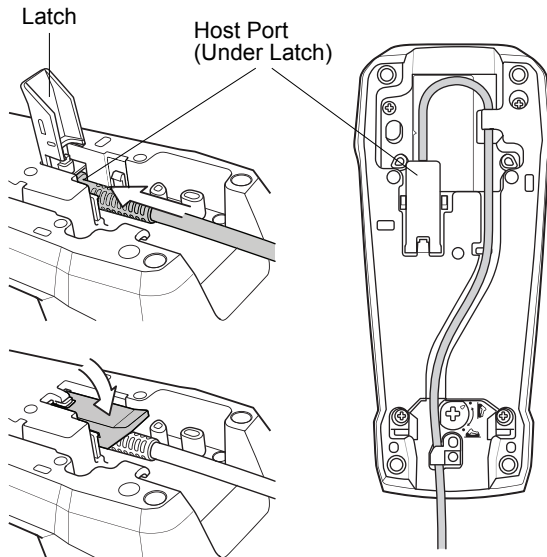

**Important:** Be sure that the interface cable is pushed all the way into the host port before you close the latch.

## Connecting the Cables to the Cradle

**Note:** Always disconnect the DC power supply BEFORE disconnecting the cable to the host end or the cradle may not recognize the new host.

**Note:** Different cables are required for different hosts. The connectors illustrated in each host chapter are examples only. The connectors may be different from those illustrated, but the steps to connect the scanner remain the same.



## **Supplying Power to the Cradle**

The cradle receives power from one of two sources:

- An external power supply.
- When connected to the host through an interface cable that supplies power.

The cradle detects whether the host or the external supply is supplying power. It always draws power from the external supply when available, regardless of the presence of power from a host.

## **Mounting the Cradle**

For information on mounting the cradle, refer to the documentation included with the cradle.

## **Wireless HS-360X Battery**

### **Battery Statistics Capabilities**

The HS-360X Wireless Scanner is equipped with PowerPrecision+ batteries. These intelligent batteries have the integrated technology required to collect the detailed real-time battery metrics needed to maximize useful battery life and ensure every battery is healthy and able to hold a full charge.

PowerPrecision+ batteries support the following remote management functionality:

- Battery Asset Information
  - Manufacture Date of Battery
  - Serial Number of Battery
  - Model Number of Battery
  - Firmware Version of Battery
  - Design Capacity
- Battery Life Statistics
  - State of Health Meter
  - Charge Cycles Consumed
- Battery Status (at Time of Poll)
  - State of Charge
  - Remaining Capacity
  - Charge Status
  - Remaining Time to Complete Charging
  - Battery Voltage / Current
- Battery Temperature
  - Present / Highest / Lowest

Battery statistics can be viewed in WebLink<sub>PC</sub> by following these steps:

1. Select **Wireless Scanner** in the **Start** menu.
2. From the **Advanced Settings** menu, go to the **Battery** tab.

**Hint:** ALT+A opens the **Advanced Settings** tab for the selected scanner.

## Inserting the Wireless HS-360X Battery

A PowerPrecision+ 3100 mAh Li-Ion rechargeable battery ships with each wireless HS-360X. Batteries are shipped in an Off mode and do not power the scanner. After inserting a new battery into the HS-360X scanner, you must insert the scanner into a cradle for the battery to turn On.

Alternatively, the battery can be placed in the four slot spare battery charger to charge and then inserted in the scanner for immediate use.

The battery resides in a chamber in the scanner handle. To insert the battery:

1. Lightly press down and slide the locking lever counterclockwise to unlock and release the battery door.
2. Open the battery door.
3. If a battery is already installed, turn the scanner upright to slide the battery out.
4. Slide the new battery into the chamber, with the rounded side toward the back and the contacts facing into the chamber.

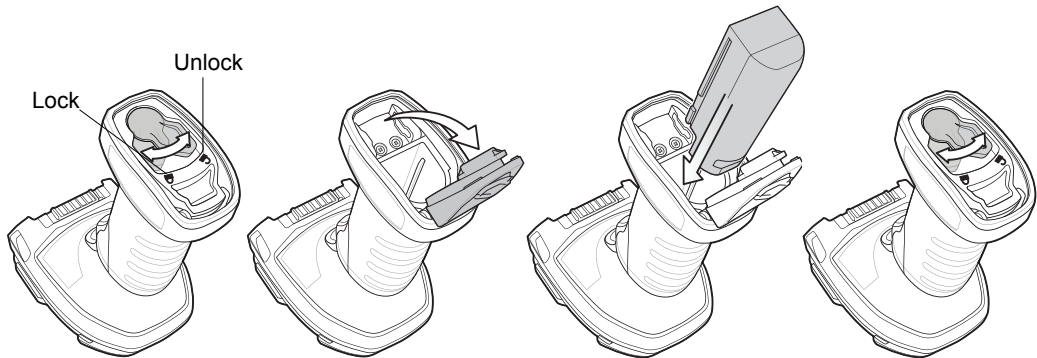

### **Inserting the Battery**

1. Close the battery door.
2. Lightly press down and slide the locking lever clockwise to lock the battery door.
3. If using a brand new battery, insert the scanner into a cradle to turn the battery on.

## Removing the HS-360X Battery

To remove the battery:

1. Lightly press down and slide the locking lever counterclockwise to unlock the battery door.
2. Open the battery door.
3. Turn the scanner upright to slide the battery out.

## Charging the HS-360X Battery

When using a new battery in the HS-360X, the battery requires a charge to be enabled. Insert the battery in the HS-360X and place the HS-360X in the cradle.

The battery begins charging when the cradle's LED indicator starts blinking amber. The HS-360X's battery has completed a charge when the cradle's LED indicator is solid green. A complete charge of a fully discharged battery can take up to three hours using external power and up to ten hours using USB power over the USB interface cable.

To avoid a battery temperature fault, always charge the battery in the scanner within the recommended temperature of 32° to 104° F (0° to 40° C) nominal, 41° to 95° F (5° to 35° C) ideal.

## Inserting the HS-360X Scanner in the Cradle

To insert the scanner in the cradle:

1. Insert the scanner into the cradle top first.
2. Push the handle until it clicks into place, engaging the contacts in the cradle and scanner.

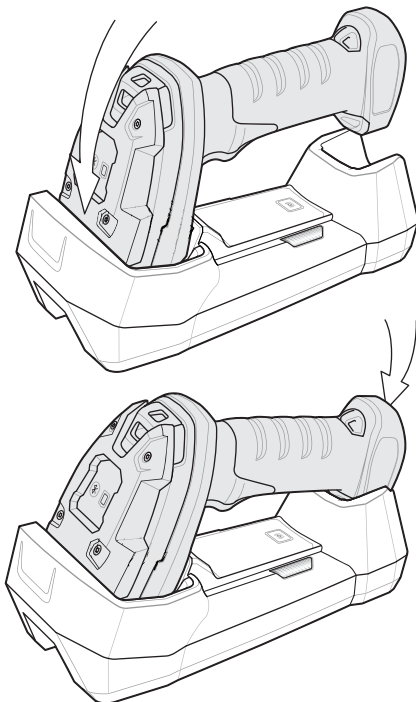

***Inserting the Scanner in the Cradle***

## **Sending Data to the Host Computer**

The cradle receives data from the scanner via a wireless radio connection and transmits it to the host computer via the host cable. The scanner and cradle must be paired for successful wireless communication.

## **Pairing**

Pairing registers a scanner to the cradle such that the scanner and cradle can exchange information. The cradle operates in two modes: Point-to-Point and Multipoint-to-Point. In Point-to-Point mode, pair the scanner to the cradle either by inserting it in the cradle (if pair on contacts is enabled), or by scanning the pairing symbol. In Multipoint-to-Point mode, you can pair up to seven scanners to one cradle.

To pair the scanner with the cradle, scan a pairing symbol. A high-low-high-low beep sequence followed by a low-high beep sequence indicates successful pairing and connection to the remote device. A long low, long high beep sequence indicates unsuccessful pairing.

The pairing symbol that connects the scanner to a cradle is unique to each cradle.

Do not scan data or parameters until pairing completes.

## **Lost Connection to Host**

If scanned data does not transmit to the cradle's host, ensure that all cables are firmly inserted and the power supply is connected to an appropriate AC outlet, if applicable. If scanned data still does not transmit to the host, reestablish a connection with the host:

1. Disconnect the power supply from the cradle.
2. Disconnect the host interface cable from the cradle.
3. Wait three seconds.
4. Reconnect the host interface cable to the cradle.
5. Reconnect the power supply to the cradle, if the host requires.
6. Reestablish pairing with the cradle by scanning the pairing symbol.

## **Configuring the Scanner**

Use the configuration symbols in this manual or the WebLink<sub>PC</sub> configuration program to configure the scanner.

## **Radio Communications**

The scanner can communicate with remote devices via Bluetooth, or by pairing with a cradle.

## Four-Slot Spare Battery Charger

The battery charger can accommodate up to four single spare batteries. The charger can sit on a desktop or be mounted on a wall. This document provides basic instructions for charger set up and use.

For best performance, fully charge the device battery before using the device for the first time. To charge the

device battery, insert the battery in the cradle. The battery begins charging when the LED indicator on the battery charger starts flashing amber. A complete charge of a fully discharged battery can take up to five hours. Charge within the recommended temperature of 32° to 104° F (0° C to 40° C) nominal, 41° to 95° F (5° to 35° C) ideal.

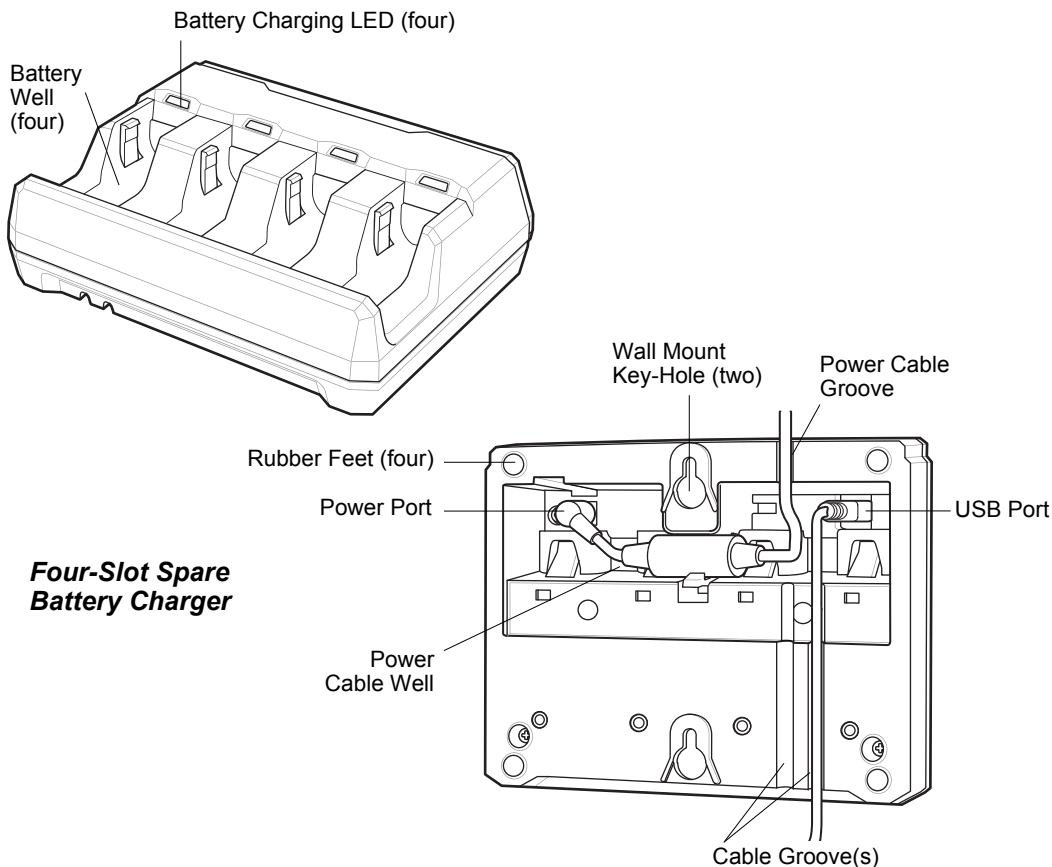

## Inserting Batteries

To insert batteries in the battery charger, angle the battery with the contacts facing up and slide the contact side of the battery under the LED indicator ledge as shown below. Push down on the label surface of the battery until it clicks in place, engaging the contacts in the battery charger.

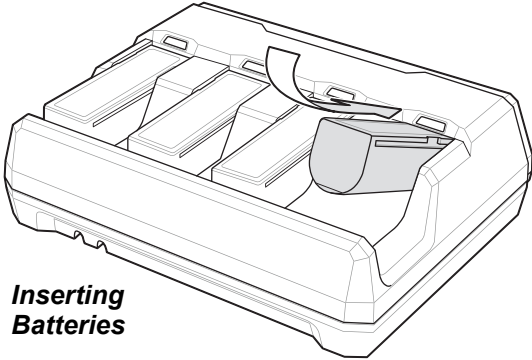

**Inserting  
Batteries**

## Lanyard

Do not attach the tool balancer to the lanyard slot at the bottom of the device.

To install the optional lanyard:

1. Insert the loop on the lanyard into the slot at the bottom of the device handle.

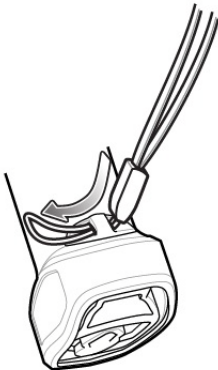

**Insert Lanyard Loop**

2. Thread the upper portion of the lanyard into the loop.



***Thread the Loop***

3. Pull the clip through the loop over the tether point and tighten into place.

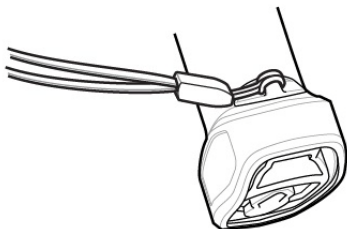

***Insert Loop into Tether Point***

## **HS-360X Accessories**

The scanner ships with a battery and the *HS-360X Wireless Scanner Quick Start Guide*. The following required accessories must be ordered:

- Interface cable for the appropriate interface.
- Universal power supply, if the interface requires this.

# HS-360X Wired Handheld DPM Scanner

## Parts

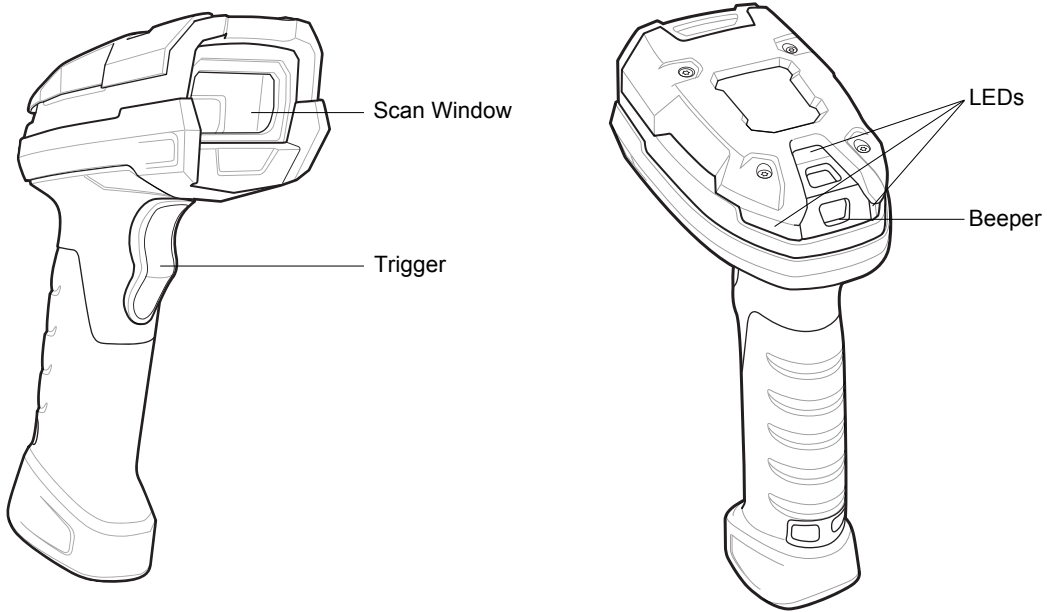



## Installing the HS-360X Interface Cable

1. Insert cable fully so that the connector is flush with the scanner surface.

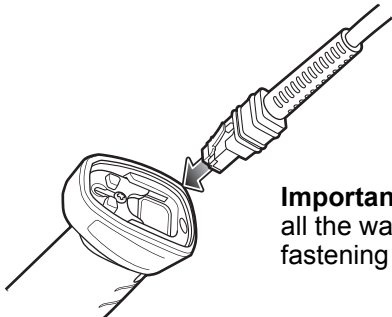

**Important:** Be sure the interface cable is pushed all the way into the connector before closing and fastening the lock plate.

### ***Inserting Cable into HS-360X***

2. Loosen metal lock plate screw using a PH1 driver.

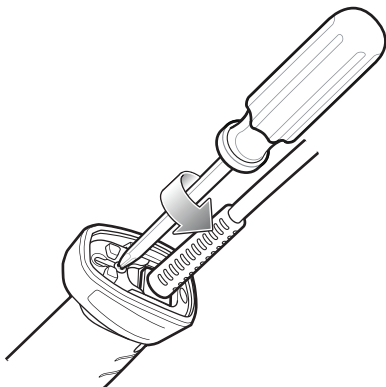

### ***Loosening HS-360X Lock Plate Screw***

3. Slide lock plate to fully locked position.

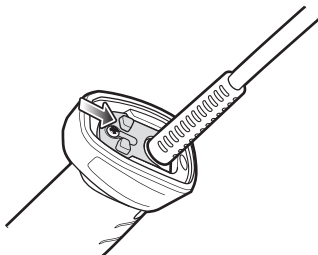

### ***Sliding Lock Plate into Locked Position***

4. Tighten lock plate screw using a PH1 driver (recommended Torque: 5 in-lbs).

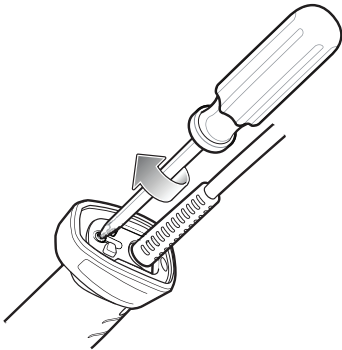

**Tightening Lock Plate**

## Removing the HS-360X Interface Cable

1. Loosen lock plate screw using a PH1 driver.

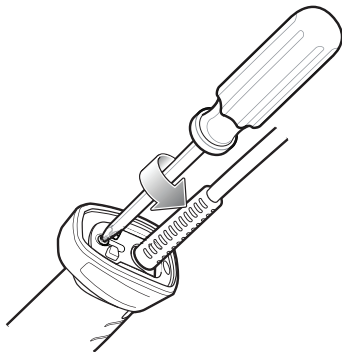

**Loosening Lock Plate**

2. Slide lock plate to fully unlocked position.

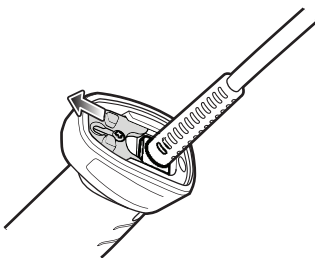

**Sliding Lock Plate into Unlocked Position**

3. Tighten lock plate to fully unlocked position.

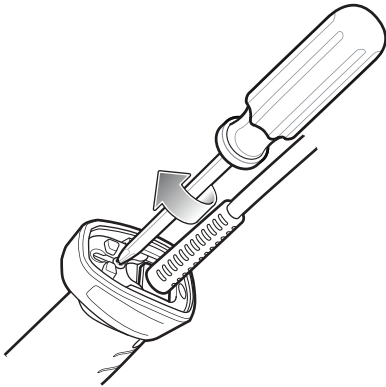

***Tightening Lock Plate into Unlocked Position***

4. Remove cable.

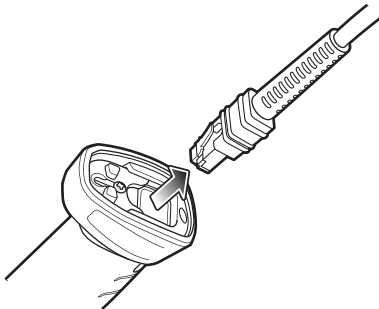

***Removing Cable from HS-360X***

## **Connecting Power to the HS-360X (If Required)**

If the host does not provide power to the scanner, connect an external power supply.

1. Plug the power supply into the power jack on the interface cable.
2. Plug the other end of the power supply into an AC outlet.

## **Configuring the HS-360X Scanner**

Use the configuration symbols included in this manual, or WebLink<sub>PC</sub> software, to configure the scanner.

## **HS-360X Accessories**

The scanner ships with the *HS-360X Wired Scanner Quick Start Guide*. The following required accessories must be ordered:

- Interface cable for the appropriate interface.
- Universal power supply, if the interface requires this.
- HS-360X Stand for hands-free operation of the scanner.

# **2 Data Capture**

This section provides beeper and LED definitions, techniques involved in scanning barcodes, general instructions and tips about scanning, and decode ranges.

## **HS-360X Wireless Scanner Beeper and LED**

The scanner issues different beep sequences/patterns and an LED display to indicate status.

### **Radio and Beeper LED Definitions**

In addition to the System/Decode LEDs, the HS-360X Wireless Scanner has a Radio and Battery LED gauge.

The Radio and Battery LED gauge is always active when inserted in the cradle. After the scanner is removed from the cradle, it is active for four seconds.

After the trigger is held for three seconds the Radio and Battery LED gauge remain active for four seconds after trigger release.

See the following page for a complete list of definitions.

## HS-360X Wireless Scanner Beeper and LED Definitions

Event	Beeper Sequence	LED
<b>Standard Use</b>		
Power up.	Low/medium/high beeps	Green
<b>Scanning</b>		
Presentation Mode on.	None	Green solid
Presentation Mode off.	None	No LED; green LED is turned off
A barcode was successfully decoded.	Medium beep (or as configured)	Green flash
Parity error.	Low/low/low/extra low beeps	Red
A transmission error was detected in a scanned symbol. The data is ignored. This occurs if a unit is not properly configured. Check option setting.	Four long low beeps	Red
Conversion or format error.	Five long low beeps	Red
A <BEL> character is received over RS-232.	High	None
<b>Wireless Operation</b>		
Out of batch storage memory, unable to store new barcode.	Low, high, low, high	Red
<b>Radio Indications</b>		
Scanner inserted into a cradle (may be disabled).	Low	System LED: None Radio LED: None
Bluetooth connection established.	Low, high	System LED: Green Radio LED: Green (Stays on after trigger hold for 3 seconds)
Bluetooth disconnection event.	High, low	System LED: Red Radio LED: Red (Stays on at trigger pull)
Bluetooth Page timeout; remote device is out of range/not powered.	Long low, long high	System LED: Red Radio LED: Red (Stays on at trigger pull)
Bluetooth connection attempt was rejected by remote device.	Long low, long high, long low, long high	System LED: None Radio LED: Red (Stays on at trigger pull)
Bluetooth attempting reconnection.	None	System LED: None Radio LED: Red blinking
Bluetooth attempting reconnection (default is disable).	Five high	System LED: None Radio LED: Red blinking
Paging state indication	Six high	System LED: Blue (fast, fast, slow)

## HS-360X Wireless Scanner Beeper and LED

Event	Beeper Sequence	LED
<b>Battery Indications</b>		
Low battery indication (on trigger release)	Four short high beeps	Red (stays on)
Battery LED status		99-51% Green 21-50% Amber 0-20% Red
Battery end of life		99-51% Green/red alternating 21-50% Amber/red alternating 0-20% Red blinking
<b>Parameter Programming</b>		
Input error, incorrect barcode or <b>Cancel</b> scanned, wrong entry, incorrect barcode programming sequence; remain in program mode.	Long low/long high beeps	Red
Keyboard parameter selected. Enter value using barcode keypad.	High/low beeps	Green
Successful program exit with change in the parameter setting.	High/low/high/low beeps	Green
Cancel rule entry. Rule entry mode exited because of an error or the user asked to exit rule entry.	Long low/long high/long low beeps	Green (turns off blinking)
<b>Host-Specific: USB-Only</b>		
Scanner has not completed initialization. Wait several seconds and scan again.	Four high beeps	None
<b>Host-Specific: RS-232-Only</b>		
RS-232 receive error.	High/high/high/low beeps	Red
A <BEL> character is received when Beep on <BEL> is enabled (Point-to-Point mode only).	High beep	None



## Cradle LED Definitions

Event	LED
<b>Standard Use</b>	
Power Up	Green (stays on)
<b>Radio Indications</b>	
Bluetooth connection established	Green (off then on)
Page button	Blue
<b>Battery Indications</b>	
Pre-charging	Amber (stays on)
Charging	Amber blinking
Fully charged	Green (stays on)
Charging Error	Amber fast blinking
<b>Battery End of Life Indications</b>	
Charging	Red blinking
Fully charged	Red (stays on)
Charging error	Red fast blinking
<b>Maintenance Indications</b>	
Enter boot loader	Red (stays on)
Firmware installation	Red blinking

## Four-Slot Battery Charger Definitions

Event	LED
<b>Standard Use</b>	
Power Up	Red, amber, green, off (all four LEDs)
Idle	Off
<b>Battery Indications</b>	
Pre-charging	Amber (stays on)
Charging	Amber blinking
Fully charged	Green (stays on)
Charging error	Amber fast blinking
<b>Battery End of Life Indications</b>	
Charging	Red blinking
Fully charged	Red (stays on)
Charging error	Red fast blinking
<b>Maintenance Indications</b>	
Enter bootloader	Red (stays on; all four LEDs)
Firmware installation	Red blinking (all four LEDs)

# HS-360X Beeper and LED Definitions

In addition to beep sequences, the scanner uses a two-color LED to indicate status.

Event	Beeper Sequence	LED Indicator
<b>Standard Use</b>		
Power up.	Low, Medium, High beeps	Green
Decode a barcode.	(as configured)	Green
Hands-free Mode (Presentation Mode On).	None	Green (stays on)
Handheld Mode (Presentation Mode Off).	None	Green (stays off)
Transmission error.	4 Low beeps	Red
Conversion or format error.	5 Low beeps	Red
RS-232 receive error (Parity Error).	Low, Low, Low, Extra-Low beeps	Red
A <BEL> character is received over RS-232.	High beep	None
<b>Parameter Programming</b>		
Input error: Incorrect barcode, programming sequence, or <b>Cancel</b> scanned.	Low, High beeps	Red
Number expected. Enter value using numeric barcodes.	High, Low beeps	Green
Successful program exit with change in parameter setting.	High, Low, High, Low beeps	Green
<b>Maintenance Indications</b>		
Enter Bootloader	High, High beeps	Red (stays on)
Firmware Installation	None	Red Blinking

## HS-360X Scanning

1. Aim the scanner at a barcode and pull the trigger to decode. The aiming laser's red dot should fall roughly in the center of the symbol as shown in the image below.
2. Pull the trigger until the scanner beeps, indicating the barcode is successfully decoded.

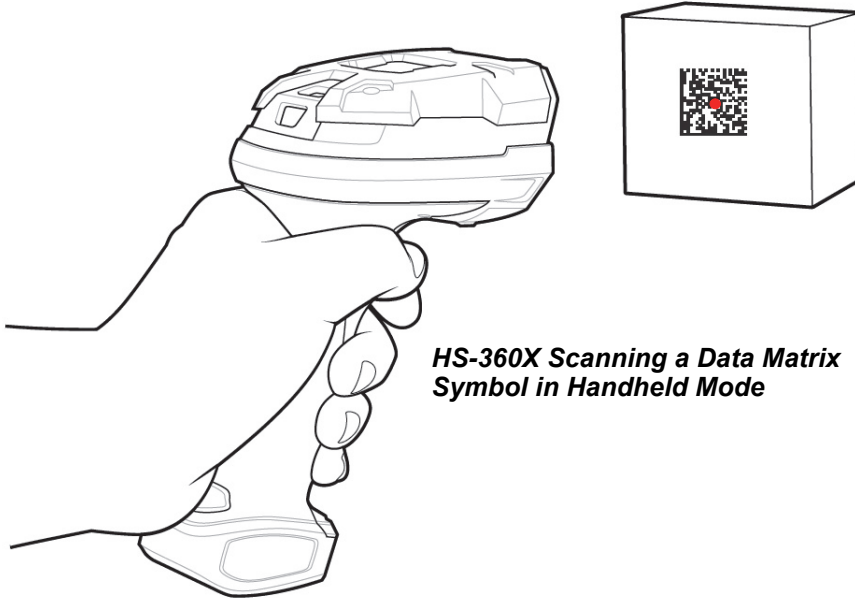

***HS-360X Scanning a Data Matrix Symbol in Handheld Mode***

## **HS-360X Wired Scanner Hands-Free Mode**

The HS-360X scanner is in Hands-free (presentation) mode when it is placed in the HS-360X Stand. In this mode, the scanner operates in continuous (constant-on) mode, where it automatically decodes a barcode presented in its field of view.

When the scanner is not used for a user-definable period of time, it enters a low power mode in which the LEDs are turned off or illumination blinks at a low duty cycle until the scanner detects an image change (e.g. motion).

### **Scanning in Hands-Free (Presentation) Mode**

The optional stand adds greater flexibility to HS-360X scanning operation. When the scanner is seated in the scanner cup, the scanner's built-in sensor places the scanner in hands-free (presentation) mode. When the scanner is removed from the stand, it automatically switches to its programmed handheld triggered mode.

#### **To operate the scanner in the HS-360X Stand:**

1. Connect the scanner to the host (see the appropriate host chapter for information on host connections).

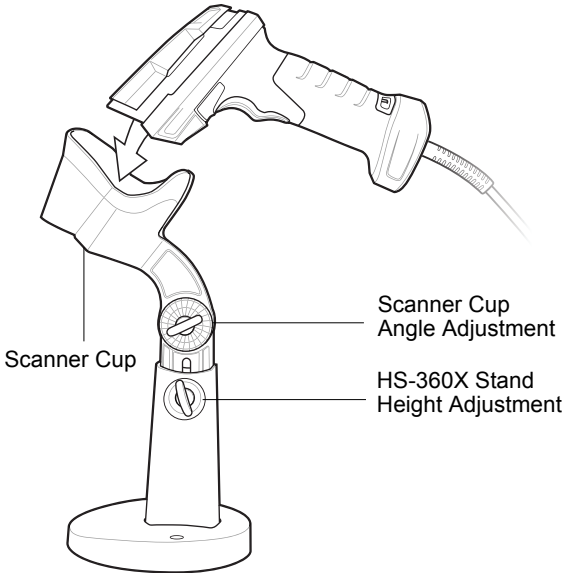

### **HS-360X Wired Scanner in Hands-Free Mode**

2. Insert the scanner in the HS-360X Stand by placing the front of the scanner into the scanner cup.
3. Use the HS-360X Stand's adjustment knobs to adjust the height and angle of the scanner.
4. Center the symbol in the aiming pattern.
5. Upon successful decode, the scanner beeps and the LED turns green.

## Aiming with the HS-360X

When scanning, the HS-360X projects a red laser aiming dot which allows you to position the symbol within the scanner's field of view.



**HS-360X Scanner  
Aiming Pattern**

The scanner beeps to indicate that it successfully decoded the symbol.

## HS-360X Decode Ranges

Barcode Type	Symbol Density	HS-360X Typical Working Ranges	
		Near	Far
Code 39	3.0 mil	0.2 in / 0.5 cm	2.8 in / 7.1 cm
PDF417	5.0 mil	0.2 in / 0.5 cm	2.8 in / 7.1 cm
	6.6 mil	* 0.2 in / 0.5 cm	3.2 in. / 8.1 cm
Data Matrix	5.0 mil	0.4 in / 1.0 cm	2.5 in / 6.3 cm
	10.0 mil	0.0 in / 0.0 cm	3.4 in / 8.6 cm
QR	5.0 mil	0.4 in / 1.0 cm	2.5 in / 6.3 cm
	10.0 mil	0.0 in / 0.0 cm	3.4 in / 8.6 cm
100% UPC	13.0 mil	* 1.0 in / 2.5 cm	* 5.8 in / 14.7 cm

**\* Field of view/barcode width limited. Decode ranges measured with DPM Mode Off, photographic paper barcodes and under 30fcd ambient light conditions.**

# **3 *Maintenance and Technical Specifications***

This section describes recommended scanner maintenance, troubleshooting, technical specifications, and pin assignments.

# Maintenance

## Known Harmful Ingredients

The following chemicals are known to damage the plastics on Omron Microscan products and should not come in contact with the device:

- Acetone
- Ammonia solutions
- Aqueous or alcoholic alkaline solutions
- Aromatic and chlorinated hydrocarbons
- Benzene
- Bleach
- Carboic acid
- Compounds of amines or ammonia
- Ethanolamine
- Ethers
- Ketones
- TB-lysoform
- Toluene
- Trichloroethylene

## Approved Cleaning Agents

The following cleaning agents are approved for cleaning Omron Microscan products:

- Pre-moistened wipes
- Isopropyl alcohol 70%



## **Tolerable Industrial Fluids and Chemicals**

Not all fluid variants and brands have been tested.

The following industrial fluids and chemicals were evaluated and deemed tolerable for the HS-360X:

- Motor/Engine Oil
- Automatic Transmission Fluid (ATF)
- Continuously Variable Transmission Fluid (CVT)
- Industrial De-Greaser (Engine Brite Heavy Duty)
- Brake Fluid (DOT4)

If the scanner comes in contact with the above fluids and chemicals frequently, Omron Microscan recommended that you clean the outside of the scanner daily using the approved cleaning agents listed on the previous page.

## **Cleaning the Scanner**

Routinely cleaning the exit window is required. A dirty window may affect scanning accuracy. Do not allow any abrasive material to touch the window.

To clean the scanner:

1. Dampen a soft cloth with one of the approved cleaning agents listed above or use pre-moistened wipes.
2. Gently wipe all surfaces, including the front, back, sides, top and bottom. Never apply liquid directly to the scanner. Be careful not to let liquid pool around the scanner window, trigger, cable connector or any other area on the device.
3. Be sure to clean the trigger and in between the trigger and the housing (use a cotton-tipped applicator to reach tight or inaccessible areas).
4. Do not spray water or other cleaning liquids directly into the exit window.
5. Wipe the scanner exit window with a lens tissue or other material suitable for cleaning optical material such as eyeglasses.
6. Immediately dry the scanner window after cleaning with a soft non-abrasive cloth to prevent streaking.
7. Allow the unit to air dry before use.
8. Scanner connectors:
  - a. Dip the cotton portion of a cotton-tipped applicator in isopropyl alcohol.
  - b. Rub the cotton portion of the cotton-tipped applicator back-and-forth across the connector on the Omron Microscan scanner at least 3 times. Do not leave any cotton residue on the connector.
  - c. Use the cotton-tipped applicator dipped in alcohol to remove any grease and dirt near the connector area.
  - d. Use a dry cotton tipped applicator and rub the cotton portion of the cotton-tipped applicator back-and-forth across the connectors at least 3 times. Do not leave any cotton residue on the connectors.

# Troubleshooting

Problem	Possible Causes	Possible Solutions
The aiming pattern does not appear when pressing the trigger.	No power to the scanner.	If the configuration requires a power supply, reconnect the power supply.
	Incorrect host interface cable is used.	Connect the correct host interface cable.
	Interface/power cables are loose.	Re-connect cables.
	Aiming pattern is disabled.	Enable the aiming pattern.
Scanner emits aiming pattern, but does not decode the barcode.	Scanner is not programmed for the correct barcode type.	Program the scanner to read that type of barcode.
	Barcode symbol is unreadable.	Scan test symbols of the same barcode type to determine if the barcode is defaced.
	The symbol is not completely inside aiming pattern.	Move the symbol completely within the aiming pattern. Move the symbol completely within the field of view (AIM pattern does NOT define FOV)
	Distance between scanner and barcode is incorrect.	Move the scanner closer to or further from the barcode.
Scanner decodes barcode, but does not transmit the data to the host.	Scanner is not programmed for the correct host type.	Scan the appropriate host type programming symbol. See the chapter corresponding to the host type.
	Interface cable is loose.	Re-connect the cable.
	Cradle is not programmed for the correct host type.	Check scanner host parameters or edit options.
	Scanner is not paired to host connected interface.	Pair scanner to the cradle by scanning the <b>PAIR</b> symbol on the cradle.
	Cradle has lost connection to the host.	In this exact order: disconnect power supply; disconnect host cable; wait three seconds; reconnect host cable; reconnect power supply; reestablish pairing.
	If the scanner emits 4 long low beeps, a transmission error occurred. This occurs if a unit is not properly configured or connected to the wrong host type.	Set the scanner's communication parameters to match the host's setting.
	If the scanner emits 5 low beeps, a conversion or format error occurred.	Configure the scanner's conversion parameters properly.
	If the scanner emits low/high/low beeps, it detected an invalid scanner rule.	Program the correct scanner rules.

Problem	Possible Causes	Possible Solutions
Host displays scanned data incorrectly.	Scanner is not programmed to work with the host.	Scan the appropriate host type programming symbol.
		For RS-232, set the scanner's communication parameters to match the host's settings.
		Program the proper editing options (e.g., UPC-E to UPC-A Conversion).
Scanner emits short low/short medium/short high beep sequence (power-up beep sequence) more than once.	The USB bus may put the scanner in a state where power to the scanner is cycled on and off more than once.	Normal during host reset.
Scanner emits 4 short high beeps during decode attempt.	Scanner has not completed USB initialization.	Wait several seconds and scan again.
Scanner emits Low/low/low/extra low beeps when not in use.	RS-232 receive error.	Normal during host reset. Otherwise, set the scanner's RS-232 parity to match the host setting.
Scanner emits low/high beeps during programming.	Input error, incorrect barcode or <b>Cancel</b> barcode was scanned.	Scan the correct numeric barcodes within range for the parameter programmed.
Scanner emits low/high/low/high beeps during programming.	Out of host parameter storage space.	Change storage preference.
Scanner emits a power-up beep after changing USB host type.	The USB bus re-established power to the scanner.	Normal when changing USB host type.
Scanner emits one high beep when not in use.	In RS-232 mode, a <BEL> character was received and Beep on <BEL> option is enabled.	Normal when <b>Beep on &lt;BEL&gt;</b> is enabled and the scanner is in RS-232 mode.
Scanner emits frequent beeps.	No power to the scanner.	Check the system power. If the configuration requires a power supply, re-connect the power supply.
	Incorrect host interface cable is used.	Verify that the correct host interface cable is used. If not, connect the correct host interface cable.
	Interface/power cables are loose.	Check for loose cable connections and re-connect cables.
Scanner emits five long low beeps after a barcode is decoded.	Conversion or format error was detected. The scanner's conversion parameters are not properly configured.	Ensure the scanner's conversion parameters are properly configured.
	Conversion or format error was detected. A barcode was scanned with characters that can't be sent for that host.	Change the barcode, or change to a host that can support the barcode.

**Note:** If the scanner still experiences problems after performing these checks, contact customer support at [www.microscan.com](http://www.microscan.com).

## **Report Software Version Barcode**

When contacting support, a support representative may ask you to scan the programming symbol below to determine the version of software installed in the scanner.



**Report Software Version**

# Technical Specifications

## HS-360X Technical Specifications

Item	Description
<b>Physical Characteristics</b>	
HS-360X Wireless Scanner Dimensions	7.3 in. H x 3.0 in. W x 5.6 in. D (18.5 cm H x 7.7 cm W x 14.3 cm D)
HS-360X Wired Scanner Dimensions	7.3 in. H x 3.0 in. W x 5.2 in. D (18.5 cm H x 7.7 cm W x 13.2 cm D)
HS-360X Wireless Scanner Weight (with Battery)	Approximately 14.18 oz./402 g
HS-360X Wired Scanner Weight (without Cable)	Approximately 10.72 oz./304 g
Power	5 VDC +/- 10% @ 360 mA (RMS typical)
Color	Black, red
<b>Performance Characteristics</b>	
Light Source	Aiming pattern: 655 nm Laser / Illumination: Warm white and red 634nm LEDs
Field of View (Horizontal x Vertical) Nominal	31° (H) x 23° (V)
Roll	0 - 360°
Pitch	+/- 60°
Skew	+/- 60°
Scans Per Charge	Up to 100,000
<b>Symbologies</b>	
1D	UPC/EAN, UPC/EAN with supplementals, Bookland EAN, ISSN, UCC Coupon Extended Code, Code 128, GS1-128, ISBT 128, ISBT Concatenation, Code 39, Code 39 Full ASCII, Trioptic Code 39, Code 32, Code 93, Code 11, Interleaved 2 of 5, Discrete 2 of 5, Codabar, MSI, Chinese 2 of 5, Matrix 2 of 5, Korean 3 of 5, GS1 DataBar variants
2D	PDF417, MicroPDF417, Composite Codes, TLC-39, Data Matrix, Maxicode, QR Code, MicroQR, Aztec, Han Xin, GS1-QR, GS1-DM
Postal	US Postnet, US Planet, UK Postal, Japan Post, Australia Post, Royal Mail 4 State Customer, KIX Code (Dutch), UPU 4 State Postal FICS (Post US4), USPS 4 State Postal (Post US3)
Typical Working Distance	See <a href="#">HS-360X Decode Ranges</a> .
Interfaces Supported	USB, RS-232 The scanner supports the following protocols over USB: HID Keyboard (default mode), SNAPI, COM Port Emulation, USB CDC

## Technical Specifications

Item	Description
Minimum Resolution	Code 39: 3 mil
	PDF417: 4 mil
	Data Matrix: 4 mil
<b>User Environment</b>	
HS-360X Wireless Scanner Operating Temperature	- 4° F to 122° F (-20° C to 50° C)
HS-360X Wired Scanner Operating Temperature	- 22° F to 122° F (-30° C to 50° C)
Storage Temperature	- 40° F to 158° F (-40° C to 70° C)
Humidity	5% to 95% RH, non-condensing
ESD	20 kV air discharge; 10 kV contact discharge
HS-360X Wireless Scanner Drop Specifications	Withstands multiple 8 ft. / 2.4 m drops to concrete at room temperature.
HS-360X Wired Scanner Drop Specifications	Withstands multiple 6.5 ft. / 2.0 m drops to concrete at -30° C to 50° C.
Environmental Sealing	IP65 and IP67
Ambient Light Immunity	0 to 10,037 Foot-Candles
	0 to 108,000 Lux
<b>Accessories</b>	
HS-360X Wired Scanner Hands-Free Option	HS-360X Stand
Power Supplies	Power supplies are available for applications that do not supply power over the host cable.

## Cradle Technical Specifications

Item	Description
Power Requirements for Host-Powered	Min 4.5 - Max 5.5
Power Requirements for External Power Supply	Min 11.4 - Max 12.6
Typical Current Draw when Not Charging	80mA @ 5V; 30mA @ 12V
Typical Current Draw in Full Charging Mode	1200mA @ 5V (BC 1.2), 475mA (non-BC1.2); 700mA @ 12V
Typical Current Draw in Safe Charging Mode	400mA @ 5V; 200mA @ 12V
Interfaces Supported	USB, RS-232
Operating Temperature	-4° to 122° F (-20° to 50° C)
Storage Temperature	-40° to 158° F (-40° to 70° C)
Charging Temperature	32° to 104° F (0° to 40° C) nominal, 41° to 95° F (5° to 35° C) ideal
Humidity	5% to 95% (non-condensing)
ESD	25 kV air discharge 10 kV contact discharge
Weight	13.7 oz (390 grams)
Dimensions	W 9.98 x L 22.94 x H 8.26 cm (W 99.8 x L 229.4 x H 82.6 mm)
Radio	Bluetooth, Up to 100 meters/300 ft. in open air range/environment Serial Port & HID Profiles 2.402 to 2.480 GHz Adaptive Frequency Hopping (co-existence with 802.11 wireless networks) 3Mbit/s (2.1Mbit/s) for Classic Bluetooth 1Mbit/s (0.27Mbit/s) for Low Energy
Electrical Safety	Certified to UL/IEC/EN 60950-1 + AM2
Input Transient Protection	IEC 1000-4-(2,3,4,5,6,11)
EMI	FCC Part 15 Class B, ICES-003 Class B European Union EMC Directive, Australian SMA, Taiwan EMC, Japan VCCI Class B

# HS-360X Wired Scanner Signal Descriptions

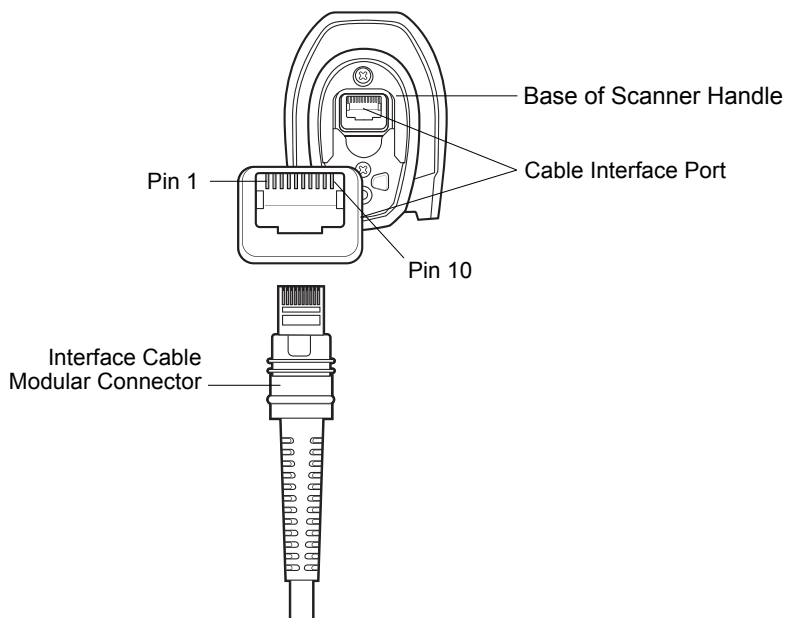

## HS-360X Wired Scanner Cable Pinouts

The signal descriptions below apply to the connectors on the HS-360X Wired Scanner and are for reference only.

Pin	RS-232	USB
1	Cable ID	Cable ID
2	Power (+5V)	Power (+5V)
3	Ground	Ground
4	TxD	Reserved
5	RxD	D +
6	RTS	Reserved
7	CTS	D -
8	Reserved	Reserved
9	Reserved	Reserved
10	Power (+12V)	Power (+12V)



# ■ **4 Radio Communications**

This section provides information about the modes of operation and features available for wireless communication between HS-360X Wireless Scanners, cradles, and hosts. This section also includes scanner configuration parameters.

## **HS-360X Wireless Scanner Radio Communications**

The scanner ships with the settings shown in the **Radio Communications Parameter Defaults**. If the default values suit requirements, programming is not necessary.

To set feature values, scan a single programming symbol or a short sequence of programming symbols. The settings are stored in non-volatile memory and are preserved even when the scanner is powered down.

If not using a USB cable with the cradle, select a host type (see each host chapter for specific host information) after the power-up beep. This is only necessary upon the first power-up when connected to a new host.

### **Scanning Sequence Examples**

In most cases, scan one programming symbol to set a specific parameter value.

### **Errors While Scanning**

Unless otherwise specified, to correct an error during a scanning sequence, just re-scan the correct parameter.

# Radio Communications Parameter Defaults

The table below lists the defaults for radio communication parameters. If you wish to change any option, scan the appropriate programming symbol(s) provided in the Radio Communications Parameters section.

See [Appendix A — Standard Default Parameters](#) for all user preferences, hosts, symbologies, and default parameters.

In this guide, the parameter numbers listed are the same as the attribute numbers for these parameters.

See [Appendix B — Country Codes](#) for Country Keyboard Types (Country Codes).

Parameter	Parameter Number <sup>1</sup>	Default
Radio Communications Host Types	383	Cradle Host
BT Friendly Name	607	n/a
Discoverable Mode	610	General
Wi-Fi Friendly Mode	1299	Disable
Wi-Fi Friendly Channel Exclusion	1297	Use All Channels
Radio Output Power	1324	High
Link Supervision Timeout	1698	5 Seconds
Bluetooth Radio State	1354	On
Bluetooth HID - Wait for Connection	1714	Disable
HID Features for Apple iOS	1114	Disable
HID Keyboard Keystroke Delay	N/A	No Delay (0 msec)
CAPS Lock Override	N/A	Disable
Ignore Unknown Characters	N/A	Send Barcodes with Unknown Characters
Emulate Keypad	N/A	Enable
Fast HID Keyboard	1361	Enable
Quick Keypad Emulation	1362	Enable
Keyboard FN1 Substitution	N/A	Disable
Function Key Mapping	N/A	Disable
Simulated Caps Lock	N/A	Disable
Convert Case	N/A	No Case Conversion
Reconnect Attempt Beep Feedback	559	Disable
Reconnect Attempt Interval	558	30 Seconds
Auto-reconnect	604	Auto-reconnect Immediately
Beep on Insertion	288	Enable

**1. Parameter number decimal values are used for programming via RSM commands.**

## Radio Communications Parameter Defaults

Parameter	Parameter Number <sup>1</sup>	Default
Beep on <BEL>	150	Enable
Modes of Operation (Point-to-Point/Multipoint-to-Point)	538	Point-to-Point
Parameter Broadcast (Cradle Host Only)	148	Enable
Pairing Modes	542	Unlocked
Pairing Methods	545	Enable
Toggle Pairing	1322	Disable
Connection Maintenance Interval	5002	15 Minutes
Batch Mode	544	Normal (Do Not Batch Data)
Persistent Batch Storage	1399	Disable
Page Button	746	Enable
Page Options Page Mode Page State Timeout	1364 1365	Page Simple
Classic and/or Low Energy Bluetooth	1355	Classic and Low Energy
PIN Code (Set and Store)	552	12345
Variable Pin Code	608	Static (Default PIN code is 12345)
Bluetooth Security Levels	1393	Low

1. Parameter number decimal values are used for programming via RSM commands.

# Wireless Beeper Definitions

When the scanner decodes the pairing symbol it issues various beep sequences indicating successful or unsuccessful operations.

## Radio Communications Host Types

### Parameter # 383

To set up the scanner for communication with a cradle, or to use standard Bluetooth profiles, scan the appropriate host type programming symbol below.

### Classic Bluetooth vs. Low Energy Bluetooth

Bluetooth Low Energy (LE) Bluetooth has a better Wi-Fi coexistence, as advertising and connection is done outside of the Wi-Fi channels 1, 6, and 11 (2402, 2426, 2480 MHz). Due to its lower data rate, Bluetooth Low Energy is up to seven times slower than Classic Bluetooth (0.27 Mbps versus 0.7-2.1 Mbps). Data intensive activities such as firmware updates, can take significantly longer over Bluetooth Low Energy.

### ***Cradle***

Select this host type when connecting a scanner to a communication cradle.

The scanner automatically tries to reconnect to a remote device when a disconnection occurs that is due to the radio losing communication.

To establish a connection (for initial setup only):

1. Scan the **Cradle-Classic Bluetooth** or **Cradle-Low Energy** programming symbol.
2. Scan the pairing symbol on the cradle or place the scanner in the cradle.



**Cradle-Classic**



**Cradle-Low Energy**

## **Keyboard Emulation (HID)**

Select this host type when connecting to a PC/tablet/phone emulating a Bluetooth keyboard.

- **HID BT Classic** - Enables the host and scanner to communicate using HID (Human Interface Device) Keyboard Profile over Bluetooth Classic radio. The scanner(s) are discoverable (Secondary mode) and also support Primary (Master) mode.

To establish a connection (initial setup only):

- i. Scan the **HID BT Classic** programming symbol.
  - ii. Connect to Primary or Secondary mode.
    - Primary mode - scan a pairing symbol with the MAC address of the host device.
    - Secondary mode - from the host, discover Bluetooth devices and select your scanner from the discovered device list.
- **HID BT LE (Discoverable)** - Enables the host to establish a HID (Human Interface Device) Keyboard Profile connection with the scanner over Bluetooth Low Energy radio. The scanner is discoverable (Secondary mode).

To establish a connection (initial setup only):

- i. Scan the **HID BT LE (Discoverable)** programming symbol.
- ii. From the host, discover Bluetooth devices.
- iii. Select your scanner from your discovered device list.



**HID Bluetooth Classic**



**HID BT LE (Discoverable)**

## Serial Port Profile (SPP)

Select this host type when connecting to a PC/tablet/phone using a Bluetooth serial connection.

- **SPP BT Classic (Non-Discoverable)** - Enables the scanner to establish a Serial Port Profile (SPP) connection with the host over Classic Bluetooth radio. The scanner is NOT discoverable (Primary mode).

To establish a connection (initial setup only):

- i. Scan the **SPP BT Classic (Non-discoverable)** programming symbol.
- ii. Scan a pairing symbol with the MAC address of the host device.

- **SPP BT Classic (Discoverable)** - Enables the host to establish a Serial Port Profile (SPP) connection with the scanner over Classic Bluetooth radio. The scanner is discoverable (Secondary mode).

To establish a connection (initial setup only):

- i. Scan the **SPP BT Classic (Discoverable)** programming symbol.
- ii. From the host, discover Bluetooth devices.
- iii. Select your scanner from the discovered device list.



**SPP BT Classic (Non-Discoverable)**



**SPP BT Classic (Discoverable)**

## **Bluetooth Technology Profile Support**

With Bluetooth Technology Profile Support, the cradle is not required for wireless communication. The scanner communicates directly to the host using Bluetooth technology. The scanner supports the standard Bluetooth Serial Port Profile (SPP) and HID Profiles which enable the scanner to communicate with other Bluetooth devices that support these profiles.

- SPP - the scanner connects to the PC/host via Bluetooth and performs like there is a serial connection.
- HID - the scanner connects to the PC/host via Bluetooth and performs like a keyboard.

## **Primary/Secondary Set Up**

The scanner can be set up as a Primary or Secondary. When the scanner is set up as a Secondary, it is discoverable and connectible to other devices. When the scanner is set up as a Primary, the Bluetooth address of the remote device to which a connection is requested is required. A pairing symbol with the remote device address must be created and scanned to attempt a connection to the remote device.

### ***Primary***

When the scanner is set up as a Primary (SPP), it initiates the radio connection to a secondary device. Initiating the connection is done by scanning a pairing symbol for the remote device.

### ***Secondary***

When the scanner is set up as a Secondary device (SPP), the scanner accepts an incoming connection request from a remote device. The number of scanners is dependent on the host's capability.



# Bluetooth-Friendly Name

## Parameter # 607

You can set a meaningful name for the scanner that appears in the application during device discovery. The default name is the scanner name followed by its serial number, e.g., HS-360X 123456789ABCDEF. Scanning Set Defaults reverts the scanner to this name; use custom defaults to maintain the user-programmed name through a Set Defaults operation.

To set a new Bluetooth Friendly Name, scan the following programming symbol, then scan up to 23 characters from [Appendix G — Alphanumeric Keyboard](#).



**Bluetooth Friendly Name**

## **Discoverable Mode**

### **Parameter # 610**

Select a discoverable mode based on the device initiating discovery:

- Select **General Discoverable Mode** when initiating connection from a PC.
- Select **Limited Discoverable Mode** when initiating connection from a mobile device (e.g., iPhone), and the device does not appear in General Discoverable Mode. Note that it can take longer to discover the device in this mode.

The device remains in Limited Discoverable Mode for 30 seconds, and green LEDs flash while in this mode. It is then non-discoverable. To re-active Limited Discoverable Mode, press the trigger.



\* **General Discoverable Mode**  
**(0)**



**Limited Discoverable Mode**  
**(1)**

# Wi-Fi Friendly Mode

## Parameter # 1299

Scanners configured for Wi-Fi friendly mode behave as follows:

- The scanner remains in sniff mode, and exits sniff mode only during firmware update.
- If any Wi-Fi channel is excluded from the hopping sequence, AFH turns off.
- Scanner (and cradle) avoid the selected Wi-Fi channels after establishing connection.

## Notes

- If using this feature, configure all scanners in the area for Wi-Fi friendly mode.
- By default, no Wi-Fi channels are excluded.
- Since Bluetooth requires a minimum of 20 channels when Wi-Fi channels 1, 6, and 11 are excluded, a smaller number of channels are cut from the hopping sequence.
- Updating Wi-Fi friendly settings before Bluetooth connection is recommended.

Scan a programming symbol below to enable or disable **Wi-Fi Friendly Mode**.



**\* Disable Wi-Fi Friendly Mode  
(0)**



**Enable Wi-Fi Friendly Mode  
(1)**

## Wi-Fi Friendly Channel Exclusion

### Parameter # 1297

#### WiFi Channel Exclusion

Select the channels to exclude:

- **Exclude Wi-Fi channel 1:** Bluetooth channels 0-21 are excluded from hopping sequence (2402-2423 MHz).
- **Exclude Wi-Fi channel 6:** Bluetooth channels 25-46 are excluded from hopping sequence (2427 - 2448 MHz).
- **Exclude Wi-Fi channel 11:** Bluetooth channels 50-71 are excluded from hopping sequence (2452 - 2473 MHz).
- **Exclude Wi-Fi channel 1, 6 and 11:** Bluetooth channels 2-19 (2404-2421 MHz), 26-45 (2428 - 2447 MHz) and 51-69 (2453 - 2471 MHz) are excluded from hopping sequence.
- **Exclude Wi-Fi channels 1 and 6:** Bluetooth channels 0-21 (2402-2423 MHz) and 25-46 (2427 - 2448 MHz) are excluded from hopping sequence.
- **Exclude Wi-Fi channels 1 and 11:** Bluetooth channels 0-21 (2402-2423 MHz) and 50-71 (2452 - 2473 MHz) are excluded from hopping sequence.
- **Exclude Wi-Fi channel 6 and 11:** Bluetooth channels 25-46 (2427 - 2448 MHz) and 50-71 (2452 - 2473 MHz) are excluded from hopping sequence.



\* Use All Channels (Standard)  
(0)



Exclude Wi-Fi Channel 1  
(1)



Exclude Wi-Fi Channel 6  
(2)



**Exclude Wi-Fi Channel 11  
(3)**



**Exclude Wi-Fi Channels 1, 6, and 11  
(4)**



**Exclude Wi-Fi Channels 1 and 6  
(5)**



**Exclude Wi-Fi Channels 1 and 11  
(6)**



**Exclude Wi-Fi Channels 6 and 11  
(7)**

# Radio Output Power

## Parameter # 1324

The HS-360X Wireless Scanner uses a Class 1 Bluetooth radio. Optionally, reduce the radio's output power to restrict the transmission range and reduce the effect of the radio on neighboring wireless systems.

Bluetooth stack resets on power change and the device loses connection.

Scan a programming symbol to select the desired power mode.



**\* High Power Setting  
(0)**



**Medium Power Setting  
(1)**



**Low Power Setting  
(2)**

## Link Supervision Timeout

### **Parameter # 1698**

Link supervision timeout controls how quickly the scanner senses that the Bluetooth radio lost connection to the remote device. A lower value helps prevent data loss at the edge of the operating range while a larger value helps prevent disconnects due to the remote device not responding in time. If you are experiencing occasional disconnects and the scanner is able to reconnect, increase the link supervision timeout value.



**.5 Seconds**



**2 Seconds**



**5 Seconds**



**10 Seconds**



**20 Seconds**

# Bluetooth Radio State

## Parameter # 1354

The only option to turn the radio on after it is turned off on the cradle, is through the host.



**Bluetooth Radio Off  
(0)**



**\* Bluetooth Radio On  
(1)**



## HID Host Parameters

The scanner supports virtual keyboard emulation for the Apple iOS, and keyboard emulation over the Bluetooth HID profile. In this mode the scanner can interact with Bluetooth enabled hosts supporting the HID profile as a Bluetooth keyboard. Scanned data is transmitted to the host as keystrokes.

### Bluetooth HID - Wait for Connection

#### **Parameter # 1714**

This setting applies to first time connection only, when scanner connects to remote device by scanning a pairing symbol.

When disabled, the scanner issues a connection after scanning a pairing symbol. This is the recommended setting for Android devices.

When enabled, the scanner waits for a connection request from a remote device, after scanning a pairing symbol and initiating pairing. This is the recommended setting for Windows devices and VC80.



**\* Disable**  
**(0)**



**Enable**  
**(1)**

## **HID Features for Apple iOS**

### ***Parameter # 1114***

This option works with Apple iOS devices to enable the opening and closing of the iOS virtual keyboard by double-pressing the trigger.

When this feature is enabled, the scanner may be incompatible with non-Apple iOS devices.



**\* Disable  
(0)**



**Enable  
(1)**

## HID Keyboard Keystroke Delay

This parameter sets the delay, in milliseconds (msec), between emulated keystrokes. Scan a programming symbol below to increase the delay when the HID host requires a slower transmission of data.



**\* No Delay (0 msec)**



**Medium Delay (20 msec)**



**Long Delay (40 msec)**

## **HID Caps Lock Override**

When enabled, the case of the data is preserved regardless of the state of the caps lock key. This setting is always enabled for the *Japanese, Windows (ASCII)* keyboard type and can not be disabled.



**\* Do Not Override Caps Lock Key  
(Disable)**



**Override Caps Lock Key  
(Enable)**

## **HID Ignore Unknown Characters**

This option applies only to the HID Keyboard Emulation device and IBM device. Unknown characters are characters the host does not recognize. When Send Barcodes With Unknown Characters is selected, all barcode data is sent except for unknown characters, and no error beeps sound. When Do Not Send Barcodes With Unknown Characters is selected, barcode data is sent up to the first unknown character, then the scanner issues an error beep.



**\* Send Barcodes With Unknown  
Characters  
(Enable)**



**Do Not Send Barcodes With Unknown  
Characters  
(Disable)**

## **Emulate Keypad**

When enabled, all characters are sent as ASCII sequences over the numeric keypad. For example, ASCII A is sent as "ALT make" 0 6 5 "ALT Break".



**Disable Keypad Emulation**



**\* Enable Keypad Emulation**

## Fast HID Keyboard

### ***Parameter # 1361***

This option transmits Bluetooth HID keyboard data at a faster rate.



**Fast HID Disable  
(0)**



**\* Fast HID Enable  
(1)**

## **Quick Keypad Emulation**

### ***Parameter # 1362***

This option applies only to a HID Keyboard Emulation Device which has **Emulate Keypad** enabled.

This parameter enables a quicker method of keypad emulation where ASCII sequences are only sent for ASCII characters not found on the keyboard.



**Quick Keypad Emulation Disable  
(0)**



**\* Quick Keypad Emulation Enable  
(1)**



## **HID Keyboard FN1 Substitution**

When enabled, this parameter allows replacement of any FN1 character in an EAN128 barcode with a Key Category and value chosen by the user.



**\* Disable Keyboard FN1 Substitution**



**Enable Keyboard FN1 Substitution**

## **HID Function Key Mapping**

ASCII values under 32 are normally sent as control-key sequences. When this parameter is enabled, the keys in bold are sent in place of the standard key mapping.

Table entries that do not have a bold entry remain the same whether or not this parameter is enabled.



**\* Disable Function Key Mapping**



**Enable Function Key Mapping**

## **Simulated Caps Lock**

When enabled, the scanner inverts upper and lower case characters on the barcode as if the Caps Lock state is enabled on the keyboard. This inversion is done regardless of the current state of the keyboard Caps Lock state.



**\* Disable Simulated Caps Lock**



**Enable Simulated Caps Lock**

## **Convert Case**

When enabled, the scanner converts all barcode data to the selected case.



**\* No Case Conversion**



**Convert All to Upper Case**



**Convert All to LowerCase**

## **Reconnect Attempt Beep Feedback**

When in SPP Primary, Cradle Host Mode, and Bluetooth Keyboard Emulation, the scanner automatically tries to reconnect to a remote device when a disconnection occurs that is due to the radio losing communication. This can happen if the scanner goes out of range with the remote device, or if the remote device powers down. The scanner tries to reconnect for the period of time specified by the Reconnect Attempt Interval setting. During that time the green LED continues to blink.

If the auto-reconnect process fails due to page time-outs, the scanner sounds a page timeout beep (long low/long high) and enters low power mode. The auto-reconnect process can be re-started by pulling the scanner trigger.

If the auto-reconnect process fails because the remote device rejects the connection attempt, the scanner sounds a connection reject beep sequence and deletes the remote pairing address. If this happens, a pairing symbol must be scanned to attempt a new connection to the remote device.

If a barcode is scanned while the auto-reconnect sequence is in process, a transmission error beep sequence sounds and the data is not transmitted to the host. After a connection is reestablished, normal scanning operation returns.

The scanner has memory available for storing a remote Bluetooth address for each Primary mode (SPP, Cradle). When switching between these modes, the scanner automatically tries to reconnect to the last device it was connected to in that mode.

Switching between Bluetooth host types by scanning a host type programming symbol causes the radio to be reset. Scanning is disabled during this time. It takes several seconds for the scanner to re-initialize the radio at which time scanning is enabled.

## **Reconnect Attempt Beep Feedback**

### ***Parameter # 559***

When a scanner disconnects as it goes out of range, it immediately attempts to reconnect. While the scanner attempts to reconnect, the green LED continues to blink. If the auto-reconnect process fails, the scanner emits a page timeout beep (long low/long high) and stops blinking the LED. The process can be restarted by pulling the trigger.

The Beep on Reconnect Attempt feature is disabled by default. When enabled, the scanner emits 5 short high beeps every 5 seconds while the re-connection attempt is in progress. Scan a programming symbol below to enable or disable Beep on Reconnect Attempt.



**\* Disable Beep on Reconnect Attempt  
(0)**



**Enable Beep on Reconnect Attempt  
(1)**

## Reconnect Attempt Interval

### **Parameter # 558**

When a scanner disconnects as it goes out of range, it immediately attempts to reconnect for the default time interval of 30 seconds. This time interval can be changed to one of the options below.

To set the Reconnect Attempt Interval, scan one of the programming symbols below.



**\* Attempt to Reconnect for 30 Seconds  
(6)**



**Attempt to Reconnect for 1 Minute  
(12)**



**Attempt to Reconnect for 5 Minutes  
(60)**



**Attempt to Reconnect for 30 Minutes  
(360)**



**Attempt to Reconnect for 1 Hour  
(720)**



**Attempt to Reconnect Indefinitely  
(0)**



## Auto-Reconnect

### Parameter # 604

In Bluetooth Keyboard Emulation (HID) mode, SPP Primary, and Cradle Host Mode, select a re-connect option for when the scanner loses its connection with a remote device:

- **Auto-reconnect on Barcode Data:** The scanner auto-reconnects when you scan a barcode. With this option, a delay can occur when transmitting the first characters. The scanner sounds a decode beep upon barcode scan, followed by a connection, a page timeout, a rejection beep, or a transmission error beep. Select this option to optimize battery life on the scanner and mobile device. Note that auto-reconnect does not occur on rejection and cable unplug commands.
- **Auto-reconnect Immediately:** When the scanner loses connection, it attempts to reconnect. If a page timeout occurs, the scanner attempts reconnect on a trigger pull. Select this option if the scanner's battery life is not an issue and you do not want a delay to occur when the first barcode is transmitted. Note that auto-reconnect does not occur on rejection and cable unplug commands.
- **Disable Auto-reconnect:** When the scanner loses connection, you must re-establish it manually.



**Auto-Reconnect on Barcode Data**

(1)



**\* Auto-Reconnect Immediately**

(2)



**Disable Auto-Reconnect**

(0)

## **Out-of-Range Indicator**

An out-of-range indicator can be set by scanning **Beep On Reconnect Attempt** and extending the time using the **Reconnect Attempt Interval**.

For example, with Beep on Reconnect Attempt disabled while the scanner loses radio connection when it is taken out of range, the scanner attempts to reconnect silently during the time interval set by scanning a Reconnect Attempt Interval.

When Beep on Reconnect Attempt is enabled, the scanner emits 5 high beeps every 5 seconds while the re-connection attempt is in progress. If the Reconnect Attempt Interval is adjusted to a longer period of time, such as 30 minutes, the scanner emits 5 high beeps every 5 seconds for 30 minutes providing an out-of-range indicator.

# Beep on Insertion

## Parameter # 288

When a scanner is inserted into a cradle and detects power, it emits a short low beep. This feature is enabled by default.

To enable or disable beeping on insertion, scan the appropriate programming symbol below.



**\* Enable Beep on Insertion  
(1)**



**Disable Beep on Insertion  
(0)**

---

Beep on <BEL>

## Beep on <BEL>

### Parameter # 150

When this parameter is enabled, the scanner issues a beep when a <BEL> character is detected on the serial line. <BEL> is issued to gain a user's attention to an illegal entry or other important events.

This parameter only applies to SPP (Serial Port Profile). The RS-232 interface on the cradle has this feature when Beep on <BEL> is enabled.

In Multipoint-to-Point mode only, the scanner that beeped last sounds Beep on <BEL>.



\* Beep on <BEL> Enable  
(1)



Beep on <BEL> Disable  
(0)

# Scanner(s)-to-Cradle Support

## Modes of Operation

### **Parameter # 538**

The charging cradle with radio supports two radio communication modes of operation, allowing the scanner to communicate wirelessly:

- Point-to-Point
- Multipoint-to-Point

### **Point-to-Point Communication**

In Point-to-Point communication mode, the cradle allows one scanner to connect to it at a time. In this mode, the scanner is paired to the cradle either by insertion into the cradle or by scanning the PAIR symbol. Communication can be locked, unlocked (default), or in a lock override state. In locked mode, locking intervals must be set by scanning a connection maintenance interval programming symbol.

To activate this mode of operation, scan Point-to-Point.

### **Multipoint-to-Point Communication**

Multipoint-to-Point communication mode allows up to seven scanners to pair to one cradle.

To activate this mode, the first scanner connected to the cradle must scan the Multipoint-to-Point programming symbol. This mode allows a parameter broadcast feature that forwards parameter programming symbol settings to all connected scanners. In this mode, programming one scanner applies the settings to all connected scanners.

To select Point-to-Point or Multipoint-to-Point mode, scan the appropriate programming symbol.

**Note:** Weblink<sub>PC</sub> is not supported when scanners are in Multipoint-to-Point pairing mode. Setup is only supported in Point-to-Point pairing.



**Multipoint-to-Point Mode  
(1)**



**\* Point-to-Point Mode  
(0)**

## Parameter Broadcast (Cradle Host Only)

### Parameter # 148

When Parameter Broadcast is disabled on one scanner in the piconet, **Parameter Broadcast** is disabled on all scanners in the piconet.

When in multipoint-to-point mode, enable Parameter Broadcast to broadcast all parameter programming symbols scanned to all other scanners in the piconet. If disabled, parameter programming symbols are processed by the individual scanner only, and the scanner ignores parameters broadcast from other scanners or from the cradle.



\* Enable Parameter Broadcast  
(1)



Disable Parameter Broadcast  
(0)

## Pairing

Pairing is the process by which a scanner initiates communication with a cradle. Scanning Multipoint-to-Point activates multi scanner-to-cradle operation and allows up to seven scanners to pair to one cradle.

To pair the scanner with the cradle, scan the pairing symbol. A high/low/high/low beep sequence indicates that the pairing symbol was decoded. When a connection between the cradle and scanner is established, a low/high beep sounds.

1. The pairing symbol that connects the scanner to a cradle is unique to each cradle.
  2. Do not scan data or parameters until pairing completes.
  3. Only when the scanner is paired to the cradle, it automatically tries to reconnect to a remote device when a disconnection occurs that is due to the radio losing communication.
- Pairing Modes

### Parameter # 542

When operating with the cradle, two modes of pairing are supported:

- **Locked Pairing Mode** - When a cradle is paired (connected) to the scanner (or up to seven scanners in Multipoint-to-Point mode), any attempt to connect a different scanner, by either scanning the **PAIR** symbol on the cradle or by inserting it into the cradle with the pairing on contacts feature enabled, is rejected. The currently connected scanner(s) maintain connection. In this mode, you must set a **Connection Maintenance Interval**.
- **Unlocked Pairing Mode** - Unlocking works in Point-to-Point mode only. Pair (connect) a new scanner to a cradle at any time by either scanning the **PAIR** symbol on the cradle or by inserting it into the cradle with the pairing on contacts feature enabled. This unpairs the previous scanner from the cradle.

To set the cradle pairing mode, scan the appropriate programming symbol below.



\* **Unlocked Pairing Mode**  
(0)



**Locked Pairing Mode**  
(1)

## Lock Override

Lock Override is applicable in Point-to-Point mode only (does not apply to Multipoint-to-Point mode). In Multipoint-to-Point mode, if seven scanners are connected, the scanners must be disconnected for a new scanner to connect.

Lock Override overrides a locked scanner base pairing and connects a new scanner. To use Lock Override, scan the programming symbol below, followed by the pairing barcode on the cradle.



**Lock Override**

## Pairing Methods

### ***Parameter # 545***

There are two pairing methods. The default method allows the scanner and cradle to pair (connect) when the pairing symbol on the cradle is scanned. A second method pairs the scanner and cradle when the scanner is inserted in the cradle. To enable this feature, scan Enable Pair On Contacts below. With this feature enabled it is not necessary to scan the pairing symbol on the cradle. If the pairing is successful, a low/high connection beep sequence sounds a few seconds after the scanner is placed in the cradle. To enable or disable pairing on contacts, scan the appropriate programming symbol below.



**\* Enable Pair On Contacts  
(1)**



**Disable Pair on Contacts  
(0)**



## Unpairing

Unpair the scanner from the cradle or PC/host to make the cradle available for pairing with another scanner. Scan the programming symbol below to disconnect the scanner from its cradle/PC host.

An unpairing symbol is also included in the *HS-360X Wireless Scanner Quick Start Guide*.



**Unpairing**

## Toggle Pairing

### **Parameter # 1322**

If the scanner is configured for Toggle Pairing, scanning the Toggle Pairing symbol a second time will unpair the scanner.



**\* Toggle Pairing Disable  
(0)**



**Toggle Pairing Enable  
(1)**

## Pairing Barcode Format

When the scanner is configured as an SPP Primary, you must create a pairing symbol for the remote Bluetooth device to which the scanner can connect. The Bluetooth address of the remote device must be known. Pairing symbols are formatted as follows:

<Fnc 3>Bxxxxxxxxxxxx

where:

- **B** (or **LNKB**) is the prefix
- xxxxxxxxxxxx represents the 12-character Bluetooth address.

### Pairing Barcode Example

If the remote device to which the scanner can connect has a Bluetooth address of 11:22:33:44:55:66, then the pairing symbol is:



Pairing Barcode Content: ————— **B112233445566**  
'B' + Bluetooth Address

## Connection Maintenance Interval

The Connection Maintenance Interval only applies in locked pairing mode.

When a scanner disconnects from a cradle due to a Link Supervision Timeout, the scanner immediately attempts to reconnect to the cradle for 30 seconds. If the auto-reconnect process fails, it can be restarted by pulling the scanner trigger.

To guarantee that a disconnected scanner can reconnect when it comes back in range, the cradle reserves the connection for that scanner for a period of time defined by the Connection Maintenance Interval. If the cradle is supporting the maximum three scanners and one scanner disconnects, a fourth scanner cannot pair to the cradle during this interval. To connect another scanner: either wait until the connection maintenance interval expires then scan the PAIR symbol on the cradle with the new scanner; or, scan Lock Override with the new scanner then scan the PAIR symbol on the cradle.

The cradle stores the remote pairing address of each scanner in memory regardless of the scanner condition (e.g., discharged battery). When you want to change the scanners paired to the cradle, unpair each scanner currently connected to the cradle by scanning the **Unpairing** symbol prior and reconnect each appropriate scanner by scanning the PAIR symbol on the cradle.

### Considerations

The system administrator determines the Connection Maintenance Interval. A shorter interval allows new users to gain access to abandoned connections more quickly, but causes problems if users leave the work area for extended periods. A longer interval allows existing users to leave the work area for longer periods of time, but ties up the system for new users.

To avoid this conflict, users who are going off-shift can scan the **Unpairing** symbol to ignore the Connection Maintenance Interval and make the connection immediately available.

## Connection Maintenance Interval (continued)

To set the Connection Maintenance Interval, scan one of the programming symbols below.



**\* Set Interval to 15 Minutes  
(0)**



**Set Interval to 30 Minutes  
(1)**



**Set Interval to 60 Minutes  
(2)**



**Set Interval to 2 Hours  
(3)**

## Connection Maintenance Interval (continued)



**Set Interval to 4 Hours**  
(4)



**Set Interval to 8 Hours**  
(5)



**Set Interval to 24 Hours**  
(6)



**Set Interval to Forever**  
(7)

# Batch Mode

## Parameter # 544

Batch mode does not apply to SPP Secondary Mode.

The scanner supports five versions of batch mode. When the scanner is configured for any of the batch modes, it attempts to store barcode data (not parameter barcodes) until transmission is initialized, or the maximum number of barcodes are stored. When a barcode is saved successfully, a good decode beep sounds and the LED flashes green. If the scanner is unable to store a new barcode, a low/high/low/high out of memory beep sounds.

In all modes, calculate the amount of data (number of barcodes) the scanner can store as follows:

Number of storable barcodes = 30,720 bytes of memory / (number of characters in the barcode + 3).

If the batch mode selection is changed while there is batched data, the new batch mode takes effect only after all the previously batched data is sent.

## Modes of Operation

- **Normal (default)** - Do not batch data. The scanner attempts to transmit every scanned barcode.
- **Out of Range Batch Mode** - The scanner starts storing barcode data when it loses its connection to a remote device (for example, when a user holding the scanner walks out of range). Data transmission is triggered by reestablishing the connection with the remote device (for example, when a user holding the scanner walks back into range).
- **Standard Batch Mode** - The scanner starts storing barcode data after **Enter Batch Mode** is scanned. Data transmission is triggered by scanning **Send Batch Data**. Transmission is halted if the connection to the remote device is lost.
- **Cradle Contact Batch Mode** - The scanner starts storing barcode data when **Enter Batch Mode** is scanned. Data transmission is triggered by insertion of the scanner into the cradle.  
If the scanner is removed from the cradle during batch data transfer, transmission halts until the scanner is re-inserted in the cradle.
- **Batch Only Mode** - The scanner radio is turned off and the scanner stores all barcode data. Data transmission is triggered by insertion of the scanner into the cradle.  
If the scanner is removed from the cradle during batch data transfer, transmission halts until the scanner is re-inserted in the cradle.  
The radio may be turned off as batch data is transmitted over the cradle contacts. This mode can only be exited by scanning **Normal** (default) mode.
- **Parameter Batch Mode** - When **Parameter Batch Mode** is entered and no connection to the cradle exists, the scanner begins storing parameter programming symbol data intended for the cradle. Parameter transmission is triggered by insertion of the scanner into the cradle. Parameter Batch Mode is exited upon the end of the transmission. Alternatively, parameter programming symbol batching may be cancelled prior to insertion of the scanner into the cradle by scanning **Exit Parameter Batch Mode**.  
**Parameter Batch Mode** may be used when the cradle and/or scanner is configured with its radio turned off or connected to a non-cradle device.



**\* Normal  
(0)**



**Out of Range Batch Mode  
(1)**



**Standard Batch Mode  
(2)**



**Cradle Contact Batch Mode  
(3)**

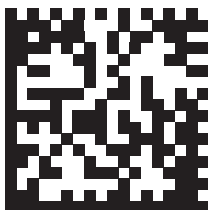

**Enter Batch Mode**



**Send Batch Data**



**Batch Only Mode**



**Enter Parameter Batch Mode**



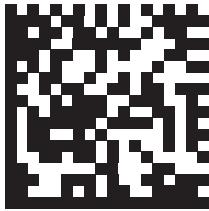

**Exit Parameter Batch Mode**

# Persistent Batch Storage

## ***Parameter #1399***

When the scanner is configured for Persistent Batch Storage, batch data is stored in non-volatile memory and preserved even when the scanner is powered down. This parameter is Disabled by default.

Frequently storing batch data with this setting *Enabled* will shorten the life of the non-volatile memory.



**\* Persistent Batch Disable  
(0)**



**Persistent Batch Enable  
(1)**

# Page Button

## Parameter # 746

The cradle offers a page button. The page button is a sensor that when touched, causes paired scanners to emit a beeping sequence. The default is Enable Page Button.

1. Place your finger over the page button sensor.
2. Press down for approximately 1 second.
3. The cradle LED will turn blue when the scanner is out of the cradle. The paired scanner will beep, blink, and vibrate. If multiple scanners are paired to the cradle, all the scanners will beep, blink, and vibrate.
4. Repeat as necessary.

Scanners out of radio range will not beep when paged.

Scan one of the following programming symbols to enable or disable this feature.



**Disable Page Button  
(0)**



**\* Enable Page Button  
(1)**

# Page Options

To select a page option, select one of the programming symbols below.

## Page Mode

### Parameter # 1364

- **Page State** - In this mode, the cradle sends a page state request to each scanner. It remains in Page State indication until every scanner sends an acknowledgment. The scanner enters Page State when the LED indicator is blinking blue and the vibrating motor and beeper are activated. When the trigger is pressed, or the scanner is inserted into the cradle, or the requested timeout (default is 30 seconds) is reached, the scanner sends the acknowledgment to the cradle and returns to its normal state.
- **Page Simple** - In this mode, the cradle sends a page indication request to each scanner, and returns to idle state. Each scanner issues a single Page State indication.



**Page State**  
**(1)**



**\* Page Simple**  
**(0)**

## Page State Timeout

### **Parameter # 1365**

Page timeout is programmable in 1 second increments from 1 to 99 seconds. The default timeout is 30 seconds.

**Page State Timeout** only applies to **Page State Mode**.

To set a page timeout:

1. Scan the **Page Timeout** programming symbol below.
2. Scan two numeric programming symbols that correspond to the desired timeout duration. Enter a leading zero for single digit numbers (for example, for a 5 second page timeout, scan the 0 programming symbol and then the 5 programming symbol).



**Page Timeout**

## **Classic Bluetooth and/or Low Energy (Cradle Host Only)**

### ***Parameter # 1355***

Set up cradle to accept both Bluetooth Classic and Low Energy connections or Low Energy Only connections.

All Classic Bluetooth connections must be terminated before the setting can change to **Low Energy Only**.



**\* Classic Bluetooth and Low Energy  
(0)**



**Low Energy Only  
(1)**

# Bluetooth Security

The scanner supports Bluetooth Authentication. Authentication can be requested by either the remote device or the scanner.

A remote device can still request Authentication.

## PIN Code

### ***Parameter # 552***

To set and store a PIN code (e.g., password) on the scanner to connect to the host:

1. Scan the **Set and Store PIN Code** programming symbol below.
2. Scan five alphanumeric programming symbols using the alphanumeric programming symbols.
3. Scan **End of Message** in the *Advanced Data Formatting Guide*.

The default PIN code is 12345.

If the scanner communicates with a host with enabled, synchronize the PIN codes on the scanner and host. To achieve this, connect the scanner to the host when setting the PIN codes. If the scanner is not connected to a host, the PIN code change only takes affect on the scanner. If is required between the scanner and host, and the PIN codes do not match, pairing fails.

An extended 16 character PIN code is available for additional with Open Bluetooth (SPP and HID).



**Set and Store PIN Code**

## Variable PIN Code

### Parameter # 608

When switching to Cradle Host mode with authentication enabled, scan Static PIN Code below to avoid entering the PIN code manually. The PIN stored in memory is used. Scan the Variable PIN Code below to manually enter a PIN code with each connection.

The default PIN code is the user-programmed PIN set and stored above. Typically, however, HID connections require entering a Variable PIN Code. If, when attempting connection, the application presents a text box that includes a PIN, scan the Variable PIN Code programming symbol, then re-attempt connection. When you hear a beep indicating the scanner is waiting for an alphanumeric entry, enter the provided variable PIN using the **Alphanumeric Programming Barcodes**, then scan **End of Message**. if the code is less than 16 characters. The scanner discards the variable PIN code after connection.



\* Static PIN Code  
(0)



Variable PIN Code  
(1)



## Bluetooth Security Levels

### Parameter # 1393

- **Low Bluetooth Security** - The low security setting is designed for ease of connection with most devices. This setting may be unacceptable to some devices. If connection fails, try re-connecting after increasing security setting on the scanner. If connecting to Bluetooth 2.1 device and above, *Just Works* method for secure and simple pairing is used.  
Data is encrypted using the **Low Bluetooth** security setting if connected to a Bluetooth 2.1 and above device.
- **Medium Bluetooth Security** - The medium security setting may require a passkey for the initial connection to pair scanner and device. If connecting to Bluetooth 2.1 device and above, *Passkey Entry* method for secure and simple pairing is used.
- **High Bluetooth Security** - The high security setting enables *Man in the Middle* protection for Bluetooth 2.1 and above. Not all devices are able to support this mode.
- **Legacy Bluetooth Security** (Bluetooth 2.0 and below) - The legacy security setting enables authentication and encryption for legacy pairing.



\* **Low Bluetooth Security**  
(0)



**Medium Bluetooth Security**  
(1)



**High Bluetooth Security  
(2)**



**Legacy Bluetooth Security  
(3)**

## Bluetooth Radio, Linking, and Batch Operation

The HS-360X Wireless Scanner has a Bluetooth Class 1 radio which achieves a range of at least 135m / 440ft (open air, line of sight). The actual range you achieve is influenced by the presence of other radios, shelving and wall materials as well as which cradle is tested. The environments vary widely and often influence radio ranges.

When the scanner goes out of communications range to the base, it can be configured for Batch Mode. The scanner has sufficient on board memory to store 500 barcodes of typical size (UPC/EAN).

### Setting Up an iOS or Android Product To Work with the Scanner

Perform the following steps on each device to establish a link.

#### HID Keyboard Emulation

1. On the HS-360X Wireless Scanner, scan Keyboard Emulator (HID).
2. On an iOS/iPad/iPhone, select *Settings* > *General* > *Bluetooth* and turn Bluetooth *On*. Choose the HS-360X Wireless Scanner from the list of discovered devices. A link should be established allowing scanning into any application with keyboard entry.
3. On an Android/ET1/Droid, select *Settings* > *Wireless and networks* > *Bluetooth* (to turn Bluetooth on, if not already on). Select *Bluetooth Settings* and choose the HS-360X Wireless Scanner from the list of discovered devices. (The HS-360X Wireless Scanner normally displays as HS-360X Wireless Scanner - xxxxxx, where xxxxxx is the serial number.)

Android devices, specifically the ET1, may require you to scan a PIN to connect. If so, a PIN displays on the device. To enter the required PIN, scan the programming symbol, then re-attempt connection. When a beep sounds, indicating the scanner is waiting for PIN entry, scan the PIN using the [Appendix H — Numeric Keyboard](#).



# ■ ***5 User Preferences and Miscellaneous Options***

This section describes user preferences and provides configuration symbols for those preferences.

## Introduction

If the default values shown in this section suit your application requirements, programming is not necessary.

To set feature values, scan a single programming symbol or a short programming symbol sequence. The settings are stored in non-volatile memory and are preserved even when the scanner is powered down.

Most computer monitors allow scanning the programming symbols directly on the screen. When scanning from the screen, be sure to set the document magnification to a level where you can see the programming symbol clearly, and bars and/or spaces are not merging.

If not using a USB cable, select a host type (see each host chapter for specific host information) after the power-up beeps sound. This is only necessary upon the first power-up when connected to a new host.

## Scanning Sequence Examples

In most cases, scanning one programming symbol sets the parameter value. For example, to set the beeper tone to high, scan the **High Frequency** (beeper tone) programming symbol. The scanner issues a fast warble beep and the LED turns green, signifying a successful parameter entry.

Other parameters require scanning several programming symbols. See these parameter descriptions for this procedure.

## Errors While Scanning

Unless otherwise specified, to correct an error during a scanning sequence, just re-scan the correct parameter.

## User Preferences Parameter Defaults

The table below lists defaults for user preferences parameters. To change the default values:

- Scan the appropriate programming symbols in this guide. These new values replace the standard default values in memory.
- Configure the scanner using WebLink<sub>PC</sub>.

See [Appendix A — Standard Default Parameters](#) for all user preferences, hosts, symbologies, and default parameters.

Parameter	Parameter Number <sup>1</sup>	Default
<b>User Preferences</b>		
Set Default Parameter		Restore Defaults
Parameter Barcode Scanning	236	Enable
Beep After Good Decode	56	Enable
Direct Decode Indicator	859	Disable
Beeper Volume	140	High
Beeper Tone	145	Medium
Beeper Duration	628	Medium
Suppress Power Up Beeps	721	Do Not Suppress
Decode Pager Motor	613	Enable
Decode Pager Motor Duration	626	150 msec
Low Power Mode	128	Enable (HS-360X Wireless Scanner) Disable (HS-360X Wired Scanner)
Time Delay to Low Power Mode	146	100 ms (HS-360X Wireless Scanner) 1 Hour (HS-360X Wired Scanner)
Timeout to Low Power Mode from Auto Aim (HS-360X Wired Only)	729	15 Seconds
Handheld Trigger Mode	138	Level
Hands-Free Mode	630	Enable
Handheld Decode Aiming Pattern	306	Enable
Hands-Free (Presentation) Decode Aiming Pattern	590	Enable Hands-Free (Presentation) Decode Aiming Pattern on PDF
Picklist Mode	402	Disabled Always
FIPS Mode (HS-360X Wired Scanner Only)	736	Disable
Continuous Barcode Read	649	Disable
Unique Barcode Reporting	723	Enable
Decode Session Timeout	136	9.9 Seconds
Hands-free Decode Session Timeout	400	15

**1. Parameter number decimal values are used for programming via RSM commands.**

## User Preferences Parameter Defaults

Parameter	Parameter Number <sup>1</sup>	Default
Timeout Between Decodes, Same Symbol	137	0.5 Seconds
Timeout Between Decodes, Different Symbols	144	0.5 Seconds
Mobile Phone/Display Mode	716	Normal
PDF Prioritization	719	Disable
PDF Prioritization Timeout	720	200 msec
Presentation Mode Field of View	609	Full
Decoding Illumination	298	Enable
Motion Tolerance (Handheld Trigger Mode Only)	858	Less Motion Tolerance
Ranging Light Immunity	1722	60Hz Immunity
Battery Threshold		
Battery Status High Threshold	1367	50%
Battery Status Medium Threshold	1368	20%
Battery Status Low Warning Threshold	1369	10%
Battery Health Low Warning Threshold	1370	60%
Add an Enter Key	N/A	N/A
Transmit Code ID Character	45	None
Prefix Value	99, 105	7013 <CR><LF>
Suffix 1 Value	98, 104	7013 <CR><LF>
Suffix 2 Value	100, 106	
Scan Data Transmission Format	235	Data as is
FN1 Substitution Values	103, 109	7013 <CR><LF>
Transmit "No Read" Message	94	Disable
Unsolicited Heartbeat Interval	1118	Disable
UID	740	Disable
UID Error Mode Options	742	UID Error Beep
Decoder Effort Level	1438	Level 3
DPM Illumination Control	429	Cycle Illumination

**1. Parameter number decimal values are used for programming via RSM commands.**



# User Preferences

## Default Parameters

The scanner can be reset to two types of defaults: factory defaults or custom defaults. Scan the appropriate programming symbol below to reset the scanner to its default settings and/or set the scanner's current settings as the custom default.

**Restore Defaults** - Resets all default parameters as follows:

- If custom default values were configured (see **Write to Custom Defaults**), the custom default values are set for all parameters each time the **Restore Defaults** programming symbol below is scanned.
- If no custom default values were configured, the factory default values are set for all parameters each time the **Restore Defaults** programming symbol below is scanned. (For factory default values, see [Appendix A — Standard Default Parameters](#).)
- **Set Factory Defaults** - Scan the **Set Factory Defaults** programming symbol below to eliminate all custom default values and set the scanner to factory default values (For factory default values, see [Appendix A — Standard Default Parameters](#).)
- **Write to Custom Defaults** - Custom default parameters can be configured to set unique default values for all parameters. After changing all parameters to the desired default values, scan the **Write to Custom Defaults** programming symbol below to configure custom defaults.



\* Restore Defaults



Set Factory Defaults



Write to Custom Defaults

## **Parameter Barcode Scanning**

### ***Parameter # 236***

To disable the decoding of parameter programming symbols, including the **Set Defaults** parameter programming symbols, scan the **Disable Parameter Scanning** programming symbol below. To enable decoding of parameter programming symbols, scan **Enable Parameter Scanning**.



**\* Enable Parameter Barcode Scanning**  
**(1)**



**Disable Parameter Barcode Scanning**  
**(0)**

## **Beep After Good Decode**

### ***Parameter # 56***

Scan a programming symbol below to select whether or not the scanner beeps after a good decode. If selecting **Do Not Beep After Good Decode**, the beeper still operates during parameter menu scanning and to indicate error conditions.



**\* Beep After Good Decode (Enable)**  
**(1)**



**Do Not Beep After Good Decode**  
**(Disable)**  
**(0)**

## Direct Decode Indicator

### Parameter # 859

This feature is only supported in Auto Aim and Standard (Level) trigger modes. Scan a programming symbol below to select optional blinking of the illumination on a successful decode:

- **Disable Direct Decode Indicator** - illumination does not blink on a successful decode.
- **1 Blink** - illumination blinks once upon a successful decode.
- **2 Blinks** - illumination blinks twice upon a successful decode.



\* **Disable Direct Decode Indicator**  
(0)



**1 Blink**  
(1)



**2 Blinks**  
(2)

## **Beeper Volume**

### ***Parameter # 140***

To select a beeper volume, scan the **Low Volume**, **Medium Volume**, or **High Volume** programming symbol.



**Low Volume  
(2)**



**Medium Volume  
(1)**



**\* High Volume  
(0)**

## **Beeper Tone**

### ***Parameter # 145***

To select a beeper tone, scan one of the following programming symbols.



**Off  
(3)**



**Low Tone  
(2)**



**\* Medium Tone  
(1)**



**High Tone  
(0)**



**Medium to High Tone (2-tone)**  
**(4)**

## **Beeper Duration**

### ***Parameter # 628***

To select the duration for the beeper, scan one of the following programming symbols.



**Short  
(0)**



**\* Medium  
(1)**



**Long  
(2)**



## **Suppress Power Up Beeps**

### ***Parameter # 721***

Scan a programming symbol below to select whether or not to suppress the scanner's power-up beeps.



**\* Do Not Suppress Power Up Beeps  
(0)**



**Suppress Power Up Beeps  
(1)**

## **Decode Pager Motor**

### ***Parameter # 613***

The scanner includes a pager motor which, when enabled, vibrates the scanner for a period of time when a successful decode occurs.

When the pager motor is enabled and the HS-360X Wired Scanner is in the HS-360X Stand, the pager motor disables until the scanner is removed from the HS-360X Stand.

Scan a programming symbol below to enable or disable the pager motor. If enabled, scan the appropriate programming symbol to set the period of time in which to vibrate the scanner.



**Pager Motor Disable  
(0)**



**\* Pager Motor Enable  
(1)**

## **Decode Pager Motor Duration**

### ***Parameter # 626***



**\* 150 msec  
(15)**



**200 msec  
(20)**



**250 msec  
(25)**



**300 msec  
(30)**



**400 msec**  
**(40)**



**500 msec**  
**(50)**



**600 msec**  
**(60)**



**750 msec**  
**(75)**

## **Low Power Mode**

### ***Parameter # 128***

This parameter determines whether or not the scanner enters low power mode after a decode attempt.

If disabled, power remains on after each decode attempt. The HS-360X Wired Scanner default is Disable. The HS-360X Wireless Scanner default is Enable.



**Disable Low Power Mode  
(0)**



**Enable Low Power Mode  
(1)**

## Time Delay to Low Power Mode

### Parameter # 146

This parameter only applies when **Lower Power Mode** is enabled.

This parameter sets the time it takes the scanner to enter Low Power Mode after any scanning activity. Scan the appropriate programming symbol below to set the time. The HS-360X Wired Scanner default is 1 Hour. The HS-360X Wireless Scanner default is 100 msec.



**100 msec**  
**(65)**



**500 msec**  
**(69)**



**1 Second**  
**(17)**



**2 sec**  
**(18)**



**3 sec  
(19)**



**4 Seconds  
(20)**



**5 Seconds  
(21)**



**10 Seconds  
(26)**



**1 Minute  
(33)**



**5 Minutes**  
**(37)**



**15 Minutes**  
**(43)**



**30 Minutes**  
**(45)**



**45 Minutes**  
**(46)**



**1 Hour**  
**(49)**





**3 Hours  
(51)**



**6 Hours  
(54)**



**9 Hours  
(57)**

## Timeout to Low Power Mode from Auto Aim

### Parameter # 729

Timeout to Low Power Mode from Auto Aim applies to the HS-360X Wired Scanner only. This parameter sets the time the scanner remains in auto aim before entering Low Power Mode.



**Disabled**  
**(0)**



**5 Seconds**  
**(5)**



**\* 15 Seconds**  
**(11)**



**30 Seconds  
(13)**



**1 Minute  
(17)**

## Handheld Trigger Mode

### Parameter # 138

Select one of the following trigger modes for the scanner.

- **Standard (Level)** - A trigger pull activates decode processing. Decode processing continues until the barcode decodes, you release the trigger, or the Decode Session Timeout occurs.
- **Presentation (Blink)** - The scanner activates decode processing when it detects a barcode in its field of view. After a period of non-use, the scanner enters a low power mode, in which the LEDs turn off until the scanner senses motion.

The scanner uses an internal dim illumination state when it enters low power mode until motion is detected.



\* Level (Standard)  
(0)



Presentation (Blink)  
(7)

## **Hands-Free Mode**

### ***Parameter # 630***

If you select **Disable Hands-free Mode**, the scanner behaves according to the setting of the **Handheld Trigger Mode**.



**\* Enable Hands-free Mode  
(1)**



**Disable Hands-free Mode  
(0)**

## Handheld Decode Aiming Pattern

### Parameter # 306

Select **Enable Handheld Decode Aiming Pattern** to project the aiming dot during barcode capture, **Disable Handheld Decode Aiming Pattern** to turn the aiming dot off, or **Enable Handheld Decode Aiming Pattern on PDF** to project the aiming dot when the scanner detects a 2D barcode.

With **Picklist Mode** enabled, the decode aiming dot flashes even when the **Handheld Decode Aiming Pattern** is disabled.



\* **Enable Handheld Decode Aiming Pattern**  
(2)



**Disable Handheld Decode Aiming Pattern**  
(0)



**Enable Handheld Decode Aiming Pattern on PDF**  
(3)

## **Hands-Free Decode Aiming Pattern**

### ***Parameter # 590***

Select **Enable Hands-free Decode Aiming Pattern** to project the aiming dot during barcode capture, **Disable Hands-free Decode Aiming Pattern** to turn the aiming dot off, or **Enable Hands-free Decode Aiming Pattern on PDF** to project the aiming dot when the scanner detects a 2D barcode.

With **Picklist Mode** enabled, the decode aiming dot flashes even when the **Decode Aiming Pattern** is disabled.



**Enable Hands-Free Decode  
Aiming Pattern  
(1)**



**Disable Hands-Free Decode  
Aiming Pattern  
(0)**



**\* Enable Hands-Free Decode  
Aiming  
Pattern on PDF  
(2)**

## FIPS Mode

### Parameter # 736

FIPS Mode applies to the HS-360X Wired Scanner only.

The Federal Information Processing Standard (FIPS) 140-2 is a U.S. government computer security standard used to accredit cryptographic modules. FIPS enabled HS-360X Wired Scanners and cradles offer this secure mode of operation.

To enable the FIPS mode of operation (disabled by default), scan the **Enable FIPS** programming symbol. The scanner attempts to establish a secure session with the cradle to which it is connected. On success, the scanner lights an amber LED on every trigger pull to signal that all data will be transmitted over Bluetooth in a secure fashion. On failure, the scanner will sound transmission failure error message on every attempt to transmit data.

To disable the FIPS mode, scan the **Disable FIPS** programming symbol at any time.



**Enable FIPS**  
(1)



**\* Disable FIPS**  
(0)



## **Decode Session Timeout**

### ***Parameter # 136***

This parameter sets the maximum time decode processing continues during a scan attempt. It is programmable in 0.1 second increments from 0.5 to 9.9 seconds. The default timeout is 9.9 seconds.

To set a Decode Session Timeout, scan the programming symbol below. Next, scan two numeric programming symbol from **Appendix H — Numeric Keyboard** that correspond to the desired on time. Enter a leading zero for single digit numbers. For example, to set a Decode Session Timeout of 0.5 seconds, scan the programming symbol below, then scan the **0** and **5** programming symbols.



**Decode Session Timeout**

## Hands-Free Decode Session Timeout

### Parameter # 400

This parameter is the Hands-free compliment to the **Decode Session Timeout**. It configures the minimum and maximum decode processing time during a Hands-free scan attempt. It only applies to the Hands-free trigger mode.

The minimum decode processing time is defined as the time in which the scanner stops decoding when an object is removed or left stationary in the imaging field of view.

The maximum decode processing time is defined as the time in which the scanner stops decoding when an object is left in or is moving in the field of view.

Both the maximum and minimum times are configured using a single setting. The relationship of this setting is as follows:

Setting Value	Minimum Time	Maximum Time
X < 25	250 msec	2.5 Seconds
X >= 25	X * 10 msec	X * 100 msec

For example, a setting value of 100 results in the scanner turning off approximately 1 second after an object is removed from the field of view or 10 seconds while an object is in the field of view moving.

The default value of the setting is 15 which results in a Minimum time of 250 msec and Maximum time of 2.5 seconds.

Adjust this setting based on your requirements. For example, when doing prioritization, this parameter should be set to a value where the maximum time is above the PDF prioritization timeout.



### Hands-free Decode Session Timeout

## **Timeout Between Decodes**

### ***Parameter # 144***

Use this option in presentation mode to control the time the scanner is inactive between decoding different symbols. It is programmable in 0.1 second increments from 0.1 to 9.9 seconds. The default is 0.5 seconds.

**Note:** Values below 0.5 seconds result in barcodes being read faster than Weblink<sub>PC</sub> can process the corresponding images.

To select the timeout between decodes for different symbols, scan the programming symbol below, then scan two numeric programming symbols from [Appendix H — Numeric Keyboard](#) that correspond to the desired interval, in 0.1 second increments.

**Timeout Between Decodes** cannot be greater than or equal to the **Decode Session Timeout**.

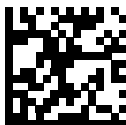

**Timeout Between Decodes**

## Mobile Phone/Display Mode

### Parameter # 716

This mode improves barcode reading performance off mobile phones and electronic displays. Select Enhanced in Handheld, Hands-free, or both modes, or select Normal Mobile Phone/Display Mode.

The scanner restricts **Mobile Phone/Display Mode**.



\* Normal Mobile Phone/Display Mode  
(0)



Enhanced in Handheld Mode  
(1)



Enhanced in Hands-free Mode  
(2)



Enhanced in Both Modes  
(3)

## PDF Prioritization

### **Parameter # 719**

Enable this feature to delay decoding a 1D barcode (Code 128) by the value specified in **PDF Prioritization Timeout**. During that time the scanner attempts to decode a PDF417 symbol (e.g., on a US driver's license), and if successful, reports this only. If it does not decode (can not find) a PDF417 symbol, it reports the 1D symbol after the timeout. The 1D symbol must be in the device's field of view for the scanner to report it. This parameter does not affect decoding other symbologies.

The 1D Code 128 barcode lengths include the following:

- 7 to 10 characters
- 14 to 22 characters
- 27 to 28 characters

In addition, a Code 39 barcode with the following lengths are considered to potentially be part of a US driver's license:

- 8 characters
- 12 characters



**\* Disable PDF Prioritization  
(0)**



**Enable PDF Prioritization  
(1)**

## **PDF Prioritization Timeout**

### ***Parameter # 720***

The **Hands-Free Decode Session Timeout** should be set to a longer duration than **PDF Prioritization Timeout** when configured.

When **PDF Prioritization** is enabled, this timeout specifies how long the scanner attempts to decode a PDF417 symbol before reporting the 1D barcode in the field of view.

Scan the following programming symbol, then scan four digits from **Appendix H — Numeric Keyboard** that specify the timeout in milliseconds. For example, to enter 400 msec, scan the following programming symbol, then scan 0400. The range is 0 to 5000 msec, and the default is 200 msec.



**PDF Prioritization Timeout**

## **Decoding Illumination**

### ***Parameter # 298***

Selecting **Enable Decoding Illumination** causes the scanner to flash illumination to aid decoding. Select **Disable Decoding Illumination** to prevent the scanner from using decoding illumination.

Enabling illumination usually results in superior images. The effectiveness of the illumination decreases as the distance to the target increases.



**\* Enable Decoding Illumination**  
**(1)**



**Disable Decoding Illumination**  
**(0)**

## Motion Tolerance (Handheld Trigger Modes Only)

### **Parameter # 858**

**Less Motion Tolerance** provides optimal decoding performance on 1D barcodes.

To increase motion tolerance and speed decoding when scanning a series of 1D barcodes in rapid progression, scan **More Motion Tolerance**.



**\* Less Motion Tolerance  
(0)**



**More Motion Tolerance  
(1)**



## Battery Threshold

Scan the appropriate programming symbol below to select the desired battery status threshold.

- **Battery Status High Threshold - Parameter #1367**  
This parameter sets the threshold used to show the Battery Status is High. When the battery status is above the High Threshold, the battery indicator is green. Scan this programming symbol followed by 2 digits from [Appendix H — Numeric Keyboard](#) that correspond to the desired percentage from 00 to 99. The default is 50%.
- **Battery Status Medium Threshold - Parameter #1368**  
This parameter sets the threshold used to show the Battery Status is Medium. When the battery status is above the Medium Threshold (and below the High Threshold), the Battery indicator is amber. When the battery status is below the Medium Threshold, the Battery indicator is red. Scan this programming symbol followed by 2 digits from [Appendix H — Numeric Keyboard](#) that correspond to the desired percentage from 00 to 99. The default is 20%.
- **Battery Status Low Warning Threshold - Parameter #1369**  
This parameter sets the threshold to indicate Batter Status is Critically Low. When the battery status is below the Low Warning Threshold, on every trigger release the scanner issues 4 short beeps. Scan this programming symbol followed by 2 digits from [Appendix H — Numeric Keyboard](#) that correspond to the desired percentage from 00 to 99. The default is 10%.
- **Battery Health Low Warning Threshold - Parameter #1370**  
This parameter sets the threshold to indicate Battery Health is Low. When the battery health is below the Low Health Threshold, all battery indication will alternate between Red and the appropriate Battery Status indication. When Battery Health is Low, you should consider replacing the battery. Scan this programming symbol followed by 2 digits from [Appendix H — Numeric Keyboard](#) that correspond to the desired percentage from 00 to 99. The default is 60%.



**Battery Status High Threshold**



**Battery Status Medium Threshold**



**Battery Status Low Warning Threshold**



**Battery Health Low Warning Threshold**

## **Add an Enter Key**

To add an Enter key (carriage return/line feed) after scanned data, scan the following programming symbol.



**Add Enter Key (Carriage Return/Line  
Feed)**

## Transmit Code ID Character

### Parameter # 45

A Code ID character identifies the code type of a scanned barcode. This is useful when decoding more than one code type. In addition to any single character prefix already selected, the Code ID character is inserted between the prefix and the decoded symbol.

Select no Code ID character, a Symbol Code ID character, or an AIM Code ID character.

If you enable Symbol Code ID Character or AIM Code ID Character, and enable Transmit "No Read" Message, the scanner appends the code ID for Code 39 to the NR message.



**Symbol Code ID Character**  
(2)



**AIM Code ID Character**  
(1)



**\* None**  
(0)

## **Prefix/Suffix Values**

Key Category Parameter # P = 99, S1 = 98, S2 = 100

Decimal Value Parameter # P = 105, S1 = 104, S2 = 106

You can append a prefix and/or one or two suffixes to scan data for use in data editing. To set a value for a prefix or suffix, scan a four-digit number (i.e., four programming symbols from [Appendix H — Numeric Keyboard](#)) that corresponds to that value. See [Appendix I — ASCII Character Sets](#) for the four-digit codes.

When using host commands to set the prefix or suffix, set the key category parameter to 1, then set the 3-digit decimal value. See [Appendix I — ASCII Character Sets](#) for the four-digit codes.

The default prefix and suffix value is 7013 <CR><LF> (the Enter key).



**Scan Prefix  
(7)**



**Scan Suffix 1  
(6)**



**Scan Suffix 2  
(8)**



**Data Format Cancel**

## Scan Data Transmission Format

### Parameter # 235

To change the scan data format, scan one of the following eight programming symbol corresponding to the desired format.

If using this parameter do not use ADF rules to set the prefix/suffix.

To set values for the prefix and/or suffix, see **Prefix/Suffix Values**.



\* Data As Is  
(0)



<DATA> <SUFFIX 1>  
(1)



<DATA> <SUFFIX 2>  
(2)



<DATA> <SUFFIX 1> <SUFFIX 2>  
(3)



<PREFIX> <DATA >  
(4)



<PREFIX> <DATA> <SUFFIX 1>  
(5)



<PREFIX> <DATA> <SUFFIX 2>  
(6)



<PREFIX> <DATA> <SUFFIX 1> <SUFFIX  
2>  
(7)



## FN1 Substitution Values

### **Key Category Parameter # 103**

### **Decimal Value Parameter # 109**

The wedge and USB HID keyboard hosts support a FN1 Substitution feature. Enabling this substitutes any FN1 character (0x1b) in an EAN128 barcode with a value. This value defaults to 7013 (Enter Key).

When using host commands to set the FN1 substitution value, set the key category parameter to 1, then set the 3-digit keystroke value. See the ASCII Character Set table for the current host interface for the desired value.

To select a FN1 substitution value via programming symbol menus:

1. Scan the programming symbol below.



### **Set FN1 Substitution Value**

2. Locate the keystroke desired for FN1 Substitution in the ASCII Character Set table for the current host interface. Enter the 4-digit ASCII Value by scanning each digit in [Appendix H — Numeric Keyboard](#).

To correct an error or change the selection, scan **Cancel**.

To enable FN1 substitution for USB HID keyboard, scan the **Enable FN1 Substitution** programming symbol.

## Transmit “No Read” Message

### Parameter # 94

Scan a programming symbol below to select whether or not to transmit a No Read message. Enable this to transmit the characters NR when a successful decode does not occur before trigger release or the **Decode Session Timeout** expires. Disable this to send nothing to the host if a symbol does not decode.

If you enable **Transmit No Read**, and also enable Symbol Code ID Character or AIM Code ID Character for **Transmit Code ID Character** the scanner appends the code ID for Code 39 to the NR message.

**Important:** When connected to **Setup** in **WebLink<sub>PC</sub>**, do not use these programming symbols. See the **WebLink<sub>PC</sub> ReadMe** for further details.



**Enable No Read**  
**(1)**



**\* Disable No Read**  
**(0)**

## Unsolicited Heartbeat Interval

### Parameter # 1118

The imager supports sending **Unsolicited Heartbeat Messages** to assist in diagnostics. To enable this feature and set the desired unsolicited heartbeat interval, scan one of the time interval programming symbols below, or scan **Set Another Interval** followed by four numeric programming symbols from **Appendix H — Numeric Keyboard** (scan sequential numbers that correspond to the desired number of seconds). The range is 0 - 9999.

Scan **Disable Unsolicited Heartbeat Interval** to turn off the feature.

The heartbeat event is sent as decode data (with no decode beep) in the form of:

**MOTEVTHB:nnn**

where **nnn** is a three-digit sequence number starting at 001 and wrapping after 100.



**10 Seconds**  
(10)



**1 Minute**  
(60)



**Set Another Interval**



**\* Disable Unsolicited Heartbeat Interval  
(0)**

## **UID Parsing**

### **Parameter # 740**

UID parsing is only supported by DP configurations of the scanner.

UID constructs are compliant with the US Department of Defense MIL - STD - 130N.

A UID, or Unique Identifier, is used to identify and track data (e.g., manufacturer, distribution, lifetime of products and other information) specified by the United States Department of Defense for all imported packages containing merchandise equal to or greater than \$5,000.00. Vendors are required to provide a legible and permanent UID marking, in the form of a Data Matrix symbol, with the contents.

DP configurations of the scanner read the Data Matrix symbol, verify it is a valid UID symbol and parse the data into a UID symbol (**Criterion: Parsed UID** symbol type with UID fields). This output can be used at a later date.

To enable/disable UID parsing, scan the appropriate programming symbol below. UID parsing is disabled by default. Scan **Enable Embedded UID Parsing** to start the parsing process.



**\* Disable UID Parsing  
(0)**



**Enable Embedded UID Parsing  
(1)**

## UID Parsing Output

When a UID is successfully parsed, the fields shown below are created. Each field is comma-separated. If data is missing from a field in the UID, a lone comma fills the field.

When a UID successfully parses, a parsed UID symbol type transmits to the host.

When parsing is unsuccessful but data transmits to the host anyway, the data is in the data matrix format.

Field	Description
1	Concatenated UID
2	Construct type (UID1 or UID2)
3	Enterprise ID
4	Serialized part #
5	Original part #
6	Lot #
7	Current part #
8	Scanned data in ASCII mode

### Example Output – Successful Parsed Data

```
D12345WS51-004041,UID2,12345,041,WS51-004,,,[> rs 06 gs 17V12345 gs 1PWS51-004  
gs S041 rs eot
```

Field	Description
1	D12345WS51-004041
2	UID2
3	12345
4	041
5	WS51-004
6	(no data supplied, comma filled field)
7	(no data supplied, comma filled field)
8	[> rs 06 gs 17V12345 gs 1PWS51-004 gs S041 rs eot

## **UID Error Mode Options**

### **Parameter # 742**

- **UID Error Beep (default):** Scan **UID Error Beep** to program the scanner not to parse the data contained in the UID when the UID is not formatted correctly. An error tone sounds and no data transmits to the host.
- **UID Error Pass Data:** Scan **UID Error Pass Data** to program the scanner to transmit data to the host even when parsing fails. The scanner reads the incorrectly encoded UID, assumes the host can process the data and transmits the unformatted contents of the barcode. No error tone sounds.
- **UID Error Beep and Pass Data:** Scan **UID Error Pass Data** to program the scanner to transmit data to the host even when parsing fails. The scanner reads the incorrectly encoded UID, assumes the host can process the data and transmits the unformatted contents of the barcode. An error tone sounds.

Scan the appropriate programming symbol below to program potential error conditions.



**\* UID Error Beep  
(0)**



**UID Error Pass Data  
(1)**



**UID Error Beep and Pass Data  
(2)**



## **Sample ADF Rule for UID**

To transmit only the concatenated UID field of the parsed UID, scan the programming symbols below, in order.



**Begin New Rule**



**Criterion: Parsed UID**



**Send Data Up to Character**



,  
**(Comma)**



**Save Rule**

## UID Sample Barcodes

### 05 Format



WS51-004041,UID2,,041,WS51-004,,[,]> rs 05 gs 01WS51-004 gs 21041 rs eot

Field	Description
1 - Concatenated UID	WS51-004041
2 - Construct type (UID1 or UID2)	UID2
3 - Enterprise ID	, (no data supplied)
4 - Serialized part #	041
5 - Original part #	WS51-004
6 - Lot #	, (no data supplied)
7 - Current part #	, (no data supplied)
8 - Scanned data in ASCII mode	[]> rs 05 gs 01WS51-004 gs 21041 rs eot

### 06 Format



D12345WS51-004041,UID2,12345,041,WS51-004,,[,]> rs 06 gs 17V12345 gs 1PWS51-004 gs S041  
rs eot

Field	Description
1 - Concatenated UID	D12345WS51-004041
2 - Construct type (UID1 or UID2)	UID2
3 - Enterprise ID	12345
4 - Serialized part #	041
5 - Original part #	WS51-004
6 - Lot #	, (no data supplied)
7 - Current part #	, (no data supplied)
8 - Scanned data in ASCII mode	[]> rs 06 gs 17V12345 gs 1PWS51-004 gs S041 rs eot

### 12 Format

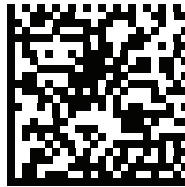

D12345WS51-004041,UID2,12345,041,WS51-004,,[> rs 12 gs MFR 12345 gs PNO WS51-004 gs SEQ 041 rs eot

Field	Description
1 - Concatenated UID	D12345WS51-004041
2 - Construct type (UID1 or UID2)	UID2
3 - Enterprise ID	12345
4 - Serialized part #	041
5 - Original part #	WS51-004
6 - Lot #	, (no data supplied)
7 - Current part #	, (no data supplied)
8 - Scanned data in ASCII mode	[> rs 12 gs MFR 12345 gs PNO WS51-004 gs SEQ 041 rs eot

### DD Format

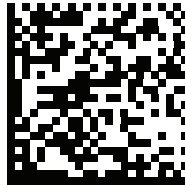

D12345WS51-004041,UID2,12345,041,WS51-004,,[> rs DD gs MFR 12345 gs PNO WS51-004 gs SEQ 041 rs eot

Field	Description
1 - Concatenated UID	D12345WS51-004041
2 - Construct type (UID1 or UID2)	UID2
3 - Enterprise ID	12345
4 - Serialized part #	041
5 - Original part #	WS51-004
6 - Lot #	, (no data supplied)
7 - Current part #	, (no data supplied)
8 - Scanned data in ASCII mode	[> rs DD gs MFR 12345 gs PNO WS51-004 gs SEQ 041 rs eot

## Decoder Effort Levels

### Parameter # 1438

Unlike symbols printed on labels, a direct part mark (DPM) is a symbol that is marked directly on an item's surface for permanent identification, using methods such as laser etching, dot-peening, or direct-printing.

Select one of the levels below based on the type of symbol being scanned.

- **Decoder Effort Level 1 – No Special DPM Processing.** Use only on high-contrast symbols printed on labels. This allows the fastest processing time when no DPM reading is required.
- **Decoder Effort Level 2 – Least Aggressive DPM Processing.** Optimized for decoding performance on smaller DPM symbols typically found on electronics and medical instruments, especially on smooth surfaces. These symbols tend to be laser-etched or direct-printed.
- **Decoder Effort Level 3 – Best Setting for Most DPMs.** Optimizes decoding performance on larger DPM symbols, typically found on industrial parts, especially on rough, grainy, or visibly machined surfaces. These symbols tend to be dot-peened or laser-etched.
- **Decoder Effort Level 4 – Most Aggressive DPM Processing.** Use only for the most difficult-to-decode marks, for which additional DPM processing may be necessary.



**Level 1 – No  
Special DPM  
Processing**



**Level 2 – Least  
Aggressive DPM  
Processing**



**Level 3 – Best  
Setting for  
Most DPMs**



**Level 4 – Most Aggressive DPM Processing**  
(You can also use the [Decoder Effort](#) slider  
in [WebLink<sub>PC</sub>](#) to Set the Scanner's Decoder  
Effort to Level 4)

**Important:** The [BC412](#) and [DotCode](#) symbologies are only supported when the scanner is set to Decoder Effort Level 4.

## DPM Illumination Control

### Parameter # 429

In Presentation Mode, the scanner uses the internal dim illumination state when it enters low power mode until motion is detected.

This parameter controls the Illumination for DPM symbol reading.

- **Direct Illumination** – scanner uses only the direct (white) illumination. Recommended for use with dot-peened symbols. Tilt the part 30 degrees.
- **Indirect Illumination** – scanner uses only the (red) illumination. Recommended for use with laser-etched symbols on curved, rough, grainy, highly reflective, visibly machined surfaces or cylinders.
- **Cycle Illumination** – scanner cycles alternately between direct and indirect illumination. The scanner starts with the illumination used during the last successful decode.



**Direct Illumination**  
(0)



**Indirect Illumination**  
(8)



**\* Cycle Illumination**  
(3)

# **6 *Imaging Preferences***

This section describes image capture preferences and provides configuration symbols for those preferences.

# Introduction

Only the Symbol Native API (SNAPI) with Imaging interface supports image capture.

See [Appendix A — Standard Default Parameters](#) for all host device and defaults. If the default values suit application requirements, programming is not necessary.

To set feature values, scan a single programming symbol or a short programming symbol sequence. The settings are stored in non-volatile memory and are preserved even when you power down the scanner.

Most computer monitors allow scanning the programming symbols directly on the screen. When scanning from the screen, be sure to set the document magnification to a level where you can see the programming symbol clearly, and bars and/or spaces are not merging.



## Scanning Sequence Examples

In most cases scanning one programming symbol sets the parameter value. For example, to disable image capture illumination, scan the **Disable Image Capture Illumination** programming symbol under **Image Capture Illumination**. The scanner issues a fast “warble” beep and the LED turns green, signifying a successful parameter entry.

Other parameters require scanning several programming symbols. See these parameter descriptions for this procedure.

## Errors While Scanning

Unless otherwise specified, to correct an error during a scanning sequence, just re-scan the correct parameter.

## Imaging Preferences Parameter Defaults

The table below lists the defaults for imaging preferences parameters. To change the default values, scan the appropriate programming symbols in this guide. These new values replace the standard default values in memory.

See [Appendix A — Standard Default Parameters](#) for all user preferences, hosts, symbologies, and default parameters.

Parameter	Parameter Number	Default
<b>Imaging Preferences</b>		
Image Size (Number of Pixels)	302	Full Resolution
JPEG Image Options	299	JPEG Quality Selector
JPEG File Size	561	160 kb
JPEG Quality and Size Value	305	65
Image File Format	304	JPEG

## Image Size (Number of Pixels)

### Parameter # 302

This option alters image resolution before compression. Multiple pixels are combined to one pixel, resulting in a smaller image containing the original content with reduced resolution.

Select one of the following values:

Resolution Value	HS-360X
Full	1280 x 800
1/2	640 x 400
1/4	320 x 200



\* Full Resolution  
(0)



1/2 Resolution  
(1)



1/4 Resolution  
(3)

## JPEG Image Options

### Parameter # 299

Select an option to optimize JPEG images for either size or for quality. Scan the **JPEG Quality Selector** programming symbol to use a quality value; the scanner then selects the corresponding image size. Scan the **JPEG Size Selector** programming symbol to use a size value; the scanner then selects the best image quality.



\* JPEG Quality Selector  
(1)



JPEG Size Selector  
(0)

## JPEG Target File Size

### Parameter # 561

Type: Word

Range: 5-350

This parameter defines the target JPEG file size in terms 1 Kilobytes (1024 bytes). The default value is 160 kB which represents 160 Kilobytes.

JPEG compress may take 10 to 15 seconds based on the amount of information in the target image. Scanning **JPEG Quality Selector** (default setting) produces a compressed image that is consistent in quality and compression time.

To set the JPEG Target File Size parameter, scan **JPEG Target File Size** below followed by three numeric programming symbols representing the value. Leading zeros are required. For example, to set an image file size value of 99, scan 0, 9, 9 in [Appendix H — Numeric Keyboard](#).

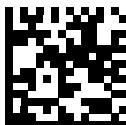

JPEG Target File Size  
(3 digits)

## **JPEG Quality and Size Value**

### ***JPEG Quality = Parameter # 305***

If you selected **JPEG Quality Selector**, scan the **JPEG Quality Value** programming symbol followed by 3 programming symbols from **Appendix H — Numeric Keyboard** corresponding to a value from 5 to 100, where 100 represents the highest quality image.



**JPEG Quality Value**  
(Default: 065)  
(5 - 100 Decimal)

## Image File Format Selector

### **Parameter # 304**

Select an image format appropriate for the system (BMP, TIF, or JPG). The scanner stores captured images in the selected format.

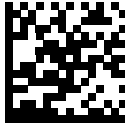

**BMP File Format**  
(3)



\* **JPEG File Format**  
(1)



**TIFF File Format**  
(4)

## **Image Rotation**

### ***Parameter # 665***

This parameter controls the rotation of the image by 0, 90, 180, or 270 degrees.



**\* Rotate 0°  
(0)**



**Rotate 90°  
(1)**



**Rotate 180°  
(2)**



**Rotate 270°  
(3)**

# **7 *USB Interface***

This section provides instructions for programming the scanner to interface with a USB host. The scanner connects directly to a USB host or a powered USB hub. The USB host powers the scanner.

## **Connecting a USB Interface**

The scanner connects to USB capable hosts including:

- TGIS (IBM) terminals
- Apple™ desktops and notebooks
- Other network computers that support more than one keyboard.

The following operating systems support the scanner through USB:

- Windows® XP, 7, 8, 10
- MacOS 8.5 - MacOS 10.6
- IBM 4690 OS.



## Connecting the HS-360X Wireless Scanner to USB Interface

The scanner also interfaces with other USB hosts which support USB Human Interface Devices (HID).

**Note:** When connecting the HS-360X and cradle to a PC, look for a USB port with a lightning bolt icon similar to the one below. This icon indicates that the port is higher-powered and is intended for charging USB devices.

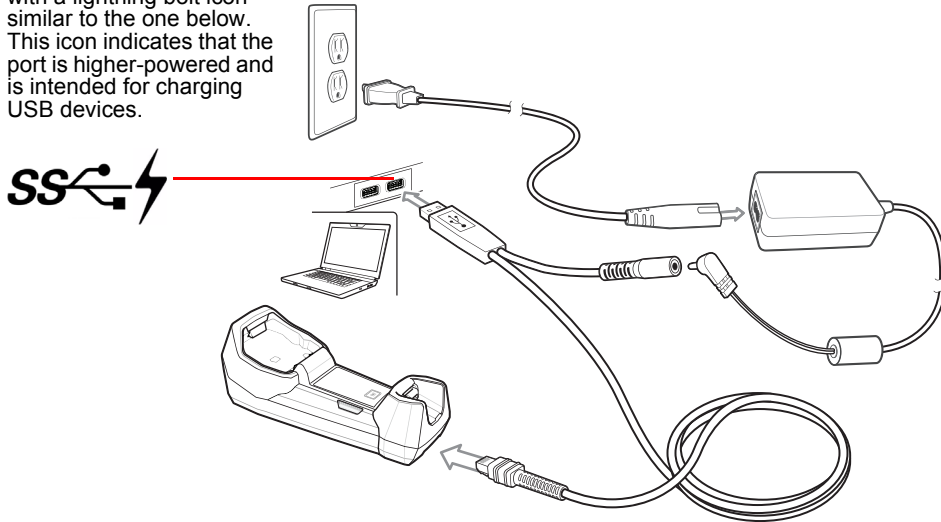

### USB Connection to HS-360X Wireless Scanner

To connect the cradle to a USB host:

1. Attach the modular connector of the USB interface cable to the cable interface port on the cradle.
2. Plug the series A connector in the USB host or hub.
3. Connect an external power supply if desired.
4. Ensure all connections are secure.
5. Pair the scanner to the cradle by scanning the symbol on the cradle.
6. Select the USB device type by scanning the appropriate programming symbol.
7. On first installation when using Windows, the software displays a prompt to select or install the **Human Interface Device** driver. To install the Human Interface Device driver provided by Windows, click **Next** through all the choices and click **Finished** on the last choice. The scanner powers up during this installation.
8. To modify any other parameter options, scan the appropriate programming symbols in this chapter.

**Note:** Interface cables vary depending on configuration.

**Note:** Disconnect the host cables before the power supply, or the scanner may not recognize the new host.

## Connecting HS-360X Wired Scanner to USB Interface

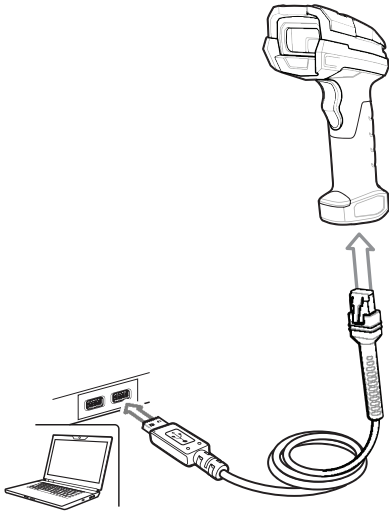

### USB Connection to HS-360X Wired Scanner

To connect the USB interface to an HS-360X Wired Scanner:

1. Attach the modular connector of the USB interface cable to the host port on the bottom of the scanner.
2. Plug the series A connector in the USB host or hub.
3. Select the USB device type by scanning the appropriate programming symbol.

**Note:** The interface cable automatically detects the host type and uses the default setting. If the default (\*) does not meet your requirements, scan another host programming symbol.

4. On first installation when using Windows, the software prompts to select or install the Human Interface Device driver. To install this driver, provided by Windows, click **Next** through all the choices and click **Finished** on the last choice. The scanner powers up during this installation.
5. To modify any other parameter options, scan the appropriate programming symbols in this chapter.

## USB Parameter Defaults

The table below lists the defaults for USB host parameters. If any option needs to be changed, scan the appropriate programming symbol(s) provided in the **Parameter Descriptions** section.

Parameter	Default
<b>USB Host Parameters</b>	
USB Device Type	HID Keyboard Emulation
Symbol Native API (SNAPI) Status Handshaking	Enable
USB Keystroke Delay	No Delay
USB CAPS Lock Override	Disable
USB Ignore Unknown Characters	Send
USB Convert Unknown to Code 39	Disable
Emulate Keypad	Enable
Emulate Keypad with Leading Zero	Enable
Quick Keypad Emulation	Enable
USB FN1 Substitution	Disable
Function Key Mapping	Disable
Simulated Caps Lock	Disable
Convert Case	No Case Conversion
USB Static CDC	Enable
Ignore Beep	Enable
Ignore Programming Symbol Configuration	Enable
USB Polling Interval	3 msec
USB Fast HID	Enable
IBM Specification Version	Version 2.2

# USB Host Parameters

## USB Device Type

Select the desired USB device type.

1. When changing USB device types, the scanner automatically restarts. The scanner issues a power-up beep sequence.
2. Before selecting **USB CDC Host**, install the Omron Microscan USB CDC Driver on the host to ensure the scanner does not stall during power up (due to a failure to enumerate USB).

To recover a stalled scanner:

- Install the CDC Driver.  
**or**
- For the HS-360X Wireless Scanner, unplug the USB cable and add power. Connect the scanner via Bluetooth and scan **HID Keyboard** or another host.
- For the HS-360X Wired Scanner, unplug the USB cable, while holding the trigger, re-plug the USB cable. After 5 seconds, the scanner temporarily comes up in HID Keyboard, scan another host.



\* **HID Keyboard Emulation**



**USB CDC Host**  
(Note 1)

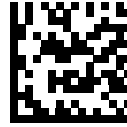

**Symbol Native API (SNAPI) without  
Imaging Interface**



**Symbol Native API (SNAPI) with Imaging  
Interface**

## **Symbol Native API (SNAPI) Status Handshaking**

After selecting a SNAPI interface as the USB device type, select whether to enable or disable status handshaking.



**\* Enable SNAPI Status Handshaking**



**Disable SNAPI Status Handshaking**

## USB Keystroke Delay

This parameter sets the delay, in milliseconds, between emulated keystrokes. Scan a programming symbol below to increase the delay when hosts require a slower transmission of data.



\* No Delay

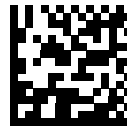

Medium Delay (20 msec)



Long Delay (40 msec)

## **USB Caps Lock Override**

This option applies only to the HID Keyboard Emulation device. When enabled, the case of the data is preserved regardless of the state of the caps lock key. This setting is always enabled for the “Japanese, Windows (ASCII)” keyboard type and can not be disabled.



**Override Caps Lock Key  
(Enable)**



**\* Do Not Override Caps Lock Key  
(Disable)**



## USB Ignore Unknown Characters

This option applies only to the HID Keyboard Emulation device and IBM device. Unknown characters are characters the host does not recognize. When **Send Barcodes With Unknown Characters** is selected, all barcode data is sent except for unknown characters, and no error beeps sound. When **Do Not Send Barcodes With Unknown Characters** is selected, barcode data is sent up to the first unknown character, then the scanner issues an error beep.



\* **Send Barcodes with Unknown Characters**



**Do Not Send Barcodes with Unknown Characters**

## **Emulate Keypad**

When enabled, all characters are sent as ASCII sequences over the numeric keypad. For example ASCII A would be sent as “ALT make” 0 6 5 “ALT Break.”

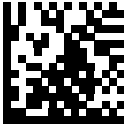

**Disable Keypad Emulation**



**\* Enable Keypad Emulation**

## Emulate Keypad with Leading Zero

Enable this to send character sequences sent over the numeric keypad as ISO characters which have a leading zero. For example ASCII A transmits as "ALT MAKE" 0 0 6 5 "ALT BREAK".



**Disable Keypad Emulation with Leading  
Zero**



**\* Enable Keypad Emulation with Leading  
Zero**

## Quick Keypad Emulation

This option applies only to the HID Keyboard Emulation Device and if Emulate Keypad is enabled. This parameter enables a quicker method of keypad emulation where ASCII sequences are only sent for ASCII characters not found on the keyboard. The default value is **Enable**.



\* **Enable Quick Keypad Emulation**



**Disable Quick Keypad Emulation**

## USB Keyboard FN 1 Substitution

This option applies only to the USB HID Keyboard Emulation device. When enabled, this allows replacement of any FN 1 characters in an EAN-128 barcode with a Key Category and value chosen by the user.



**Enable FN1 Substitution**



**\* Disable FN1 Substitution**

## Function Key Mapping

ASCII values under 32 are normally sent as a control-key sequences. When this parameter is enabled, the keys in bold are sent in place of the standard key mapping. Table entries that do not have a bold entry remain the same whether or not this parameter is enabled.



\* **Disable Function Key Mapping**



**Enable Function Key Mapping**

## Simulated Caps Lock

When enabled, the scanner inverts upper and lower case characters on the barcode as if the Caps Lock state is enabled on the keyboard. This inversion is done regardless of the current state of the keyboard's Caps Lock state.



**\* Disable Simulated Caps Lock**



**Enable Simulated Caps Lock**

## Convert Case

When enabled, the scanner converts all barcode data to the selected case.



\* No Case Conversion



Convert All to Upper Case



Convert All to Lower Case



## USB Static CDC

### **Parameter # 670**

When disabled, each device connected consumes another COM port (first device = COM1, second device = COM2, third device = COM3, etc.)

When enabled, each device connects to the same COM port.



**\* Enable USB Static CDC  
(1)**



**Disable USB Static CDC  
(0)**

## **Optional USB Parameters**

If you configure the scanner and find the settings were not saved, or changed, when the system is restarted scan the programming symbols that follow to override USB interface defaults.

Scan a programming symbol below after setting defaults and before configuring the scanner.

### ***Ignore Beep***

The host can send a beep request to the scanner. When this parameter is enabled, the request is not sent to the attached scanner. All directives are still acknowledged to the USB host as if it were processed.

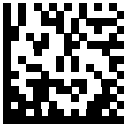

**Disable Ignore Beep**



**\* Enable Ignore Beep**

## ***Ignore Barcode Configuration***

The host has the ability to enable/disable code types. When this parameter is enabled, the request is not sent to the attached scanner. All directives are still acknowledged to the USB host as if it were processed.



**Disable Ignore Barcode Configuration**



**\* Enable Ignore Barcode Configuration**

## **USB Polling Interval**

Scan a programming symbol below to set the polling interval. The polling interval determines the rate at which data can be sent between the scanner and host computer. A lower number indicates a faster data rate.

When changing USB Device Types, the scanner automatically restarts and issues a disconnect-reconnect beep sequence.

Ensure your host machine can handle the selected data rate.

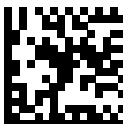

**1 msec**

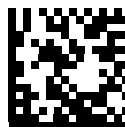

**2 msec**



**\* 3 msec**



**4 msec**



5 msec

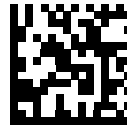

6 msec

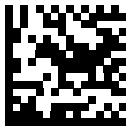

7 msec



8 msec



**9 msec**



**10 msec**

## USB Fast HID

This option transmits USB HID data at a faster rate.



**\* Enable USB Fast HID**

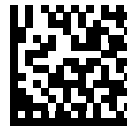

**Disable USB Fast HID**

## **ASCII Character Set for USB**

See [Appendix H — Numeric Keyboard](#) for the following:

- **ASCII Character Set;**
- **ALT Key Character Set;**
- **GUI Key Character Set;**
- **F Key Character Set.**



# **8 *RS-232 Interface***

This section describes how to set up the scanner with an RS-232 host. Use the RS-232 interface to connect the scanner to a host computer or COM port.

## **Introduction**

If your host does not appear in the **RS-232 Host Parameters table**, refer to the documentation for the host device to set communication parameters to match the host.

The scanner uses TTL RS-232 signal levels, which interface with most system architectures.

Most computer monitors allow scanning the programming symbols directly on the screen. When scanning from the screen, be sure to set the document magnification to a level where you can see the programming symbol clearly, and bars and/or spaces are not merging.

# Connecting an RS-232 Interface

## Connecting HS-360X Wireless Scanner to RS-232 Interface

Connect the scanner directly to the host computer.

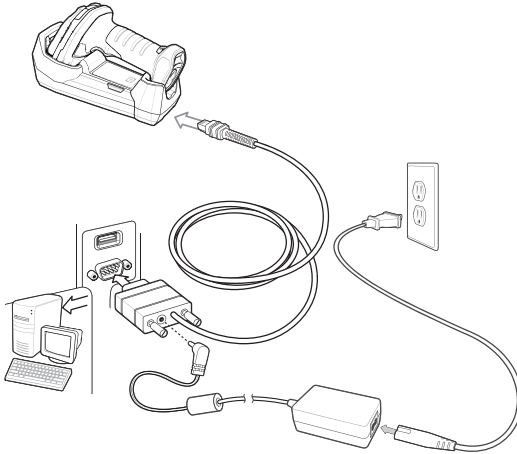

### RS-232 Direct Connection to HS-360X Wireless Scanner

Interface cables vary depending on configuration.

Disconnect the host cables before the power supply, or the scanner may not recognize the new host.

To connect the cradle with a RS-232 interface:

1. Connect the other end of the RS-232 interface cable to the serial port on the host.
2. Attach the modular connector of the RS-232 interface cable to the cable interface port on the cradle.
3. If required, connect the power supply.
4. Ensure that all connections are secure.
5. Pair the scanner to the cradle by scanning the symbol on the cradle.
6. Select the RS-232 host type by scanning the appropriate programming symbol from **RS-232 Host Types**.

The interface cable automatically detects the host interface type and uses the default setting. If the default (\*) does not meet your requirements, scan another host programming symbol.

7. To modify any other parameter options, scan the appropriate programming symbols in this chapter.

## Connecting the HS-360X Wired Scanner to an RS-232 Interface

Connect the scanner directly to the host computer.

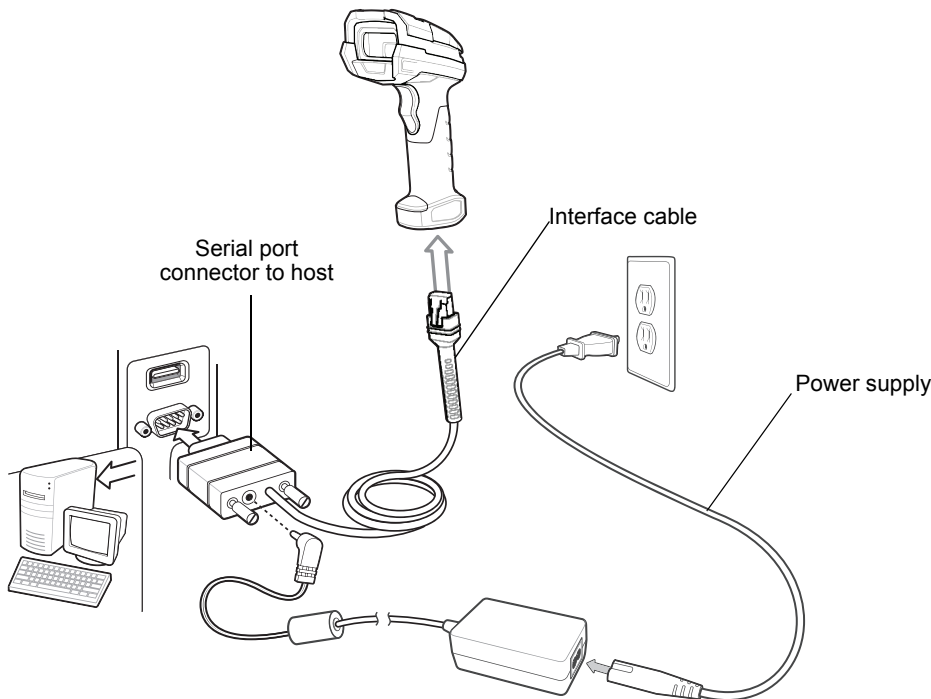

### RS-232 Direct Connection to HS-360X Wired Scanner

Interface cables vary depending on configuration.

1. Attach the modular connector of the RS-232 interface cable to the cable interface port on the scanner.
2. Connect the other end of the RS-232 interface cable to the serial port on the host.
3. Connect the power supply to the serial connector end of the RS-232 interface cable. Plug the power supply into an appropriate outlet.
4. The scanner automatically detects the host interface type and uses the default setting. If the default (\*) does not meet your requirements, select another RS-232 host type by scanning the appropriate programming symbol from **RS-232 Host Types**.
5. To modify any other parameter options, scan the appropriate programming symbols in this chapter.

## RS-232 Parameter Defaults

The table below lists the defaults for RS-232 host parameters. To change any option, scan the appropriate programming symbol(s) provided in the RS-232 Host Parameters section.

Parameter	Default
<b>RS-232 Host Parameters</b>	
RS-232 Host Types	Standard
Baud Rate	9600
Parity Type	None
Stop Bits	1 Stop Bit
Data Bits	8-Bit
Check Receive Errors	Enable
Hardware Handshaking	None
Software Handshaking	None
Host Serial Response Time-out	2 Seconds
RTS Line State	Low RTS
Beep on <BEL>	Disable
Intercharacter Delay	0 msec
Nixdorf Beep/LED Options	Normal Operation
Ignore Unknown Characters	Send Barcode

## **RS-232 Host**

To select RS-232 Host interface, scan the programming symbol below. Scanning the Standard RS-232 symbol activates the RS-232 driver, but does not change port settings (e.g., parity, data bits, handshaking). Selecting another RS-232 host type programming symbol changes these settings.



**\* Standard RS-232<sup>1</sup>**

## Baud Rate

Baud rate is the number of bits of data transmitted per second. Set the scanner's baud rate to match the baud rate setting of the host device. Otherwise, data may not reach the host device or may reach it in distorted form.

**Note:** The scanner does not support baud rates below 9600.



\* Baud Rate 9600



Baud Rate 19,200



Baud Rate 38,400



Baud Rate 57,600



Baud Rate 115,200

## Parity

A parity check bit is the most significant bit of each ASCII coded character. Select the parity type according to host device requirements.

- Select **Odd** parity to set the parity bit value to 0 or 1, based on data, to ensure that the coded character contains an odd number of 1 bits.
- Select **Even** parity to set the parity bit value is set to 0 or 1, based on data, to ensure that the coded character contains an even number of 1 bits.
- Select **None** when no parity bit is required.



**Odd**



**Even**



**\* None**



## Stop Bit Select

The stop bit(s) at the end of each transmitted character marks the end of transmission of one character and prepares the receiving device for the next character in the serial data stream. Select the number of stop bits (one or two) based on the number the receiving terminal is programmed to accommodate. Set the number of stop bits to match host device requirements.



\* 1 Stop Bit



2 Stop Bits

## **Data Bits**

This parameter allows the scanner to interface with devices requiring a 7-bit or 8-bit ASCII protocol.



**7-Bit**



**\* 8-Bit**

## Check Receive Errors

Select whether or not to check the parity, framing, and overrun of received characters. The parity value of received characters is verified against the parity parameter selected above.



\* **Check For Received Errors**



**Do Not Check For Received Errors**

## Hardware Handshaking

The data interface consists of an RS-232 port designed to operate either with or without the hardware handshaking lines, **Request to Send** (RTS), and **Clear to Send** (CTS).

Disable Standard RTS/CTS handshaking to transmit scan data as it becomes available. Select Standard RTS/CTS handshaking to transmit scan data according to the following sequence:

- The scanner reads the CTS line for activity. If CTS is asserted, the scanner waits up to Host Serial Response Time-out for the host to de-assert the CTS line. If, after Host Serial Response Time-out (default), the CTS line is still asserted, the scanner sounds a transmit error, and discards any scanned data.
- When the CTS line is de-asserted, the scanner asserts the RTS line and waits up to Host Serial Response Time-out for the host to assert CTS. When the host asserts CTS, the scanner transmits data. If, after Host Serial Response Time-out (default), the CTS line is not asserted, the scanner sounds a transmit error, and discards the data.
- When data transmission completes, the scanner de-asserts RTS 10 msec after sending the last character.
- The host should respond by negating CTS. The scanner checks for a de-asserted CTS upon the next transmission of data.

During the transmission of data, the CTS line should be asserted. If CTS is deasserted for more than 50 msec between characters, the scanner aborts transmission, sounds a transmission error, and discards the data.

If this communication sequence fails, the scanner issues an error indication. In this case, the data is lost and must be rescanned.

If hardware handshaking and software handshaking are both enabled, hardware handshaking takes precedence.

**Note:** The DTR signal is jumpered to the active state.

- **None:** Scan this programming symbol to disable hardware handshaking.
- **Standard RTS/CTS:** Scan this programming symbol to select Standard RTS/CTS Hardware Handshaking.
- **RTS/CTS Option 1:** If you select RTS/CTS Option 1, the scanner asserts RTS before transmitting and ignores the state of CTS. The scanner de-asserts RTS when the transmission completes.
- **RTS/CTS Option 2:** If you select Option 2, RTS is always high or low (user-programmed logic level). However, the scanner waits for CTS to be asserted before transmitting data. If CTS is not asserted within Host Serial Response Time-out (default), the scanner issues an error indication and discards the data.
- **RTS/CTS Option 3:** If you select Option 3, the scanner asserts RTS prior to any data transmission, regardless of the state of CTS. The scanner waits up to Host Serial Response Time-out (default) for CTS to be asserted. If CTS is not asserted during this time, the scanner issues an error indication and discards the data. The scanner de-asserts RTS when transmission is complete.



\* None



Standard RTS/CTS



RTS/CTS Option 1



RTS/CTS Option 2



RTS/CTS Option 3

## Software Handshaking

This parameter offers control of the data transmission process in addition to, or instead of, that offered by hardware handshaking. There are five options.

If software handshaking and hardware handshaking are both enabled, hardware handshaking takes precedence.

- **None:** Select this to transmit data immediately. The scanner expects no response from the host.
- **ACK/NAK:** If you select this option, after transmitting data, the scanner expects either an ACK or NAK response from the host. When it receives a NAK, the scanner transmits the same data again and waits for either an ACK or NAK. After three unsuccessful attempts to send data after receiving NAKs, the scanner issues an error indication and discards the data.

The scanner waits up to the programmable Host Serial Response Time-out to receive an ACK or NAK. If the scanner does not get a response in this time, it issues an error indication and discards the data. There are no retries when a time-out occurs.

- **ENQ:** If you select this option, the scanner waits for an ENQ character from the host before transmitting data. If it does not receive an ENQ within the Host Serial Response Time-out, the scanner issues an error indication and discards the data. The host must transmit an ENQ character at least every Host Serial Response Time-out to prevent transmission errors.
- **ACK/NAK with ENQ:** This combines the two previous options. For re-transmissions of data, due to a NAK from the host, an additional ENQ is not required.
- **XON/XOFF:** An XOFF character turns the scanner transmission off until the scanner receives an XON character. There are two situations for XON/XOFF:
  - The scanner receives an XOFF before has data to send. When the scanner has data to send, it waits up to Host Serial Response Time-out for an XON character before transmission. If it does not receive the XON within this time, the scanner issues an error indication and discards the data.
  - The scanner receives an XOFF during a transmission. Data transmission then stops after sending the current byte. When the scanner receives an XON character, it sends the rest of the data message. The scanner waits indefinitely for the XON.



\* None



ACK/NAK



ENQ



ACK/NAK with ENQ



XON/XOFF

## Host Serial Response Timeout

This parameter specifies how long the scanner waits for an ACK, NAK, or CTS before determining that a transmission error occurred. This only applies when in one of the ACK/NAK software handshaking modes, or RTS/CTS hardware handshaking mode.



\* **Minimum: 2 Seconds**



**Low: 2.5 Seconds**



**Medium: 5 Seconds**



**High: 7.5 Seconds**



**Maximum: 9.9 Seconds**



## RTS Line State

This parameter sets the idle state of the Serial Host RTS line. Scan a programming symbol below to select **Low RTS** or **High RTS** line state.



\* Host: Low RTS



Host: High RTS

## Beep on <BEL>

If you enable this parameter, the scanner issues a beep when it detects a <BEL> character on the RS-232 serial line. <BEL> indicates an illegal entry or other important event.



**Beep On <BEL> Character  
(Enable)**



**\* Do Not Beep On <BEL> Character  
(Disable)**

## Intercharacter Delay

This parameter specifies the intercharacter delay inserted between character transmissions.



\* Minimum: 0 msec



Low: 25 msec



Medium: 50 msec



High: 75 msec



Maximum: 99 msec

## Ignore Unknown Characters

Unknown characters are characters the host does not recognize. Select **Send Barcode with Unknown Characters** to send all barcode data except for unknown characters. The scanner issues no error beeps.

Select **Do Not Send Barcodes With Unknown Characters** to send barcode data up to the first unknown character. The scanner issues an error beep.



\* **Send Barcode**  
(with unknown characters)



**Do Not Send Barcodes**  
(with unknown characters)

# ASCII Character Set for RS-232

See [Appendix I — ASCII Character Sets](#) for Prefix/Suffix values.



# 9 *Symbologies*

This section describes symbology features and provides programming symbols for selecting those features.

To set feature parameters, scan a single programming symbol or a short barcode sequence. The settings are stored in non-volatile memory and are preserved even when the scanner powers down.

## Introduction

Most computer monitors allow scanning the programming symbols directly on the screen. When scanning from the screen, be sure to set the document magnification to a level where you can see the programming symbol clearly, and bars and/or spaces do not merge.

Select a host type (see each host chapter for specific host information) after the power-up beeps sound. This is only necessary upon the first power-up when connected to a new host.

## Scanning Sequence Examples

In most cases, scanning one programming symbol sets the parameter value. For example, to transmit barcode data without the UPC-A check digit, simply scan the **Do Not Transmit UPC-A Check Digit** programming symbol under **Transmit UPC-A Check Digit**. The scanner issues a fast warble beep and the LED turns green, signifying a successful parameter entry.

Other parameters, such as **Set Length(s) for D 2 of 5** require scanning several programming symbols. See the individual parameter, such as **Set Length(s) for D 2 of 5**, for this procedure.

## Errors While Scanning

Unless otherwise specified, to correct an error during a scanning sequence, just re-scan the correct parameter.



## Symbology Parameter Defaults

The table below lists the defaults for all symbology parameters. To change the default values, scan the appropriate programming symbols in this guide. These new values replace the standard default values in memory.

Parameter	Parameter Number	Default
<b>Enable/Disable All Code Types</b>		
<b>1D Symbologies</b>		
<b>UPC/EAN</b>		
UPC-A	1	Enable
UPC-E	2	Enable
UPC-E1	12	Disable
EAN-8/JAN 8	4	Enable
EAN-13/JAN 13	3	Enable
Bookland EAN	83	Disable
Decode UPC/EAN/JAN Supplementals (2 and 5 digits)	16	Ignore
User-Programmable Supplementals Supplemental 1: Supplemental 2:	579 580	000
UPC/EAN/JAN Supplemental Redundancy	80	10
Decode UPC/EAN/JAN Supplemental AIM ID	672	Combined
UPC Reduced Quiet Zone	1289	Disable
Transmit UPC-A Check Digit	40	Enable
Transmit UPC-E Check Digit	41	Enable
Transmit UPC-E1 Check Digit	42	Enable
UPC-A Preamble	34	System Character
UPC-E Preamble	35	System Character
UPC-E1 Preamble	36	System Character
Convert UPC-E to A	37	Disable
Convert UPC-E1 to A	38	Disable
EAN-8/JAN-8 Extend	39	Disable
Bookland ISBN Format	576	ISBN-10
UCC Coupon Extended Code	85	Disable
Coupon Report	730	New Coupon Format
ISSN EAN	617	Disable
<b>Code 128</b>		
Code 128	8	Enable

## Symbology Parameter Defaults

Parameter	Parameter Number	Default
Set Length(s) for Code 128	209, 210	1 to 55
GS1-128 (formerly UCC/EAN-128)	14	Enable
ISBT 128	84	Disable
ISBT Concatenation	577	Autodiscriminate
Check ISBT Table	578	Enable
ISBT Concatenation Redundancy	223	10
Code 128 Security Level	751	Security Level 1
Code 128 Reduced Quiet Zone	1208	Disable
Ignore Code 128 <FNC4>	1254	Disable
<b>Code 39</b>		
Code 39	0	Enable
Trioptic Code 39	13	Disable
Convert Code 39 to Code 32 (Italian Pharmacy Code)	86	Disable
Code 32 Prefix	231	Disable
Set Length(s) for Code 39	18, 19	1 to 55
Code 39 Check Digit Verification	48	Disable
Transmit Code 39 Check Digit	43	Disable
Code 39 Full ASCII Conversion	17	Disable
Code 39 Security Level	750	Security Level 1
Code 39 Reduced Quiet Zone	1209	Disable
<b>Code 93</b>		
Code 93	9	Enable
Set Length(s) for Code 93	26, 27	1 to 55
<b>Code 11</b>		
Code 11	10	Disable
Set Lengths for Code 11	28, 29	4 to 55
Code 11 Check Digit Verification	52	Disable
Transmit Code 11 Check Digit(s)	47	Disable
<b>Interleaved 2 of 5 (ITF)</b>		
Interleaved 2 of 5 (ITF)	6	Disable
Set Lengths for I 2 of 5	22, 23	6 to 55
I 2 of 5 Check Digit Verification	49	Disable
Transmit I 2 of 5 Check Digit	44	Disable
Convert I 2 of 5 to EAN 13	82	Disable

Parameter	Parameter Number	Default
I 2 of 5 Security Level	1121	Security Level 1
I 2 of 5 Reduced Quiet Zone	1210	Disable
<b>Discrete 2 of 5 (DTF)</b>		
Discrete 2 of 5	5	Disable
Set Length(s) for D 2 of 5	20, 21	1 to 55
<b>Codabar (NW - 7)</b>		
Codabar	7	Enable
Set Lengths for Codabar	24, 25	4 to 55
CLSI Editing	54	Disable
NOTIS Editing	55	Disable
Codabar Upper or Lower Case Start/ Stop Characters Detection	855	Upper Case
<b>MSI</b>		
MSI	11	Disable
Set Length(s) for MSI	30, 31	4 to 55
MSI Check Digits	50	One
Transmit MSI Check Digit	46	Disable
MSI Check Digit Algorithm	51	Mod 10/Mod 10
<b>Chinese 2 of 5</b>		
Chinese 2 of 5	408	Disable
<b>Matrix 2 of 5</b>		
Matrix 2 of 5	618	Disable
Matrix 2 of 5 Lengths	619 620	4 to 55
Matrix 2 of 5 Check Digit	622	Disable
Transmit Matrix 2 of 5 Check Digit	623	Disable
<b>Korean 3 of 5</b>		
Korean 3 of 5	581	Disable
<b>Inverse 1D</b>		
	586	Regular
<b>GS1 DataBar</b>		
GS1 DataBar-14	338	Enable
GS1 DataBar Limited	339	Enable
GS1 DataBar Expanded	340	Enable
Convert GS1 DataBar to UPC/EAN	397	Disable
GS1 DataBar Limited Security Level	728	Level 3

## Symbology Parameter Defaults

Parameter	Parameter Number	Default
<b>Composite</b>		
Composite CC-C	341	Disable
Composite CC-A/B	342	Disable
Composite TLC-39	371	Disable
UPC Composite Mode	344	UPC Never Linked
Composite Beep Mode	398	Beep As Each Code Type is Decoded
GS1-128 Emulation Mode for UCC/EAN Composite Codes	427	Disable
<b>2D Symbologies</b>		
PDF417	15	Enable
MicroPDF417	227	Disable
Code 128 Emulation	123	Disable
Data Matrix	292	Enable
GS1 Data Matrix	1336	Disable
Data Matrix Inverse	588	Inverse Autodetect
Maxicode	294	Disable
QR Code	293	Enable
GS1 QR	1343	Disable
MicroQR	573	Enable
Aztec	574	Enable
Aztec Inverse	589	Inverse Autodetect
Han Xin	1167	Disable
Han Xin Inverse	1168	Regular
<b>Postal Codes</b>		
US Postnet	89	Disable
US Planet	90	Disable
Transmit US Postal Check Digit	95	Enable
UK Postal	91	Disable
Transmit UK Postal Check Digit	96	Enable
Japan Postal	290	Disable
Australia Post	291	Disable
Australia Post Format	718	Autodiscriminate
Netherlands KIX Code	326	Disable
USPS 4CB/One Code/Intelligent Mail	592	Disable
UPU FICS Postal	611	Disable
Mailmark	1337	Disable

Parameter	Parameter Number	Default
<b>Symbology-Specific Security Levels</b>		
Redundancy Level	78	1
Security Level	77	1
1D Quiet Zone Level	1288	1
Intercharacter Gap Size	381	Normal
Report Version		
<b>Macro PDF</b>		
Flush Macro PDF Buffer	N/A	N/A
Abort Macro PDF Entry	N/A	N/A

## **Enable/Disable All Code Types**

To disable all symbologies, scan **Disable All Code Types** below. This is useful when enabling only a few code types.

Scan **Enable All Code Types** turn on (enable) all code types. This is useful when you want to read all codes, or when you want to disable only a few code types.



**Disable All Code Types**



**Enable All Code Types**

# UPC/EAN

## Enable/Disable UPC-A

### ***Parameter # 1***

To enable or disable UPC-A, scan the appropriate programming symbol below.



**\* Enable UPC-A  
(1)**



**Disable UPC-A  
(0)**

## Enable/Disable UPC-E

### ***Parameter # 2***

To enable or disable UPC-E, scan the appropriate programming symbol below.



**\* Enable UPC-E  
(1)**



**Disable UPC-E  
(0)**



## Enable/Disable UPC-E1

### **Parameter # 12**

UPC-E1 is disabled by default.

To enable or disable UPC-E1, scan the appropriate programming symbol below.

UPC-E1 is not a UCC (Uniform Code Council) approved symbology.

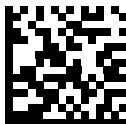

**Enable UPC-E1  
(1)**



**\* Disable UPC-E1  
(0)**

## Enable/Disable EAN-8/JAN-8

### ***Parameter # 4***

To enable or disable EAN-8/JAN-8, scan the appropriate programming symbol below.



**\* Enable EAN-8/JAN-8  
(1)**



**Disable EAN-8/JAN-8  
(0)**

## Enable/Disable EAN-13/JAN-13

### **Parameter # 3**

To enable or disable EAN-13/JAN-13, scan the appropriate programming symbol below.



**\* Enable EAN-13/JAN-13  
(1)**



**Disable EAN-13/JAN-13  
(0)**

## Enable/Disable Bookland EAN

### **Parameter # 83**

To enable or disable Bookland EAN, scan the appropriate programming symbol below.

If you enable Bookland EAN, select Bookland ISBN Format. Also select either Decode UPC/EAN Supplementals, Autodiscriminate UPC/EAN Supplementals, or Enable 978/979 Supplemental Mode in Decode UPC/EAN/JAN Supplementals.



**Enable Bookland EAN**  
**(1)**



**\* Disable Bookland EAN**  
**(0)**

## Decode UPC/EAN/JAN Supplementals

### Parameter # 16

Supplementals are appended according to specific format conventions (e.g., UPC A+2, UPC E+2, EAN 13+2). The following options are available:

- If you select **Ignore UPC/EAN with Supplementals**, and the scanner is presented with a UPC/EAN plus supplemental symbol, the scanner decodes UPC/EAN and ignores the supplemental characters.
  - If you select **Decode UPC/EAN with Supplementals**, the scanner only decodes UPC/EAN symbols with supplemental characters, and ignores symbols without supplementals.
  - If you select **Autodiscriminate UPC/EAN Supplementals**, the scanner decodes UPC/EAN symbols with supplemental characters immediately. If the symbol does not have a supplemental, the scanner must decode the barcode the number of times set via **UPC/EAN/JAN Supplemental Redundancy** before transmitting its data to confirm that there is no supplemental.
  - If you select one of the following **Supplemental Mode** options, the scanner immediately transmits EAN-13 barcodes starting with that prefix that have supplemental characters. If the symbol does not have a supplemental, the scanner must decode the barcode the number of times set via **UPC/EAN/JAN Supplemental Redundancy** before transmitting its data to confirm that there is no supplemental. The scanner transmits UPC/EAN barcodes that do not have that prefix immediately.
    - **Enable 378/379 Supplemental Mode**
    - **Enable 978/979 Supplemental Mode**
    - **Enable 977 Supplemental Mode**
    - **Enable 414/419/434/439 Supplemental Mode**
    - **Enable 491 Supplemental Mode**
    - **Enable Smart Supplemental Mode** - applies to EAN-13 barcodes starting with any prefix listed previously.
    - **Supplemental User-Programmable Type 1** applies to EAN-13 barcodes starting with a 3-digit user-defined prefix. Set this 3-digit prefix using **User-Programmable Supplementals**.
    - **Supplemental User-Programmable Type 1 and 2** applies to EAN-13 barcodes starting with either of two 3-digit user-defined prefixes. Set the 3-digit prefixes using **User-Programmable Supplementals**.
    - **Smart Supplemental Plus User-Programmable 1** applies to EAN-13 barcodes starting with any prefix listed previously or the user-defined prefix set using **User-Programmable Supplementals**.
    - **Smart Supplemental Plus User-Programmable 1 and 2** applies to EAN-13 barcodes starting with any prefix listed previously or one of the two user-defined prefixes set using **User-Programmable Supplementals**.
- Note:** To minimize the risk of invalid data transmission, select either to decode or ignore supplemental characters.



**Decode UPC/EAN/JAN Only With  
Supplementals  
(1)**



**\* Ignore Supplementals  
(0)**



**Autodiscriminate UPC/EAN/JAN  
Supplementals  
(2)**



**Enable 378/379 Supplemental Mode  
(4)**

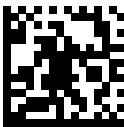

**Enable 978/979 Supplemental Mode  
(5)**



**Enable 977 Supplemental Mode  
(7)**



**Enable 414/419/434/439 Supplemental  
Mode  
(6)**



**Enable 491 Supplemental Mode  
(8)**



**Enable Smart Supplemental Mode  
(3)**

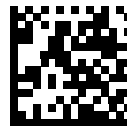

**Supplemental User-Programmable Type 1  
(9)**



**Supplemental User-Programmable Type 1  
and 2  
(10)**



**Smart Supplemental Plus User-  
Programmable 1  
(11)**



**Smart Supplemental Plus User-  
Programmable 1 and 2  
(12)**



## User-Programmable Supplementals

### **Supplemental 1: Parameter # 579**

### **Supplemental 2: Parameter # 580**

If you selected a Supplemental User-Programmable option from **Decode UPC/EAN/JAN Supplementals**, select **User-Programmable Supplemental 1** to set the 3-digit prefix. Then select the 3 digits using the numeric programming symbols. Select **User-Programmable Supplemental 2** to set a second 3-digit prefix. Then select the 3 digits using the numeric programming symbols . The default is 000 (zeroes).



**User-Programmable Supplemental 1**

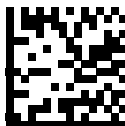

**User-Programmable Supplemental 2**

## UPC/EAN/JAN Supplemental Redundancy

### **Parameter # 80**

If you selected **Autodiscriminate UPC/EAN/JAN Supplementals**, this option adjusts the number of times to decode a symbol without supplementals before transmission. The range is from two to thirty times. Five or above is recommended when decoding a mix of UPC/EAN/JAN symbols with and without supplementals. The default is 10.

Scan the programming symbol below to set a decode redundancy value. Next, scan two numeric programming symbols in [Appendix H — Numeric Keyboard](#). Enter a leading zero for single digit numbers.



**UPC/EAN/JAN Supplemental  
Redundancy**

## UPC/EAN/JAN Supplemental AIM ID Format

### Parameter # 672

Select an output format when reporting UPC/EAN/JAN barcodes with Supplementals using **AIM Code ID Character**:

- **Separate** - transmit UPC/EAN with supplementals with separate AIM IDs but one transmission, i.e.:

]E<0 or 4><data>]E<1 or 2>[supplemental data]

- **Combined** – transmit UPC/EAN with supplementals with one AIM ID and one transmission, i.e.:

]E3<data+supplemental data>

- **Separate Transmissions** - transmit UPC/EAN with supplementals with separate AIM IDs and separate transmissions, i.e.:

]E<0 or 4><data>

]E<1 or 2>[supplemental data]

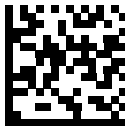

**Separate**  
(0)

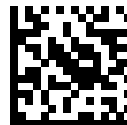

**\* Combined**  
(1)

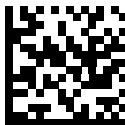

**Separate Transmissions**  
(2)

## UPC Reduced Quiet Zone

### **Parameter # 1289**

Scan one of the following programming symbols to enable or disable decoding UPC barcodes with reduced quiet zones. If you select **Enable**, select **1D Quiet Zone**.

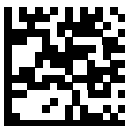

**Enable UPC Reduced Quiet Zone  
(1)**

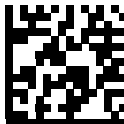

**\* Disable UPC Reduced Quiet Zone  
(0)**

## Transmit UPC-A Check Digit

### ***Parameter # 40***

The check digit is the last character of the symbol used to verify the integrity of the data. Scan the appropriate programming symbol below to transmit the barcode data with or without the UPC-A check digit. It is always verified to guarantee the integrity of the data.



**\* Transmit UPC-A Check Digit  
(1)**

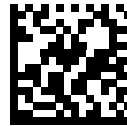

**Do Not Transmit UPC-A Check Digit  
(0)**

## Transmit UPC-E Check Digit

### ***Parameter # 41***

The check digit is the last character of the symbol used to verify the integrity of the data. Scan the appropriate programming symbol below to transmit the barcode data with or without the UPC-E check digit. It is always verified to guarantee the integrity of the data.



**\* Transmit UPC-E Check Digit  
(1)**



**Do Not Transmit UPC-E Check Digit  
(0)**

## Transmit UPC-E1 Check Digit

### **Parameter # 42**

The check digit is the last character of the symbol used to verify the integrity of the data. Scan the appropriate programming symbol below to transmit the barcode data with or without the UPC-E1 check digit. It is always verified to guarantee the integrity of the data.



**\* Transmit UPC-E1 Check Digit  
(1)**



**Do Not Transmit UPC-E1 Check Digit  
(0)**

## UPC-A Preamble

### Parameter # 34

Preamble characters are part of the UPC symbol, and include Country Code and System Character. There are three options for transmitting a UPC-A preamble to the host device: transmit System Character only, transmit System Character and Country Code ("0" for USA), and transmit no preamble. Select the appropriate option to match the host system.

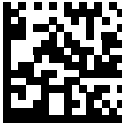

No Preamble (<DATA>  
(0)



\* System Character (<SYSTEM  
CHARACTER> <DATA>  
(1)

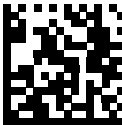

System Character & Country Code  
(< COUNTRY CODE> <SYSTEM  
CHARACTER> <DATA>  
(2)



## UPC-E Preamble

### Parameter # 35

Preamble characters are part of the UPC symbol, and include Country Code and System Character. There are three options for transmitting a UPC-E preamble to the host device: transmit System Character only, transmit System Character and Country Code ("0" for USA), and transmit no preamble. Select the appropriate option to match the host system.

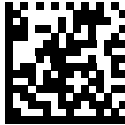

No Preamble (<DATA>  
(0)



\* System Character (<SYSTEM  
CHARACTER> <DATA>  
(1)

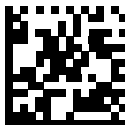

System Character & Country Code  
(< COUNTRY CODE> <SYSTEM  
CHARACTER> <DATA>  
(2)

## UPC-E1 Preamble

### Parameter # 36

Preamble characters are part of the UPC symbol, and include Country Code and System Character. There are three options for transmitting a UPC-E1 preamble to the host device: transmit System Character only, transmit System Character and Country Code ("0" for USA), and transmit no preamble. Select the appropriate option to match the host system.



No Preamble (<DATA>)  
(0)



\* System Character (<SYSTEM  
CHARACTER> <DATA>)  
(1)

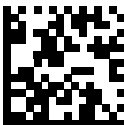

System Character & Country Code  
(< COUNTRY CODE> <SYSTEM  
CHARACTER> <DATA>)  
(2)

## Convert UPC-E to UPC-A

### **Parameter # 37**

Enable this to convert UPC-E (zero suppressed) decoded data to UPC-A format before transmission. After conversion, the data follows UPC-A format and is affected by UPC-A programming selections (e.g., Preamble, Check Digit).

Disable this to transmit UPC-E decoded data as UPC-E data, without conversion.



**Convert UPC-E to UPC-A (Enable)**  
**(1)**

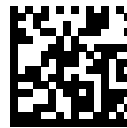

**\* Do Not Convert UPC-E to UPC-A**  
**(Disable)**  
**(0)**

## Convert UPC-E1 to UPC-A

### Parameter # 38

Enable this to convert UPC-E1 decoded data to UPC-A format before transmission. After conversion, the data follows UPC-A format and is affected by UPC-A programming selections (e.g., Preamble, Check Digit).

Disable this to transmit UPC-E1 decoded data as UPC-E1 data, without conversion.



**Convert UPC-E1 to UPC-A (Enable)**  
**(1)**



**\* Do Not Convert UPC-E1 to UPC-A**  
**(Disable)**  
**(0)**

## EAN-8/JAN-8 Extend

### **Parameter # 39**

Enable this parameter to add five leading zeros to decoded EAN-8 symbols to make them compatible in format to EAN-13 symbols. Disable this to transmit EAN-8 symbols as is.

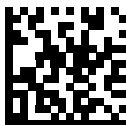

**Enable EAN/JAN Zero Extend  
(1)**



**\* Disable EAN/JAN Zero Extend  
(0)**

## Bookland ISBN Format

### Parameter # 576

If you enabled Bookland EAN using **Enable/Disable Bookland EAN**, select one of the following formats for Bookland data:

- **Bookland ISBN-10** - The scanner reports Bookland data starting with 978 in traditional 10-digit format with the special Bookland check digit for backward-compatibility. Data starting with 979 is not considered Bookland in this mode.
- **Bookland ISBN-13** - The scanner reports Bookland data (starting with either 978 or 979) as EAN-13 in 13-digit format to meet the 2007 ISBN-13 protocol.



\* Bookland ISBN-10  
(0)



Bookland ISBN-13  
(1)

For Bookland EAN to function properly, first enable Bookland EAN using **Enable/Disable Bookland EAN**, then select either Decode UPC/EAN Supplementals, Autodiscriminate UPC/EAN Supplementals, or Enable 978/979 Supplemental Mode in **Decode UPC/EAN/JAN Supplementals**.

## UCC Coupon Extended Code

### **Parameter # 85**

Enable this parameter to decode UPC-A barcodes starting with digit '5', EAN-13 barcodes starting with digit '99', and UPC-A/GS1-128 Coupon Codes. UPCA, EAN-13, and GS1-128 must be enabled to scan all types of Coupon Codes.

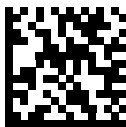

**Enable UCC Coupon Extended Code**  
(1)



**\* Disable UCC Coupon Extended Code**  
(0)

See **UPC/EAN/JAN Supplemental Redundancy** to control autodiscrimination of the GS1-128 (right half) of a coupon code.

## Coupon Report

### **Parameter # 730**

Select an option to determine which type of coupon format to support.

- Select **Old Coupon Format** to support UPC-A/GS1-128 and EAN-13/GS1-128.
- Select **New Coupon Format** as an interim format to support UPC-A/GS1-DataBar and EAN-13/GS1-DataBar.
- If you select **Autodiscriminate Format**, the scanner supports both **Old Coupon Format** and **New Coupon Format**.

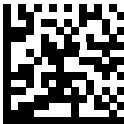

**Old Coupon Format**  
(0)



**\* New Coupon Format**  
(1)



**Autodiscriminate Coupon Format**  
(2)



## ISSN EAN

### ***Parameter # 617***

To enable or disable ISSN EAN, scan the appropriate programming symbol below.



**Enable ISSN EAN  
(1)**

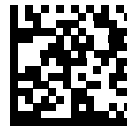

**\* Disable ISSN EAN  
(0)**

# Code 128

## Enable/Disable Code 128

### ***Parameter # 8***

To enable or disable Code 128, scan the appropriate programming symbol below.



**\* Enable Code 128  
(1)**



**Disable Code 128  
(0)**

## Set Lengths for Code 128

### **Parameter # L1 = 209, L2 = 210**

The length of a code refers to the number of characters (i.e., human readable characters), including check digit(s) the code contains. Set lengths for Code 128 to any length, one or two discrete lengths, or lengths within a specific range. The default is 1 to 55.

When setting lengths for different barcode types, enter a leading zero for single digit numbers.

- **One Discrete Length** - Select this option to decode only Code 128 symbols containing a selected length. Select the length using the numeric programming symbols in [Appendix H — Numeric Keyboard](#). For example, to decode only Code 128 symbols with 14 characters, scan **Code 128 - One Discrete Length**, then scan **1** followed by **4**.
- **Two Discrete Lengths** - Select this option to decode only Code 128 symbols containing either of two selected lengths. Select lengths using the numeric programming symbols in [Appendix H — Numeric Keyboard](#). For example, to decode only Code 128 symbols containing either 2 or 14 characters, select **Code 128 - Two Discrete Lengths**, then scan **0**, **2**, **1**, and then **4**.
- **Length Within Range** - Select this option to decode a Code 128 symbol with a specific length range. Select lengths using numeric programming symbols in [Appendix H — Numeric Keyboard](#). For example, to decode Code 128 symbols containing between 4 and 12 characters, first scan **Code 128 - Length Within Range**. Then scan **0**, **4**, **1**, and **2** (enter a leading zero for single digit numbers).
- **Any Length** - Select this option to decode Code 128 symbols containing any number of characters within the scanner's capability.

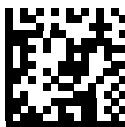

**Code 128 - One Discrete Length**



**Code 128 - Two Discrete Lengths**

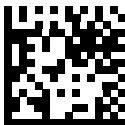

**Code 128 - Length Within Range**



**Code 128 - Any Length**

## **Enable/Disable GS1-128 (formerly UCC/EAN-128)**

### ***Parameter # 14***

To enable or disable GS1-128, scan the appropriate programming symbol below.

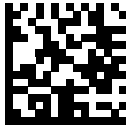

**\* Enable GS1-128  
(1)**

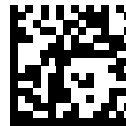

**Disable GS1-128  
(0)**

## Enable/Disable ISBT 128

### ***Parameter # 84***

ISBT 128 is a variant of Code 128 used in the blood bank industry. Scan a programming symbol below to enable or disable ISBT 128. If necessary, the host must perform concatenation of the ISBT data.



**Enable ISBT 128  
(1)**

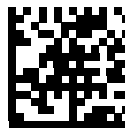

**\* Disable ISBT 128  
(0)**

## ISBT Concatenation

### **Parameter # 577**

Select an option for concatenating pairs of ISBT code types:

- If you select **Disable ISBT Concatenation**, the scanner does not concatenate pairs of ISBT codes it encounters.
- If you select **Enable ISBT Concatenation**, there must be two ISBT codes in order for the scanner to decode and perform concatenation. The scanner does not decode single ISBT symbols.
- If you select **Autodiscriminate ISBT Concatenation**, the scanner decodes and concatenates pairs of ISBT codes immediately. If only a single ISBT symbol is present, the scanner must decode the symbol the number of times set via **ISBT Concatenation Redundancy** before transmitting its data to confirm that there is no additional ISBT symbol.



**Disable ISBT Concatenation**  
(0)



**Enable ISBT Concatenation**  
(1)

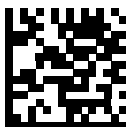

**\* Autodiscriminate ISBT Concatenation**  
(2)

## Check ISBT Table

### **Parameter # 578**

The ISBT specification includes a table that lists several types of ISBT barcodes that are commonly used in pairs. If you set **ISBT Concatenation** to **Enable**, enable **Check ISBT Table** to concatenate only those pairs found in this table. Other types of ISBT codes are not concatenated.



\* Enable Check ISBT Table  
(1)



Disable Check ISBT Table  
(0)



## **ISBT Concatenation Redundancy**

### ***Parameter # 223***

If you set **ISBT Concatenation** to **Autodiscriminate**, use this parameter to set the number of times the scanner must decode an ISBT symbol before determining that there is no additional symbol.

Scan the programming symbol below, then scan two numeric programming symbols in [Appendix H — Numeric Keyboard](#) to set a value between 2 and 20. Enter a leading zero for single digit numbers.



**ISBT Concatenation Redundancy**

## Code 128 Security Level

### Parameter # 751

Code 128 barcodes are vulnerable to misdecodes, particularly when Code 128 Lengths is set to **Any Length**. The scanner offers four levels of decode security for Code 128 barcodes. There is an inverse relationship between security and scanner aggressiveness. Increasing the level of security can reduce scanning aggressiveness, so select only the level of security necessary.

- **Code 128 Security Level 0:** This setting allows the scanner to operate in its most aggressive state, while providing sufficient security in decoding most in-spec barcodes.
- **Code 128 Security Level 1:** A barcode must be successfully read twice, and satisfy certain safety requirements before being decoded. This default setting eliminates most misdecodes.
- **Code 128 Security Level 2:** Select this option with greater barcode security requirements if **Security Level 1** fails to eliminate misdecodes.
- **Code 128 Security Level 3:** If you selected **Security Level 2**, and misdecodes still occur, select this security level to apply the highest safety requirements. A barcode must be successfully read three times before being decoded.

**Note:** Selecting this option is an extreme measure against mis-decoding severely out-of-spec barcodes. Selecting this level of security significantly impairs the decoding ability of the scanner. If this level of security is required, try to improve the quality of the barcodes.



Code 128 Security Level 0  
(0)



\* Code 128 Security Level 1  
(1)



Code 128 Security Level 2  
(2)



**Code 128 Security Level 3  
(3)**

## Code 128 Reduced Quiet Zone

### **Parameter # 1208**

Scan one of the following programming symbols to enable or disable decoding Code 128 barcodes with reduced quiet zones. If you select **Enable**, select **1D Quiet Zone Level**.



**Enable Code 128 Reduced Quiet Zone  
(1)**



**\* Disable Code 128 Reduced Quiet Zone  
(0)**

## Ignore Code 128 <FNC4>

### **Parameter # 1254**

This feature applies to Code 128 barcodes with an embedded <FNC4> character. Enable this to strip the <FNC4> character from the decode data. The remaining characters are sent to the host unchanged. When disabled, the <FNC4> character is processed normally as per Code 128 standard.



**Enable Ignore Code 128 <FNC4>**  
(1)

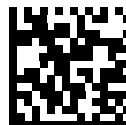

**\* Disable Ignore Code 128 <FNC4>**  
(0)

# Code 39

## ***Enable/Disable Code 39***

### ***Parameter # 0***

To enable or disable Code 39, scan the appropriate programming symbol below.



**\* Enable Code 39  
(1)**



**Disable Code 39  
(0)**

## Enable/Disable Trioptic Code 39

### **Parameter # 13**

Trioptic Code 39 is a variant of Code 39 used in the marking of computer tape cartridges. Trioptic Code 39 symbols always contain six characters. To enable or disable Trioptic Code 39, scan the appropriate programming symbol below.

**Note:** You cannot enable Trioptic Code 39 and Code 39 Full ASCII simultaneously.



**Enable Trioptic Code 39  
(1)**

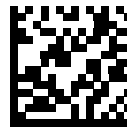

**\* Disable Trioptic Code 39  
(0)**

## Convert Code 39 to Code 32

### ***Parameter # 86***

Code 32 is a variant of Code 39 used by the Italian pharmaceutical industry. Scan the appropriate programming symbol below to enable or disable converting Code 39 to Code 32. Code 39 must be enabled for this parameter to function.

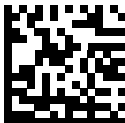

**Enable Convert Code 39 to Code 32**  
**(1)**

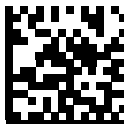

**\* Disable Convert Code 39 to Code 32**  
**(0)**



## Code 32 Prefix

### ***Parameter # 231***

Scan the appropriate programming symbol below to enable or disable adding the prefix character “A” to all Code 32 barcodes.

Convert Code 39 to Code 32 must be enabled for this parameter to function.

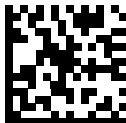

**Enable Code 32 Prefix  
(1)**

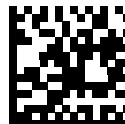

**\* Disable Code 32 Prefix  
(0)**

## Set Lengths for Code 39

### Parameter # L1 = 18, L2 = 19

The length of a code refers to the number of characters (i.e., human readable characters), including check digit(s) the code contains. Set lengths for Code 39 to any length, one or two discrete lengths, or lengths within a specific range. If Code 39 Full ASCII is enabled, **Length Within a Range** or **Any Length** are the preferred options. The default is 1 to 55.

When setting lengths for different barcode types, enter a leading zero for single digit numbers.

- **One Discrete Length** - Select this option to decode only Code 39 symbols containing a selected length. Select the length using the numeric programming symbols in [Appendix H — Numeric Keyboard](#). For example, to decode only Code 39 symbols with 14 characters, scan **Code 39 - One Discrete Length**, then scan **1** followed by **4**.
- **Two Discrete Lengths** - Select this option to decode only Code 39 symbols containing either of two selected lengths. Select lengths using the numeric programming symbols in [Appendix H — Numeric Keyboard](#). For example, to decode only Code 39 symbols containing either 2 or 14 characters, select **Code 39 - Two Discrete Lengths**, then scan **0**, **2**, **1**, and then **4**.
- **Length Within Range** - Select this option to decode a Code 39 symbol with a specific length range. Select lengths using numeric programming symbols in [Appendix H — Numeric Keyboard](#). For example, to decode Code 39 symbols containing between 4 and 12 characters, first scan **Code 39 - Length Within Range**. Then scan **0**, **4**, **1**, and **2** (enter a leading zero for single digit numbers).
- **Any Length** - Select this option to decode Code 39 symbols containing any number of characters within the scanner's capability.



Code 39 - One Discrete Length



Code 39 - Two Discrete Lengths



Code 39 - Length Within Range

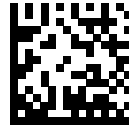

**Code 39 - Any Length**

## Code 39 Check Digit Verification

### **Parameter # 48**

Enable this feature to check the integrity of all Code 39 symbols to verify that the data complies with specified check digit algorithm. Only Code 39 symbols which include a Modulo 43 check digit are decoded. Enable this feature if the Code 39 symbols contain a Modulo 43 check digit.



**Enable Code 39 Check Digit  
(1)**



**\* Disable Code 39 Check Digit  
(0)**

## Transmit Code 39 Check Digit

### **Parameter # 43**

Scan a programming symbol below to transmit Code 39 data with or without the check digit. Code 39 Check Digit Verification must be enabled for this parameter to function.

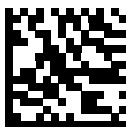

**Transmit Code 39 Check Digit (Enable)**  
(1)

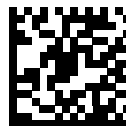

**\* Do Not Transmit Code 39 Check Digit (Disable)**  
(0)

## Code 39 Full ASCII Conversion

### **Parameter # 17**

Code 39 Full ASCII is a variant of Code 39 which pairs characters to encode the full ASCII character set. To enable or disable Code 39 Full ASCII, scan the appropriate programming symbol below.

You cannot enable Trioptic Code 39 and Code 39 Full ASCII simultaneously.

Code 39 Full ASCII to Full ASCII Correlation is host-dependent, and is therefore described in the ASCII Character Set Table for the appropriate interface.



**Enable Code 39 Full ASCII  
(1)**



**\* Disable Code 39 Full ASCII  
(0)**

## Code 39 Security Level

### Parameter # 750

The scanner offers four levels of decode security for Code 39 barcodes. There is an inverse relationship between security and scanner aggressiveness. Increasing the level of security can reduce scanning aggressiveness, so select only the level of security necessary.

- **Code 39 Security Level 0:** This setting allows the scanner to operate in its most aggressive state, while providing sufficient security in decoding most in-spec barcodes.
- **Code 39 Security Level 1:** This default setting eliminates most misdecodes.
- **Code 39 Security Level 2:** Select this option with greater barcode security requirements if **Security Level 1** fails to eliminate misdecodes.
- **Code 39 Security Level 3:** If you selected **Security Level 2**, and misdecodes still occur, select this security level to apply the highest safety requirements.

Selecting this option is an extreme measure against mis-decoding severely out-of-spec barcodes. Selecting this level of security significantly impairs the decoding ability of the scanner. If this level of security is required, try to improve the quality of the barcodes.

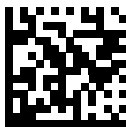

**Code 39 Security Level 0**  
(0)

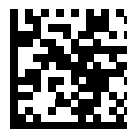

\* **Code 39 Security Level 1**  
(1)



**Code 39 Security Level 2**  
(2)



**Code 39 Security Level 3  
(3)**



## Code 39 Reduced Quiet Zone

### **Parameter # 1209**

Scan one of the following programming symbols to enable or disable decoding Code 39 barcodes with reduced quiet zones. If you select **Enable**, select **1D Quiet Zone Level**.



**Enable Code 39 Reduced Quiet Zone  
(1)**



**\* Disable Code 39 Reduced Quiet Zone  
(0)**

# Code 93

## Enable/Disable Code 93

### ***Parameter # 9***

To enable or disable Code 93, scan the appropriate programming symbol below.



**\* Enable Code 93  
(1)**



**Disable Code 93  
(0)**

## Set Lengths for Code 93

### **Parameter # L1 = 26, L2 = 27**

The length of a code refers to the number of characters (i.e., human readable characters), including check digit(s) the code contains. Set lengths for Code 93 to any length, one or two discrete lengths, or lengths within a specific range. The default is 1 to 55.

- **One Discrete Length** - Select this option to decode only Code 93 symbols containing a selected length. Select the length using the numeric programming symbols in [Appendix H — Numeric Keyboard](#). For example, to decode only Code 93 symbols with 14 characters, scan **Code 93 - One Discrete Length**, then scan **1** followed by **4**.
- **Two Discrete Lengths** - Select this option to decode only Code 93 symbols containing either of two selected lengths. Select lengths using the numeric programming symbols in [Appendix H — Numeric Keyboard](#). For example, to decode only Code 93 symbols containing either 2 or 14 characters, select **Code 93 - Two Discrete Lengths**, then scan **0, 2, 1**, and then **4**.
- **Length Within Range** - Select this option to decode a Code 93 symbol with a specific length range. Select lengths using the numeric programming symbols in [Appendix H — Numeric Keyboard](#). For example, to decode Code 93 symbols containing between 4 and 12 characters, first scan **Code 93 - Length Within Range**. Then scan **0, 4, 1**, and **2** (enter a leading zero for single digit numbers).
- **Any Length** - Scan this option to decode Code 93 symbols containing any number of characters within the scanner's capability.



**Code 93 - One Discrete Length**



**Code 93 - Two Discrete Lengths**

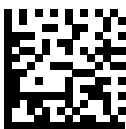

**Code 93 - Length Within Range**



**Code 93 - Any Length**

# Code 11

## Code 11

### ***Parameter # 10***

To enable or disable Code 11, scan the appropriate programming symbol below.

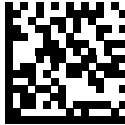

**Enable Code 11  
(1)**



**\* Disable Code 11  
(0)**

## Set Lengths for Code 11

### Parameter # L1 = 28, L2 = 29

The length of a code refers to the number of characters (i.e., human readable characters), including check digit(s) the code contains. Set lengths for Code 11 to any length, one or two discrete lengths, or lengths within a specific range. The default is 4 to 55.

- **One Discrete Length** - Select this option to decode only Code 11 symbols containing a selected length. Select the length using the numeric programming symbols in [Appendix H — Numeric Keyboard](#). For example, to decode only Code 11 symbols with 14 characters, scan **Code 11 - One Discrete Length**, then scan **1** followed by **4**.
- **Two Discrete Lengths** - Select this option to decode only Code 11 symbols containing either of two selected lengths. Select lengths using the numeric programming symbols in [Appendix H — Numeric Keyboard](#). For example, to decode only Code 11 symbols containing either 2 or 14 characters, select **Code 11 - Two Discrete Lengths**, then scan **0**, **2**, **1**, and then **4**.
- **Length Within Range** - Select this option to decode a Code 11 symbol with a specific length range. Select lengths using numeric programming symbols in [Appendix H — Numeric Keyboard](#). For example, to decode Code 11 symbols containing between 4 and 12 characters, first scan **Code 11 - Length Within Range**. Then scan **0**, **4**, **1**, and **2** (enter a leading zero for single digit numbers).
- **Any Length** - Scan this option to decode Code 11 symbols containing any number of characters within the scanner's capability.



Code 11 - One Discrete Length



Code 11 - Two Discrete Lengths

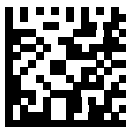

**Code 11 - Length Within Range**



**Code 11 - Any Length**

## Code 11 Check Digit Verification

### Parameter # 52

This feature allows the scanner to check the integrity of all Code 11 symbols to verify that the data complies with the specified check digit algorithm. This selects the check digit mechanism for the decoded Code 11 barcode. The options are to check for one check digit, check for two check digits, or disable the feature.

To enable this feature, scan the programming symbol below corresponding to the number of check digits encoded in the Code 11 symbols.



\* Disable  
(0)



One Check Digit  
(1)



Two Check Digits  
(2)



## Transmit Code 11 Check Digits

### **Parameter # 47**

This feature selects whether or not to transmit the Code 11 check digit(s).

**Note:** Code 11 Check Digit Verification must be enabled for this parameter to function.



**Transmit Code 11 Check Digit(s) (Enable)**  
(1)



**\* Do Not Transmit Code 11 Check Digit(s)**  
**(Disable)**  
(0)

# Interleaved 2 of 5 (ITF)

## Enable/Disable Interleaved 2 of 5

### ***Parameter # 6***

To enable or disable Interleaved 2 of 5, scan the appropriate programming symbol below, and select an Interleaved 2 of 5 length from the following pages.

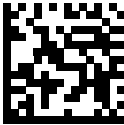

**Enable Interleaved 2 of 5  
(1)**



**\* Disable Interleaved 2 of 5  
(0)**

## Set Lengths for Interleaved 2 of 5

### Parameter # L1 = 22, L2 = 23

The length of a code refers to the number of characters (i.e., human readable characters), including check digit(s) the code contains. Set lengths for I 2 of 5 to any length, one or two discrete lengths, or lengths within a specific range. The range for Interleaved 2 of 5 lengths is 0 - 55. The default is 6 to 55.

- **One Discrete Length** - Select this option to decode only I 2 of 5 symbols containing a selected length. Select the length using the numeric programming symbols in [Appendix H — Numeric Keyboard](#). For example, to decode only I 2 of 5 symbols with 14 characters, scan **I 2 of 5 - One Discrete Length**, then scan **1** followed by **4**.
- **Two Discrete Lengths** - Select this option to decode only I 2 of 5 symbols containing either of two selected lengths. Select lengths using the numeric programming symbols in [Appendix H — Numeric Keyboard](#). For example, to decode only I 2 of 5 symbols containing either 2 or 14 characters, select **I 2 of 5 - Two Discrete Lengths**, then scan **0, 2, 1**, and then **4**.
- **Length Within Range** - Select this option to decode an I 2 of 5 symbol with a specific length range. Select lengths using numeric programming symbols in [Appendix H — Numeric Keyboard](#). For example, to decode I 2 of 5 symbols containing between 4 and 12 characters, first scan **I 2 of 5 - Length Within Range**. Then scan **0, 4, 1, and 2** (enter a leading zero for single digit numbers).
- **Any Length** - Scan this option to decode I 2 of 5 symbols containing any number of characters within the scanner's capability.

**Note:** Due to the construction of the I 2 of 5 symbology, it is possible for a scan covering only a portion of the code to transmit as a complete scan, yielding less data than is encoded in the barcode. To prevent this, select specific lengths (I 2 of 5 - One Discrete Length, Two Discrete Lengths) for I 2 of 5 applications.

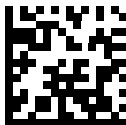

I 2 of 5 - One Discrete Length



I 2 of 5 - Two Discrete Lengths



**I 2 of 5 - Length Within Range**



**I 2 of 5 - Any Length**

## I 2 of 5 Check Digit Verification

### **Parameter # 49**

Enable this feature to check the integrity of all I 2 of 5 symbols to verify the data complies with either the specified Uniform Symbology Specification (USS), or the Optical Product Code Council (OPCC) check digit algorithm.



**\* Disable  
(0)**

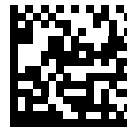

**USS Check Digit  
(1)**



**OPCC Check Digit  
(2)**

## **Transmit I 2 of 5 Check Digit**

### ***Parameter # 44***

Scan the appropriate programming symbol below to transmit I 2 of 5 data with or without the check digit.

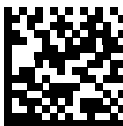

**Transmit I 2 of 5 Check Digit (Enable)**  
**(1)**



**\* Do Not Transmit I 2 of 5 Check Digit**  
**(Disable)**  
**(0)**

## Convert I 2 of 5 to EAN-13

### **Parameter # 82**

Enable this parameter to convert 14-character I 2 of 5 codes to EAN-13, and transmit to the host as EAN-13. To accomplish this, the I 2 of 5 code must be enabled, and the code must have a leading zero and a valid EAN-13 check digit.



**Convert I 2 of 5 to EAN-13 (Enable)**  
(1)



**\* Do Not Convert I 2 of 5 to EAN-13**  
**(Disable)**  
(0)

## I 2 of 5 Security Level

### Parameter # 1121

Interleaved 2 of 5 barcodes are vulnerable to misdecodes, particularly when I 2 of 5 Lengths is set to **Any Length**. The scanner offers four levels of decode security for Interleaved 2 of 5 barcodes. There is an inverse relationship between security and scanner aggressiveness. Increasing the level of security can reduce scanning aggressiveness, so select only the level of security necessary.

- **I 2 of 5 Security Level 0:** This setting allows the scanner to operate in its most aggressive state, while providing sufficient security in decoding most in-spec barcodes.
- **I 2 of 5 Security Level 1:** A barcode must be successfully read twice, and satisfy certain safety requirements before being decoded. This default setting eliminates most misdecodes.
- **I 2 of 5 Security Level 2:** Select this option with greater barcode security requirements if **Security Level 1** fails to eliminate misdecodes.
- **I 2 of 5 Security Level 3:** If you selected **Security Level 2**, and misdecodes still occur, select this security level. The highest safety requirements are applied. A barcode must be successfully read three times before being decoded.

**Note:** Selecting this option is an extreme measure against mis-decoding severely out-of-spec barcodes. Selecting this level of security significantly impairs the decoding ability of the scanner. If this level of security is required, try to improve the quality of the barcodes.



I 2 of 5 Security Level 0  
(0)



\* I 2 of 5 Security Level 1  
(1)



I 2 of 5 Security Level 2  
(2)





**1 2 of 5 Security Level 3  
(3)**

## **I 2 of 5 Reduced Quiet Zone**

### ***Parameter # 1210***

Scan one of the following programming symbols to enable or disable decoding I 2 of 5 barcodes with reduced quiet zones. If you select **Enable**, select **1D Quiet Zone Level**.



**Enable I 2 of 5 Reduced Quiet Zone  
(1)**



**\* Disable I 2 of 5 Reduced Quiet Zone  
(0)**

# Discrete 2 of 5 (DTF)

## Enable/Disable Discrete 2 of 5

### ***Parameter # 5***

To enable or disable Discrete 2 of 5, scan the appropriate programming symbol below.

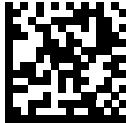

**Enable Discrete 2 of 5  
(1)**



**\* Disable Discrete 2 of 5  
(0)**

## Set Lengths for Discrete 2 of 5

### Parameter # L1 = 20, L2 = 21

The length of a code refers to the number of characters (i.e., human readable characters), including check digit(s) the code contains. Set lengths for D 2 of 5 to any length, one or two discrete lengths, or lengths within a specific range. The range for Discrete 2 of 5 lengths is 1 - 55.

- **One Discrete Length** - Select this option to decode only D 2 of 5 symbols containing a selected length. Select the length using the numeric programming symbols in [Appendix H — Numeric Keyboard](#). For example, to decode only D 2 of 5 symbols with 14 characters, scan **D 2 of 5 - One Discrete Length**, then scan **1** followed by **4**.
- **Two Discrete Lengths** - Select this option to decode only D 2 of 5 symbols containing either of two selected lengths. Select lengths using the numeric programming symbols in [Appendix H — Numeric Keyboard](#). For example, to decode only D 2 of 5 symbols containing either 2 or 14 characters, select **D 2 of 5 - Two Discrete Lengths**, then scan **0**, **2**, **1**, and then **4**.
- **Length Within Range** - Select this option to decode a D 2 of 5 symbol with a specific length range. Select lengths using numeric programming symbols in [Appendix H — Numeric Keyboard](#). For example, to decode D 2 of 5 symbols containing between 4 and 12 characters, first scan **D 2 of 5 - Length Within Range**. Then scan **0**, **4**, **1**, and **2** (enter a leading zero for single digit numbers).
- **Any Length** - Scan this option to decode D 2 of 5 symbols containing any number of characters within the scanner's capability.

**Note:** Due to the construction of the D 2 of 5 symbology, it is possible for a scan covering only a portion of the code to transmit as a complete scan, yielding less data than is encoded in the barcode. To prevent this, select specific lengths (**D 2 of 5 - One Discrete Length**, **Two Discrete Lengths**) for D 2 of 5 applications.

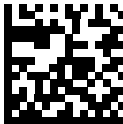

D 2 of 5 - One Discrete Length



D 2 of 5 - Two Discrete Lengths

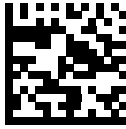

**D 2 of 5 - Length Within Range**

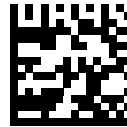

**D 2 of 5 - Any Length**

# Codabar (NW - 7)

## Enable/Disable Codabar

### ***Parameter # 7***

To enable or disable Codabar, scan the appropriate programming symbol below.



**\* Enable Codabar  
(1)**



**Disable Codabar  
(0)**

## Set Lengths for Codabar

### **Parameter # L1 = 24, L2 = 25**

The length of a code refers to the number of characters (i.e., human readable characters), including check digit(s) the code contains. Set lengths for Codabar to any length, one or two discrete lengths, or lengths within a specific range. The default is 4 to 55.

- **One Discrete Length** - Select this option to decode only Codabar symbols containing a selected length. Select the length using the numeric programming symbols in [Appendix H — Numeric Keyboard](#). For example, to decode only Codabar symbols with 14 characters, scan **Codabar - One Discrete Length**, then scan **1** followed by **4**.
- **Two Discrete Lengths** - Select this option to decode only Codabar symbols containing either of two selected lengths. Select lengths using the numeric programming symbols in [Appendix H — Numeric Keyboard](#). For example, to decode only Codabar symbols containing either 2 or 14 characters, select **Codabar - Two Discrete Lengths**, then scan **0, 2, 1**, and then **4**.
- **Length Within Range** - Select this option to decode a Codabar symbol with a specific length range. Select lengths using numeric programming symbols in [Appendix H — Numeric Keyboard](#). For example, to decode Codabar symbols containing between 4 and 12 characters, first scan **Codabar - Length Within Range**. Then scan **0, 4, 1**, and **2** (enter a leading zero for single digit numbers).
- **Any Length** - Scan this option to decode Codabar symbols containing any number of characters within the scanner's capability.



**Codabar - One Discrete Length**



**Codabar - Two Discrete Lengths**

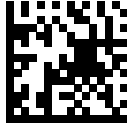

**Codabar - Length Within Range**

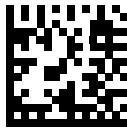

**Codabar - Any Length**



## CLSI Editing

### **Parameter # 54**

Enable this parameter to strip the start and stop characters and insert a space after the first, fifth, and tenth characters of a 14-character Codabar symbol. Enable this feature if the host system requires this data format.

**Note:** Symbol length does not include start and stop characters.

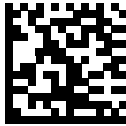

**Enable CLSI Editing  
(1)**

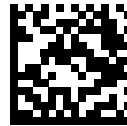

**\* Disable CLSI Editing  
(0)**

## NOTIS Editing

### ***Parameter # 55***

Enable this parameter to strip the start and stop characters from a decoded Codabar symbol. Enable this feature if the host system requires this data format.



**Enable NOTIS Editing**  
**(1)**



**\* Disable NOTIS Editing**  
**(0)**

## Codabar Upper or Lower Case Start/Stop Characters Detection

### ***Parameter # 855***

Select whether to detect upper case or lower case Codabar start/stop characters.



**Lower Case  
(1)**



**\* Upper Case  
(0)**

# MSI

## Enable/Disable MSI

### ***Parameter # 11***

To enable or disable MSI, scan the appropriate programming symbol below.



**Enable MSI  
(1)**



**\* Disable MSI  
(0)**

## Set Lengths for MSI

### **Parameter # L1 = 30, L2 = 31**

The length of a code refers to the number of characters (i.e., human readable characters), including check digit(s) the code contains. Set lengths for MSI to any length, one or two discrete lengths, or lengths within a specific range. The default is 4 to 55.

- **One Discrete Length** - Select this option to decode only MSI symbols containing a selected length. Select the length using the numeric programming symbols in [Appendix H — Numeric Keyboard](#). For example, to decode only MSI symbols with 14 characters, scan **MSI - One Discrete Length**, then scan **1** followed by **4**.
- **Two Discrete Lengths** - Select this option to decode only MSI symbols containing either of two selected lengths. Select lengths using the numeric programming symbols in [Appendix H — Numeric Keyboard](#). For example, to decode only MSI symbols containing either 2 or 14 characters, select **MSI - Two Discrete Lengths**, then scan **0**, **2**, **1**, and then **4**.
- **Length Within Range** - Select this option to decode a MSI symbol with a specific length range. Select lengths using numeric programming symbols in [Appendix H — Numeric Keyboard](#). For example, to decode MSI symbols containing between 4 and 12 characters, first scan **MSI - Length Within Range**. Then scan **0**, **4**, **1**, and **2** (enter a leading zero for single digit numbers).
- **Any Length** - Scan this option to decode MSI symbols containing any number of characters within the scanner's capability.
- Due to the construction of the MSI symbology, it is possible for a scan covering only a portion of the code to transmit as a complete scan, yielding less data than is encoded in the programming symbol. To prevent this, select specific lengths (**MSI - One Discrete Length**, **Two Discrete Lengths**) for MSI applications.



**MSI - One Discrete Length**



**MSI - Two Discrete Lengths**



**MSI - Length Within Range**



**MSI - Any Length**

## MSI Check Digits

### **Parameter # 50**

With MSI symbols, one check digit is mandatory and always verified by the reader. The second check digit is optional. If the MSI codes include two check digits, scan the **Two MSI Check Digits** programming symbol to enable verification of the second check digit.



\* One MSI Check Digit  
(0)

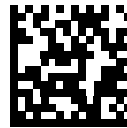

Two MSI Check Digits  
(1)

## Transmit MSI Check Digit(s)

### **Parameter # 46**

Scan a programming symbol below to transmit MSI data with or without the check digit.

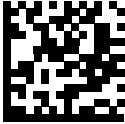

**Transmit MSI Check Digit(s) (Enable)**  
**(1)**



**\* Do Not Transmit MSI Check Digit(s)**  
**(Disable)**  
**(0)**



## MSI Check Digit Algorithm

### ***Parameter # 51***

Two algorithms are possible for the verification of the second MSI check digit. Select the programming symbol below corresponding to the algorithm used to encode the check digit.



**MOD 10/MOD 11  
(0)**



**\* MOD 10/MOD 10  
(1)**

## Chinese 2 of 5

### Enable/Disable Chinese 2 of 5

#### ***Parameter # 408***

To enable or disable Chinese 2 of 5, scan the appropriate programming symbol below.



**Enable Chinese 2 of 5  
(1)**



**\* Disable Chinese 2 of 5  
(0)**

# Matrix 2 of 5

## Enable/Disable Matrix 2 of 5

### *Parameter # 618*

To enable or disable Matrix 2 of 5, scan the appropriate programming symbol below.



**Enable Matrix 2 of 5  
(1)**



**\* Disable Matrix 2 of 5  
(0)**

## Set Lengths for Matrix 2 of 5

### Parameter # L1 = 619, L2 = 620

The length of a code refers to the number of characters (i.e., human readable characters), including check digit(s) the code contains. Set lengths for Matrix 2 of 5 to any length, one or two discrete lengths, or lengths within a specific range. The default is **4 to 55**.

- **One Discrete Length** - Select this option to decode only Matrix 2 of 5 symbols containing a selected length. Select the length using the numeric programming symbols in [Appendix H — Numeric Keyboard](#). For example, to decode only Matrix 2 of 5 symbols with 14 characters, scan **Matrix 2 of 5 - One Discrete Length**, then scan **1** followed by **4**.
- **Two Discrete Lengths** - Select this option to decode only Matrix 2 of 5 symbols containing either of two selected lengths. Select lengths using the numeric programming symbols in [Appendix H — Numeric Keyboard](#). For example, to decode only Matrix 2 of 5 symbols containing either 2 or 14 characters, select **Matrix 2 of 5 - Two Discrete Lengths**, then scan **0**, **2**, **1**, and then **4**.
- **Length Within Range** - Select this option to decode a Matrix 2 of 5 symbol with a specific length range. Select lengths using the numeric programming symbols in [Appendix H — Numeric Keyboard](#). For example, to decode Matrix 2 of 5 symbols containing between 4 and 12 characters, first scan **Matrix 2 of 5 - Length Within Range**. Then scan **0**, **4**, **1**, and **2** (enter a leading zero for single digit numbers).
- **Any Length** - Scan this option to decode Matrix 2 of 5 symbols containing any number of characters within the scanner's capability.

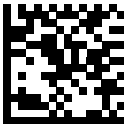

Matrix 2 of 5 - One Discrete Length



Matrix 2 of 5 - Two Discrete Lengths

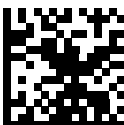

Matrix 2 of 5 - Length Within Range

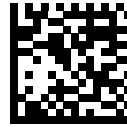

**Matrix 2 of 5 - Any Length**

## Matrix 2 of 5 Check Digit

### ***Parameter # 622***

The check digit is the last character of the symbol used to verify the integrity of the data. Scan the appropriate programming symbol below to transmit the barcode data with or without the Matrix 2 of 5 check digit.



**Enable Matrix 2 of 5 Check Digit  
(1)**

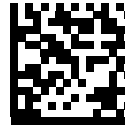

**\* Disable Matrix 2 of 5 Check Digit  
(0)**

## **Transmit Matrix 2 of 5 Check Digit**

### ***Parameter # 623***

Scan a programming symbol below to transmit Matrix 2 of 5 data with or without the check digit.



**Transmit Matrix 2 of 5 Check Digit  
(1)**

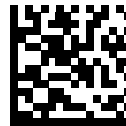

**\* Do Not Transmit Matrix 2 of 5 Check  
Digit  
(0)**

# Korean 3 of 5

## Enable/Disable Korean 3 of 5

### **Parameter # 581**

To enable or disable Korean 3 of 5, scan the appropriate programming symbol below.

**Note:** The length for Korean 3 of 5 is fixed at 6.



**Enable Korean 3 of 5  
(1)**



**\* Disable Korean 3 of 5  
(0)**



# Inverse 1D

## **Parameter # 586**

This parameter sets the 1D inverse decoder setting. Options are:

- **Regular Only** - the scanner decodes regular 1D barcodes only.
- **Inverse Only** - the scanner decodes inverse 1D barcodes only.
- **Inverse Autodetect** - the scanner decodes both regular and inverse 1D barcodes.

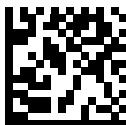

\* Regular  
(0)



Inverse Only  
(1)



Inverse Autodetect  
(2)

## GS1 DataBar

The variants of GS1 DataBar are DataBar-14, DataBar Expanded, and DataBar Limited. The limited and expanded versions have stacked variants. Scan the appropriate programming symbols to enable or disable each variant of GS1 DataBar.

### GS1 DataBar-14

#### *Parameter # 338*



**\* Enable GS1 DataBar-14  
(1)**



**Disable GS1 DataBar-14  
(0)**

## GS1 DataBar Limited

### Parameter # 339



\* Enable GS1 DataBar Limited  
(1)



Disable GS1 DataBar Limited  
(0)

## GS1 DataBar Expanded

### Parameter # 340



\* Enable GS1 DataBar Expanded  
(1)

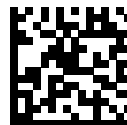

Disable GS1 DataBar Expanded  
(0)

## Convert GS1 DataBar to UPC/EAN

### Parameter # 397

This parameter only applies to GS1 DataBar-14 and GS1 DataBar Limited symbols not decoded as part of a Composite symbol. Enable this to strip the leading '010' from DataBar-14 and DataBar Limited symbols encoding a single zero as the first digit, and report the barcode as EAN-13.

For barcodes beginning with two or more zeros but not six zeros, this parameter strips the leading '0100' and reports the barcode as UPC-A. The UPC-A Preamble parameter that transmits the system character and country code applies to converted barcodes. Note that neither the system character nor the check digit can be stripped.



**Enable Convert GS1 DataBar to UPC/EAN**

**(1)**



**\* Disable Convert GS1 DataBar to UPC/EAN**

**(0)**

## GS1 DataBar Limited Security Level

### Parameter # 728

The scanner offers four levels of decode security for GS1 DataBar Limited barcodes. There is an inverse relationship between security and scanner aggressiveness. Increasing the level of security may result in reduced aggressiveness in scanning, so choose only that level of security necessary.

- Level 1 – No clear margin required. This complies with the original GS1 standard, yet might result in erroneous decoding of the DataBar Limited barcode when scanning some UPC symbols that start with digits “9” and “7”
- Level 2 – Automatic risk detection. This level of security may result in erroneous decoding of DataBar Limited barcodes when scanning some UPC symbols. The scanner defaults to Level 3, otherwise to Level 1.
- Level 3 – Security level reflects newly proposed GS1 standard that requires a 5 times trailing clear margin.
- Level 4 – Security level extends beyond the standard required by GS1. This level of security requires a 5 times leading and trailing clear margin.

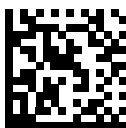

**GS1 DataBar Limited Security Level 1**

(1)

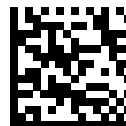

**GS1 DataBar Limited Security Level 2**

(2)



**\* GS1 DataBar Limited Security Level 3**

(3)



**GS1 DataBar Limited Security Level 4  
(4)**

## BC412

**Important:** **Decoder Effort** must be set to **Level 4** for the scanner to support BC412.

To enable or disable BC412, scan the appropriate symbol below.



**Enable BC412**  
(1)



**\* Disable BC412**  
(0)

# Composite

## Composite CC-C

### ***Parameter # 341***

Scan a programming symbol below to enable or disable Composite barcodes of type CC-C.



**Enable CC-C  
(1)**



**\* Disable CC-C  
(0)**



## Composite CC-A/B

### **Parameter # 342**

Scan a programming symbol below to enable or disable Composite barcodes of type CC-A/B.



**Enable CC-A/B  
(1)**

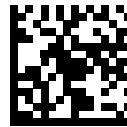

**\* Disable CC-A/B  
(0)**

## Composite TLC-39

### ***Parameter # 371***

Scan a programming symbol below to enable or disable Composite barcodes of type TLC-39.



**Enable TLC39  
(1)**



**\* Disable TLC39  
(0)**

## UPC Composite Mode

### Parameter # 344

Select an option for linking UPC symbols with a 2D symbol during transmission as if they were one symbol:

- Select **UPC Never Linked** to transmit UPC barcodes regardless of whether a 2D symbol is detected.
- Select **UPC Always Linked** to transmit UPC barcodes and the 2D portion. If 2D is not present, the UPC barcode does not transmit.
- If you select **Autodiscriminate UPC Composites**, the scanner determines if there is a 2D portion, then transmits the UPC, as well as the 2D portion if present.



\* **UPC Never Linked**  
(0)



**UPC Always Linked**  
(1)



**Autodiscriminate UPC Composites**  
(2)

## Composite Beep Mode

### ***Parameter # 398***

To select the number of decode beeps when a composite barcode is decoded, scan the appropriate programming symbol.



Single Beep after both are decoded  
(0)



\* Beep as each code type is decoded  
(1)



Double Beep after both are decoded  
(2)

## GS1-128 Emulation Mode for UCC/EAN Composite Codes

### **Parameter # 427**

Select whether to enable or disable this mode.

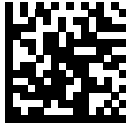

**Enable GS1-128 Emulation Mode for  
UCC/EAN Composite Codes  
(1)**



**\* Disable GS1-128 Emulation Mode for  
UCC/EAN Composite Codes  
(0)**

## 2D Symbologies

### Enable/Disable PDF417

#### ***Parameter # 15***

To enable or disable PDF417, scan the appropriate programming symbol below.



**\* Enable PDF417  
(1)**



**Disable PDF417  
(0)**

## Enable/Disable MicroPDF417

### ***Parameter # 227***

To enable or disable MicroPDF417, scan the appropriate programming symbol below.



**Enable MicroPDF417  
(1)**

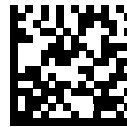

**\* Disable MicroPDF417  
(0)**

## Code 128 Emulation

### Parameter # 123

Enable this parameter to transmit data from certain MicroPDF417 symbols as Code 128.

**AIM Code ID Character** must be enabled for this parameter to work.

Enable Code 128 Emulation to transmit these MicroPDF417 symbols with one of the following prefixes:

- ]C1 if the first codeword is 903-905
- ]C2 if the first codeword is 908 or 909
- ]C0 if the first codeword is 910 or 911

Disable Code 128 Emulation to transmit these MicroPDF417 symbols with one of the following prefixes:

- ]L3 if the first codeword is 903-905
- ]L4 if the first codeword is 908 or 909
- ]L5 if the first codeword is 910 or 911

Scan a programming symbol below to enable or disable Code 128 Emulation.

Linked Micro PDF codewords 906, 907, 912, 914, and 915 are not supported. Use GS1 Composites instead.



Enable Code 128 Emulation  
(1)



\* Disable Code 128 Emulation  
(0)



## Data Matrix

### ***Parameter # 292***

To enable or disable Data Matrix, scan the appropriate programming symbol below.



**\* Enable Data Matrix  
(1)**

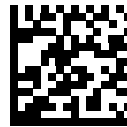

**Disable Data Matrix  
(0)**

## GS1 Data Matrix

### ***Parameter # 1336***

To enable or disable GS1 Data Matrix, scan the appropriate programming symbol below.

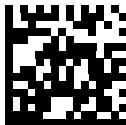

**\* Disable GS1 Data Matrix  
(0)**



**Enable GS1 Data Matrix  
(1)**

## Data Matrix Inverse

### **Parameter # 588**

This parameter sets the Data Matrix inverse decoder setting. Options are:

- **Regular Only** - The scanner decodes regular Data Matrix symbols only.
- **Inverse Only** - The scanner decodes inverse Data Matrix symbols only.
- **Inverse Autodetect** - The scanner decodes both regular and inverse Data Matrix symbols.



**Regular  
(0)**



**Inverse Only  
(1)**



**\* Inverse Autodetect  
(2)**

## Maxicode

### ***Parameter # 294***

To enable or disable Maxicode, scan the appropriate programming symbol below.



**Enable Maxicode  
(1)**

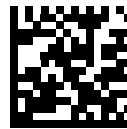

**\* Disable Maxicode  
(0)**

## QR Code

### **Parameter # 293**

**Inverse QR** symbols decode if **QR Code** is enabled.

To enable or disable QR Code, scan the appropriate programming symbol below.



\* Enable QR Code  
(1)



Disable QR Code  
(0)

## GS1 QR

### ***Parameter # 1343***

To enable or disable, scan the appropriate programming symbol below.



**\* Disable  
(0)**

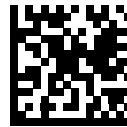

**Enable  
(1)**

## Micro QR Code

### ***Parameter # 573***

To enable or disable Micro QR Code, scan the appropriate programming symbol below.



\* Enable MicroQR  
(1)



Disable MicroQR  
(0)

## Aztec

### Parameter # 574

To enable or disable Aztec, scan the appropriate programming symbol below.

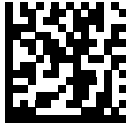

\* Enable Aztec  
(1)

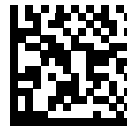

Disable Aztec  
(0)

## Aztec Inverse

### Parameter # 589

This parameter sets the Aztec inverse decoder setting. Options are:

- **Regular Only** - The scanner decodes regular Aztec symbols only.
- **Inverse Only** - The scanner decodes inverse Aztec symbols only.
- **Inverse Autodetect** - The scanner decodes both regular and inverse Aztec symbols.



Regular  
(0)

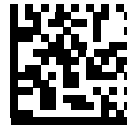

Inverse Only  
(1)



\* Inverse Autodetect  
(2)



## Han Xin

### ***Parameter # 1167***

To enable or disable Han Xin, scan the appropriate programming symbol below.



**Enable Han Xin  
(1)**



**\* Disable Han Xin  
(0)**

## Han Xin Inverse

### **Parameter # 1168**

Select a Han Xin inverse decoder setting:

- **Regular Only** - The decoder decodes Han Xin barcodes with normal reflectance only.
- **Inverse Only** - The decoder decodes Han Xin barcodes with inverse reflectance only.
- **Inverse Autodetect** - The decoder decodes both regular and inverse Han Xin barcodes.



\* Regular  
(0)



Inverse Only  
(1)



Inverse Autodetect  
(2)

## DotCode

**Important:** **Decoder Effort** must be set to **Level 4** for the scanner to support DotCode.

To enable or disable DotCode, scan the appropriate symbol below.



**Enable DotCode  
(1)**



**\* Disable DotCode  
(0)**

# Postal Codes

## US Postnet

### **Parameter # 89**

To enable or disable US Postnet, scan the appropriate programming symbol below.



**Enable US Postnet  
(1)**



**\* Disable US Postnet  
(0)**

## US Planet

### ***Parameter # 90***

To enable or disable US Planet, scan the appropriate programming symbol below.



**Enable US Planet  
(1)**



**\* Disable US Planet  
(0)**

## Transmit US Postal Check Digit

### **Parameter # 95**

Select whether to transmit US Postal data, which includes both US Postnet and US Planet, with or without the check digit.

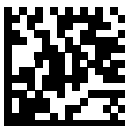

\* Transmit US Postal Check Digit  
(1)

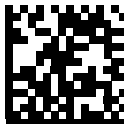

Do Not Transmit US Postal Check Digit  
(0)

## UK Postal

### ***Parameter # 91***

To enable or disable UK Postal, scan the appropriate programming symbol below.



**Enable UK Postal  
(1)**

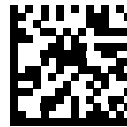

**\* Disable UK Postal  
(0)**

## Transmit UK Postal Check Digit

### **Parameter # 96**

Select whether to transmit UK Postal data with or without the check digit.

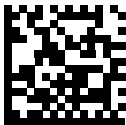

\* Transmit UK Postal  
Check Digit  
(1)



Do Not Transmit UK Postal Check Digit  
(0)



## Japan Postal

### ***Parameter # 290***

To enable or disable Japan Postal, scan the appropriate programming symbol below.

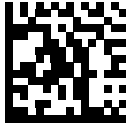

**Enable Japan Postal  
(1)**



**\* Disable Japan Postal  
(0)**

## Australia Post

### Parameter # 291

To enable or disable Australia Post, scan the appropriate programming symbol below.



Enable Australia Post  
(1)

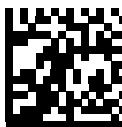

\* Disable Australia Post  
(0)

## Australia Post Format

### Parameter # 718

To select one of the following formats for Australia Post, scan the appropriate programming symbol below:

- **Autodiscriminate** (or Smart mode) - Attempt to decode the Customer Information Field using the N and C Encoding Tables.

**Note:** This option increases the risk of misdecodes because the encoded data format does not specify the Encoding Table used for encoding.

- **Raw Format** - Output raw bar patterns as a series of numbers 0 through 3.
- **Alphanumeric Encoding** - Decode the Customer Information Field using the C Encoding Table.
- **Numeric Encoding** - Decode the Customer Information Field using the N Encoding Table.

For more information on Australia Post encoding tables, refer to the Australia Post customer barcoding technical specifications available at:

<https://auspost.com.au/business/marketing-and-communications/bulk-mailouts/barcoding-process>.

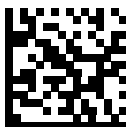

\* Autodiscriminate  
(0)



Raw Format  
(1)



Alphanumeric Encoding  
(2)



**Numeric Encoding  
(3)**

## Netherlands KIX Code

### ***Parameter # 326***

To enable or disable Netherlands KIX Code, scan the appropriate programming symbol below.



**Enable Netherlands KIX Code  
(1)**

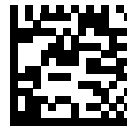

**\* Disable Netherlands KIX Code  
(0)**

## USPS 4CB/One Code/Intelligent Mail

### **Parameter # 592**

To enable or disable USPS 4CB/One Code/Intelligent Mail, scan the appropriate programming symbol below.

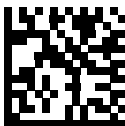

**Enable USPS 4CB/One Code/Intelligent Mail**  
(1)



**\* Disable USPS 4CB/One Code/Intelligent Mail**  
(0)

## UPU FICS Postal

### ***Parameter # 611***

To enable or disable UPU FICS Postal, scan the appropriate programming symbol below.



**Enable UPU FICS Postal  
(1)**

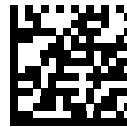

**\* Disable UPU FICS Postal  
(0)**

## **Mailmark**

### ***Parameter # 1337***

To enable or disable Mailmark, scan the appropriate programming symbol below.



**\* Disable Mailmark  
(0)**

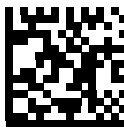

**Enable Mailmark  
(1)**



# Symbology-Specific Security Levels

## Redundancy Level

### ***Parameter # 78***

The scanner offers four levels of decode redundancy. Select higher redundancy levels for decreasing levels of barcode quality. As redundancy levels increase, the scanner's aggressiveness decreases.

Select the redundancy level appropriate for the barcode quality.

### **Redundancy Level 1**

The following code types must be successfully read twice before being decoded:

<b>Code Type</b>	<b>Code Length</b>
Codabar	8 characters or less
MSI	4 characters or less
D 2 of 5	8 characters or less
I 2 of 5	8 characters or less

### **Redundancy Level 2**

The following code types must be successfully read twice before being decoded:

<b>Code Type</b>	<b>Code Length</b>
All	All

### **Redundancy Level 3**

Code types other than the following must be successfully read twice before being decoded. The following codes must be read three times:

<b>Code Type</b>	<b>Code Length</b>
MSI	4 characters or less
D 2 of 5	8 characters or less
I 2 of 5	8 characters or less
Codabar	8 characters or less

---

*Symbology-Specific Security Levels*

**Redundancy Level 4**

The following code types must be successfully read three times before being decoded:

Code Type	Code Length
All	All



\* Redundancy Level 1  
(1)



Redundancy Level 2  
(2)

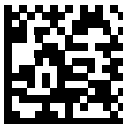

Redundancy Level 3  
(3)



Redundancy Level 4  
(4)

## Security Level

### Parameter # 77

The scanner offers four levels of decode security for delta barcodes, which include the Code 128 family, UPC/EAN, and Code 93. Select increasing levels of security for decreasing levels of barcode quality. There is an inverse relationship between security and scanner aggressiveness, so choose only that level of security necessary for any given application.

- **Security Level 0:** This setting allows the scanner to operate in its most aggressive state, while providing sufficient security in decoding most “in-spec” barcodes.
- **Security Level 1:** This default setting eliminates most misdecodes.
- **Security Level 2:** Select this option if Security level 1 fails to eliminate misdecodes.
- **Security Level 3:** If you selected Security Level 2 and misdecodes still occur, select this security level. Be advised, selecting this option is an extreme measure against mis-decoding severely out-of-spec barcodes. Selecting this level of security significantly impairs the decoding ability of the scanner. If you need this level of security, try to improve the quality of the barcodes.



Security Level 0  
(0)



\* Security Level 1  
(1)

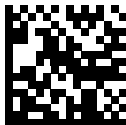

Security Level 2  
(2)



**Security Level 3**  
**(3)**

## 1D Quiet Zone Level

### Parameter # 1288

This feature sets the level of aggressiveness in decoding barcodes with a reduced quiet zone (the area in front of and at the end of a barcode), and applies to symbologies enabled by a Reduced Quiet Zone parameter. Because higher levels increase the decoding time and risk of misdecodes, Symbol Technologies strongly recommends enabling only the symbologies which require higher quiet zone levels, and leaving Reduced Quiet Zone disabled for all other symbologies. Options are:

- **0** - The scanner performs normally in terms of quiet zone.
- **1** - The scanner performs more aggressively in terms of quiet zone.
- **2** - The scanner only requires one side EB (end of barcode) for decoding.
- **3** - The scanner decodes anything in terms of quiet zone or end of barcode.

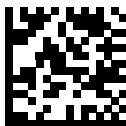

1D Quiet Zone Level 0  
(0)



\* 1D Quiet Zone Level 1  
(1)

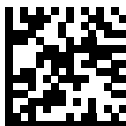

1D Quiet Zone Level 2  
(2)



1D Quiet Zone Level 3  
(3)

## **Intercharacter Gap Size**

### ***Parameter # 381***

The Code 39 and Codabar symbologies have an intercharacter gap that is typically quite small. Due to various barcode-printing technologies, this gap can grow larger than the maximum size allowed, preventing the scanner from decoding the symbol. If this problem occurs, scan the **Large Intercharacter Gaps** parameter to tolerate these out-of-spec barcodes.



\* **Normal Intercharacter Gaps**  
(6)



**Large Intercharacter Gaps**  
(10)

## **Report Version**

Scan the programming symbol below to report the version of software installed in the scanner.



**Report Software Version**

## MacroPDF Features

MacroPDF is a special feature for concatenating multiple PDF symbols into one file. The scanner can decode symbols that are encoded with this feature, and can store more than 64 Kb of decoded data stored in up to 50 MacroPDF symbols.

**Caution:** When printing, keep each MacroPDF sequence separate, as each sequence has unique identifiers. Do not mix barcodes from several MacroPDF sequences, even if they encode the same data. When scanning MacroPDF sequences, scan the entire MacroPDF sequence without interruption. If, when scanning a mixed sequence, the scanner emits two long low beeps (Low/Low) this indicates an inconsistent file ID or inconsistent symbology error.

### Flush Macro Buffer

This flushes the buffer of all decoded MacroPDF data stored to that point, transmits it to the host device, and aborts from MacroPDF mode.



Flush MacroPDF Buffer

### Abort MacroPDF Entry

This clears all currently-stored MacroPDF data in the buffer without transmission and aborts from MacroPDF mode.



Abort MacroPDF Entry



# 10 WebLink<sub>PC</sub>

This section describes how to set up and use WebLink<sub>PC</sub>, Omron Microscan's configuration software for the HS-360X Handheld DPM Scanner.

**Important:** Full WebLink<sub>PC</sub> documentation is located in WebLink<sub>PC</sub> Help, which can be accessed by clicking the Question Mark icon at the upper right of the WebLink<sub>PC</sub> user interface.

**Important:** Scanning programming symbols while using WebLink<sub>PC</sub> may cause unexpected behavior when the scanner is in Setup or Run mode. For example, scanning the USB CDC programming symbol while in Setup mode may cause additional data to be output with the string data once the communication mode is switched. Use WebLink<sub>PC</sub> controls to perform this function, or scan additional programming symbols after exiting WebLink<sub>PC</sub>.

# Set Up HS-360X Host Interface

**Note:** Cables may vary depending on configuration.

When connecting the HS-360X and cradle to a PC, look for a USB port with a lightning bolt icon similar to the one shown here. This icon indicates that the port is higher-powered and is intended for charging USB devices.

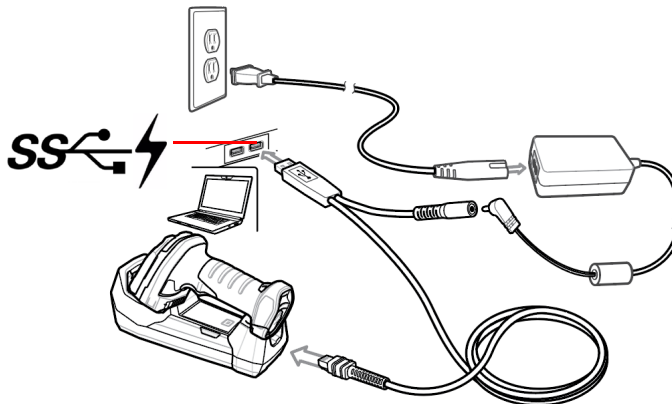

**HS-360X Wireless Scanner USB Host Interface**

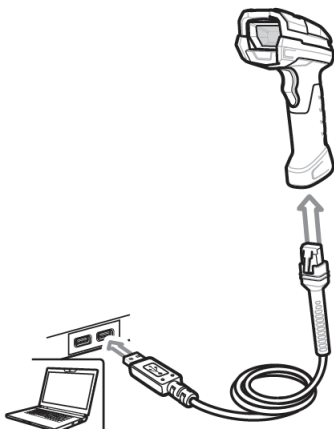

**HS-360X Wired Scanner USB Host Interface**

Scan one of the programming symbols below.

The interface cable automatically detects the host interface type and uses the default setting. If the default (\*) does not meet your requirements, scan the other host symbol below.



\* USB Keyboard (HID)



SNAPi with Imaging Interface



USB CDC Host

## Install WebLink<sub>PC</sub>

The WebLink<sub>PC</sub> installer can be found in the following two locations:

- On the Download Center at: [www.microscan.com/downloadcenter](http://www.microscan.com/downloadcenter)
- On the Omron Microscan Tools Drive: P/N 37-000010-01.
  1. Download WebLink<sub>PC</sub> and follow the installation prompts.
  2. Click on the WebLink<sub>PC</sub> icon to run the program.

### ***Minimum PC Requirements***

- Intel® Core™ 2 Duo Processor
- Microsoft Windows 7 (32-bit)
- Internet Explorer 11 or higher, Microsoft Edge, Mozilla Firefox, or Opera
- 1 GB / 128 MB Video RAM
- 100 MB hard drive space
- 16-bit color display
- 3.0 Windows Experience Index

### ***Recommended PC Requirements***

- Intel® Core™ i3 Duo Processor
- Microsoft Windows 7 (64-bit) or Microsoft Windows 10 (64-bit)
- Google Chrome, current version
- 2 GB RAM / 128 MB Video RAM (Windows 7)
- 500 MB hard drive space
- 32-bit color display
- 4.0 Windows Experience Index

---

Connect to WebLink<sub>PC</sub>

## Connect to WebLink<sub>PC</sub>

To start WebLink<sub>PC</sub>, double-click the icon that was placed on your desktop during installation.



You can also start WebLink<sub>PC</sub> by connecting the HS-360X to your PC, opening a browser of your choice, and typing `http://localhost:8090` or `http://127.0.0.1:8090` in the address bar.

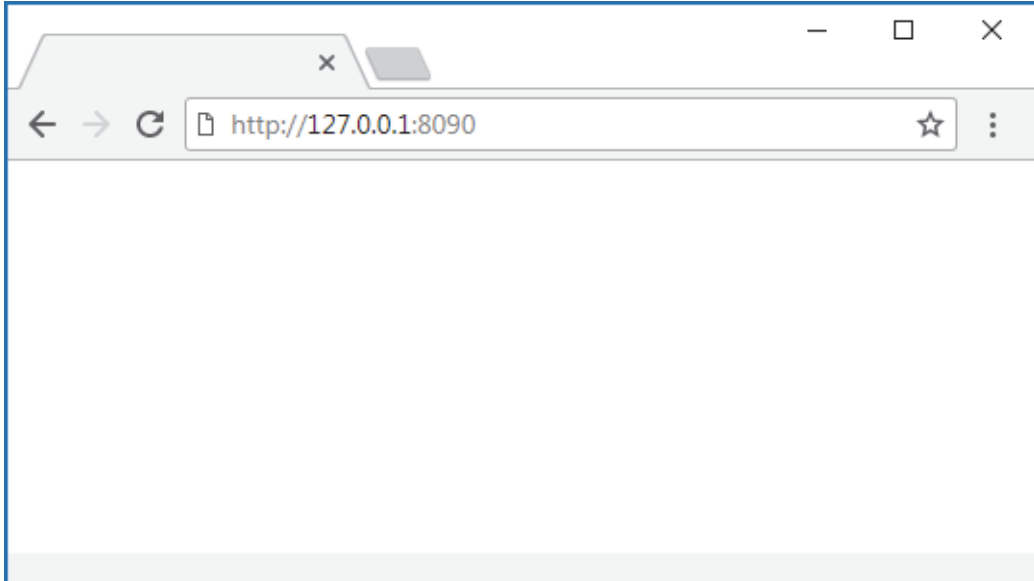

# Explore the Start View

The **Start** view shows all the scanners available to the system. The **Reader Model**, **Serial Number**, and **Firmware Version** of each scanner are displayed. This view allows you to choose **Assisted Setup**, to **Create a New Setup**, or to **Load a Setup**. The **Gear icon** in the upper right brings up the **Application Settings Menu**.

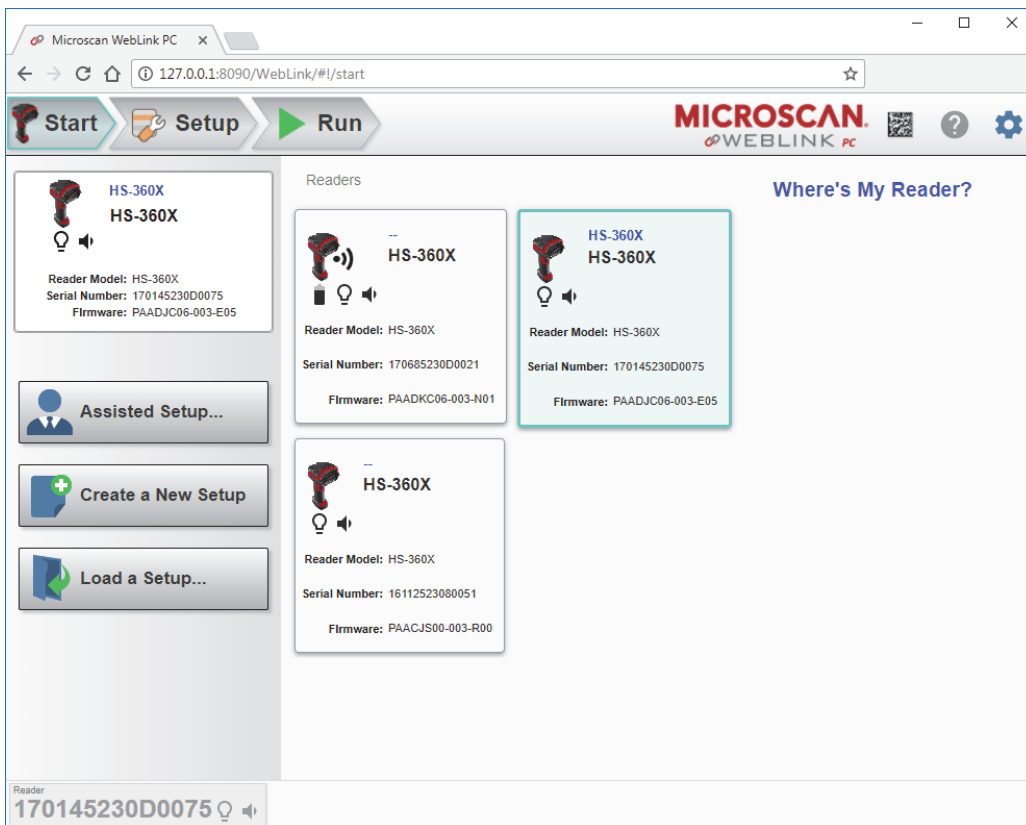

## Create a New Setup or Load an Existing Setup

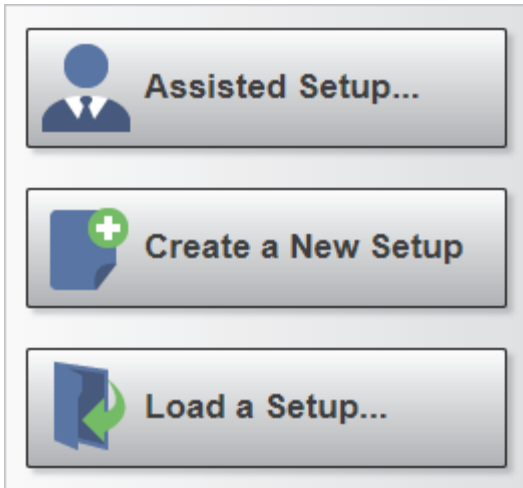

### ***Assisted Setup***

When you click the **Assisted Setup** button in the **Start** view, a dialog will appear asking you a series of application-related questions. Based on your answers, WebLink<sub>PC</sub> generates your initial setup automatically. Once the setup is created, you can fine-tune its parameters in the **Setup** view.

### ***Create a New Setup***

The **Start** view also allows you to create a **New Setup** without using **Assisted Setup**. When you click the **Create a New Setup** button, WebLink<sub>PC</sub> searches for any differences from default in the scanner parameters. If no differences from default are found, you will see the **Setup** view. If differences from default are found, the following message will appear:

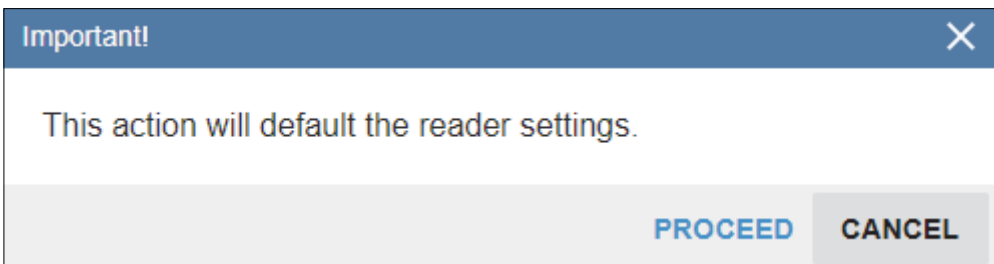

### ***Load a Setup***

Select **Load a Setup** to load an existing **.rls** WebLink<sub>PC</sub> setup file.

# Explore the Setup View

The **Setup** view allows you to configure the scanner, view the current captured image, and view decoded symbol data.

The following read cycle steps are shown at the left side of the screen:

- **Cycle**
- **Performance**
- **Decode**
- **Format Output**

The screenshot displays the Microscan WebLink PC Setup View. The central area shows a live camera feed of a QR code with the text "Data" above it and "Grade-A" below it. The QR code is labeled with the ID "ID20304092015".

On the left side, there are four configuration panels:

- Read Cycle:** Trigger Mode: Manual, Decode Timeout: 9.9 seconds, No Read Message.
- Performance:** Decoder Effort slider (Min to Max), Enhance/Shrink Dark, Illumination Control, Cycle.
- Decode:** 1D Codes, 2D Codes.
- Format Output:** Append Return, Append Tab.

On the right side, there are two panels:

- Counts:** Cycle Count: 1198, Cycle Time: 86 ms.
- Output Data:** A list of IDs with "CTRL-IP" buttons.

At the bottom left, there is a "Favorites" section and a "Reader" ID: 17272523080461.

# Configure Cycle Settings

The **Cycle** step allows you to choose between **Manual** and **Presentation** Trigger Modes. In **Manual** mode, a decode is attempted when you pull the trigger.

Manual mode in the Cycle step allows you to set **Decode Timeout** and enable or disable a **No Read Message**.

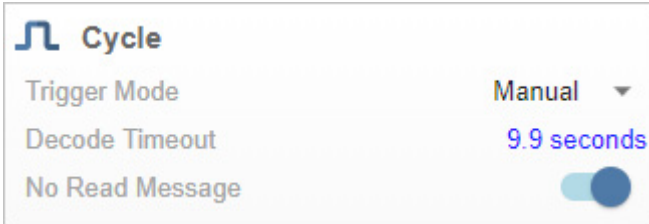

In **Presentation** mode, the read cycle begins when a symbol is detected moving into the scanner's field of view.

Presentation mode in the Cycle step allows you to enable or disable a **Presentation Target**, set the **Hands-Free Decode Timeout**, set the **Timeout Between Decodes**, and enable or disable a **No Read Message**.

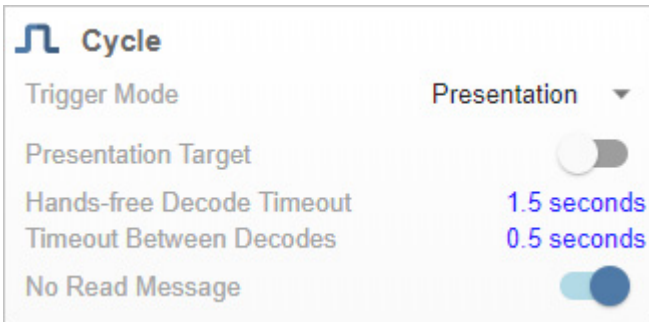

**Note:** The scanner is automatically set to Presentation mode when placed in the **HS-360X Stand**, shown below.

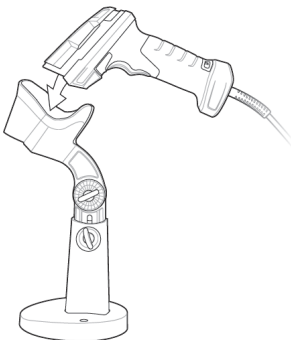



## Configure Performance Settings

The **Performance** step allows you to optimize the scanner for **Direct Part Mark (DPM)** decoding. A DPM is a permanent mark created by laser etch, chemical etch, or other method, directly on a substrate. DPMS are often harder to read than other symbols, and may require a few attempts before finding optimal settings. The **Decoder Effort** slider has four settings: **Level 1**, corresponding to **Min** on the slider; **Level 2**; **Level 3**; and **Level 4**, corresponding to **Max** on the slider. As Decoder Effort is moved toward Max, the decoder spends an increasing amount of time trying to decode the symbol.

In **Level 4**, you can also enable the **Enhance** option, which improves readability by adding an image pre-processing operation (**Shrink Dark** or **Grow Dark**) to improve decode performance on marks whose cells are not properly formed. You can also select the size (**Small**, **Medium**, or **Large**) of the area or "pixel neighborhood" in which the pre-processing operation is performed. Small = 3 x 3 pixels, Medium = 5 x 5 pixels, and Large = 7 x 7 pixels.

The **Illumination Control** options are:

- **Direct:** White LED illumination only. Recommended for use with dot-peened symbols. Tilt the part 30° to avoid specular reflection when using Direct illumination.
- **Indirect:** Red LED illumination only. Recommended for use with laser-etched symbols on curved, rough, grainy, highly-reflective, or visibly-machined surfaces or cylinders.
- **Cycle:** Alternates between Direct and Indirect illumination, starting with the type of illumination used during the last successful decode.

### Examples of Performance Configurations

- **Level 4 (Maximum) Decoder Effort;**
- **Enhance – Shrink Dark** pre-processing operation enabled;
- **Medium**-sized pre-processing area;
- **Illumination Control** set to **Cycle**.

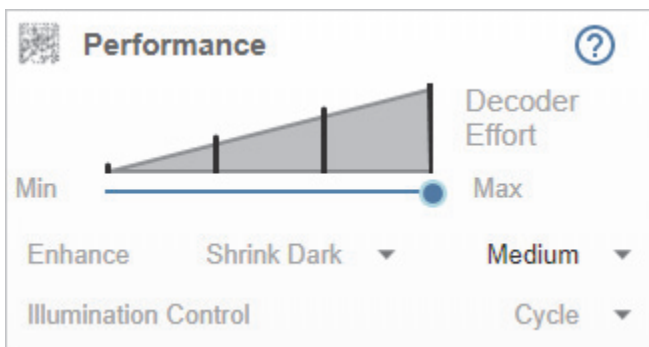

## Configure Performance Settings

- **Level 3 Decoder Effort;**
- **Illumination Control** set to **Cycle**.

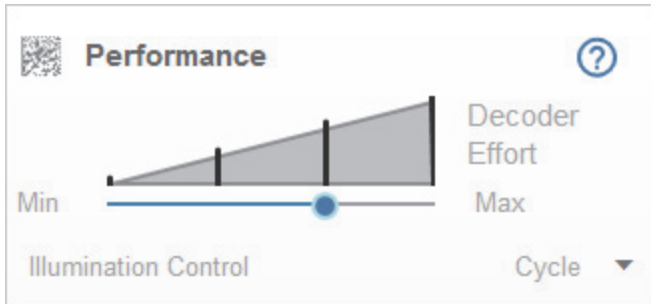

- **Level 4 (Maximum) Decoder Effort;**
- **Enhance – Shrink Dark** pre-processing operation enabled;
- **Small** pre-processing area;
- **Illumination Control** set to **Cycle**.



Clicking the **Question Mark** icon in the upper right corner of the Performance step editor brings up a dialog with more detail about each level of decoder effort.

**Decoder Effort**



### No Special DPM Processing (Min)

Use only on high-contrast symbols that are printed on labels. This allows the fastest processing time when no DPM reading is required.

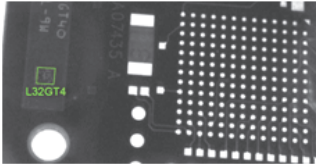

### Least Aggressive DPM Processing

Optimized for decoding performance on smaller DPM symbols typically found on electronics and medical instruments, especially on smooth surfaces. These symbols tend to be laser-etched or direct-printed.

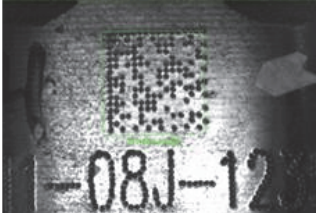

### Best Setting for Most DPMs

Optimized for decoding performance on larger DPM symbols typically found on industrial parts, especially on rough, grainy or visibly machined surfaces. These symbols tend to be dot-peened or laser-etched. This setting is the best blend of decode performance and speed to read.

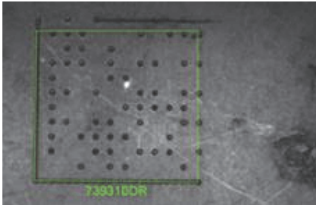

### Most Aggressive DPM Processing (Max)

Use only for most difficult-to-read marks, for which additional DPM processing may be necessary.

OK

# Configure Symbology and Decode Settings

The **Decode** step allows you to select which symbologies to enable and disable. Clicking the **1D Codes** and **2D Codes** checkboxes will enable or disable all the symbologies in that group.

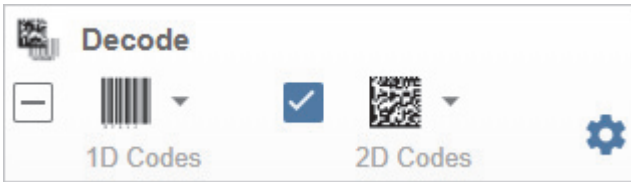

You can also click directly on the images of the 1D and 2D symbols and a popup menu with checkboxes will appear, allowing you to select individual symbologies to enable or disable. In the example below, the user has clicked on the image of the Data Matrix symbol, causing the **2D Codes** menu to appear.

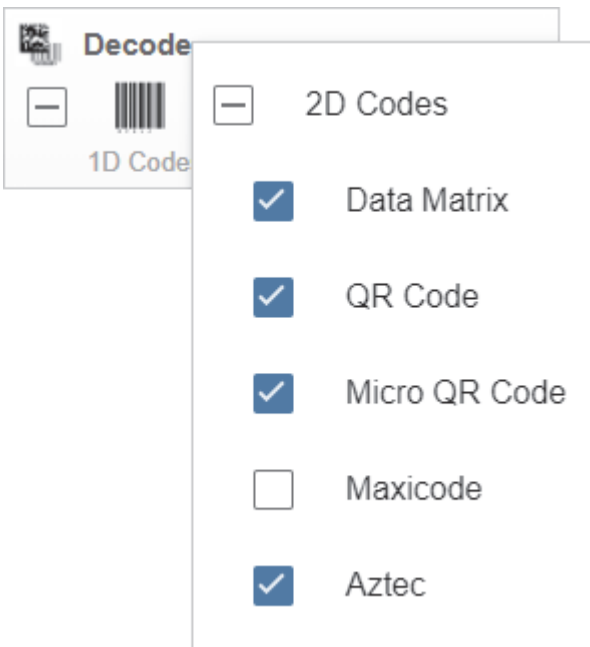

Clicking the **Gear icon** to the right of the **1D Codes** and **2D Codes** checkboxes brings up a **Symbology Settings** dialog that allows you to modify specific parameters for each symbology.

Symbology Settings		
<b>UPC</b>	☆	
Code 128	☆	UPC-A <input checked="" type="checkbox"/>
Code 39	☆	UPC-E <input checked="" type="checkbox"/>
Code 93		
Codabar	☆	UPC-E1 <input type="checkbox"/>
Aztec	☆	EAN-8/JAN8 <input checked="" type="checkbox"/>
	☆	EAN-13/JAN13 <input checked="" type="checkbox"/>
	☆	BooklandEAN <input type="checkbox"/>
	☆	UPC/EAN/JAN Supplementals <a href="#">Ignore Supplemental</a>
	☆	UPC/EAN/JAN Supplemental AIM ID Format <a href="#">Combined</a>
	☆	UPC Reduced Quiet Zone <input type="checkbox"/>

# Configure Output Formatting

The **Format Output** step allows you to configure **Preambles** and **Postambles** (Prefixes and Suffixes) to add to symbol data output.

The **Simplified** version of this control allows you to **Append Return** or **Append Tab** after each string of data output.

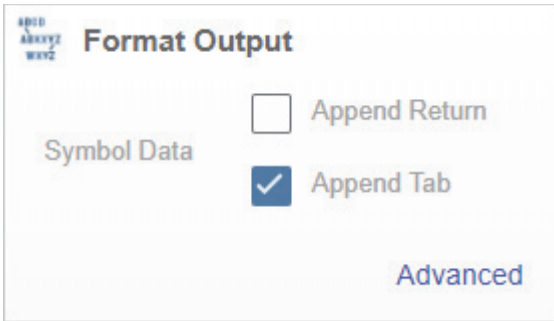

The **Advanced** version allows you to choose from a wide variety of keyboard characters that can be output as a Preamble or Postamble. You can also add a second Postamble if required. You can toggle between the two views by clicking directly on the words **Advanced** and **Simplified** in the lower right corner of the dialog.

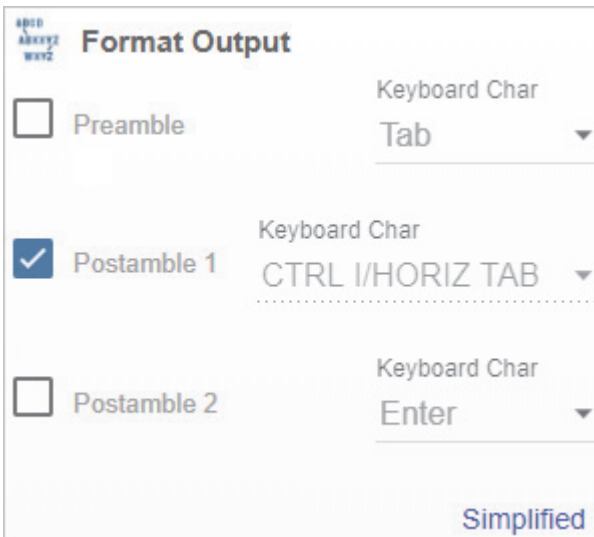

If Preamble or Postamble are enabled, the user-selected keyboard character value will appear in **Output Data**. In the example below, the **CTRL I/HORIZ TAB** value is set as **Postamble 1**, which is why it appears after the symbol data (ID20304092015).

Output Data	
ID20304092015	CTRL I/H
ID20304092015	CTRL I/H
ID20304092015	CTRL I/H
ID20304092015	CTRL I/H
ID20304092015	CTRL I/H
ID20304092015	CTRL I/H
ID20304092015	CTRL I/H
ID20304092015	CTRL I/H
ID20304092015	CTRL I/H
ID20304092015	CTRL I/H
ID20304092015	CTRL I/H
ID20304092015	CTRL I/H
ID20304092015	CTRL I/H
ID20304092015	CTRL I/H

# Run the Application

The **Run** view allows you to keep track of your application during runtime. The current captured image is shown along with a row of image control tools. A history of decoded symbol data is shown in the right pane along with any preambles or postambles that have been defined.

The **Output Data** display in the right pane shows a list of previous read cycle results. Each result is selectable and erasable.

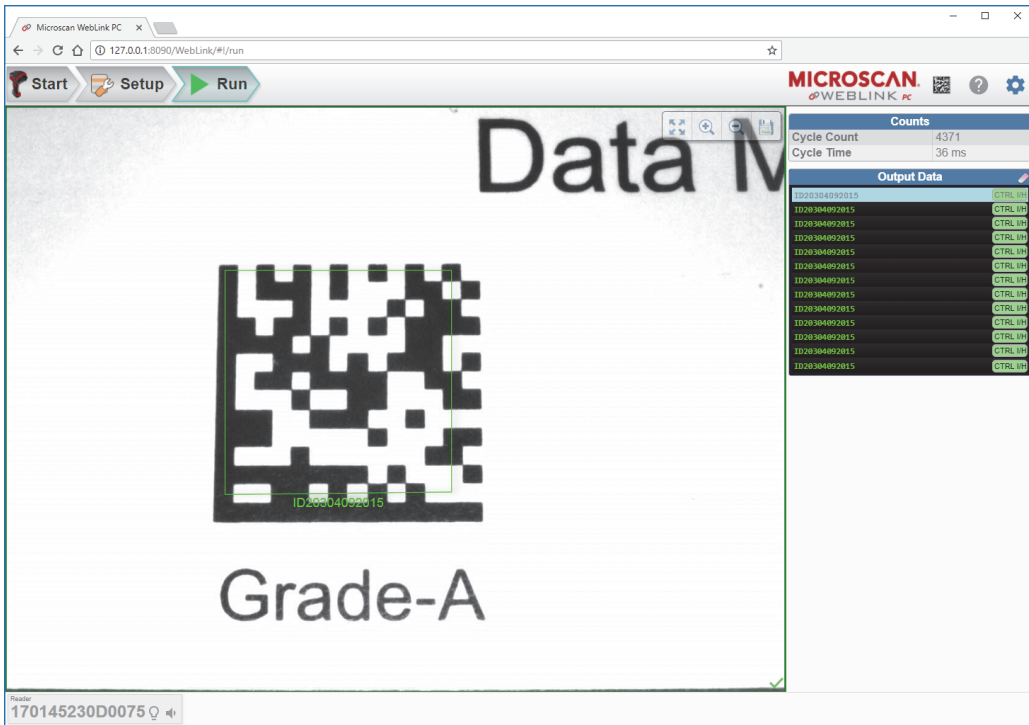

## Image Control Tools

Image control tools are available at the upper right of the image view.

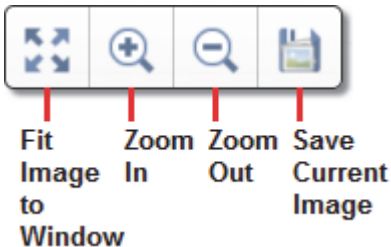



# **Appendices**

## Appendix A — Standard Default Parameters

Parameter	Parameter Number	Default
<b>Radio Communications</b>		
Radio Communications Host Types	383	Cradle Host
BT Friendly Name	607	n/a
Discoverable Mode	610	General
Wi-Fi Friendly Mode	1299	Disable
Wi-Fi Friendly Channel Exclusion	1297	Use All Channels
Radio Output Power	1324	High
Link Supervision Timeout	1698	.5 Seconds 5 Seconds
Bluetooth Radio State	1354	On
Bluetooth HID - Wait for Connection	1714	Disable
HID Features for Apple iOS	1114	Disable
HID Keyboard Keystroke Delay	N/A	No Delay (0 msec)
CAPS Lock Override	N/A	Disable
Ignore Unknown Characters	N/A	Send Barcodes with Unknown Characters
Emulate Keypad	N/A	Enable
Fast HID Keyboard	1361	Enable
Quick Keypad Emulation	1362	Enable
Keyboard FN1 Substitution	N/A	Disable
Function Key Mapping	N/A	Disable
Simulated Caps Lock	N/A	Disable
Convert Case	N/A	No Case Conversion
Reconnect Attempt Beep Feedback	559	Disable
Reconnect Attempt Interval	558	30 Seconds
Auto-reconnect	604	Auto-reconnect Immediately
Beep on Insertion	288	Enable
Beep on <BEL>	150	Enable
Modes of Operation (Point-to-Point/ Multipoint-to-Point)	538	Point-to-Point
Parameter Broadcast (Cradle Host Only)	148	Enable
Pairing Modes	542	Unlocked
Pairing Methods	545	Enable

Parameter	Parameter Number	Default
Toggle Pairing	1322	Disable
Connection Maintenance Interval	5002	15 Minutes
Batch Mode	544	Normal (Do Not Batch Data)
Persistent Batch Storage	1399	Disable
Page Button	746	Enable
Page Options Page Mode Page State Timeout	1364 1365	Page Simple
Classic and/or Low Energy Bluetooth	1355	Classic and Low Energy
PIN Code (Set and Store)	552	12345
Variable Pin Code	608	Static (Default PIN code is 12345)
Bluetooth Security Levels	1393	Low
<b>User Preferences</b>		
Set Default Parameter	N/A	Restore Defaults
Parameter Barcode Scanning	236	Enable
Beep After Good Decode	56	Enable
Direct Decode Indicator	859	Disable
Beeper Volume	140	High
Beeper Tone	145	Medium
Beeper Duration	628	Medium
Suppress Power Up Beeps	721	Do Not Suppress
Decode Pager Motor	613	Enable
Decode Pager Motor Duration	626	150 msec
Low Power Mode	128	Enable (HS-360X Wireless) Disable (HS-360X Wired Scanner)
Time Delay to Low Power Mode	146	100 msec (HS-360X Wireless) 1 Hour (HS-360X Wired Scanner)
Timeout to Low Power Mode from Auto Aim (HS-360X Wireless Only)	729	15 Seconds
Handheld Trigger Mode	138	Level
Hands-free Mode	630	Enable
Handheld Decode Aiming Pattern	306	Enable
Hands-free (Presentation) Decode Aiming Pattern	590	Enable Hands-free (Presentation) Decode Aiming Pattern on PDF
Picklist Mode	402	Disabled Always
FIPS Mode (HS-360X Wireless Only)	736	Disable
Continuous Barcode Read	649	Disable
Unique Barcode Reporting	723	Enable

## Standard Default Parameters

Parameter	Parameter Number	Default
Decode Session Timeout	136	9.9 Seconds
Hands-free Decode Session Timeout	400	15
Timeout Between Decodes, Same Symbol	137	0.5 Seconds
Timeout Between Decodes, Different Symbols	144	0.5 Seconds
Mobile Phone/Display Mode	716	Normal
PDF Prioritization	719	Disable
PDF Prioritization Timeout	720	200 msec
Decoding Illumination	298	Enable
Motion Tolerance (Handheld Trigger Mode Only)	858	Less
Battery Threshold	1367	50%
Battery Status High Threshold	1368	20%
Battery Status Medium Threshold	1369	10%
Battery Status Low Warning Threshold	1370	60%
Add an Enter Key	N/A	N/A
Transmit Code ID Character	45	None
Prefix Value	99, 105	7013 <CR><LF>
Suffix 1 Value	98, 104	7013 <CR><LF>
Suffix 2 Value	100, 106	7013 <CR><LF>
Scan Data Transmission Format	235	Data as is
FN1 Substitution Values	103, 109	7013 <CR><LF>
Transmit "No Read" Message	94	Disable
Unsolicited Heartbeat Interval	1118	Disable
UID	740	Disable
UID Error Mode Options	742	UID Error Beep
Decoder Effort Level	1438	Level 3
DPM Illumination Control	429	Cycle Illumination
<b>Imaging Preferences</b>		
Operational Modes	N/A	N/A
Image Size (Number of Pixels)	302	Full
JPEG Image Options	299	Quality
JPEG Target File Size	561	160 kB
JPEG Quality and Size Value	305	65
Image File Format Selection	304	JPEG
Image Rotation	665	0°

Parameter	Parameter Number	Default
<b>USB Host Parameters</b>		
USB Device Type	N/A	USB Keyboard HID
Symbol Native API (SNAPI) Status Handshaking	N/A	Enable
USB Keystroke Delay	N/A	No Delay
USB CAPS Lock Override	N/A	Disable
USB Ignore Unknown Characters	N/A	Send Barcodes with Unknown Characters
Emulate Keypad	N/A	Enable
Emulate Keypad with Leading Zero	N/A	Enable
Quick Keypad Emulation	N/A	Enable
USB FN1 Substitution	N/A	Disable
Function Key Mapping	N/A	Disable
Simulated Caps Lock	N/A	Disable
Convert Case	N/A	None
USB Static CDC	N/A	Enable
Ignore Beep Directive	N/A	Enable (Ignore)
Ignore Barcode Configuration	N/A	Enable (Ignore)
USB Polling Interval	N/A	3 msec
USB Fast HID	N/A	Enable
IBM Specification Version	N/A	Version 2.2
<b>RS-232 Host Parameters</b>		
RS-232 Host Types	N/A	Standard
Baud Rate	N/A	9600
Parity Type	N/A	None
Stop Bits	N/A	1 Stop Bit
Data Bits	N/A	8-Bit
Check Receive Errors	N/A	Enable
Hardware Handshaking	N/A	None
Software Handshaking	N/A	None
Host Serial Response Time-out	N/A	2 Seconds
RTS Line State	N/A	Low RTS
Beep on <BEL>	N/A	Disable
Intercharacter Delay	N/A	0 msec
Nixdorf Beep/LED Options	N/A	Normal Operation
Ignore Unknown Characters	N/A	Send Barcode

## Standard Default Parameters

Parameter	Parameter Number	Default
Keyboard Wedge Host Type	N/A	IBM AT Notebook
Ignore Unknown Characters	N/A	Send Barcodes with Unknown Characters
Keystroke Delay	N/A	No Delay
Intra-Keystroke Delay	N/A	Disable
Alternate Numeric Keypad Emulation	N/A	Enable
Quick Keypad Emulation	N/A	Enable
Simulated Caps Lock	N/A	Disable
Caps Lock Override	N/A	Disable
Convert Wedge Case	N/A	No Convert
Function Key Mapping	N/A	Disable
FN1 Substitution	N/A	Disable
Send Make and Break	N/A	Send Make and Break Scan Codes
<b>Enable/Disable All Code Types</b>		
<b>1D Symbologies</b>		
<b>UPC/EAN</b>		
UPC-A	1	Enable
UPC-E	2	Enable
UPC-E1	12	Disable
EAN-8/JAN 8	4	Enable
EAN-13/JAN 13	3	Enable
Bookland EAN	83	Disable
Decode UPC/EAN/JAN Supplementals (2 and 5 digits)	16	Ignore
User-Programmable Supplementals Supplemental 1: Supplemental 2:	579 580	000
UPC/EAN/JAN Supplemental Redundancy	80	10
Decode UPC/EAN/JAN Supplemental AIM ID	672	Combined
UPC Reduced Quiet Zone	1289	Disable
Transmit UPC-A Check Digit	40	Enable
Transmit UPC-E Check Digit	41	Enable
Transmit UPC-E1 Check Digit	42	Enable
UPC-A Preamble	34	System Character
UPC-E Preamble	35	System Character
UPC-E1 Preamble	36	System Character

Parameter	Parameter Number	Default
Convert UPC-E to A	37	Disable
Convert UPC-E1 to A	38	Disable
EAN-8/JAN-8 Extend	39	Disable
Bookland ISBN Format	576	ISBN-10
ISSN EAN	617	Disable
<b>Code 128</b>		
Code 128	8	Enable
Set Length(s) for Code 128	209, 210	1 to 55
GS1-128 (formerly UCC/EAN-128)	14	Enable
ISBT 128	84	Disable
ISBT Concatenation	577	Autodiscriminate
Check ISBT Table	578	Enable
ISBT Concatenation Redundancy	223	10
Code 128 Security Level	751	Security Level 1
Code 128 Reduced Quiet Zone	1208	Disable
Ignore Code 128 <FNC4>	1254	Disable
<b>Code 39</b>		
Code 39	0	Enable
Trioptic Code 39	13	Disable
Convert Code 39 to Code 32 (Italian Pharmacy Code)	86	Disable
Code 32 Prefix	231	Disable
Set Length(s) for Code 39	18, 19	1 to 55
Code 39 Check Digit Verification	48	Disable
Transmit Code 39 Check Digit	43	Disable
Code 39 Full ASCII Conversion	17	Disable
Code 39 Security Level	750	Security Level 1
Code 39 Reduced Quiet Zone	1209	Disable
<b>Code 93</b>		
Code 93	9	Enable
Set Length(s) for Code 93	26, 27	1 to 55
<b>Code 11</b>		
Code 11	10	Disable
Set Lengths for Code 11	28, 29	4 to 55
Code 11 Check Digit Verification	52	Disable
Transmit Code 11 Check Digit(s)	47	Disable

## Standard Default Parameters

Parameter	Parameter Number	Default
Code 11 Check Digit Verification	52	Disable
Transmit Code 11 Check Digit(s)	47	Disable
<b>Interleaved 2 of 5 (ITF)</b>		
Interleaved 2 of 5 (ITF)	6	Disable
Set Lengths for I 2 of 5	22, 23	6 to 55
I 2 of 5 Check Digit Verification	49	Disable
Transmit I 2 of 5 Check Digit	44	Disable
Convert I 2 of 5 to EAN 13	82	Disable
I 2 of 5 Security Level	1121	Security Level 1
I 2 of 5 Reduced Quiet Zone	1210	Disable
<b>Discrete 2 of 5 (DTF)</b>		
Discrete 2 of 5	5	Disable
Set Length(s) for D 2 of 5	20, 21	1 to 55
<b>Codabar (NW - 7)</b>		
Codabar	7	Enable
Set Lengths for Codabar	24, 25	4 to 55
CLSI Editing	54	Disable
NOTIS Editing	55	Disable
Codabar Upper or Lower Case Start/Stop Characters Detection	855	Upper Case
<b>MSI</b>		
MSI	11	Disable
Set Length(s) for MSI	30, 31	4 to 55
MSI Check Digits	50	One
Transmit MSI Check Digit	46	Disable
MSI Check Digit Algorithm	51	Mod 10/Mod 10
<b>Chinese 2 of 5</b>		
Chinese 2 of 5	408	Disable
<b>Matrix 2 of 5</b>		
Matrix 2 of 5	618	Disable
Matrix 2 of 5 Lengths	619 620	4 to 55
Matrix 2 of 5 Check Digit	622	Disable
Transmit Matrix 2 of 5 Check Digit	623	Disable
<b>Korean 3 of 5</b>		
Korean 3 of 5	581	Disable
<b>Inverse 1D</b>	586	Regular



Parameter	Parameter Number	Default
<b>GS1 DataBar</b>		
GS1 DataBar-14	338	Enable
GS1 DataBar Limited	339	Enable
GS1 DataBar Expanded	340	Enable
Convert GS1 DataBar to UPC/EAN	397	Disable
GS1 DataBar Limited Security Level	728	Level 3
<b>Composite</b>		
Composite CC-C	341	Disable
Composite CC-A/B	342	Disable
Composite TLC-39	371	Disable
UPC Composite Mode	344	UPC Never Linked
Composite Beep Mode	398	Beep As Each Code Type is Decoded
GS1-128 Emulation Mode for UCC/EAN Composite Codes	427	Disable
<b>2D Symbolologies</b>		
PDF417	15	Enable
MicroPDF417	227	Disable
Code 128 Emulation	123	Disable
Data Matrix	292	Enable
GS1 Data Matrix	1336	Disable
Data Matrix Inverse	588	Inverse Autodetect
Maxicode	294	Disable
QR Code	293	Enable
GS1 QR	1343	Disable
MicroQR	573	Enable
Aztec	574	Enable
Aztec Inverse	589	Inverse Autodetect
Han Xin	1167	Disable
Han Xin Inverse	1168	Regular
<b>Postal Codes</b>		
US Postnet	89	Disable
US Planet	90	Disable
Transmit US Postal Check Digit	95	Enable
UK Postal	91	Disable
Transmit UK Postal Check Digit	96	Enable
Japan Postal	290	Disable

---

## Standard Default Parameters

<b>Parameter</b>	<b>Parameter Number</b>	<b>Default</b>
Australia Post	291	Disable
Australia Post Format	718	Autodiscriminate
Netherlands KIX Code	326	Disable
USPS 4CB/One Code/Intelligent Mail	592	Disable
UPU FICS Postal	611	Disable
Mailmark	1337	Disable
<b>Symbology-Specific Security Levels</b>		
Redundancy Level	78	1
Security Level	77	1
1D Quiet Zone Level	1288	1
Intercharacter Gap Size	381	Normal
Report Version		

## Appendix B — Country Codes

### Introduction

This section provides instructions for programming the keyboard to interface with a USB host. The host powers the scanner.

To select a code page for the country keyboard type, see [Appendix C — Country Code Pages](#).

### USB Country Keyboard Types (Country Codes)

Scan the programming symbol corresponding to the keyboard type. For a USB host, this setting applies only to the USB Keyboard (HID) device. If the keyboard type is not listed, see **Emulate Keypad** for the USB HID host. For a keyboard wedge host, see **Alternate Numeric Keypad Emulation**.

**Note:** When changing USB country keyboard types the scanner automatically resets and issues the standard startup beep sequences.

**Note:** For best results when using international keyboards, enable **Quick Keypad Emulation**.

**Note:** Some country keyboard programming symbols are specific to certain Windows Operating Systems (i.e., Windows 7 or higher). Programming symbols requiring a specific Windows OS are identified in their captions.

**Note:** Use the **French International** programming symbol for Belgian French keyboards.



\* US English (North American)



US English (Mac)



Albanian

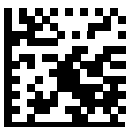

**Arabic (101)**



**Arabic (102)**



**Arabic (102) AZERTY**



**Azeri (Latin)**



**Azeri (Cyrillic)**



**Belarusian**



**Bosnian (Latin)**



**Bosnian (Cyrillic)**



**Bulgarian (Latin)**

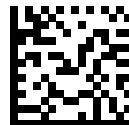

**Bulgarian Cyrillic (Typewriter)  
(Bulgarian -Windows XP  
Typewriter - Win 7 or higher)**

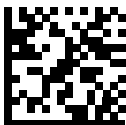

**Canadian French Win7**

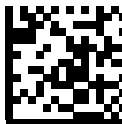

**Canadian French (Legacy)**



**Canadian Multilingual Standard**



**Chinese (ASCII)**



**Chinese (Simplified) \***

\* For CJK keyboard types, see [Appendix D — Chinese, Japanese, and Korean \(CJK\) Decode Control](#).



**Chinese (Traditional) \***

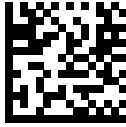

Croatian



Czech



Czech (Programmer)



Czech (QWERTY)

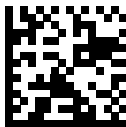

Danish



**Dutch (Netherlands)**



**Estonian**



**Faeroese**

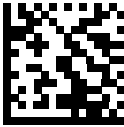

**Finnish**



**French (France)**



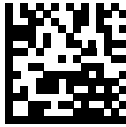

**French International  
(Belgian French)**



**French (Canada) 95/98**

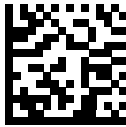

**French (Canada) 2000/XP \***

\* Note that there is also a country code programming symbol for **Canadian Multilingual Standard**. Select the appropriate programming symbol for your host system.

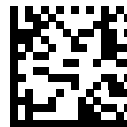

**Galician**



**German**

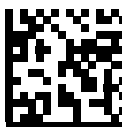

**Greek Latin**



**Greek (220) Latin**



**Greek (319) Latin**

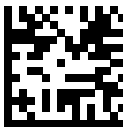

**Greek**



**Greek (220)**



**Greek (319)**



**Greek Polytonic**

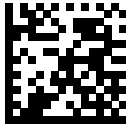

**Hebrew Israel**

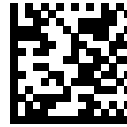

**Hungarian**



**Hungarian\_101KEY**



Icelandic



Irish



Italian



Italian (142)



Japanese (ASCII)

\* For CJK keyboard types, see [Appendix D — Chinese, Japanese, and Korean \(CJK\) Decode Control](#).



Japanese (SHIFT-JIS) \*



Kazakh



Korean (ASCII)

\* For CJK keyboard types, see [Appendix D — Chinese, Japanese, and Korean \(CJK\) Decode Control](#).

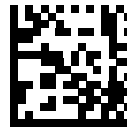

Korean (Hangul) \*

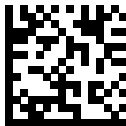

Kyrgyz



**Latin American**



**Latvian**



**Latvian (QWERTY)**

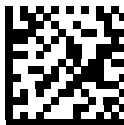

**Lithuanian**

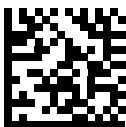

**Lithuanian (IBM)**



**Macedonian (FYROM)**

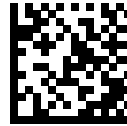

**Maltese\_47KEY**



**Mongolian**

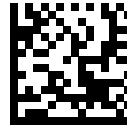

**Norwegian**

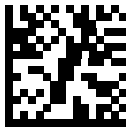

**Polish (214)**



**Polish (Programmer)**



**Portuguese (Brazil)  
(Windows XP)**

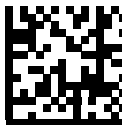

**Portuguese (Brazilian ABNT)**



**Portuguese (Brazilian ABNT2)**



**Portuguese (Portugal)**





**Romanian  
(Windows XP)**



**Romanian (Legacy)  
(Win 7 or higher)**



**Romanian (Standard)  
(Win 7 or higher)**

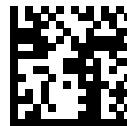

**Romanian (Programmer)  
(Win 7 or higher)**



**Russian**

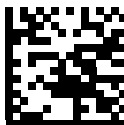

**Russian (Typewriter)**



**Serbian (Latin)**



**Serbian (Cyrillic)**



**Slovak**



**Slovak (QWERTY)**

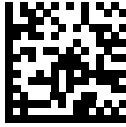

**Slovenian**

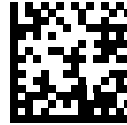

**Spanish**

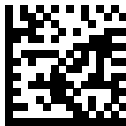

**Spanish (Variation)**

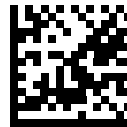

**Swedish**



**Swiss French**

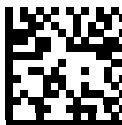

**Swiss German**



**Tatar**

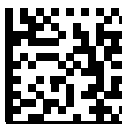

**Thai (Kedmanee)**

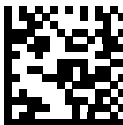

**Turkish F**



**Turkish Q**



**UK English**



**Ukrainian**



**US Dvorak**



**US Dvorak Left**



**US Dvorak Right**

---

*Country Codes*



**US International**

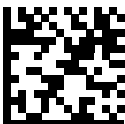

**Uzbek**



**Vietnamese**

## Appendix C — Country Code Pages

### Introduction

This chapter provides programming symbols for selecting code pages for the country keyboard type selected in [Appendix A — Standard Default Parameters](#). If the default code page in the table below is appropriate for your selected country keyboard type, you do not need to scan a country code page programming symbol.

### Country Code Page Defaults

The table below lists the code page default for each country keyboard.

Country Keyboard	Code Page Default
US English (North American)	Windows 1252
US English (Mac)	Mac CP10000
Albanian	Windows 1250
Arabic 101	Windows 1256
Arabic 102	Windows 1256
Arabic 102 AZERTY	Windows 1256
Azeri Latin	Windows 1254
Azeri Cyrillic	Windows 1251
Belarusian	Windows 1251
Bosnian Latin	Windows 1250
Bosnian Cyrillic	Windows 1251
Bulgarian Latin	Windows 1250
Bulgarian Cyrillic	Windows 1251
Canadian French Win7	Windows 1252
Canadian French (Legacy)	Windows 1252
Canadian Multilingual	Windows 1252
Croatian	Windows 1250
Chinese ASCII	Windows 1252
Chinese (Simplified)	Windows 936, GBK
Chinese (Traditional)	Windows 950, Big5
Czech	Windows 1250
Czech Programmers	Windows 1250
Czech QWERTY	Windows 1250
Danish	Windows 1252
Dutch Netherland	Windows 1252
Estonian	Windows 1257
Faeroese	Windows 1252

---

## Country Code Pages

<b>Country Keyboard</b>	<b>Code Page Default</b>
Finnish	Windows 1252
French (France)	Windows 1252
French (Canada) 95/98	Windows 1252
French (Canada) 2000/XP	Windows 1252
French International (Belgian French)	Windows 1252
Galician	Windows 1252
German	Windows 1252
Greek Latin	Windows 1252
Greek220 Latin	Windows 1253
Greek319 Latin	Windows 1252
Greek	Windows 1253
Greek220	Windows 1253
Greek319	Windows 1253
Greek Polytonic	Windows 1253
Hebrew Israel	Windows 1255
Hungarian	Windows 1250
Hungarian_101KEY	Windows 1250
Icelandic	Windows 1252
Irish	Windows 1252
Italian	Windows 1252
Italian_142	Windows 1252
Japanese ASCII	Windows 1252
Japanese (Shift-JIS)	Windows 932, Shift-JIS
Kazakh	Windows 1251
Korean ASCII	Windows 1252
Korean (Hangul)	Windows 949, Hangul
Kyrgyz Cyrillic	Windows 1251
Latin America	Windows 1252
Latvian	Windows 1257
Latvian QWERTY	Windows 1257
Lithuanian	Windows 1257
Lithuanian_IBM	Windows 1257
Macedonian -FYROM	Windows 1251
Maltese_47KEY	Windows 1252
Mongolian-Cyrillic	Windows 1251
Norwegian	Windows 1252



<b>Country Keyboard</b>	<b>Code Page Default</b>
Polish_214	Windows 1250
Polish Programmer	Windows 1250
Portuguese Brazil	Windows 1252
Portuguese Brazilian ABNT	Windows 1252
Portuguese Brazilian ABNT2	Windows 1252
Portuguese Portugal	Windows 1252
Romanian	Windows 1250
Romanian Legacy	Windows 1250
Romanian Standard	Windows 1250
Romanian Programmer	Windows 1250
Russian	Windows 1251
Russian Typewriter	Windows 1251
Serbian Latin	Windows 1250
Serbian Cyrillic	Windows 1251
Slovak	Windows 1250
Slovak QWERTY	Windows 1250
Slovenian	Windows 1250
Spanish	Windows 1252
Spanish Variation	Windows 1252
Swedish	Windows 1252
Swiss French	Windows 1252
Swiss German	Windows 1252
Tatar	Windows 1251
Thai-Kedmanee	Windows 874
Turkish F	Windows 1254
Turkish Q	Windows 1254
Ukrainian	Windows 1251
United Kingdom	Windows 1252
United States	Windows 1252
US Dvorak	Windows 1252
US Dvorak Left Hand	Windows 1252
US Dvorak Right Hand	Windows 1252
US International	Windows 1252
Uzbek Cyrillic	Windows 1251
Vietnamese	Windows 1258

## **Country Code Page Barcodes**

Scan the programming symbol corresponding to the country keyboard code page.



**Windows 1250**  
**Latin 2, Central European**



**Windows 1251**  
**Cyrillic, Slavic**



**Windows 1252**  
**Latin 1, Western European**



**Windows 1253**  
**Greek**



**Windows 1254  
Latin 5, Turkish**



**Windows 1255  
Hebrew**

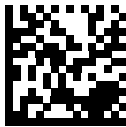

**Windows 1256  
Arabic**

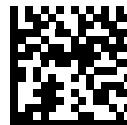

**Windows 1257  
Baltic**

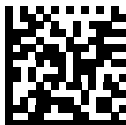

**Windows 1258  
Vietnamese**



**Windows 874  
Thai**



**Windows 20866  
Cyrillic KOI8-R**

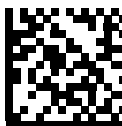

**Windows 932  
Japanese Shift-JIS**

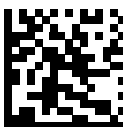

**Windows 936  
Simplified Chinese GBK**

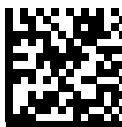

**Windows 54936  
Simplified Chinese GB18030**



**Windows 949  
Korean Hangul**

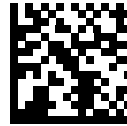

**Windows 950  
Traditional Chinese Big5**



**MS-DOS 437  
Latin US**

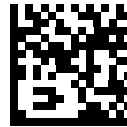

**MS-DOS 737  
Greek**

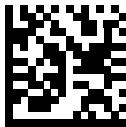

**MS-DOS 775  
Baltic**



**MS-DOS 850**  
**Latin 1**

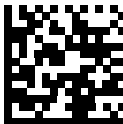

**MS-DOS 852**  
**Latin 2**

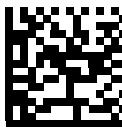

**MS-DOS 855**  
**Cyrillic**



**MS-DOS 857**  
**Turkish**

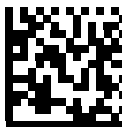

**MS-DOS 860**  
**Portuguese**



**MS-DOS 861**  
Icelandic

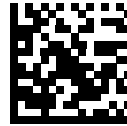

**MS-DOS 862**  
Hebrew

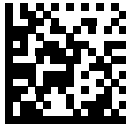

**MS-DOS 863**  
Canadian French

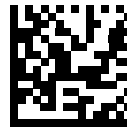

**MS-DOS 865**  
Nordic

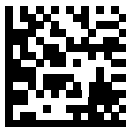

**MS-DOS 866**  
Cyrillic

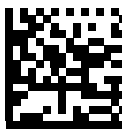

**MS-DOS 869  
Greek 2**

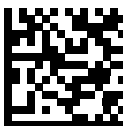

**ISO 8859-1  
Latin 1, Western European**



**ISO 8859-2  
Latin 2, Central European**



**ISO 8859-3  
Latin 3, Southern European**



**ISO 8859-4  
Latin 4, Northern European**





**ISO 8859-5**  
**Cyrillic**



**ISO 8859-6**  
**Arabic**

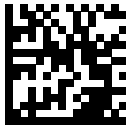

**ISO 8859-7**  
**Greek**

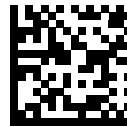

**ISO 8859-8**  
**Hebrew**

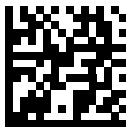

**ISO 8859-9**  
**Latin 5, Turkish**



**ISO 8859-10**  
**Latin 6, Nordic**



**ISO 8859-11**  
**Thai**

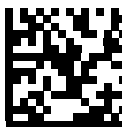

**ISO 8859-13**  
**Latin 7, Baltic**



**ISO 8859-14**  
**Latin 8, Celtic**

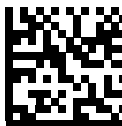

**ISO 8859-15**  
**Latin 9**

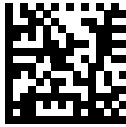

**ISO 8859-16**  
**Latin 10, South-Eastern European**



**UTF-8**



**UTF-16LE**  
**UTF-16 Little Endian**



**UTF-16BE**  
**UTF-16 Big Endian**



**Mac CP10000**  
**Roman**

# Appendix D — Chinese, Japanese, and Korean (CJK) Decode Control

## Introduction

This appendix describes control parameters for CJK (Chinese, Japanese, Korean) barcode decoding through USB HID Keyboard Emulation mode.

## CJK Control Parameters – Unicode Output Control

### Parameter # 973

For a Unicode-encoded CJK barcode, select one of the following options for unicode output:

- **Universal Output to Unicode and MBCS Application** - This default method applies to Unicode and MBCS expected applications, such as MS Word and Notepad on a Windows host.

**Note:** To support Unicode universal output, set up the registry table for the Windows host.

- **Output to Unicode Application Only** - This method applies only to Unicode-expected applications, such as MS Word and WordPad, but not Notepad.



\* Universal Output  
(0)



Unicode Application Only  
(1)

## CJK Output Method to Windows Host

### Parameter # 972

For a national standard encoded CJK barcode, select one of the following options for CJK output to a Windows host:

- **Universal CJK Output** - This is the default universal CJK output method for US English IME or Chinese/Japanese/Korean ASCII IME on a Windows host. This method converts CJK characters to Unicode and emulates the characters when transmitting to the host. Use the **Unicode Output Control** parameter to control Unicode output.

**Note:** To support universal CJK output, set up the registry table for the Windows host. See **Unicode/CJK Decode Setup with Windows Host**.

- **Other options for CJK output** - With the following methods, the scanner sends the CJK character hexadecimal internal code (Nei Ma) value to host, or converts the CJK character to Unicode and sends the hexadecimal Unicode value to host. When using these methods, the Windows host must select the corresponding IME to accept the CJK character. See **Unicode/CJK Decode Setup with Windows Host**.

- **Japanese Unicode Output**
- **Simplified Chinese GBK Code Output**
- **Simplified Chinese Unicode Output**
- **Korean Unicode Code Output**
- **Traditional Chinese Big5 Code Output** (Windows XP)
- **Traditional Chinese Big5 Code Output** (Windows 7)
- **Traditional Chinese Unicode Code Output** (Windows XP)
- **Traditional Chinese Unicode Code Output** (Windows 7)

**Note:** The Unicode emulate output method depends on the host system (Windows XP or Windows 7).

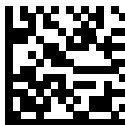

\* Universal CJK Output  
(0)



**Japanese Unicode Output  
(34)**

(For Japanese Unicode Output,  
select Simplified Chinese Unicode  
IME on the Windows host.)



**Chinese (Simplified) GBK Output  
(1)**



**Chinese (Simplified) Unicode Output  
(2)**



**Korean Unicode Output  
(50)**

(For Korean Unicode Output,  
select Simplified Chinese Unicode  
IME on the Windows host.)



**Chinese (Traditional) Big5 Output  
(Windows XP) (17)**



**Chinese (Traditional) Big5 Output  
(Windows 7)  
(19)**



**Chinese (Traditional) Unicode Output  
(Windows XP)  
(18)**

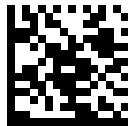

**Chinese (Traditional) Unicode Output  
(Windows 7)  
(20)**

## Non-CJK UTF Barcode Output

### **Parameter # 960**

Some country keyboard type layouts contain characters that do not exist in the default code page (see **Country Keyboard Type Missing Characters** on the next page). Although the default code page can not encode these characters in a barcode, they can be encoded in the UTF-8 barcode. Scan this parameter programming symbol to output the Unicode values by emulation mode.

**Note:** Use this special country keyboard type to decode the non-CJK UTF-8 barcode. After decoding, re-configure the scanner to use the original country keyboard type. Use US English IME on Windows.

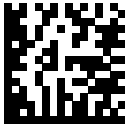

**Non-CJK UTF-8 Emulation Output**



## Country Keyboard Type Missing Characters

Country keyboard type: **Tatar, Uzbek, Mongolian, Kyrgyz, Kazakh and Azeri**

Default code page: CP1251

Missing characters:

ƒ	F
х	X
к	К
h	h
ө	Ө
ə	Ə
Ү	Y
ң	Ң
ж	Ж
ƒ	
ң	Ң
Ү	Y
к	К
қ	Қ
к	К

Country keyboard type: **Romanian (Standard)**

Default code page: CP1250

Missing characters:

ș	Ș
ț	Ț

Country keyboard type: **Portuguese-Brazilian (ABNT), Portuguese-Brazilian (ABNT2)**

Default code page: CP1252

Missing character: **€**

Country keyboard type: **Azeri-Latin**

Default code page: CP1254

Missing characters: ə, Ə

# Unicode/CJK Decode Setup with Windows Host

This section describes how to set up CJK decode with a Windows host.

## Setting Up the Windows Registry Table for Unicode Universal Output

To support the Unicode universal output method, set up the Windows host registry table as follows:

1. Select **Start > Run > regedt32** to start the registry editor.
2. Under **HKEY\_Current\_User\Control Panel\Input Method**, set **EnableHexNumpad** to **1** as follows:

```
[HKEY_CURRENT_USER\Control Panel\Input Method]
```

```
"EnableHexNumpad"="1"
```

If this key does not exist, add it as type **REG\_SZ** (string value).

3. Reboot the computer to implement the registry change.

## Adding CJK IME on Windows

To add the desired CJK input language:

1. Click **Start > Control Panel**.
2. If the Control Panel opens in category view, select **Switch to Classic View** in the top left corner.
3. Select **Regional and Language Options**.
4. Click the **Language** tab.
5. Under **Supplemental Language Support**, select the **Install Files for East Asian Languages** check box if not already selected, and click **Apply**. This may require a Windows installation CD to install the required files. This step ensures that the East Asian Languages (CJK) are available.
6. Under **Text Services and Input Language**, click **Details**.
7. Under **Installed Services**, click **Add**.
8. In the **Add Input Language** dialog box, choose the CJK input language and keyboard layout or Input Method Editor (IME) to add.
9. Click **OK** twice. The language indicator appears in the system tray (at bottom right corner of the desktop by default). To switch between input languages (keyboard languages) select the language indicator in the system tray.
10. Select the language indicator in the system tray to select the desired country keyboard type.
11. Verify that the characters displayed on each country's keyboard appear.

## Selecting the Simplified Chinese Input Method on the Host

To select the Simplified Chinese input method:

- Select Unicode/GBK input on Windows XP: **Chinese (Simplified) - NeiMa**, then click the input bar to select **Unicode** or **GBK NeiMa** input.

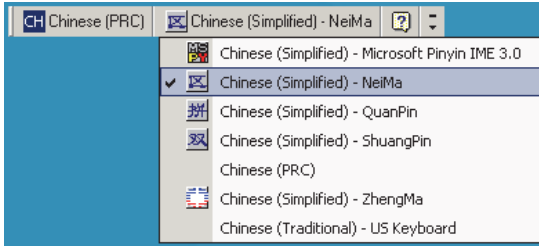

or



### Unicode/GBK Input on Windows XP

- Select Unicode/GBK input on Windows 7: **Chinese (Simplified) - Microsoft Pinyin New Experience Input Style**, then select **Tool Menu > Secondary Inputs > Unicode Input** or **GB Code Input**.

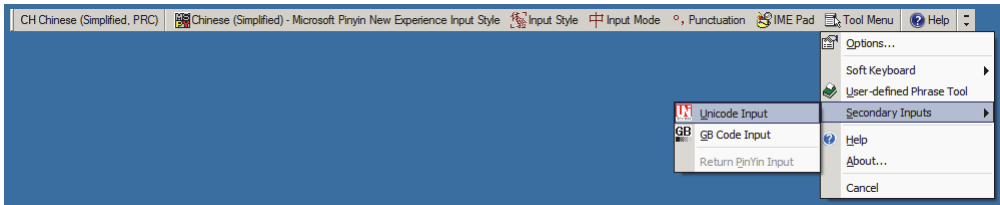

### Unicode/GBK Input on Windows 7

## Selecting the Traditional Chinese Input Method on the Host

To select the Traditional Chinese input method:

- Select Unicode input on Windows XP: Chinese (Traditional) - Unicode

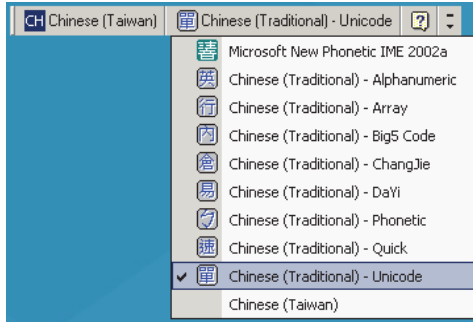

- Select Big5 input on Windows XP: Chinese (Traditional) - Big5 Code

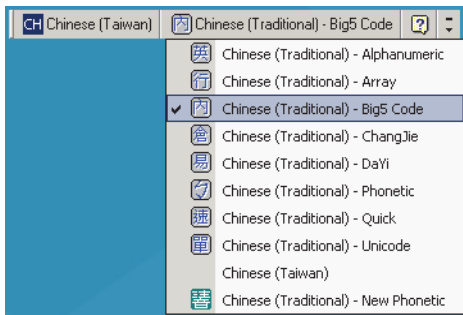

- Select Unicode/Big5 input on Windows 7: Chinese (Traditional) - New Quick. This option support both Unicode and Big5 input.

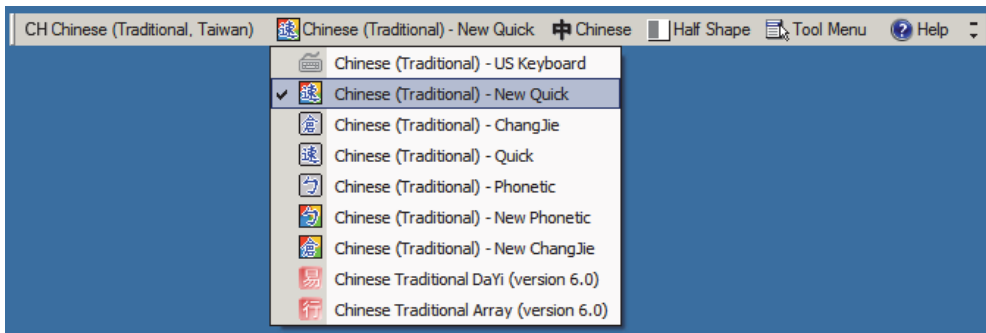

# Appendix E — Programming Reference

## Symbology Identifiers

Code Character	Code Type
A	UPC-A, UPC-E, UPC-E1, EAN-8, EAN-13
B	Code 39, Code 32
C	Codabar
D	Code 128, ISBT 128, ISBT 128 Concatenated
E	Code 93
F	Interleaved 2 of 5
G	Discrete 2 of 5, or Discrete 2 of 5 IATA
H	Code 11
J	MSI
K	GS1-128
L	Bookland EAN
M	Trioptic Code 39
N	Coupon Code
R	GS1 DataBar Family
S	Matrix 2 of 5
T	UCC Composite, TLC 39
U	Chinese 2 of 5
V	Korean 3 of 5
X	ISSN EAN, PDF417, Macro PDF417, Micro PDF417
z	Aztec, Aztec Rune
P00	Data Matrix
P01	QR Code, MicroQR
P02	Maxicode
P03	US Postnet
P04	US Planet
P05	Japan Postal
P06	UK Postal
P08	Netherlands KIX Code
P09	Australia Post
P0A	USPS 4CB/One Code/Intelligent Mail
P0B	UPU FICS Postal
P0C	Mailmark
P0H	Han Xin
P0G	GS1 Data Matrix
P0Q	GS1 QR
P0X	Signature Capture

## AIM Code Identifiers

Each AIM Code Identifier contains the three-character string **Jcm** where:

- J = Flag Character (ASCII 93)
- c = Code Character
- m = Modifier Character

Code Character	Code Type
A	Code 39, Code 39 Full ASCII, Code 32
C	Code 128, ISBT 128, ISBT 128 Concatenated, GS1-128, Coupon (Code 128 portion)
d	Data Matrix, GS1-DM
E	UPC/EAN, Coupon (UPC portion)
e	GS1 DataBar Family
F	Codabar
G	Code 93
H	Code 11
h	Han Xin
I	Interleaved 2 of 5
L	PDF417, Macro PDF417, Micro PDF417
L2	TLC 39
M	MSI
Q	QR Code, MicroQR, GS1-QR
S	Discrete 2 of 5, IATA 2 of 5
U	Maxicode
z	Aztec, Aztec Rune
X	Bookland EAN, ISSN EAN, Trioptic Code 39, Chinese 2 of 5, Matrix 2 of 5, Korean 3 of 5, US Postnet, US Planet, UK Postal, Japan Postal, Australia Post, Netherlands KIX Code, USPS 4CB/One Code/ Intelligent Mail, UPU FICS Postal, Signature Capture, Mailmark

## Modifier Characters

The modifier character is the sum of the applicable option values based on the table below.

Code Type	Option Value	Option
<b>Code 39</b>	0	No check character or Full ASCII processing.
	1	Reader has checked one check character.
	3	Reader has checked and stripped check character.
	4	Reader has performed Full ASCII character conversion.
	5	Reader has performed Full ASCII character conversion and checked one check character.
	7	Reader has performed Full ASCII character conversion and checked and stripped check character.
	Example: A Full ASCII barcode with check character W, <b>A+I+MI+DW</b> , is transmitted as <b>J</b> A7AIMID where 7 = (3+4).	
<b>Trioptic Code 39</b>	0	No option specified at this time. Always transmit 0.
	Example: A Trioptic barcode 412356 is transmitted as <b>J</b> X0412356	
<b>Mailmark</b>	0	No option specified at this time. Always transmit 0.
<b>Code 128</b>	0	Standard data packet, no Function code 1 in first symbol position.
	1	Function code 1 in first symbol character position.
	2	Function code 1 in second symbol character position.
	Example: A Code (EAN) 128 barcode with Function 1 character <sup>FNC1</sup> in the first position, AIMID is transmitted as <b>J</b> C1AIMID	
<b>I 2 of 5</b>	0	No check digit processing.
	1	Reader has validated check digit.
	3	Reader has validated and stripped check digit.
	Example: An I 2 of 5 barcode without check digit, 4123, is transmitted as <b>J</b> I04123	
<b>Codabar</b>	0	No check digit processing.
	1	Reader has checked check digit.
	3	Reader has stripped check digit before transmission.
	Example: A Codabar barcode without check digit, 4123, is transmitted as <b>J</b> F04123	
<b>Code 93</b>	0	No options specified at this time. Always transmit 0.
	Example: A Code 93 barcode 012345678905 is transmitted as <b>J</b> G0012345678905	
<b>MSI</b>	0	Check digits are sent.
	1	No check digit is sent.
	Example: An MSI barcode 4123, with a single check digit checked, is transmitted as <b>J</b> M14123	
<b>D 2 of 5</b>	0	No options specified at this time. Always transmit 0.
	Example: A D 2 of 5 barcode 4123, is transmitted as <b>J</b> S04123	

Code Type	Option Value	Option
<b>UPC/EAN</b>	0	Standard data packet in full EAN format, i.e. 13 digits for UPC-A, UPC-E, and EAN-13 (not including supplemental data).
	1	Two digit supplemental data only.
	2	Five digit supplemental data only.
	3	Combined data packet comprising 13 digits from EAN-13, UPC-A or UPC-E symbol and 2 or 5 digits from supplemental symbol.
	4	EAN-8 data packet.
	Example: A UPC-A barcode 012345678905 is transmitted as <b>JE00012345678905</b>	
<b>Bookland EAN</b>	0	No options specified at this time. Always transmit 0.
	Example: A Bookland EAN barcode 123456789X is transmitted as <b>JX0123456789X</b>	
<b>ISSN EAN</b>	0	No options specified at this time. Always transmit 0.
	Example: An ISSN EAN barcode 123456789X is transmitted as <b>JX0123456789X</b>	
<b>Code 11</b>	0	Single check digit
	1	Two check digits
	3	Check characters validated but not transmitted.
<b>GS1 DataBar Family</b>		No option specified at this time. Always transmit 0. GS1 DataBar-14 and GS1 DataBar Limited transmit with an Application Identifier "01". Note: In GS1-128 emulation mode, GS1 DataBar is transmitted using Code 128 rules (i.e., J C1).
	Example: A GS1 DataBar-14 barcode 0110012345678902 is transmitted as <b>Je00110012345678902</b> .	
<b>EAN.UCC Composites (GS1 DataBar, GS1-128, 2D portion of UPC composite)</b>		Native mode transmission. Note: UPC portion of composite is transmitted using UPC rules.
	0	Standard data packet.
	1	Data packet containing the data following an encoded symbol separator character.
	2	Data packet containing the data following an escape mechanism character. The data packet does not support the ECI protocol.
	3	Data packet containing the data following an escape mechanism character. The data packet supports the ECI protocol.
		GS1-128 emulation Note: UPC portion of composite is transmitted using UPC rules.
	1	Data packet is a GS1-128 symbol (i.e., data is preceded with J C1).



Code Type	Option Value	Option
<b>PDF417, Micro PDF417</b>	0	Reader set to conform to protocol defined in 1994 PDF417 symbology specifications. <b>Note:</b> When this option is transmitted, the receiver cannot reliably determine whether ECIs have been invoked or whether data byte 92 <sub>DEC</sub> has been doubled in transmission.
	1	Reader set to follow the ECI protocol (Extended Channel Interpretation). All data characters 92 <sub>DEC</sub> are doubled.
	2	Reader set for Basic Channel operation (no escape character transmission protocol). Data characters 92 <sub>DEC</sub> are not doubled. <b>Note:</b> When decoders are set to this mode, unbuffered Macro symbols and symbols requiring the decoder to convey ECI escape sequences cannot be transmitted.
	3	The barcode contains a GS1-128 symbol, and the first codeword is 903-907, 912, 914, 915.
	4	The barcode contains a GS1-128 symbol, and the first codeword is in the range 908-909.
	5	The barcode contains a GS1-128 symbol, and the first codeword is in the range 910-911.
	Example: A PDF417 barcode ABCD, with no transmission protocol enabled, is transmitted as jL2ABCD.	
<b>Data Matrix</b>	0	ECC 000-140, not supported.
	1	ECC 200.
	2	ECC 200, FNC1 in first or fifth position.
	3	ECC 200, FNC1 in second or sixth position.
	4	ECC 200, ECI protocol implemented.
	5	ECC 200, FNC1 in first or fifth position, ECI protocol implemented.
<b>GS1 Data Matrix</b>	2	ECC 200, FNC1 in first or fifth position.
	0	Symbol in Mode 4 or 5.
<b>MaxiCode</b>	1	Symbol in Mode 2 or 3.
	2	Symbol in Mode 4 or 5, ECI protocol implemented.
	3	Symbol in Mode 2 or 3, ECI protocol implemented in secondary message.

Code Type	Option Value	Option
<b>QR Code</b>	0	Model 1 symbol.
	1	Model 2 / MicroQR symbol, ECI protocol not implemented.
	2	Model 2 symbol, ECI protocol implemented.
	3	Model 2 symbol, ECI protocol not implemented, FNC1 implied in first position.
	4	Model 2 symbol, ECI protocol implemented, FNC1 implied in first position.
	5	Model 2 symbol, ECI protocol not implemented, FNC1 implied in second position.
	6	Model 2 symbol, ECI protocol implemented, FNC1 implied in second position.
<b>GS1 QR</b>	3	Model 2 symbol, ECI protocol not implemented, FNC1 implied in first position.
<b>Aztec</b>	0	Aztec symbol.
	C	Aztec Rune symbol.
<b>Han Xin</b>	0	Generic data, no special features are set. The transmitted data does not follow the AIM ECI protocol.
	1	ECI protocol enabled. There is at least one ECI mode encoded. Transmitted data must follow the AIM ECI protocol.

# Appendix F — Sample Symbols

## Code 39



## UPC/EAN

### *UPC-A, 100%*



### *EAN-13, 100%*



## Code 128



---

*Sample Symbols*

### **Interleaved 2 of 5**



12345678901231

### **GS1 DataBar-14**

DataBar-14 must be enabled to read the barcode below.



### **PDF417**



### **Data Matrix**



### **Maxicode**

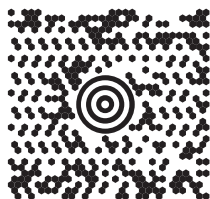

## QR Code



## US Postnet



## UK Postal



# Appendix G — Alphanumeric Keyboard

## Alphanumeric Programming Symbols

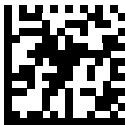

Space



#



\$



%



\*

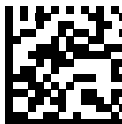

+



-



\*



/

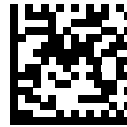

!



“

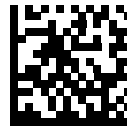

&



{



)



;

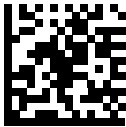

=



(



:



<



>





?

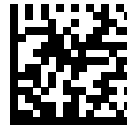

@

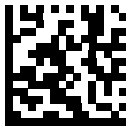

[



\



]



^



-



,

---

*Alphanumeric Keyboard*

**Important:** Do not confuse the following programming symbols with those on the numeric keypad.



1



3



5



0

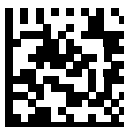

2

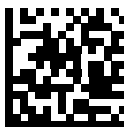

4

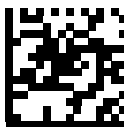

6

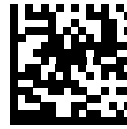

7



8



9



**End of Message**



**Cancel**

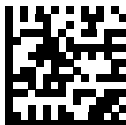

**A**



B

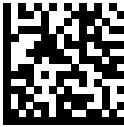

C



D



E



F



G

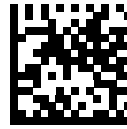

H



I



J



K



L



M

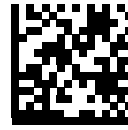

N

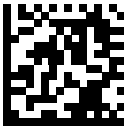

O



P



Q



R



S



T



U



V

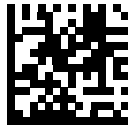

W



X

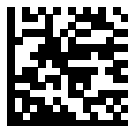

Y

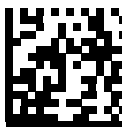

Z



a



b



c



d

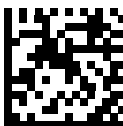

e



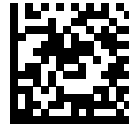

f



g



h



i



j

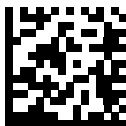

k



l



m



n



o



p



q



r



s



t



u



v

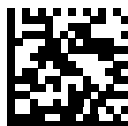

w

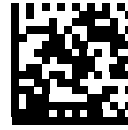

x



y



z



{



|



}

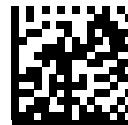

~

# Appendix H — Numeric Keyboard

## Numeric Programming Symbols

For parameters requiring specific numeric values, scan the appropriately numbered programming symbol(s).



0



1



2

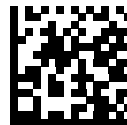

3



4



5



6



7



8



9

### **Cancel**

To correct an error or change a selection, scan the programming symbol below.

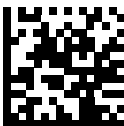

**Cancel**

## Appendix I — ASCII Character Sets

ASCII Value	Full ASCII Code 39 Encode Char	Keystroke
1000	%U	CTRL 2
1001	\$A	CTRL A
1002	\$B	CTRL B
1003	\$C	CTRL C
1004	\$D	CTRL D
1005	\$E	CTRL E
1006	\$F	CTRL F
1007	\$G	CTRL G
1008	\$H	CTRL H/ <b>BACKSPACE</b> <sup>1</sup>
1009	\$I	CTRL I/ <b>HORIZONTAL TAB</b> <sup>1</sup>
1010	\$J	CTRL J
1011	\$K	CTRL K
1012	\$L	CTRL L
1013	\$M	CTRL M/ <b>ENTER</b> <sup>1</sup>
1014	\$N	CTRL N
1015	\$O	CTRL O
1016	\$P	CTRL P
1017	\$Q	CTRL Q
1018	\$R	CTRL R
1019	\$S	CTRL S
1020	\$T	CTRL T
1021	\$U	CTRL U
1022	\$V	CTRL V
1023	\$W	CTRL W
1024	\$X	CTRL X
1025	\$Y	CTRL Y
1026	\$Z	CTRL Z
1027	%A	CTRL [
1028	%B	CTRL \
1029	%C	CTRL ]
1030	%D	CTRL 6
1031	%E	CTRL -

**The keystroke in bold transmits only if you enabled Function Key Mapping. Otherwise, the non-bold keystroke transmits.**

## ASCII Character Sets

ASCII Value	Full ASCII Code 39 Encode Char	Keystroke
1032	Space	Space
1033	/A	!
1034	/B	"
1035	/C	#
1036	/D	\$
1037	/E	%
1038	/F	&
1039	/G	'
1040	/H	(
1041	/I	)
1042	/J	*
1043	/K	+
1044	/L	,
1045	-	-
1046	.	.
1047	/o	/
1048	0	0
1049	1	1
1050	2	2
1051	3	3
1052	4	4
1053	5	5
1054	6	6
1055	7	7
1056	8	8
1057	9	9
1058	/Z	:
1059	%F	;
1060	%G	<
1061	%H	=
1062	%I	>
1063	%J	?
1064	%V	@
1065	A	A

The keystroke in bold transmits only if you enabled Function Key Mapping. Otherwise, the non-bold keystroke transmits.



ASCII Value	Full ASCII Code 39 Encode Char	Keystroke
1066	B	B
1067	C	C
1068	D	D
1069	E	E
1070	F	F
1071	G	G
1072	H	H
1073	I	I
1074	J	J
1075	K	K
1076	L	L
1077	M	M
1078	N	N
1079	O	O
1080	P	P
1081	Q	Q
1082	R	R
1083	S	S
1084	T	T
1085	U	U
1086	V	V
1087	W	W
1088	X	X
1089	Y	Y
1090	Z	Z
1091	%K	[
1092	%L	\
1093	%M	]
1094	%N	^
1095	%O	_
1096	%W	'
1097	+A	<b>a</b>
1098	+B	<b>b</b>
1099	+C	<b>c</b>

**The keystroke in bold transmits only if you enabled Function Key Mapping. Otherwise, the non-bold keystroke transmits.**

## ASCII Character Sets

ASCII Value	Full ASCII Code 39 Encode Char	Keystroke
1100	+D	d
1101	+E	e
1102	+F	f
1103	+G	g
1104	+H	h
1105	+I	i
1106	+J	j
1107	+K	k
1108	+L	l
1109	+M	m
1110	+N	n
1111	+O	o
1112	+P	p
1113	+Q	q
1114	+R	r
1115	+S	s
1116	+T	t
1117	+U	u
1118	+V	v
1119	+W	w
1120	+X	x
1121	+Y	y
1122	+Z	z
1123	%P	{
1124	%Q	
1125	%R	}
1126	%S	~
1127		Undefined

**The keystroke in bold transmits only if you enabled Function Key Mapping. Otherwise, the non-bold keystroke transmits.**

ALT Keys	Keystroke
2050	ALT 2
2054	ALT 6
2064	ALT @
2065	ALT A
2066	ALT B

<b>ALT Keys</b>	<b>Keystroke</b>
2067	ALT C
2068	ALT D
2069	ALT E
2070	ALT F
2071	ALT G
2072	ALT H
2073	ALT I
2074	ALT J
2075	ALT K
2076	ALT L
2077	ALT M
2078	ALT N
2079	ALT O
2080	ALT P
2081	ALT Q
2082	ALT R
2083	ALT S
2084	ALT T
2085	ALT U
2086	ALT V
2087	ALT W
2088	ALT X
2089	ALT Y
2090	ALT Z
2091	ALT [
2092	ALT \
2093	ALT ]

<b>GUI Key</b>	<b>Keystroke</b>
3000	Right Control Key
3001	PA 1
3002	PA 2
3003	CMD 1
3004	CMD 2
3005	CMD 3

**Note: GUI Shift Keys - The Apple™ iMac keyboard has an apple key on either side of the space bar. Windows-based systems have a GUI key to the left of the left ALT key, and to the right of the right ALT key.**

---

## ASCII Character Sets

GUI Key	Keystroke
3006	CMD 4
3007	CMD 5
3008	CMD 6
3009	CMD 7
3010	CMD 8
3011	CMD 9
3012	CMD 10
3013	CMD 11
3014	CMD 12
3015	CMD 13
3016	CMD 14
3048	GUI 0
3049	GUI 1
3050	GUI 2
3051	GUI 3
3052	GUI 4
3053	GUI 5
3054	GUI 6
3055	GUI 7
3056	GUI 8
3057	GUI 9
3065	GUI A
3066	GUI B
3067	GUI C
3068	GUI D
3069	GUI E
3070	GUI F
3071	GUI G
3072	GUI H
3073	GUI I
3074	GUI J
3075	GUI K
3076	GUI L
3077	GUI M

**Note: GUI Shift Keys - The Apple™ iMac keyboard has an apple key on either side of the space bar. Windows-based systems have a GUI key to the left of the left ALT key, and to the right of the right ALT key.**

GUI Key	Keystroke
3078	GUI N
3079	GUI O
3080	GUI P
3081	GUI Q
3082	GUI R
3083	GUI S
3084	GUI T
3085	GUI U
3086	GUI V
3087	GUI W
3088	GUI X
3089	GUI Y
3090	GUI Z

**Note: GUI Shift Keys - The Apple™ iMac keyboard has an apple key on either side of the space bar. Windows-based systems have a GUI key to the left of the left ALT key, and to the right of the right ALT key.**

---

## ASCII Character Sets

<b>PF Keys</b>	<b>Keystroke</b>
4001	PF 1
4002	PF 2
4003	PF 3
4004	PF 4
4005	PF 5
4006	PF 6
4007	PF 7
4008	PF 8
4009	PF 9
4010	PF 10
4011	PF 11
4012	PF 12
4013	PF 13
4014	PF 14
4015	PF 15
4016	PF 16

<b>F Keys</b>	<b>Keystroke</b>
5001	F 1
5002	F 2
5003	F 3
5004	F 4
5005	F 5
5006	F 6
5007	F 7
5008	F 8
5009	F 9
5010	F 10
5011	F 11
5012	F 12
5013	F 13
5014	F 14
5015	F 15
5016	F 16
5017	F 17
5018	F 18
5019	F 19
5020	F 20
5021	F 21
5022	F 22
5023	F 23
5024	F 24

---

## ASCII Character Sets

<b>Numeric Keypad</b>	<b>Keystroke</b>
6042	*
6043	+
6044	Undefined
6045	-
6046	.
6047	/
6048	0
6049	1
6050	2
6051	3
6052	4
6053	5
6054	6
6055	7
6056	8
6057	9
6058	Enter
6059	Num Lock



<b>Extended Keypad</b>	<b>Keystroke</b>
7001	Break
7002	Delete
7003	Pg Up
7004	End
7005	Pg Dn
7006	Pause
7007	Scroll Lock
7008	Backspace
7009	Tab
7010	Print Screen
7011	Insert
7012	Home
7013	Enter
7014	Escape
7015	Up Arrow
7016	Dn Arrow
7017	Left Arrow
7018	Right Arrow

## Appendix J — Non-Parameter Attributes

### Introduction

This appendix defines non-parameter attributes.

### Attributes

#### **Model Number**

##### **Attribute #533**

Model number of the scanner. This electronic output matches the printout on the physical device label, for example **LI2208-SR00006ZZWW**.

<b>Type</b>	S
<b>Size (Bytes)</b>	18
<b>User Mode Access</b>	R
<b>Values</b>	Variable

#### **Serial Number**

##### **Attribute #534**

Unique serial number assigned in the manufacturing facility. This electronic output matches the printout on the physical device label, for example **M1J26F45V**.

<b>Type</b>	S
<b>Size (Bytes)</b>	16
<b>User Mode Access</b>	R
<b>Values</b>	Variable

#### **Date of Manufacture**

##### **Attribute #535**

Date of device manufacture assigned in the manufacturing facility. This electronic output matches the printout on the physical device label, for example **30APR14** (which reads the 30th of April 2014).

<b>Type</b>	S
<b>Size (Bytes)</b>	7
<b>User Mode Access</b>	R
<b>Values</b>	Variable

## **Date of First Programming**

### **Attribute #614**

Date of first electronic programming represents the first time settings were electronically loaded to the scanner either by 123Scan or via SMS, for example **18MAY14** (which reads the 18th of May 2014).

<b>Type</b>	S
<b>Size (Bytes)</b>	7
<b>User Mode Access</b>	R
<b>Values</b>	Variable

## **Configuration Filename**

### **Attribute #616**

The name assigned to the configuration settings loaded electronically to the device either by 123Scan or via SMS.

**Note:** Scanning the **Set Defaults** programming symbol automatically changes the configuration filename to *factory defaults*.

To indicate the configuration settings loaded to the device were changed, the configuration filename changes to *Modified* upon scanning any parameter programming symbol.

<b>Type</b>	S
<b>Size (Bytes)</b>	17
<b>User Mode Access</b>	RW
<b>Values</b>	Variable

## **Beeper/LED**

### **Attribute #6000**

Activates the beeper and/or LED.

<b>Type</b>	X
<b>Size (Bytes)</b>	N/A
<b>User Mode Access</b>	W

#### **Values:**

<b>Beep / LED Action</b>	<b>Value</b>
1 high short beep	0
2 high short beeps	1
3 high short beeps	2
4 high short beeps	3
5 high short beeps	4
1 low short beep	5
2 low short beeps	6

---

### *Non-Parameter Attributes*

3 low short beeps	7
4 low short beeps	8
5 low short beeps	9
1 high long beep	10
2 high long beeps	11
3 high long beeps	12
4 high long beeps	13
5 high long beeps	14
1 low long beep	15
2 low long beeps	16
3 low long beeps	17
4 low long beeps	18
5 low long beeps	19
Fast warble beep	20
Slow warble beep	21
High-low beep	22
Low-high beep	23
High-low-high beep	24
Low-high-low beep	25
High-high-low-low beep	26
Green LED off	42
Green LED on	43
Red LED on	47
Red LED off	48

### ***Parameter Defaults***

#### **Attribute #6001**

This attribute restores all parameters to their factory defaults.

**Type** X

**Size (Bytes)** N/A

**User Mode Access** W

**Values**  
0 = Restore Defaults  
1 = Restore Factory Defaults  
2 = Write Custom Defaults

**Beep on Next Bootup****Attribute #6003**

This attribute configures (enables or disables) beep on next boot up of scanner.

<b>Type</b>	X
<b>Size (Bytes)</b>	N/A
<b>User Mode Access</b>	W
<b>Values</b>	0 = Disable beep on next bootup 1 = Enable beep on next bootup

**Reboot****Attribute #6004**

This attribute initiates a device reboot.

<b>Type</b>	X
<b>Size (Bytes)</b>	N/A
<b>User Mode Access</b>	W
<b>Values</b>	N/A

**Host Trigger Session****Attribute #6005**

This attribute triggers a decode session similar to manually depressing the scanner trigger button.

<b>Type</b>	X
<b>Size (Bytes)</b>	N/A
<b>User Mode Access</b>	W
<b>Values</b>	1 = Start Host Trigger Session 0 = Stop Host Trigger Session

**Firmware Version****Attribute #20004**

The scanner's operating system version. For example, NBRFMAAC or PAAAABS00-007-R03D0.

<b>Type</b>	S
<b>Size (Bytes)</b>	Variable
<b>User Mode Access</b>	R
<b>Values</b>	Variable

---

## Non-Parameter Attributes

### **Scankit Version**

#### **Attribute #20008**

Identifies the 1D decode algorithms resident on the device, for example **SKIT4.33T02**.

<b>Type</b>	S
<b>Size (Bytes)</b>	Variable
<b>User Mode Access</b>	R
<b>Values</b>	Variable

### **ImageKit Version**

#### **Attribute #20013**

Identifies the 2D decode algorithms resident on the device, for example **IMGKIT\_7.01T08.31**.

<b>Type</b>	S
<b>Size (Bytes)</b>	Variable
<b>User Mode Access</b>	R
<b>Values</b>	Variable

Copyright ©2018  
Omron Microscan Systems, Inc.

[www.microscan.com](http://www.microscan.com)  
Tel: +1.425.226.5700 / 800.762.1149  
Fax: +1.425.226.8250

All rights reserved. The information contained herein is proprietary and is provided solely for the purpose of allowing customers to operate and/or service Omron Microscan-manufactured equipment and is not to be released, reproduced, or used for any other purpose without written permission of Omron Microscan. Throughout this manual, trademarked names might be used. We state herein that we are using the names to the benefit of the trademark owner, with no intention of infringement.