

## Thermal Condition Monitoring Device

### User's Manual K6PM-TH

1  
Outline

2  
Installation and  
Wiring

3  
Initial Settings

4  
Monitoring the Temperature  
in Control Panel with the Main  
Unit and the Software Tool

5  
Monitoring and Setting  
with the EtherNet/IP  
Communications

6  
Monitoring and Setting  
with the Modbus TCP

7  
Troubleshooting

8  
Appendices

I  
Index



## **NOTE**

All rights reserved. No part of this publication may be reproduced, stored in a retrieval system, or transmitted, in any form, or by any means, mechanical, electronic, photocopying, recording, or otherwise, without the prior written permission of OMRON.

No patent liability is assumed with respect to the use of the information contained herein. Moreover, because OMRON is constantly striving to improve its high-quality products, the information contained in this manual is subject to change without notice. Every precaution has been taken in the preparation of this manual. Nevertheless, OMRON assumes no responsibility for errors or omissions. Neither is any liability assumed for damages resulting from the use of the information contained in this publication.

## **Trademarks**

- Microsoft, Windows is either registered trademarks or trademarks of Microsoft Corporation in the United States and other countries.
- ODVA, CIP, CompoNet, DeviceNet, and EtherNet/IP are trademarks of ODVA.
- Modbus is a registered trademark of Schneider Electric.

Other company names and product names in this document are the trademarks or registered trademarks of their respective companies.

## **Copyrights**

Microsoft product screen shots reprinted with permission from Microsoft Corporation.

# Preface

---

Thank you for purchasing the K6PM-TH Thermal Condition Monitoring Device. This manual describes how to use the K6PM-TH.

Read this manual thoroughly and be sure you understand it before attempting to use the K6PM-TH correctly according to the information provided. Keep this manual in a safe place for easy reference.

PDF version of this manual can be downloaded from the OMRON website. (<http://www.omron.com>)

# Terms and Conditions Agreement

## Warranty, Limitations of Liability

### Warranties

#### ● Exclusive Warranty

Omron's exclusive warranty is that the Products will be free from defects in materials and workmanship for a period of twelve months from the date of sale by Omron (or such other period expressed in writing by Omron). Omron disclaims all other warranties, express or implied.

#### ● Limitations

OMRON MAKES NO WARRANTY OR REPRESENTATION, EXPRESS OR IMPLIED, ABOUT NON-INFRINGEMENT, MERCHANTABILITY OR FITNESS FOR A PARTICULAR PURPOSE OF THE PRODUCTS. BUYER ACKNOWLEDGES THAT IT ALONE HAS DETERMINED THAT THE PRODUCTS WILL SUITABLY MEET THE REQUIREMENTS OF THEIR INTENDED USE.

Omron further disclaims all warranties and responsibility of any type for claims or expenses based on infringement by the Products or otherwise of any intellectual property right.

#### ● Buyer Remedy

Omron's sole obligation hereunder shall be, at Omron's election, to (i) replace (in the form originally shipped with Buyer responsible for labor charges for removal or replacement thereof) the non-complying Product, (ii) repair the non-complying Product, or (iii) repay or credit Buyer an amount equal to the purchase price of the non-complying Product; provided that in no event shall Omron be responsible for warranty, repair, indemnity or any other claims or expenses regarding the Products unless Omron's analysis confirms that the Products were properly handled, stored, installed and maintained and not subject to contamination, abuse, misuse or inappropriate modification. Return of any Products by Buyer must be approved in writing by Omron before shipment. Omron Companies shall not be liable for the suitability or unsuitability or the results from the use of Products in combination with any electrical or electronic components, circuits, system assemblies or any other materials or substances or environments. Any advice, recommendations or information given orally or in writing, are not to be construed as an amendment or addition to the above warranty.

See <http://www.omron.com/global/> or contact your Omron representative for published information.

### Limitation on Liability; Etc

OMRON COMPANIES SHALL NOT BE LIABLE FOR SPECIAL, INDIRECT, INCIDENTAL, OR CONSEQUENTIAL DAMAGES, LOSS OF PROFITS OR PRODUCTION OR COMMERCIAL LOSS IN ANY WAY CONNECTED WITH THE PRODUCTS, WHETHER SUCH CLAIM IS BASED IN CONTRACT, WARRANTY, NEGLIGENCE OR STRICT LIABILITY.

Further, in no event shall liability of Omron Companies exceed the individual price of the Product on which liability is asserted.

## Application Considerations

### Suitability of Use

Omron Companies shall not be responsible for conformity with any standards, codes or regulations which apply to the combination of the Product in the Buyer's application or use of the Product. At Buyer's request, Omron will provide applicable third party certification documents identifying ratings and limitations of use which apply to the Product. This information by itself is not sufficient for a complete determination of the suitability of the Product in combination with the end product, machine, system, or other application or use. Buyer shall be solely responsible for determining appropriateness of the particular Product with respect to Buyer's application, product or system. Buyer shall take application responsibility in all cases.

NEVER USE THE PRODUCT FOR AN APPLICATION INVOLVING SERIOUS RISK TO LIFE OR PROPERTY OR IN LARGE QUANTITIES WITHOUT ENSURING THAT THE SYSTEM AS A WHOLE HAS BEEN DESIGNED TO ADDRESS THE RISKS, AND THAT THE OMRON PRODUCT(S) IS PROPERLY RATED AND INSTALLED FOR THE INTENDED USE WITHIN THE OVERALL EQUIPMENT OR SYSTEM.

### Programmable Products

Omron Companies shall not be responsible for the user's programming of a programmable Product, or any consequence thereof.

## Disclaimers

### Performance Data

Data presented in Omron Company websites, catalogs and other materials is provided as a guide for the user in determining suitability and does not constitute a warranty. It may represent the result of Omron's test conditions, and the user must correlate it to actual application requirements. Actual performance is subject to the Omron's Warranty and Limitations of Liability.

### Change in Specifications

Product specifications and accessories may be changed at any time based on improvements and other reasons. It is our practice to change part numbers when published ratings or features are changed, or when significant construction changes are made. However, some specifications of the Product may be changed without any notice. When in doubt, special part numbers may be assigned to fix or establish key specifications for your application. Please consult with your Omron's representative at any time to confirm actual specifications of purchased Product.

### Errors and Omissions

Information presented by Omron Companies has been checked and is believed to be accurate; however, no responsibility is assumed for clerical, typographical or proofreading errors or omissions.

# Safety Precautions

## Definition of Precautionary Information





The following notation is used in this manual to provide precautions required to ensure safe usage of the K6PM-TH Thermal Condition Monitoring Device.



The safety precautions that are provided are extremely important to safety. Always read and heed the information provided in all safety precautions. The following notation is used.









 <b>WARNING</b>	Indicates a potentially hazardous situation which, if not avoided, could result in death or serious injury. Additionally there may be significant property damage.
--	--

 <b>CAUTION</b>	Indicates a potentially hazardous situation which, if not avoided, may result in minor or moderate injury or in property damage.
--	--

## Symbols



Symbol		Meaning
Caution		<ul style="list-style-type: none"> <li>General Caution</li> </ul> Indicates non-specific general cautions, warnings, and dangers.
		<ul style="list-style-type: none"> <li>Electrical Shock Caution</li> </ul> Indicates possibility of electric shock under specific conditions.
Prohibition		<ul style="list-style-type: none"> <li>General Prohibition</li> </ul> Indicates non-specific general prohibitions.
		<ul style="list-style-type: none"> <li>Disassembly Prohibition</li> </ul> Indicates prohibitions when there is a possibility of injury, such as from electric shock, as the result of disassembly.
Mandatory Caution		<ul style="list-style-type: none"> <li>General Caution</li> </ul> Indicates non-specific general cautions, warnings, and dangers.



 <b>WARNING</b>	
The temperature may not be measured correctly. Do not use the product at locations where dust or oil content may settle on the lens. Also, do not directly touch the lens when installing the sensor.	
If the product fails, monitoring and alarm outputs may fail to operate. This may result in physical damage to the facilities, equipment, or other devices that are connected to it. To reduce this risk, inspect the product regularly. To make the product fail-safe, take alternative safety measures, such as the installation of monitoring devices on a separate circuit.	

 <b>CAUTION</b>	
Electrical shock may cause minor injury. Do not touch the product except for the front-panel buttons while electricity is being supplied.	
Electric shock may occasionally occur. Be sure to turn OFF the power supply before connecting the sensor.	
There is a risk of minor electrical shock, fire, or device failure. Do not allow any pieces of metal, conductors, or cutting chips that occur during the installation process to enter the product.	
Explosions may cause minor injuries. Do not use the product in locations with inflammable or explosive gases.	
There is a risk of minor electrical shock, fire, or device failure. Never disassemble, modify or repair the product or touch any of the internal parts.	
Incorrect wiring the input and output may occasionally result in fire and may occasionally occur resulting in property damage to connected equipment and machinery. Wire the input and output terminals correctly before power is supplied.	
If installation of wiring material is shallow, material damage due to ignition may occur in rare cases. When wiring, be sure to insert the wiring material all the way in.	





Take adequate security measures against DDoS attacks (Distributed Denial of Service attacks), computer viruses and other technologically harmful programs, unauthorized access and other possible attacks before using this product.

## Security Measures

<p><b>Anti-virus protection</b></p> <p>Install the latest commercial-quality antivirus software on the computer connected to the control/monitor system and maintain to keep the software up-to-date.</p>	
<p><b>Security measures to prevent unauthorized access</b></p> <p>Take the following measures to prevent unauthorized access to our products.</p> <ul style="list-style-type: none"> <li>• Install physical controls so that only authorized personnel can access control/monitor systems and equipment.</li> <li>• Reduce connections to control/monitor systems and equipment via networks to prevent access from untrusted devices.</li> <li>• Install firewalls to shut down unused communications ports and limit communications hosts and isolate control/monitor systems and equipment from the IT network.</li> <li>• Use a virtual private network (VPN) for remote access to control/monitor systems and equipment.</li> <li>• Scan virus to ensure safety of SD cards or other external storages before connecting them to control/monitor systems and equipment.</li> </ul>	

<p><b>Data input and output protection</b>                  Validate backups and ranges to cope with unintentional modification of input/output data to control/monitor systems and equipment.</p> <ul style="list-style-type: none"> <li>• Checking the scope of data</li> <li>• Checking validity of backups and preparing data for restore in case of falsification and abnormalities</li> <li>• Safety design, such as emergency shutdown, in case of data tampering and abnormalities</li> </ul>	
<p><b>Data recovery</b>                  Backup data and keep the data up-to-date periodically to prepare for data loss.</p>	

## Security Measures of Software Tool (Thermal Condition Monitoring Tool)

<p>To prevent computer viruses, install antivirus software on a computer where you use this software. Make sure to keep the antivirus software updated.</p>	
<p>Keep your computer's OS updated to avoid security risks caused by a vulnerability in the OS. Manage usernames and passwords in the OS or this software carefully to protect them from unauthorized uses.</p>	
<p>Always use the highest version of this software to add new features, increase operability, and enhance security.</p>	
<p>Set up a firewall (E.g., disabling unused communication ports, limiting communication hosts, etc.) on a network for a control/monitor system and devices to separate them from other IT networks. Make sure to connect to the control/monitor system inside the firewall.</p>	
<p>Use a virtual private network (VPN) for remote access to a control/monitor system and devices from this software.</p>	

### Conformance to Safety Standards

<ul style="list-style-type: none"> <li>• Reinforced insulation is provided between input power supply, output, and between other terminals (Main Unit only).</li> <li>• If the equipment is used in a manner not specified by the manufacturer, the protection provided by the equipment may be impaired.</li> <li>• K6PM-TH must be installed within a control panel as an embedded device, if using as a UL certified product.</li> <li>• Be sure to use the recommended fuse specified in the instruction manual by mounting it on the power supply input terminal of the Main Unit (+) or the power supply input terminal of the sensor (+V).</li> </ul>	
--	---

### Conformance to EN/IEC Standards

<p>This is a class A product. This is a class A product. In residential areas it may cause radio interference, in which case the user may be required to take adequate measures to reduce interference.</p> <p>To comply with EN standards, use an EN standard-compatible switching power supply for supplying the power supply voltage to the K6PM. Also, use a shielded cable between the sensor and the Main Unit, and between two sensors.</p>	
--	---



# Precautions for Safe Use

---

Be sure to observe the following precautions to prevent malfunction or adverse affects on the performance or functionality of the product. Not doing so may occasionally result in unexpected events. Do not handle the K6PM-TH in ways that exceed the ratings.

## ● Common for the Main Unit and Sensor

- (1) Do not use or store the product in the following locations:
  - Locations subject to water or oil
  - Outdoor or locations subject to direct sunlight
  - Locations subject to dust or corrosive gases (particularly sulfurizing gases, ammonia, etc.)
  - Locations subject to rapid temperature changes
  - Locations prone to icing and dew condensation
  - Locations subject to excessive vibration or shock
  - Locations subject to rain and wind damage
  - Locations subject to influence of static electricity and noise
  - Locations subject to bugs and small animals
- (2) Use and store the product in a location where the ambient temperature and humidity are within the specified ranges. If applicable, provide forced cooling.
- (3) Check terminal polarity when wiring and wire all connections correctly.
- (4) Do not wire the input and output terminals incorrectly.
- (5) Be sure the power voltage is within the rated range.
- (6) In order to prevent inductive noise, wire the lines connected to the product separately from power lines carrying high voltages or currents. Also, do not wire in parallel with or on the same cables as power lines. Other measures for reducing noise are to separate from ducts including noisy lines.
- (7) Do not use the product near radio wave receivers. Doing so may cause incoming radio wave interference.
- (8) When discarding the product, properly dispose of it as industrial waste.
- (9) The maximum terminal temperature is 80°C. Use wires with a heat resistance of 80°C min to wire the terminals.
- (10) Don't use because it may be damaged inside the product when the product fall by mistake.
- (11) Confirm the wiring the input and output terminals correctly before power is supplied.
- (12) Do not bend a wire past its natural bending radius or pull on it with excessive force. Doing so may cause the wire disconnection.
- (13) Use the cable within the length that is rated in the specification requirements for the wiring between the sensor and the product. As for the requirements on the cable distance, refer to *2-3-3 I/O Wiring* on page 2-17.
- (14) Do not connect or disconnect the cables between the sensor and the product while power is being supplied. Doing so may result in malfunction or failure of the product.
- (15) Do not place heavy objects on the cables between the sensor and the Product, and do not apply excessive force to bend or pull the cables. Doing so may cause a failure.
- (16) When using the arrival prediction function, make sure multiple targets with different heat-emitting tendencies are not included in the segment, and at the same time, make sure the ambient temperature does not change rapidly due to the effect of the air-cooling fan, or the opening/closing of the control panel door, in order to correctly measure the arrival prediction.
- (17) Do not install the product at a location where the sensor unit may be shaken due to vibrations or impact.
- (18) Use this product inside the control panel to prevent external noise.

- (19) Use the wire given in this manual.
- (20) When wiring, wire by enough length.

● **Main Unit Only**

- (1) Mount the product in the correct direction for installation.
- (2) Make sure the crimp terminals for wiring are of the specified size.
- (3) Do not connect anything to terminals that are not being used.
- (4) The alarm output function is a function for the output of an alarm when the set threshold value is exceeded. Do not use this function for control, etc.
- (5) Make sure the LCD and the LEDs for output indicators operate correctly. Depending on the application environment, the indicators and other plastic parts may wear prematurely and become difficult to see. Check and replace these parts regularly.
- (6) Be sure to use power terminals carefully, because power supply terminals have hazardous voltage.
- (7) Do not wire anything to the release holes.
- (8) Do not tilt or twist a flat-blade screwdriver while it is inserted into a release hole on the terminal block. The terminal block may be damaged.
- (9) Insert a flat-blade screwdriver into the release holes at an angle. The terminal block may be damaged if you insert the screwdriver straight in.
- (10) Do not allow the flat-blade screwdriver to fall out while it is inserted into a release hole.
- (11) The terminal block may be damaged if you insert a flat-blade screwdriver in the release hole with excessive force. Insert the flat-blade screwdriver into the release holes with a force of 15 N or less.
- (12) Do not insert more than one wire into each terminal insertion hole.
- (13) To prevent wiring materials from smoking or ignition, use the wiring materials given in the following table.

Wire type	Wiring material	Recommended Wire	Stripping length
			Without ferrules
Solid/ Stranded wire	Copper	0.25 to 1.5 mm <sup>2</sup> AWG24 to AWG16	8 mm

- (14) Follow the directions indicated in the manual for connecting EtherNet/IP™ or the cable. It may result in communications failure.
- (15) If EtherNet/IP™ tag data links (cyclic communications) are used with a repeating hub, the communications load on the network will increase. This will increase collisions and may prevent stable communications.
- (16) Do not use the Temperature Controller if the front sheet is peeling off or torn.
- (17) The automatic setting of the alarm temperature threshold function automatically calculates the threshold value based on the past temperature data up to the time when the **Calculation** Button was clicked. If the installation environment or operation state changes due to operation of the cooling fans or opening and closing of the control panel door, click the **Calculation** Button again to reset the threshold value. To set the threshold value in more detail, we recommend setting it for each segment individually, instead of using the automatic setting of the alarm temperature threshold function.
- (18) Always use OMRON-designated sensors.

### ● Sensor Only

- (1) To prevent wiring materials from smoking or ignition, use the wiring materials given in the following table.

Wire type	Wiring material	Recommended Wire
Solid/ Stranded wire	Copper	0.25 to 1.5 mm <sup>2</sup> AWG24 to AWG16

- (2) Check that the LED indicators are operating normally. Depending on the application environment, the indicators and other plastic parts may wear prematurely and become difficult to see. Check and replace these parts regularly.
- (3) Do not use the sensor at temperatures exceeding the maximum operating temperature. Doing so may result in deterioration or be damaged of the internal components. Consider the effect of heat radiated from the measurement object as well.
- (4) When setting the distance from the measurement object, also consider the voltage generated by the measurement object as well as safety standard certification requirements.

# Precautions for Correct Use

---

Observe the following operating methods to prevent failure and malfunction.

## ● Common for the Main Unit and Sensor

- (1) When cleaning the product, do not use thinners or solvents. Use commercial alcohol.
- (2) Confirm that wire does not stick up after wiring of stranded cable.
- (3) Do not install the product near equipment that generates high frequencies or surges.
- (4) Read this manual carefully before using the product.
- (5) Install product so that the load doesn't span the product body.
- (6) Only a professional with an understanding of electricity and electric devices must handle it.
- (7) Do not install the product close contact with the heating element.
- (8) During periodic inspection, installation of an additional sensor, or adjustment of sensor position, use the product after ensuring that correct operation can be performed.
- (9) Do not use the product as a safety apparatus, or for the rescue of human lives.

## ● Main Unit Only

- (1) Use the power supply voltage, input power, and other power supplies and transformers with suitable capacities and rated outputs.
- (2) If you wire crossovers and connect terminal blocks in parallel, a large current will flow. Make sure that the current does not exceed 10 A.
- (3) The terminal block may be damaged if the recommended tool is not used. Use the recommended flat-blade screwdriver to operate the release holes.
- (4) Do not bend the communications cables past its natural bending radius or pull on it with excessive force. Do not place heavy objects on top of the communications cables or other wiring lines. Doing so may cause the wire disconnection.
- (5) Refer to the status information of the product on the data link communications and refer to the received data only in case of no errors occur with the product.
- (6) Use a power supply that will reach the rated voltage within 1 second after the power is turned ON.

## ● Sensor Only

- (1) Note that if the sensor is tilted and installed, the measurement range will also tilt.
- (2) The sensor must be installed in a specific direction. Check the measurement range before installing the sensor, and install the sensor in the correct direction.
- (3) The measurement range differs depending on the distance from the object to be measured up to the sensor. Be sure to check the measurement range before installing the sensor.
- (4) The sensor is a special product. Do not use it for any other purposes. Otherwise, failure may occur.
- (5) When installing the sensor, make sure there is no obstacle between the measurement target and the sensor as this could result in incorrect measurement of the temperature.
- (6) Do not use the alarm output function for control. This function can be used only to detect abnormal conditions and to output the alarm.
- (7) When cleaning during periodic inspection, lightly wipe the surface with a dry, soft cloth. Also, do not directly spray the cleaning solution on the sensor.
- (8) Do not forcibly remove the product. When power is supplied to the devices after re-installing the product, it may result in incorrect operation or device damage.
- (9) The easy-positioning magnet is for the purpose of seeking the detected position. In the case of using the product permanently, be sure to use it after it is mounted by screws.
- (10) When the product is installed vertically or upside down, ensure that the sensor does not fall off.

- (11) Refer to *2-2-3 Installation of the Infrared Thermal Sensor* on page 2-5 to install the sensor correctly. If the sensor is not correctly installed, the temperature may not be measured properly.
- (12) Do not disassemble the sensor. It may not operate correctly.
- (13) Be careful of incorrect wiring or short circuit for wiring.
- (14) In the case of insertion and removal of connector, be sure to do it by holding the connector with hands.
- (15) Do not remove the connector with holding the cable.
- (16) Do not wire with wet hands. It may result in operation failure or product damage when power is being supplied to the product.
- (17) When fitting the connector, be sure to do it with hands, not to use tools. It may result in damages if the tool like plier is used.
- (18) When removing the connector from the sensor, make sure that water or dirt does not adhere to the mating face of the connector. It may result in faulty contact at the connector.
- (19) Install cables to avoid any force is applied to the connector. In case the any force is applied to the connector, it causes that the performance of protection structure becomes incapable.
- (20) Do not mount the way that the force is directly applied to the fitting part of the connector or the root part of the cable connection. It may result in connector damage or cable disconnection.
- (21) Do not use the connector as a scaffold or put heavy objects on it. It may result in connector damage.
- (22) Fix the sensor with screws before using it. In case of using unfixed one, it is in the condition that force is easily applied to the cable, and the cable may be broken.
- (23) Make sure that the DIP switches are set as intended before you close the DIP switches cover.
- (24) To increase the accuracy of temperature measurement, install the sensor at a distance where the measurement object is as close to the center of view as possible and can be imaged as large as possible.

# Manual Structure

---

## Abbreviated Indicators

From the viewpoint of making it easier to read "Infrared thermal sensor" in the figures and text, it may be simply abbreviated as "sensor" at some places.

# Revision History

---

A manual revision code appears as a suffix to the catalog number on the front cover of the manual.

<b>Cat. No.</b>	<b>H231-E1-04</b>
-----------------	-------------------

↑  
Revision code

Revision code	Date	Revised content
01	May 2019	Original production
02	June 2019	Corrected mistakes.
03	April 2020	Made changes accompanying the following corrections. Page 5-3 and Page A-4: Added descriptions on the number of clients that can communicate at one time in the communications specifications. Page A-4: Changed and added descriptions in indicator specifications.
04	September 2022	Added information on <i>Safety Precautions</i> .





# Sections in this Manual

---

<b>1</b>	<b>Outline</b>	<b>1</b>
<b>2</b>	<b>Installation and Wiring</b>	<b>2</b>
<b>3</b>	<b>Initial Setting</b>	<b>3</b>
<b>4</b>	<b>Monitoring the Temperature in Control Panel with the Main Unit and the Software Tool</b>	<b>4</b>
<b>5</b>	<b>Monitoring and Setting with the EtherNet/IP Communications</b>	<b>5</b>
<b>6</b>	<b>Monitoring and Setting with the Modbus TCP</b>	<b>6</b>
<b>7</b>	<b>Troubleshooting</b>	<b>7</b>
<b>A</b>	<b>Appendices</b>	<b>A</b>
<b>I</b>	<b>Index</b>	<b>I</b>

# CONTENTS

---

<b>Preface .....</b>	<b>1</b>
<b>Terms and Conditions Agreement .....</b>	<b>2</b>
Warranty, Limitations of Liability .....	2
Application Considerations .....	3
Disclaimers .....	3
<b>Safety Precautions .....</b>	<b>4</b>
Definition of Precautionary Information.....	4
Symbols .....	4
<b>Precautions for Safe Use .....</b>	<b>7</b>
<b>Precautions for Correct Use.....</b>	<b>10</b>
<b>Manual Structure .....</b>	<b>12</b>
Abbreviated Indicators.....	12
<b>Revision History .....</b>	<b>13</b>
<b>Sections in this Manual .....</b>	<b>15</b>
<b>CONTENTS.....</b>	<b>16</b>

## Section 1 Outline

---

<b>1-1 Overview and Features .....</b>	<b>1-2</b>
1-1-1 Outline.....	1-2
1-1-2 Features .....	1-3
<b>1-2 Mechanism of Temperature Measurement and Monitoring .....</b>	<b>1-4</b>
1-2-1 Input .....	1-4
1-2-2 Measurement, Monitoring and Output.....	1-5
<b>1-3 List of Models and System Configurations.....</b>	<b>1-6</b>
1-3-1 List of Models .....	1-6
1-3-2 System Configurations .....	1-7
<b>1-4 Part Names and Functions .....</b>	<b>1-9</b>
1-4-1 Main Unit.....	1-9
1-4-2 Operating Modes of the Main Unit .....	1-12
1-4-3 Operation Flow on the Main Unit Front-Panel.....	1-13
1-4-4 Infrared Thermal Sensor .....	1-16
<b>1-5 Procedure .....</b>	<b>1-18</b>

## Section 2 Installation and Wiring

---

<b>2-1 Dimensions .....</b>	<b>2-2</b>
2-1-1 Main Unit.....	2-2
2-1-2 Infrared Thermal Sensor .....	2-2
<b>2-2 Installation.....</b>	<b>2-3</b>
2-2-1 Precautions at Installation.....	2-3
2-2-2 Installing the Main Unit.....	2-3
2-2-3 Installation of the Infrared Thermal Sensor .....	2-5
2-2-4 Position Registration of the Infrared Thermal Sensor .....	2-9

<b>2-3</b>	<b>Wiring</b> .....	<b>2-10</b>
2-3-1	How to Connect to the Push-In Plus Terminal Blocks.....	2-10
2-3-2	Diagram of Terminal Description.....	2-15
2-3-3	I/O Wiring.....	2-17
2-3-4	Ethernet Wiring.....	2-17

## Section 3 Initial Setting

---

<b>3-1</b>	<b>Installation and Uninstallation, Starting up</b> .....	<b>3-2</b>
3-1-1	Installing the Software Tool.....	3-2
3-1-2	Uninstalling the Software Tool .....	3-6
<b>3-2</b>	<b>IP Address Setting</b> .....	<b>3-7</b>
3-2-1	IP Address Setting of Your PC.....	3-7
3-2-2	Setting the IP Address of the Main Units with the Software Tool .....	3-9
<b>3-3</b>	<b>Registering the Sensor Position (Setting sensor screen)</b> .....	<b>3-15</b>
<b>3-4</b>	<b>Registering the Initial Settings and Sensor Configuration of the Main Unit (Setting K6PM screen)</b> .....	<b>3-18</b>

## Section 4 Monitoring the Temperature in Control Panel with the Main Unit and the Software Tool

---

<b>4-1</b>	<b>Method of Monitoring the Temperature in the Control Panel</b> .....	<b>4-2</b>
4-1-1	Overview of Temperature Monitoring.....	4-2
4-1-2	Display on the Main Unit after Registration of Sensor Configuration.....	4-2
4-1-3	Monitoring with the Main Unit .....	4-3
4-1-4	Monitoring Using Software Tools .....	4-5
<b>4-2</b>	<b>Functions of Monitoring the Temperature in the Control Panel</b> .....	<b>4-13</b>
4-2-1	Functions of Monitoring the Temperature in Control Panel with the Main Unit and the Software Tool .....	4-13
4-2-2	Operation Example of an Alarm.....	4-17
4-2-3	Automatic Saving Log Files .....	4-19
<b>4-3</b>	<b>Alarm Threshold Setting</b> .....	<b>4-23</b>
<b>4-4</b>	<b>Procedure for Taking Actions When an Alarm Occurs</b> .....	<b>4-25</b>

## Section 5 Monitoring and Setting with the EtherNet/IP Communications

---

<b>5-1</b>	<b>Outline</b> .....	<b>5-2</b>
5-1-1	What is Monitoring Using EtherNet/IP? .....	5-2
5-1-2	EtherNet/IP Communications Specifications .....	5-3
<b>5-2</b>	<b>Monitoring Using the Tag Data Link</b> .....	<b>5-4</b>
5-2-1	Connection Setting .....	5-4
5-2-2	Setting the Assembly Object.....	5-7
5-2-3	Assigning the Assembly Instance .....	5-7
<b>5-3</b>	<b>Monitoring and Setting Using the CIP Message Communications and Examples of Communications Instructions</b> .....	<b>5-10</b>
5-3-1	Services Supported by Objects in Main Units.....	5-10
5-3-2	Main Unit Monitor Object (Class ID: 374 hex) .....	5-10
5-3-3	K6PM-TH Sensor Monitor Object (Class ID: 375 hex) .....	5-12
5-3-4	K6PM-TH Sensor Temperature Monitor Object (Class ID: 376 hex) .....	5-14
5-3-5	Main Unit Setting Object (Class ID: 377 hex) .....	5-17
5-3-6	K6PM-TH Sensor Alarm Setting Object (Class ID: 378 hex).....	5-20
5-3-7	Identity Object (Class ID: 01 hex).....	5-22
5-3-8	TCP/IP Interface Object (Class ID: F5 hex).....	5-24

5-3-9	Examples of CIP Message Communications Instruction .....	5-27
-------	--	------

## Section 6 Monitoring and Setting with the Modbus TCP

<b>6-1</b>	<b>Outline .....</b>	<b>6-2</b>
<b>6-2</b>	<b>Function Codes .....</b>	<b>6-3</b>
6-2-1	Function Code List .....	6-3
6-2-2	03 hex: Reading of Multiple Registers .....	6-3
6-2-3	06 hex: Operation Command .....	6-5
6-2-4	10 hex: Writing of Multiple Registers.....	6-6
6-2-5	Exception Code List .....	6-7
<b>6-3</b>	<b>Register Address Lists.....</b>	<b>6-8</b>
6-3-1	Main Unit Monitor .....	6-8
6-3-2	K6PM-TH Sensor Temperature Monitor (1 to 31) .....	6-9
6-3-3	Main Unit Setting.....	6-12
6-3-4	Product Information.....	6-14
6-3-5	IP Address.....	6-14
6-3-6	K6PM-TH Sensor Alarm Setting (1 to 31).....	6-15
6-3-7	Operation Command.....	6-18

## Section 7 Troubleshooting

<b>7-1</b>	<b>Main Unit .....</b>	<b>7-2</b>
<b>7-2</b>	<b>Using the Software Tool.....</b>	<b>7-6</b>
<b>7-3</b>	<b>Using EtherNet Communications .....</b>	<b>7-7</b>

## Appendices

<b>A-1</b>	<b>Specifications .....</b>	<b>A-2</b>
A-1-1	Main Unit Specifications.....	A-2
A-1-2	Infrared Thermal Sensor .....	A-6
A-1-3	Software Tool .....	A-9
<b>A-2</b>	<b>Screen Flow of the Software Tool .....</b>	<b>A-12</b>
<b>A-3</b>	<b>Tag Data Link Connection Setting Procedures.....</b>	<b>A-13</b>
A-3-1	Preface.....	A-13
A-3-2	Using the CS/CJ-series.....	A-13
A-3-3	Using the NJ/NX-series.....	A-26
<b>A-4</b>	<b>Expansion Error Code of the CIP Message Communications.....</b>	<b>A-36</b>
A-4-1	General Status .....	A-36
A-4-2	Additional Status When General Status Is 01 hex .....	A-38

## Index

# 1

## Outline

This section describes an overview of the K6PM-TH Motor Condition Monitoring Device.

---

<b>1-1 Overview and Features</b> .....	<b>1-2</b>
1-1-1 Outline .....	1-2
1-1-2 Features .....	1-3
<b>1-2 Mechanism of Temperature Measurement and Monitoring</b> .....	<b>1-4</b>
1-2-1 Input .....	1-4
1-2-2 Measurement, Monitoring and Output .....	1-5
<b>1-3 List of Models and System Configurations</b> .....	<b>1-6</b>
1-3-1 List of Models .....	1-6
1-3-2 System Configurations .....	1-7
<b>1-4 Part Names and Functions</b> .....	<b>1-9</b>
1-4-1 Main Unit .....	1-9
1-4-2 Operating Modes of the Main Unit .....	1-12
1-4-3 Operation Flow on the Main Unit Front-Panel .....	1-13
1-4-4 Infrared Thermal Sensor .....	1-16
<b>1-5 Procedure</b> .....	<b>1-18</b>

# 1-1 Overview and Features

This section describes an overview and features of the Main Unit.

## 1-1-1 Outline

The Main Unit and the K6PM-TH sensor are used together to measure and monitor the surface temperature of devices in the control panel. A maximum of 31 infrared thermal sensors can be connected to one Main Unit. The surface temperature of devices in the control panel is measured with the infrared thermal sensor.

Use the software tool to make the Main Unit settings.

## Monitoring

The Main Unit can monitor the temperature of devices in the control panel by the following three methods:

### ● Monitoring with Main Unit

1) Set an alarm threshold for the Main Unit, and perform judgment output from the Main Unit based on transistor output.

### ● Monitoring with Software Tool

2) Perform monitoring with the software tool via Ethernet.

### ● Monitoring with PLC or PC

3) Perform monitoring from the PLC or PC via Ethernet (EtherNet/IP or Modbus TCP).

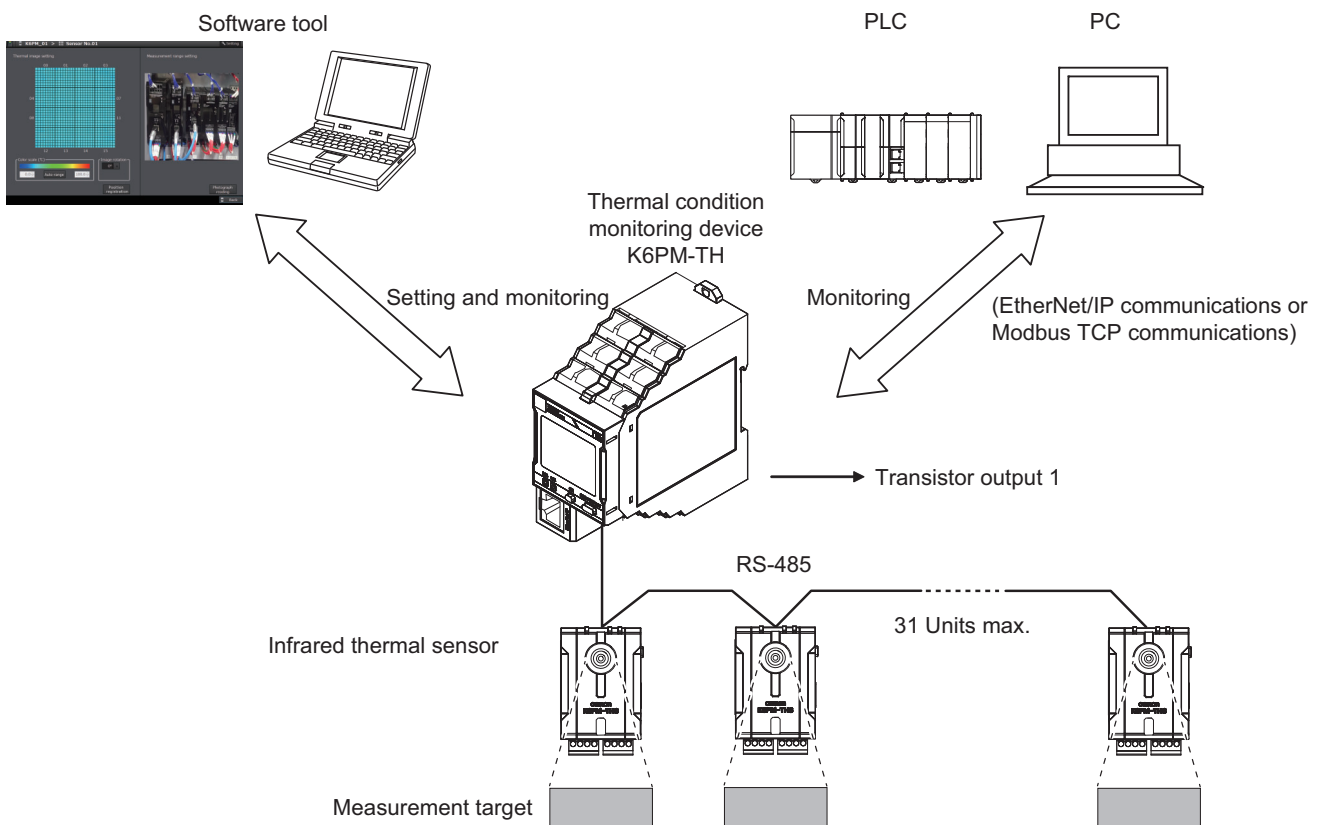

## 1-1-2 Features

### Alarm Determination Function

- Individual alarm determination can be performed in two levels of threshold 1 and threshold 2 for the measurement temperature of the target in the field of view of each infrared thermal sensor.
- If an individual alarm occurs in any of the infrared thermal sensors connected to the Main Unit, transistor output can be performed as a comprehensive alarm.
- With the help of the arrival prediction function of the Main Unit, it is possible to predict the temperature that will be finally reached from the temperature at the time of startup, and alarm determination can be performed based on this predicted value.
- It is possible to monitor each measured value and the alarm status of each infrared thermal sensor from the PLC or PC. EtherNet/IP (tag data link or CIP communications) or Modbus TCP can be used as the communications method.

#### ● Image of Alarm Determination Function

Threshold 1: Set as the minimum temperature at which maintenance is required (When Threshold Automatic Setting Function of Alarm Temperature is used, the minimum temperature at which maintenance is recommended is automatically set).

Threshold 2: Set as the minimum temperature at which urgent maintenance is required (When Threshold Automatic Setting Function of Alarm Temperature is used, the minimum temperature at which urgent maintenance is recommended automatically set).

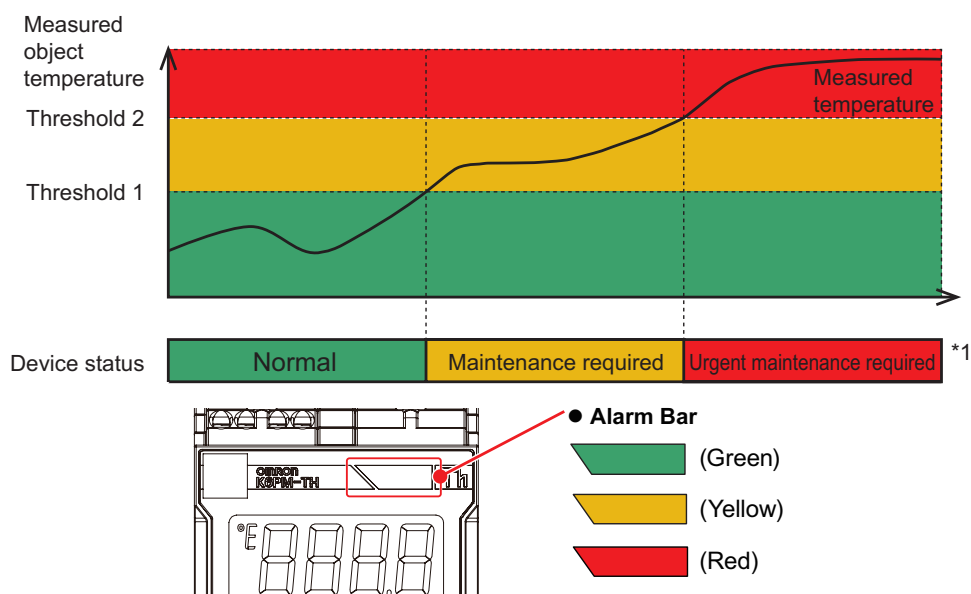

\*1. You can identify the status of the device from the color of the Main Unit alarm bar. You can also identify the status of the device from the state of transistor output 1 or 2.

### Settings and Monitoring by Software Tool

- A maximum of five Main Units can be connected to the software tool.
  - Setting the sampling cycle in the range of 1 to 99 minutes or 1 to 99 hours from the software tool
  - Displaying the thermal image of each infrared thermal sensor on the software tool
  - Automatically calculating the temperature alarm threshold from the past results
  - Logging the temperature data and status
  - Displaying the photo image of the installation location of the K6PM-TH sensor (measurement location) \*2
- \*2. Photo images must be captured by the customer.

### External Trigger Input

- It is possible to interrupt the measurement by an external trigger input (purpose: when the control panel door is opened/closed, etc.).

# 1-2 Mechanism of Temperature Measurement and Monitoring

This section shows each model and the model configuration of the Main Unit and the infrared thermal sensor.

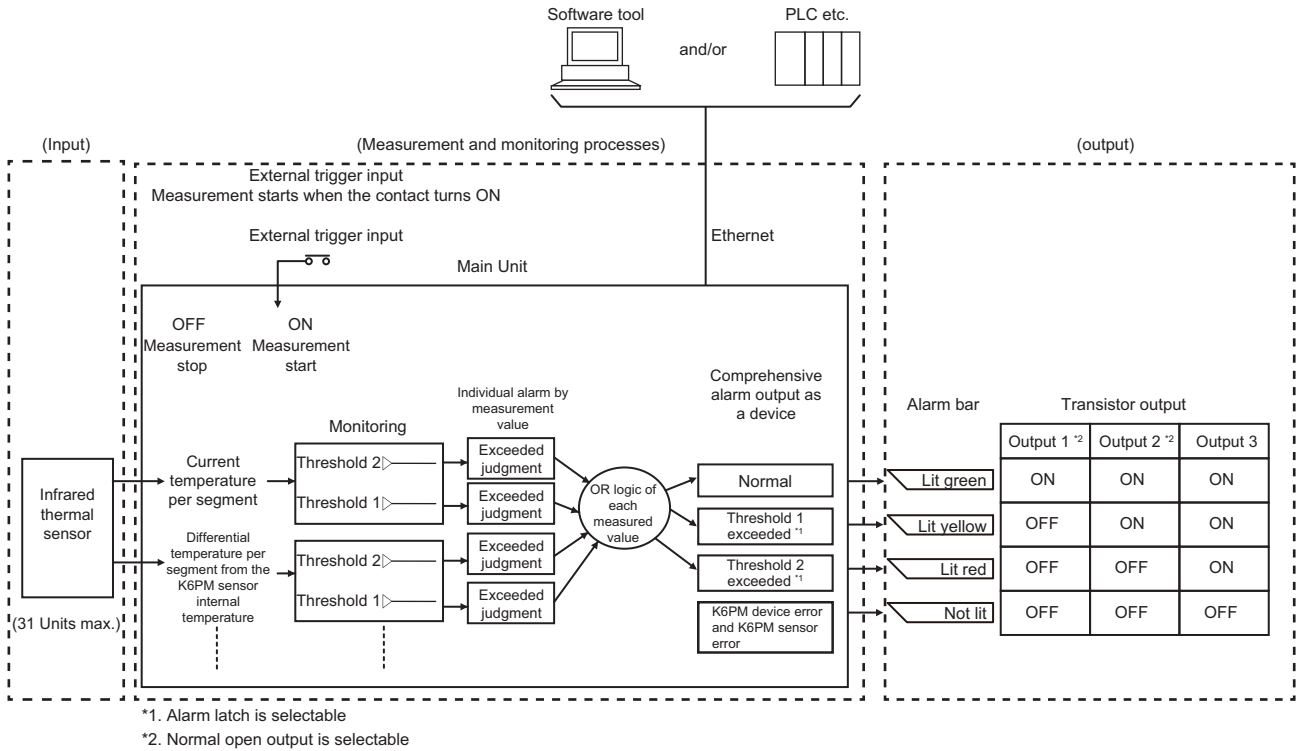

## 1-2-1 Input

### Measurement Field of View of Infrared Thermal Sensor

The measurement field of view of an infrared thermal sensor is made of the following elements.

With one segment as 8 pixels × 8 pixels, the measurement field of view is made of 16 segments per infrared thermal sensor.

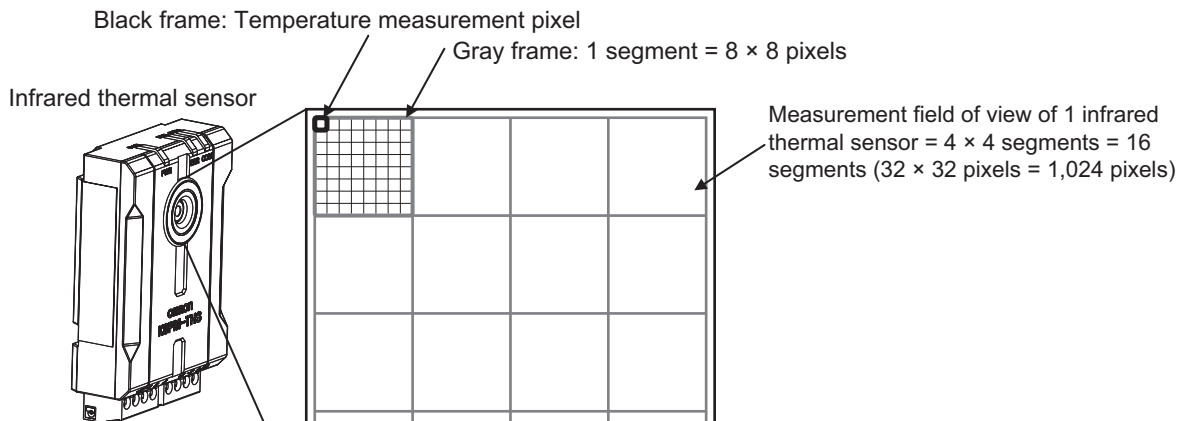

In the Main Unit, the alarm threshold is set in the "segment" unit rather than the pixel unit or the infrared thermal sensor unit, and alarm determination is performed.



## 1-2-2 Measurement, Monitoring and Output

### Types of Measurement Values

The measurement values are of the following types.

- Current temperature per segment of each infrared thermal sensor, or the predicted arrival temperature
- Internal current temperature of each infrared thermal sensor, or the predicted arrival temperature
- Differential temperature between the current temperature of each infrared thermal sensor and the K6PM-TH sensor internal current temperature

### Monitoring (alarms) and Output

- During monitoring (alarm), threshold judgment is first performed for threshold 1 and threshold 2 with respect to each of the above measurement values, and the "individual alarm" is judged.
  - Next, the OR logic is obtained for each "individual alarm" and normal, threshold 1 exceeded, or threshold 2 exceeded is judged for each monitor target as the "comprehensive alarm".
  - Finally, the "comprehensive alarm" is displayed on the alarm bar of the Main Unit front-panel and transistor output is performed. <sup>\*1</sup>
- \*1. If the alarm latch is set to "ON", the alarm status of the K6PM-TH comprehensive judgment (such as alarm bar and transistor outputs 1 and 2) is held. Press and hold the **SEG/ALM RST** Key on the Main Unit front-panel to release the latch. Also, the transistor output type of output 1 and output 2 can be set to Normally closed or Normally open.

# 1-3 List of Models and System Configurations

This section shows each model and the model configuration of the Main Unit and the infrared thermal sensor.

## 1-3-1 List of Models

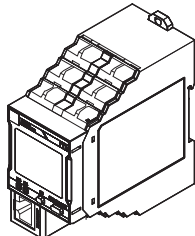
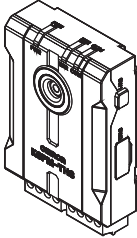
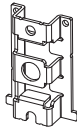
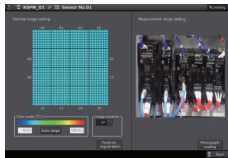
Item	Appearance	Models	Description
Thermal condition monitoring device Main Unit		K6PM-THMD-EIP	A maximum of 31 infrared thermal sensors can be connected Temperature data: 16 data items per sensor Internal temperature: 1 reading (per sensor)
Infrared thermal sensor		K6PM-THS3232	Detection resolution 32 × 32 (1,024 pixels) Viewing angle: 90° × 90° For an installation distance of 100 mm, the field of view for monitoring is 200 × 200 mm For an installation distance of 200 mm, the field of view for monitoring is 400 × 400 mm
Mounting brackets		----	With a magnet Screw mounting and magnet mounting are possible. (Included with the K6PM-THS3232)
Software tool		----	A maximum of five Main Units can be connected (Can be downloaded from the following OMRON website: <a href="http://www.ia.omron.com/k6pm_tool">http://www.ia.omron.com/k6pm_tool</a> )

## Model Number Structure

### ● Main Unit

K6PM - T H - M D - E I P

①                      ②                      ③

No.	Classification	Symbol	Meaning
(1)	Product classification	TH	Thermal condition monitoring device
(2)	Product classification	MD	Main Unit
(3)	Communications method	EIP	Supports EtherNet/IP and Modbus TCP communications

● Infrared Thermal Sensor (Special Thermal Imaging Sensor)

K6PM - 

T	H
---	---

S
---

3	2	3	2
---	---	---	---

①                      ②                      ③

No.	Classification	Symbol	Meaning
(1)	Product classification	TH	Thermal condition monitoring device
(2)	Product classification	S	Infrared thermal sensor
(3)	Model classification	3232	Number of K6PM-TH sensor pixels: 32 × 32

**1-3-2 System Configurations**

**Using the Software Tool**

With the software tool, a maximum of five K6PM-THMD devices can be connected via an Ethernet cable, and settings and monitoring can be performed.

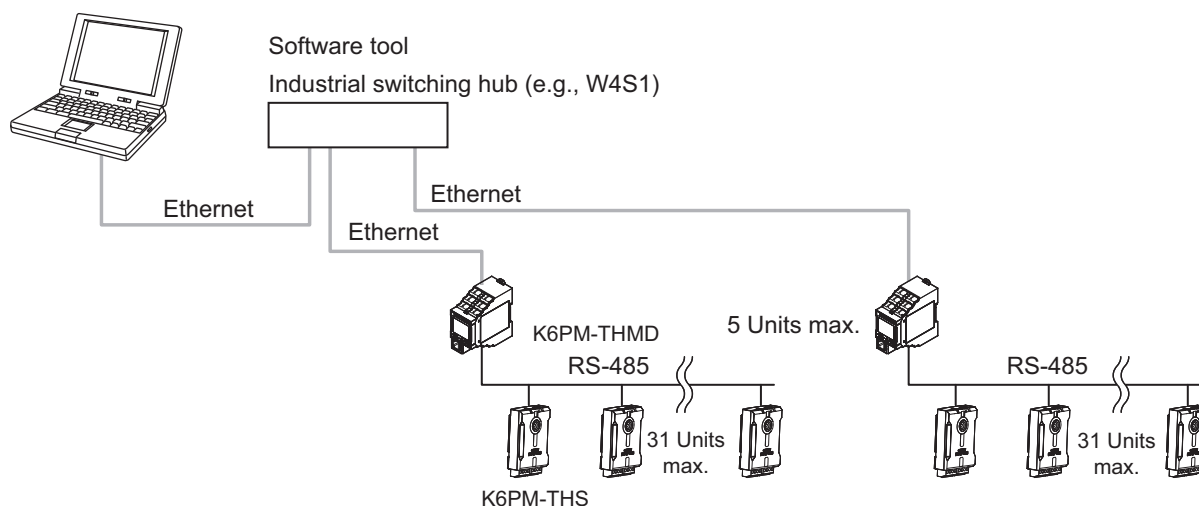

● When the Main Unit IP Address Is Set

Only when setting the IP address, connect the PC and the K6PM-THMD device one to one with an Ethernet cable as shown below.

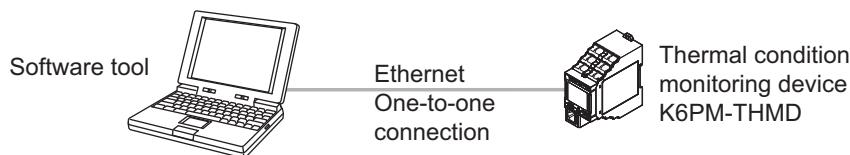

## When Monitoring is Performed by the PLC or PC

Multiple K6PM-THMD devices can be connected to the PLC or PC via an Ethernet cable, and monitoring can be performed.

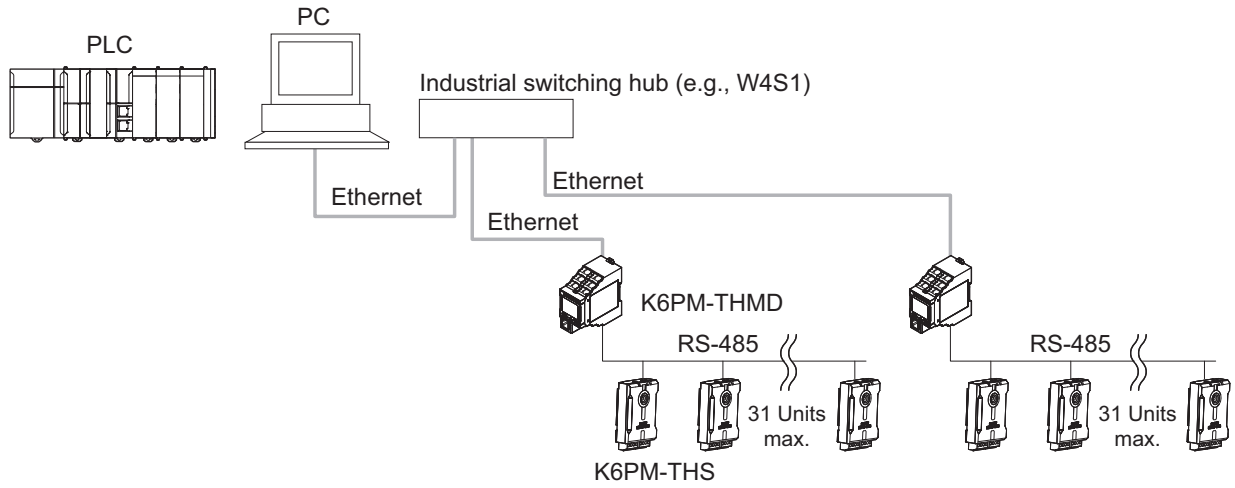

# 1-4 Part Names and Functions

This section describes the name and functions of each part of the Main Unit and the infrared thermal sensor.

## 1-4-1 Main Unit

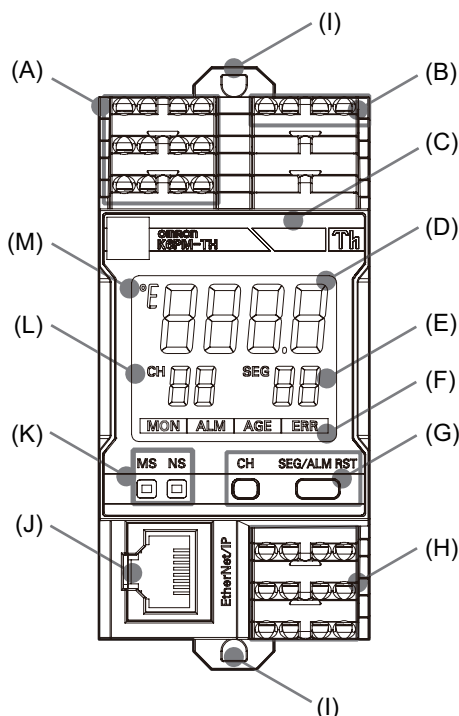

Symbol	Name	Function
(A)	Upper terminal	Push-In Plus terminal <ul style="list-style-type: none"> <li>• Power supply 24 VDC input to the Main Unit</li> <li>• External trigger input ON: Measurement is interrupted. OFF: Measurement is performed.</li> </ul>
(B)	Upper terminal	Push-In Plus terminal <ul style="list-style-type: none"> <li>• Infrared thermal sensor input (RS-485 communications)</li> </ul>
(C)	Alarm bar	Displays the following states of the Main Unit. <ul style="list-style-type: none"> <li>• Normal (no alarm has occurred): Lit green</li> <li>• No operation is being performed (power supply is not connected): Not lit</li> <li>• Search or position adjustment mode: Not lit</li> <li>• An alarm has occurred Current temperature / differential temperature over threshold 1: Lights yellow Current temperature / differential temperature over threshold 2: Lights red</li> <li>• When the arrival prediction function is enabled:<sup>*1</sup></li> </ul>

Symbol	Name	Function
(D)	Numeric LCD display	<p>Depending on the operating mode, the display differs as shown below.</p> <ul style="list-style-type: none"> <li>Monitoring mode: Current temperature of the selected segment of the selected sensor <ul style="list-style-type: none"> <li>(a) When communications are not established with the sensor: "----" is displayed</li> <li>(b) When a K6PM-TH sensor communications error occurs: "SErr" is displayed</li> <li>(c) When the sensor temperature exceeds the measurement range: The current temperature flashes</li> <li>(d) During measurement interruption due to an external trigger: The display is fixed as the value immediately before interruption</li> <li>(e) K6PM-TH sensor search mode: "On" is displayed for a sensor that sends a response, and "OFF" is displayed for a sensor that sends no response</li> </ul> </li> <li>K6PM-TH sensor position adjustment mode: "Adj" is displayed</li> <li>When a Main Unit internal error occurs: "EEEE" flashes</li> </ul>
(E)	SEG	<p>The segment number or the number of currently-connected infrared thermal sensors is displayed. Depending on the operating mode, the display differs as shown below.</p> <ul style="list-style-type: none"> <li>Monitoring mode: The segment number selected by the <b>SEG/ALM RST</b> Key is displayed. 0 to 15 Sensor internal temperature: 99</li> <li>K6PM-TH sensor search mode: The number of infrared thermal sensors currently connected to the Main Unit is displayed.</li> <li>K6PM-TH sensor position adjustment mode: The number of infrared thermal sensors currently connected to the Main Unit is displayed.</li> </ul>
(F)	Status display	<p>The status of the Main Unit is displayed as follows:</p> <ul style="list-style-type: none"> <li>MON: K6PM-TH sensor monitoring state. The indicator is not lit during measurement interruption due to an external trigger.</li> <li>ALM: Alarm occurrence state (lit only when the corresponding K6PM-TH sensor number is being displayed)</li> <li>AGE: Running time reaches 100%</li> <li>ERR: Main Unit internal error</li> </ul>
(G)	Operation Keys	<p><b>CH</b> Key: Switching of sensor number</p> <p><b>SEG/ALM RST</b> Key pressed for less than 5 seconds: Switching of segment number</p> <p><b>SEG/ALM RST</b> Key pressed and held (5 seconds min.): Alarm latch released (Can be performed only by this operation. The latch cannot be released by the software tool and communications.)</p> <p><b>CH</b> Key and <b>SEG/ALM RST</b> Key simultaneously pressed and held (5 seconds min.): Initialization (Operation returns to the factory state.)</p>
(H)	Lower terminal	<p>Connection is established by the Push-In Plus terminal.</p> <ul style="list-style-type: none"> <li>Transistor output 1 to 3</li> </ul> <p>For details, refer to <i>Transistor Output</i> on page 1-12.</p>
(I)	DIN Track mounting hook	Used for mounting to the DIN Track.
(J)	Communications connector	Connects the communications cable of the EtherNet/IP network.

Symbol	Name	Function
(K)	Indicators	Indicates the product status or network status by LEDs. <ul style="list-style-type: none"> <li>• "MS": Module Status. Displays the status of the Main Unit. It is green when it is normal.</li> <li>• "NS": Network Status. Displays the state of the communications. It lights or flashes green when it is normal.</li> </ul> For details, refer to <i>Indicator Specifications</i> on page 1-11.
(L)	CH	Indicates the K6PM-TH sensor number. 1 to 31.
(M)	°E Temperature unit	Displays the temperature unit. °C or °F.

\*1. The display is as follows when the arrival prediction function is enabled.

- The predicted arrival temperature exceeds threshold 1, and the current temperature or differential temperature does not exceed the threshold: Flashes yellow
- Regardless of whether the predicted arrival temperature exceeds threshold 1, the current temperature or differential temperature exceeds threshold 1: Lit in yellow
- Regardless of whether the current temperature or differential temperature exceeds threshold 1, the predicted arrival temperature exceeds threshold 2: Flashes red
- Regardless of whether the predicted arrival temperature exceeds the threshold, the current temperature or differential temperature exceeds threshold 2: Lit in red

## ● Indicator Specifications

Symbol	Name	Color	Status	Operating condition
MS	Product status indication (Module Status)	Green	Lit.	Normal status
			Flashes at 1-s intervals.	BOOTP server connection error state
		Red	Lit.	One of the following fatal errors (Main Unit internal error) <ul style="list-style-type: none"> <li>• Internal CPU error</li> <li>• Internal memory error</li> </ul>
			Flashes at 1-s intervals.	One of the following conditions <ul style="list-style-type: none"> <li>• K6PM-TH sensor communications error</li> <li>• The detection of the K6PM-TH sensor angle deviation</li> <li>• Sensor type error</li> <li>• Temperature measurement range exceeded</li> <li>• Running time error</li> </ul>
--	Not lit.	No power supply		
NS	Network status indication (Network Status)	Green	Lit.	Tag data link or message connection established
			Flashes at 1-s intervals.	No tag data link or message connection established
		Red	Lit.	IP address duplication status
			Flashes at 1-s intervals.	The connection has timed out
		--	Not lit.	No power supply, or IP address not set

## ● Transistor Output

Name	Description	
Transistor output 1	Threshold 1 excess output of comprehensive alarm.  Transistor output type can be set to Normally Closed or Normally Open.	When the "Transistor output type" is set to "Normally closed": If threshold 1 exceeded occurs for the comprehensive alarm, transistor output remains OFF and transistor output 2 remains ON.  If threshold 2 exceeded occurs for the comprehensive alarm, both transistor output and transistor output 2 turn OFF.  (By default, it is set to "Normally closed". By setting it to "Normally open" with the software tool, ON/OFF can be reversed.)
Transistor output 2	Threshold 2 excess output of comprehensive alarm. Transistor output type can be set to Normally Closed or Normally Open.	
Transistor output 3	Main Unit error and K6PM-TH sensor error output <ul style="list-style-type: none"> <li>• Normal: ON</li> <li>• Main Unit error and K6PM-TH sensor error: OFF</li> </ul> Note 1: The Main Unit error and K6PM-TH sensor error specify any one of the following: <ul style="list-style-type: none"> <li>• Main Unit internal error (internal CPU error or internal memory error)</li> <li>• K6PM-TH sensor communications error or sensor type error</li> <li>• The detection of the K6PM-TH sensor angle deviation</li> <li>• Temperature measurement range exceeded</li> <li>• Running time error</li> </ul> Note 2: The output type of transistor 3 is fixed as Normally closed.	

## 1-4-2 Operating Modes of the Main Unit

The Main Unit has the following operating modes.

### Before Registering the Configuration of the Infrared Thermal Sensors

There are the following two operating modes before registering the configuration of the infrared thermal sensors.

#### ● K6PM-TH Sensor Search Mode

In this mode, the Main Unit automatically searches for the connected infrared thermal sensors when the power supply is turned ON or when the software is reset, and decides the configuration of the infrared thermal sensors.

The search results can be checked on the Setting K6PM screen of the software tool (for details, refer to 3-4 *Registering the Initial Settings and Sensor Configuration of the Main Unit (Setting K6PM screen)* on page 3-18).

#### ● K6PM-TH Sensor Position Adjustment Mode

In this mode, communications are performed with only one fixed infrared thermal sensor in order to perform position adjustment of the infrared thermal sensor.

When you switch to the Setting K6PM screen with the software tool, the Main Unit automatically switches to this mode (for details, refer to 3-3 *Registering the Sensor Position (Setting sensor screen)* on page 3-15).



## After Registering the Configuration of the Infrared Thermal Sensors

After the configuration of the infrared thermal sensors has been registered by using the software tool or communications, switching to the following monitoring mode occurs automatically.

### ● Monitoring Mode

In this mode, the measurement and monitoring processes (such as alarm determination, etc.) are carried out based on the registered sensor configuration. When you click the **Register** Button on the Setting K6PM screen of the software tool, the Main Unit automatically switches to this mode (for details, refer to *3-4 Registering the Initial Settings and Sensor Configuration of the Main Unit (Setting K6PM screen)* on page 3-18).

### 1-4-3 Operation Flow on the Main Unit Front-Panel

The flow of operation in the K6PM device screen after the power is turned on or a software reset varies depending on whether or not the infrared thermal sensor configuration has been registered (including the first time the device is used).

For details on how to register the configuration of the infrared thermal sensors, refer to *3-4 Registering the Initial Settings and Sensor Configuration of the Main Unit (Setting K6PM screen)* on page 3-18.

## When the Sensor Configuration Has Not Been Registered ("K6PM-TH Sensor Search Mode", or "K6PM-TH Sensor Position Adjustment Mode")

After turning on the power or a software reset, you can check the status of communications with infra-red thermal sensors on the front panel of the Main Unit.

### ● Changing K6PM-TH Sensor Numbers in Succession

Press the **CH** Key and successively change the K6PM-TH sensor numbers.

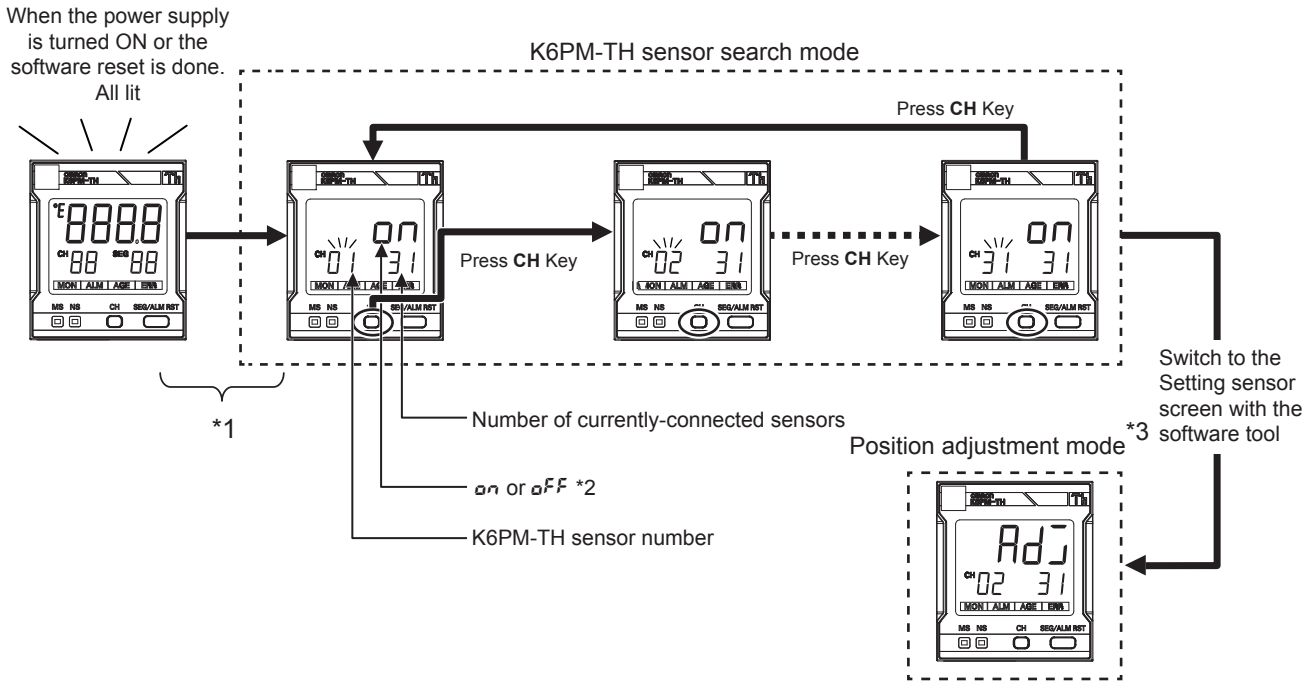

\*1. After turning on the power or a software reset, up to 30 seconds is required to calculate all temperature data.

\*2. "on" is displayed for a sensor that sends a response, and "off" is displayed for a sensor that sends no response.

\*3. Example: If you select sensor 2 and display the Setting sensor screen in the software tool, "Adj" will appear.

## When the Sensor Configuration Has Already Been Registered ("Monitoring Mode")

After the sensor configuration has been registered by using the software tool or communications, the operation flow is as described below. After turning on the power or a software reset, the Main Unit enters monitoring mode. The measurement/monitor status can be checked on the front of the Main Unit.

### ● Changing K6PM-TH Sensor Numbers In Succession

To change K6PM-TH sensor numbers in succession, press the **CH** Key.

### ● Check Segment Values of a Sensor

To change segment numbers in succession, press the **SEG / ALM RST** Key.

The segment numbers change in order from "0" to "15". "99" appears next, indicating sensor internal temperature.

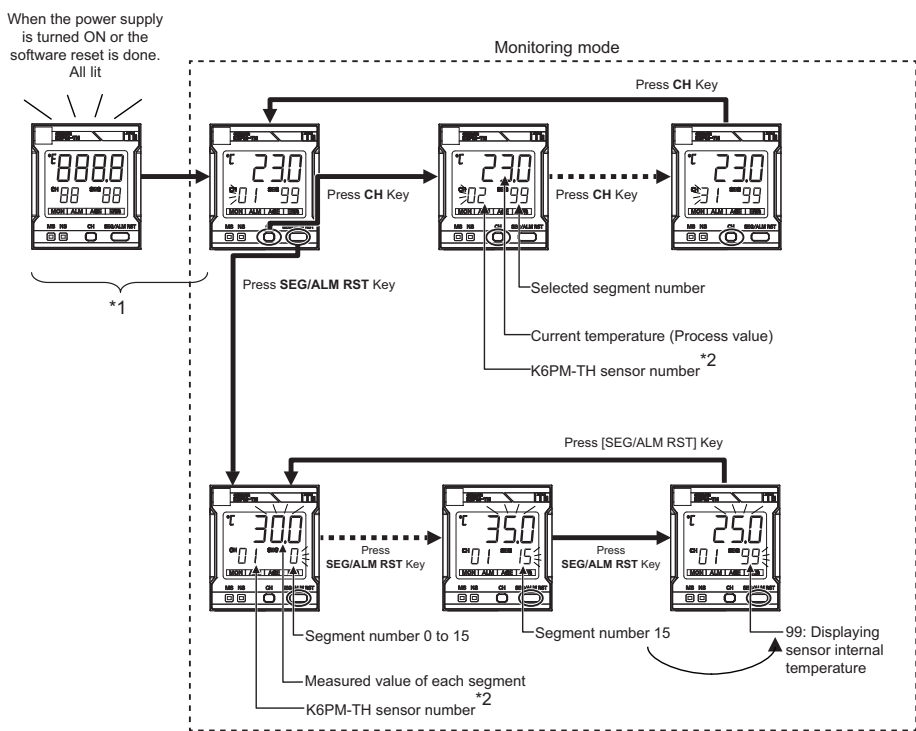

- \*1. After turning on the power or a software reset, up to 30 seconds is required to calculate all temperature data. If communications with the sensor is not established, "----" appears. If a communications error occurs after communications have been established with the sensor, "Err" is displayed. When the measured temperature of the sensor exceeds the measurement range, the current temperature flashes.
- \*2. If an angle deviation occurs in the sensor, or a communications error with the sensor occurs, the sensor number flashes.

## 1-4-4 Infrared Thermal Sensor

### ● Nomenclature

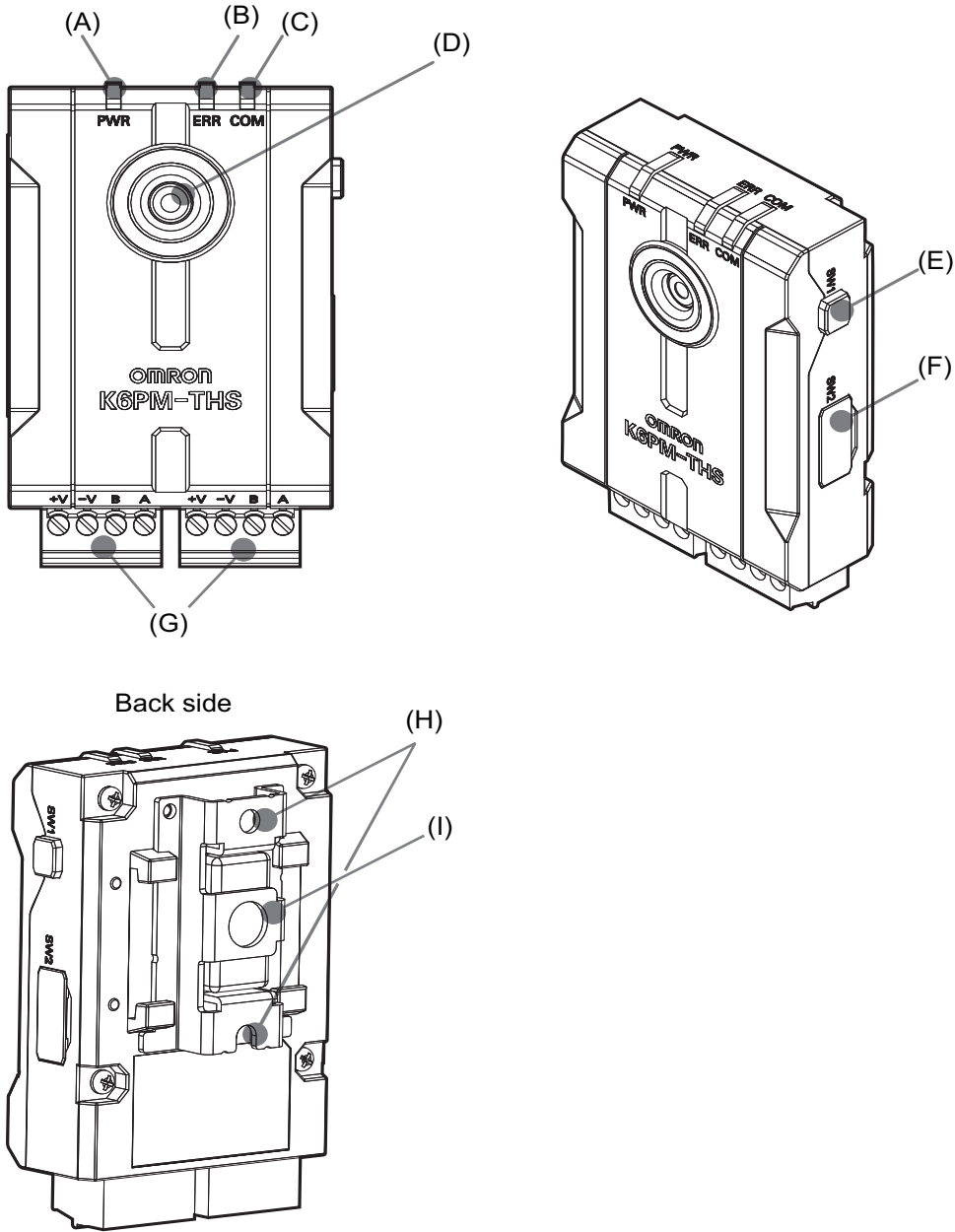

Symbol	Name	Function
(A)	Power indicator (Green)	Lit when power is turned ON
(B)	Alarm indicator (Red)	<ul style="list-style-type: none"> <li>• Lit in red: Measurement temperature or internal temperature over</li> <li>• Flashing red: K6PM-TH sensor angle deviation occurs</li> </ul>
(C)	Communications indicator (orange)	<ul style="list-style-type: none"> <li>• Communications: Lit</li> <li>• Standby: Not lit (stopped)</li> </ul>
(D)	Temperature sensor lens	---
(E)	Reset switch for the K6PM-TH sensor angle deviation	Resets the sensor internal angle deviation occurrence flag.
(F)	DIP switches	For details, refer to <i>DIP Switch Settings</i> on page 1-17.
(G)	Connector-terminal block conversion unit	For 24 VDC power supply and RS-485 wiring

Symbol	Name	Function
(H)	Screw hole for fixing mounting bracket	For direct sheet metal attachment
(I)	Screw fastening hole	1/4-20 UNC mounting hole (nut not included)

● **DIP Switch Settings**

The setting contents of the DIP switch pin are as follows:

SW	Setting contents	Value
1 to 5	K6PM-TH sensor number setting	Set in binary with ON as 1 and OFF as 0 (Pin 1: Least significant bit, Pin 5: Most significant bit) 00001 to 11111: K6PM-TH sensor number 1 to 31 00000: Not used. Factory default: 00001
6	RS-485 terminating resistance	OFF: Without terminating resistance (factory default) ON: With terminating resistance
7	The detection of the K6PM-TH sensor angle deviation	OFF: No detection (factory default) ON: With detection
8	Reserved.	----



**Precautions for Correct Use**

When closing the cover of the sensor DIP switch pin, make sure the DIP switch pin settings have been made as intended.

# 1-5 Procedure

The K6PM-THs can be used in the following procedure.

Step	Reference
1. Installation and Wiring	Section 2 Installation and Wiring
2. IP address setting of your PC and the Main Unit	3-2 <i>IP Address Setting</i> on page 3-7
3. Registering the sensor position	3-3 <i>Registering the Sensor Position (Setting sensor screen)</i> on page 3-15
4. Registering the initial settings and sensor configuration of the Main Unit	3-4 <i>Registering the Initial Settings and Sensor Configuration of the Main Unit (Setting K6PM screen)</i> on page 3-18
5. Monitor	Section 4 <i>Monitoring the Temperature in Control Panel with the Main Unit and the Software Tool</i> , Section 5 <i>Monitoring and Setting with the EtherNet/IP Communications</i> , Section 6 <i>Monitoring and Setting with the Modbus TCP</i>
5. Alarm threshold setting	4-3 <i>Alarm Threshold Setting</i> on page 4-23
6. Actions to take when an alarm occurs	4-4 <i>Procedure for Taking Actions When an Alarm Occurs</i> on page 4-25

# 2

## Installation and Wiring

This section describes the installation and wiring of the Main Units.

---

<b>2-1</b>	<b>Dimensions</b> .....	<b>2-2</b>
2-1-1	Main Unit .....	2-2
2-2-1	Precautions at Installation .....	2-3
<b>2-2</b>	<b>Installation</b> .....	<b>2-3</b>
2-2-1	Precautions at Installation .....	2-3
2-2-2	Installing the Main Unit .....	2-3
2-2-3	Installation of the Infrared Thermal Sensor .....	2-5
2-2-4	Position Registration of the Infrared Thermal Sensor .....	2-9
<b>2-3</b>	<b>Wiring</b> .....	<b>2-10</b>
2-3-1	How to Connect to the Push-In Plus Terminal Blocks .....	2-10
2-3-2	Diagram of Terminal Description .....	2-15
2-3-3	I/O Wiring .....	2-17
2-3-4	Ethernet Wiring .....	2-17

# 2-1 Dimensions

This section shows the external dimensions of the Main Unit and the infrared thermal sensors.

## 2-1-1 Main Unit

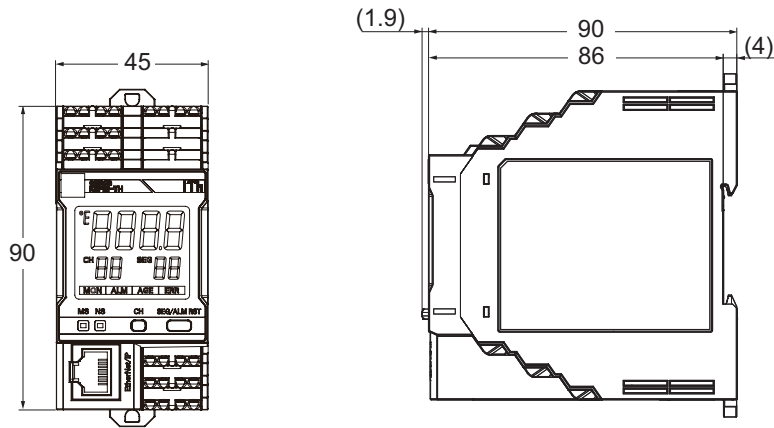

## 2-1-2 Infrared Thermal Sensor

- With Mounting Bracket Attached

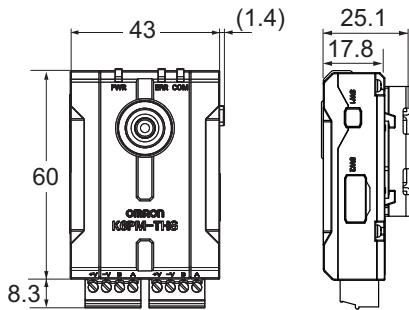



## 2-2 Installation

This section describes the installation of the Main Unit and the infrared thermal sensors.

### 2-2-1 Precautions at Installation

Refer to the *Precautions for Safe Use* on page 7.

### 2-2-2 Installing the Main Unit

For installation of the Main Unit, it is possible to install it on the DIN rail or install it with screws on the wall.

#### When Installing on DIN Track

Screw the DIN Track in three or more places in a control cabinet.

- Recommended DIN Track

Model	Dimensions	Manufacturer
PFP-100N	1,000 mm	OMRON
PFP-50N	500 mm	

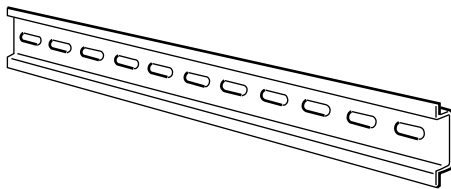

- PFP-M End Plate (2 Pieces)

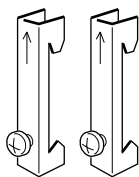

- Installation Direction

There is no particular restriction on the mounting direction of the Main Unit, but install it securely in the horizontal or vertical direction as much as possible.

● **How to Install the Main Unit**

To mount the Main Unit to a DIN Track, hook the device onto the DIN Track and press the device in the direction of the arrow until you hear it lock into place.

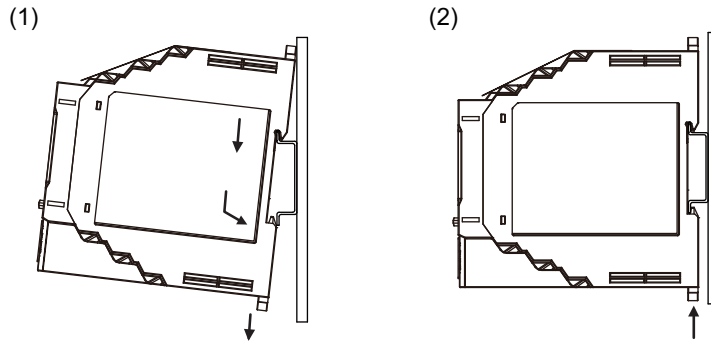

● **How to Remove the Main Unit**

Pull down on the bottom hook with a flat-blade screwdriver and lift up on the product.

Leave at least 30 mm of space between the Main Unit and other devices to allow easy installation and removal.

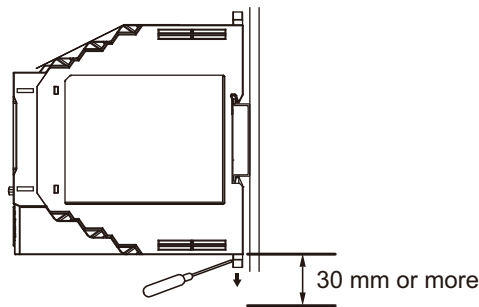

**Screw Mounting**

(1) Pull out 2 hooks in the Main Unit back outside until they click.

(2) Insert M3 screw in a hole of a hook and fix.

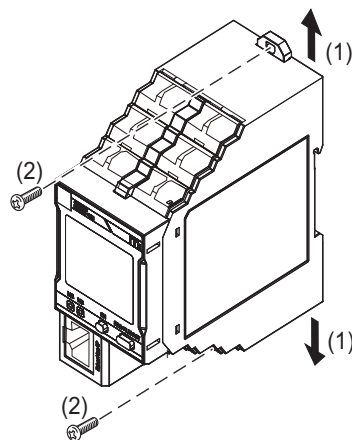

Mounting Hole Dimensions

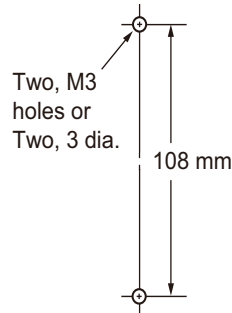

Note 1. Pull out the hooks to mount the Main Unit with screws.

2. Recommended tightening torque is 0.5 to 0.6 N·m.

3. Group mounting is not possible in the vertical direction.

## 2-2-3 Installation of the Infrared Thermal Sensor

This section describes how to install the infrared thermal sensors.

### Installation Position

Install the infrared thermal sensor at the back of the control panel door, or on the internal side surface of the control panel.

The infrared thermal sensor can be installed either directly on the control panel, or can be installed by using a commercially available pan head.

- Installing on the back of the control panel door either directly or by using a commercially available pan head

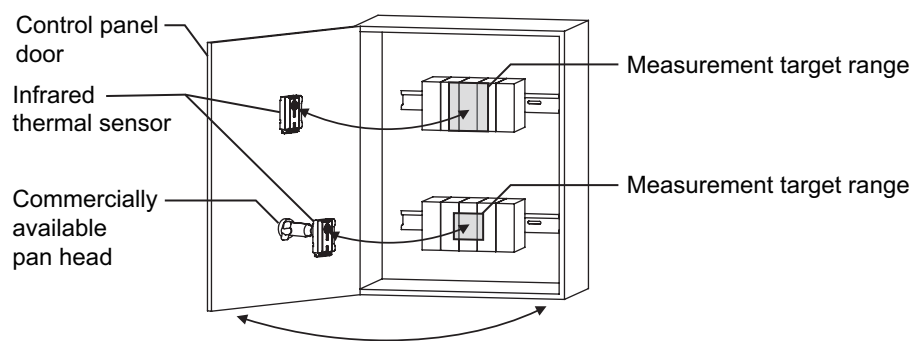

- Installing on the internal side surface of the control panel by using a commercially available pan head

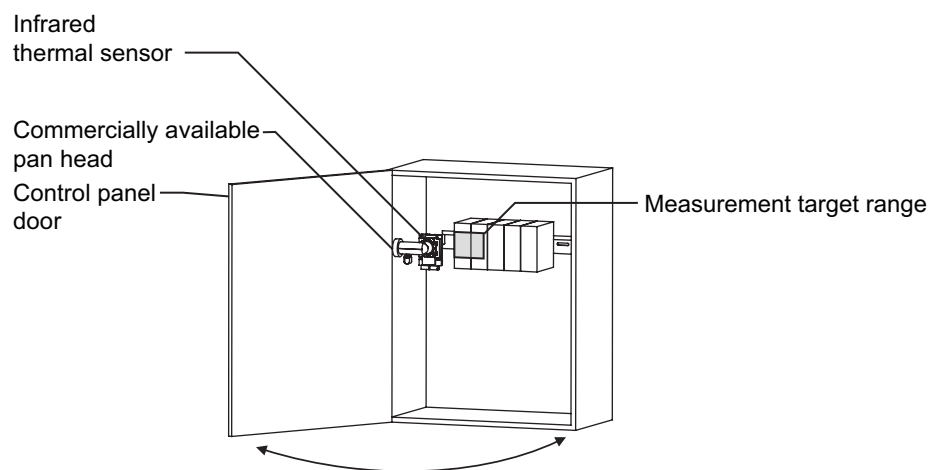

## Relationship between the Measurement Surface and Measured Distance

In order to measure the temperature more correctly, as shown in the figure below, install the infrared thermal sensor at a distance where the measurement object can be captured as a large image, as far as possible at the center of the field of view.

The relationship between the sensor visual field width and the distance from the infrared thermal sensor to the measurement object is as shown below.

Sensor visual field width =  $2 \times$  (Distance from infrared thermal sensor up to the measurement object)

Example: When the distance from the infrared thermal sensor up to the measurement object is 100 mm

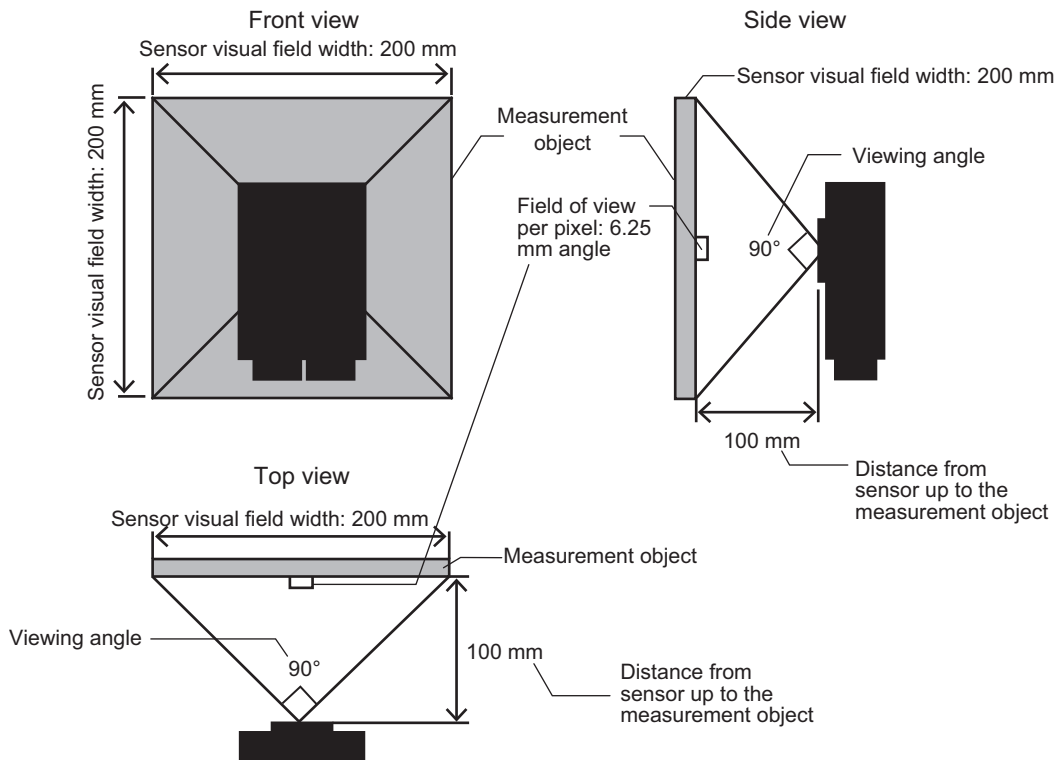

### Precautions for Correct Use

- Measurement objects:  
Metals and transparent resin materials cannot be properly measured.
- Set the distance up to the measurement object in view of the occurrence voltage of the measurement object and the safety certifications, etc.

## Required Space for Installation of the Infrared Thermal Sensor

### ● Required Space between the Infrared Thermal Sensor and the Measurement Object

Install the infrared thermal sensor at a position where the following space can be secured from the measurement object.

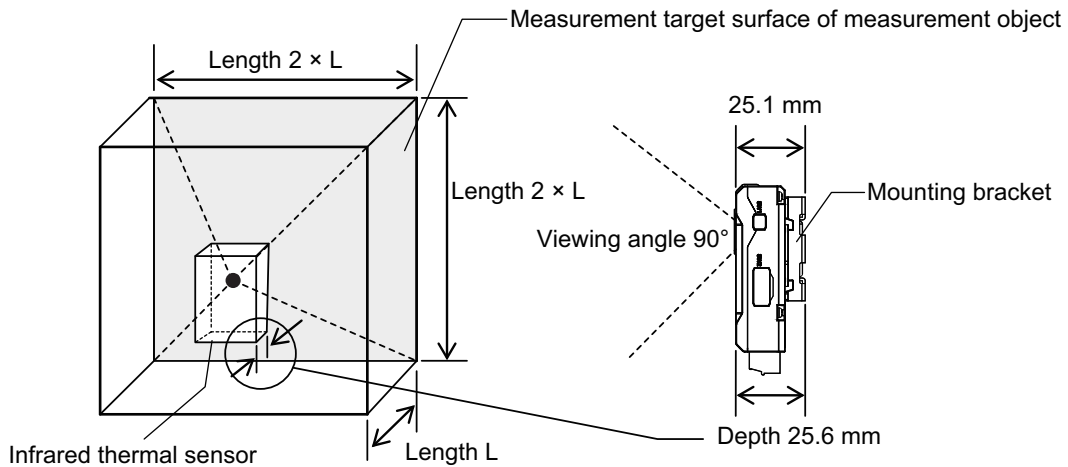

- Install the infrared thermal sensor at a position where the measurement object can be captured as a large image, as far as possible at the center of the screen.
- Make sure there is no obstacle in the distance up to the measurement object surface.
- Secure a space of approximately 30 mm from the end of the connector in view of the sensor wiring.

## Installing the Infrared Thermal Sensor

- Use the supplied magnet until the positioning is identified.  
In the case of using the product permanently, be sure to mount it by screws according to the following dimensions.
- When handling the mounting bracket, take care not to injure yourself on the corners and other parts of the bracket.

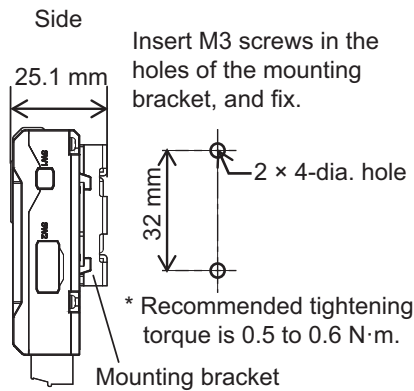

With mounting bracket attached

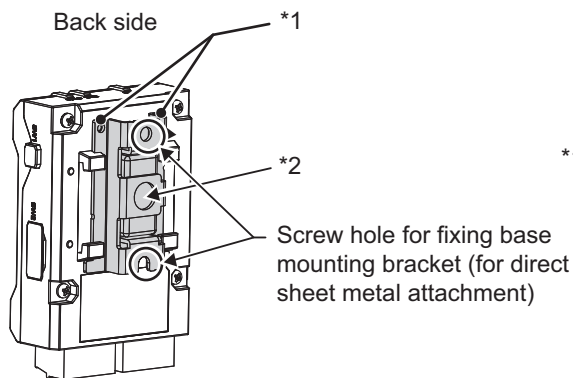

When the mounting bracket is mounted vertically

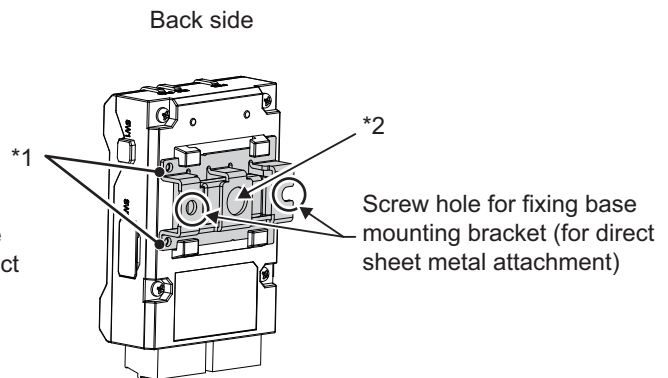

When the mounting bracket is mounted horizontally

- \*1. Fit the holes in the mounting bracket onto the protrusions on the case.
- \*2. 1/4-20 UNC mounting hole (nut not included)
- If the position and space for directly installing the infrared thermal sensor on the back surface of the control panel door cannot be secured, examine whether or not it is possible to perform measurement by installing the infrared thermal sensor on a commercially available pan head such as that shown below, and adjusting the position.  
Install the commercially available pan head, etc. at the back of the control panel door, or on the internal side surface of the control panel.

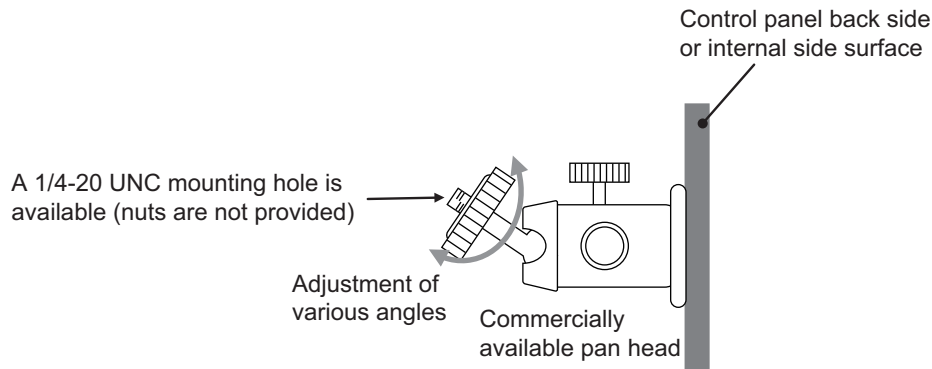

## When Threshold Automatic Setting Function of Alarm Temperature is Used

In order to set the correct alarm threshold, install the infrared thermal sensor according to the procedure described below.

- 1** Identify the measurement target range  
Decide the range of the object for which the temperature is to be monitored (for example, if the wiring temperature is to be monitored, the wiring width will be applicable).
- 2** Decide the distance between the infrared thermal sensor and the measurement object  
Install the infrared thermal sensor at a distance where the field of view per pixel is smaller than the range of the measurement object.  
Specifically, install the infrared thermal sensor at a distance where the following relationship is satisfied.  
$$\text{Distance} \leq (32 \times \text{Range of measurement object}) \div 4 \text{ (mm)}$$
- 3** Decide the installation location  
Install the infrared thermal sensor at the distance calculated in Step 2.
- 4** Install the infrared thermal sensor after adjusting the measurement object to a position where it can be appropriately measured while checking the thermal image of the software tool.

### 2-2-4 Position Registration of the Infrared Thermal Sensor

After installing the infrared thermal sensor, it is necessary to register the position of the sensor in the Main Unit.

For details on how to register the sensor position with the software tool, refer to *3-3 Registering the Sensor Position (Setting sensor screen)* on page 3-15. For details on how to register the sensor position with the CIP message communications of EtherNet/IP, refer to *Section 5 Monitoring and Setting with the EtherNet/IP Communications*. For details on how to register the sensor position with Modbus TCP communications, refer to *Section 6 Monitoring and Setting with the Modbus TCP*.

## 2-3 Wiring

This section describes the wiring of the Main Units.

### 2-3-1 How to Connect to the Push-In Plus Terminal Blocks

This section describes how to connect the Main Units to the Push-In Plus terminal blocks.

All terminals of the Main Unit are Push-In Plus terminals.



#### Precautions for Safe Use

- To prevent wire materials from smoking or igniting, use the wiring materials given in the following table.

Recommended Wire	Stripping length (Without Ferrules)
0.25 to 1.5 mm <sup>2</sup> (AWG24 to AWG16)	8 mm

- Make sure the crimp terminals for wiring are of the specified size.
- Do not insert more than one wire into each terminal insertion hole.
- Do not connect anything to terminals that are not being used.
- Do not wire anything to the release holes.
- Do not tilt or twist a flat-blade screwdriver while it is inserted into a release hole on the terminal block. The terminal block may be damaged.
- Insert a flat-blade screwdriver into the release holes at an angle. The terminal block may be damaged if you insert the screwdriver straight in.
- Do not allow the flat-blade screwdriver to fall out while it is inserted into a release hole.
- Do not place product wiring in parallel with or in the same path as high-voltage or high-current lines. Keep wiring separate from high voltages and power lines that draw large currents.
- Do not bend a wire past its natural bending radius or pull on it with excessive force. Doing so may cause the wire disconnection.
- When wiring the terminals, allow some leeway in the wire length.



#### Precautions for Correct Use

- When you are finished with wiring, make sure that no stranded wire comes loose.
- If you wire crossovers and connect terminal blocks in parallel, a large current will flow. Make sure that the current does not exceed 10 A.
- The terminal block may be damaged if the recommended tool is not used. Use the recommended flat-blade screwdriver to operate the release holes.



## Push-In Plus Terminal Blocks

Item	Specification
<b>Construction</b>	Push-in compatible with 1-pole 2-terminal interwiring wiring Hands free Front-in front and front-release
<b>Applicable wires</b>	Stranded wires, solid wires, or ferrules
<b>Applicable wire size</b>	0.25 to 1.5 mm <sup>2</sup> (AWG24 to AWG16)
<b>Wire insertion force</b>	8 N max. for AWG20 wire
<b>Screwdriver insertion force</b>	15 N max.
<b>Wire stripping length</b>	8 mm <sup>*1</sup> , 10 mm, 12 mm
<b>Ferrule length</b>	8 mm, 10 mm
<b>Recommended flat-blade screwdriver</b>	XW4Z-00B (Refer to <i>Recommended Flat-blade Screwdriver</i> on page 2-14 under <i>Recommended Ferrules and Crimp Tools</i> on page 2-14.)
<b>Current capacity</b>	10 A (per pole)
<b>Number of insertions</b>	50 times
<b>Recommended ferrules</b>	Refer to <i>Recommended Ferrules</i> on page 2-14 under <i>Recommended Ferrules and Crimp Tools</i> on page 2-14.

\*1. Without ferrules

## Nomenclature of the Push-In Plus Terminal Block and Connections

### ● Nomenclature of the Terminal Block

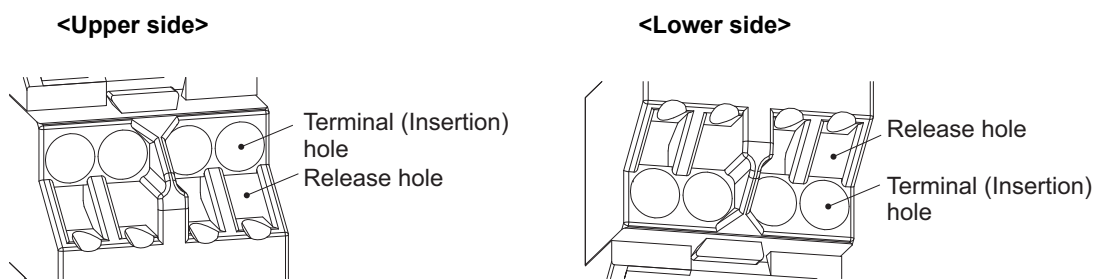

### ● Connecting Wires with Ferrules and Solid Wires

Insert the solid wire or ferrule straight into the terminal block until the end strikes the terminal block.

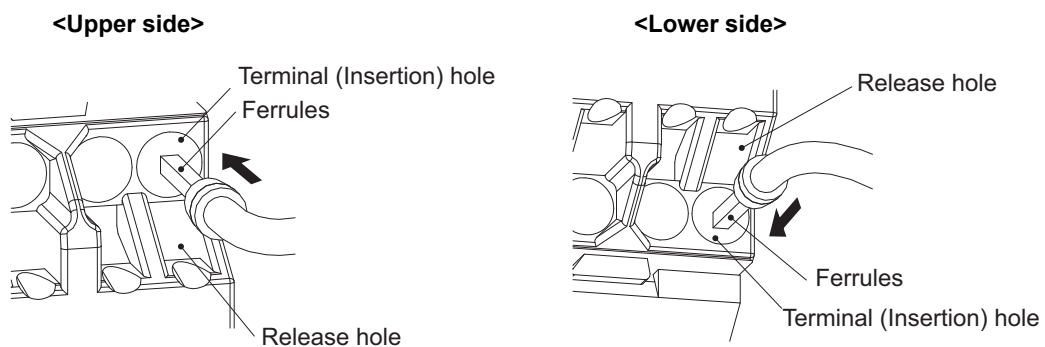

If a wire is difficult to connect because it is too thin, use a flat-blade screwdriver in the same way as when connecting stranded wire.

● **Connecting Stranded Wires**

Use the following procedure to connect the wires to the terminal block.

- 1 Hold a flat-blade screwdriver at an angle and insert it into the release hole.  
The angle should be between 10° and 15°. If the flat-blade screwdriver is inserted correctly, you will feel the spring in the release hole.

<b>CAUTION</b>	
The terminal block may be damaged if you insert a flat-blade screwdriver in the release hole with excessive force. Insert the flat-blade screwdriver into the release holes with a force of 15 N or less.	

- 2 With the flat-blade screwdriver still inserted into the release hole, insert the wire into the terminal hole until it strikes the terminal block.
- 3 Remove the flat-blade screwdriver from the release hole.

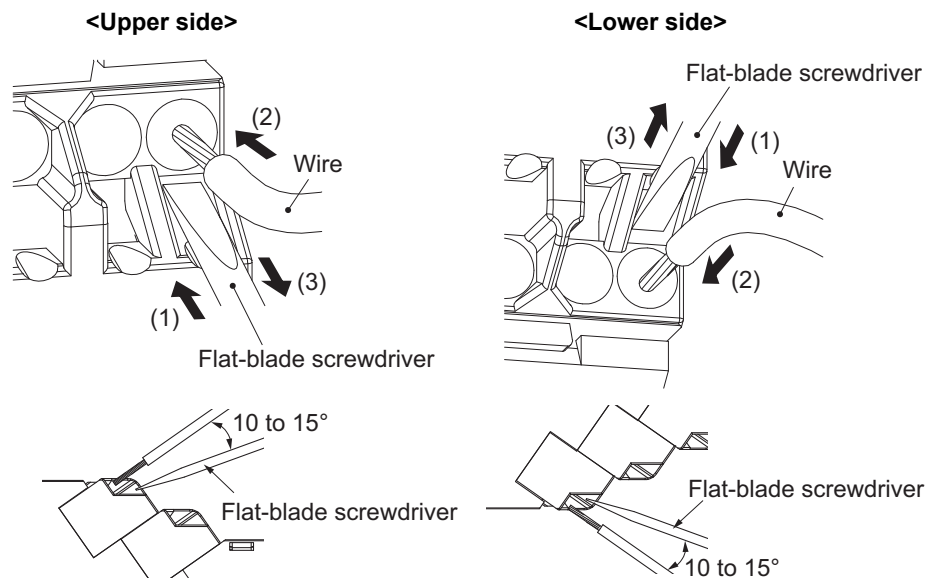

● **Checking Connection**

- After the insertion, pull gently on the wire to make sure that it will not come off and the wire is securely fastened to the terminal block.
- If you use a ferrule with a conductor length of 10 mm, part of the conductor may be visible after the ferrule is inserted into the terminal block, but the product insulation distance will still be satisfied.
- To prevent short circuits, insert the stripped part of a stranded or solid wire or the conductor part of a ferrule until it is hidden inside the terminal insertion hole.
- For the stranded wires, make sure that some of the wires from adjacent terminals are not accidentally inserted.  
(Refer to the following diagram.)



### ● Removing Wires from the Push-In Plus Terminal Block

Use the following procedure to remove wires from the terminal block.

The same method is used to remove stranded wires, solid wires, and ferrules.

- 1** Hold a flat-blade screwdriver at an angle and insert it into the release hole.
- 2** With the flat-blade screwdriver still inserted into the release hole, remove the wire from the terminal insertion hole.
- 3** Remove the flat-blade screwdriver from the release hole.

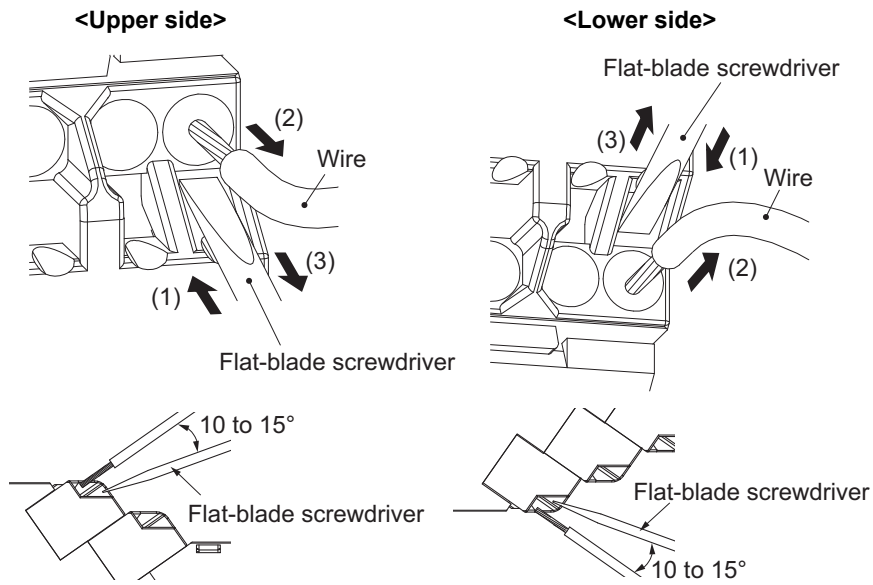

## Recommended Ferrules and Crimp Tools

### ● Recommended Ferrules

Applicable wire		Ferrule Conductor length (mm)	Stripping length (mm) (Ferrules used)	Recommended ferrules		
(mm <sup>2</sup> )	AWG			Manufactured by Phoenix Contact	Manufactured by Weidmuller	Manufactured by Wago
0.25	24	8	10	Al 0,25-8	H0.25/12	FE-0.25-8N-YE
		10	12	Al 0,25-10	----	----
0.34	22	8	10	Al 0,34-8	H0.34/12	FE-0.34-8N-TQ
		10	12	Al 0,34-10	----	----
0.5	20	8	10	Al 0,5-8	H0.5/14	FE-0.5-8N-WH
		10	12	Al 0,5-10	H0.5/16	FE-0.5-10N-WH
0.75	18	8	10	Al 0,75-8	H0.75/14	FE-0.75-8N-GY
		10	12	Al 0,75-10	H0.75/16	FE-0.75-10N-GY
1/1.25	18/17	8	10	Al 1-8	H1.0/14	FE-1.0-8N-RD
		10	12	Al 1-10	H1.0/16	FE-1.0-10N-RD
1.25/1.5	17/16	8	10	Al 1,5-8	H1.5/14	FE-1.5-8N-BK
		10	12	Al 1,5-10	H1.5/16	FE-1.5-10N-BK
Recommended crimp tool				CRIMPFOX6 CRIMPFOX6T-F CRIMPFOX10S	PZ6 roto	Variocrimp4

- Note 1. Make sure that the outer diameter of the wire coating is smaller than the inner diameter of the insulation sleeve of the recommended ferrule.
2. Make sure that the ferrule processing dimensions conform to the following figures.

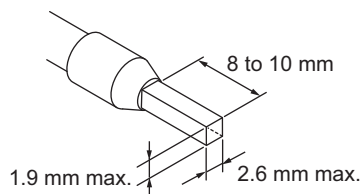

### ● Recommended Flat-blade Screwdriver

Use a flat-blade screwdriver to connect and remove wires.

Use the following flat-blade screwdriver.

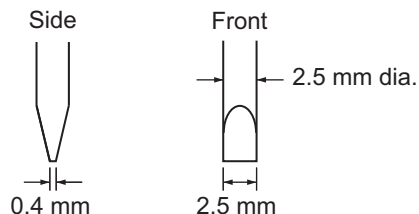

Model	Manufacturer
ESD 0.40×2.5	Wera
SZS 0,4×2,5	Phoenix Contact
SZF 0-0.4×2.5*1	
0.4×2.5×75 302	Wiha
AEF.2,5×75	Facom

Model	Manufacturer
210-719	Wago
SDI 0.4×2.5×75	Weidmuller

\*1. OMRON's exclusive purchase model XW4Z-00B is available to order as SZF 0-0.4 x 2.5 (manufactured by Phoenix Contact).

## 2-3-2 Diagram of Terminal Description

This section shows each terminal layout of the Main Unit and the infrared thermal sensors.

### Terminal Layout of the Main Unit

The diagram below shows the terminal layout of the following:

- 24 VDC
- External trigger input
- Infrared thermal sensor input
- Transistor output 1 to 3

All wiring connections are established by Push-In Plus terminals.

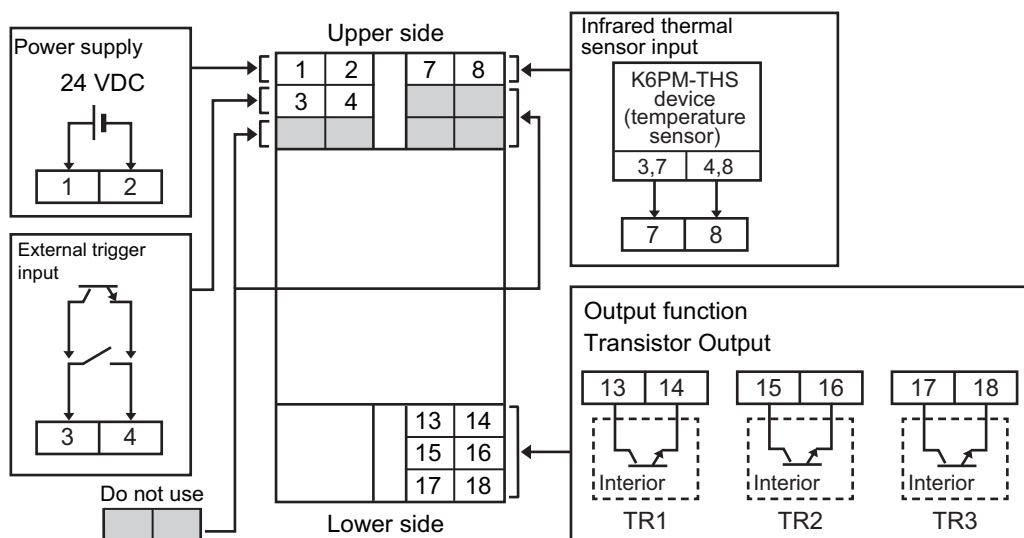

Terminal number	Terminal name	Function
1	Power supply input	24 VDC input terminal (polarity)
2	Power supply input	0 VDC input terminal (polarity)
3,4	External trigger input	ON: Interruption of temperature measurement
7	SDB(+)	RS-485 communications terminal (connected with sensor number 3 or 7)
8	SDA(-)	RS-485 communications terminal (connected with sensor number 4 or 8)
13 or 14	Transistor Output 1 (TR1)	Temperature error Threshold 1 exceeded
15 or 16	Transistor Output 2 (TR2)	Temperature error Threshold 2 exceeded
17 or 18	Transistor Output 3 (TR3)	Main Unit error and K6PM-TH sensor error

## Terminal Layout of Infrared Thermal Sensors

There are two connectors at the bottom of the infrared thermal sensor.

These two connectors are shorted internally for crossover wiring.

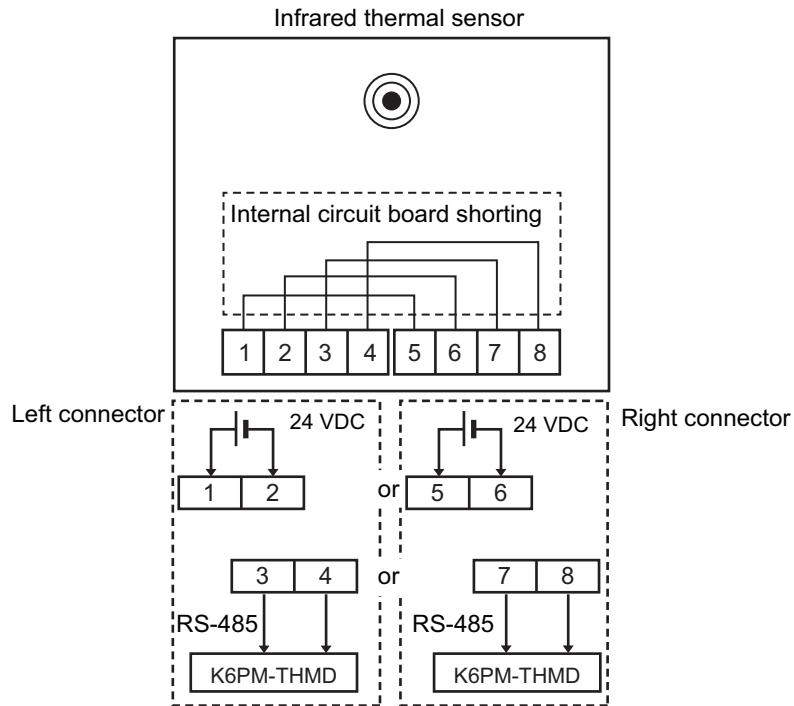

Terminal number	Terminal name	Function
1 or 5	Power supply input (+V)	24 VDC input terminal (polarity)
2 or 6	Power supply input (-V)	0 VDC input terminal (polarity)
3 or 7	RS-485 communications (B)	B (+) RS-485 communications terminal (connected with Main Unit number 7)
4 or 8	RD-485 communications (A)	A (-) RS-485 communications terminal (connected with Main Unit number 8)

### 2-3-3 I/O Wiring

This section shows the following input/output wiring diagram.

- Power supply wiring to the Main Unit and infrared thermal sensors
- RS-485 wiring between the Main Unit and infrared thermal sensors
- External trigger input wiring, transistor output wiring, and Ethernet communications wiring to the Main Unit

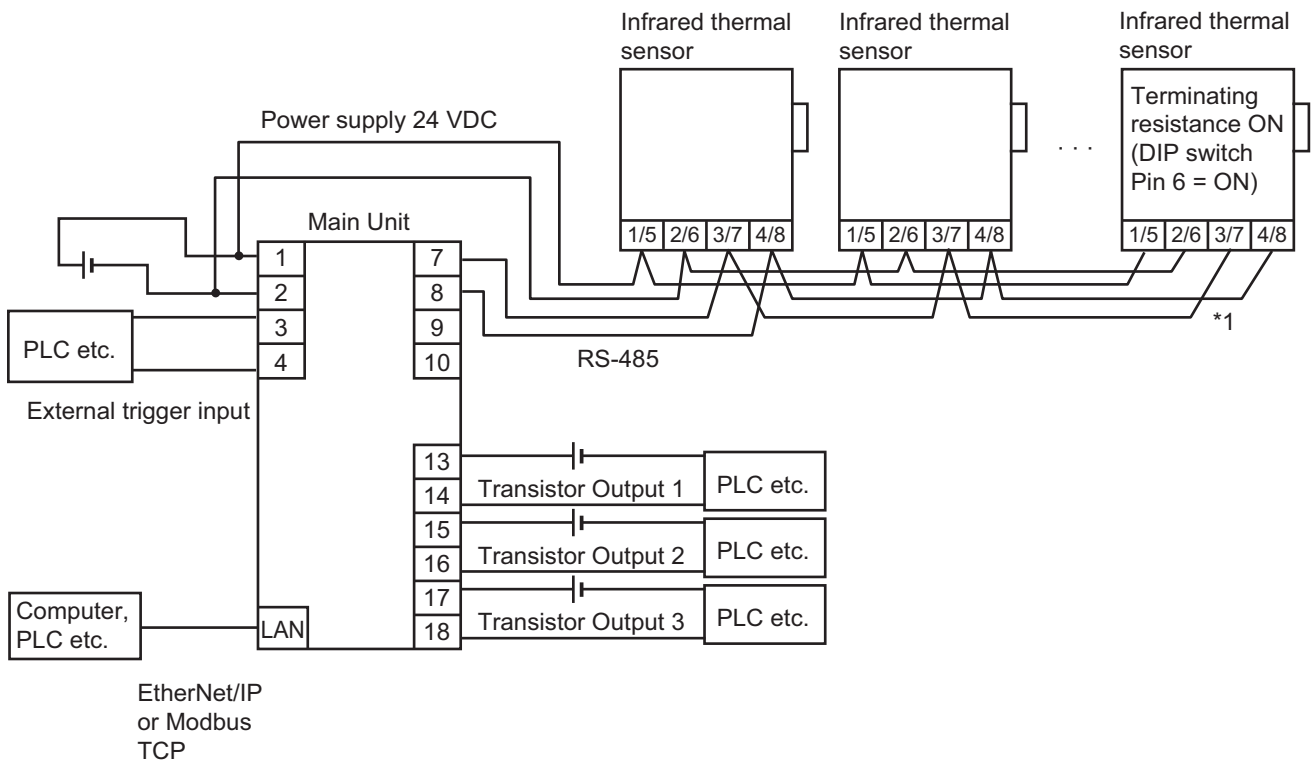

\*1. Fix the cable wiring to the sensors so that the weight of cable does not bear on the connector.

#### ● RS-485 Wiring Length and Recommended Cables

The length of the RS-485 wiring between the Main Unit and infrared thermal sensors is 500 m max. Use commercially available communications cables with one shielded twisted-pair cable (stranded wire, 2-conductor) and AWG24 to AWG16 (0.25 to 1.5 mm<sup>2</sup>) as the standard.

- Recommended cable for use between the Main Unit and infrared thermal sensors

Models	Manufacturer
2464C BIOS series	Bando Densen Co., Ltd.

#### ● Terminal Sensors in the RS-485 Transmission Path

In the case of terminal sensors in the RS-485 transmission path, turn ON the terminating resistance (change the sensor DIP switch Pin 6 to ON). Refer to *DIP Switch Settings* on page 1-17.

### 2-3-4 Ethernet Wiring

Connect the Main Units with the software tool, PLC, or PC via the industrial switching hub with the Ethernet cables.

Use an STP (shielded twisted-pair) cable of Ethernet category 5 or higher. You can use either a straight or cross cable.

## Recommended Ethernet Cables/connectors

Part name	Manufacturer	Model
Ethernet cable	Hitachi Metals, Ltd.	NETSTAR-C5E SA 0.5×4P*1
RJ45 connector	Panduit Corp.	MPS588-C*1

\*1. We recommend use of these cables and connectors in the above combinations.

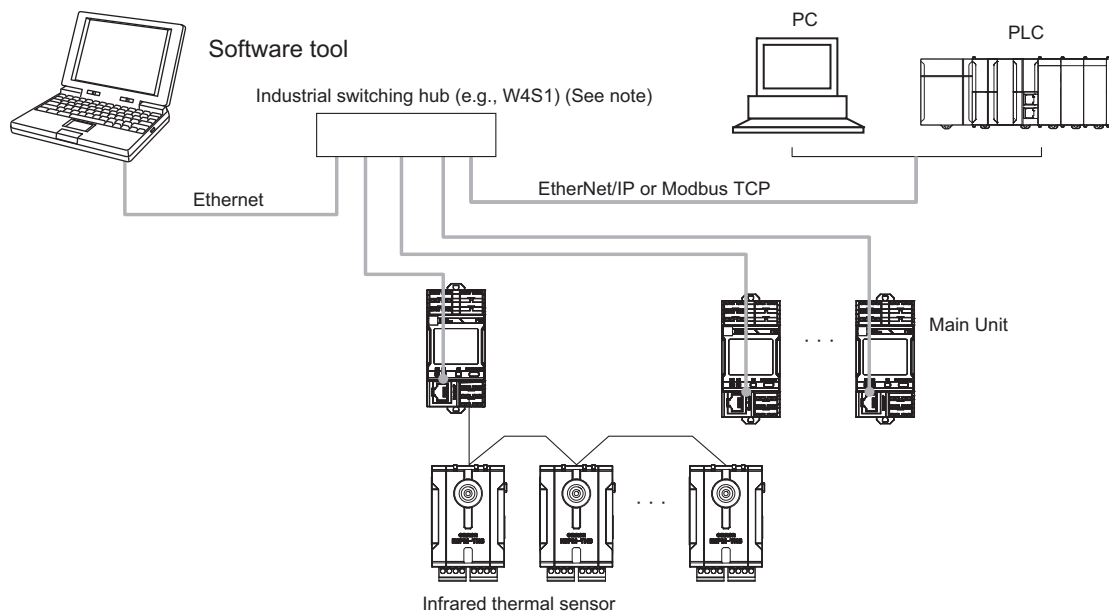

Note In the default setting state, the Main Units are connected one-to-one by Ethernet cable without using a switching hub.

### ● Recommended Ethernet Switches

Ethernet switches are recommended for use in environments that can be used in FA environments and devices that can use QoS (Packet Priority Control) dedicated to EtherNet/IP.

The following are recommended items.

Manufacturer	Model	Description
OMRON	W4S1-03B	Packet priority control (QoS): EtherNet/IP control data priority
	W4S1-05B	Failure detection: Broadcast storm, LSI failure detection
	W4S1-05C	100Base-TX/10Base-T, Auto negotiation
		Number of ports: three for the W4S1-03B, or five each for the W4S1-05B and W4S1-05C
		Failure detection output (W4S1-05C only)
Cisco Systems, Inc	Consult the manufacturer. <a href="https://www.cisco.com/">https://www.cisco.com/</a>	
Contec USA, Inc.	Consult the manufacturer. <a href="https://www.contec.com/us/">https://www.contec.com/us/</a>	
Phoenix Contact USA	Consult the manufacturer. <a href="https://www.phoenixcontact.com/online/portal/pc">https://www.phoenixcontact.com/online/portal/pc</a>	





### Precautions for Correct Use

- Always use an Ethernet switch for tag data links in the network.  
If EtherNet/IP tag data links (cyclic communications) are used with a repeating hub, the communications load on the network will increase. This will increase collisions and may prevent stable communications.
- Do not bend the communications cables past its natural bending radius or pull on it with excessive force.
- Do not place heavy objects on top of the communications cables or other wiring lines. Doing so may cause the wire disconnection.
- Do not exceed the communications distance that is given in the specifications and use the specified communications cable.
- Make the following settings for the switching hub used to connect the Main Unit. Set the switching hub connected to the Main Units as follows.

K6PM-TH Switching hub		AUTO-Nego
AUTO-Nego		Recommended
100 Mbps fixed	FULL	Not allowed
	HALF	Allowed

- In tag data links, when a network system is constructed together with a node for which multicast communications settings have been made, a tag data link timeout may occur. Block the multicast by using a switching hub having a multicast block function so that multicast packets do not reach the main K6PM-TH Unit. (The OMRON W4S1 series does not have the multicast block function.)



# 3

## Initial Setting

This section describes the initial settings of the Main Units using the software tool.

---

<b>3-1</b>	<b>Installation and Uninstallation, Starting up</b> .....	<b>3-2</b>
3-1-1	Installing the Software Tool .....	3-2
3-1-2	Uninstalling the Software Tool .....	3-6
<b>3-2</b>	<b>IP Address Setting</b> .....	<b>3-7</b>
3-2-1	IP Address Setting of Your PC .....	3-7
3-2-2	Setting the IP Address of the Main Units with the Software Tool .....	3-9
<b>3-3</b>	<b>Registering the Sensor Position (Setting sensor screen)</b> .....	<b>3-15</b>
<b>3-4</b>	<b>Registering the Initial Settings and Sensor Configuration of the Main Unit (Setting K6PM screen)</b> .....	<b>3-18</b>

## 3-1 Installation and Uninstallation, Starting up

This section describes how to install and uninstall the software tool and how to start it.

Microsoft .NET Framework 4.7.2 is used to run the software tool.

If .NET Framework 4.7.2 is not installed on your computer, install it as well.

### 3-1-1 Installing the Software Tool

The procedure for installing the software tool is explained below.



#### Precautions for Correct Use

Your computer may be set to show a User Account Control message box during installation. If there is no problem, click the **Yes** Button.

- 1 Download the software tool from our website.  
[https://www.ia.omron.com/k6pm\\_tool](https://www.ia.omron.com/k6pm_tool)
- 2 Run "setup.exe" in the downloaded software.  
The Select Language dialog box appears.



#### Precautions for Correct Use

If the following dialog box appears, the same version of the software tool as the installer you ran has been installed on your computer. If you do not need to reinstall or uninstall the software tool, click the **Cancel** Button to close the installation window.

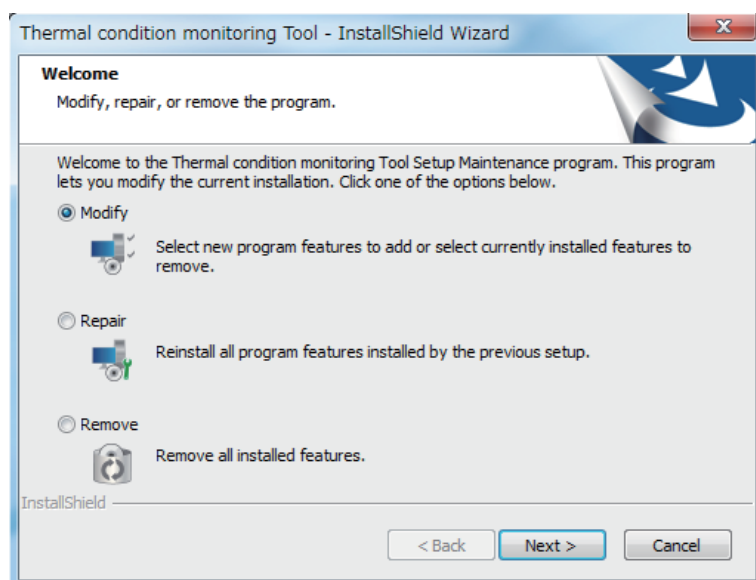

- Explanation of option buttons
  - Change: Select to change the functions that are installed. Do not use this option because it is for future use.
  - Modify: Select to reinstall the software tool.
  - Delete: Select to uninstall the software tool.

- 3** Select Japanese or English, and click the **OK** Button.

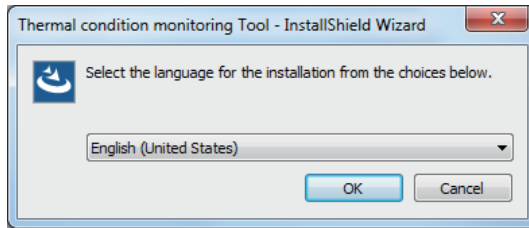

**Note** If you select Japanese on a computer whose operating system is not Japanese, text may not display correctly during installation or the software tool may not operate correctly.

- 4** Install Microsoft .NET Framework 4.7.2. (If already installed, go to step 5.)

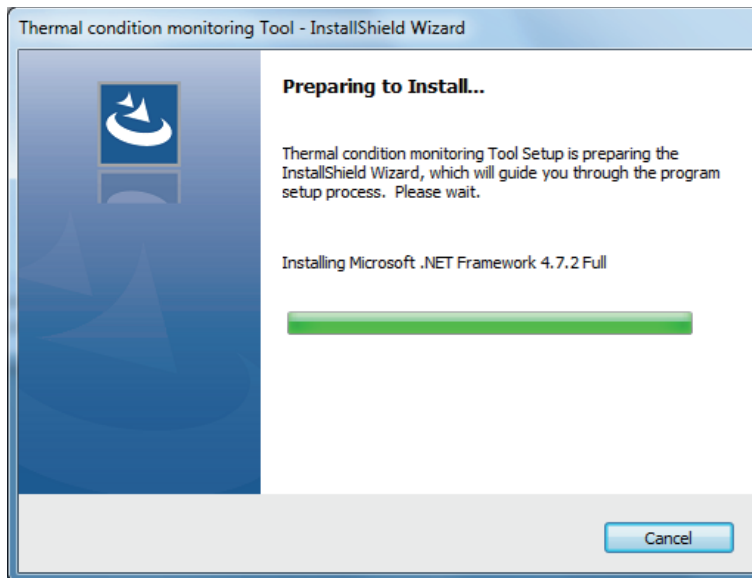

- 5** Click the **Next** Button, read the Product license agreement, and if you agree to all terms of the agreement, select the I agree to all terms check box and click the **Next** Button.

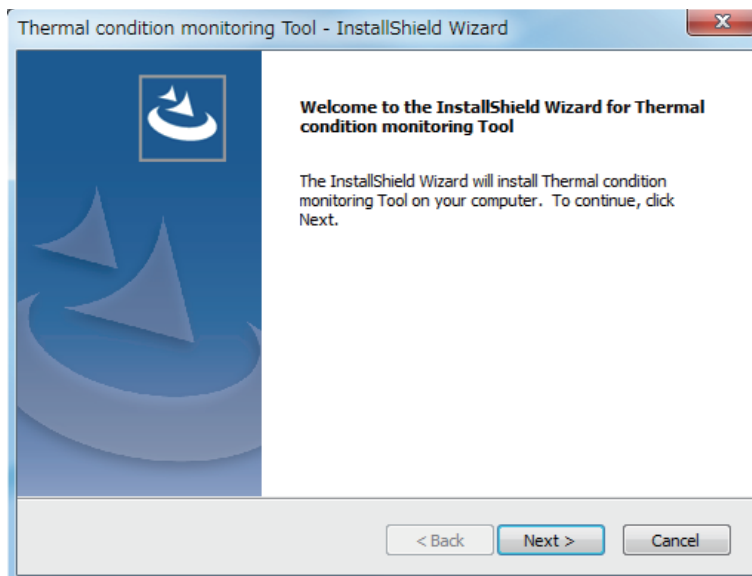

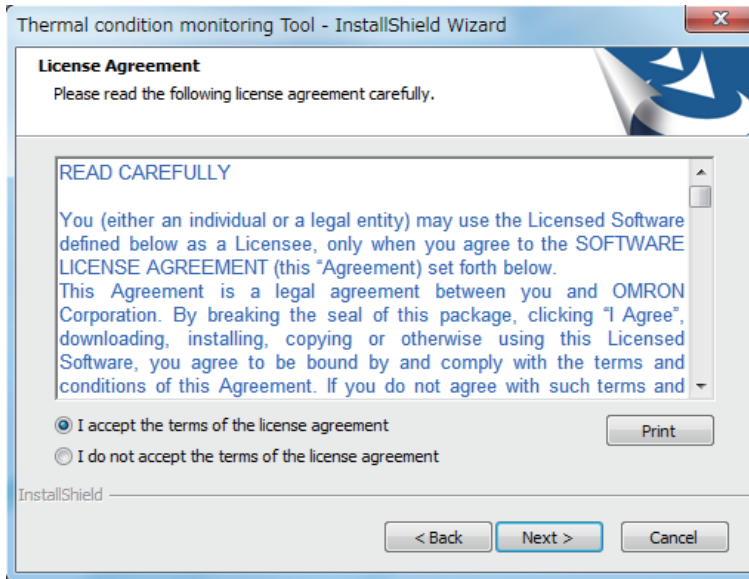

The User Information dialog box appears.

- 6** Register your user information, enter the license key, and click the **Next** Button.  
The license key is included with the K6PM-THMD-EIP (Main Unit).

The Confirm Registration message box appears.

- 7** Make sure the registered information is correct, and click the **Yes** Button.

The Ready to Install dialog box appears

- 8** Click the **Install** Button.

Installation of the software tool starts.

When installation is completed, the message below appears in the Installation Wizard.

- 9 Click the **Finish** Button.

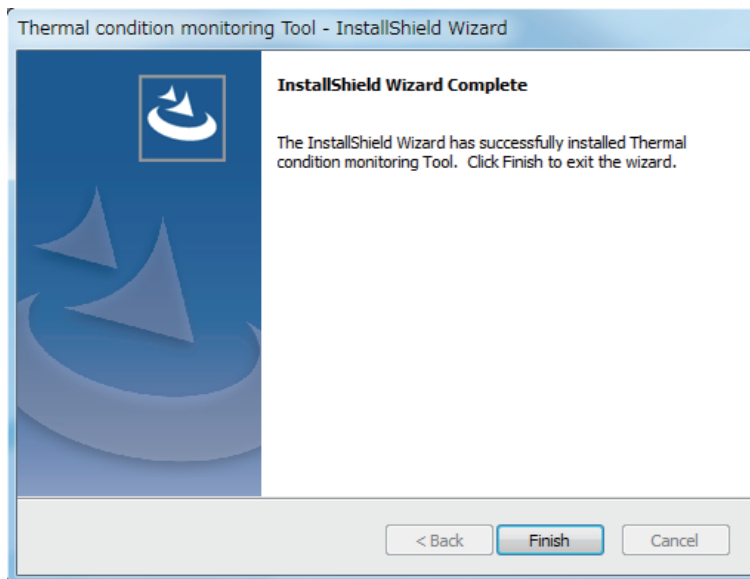

This completes installation of the software tool.

#### 3-1-2 Uninstalling the Software Tool

##### ● Windows 7

- 1 Select **Control Panel | Add or Remove Program** from the start menu.  
The **Add or Remove Programs** dialog box appears.
- 2 Select Thermal condition monitoring tool and click the **Delete** Button.  
A dialog box appears to confirm full deletion of the software tool.
- 3 Click the **Yes** Button. When deletion is finished, the uninstallation completed dialog box appears.
- 4 Click the **Finish** Button.

##### ● Windows 8.1 / Windows 10

- 1 Select **Control Panel | Uninstall a program** from the start menu.  
The **Uninstall or change a program** dialog box appears.
- 2 Select Thermal condition monitoring tool and click the **Delete** Button.  
A dialog box appears to confirm full deletion of Thermal condition monitoring Tool.
- 3 Click the **Yes** Button.  
When uninstallation is finished, the uninstallation completed dialog box appears.
- 4 Click the **Finish** Button.



## 3-2 IP Address Setting

This section describes the setting of the IP address of your PC and each IP address of the Main Units.

### 3-2-1 IP Address Setting of Your PC

Before starting this tool and monitoring and logging the Main Unit, it is necessary to set the IP address of the computer to the IP address of the same segment as the Main Unit. It shows the procedure.

Note that when setting only the Main Unit with an automatic connection, it is not necessary to set the IP address on the computer side.

For the initial setting of K6PM-TH, refer to 3-2-2 *Setting the IP Address of the Main Units with the Software Tool* on page 3-9.

#### ● Windows 7

- 1 Select **Start | Control Panel | Network and Internet | Network and Sharing Center | Change Adapter Settings**.
- 2 Right-click **Local Area Connection** and select **Properties**.
- 3 Select **Internet Protocol Version 4 (TCP / IPv4)** and click **Properties**.  
Check "Use next IP address" and manually set the IP address of the computer.

#### ● Windows 8.1

- 1 Right-click **Start**.
- 2 Select **Network connection**.
- 3 Right-click **Ethernet**, and click **Properties**.
- 4 Select **Internet Protocol Version 4 (TCP / IPv4)** and click **Properties**.  
Check "Use next IP address" and manually set the IP address of the computer.

#### ● Windows 10

- 1 Click **Start** and select **Windows System Tools | Control Panel**.
- 2 Select **Network and Internet | Network and Sharing Center | Change Adapter Settings**.
- 3 Right-click **Ethernet** and click **Properties**.
- 4 Select **Internet Protocol Version 4 (TCP / IPv4)** and click **Properties**.  
Check "Use next IP address" and manually set the IP address of the computer.

## IP Address Settings Example

When using Ethernet for the first time, if you set the IP address and subnet mask of the computer and Main Unit as below, it is possible to connect the software tool to the Main Unit.

Device name	IP address	Sub-net mask	Default gateway
Computer	192.168.250.100	255.255.255.0	Blank
Main Unit 1st Unit	192.168.250.1	255.255.255.0	No change required (0.0.0.0)
Main Unit 2nd Unit	192.168.250.2	255.255.255.0	No change required (0.0.0.0)
Main Unit 3rd Unit	192.168.250.3	255.255.255.0	No change required (0.0.0.0)
⋮	⋮	⋮	⋮
Main Unit 30th Unit	192.168.250.30	255.255.255.0	No change required (0.0.0.0)

When the subnet mask is "255.255.255.0", the range of IP addresses that can be set for the devices 192.168.250.1 to 192.168.250.254. Assign IP address in this range to each Main Unit.

The same IP address can not be assigned to more than one device.

The default value of the IP address of type Main Unit is "192.168.250.30" common to all models.

When subnet mask set for the all devices is "255.255.255.0", each of devices having an IP address within the range of 192.168.250.1 to 192.168.250.254 can communicate via Ethernet as the devices are exist on the same network (segment).

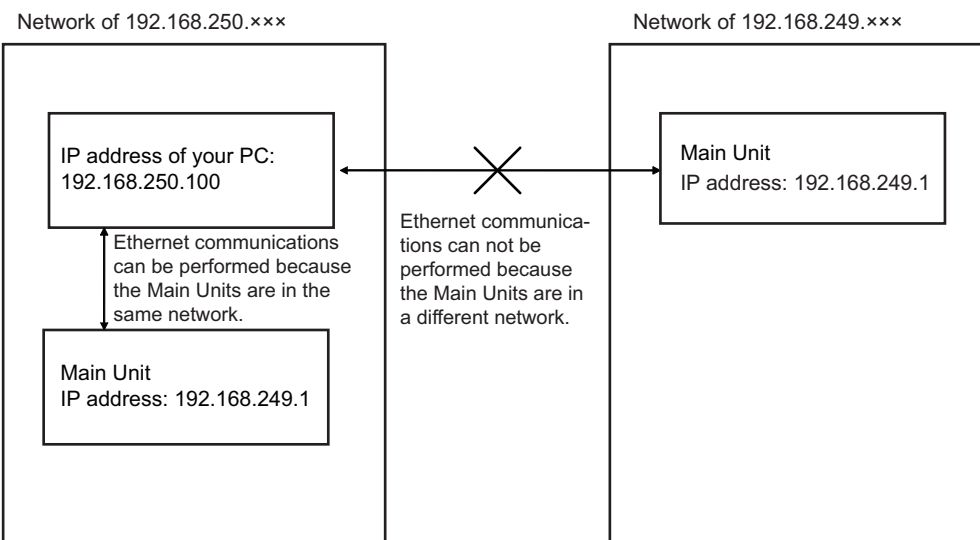

## 3-2-2 Setting the IP Address of the Main Units with the Software Tool

### Establish a One-to-one Connection between the PC and the Main Units

Connect a PC on which the software tool has been installed one to one with each Main Unit, either directly or via a hub.

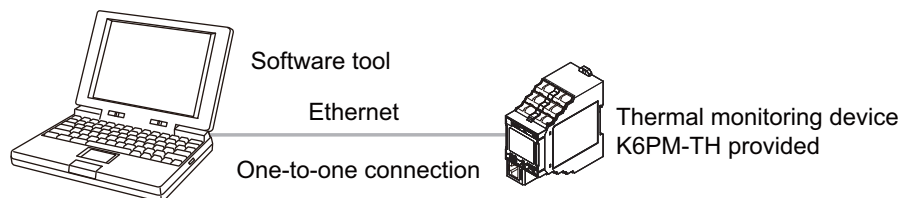

### Create New Project

Connect a PC on which the software tool has been installed one to one with each Main Unit, either directly or via a hub.

- 1 Start the software tool with the following method.

Select All Programs - OMRON - Thermal condition Monitoring Tool from the Windows Start Menu. Or double-click the shortcut icon of the Thermal condition Monitoring Tool on the desktop.



#### Additional Information

For details on the screen flow after starting the software tool, refer to *A-2 Screen Flow of the Software Tool* on page A-12.

- 2 When the software tool starts, the following Select the project Dialog Box is displayed.

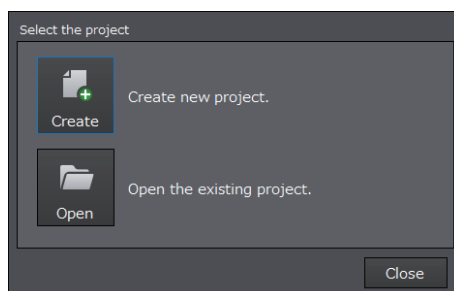

- 3 Click the **Create** Button.

## Display of Device List of K6PM-TH screen

If you click the **Create** Button on the Select the project Dialog Box, the Device List of K6PM screen shown below will be displayed.

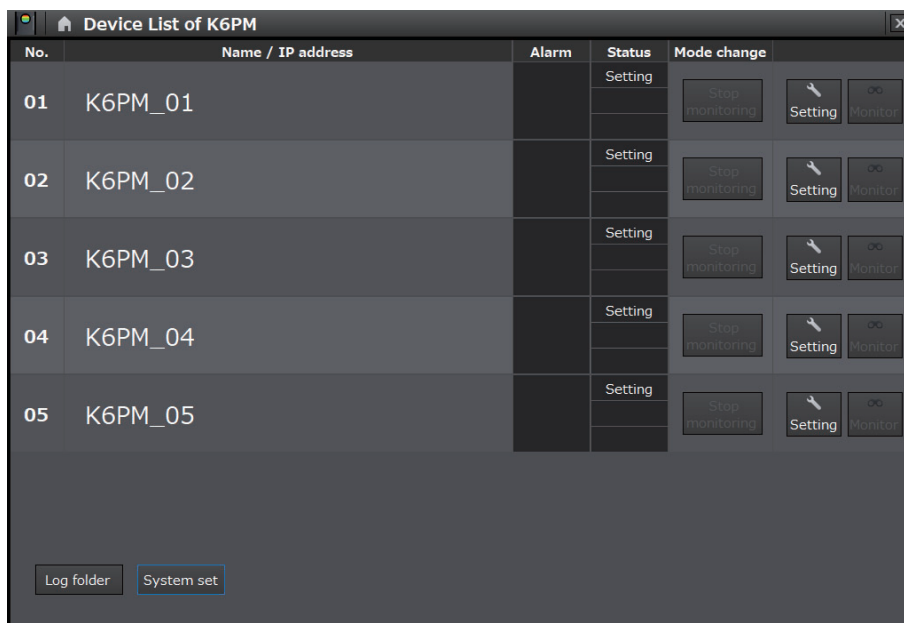

Click the **Setting** Button to display the Setting K6PM screen.



### Additional Information

If you want to change the language of the software tool to English, click the **System setting** Button on the Device List of K6PM screen to display the dialog box shown below.

From the Language group box, select "English", and then click the **OK** Button. You can change the language by restarting the software tool.

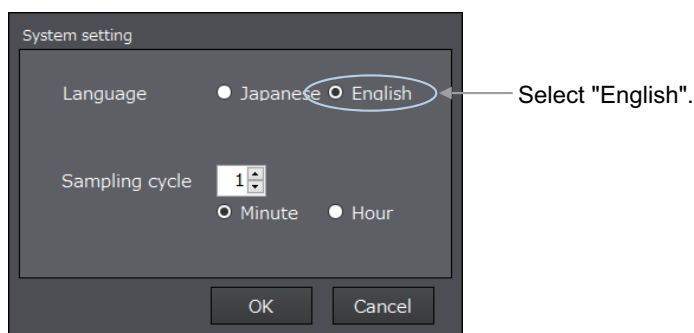

## Display of the Setting K6PM screen

If you click the **Setting** Button on the Device List of K6PM screen, the screen shown below will appear. To return to the Device List of K6PM screen, click the **Device List** Button.

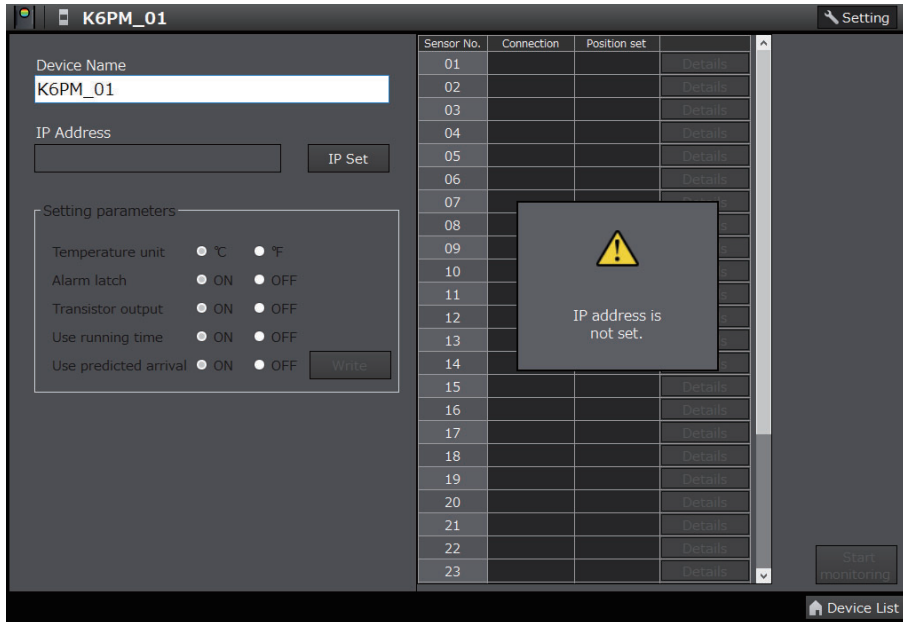

### ● When the IP Address Is Not Set

When the IP address of the target Main Unit is not set, the following dialog box appears. In this case, only the **Set IP** Button and **Device List** Button are enabled.

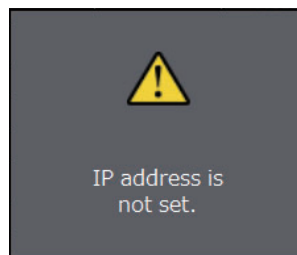

## Display of the IP Address Setting screen

- 1 If you click the **IP setting** Button on the Setting K6PM screen, the screen shown below will appear.

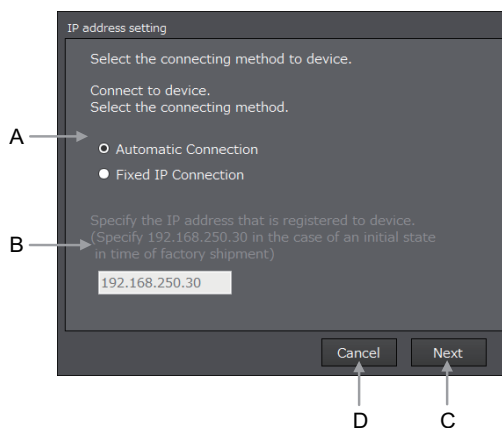

Symbol	Name	Description
A	Select the connecting method to device.	Select the connection method from below. <ul style="list-style-type: none"> <li>• Automatic Connection</li> <li>• Fixed IP Connection</li> </ul>
B	IP address at Fixed IP Connection	If you select a fixed IP connection, enter the IP address of the target Main Unit here.
C	<b>Next</b> Button	Use this button to proceed to the next screen.
D	<b>Cancel</b> Button	Use this button to close this screen and return to the Setting K6PM screen.

**2** Select either "Automatic Connection" or "Fixed IP Connection", and click the **Next** Button.

If you select "Fixed IP Connection", enter the IP address of the target Main Unit.

The following tab page is displayed.

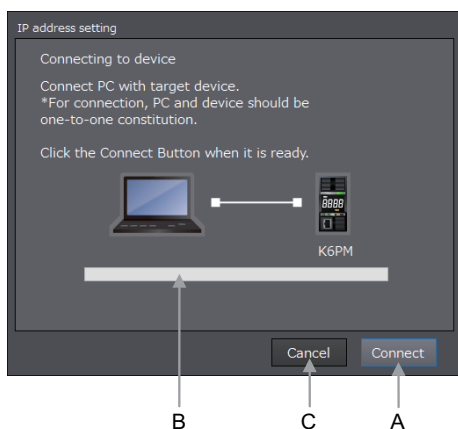

Symbol	Name	Description
A	<b>Connect</b> Button	Use this button to start a connection.
B	Progress bar	A green bar with "Connecting" displayed under it will be displayed while a connection is being established with the Main Unit.
C	<b>Cancel</b> Button	Use this button to close this screen and return to the Setting K6PM screen.

**3** Click the **Connection** Button.

Note If an attempt to establish a connection fails, the following message box will be displayed.

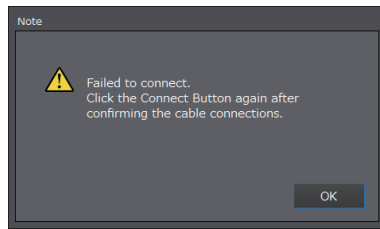

If the connection is successfully established, the following dialog box will be displayed.

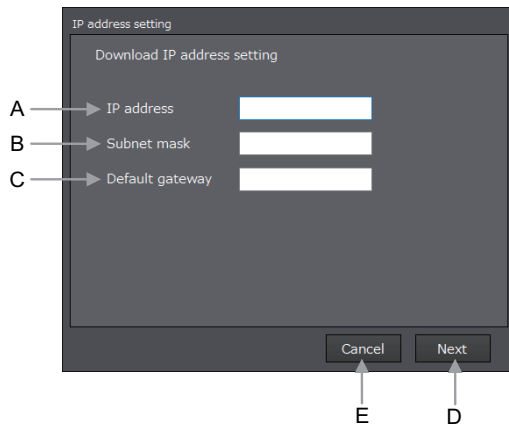

Symbol	Name	Description
A	IP address	Enter the IP address.
B	Subnet mask.	Enter the subnet mask.
C	The default gateway.	Enter the default gateway.
D	<b>Next</b> Button	Use this button to proceed to the next screen.
E	<b>Cancel</b> Button	Use this button to close this screen and return to the Setting K6PM screen.

**4** Enter the IP address, Subnet mask and The default gateway you want to set for the target Main Unit.

Click the **Next** Button to display the following screen.

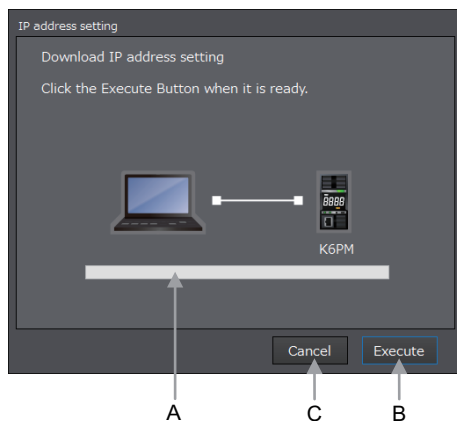

Symbol	Name	Description
A	Progress bar	A green bar with "Downloading" displayed under it will be displayed while a connection is being established with the Main Unit.
B	<b>Execute</b> Button	Use this button to start the download.
C	<b>Cancel</b> Button	Use this button to close this screen and return to the Setting K6PM screen.

- 5** When download to the Main Unit for which the IP address has to be set is successful, the following screen will be displayed.

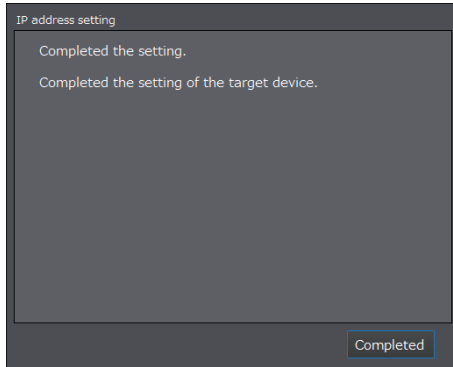

- 6** Click the **Finish** Button. The display will return to the Setting K6PM screen.
- 7** If you click the **Device List** Button or the **Start monitoring** Button on the Setting K6PM screen, the display will return to the Device List of K6PM screen.

## Save the Project

If you exit the Device List of K6PM screen by clicking the × Button at the top right of the Device List of K6PM screen, the Save the project message box shown below will appear.

Click the **Save** Button or **Save As** Button to save the project.

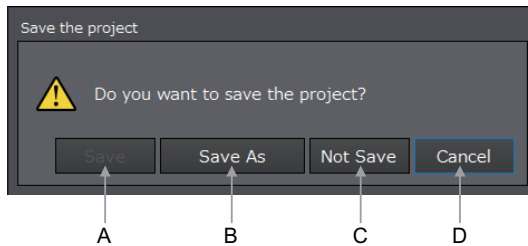

Symbol	Name	Description
A	<b>Save</b> Button	Use this button to save a selected existing project in the same file without opening the File Selection screen.
B	<b>Save As</b> Button	Use this button to open the File Selection screen, and save the project information.
C	<b>Not save</b> Button	Exit the software tool without saving the file.
D	<b>Cancel</b> Button	Use this button to return to the Device List of K6PM screen.



## 3-3 Registering the Sensor Position (Setting sensor screen)

Before using a Main Unit, it is necessary to register the position of each infrared thermal sensor in the Main Unit.

The method of registering an infrared thermal sensor with the software tool is described below.

Perform position registration of each infrared thermal sensor according to the procedure below.

Note that if the sensor configuration has already been registered, and you want to suspend the measurement by the Main Unit, turn ON the external trigger input before performing Step 1 below to suspend measurement.

- 1 After selecting the Main Unit on the Device List of K6PM-TH screen, click the **Setting** Button. The Setting K6PM-TH screen will be displayed.
- 2 Select the sensor number, and then click the **Details** Button. The following Setting sensor screen will be displayed. Note that the corresponding selected infrared thermal sensor is automatically set to the K6PM-TH sensor position adjustment mode (the main numeric display on the front panel changes to "Rd").

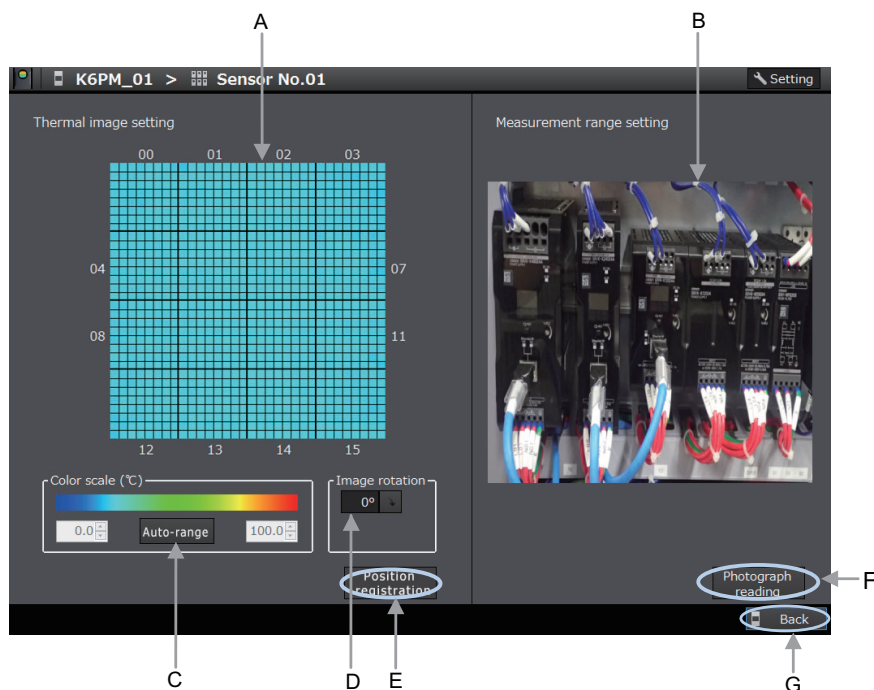

Symbol	Name	Description
A	Thermal image setting	Each temperature of 1,024 pixels (32 × 32) is displayed by a color. If you place the cursor on the thermal image, the temperature of the target pixel will be displayed.
B	Measurement range setting	Displays the photo image of the measurement location.
C	Color scale	The display color scale of temperature can be adjusted. Adjust the color scale in accordance with the temperature difference. Click the <b>Auto-range</b> Button to perform automatic adjustment.
D	Image rotation	Click  to rotate the thermal image in units of 90°. The image is displayed rotated to the right by the specified angle. 0 to 270°

Symbol	Name	Description
E	<b>Position registration</b> Button	Register the correct position of the infrared thermal sensor based on the current position.
F	<b>Photograph reading</b> Button	Select the photo image of the measurement location, and paste it. *1 To read the photo image showing the measurement target, start Explorer. When file selection is complete, copy the image under the "cfg\image" folder.
G	<b>Back</b> Button	Use this button to close this screen and return to the Setting K6PM screen.

\*1. Photo images must be captured by the customer.

**3** Hold up the heat-generating device in the area to be measured, and perform position adjustment while checking the thermal image on this screen.

Note To display the photo image of the measurement location, click the **Photograph reading** Button on the Setting sensor screen to select the photograph of the measurement location.

**4** After ending position adjustment, click the **Position registration** Button. The current sensor position is registered in the Main Unit.

**5** Click the **Back** Button to return to the Setting K6PM screen, and register the position of the other sensors in a similar manner.

If an angle deviation occurs in the infrared thermal sensor while the Setting K6PM screen shown below is being displayed, the  icon will be displayed in the position setting column.

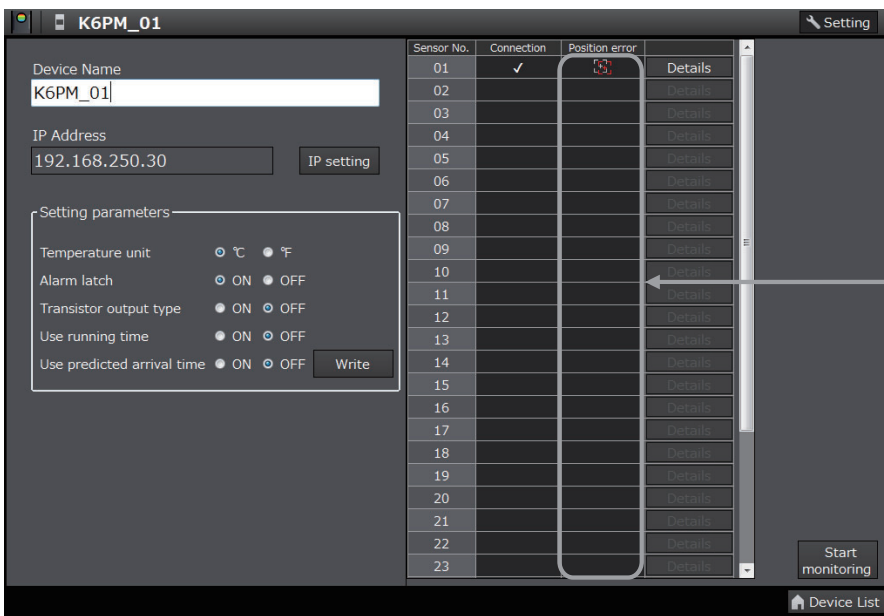

If an angle deviation has occurred, the  icon will be displayed.

In such a case, click the **Details** Button, and after adjusting the position again on the Setting sensor screen, click the **Position registration** Button.

- When a communications error occurs

When a communications error occurs while the software tool is communicating with the target Main Unit during the display of the Setting sensor screen, the following dialog box will be displayed. At this time, the thermal image display part turns gray. Only the **Photograph reading** Button and the **Back** Button are enabled.

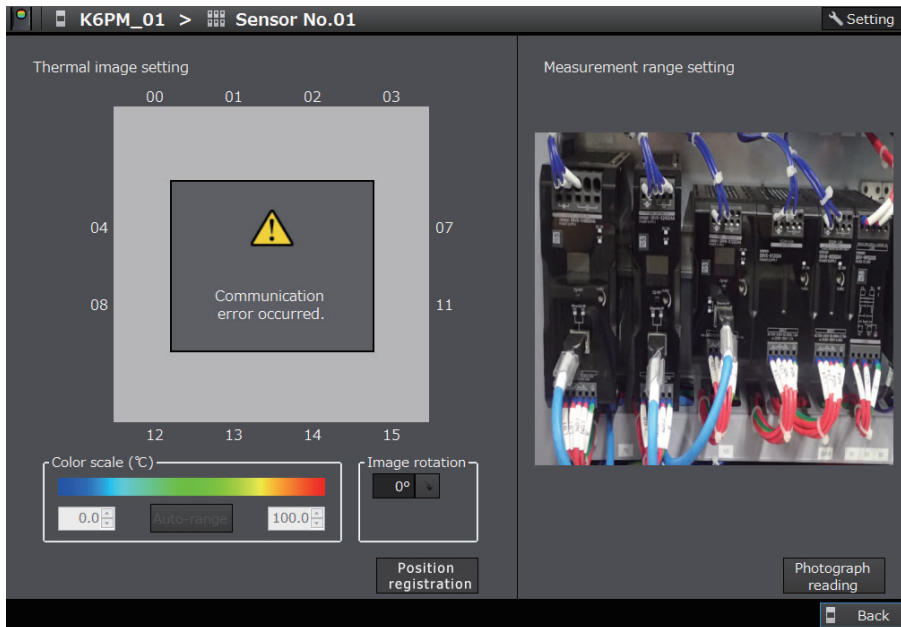

## 3-4 Registering the Initial Settings and Sensor Configuration of the Main Unit (Setting K6PM screen)

Before using a Main Unit, it is necessary to register the initial settings of the Main Unit as well as the sensor configuration in the Main Unit.

Registration must be performed after confirming that angle deviation has not occurred in all infrared thermal sensors.

### ● Initial Settings of the Main Unit

Set the following items when making the initial settings of the Main Unit.

Item	Description	Value	Reference destination of function details
Temperature unit	On the Main Unit front-panel, select whether to display the temperature in °C or °F.	°C (default), °F	---
Alarm latch	Select whether to use the function for latching the alarm status of the comprehensive alarm (threshold 1 or 2).	ON: Use (default) OFF: Not used	<i>Alarm Latch of the Main Unit</i> on page 4-16 of <i>4-2-1 Functions of Monitoring the Temperature in Control Panel with the Main Unit and the Software Tool</i> on page 4-13
Output inversion	Set the logic of the transistor output method of the comprehensive alarm.	ON: Normally open OFF: Normally closed (default)	<i>Transistor Output Type of the Main Unit</i> on page 4-15 of same as above
Use Running Time	Select whether or not to use the Notification of the Main Unit Replacement Timing.	ON: Use OFF: Not used (default)	<i>Maintenance Forecast Monitor Function</i> on page 4-17 of same as above
Use arrival prediction	Select whether or not to use the Temperature arrival prediction.	ON: Use OFF: Not used (default)	<i>Arrival Prediction</i> on page 4-15 of same as above

### ● Sensor Configuration

When power is supplied, the Main Unit automatically searches the connected infrared thermal sensors. After confirming the search results as the sensor configuration, it is necessary to register them to the Main Unit if they are correct.

If the sensor configuration is not correct, check the connection between the Main Unit and each infrared thermal sensor, and also each K6PM-TH sensor number setting<sup>\*1</sup>. Thereafter, again turn ON the power supply to the Main Unit, and check the current sensor configuration.

\*1. The setting depends on the DIP switch pin on the side surface of the infrared thermal sensor. For details, refer to *DIP Switch Settings* on page 1-17.

The method using the software tool is described below.

- 1** After selecting the Main Unit on the Device List of K6PM screen, click the **Setting** Button. The Setting K6PM screen will be displayed.
- 2** In the Setting parameters group box, select the **option** Button of each setting item.
- 3** Check the sensor number, connection status, and position setting.

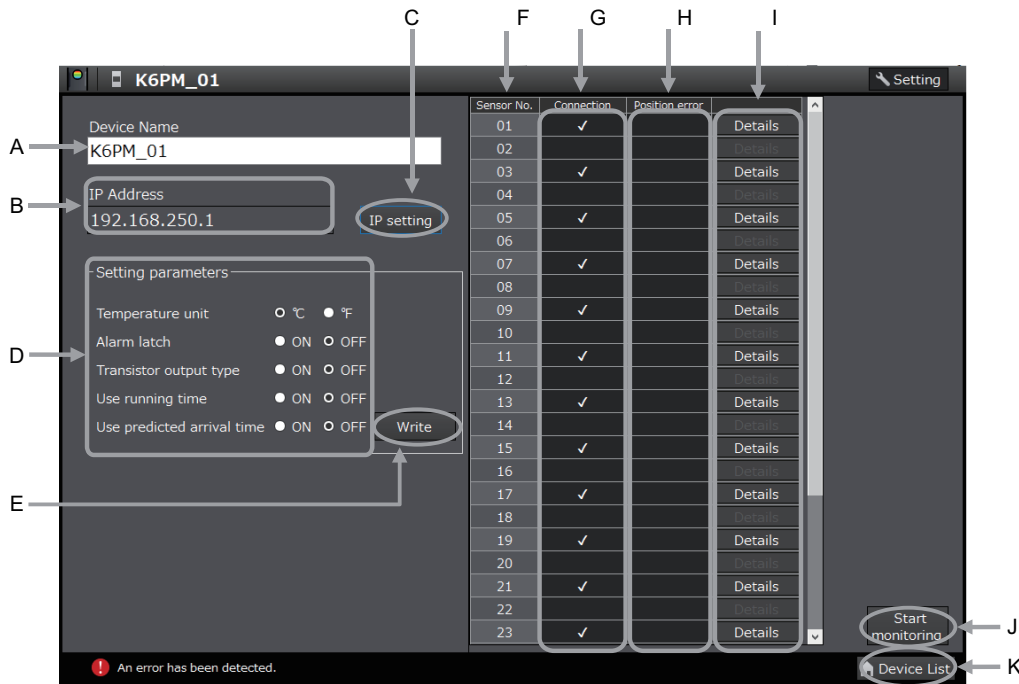

Symbol	Name	Description
A	Device Name	Name of the Main Unit. Default: K6PM_01 to 05 (can be changed) Up to 32 single-byte characters and 16 double-byte characters.
B	IP address	Displays the IP address.
C	<b>IP settings</b> Button	Used to set the IP address. Click this button to move to the IP address setting screen.
D	Setting value	Used to select each setting item of the Main Unit.
E	<b>Write</b> Button	Used to write each setting value of the Main Unit.
F	Sensor No.	This is the sensor number connected to the Main Unit.
G	Connection	Check if the sensor configuration is correct. If normal communications are performed, <input checked="" type="checkbox"/> is displayed.
H	Position error	If K6PM-TH sensor angle deviation has occurred, the  icon is displayed. In such a case, click the <b>Details</b> Button and again adjust the position on the Setting sensor screen, and thereafter, register the position.
I	Description	Used to move to the Setting sensor screen of each sensor number
J	<b>Start monitoring</b> Button	Use this button to move to the monitoring mode.
K	<b>Device List</b> Button	Use this button to return to the Device List of K6PM screen.

**4** If the initial settings of the Main Unit and the sensor configuration are correct, the registration of all sensor positions is complete, and angle deviation of the sensors has not occurred, click the **Start monitoring** Button. As a result, the Main Unit enters the monitoring mode.

 **Precautions for Correct Use**

Before clicking the **Start monitoring** Button, be sure to perform position registration of all infrared thermal sensors. For details on how to register the sensor position, refer to 3-3 *Registering the Sensor Position (Setting sensor screen)* on page 3-15.



# 4

## Monitoring the Temperature in Control Panel with the Main Unit and the Software Tool

This section describes the details of monitoring the temperature in the control panel with the Main Unit and the software tool.

4

---

<b>4-1</b>	<b>Method of Monitoring the Temperature in the Control Panel</b>	<b>4-2</b>
4-1-1	Overview of Temperature Monitoring	4-2
4-1-2	Display on the Main Unit after Registration of Sensor Configuration	4-2
4-1-3	Monitoring with the Main Unit	4-3
4-1-4	Monitoring Using Software Tools	4-5
<b>4-2</b>	<b>Functions of Monitoring the Temperature in the Control Panel</b>	<b>4-13</b>
4-2-1	Functions of Monitoring the Temperature in Control Panel with the Main Unit and the Software Tool	4-13
4-2-2	Operation Example of an Alarm	4-17
4-2-3	Automatic Saving Log Files	4-19
<b>4-3</b>	<b>Alarm Threshold Setting</b>	<b>4-23</b>
<b>4-4</b>	<b>Procedure for Taking Actions When an Alarm Occurs</b>	<b>4-25</b>

## 4-1 Method of Monitoring the Temperature in the Control Panel

This section describes how to monitor the temperature inside the control panel.

### 4-1-1 Overview of Temperature Monitoring

When temperature monitoring is performed with the Main Unit by using an infrared thermal sensor, the following measurement levels are present.

The methods that can be used for checking are as described below.

Measurement level	Methods for checking		
	Main Unit	Software tool	Communications
Temperature of each segment and sensor internal temperature	The segment display of each sensor can be switched on the Main Unit front-panel.	Can be checked on the <b>Monitoring sensor</b> Screen.	<ul style="list-style-type: none"> <li>• EtherNet/IP tag data link communications</li> <li>• EtherNet/IP CIP message communications</li> <li>• Modbus TCP communications</li> </ul>
Differential temperature per segment from the K6PM-TH sensor internal temperature	Not supported		
Temperature of each infrared thermal sensor	Not supported	The past maximum value can be monitored on the <b>Monitoring K6PM</b> Screen.	Not supported
Temperature of each pixel	Not supported	The temperature can be displayed when the cursor is placed on the thermal image on the <b>Monitoring sensor</b> Screen.	<ul style="list-style-type: none"> <li>• EtherNet/IP CIP message communications</li> <li>• Modbus TCP communications</li> </ul>
Alarms of each Main Unit (Alarms of all infrared thermal sensors connected to the Main Unit)	You can check if an alarm has occurred on the alarm bar and by transistor output.	The occurrence of an alarm can be checked on the <b>Device List of K6PM</b> Screen.	The occurrence of an alarm can be checked from the Main Unit status.

### 4-1-2 Display on the Main Unit after Registration of Sensor Configuration

When the configuration of the infrared thermal sensor is registered in the Main Unit by the software tool or communications, the Main Unit shifts to the monitoring mode at that point of time, and the measurement and monitoring of the Main Unit starts automatically (there is no need to particularly perform the "Start" operation for measurement and monitoring).

At the same time, logging is started by the software tool.

At this time, the measured value is displayed on the numeric display on the Main Unit front-panel.



### 4-1-3 Monitoring with the Main Unit

Monitoring can be performed with the Main Unit by the following methods.

- Alarm bar, status display LED, and product status indication LED (MS)
- Transistor output

#### Monitoring with the Alarm Bar, Status Display LED, and Product Status Indication (MS) LED

The following can be monitored by combining together the alarm bar and product status indication (MS) LED.

Alarm bar	Status display LED	Product status indication (MS) LED	Status	Meaning
Lit green	"MON" lit	Lit green	Comprehensive alarm: normal	This is the state when the comprehensive alarm has not occurred (normal).
	"MON" lit	Flashing red	The detection of the K6PM-TH sensor angle deviation	This is the state when angle deviation of the corresponding sensor has occurred. The corresponding K6PM-TH sensor number flashes (only when the corresponding K6PM-TH sensor number is being displayed).
	"MON" lit	Flashing red	Temperature measurement range exceeded	This is the state when the measurement temperature has exceeded 200.0°C while threshold 1 and threshold 2 have been set to a value larger than 200.0°C. The current temperature blinks (only when the applicable segment of the applicable K6PM-TH sensor number is displayed).
	Not lit.	Lit green	During measurement interruption	This is the state when measurement has been interrupted due to an external trigger.
Lit red	"MON" lit "ALM" lit	Flashing red	Temperature measurement range exceeded	This is the state when the measurement temperature has exceeded 200.0°C while threshold 2 has been set to 200°C max. The current temperature flashes (only when the corresponding segment of the corresponding K6PM-TH sensor number is being displayed).

Alarm bar	Status display LED	Product status indication (MS) LED	Status	Meaning
Lit yellow	"ALM" and "MON" light up simultaneously (only when the corresponding K6PM-TH sensor number is being displayed)	Lit green	Comprehensive alarm: Threshold 1 exceeded	There are no "Over threshold 2" results and at least one "Over threshold 1" result in the measured values. If the conditions for blinking and lighting are both met, lighting is given priority.
Flashing yellow		Lit green	Comprehensive alarm: Arrival prediction threshold 1 exceeded (When the arrival prediction function is enabled)	
Lit red		Lit green	Comprehensive alarm: Threshold 2 exceeded	There is at least one "Over threshold 2" result in the measured values. If the conditions for blinking and lighting are both met, lighting is given priority.
Flashing red		Lit green	Comprehensive alarm: Arrival prediction threshold 2 exceeded (When the arrival prediction function is enabled)	
Not lit.	"ERR" lit	Lit red	A Main Unit internal error has occurred This is the state when a Main Unit internal error has occurred. "8888" flashes on the main numeric display. Note The alarm bar does not light up when a Main Unit internal error occurs.	

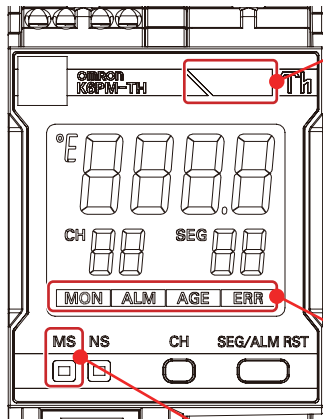

- Alarm bar
  - (Green): Comprehensive alarm (normal): Lit
  - (Yellow): Comprehensive alarm (threshold 1 exceeded): Lit, Comprehensive alarm (arrival prediction threshold 1 exceeded): Flashing
  - (Red): Comprehensive alarm (threshold 2 exceeded): Lit, Comprehensive alarm (arrival prediction threshold 2 exceeded): Flashing
  - (Not lit): Other than the above.
- Status display LED:
  - "MON" Lit: K6PM sensor monitoring state
  - "ERR" Lit: Internal device error occurred
  - "ALM" Lit: An alarm has occurred (only when the corresponding K6PM sensor number is being displayed)
  - "AGE" Lit: The running time has reached 100%
- Product status indication (MS) LED

## Monitor with the Transistor Outputs

When monitoring with the transistor outputs, the following monitoring is available.

Transistor Output 1	Transistor output 2	Transistor output 3	Status	Meaning
ON*1	ON*1	ON*2	Comprehensive alarm: Normal	All measured values are in normal condition.
OFF*1	ON*1	ON*2	Comprehensive alarm: Threshold 1 exceeded	This is the state when there is no "Threshold 2 exceeded" in the measured value, and there is at least one "Threshold 1 exceeded".
OFF*1	OFF*1	ON*2	Comprehensive alarm: Threshold 2 exceeded	This is the state when there is at least one "Threshold 2 exceeded" in the measured value.
OFF	OFF	OFF	Main Unit error and K6PM-TH sensor error occurrence	This is the state when a Main Unit error and K6PM-TH sensor error has occurred.

\*1. This is the output result when "Transistor output type" is set to "Normally closed". By default, it is set to "Normally open". By setting it to "Normally open" with the software tool or communications, ON/OFF can be reversed.

\*2. ON/OFF cannot be reversed for transistor output 3.

### 4-1-4 Monitoring Using Software Tools

The following can be monitored on each screen when monitoring of the temperature in the control panel is performed with the software tool.

- **Device List of K6PM** Screen: Monitoring of each Main Unit
- **Monitoring K6PM** Screen: Monitoring of each infrared thermal sensor
- **Monitoring sensor** Screen: Monitoring of each segment

## Monitoring of each Main Unit (Device List of K6PM Screen)

When you start the software tool, the following **Select the project** Dialog Box is displayed.

Click the **Create** Button or the **Open** Button.

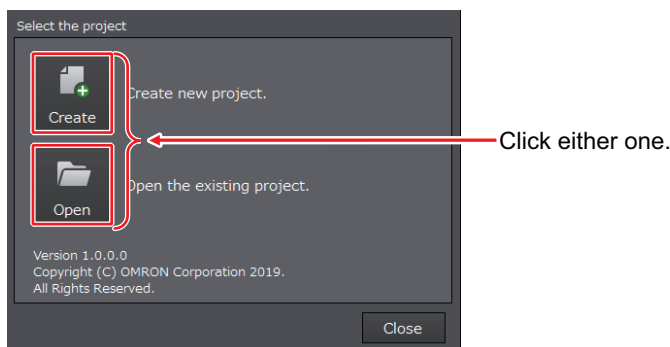

If you click the **Open** Button, a window for selecting the existing project is displayed. Select a project file and then click the **Open** Button.

The following **Device List of K6PM** Screen is displayed.

You can perform monitoring for each Main Unit.

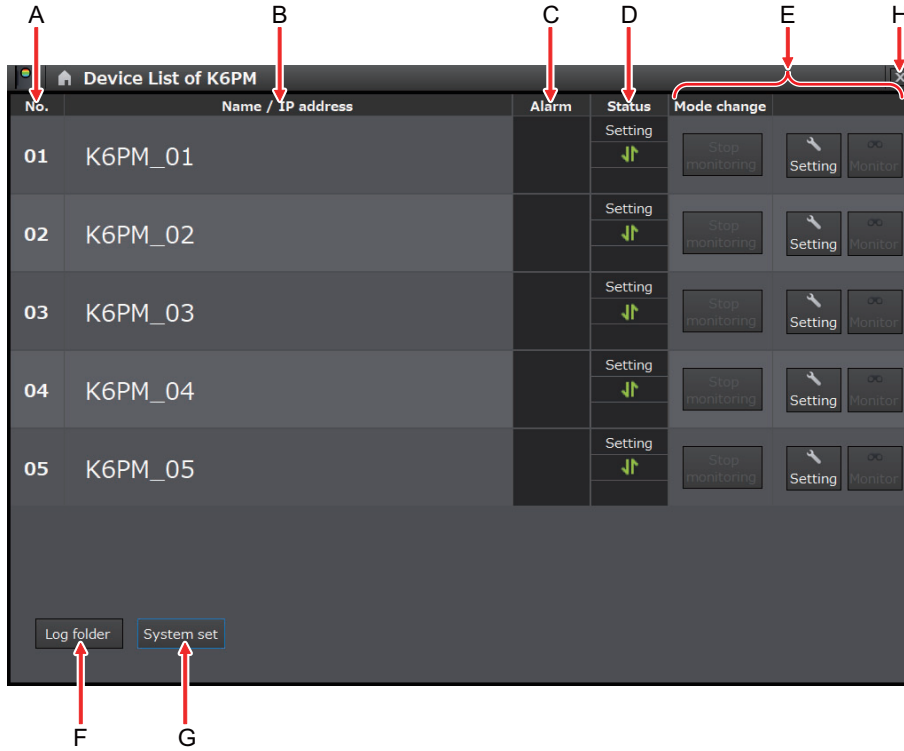

Symbol	Name	Description
A	No.	This is the number of the Main Unit. 01 to 05 It cannot be changed (only for this screen).
B	Name/IP address	Displays the name and IP address of the Main Unit. <ul style="list-style-type: none"> <li>The default name of the Main Unit is from K6PM_01 to 05 (can be changed), and can be up to 32 single-byte characters and 16 double-byte characters.</li> <li>The IP address of the Main Unit set on the <b>Setting K6PM</b> Screen is displayed as the IP address. During startup, the IP address read from the project file is displayed.</li> </ul>
C	Alarm	Comprehensive alarm occurrence (Threshold 1 exceeded or threshold 2 exceeded.) : Threshold 1 exceeded, : Threshold 2 exceeded*1
D	Status	The top three of the following are displayed. <ul style="list-style-type: none"> <li>Any one of during monitoring, during setting, or during interruption</li> <li>During monitoring: Registration state</li> <li>Setting: Unregistered state</li> <li>During interruption: During measurement interruption due to the input of an external trigger</li> <li>Communications status with the Main Unit  : Normal, : Error</li> <li>K6PM-TH sensor error occurrence state  : Sensor type error, : Temperature measurement range exceeded, : K6PM-TH sensor angle deviation detected, : K6PM-TH sensor communications error</li> </ul>
E	<b>Switch Status</b> Button	The status of the Main Unit can be switched by any one of the following: <ul style="list-style-type: none"> <li>Setting: The display moves to the <b>Setting K6PM</b> Screen.</li> <li>Monitoring: The display moves to the <b>Monitoring K6PM</b> Screen.</li> <li>Stop monitoring: The monitoring of the Main Unit is stopped.</li> </ul>
F	<b>Log folder</b> Button	Place the cursor on this button to view the folders for saving the log file. Click the button to open the folder for saving the log file in Explorer.
G	<b>System setting</b> Button	The display moves to the System setting Dialog Box. The language and sampling cycle can be set.
H	<b>Close</b> Button	Use this button to exit the <b>Device List of K6PM</b> Screen, and view the screen for confirming that the project has been saved.

\*1. Blinks when over due to arrival prediction function.

## ● Setting the Sampling Cycle

Before monitoring the Main Unit with the software tool, set the sampling cycle of the software tool on the **System setting** Dialog Box.

The range that can be set is from 1 to 99 minutes or from 1 to 99 hours. The default is 1 minute.

- 1 On the **Device List of K6PM** Screen of the software tool, click the **System setting** Button.



Click here.

- 2 In the **System setting** Dialog Box shown below, set the sampling cycle and then click the **OK** Button.

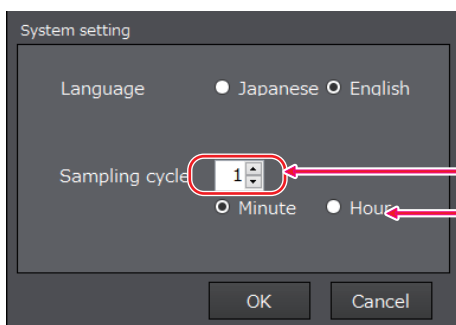

Set the numeric value with the spin box.

Select the unit from "min" and "hour".

## Monitoring of each Infrared Thermal Sensor (Monitoring K6PM Screen)

Each infrared thermal sensor connected to each Main Unit is monitored.

If you click the **Monitoring** Button on the **Device List** of **K6PM** Screen, the following **Monitoring K6PM** Screen will be displayed.

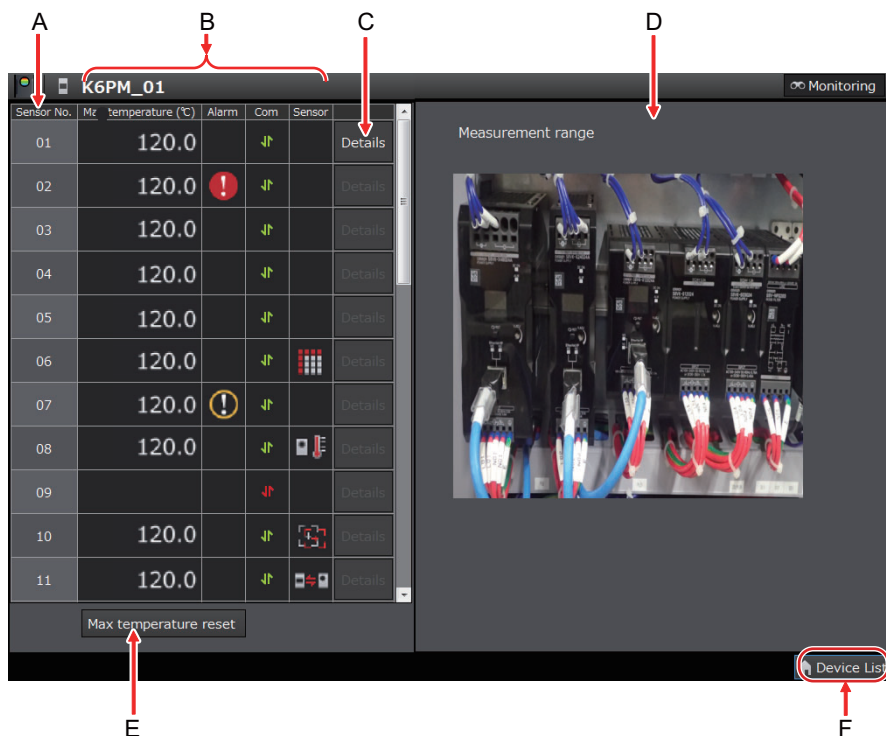

Symbol	Name	Description
A	Sensor No.	Sensor number of the infrared thermal sensor connected to the Main Unit. 01 to 31
B	(Status of each sensor)	<p>Indicates the following for each sensor.</p> <ul style="list-style-type: none"> <li>• Max. temperature: The past maximum value of the current temperature (of each infrared thermal sensor)</li> <li>• Alarm: The alarm level is displayed as follows when any of the individual alarms of the corresponding sensor occur                      ⚠: Threshold 1 exceeded, 🚨: Threshold 2 exceeded<sup>*1</sup></li> <li>• Communications: Communications status of the Main Unit and the infrared thermal sensor                      🟢: Normal, 🟡: Error</li> <li>• Sensor: The K6PM-TH sensor error occurrence state is displayed by any of the following icons.                      🟡: Sensor type error, 🚨: Temperature measurement range exceeded,                      ⚡: K6PM-TH sensor angle deviation detected</li> </ul>
C	Description	The display moves to the <b>Monitoring sensor</b> Screen of each sensor number
D	Measurement Range	If you click the corresponding sensor area with the mouse, the sensor image (photograph) read on the <b>Setting sensor</b> Screen is displayed. At this time, the area of the specified sensor is highlighted.
E	<b>Max. temperature reset</b> Button	Use this button to reset the maximum temperature of all sensors connected to the Main Unit.
F	<b>Device List</b> Button	Use this button to return to the Device List of K6PM screen.

\*1. Blinks when over due to arrival prediction function.

- When a communications error occurs

When a communications error occurs while the software tool is communicating with the target Main Unit during the display of the **Monitoring K6PM** Screen, the following dialog box will be displayed. At this time, only the **Device List** Button is enabled.

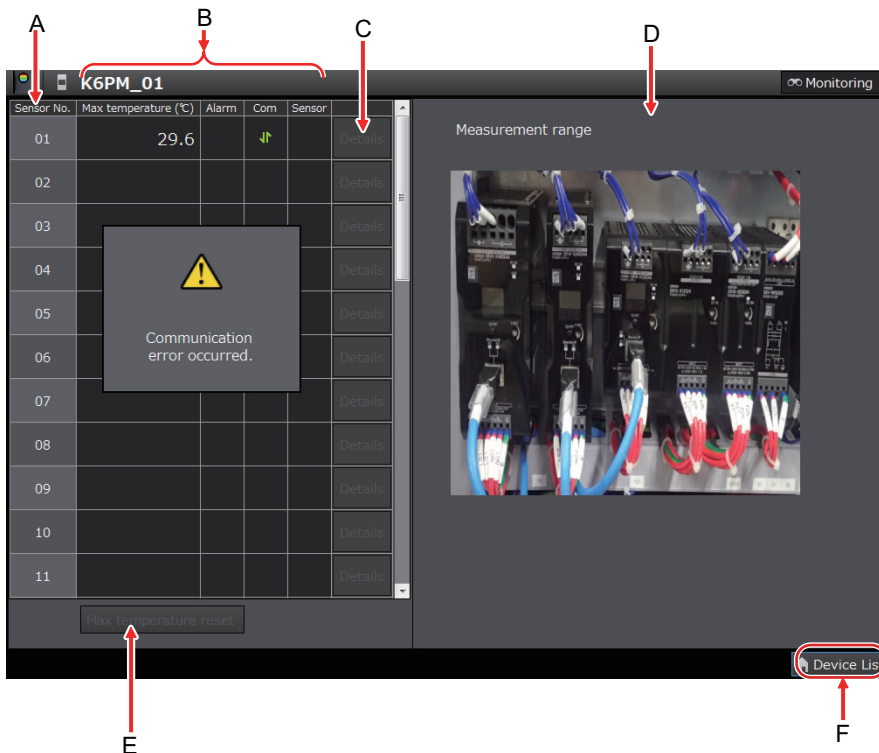

- When registration is canceled

If the target Main Unit moves to the K6PM-TH sensor search mode during monitoring, the following message box will be displayed.

If you click the **OK** Button, the display will return to the **Device List** of **K6PM** Screen.

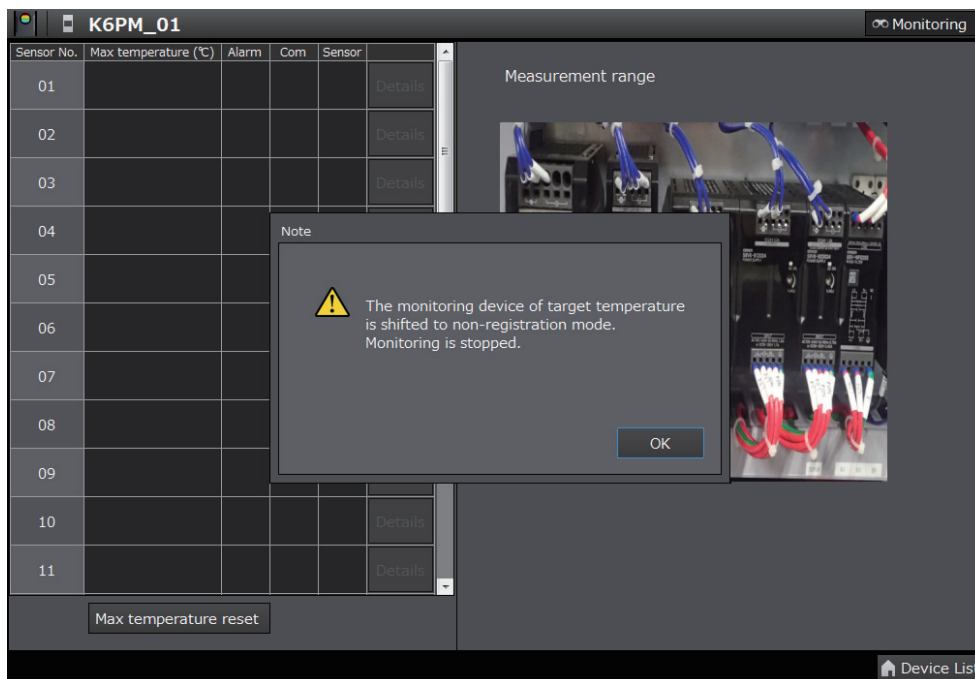

## Monitoring of each Segment of the Infrared Thermal Sensors (Monitoring Sensor Screen)

Monitor each segment of each infrared thermal sensor.

If you click the **Details** Button after selecting the sensor number on the **Monitoring K6PM** Screen, the following **Monitoring sensor** Screen will be displayed.

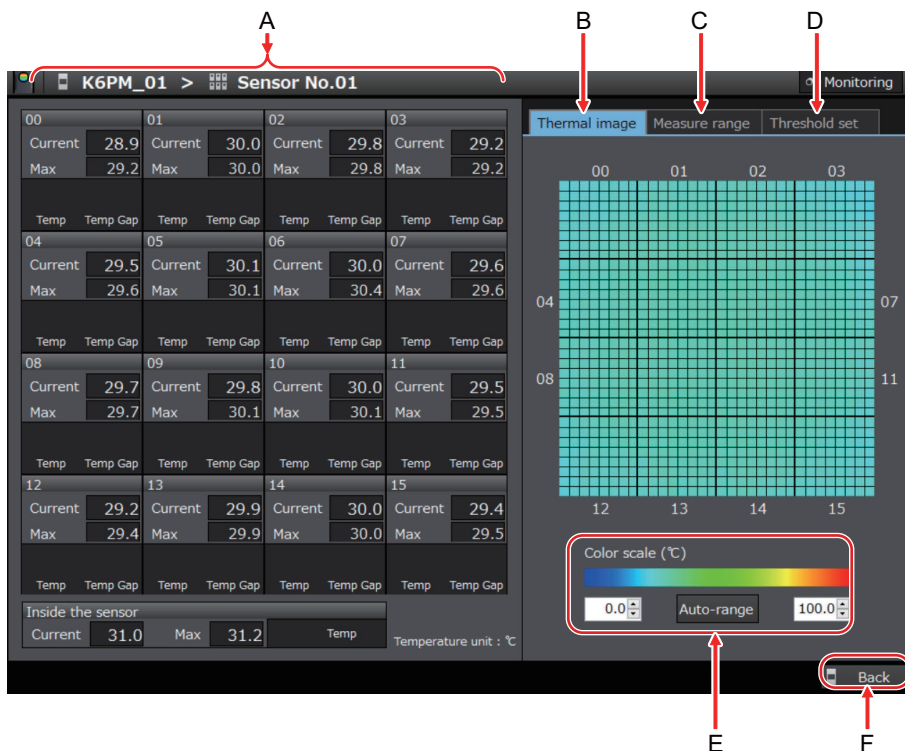

Symbol	Name	Description
A*1	Temperature and alarm occurrence state of each segment	<p>The following is displayed for each segment:</p> <ul style="list-style-type: none"> <li>• 00 to 15: Segment number in the field of view of each infrared thermal sensor.</li> <li>• Current temperature: The current temperature value per segment</li> <li>• Max. temperature: The past maximum value of the current temperature in the past per segment</li> </ul> <p>Below this, each alarm occurrence state of the current temperature and differential temperature for each segment is displayed.</p> <p>⚠: Threshold 1 exceeded, 🚫: Threshold 2 exceeded*2</p>
	Temperature inside the sensor and alarm occurrence state	<p>Sensor internal temperature</p> <ul style="list-style-type: none"> <li>• Current temperature: The current temperature value inside the sensor</li> <li>• Max. temperature: The maximum value of the current temperature inside the sensor</li> </ul> <p>On the right, the alarm occurrence state of the temperature based on the sensor internal temperature is displayed.</p> <p>⚠: Threshold 1 exceeded, 🚫: Threshold 2 exceeded*2</p>
B	Thermal image	<p>Each temperature of 1,024 pixels (32 × 32) is displayed by a color.</p> <p>If you place the cursor on the thermal image, the temperature of the target pixel will be displayed.</p>
C	Measurement Range	<p>The sensor image (photograph) read on the <b>Setting sensor</b> Screen is displayed.</p>



Sym- bol	Name	Description
D	Threshold setting mode	Set the alarm threshold value (threshold 1 and threshold 2) of each segment. Refer to <i>4-3 Alarm Threshold Setting</i> on page 4-23 for details.
E	Color scale	The display color scale can be adjusted. Adjust the color scale in accordance with the temperature difference. Click the <b>Auto-range</b> Button to perform automatic adjustment.
F	<b>Back</b> Button	Use this button to close this screen and return to the <b>Monitoring K6PM</b> Screen.

\*1. In the following cases, the alarm occurrence state is not displayed.

- When the measured value is less than threshold 1 or threshold 2 by the amount of hysteresis (3°C/5.4°F)
- When the alarm latch is enabled and the measured value is less than threshold 1 or threshold 2

\*2. The result of comparison of the set threshold to current temperature is displayed.

Alarm hysteresis and alarm latch are not applied.

- When a communications error occurs

When a communications error occurs while the software tool is communicating with the target Main Unit during the display of the **Monitoring sensor** Screen, the following dialog box will be displayed. At this time, the thermal image display part turns gray. Only the **Back** Button is enabled.

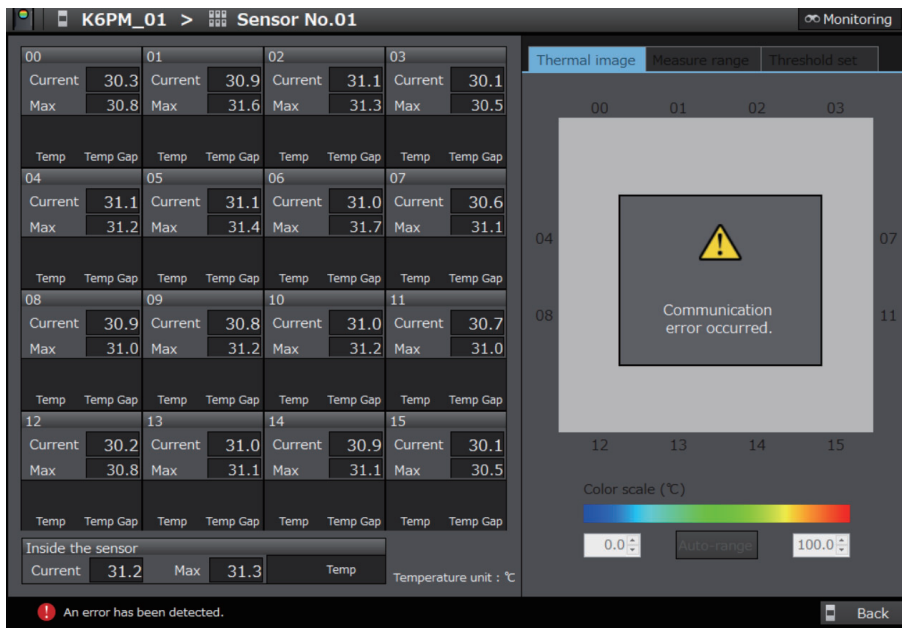

- When registration is canceled

If the target Main Unit moves to the sensor search mode during monitoring, the following message box will be displayed.

If you click the **OK** Button, the display will return to the **Device List of K6PM** Screen.

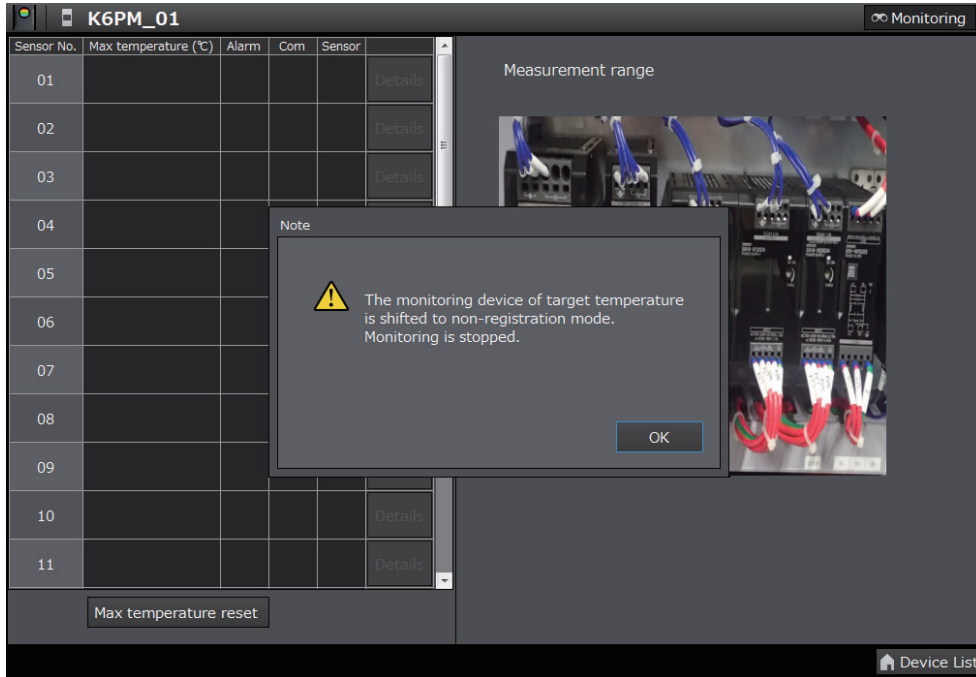

## 4-2 Functions of Monitoring the Temperature in the Control Panel

This section describes each function related to monitoring of temperature inside the control panel.

### 4-2-1 Functions of Monitoring the Temperature in Control Panel with the Main Unit and the Software Tool

This section describes each function of monitoring the temperature in the control panel with the Main Unit and the software tool.

#### K6PM-TH Sensor Position Registration, and K6PM-TH Sensor Angle Deviation Notification

If the infrared thermal sensor drops or gets tilted, it will not be possible to perform correct temperature monitoring.

Therefore, it is possible to register the correct position of each connected infrared thermal sensor in the Main Unit, and if a deviation of the installation angle of the K6PM-TH sensor occurs, the user can be notified about the same.

In the factory default settings, this function of the infrared thermal sensors is disabled. To enable this function, change the DIP switch Pin 7 on the side surface of the infrared thermal sensor to ON (with detection).

**Note** Since the K6PM-TH sensor angle deviation notification function detects the change in the angle in the direction of gravity, the change cannot be detected for movement in the horizontal direction and rotation performed with the direction of gravity as an axis.

#### ● How to Register the K6PM-TH Sensor Location

Register the sensor position by either one of the following methods:

- On the **Setting sensor** Screen of the software tool, click the **Position registration** Button for each sensor.
- Register the sensor position by communications.
- Long-press the K6PM-TH sensor angle deviation reset switch on the side of the sensor for at least 3 seconds.

#### ● K6PM-TH Sensor Angle Deviation Notification Method

The K6PM-TH sensor angle deviation can be checked by any of the following methods:

- Display the angle deviation for each sensor on the **Setting K6PM** Screen of the software tool.
- Display the angle deviation for each sensor on the **Monitoring K6PM** Screen of the software tool.
- Display the angle deviation as a Main Unit error and K6PM-TH sensor error for each Main Unit on the **Device List of K6PM** Screen of the software tool.
- The bit indicating the K6PM-TH sensor angle deviation error for the sensor status turns ON. It can be read through communications.
- The product status (MS) LED on the Main Unit blinks red.
- The alarm or other indicator on the sensor blinks.

## Temperature Alarm

In the Main Unit, the temperature alarm includes the individual alarm and the comprehensive alarm.

### ● Individual Alarm

An individual alarm is an alarm for each of the following measured values. It includes threshold 1 exceeded and threshold 2 exceeded.

- Current temperature per segment of each infrared thermal sensor  
(The predicted arrival temperature when "Use predicted arrival time" is set to ON on the **Setting K6PM** Screen)
- Differential temperature between the current temperature per segment of each infrared thermal sensor and the sensor internal temperature
- Current value of the sensor internal temperature of each infrared thermal sensor  
(The predicted arrival temperature when "Use predicted arrival time" is set to ON on the **Setting K6PM** Screen)

Whether threshold 1 or threshold 2 exceeded has occurred for each of the above individual alarms can be checked by the following methods.

- **Monitoring sensor** Screen of the software tool

Whether threshold 1 exceeded or threshold 2 exceeded has occurred for any of the above individual alarms can be checked by the following methods for each infrared thermal sensor.

- **Monitoring K6PM** Screen of the software tool
- Each bit of the K6PM-TH sensor alarm status per sensor turns ON. It can be read through communications.

### ● Comprehensive Alarm

A comprehensive alarm is an alarm that occurs for each Main Unit.

Threshold 1 exceeded occurs for the comprehensive alarm if there is no "Threshold 2 exceeded" in the measured value of the individual alarm of all connected infrared thermal sensors, and there is at least one "Threshold 1 exceeded". Similarly, if there is at least one "Threshold 2 exceeded", then threshold 2 exceeded occurs for the comprehensive alarm.

Whether threshold 1 exceeded or threshold 2 exceeded has occurred for the comprehensive alarm can be checked by the following methods.

- Alarm bar on the Main Unit front-panel and transistor output 1 and 2
- **Device List of K6PM** Screen of the software tool
- The bit indicating the comprehensive temperature alarm (threshold 1 exceeded) or the comprehensive temperature alarm (threshold 2) for the Main Unit status turns ON. It can be read through communications.

Whether or not the alarm is based on the arrival prediction can be judged from whether the front alarm bar is flashing (arrival prediction during flashing).

## Threshold Automatic Setting Function of Alarm Temperature

In the Main Unit, the following maximum values are automatically retained in the built-in flash memory every hour.

- Maximum value of each segment temperature
- Maximum value of the sensor internal temperature

By using this function, the software tool can automatically calculate the alarm threshold values given below based on the maximum values saved automatically in the Main Unit in the past after the start of monitoring. <sup>\*1</sup>

- Alarm threshold value (threshold 1 exceeded or threshold 2 exceeded) of each segment temperature
- Differential alarm threshold value (threshold 1 exceeded or threshold 2 exceeded) with respect to the sensor internal temperature of each segment

\*1. The maximum values retained in the built-in flash memory can be reset either by the **Max. temperature reset** Button on the **Monitoring K6PM** Screen of the software tool, or through communications.

## Arrival Prediction

This is a function for predicting and calculating the temperature that will be finally reached from the data during each startup, with respect to the current temperature value (of each segment) and the sensor internal temperature.

It is set for each Main Unit. This setting is common for all connected infrared thermal sensors.

If the arrival prediction is enabled, the Main Unit calculates the predicted arrival temperature. In such a case, all individual alarms are judged not only for the alarm threshold value, but also for the arrival predicted value. When the arrival prediction is being prepared (calculation has still not been performed), the predicted arrival temperature value becomes the current temperature value.

Make the following setting either by setting whether or not to enable "Use predicted arrival time" on the **Setting K6PM** Screen of the software tool, or through communications.

Setting name	Setting range	Initial value
Use arrival prediction	ON (Enable), OFF (Disable)	OFF (Disable)

The changed setting parameter is enabled after power is again supplied to the Main Unit, or after software reset.

- Note
- The arrival prediction predicts high temperature from the rise in temperature. It does not predict low temperature from the drop in temperature.
  - The arrival prediction alarm is output when the predicted temperature exceeds the threshold value. Even if the actual temperature has dropped but the predicted temperature has exceeded the threshold value, the alarm output is likely to be retained.

## Transistor Output Type of the Main Unit

This is a function for inverting the logic of transistor output 1 and 2 (selecting the transistor output method).

Make the following setting either by setting the "Transistor output type" on the **Setting K6PM** Screen of the software tool, or through communications.

Setting name	Setting range	Initial value
Output inversion	ON (Normally open), OFF (Normally closed)	OFF (Normally closed)

The changed setting parameter is enabled after power is again supplied to the Main Unit, or after software reset.

## Alarm Latch of the Main Unit

This function is used to latch the alarm status of the comprehensive alarm (threshold 1 or 2).

Even if the measured value drops by as much as the amount of hysteresis (3°C/5.4°F) from the threshold values threshold 1 or threshold 2 after the comprehensive alarm (threshold 1 or 2) occurs, the status of the comprehensive alarm (alarm bar and transistor output 1 and 2) is retained (alarm latch).

The alarm latch is released by pressing and holding (for 5 seconds min.) the **SEG/ALM RST** Key on the Main Unit front-panel.

Make the following setting either by enabling the "Alarm latch" on the **Setting K6PM** Screen of the software tool, or through communications.

Setting name	Setting range	Initial value
Alarm latch	ON (Enable), OFF (Disable)	ON (Enable)

The changed setting parameter is enabled after power is again supplied to the Main Unit, or after software reset.

## External Trigger Input of the Main Unit

This is a function for temporarily interrupting the measurement by an external trigger input of an external contact.

Temperature measurement is stopped while the external trigger input is ON.

Temperature measurement is performed while the external trigger input is OFF.

During measurement interruption due to an external trigger input, the temperature display on the Main Unit front-panel is fixed to the value immediately before interruption, and the "MON" LED is not lit.

Application example:

When an infrared thermal sensor is installed, the temperature monitor target may be deviated due to opening or closing of the door. Therefore, stop temperature measurement by turning ON the external trigger input. Restart measurement by turning OFF the external trigger input after installation is complete.

**Note** When measurement interruption or restart is performed as a result of an external trigger input, the measurement is interrupted or restarted immediately, and the status display "MON" lights up or goes out after communications with the temperature sensor is checked. Therefore, depending on the number of connected temperature sensors, it may take time for the "MON" LED to light up or go out as a result of ON/OFF of the external trigger input (approximately 30 seconds when 31 temperature sensors are connected).

## Maintenance Forecast Monitor Function

When the Main Unit reaches the time when it can no longer exhibit sufficient performance due to the degradation of characteristics of the electrolytic capacitor inside the Main Unit, the display on the Main Unit and the communications status change. Use this function to know the approximate replacement time of the Main Unit.

**Note** The replacement timing announcement indicates a guideline that the Main Unit cannot achieve sufficient performance due to deterioration of the electrolytic capacitor. The guideline does not include failures caused by other factors.

When the Main Unit reaches the approximate replacement time, it will be notified by the following methods.

- The AGE indicator on the Main Unit front-panel that displays the status lights to notify users when to replace.

(Note) Turn ON the Use Running Time, so that the AGE LED lights up when the guideline for the replacement time is reached. The default setting of the Use Running Time is OFF.

- The Running Time bit ON in the Main Unit status notifies users when to replace. It can be read through communications.

Setting name	Setting range	Initial value
Use Running Time	ON (Enable), OFF (Disable)	OFF (Disable)

The changed setting parameter is enabled after power is again supplied to the Main Unit, or after software reset.

### 4-2-2 Operation Example of an Alarm

An operation example of an alarm is described below.

#### Operation under General Conditions

The operation performed under the following general conditions is as described below.

Conditions: When the threshold value is such that threshold 2 > threshold 1, there is no alarm latch, and there is no arrival prediction

Example:

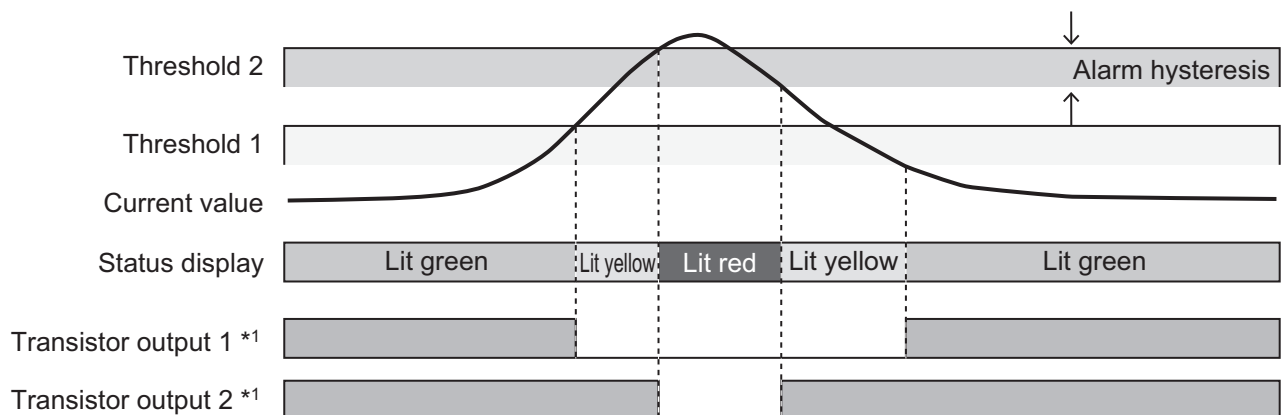

**Note** The above example is for a case when there is one current value. In actuality, individual alarm determination is performed based on multiple current values, and the result of OR logic is reflected in status display and transistor output as a comprehensive alarm.

\*1. When the transistor output setting is Normally Closed

## Operation under Exceptional Conditions

The operation performed when threshold 1  $\geq$  threshold 2 is as described below.

Example: Conditions: When the threshold value is such that threshold 1 = threshold 2, there is an alarm latch, and there is no arrival prediction

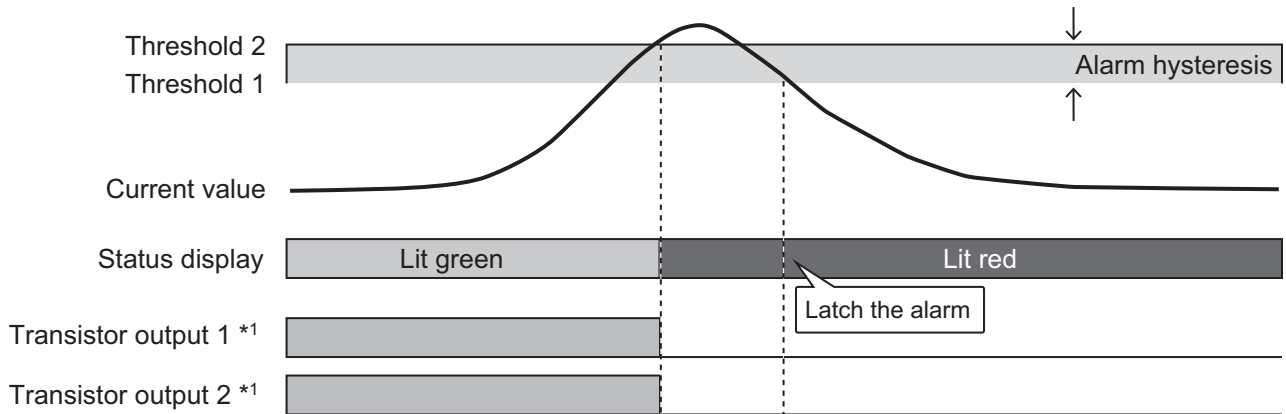

Note When the transistor output setting is Normally Closed

## When There Is an Arrival Prediction

The operation performed when there is an arrival prediction is as described below.

Example: Conditions: When the threshold value is such that threshold 2 > threshold 1, there is no alarm latch, and there is an arrival prediction

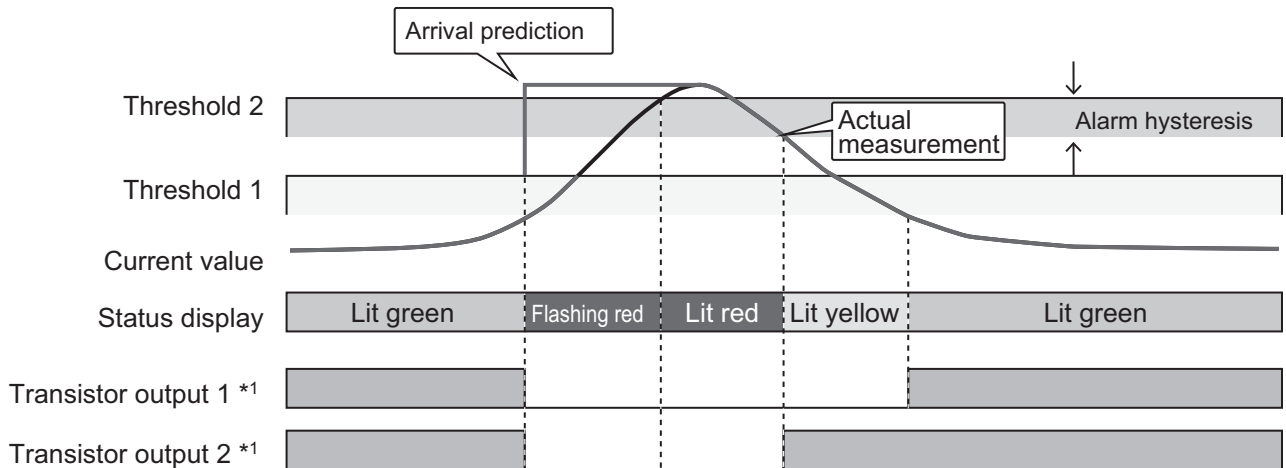

Note The above example is for a case when there is one current value. In actuality, individual alarm determination is performed based on multiple current values, and the result of OR logic is reflected in status display and transistor output as a comprehensive alarm.

\*1. When the transistor output setting is Normally Closed



## Operation for Releasing the Alarm Latch

The operation performed to release the alarm latch is as described below.

Example: Conditions: When the threshold value is such that threshold 2 > threshold 1, there is an alarm latch, and there is no arrival prediction

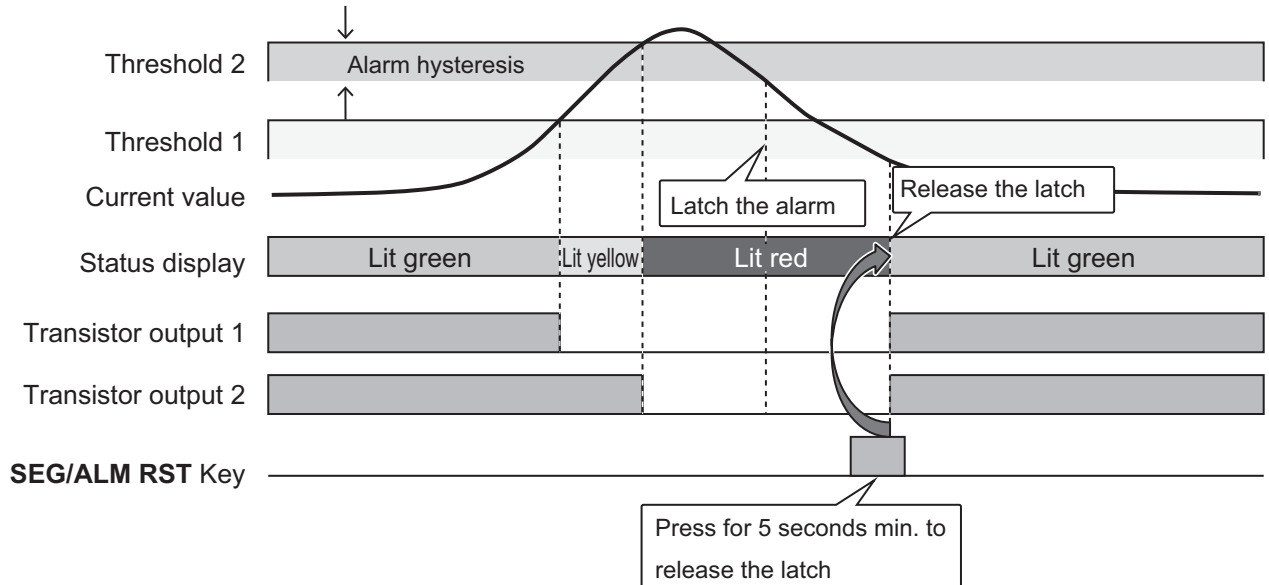

### 4-2-3 Automatic Saving Log Files

#### Outline

The software tool saves the following data acquired from the Main Unit to be monitored in each sampling cycle in a tab-delimited text file (.txt file).

- Current temperature per segment and maximum temperature per segment
- K6PM-TH sensor internal current temperature and maximum temperature
- Infrared thermal sensor status
- Main Unit status
- Date time

The timing of executing save is "Always", as long as the software tool is operating and the corresponding Main Unit is in the monitoring mode.

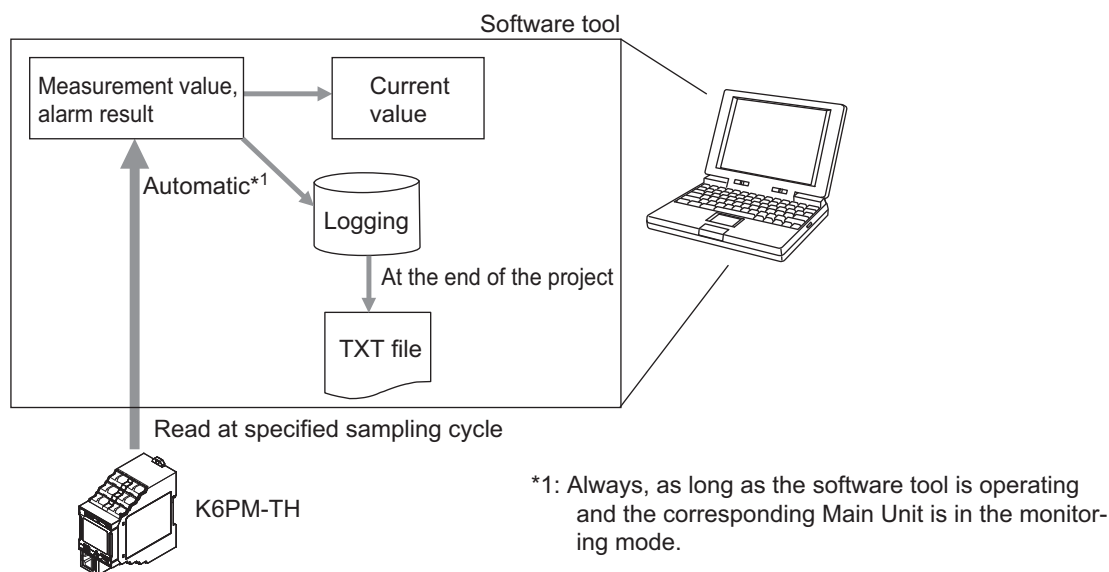

## Description

The following log file and folder are created in the PC.

### ● Log File Save Location

Folder name: "(Installation-destination folder)\log\[Main Unit number (2 digits)]"

Example: "\Program files\OMRON\Thermal Condition Monitoring Tool\log\01"

Note If there is no folder when the software tool is started, the folder is automatically created.



### Additional Information

You can also check this by clicking the **Log folder** Button on the **Device List of K6PM** Screen.

### ● Save Timing

- In each sampling cycle
- When you exit the **Device List of K6PM** Screen by clicking the **×** Button at the top right of the **Device List of K6PM** Screen

### ● Specifications of Log File

- File unit  
A file is created for each Main Unit name.
- File name  
Specify the Main Unit number and date in the file name.  
The format of the file name is as described below.  
Folder name\_YYYYMMDDHHMMSS.txt  
"YYYYMMDDHHMMSS" is the sampling time when writing is first started.  
YYYY: Year, MM: Month, DD: Date, HH: Hour, MM: Minutes, SS: Seconds
- If the Main Unit name is changed on the software tool, the header information (described later) in the file will change. Therefore, create the next new log file, and record the measurement data in this log file.
- A new log file is created after every 1,440 rows (excluding the header) regardless of the sampling interval.

- File Format

The data is saved in the following format.

The data is tag-delimited.

First row: Project name

Second row: Main Unit name (header information)

Third row: IP address (header information)

Fourth row: Serial No. (header information)

The serial number obtained from the Main Unit is output.

Fifth row: Temperature unit (header information)

"C" is output for Celsius, and "F" for Fahrenheit.

Sixth row: Item name (header information)

```
MeasureTime\tK6PMStatus\tSensor1Status\tSensor1CurrentVal[0]\tSensor1MaxVal[0]...
...Sensor1CurrentVal[15]\tSensor1MaxVal[15]\tSensor1InnerVal...
...(The output format is same as the Japanese notation hereinafter.)
"\t" indicates a tab.
```

Seventh row and thereafter: Measurement data

The following items are output. The sensor status and temperature data for all sensors is output in one row.

(1) Measurement date and time

Output in the display format corresponding to the locale set in the PC.

(2) Main Unit status

The double-byte data of the Main Unit status that is maintained in the Main Unit is output in hexadecimal.

For the detailed content of each bit, refer to "Main Unit status" in *5-3-2 Main Unit Monitor Object (Class ID: 374 hex)* on page 5-10.

(3) K6PM-TH sensor status

The double-byte data of the K6PM-TH sensor status that is maintained in the Main Unit is output in hexadecimal.

For the detailed content of each bit, refer to "K6PM-TH sensor status per sensor" in *5-3-2 Main Unit Monitor Object (Class ID: 374 hex)* on page 5-10.

(4) Temperature data

The current temperature per segment and the maximum temperature per segment measured by the Main Unit is output in the order of the segment number, and the internal temperature is output in the end.

- Note 1. When a communications error occurs with respect to the Main Unit, only (1) Measurement date and time is output.
2. During measurement interruption due to an external trigger, the entire (4) Temperature data is output with the values immediately before interruption being retained.
- Maximum number of rows of the log file
    - 1,440 rows. If it exceeds the maximum number of lines, create a new log file and save the log.

# 4-3 Alarm Threshold Setting

The alarm threshold setting of the Main Unit depends on the following procedure.

- 1 When setting the alarm threshold to automatic setting, be sure to perform monitoring for a few days in advance. This will enable automatic storage of the maximum temperature for each segment and the maximum temperature of the sensor internal temperature inside the Main Unit (by the maximum value holding function in the built-in flash memory).
- 2 Select the sensor number on the **Monitoring K6PM** Screen of the software tool, and then click the **Details** Button. The **Monitoring sensor** Screen will appear.
- 3 Click the **Threshold set** Tab.  
Set alarm threshold to automatic setting, or perform correction of the automatic setting parameter, or perform manual setting.

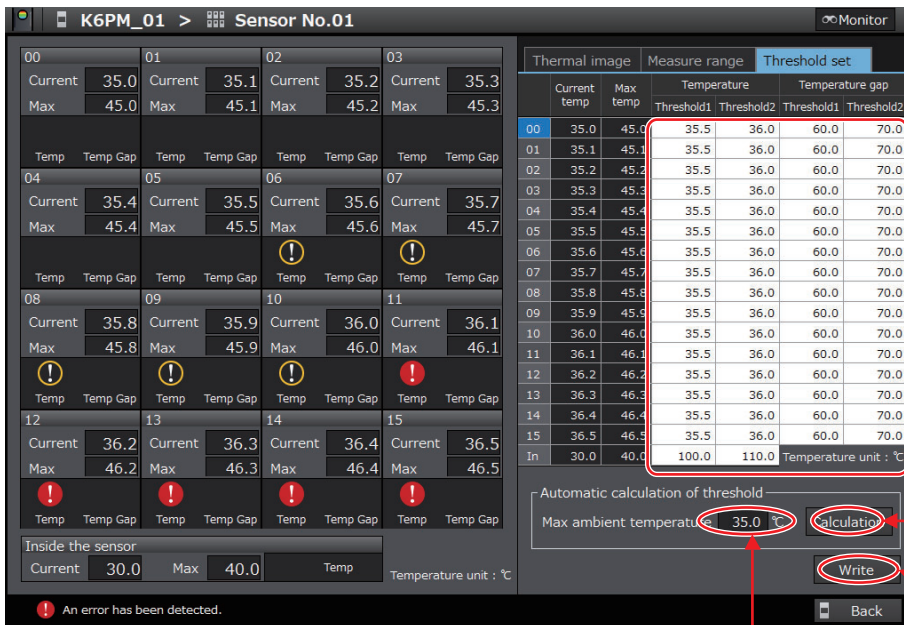

During correction of the automatic setting parameter or during manual settings, enter the threshold value for each segment and the sensor internal temperature.

Click here for automatic calculation of threshold.

The threshold setting parameter is written to the Main Unit either automatically or manually.

The standard temperature used in the automatic calculation of threshold is displayed here.

- When automatic setting is set for the alarm threshold

Click the **Calculation** Button under the Threshold set tab. The following tab page is displayed.

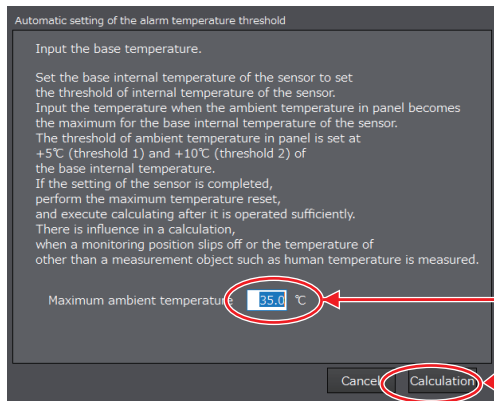

Enter the max. ambient temperature for the base internal temperature of the sensor.

Click during calculation.

Enter the "Max. ambient temperature" in the following range.

Setting range: 0.0 to 80.0 (°C), 32.0 to 176.0 (°F)

Ideally, perform the operation until the ambient temperature stabilizes, and thereafter, enter the maximum ambient temperature in view of temperature variation in summer time.

Click the **Calculation** Button. The alarm threshold is automatically calculated.

Note The maximum ambient temperature used in the automatic calculation of threshold is displayed in "Max. ambient temperature" under the **Threshold set** Tab.

- When the alarm threshold automatic setting parameter is to be corrected, or when setting is performed manually

Enter each "Threshold 1" and "Threshold 2" of the "Temp." and "Temp. Gap" for each segment, and the "Threshold 1" and "Threshold 2" of the sensor internal temperature within the range specified below.

Threshold 1 and Threshold 2: 0.0 to 999.9 (°C) or 0.0 to 999.9 (°F)

When setting the alarm threshold, if you set a value exceeding 200.0°C (392°F), an alarm will not be output.

**4** Click the **Write** Button to write the threshold setting to the Main Unit.

**5** If you click the **Back** Button, the display will return to the **Monitoring K6PM** Screen.



### Precautions for Safe Use

The threshold automatic setting function of alarm temperature automatically calculates the threshold based on the past temperature data up to the time when the **Calculation** Button was clicked. Therefore, if a change in the installation environment and operating status, etc. occurs due to the effect of the air-cooling fan, or the opening/closing of the control panel door, click the **Calculation** Button again to reset the alarm threshold.

To set the alarm threshold in more detail, it is recommended to set the threshold individually for each segment without using the threshold automatic setting function of alarm temperature.

## 4-4 Procedure for Taking Actions When an Alarm Occurs

---

Follow the procedure described below to take action when an alarm occurs.

- 1** On the **Device List of K6PM** Screen, identify the Main Unit in which an alarm has occurred, and after selecting the Main Unit, click the **Monitoring** Button.
- 2** On the **Monitoring K6PM** Screen, identify the sensor in which an alarm has occurred, and then check its "Max. temperature".
- 3** Select the sensor number, and then click the **Details** Button.
- 4** On the **Monitoring sensor** Screen, identify the segment in which an alarm has occurred, and then check its "Current temp." and "Max. temperature".
- 5** Check the log file of each Main Unit that is saved automatically by the logging function of the software tool, and understand the temperature changes of each segment based on the time.
- 6** Identify the corresponding location of the segment in which an alarm has occurred from the photograph.
- 7** Take action for the corresponding location.





# 5

## Monitoring and Setting with the EtherNet/IP Communications

Main Units can also be monitored or set using EtherNet/IP compatible devices. This section describes how to monitor using the EtherNet/IP.

---

<b>5-1</b>	<b>Outline</b> .....	<b>5-2</b>
5-1-1	What is Monitoring Using EtherNet/IP? .....	5-2
5-1-2	EtherNet/IP Communications Specifications .....	5-3
<b>5-2</b>	<b>Monitoring Using the Tag Data Link</b> .....	<b>5-4</b>
5-2-1	Connection Setting .....	5-4
5-2-2	Setting the Assembly Object .....	5-7
5-2-3	Assigning the Assembly Instance .....	5-7
<b>5-3</b>	<b>Monitoring and Setting Using the CIP Message Communications and Examples of Communications Instructions</b> .....	<b>5-10</b>
5-3-1	Services Supported by Objects in Main Units .....	5-10
5-3-2	Main Unit Monitor Object (Class ID: 374 hex) .....	5-10
5-3-3	K6PM-TH Sensor Monitor Object (Class ID: 375 hex) .....	5-12
5-3-4	K6PM-TH Sensor Temperature Monitor Object (Class ID: 376 hex) .....	5-14
5-3-5	Main Unit Setting Object (Class ID: 377 hex) .....	5-17
5-3-6	K6PM-TH Sensor Alarm Setting Object (Class ID: 378 hex) .....	5-20
5-3-7	Identity Object (Class ID: 01 hex) .....	5-22
5-3-8	TCP/IP Interface Object (Class ID: F5 hex) .....	5-24
5-3-9	Examples of CIP Message Communications Instruction .....	5-27

# 5-1 Outline

This section describes how to monitor the Main Units using the EtherNet/IP.

## 5-1-1 What is Monitoring Using EtherNet/IP?

The Main Units can be monitored from a PLC or PC via EtherNet/IP.

The following two communications methods can be used.

Communications method	Outline	For the Main Units	
		Monitor	Settings
Tag data link	Multiple data such as measured values can be monitored without using a communications program. For data that can be monitored, refer to 5-2 <i>Monitoring Using the Tag Data Link</i> on page 5-4.	Supported	Not supported
CIP message communications	Individual data such as measured values can be read and written by using communications program. It can also be used during tag data link.	Supported	Supported

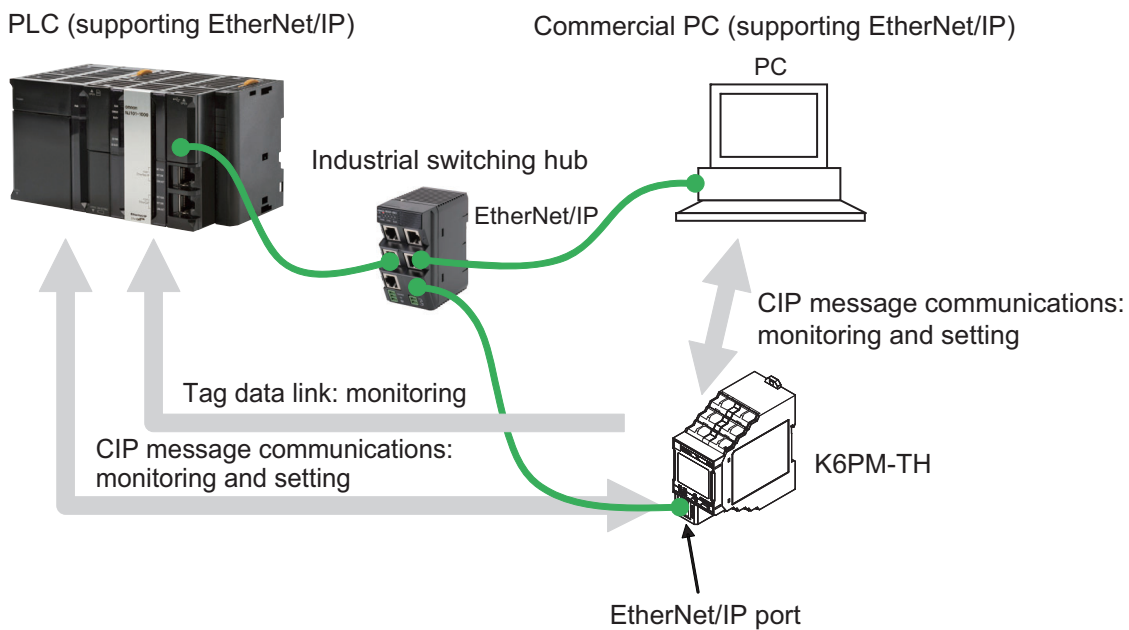

## Tag Data Link

Multiple data such as measured values of the Main Units are periodically sent to the specified area of the PLC. The K6PM-TH can perform tag data link communications over four connections.

- PLC-side input tag set

The I/O memory address or variables are assigned. The data sizes of the four segments are 128 bytes, 380 bytes, 380 bytes, and 418 bytes (K6PM-TH internal data sizes), for a total of 1306 bytes.

- Main Unit-side output tag set

The Main Unit assigns the instance ID of the internal data to be tagged data link. The data sizes are 128 bytes, 380 bytes, 380 bytes, and 418 bytes for a total of 1306 bytes.

### ● Configuration Tool

When configuring with OMRON controllers, the following setting tools for the tag data link should be used.

Configurations	Tag data link setting tool (configuration tool) to be used
CS/CJ-series	Network Configurator
NJ/NX-series	Network Configurator or Sysmac Studio

## CIP Message Communications

A CIP client such as the NJ/NX-series issues any CIP command in the Explicit message to the Main Units. This allows you to read and write all the data of the Main Unit.

### ● Communications Instructions

When sending a CIP command with Explicit messages from OMRON PLCs or Controllers, use the following communications Instruction.

Configurations	Communications Instruction
CS/CJ-series	• Explicit message send commands (2810 hex) for CIP routing are issued by CMND instructions
NJ/NX-series	• CIPSend (Send Explicit Message Class 3) instruction Or • CIPUCMMSend (Send Explicit Message UCMM) instruction

## 5-1-2 EtherNet/IP Communications Specifications

	Item	Specification
Tag data link	Class1	Connection resource: 4 max.
	Packet interval (RPI)	1,000 to 10,000 ms
	Timeout value	Multiples of RPI (4 times, 8 times, 16 times, ..., and 512 times)
	Connection type	Point To Point Connection (fixed)
Explicit message	Class 3	Number of clients that can communicate at one time: 2 max.
	UCMM	Number of clients that can communicate at one time: 2 max.
Conformance	EtherNet/IP conformance test	Conforms to CT16

## 5-2 Monitoring Using the Tag Data Link

This section describes the contents of monitoring with the tag data link.

### 5-2-1 Connection Setting

Setting items		Function
Originator device (PLC)	Input tag set	Specify any one of the PLC-side tag sets from 128 bytes, 380 bytes, and 418 bytes.*1
	Connection type	Specify "Point to Point connection".
Target device (K6PM-TH)	Assembly instance (output)	You can specify any of the following. <ul style="list-style-type: none"> <li>Instance ID: 100, Size: 128 bytes</li> <li>Instance ID: 101, Size: 380 bytes</li> <li>Instance ID: 102, Size: 380 bytes</li> <li>Instance ID: 103, Size: 418 bytes</li> </ul>
Packet interval (RPI)		1,000 ms to 10,000 ms (default: 1,000 ms)
Timeout value		Multiples of RPI (4 times, 8 times, 16 times, ..., and 512 times)

\*1. Match the size of the PLC-side tag set with the instance ID (identification number of the internal data of the Main Unit) to be selected. Only a single connection can be established with each instance ID. If you try to establish multiple connections, an error will occur.



#### Precautions for Safe Use

If I/O memory addresses are specified for the communications areas, the information in the communications areas will be cleared when the operating mode of the PLC changes unless addresses in the Area, which are maintained, are specified.

### Connection to be Created

The method of setting the connection "Using the CS/CJ-series" and "Using the NJ/NX-series" is described below.

For details on the setting procedure, refer to *A-3 Tag Data Link Connection Setting Procedures* on page A-13.

#### ● Using the CS/CJ-series

For detailed information on the Network Configurator, refer to the following manual. CS/CJ Series EtherNet/IP Units Operation Manual (Cat. No. W465)

#### 1 Install and start

- 1) Install Network Configurator.
- 2) Start Network Configurator.
- 3) Download the K6PM EDS file from our I-Web and install it on the Network Configurator.

#### 2 Settings

- 1) Register PLC and K6PM devices in the network configuration and set the IP address.
- 2) Configure settings to add a connection between devices (i.e., "make a connection").

Things to check beforehand:

- Which memory area (I/O memory or variables) in the PLC should be used for the tag data link.

- The size of the internal data (parameter) of the K6PM device must be any one of 128 bytes, 380 bytes, and 418 bytes.
  - 2)-1 Drag a K6PM-TH to the PLC and register it.
  - 2)-2 Click the **Edit Tag Sets** Button to create input tags with the above sizes.
  - 2)-3 Register the input tag as it is as input tag set.
  - 2)-4 Select the input tag set created in 2)-3 above from the pull-down list.
  - 2)-5 Match the connection I/O type and instance ID of the output tag set.
  - 2)-6 Register the connection.

**Connection Allocation to K6PM Device Dialog Box**

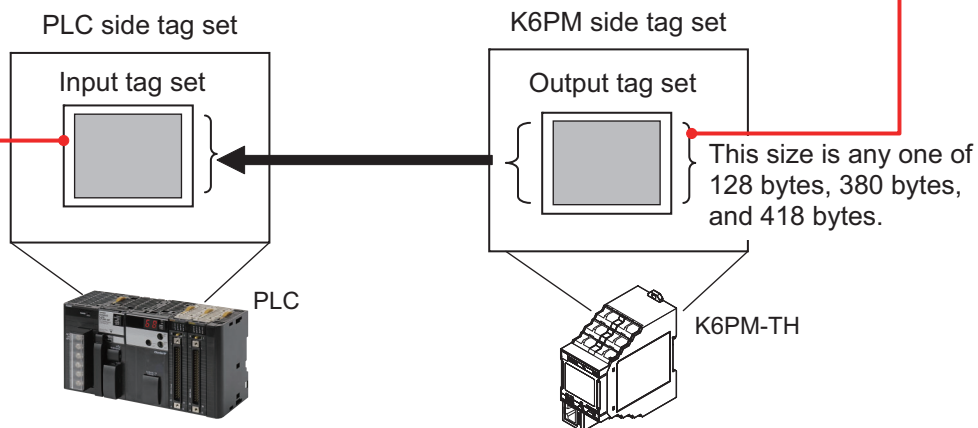
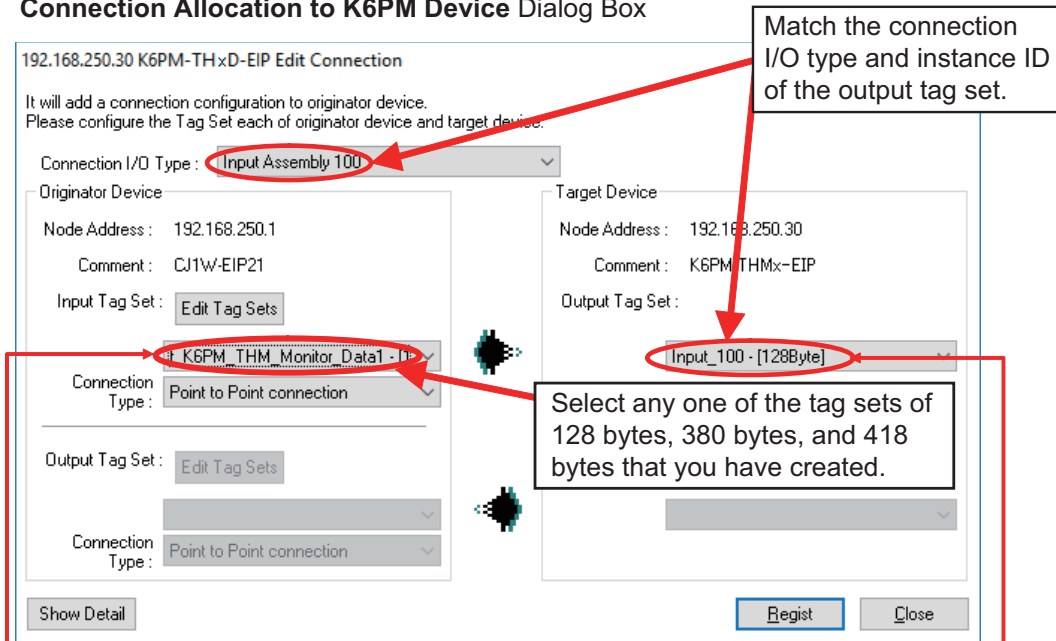

Create a tag that matches any one of the sizes of 128 bytes, 380 bytes, and 418 bytes of the internal data of the K6PM device selected on the right, and set it as the input tag set as it is.

Select the output tag set name to be displayed from below.

- "Input\_100-[128Bytes]"
- "Input\_101-[380Bytes]"
- "Input\_102-[380Bytes]"
- "Input\_103-[418Bytes]"

- 3 Download the connections that were set to the PLC.  
Tag data link communications are automatically started.
- 4 Confirm each LED of the PLC and the K6PM devices, and status information in the **Device Monitor** Dialog Box of the Network Configurator.

● **Sysmac Studio**

- 1 Select **EtherNet/IP connection settings** from the Tools Menu.
- 2 Right-click on the target device list in the tool box on the EtherNet/IP connection settings Tab page and select the **Display EDS Library** Menu.
- 3 Click the **Install** Button and import the EDS file of each K6PM device in the **EDS Library** Dialog Box.
- 4 Click **+** (**Add device**) Button in Toolbox and select the K6PM device in the Built-in EtherNet/IP Port Settings Connection Tab page.
- 5 Select the K6PM device that has been added from the pull-down list in the **Target Device** Column in **▼ Connection list** in the Connection Tab Page of PLC side (originator side).
- 6 In the **Target Variable** Column, press the **Ctrl** and **Space** Keys at the same time and the available identification numbers are displayed on the pull down list, so select the identification number to use.
- 7 Match the connection I/O type and target variables.

Example: When the instance ID is 100:

- Connection I/O type: Input Assembly 100
- Target variable: 100

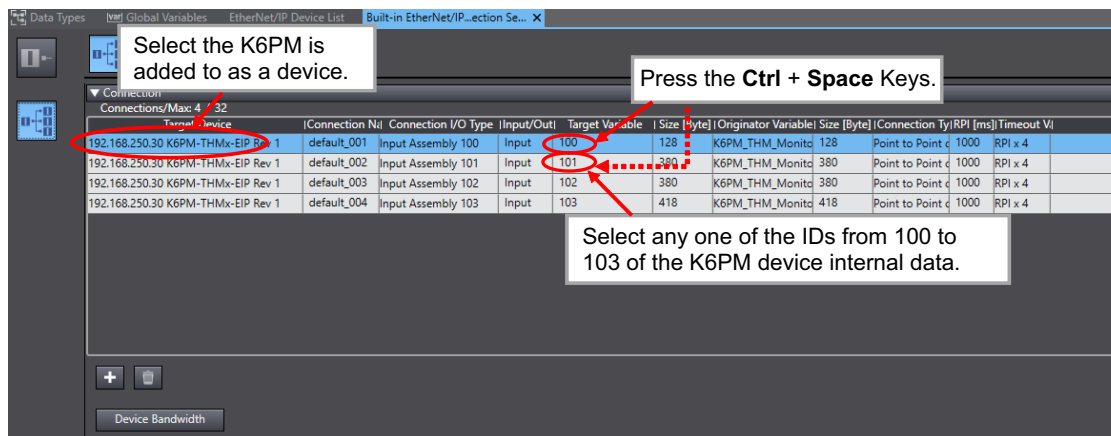

When you select an identification number, the size is automatically entered synchronously.

- 8 In the **Originator Variable** Column, select the global variable of the NJ/NX-series CPU Unit. (Beforehand, it is necessary to register global variables whose network publish attribute is "Input" or "Output" in the global variable table.)

## 5-2-2 Setting the Assembly Object

Parameter name	Setting value	Remarks	Function
Instance ID	64 hex (Input_100)	Output connection (Size: 128 bytes)	<ul style="list-style-type: none"> <li>• K6PM-TH status</li> <li>• Running time data</li> <li>• Status of sensors 1 to 31</li> <li>• Alarm status of sensors 1 to 31</li> </ul>
	65 hex (Input_101)	Output connection (Size: 380 bytes)	<ul style="list-style-type: none"> <li>• Status of sensors 1 to 10</li> <li>• Alarm status of sensors 1 to 10</li> <li>• Internal temperature value of sensors 1 to 10</li> <li>• Segment current temperature value of sensors 1 to 10</li> </ul>
	66 hex (Input_102)	Output connection (Size: 380 bytes)	<ul style="list-style-type: none"> <li>• Status of sensors 11 to 20</li> <li>• Alarm status of sensors 11 to 20</li> <li>• Internal temperature value of sensors 11 to 20</li> <li>• Segment current temperature value of sensors 11 to 20</li> </ul>
	67 hex (Input_103)	Output connection (Size: 418 bytes)	<ul style="list-style-type: none"> <li>• Status of sensors 21 to 31</li> <li>• Alarm status of sensors 21 to 31</li> <li>• Internal temperature value of sensors 21 to 31</li> <li>• Segment current temperature value of sensors 21 to 31</li> </ul>

## 5-2-3 Assigning the Assembly Instance

For details on the data, refer to *5-3 Monitoring and Setting Using the CIP Message Communications and Examples of Communications Instructions* on page 5-10.

### Instance ID: 64 hex

Word	Bit															
	15	14	13	12	11	10	9	8	7	6	5	4	3	2	1	0
+0	Main Unit status Refer to "Main Unit status" described later.															
+1	Running time data															
+2	K6PM-TH sensor 1 status Refer to "K6PM-TH sensor status per sensor" in <i>5-3-3 K6PM-TH Sensor Monitor Object (Class ID: 375 hex)</i> on page 5-12 described later.															
+3	K6PM-TH sensor 1 alarm status Refer to "K6PM-TH sensor alarm status per sensor" in <i>5-3-3 K6PM-TH Sensor Monitor Object (Class ID: 375 hex)</i> on page 5-12 described later.															
+4	K6PM-TH sensor 2 status															
+5	K6PM-TH sensor 2 alarm status															
+6	K6PM-TH sensor 3 status															
+7	K6PM-TH sensor 3 alarm status															
:	:															
:	:															
:	:															
:	:															
+62	K6PM-TH sensor 31 status															
+63	K6PM-TH sensor 31 alarm status															

**Instance ID: 65 hex**

Word	Bit															
	15	14	13	12	11	10	9	8	7	6	5	4	3	2	1	0
+0	K6PM-TH sensor 1 status Refer to "K6PM-TH sensor status per sensor" in 5-3-3 <i>K6PM-TH Sensor Monitor Object (Class ID: 375 hex)</i> on page 5-12 described later.															
+1	K6PM-TH sensor 1 alarm status Refer to "K6PM-TH sensor alarm status per sensor" in 5-3-3 <i>K6PM-TH Sensor Monitor Object (Class ID: 375 hex)</i> on page 5-12 described later.															
+2	Internal temperature value of K6PM-TH sensor 1															
+3	Current temperature value of K6PM-TH sensor 1 segment 0 (per segment)															
+4	Current temperature value of K6PM-TH sensor 1 segment 1 (per segment)															
:	:															
+18	Current temperature value of K6PM-TH sensor 1 segment 15 (per segment)															
+19	K6PM-TH sensor 2 status															
+20	K6PM-TH sensor 2 alarm status															
+21	Current internal temperature value of K6PM-TH sensor 2															
+22	Current temperature value of K6PM-TH sensor 2 segment 0 (per segment)															
+23	Current temperature value of K6PM-TH sensor 2 segment 1 (per segment)															
:	:															
+37	Current temperature value of K6PM-TH sensor 2 segment 15 (per segment)															
:	:															
:	:															
+171	K6PM-TH sensor 10 status															
+172	K6PM-TH sensor 10 alarm status															
+173	Internal temperature value of K6PM-TH sensor 10															
+174	Current temperature value of K6PM-TH sensor 10 segment 0 (per segment)															
+175	Current temperature value of K6PM-TH sensor 10 segment 1 (per segment)															
:	:															
+189	Current temperature value of K6PM-TH sensor 10 segment 15 (per segment)															

**Instance ID: 66 hex**

Word	Bit															
	15	14	13	12	11	10	9	8	7	6	5	4	3	2	1	0
+0	K6PM-TH sensor 11 status Refer to "K6PM-TH sensor status per sensor" in 5-3-3 <i>K6PM-TH Sensor Monitor Object (Class ID: 375 hex)</i> on page 5-12 described later.															
+1	K6PM-TH sensor 11 alarm status Refer to "K6PM-TH sensor alarm status per sensor" in 5-3-3 <i>K6PM-TH Sensor Monitor Object (Class ID: 375 hex)</i> on page 5-12 described later.															
+2	Internal temperature value of K6PM-TH sensor 11															
+3	Current temperature value of K6PM-TH sensor 11 segment 0 (per segment)															
+4	Current temperature value of K6PM-TH sensor 11 segment 1 (per segment)															
:	:															
+18	Current temperature value of K6PM-TH sensor 11 segment 15 (per segment)															
+19	K6PM-TH sensor 12 status															
+20	K6PM-TH sensor 12 alarm status															
+21	Internal temperature value of K6PM-TH sensor 12															
+22	Current temperature value of K6PM-TH sensor 12 segment 0 (per segment)															
+23	Current temperature value of K6PM-TH sensor 12 segment 1 (per segment)															
:	:															
+37	Current temperature value of K6PM-TH sensor 12 segment 15 (per segment)															
:	:															



Word	Bit															
	15	14	13	12	11	10	9	8	7	6	5	4	3	2	1	0
:	:															
+171	K6PM-TH sensor 20 status															
+172	K6PM-TH sensor 20 alarm status															
+173	Internal temperature value of K6PM-TH sensor 20															
+174	Current temperature value of K6PM-TH sensor 20 segment 0 (per segment)															
+175	Current temperature value of K6PM-TH sensor 20 segment 1 (per segment)															
:	:															
+189	Current temperature value of K6PM-TH sensor 20 segment 15 (per segment)															

### Instance ID: 67 hex

Word	Bit															
	15	14	13	12	11	10	9	8	7	6	5	4	3	2	1	0
+0	K6PM-TH sensor 21 status Refer to "K6PM-TH sensor status per sensor" in 5-3-3 <i>K6PM-TH Sensor Monitor Object (Class ID: 375 hex)</i> on page 5-12 described later.															
+1	K6PM-TH sensor 21 alarm status Refer to "K6PM-TH sensor alarm status per sensor" in 5-3-3 <i>K6PM-TH Sensor Monitor Object (Class ID: 375 hex)</i> on page 5-12 described later.															
+2	Internal temperature value of K6PM-TH sensor 21															
+3	Current temperature value of K6PM-TH sensor 21 segment 0 (per segment)															
+4	Current temperature value of K6PM-TH sensor 21 segment 1 (per segment)															
:	:															
+18	Current temperature value of K6PM-TH sensor 21 segment 15 (per segment)															
+19	K6PM-TH sensor 22 status															
+20	K6PM-TH sensor 22 alarm status															
+21	Internal temperature value of K6PM-TH sensor 22															
+22	Current temperature value of K6PM-TH sensor 22 segment 0 (per segment)															
+23	Current temperature value of K6PM-TH sensor 22 segment 1 (per segment)															
:	:															
+37	Current temperature value of K6PM-TH sensor 22 segment 15 (per segment)															
:	:															
:	:															
+190	K6PM-TH sensor 31 status															
+191	K6PM-TH sensor 31 alarm status															
+192	Internal temperature value of K6PM-TH sensor 31															
+193	Current temperature value of K6PM-TH sensor 31 segment 0 (per segment)															
+194	Current temperature value of K6PM-TH sensor 31 segment 1 (per segment)															
:	:															
+208	Current temperature value of K6PM-TH sensor 31 segment 15 (per segment)															

## 5-3 Monitoring and Setting Using the CIP Message Communications and Examples of Communications Instructions

This section shows the contents of monitoring and setting using the CIP message communications and examples of communications instructions.

### 5-3-1 Services Supported by Objects in Main Units

The services supported by the objects in Main Unit are as follows.

Object name	Class ID	Function
Main Unit monitor object	374 hex	This object reads the Main Unit status and number of connected K6PM-TH sensors.
K6PM-TH sensor monitor object	375 hex	This object reads the status of each sensor of the Main Unit and the current temperature value of each segment.
K6PM-TH sensor temperature monitor object	376 hex	This object reads the current temperature value of each pixel of each sensor of the Main Unit.
Main Unit setting object	377 hex	This object writes the setting parameters (such as the existence of alarm latch, transistor output method, enabling or disabling of "Use predicted arrival time", etc.) of the Main Unit. Alternatively, it performs each operation instruction (such as K6PM-TH sensor registration, K6PM-TH sensor location registration, reset of the maximum temperature of all sensors connected to the corresponding Main Unit, etc.).
K6PM-TH sensor alarm setting object	378 hex	This object writes the temperature alarm parameter of each sensor of the Main Unit.
Identity Object	01 hex	This object reads the Main Unit software reset and the Main Unit identification information, and also reads the state of the built-in EtherNet/IP port.
TCP/IP Interface object	F5 hex	This object reads and writes settings such as the IP address, subnet mask, default gateway, etc.

### 5-3-2 Main Unit Monitor Object (Class ID: 374 hex)

This object reads the Main Unit status and number of connected K6PM-TH sensors.

#### Service Codes

Service code	Service name	Description	Supported services	
			Classes	Instances
01 hex	Get_Attributes_All	Reads the values of all attributes.	Not supported	Supported
0E hex	Get_Attribute_Single	Reads the value of the specified attribute.	Not supported	Supported

#### Class ID

Specify 374 hex.

#### Instance ID

Specify 01 hex.

## Attribute ID

The attribute ID specifies the information to read.

### ● Class Attribute ID

None

### ● Instance Attribute ID

The instance attribute ID specifies the per-instance attribute.

An example of a case where the instance ID is 01 hex is described below.

Attribute ID	Parameter name	Description	Attribute	Data
				Data type
64 hex	Main Unit status	Refer to <i>Main Unit status</i> on page 5-11 described later.	Read	UINT
65 hex	Running time data	Running time ratio 0 to 100% (0000 hex to 0064 hex)	Read	UINT
66 hex	Software version	Software version Set as desired by a double-byte BCD expression. Example: 0110 hex for V1.10	Read	UINT
67 hex	Number of connected K6PM-TH sensors	0 to 31 (0000 to 001F hex)	Read	UINT
68 hex	Target sensor in position adjustment mode	0: No target sensor in position adjustment mode 1: K6PM-TH sensor 1 position adjustment mode ...: 31: K6PM-TH sensor 31 position adjustment mode (0000 to 001F hex)	Read	UINT

#### • Main Unit status

Bit position	Status	Bit contents	
		0	1
0	Main Unit internal error	Not occurred	Occurred
1	K6PM-TH sensor error <sup>*1</sup>	Not occurred	Occurred
2	Running time error <sup>*2</sup>	Not occurred	Occurred
3	Running time reaches 100%.	Unreached	Reached
4	monitoring mode	Stop	Execute
5	K6PM-TH sensor search mode	Stop	Execute
6	K6PM-TH sensor position adjustment mode	Stop	Execute
7	Interruption of temperature measurement	Not occurred	Occurred
8	comprehensive temperature alarm (threshold 1 exceeded)	Not occurred	Occurred
9	comprehensive temperature alarm (threshold 2 exceeded)	Not occurred	Occurred
10	Reserved		
11	Reserved		
12	Reserved		
13	TR 1 (transistor 1 output state)	OFF	ON
14	TR 2 (transistor 2 output state)	OFF	ON
15	TR 3 (transistor 3 output state)	OFF	ON

\*1. When any one of a K6PM-TH sensor communications error, sensor type error, K6PM-TH sensor angle deviation error, and temperature measurement range exceeded occurs in any of the sensors connected to the Main Unit.

- \*2. Notification of the Main Unit Replacement Timing is not operating normally. The hardware used for the replacement time alert function may have failed.

### 5-3-3 K6PM-TH Sensor Monitor Object (Class ID: 375 hex)

This object reads the status of each sensor of the Main Unit and the current temperature value of each segment.

#### Service Codes

Service code	Service name	Description	Supported services	
			Classes	Instances
01 hex	Get_Attributes_All	Reads the values of all attributes.	Not supported	Supported
0E hex	Get_Attribute_Single	Reads the value of the specified attribute.	Not supported	Supported

#### Class ID

Specify 375 hex.

#### Instance ID

Specify the following data according to the target.

- For class: Specify 00 hex.
- For instance: Specify 01 to 1F hex (compatible with sensor number 1 to 31).

#### Attribute ID

The attribute ID specifies the information to read.

##### ● Class Attribute ID

None

##### ● Instance Attribute ID

The instance attribute ID specifies the per-instance attribute.

An example of a case where the instance ID is 01 hex is described below.

Attribute ID	Parameter name	Description	Attribute	Data
				Data type
64 hex	K6PM-TH sensor 1 version	Set the sensor version as D6** hex. Example: D611 hex for Version D611	Read	UINT
65 hex	K6PM-TH sensor 1 status	Refer to <i>K6PM-TH sensor status per sensor</i> on page 5-13.	Read	UINT
66 hex	K6PM-TH sensor 1 alarm status	Refer to <i>K6PM-TH sensor alarm status per sensor</i> on page 5-14.	Read	UINT
67 hex	Internal temperature value of K6PM-TH sensor 1	Current value of the K6PM-TH sensor internal temperature	Read	UINT
68 hex	K6PM-TH sensor 1 internal maximum temperature value	Past maximum value of the K6PM-TH sensor internal temperature	Read	UINT
69 hex	K6PM-TH sensor 1 internal predicted arrival time temperature value	Arrival prediction value of the K6PM-TH sensor internal temperature	Read	UINT

Attribute ID	Parameter name	Description	Attribute	Data
				Data type
6A hex	Current value of the K6PM-TH sensor 1 segment 0 temperature	Current value of the segment temperature	:	:
6B hex	Current value of the K6PM-TH sensor 1 segment 1 temperature	Current value of the segment temperature	Read	UINT
:	:	:	Read	UINT
79 hex	Current value of the K6PM-TH sensor 1 segment 15 temperature	Current value of the segment temperature	Read	UINT
7A hex	Maximum value of the K6PM-TH sensor 1 segment 0 temperature	Past maximum value of the segment temperature	:	:
7B hex	Maximum value of the K6PM-TH sensor 1 segment 1 temperature	Past maximum value of the segment temperature	Read	UINT
:	:	:	:	:
89 hex	Maximum value of the K6PM-TH sensor 1 segment 15 temperature	Past maximum value of the segment temperature	Read	UINT
8A hex	K6PM-TH sensor 1 segment 0 predicted value	Arrival prediction value of the segment temperature	Read	UINT
8B hex	K6PM-TH sensor 1 segment 1 predicted value	Arrival prediction value of the segment temperature	Read	UINT
:	:	:	:	:
99 hex	K6PM-TH sensor 1 segment 15 predicted value	Arrival prediction value of the segment temperature	Read	UINT

- K6PM-TH sensor status per sensor

Bit position	Status	Bit contents	
		0	1
0	Monitor target	Not supported	Supported
1	Reserved		
2	Reserved		
3	Reserved		
4	K6PM-TH sensor type	00: Not determined	
5		01: 32 × 32	
6	Reserved		
7	Reserved		
8	K6PM-TH sensor communications error	Not occurred	Occurred
9	K6PM-TH sensor angle deviation	Not occurred	Occurred
10	Temperature measurement range exceeded	Not occurred	Occurred
11	Reserved		
12	Reserved		
13	Reserved		
14	Reserved		
15	Reserved		

The monitor target (bit 0) of the K6PM-TH sensor status is a target for the registration sensor in the monitoring mode.

The user can recognize which sensor is the monitor target in the monitoring mode by checking the monitor target (bit 0).

The bit that is updated in the KP6M-TH sensor search mode or the K6PM-TH sensor position adjustment mode is only the K6PM-TH sensor type and the K6PM-TH sensor angle deviation error.

- K6PM-TH sensor alarm status per sensor

Bit position	Status	Bit contents	
		0	1
0	Internal temperature alarm (threshold 1 exceeded)	Not occurred	Occurred
1	Internal temperature alarm (threshold 2 exceeded)	Not occurred	Occurred
2	Current temperature alarm (threshold 1 exceeded)	Not occurred	Occurred
3	Current temperature alarm (threshold 2 exceeded)	Not occurred	Occurred
4	Differential temperature alarm (threshold 1 exceeded)	Not occurred	Occurred
5	Differential temperature alarm (threshold 2 exceeded)	Not occurred	Occurred
6	Internal predicted arrival time temperature alarm (threshold value 1 exceeded)	Not occurred	Occurred
7	Internal predicted arrival time temperature alarm (threshold value 2 exceeded)	Not occurred	Occurred
8	Predicted arrival time temperature alarm (threshold value 1 exceeded)	Not occurred	Occurred
9	Predicted arrival time temperature alarm (threshold value 2 exceeded)	Not occurred	Occurred
10	Reserved		
11	Reserved		
12	Reserved		
13	Reserved		
14	Reserved		
15	Reserved		

### 5-3-4 K6PM-TH Sensor Temperature Monitor Object (Class ID: 376 hex)

This object reads the current temperature value of each pixel of each sensor of the Main Unit for each segment (64 pixels). The current temperature value of the read pixel is saved in an array variable having 64 elements.

#### Service Codes

Service code	Service name	Description	Supported services	
			Classes	Instances
0E hex	Get_Attribute_Single	Reads the value of the specified attribute.	Not supported	Supported

#### Class ID

Specify 376 hex.

#### Instance ID

Specify the following data according to the target.

- For class: Specify 00 hex.
- For instance: Specify 01 to 1F hex (compatible with sensor number 1 to 31).

## Attribute ID

The attribute ID specifies the information to read.

### ● Class Attribute ID

None

### ● Instance Attribute ID

The instance attribute ID specifies the per-instance attribute.

An example of a case where the instance ID is 01 hex is described below.

Attribute ID	Parameter name	Description	Attribute	Data type
64 hex	K6PM-TH sensor 1 pixel current temperature value 0	Temperature data of each pixel from 0 to 63 pixels of the K6PM-TH sensor. For details on the procedure of saving data, refer to "Temperature data of each pixel" described later.	Read	Array of UINT[64]
65 hex	K6PM-TH sensor 1 pixel current temperature value 1	Temperature data of each pixel from 64 to 127 pixels of the K6PM-TH sensor.	Read	Array of UINT[64]
66 hex	K6PM-TH sensor 1 pixel current temperature value 2	Temperature data of each pixel from 128 to 191 pixels of the K6PM-TH sensor.	Read	Array of UINT[64]
67 hex	K6PM-TH sensor 1 pixel current temperature value 3	Temperature data of each pixel from 192 to 255 pixels of the K6PM-TH sensor.	Read	Array of UINT[64]
68 hex	K6PM-TH sensor 1 pixel current temperature value 4	Temperature data of each pixel from 256 to 319 pixels of the K6PM-TH sensor.	Read	Array of UINT[64]
69 hex	K6PM-TH sensor 1 pixel current temperature value 5	Temperature data of each pixel from 320 to 383 pixels of the K6PM-TH sensor.	Read	Array of UINT[64]
6A hex	K6PM-TH sensor 1 pixel current temperature value 6	Temperature data of each pixel from 384 to 447 pixels of the K6PM-TH sensor.	Read	Array of UINT[64]
6B hex	K6PM-TH sensor 1 pixel current temperature value 7	Temperature data of each pixel from 448 to 511 pixels of the K6PM-TH sensor.	Read	Array of UINT[64]
6C hex	K6PM-TH sensor 1 pixel current temperature value 8	Temperature data of each pixel from 512 to 575 pixels of the K6PM-TH sensor.	Read	Array of UINT[64]
6D hex	K6PM-TH sensor 1 pixel current temperature value 9	Temperature data of each pixel from 576 to 639 pixels of the K6PM-TH sensor.	Read	Array of UINT[64]
6E hex	K6PM-TH sensor 1 pixel current temperature value 10	Temperature data of each pixel from 640 to 703 pixels of the K6PM-TH sensor.	Read	Array of UINT[64]
6F hex	K6PM-TH sensor 1 pixel current temperature value 11	Temperature data of each pixel from 704 to 767 pixels of the K6PM-TH sensor.	Read	Array of UINT[64]
70 hex	K6PM-TH sensor 1 pixel current temperature value 12	Temperature data of each pixel from 768 to 831 pixels of the K6PM-TH sensor.	Read	Array of UINT[64]

Attribute ID	Parameter name	Description	Attribute	Data type
71 hex	K6PM-TH sensor 1 pixel current temperature value 13	Temperature data of each pixel from 832 to 895 pixels of the K6PM-TH sensor.	Read	Array of UINT[64]
72 hex	K6PM-TH sensor 1 pixel current temperature value 14	Temperature data of each pixel from 896 to 959 pixels of the K6PM-TH sensor.	Read	Array of UINT[64]
73 hex	K6PM-TH sensor 1 pixel current temperature value 15	Temperature data of each pixel from 960 to 1,023 pixels of the K6PM-TH sensor.	Read	Array of UINT[64]

Temperature data of each pixel:

The temperature data of each pixel is saved in the following order.

8 × 8 pixels are considered as one segment, and the maximum value within one segment is considered as the segment temperature value.

The relationship between the pixel position and the segment temperature value is as shown below.

◆32x32

0	1	2	3	4	5	6	7	8	9	10	...	29	30	31
32														
64														
96														
128			0							1			3	
160														
192														
224														
256														
288			4							5			7	
320														
...														
928														
960			12							13			15	
992														1023

Light-gray colored characters: Indicate the pixel number.

Black-colored characters: Indicate the segment number.



### 5-3-5 Main Unit Setting Object (Class ID: 377 hex)

This object writes the setting parameters (such as the existence of alarm latch, transistor output method, enabling or disabling of "Use predicted arrival time", etc.) of the Main Unit.

Alternatively, it performs each operation instruction (such as K6PM-TH sensor registration, K6PM-TH sensor location registration, reset of the maximum temperature of all sensors connected to the corresponding Main Unit, etc.).

Note Software reset uses the Identity object (Class ID: 01 hex).

## Service Codes

Service code	Service name	Description	Supported services	
			Classes	Instances
01 hex	Get_Attributes_All	Reads the values of all attributes.	Not supported	Supported
02 hex	Set_Attributes_All	Write values to all attributes.	Not supported	Supported
0E hex	Get_Attribute_Single	Reads the value of the specified attribute.	Not supported	Supported
10 hex	Set_Attribute_Single	Write the value of the specified attribute.	Not supported	Supported
4B hex	Sensor_Registration	K6PM-TH sensor registration Request data*1... 1: Cancel sensor registration. (Change to sensor search mode), 2: Register sensor. (Change to monitoring mode) (0001 to 0002 hex, Data type: UINT)	Not supported	Supported
4C hex	Sensor_ - Mode_Change	Change the K6PM-TH sensor mode Request data*2... 0: K6PM-TH sensor search mode, 1: K6PM-TH sensor 1 position adjustment mode, 2: K6PM-TH sensor 2 position adjustment mode, : 31: K6PM-TH sensor 31 position adjustment mode (0000 to 001F hex, Data type: UINT)	Not supported	Supported

\*1. Reset occurs after the command ends normally.

If the mode is already a transition target, an error response (0B hex) is returned.

If 0 sensors are registered for K6PM-TH sensor type registration, an error response (0C hex) is returned.

\*2. The K6PM-TH sensor number in the position adjustment mode is reflected in the "Target sensor in position adjustment mode" of the Main Unit monitor object.

At the same time, bits 5 and 6 of the Main Unit status are updated.

An error response (10 hex) is returned when in the monitoring mode.

Service code	Service name	Description	Supported services	
			Classes	Instances
4D hex	Search_Results_Reflect	Reflect K6PM-TH sensor search result Request data *1... 1: Reflect sensor search result (0001 hex, Data type: UINT)	Not supported	Supported
4E hex	Sensor_Position_Registration	K6PM-TH sensor location registration Request data *2... 1: K6PM-TH sensor 1 location registration, 2: K6PM-TH sensor 2 location registration, : 31: K6PM-TH sensor 31 location registration (0001 to 001F hex, Data type: UINT)	Not supported	Supported
4F hex	Max_Reset	Max. temperature reset Resets the maximum temperature of all sensors connected to the corresponding Main Unit. Request data... 1: Reset the past maximum temperature of all sensor segments (0001 hex, Data type: UINT)	Not supported	Supported

\*1. The "K6PM-TH sensor type" in the K6PM-TH sensor status is reflected in the "K6PM-TH sensor type registration" of the setting object.

An error response (10 hex) is returned when in the monitoring mode and K6PM-TH sensor position adjustment mode.

\*2. An error response (10 hex) is returned when in the monitoring mode.

If position registration is not performed for the target sensor, an error response (0C hex) is returned.

Note The contents of the error response code that can occur when the above service codes are executed are as described below.

Error response code	Error response name	Error contents
0B hex	Already in requested mode/state	The object is already in the mode or state being requested by the service.
0C hex	Object state conflict	The object cannot execute the requested service in its current state.
10 hex	Device state conflict	The device cannot execute the requested service in the current mode or state.

**Class ID**

Specify 377 hex.

**Instance ID**

Specify 01 hex.

**Attribute ID**

Specify the information to write.

● **Class Attribute ID**

None

● **Instance Attribute ID**

The instance attribute ID specifies the per-instance attribute.

The setting parameter is enabled after the power supply is reset.

Attribute ID	Parameter name	Description	Attribute	Data	
				Data type	Default value
64 hex	Alarm latch	0: Disabled 1: Enable	Write	UINT	0001 hex
65 hex	Use Running Time	Sets the notification of the Main Unit replacement timing to Enable or Disable. 0: Disabled 1: Enable	Write	UINT	0000 hex
66 hex	Temperature unit	0: °C 1: °F	Write	UINT	0000 hex
67 hex	Output inversion	0: Normally closed 1: Normally open	Write	UINT	0000 hex
68 hex	Use arrival prediction	0: Disabled 1: Enable	Write	UINT	0000 hex
69 hex	K6PM-TH sensor 1 type registration	0: Unregistered 1: 32 x 32	Write	UINT	0000 hex
:	:	:	:	:	:
87 hex	K6PM-TH sensor 31 type registration	0: Unregistered 1: 32 x 32	Write	UINT	0000 hex

### 5-3-6 K6PM-TH Sensor Alarm Setting Object (Class ID: 378 hex)

This object sets the alarm threshold of the Main Unit.

#### Service Codes

Service code	Service name	Description	Supported services	
			Classes	Instances
01 hex	Get_Attributes_All	Reads the values of all attributes.	Not supported	Supported
02 hex	Set_Attributes_All	Write values to all attributes.	Not supported	Supported
0E hex	Get_Attribute_Single	Reads the value of the specified attribute.	Not supported	Supported
10 hex	Set_Attribute_Single	Write the value of the specified attribute.	Not supported	Supported

#### Class ID

Specify 378 hex.

#### Instance ID

Specify the following data according to the target.

- For class: Specify 00 hex.
- For instance: Specify 01 to 1F hex (compatible with sensor number 1 to 31).

#### Attribute ID

Specify the information to write.

##### ● Class Attribute ID

None

##### ● Instance Attribute ID

The instance attribute ID specifies the per-instance attribute.

The setting parameter is enabled after the power supply is reset.

An example of a case where the instance ID is 01 hex is described below.

Attribute ID	Parameter name	Description	Attribute	Data	
				Data type	Default value
64 hex	Sensor 1 Internal temperature alarm setting (threshold 1)	(0000 to 270F hex) (0 to 999.9 (unit: °C/°F))	Write	UINT	01C2 hex (45.0)
65 hex	Sensor 1 Internal temperature alarm setting (threshold 2)	(0000 to 270F hex) (0 to 999.9 (unit: °C/°F))	Write	UINT	0226 hex (55.0)
66 hex	K6PM-TH sensor 1 segment 0 Current temperature alarm setting (threshold 1)	(0000 to 270F hex) (0 to 999.9 (unit: °C/°F))	Write	UINT	02BC hex (70.0)

Attribute ID	Parameter name	Description	Attribute	Data	
				Data type	Default value
67 hex	K6PM-TH sensor 1 segment 0 Current temperature alarm setting (threshold 2)	(0000 to 270F hex) (0 to 999.9 (unit: °C/°F))	Write	UINT	03E8 hex (100.0)
68 hex	K6PM-TH sensor 1 segment 0 Differential temperature alarm setting (threshold 1)	(0000 to 270F hex) (0 to 999.9 (unit: °C/°F))	Write	UINT	012C hex (30.0)
69 hex	K6PM-TH sensor 1 segment 0 Differential temperature alarm setting (threshold 2)	(0000 to 270F hex) (0 to 999.9 (unit: °C/°F))	Write	UINT	01C2 hex (45.0)
6A hex	K6PM-TH sensor 1 segment 1 Current temperature alarm setting (threshold 1)	(0000 to 270F hex) (0 to 999.9 (unit: °C/°F))	Write	UINT	02BC hex (70.0)
6B hex	K6PM-TH sensor 1 segment 1 Current temperature alarm setting (threshold 2)	(0000 to 270F hex) (0 to 999.9 (unit: °C/°F))	Write	UINT	03E8 hex (100.0)
6C hex	K6PM-TH sensor 1 segment 1 Differential temperature alarm setting (threshold 1)	(0000 to 270F hex) (0 to 999.9 (unit: °C/°F))	Write	UINT	012C hex (30.0)
6D hex	K6PM-TH sensor 1 segment 1 Differential temperature alarm setting (threshold 2)	(0000 to 270F hex) (0 to 999.9 (unit: °C/°F))	Write	UINT	01C2 hex (45.0)
:	:	:	:	:	:
A2 hex	K6PM-TH sensor 1 segment 15 Current temperature alarm setting (threshold 1)	(0000 to 270F hex) (0 to 999.9 (unit: °C/°F))	Write	UINT	02BC hex (70.0)
A3 hex	K6PM-TH sensor 1 segment 15 Current temperature alarm setting (threshold 2)	(0000 to 270F hex) (0 to 999.9 (unit: °C/°F))	Write	UINT	03E8 hex (100.0)
A4 hex	K6PM-TH sensor 1 segment 15 Differential temperature alarm setting (threshold 1)	(0000 to 270F hex) (0 to 999.9 (unit: °C/°F))	Write	UINT	012C hex (30.0)
A5 hex	K6PM-TH sensor 1 segment 15 Differential temperature alarm setting (threshold 2)	(0000 to 270F hex) (0 to 999.9 (unit: °C/°F))	Write	UINT	01C2 hex (45.0)

### 5-3-7 Identity Object (Class ID: 01 hex)

This object reads the Main Unit software reset and the Main Unit identification information, and also reads the state of the built-in EtherNet/IP port.

#### Service Codes

Service code	Service name	Description	Supported services	
			Classes	Instances
01 hex	Get_Attributes_All	Reads the values of all attributes.	Supported	Supported
0E hex	Get_Attribute_Single	Reads the value of the specified attribute.	Supported	Supported
05 hex	Reset	Performs software reset of the Main Unit. Execute this service code to perform software reset of the Main Unit when you change the parameter settings and want to apply the changed parameters.	Not supported	Supported

#### Class ID

Specify 01 hex.

#### Instance ID

Specify 01 hex.

#### Attribute ID

The attribute ID specifies the information to read.

##### ● Class Attribute ID

The class attribute ID specifies the attribute of the object class.

Attribute ID	Parameter name	Description	Attribute	Data	
				Data type	Default value
01 hex	Revision	Revision of the object	Read	UINT	0001 hex

## ● Instance Attribute ID

The instance attribute ID specifies the per-instance attribute.

Attribute ID	Parameter name	Description	Attribute	Data	
				Data type	Default value
01 hex	Vendor ID	Vendor ID	Read	UINT	002F hex
02 hex	Device Type	Device type	Read	UINT	0304 hex
03 hex	Product Code	Product code	Read	UINT	*1
04 hex	Revision	Device revision	Read	Struct of	- - -
	Major Revision	Major revision	Read	USINT	Product specific
	Minor Revision	Minor revision	Read	USINT	Product specific
05 hex	Status	Status of the EtherNet/IP Port	Read	WORD	*2
06 hex	Serial Number	Serial number	Read	UDINT	Product specific
07 hex	Product Name	Product name	Read	SHORT_S TRING	Product specific

\*1. Product code

Models	Product Code
K6PM-THMD-EIP	512 (200 hex)

\*2. Status of the built-in Ether- Net/IP port

Bit	Name	Description
0	Owned	Indicates when the built-in EtherNet/IP port has an open connection as the target of a tag data link.
1	Reserved.	Always FALSE.
2	Configured	Tag data link settings exist.
3	Reserved.	Always FALSE.
4 to 7	Extended Device Status Indicates the status of the built-in EtherNet/IP port.	Indicates the status of the built-in EtherNet/IP port. 0: Not used 1: Not used 2: One or more I/O connection failures 3: I/O connection is not established 4: Not used 5: Serious defect occurred (MS Criticality) 6: One or more I/O connections are established and one or more are in the RUN state 7: One or more I/O connections are established and all are idle 8 to 15: Unused
8	Minor Recoverable Fault Indicates the status of the built-in EtherNet/IP port.	Always FALSE.
9	Minor Unrecoverable Fault Indicates the status of the built-in EtherNet/IP port.	Always FALSE.
10	Major Recoverable Fault Indicates the status of the built-in EtherNet/IP port.	When the MS indicator matches conditions of the flashing red: True
11	Major Unrecoverable Fault Indicates the status of the built-in EtherNet/IP port.	When the MS indicator matches conditions of the flashing red: True
12 to 15	Reserved.	Always FALSE.

### 5-3-8 TCP/IP Interface Object (Class ID: F5 hex)

This object is used to read and write settings such as the IP address, subnet mask, and default gateway.

#### Service Codes

Service code	Service name	Description	Supported services	
			Classes	Instances
01 hex	Get_Attributes_All	Reads the values of all attributes.	Not supported	Supported
0E hex	Get_Attribute_Single	Reads the value of the specified attribute.	Supported	Supported
10 hex	Set_Attribute_Single	Writes the value to the specified attribute.	Not supported	Supported

#### Class ID

Specify F5 hex.

#### Instance ID

Specify 01 hex.

#### Attribute ID

The attribute ID specifies the information to read.

##### ● Class Attribute ID

The class attribute ID specifies the attribute of the object class.

Attribute ID	Parameter name	Description	Attribute	Data	
				Data type	Default value
01 hex	Revision	Revision of the object	Read	UINT	0004 hex



### ● Instance Attribute ID

The instance attribute ID specifies the per-instance attribute.

Attribute ID	Parameter name	Description	Attribute	Data	
				Data type	Default value
01 hex	Interface Configuration Status	<p>Indicates the IP address settings status of the interface.</p> <p>Bits 0 to 3: Interface Configuration Status:</p> <p>0 = IP address is not set. (This includes when BOOTP is starting.)</p> <p>1 = IP address is set.</p> <p>Bits 4 to 31: Reserved (always FALSE).</p>	Read	DWORD	1
02 hex	Configuration Capability	<p>Indicates a Setup that can be set to the built-in interface.</p> <p>Bit 0: BOOTP Client: TRUE (fixed).</p> <p>Bit 1: DNS Client: FALSE (fixed).</p> <p>Bit 2: DHCP Client: FALSE (fixed).</p> <p>Bit 3: DHCP-DNS Update: FALSE (fixed).</p> <p>Bit 4: Configuration Settable: TRUE (fixed).</p> <p>(Can the Interface Configuration attribute be set?)</p> <p>Bit 5: Hardware Configurable: FALSE (fixed).</p> <p>(Can the IP address be set by the hardware?)</p> <p>Bit 6: Interface Configuration Change Requires Reset: TRUE (fixed).</p> <p>(Is it necessary to restart the device after changing the Interface Configuration attribute?)</p> <p>(Is it necessary to restart the device after changing the Interface Configuration attribute?)</p> <p>Bit 7: ACD Capable: FALSE (fixed)</p> <p>(Whether or not ACD function is available)</p> <p>Bit 8 to 31: Reserved area FALSE.</p>	Read	DWORD	00000051 hex

Attribute ID	Parameter name	Description	Attribute	Data	
				Data type	Default value
03 hex	Configuration Control	Sets the method used to set the IP address when the interface starts. 0: Static IP address. 1: Set by BOOTP.	Write	DWORD	00000000 hex
04 hex	Physical Link Object	The path to the link object in the physical layer	Read	Struct of	- - -
	Path size	The path size (WORD size).		UINT	0002 hex
	Path	The path to the link object in the physical layer (Path to the Ethernet Link object (Class ID: F6 hex))		Padded EPATH	20F6 2401 hex
05 hex	Interface Configuration	Interface settings	Write	Struct of	- - -
	IP Address	IP address		UDINT	Set value (Factory default: 192.168.250.30)
	Network Mask	Subnet mask.		UDINT	255.255.255.0
	Gateway Address	The default gateway.		UDINT	0.0.0.0
	Name Server	The primary name server.		UDINT	0.0.0.0
	Nana Server2	The secondary name server.		UDINT	0.0.0.0
	Domain Name	The domain name.		STRING	0000 hex. (fixed)
06 hex	Host Name	The host name (reserved). <sup>*1</sup>	Write	STRING	0000 hex. (fixed)
0D hex	Encapsulation Inactivity Timeout	Encapsulation session timeout time (Timeout time of TCP connection or DLTS connection)	Write	UINT	0078 hex (120 seconds) Setting range: 1 to 3,600 seconds (0: Prohibited)

\*1. Only the Host Name immediately reflects the change in settings. (It is not necessary to reset the power supply to apply the changes in the setting parameters to the operation)

### 5-3-9 Examples of CIP Message Communications Instruction

An example of reading data in the Main Unit using the CIP message communications is shown below.

Example: The following is an example of reading the Main Unit status using the CIP message communications instruction of the NJ/NX-series Controller.

The CIPUCMMSend (Send Explicit Message UCMM) instruction is used a CIP message communications instruction.

Send the following CIP message.

- Service code: 16#0E (Get\_Attribute\_Single: read the value of the specified attribute)
- Class ID: 374 hex
- Instance ID: 01 hex
- Attribute ID: 64 hex (Main Unit status)

The CIPUCMMSend instruction sends the command data "ServiceDat" as a UCMM message corresponding to the service specified by the "ServiceCode".

The destination is specified by the route path "RoutePath". The request path is specified by "RqPath".

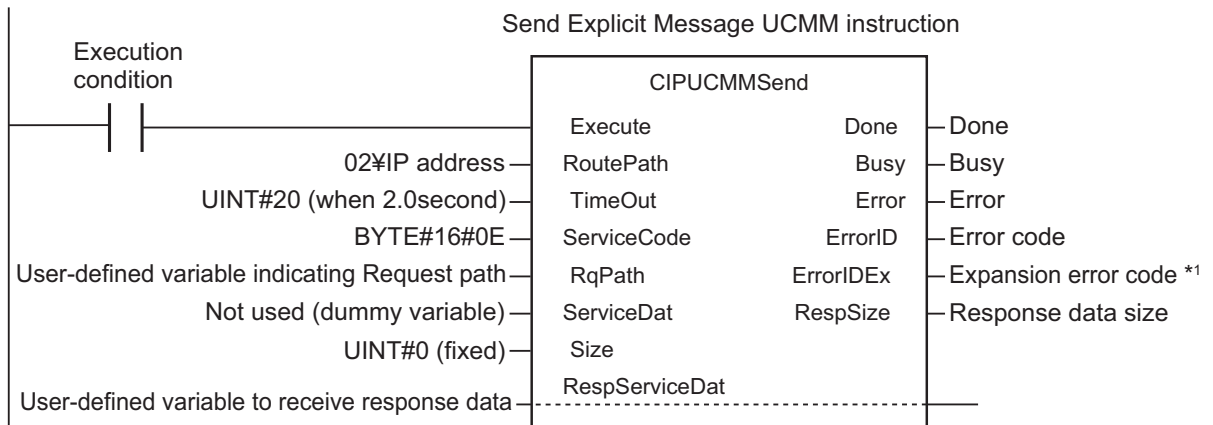

Set the following value to the input variable of the above communications instruction.

Input variable of the communications instruction	Specification	Value to pass to input variable	Meaning
RoutePath	Route path specification	02\IPaddress	"02" specifies the output from the NJ-series built-in EtherNet/IP port or the NX-series built-in EtherNet/IP port 1. The IP address specifies the IP address of the Main Unit.
TimeOut	Timeout time specification	UINT#20	Timeout time is specified. The integer "20" specifies 2.0 s as the timeout time. It is 0.1 s unit.
ServiceCode	Service code	BYTE#16#0E	0EHex specifies "Get_Attribute_Single" as a service code which reads the value of the specified attribute.

Input variable of the communications instruction	Specification	Value to pass to input variable	Meaning
RqPath	Request path specification	Specified by user variable indicating the Request path	<p>Specify a user-defined variable.</p> <p>Use the data type "_sREQUEST_PATH" corresponding to the input variable "RqPath". You can use any variable name.</p> <p>Specify the following.</p> <p>Class ID, Instance ID, Attribute ID</p> <p>Example: Reading the Main Unit status: Specify the following.</p> <p>ClassID: = 374 hex (meaning of "Main Unit monitor object")</p> <p>InstanceID: = 01 hex (fixed)</p> <p>isAttributeID: = TRUE (meaning to use an attribute ID)</p> <p>AttributeID: = 64 hex (meaning of Main Unit status)</p>
ServiceDat	Data to send	Not used (dummy variable)	Since the service code is "read", specify a dummy variable.
Size	Number of elements to send	UINT#0	Since the service code is "read", specify integer 0 (fixed).
RespServiceDat	Response data specification	Specified by user variable r variable to receive response data	<p>Specify a user-defined variable.</p> <p>Use the data type "ARRAY [0..10] OF BYTE" corresponding to the input/output variable "RespServiceDat". You can use any variable name.</p>

\*1. If the value of "ErrorID" is WORD#16#1C00 (Explicit error), the CIP message error code is stored in "ErrorIDEx". For details on "ErrorIDEx", refer to *A-4 Expansion Error Code of the CIP Message Communications* on page A-36.

# 6

## Monitoring and Setting with the Modbus TCP

Main Units can also be monitored or set using Modbus TCP compatible devices. This section describes how to monitor using the EtherNet/IP.

---

<b>6-1</b>	<b>Outline</b>	<b>6-2</b>
<b>6-2</b>	<b>Function Codes</b>	<b>6-3</b>
6-2-1	Function Code List	6-3
6-2-2	03 hex: Reading of Multiple Registers	6-3
6-2-3	06 hex: Operation Command	6-5
6-2-4	10 hex: Writing of Multiple Registers	6-6
6-2-5	Exception Code List	6-7
<b>6-3</b>	<b>Register Address Lists</b>	<b>6-8</b>
6-3-1	Main Unit Monitor	6-8
6-3-2	K6PM-TH Sensor Temperature Monitor (1 to 31)	6-9
6-3-3	Main Unit Setting	6-12
6-3-4	Product Information	6-14
6-3-5	IP Address	6-14
6-3-6	K6PM-TH Sensor Alarm Setting (1 to 31)	6-15
6-3-7	Operation Command	6-18

## 6-1 Outline

This section provides an overview of how to monitor the K6PM-TH using the Modbus TCP.

Modbus TCP is a communications protocol that uses TCP/IP to communicate with host devices such as PLCs.

This communications protocol allows host devices with a TCP/IP socket interface to read and write the internal data of the K6PM-TH.

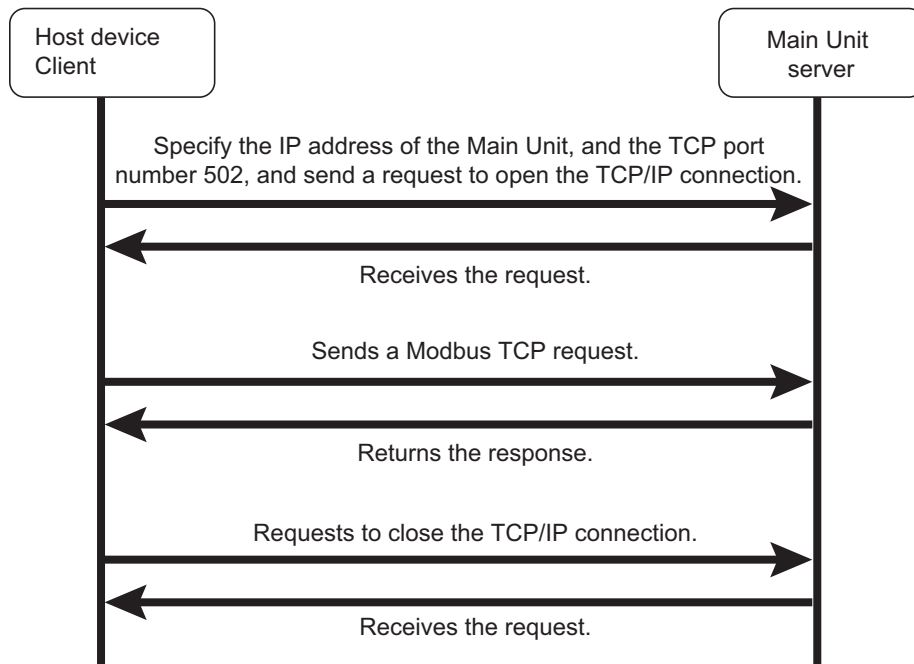
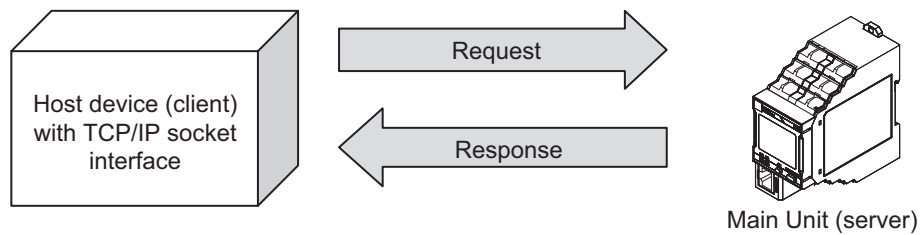

**Note** The socket is an interface for using TCP directly from the user program. The host device specifies the IP address of K6PM-TH and TCP port number of 502 (01F6 hex) and opens the socket in Active. After that, it sends Modbus TCP request and reads and writes the internal data of the K6PM-TH.

In addition, Modbus TCP can be connected to up to two clients simultaneously.

## 6-2 Function Codes

This section describes function codes that can be used with Modbus TCP.

### 6-2-1 Function Code List

The function codes that can be used are as follows.

Function code	Name	Usages
03 hex	Reading of multiple registers	Used to read the Main Unit status, alarm status, current value of the temperature, IP address, etc.
06 hex	Operation command	Used to instruct software reset, K6PM-TH sensor registration, K6PM-TH sensor mode change, K6PM-TH sensor location registration, max. temperature reset, etc.
10 hex	Writing of multiple registers	Used to set the IP address, Main Unit initial setting, etc.

### 6-2-2 03 hex: Reading of Multiple Registers

This function can read the contents of multiple registers starting from the specified address.

#### Frame Configurations

The frame configurations of Modbus TCP are as follows.

##### ● Request

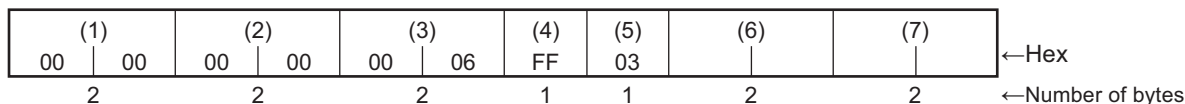

- |                                  |  |
|----------------------------------|--|
| (1): Transaction ID              | Specify any value. For example, 0000 hex is used in this explanation.  |
| (2): Protocol ID                 | Specify 0000 hex.  |
| (3): Number of bytes transferred | Specify the total number of bytes of (4) and the successor. In the above case, it is from (4) to (7), so it is 0006 hex. |
| (4): Unit ID                     | Specify FF hex.  |
| (5): Function code               | Specify 03 hex (Reading of multiple registers).  |
| (6): Start address               | Specify the address to start reading.<br>Refer to <i>6-3 Register Address Lists</i> on page 6-8.                         |
| (7): Number of words to read     | Specify the number of words of the register to be read. The maximum value is 125 (007D hex).                             |

### ● Normal Response

(1) 00   00	(2) 00   00	(3) 00	(4) FF	(5) 03	(8) 	(9) 	---	(9) 
2	2	2	1	1	1	2		2

### ● Error Response

(1) 00   00	(2) 00   00	(3) 00   03	(4) FF	(5) 83	(10) 
2	2	2	1	1	1

(3): Number of bytes transferred The total number of bytes of (4) and the successor is set.

(8): Byte count The total number of bytes of (9) is set.

(9): Register contents Register contents from the start address to the number of read words are set.

(10): Exception code Error information is set. Refer to *6-2-5 Exception Code List* on page 6-7.

Note 1. For the other elements (the elements shaded in the above figure), the value specified in the request is set.

2. The function code of (5) at error response is 83 hex.

## Example: Reading the Main Unit Status

### ● Request

(1) 00   00	(2) 00   00	(3) 00   06	(4) FF	(5) 03	(6) 00   00	(7) 00   01
----------------	----------------	----------------	-----------	-----------	----------------	----------------

(6): Start address Specify the address of the K6PM-TH status.

(7): Number of words to read The entire measurement information is 1 word (2 bytes), so specify 0001 hex.

### ● Normal Response

(1) 00   00	(2) 00   00	(3) 00   05	(4) FF	(5) 03	(8) 02	K6PM-TH status
----------------	----------------	----------------	-----------	-----------	-----------	-------------------

(3): Number of bytes transferred The total number of bytes of (4) and the successor are 5, so 0005 hex is set.

(8): Byte count The Main Unit status is 2 bytes, so 2 hex is set.

Note For the other elements (the elements shaded in the above figure), the value specified in the request is set.



### 6-2-3 06 hex: Operation Command

Software reset, K6PM-TH sensor registration, K6PM-TH sensor mode change, K6PM-TH sensor location registration, max. temperature reset, etc. are executed.

## Frame Configurations

The frame configurations of Modbus TCP are as follows.

### ● Request

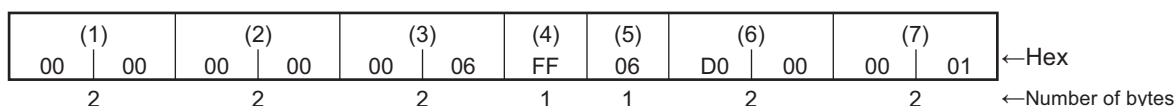

- |                                  |  |
|----------------------------------|--|
| (1): Transaction ID              | Specify any value. For example, 0000 hex is used in this explanation.  |
| (2): Protocol ID                 | Specify 0000 hex.  |
| (3): Number of bytes transferred | Specify the total number of bytes of (4) and the successor. In the above case, it is from (4) to (7), so it is 0006 hex. |
| (4): Unit ID                     | Specify FF hex.  |
| (5): Function code               | Specify 06 hex (Operation command).  |
| (6): Start address               | Specify D000 hex (Software reset).   |
| (7): Number of words to read     | Specify 0001 hex (Reset).  |

### ● Normal Response

It is the same as the request.

### ● Error Response

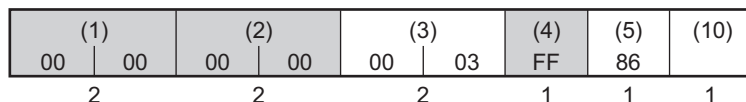

- |                                  |  |
|----------------------------------|--|
| (3): Number of bytes transferred | The total number of bytes of (4) and the successor is set.                       |
| (5): Function code               | 86 hex is set.   |
| (10): Exception code             | Error information is set. Refer to 6-2-5 <i>Exception Code List</i> on page 6-7. |

Note For the other elements (the elements shaded in the above figure), the value specified in the request is set.

## 6-2-4 10 hex: Writing of Multiple Registers

This function can write data to multiple registers with the specified address as the start address.

### Frame Configurations

The frame configurations of Modbus TCP are as follows.

#### ● Request

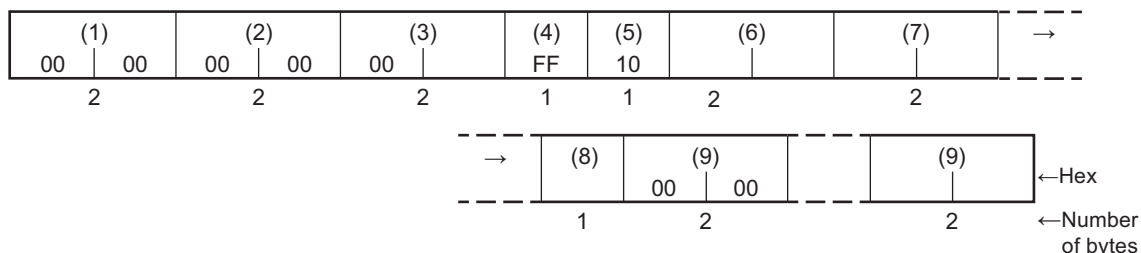

- |                                  |  |
|----------------------------------|--|
| (1): Transaction ID              | Specify any value. For example, 0000 hex is used in this explanation.                            |
| (2): Protocol ID                 | Specify 0000 hex.  |
| (3): Number of bytes transferred | Specify the total number of bytes of (4) and the successor.                                      |
| (4): Unit ID                     | Specify FF hex.  |
| (5): Function code               | 10 hex (Writing of multiple registers) is specified.   |
| (6): Start address               | Specify the address to start writing.<br>Refer to <i>6-3 Register Address Lists</i> on page 6-8. |
| (7): Number of words to read     | Specify the number of words of the register to be write. The maximum value is 125 (007D hex).    |
| (8): Byte count                  | Specify the total number of bytes of (9).  |
| (9): Data                        | Register contents from the start address to the number of write words are set.                   |

#### ● Normal Response

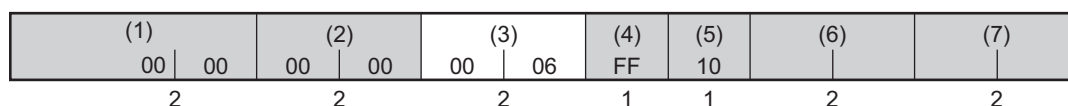

#### ● Error Response

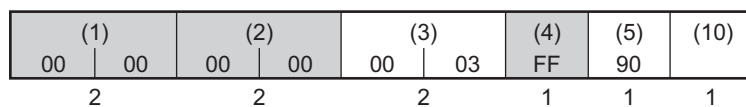

- |                                  |  |
|----------------------------------|--|
| (3): Number of bytes transferred | The total number of bytes of (4) and the successor is set.                       |
| (10): Exception code             | Error information is set. Refer to <i>6-2-5 Exception Code List</i> on page 6-7. |

Note 1. The elements shaded in the above figures are set to the value specified in the request.

2. The function code of (5) at error response is 90 hex.

## Example: Change IP Address

### ● Request

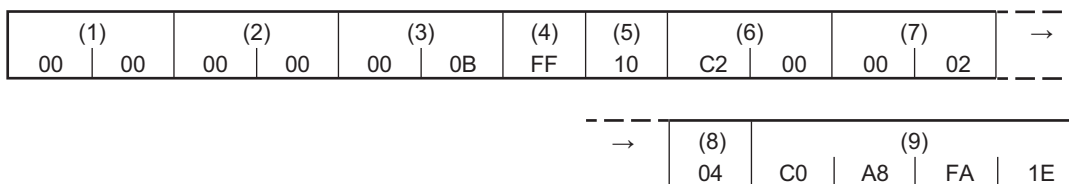

- (1): Transaction ID                      Specify any value. For example, 0000 hex is used in this explanation.
- (2): Protocol ID                          Specify 0000 hex.
- (3): Number of bytes transferred      The total number of bytes of (4) and the successor are 11, so specify 000B hex.
- (4): Unit ID                                Specify FF hex.
- (5): Function code                        10 hex (Writing of multiple registers) is specified.
- (6): Start address                         Specify the register address of the IP address.
- (7): Number of words to read          The IP address is 2 words (4 bytes), so specify 0002 hex.
- (8): Byte count                          The total number of bytes of (9) is 4 bytes, so specify 04 hex.
- (9): Data                                    Specify 192.168.250.30 (C0 A8 FA 1E hex) as the IP address.

### ● Normal Response

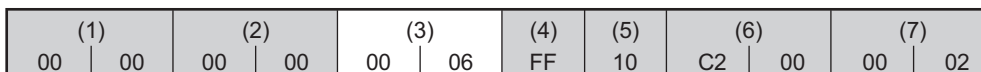

- (3): Number of bytes transferred      The total number of bytes of (4) and the successor are 6, so 0006 hex is set.

Note For the other elements (the elements shaded in the above figure), the value specified in the request is set.

## 6-2-5 Exception Code List

The following is the exception codes when an error response occurs. Confirm this content and review the request.

Exception code	Types of error	Function
01 hex	Illegal function codes	In the case of an unsupported function code.
02 hex	Illegal data address	When an address that cannot be read or written is included.
03 hex	Illegal data value	When data that cannot be written, such as data that is outside the setting range, is included.
04 hex	Failure in associated device	This is the state in which normal execution cannot be performed. <ul style="list-style-type: none"> <li>• When K6PM-TH is an error state.</li> <li>• When an operation command and writing of multiple registers cannot be performed. Refer to 6-3 <i>Register Address Lists</i> on page 6-8 for details.</li> </ul>

## 6-3 Register Address Lists

Registers that can be read and written using Modbus TCP are as follows.

Offset address (hexadecimal)	Contents (communications area)	R/W
0000 to 0004 hex	Main Unit monitor	R
0010 to 9A3F hex	K6PM-TH sensor temperature monitor 1 to 31	R
A000 to A023 hex	Main Unit setting	R/W
A100 to BF41 hex	K6PM-TH sensor alarm setting 1 to 31	R/W
C000 to C019 hex	Product information	R
C200 to C208 hex	IP address	R/W
D000 to D005 hex	Operation command	W

### 6-3-1 Main Unit Monitor

Address	Parameter name	Description	Number of bytes	R/W*1
0000 hex	Main Unit status	Status of the Main Unit Refer to "Main Unit status" in 5-3-2 <i>Main Unit Monitor Object (Class ID: 374 hex)</i> on page 5-10.	2	R
0001 hex	Running time data	Running time ratio 0 to 100% (0000 hex to 0064 hex)	2	R
0002 hex	Software version	Software version	2	R
0003 hex	Number of connected K6PM-TH sensors	0 to 31 (0000 to 001F hex)	2	R
0004 hex	Target sensor in position adjustment mode	0: No target position adjustment sensor 1: K6PM-TH sensor 1 position adjustment mode : 31: K6PM-TH sensor 31 position adjustment mode (0000 to 001F hex)	2	R
0005 hex 000E hex	Reserved	0000 hex is returned.	18	R
000F hex	Illegal address	Exception code 02 hex (illegal data address) is returned.	----	----

\*1. R: Read using Reading of multiple registers (03 hex).

## 6-3-2 K6PM-TH Sensor Temperature Monitor (1 to 31)

## List of Addresses of K6PM-TH Sensor Temperature Monitors (For 31 Sensors)

Address	Data name	Number of bytes	R/W*1	Address	Data name	Number of bytes	R/W*1
0010 hex	K6PM-TH sensor 1 monitor related	108 byte	R	5000 hex	K6PM-TH sensor 17 monitor related	108 byte	R
0050 hex	K6PM-TH sensor 1 pixel temperature	2048 byte	R	5040 hex	K6PM-TH sensor 17 pixel temperature	2048 byte	R
0500 hex	K6PM-TH sensor 2 monitor related	108 byte	R	5500 hex	K6PM-TH sensor 18 monitor related	108 byte	R
0540 hex	K6PM-TH sensor 2 pixel temperature	2048 byte	R	5540 hex	K6PM-TH sensor 18 pixel temperature	2048 byte	R
0A00 hex	K6PM-TH sensor 3 monitor related	108 byte	R	5A00 hex	K6PM-TH sensor 19 monitor related	108 byte	R
0A40 hex	K6PM-TH sensor 3 pixel temperature	2048 byte	R	5A40 hex	K6PM-TH sensor 19 pixel temperature	2048 byte	R
0F00 hex	K6PM-TH sensor 4 monitor related	108 byte	R	5F00 hex	K6PM-TH sensor 20 monitor related	108 byte	R
0F40 hex	K6PM-TH sensor 4 pixel temperature	2048 byte	R	5F40 hex	K6PM-TH sensor 20 pixel temperature	2048 byte	R
1400 hex	K6PM-TH sensor 5 monitor related	108 byte	R	6400 hex	K6PM-TH sensor 21 monitor related	108 byte	R
1440 hex	K6PM-TH sensor 5 pixel temperature	2048 byte	R	6440 hex	K6PM-TH sensor 21 pixel temperature	2048 byte	R
1900 hex	K6PM-TH sensor 6 monitor related	108 byte	R	6900 hex	K6PM-TH sensor 22 monitor related	108 byte	R
1940 hex	K6PM-TH sensor 6 pixel temperature	2048 byte	R	6940 hex	K6PM-TH sensor 22 pixel temperature	2048 byte	R
1E00 hex	K6PM-TH sensor 7 monitor related	108 byte	R	6E00 hex	K6PM-TH sensor 23 monitor related	108 byte	R
1E40 hex	K6PM-TH sensor 7 pixel temperature	2048 byte	R	6E40 hex	K6PM-TH sensor 23 pixel temperature	2048 byte	R
2300 hex	K6PM-TH sensor 8 monitor related	108 byte	R	7300 hex	K6PM-TH sensor 24 monitor related	108 byte	R
2340 hex	K6PM-TH sensor 8 pixel temperature	2048 byte	R	7340 hex	K6PM-TH sensor 24 pixel temperature	2048 byte	R
2800 hex	K6PM-TH sensor 9 monitor related	108 byte	R	7800 hex	K6PM-TH sensor 25 monitor related	108 byte	R
2840 hex	K6PM-TH sensor 9 pixel temperature	2048 byte	R	7840 hex	K6PM-TH sensor 25 pixel temperature	2048 byte	R
2D00 hex	K6PM-TH sensor 10 monitor related	108 byte	R	7D00 hex	K6PM-TH sensor 26 monitor related	108 byte	R

Address	Data name	Number of bytes	R/W*1	Address	Data name	Number of bytes	R/W*1
2D40 hex	K6PM-TH sensor 10 pixel temperature	2048 byte	R	7D40 hex	K6PM-TH sensor 26 pixel temperature	2048 byte	R
3200 hex	K6PM-TH sensor 11 monitor related	108 byte	R	8200 hex	K6PM-TH sensor 27 monitor related	108 byte	R
3240 hex	K6PM-TH sensor 11 pixel temperature	2048 byte	R	8240 hex	K6PM-TH sensor 27 pixel temperature	2048 byte	R
3700 hex	K6PM-TH sensor 12 monitor related	108 byte	R	8700 hex	K6PM-TH sensor 28 monitor related	108 byte	R
3740 hex	K6PM-TH sensor 12 pixel temperature	2048 byte	R	8740 hex	K6PM-TH sensor 28 pixel temperature	2048 byte	R
3C00 hex	K6PM-TH sensor 13 monitor related	108 byte	R	8C00 hex	K6PM-TH sensor 29 monitor related	108 byte	R
3C40 hex	K6PM-TH sensor 13 pixel temperature	2048 byte	R	8C40 hex	K6PM-TH sensor 29 pixel temperature	2048 byte	R
4100 hex	K6PM-TH sensor 14 monitor related	108 byte	R	9100 hex	K6PM-TH sensor 30 monitor related	108 byte	R
4140 hex	K6PM-TH sensor 14 pixel temperature	2048 byte	R	9140 hex	K6PM-TH sensor 30 pixel temperature	2048 byte	R
4600 hex	K6PM-TH sensor 15 monitor related	108 byte	R	9600 hex	K6PM-TH sensor 31 monitor related	108 byte	R
4640 hex	K6PM-TH sensor 15 pixel temperature	2048 byte	R	9640 hex	K6PM-TH sensor 31 pixel temperature	2048 byte	R
4B00 hex	K6PM-TH sensor 16 monitor related	108 byte	R				
4B40 hex	K6PM-TH sensor 16 pixel temperature	2048 byte	R				

\*1. R: Read using Reading of multiple registers (03 hex).

## List of Addresses Related to K6PM-TH Sensor Temperature Monitors (Sensor 1 Detailed Parameters)

The detailed parameters of sensor 1 are as described below.

The detailed parameters of sensors 2 to 31 are also same as those of sensor 1.

Address	Parameter name	Description	Number of bytes	R/W*1
0010 hex	K6PM-TH sensor 1 version	Set the sensor version as D6** hex. Example: D611 hex for Version D611	2	R
0011 hex	K6PM-TH sensor 1 status	Refer to "K6PM-TH sensor status per sensor" in 5-3-3 <i>K6PM-TH Sensor Monitor Object (Class ID: 375 hex)</i> on page 5-12.	2	R
0012 hex	K6PM-TH sensor 1 alarm status	Refer to "K6PM-TH sensor alarm status per sensor" in 5-3-3 <i>K6PM-TH Sensor Monitor Object (Class ID: 375 hex)</i> on page 5-12.	2	R
0013 hex	Internal temperature value of K6PM-TH sensor 1	Current value of the K6PM-TH sensor internal temperature*2	2	R

Address	Parameter name	Description	Number of bytes	R/W <sup>*1</sup>
0014 hex	K6PM-TH sensor 1 internal maximum temperature	Past maximum value of the K6PM-TH sensor internal temperature	2	R
0015 hex	K6PM-TH sensor 1 internal predicted arrival time temperature value	Arrival prediction value of the K6PM-TH sensor internal temperature	2	R
0016 hex	Current value of the K6PM-TH sensor 1 segment 0 temperature	Current value of the segment temperature	2	R
0017 hex	Current value of the K6PM-TH sensor 1 segment 1 temperature	Current value of the segment temperature	2	R
:	:	:	:	:
0025 hex	Current value of the K6PM-TH sensor 1 segment 15 temperature	Current value of the segment temperature	2	R
0026 hex	Maximum value of the K6PM-TH sensor 1 segment 0 temperature	Past maximum value of the segment temperature	2	R
0027 hex	Maximum value of the K6PM-TH sensor 1 segment 1 temperature	Past maximum value of the segment temperature	2	R
:	:	:	:	:
0035 hex	Maximum value of the K6PM-TH sensor 1 segment 15 temperature	Past maximum value of the segment temperature	2	R
0036 hex	K6PM-TH sensor 1 segment 0 predicted value	Arrival prediction value of the segment temperature	2	R
0037 hex	K6PM-TH sensor 1 segment 1 predicted value	Arrival prediction value of the segment temperature	2	R
:	:	:	:	:
0045 hex	K6PM-TH sensor 1 segment 15 predicted value	Arrival prediction value of the segment temperature	2	R
0046 hex 004E hex	Reserved	0000 hex is returned.	16	R
004F hex	Illegal address	Exception code 02 hex (illegal data address) is returned.	----	----
0050 hex	K6PM-TH sensor 1 pixel current temperature value 0	Temperature data of each pixel from 0 to 63 pixels of the K6PM-TH sensor. For details on the order of saving the data, refer to "Temperature data of each pixel" in <i>5-3-2 Main Unit Monitor Object (Class ID: 374 hex)</i> on page 5-10.	128	R
0090 hex	K6PM-TH sensor 1 pixel current temperature value 1	Temperature data of each pixel from 64 to 127 pixels of the K6PM-TH sensor.	128	R
00D0 hex	K6PM-TH sensor 1 pixel current temperature value 2	Temperature data of each pixel from 128 to 191 pixels of the K6PM-TH sensor.	128	R
0110 hex	K6PM-TH sensor 1 pixel current temperature value 3	Temperature data of each pixel from 192 to 255 pixels of the K6PM-TH sensor.	128	R
0150 hex	K6PM-TH sensor 1 pixel current temperature value 4	Temperature data of each pixel from 256 to 319 pixels of the K6PM-TH sensor.	128	R

Address	Parameter name	Description	Number of bytes	R/W*1
0190 hex	K6PM-TH sensor 1 pixel current temperature value 5	Temperature data of each pixel from 320 to 383 pixels of the K6PM-TH sensor.	128	R
01D0 hex	K6PM-TH sensor 1 pixel current temperature value 6	Temperature data of each pixel from 384 to 447 pixels of the K6PM-TH sensor.	128	R
0210 hex	K6PM-TH sensor 1 pixel current temperature value 7	Temperature data of each pixel from 448 to 511 pixels of the K6PM-TH sensor.	128	R
0250 hex	K6PM-TH sensor 1 pixel current temperature value 8	Temperature data of each pixel from 512 to 575 pixels of the K6PM-TH sensor.	128	R
0290 hex	K6PM-TH sensor 1 pixel current temperature value 9	Temperature data of each pixel from 576 to 639 pixels of the K6PM-TH sensor.	128	R
02D0 hex	K6PM-TH sensor 1 pixel current temperature value 10	Temperature data of each pixel from 640 to 703 pixels of the K6PM-TH sensor.	128	R
0310 hex	K6PM-TH sensor 1 pixel current temperature value 11	Temperature data of each pixel from 704 to 767 pixels of the K6PM-TH sensor.	128	R
0350 hex	K6PM-TH sensor 1 pixel current temperature value 12	Temperature data of each pixel from 768 to 831 pixels of the K6PM-TH sensor.	128	R
0390 hex	K6PM-TH sensor 1 pixel current temperature value 13	Temperature data of each pixel from 832 to 895 pixels of the K6PM-TH sensor.	128	R
03D0 hex	K6PM-TH sensor 1 pixel current temperature value 14	Temperature data of each pixel from 896 to 959 pixels of the K6PM-TH sensor.	128	R
0410 hex	K6PM-TH sensor 1 pixel current temperature value 15	Temperature data of each pixel from 960 to 1,023 pixels of the K6PM-TH sensor.	128	R
0450 hex : 04FE hex	Reserved	0000 hex is returned.	350	R
04FF hex	Illegal address	Exception code 02 hex (illegal data address) is returned.	----	----

\*1. R: Read using Reading of multiple registers (03 hex).

\*2. A hexadecimal value in the range of 0.0 to 80.0°C (32.0 to 176.0°F).  
(Example: C8 in the case of 20.0°C)

### 6-3-3 Main Unit Setting

Address	Parameter name	Description	Initial value	Number of bytes	R/W*1
A000 hex	Alarm latch	0: Disable (no latch) 1: Enable (with latch)	0001 hex	2	R/W



Address	Parameter name	Description	Initial value	Number of bytes	R/W <sup>*1</sup>
A001 hex	Use Running Time	Sets the notification of the Main Unit replacement timing to Enable or Disable. 0: Disabled 1: Enable	0000 hex	2	R/W
A002 hex	Temperature unit	0: °C 1: °F	0000 hex	2	R/W
A003 hex	Output inversion	0: Normally closed 1: Normally open	0000 hex	2	R/W
A004 hex	Use arrival prediction	0: Disabled 1: Enable	0000 hex	2	R/W
A005 hex	K6PM-TH sensor 1 type registration <sup>*2</sup>	0: Unregistered 1: 32 x 32	0000 hex	2	R/W
:	:	:	:	:	:
A023 hex	K6PM-TH sensor 31 type registration <sup>*2</sup>	0: Unregistered 1: 32 x 32	0000 hex	2	R/W
A024 hex A0FE hex A0FF hex	Reserved	0000 hex is returned.	0000 hex	438	R
	Illegal address	Exception code 02 hex (illegal data address) is returned.	----	----	----

\*1. R: Read using Reading of multiple registers (03 hex).  
W: Write using Writing of multiple registers (10 hex).

\*2. When writing is performed in the K6PM-TH monitoring mode, the exception code 04 hex (failure in associated device) is returned.

### 6-3-4 Product Information

Address	Data name	Data Range	Number of bytes	R/W <sup>*1</sup>
C000 hex	Vendor ID	002F hex	2	R
C001 hex	Device type	0304 hex	2	R
C002 hex	Product code	*2	2	R
C003 hex	Device major revision	*3	2	R
C004 hex	Device minor revision	*3	2	R
C005 hex	Serial number	Product specific	4	R
C007 hex	MAC address	00 00 0A ** ** ** hex	6	R
C00A hex	Product name	*4	32	R

\*1. R: Read using Reading of multiple registers (03 hex).

\*2. Product code

Product code	Model
512 (200 hex)	K6PM-THMD-EIP

\*3. The device revision is as follows.

Example: In the case of version 1.23

Major: 0001 hex

Minor: 0023 hex

\*4. Product name is in ASCII notation.

Example: 4B 36 50 4D...hex (K6PM...)

If the name is in less than 32 characters, all the succeeding areas become 00 hex.

### 6-3-5 IP Address

Address	Data name	Data Range	Number of bytes	R/W <sup>*1</sup>
C200 hex	IP address	Example: C0 A8 FA 1E hex (192.168.250.30)	4	R/W
C202 hex	Subnet mask	Default value: FF FF FF 00 hex (255.255.255.0)	4	R/W
C204 hex	The default gateway	Default value: 00 00 00 00 hex (0.0.0.0)	4	R/W
C206 hex	IP address setting method	00000000 hex: Static IP address. 00000001 hex: Set by BOOTP. 00000002 hex: BOOTP one-shot.	4	R/W

\*1. R: Read using Reading of multiple registers (03 hex).

W: Write using Writing of multiple registers (10 hex).

## 6-3-6 K6PM-TH Sensor Alarm Setting (1 to 31)

## List of Addresses of K6PM-TH Sensor Alarm Setting (For 31 Sensors)

Address	Data	Size	R/W*1
A100 hex	K6PM-TH sensor 1 alarm setting	132 byte	R/W
A200 hex	K6PM-TH sensor 2 alarm setting	132 byte	R/W
A300 hex	K6PM-TH sensor 3 alarm setting	132 byte	R/W
A400 hex	K6PM-TH sensor 4 alarm setting	132 byte	R/W
A500 hex	K6PM-TH sensor 5 alarm setting	132 byte	R/W
A600 hex	K6PM-TH sensor 6 alarm setting	132 byte	R/W
A700 hex	K6PM-TH sensor 7 alarm setting	132 byte	R/W
A800 hex	K6PM-TH sensor 8 alarm setting	132 byte	R/W
A900 hex	K6PM-TH sensor 9 alarm setting	132 byte	R/W
AA00 hex	K6PM-TH sensor 10 alarm setting	132 byte	R/W
AB00 hex	K6PM-TH sensor 11 alarm setting	132 byte	R/W
AC00 hex	K6PM-TH sensor 12 alarm setting	132 byte	R/W
AD00 hex	K6PM-TH sensor 13 alarm setting	132 byte	R/W
AE00 hex	K6PM-TH sensor 14 alarm setting	132 byte	R/W
AF00 hex	K6PM-TH sensor 15 alarm setting	132 byte	R/W
B000 hex	K6PM-TH sensor 16 alarm setting	132 byte	R/W

Address	Data	Size	R/W*1
B100 hex	K6PM-TH sensor 17 alarm setting	132 byte	R/W
B200 hex	K6PM-TH sensor 18 alarm setting	132 byte	R/W
B300 hex	K6PM-TH sensor 19 alarm setting	132 byte	R/W
B400 hex	K6PM-TH sensor 20 alarm setting	132 byte	R/W
B500 hex	K6PM-TH sensor 21 alarm setting	132 byte	R/W
B600 hex	K6PM-TH sensor 22 alarm setting	132 byte	R/W
B700 hex	K6PM-TH sensor 23 alarm setting	132 byte	R/W
B800 hex	K6PM-TH sensor 24 alarm setting	132 byte	R/W
B900 hex	K6PM-TH sensor 25 alarm setting	132 byte	R/W
BA00 hex	K6PM-TH sensor 26 alarm setting	132 byte	R/W
BB00 hex	K6PM-TH sensor 27 alarm setting	132 byte	R/W
BC00 hex	K6PM-TH sensor 28 alarm setting	132 byte	R/W
BD00 hex	K6PM-TH sensor 29 alarm setting	132 byte	R/W
BE00 hex	K6PM-TH sensor 30 alarm setting	132 byte	R/W
BF00 hex	K6PM-TH sensor 31 alarm setting	132 byte	R/W

\*1. R: Read using Reading of multiple registers (03 hex).  
W: Write using Writing of multiple registers (10 hex).

## K6PM-TH Sensor Alarm Setting (Example: Sensor 1 Detailed Parameters)

The detailed parameters of sensor 1 are as described below.

The detailed parameters of sensors 2 to 31 are also same as those of sensor 1.

Address	Parameter name	Data range	Initial value	Number of bytes	R/W*1
A100 hex	Sensor 1 Internal temperature alarm value (threshold 1)	(0000 to 270F hex) (0 to 999.9 [Unit: °C or °F])	01F4 hex (50.0)	2	R/W
A101 hex	Sensor 1 Internal temperature alarm value (threshold 2)	0000 to 270F hex (0 to 999.9 [Unit: °C or °F])	0258 hex (60.0)	2	R/W
A102 hex	K6PM-TH sensor 1 segment 0 Current temperature alarm setting (threshold 1)	0000 to 270F hex (0 to 999.9 [Unit: °C or °F])	0320 hex (80.0)	2	R/W
A103 hex	K6PM-TH sensor 1 segment 0 Current temperature alarm setting (threshold 2)	0000 to 270F hex (0 to 999.9 [Unit: °C or °F])	03E8 hex (100.0)	2	R/W
A104 hex	K6PM-TH sensor 1 segment 0 Differential temperature alarm value (threshold 1)	0000 to 270F hex (0 to 999.9 [Unit: °C or °F])	0320 hex (80.0)	2	R/W
A105 hex	K6PM-TH sensor 1 segment 0 Differential temperature alarm value (threshold 2)	0000 to 270F hex (0 to 999.9 [Unit: °C or °F])	03E8 hex (100.0)	2	R/W
A106 hex	K6PM-TH sensor 1 segment 1 Current temperature alarm setting (threshold 1)	0000 to 270F hex (0 to 999.9 [Unit: °C or °F])	0320 hex (80.0)	2	R/W
A107 hex	K6PM-TH sensor 1 segment 1 Current temperature alarm setting (threshold 2)	0000 to 270F hex (0 to 999.9 [Unit: °C or °F])	03E8 hex (100.0)	2	R/W
A108 hex	K6PM-TH sensor 1 segment 1 Differential temperature alarm value (threshold 1)	0000 to 270F hex (0 to 999.9 [Unit: °C or °F])	0320 hex (80.0)	2	R/W
A109 hex	K6PM-TH sensor 1 segment 1 Differential temperature alarm value (threshold 2)	0000 to 270F hex (0 to 999.9 [Unit: °C or °F])	03E8 hex (100.0)	2	R/W
:	:	:	:	:	:
A13E hex	K6PM-TH sensor 1 segment 15 Current temperature alarm setting (threshold 1)	0000 to 270F hex (0 to 999.9 [Unit: °C or °F])	0320 hex (80.0)	2	R/W

Address	Parameter name	Data range	Initial value	Number of bytes	R/W*1
A13F hex	K6PM-TH sensor 1 segment 15 Absolute temperature alarm value (threshold 2)	0000 to 270F hex (0 to 999.9 [Unit: °C or °F])	03E8 hex (100.0)	2	R/W
A140 hex	K6PM-TH sensor 1 segment 15 Differential temperature alarm value (threshold 1)	0000 to 270F hex (0 to 999.9 [Unit: °C or °F])	0320 hex (80.0)	2	R/W
A141 hex	K6PM-TH sensor 1 segment 15 Differential temperature alarm value (threshold 2)	0000 to 270F hex (0 to 999.9 [Unit: °C or °F])	03E8 hex (100.0)	2	R/W
A142 hex A1FE hex A1FF hex	Reserved Illegal address	0000 hex is returned. Exception code 02 hex (illegal data address) is returned.	0000 hex ----	376 ----	R ----

\*1. R: Read using Reading of multiple registers (03 hex).  
W: Write using Writing of multiple registers (10 hex).

### 6-3-7 Operation Command

Address	Data name	Data Range	Number of bytes	R/W <sup>*1</sup>
D000 hex	Software reset	0001 hex: Software reset	2	W
D001 hex	K6PM-TH sensor registration <sup>*2</sup>	0001 hex: Cancel sensor registration. (Change to sensor search mode) 0002 hex: Register sensor. (Change to monitoring mode)	2	W
D002 hex	Change the K6PM-TH sensor mode <sup>*3</sup>	0000 hex: K6PM-TH sensor search mode 0001 hex: K6PM-TH sensor 1 position adjustment mode 0002 hex: K6PM-TH sensor 2 position adjustment mode ... 001F hex: K6PM-TH sensor 31 position adjustment mode	2	W
D003 hex	Reflect K6PM-TH sensor search result <sup>*4</sup>	0001 hex: Reflect sensor search result	2	W
D004 hex	K6PM-TH sensor location registration <sup>*5</sup>	0001 hex: K6PM-TH sensor 1 location registration 0002 hex: K6PM-TH sensor 2 location registration ... 001F hex: K6PM-TH sensor 31 location registration	2	W
D005 hex	Max. temperature reset	0001 hex: Reset the maximum temperature of all segments of all sensors	2	W

\*1. W: Write using Writing of multiple registers (10 hex).

\*2. Reset occurs after the command ends normally.

If the mode is already a transition target, the exception code 04 hex (failure in associated device) is returned.  
If 0 sensors are registered for K6PM-TH sensor type registration, the exception code 04 hex (failure in associated device) is returned.

\*3. In the monitoring mode, the exception code 04 hex (failure in associated device) is returned.

\*4. Register the sensor detected in K6PM-TH sensor search mode in the Main Unit.

In the monitoring mode K6PM-TH and sensor position adjustment mode, the exception code 04 hex (failure in associated device) is returned.

\*5. In the monitoring mode, the exception code 04 hex (failure in associated device) is returned.

If position registration is not performed for the target sensor, the exception code 04 hex (failure in associated device) is returned.



# Troubleshooting

---

This section describes troubleshooting when using the Main Units.

---

<b>7-1 Main Unit</b> .....	<b>7-2</b>
<b>7-2 Using the Software Tool</b> .....	<b>7-6</b>
<b>7-3 Using EtherNet Communications</b> .....	<b>7-7</b>

# 7-1 Main Unit

This section shows how to troubleshoot the Main Units.

If the Main Unit does not operate properly, check the items below as required before repair is requested. If it still does not work properly, return it through our sales department.

## ● Troubleshooting

Problems		Cause	Possible correction	Reference
Measurement values are not displayed.	"----" displayed	This is the state before the establishment of communications with the sensor. (From after the power supply is turned ON or the software is reset until the initial measurement value is calculated)	Wait until communications is established with all connected sensors. It takes a maximum of approximately 30 seconds for communications to be established.	---
	"5Err" is displayed.	The sensor is not properly connected and installed.	<ul style="list-style-type: none"> <li>• Check the power supply to the sensor.</li> <li>• Check the communications wiring with the sensor.</li> <li>• Check the terminating resistance (by the DIP switch pin) of the sensor.</li> <li>• Turn ON the power supply to the sensor again.</li> <li>• If no improvement is seen after taking the above action, replace the sensor.</li> </ul>	<i>1-4-4 Infrared Thermal Sensor</i> on page 1-16
	"8888" lights up.	The Main Unit may be damaged.	Turn ON the power supply to the Main Unit again. If it still occurs, contact our sales or distributor.	---
	The current temperature is displayed, but MS blinks red and K6PM sensor error is ON in the K6PM device status.	A K6PM-TH sensor error has occurred. One of the following. <ul style="list-style-type: none"> <li>• K6PM-TH sensor communications error</li> <li>• The detection of the K6PM-TH sensor angle deviation</li> <li>• Temperature measurement range exceeded</li> </ul>	<ul style="list-style-type: none"> <li>• Check the power supply to the sensor.</li> <li>• Check the communications wiring with the sensor.</li> <li>• Check the terminating resistance (by the DIP switch pin) of the sensor.</li> <li>• Return the sensor angle to its original state.</li> <li>• Alternatively, perform position adjustment and position registration.</li> <li>• Make sure there is no error in the measurement object.</li> </ul>	<i>1-4-1 Main Unit</i> on page 1-9 Refer to the Product and Network Status Indications Details. Refer to <i>Actions to Take When Angle Deviation Occurs</i> on page 7-5 described later.



Problems		Cause	Possible correction	Reference
Measurement values are not displayed.	MS blinks red and running time error is ON in the device status.	The hardware used for the replacement time alert function may have failed.	Cycle the K6PM power off and then on. If the error still occurs, contact OMRON sales or your dealer.	
	MS indicator is lit red.	The Main Unit may be damaged.	Turn ON the power supply to the Main Unit again. If it still occurs, contact our sales or distributor.	---
The current temperature is displayed, but MS blinks red and K6PM sensor error is ON in the K6PM device status.		A K6PM-TH sensor angle deviation has occurred.	Return the sensor angle to its original state. Alternatively, perform position adjustment and position registration. If the event cannot be cleared with the above action, turn ON the power supply to the sensor again. This event may be cleared by turning ON the power supply to the sensor multiple times. If no improvement is seen in the event after taking the above action, replace the sensor.	4-2-1 <i>Functions of Monitoring the Temperature in Control Panel with the Main Unit and the Software Tool</i> on page 4-13 Refer to K6PM-TH sensor location registration or K6PM-TH sensor angle deviation notification function. Refer to <i>Actions to Take When Angle Deviation Occurs</i> on page 7-5 described later.
The current temperature value is displayed, but "AGE" lights up.		The Main Unit running time has reached the approximate replacement time.	Consider replacing the Main Unit.	4-2-1 <i>Functions of Monitoring the Temperature in Control Panel with the Main Unit and the Software Tool</i> on page 4-13 Refer to the Notification of the Main Unit replacement timing.
The measured value displayed is incorrect.	The measured value is fixed and does not change	In the case of a trigger (external trigger), the measured value is held and displayed.	Either turn ON the power again or turn OFF the external trigger input.	4-2-1 <i>Functions of Monitoring the Temperature in Control Panel with the Main Unit and the Software Tool</i> on page 4-13 Refer to External trigger input of the Main Unit.
Transistor output 1, 2	Transistor output 1 or 2 does not return during measuring and monitoring despite the measured value that comprehensive alarm should be normal.	Alarm latch is set to "enable"	Long-press the SEG / ALMRST key on the front panel of the K6PM device for at least 5 seconds to release the alarm latch. Or, change the alarm latch setting to None (Disabled).	4-2-1 <i>Functions of Monitoring the Temperature in Control Panel with the Main Unit and the Software Tool</i> on page 4-13 Refer to Alarm latch of the Main Unit.

Problems		Cause	Possible correction	Reference
Transistor output 3	Transistor output 3 is OFF	<p>A Main Unit error or K6PM-TH sensor error has occurred.</p> <p>One of the following Internal CPU error, internal memory error, K6PM-TH sensor communications error, K6PM-TH sensor angle deviation detected, temperature measurement range exceeded, running time error</p>	<ul style="list-style-type: none"> <li>• Turn ON the power again.</li> <li>• Check the power supply to the sensor.</li> <li>• Check the communications wiring with the sensor.</li> <li>• Return the sensor angle to its original state.</li> <li>• Alternatively, perform position adjustment and position registration.</li> <li>• Make sure there is no error in the measurement object.</li> <li>• If it still occurs, contact our sales or distributor.</li> </ul>	<p><i>1-4-1 Main Unit</i> on page 1-9</p> <p>Refer to "Transistor output".</p>

## ● Actions to Take When Angle Deviation Occurs

Step	Procedures	
1. On the computer for monitoring, check if angle deviation has occurred.	On the <b>Device List of K6PM</b> Screen, check in which Main Unit has the angle deviation occurred on the PC for monitoring.	
	↓	
	On the <b>Monitoring K6PM</b> Screen, check in which K6PM-TH sensor has angle deviation occurred.	
	▼	
2. Identification of angle deviation occurrence location in the PC for setting	Move to the location of the control panel where the target sensor is present.	
	↓	
	(Turn ON the external trigger input. The measurement is interrupted.)	
	↓	
	Open the corresponding project file in the PC for setting	
	↓	
	On the <b>Setting K6PM</b> Screen, check the sensor number in which angle deviation has occurred.	
	↓	
	Select the sensor number on the <b>Setting K6PM</b> Screen, and then click the <b>Details</b> Button.	
	▼	
3. Position adjustment	Move to the <b>Setting sensor</b> Screen, and perform position adjustment while referring to the image data. Make sure the red LED indicator is flashing.	
	↓	
	<table border="0" style="width: 100%;"> <tr> <td style="width: 50%; vertical-align: top;"> <ul style="list-style-type: none"> <li>• To cancel the angle deviation Move to the Setting sensor screen, and adjust the position while viewing the image data.</li> </ul> </td> <td style="width: 50%; vertical-align: top;"> <ul style="list-style-type: none"> <li>• Registering a new position or changing a position On the <b>Setting sensor</b> Screen, click the <b>Position registration</b> Button. Press the reset switch for the K6PM-TH sensor angle deviation on the side surface of the infrared thermal sensor.</li> </ul> </td> </tr> </table>	<ul style="list-style-type: none"> <li>• To cancel the angle deviation Move to the Setting sensor screen, and adjust the position while viewing the image data.</li> </ul>
<ul style="list-style-type: none"> <li>• To cancel the angle deviation Move to the Setting sensor screen, and adjust the position while viewing the image data.</li> </ul>	<ul style="list-style-type: none"> <li>• Registering a new position or changing a position On the <b>Setting sensor</b> Screen, click the <b>Position registration</b> Button. Press the reset switch for the K6PM-TH sensor angle deviation on the side surface of the infrared thermal sensor.</li> </ul>	
Make sure the red LED stops blinking.		
	▼	
4. Resuming monitoring	Return to the <b>Setting K6PM</b> Screen, and click the <b>Start monitoring</b> Button. The Main Unit switches to the monitoring mode.	
	↓	
	Turn OFF the external trigger input. The measurement is resumed.	

## 7-2 Using the Software Tool

This section shows troubleshooting when using the software tool.

Problems	Cause	Possible correction	Reference
It is not possible to communicate with the Main Unit from the software tool	The IP address of the computer is automatically acquired or fixedly set to a segment different from the IP address of the Main Unit.	Set the IP address of the computer to IP address of same segment as the Main Unit.	---
	The IP address setting of the Main Unit on the project is different from the actual IP address.	Reset the IP address of the target Main Unit on the <b>Setting K6PM</b> Screen.	---
The measured value is displayed, but the value at a certain time is fixed and does not change	If the external trigger input turns ON, the measurement value immediately before the input turns ON is held and displayed.	Turn OFF the external trigger.	---

## 7-3 Using EtherNet Communications

This section shows troubleshooting when using the EtherNet/IP or Modbus TCP.

### ● EtherNet/IP

Problems		Cause	Possible correction	Reference
EtherNet/IP communications can not be executed when using BOOTP mode	NS LED is not lit	IP address has not been acquired from the BOOTP server	Check the connection between BOOTP server and the Main Units. If you do not have a BOOTP server, press the <b>CH</b> Key and the <b>SEG/ALM RST</b> Key at the same time for at least five seconds to initialize all settings of the Main Unit.	---
EtherNet/IP communications are not possible.	NS LED blinking red	The IP address of the built-in EtherNet/IP port is also used as the IP address of another node.	Change the IP address setting to avoid duplication.	---
	NS LED is not lit	An Ethernet link OFF was detected.	Check the connection between the switching hub and the Main Units to see if the following items are normal. <ul style="list-style-type: none"> <li>• Whether the Ethernet cable is broken, loose, or disconnected</li> <li>• Power state of the switching hub</li> <li>• Communications settings of the switching hub</li> </ul>	
A timeout occurred in a tag data link.	NS LED blinking red	Communications with the originator device timed out.	Make sure the following items are normal on the communications route. <ul style="list-style-type: none"> <li>• Whether the Ethernet cable is broken, loose, or disconnected</li> <li>• Power supply state and operation state of the originator</li> <li>• Power state of the switching hub</li> <li>• State of noise</li> </ul>	

### ● Modbus TCP

Problems		Cause	Possible correction	Reference
Modbus TCP communications cannot be performed when using BOOTP mode	NS LED is not lit	IP address has not been acquired from the BOOTP server	Check the connection between BOOTP server and the Main Units. If you do not have a BOOTP server, press the <b>CH</b> Key and the <b>SEG/ALM RST</b> Key at the same time for at least five seconds to initialize all settings of the Main Unit.	---



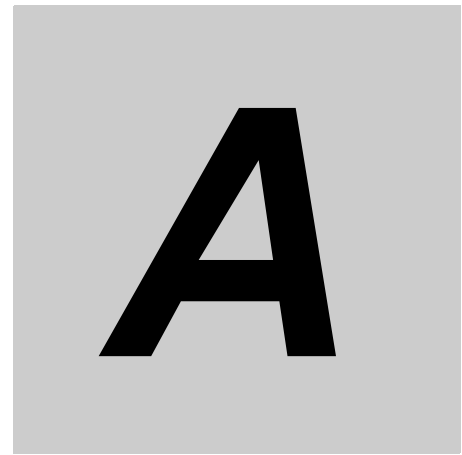

# Appendices

---

This section describes the specifications of the Main Units.

---

<b>A-1 Specifications</b> .....	<b>A-2</b>
A-1-1 Main Unit Specifications .....	A-2
A-1-2 Infrared Thermal Sensor .....	A-6
A-1-3 Software Tool .....	A-9
<b>A-2 Screen Flow of the Software Tool</b> .....	<b>A-12</b>
<b>A-3 Tag Data Link Connection Setting Procedures</b> .....	<b>A-13</b>
A-3-1 Preface .....	A-13
A-3-2 Using the CS/CJ-series .....	A-13
A-3-3 Using the NJ/NX-series .....	A-26
<b>A-4 Expansion Error Code of the CIP Message Communications</b> .....	<b>A-36</b>
A-4-1 General Status .....	A-36
A-4-2 Additional Status When General Status Is 01 hex .....	A-38

# A-1 Specifications

## A-1-1 Main Unit Specifications

### Main Unit Ratings

Model		K6PM-THMD-EIP
Item		
Power supply	Power supply voltage	24 VDC
	Allowable operating voltage range	85% to 110% of the power supply voltage
	Power supply frequency range	---
	Power consumption	1.6 W max.
Input	Compatible sensor	K6PM-THS3232
	Number of connected K6PM-TH sensors	31 Units
Output	Output form	Transistor output
	Number of outputs	3 points
	Rated voltage	24 VDC
	Maximum current	50 mA
Ambient operating temperature		-10 to +55°C (with no condensation or freezing)
Ambient storage temperature		-20 to +65°C (with no condensation or freezing)
Ambient operating humidity		25% to 85% (with no condensation)
Storage humidity		25% to 85% (with no condensation)
Exterior color		Black
Case material		PC UL94-V0
Altitude		2,000 m max.
Applicable wires		Stranded wires, solid wires, or ferrules
Applicable wire size		0.25 to 1.5 mm <sup>2</sup> (AWG24 to AWG16)
Wire insertion force		8 N max. for AWG20 wire
Screwdriver insertion force		15 N max.
Wire stripping length		8 mm <sup>*1</sup> , 10 mm, 12 mm
Recommended flat-blade screwdriver		XW4Z-00B
Current capacity		10 A (per pole)
Number of insertions		50 times
Weight		Approx. 200 g
Mounting <sup>*2</sup>		DIN Track mounting
		Screw mounting
Dimensions		45 × 90 × 90 mm (W×H×D)
Setting method		Communication settings from software tool
Other functions		Display value selection, Main Unit error and K6PM-TH sensor error output, setting parameters initialization, running time
Accessories		Instruction manual, Software Tool (thermal condition monitoring tool) license number

\*1. Without ferrules

\*2. For details on mounting on a DIN track and screw attachment, refer to 2-2-2 *Installing the Main Unit* on page 2-3.



## Main Unit Characteristics

Model		K6PM-THMD-EIP
Temperature measurement range		The temperature measurement range is described in the temperature sensor (K6PM-THS3232) performance.
Measurement temperature accuracy		The measurement temperature accuracy is described in the temperature sensor (K6PM-THS3232) performance.
Sampling cycle for the sensor		Approx. 1 second per Unit
External trigger	External contact input specifications	Short circuit: Residual voltage 1.5 V max. Open: Leakage current 0.1 mA max.
	Short circuit current	Approx. 7 mA
Alarm	Measurement parameters	Current temperature, differential temperature, sensor internal temperature
	Expression method	Transistor output, alarm bar display
	Number of variables	Two threshold values per segment (Threshold 1 and Threshold 2)
	Threshold setting range	0.0 to 999.9°C (0.0 to 999.9°F)
	Hysteresis	3.0°C width (5.4°F width)
	Resetting method	Manual resetting <sup>*1</sup> or automatic resetting (switching)
LCD display		7-segment digital displays and individual indicators
Display resolution		0.1°C
Applicable standards	Approved standards	UL61010-1 (listing) installation location: Pollution degree 2, Korean Radio Waves Act
	Conforming standards	RCM
	EMC	EN61326-1 (EMI: Class A EMS: Industrial Location)
Recommended fuse		T2A, time lag, shut-off capacity
Insulation resistance		20 MΩ min. Between all external terminals and the case Between all power supply terminals and all other terminals Between all RS-485 communications terminals, and all external trigger input terminals, all transistor output terminals and all Ethernet ports
Dielectric strength		2,000 VAC for 1 minute Between all external terminals and the case Between all power supply terminals and all other terminals Between all RS-485 communications terminals, and all external trigger input terminals, all transistor output terminals and all Ethernet ports
Vibration resistance		Frequency: 10 to 55 Hz, 0.35-mm single amplitude in X, Y, and Z directions (10 sweeps of 5 min each)
Shock resistance		150 m/s <sup>2</sup> , 3 times each in X, Y, and Z axes, 6 directions
Degree of protection		IP20
Warranty period		1 year
Indicators	Alarm bar	Red, yellow, and green
	MS and NS	Red and green

\*1. Manual resetting method: Press and hold the **SEG/ALM RST** Button

Item	Model	K6PM-THMD-EIP	
Ethernet communications	Supported services		EtherNet/IP (tag data link or CIP message communications) BOOTP client Modbus TCP
	Physical layer		100Base-TX
	Transmission specifications	Transmission speed	100 Mbps
		Transmission medium	Twisted pair cable (with shield: STP): Category 5 or higher
		Transmission distance	100 m max. (distance between hub and node)
	Tag data link*1	Class1	Connection resource: 4 max.
		Packet interval (RPI)	1,000 to 10,000 ms
		Timeout value	Multiples of RPI (4 times, 8 times, 16 times, 32 times, 64 times, 128 times, 256 times, 512 times)
		Connection type	Point To Point Connection (fixed)
	Explicit message*1	Class 3	Number of clients that can communicate at one time: 2 max.
		UCMM	Number of clients that can communicate at one time: 2 max.
	Modbus message*1	Modbus TCP	Number of clients that can communicate at one time: 2 max.
	Factory default values	IP address	192.168.250.30
		Subnet mask	255.255.255.0
Default way		0.0.0.0	
IP address setting method		Static IP address	

\*1. When you use tag data link, explicit message communications, and Modbus message communications simultaneously, limit the number of client nodes to 4 or less. If simultaneous communication is carried out with 5 or more nodes, a timeout may occur due to the communications load.

### ● Indicator Specifications

Symbol	Name	Color	Status	Operating condition
MS	Module Status	Green	Lit	Normal status
			Flashes at 1-s intervals	BOOTP server connection error state
		Red	Lit	One of the following fatal errors (Main Unit internal error) • Internal CPU error • Internal memory error
			Flashes at 1-s intervals	One of the following conditions • K6PM-TH sensor communications error • The detection of the K6PM-TH sensor angle deviation • Sensor type error • Temperature measurement range exceeded • Running time error
---	Not lit	No power supply		

Symbol	Name	Color	Status	Operating condition
NS	Net-work Status	Green	Lit	Tag data link or message connection established
			Flashes at 1-s intervals	No tag data link or message connection established
		Red	Lit.	IP address duplication status
			Flashes at 1-s intervals	The connection has timed out
		---	Not lit	No power supply, or IP address not set

● **Transistor Output Specifications**

Name	Description	
Transistor Output 1	Threshold 1 excess output of comprehensive alarm.	If threshold 1 exceeded occurs for the comprehensive alarm, transistor output 1 remains OFF and transistor output 2 remains ON.
	Transistor output type can be set to Normally Closed or Normally Open.	
Transistor output 2	Threshold 2 excess output of comprehensive alarm.	If threshold 2 exceeded occurs for the comprehensive alarm, both transistor output 1 and transistor output 2 turn OFF. (Normally closed type)
	Transistor output type can be set to Normally Closed or Normally Open.	
Transistor output 3	Main Unit error and K6PM-TH sensor error output*1 <ul style="list-style-type: none"> <li>• Normal: ON</li> <li>• Main Unit error and K6PM-TH sensor error: OFF</li> </ul> The output type of transistor output 3 is fixed as Normally closed.	*2

\*1. The Main Unit error and K6PM-TH sensor error specify any one of the following:

- Main Unit internal error (internal CPU error or internal memory error)
- K6PM-TH sensor communications error or sensor type error
- The detection of the K6PM-TH sensor angle deviation
- Temperature measurement range exceeded
- Running time error

\*2. The operation of transistor output 3 is as described below.

Status of Main Unit	Status		Transistor output 3
	Status of infrared thermal sensor		
Operating			OFF
Main Unit internal error			
In monitoring mode	Before data acquisition		ON
	Normal		
	K6PM-TH sensor communications error or sensor type error		OFF
	The detection of the K6PM-TH sensor angle deviation		
	Temperature measurement range exceeded		
Running time error			
K6PM-TH sensor search mode or K6PM-TH sensor position adjustment mode	Before data acquisition		ON
	Normal		
	K6PM-TH sensor communications error or sensor type error		OFF
	The detection of the K6PM-TH sensor angle deviation		
	Temperature measurement range exceeded		
Running time error			

● Measured Value Display

Measurement level	Methods for checking		
	Main Unit (display)	Software tool	Communications
Temperature of each segment and sensor internal temperature	The segment display of each sensor can be switched on the Main Unit front-panel.	Can be checked on the Monitoring sensor screen.	<ul style="list-style-type: none"> <li>• EtherNet/IP tag data link communications</li> <li>• EtherNet/IP message communications</li> <li>• Modbus TCP communications</li> </ul>
Differential temperature per segment from the K6PM-TH sensor internal temperature	Not supported	Not supported	Not supported
Temperature of each infrared thermal sensor	Not supported	The past maximum value can be monitored on the <b>Monitoring K6PM</b> Screen.	Not supported
Temperature of each pixel	Not supported	The temperature can be displayed when the cursor is placed on the thermal image on the <b>Monitoring sensor</b> Screen.	<ul style="list-style-type: none"> <li>• EtherNet/IP message communications</li> <li>• Modbus TCP communications</li> </ul>
Alarms of each Main Unit (Alarms of all infrared thermal sensors connected to the Main Unit)	The occurrence of an alarm can be checked on the alarm bar.	The occurrence of an alarm can be checked on the <b>Device List of K6PM</b> Screen.	The occurrence of an alarm can be checked from the Main Unit status.

**A-1-2 Infrared Thermal Sensor**

**Infrared Thermal Sensor Ratings**

Item		Model	K6PM-THS3232
Power supply	Power supply voltage		24 VDC
	Allowable operating voltage range		85% to 110% of the power supply voltage
	Power supply frequency range		---
	Power consumption		0.4 W max./Unit at 24 VDC*1
Ambient operating temperature			-10 to +55°C (with no condensation or freezing)
Storage temperature			-20 to +65°C (with no condensation or freezing)
Ambient operating humidity			25% to 85% (with no condensation)
Storage humidity			25% to 85% (with no condensation)
Exterior color			Black
Case material			PC UL94-V0
Altitude			2,000 m max.
Applicable wires			Stranded wires or solid wires
Applicable wire size			0.25 to 1.5 mm <sup>2</sup> (AWG24 to AWG16)
Current capacity			8 A (per pole)
Weight			50 g max.
Mounting			Mounting*2 Screw Mounting
Dimensions			43 × 60 × 25.1 mm (W×H×D) Terminals not included

Item	Model
Accessories <sup>*3</sup>	K6PM-THS3232 Instruction manual, mounting bracket, magnet (for positioning) <sup>*4</sup>

- \*1. The power consumption increases according to the number of connected devices. Take note of the choice of wiring and the wiring diameter.
- \*2. A 1/4-20 UNC mounting hole is available (nuts are not provided).
- \*3. The pan head is sold separately.
- \*4. Use magnet mounting for positioning the sensor.

## Infrared Thermal Sensor Characteristics

Model		K6PM-THS3232
Temperature measurement	Temperature measurement range	Temperature measurement range: 0.0°C to 200.0°C (32.0°F to 392.0°F)
	Detection resolution	32 × 32 (1,024 pixels)
	Temperature accuracy	±5°C (at an ambient temperature of 25°C) <sup>*1*2</sup>
	Emissivity	0.94
	Reproducibility	±1°C (at an ambient temperature of 25°C) <sup>*3</sup>
	Temperature drift	0.15°C
	Warm up time	15 minutes
	Viewing angle [FOV]	90° × 90°
Other functions	Temperature measurement range exceeded	Outputs K6PM-TH sensor error in following condition Temperature: 200.0°C or higher Sensor internal temperature: 80°C or higher
	Angle deviation detection <sup>*4</sup>	Detection of only angle deviation <sup>*5</sup> Angle deviations of 5° (typ) min. and those that continue for 3 seconds min. can be detected.
Output	Communications method	RS-485 communications
	Maximum cable length	500 m
Applicable standards	Approved standards	UL61010-1 (listing) installation location: Pollution degree 2 Korean Radio Waves Act
	Conforming standards	RCM
	EMC	EN61326-1 (EMI: Class A EMS: Industrial Location), Measured temperature fluctuation range: ±6°C
Recommended fuse		T2A, time lag, shut-off capacity
Insulation resistance		20 MΩ min. Between all terminals and the case
Dielectric strength		1,000 VAC for 1 minute Between all terminals and the case
Vibration resistance		Frequency: 10 to 55 Hz, 0.35-mm single amplitude in X, Y, and Z directions (10 sweeps of 5 min each) <sup>*6</sup>
Shock resistance		150 m/s <sup>2</sup> , 3 times each in 6 directions along 3 axes <sup>*6</sup>
Degree of protection		IP20
Indicators	Power indicator	Green (when power is on: Lit, when power is not on: Not lit)
	Communications indicator	Orange (when communications are performed: Lit, when communications are not performed: Not lit)
	Alarm indicator	Red (when a sensor error occurs: Lit, when an angle deviation is detected: Flashing)

- \*1. Accuracy may vary depending on the measured distance, the object's emissivity, and ambient temperature.
- \*2. Accuracy for the central four segments when the measured object is 25°C to 80°C. If a high temperature object is measured with the outer 12 segments, the accuracy may decrease due to area effect.
- \*3. Performance of central four segments. ±2°C for the outer 12 segments.
- \*4. Make ON/OFF settings on the DIP switch Pin 2 (default value: OFF). For details, refer to *DIP Switch Settings* on page 1-17.
- \*5. Since the operation is not stable at a location subject to vibrations, it may not be possible to detect angle deviation.
- \*6. During screw mounting

### A-1-3 Software Tool

Item		Specification
Project	Number of files that can be created	No limit
Sampling cycle of infrared thermal sensor: 1 to 99		1 to 99 minutes, or 1 to 99 hours (default value: 1 minute)
Logging	Supported file format	Tab-delimited text file format
	Measurement interval	Sampling cycle
	Log file unit	A new file for every 1,440 rows (excluding the header) regardless of the sampling interval
1 Number that can be registered in the project	Number of Main Units	5 Units max.
Files to create		The following are created in the installation folder \cfg: <ul style="list-style-type: none"> <li>• Project file (INI file format)</li> <li>• Configuration file (INI file format)</li> </ul> The following is created in the installation folder \log: <ul style="list-style-type: none"> <li>• Log file (txt format)</li> </ul> Refer to <i>Details of the File to be Created</i> on page A-9 under for details.
Photo image file format that can be read and displayed		JPG/JPEG format
Temperature alarm threshold automatic setting		Supported

#### ● Details of the File to be Created

File type	Extension	Description	Save position by default
Project file	.ini	Text file including the following: <ul style="list-style-type: none"> <li>• Sampling cycle</li> <li>• Device name (of 5 Units max.)</li> <li>• IP address information of Main Unit (of 5 Units max.)</li> <li>• Sensor image display direction (of 31 Units max.)</li> <li>• Sensor color scale setting (of 31 Units max.)</li> <li>• Measurement location image file name (of 31 Units max.)</li> </ul>	C:\Program Files\OMRON\Thermal Condition Monitoring Tool\cfg
Configuration file	.ini	Text file including the following (file name = fixed as "app.ini"): <ul style="list-style-type: none"> <li>• Language</li> </ul>	C:\Program Files\OMRON\Thermal Condition Monitoring Tool\cfg
Log file	.txt	A file is created for each Main Unit. It is text file format, so it can be used by other applications. Refer to 4-2-3 <i>Automatic Saving Log Files</i> on page 4-19 for details.	C:\Program Files\OMRON\Thermal Condition Monitoring Tool\log\[Main Unit number (2 digits)]

## Folder and File Configuration of the Software Tool

The folder and file configuration of the software tool is shown below.

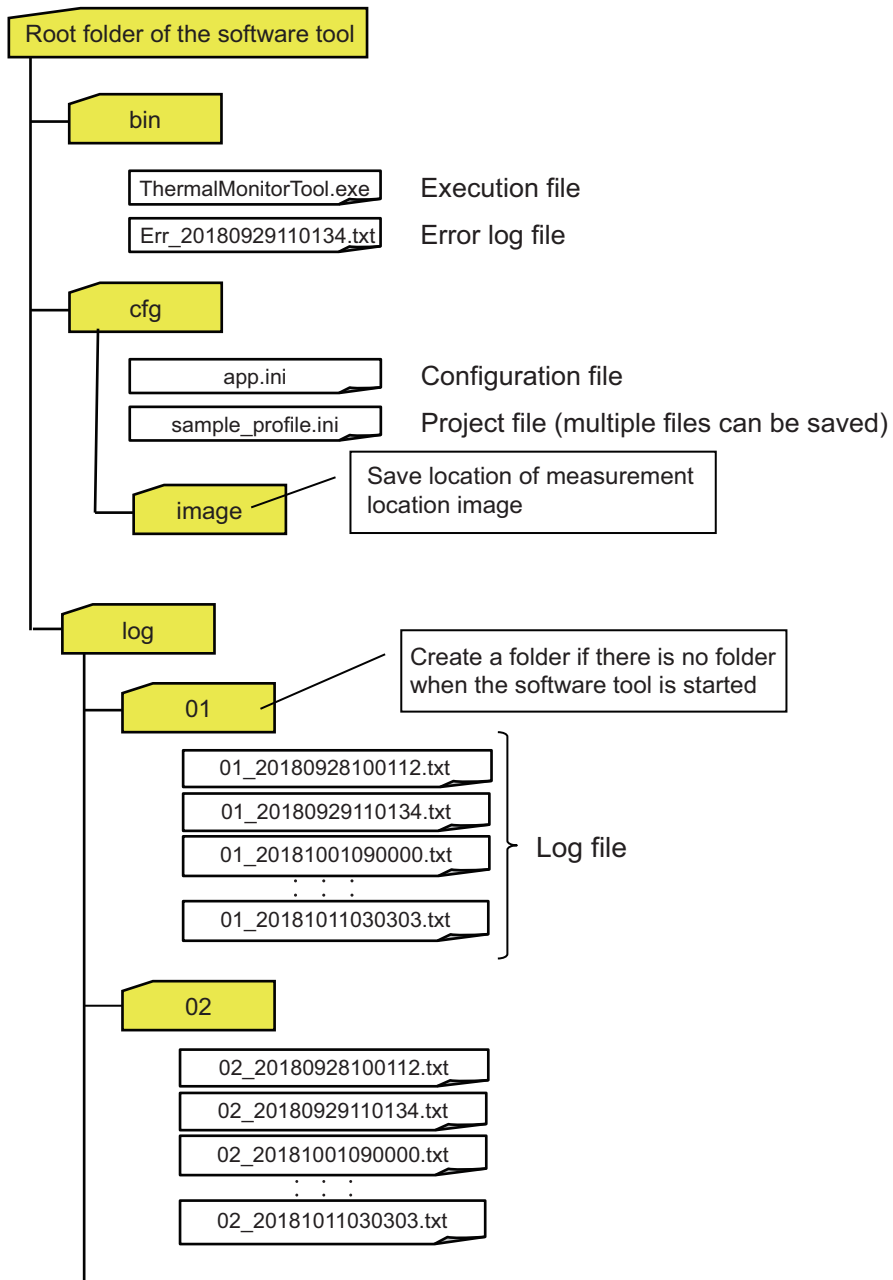



## Operating Environment of the Software Tool

Item	Description
OS	Windows 7, Windows 8.1, Windows 10 (32 bit / 64 bit) (JP / EN)
CPU	2.4 GHz min., 32 bit or 64 bit processor
Memory	4 GB min.
Disk reserved area capacity	64 GB min.
Monitor resolution	1024 × 768 (XGA), High Color 16 bit min.
.NET Framework	.NET Framework 4.7.2 <sup>*1</sup>
Others	LAN port: For network connection

\*1. The operation requires .NET Framework 4.7.2.

Download the software tool from the OMRON website as follows:

[https://www.ia.omron.com/k6pm\\_tool](https://www.ia.omron.com/k6pm_tool)

# A-2 Screen Flow of the Software Tool

The software tool undergoes the following screen transitions after it is started.

Execute

Select the project Dialog Box

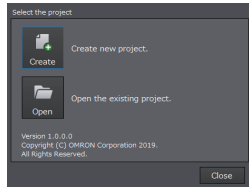

Create or Open Button

Device List of K6PM screen



System setting Dialog Box

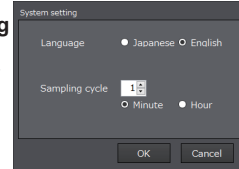

System setting Button

Setting Button

Monitoring Button

Device List Button

Device List Button

Setting K6PM Screen

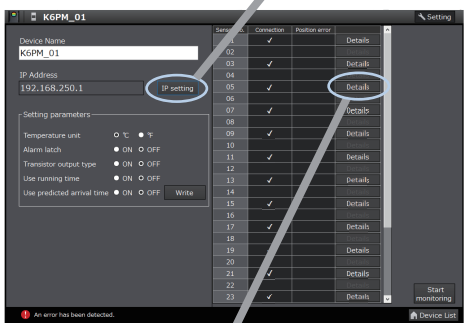

IP setting Button

IP Address Setting of the K6PM Devices

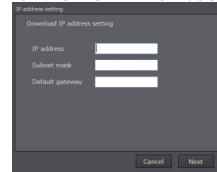

Next Button

Monitoring K6PM Screen

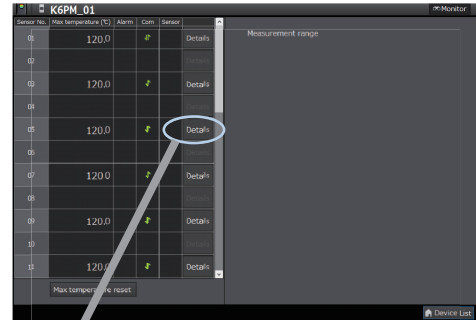

Back Button

Details Button of any one sensor number

Back Button

Setting sensor Screen

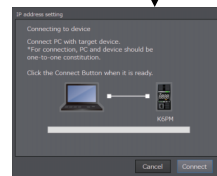
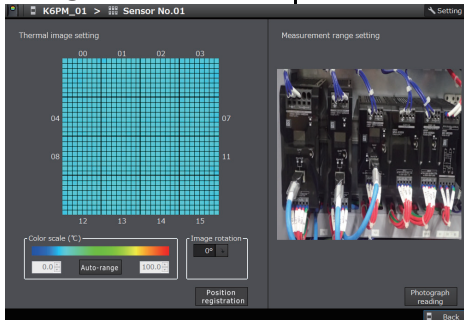

Execute Button



Completed Button

If necessary, select the sensor number, and then click the Details Button.

Monitoring sensor Screen

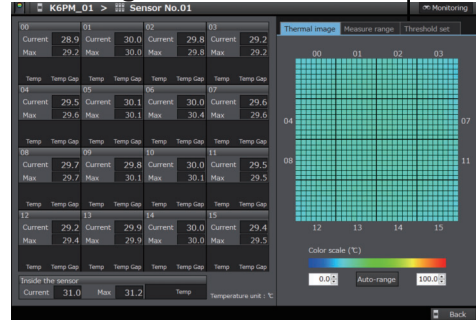

Check the thermal image

Adjust the sensor position, and then register the position with the Position registration Button.

# A-3 Tag Data Link Connection Setting Procedures

## A-3-1 Preface

The internal data (parameters) of the tag data link supported by the Main Unit is assigned to any one of the four tag sets. Therefore, it is necessary to select the tag set to use according to the purpose of the customer, and then set it. See below for the size and contents of the four tag sets.

### ● Size and Contents of Tag Sets

Identification number (Instance ID of Assembly object)	Size	Function
64 hex (Input_100)	128 bytes	<ul style="list-style-type: none"> <li>• K6PM-TH status</li> <li>• Running Time data</li> <li>• Status of sensors 1 to 31</li> <li>• Alarm status of sensors 1 to 31</li> </ul>
65 hex (Input_101)	380 bytes	<ul style="list-style-type: none"> <li>• Status of sensors 1 to 10</li> <li>• Alarm status of sensors 1 to 10</li> <li>• Internal temperature value of sensors 1 to 10</li> <li>• Segment current temperature value of sensors 1 to 10</li> </ul>
66 hex (Input_102)	380 bytes	<ul style="list-style-type: none"> <li>• Status of sensors 11 to 20</li> <li>• Alarm status of sensors 11 to 20</li> <li>• Internal temperature value of sensors 11 to 20</li> <li>• Segment current temperature value of sensors 11 to 20</li> </ul>
67 hex (Input_103)	418 bytes	<ul style="list-style-type: none"> <li>• Status of sensors 21 to 31</li> <li>• Alarm status of sensors 21 to 31</li> <li>• Internal temperature value of sensors 21 to 31</li> <li>• Segment current temperature value of sensors 21 to 31</li> </ul>

## A-3-2 Using the CS/CJ-series

You can set tag data link settings using the Network Configurator for EtherNet/IP.

When using the CS/CJ-series PLC as an originator, use the Network Configurator for EtherNet/IP supporting the model and version of the CPU Unit. Refer to the CS/CJ Series EtherNet/IP Units Operation Manual (Cat. No. W465) for the setting status of the setting tool.

The setting method when the CS/CJ-series PLC is an originator is as follows.

## 1 Starting the Network Configurator for EtherNet/IP

To start the Network Configurator, select **All Programs | OMRON | Sysmac Studio | Network Configurator for EtherNetIP | Network Configurator** from the Windows Start Menu.

The Main Window consists of a Hardware List and a Network Configuration Pane, as shown in the following diagram.

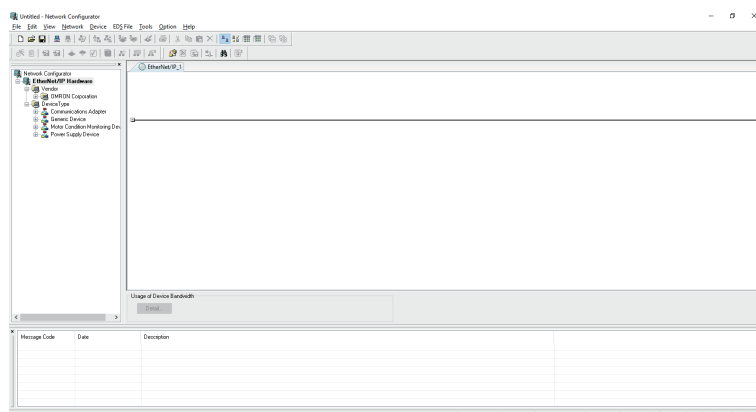

## 2 Installing EDS Files

To configure K6PM-TH as an EtherNet/IP tag data link communications target, install the EDS file containing the configuration information of the K6PM-TH in the Network Configurator. Once this installation is done, this operation is unnecessary from the next setting.

EDS files can also be downloaded from our website.

Register the CIP revision corresponding to the EIP version on the side label of the Main Unit.

EIP version	CIP revision	
	Major revision	Revision on the Hardware list
Ver.1.0	1	Rev1

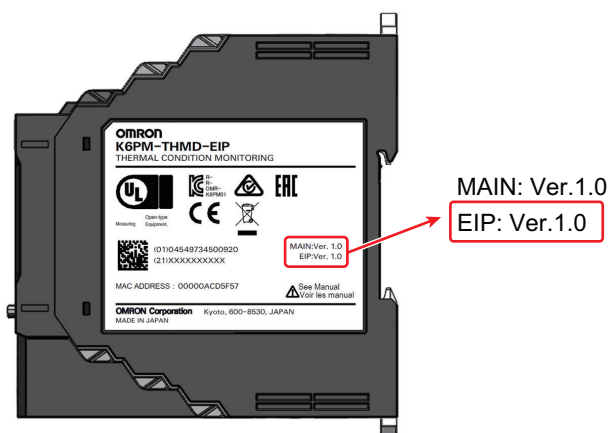

Select **EDS File (S) | Install (I) ...** on the menu bar.

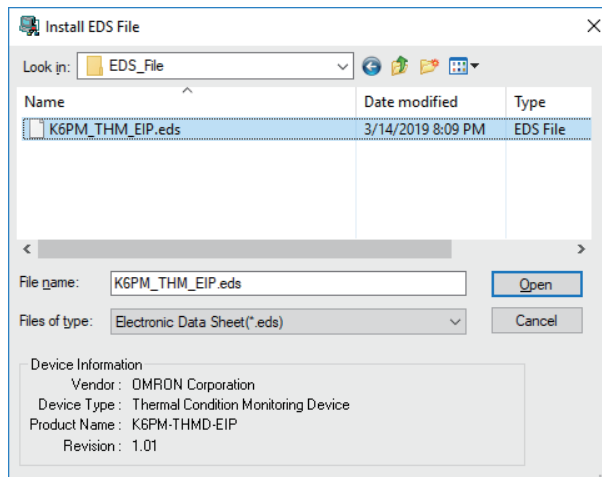

After selecting the following EDS file, click **Open** and install it.

Model name of the K6PM	EDS file name
K6PM-THM	K6PM_THM_EIP.eds

At this time, an icon confirmation message will be displayed. Click **Yes (Y)**.

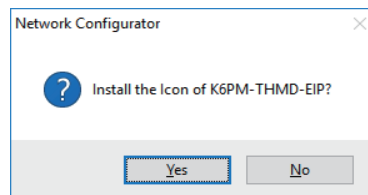

After selecting the following ICON file, click **Open** and install it.

Model name of the K6PM	ICON file name
K6PM-THM	K6PM.ico

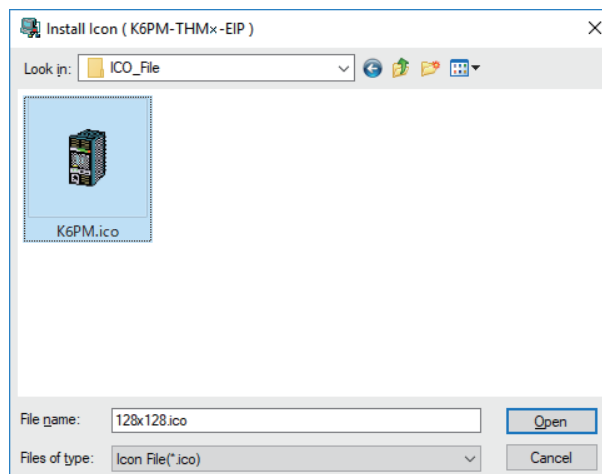

When the installation is completed, the device is added to the hardware list.

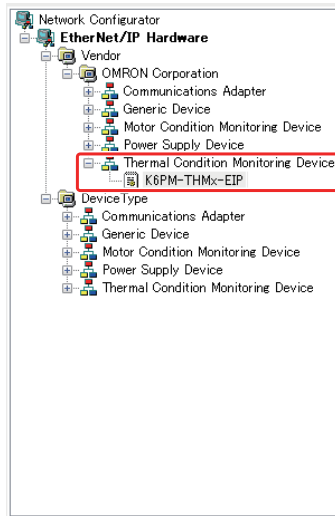

### 3 Registering devices

#### (1) Device registration to the network configuration

Register the EtherNet/IP devices which participate in the tag data links in the Network Configuration Window.

From the hardware list, you can register a PLC as an originator device and Main Units, by dragging and dropping each device at a time, or by selecting and double-clicking it.

As an example, register a CJ1W-EIP21 (Rev 3) in the "Communications Adapter" category as an originator device and register a K6PM-THM as a target device.

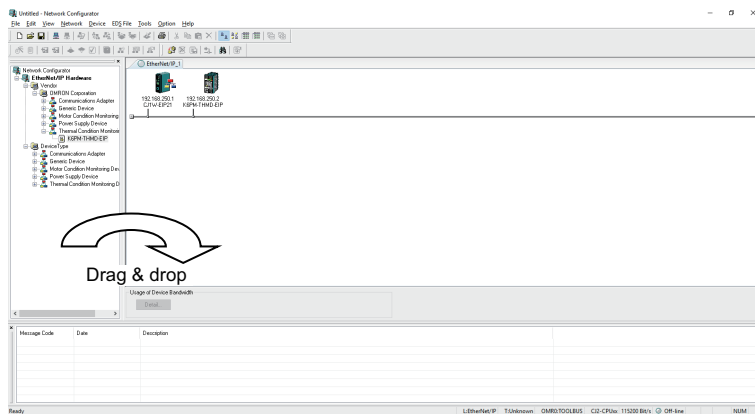

**Note** Select the same model as the device you use and register it.

The device names and major CIP revisions (Rev □) are displayed in the hardware list.  
The device name and the major CIP revision of the CS/CJ-series CPU Unit are as follows.

Device name in hardware list	Unit version	CIP revision	
		Major revision	Revision name in hardware list
CJ2B-EIP21	Unit version.2.0 and 2.1	2	Rev2
	Unit version.3.0	3	Rev3
CJ2M-EIP21	Unit version.2.0 and 2.1	2	Not available.
CJ1W-EIP21	Unit version.1.0	1	Rev1
	Unit version.2.0 and 2.1	2	Rev2
	Unit version.3.0	3	Rev3
CJ1W-EIP21	Unit version.1.0	1	Rev1
	Unit version.2.0 and 2.1	2	Rev2
	Unit version.3.0	3	Rev3
CJ1W-EIP21(CJ2)*1	Unit version.2.0 and 2.1	2	Rev2
	Unit version.3.0	3	Rev3

\*1. This shows the case where the CJ1W-EIP21 Unit is mounted on the CJ2 CPU Unit.

(2) Device Node Address (IP Address) Setting

Set the node address (IP address) of the device to be used.

In the Network Configuration Window, click the device you want to change the node address (IP address), right click and select **Change Node Address (A)**....

Enter the node address (IP address) of the device to be used actually, and click **OK**.

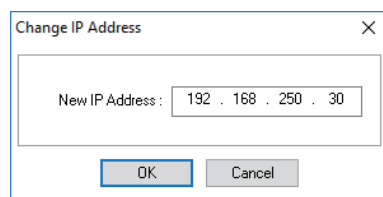

## 4 EtherNet/IP Connection Settings

The procedure of creating the tag sets and setting the connections is described below. The internal data (parameters) of the tag data link supported by the Main Unit is assigned to any one of the four tag sets. Therefore, it is necessary to select the tag set to use according to the purpose of the customer, and then set it.

(1) Create Tag sets and Tags

Create tag sets and those members tags necessary for connection for the registered EtherNet/IP Unit. For tags, you can set the I/O memory address or network symbols used by the control program (CJ2H-CPU6□-EIP21 and CJ2M-CPU3□ only).



### Additional Information

The setting contents depend on the originator device connecting the K6PM series.

For detailed settings, refer to the manual of the originator device.

- "SYSMAC CS/CJ Series EtherNet/IP Units Operation Manual (Cat. No. W465)"



**Additional Information**

Tag set names and tag names can also be created in advance using the CX-Programmer. When creating in advance, make them the same names as the tags to be created with the Network Configurator. You can also use them as symbol variables of PLC by sharing them with CX-Programmer by importing from or exporting to a file the tag set names and tag names of PLC edited with Network Configurator.

For detailed settings, refer to the manual of the originator.

- "SYSMAC CS/CJ Series EtherNet/IP Units Operation Manual (Cat. No. W465)"

(1) Tag Editing

Select the device (e.g., CJ1W-EIP21) for editing the tag set and the tag.

Then right-click it and select **Parameter (P) | Edit (E) ...** or double-click it.

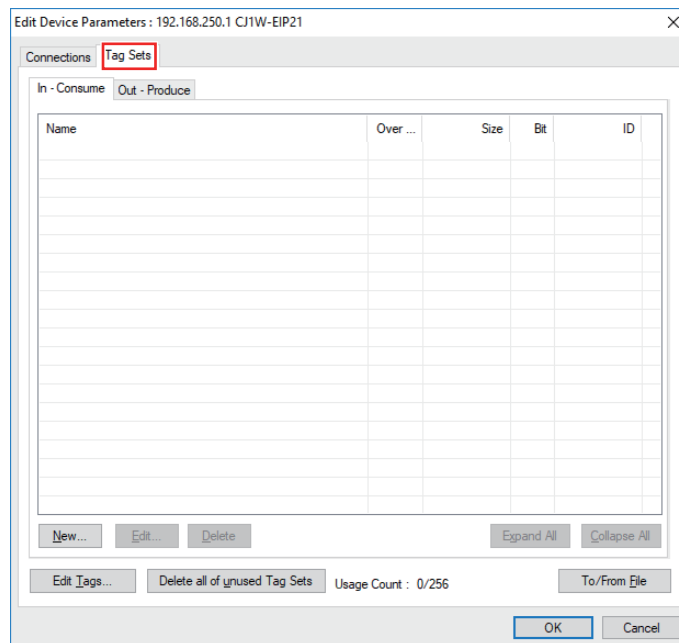

Click the **Tag Sets** Tab at in the Edit Device Parameters Dialog Box.

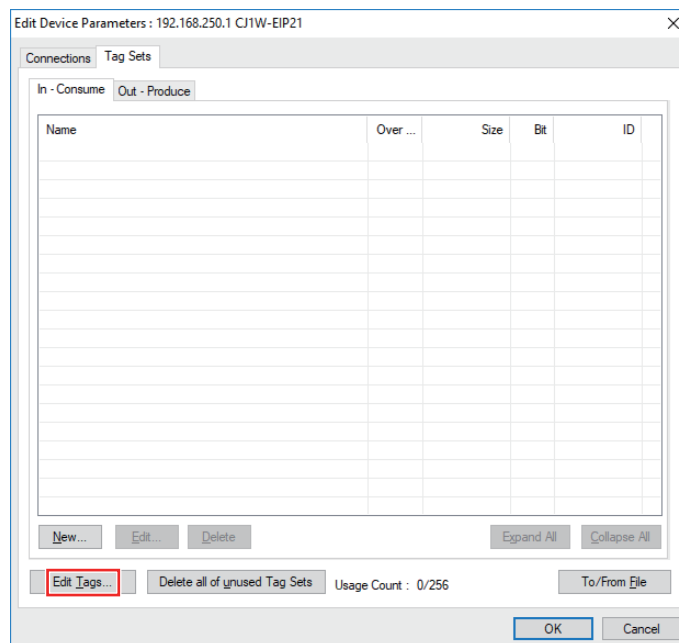





**Additional Information**

If you have created network symbols, tag set names and tag names in advance with the CX-Programmer and have the exported file (.CSV), click **To/From File** at the lower right, select **Import from File....** By doing so, you can omit the following "(1) -1 Tag editing" and "(1) -2 Editing tag set" below.

Click **Edit Tag (T) ...** in the Edit Device Parameters Dialog Box to edit tag sets.

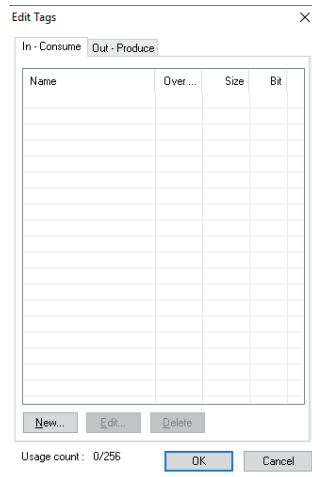

To enter tags, there are tabs for Input (Consume) and Output (Produce), but set only the Input (Consume) tab when connecting the K6PM series. Select the **In - Consume** Tab and click **New (N) ...**, the Edit Tags Dialog Box will be displayed.

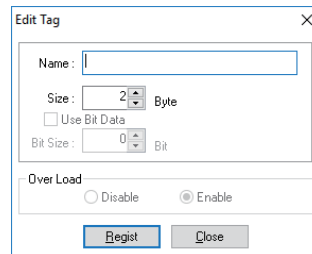

Enter the tag name and its size (128 bytes, 380 bytes or 418 bytes), and click **Register (R)**.

As a "tag name", enter the character string for the CPU Unit's I/O memory address or a network symbol (e.g., 100, W100, D0, Input\_Signal).

Addresses in the following I/O memory areas can be set.

CPU Unit's data area		Address (Text to input in Name Field)
CIO Area		0000 to 6143
Holding Area		H000 to H511
Work Area		W000 to W511
DM Area		D00000 to D32767
EM Area	Bank 0 hex	E0_00000 to E0_32767
	:	:
	Bank 18 hex	E18_00000 to E18_32767



**Additional Information**

Here, create a symbol that matches the name of the I/O memory address used in the PLC or the name of the network symbol (input).

Continue to edit tags. Click **Close (C)** to end tag editing.

As an example, register a tag with the following information:

Tag name: "D00000"

Size: 128 bytes

Register the tag according to the required number of connections.

The tags registered are displayed in the Edit Tag Dialog Box.

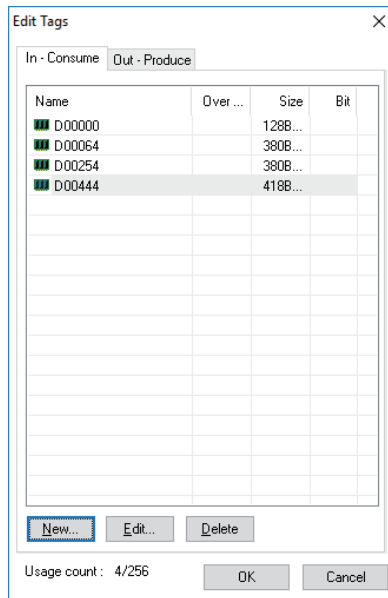

Click **OK** in the Edit Tag Dialog to register tags and complete tag editing.

At that time, if you have created a new tag, the following confirmation message will be displayed. To register the tag name as it is as the tag set name, click **Yes (Y)**. If you register the tag name as it is as the tag set name, one tag is registered as one tag set. Here, when selecting **Yes (Y)**, you can omit "(1) -2. Editing tag set" for the newly created tag.

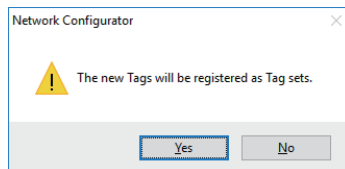

(1)-2 Editing tag set

To enter tags, there are tabs for Input (Consume) and Output (Produce), but set only the Input (Consume) tab when connecting the K6PM series.

For editing tag set, click **New (N) ...** in the following Edit Tag Set Dialog Box.

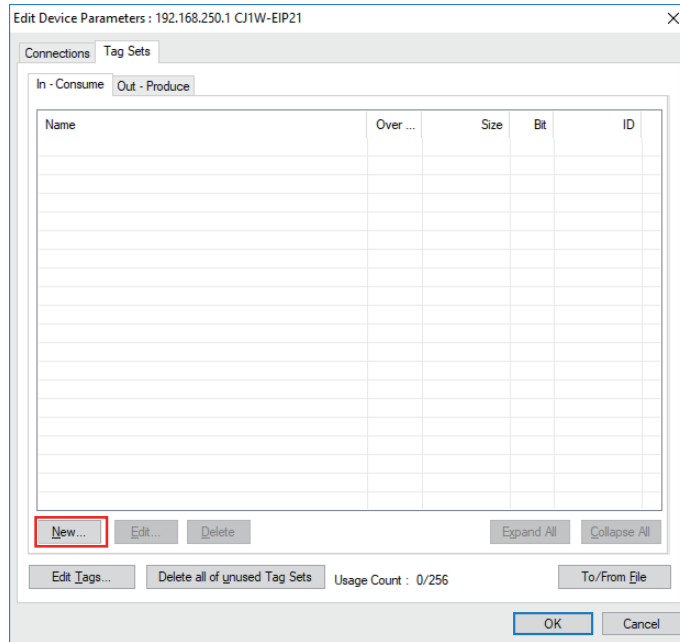

The Edit Tag Set Dialog Box is displayed.

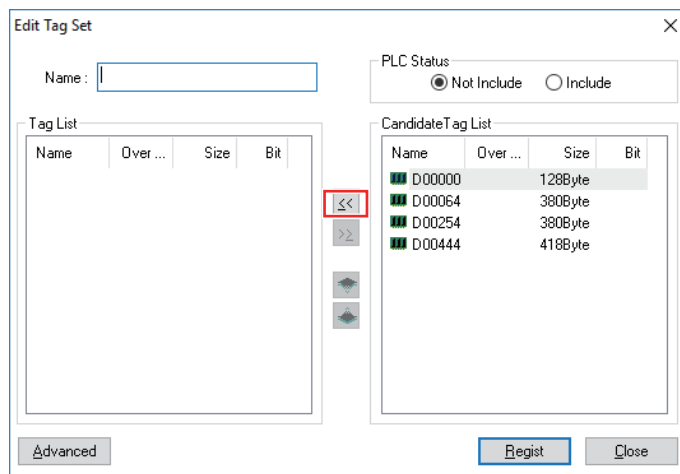

Enter the tag set name, select from the candidate tag list the tag to be a member, and add it by clicking the **<<** (**add tag**) Button at the center or by double-clicking it.

After adding a member, you can register tag set by clicking **Register (R)**.

In this example, we set "t\_K6PM\_Monitor\_Data1" to "t\_K6PM\_Monitor\_Data4" as the tag set name.

 **Additional Information**

If you add a tag without specifying a tag set name and click **Register (R)**, the tag name at the top of the tag list is automatically entered as the tag set name.

Continue to edit tag sets. Click **Close (C)** to end tag set editing and return to the Edit Tag Set Dialog Box.

The registered tag set is displayed.

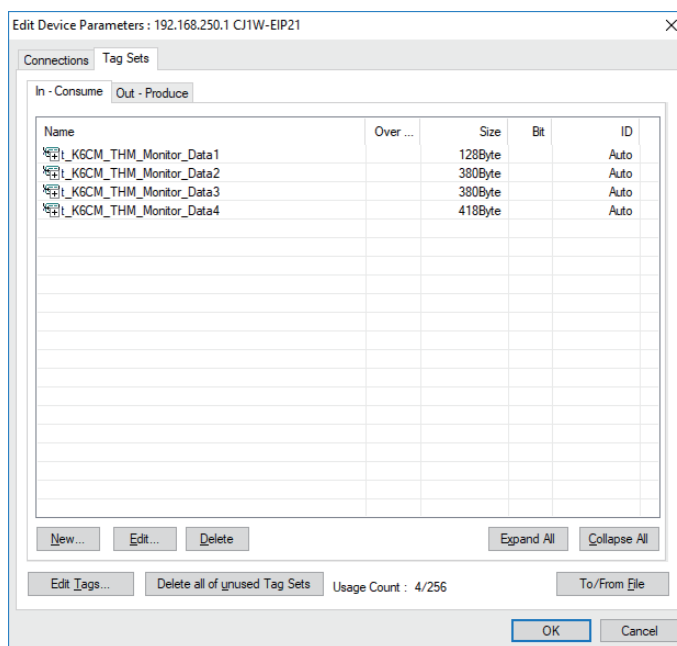

(2) EtherNet/IP Connection Settings

Set communications parameters for tag data link communications.

Select the **Connections** Tab in the Edit Device Parameters Dialog Box,

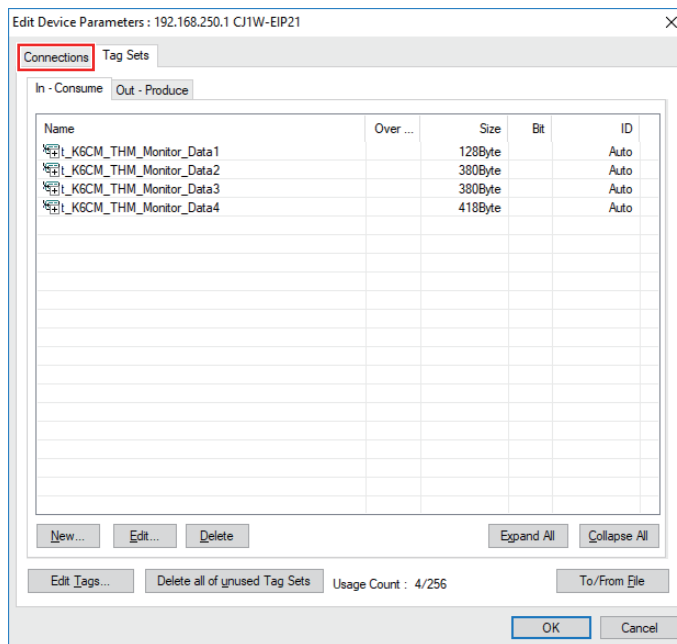

The Connection Edit is displayed in the Edit Device Parameters Dialog Box.

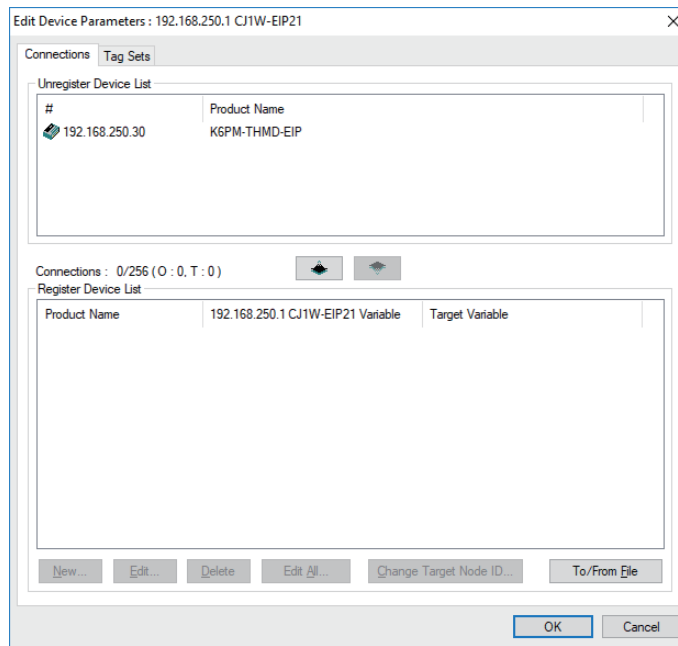

Select the K6PM series, and then click the middle  **(Add device)** Button to register the connection in the tag data link.

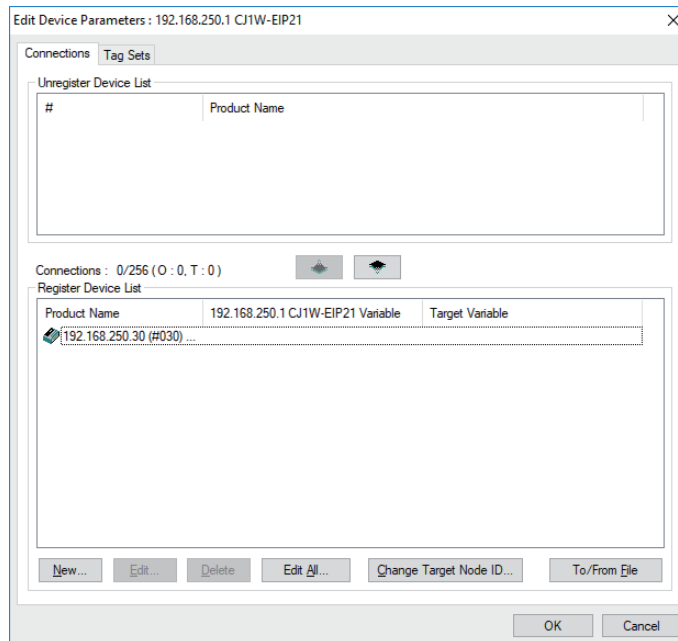

Select the K6PM series displayed in the registered device list, click **New (N) ...** or double-click the device, the Connection Allocation Dialog Box will be displayed.

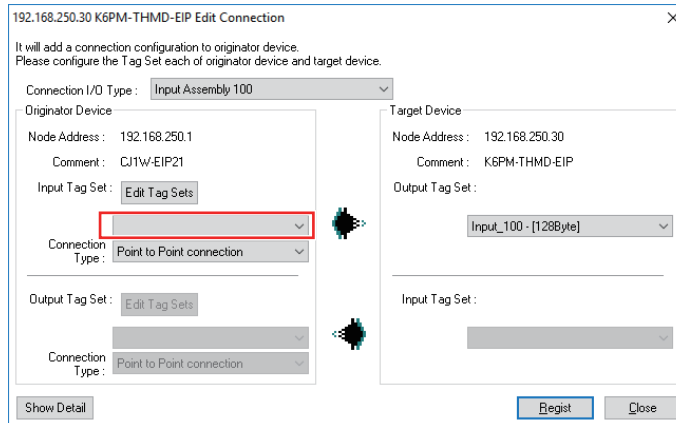

The default values of each parameter are displayed, and then set the following items.

- Connection I/O Type

Set the connection to register from the drop-down list. The output tag set is automatically selected according to the setting.

Connection I/O Type	Output tag set
Input Assembly 100	Input_100 - [128 bytes]
Input Assembly 101	Input_101 - [380 bytes]
Input Assembly 102	Input_102 - [380 bytes]
Input Assembly 103	Input_103 - [418 bytes]

- Input tag set

Select the tag set name edited in "(1) -2. Editing tag set" from the drop down list and set it.

- Packet Interval (RPI)

From the setting range of K6PM (1000 ms to 10000 ms), set the data send interval from K6PM according to the system.

- Timeout value

Select the timeout value at the occurrence of a communications error from the pull down list and set it. The value can be set by multiple of packet interval (RPI). (4 times, 8 times, 16 times, ..., 512 times)



### Additional Information

If detailed parameters (i.e., packet interval (RPI), timeout value) are not displayed, it can be displayed by clicking **Detail View**.

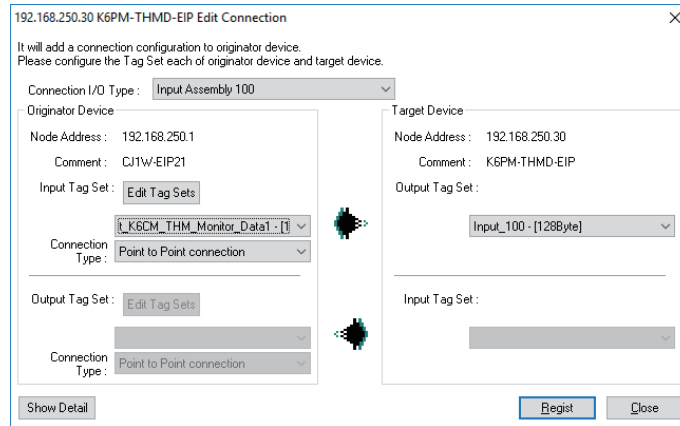

Click **Register** after connection allocations, then connection allocations are completed. Register the connections one by one. Click **Close** and return from the Connection Allocation Dialog Box.

When the setting is completed, it is displayed as follows.

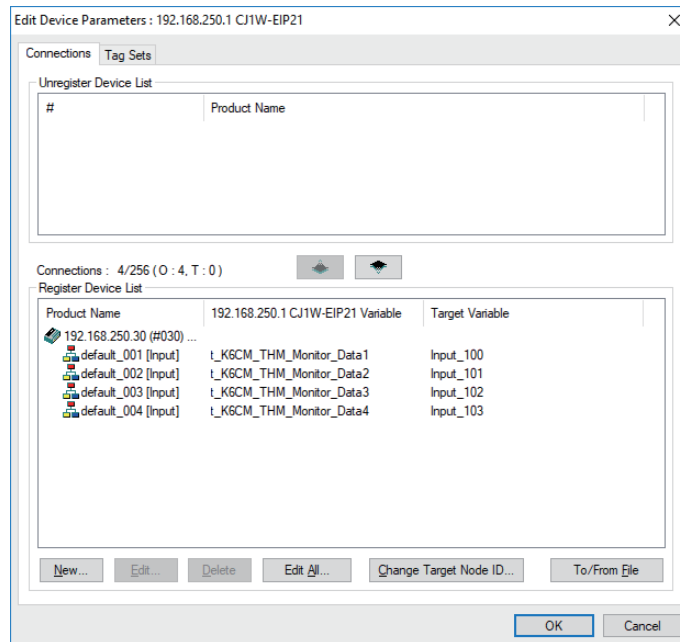

Setting is completed by clicking **OK** at the lower right.

## 5 Downloading settings

Connect online to the originator device and download the configuration settings.

(The EtherNet/IP tag data link communications setting of the K6PM series is fixed, so you do not need to download it to the K6PM.)

### (1) Online

Select the communications interface to use from **Option (O) | Select Interface (I)** on the menu bar. (This operation is unnecessary if interface is not changed after interface setting.)

Then, select **Network (N) | Connection (C) ...** on the menu bar or click  (Online button) to go online to the EtherNet/IP network.

After online, select the originator device (PLC) to download, right click it and select **Parameter (P) | Download (D)** and download it.



### Additional Information

For details on online and download operations, refer to the manual of the originator device.

For detailed settings, refer to the manual of the originator device.

- "SYSMAC CS/CJ Series EtherNet/IP Units Operation Manual (Cat. No. W465)"

## A-3-3 Using the NJ/NX-series

With the Sysmac Studio Ver.1.10 or higher, tag data link (EtherNet/IP connection) setting is possible when using NJ/NX-series PLC as a tag data link originator.

### ● Creating Network Variables (Input)

Create Input area in the PLC to receive Input data from K6PM devices.

The setting method for the NJ/NX-series PLC is shown below.

#### 1 Starting the SysmacStudio

Start the SysmacStudio in one of the following ways.

- Double-click the shortcut icon of **Sysmac Studio** on the desktop.



- To start the Sysmac Studio, select **All Programs | OMRON | Sysmac Studio | Sysmac Studio** from the Windows Start Menu.



## 2 Creating Project File

Click **New Project** in the upper left in the start page.

To edit an existing project file, click **Open Project** and select the saved project.



Enter the Project name, author, and comment in the **Project Properties Dialog Box**, select the device category, the device (PLC model) to use and its version, and then click the **Create** Button. (Only the project name is required.)

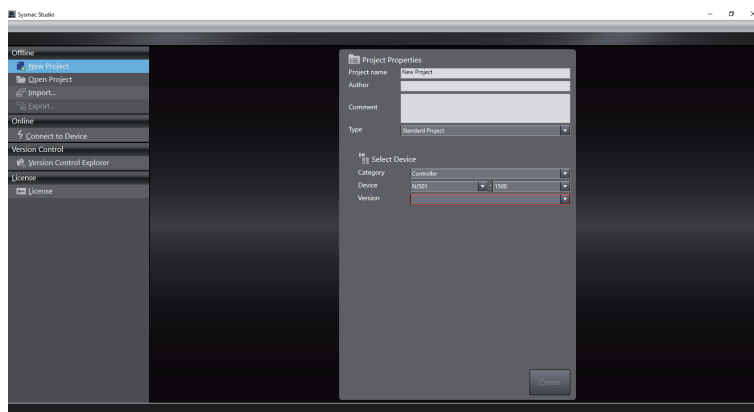

When you finish setting **Project Properties**, the following screen will be displayed.

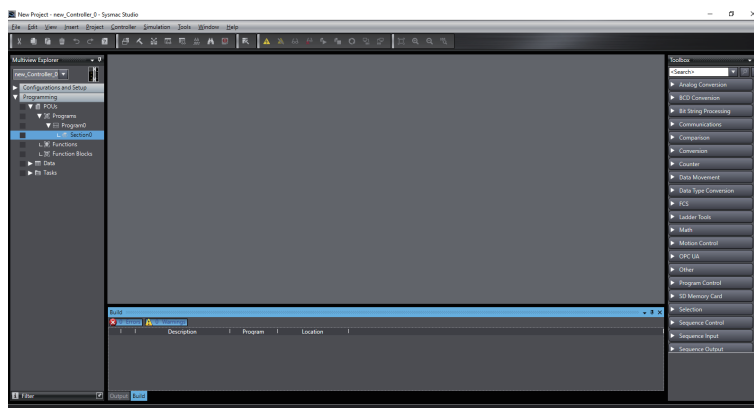

### 3 Creating Network Variables (Input)

Create network variables to be the input area in the PLC.

The Main Unit sends the required tag sets from among the four tag sets (128 bytes, 380 bytes, 380 bytes, and 418 bytes) as input data, therefore the network variable must be created as a structure variable or an array variable.

This section shows how to create structure variables. (For array variables, the following "(1) data type registration" are unnecessary.)

#### (1) Registering Data Type

Create a structure type as a basis by the following procedure to create a structure type network variable (128 bytes, 380 bytes, 380 bytes, or 418 bytes) for receiving the input data of the Main Unit.

##### (1)-1 Opening the Data Types Tab Page

Double-click **Data Type** under **Programming | Data** in the Multiview Explorer, or right-click **Data Type** and select **Edit** from the menu.

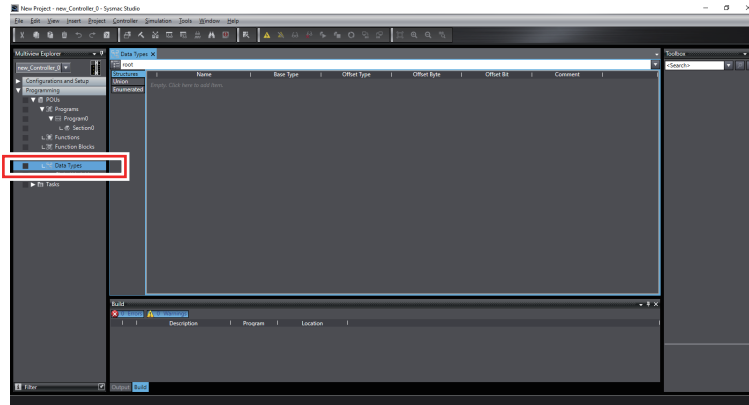

##### (1)-2 Registering structure Type

Click the **Structures** Side Tab in the Data Type Editor, and then the Structure Data Type Editor is displayed.

In the Data Type Editor, press the **Insert** Key or right-click and select **Create New Data Type (N)**, and enter a structure name. As an example, we set "t\_K6PM\_THM1" to "t\_K6PM\_THM4" here. An error is displayed because there is no structure member registration at this time.

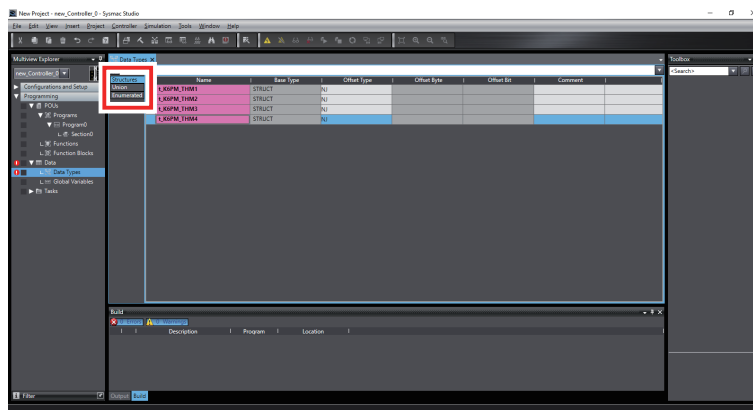

(1)-3 Adding structure Members

Right-click the structure data type you just created and select **Create New Member (M)** from the menu. Register members and data types to match data received from the Main Unit.

The registered Pane will be as follows. The data of tag data links includes 128 bytes, 380 bytes, 380 bytes, and 418 bytes. The member name can be changed as appropriate.

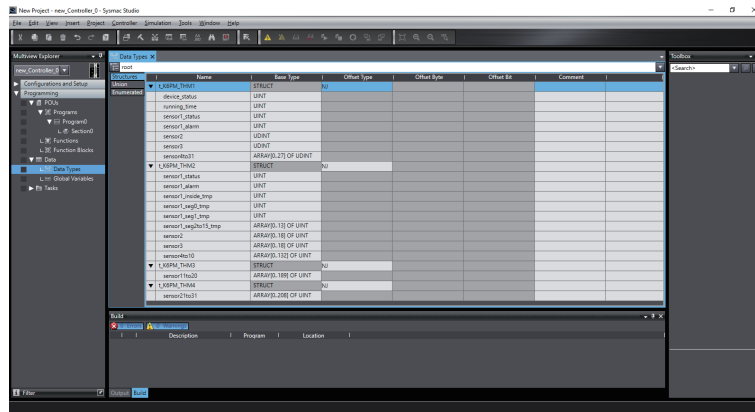

(2) Network Variables (Input) Definition

(2)-1 Opening the Global Variable Tab Page

Double-click **Global Variables** under **Programming | Data** in the Multiview Explorer, or right-click **Global Variables** and select **Edit** from the menu.

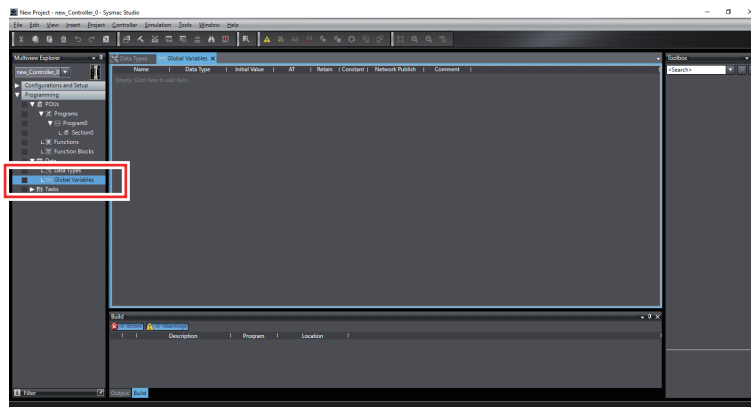

(2)-2 Registering Network Variables (Input)

In the global variable table, press the **Insert** Key or right-click and select **Create New (N)**, and enter a variable name. Next, change **Data Type** to the structure type name created in "(1) Registering Data Type", and change the **Network Publish** Attribute to **Input** from the pull down list. In this example, the name of the network variable (input) is set to "K6PM\_THM\_Monitor\_Data1" to "K6PM\_THM\_Monitor\_Data4" and the data type is set to "t\_K6PM\_THM1" to "t\_K6PM\_THM4" created in "(1) Registering Data Type".

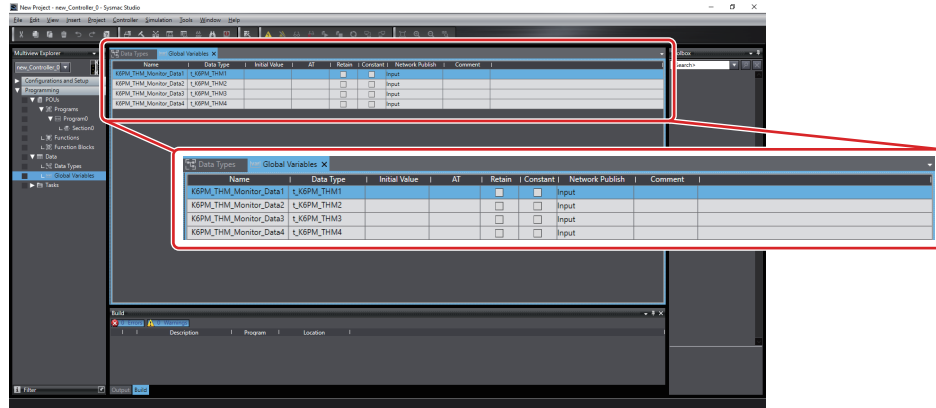

Associate the network variables created here with the tags used in the EtherNet/IP connection settings described below.



**Additional Information**

To process the input data as an array variable instead of a structure variable, create a network variable having the required tag set from among 128 bytes, 380 bytes, 380 bytes, and 418 bytes with an array of UINT as **Data Type** in the following example.

Name	Data Type	Initial Value	AT	Retain	Constant	Network Publish	Comment
K6PM_THM_Monitor_Data1	ARRAY(0..127) OF UINT			<input type="checkbox"/>	<input type="checkbox"/>	Input	
K6PM_THM_Monitor_Data2	ARRAY(0..379) OF UINT			<input type="checkbox"/>	<input type="checkbox"/>	Input	
K6PM_THM_Monitor_Data3	ARRAY(0..379) OF UINT			<input type="checkbox"/>	<input type="checkbox"/>	Input	
K6PM_THM_Monitor_Data4	ARRAY(0..379) OF UINT			<input type="checkbox"/>	<input type="checkbox"/>	Input	

## 4 EtherNet/IP Connection Settings

After creating the network variables (input), perform setting the EtherNet/IP connection for EtherNet/IP tag data link communications.

### (1) Opening the EtherNet/IP Device List Tab Page

Select **Tool (T) | EtherNet/IP Connection Settings (N)** on the menu bar.

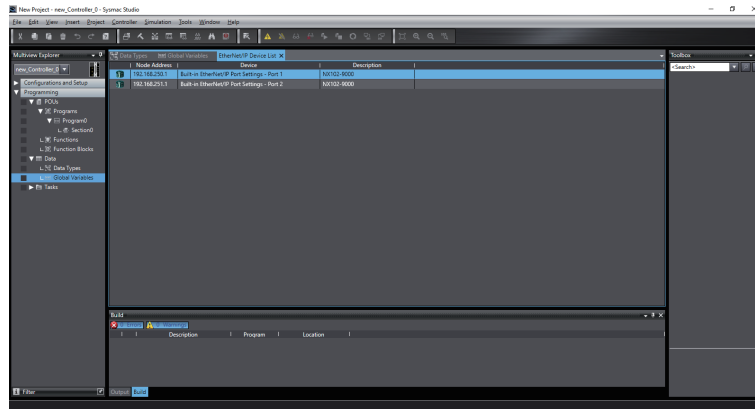

### (2) Opening the EtherNet/IP Connection Settings (Tag Set Display)

Select the EtherNet/IP originator device and double-click it, or right-click the originator device and select **Edit (E)**. (If you use the built-in EtherNet/IP port, only the built-in EtherNet/IP port is displayed as an originator device. In that case select it, highlight it and then operate it.)

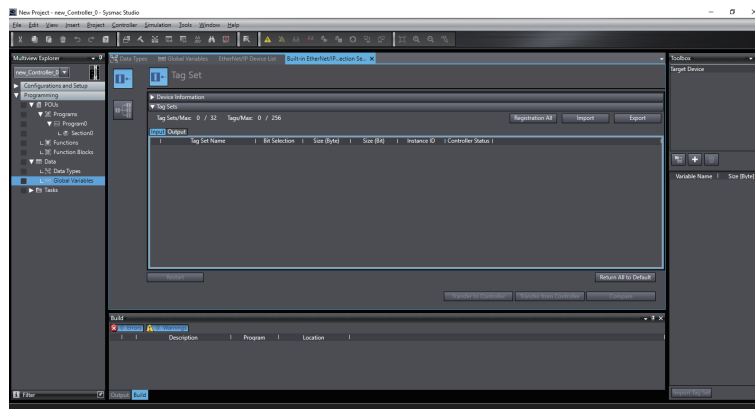

### (3) Registering the K6PM Devices to the Network

Make the following settings so that the K6PM device operates as a target.

#### (3)-1 Installing EDS Files

To configure K6PM as an EtherNet/IP tag data link communications target, install the EDS file containing the configuration information of the K6PM in the SysmacStudio. Once this installation is done, this operation is unnecessary from the next setting.

This operation is unnecessary because it is preinstalled if you use the SysmacStudio Ver.1.21 or higher.

You can download the EDS file from our website.

Register the CIP revision that corresponds to the EIP version indicated on the side label of the Main Unit.

To check the CIP revision, refer to the label on the side of the Main Unit (page A-14).

Right-click anywhere in the **Target Device** List in the Toolbox on the right of the EtherNet/IP Connection Setting Tab Page and select **Display EDS Library** from the menu.

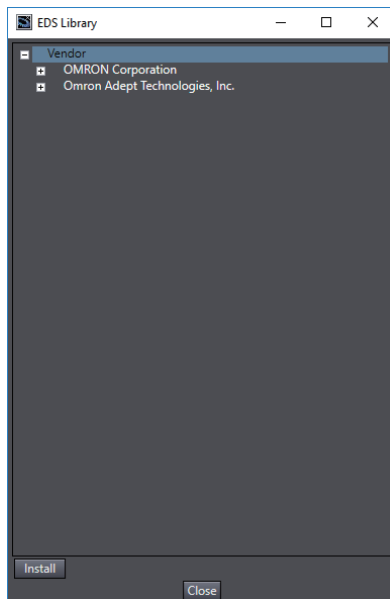

Click the **Install** Button at the bottom left, select the following EDS file, click **Open** and install it.

Model name of the K6PM	EDS file name
K6PM-THM	K6PM_THMD_EIP.eds

When installation is completed, the category “Motor Condition Monitoring Device” and the registered K6PM devices are displayed under the tree of the OMRON Corporation in the EDS Library Dialog Box.

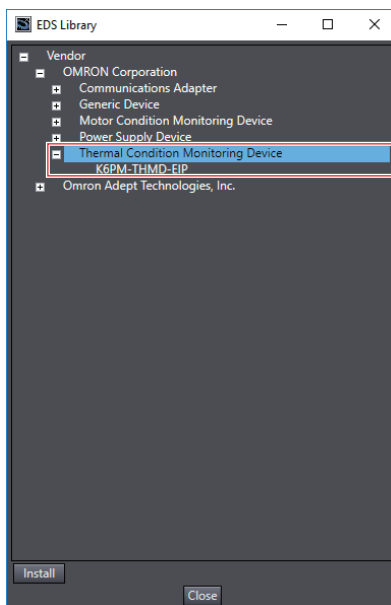

(3)-2 Adding K6PM Devices to the Network

Click the **+** (Add Target Device) Button in the **Toolbox** on the right of the EtherNet/IP Connection Setting Tab Page.

As shown in the following example, enter the node address (IP address), and from the pull-down list, select the model and revision.

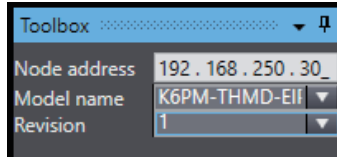

Click the **Add** Button at the bottom of the toolbox. The K6PM device will be added as a target device.

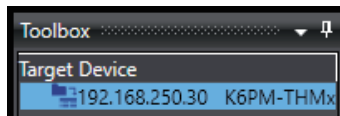

(4) Editing tag set

Map the K6PM Input data to the memory area of the PLC using the EtherNet/IP tag data link by associating the network variable (input) of the PLC with the tag used in the network. As a method of editing the tag set, there is a method of registering all tag sets, and a method of individual registering by right-clicking and selecting Create New Tag Set. Here, the method of registering is described.

(4)-1 Open Tag Set Registration Setting Dialog Box

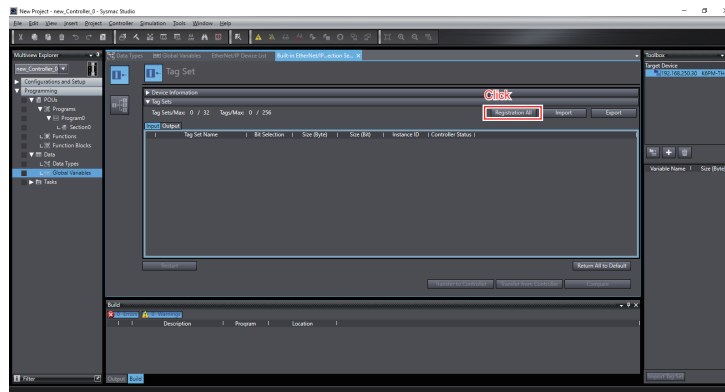

Click the **Registration All** Button in the Tag Set Pane, a list of network-published global variables will be displayed. In this example, only "K6PM\_THM\_Monitor\_Data1" to "K6PM\_THM\_Monitor\_Data4" which was registered as a network variable (input) is displayed.

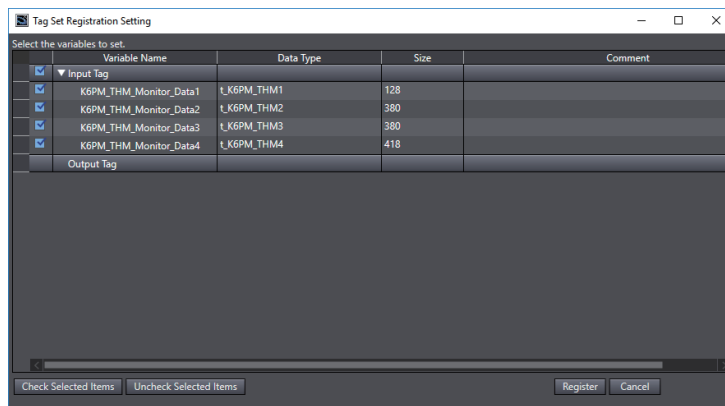

(4)-2 Registering All Tag Sets

Check the check box of the network variable to be used as the input tag among the network-published variables and click the **Register** Button, and then the specified tag is displayed in the tag set Pane.

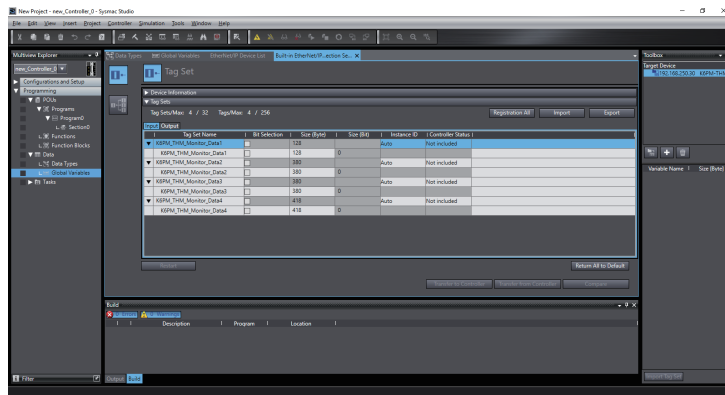

If you perform the registering all tag set, the tag set and the tag are displayed as the same name.

The tag set names displayed can be used as connection settings. (Use these tag set names, when configuring EtherNet/IP connections using the Network Configurator.)

You can change the tag set names as required.

Also, the tag name displayed under the tag set name must match the variable name registered as a network variable (input).



**Additional Information**

If you create connection settings using the Network Configurator, you can share the tag set names and tag names of the PLC you edit here with the Network Configurator.

(5) Opening the EtherNet/IP Connection Settings (Connection Display)

Click the Connection Button  at the upper left of the EtherNet/IP Connection Settings (Tag Set Display) to display the Connection.

(6) Target Devices Registration to the Connection Settings of the Originator

Register the K6PM devices to the connection settings of the originator device (PLC).

Right click and select **Create New (A)** or click the **+** (New) Button in the EtherNet/IP Connection Setting Tab Page, then select the K6PM from the pull-down list as the target device. (This operation can also be performed by double clicking the K6PM in the **Target Device** Pane of the Toolbox.)

Target Device	Connection No	Connection I/O Type	Input/Output	Target Variable	Size [Byte]	Originator Variable	Size [Byte]	Connection Type	RPI [ms]	Timeout
192.168.250.30 K6PM-THM	default_001	Input Assembly	100	Input				Point to Point	50.0	RPI x 4

The **Connection I/O Type** is set individually for each connection.

Connection I/O Type	Target Variable
Input Assembly 100	100
Input Assembly 101	101
Input Assembly 102	102
Input Assembly 103	103

Next, when setting a target variable, if you press **Ctrl + space** Key at the same time, the selectable ID number is displayed, so select the ID number to use.



For originator variables, select the tag set created in "(4) Editing tag set" from the pull down list and set it.

In **RPI (ms)**, from the setting range of the K6PM device (1000 ms to 10,000 ms), set the data send interval from the K6PM device according to the system. Select the **Timeout value** from the pull-down list and set it.

The timeout time when a communications error occurs can be calculated as follows.

Timeout time = RPI (ms) × multiple of RPI set by timeout value (4 times, 8 times, 16 times, ..., 512 times)

Target Device	Connection No	Connection I/O Type	Input/Out	Target Variable	Size [Byte]	Originator Variable	Size [Byte]	Connection Type	RPI [ms]	Timeout Value
192.168.250.30 K6PM-THMD-EIP Rev 1	default_001	Input Assembly 100	Input	100	128	K6PM_THM_Monitd	128	Point to Point	1000	RPI x 4
192.168.250.30 K6PM-THMD-EIP Rev 1	default_002	Input Assembly 101	Input	101	380	K6PM_THM_Monitd	380	Point to Point	1000	RPI x 4
192.168.250.30 K6PM-THMD-EIP Rev 1	default_003	Input Assembly 102	Input	102	380	K6PM_THM_Monitd	380	Point to Point	1000	RPI x 4
192.168.250.30 K6PM-THMD-EIP Rev 1	default_004	Input Assembly 103	Input	103	418	K6PM_THM_Monitd	418	Point to Point	1000	RPI x 4

This completes the tag data link setting. Go online to the originator device (PLC) and download the EtherNet/IP tag data link settings to the PLC by clicking **Transfer to Controller** Button. (The EtherNet/IP tag data communications setting of the K6PM series is fixed, so you do not need to download it to the K6PM device.)

# A-4 Expansion Error Code of the CIP Message Communications

This section describes the expansion error code when an explicit error occurs in the CIP message communications command.

The format of the expansion error code is as follows.

Data type: DWORD

Value: 16#XXYYZZZZ

(XX: General Status, YY: Additional Status size (unit: WORD), ZZZZ: Additional Status)

However, ZZZZ of Additional Status is enabled only when XX of General Status is 01 (hex).

In other cases, size YY is 00 and ZZZZ of Additional Status does not exist.

## A-4-1 General Status

General Status (hex)	Status Name	Description of Status
00	Success	Service was successfully performed by the object specified.
01	Connection failure	A connection related service failed along the connection path.
02	Resource unavailable	Resources needed for the object to perform the requested service were unavailable.
03	Invalid parameter value	See Status Code 20 hex, which is the preferred value to use for this condition.
04	Path segment error	The path segment identifier or the segment syntax was not understood by the processing node. Path processing shall stop when a path segment error is encountered.
05	Path destination unknown	The path is referencing an object class, instance or structure element that is not known or is not contained in the processing node. Path processing shall stop when a path destination unknown error is encountered.
06	Partial transfer	Only part of the expected data was transferred.
07	Connection lost	The messaging connection was lost.
08	Service not supported	The requested service was not supported or was not defined for this object class/instance. The requested service was not supported or was not defined for this object class/instance.
09	Invalid attribute value	Invalid attribute data detected.
0A	Attribute list error	An attribute in the Get_Attribute_List or Set_Attribute_List response has a non-zero status.
0B	Already in requested mode/state	The object is already in the mode/state being requested by the service.
0C	Object state conflict	The object cannot perform the requested service in its current mode/state.
0D	Object already exists	The requested instance of object to be created already exists.
0E	Attribute not settable	A request to modify a non-modifiable attribute was received.
0F	Privilege violation	A permission/privilege check failed.
10	Device state conflict	The device's current mode/state prohibits the execution of the requested service.
11	Reply data too large	The data to be transmitted in the response buffer is larger than the allocated response buffer.

General Status (hex)	Status Name	Description of Status
12	Fragmentation of a primitive value	The service specified an operation that is going to fragment a primitive data value, i.e. half a REAL data type.
13	Not enough data	The service did not supply enough data to perform the specified operation.
14	Attribute not supported	The attribute specified in the request is not supported.
15	Too much data	The service supplied more data than was expected.
16	Object does not exist	The object specified does not exist in the device.
17	Service fragmentation sequence not in progress	The fragmentation sequence for this service is not currently active for this data.
18	No stored attribute data	The attribute data of this object was not saved prior to the requested service.
19	Store operation failure	The attribute data of this object was not saved due to a failure during the attempt.
1A	Routing failure (request packet too large)	The service request packet was too large for transmission on a network in the path to the destination. The routing device was forced to abort the service.
1B	Routing failure (response packet too large)	The service response packet was too large for transmission on a network in the path from the destination. The routing device was forced to abort the service.
1C	Missing attribute list entry data	The service did not supply an attribute in a list of attributes that was needed by the service to perform the requested behavior.
1D	Invalid attribute value list	The service is returning the list of attributes supplied with status information for those attributes that were invalid.
1E	Embedded service error	An embedded service resulted in an error.
20	Invalid parameter	A parameter associated with the request was invalid. This code is used when a parameter does not meet the requirements of this specification and/or the requirements defined in an Application Object Specification.
21	Write-once value or medium already written	An attempt was made to write to a write-once medium (e.g. WORM drive, PROM) that has already been written, or to modify a value that cannot be changed once established.
22	Invalid Reply Received	An invalid reply is received (For example, the reply service code does not match the request service code, or the reply message is shorter than the minimum expected reply size.) This status code can serve for other causes of invalid replies.
23-24		Reserved by CIP for future extensions.
25	Key Failure in path	The Key Segment that was included as the first segment in the path does not match the destination module. The object specific status shall indicate which part of the key check failed.
26	Path Size Invalid	The size of the path which was sent with the Service Request is either not large enough to allow the Request to be routed to an object or too much routing data was included.
27	Unexpected attribute in list	An attempt was made to set an attribute that is not able to be set at this time.
28	Invalid Member ID	The Member ID specified in the request does not exist in the specified Class/Instance/Attribute.
29	Member not settable	A request to modify a non-modifiable member was received.
2B-CF		Reserved by CIP for future extensions.
D0-FF	Reserved for Object Class and service errors	This range of error codes is to be used to indicate Object Class specific errors. Use of this range should only be performed when none of the Error Codes presented in this table accurately reflect the error that was encountered. The additional code field is used to describe the general error code in more detail.

## A-4-2 Additional Status When General Status Is 01 hex

General Status (hex)	Additional Status (hex)	Explanation
01	0100	Connection in Use or Duplicate Forward Open.
01	0103	Transport Class and Trigger combination not supported.
01	0106	Ownership Conflict.
01	0107	Connection not found at target application.
01	0108	Invalid Connection Type. Indicates a problem with either the Connection Type or Priority of the Connection.
01	0109	Invalid Connection Size.
01	0110	Device not configured.
01	0111	RPI not supported. May also indicate problem with connection time-out multiplier, or production inhibit time.
01	0113	Connection Manager cannot support any more connections.
01	0114	Either the Vendor Id or the Product Code in the key segment did not match the device.
01	0115	Product Type in the key segment did not match the device.
01	0116	Major or Minor Revision information in the key segment did not match the device.
01	0117	Invalid Connection Point.
01	0118	Invalid Configuration Format.
01	0119	Connection request fails since there is no controlling connection currently open.
01	011A	Target Application cannot support any more connections.
01	011B	RPI is smaller than the Production Inhibit Time.
01	0203	Connection cannot be closed since the connection has timed out.
01	0204	Unconnected_Send timed out waiting for a response.
01	0205	Parameter Error in Unconnected_Send Service.
01	0206	Message too large for Unconnected message service.
01	0207	Unconnected acknowledge without reply.
01	0301	No buffer memory available.
01	0302	Network Bandwidth not available for data.
01	0303	No Tag filters available.
01	0304	Not Configured to send real-time data.
01	0311	Port specified in Port Segment Not Available.
01	0312	Link Address specified in Port Segment Not Available.
01	0315	Invalid Segment Type or Segment Value in Path.
01	0316	Path and Connection not equal in close.
01	0317	Either the segment is not present or the encoded value in the network segment is invalid. Either the segment is not present or the encoded value in the network segment is invalid.
01	0318	Link Address to Self Invalid.
01	0319	Resources on Secondary Unavailable.
01	031A	Connection already established.
01	031B	Direct connection already established.
01	031C	Miscellaneous.
01	031D	Redundant connection mismatch.
01	031E	There are no more available reception resources in the sending module.
01	031F	No connection resources exist for target path.
01	0320- 07FF	unused.



# Index



# Index

<b>A</b>	
Add device .....	A-33
adj .....	1-10
AGE .....	1-10, 4-4
Alarm bar .....	1-9
Alarm latch .....	3-18, 4-16
Alarm threshold setting .....	4-23
ALM .....	1-10, 4-4
<b>C</b>	
CH .....	1-11
CH Key .....	1-10
CIP message communications .....	5-10, A-36
Comprehensive alarm .....	4-14
<b>E</b>	
ERR .....	1-10, 4-4
EtherNet/IP .....	7-7
EtherNet/IP Communications .....	5-1
External trigger input .....	2-15, 4-16
<b>I</b>	
I/O Wiring .....	2-17
Individual alarm .....	4-14
individual alarm .....	4-14
Infrared thermal sensor .....	1-16
Installation .....	2-5
Installing .....	2-3
IP Address .....	3-7
IP Address Setting .....	3-7
<b>K</b>	
K6PM settings .....	1-2
K6PM-TH sensor angle deviation .....	4-3, 4-13
K6PM-TH sensor position adjustment mode .....	1-12
K6PM-TH sensor search mode .....	1-12
K6PM-THM .....	1-6, A-2
K6PM-THS .....	1-6, A-6
<b>L</b>	
Log file .....	A-9
<b>M</b>	
Measurement value .....	1-5, A-6
Modbus TCP .....	6-1
MON .....	4-4
Monitoring mode .....	1-13
Monitoring using software tools .....	4-5
Monitoring with the Main Unit .....	4-3
Mounting .....	2-4
MS .....	4-4, A-4
<b>N</b>	
normal .....	4-3, 4-5
NS .....	A-5
<b>P</b>	
Part names and functions .....	1-9
Project file .....	A-9
Push-In plus terminal blocks .....	2-10
<b>R</b>	
Recommended ethernet switches .....	2-18
<b>S</b>	
Sampling cycle .....	4-7
Sampling cycle for the sensor .....	A-3
sampling cycle of the software tool .....	4-7
SEG .....	1-10
SEG/ALM RST Key .....	1-10
Segments .....	1-4
Sensor internal temperature .....	4-2
serr .....	1-10, 7-2
Setting parameters of the Main Unit .....	5-10
Specifications .....	A-2
<b>T</b>	
Tag data link .....	5-2, 5-4
Tag data link communications .....	5-3
Temperature arrival prediction .....	3-18
Transistor output .....	1-12



**OMRON Corporation Industrial Automation Company**

**Kyoto, JAPAN**

**Contact : [www.ia.omron.com](http://www.ia.omron.com)**

**Regional Headquarters**

**OMRON EUROPE B.V.**

Wegalaan 67-69, 2132 JD Hoofddorp  
The Netherlands  
Tel: (31) 2356-81-300 Fax: (31) 2356-81-388

**OMRON ELECTRONICS LLC**

2895 Greenspoint Parkway, Suite 200  
Hoffman Estates, IL 60169 U.S.A.  
Tel: (1) 847-843-7900 Fax: (1) 847-843-7787

**OMRON ASIA PACIFIC PTE. LTD.**

438B Alexandra Road, #08-01/02 Alexandra  
Technopark, Singapore 119968  
Tel: (65) 6835-3011 Fax: (65) 6835-2711

**OMRON (CHINA) CO., LTD.**

Room 2211, Bank of China Tower,  
200 Yin Cheng Zhong Road,  
PuDong New Area, Shanghai, 200120, China  
Tel: (86) 21-5037-2222 Fax: (86) 21-5037-2200

**Authorized Distributor:**

©OMRON Corporation 2019-2022 All Rights Reserved.  
In the interest of product improvement,  
specifications are subject to change without notice.

**Cat. No. H231-E1-04**

0922