

# OMRON

**Vision Sensor  
FH/FZ5 Series**

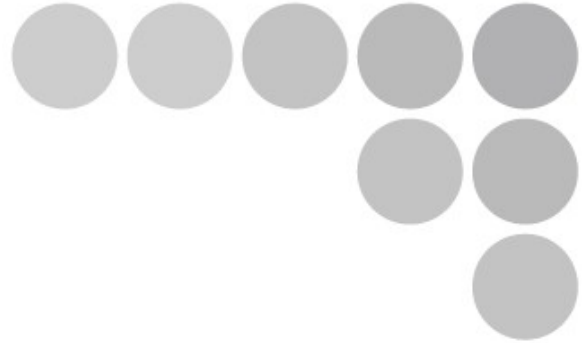

**User's Short Manual**

**ver. 1.00**

# CONTENTS

## 1. Getting started

- 1-1, Checking System Configuration
- 1-2, Preparing Controllers and Cameras
- 1-3, Software Overview

## 2. General description

- 2-1, What Is a Scene?
- 2-2, Create a Scene
- 2-3, Property window of Processing items

## 3. Measurement setting example

## 4. Processing Item overview

- 4-1, Pattern Search
- 4-2, Shape Search III
- 4-3, EC Circle Search
- 4-4, Sensitive Search
- 4-5, Classification
- 4-6, Edge Position
- 4-7, Edge Pitch
- 4-8, Scan Edge Position
- 4-9, Scan Edge Width
- 4-10, Color Data
- 4-11, Gravity and Area
- 4-12, Labeling
- 4-13, Label Data
- 4-14, Defect
- 4-15, Precise Defect
- 4-16, Fine Matching
- 4-17, Circle Angle
- 4-18, Barcode
- 4-19, 2D code
- 4-20, OCR/Character inspection
- 4-21, Date Verification
- 4-22, Image Logging
- 4-23, Data output
- 4-24, Position compensation

## 5. Appendix

- 5-1, Processing item guidelines

# 1 Getting started

## 1-1. Checking System Configuration

This The FH/FZ5 is a Vision Sensor that uses a controller to process measurements of objects that are imaged with aCamera.

You connect an LCD for operations and monitoring, and various Cameras to the FH/FZ5-series SensorController.

You connect external devices, such as a PLC or a computer, through a parallel, Ethernet, or RS-232C cable.

You can connect up to eight Cameras, depending on the model of the Controller.

To measure more than one line with a single Sensor Controller, you assign the Camera for the measurements to each line beforehand, and switch between Cameras during the measurement flow.

## Basic Configuration of FH/FZ5 Series

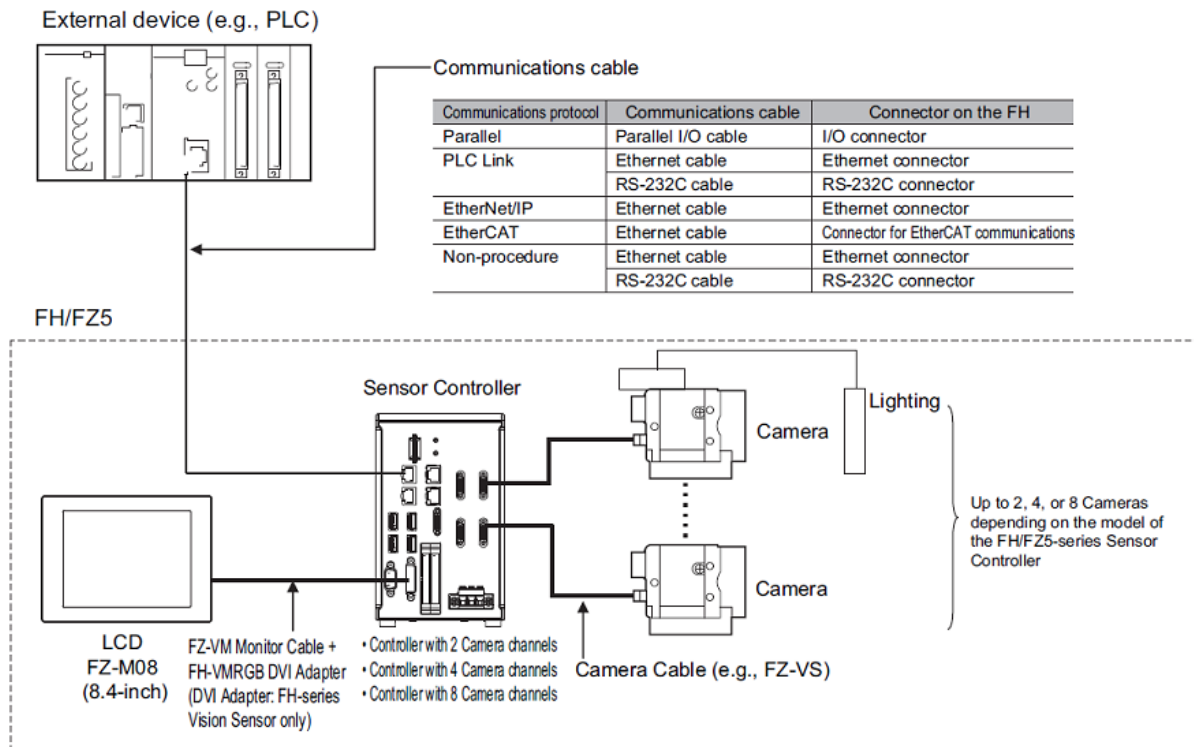

Or with Touch monitor FH-MT12

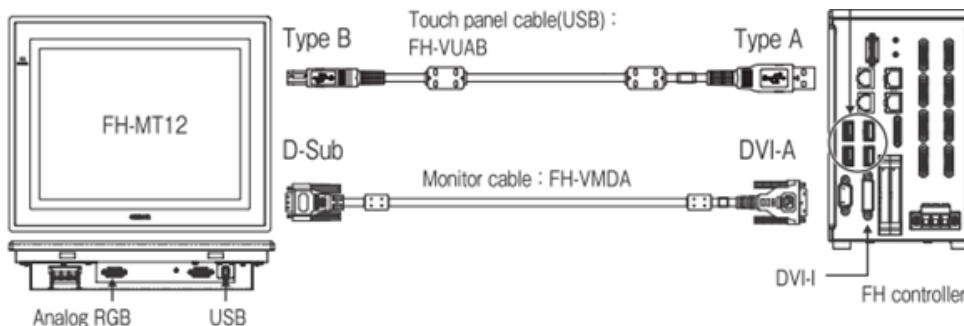

### Sensor controller

The Controller performs the image processing specified by the user settings and outputs the measurement results.

#### Camera 2ch type

FH-3050

FH-1050

#### Camera 4ch type

FH-3050-10

FH-1050-10

#### Camera 8ch type

FH-3050-20

FH-1050-20

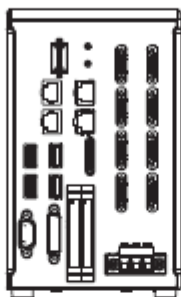
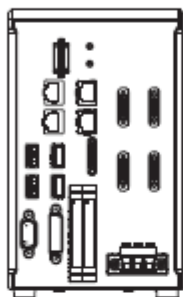
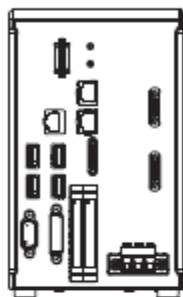

### Camera cable

#### Camera cable

FZ-VS (2m, 5m, 10m, min. bending radius: 69mm)

Bend resistant camera cable

FZ-VSB (2m, 5m, 10m min. bending radius: 69mm)

Right-angle camera cable

FZ-VSL (2m, 5m, 10m min. bending radius: 69mm)

Long-distance camera cable

FZ-VS2 (15m min. bending radius: 93mm)

Long-distance Right-angle camera cable

FZ-VSL2 (15m min. bending radius: 93mm)

### Camera

Detects workpieces as images.

Standalone camera

FZ-SC/FZ-S/

FZ-SC2M/FZ-S2M/

FZ-SFC/FZ-SF/

FZ-SPC/FZ-SP/

FZ-SHC/FZ-SH

FH-SC/SM

FH-SC02/SM02

FH-SC04/SM04

FZ-S C5M2/FZ-S5M2

FH-SC12/SM12

Intelligent compact camera

FZ-SQ010F/FZ-SQ050F/

FZ-SQ100F/FZ-SQ100N

Intelligent camera

FZ-SLC15/FZ-SLC100

Automatic focus camera

FZ-SZC15/FZ-SZC100

### LCD monitor

Use the monitor to check images and display the condition-setting menus.

FZ-M08 (8.4-inch)

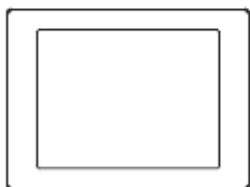

### Monitor cable

FZ-VM (2m, 5m, min. bending radius: 75mm)

### Monitor conversion cable

FH-VMRGB

### Camera with Lighting

Lighting controller

FLV-TCC1/FLV-TCC4/FL-TCC1

### Peripheral Device

\* USB memory  
FZ-MEM2G

### Power Supply

The power supply connected to FH Sensor Controller varies depending on the number of connected cameras and types for various

### Touch monitor



## 1-2. Preparing Controllers and Cameras

### Preparing Controllers

The first time the program is started up, the Language Setting window is displayed, so select the language.

Please check that the controller is switched on and that the Main screen is displayed.

### Adjusting Cameras

1. Tap [ ▼ ] of "Image mode" in [Image display] of the Main screen Control area, and select "Through".

The through images captured from the camera are viewed in the Image Display area.

Reference: ▶ Changing Display Contents

#### Note

- The same operation is available by tapping [View] - [Image mode] - [Through].

2. Adjust the position of measurement objects so that they display at the center of the monitor.



Adjust the positions of objects to be measurement

3. Adjust the focal distance of the lens.

When using an auto-focus camera or an intelligent camera, focus and the iris can be automatically adjusted.

#### Note

- If a camera is used together with a lens, turn the focus ring of the lens to adjust the focus.  
Reference: ▶ "Processing Item List Manual", "Lens Setting"
- The light intensity of an intelligent camera can be adjusted from the controller.  
Reference: ▶ "Processing Item List Manual", "Lighting Control"

#### Important

- When using a small-size digital camera, check that the model and serial number of the camera head and camera amplifier match. When a camera head and camera amplifier of different models and serial numbers are connected, they may not operate correctly.

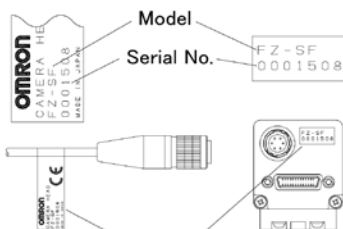

Check model and serial No.

# 1-3 Software Overview

Application-oriented measurement can be configured by combining processing items or changing the settings of processing items.

## Main Window (Layout 0): Adjustment Window (Default)

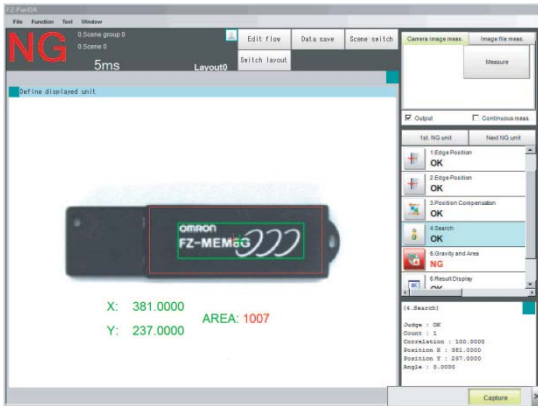

## Main Window (Layout 1): Run Window (Default)

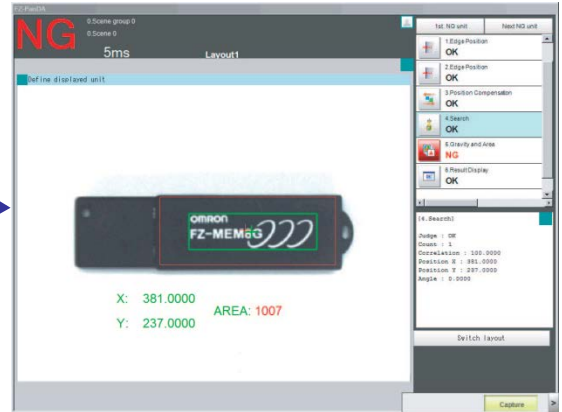

Layout 0 is set as an adjustment window by default. (This can be changed in Layout Modification Mode.)

Layout 1 is set as a run window by default. (This can be changed in Layout Modification Mode.)

The flow, detailed results, and tool box are displayed in the Control Area.

## Editing Processing Units in Scenes

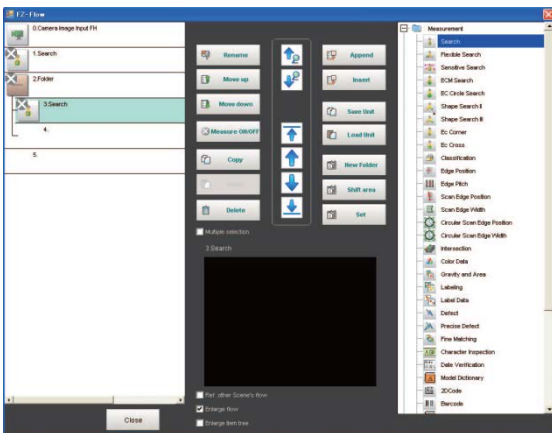

## Properties Dialog Box

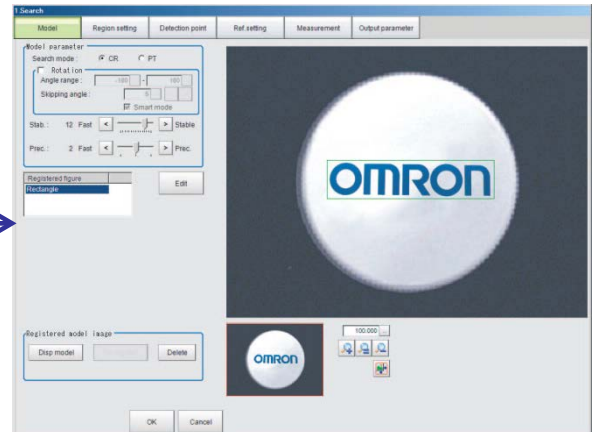

You use the edit buttons in the edit flow window to arrange processing units in a scene, or to delete processing units.

dialog box is used to set measurement parameters, judgement conditions, and other conditions for processing items that are registered as processing units in the measurement flow.

# 2 General description

## 2-1 What Is a Scene?

A combination of processing items is called a "scene" and scenes can be easily created by combining processing items that are suited to the measurement purpose from the list of processing items provided.

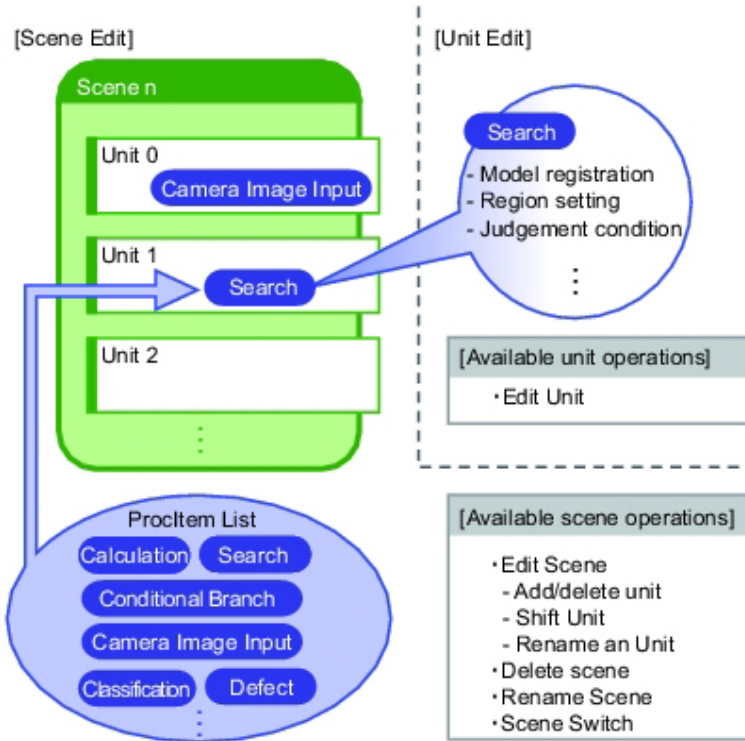

## Scene Examples

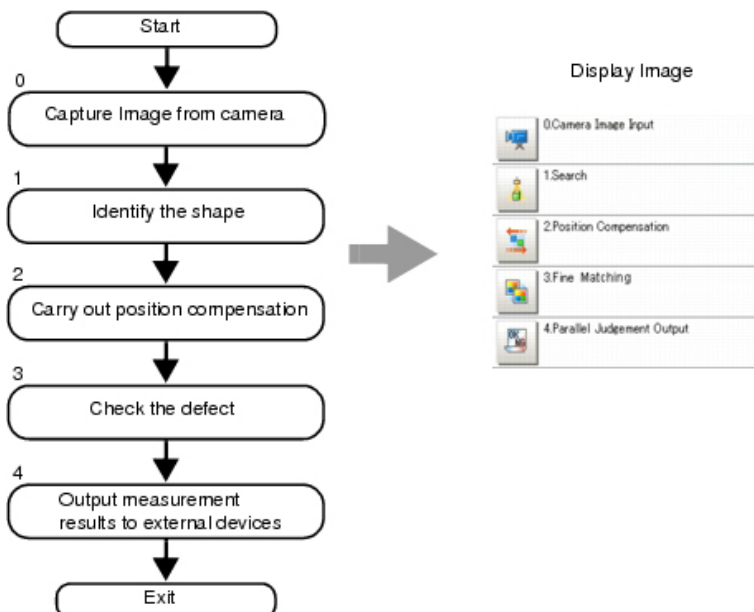

# Switching Scenes

1. Tap "Scene switch" in the toolbar on the Main screen.

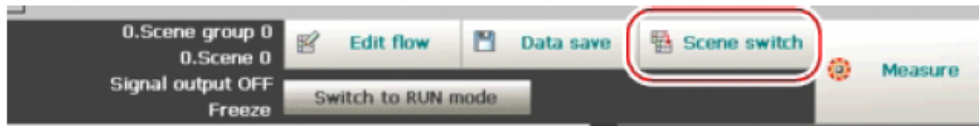

The Switch Scene window is displayed.

## Note

- The same operation is available by tapping [Scene] menu - [Scene switch].

2. Tap [ ▼ ] to select the scene to switch.

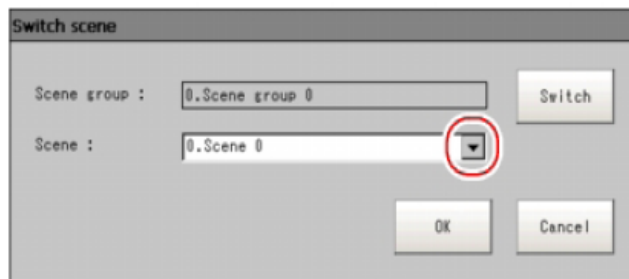

To switch a scene group, tap [Switch], then tap [ ▼ ] in the displayed window to select the scene group to switch.

3. Tap [OK].  
The scene switches.



## 2-2 Create a Scene

In the Edit Flow window, editing buttons in the window can be used to change the order of processing units within the scene or to delete processing units.

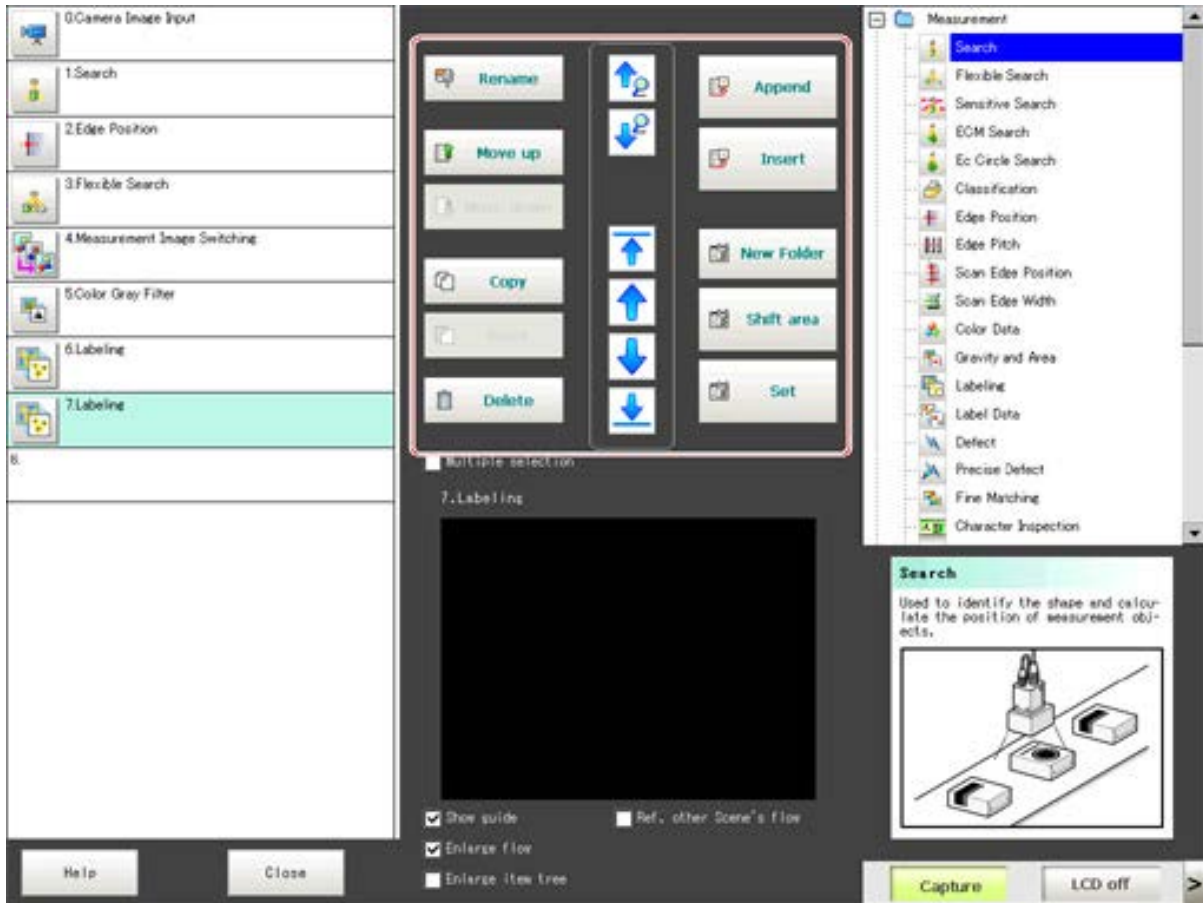

- Specifying the position for a processing unit and adding it
- Moving a processing unit
- Copies and pastes a processing unit with settings data.
- Deleting a processing unit
- Changing the name of a processing unit
- Setting details of a processing unit



## 2-3 Property window of Processing items

This window is used for detailed setting of measurement parameters and judgement conditions for processing items. All of Processing items have similar layout.

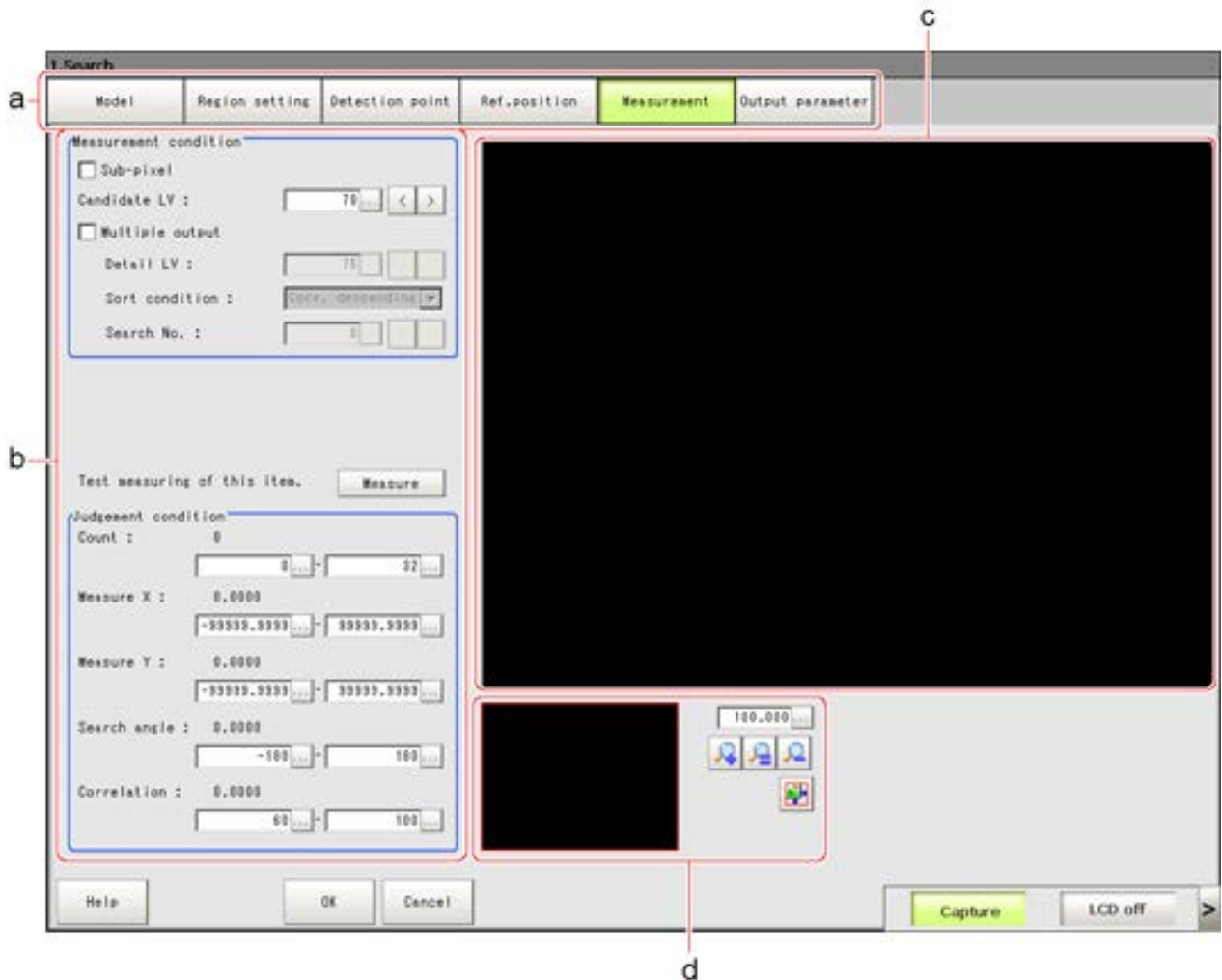

### a. Item Tab Area

Displays the settings items for the processing unit currently being set. Perform settings starting with the item on the left.

### b. Detail Area

Set detailed items.

### c. Image Display Area

Displays camera images, figures, and coordinates.

### d. Zoom Browser Area

Zooms in and out from the displayed image.

# 3 Measurement setting example

Define and perform measurement with display of the results.

1. Tap [Edit flow] in Toolbar.



The Edit Flow window is displayed.

2. Select a processing item to be added from the processing item tree.

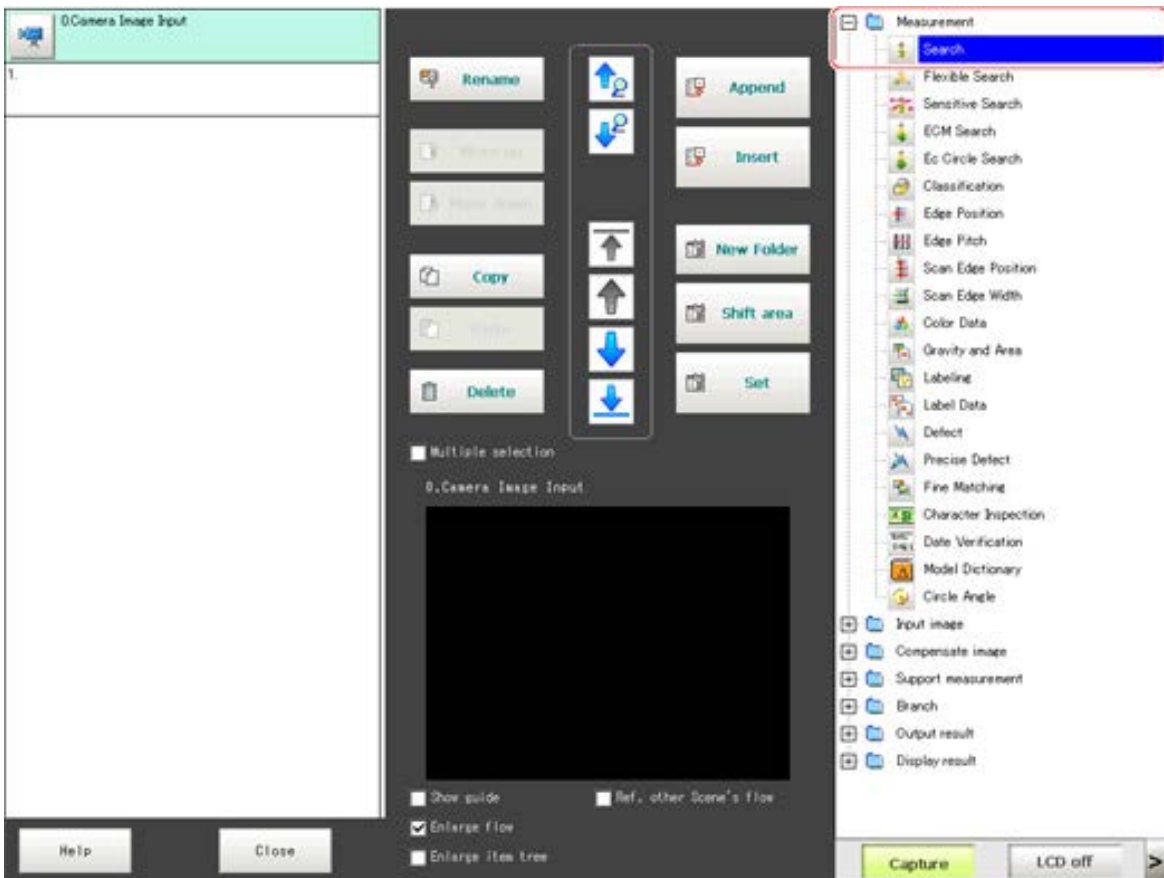

3. Tap [Append].



4. To continue to add processing units. Repeat step 3.
5. Either tap the icon of the processing unit to be set or tap the Set button.

### Proclitem setting button



The property setting window is displayed. Set detailed conditions. The displayed contents vary depending on the processing item.

6. Set conditions.  
The displayed contents vary depending on the processing item.

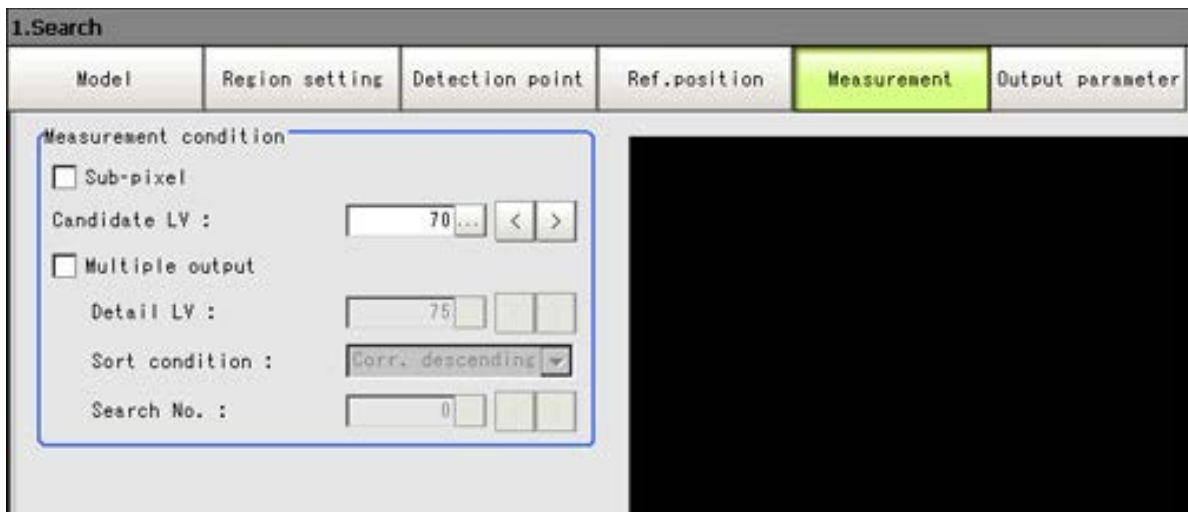

# 4. Processing ITEM overview

## 4.1 Search

Register the feature sections of the measurement object as an image pattern (model), then find the most similar part to these models from the input images to detect the position.

The correlation value showing the degree of similarity, measurement object position, and inclination can be output.

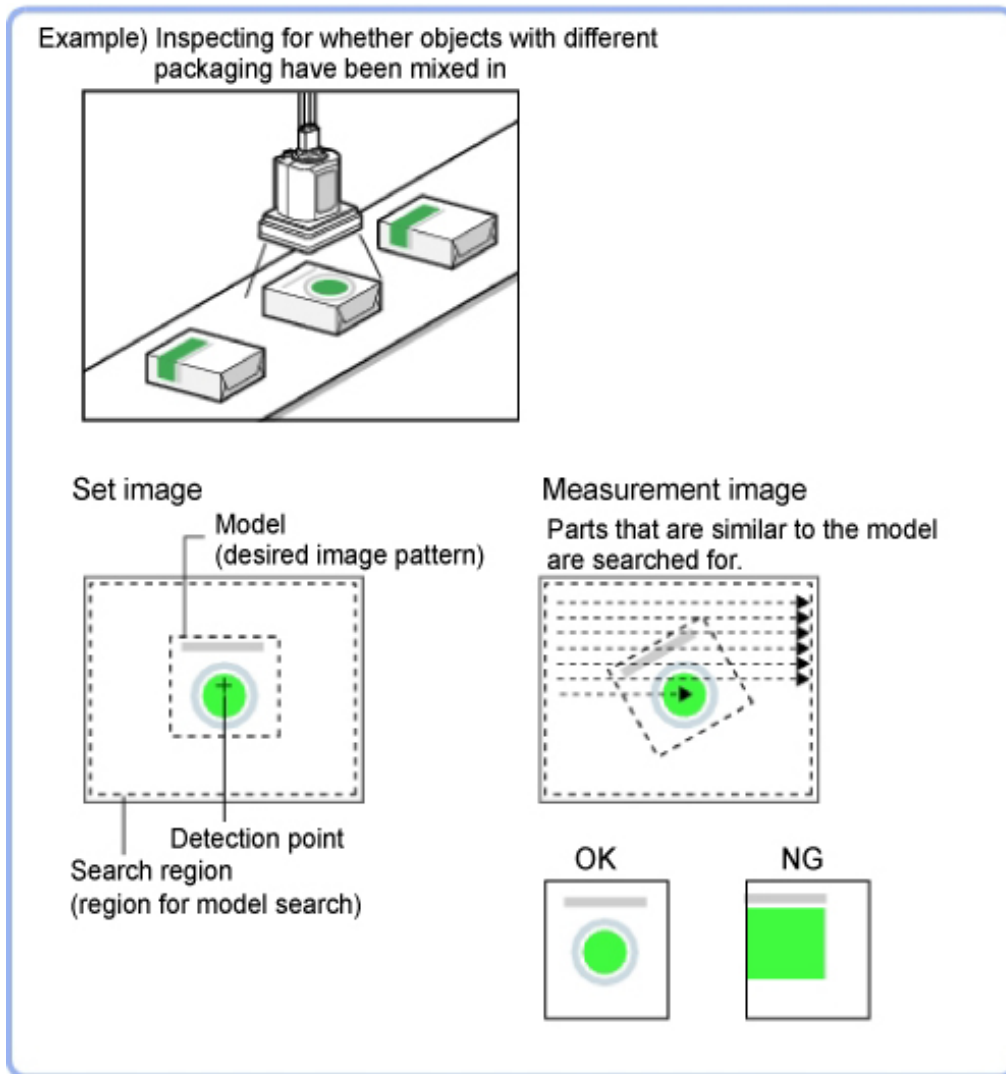

## 4.2 Shape Search III

This function is for detecting user-defined target to estimate target position and pose precisely. The correlation value indicating the degree of similarity, measurement target position, and orientation can be output.

In shape search III, edge information is used as features, whereas in a normal search mode, color and texture information are used.

It enables highly robust and fast detection robust to environmental variations including shadings, reflections, lightings, shape deformations, pose and noises.

Since state-of-the-art object detection algorithm is exploited in shape search III, it can provide much more reliable position and pose estimation with higher speed compared to shape search II. Furthermore, it has much more parameter to tune to support a wider variety of applications.

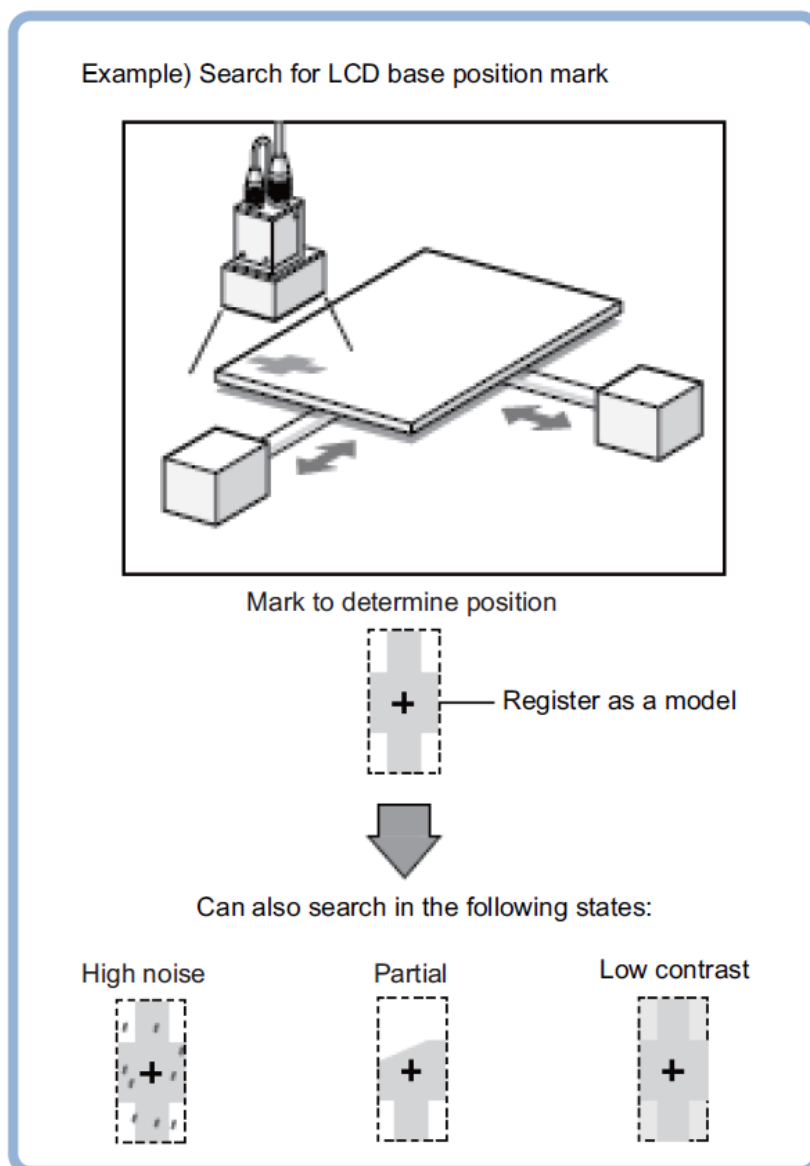

## 4.3 EC Circle Search

This processing item searches the input image for parts having a high degree of similarity to the target circle mark (model), and measures its circle evaluated value (similarity) and position. In a normal search, image pattern models are used that look at the color and light/dark information. In EC Circle Search, however, models are used that look at the profile. Therefore, this processing assures a reliable search even for low-contrast or noisy images. It is also possible to measure the number of circles in the input image.

- This counts how many circles there are of the specified size. Since circles are extracted using the shape information in "Round", the circles being deformed or dirty does not affect counting.

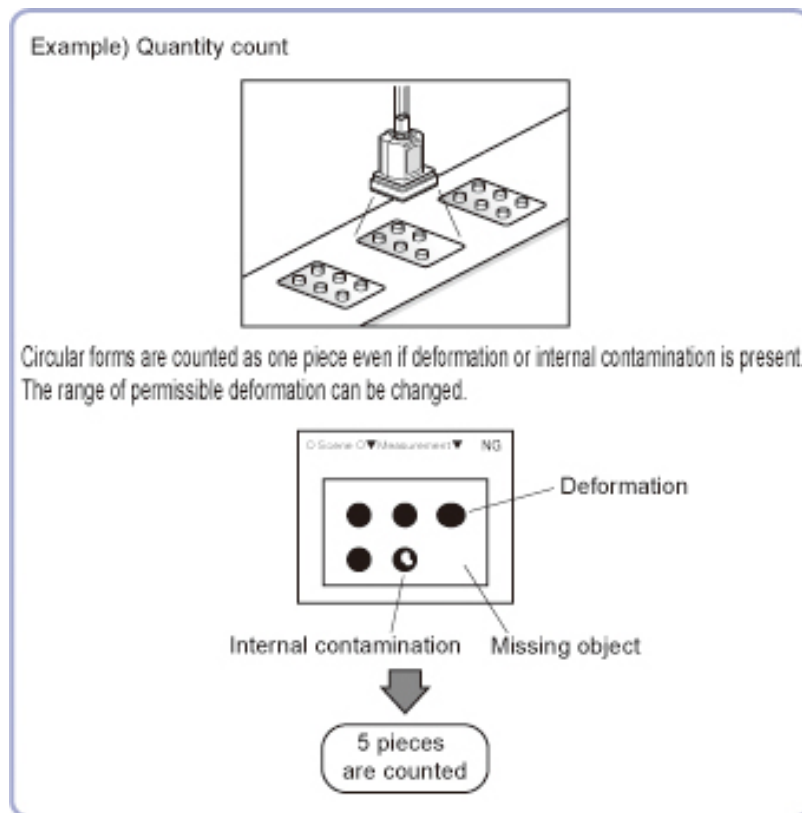

### • Measurement Parameters

Setting item	Set value	Description
Search type	Single search	This is set when there is one search target.
	Multi search	This is set when there is more than one search target.
Radius	1 to 9999	This item sets the radius of the circle measured. This is displayed on the screen with a solid blue line.
Radius range	[1] to 9999	This measures the measured circle radius $\pm$ the permitted radius width. This is displayed with a broken blue line.

## 4.4 Sensitive Search

The registered models are automatically finely divided and matched in detail, the one with the lowest correlation is output. Sensitive search is suitable when the difference between the model image and measurement image is small and regular searches do not produce differences in correlation.

- When identifying the shape of the divided area

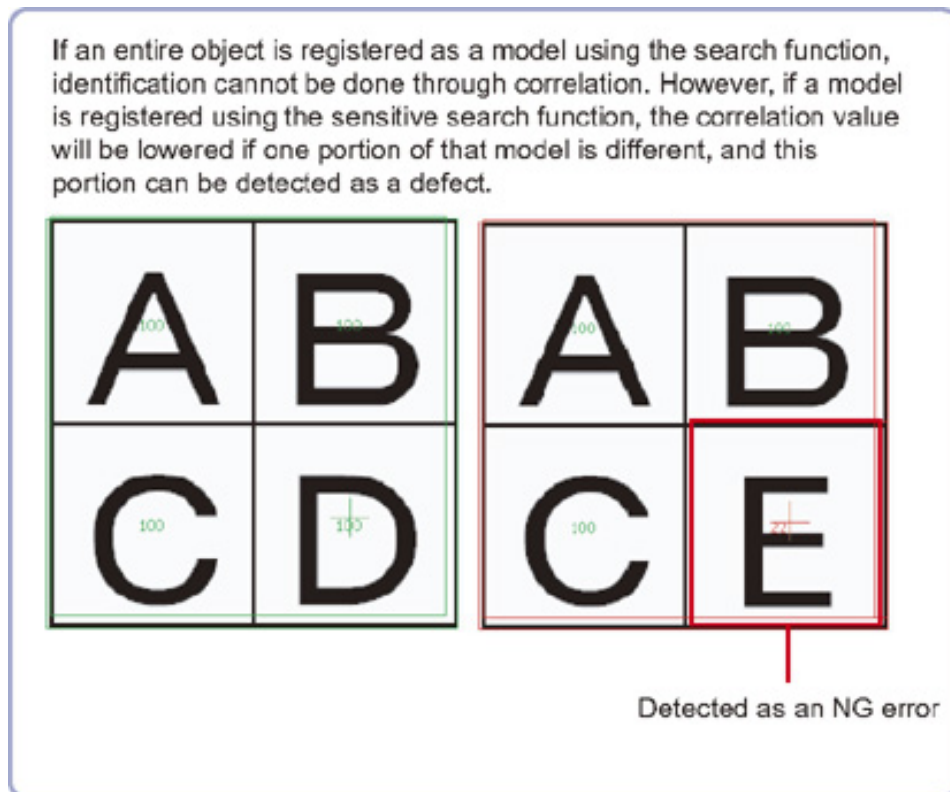

- Set up the sub-model parameter.

Setting item	Set value	Description
Sub-model Number X	0 to 10	This sets the number of divisions of the registered model in the X direction.
Sub-model Number Y	0 to 10	This sets the number of divisions of the registered model in the Y direction.
Stab.	1 to 15	Specify the priority for measurement stability or speed. If lowering stability does not speed up processing, it is likely that many candidates have been detected. In this case, specify a larger value for "Candidate LV" or "Stab."
Prec.	1 to 3	Specify the priority, measurement precision or speed.
Plain inspection	-Checked -Unchecked	Specify whether or not to inspect the plain region.



## 4.5 Classification

- When various kinds of products on a production line need to be classified and identified

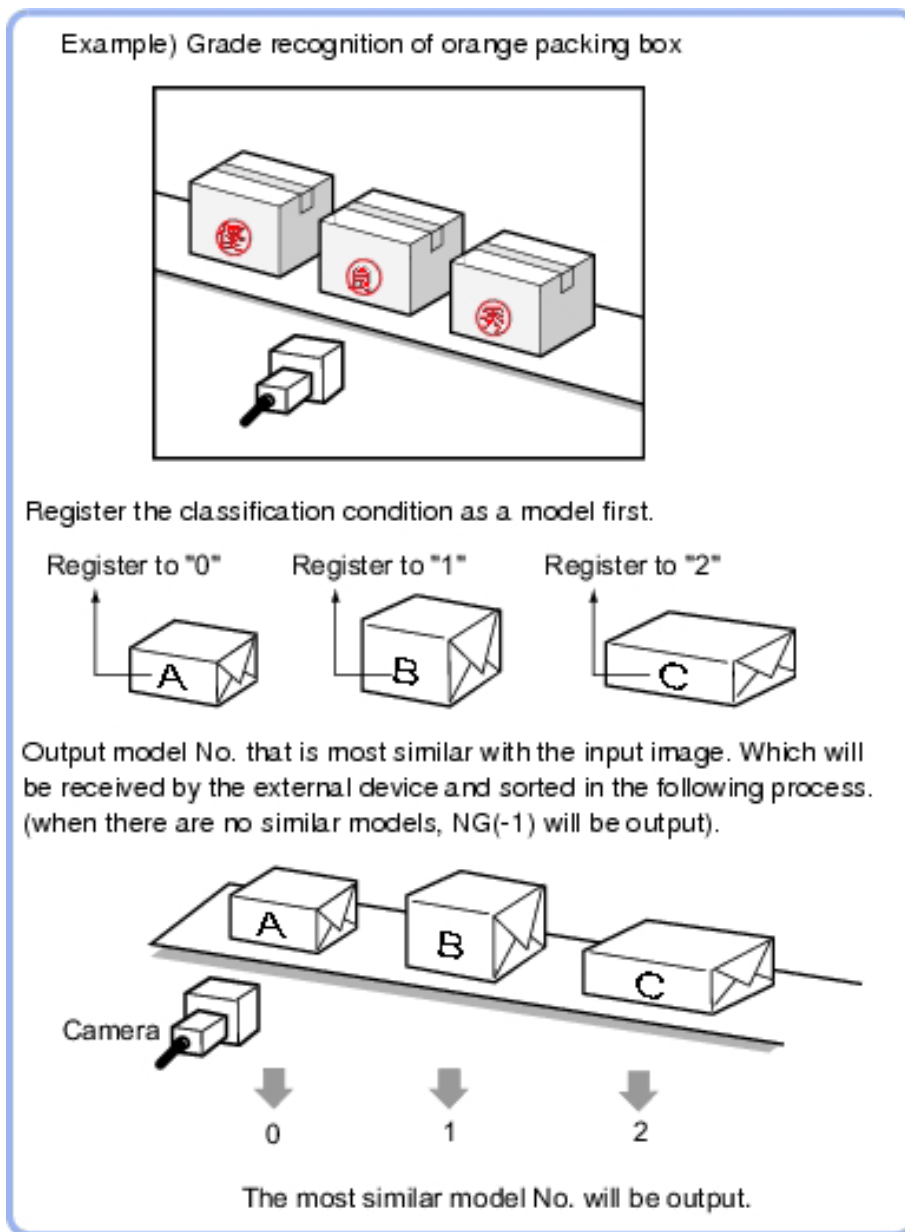

### • Model Registration

Pre-register as models the sections to be used as reference for classification. Models can be registered with any of 36 indexes, from 0 to 35, and up to 5 models can be registered for each index. When there is variation among the model print quality and shapes, pre-register multiple models for the same index.

## 4.6 Edge Position

This processing item detects the position of the measurement object by using the change in color within the measurement region.

- To calculate edge coordinates of measurement objects

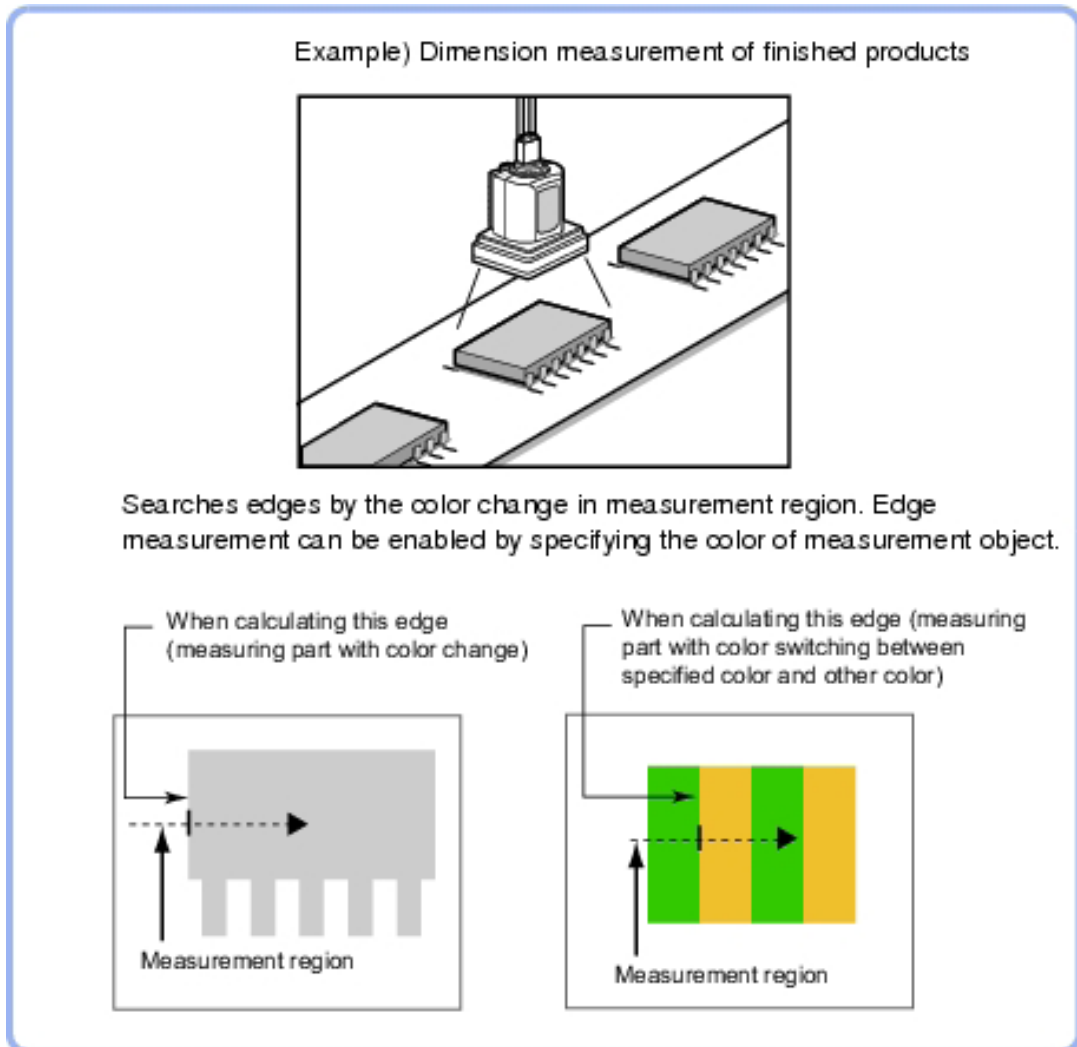

- To find the width of a measurement object  
Using a Expression, the width of a measurement object can be calculated from the difference between two edge positions.
- The edge is scanned from the start point of the area toward the end point.  
When setting up the measurement region, pay attention to the detection direction of the edge.

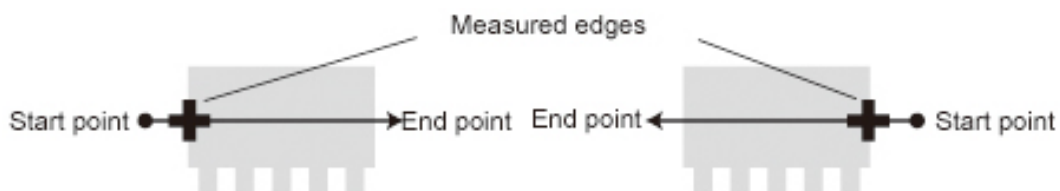

Drawing the line from left to right and from right to left will lead to different measured edges.

## 4.7 Edge Pitch

Finds and counts the edges by measuring the color change within the measurement region.

- When calculating number of pins of IC or connectors

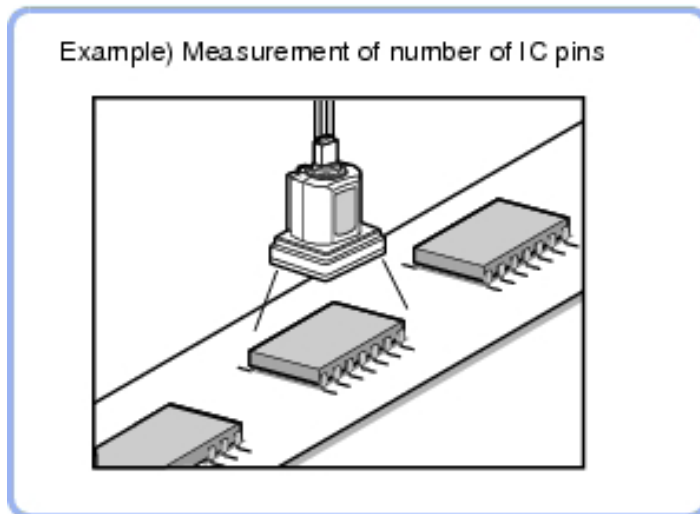

- To calculate the pin width and the distance (pitch) between mid-points between two pins

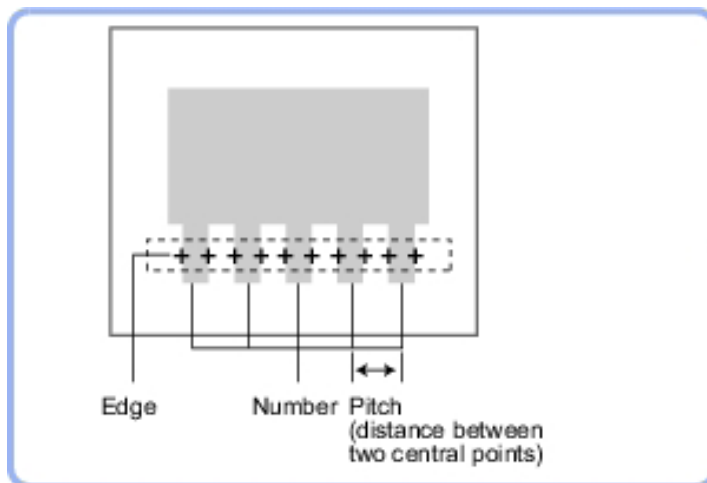

- When setting up a measurement region, please include all the edges to be detected.

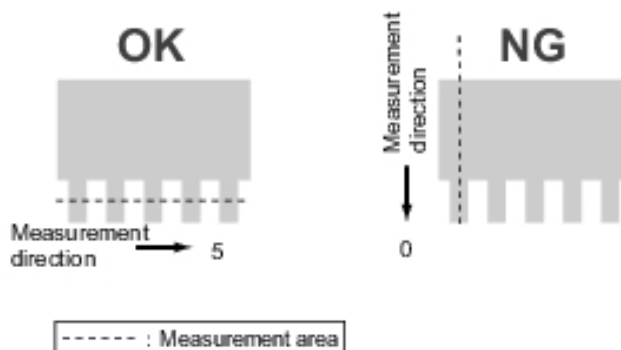

## 4.8 Scan Edge Position

This processing item detects the position of the measurement object by using the change in color within the measurement region. By dividing the measurement region, the following effects can be expected compared to ordinary edge position measurement.

- Detailed information, such as the closest point or furthest point from the measurement start point, can be calculated.
  - The inclination or degree of unevenness of the measured object can be calculated.
- To calculate multiple edge positions of the measurement object from statistical data

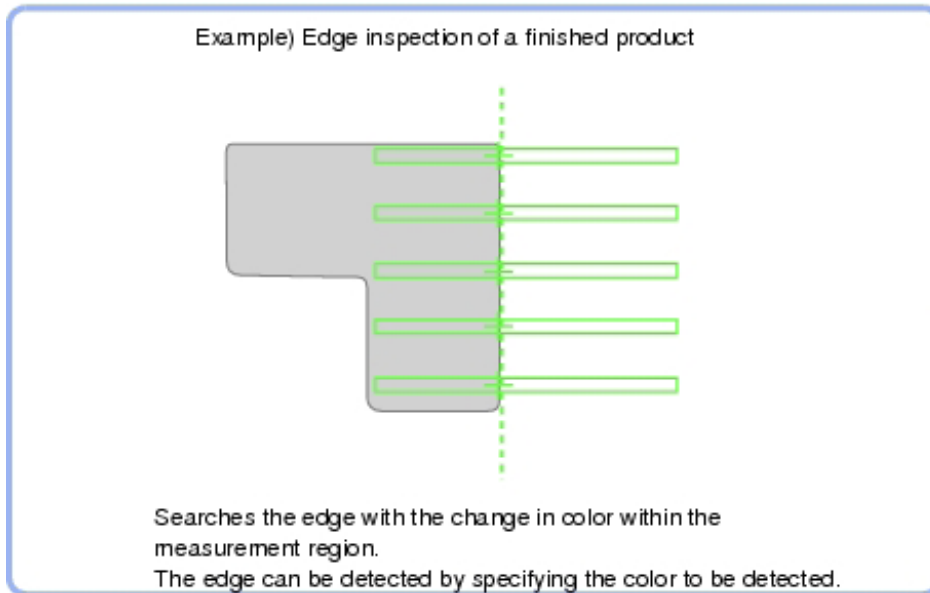

### Judgment Conditions

- Specify the range to be judged as OK.

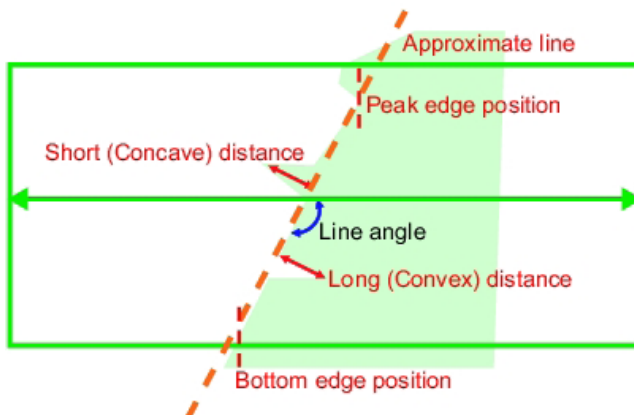

Judgement	
Peak edge position X :	0.0000
<input type="text" value="-99999.999"/>	<input type="text" value="99999.999"/>
Peak edge position / :	0.0000
<input type="text" value="-99999.999"/>	<input type="text" value="99999.999"/>
Bottom edge position X :	0.0000
<input type="text" value="-99999.999"/>	<input type="text" value="99999.999"/>
Bottom edge position Y :	0.0000
<input type="text" value="-99999.999"/>	<input type="text" value="99999.999"/>
Edge position X Ave. :	0.0000
<input type="text" value="-99999.999"/>	<input type="text" value="99999.999"/>
Edge position Y Ave. :	0.0000
<input type="text" value="-99999.999"/>	<input type="text" value="99999.999"/>
Long distance Max. :	0.0000
<input type="text" value="0.000"/>	<input type="text" value="99999.999"/>
Short distance Max. :	0.0000
<input type="text" value="0.000"/>	<input type="text" value="99999.999"/>
Deviation :	0.0000
<input type="text" value="0.000"/>	<input type="text" value="99999.999"/>
Line angle :	0.0000
<input type="text" value="-18"/>	<input type="text" value="18"/>
Lost point count :	0
<input type="text" value=""/>	<input type="text" value="10"/>

## 4.9 Scan Edge Width

This processing item detects the position of the measurement object by using the change in color within the measurement region. By dividing the measurement region, you can get the following values.

- Local width of the work
- Average width of the work
- When getting several widths of a measurement object

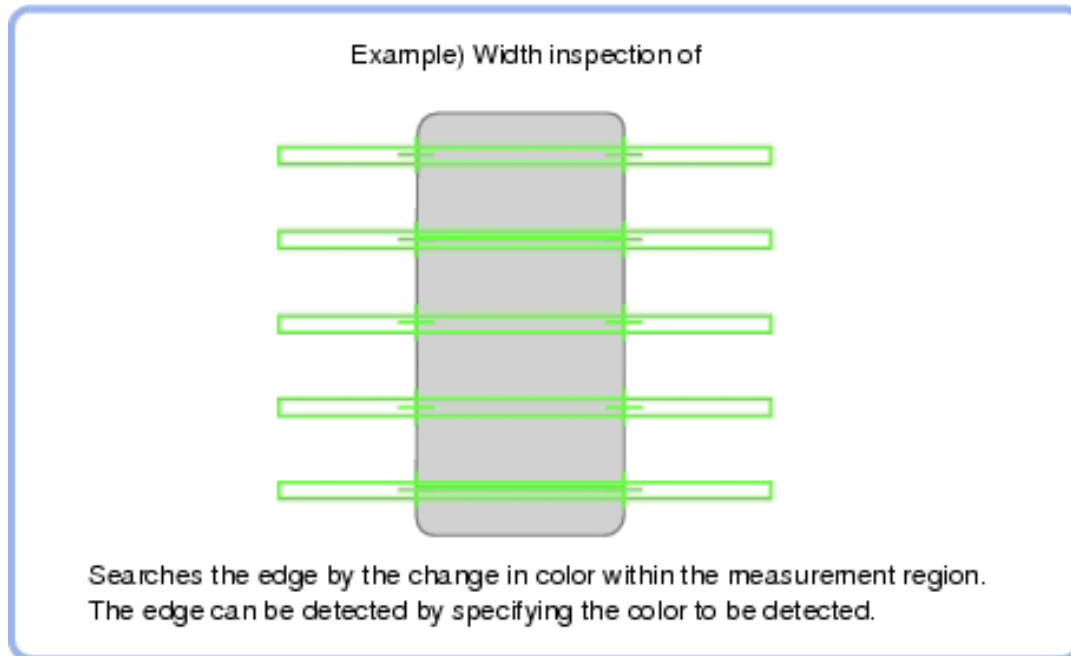

- To find the width of a measurement object  
Using a Expression, the width of a measurement object can be calculated from the difference between two edge positions.
- The scan area is divided equally according to the setting.

The scan area, when the number of divided areas is 1

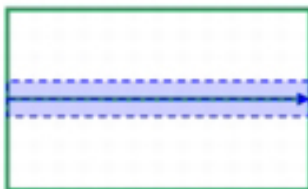

The scan area, when the number of divided areas is 3

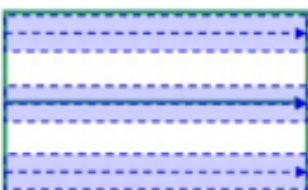

The scan area, when the number of divided areas is 2

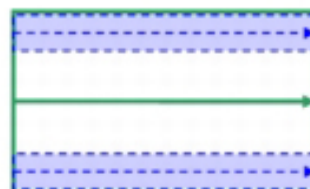

The scan area, when the number of divided areas is 4

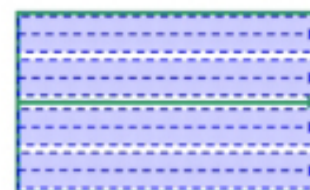

## 4.10 Color Data

Inspect by finding the average color of the measurement region and using its difference from the registered reference color and the color variation in the measurement area. Alternatively, you can only detect the color tone while neglect the effect of image brightness.

For monochrome cameras, examination is performed by measuring the difference between the average density of the measurement region and the registered reference density (density average), and the density deviation in the measurement region (density deviation).

- When measuring the presence of measurement objects

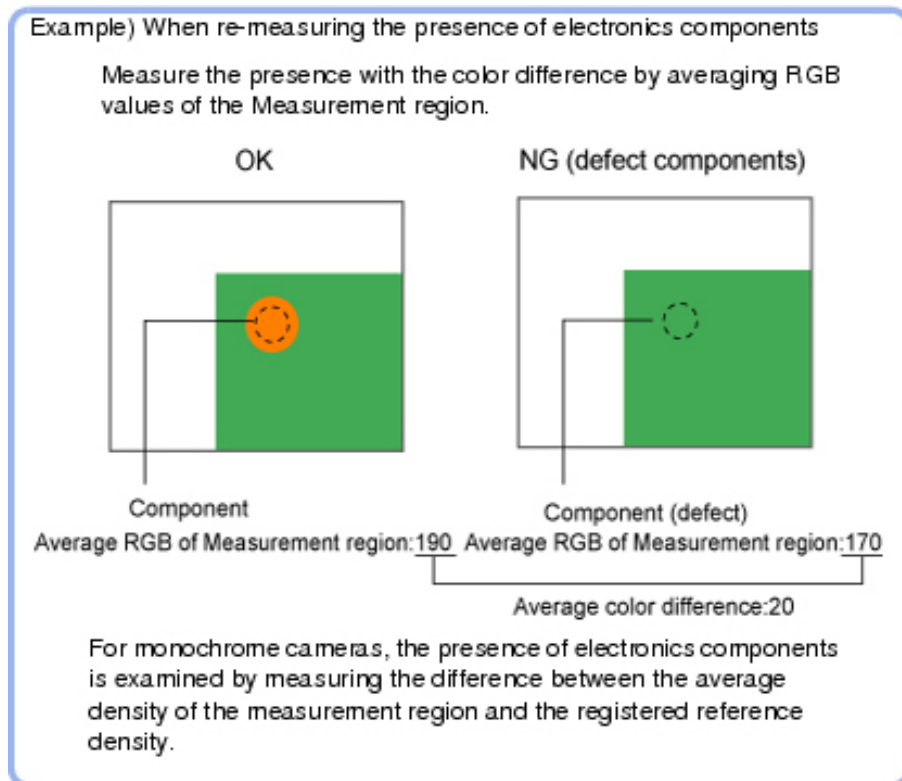

	Setting item	Set value	Description
Color Camera	Color difference	0 to 442	Specify the upper and lower limit values for the Difference between the average color of the Measurement region and the reference color.
	Color deviation	0 to 221	Specify the upper and lower limit values for the deviation of the average color in the measurement region.
Mono-Chrome camera	Density average	0 to 255	Specify the upper and lower limit values for judging the Average density of the measurement region.
	Density deviation	0 to 127	Specify the upper and lower limit values for the deviation of the average density in the measurement region.

## 4.11 Gravity and Area

Inspect using the area of the specified color.

- Label deviation measurement

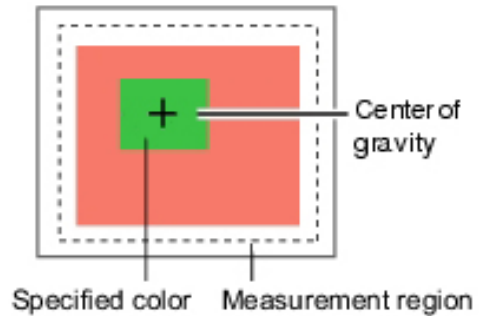
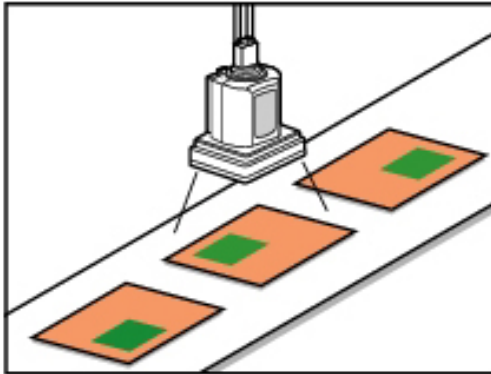

Measurement can be enabled by gravity coordinates of specified color in measurement region.

- Detection of defects, contamination, and stains of measurement objects whose appearance is not defined

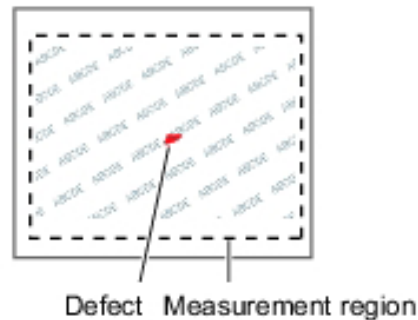
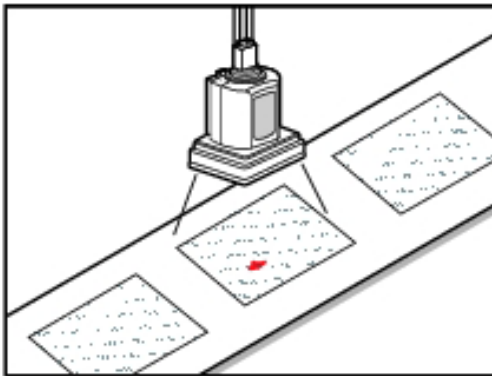

Measurement can be enabled by area of specified color in measurement region.

- Measurement Parameters

Setting item	Set value	Description
Area	0 to 999999.99	Specify the area to be judged as OK.
Gravity X	-99999.99 to 99999.99	Specify the range of X-axis shifting that is judged to be OK.
Gravity Y	-99999.99 to 9999.99	Specify the range of Y-axis shifting that is judged to be OK.

## 4.12 Labeling

You can count the number of labels with a specified color or find the area and center of gravity of a specified label number.

- Label count inspection

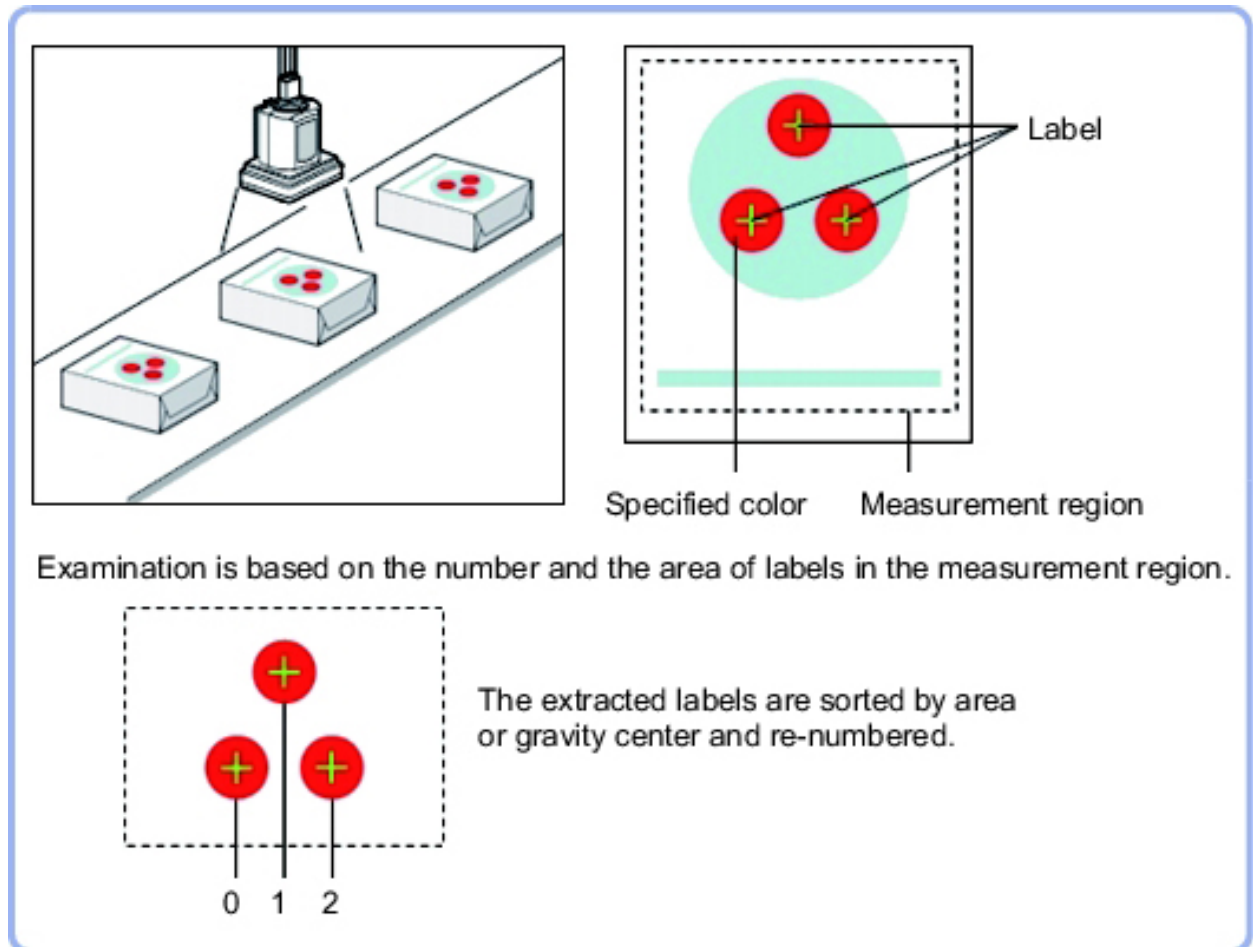

- color extraction



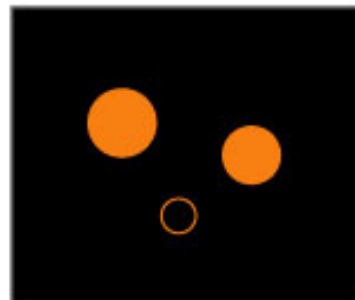

Extract image  
(before specifying colors)



Extract image  
(after specifying colors - background color:black)



## • Measurement Parameters

Setting item	Set value [Factory default]	Description
Filling up holes	<input checked="" type="radio"/> Checked <input type="radio"/> [Unchecked]	<p>Select the process method for the part encircled by the designated color circle.</p> <p>When checked, the hole is processed as having the specified color.</p> <p>Input image      Image after filling up hole</p> 
Outside trimming	<input checked="" type="radio"/> Checked <input type="radio"/> [Unchecked]	<p>This option can be used only when there is a section of the designated color in the measurement region that does not need to be measured.</p> <p>When "Checked" is set, the whole area outside of the measurement region is extracted as having the specified color.</p> <p>Measurement region</p>  <p>When calculating the position and area of this label</p> <p>The area outside of the measurement region turns the color of the measurement target. Sort mode: Area descending Label No.: 1 With the settings above, the position and area of the middle label will be measured.</p>
Object area range	0 to 999999999	Specify the range of the area to be judged as a label.
Sort condition	Area ascending <input checked="" type="radio"/> [Area descending] <input type="radio"/> X ascending <input type="radio"/> X descending <input type="radio"/> Y ascending <input type="radio"/> Y descending	<p>Specify the conditions by which label number is re-assigned.</p> <p>When sorting referencing the X and Y coordinates, the upper left is the origin.</p>
Label No.	[0] to 2499	Input the label number for the data to be output.

## 4.13 Label Data

You can specify a desired label number and obtain measurement values for that label stored by other processing units that perform the labeling processing (“Labeling”).

- Label position acquisition

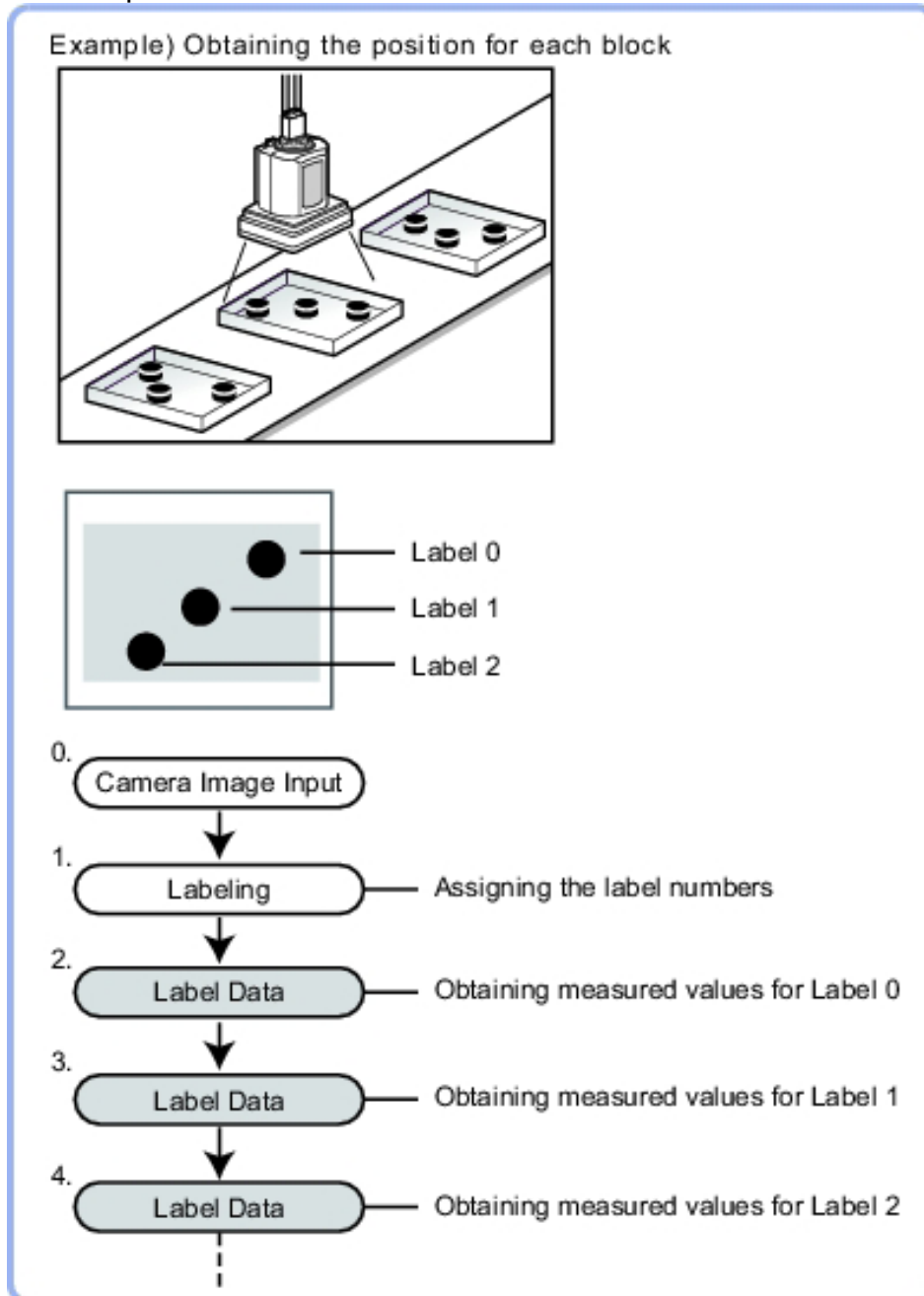

### Note

Do not insert the following processing items between Label Data and Labeling units.

- Camera Image Input
- Camera Switching
- Position Compensation
- Color Gray Filter
- Filtering

## 4.14 Defect

Detect defects and contamination using color variation within the measurement region. This is real color processing, so even if defect and contamination colors change or the background color changes, stable inspection is possible.

- Detecting defects, contaminations and spots on plain measurement objects

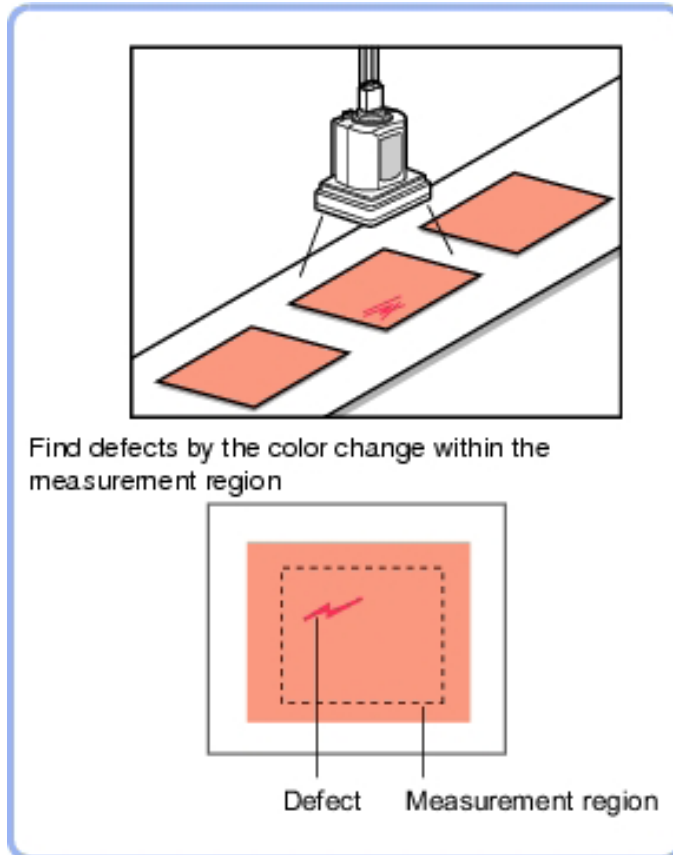

- Measure appearance defects and defects of parts

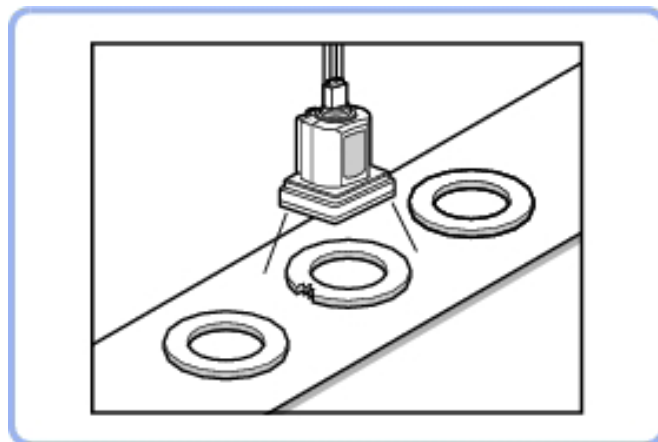

- Region Setting

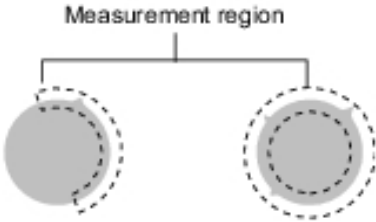
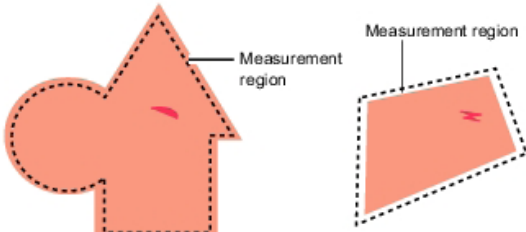
PT (type)	Description
Wide line	Selected when detecting defects and burrs of the measurement objects. 
Wide circle, wide arc	Selected when detecting defects and burrs of the circle measurement objects. 
Rectangle, Ellipse(circle), polygon	Selected when detecting the overall defects of specified zones and Measurement objects. 

- Defect detection mechanism

While moving the defect detection region around, calculate the RGB color averages at each location and find the defect detection difference with surrounding defects. This difference is called the defect level. Calculate the defect level for all defect detection areas. If the maximum value exceeds the judgment value, it is judged that there are defects in the measurement region.

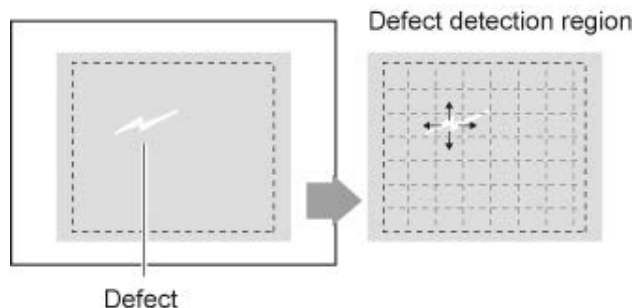

- Measurement Parameters

Item	Set value	Description
Defect judgment	0 to 999	Specify the upper limit for defect judgment. When "30" is set, the OK value should be within the range of 0 to 30.
Area judgment	0 to A_MAX	Specify the maximum defect area. A_MAX: 307,200 for a 0.3-megapixel camera, 1,920,000 for a 2-megapixel camera

## 4.15 Precise Defect

Defects and contamination on plain measurement objects can be detected with high precision by performing differential processing on the image. By changing the size of elements used for detection, comparison intervals, etc., fine customization of speed and precision is possible.

- Measurement parameters

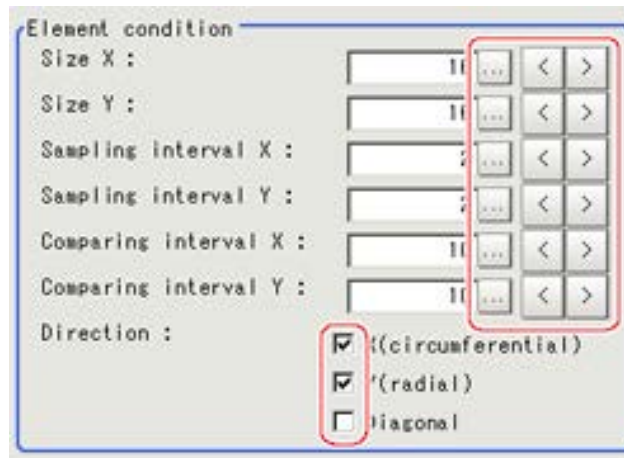

item	Set value	Description
Size X	4 to 64	Specify the X-axis size of defects/contamination to be detected. The higher this value, the higher the degree of defects for large defects. Specify in units of pixels.
Size Y	4 to 64	Specify the Y-axis size of defects/contamination to be detected.
Sampling Interval X	1 to 64	Specify the interval for creating elements along the X axis. The smaller this value, the greater the defect detection performance, but the slower the processing speed. Specify in units of pixels.
Sampling Interval Y	1 to 64	Specify the interval for creating elements along the Y axis.
Comparing interval X	1 to 32	Set the number of neighboring elements compared with when the degree of defect is calculated, For example, if the Sampling interval X is set to 4 and the comparing interval X is set to 2, comparison is with separate elements of $4 \times 2 = 8$ pixels along the X axis.
Comparing Interval Y	1 to 32	Set the number of neighboring elements compared with when the degree of defect is calculated,
Direction	-X(circumferential) -Y(radial) -Diagonal	Set the direction for detecting defects. The smaller the direction setting count, the shorter the processing time.

## 4.16 Fine Matching

Differences can be detected in a fast and highly precise way by overlapping registered fine images with input images (matching).

- To precisely detect trivial defects at the edges of text and patterns

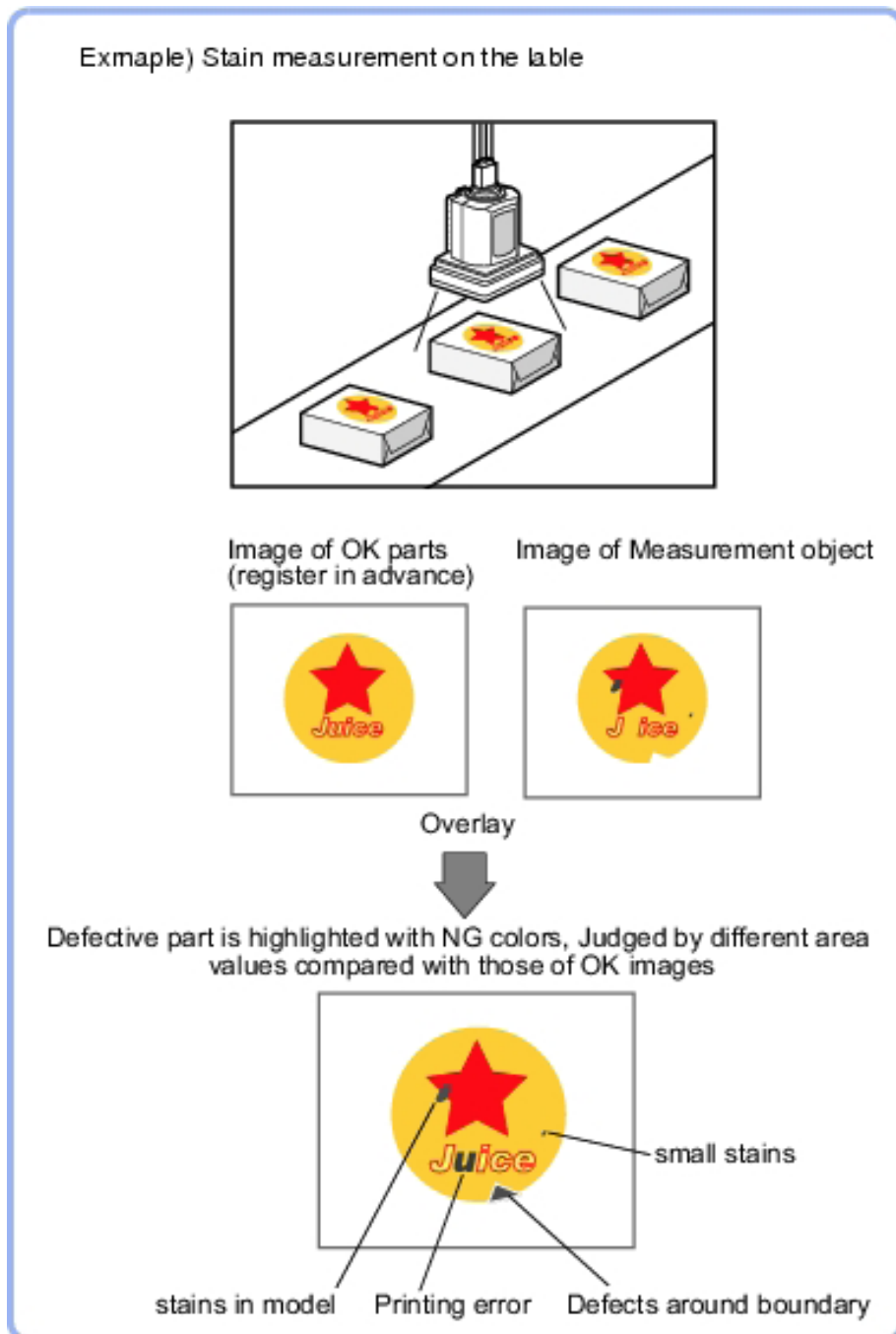

## 4.17 Circle Angle

- To correct the tilting of circle measurement objects

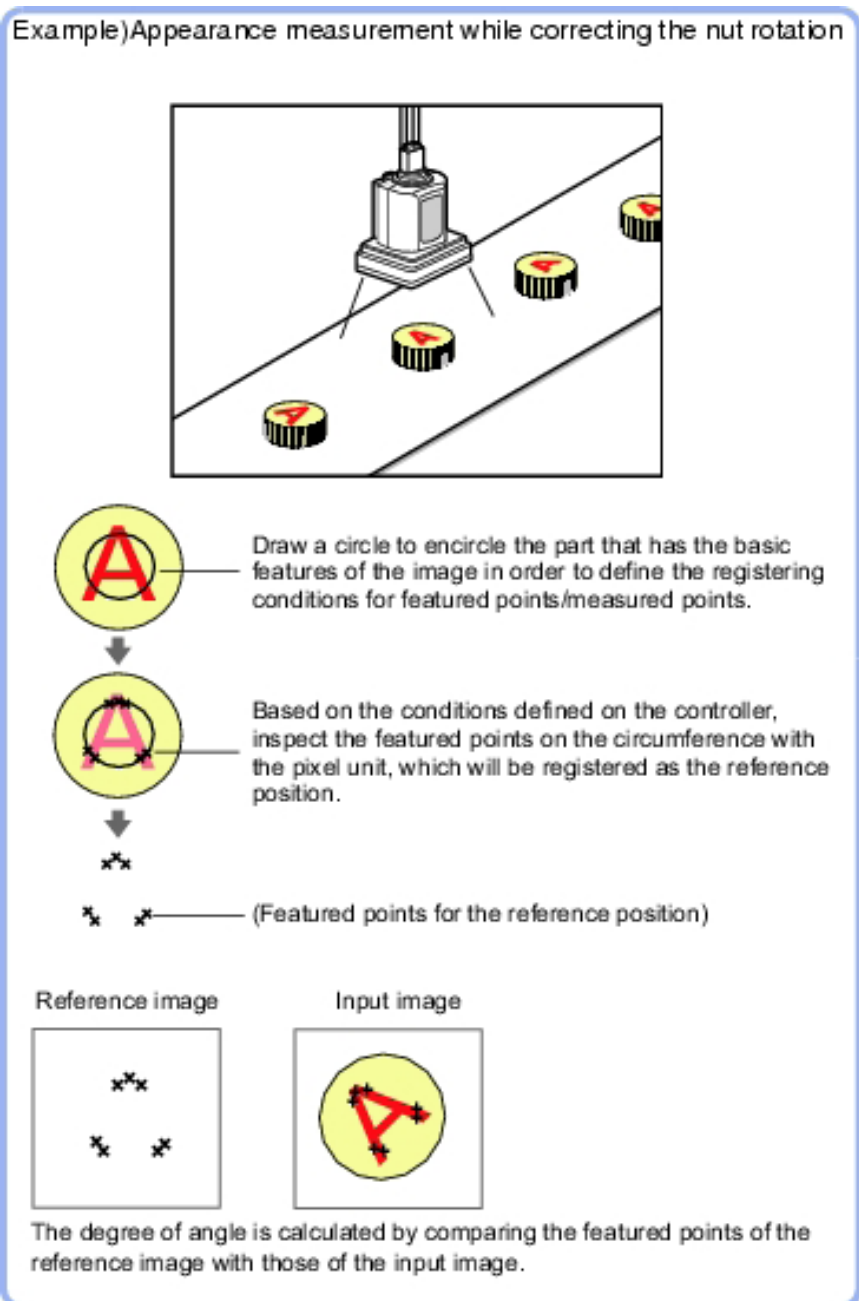

- When drawing the measurement region, the featured part should lie on the circumference.



## 4.18 Barcode

Read in barcodes.

Processing can also classify the read-in results.

- To read in barcodes and output them to an external device

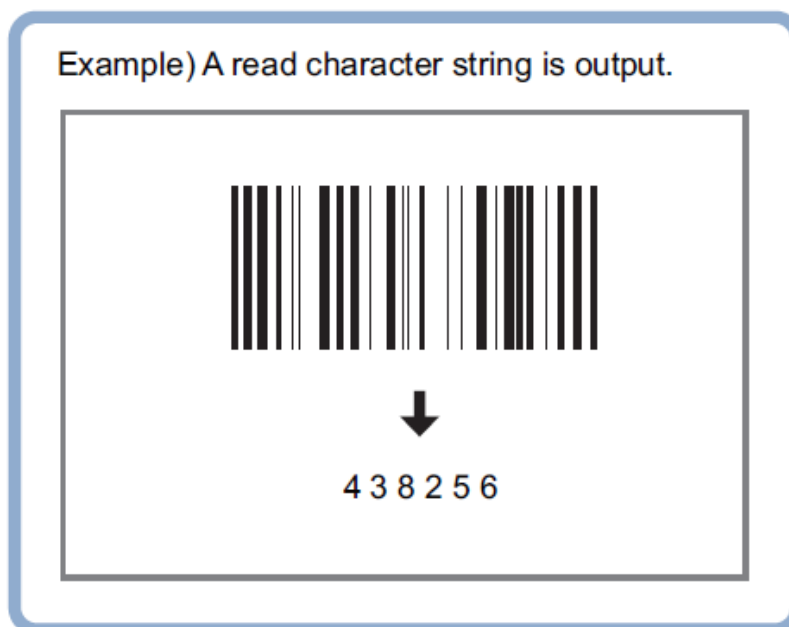

Setting item	Set value [Factory default]	Description
Code Type	<ul style="list-style-type: none"> <li>• [JAN/EAN/UPC]</li> <li>• Code39</li> <li>• Codabar</li> <li>• ITF</li> <li>• Code93</li> <li>• Code 128/GS1-128</li> <li>• GS1 DataBar</li> <li>• Pharmacode</li> </ul>	<p>Select the code type for the code to read.</p> <ul style="list-style-type: none"> <li>• JAN/EAN/UPC: Read JAN/EAN/UPC-format barcodes.</li> <li>• Code39: Read Code39-format barcodes.</li> <li>• Codabar: Read Codabar(NW-7)-format barcodes.</li> <li>• ITF: Read ITF(Interleaved 2 of 5)-format barcodes.</li> <li>• Code93: Read Code93-format barcodes.</li> <li>• Code 128/GS1-128: Read barcodes in the Code128/GS-128 and GS1-128 Composite Code (CC-A, CC-B, CC-C) formats.</li> <li>• GS1 DataBar: Read barcodes in the GS1 DataBar* (Truncated, Stacked, Omni-directional, Stacked Omni-directional, Limited, Expanded, Expanded Stacked) and GS1-DataBar Composite Code (CC-A, CC-B) formats.</li> <li>• Pharmacode: Read Pharmacode-format barcodes.</li> </ul>



## 4.19 2D Code

Read in 2D Code. Printing quality evaluation based on ISO standards is supported.

Applicable standards: ISO/IEC 15415 (The data matrix standard in ECC 200 is supported) and ISO/IEC 15416.

With 2D Code, detailed communication and reading result can be output.

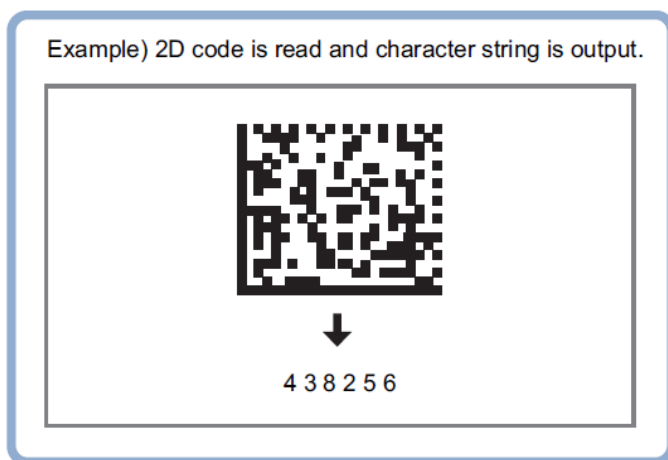

Setting item		Set value [Factory default]	Description
Common			
	Code type	<ul style="list-style-type: none"> <li>• [Auto]</li> <li>• DataMatrix</li> <li>• QRCode</li> <li>• MicroQR</li> <li>• PDF417</li> <li>• MicroPDF</li> </ul>	Set the code type. The symbol sizes that can be read in are as follows. DataMatrix: Symbol size 64 × 64 max. QRCode: Symbol size 57 × 57 max. (Version 10)
	Code color	<ul style="list-style-type: none"> <li>• [Auto]</li> <li>• Black</li> <li>• White</li> </ul>	Specify the color of the 2D Code to read. Auto: Select to automatically determine the color setting. Black: Select this for black 2D Code with white background. White: Select this for white 2D Code with black background.
	Code length: Auto	<ul style="list-style-type: none"> <li>• [Checked]</li> <li>• Unchecked</li> </ul>	Place a check when automatically determining the code length.
	Code length	50 to 2448 [50]	Specify the code length.
	Mirror setting	<ul style="list-style-type: none"> <li>• [Auto]</li> <li>• Normal</li> <li>• Reverse</li> </ul>	Specify whether to reverse the image horizontally.
	Magnify level: Auto	<ul style="list-style-type: none"> <li>• [Checked]</li> <li>• Unchecked</li> </ul>	Select whether to automatically set the reduction ratio of images when reading code.
	Magnify level	<ul style="list-style-type: none"> <li>• 0 to 4</li> <li>• [0]</li> </ul>	Set the reduction ratio for images when reading code. It is determined by the teaching process.

## 4.20 OCR / Character Inspection

These processing items provide the functions that are required for inspections of characters such as dates and lot codes.

Characters in images can be recognized and read as text information using the internal font information without the need to prepare dictionary data. You can also prepare a custom user dictionary to recognize characters in special fonts.

OCR provides a higher level of recognition stability than character inspection when reading closely spaced characters, curved text strings, and other deviational characters. Setup is easy because there is no need to create a dictionary.

Example: Inspection of expiration date, lot number, or other text printed on a curved surface such as a can or bottle.

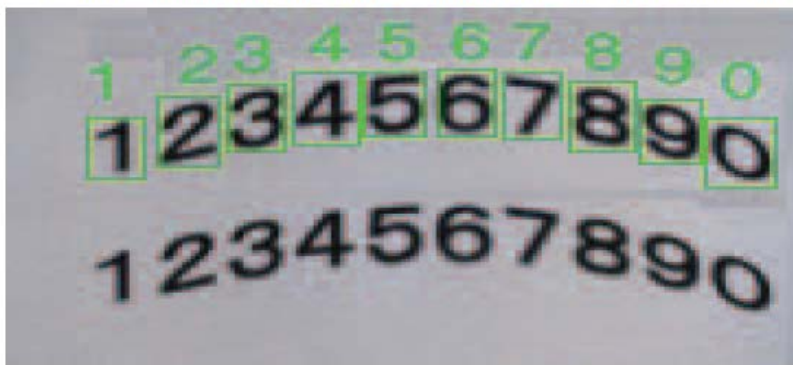

Example: Inspection of manufacturing date, expiration date, or other text printed on a package or label.

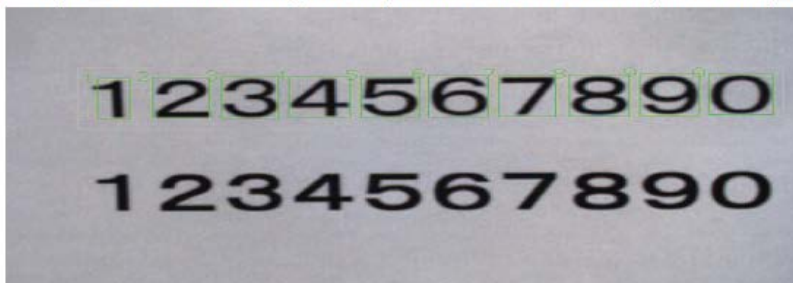

\* The OCR function recognizes alphabetical text strings in capital letters.

## 4.21 Date Verification

This processing item creates a target string from the current date/time and compares it with read-in strings from [Character Inspection].

- When inspecting date of manufacture

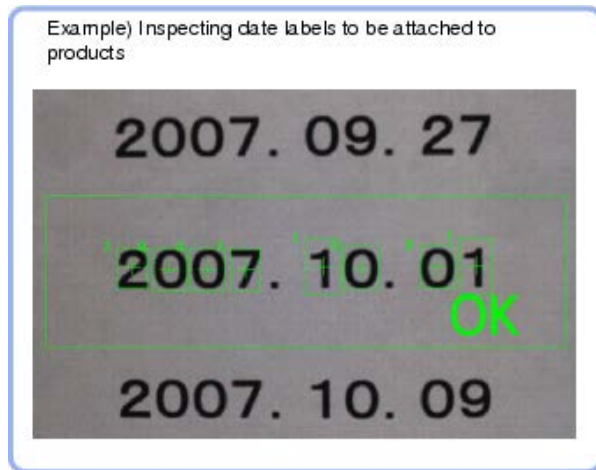

- "Target string expression"  
In the "Target string setting"



Label	Description
0 to 9	Normal numeric value input
A to Z	Normal alphabet input
' - . : /	Normal mark input
*	Character presence judgment
\$	Number judgment
mYY	last two digits of the current year
mYYYY	Four digits of the current year
mMM	Current month
mDD	Current day
mRR	Current hour
mNN	Current minute
vYY	The last two digits of the year after a set period of time
vYYYY	Four digits of the year after a set period of time
vMM	Month after a set period of time
vDD	Day after a set period of time
eY1	Encrypted year 1
eM1	Encrypted month 1
eD1	Encrypted day 1
eR1	Encrypted hour 1
eN1	Encrypted minute 1

## 4.22 Image Logging

This is used when saving measurement images to on-board memory, RAMDisk or USB memory.

This enables preparation of logging conditions using an expression and is more flexible than the system image logging conditions settings.

However, the settings of this unit are enabled if "None" is set on the [Logging setting] of the main screen [Measure] menu.

If settings that perform image logging for multiple units during measurement are executed, the last settings executed are enabled.

- This is used when saving logging images under specific conditions.

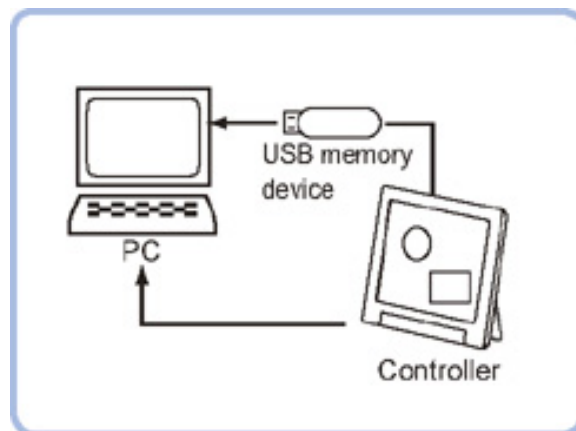

- Logging Conditions

Logging condition

Condition :  None  Only NG  All

Arithmetic expression :

Arithmetic result : 0.0000

Judgment condition :  -

Setting item	Set value	Description
Logging condition	[None]	No images are saved.
	Only NG	Saves images only if an NG occurs. If an NG occurs downstream from the image logging processing unit, image logging is not performed. Insert image logging as close to the end of the scene as possible
	All	All measured images are saved.

## 4.23 Data Output

- Output data to the external devices such as programmable controller and PC with the no-order mode via the serial interface.

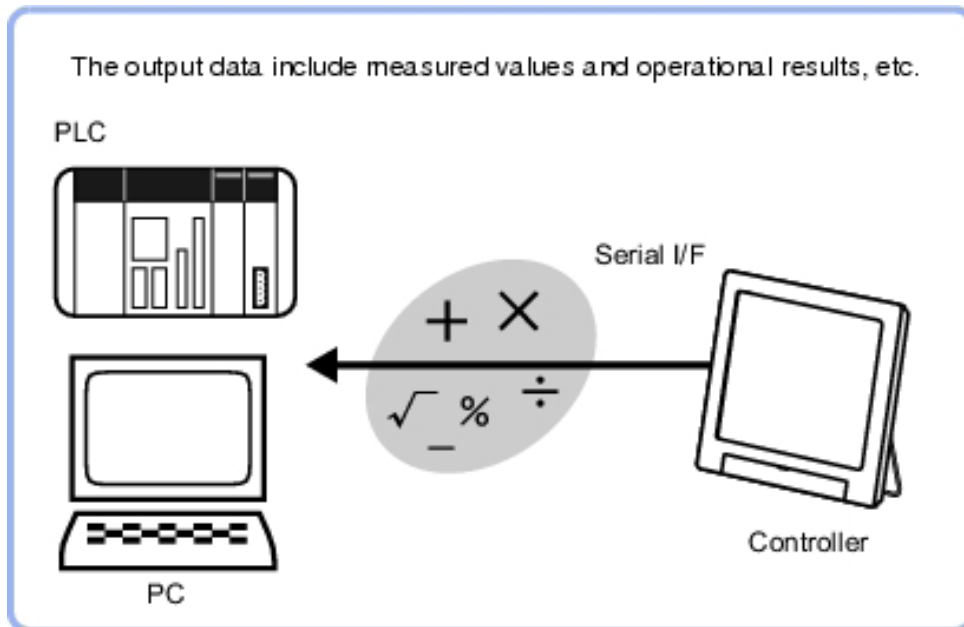

- Settings

Set up the output contents with the expression.

Up to 8 expressions including 0 to 7 can be set in each unit.

- Output Format

Output Setting

Communication method :

RS-232C/RS-422       Ethernet

Format setting :

Output form :       ASCII       Binary

Digits of integer :       Digits

Digits of decimal :       Digits

Set value	Description
[RS-232C/RS-422]	Communication is performed via a RS-232C/RS-422 connection.
Ethernet	Communication is performed via the Ethernet.
[ASCII]	Outputs in the ASCII format.
Binary	Outputs as binary data. Measurement values are multiplied by 1000 and output is continuous with 4 bytes per each data item.

## 4.24 Position compensation

The positional deviation of measurement objects can be corrected using measured values saved by other processing units. Compare the measured coordinates with the reference coordinates of the applicable processing unit, and move the image by the amount of the difference.

- Even with different positions for the same measurement object, correct measurement can still be performed by correcting the position of the input image. There is no need to reposition the measurement object itself.

Example) Using the searched position to perform position compensation

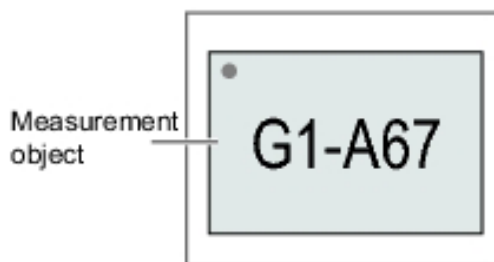
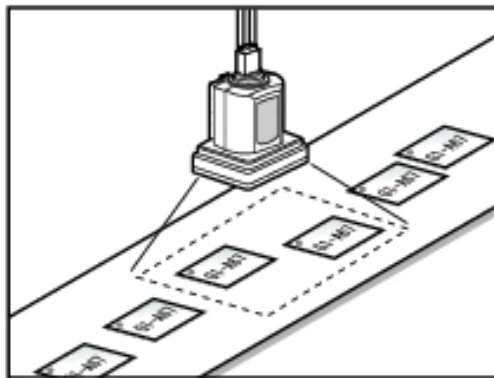

0. Camera Image Input

1. Search

2. Position Compensation

Use the measurement values (searched measurement coordinate of X and Y) of the previous unit to modify the position of the measurement object

# 5. Appendix

## 5-1 Processing item guidelines

Application-oriented measurement can be configured by combining processing items or changing the settings of processing items.

### Position Compensation

Marking for position compensation?

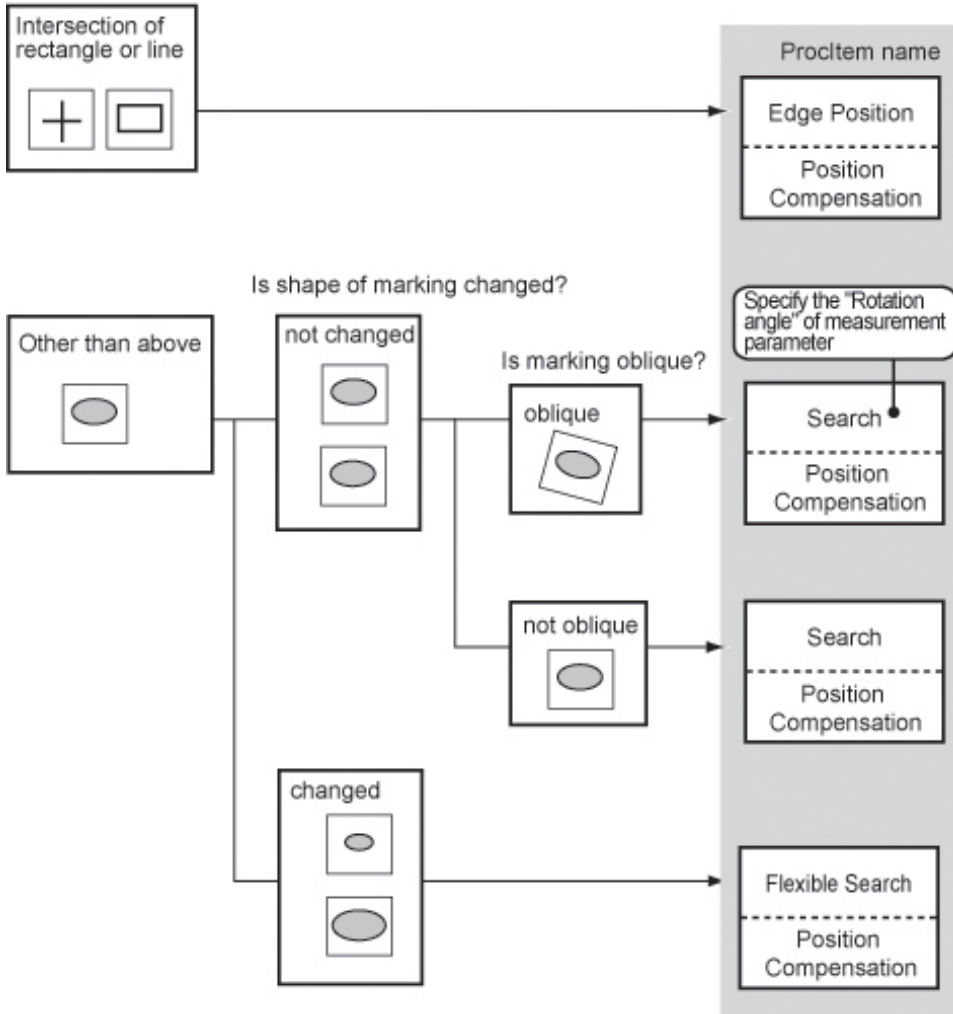

# Locating (Measurement Objects Not Inclined)

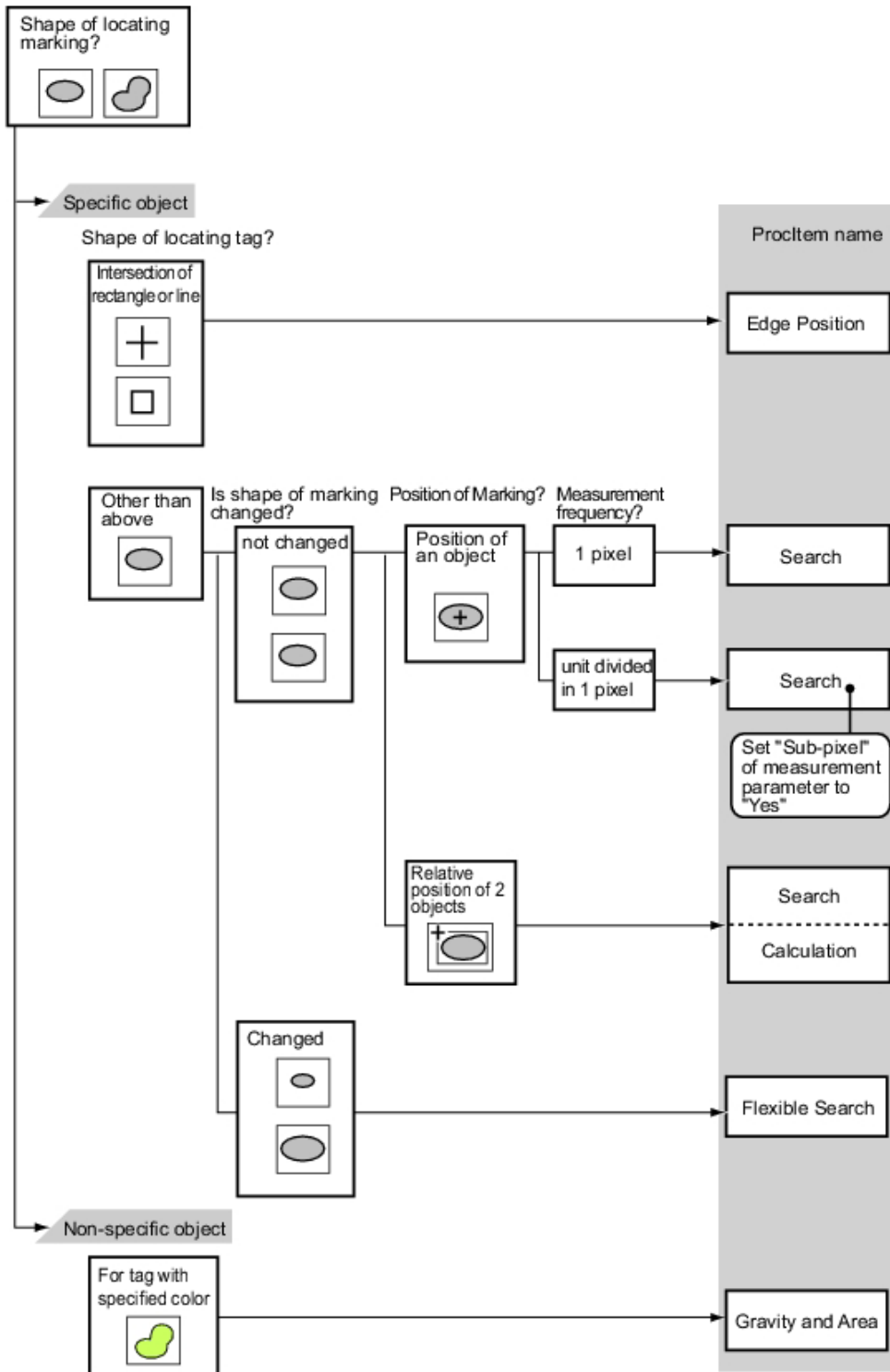



## Locating (Measurement Objects Inclined)

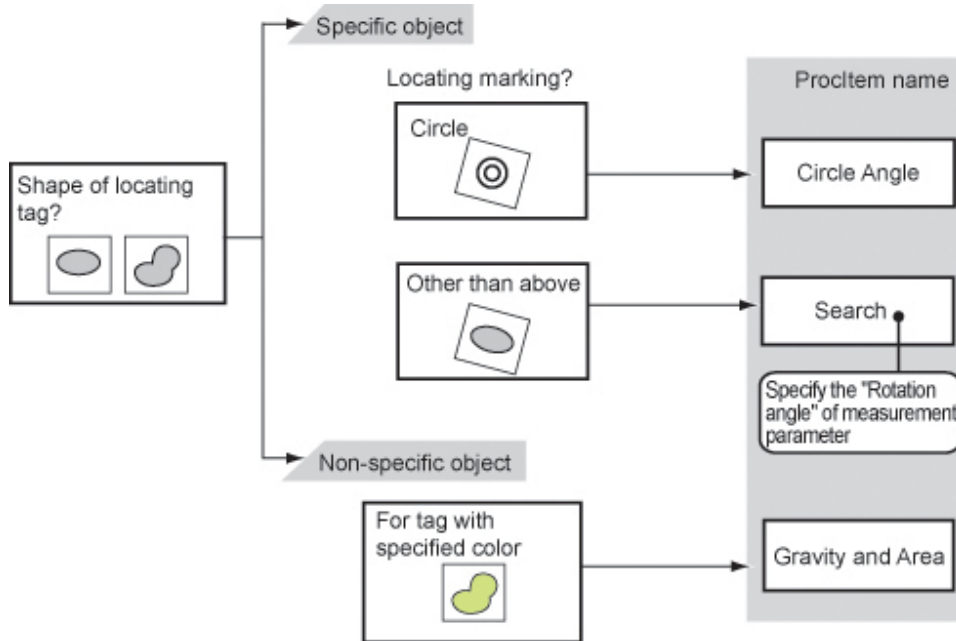

## Internal and External Inspection

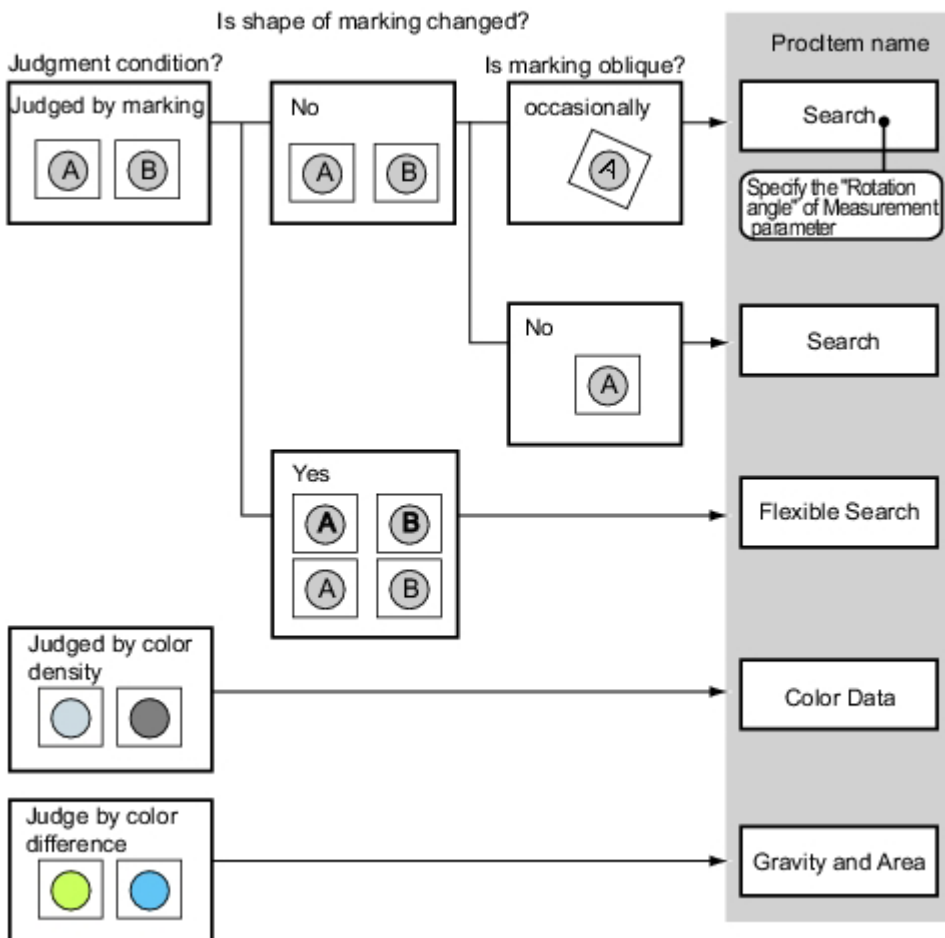

## Presence Inspection

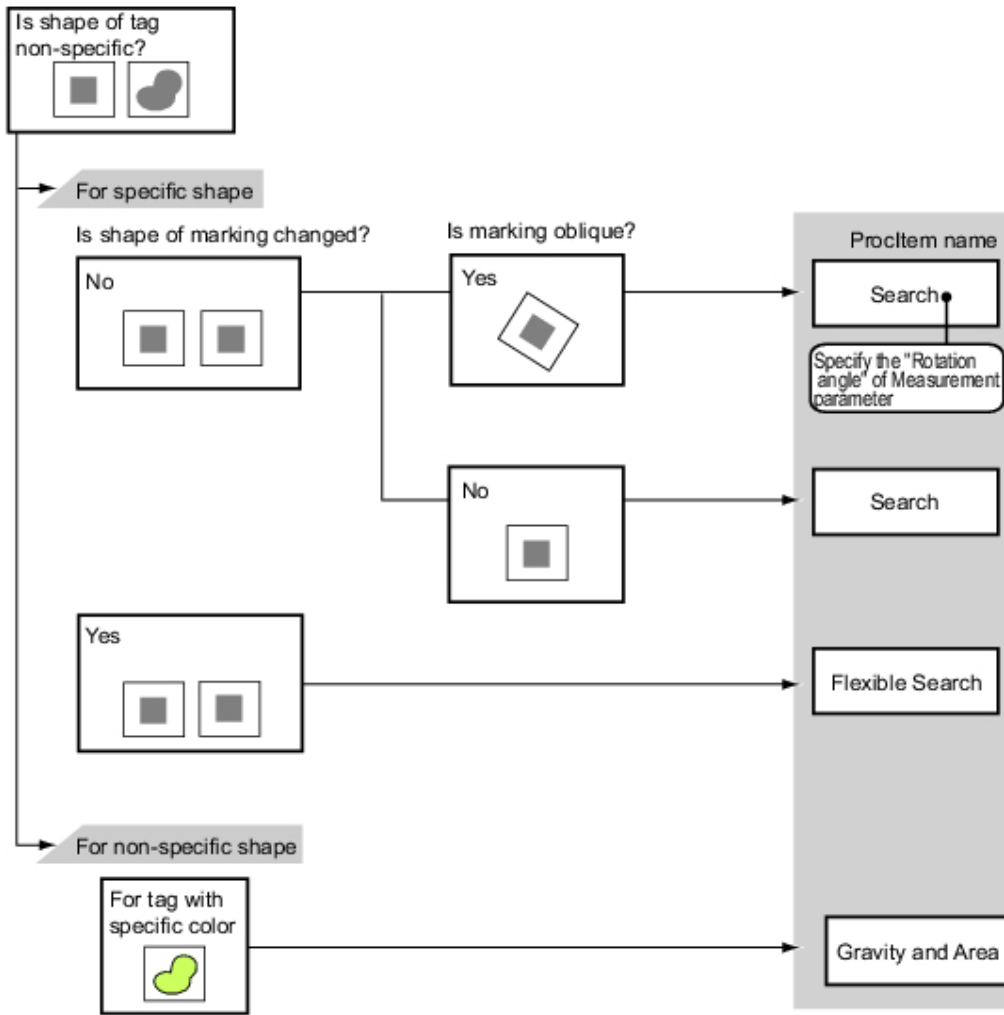

## Dimension Inspection/Measurement



## Burr Inspection

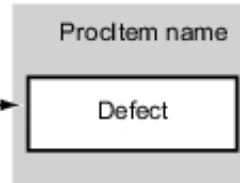
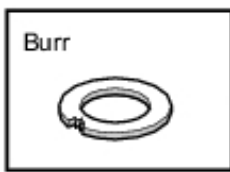

## Text Comparison/Inspection

Do you want to set the date to be checked automatically?

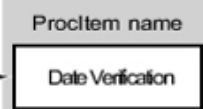
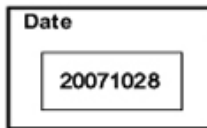

Are the character types more than two?

Yes

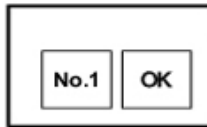

No

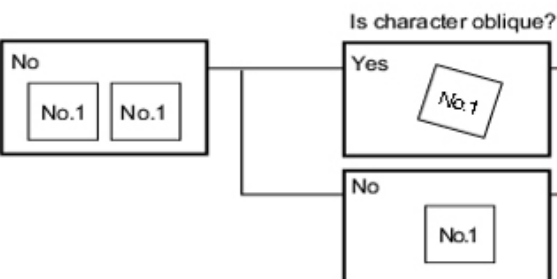
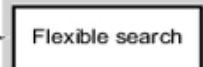
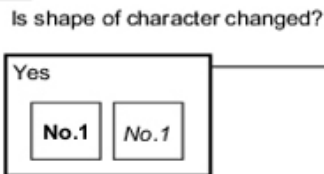

Specify the "Rotation angle" of measurement parameter



## Defect/Contamination Inspection

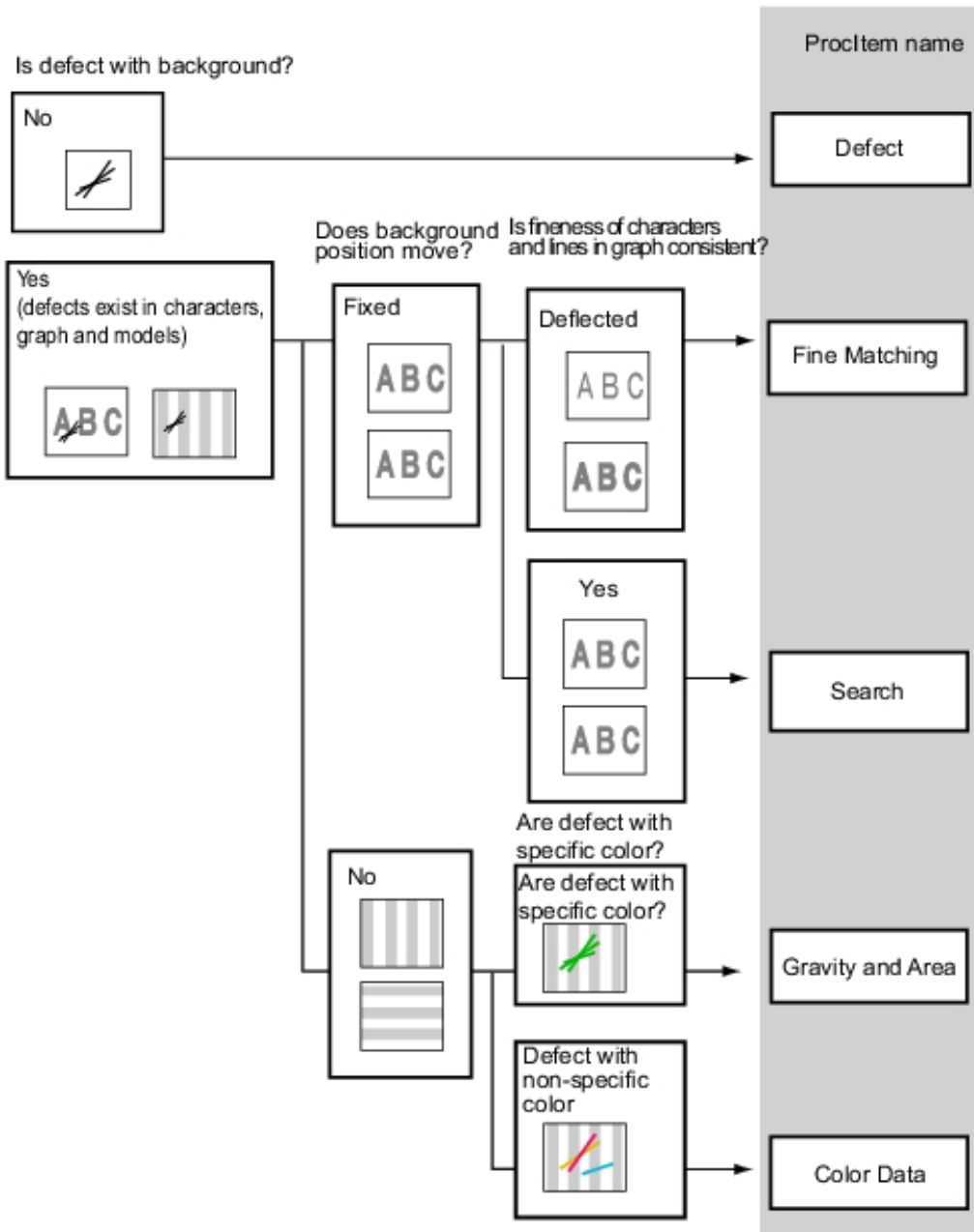

## Quantity Inspection/Measurement



## Inspection for Presence of Different Objects

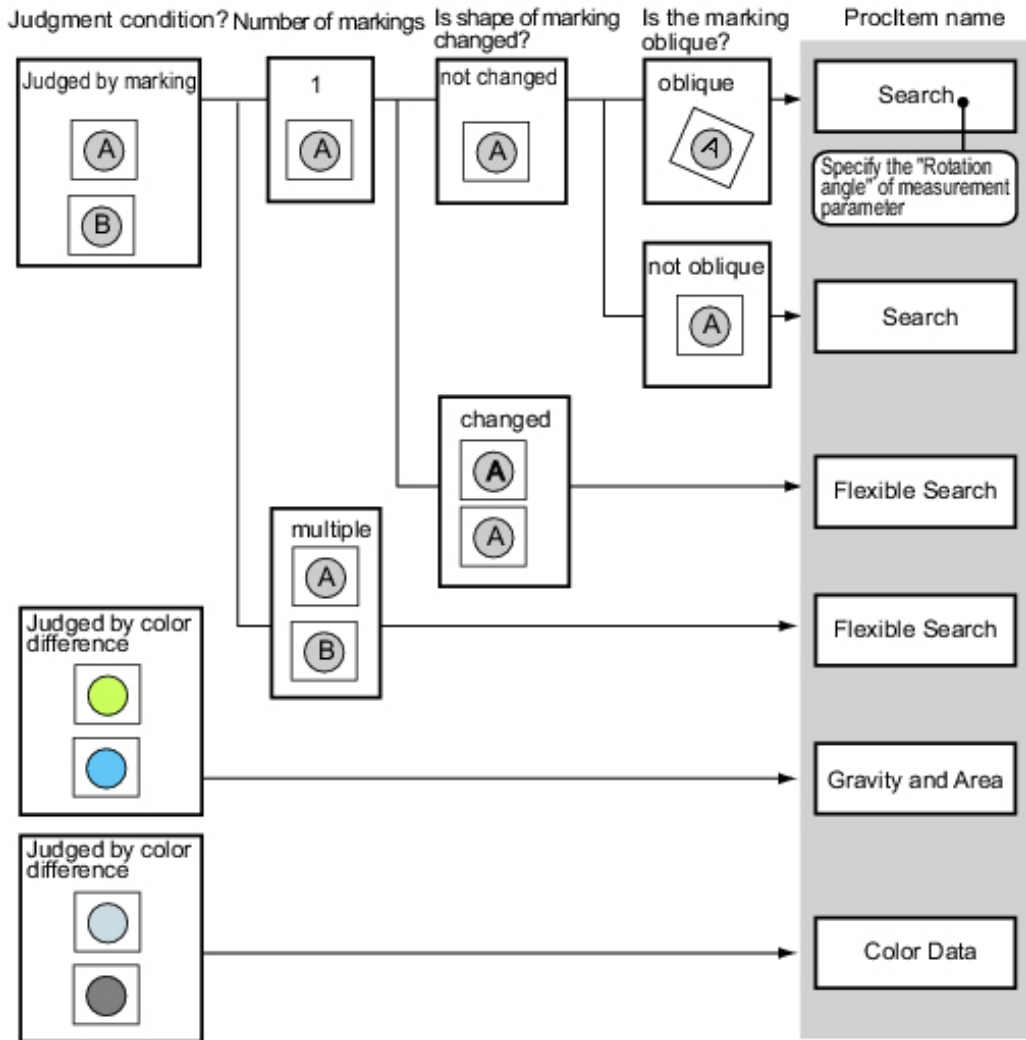

## Hole Position Measurement

