

Model D41G

High-Coded Guard Lock Safety-Door Switch

EN Instruction Manual

Thank you for purchasing Omron products. This product is a high-coded safety door switch. Please read and understand this document before using the products. Keep this document ready to use whenever needed. Only qualified person trained in professional electrical technique should handle the product. Please consult your Omron representative if you have any questions or comments. Make sure that information written in this document are delivered to the final user of the product.

OMRON Corporation

© OMRON Corporation 2021 All Rights Reserved. Original Instructions 5673897-0B

D41G is designed for safety circuits and is used to monitor the position of movable guards.

EU Declaration of Conformity

OMRON declares that the D41G is in conformity with the requirements of the following EU Directives: Machinery Directive 2006/42/EC RE Directive 2014/53/EU

Standards

D41G is designed and manufactured in accordance with the following standards:
 

- EN ISO 13849-1: 2015 PL e, Category 4
- EN 60947-5-3
- EN 300 330
- EN 61508
- EN 62061
- EN ISO 14119

Dispose in accordance with applicable regulations.

Safety Precautions

WARNING

Indicates a potentially hazardous situation which, if not avoided, will result in minor or moderate injury, or may result in serious injury or death. Additionally there may be significant property damage.

Alert Statements

WARNING

Use only appropriate components or devices complying with relevant safety standards corresponding to the required performance level and safety category. Failure to do so may result in serious injury or death. Conformity to requirements of the performance level and safety category must be determined as an entire system. It is recommended to consult a certification body regarding assessment of conformity to the required safety level.

Do not apply DC voltages exceeding the rated voltages, nor any AC voltages to the product. Failure to do so may result in serious injury or death.

Install the switch and actuator in a position where the opening of the guard door can be detected within a safe distance. Failure to do so may result in serious injury or death.

Do not apply force exceeding the specified holding force (Fzh). Either install another locking component (e.g., a hook) in addition to the product, or use a warning measures or an indicator showing the controlled system is locked to avoid overloading the holding force in lock mode. Failure to do so may result in serious injury or death.

When complying with safety standards, install the product in an appropriate manner in accordance with ISO 14119, with due consideration of the risk of defeat by the operator. Failure to do so may result in serious injury or death.

Make sure that the DC power supply meets the following items. Failure to do so may result in serious injury or death.
 

- Satisfies the requirements of PELV power supply defined in IEC 60204-1.
- Satisfies the requirements of class 2 circuits defined in UL508.

Precautions for Safe Use

- 1) Disconnect the product from power supply when wiring the product. Failure to do so may cause unexpected operation of devices connected to the product.
- 2) Wire the input and output terminals correctly and verify the correct operation of the product before using the system in which the product is incorporated. Incorrect wiring may lead to loss of the safety function.
- 3) Install the actuator in a place where it will not come in contact with your body when opening or closing the guard door. Failure to do so may result in injury.
- 4) Do not use the product in any direction other than the specified mounting orientations of the main body and actuator.
- 5) Dispose of the product in accordance with the laws set by each country.

6) When the door is closed (with the actuator inserted), the actuator may be pushed back beyond the mounting play due to the weight of the door or the cushioning rubber of the door. Secure the door with a hook or by similar means so that it stays within the mounting play. (Refer to the D41G actuator's Quick Installation Manual.)

Precautions for Correct Use

- 1) Do not drop the product to the ground or expose to excessive vibration or mechanical shocks. Doing so may damage the product and cause failure.
- 2) Do not store or use the product under the following conditions. Doing so may damage the product and cause failure.
  - 1) At ambient operating temperatures out of the range of -10 to 55°C
  - 2) At ambient storage temperatures out of the range of -10 to 55°C
  - 3) At relative humidity of 93% or more
  - 4) In direct sunlight
  - 5) Under drastic temperature changes
  - 6) In high humidity that causes condensation
- 3) Keep the product away from oil or solvent. Oil or solvent make the marking on the product illegible and cause deterioration of some parts.
- 4) Do not use in an environment with corrosive gas.
- 5) The product may not operate normally in the vicinity of devices that generate strong radio waves or magnetic fields, such as RFID systems, proximity sensors, motors, inverters, and switch-mode power supplies. If the device is used in the vicinity of such devices, check the effect before use.
- 6) Installing the switch and the actuator on a metallic material may affect the operating distance. If installation on a metallic material is necessary, be sure to check the effect on the operating distance before use.
- 7) Tighten the screws with a specified torque.
- 8) Use the wires specified by OMRON to wire the product. (Refer to Connection.)
- 9) Do not extend the cables in excess of the specification of this product. Carry out electrical connection according to the wiring examples shown in this document and verify the correct operation of the product.
- 10) Do not pull or bend the cable excessively. A disconnection may cause a malfunction.
- 11) Risk time remains unchanged by series connection. However, carry out electrical connection according to the wiring examples shown in this document.
- 12) Be sure to inspect the product daily and every 6 months. Failure to do so may cause a system failure and serious injury.
- 13) When determining the safety distance, take into account the delay of the output of the product caused by the response time. Failure to do so may cause the operator to reach the hazardous source before the machine is stopped, resulting in serious injury.
- 14) During installation, make sure that the safety door switch does not come in contact with the actuator due to rattling of the guard door. (The performance of the product may be degraded by a collision caused by opening or closing the guard door.)
- 15) Install the product so that the LED indicators of the safety door switch are as visible as possible. Misinterpreting the status of the safety door switch may result in danger.
- 16) Do not use the product at an altitude of 2,000 m or higher.
- 17) Do not connect a product different from this product in series with this product. Doing so may disturb waveforms of the input and output signals, leading to loss of the safety function.
- 18) Do not use the product in the water or continuous water exposure environment. Doing so may cause water to leak into the product. (The degree of protection does not guarantee the protection under continuous water exposure environment.)
- 19) Do not tamper the product with a replacement actuator. Store replacement actuators in a safe place where they cannot be easily reached.
- 20) Build a safety system using the outputs of both Safety Outputs 1 and 2. Wiring with only one safety output may lead to loss of the safety function due to a single failure.
- 21) Wiring should meet the requirements specified in Section 9.4.3 of IEC 60204-1 to prevent malfunction due to ground faults in the safety output lines.
- 22) In the power-to-lock type, close the door before energizing the safety door switch.
- 23) In the power-to-lock type, the safety door switch is locked only when the solenoid is energized. If the solenoid is de-energized due to a sudden power failure, the operator may be exposed to a hazardous source. Use the power-to-lock type only for process protection.
- 24) Do not use the emergency-exit type for switching the machine on and off. Doing so may place operators at risk due to being trapped inside or unexpected operation of the machine.
- 25) Install the emergency-exit type so that it cannot be operated from outside a safety zone.
- 26) Do not apply excessive force on the actuator while the actuator is inserted into the switch body or do not drop the product. Doing so may deform the actuator or damage the switch body.
- 27) Insert the actuator with a tolerance of ±1.5mm for X, ±5.0mm for Y and ±1.0mm for Z to the center of the key hole. Misalignment or tilting may cause premature wear or damage. (Refer to the D41G actuator's Quick Installation Manual for the corresponding actuator.)
- 28) The safety function may not operate normally due to a malfunction of the wiring, setting, or switch, and the machine may continue to operate, which may result in personal injury. Make sure that the safety function works before starting operation.
- 29) Do not pull on lead wires with excessive force. Doing so may cause loose connection.
- 30) The current consumption of the safety door switch is different between when it is turned on and when it is in a normal operation. Apply the supply voltage to the safety door switch in consideration of the voltage drop in the wiring.
- 31) Do not turn beyond the latching point. After being put into operation, the manual release must be secured by closing the cover with the seal, which is included in delivery.
- 32) After installation of the product, qualified personnel should verify to see that the installation, inspection, and maintenance are properly performed. The qualified personnel should be qualified and authorized to secure the safety on each phase of design, installation, running, maintenance and disposal of system.
- 33) Do not wire the product to an input of a safety controller in parallel.
- 34) Disconnect the product and the controller connected to the product from power supply when replacing the product. Failure to do so may cause unexpected operation of devices connected to the product.
- 35) Install the product to a position near a handle of the guard door. Installing it near a hinge may cause the locking part of the product to receive larger load than the operating force, leading to damage to the locking mechanism.
- 36) Do not use the product as a door stopper. (The performance of the product may be degraded due to a collision caused by opening and closing the guard door.)
- 37) Do not try to disassemble, repair, or modify the product. Doing so may cause loss of the safety function.
- 38) Be sure to attach the cover after wiring work. Also, do not energize with the cover open. There is a risk of electric shock.
- 39) Do not operate the product in an environment with flammable or explosive gas.
- 40) Auxiliary output is NOT a safety output. Do not use the Auxiliary output individually for any safety function. Such incorrect use causes loss of the safety function of the product and its relevant systems.

Ratings and Specifications

Model	D41G	
<b>Technical</b>		
Detection method	RFID	
Frequency band	125 kHz	
Transmitter outputs	-6 dBm max.	
Interface type (ISO 14119)	Type 4	
Coded level (ISO 14119)	D41G-1: High (individual coding) D41G-2: High (individual coding re-teaching enabled)	
Actuator (*1)	D41G-A1, D41G-A2	
Response time (ON to OFF)	100 ms max.	
Response time (input)	1.5 ms max.	
Risk time	200 ms max.	
Startup time	4 s max.	
<b>Electrical</b>		
Supply voltage (Ue)	24 VDC -15%/+10% (stabilized PELV power supply)	
Current consumption (Io)	0.05 A max.	
Overvoltage category	III	
Pollution degree	3	
Operating current device with magnet switched on	Average < 0.2 A Peak < 0.7 A/100 ms	
Conditional short-circuit current	100 A	
External device fuse rating	Screws or cage clamps 4 A max. (UL508 compliant) Connector M12 2 A max.	
Safety input	Switching thresholds	-3 to 5 V (low) 15 to 30 V (high)
	Current consumption per input	2 mA/24 V (typical)
	Accepted test pulse duration on input signal	1.0 ms max.
	Test pulse interval	100 ms min.
Safety output (OSSD)	Switching element	PNP type, short-circuit proof
	Utilization category	DC-13: 24 VDC (Ue)/0.25 A (Ie)
	Rated operating current (Ie)	Each 0.25 A max.
	OFF-state leakage current (Ir)	0.5 mA max.
	Voltage drop (Ud)	4 V max.
	Cross-wire monitoring by device	Yes
Auxiliary output	Switching element	PNP type, short-circuit proof
	Utilization category	DC-13: 24 VDC (Ue)/0.05 A (Ie)
	Rated operating current (Ie)	0.05 A max.
	Voltage drop (Ud)	4 V max.
Solenoid	Switching thresholds	-3 to 5 V (low) 15 to 30 V (high)
	Power consumption	10 mA/24 V (typical) 20 mA (dynamic)
	Duty ratio solenoid (ED)	100 %
	Accepted test pulse duration on input signal	5.0 ms max.
<b>Protection class</b>		
Switching frequency	III	
Rated insulation voltage (Ui)	1 Hz max.	
Rated impulse withstand voltage (Uimp)	32 VDC	
Minimum operating current (Im)	0.8 kV	
<b>Mechanical</b>		
Fixing screws	2 × M6	
Tightening torque of fixing screws	8 N·m	
Tightening torque of cover screw	0.7 to 1.0 N·m (Torx T10)	
Latching force	30 N	
Holding force (Fzh) (min.)	2,000 N	
Operating speed	0.2 m/s max.	
Mechanical durability	1,000,000 operations min.	
Material	Fiberglass reinforced thermoplastic self-digestion (enclosure)	
Weight	Unit: <510 g, Packaged: <600 g	
<b>Environmental</b>		
Ambient operating temperature	-10 to 55°C	
Ambient operating humidity	93% max. (non-condensing, non-icing)	
Degree of protection (IEC 60529)	IP66 and IP67	
Vibration resistance	10 to 150 Hz, amplitude 0.35 mm	
Shock resistance	30 g/11 ms	
<b>Connection</b>		
Series connection	31 max. (*2)	
Cable lengths	40 m max. (between switch and power supply)	
<b>Connection</b>		
Connection	Screw terminal or connector M12	
Cable type	Rigid single-wire, rigid multi-wire or flexible	
Cable section	0.25 mm <sup>2</sup> min. 1.5 mm <sup>2</sup> max. (including conductor ferrules)	
Cable entry	M20	

\*1. D41G-A1 is suitable for sliding safety guards and D41G-A2 is for hinged safety guards.  
 Only if the information described in this operating instructions manual are realized correctly, the safety function and therefore the compliance with the Machinery Directive are maintained.  
 \*2. Refer to the product catalog for connection specifications with the controller.

Safety classification information

Safety classification (interlocking function)	
Standard	ISO 13849-1, IEC 61508, IEC 62061
PL	e
DC	99 %
Safety category	4
PFH	1.9 × 10 <sup>-9</sup> /h
PFD	1.6 × 10 <sup>-4</sup>
SIL	Suitable for SIL3 applications
Mission time	20 years

Safety classification (guard lock function)	
Standard	ISO 13849-1, IEC 61508, IEC 62061
PL	d
DC	99 %
Safety category	2
PFH	1.0 × 10 <sup>-9</sup> /h
PFD	8.9 × 10 <sup>-4</sup>
SIL	Suitable for SIL2 applications
Mission time	20 years

- Note: 1. The actuation of the interlock must be compared with the external OSSD enabler. If a shut-down now occurs due to an unintentional unlocking this is detected by an external diagnostic.  
 Note: 2. The safety consideration of the guard locking function only applies for monitored safety door switch D41G-\*Y.  
 Note: 3. If for a certain application the power-to-unlock type of a safety door switch cannot be used, then for this exception the power-to-lock type of a safety door switch can be used if additional safety measure need to be realized that have an equivalent safety level.  
 Note: 4. The safety analysis of the guard locking function refers to the component safety door switch as part of the complete system. In the event of a fault resulting in the unlocking of the guard locking, this is detected by the safety outputs Y1/Y2 of the safety door switch switch off. When such a fault occurs the protection equipment may open immediately, just once, before the safe condition of the machine is reached. The system reaction of category 2 allows that a fault can occur between tests causing the loss of the safety function which is detected by the test.  
 Note: 5. If multiple safety door switches are involved in the same safety function, the PFH values of the individual components must be added.

Use isolated power supply only. For use in NFPA 79 Applications only. Adapters providing field wiring means are available from the manufacturer. Refer to manufacturers information.

This device complies with part 15 of the FCC Rules and Industry Canada license-exempt RSS standard(s). Operation is subject to the following two conditions: (1) This device may not cause harmful interference, and (2) this device must accept any interference received, including interference that may cause undesired operation.

This device complies with the Nerve Stimulation Exposure Limits (ISED RSS-102) for direct touch operations. Changes or modifications not expressly approved by OMRON Corporation could void the user's authority to operate the equipment.

Le présent appareil est conforme aux CNR d'Industrie Canada applicables aux appareils radio exempts de licence. L'exploitation est autorisée aux deux conditions suivantes: (1) l'appareil ne doit pas produire de brouillage, et (2) l'utilisateur de l'appareil doit accepter tout brouillage radioélectrique subi, même si le brouillage est susceptible d'en compromettre le fonctionnement.

Cet appareil est conforme aux limites d'exposition relatives à la stimulation des nerfs (ISED CNR-102) pour les opérations tactiles directes. Changements ou modifications non expressément approuvés par OMRON corporation pourrait annuler le droit de l'utilisateur à utiliser l'équipement.

Dimensions

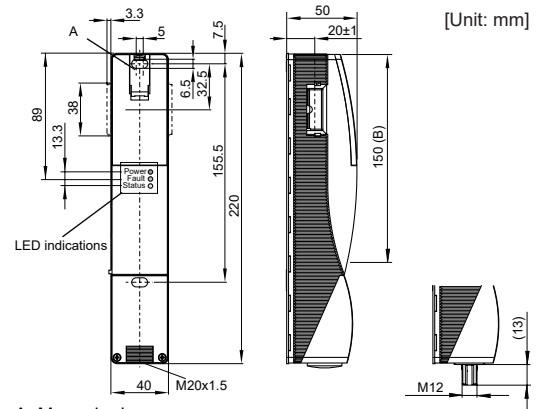

A: Manual release cover  
 B: Active RFID area

Mounting

For fitting the safety door switch, two mounting holes for M6 screws with washers (washers included in delivery) are provided. (tightening torque: 8 N·m) The safety door switch must not be used as a door stopper. Any mounting position. The mounting position however must be chosen so that the ingress of dirt and soiling in the used opening is avoided. The unused actuator opening must be sealed by means of the dust-proof cover (included in delivery).

Minimum distance between two safety door switches as well as other systems with same frequency (125 kHz): 100 mm.

Manual Release

For the machine set-up, the safety door switch can be unlocked in a de-energized condition. After opening of the manual release cover "A" (refer to image "Dimensions"), the triangular key must be turned clockwise to bring the blocking bolt in unlocking condition. The normal locking function is only restored after the triangular key has been returned to its original position.

Component ready for operation      Component not ready for operation

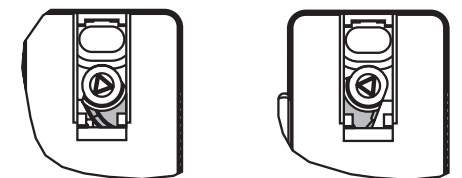

Actuator

Mounting of the safety door switch and the actuator Refer to the D41G actuator's Quick Installation Manual for the corresponding actuator. The actuator must be permanently fitted to the guard doors and protected against displacement by suitable measures (tamper-proof screws, gluing, drilling of the screw heads).

Teaching

Individually coded safety door switch and actuators will require the following teach-in procedure:

1. Keep the actuator away from the detection range and switch the safety door switch's voltage supply off and back on.
2. Introduce the actuator in the detection range. The teach-in procedure is signaled at the safety door switch, green LED off, red LED on, yellow LED flashes (1 Hz).
3. After 10 seconds, the yellow LED gives brief cyclic flashes (3 Hz). Switch off the supply voltage of the safety door switch. (If the voltage is not switched off within 5 minutes, the safety door switch cancels the teach-in procedure and signals a false actuator by 5 red flashes).
4. Switch the supply voltage back on. The actuator must be detected once more in order to activate the taught actuator code. In this way, the activated code is definitively saved.

For ordering suffix D41G-1, the executed allocation of safety interlock and actuator is irreversible.

For ordering suffix D41G-2, the teach-in procedure for a new actuator can be repeated an unlimited number of times. When a new actuator is taught, the code, which was applicable until that moment, becomes invalid. Subsequent to that, the safety outputs will be disabled for ten minutes, thus providing for an increased protection against intentional tampering. The green LED will flash until the expiration of the time (10 minutes) of the enabling inhibit and the detection of the new actuator. In case of power failure during the lapse of time, the 10-minutes tampering protection time will restart.

Operating Principle

Magnet control

In the power-to-unlock version of the D41G, the safety door switch is unlocked when the Solenoid Control signal (= 24 V) is set. In the power-to-lock version of the D41G, the safety door switch is locked when the Solenoid Control signal (= 24 V) is set.

If the risk analysis indicates the use of a monitored interlock then a variant (D41G-\*Y) with the monitored interlock is to be used, labelled with the symbol.

The actuator monitoring variant (D41G-\*Z) is a safety door switch with an interlock function for process protection.

Mode of operation of the safety outputs

In the D41G-\*Y, the unlocking of the safety door switch causes the safety outputs to be disabled. The unlocked guard door can be relocked as long as the actuator is inserted in the D41G safety door switch; in that case, the safety outputs are re-enabled. The guard door must not be opened.

In the D41G-\*Z, the opening of the guard door causes the safety outputs to be disabled.



## Connections

### Pin assignment

Function	Pin configuration of the connector	Color code of the OMRON's connector to DIN 47100 D41L-8P5-CFM12-9**M
24 V	U <sub>0</sub>	1
X1	Safety input 1	2
GND	GND	3
Y1	Safety output 1	4
OUT	Auxiliary output	5
X2	Safety input 2	6
Y2	Safety output 2	7
IN	Solenoid control	8

### Terminal block (suffix T1)

24V	24V	X1	X2	IN
D41G-****-T1				
GND		Y1	Y2	OUT

### Connector plug (suffix N2)

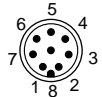

The cable entry is realized by a metric M20 gland. This gland must be measured by the user so that it is suitable for the cable used. A cable gland with strain relief and suitable IP protection class must be used.  
Length X of the cable at terminals: 8.0 mm (for screw terminals of -T1)

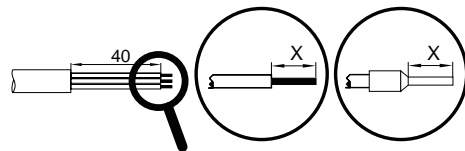

## Wiring Example

The application examples shown are suggestions. They however do not release the user from carefully checking whether the safety door switch and its set-up are suitable for the individual application.

The power supply for the safety door switch must provide protection against permanent overvoltage. To that effect, stabilized PELV supply units must be used. The safety outputs can be directly integrated in the safety circuit of the control system. For applications of PL e / safety category 4 in accordance with ISO 13849-1, the safety outputs of safety door switch or safety door switch of the chain must be connected to a safety controller or safety relay unit of the same Safety Category. Inductive loads (e.g. contactors, relays, etc.) are to be provided with suitable interference suppression circuitry. If the safety door switch is wired to relays or to non-safety relevant control components, a new risk analysis must be carried out. If the safety door switch is connected to the safety input of a safety controller or safety relay unit, the controller must have a dual-channel monitoring time of at least 100 ms and the accepted test pulse duration of at least 1 ms. Also, the cross-wire-short monitoring function must be disabled.

### D41G series connection

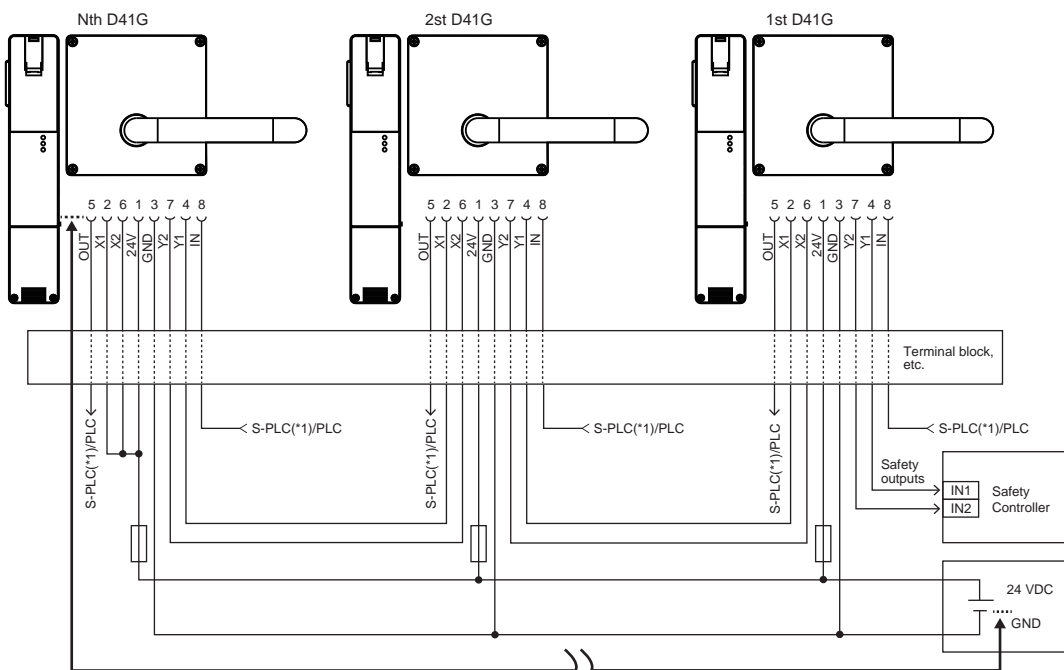

\*1. Referred to as a safety PLC.

between switch and power supply

Note: 1. Configuration of the safety For the recommended safety controller, refer to the product catalog of this product.

## Diagnostic Function

### Diagnostic LEDs

The safety door switch indicates the operating condition and faults by means of three-color LEDs located in the front surface of the safety door switch.

- Green (Power): Supply voltage on
- Yellow (Status): Operating condition
- Red (Fault): Error (refer to Table 2)

### Safety door switch with auxiliary output

The auxiliary output OUT can be used for central visualization of operating states or control functions, e.g. in a PLC. The auxiliary output is not a safety-related output.

### Behavior of the auxiliary output

(Example: power-to-unlock version)

### Input signal magnet control

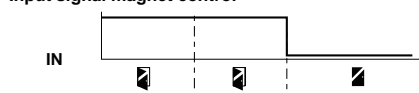

### Normal sequence, door was locked



### Door could not be locked or fault



### Key

- Guard door open
- Unlock guard door
- Locking time: 150 ... 250 ms, typically 200 ms
- Guard door closed
- Guard door locked
- Guard door not locked or fault

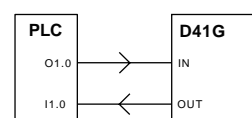

Power-to-unlock: IN = 0 = locking

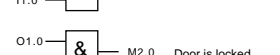
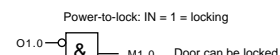
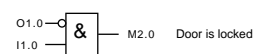
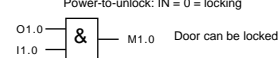

## Troubleshooting

### Error

Errors, which no longer guarantee the function of the safety door switch (internal errors) cause the safety outputs to be disabled immediately. Any error that does not immediately affect the safe functionality of the safety door switch (e.g. too high ambient temperature, interference potential at the safety outputs, cross-wire short) will lead to a warning message, disabling of the auxiliary output and a delayed shutdown of the safety outputs. (Refer to Table 2.) After fault rectification, the sensor can be reset by opening and locking the relevant guard door. The safety outputs enable and allow a restart. An interlocking chain of the safety door switch must be "locked" to enable the reactivation.

Automatic, electronic locking takes place if more than one fault is detected at the safety outputs or a cross circuit is detected between Y1 and Y2. To reset this type of interlocking, the safety door switch must be isolated from the power supply after elimination of the error causes.

### Error warning

A fault has occurred, which causes the safety outputs to be disabled after 30 minutes. The safety outputs initially remain enabled. This signal combination, auxiliary output disabled, and safety channels still enabled, can be used to stop the production process in a controlled manner. An error warning is deleted when the cause of error is eliminated.

Table 1: Diagnostic information for safety door switch

The safety door switch signals the switching condition as well as malfunctions via three colored LEDs installed on the device.

System condition	Solenoid control (IN)		LED			Safety outputs Y1, Y2		Auxiliary output OUT
	Power-to-unlock	Power-to-lock	Green	Red	Yellow	D41G-Y	D41G-Z	
Door open	24 V (0 V)	0 V (24 V)	On	Off	Off	0 V	0 V	0 V
Door closed, actuator not inserted	24 V	0 V	On	Off	Off	0 V	0 V	0 V
Door closed, actuator inserted, not locked	24 V	0 V	On	Off	Flashes	0 V	24 V	24 V
Door closed, actuator inserted, interlocking blocked	0 V	24 V	On	Off	Flashes	0 V	24 V	0 V
Guard closed, actuator inserted and locked	0 V	24 V	On	Off	On	24 V	24 V	24 V
Error warning <sup>(*)</sup> safety door switch locked	0 V	24 V	On	Flashes <sup>(**)</sup>	On	24 V <sup>(**)</sup>	24 V <sup>(**)</sup>	0 V
Error	0 V (24 V)	24 V (0 V)	On	Flashes <sup>(**)</sup>	Off	0 V	0 V	0 V
<b>Additionally for variant D41G-1/-2:</b>								
Teach-in procedure actuator started			Off	On	Flashes	0 V	0 V	0 V
Only D41G-2: Tampering protection time (*3)			Flashes	Off	Off	0 V	0 V	0 V

\*1. After 30 min: disabling due to fault

\*2. Refer to flash code

\*3. Refer to Teaching.

Table 2: Error messages / flash codes red diagnostic LED

Flash codes (Red)	Designation	Autonomous switch-off after	Error cause
1 flash pulse	Error (warning) at output Y1	30 min	Fault in output test or voltage at output Y1, although the output is disabled.
2 flash pulses	Error (warning) at output Y2	30 min	Fault in output test or voltage at output Y2, although the output is disabled.
3 flash pulses	Error (warning) cross-wire short	30 min	Cross-wire short between the output cables or fault at both outputs
4 flash pulses	Error (warning) temperature too high	30 min	The temperature measurement reveals an internal temperature that is too high
5 flash pulses	Actuator fault	0 min	Incorrect or defective actuator
6 flash pulses	Error actuator combination	0 min	An invalid combination of actuators was detected (blocking bolt detection or tamper attempt).
Continuous red	Internal fault / overvoltage or undervoltage fault	0 min	Device defective / supply voltage not within specifications

## Declaration of Conformity

No.EUSC0006A

Original

**OMRON**

**EU DECLARATION OF CONFORMITY**

- Product Model(s)/Products:**  
D41G series
- Name and address of the manufacturer:**  
OMRON Corporation  
Shiokoji Horikawa Shimogyo-Ku, Kyoto, 600-8530 Japan
- This declaration of conformity is issued under the sole responsibility of the manufacturer.**
- Objects of the declaration:**  
D41G Series, Safety Door Switch
- The objects of the declaration described above are in conformity with the relevant Union harmonisation legislation:**  
2014/53/EU RE Directive  
2011/65/EU RoHS Directive  
2006/42/EC Machinery Directive
- References to the relevant harmonised standards used or references to the other technical specifications in relation to which conformity is declared:**  
RE Directive: EN 300 330 V2.1:2017, EN 60947-5-3:2013  
Machinery Directive: EN 60947-5-3:2013, EN ISO 14119:2013, EN ISO 13849-1:2015  
EN 62061:2005+A1:2013+A2:2015, EN 61508 part1-7:2010  
RoHS Directive: EN IEC 63000:2018
- Name, address, and identification number of Notified Body, Number of EC Type Examination**  
Machinery Directive:  
Notified body: TÜV Rheinland Industrie Service GmbH  
Address: Am Grauen Stein, 51105 Köln, Germany  
Notified Body identification No.: 0035  
Certificate for EU Type Examination: 01/205/5824/00/21

1/2  
GQ-151845A1

No.EUSC0006A

Signed and on behalf of: OMRON Corporation  
Place and date of issue: Kyoto, Japan

**Signature:** \_\_\_\_\_  
**Name:** Jaehyoung Yi  
**Function:** Industrial Automation Company, Safety Division, General Manager

**Name and address of contact in EU**  
OMRON Europe B.V.  
Quality & Environment Department  
Attn: J.J.P.W. Vogelelaar, European Quality & Environment Manager  
Zilverenberg 2, 5234 GM, 's-Hertogenbosch, The Netherlands

**Additional Information**  
**Type D41G**  
Type: D41G Series

D41G:	( )	( )	( )	( )
	I	II	III	IV

I : 1, 2  
II : Z, Y  
III : A, G  
IV : T1, N2

2/2  
GQ-151845A1

## Set-up and Maintenance

### Functional testing

The safety function of the safety components must be tested. The following conditions must be previously checked and met:

- Fitting of the safety door switch and the actuator
- Check the integrity of the cable entry and connections
- Check the switch enclosure for damage

### Maintenance

Maintenance frequency  
SIL3 / PL e at least once a month  
SIL2 / PL d at least once a year

(Daily inspection)

- For each guard door, check that the machine stops when the guard door opens.

(Inspection every 6 months)

- Check for tight installation of the safety door switch and the actuator.
- Check maximum axial offset of the safety door switch and the actuator.
- Remove particles of dust and soiling
- Check cable entry and connections

## Disassembly and Disposal

### Disassembly

The product must be disassembled in a de-energized condition only.

### Disposal

The product must be disposed of in an appropriate manner in accordance with the national prescriptions and legislations.

## Suitability for Use

Omron Companies shall not be responsible for conformity with any standards, codes or regulations which apply to the combination of the Product in the Buyer's application or use of the Product. At Buyer's request, Omron will provide applicable third party certification documents identifying ratings and limitations of use which apply to the Product. This information by itself is not sufficient for a complete determination of the suitability of the Product in combination with the end product, machine, system, or other application or use. Buyer shall be solely responsible for determining appropriateness of the particular Product with respect to Buyer's application, product or system. Buyer shall take application responsibility in all cases.

NEVER USE THE PRODUCT FOR AN APPLICATION INVOLVING SERIOUS RISK TO LIFE OR PROPERTY OR IN LARGE QUANTITIES WITHOUT ENSURING THAT THE SYSTEM AS A WHOLE HAS BEEN DESIGNED TO ADDRESS THE RISKS, AND THAT THE OMRON PRODUCT(S) IS PROPERLY RATED AND INSTALLED FOR THE INTENDED USE WITHIN THE OVERALL EQUIPMENT OR SYSTEM.

**OMRON Corporation (Manufacturer)**  
Shiokoji Horikawa, Shimogyo-ku, Kyoto, 600-8530 JAPAN  
Contact: [www.ia.omron.com](http://www.ia.omron.com)

**Regional Headquarters**

- OMRON EUROPE B.V. (Importer in EU)**  
Wegalaan 67-69, 2132 JD Hoofddorp  
The Netherlands  
Tel: (31)2356-81-300/Fax: (31)2356-81-388
- OMRON ELECTRONICS LLC**  
2895 Greenspoint Parkway, Suite 200  
Hoffman Estates, IL 60169 U.S.A.  
Tel: (1) 847-843-7900/Fax: (1) 847-843-7787
- OMRON ASIA PACIFIC PTE. LTD.**  
No. 438A Alexandra Road # 05-05/08 (Lobby 2),  
Alexandra Technopark,  
Singapore 119967  
Tel: (65) 6835-3011/Fax: (65) 6835-2711
- OMRON (CHINA) CO., LTD.**  
Room 2211, Bank of China Tower,  
200 Yim Cheng Zhong Road,  
PuDong New Area, Shanghai, 200120, China  
Tel: (86) 21-5037-2222/Fax: (86) 21-5037-2200