

OMRON

Model **E3AS-HL150** / **HL500**

CMOS Laser Sensor

INSTRUCTION SHEET

Thank you for selecting OMRON product. This sheet primarily describes precautions required in installing and operating the product. Before operating the product, read the sheet thoroughly to acquire sufficient knowledge of the product. For your convenience, keep the sheet at your disposal.

TRACEABILITY INFORMATION:

Importer in EU:
Omron Europe B.V.
Wegalaan 67-69
NL-2132 JD Hoofddorp,
The Netherlands

Manufacturer:
Omron Corporation,
Shiokoji Horikawa, Shimogyo-ku,
Kyoto 600-8530 JAPAN

The following notice applies only to products that carry the CE mark.

Notice:

In a residential environment, this product may cause radio interference, in which case the user may be required to take adequate measures.



© OMRON Corporation 2020 All Rights Reserved.

PRECAUTIONS ON SAFETY

● Meaning of Signal Words

⚠ WARNING

Indicates a potentially hazardous situation which, if not avoided, will result in minor or moderate injury, or may result in serious injury or death. Additionally there may be significant property damage.

⚠ CAUTION

Indicates a potentially hazardous situation which, if not avoided, may result in minor or moderate injury or in property damage.

⚠ WARNING

This product is not designed or rated for ensuring safety of persons either directly or indirectly. Do not use it for such purpose.



Do not use the product with voltage in excess of the rated voltage. Excess voltage may result in malfunction or fire.



⚠ CAUTION

Its component may be damaged and/or degree of protection may be degraded. Please do not apply high pressure water intensively at one place during cleaning.



To safely use laser products

⚠ WARNING

Looking into the Outgoing light continuously may cause visual impairment. Do not look directly into the Outgoing light.

Caution-Use of controls or adjustments or performance of procedures other than those specified herein may result in hazardous radiation exposure
Attention-L'utilisation des commandes ou réglages ou l'exécution des procédures autres que celles spécifiées dans les présentes exigences peuvent être la cause d'une exposition à un rayonnement dangereux



Do not disassemble this product. Doing so may cause exposure to the built-in light source which can damage eyes and skin. Never disassemble it.



Laser safety measures for laser equipment are stipulated by the country of use. Follow the instructions described below categorized in four cases.

• Usage in Japan

The JIS C6802:2014 standard stipulates the safety precautions that users must take according to the class of the laser product. This product is classified into class 1 defined by this standard.

• Usage in U.S.

This product is subjected to the U.S. FDA (Food and Drug Administration) laser regulations. This product is classified into Class 1 by the IEC 60825-1:2014 standard according to the regulations of Laser Notice No.56 of the FDA standard. This product is already reported to CDRH (Center for Devices and Radiological Health).
Accession Number: 1920014-001

When using a device equipped with the product in the U.S., attach an FDA certification label near the sensor mounted on customer equipment.

FDA certification label

This laser product complies with 21 CFR 1040.10 and 1040.11 except for conformance with IEC 60825-1 Ed. 3, as described in Laser Notice No. 56, dated May 8, 2018.
OMRON Corporation
Shiokoji Horikawa, Shimogyo-ku,
Kyoto 600-8530 JAPAN
Place of manufacture:
Shanghai Factory/OMRON Corp.
Manufactured in

• Usage in China

This product is classified into Class 2 by the GB7247.1:2012(IEC60825-1:2007) standard. When using a device equipped with the product in China, attach a Warning label near the sensor mounted on customer equipment.

Warning label



Center of laser projection

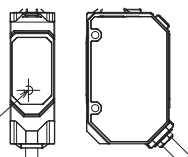

• Usage in countries other than U.S. and China

This product is classified into Class 1 by the IEC60825-1:2014/EN60825-1:2014+A11:2021 standard.

Precautions for Safe Use

Please observe the following precautions for safe use of the products.

- Do not reverse connection of DC power supply polarity. Do not connect to AC power supply.
- Do not short-circuit the load.
- Never use this product with AC power supply. Otherwise it may explode.
- The maximum power supply voltage is 30 VDC. Before turning on the product's power, make sure that the supply voltage does not exceed the maximum power supply voltage.
- Do not use the product in environments where flammable or explosive gases are present.
- Please assess the safety beforehand when using the product in chemicals and/or oil environments.
- Do not remodel the product.
- Do not touch the metal surface with your bare hands when the temperature is low. Touching the surface may result in a cold burn.
- Burn injury may occur. The product surface temperature rises depending on application conditions, such as the ambient temperature and the power supply voltage. Attention must be paid during operation or cleaning.

Precautions for Correct Use

- Do not hit the product using a hammer for installation.
- The product must be installed with the specified torque or less. For M8 connector and Pre-wired M8 connector, the proper tightening torque is from 0.3 to 0.4 N·m. In case of M12 Pre-wired smartclick connector, manually tighten the connector.
- Tightening torque for the mounting hole is 0.6 N·m or less (M3 screw).
- Do not use the product in ambient atmosphere or environment exceeding the rating.
- Output pulses may be generated when the power is turned off. It is recommended to turn off the power of the load or load line first.
- The extension of the cord under the standard I/O mode should be 100 m or less. Under the IO-Link mode, the length should be 20 m or less.
- Do not pull the cord too strongly.
- Be sure to turn off the power supply when connecting or disconnecting the cable.
- Wait for at least 600 ms after turning on the product's power.
- The product is rated as IP67 but please avoid using the product underwater, under rain, and outdoors.
- If the Sensor wiring is placed in the same conduits or ducts as high-voltage or high-power lines, inductive noise may cause malfunction or damage. Wire the cables separately or use a shielded cable.
- Do not use the product in direct sunlight.
- Do not use the product where humidity is high and dew condensation may occur.
- Do not use the product where corrosive gases may exist.
- Use a key lock to prevent malfunction if high-pressure wash water or other substances come into contact with the button.
- Do not apply high-pressure washing water directly to the sensor's light emitting / receiving surface from a short distance. As the antifouling feature may be impaired, keep a sufficient distance from the light emitting / receiving surface.
- Do not use the product at a location subject to shock or vibration.
- To use a commercially available switching regulator, FG (frame ground) must be grounded.
- This product cannot be used as a detection device for human body protection.
- Do not use organic solvents (e.g. paint thinner and alcohol) for cleaning. Otherwise optical properties and protective structure may deteriorate.
- Be sure to check the influence caused by surrounding environments such as background objects and/or LED lighting before using the product.
- Do not exceed 100,000 writing operations of the EEPROM (non-volatile memory). Setting information is written to the EEPROM when a threshold value change, teaching, or zero reset is executed.

Dispose in accordance with applicable regulations.

Package contents

Instruction sheet (this sheet), Compliance sheet, Index list (attached for IO-Link type only), FDA certification label, Warning label

1 Installation

1-1 Mounting of the Sensor

<Size of installation holes (Unit: mm)>

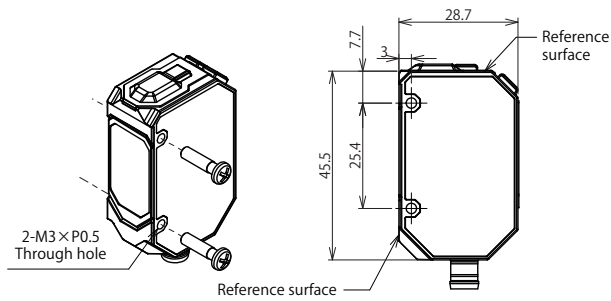

Mounting brackets are sold separately.
Tightening torque for the mounting hole is 0.6 N·m or less (M3 screw).

Do not touch the emitter and/or receiver block of the sensor. Fingerprint deposits may result in improper detection. If accidentally touched, please wipe gently with a dry cloth. Do not use organic solvent (e.g. paint thinner and alcohol).

1-2 Constraints on Sensor Installation

Orientation considerations for installation

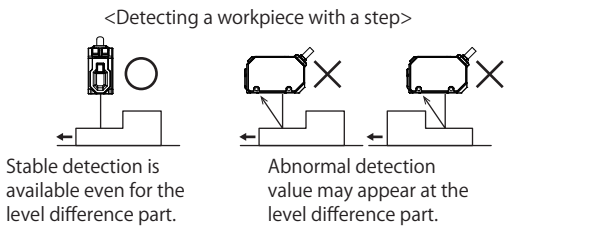
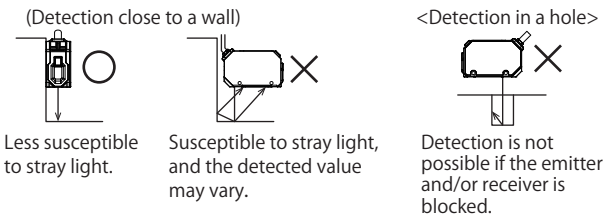

2 Connection

2-1 Input/Output Circuit Diagram

■ Using Pin2 (white wire) as output

Model	Output method	Input/Output circuit diagram
E3AS-□□N□	NPN	
E3AS-□□D□ or E3AS-□□T□	PNP/COM□ Standard I/O Mode	
	PNP/COM□ IO-Link Mode	

Note 1. The standard I/O mode is used as PNP ON/OFF output.
Note 2. The IO-Link mode is used for communications with the IO-Link master. The C/Q is used for IO-Link communications. The sensor output DO is used for ON/OFF output.
Note 3. For detailed information on models, ratings, and performance, refer to "8 Ratings and Specifications" (page 12).

■ Using Pin2 (white wire) as external input "3-3 External Input" (page 3).

Model	Method	Input/Output circuit diagram
E3AS-□□N□	NPN	
E3AS-□□D□ or E3AS-□□T□	PNP/COM□ Standard I/O Mode	
	PNP/COM□ IO-Link Mode	

External input	NPN	PNP
ON time	0V short-circuit or 1.5V or less	Power supply voltage short-circuit or within power supply voltage - 1.5V
OFF time	Power supply voltage short-circuit or open	0V short-circuit or open

2-2 Connection Method

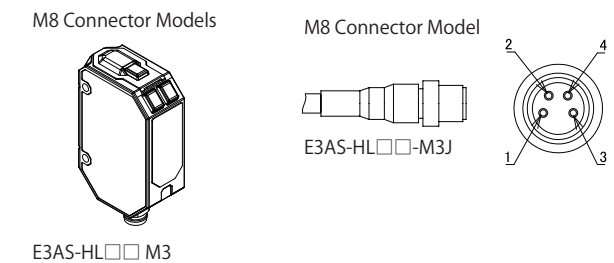
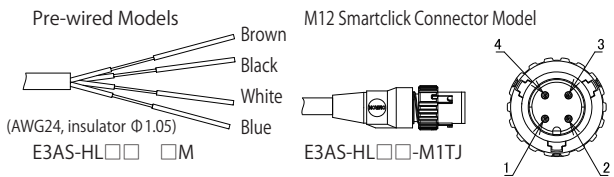

The extension of the cord under the standard I/O mode should be 100 m or less. The extension of the cord in the IO-Link mode should be 20 m or less.

2-3 Cord Allowable Bending Radius

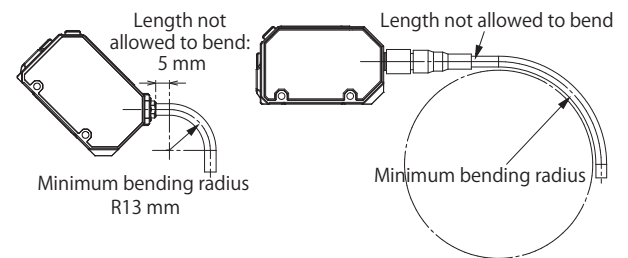

Bending for Pre-wired and Connector Models				
Cable spec.	External diameter	Minimum bending radius: mm	Length not allowed to bend: mm	
PVC cable	Φ4	13	5	
Bending of sensor I/O connector cord				
Model	Cable Material spec.	External diameter	Minimum bending radius: mm	Length not allowed to bend: mm
XS3F-M8PVC	PVC	Φ5	36	0
XS2F/W-D4-F	Incombustible robot	Φ6	40	0
XS5F/W-D4-F	Incombustible robot	Φ6	40	0
XS5F/W-D4-X	Highly oil-resistant PVC	Φ6	40	0
XS5F/W-D4-XR	Highly oil-resistant robot PVC	Φ6	40	0

3 Settings

3-1 Operation/Display Lookup Table

■ Name and function of each part

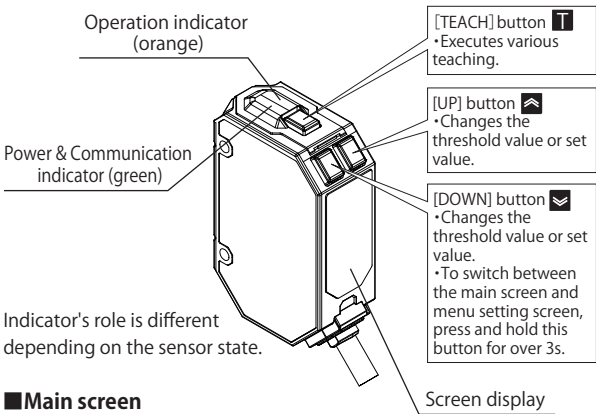

■ Main screen

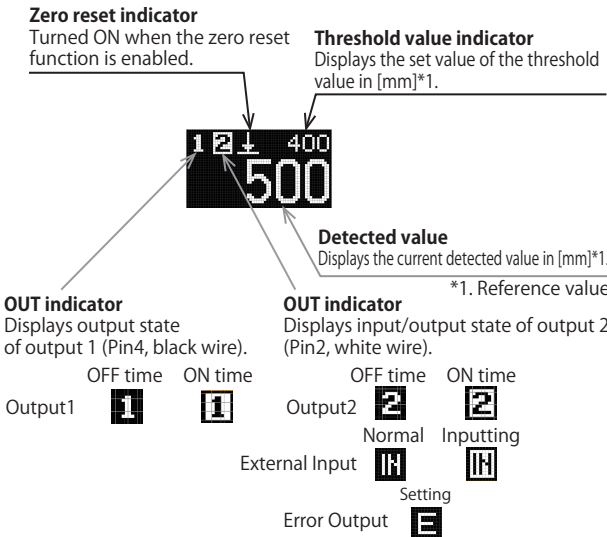

■ Other button operations

Item	Operation	Reference
Teaching execution	[TEACH]	"4 Teaching" (page 5)
Zero reset execution	[DOWN] + [TEACH] Simultaneously for over 3s.	"5-3 Zero Reset" (page 7)
Zero reset cancel	[UP] + [TEACH] Simultaneously for over 3s.	
Key lock execution/cancel	[TEACH] + [UP] + [DOWN] Simultaneously for over 3s.	"5-1 Key Lock" (page 7)

■ How to switch to each screen

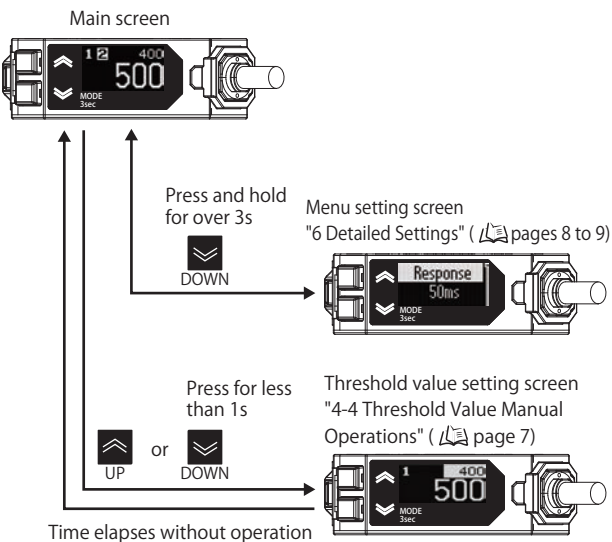

3-2 Output2 Function

The function assigned to output 2 (Pin2, white wire) can be selected. The output 2 function can be selected from the menu setting section. Output 2 function in "6 Detailed Settings" (page 8)

Menu display	Function
Out1 Invert	Output 1 Invert
Out2 Single	Output 2 [Single]
Input	External Input
Error	Error Output *1

*1. Output 2 turns ON when a system error or load short circuit error occurs.

3-3 External Input

External input can be selected from the menu setting screen. External Input in "6 Detailed Settings" (page 8). The external input of "Output 2 Function" cannot be used in IO-Link mode.

■ Lase OFF

Laser emission is turned OFF. When the laser emission is stopped, the intensity is insufficient.

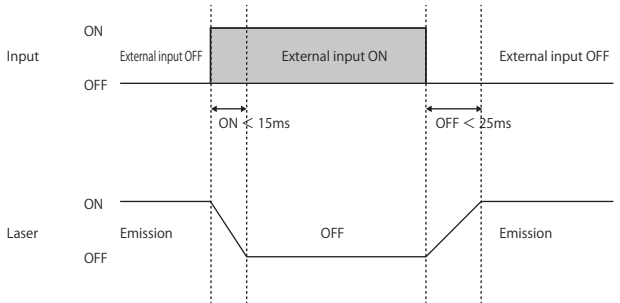

■ Teaching

Various teaching can be executed within as much time as spent for button operations. "4 Teaching" (page 5 to 6).

■ Zero Reset

The detected value when zero reset is executed is set to "0."

● Zero reset execution

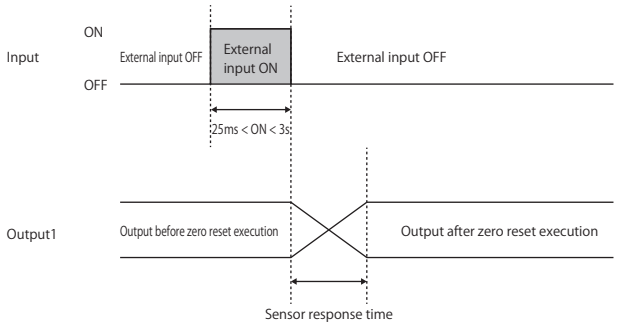



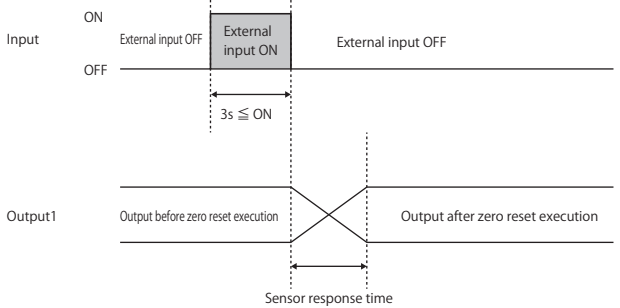



● Zero reset cancel



The mode of output 1 (Pin4, black wire) can be selected.

An output mode can be selected from the menu setting screen. Output Mode in "6 Detailed Settings" ( page 8)

Output mode is selected automatically by executing each teaching."4 Teaching" ( page 5 to 6)

Output mode	Function		Relations with teaching	Reference
	Description	Sensing method *1		
Single Point [Single]	The output is inverted when the detected value falls below the threshold value (SP1).	BGS	2-point/Background teaching	"4-1 Basic Teaching" ( page 5)
Window BGS [Window BGS]			Background teaching	"4-1 Basic Teaching" ( page 5)
Window FGS [Window FGS]	The output is inverted when the detected value is between the Far side (SP1) and Near side (SP2) threshold values.	FGS	Object teaching	"4-2 Advanced Teaching" ( page 6)
Distance + Intensity*2 [Dist + Int]			Background reference teaching (normal)	"4-1 Basic Teaching" ( page 5)
	The output is inverted when the coincidence between the distance and intensity is less than the threshold value.	FGS	Background reference teaching (sensitive)	"4-2 Advanced Teaching" ( page 6) "6-11 ABT Function" ( page 11)

*1.BGS operation: When intensity is not sufficient and distance is out of range, if N.O. or N.C. is set, output is OFF or ON, respectively.

FGS operation: When intensity is not sufficient and distance is out of range, if N.O. or N.C. is set, output is ON or OFF, respectively.

*2.Enabled only if background reference teaching (sensitive) is executed. So, it is not possible to select the "Distance + Intensity" mode from the menu setting screen.

Difference between BGS and FGS

BGS: Influence from the background is controlled. BGS is suitable for detection when there is no background or when the object is far from the background.

BGS is usable irrespective of the presence of background.

FGS: Influence from the close-range view is controlled. FGS is suitable for detection when the background is close to the object or when the object has a mirror-surface, level difference, or lowly reflective object. FGS is not usable without a background because the background is always detected.



3-5 Display Specification

Single Point Mode[Single]

Single Point Mode[Single]

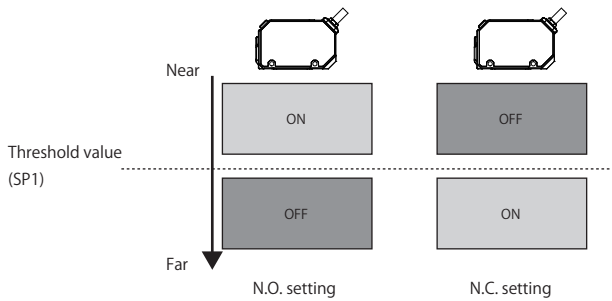

		Rated sensing distance range	
		Threshold	
Standard I/O Mode	Power/Communication indicator (green)	ON	ON
		OFF	OFF
	Operation Indicator (orange)	ON	ON
		OFF	OFF
	Output 1	ON	ON
	OFF	OFF	
	Output 2	ON	ON
		OFF	OFF
IO-Link Mode	Power/Communication indicator (green)	Flashing (1second cycle)	Flashing (1second cycle)
		ON	ON
	Operation Indicator (orange)	ON	ON
		OFF	OFF
	Communication Output	1	1
	0	0	
	Output 2	ON	ON
		OFF	OFF

Window BGS mode[Window BGS]

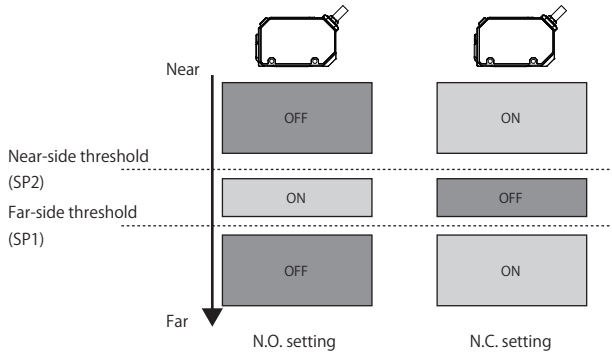

Window BGS mode[Window BGS]

		Rated sensing distance range	
		Near-side threshold	Far-side threshold
Standard I/O Mode	Power/Communication indicator (green)	ON	ON
		OFF	OFF
	Operation Indicator (orange)	ON	ON
		OFF	OFF
	Output 1	ON	ON
	OFF	OFF	
	Output 2	ON	ON
		OFF	OFF
IO-Link Mode	Power/Communication indicator (green)	Flashing (1second cycle)	Flashing (1second cycle)
		ON	ON
	Operation Indicator (orange)	ON	ON
		OFF	OFF
	Communication Output	1	1
	0	0	
	Output 2	ON	ON
		OFF	OFF

Window FGS mode[Window FGS]

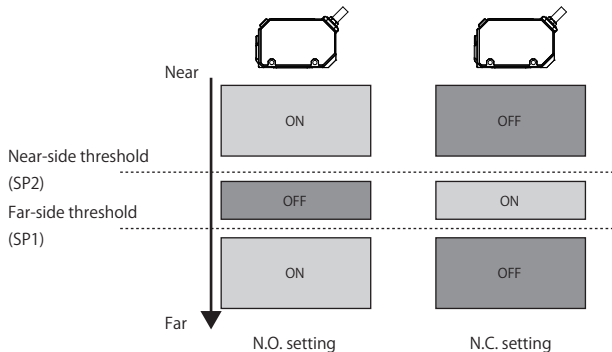

Window FGS mode[Window FGS]



		Rated sensing distance range	
		Near-side threshold	Far-side threshold
Standard I/O Mode	Power/Communication indicator (green)	ON	ON
		OFF	OFF
	Operation Indicator (orange)	ON	ON
		OFF	OFF
	Output 1	ON	ON
	OFF	OFF	
	Output 2	ON	ON
		OFF	OFF
IO-Link Mode	Power/Communication indicator (green)	Flashing (1second cycle)	Flashing (1second cycle)
		ON	ON
	Operation Indicator (orange)	ON	ON
		OFF	OFF
	Communication Output	1	1
	0	0	
	Output 2	ON	ON
		OFF	OFF



Note 1. Shown above are the product operation of factory settings. For the initial factory settings, refer to "6 Detailed Settings"  page 9.



4 Teaching

- For output 1 (Pin4, black wire), 5 types of teaching are usable by button operations.
- For output 2 (Pin2, white wire), teaching is not usable by button operations. However, output 2 teaching can be executed by the communication commands of IO-Link (only 2-point teaching and background teaching is usable).



Teaching operation lookup table

Item	Operation
2-point teaching	Press Quickly  → Press Quickly 

Item	Operation	Teaching Selection [Teach 3sec]
Background teaching	Press&Hold 	[Background] *1
Object teaching		[Object]

Item	Operation	Bg. Ref. Teaching Selection [Ref. Teach]
Bg. reference teaching (normal)	Press Quickly  Press&Hold 	[Normal] *1
Bg. reference teaching (sensitive)		[Sensitive]

*1. This is the factory setting.

-  When pressing quickly, it must longer than 25ms and shorter than 1s.
-  When pressing and holding, it must shorter than 5s.

4-1 Basic Teaching

2-point Teaching

This is the basic setting.

BGS

1. Press the  button quickly without any objects (longer than 25 ms and shorter than 1s).

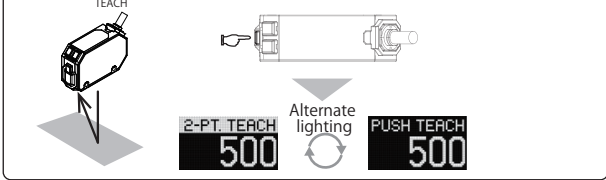

2. Press the  button quickly with an object (longer than 25ms and shorter than 1s).

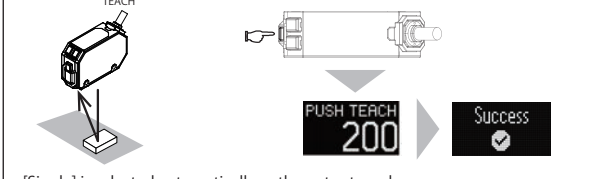

- [Single] is selected automatically as the output mode.
- Setting is no problem even if user operations with an object and without any objects are performed inversely.

Threshold setting after teaching is completed

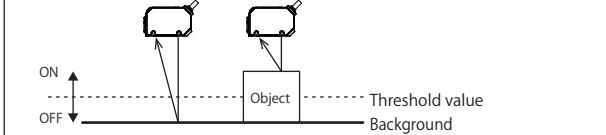

- The threshold value is set at a distance between background and object.
- Maximum detection distance is set (threshold value is set with HL150□: 150 mm, HL500□: 500 mm as a teaching point) when teaching is performed with either the first or second point without detected object or background.
- Shown above is applicable to the case of N.O. output logic. In the case of N.C., this is inverted.

Background Teaching [Teach 3sec (Background)]

BGS

Use to detect an object closer than the background.

- This can be executed if setting [Background] when executing Teaching Selection in "6 Detailed Settings" (page 9) ([Background] is the factory setting.)

1. Press and hold the  button without any objects (longer than 1s and shorter than 5s). Release the button when [Background Teach] is displayed on the display

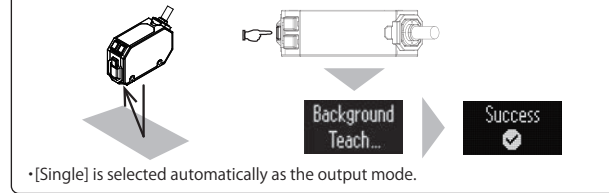

• [Single] is selected automatically as the output mode.

Threshold setting after teaching is completed



- The threshold value is set on the near side to the background.
- If teaching is executed without any backgrounds, the maximum detecting distance (HL150□: 150mm, HL500□: 500mm) will be set as the threshold value.
- Margin is set automatically to the optimal value according to the detecting distance.
- Shown above is applicable to the case of N.O. output logic. In the case of N.C., this is inverted.

Background Reference Teaching (Normal) [Ref. Tech (Normal)]

Use to detect something shaped complicatedly.

(FGS)

- This is suitable for detection of an object from which small amount of light is returned to the receiving surface (such as mirror, uneven, and low reflectance).
- This teaching can be executed if setting [Normal] when executing Background Reference Teaching Selection in "6 Detailed Settings" (page 9) ([Normal] is the factory setting.)

1. Press the  button quickly without any objects (longer than 25ms and shorter than 1s).

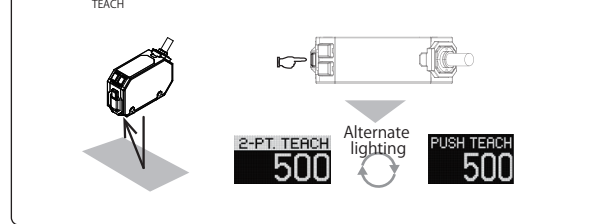

2. Press and hold the  button without any objects (longer than 1s and shorter than 5s). Release the button when [Reference (Normal)] is displayed on the display

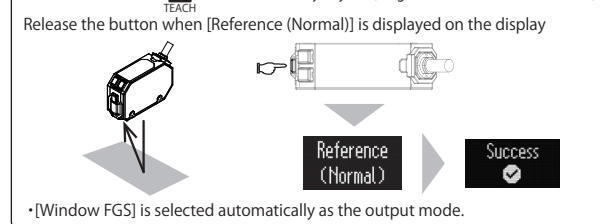

• [Window FGS] is selected automatically as the output mode.

Threshold setting after teaching is completed

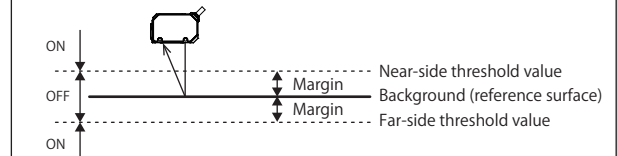

- The threshold value is set with ± margin to the background.
- Margin is set automatically to the optimal value according to the detecting distance.
- Shown above is applicable to the case of N.O. output logic. In the case of N.C., this is inverted.

4-2 Advanced Teaching

Object Teaching [Teach 3sec (Object)] BGS

Use for teaching with an object.
 • This can be executed if [Object] is set when Teaching Selection in "6 Detailed Settings" ( page 9) is executed. ([Background] is the factory setting.)

1. Press and hold the **T** button with an object (longer than 1s and shorter than 5s).
 Release the button when [Object Teach] is displayed on the display

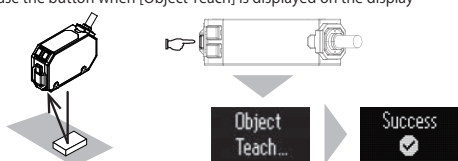

• [Window BGS] is selected automatically as the output mode.

● Threshold setting after teaching is completed

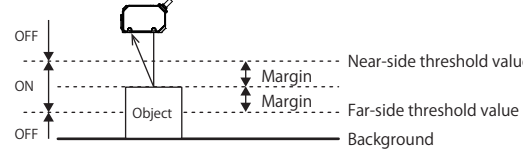

• The threshold value is set with ± margin to the background.
 • Margin is set automatically to the optimal value depending on the detecting distance.
 • Shown above is applicable to the case of N.O. output logic. In the case of N.C., this is inverted.

Background Reference Teaching (Sensitive) FGS

Use to detect something transparent.
 • When this teaching is executed, the sensor memorizes background information (distance + intensity *1) and obtain difference from that information to detect the object.
 • This can be executed if [Sensitive] is set when Background Reference Teaching in "6 Detailed Settings" ( page 9) is executed. ([Normal] is the factory setting.)
 *1. Intensity varies depending on the reflectance or the surface state.

1. Press the **T** button quickly without any objects (longer than 25ms and shorter than 1s).

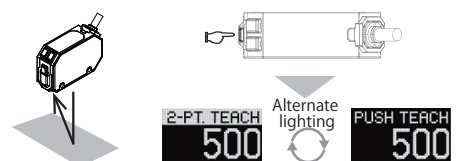

2. Press and hold the **T** button without any objects (longer than 1s and shorter than 5s).
 Release the button when [Reference (Sensitive)] is displayed on the display

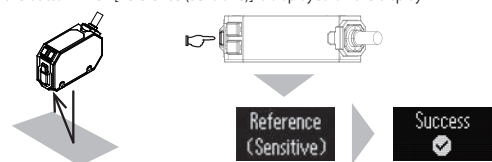

• [Dist + Int] is selected automatically as the output mode.
 • With the output 2 function set to [Out2 Single], if background reference teaching (sensitive) is executed, the output 2 function is forcibly changed to [Out1 Invert].

● Main screen after teaching is completed



• Coincidence with the background information is displayed as 0-100%. The displayed value is set as 100 after teaching for the background. Coincidence decreases as difference from the background information.
 • The threshold value of the factory setting is 90.

Note 1. When background reference teaching (sensitive) has been executed, use the sensor at least 10 minutes after turning ON the power.
 Note 2. When using the sensor to detect a transparent object, be sure to check operation in advance.
 Note 3. When response time has been changed, execute teaching again.
 The ABT function which controls the influence of the moderate variation of the background is enabled automatically. The memorized background information is corrected automatically. In ABT function, correction time can be selected from four options (OFF / 0.3sec / 1sec / 3min). *6-11 ABT Function" ( page 11)

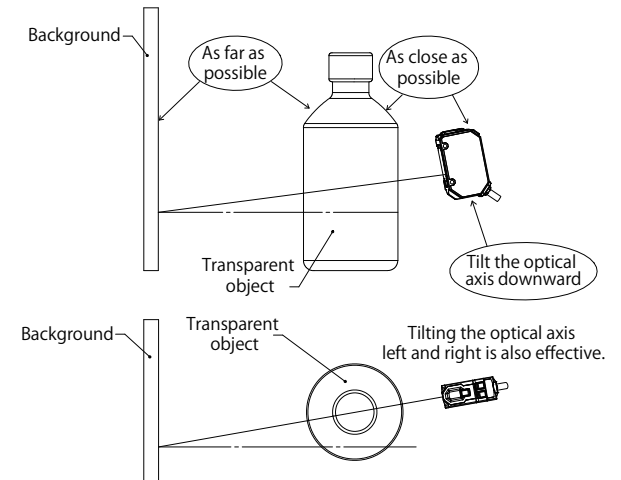

● If detection is not stable when background reference teaching (sensitive) is executed: Possible causes are as follows. Check the installation state and execute teaching again.

Factor	Countermeasure
The distance between the sensor and the background varies by more than 5% of the detection distance.	Check the installation condition.
The reflected light from the background does not have sufficient intensity.	Keep the distance between the sensor and the background close.
The specular reflection light from the background enters.	Tilt the sensor to prevent specular reflection light from entering (10° or more). The installation shown below is recommended for the detection of transparent objects.





4-3 Teaching Display



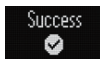

Teaching cancel display

Display	Indicator		Description
	Orange	Green *1	
Teaching Cancelled 	Normal operation		When 2-point teaching is put on hold, if the Teach button is pressed and held for 5s or more, [Teach Cancel] is displayed and teaching can be cancelled.

Teaching success display*2

Display	Indicator	
	Orange*3	Green *1
Teaching succeeded 	 Flashing (at 0.6s intervals)	

Teaching error display*2

Error name /display	Indicator		Possible causes	Countermeasure
	Orange	Green *1		
Teaching execution error 			Teaching failed.	Confirm that the sensor-object distance is within the detecting range and execute teaching again.
Teaching near error 	 Flashing (at 0.2s intervals)		The difference of the detected values of the 1st and 2nd points is too small when 2-point teaching is executed.	Expand the distance between 1st and 2nd points and execute teaching again.

*1. This is the operation in the standard I/O mode. The indicator blinks in the IO-Link mode (at 1s intervals).
 *2. The display time is 2 seconds after teaching is executed.
 *3. When 2-point teaching is put on hold or the button is pressed and held, the orange indicator blinks slowly (at 1s intervals).

4-4 Threshold Value Manual Operations

The threshold value can be adjusted using the [UP] button and the [DOWN] button.

- The threshold value increases.
 - The threshold value decreases.
- Quick adjustment is usable by pressing and holding the button.

■ When output mode is [Single]

The threshold values of output 1 and output 2 can be adjusted.

Model	Setting range	Threshold value	
		Output1	Output2
HL500□	-600~600	400	400
HL150□	-160.0~160.0	100.0	100.0

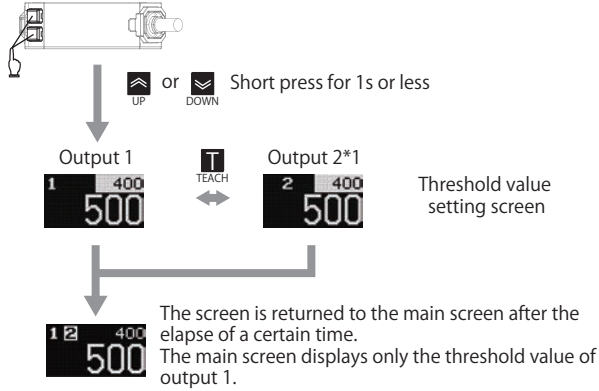

■ When output mode is [Window FGS] or [Window BGS]

The threshold values of output 1 near side, output 1 far side, and output 2 can be adjusted.

Model	Setting range	Threshold value		
		Output1 Near side	Output1 far side	Output2
HL500□	-600~600	350	400	400
HL150□	-160.0~160.0	80.0	100.0	100.0

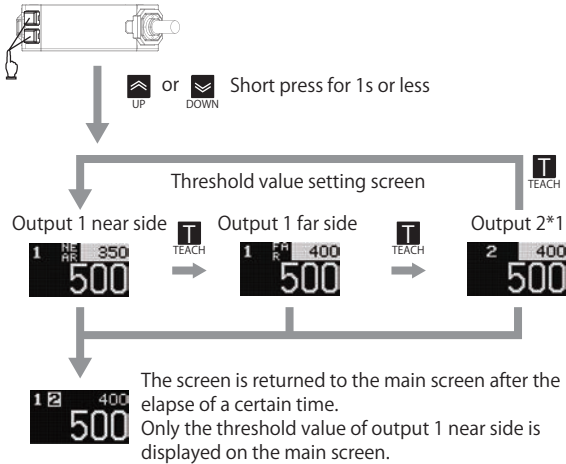

*1. Displayed only when [OUT2 Single] is set for Output 2 function.

5 Useful Functions

5-1 Key Lock

Acceptance of button operations can be disabled to prevent incorrect operations.

● Key lock execution

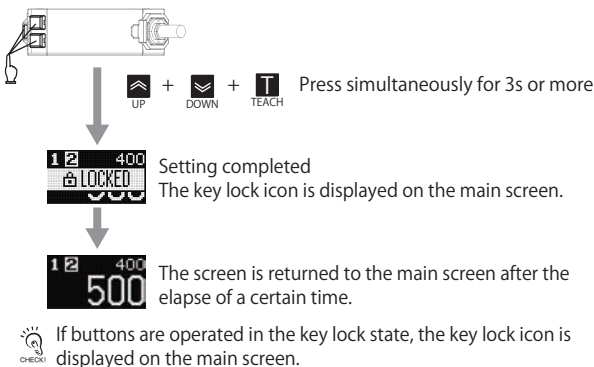

● Key lock cancel

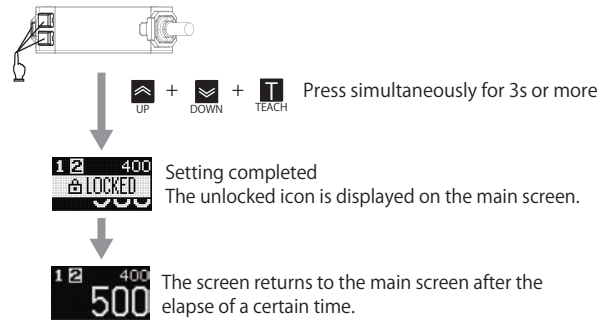

5-2 Initialization

Settings are initialized and returned to the factory settings. Initialization in "6 Detailed Settings" (page 8)

5-3 Zero Reset

The detection value when zero reset is executed is set to [0].

● Zero reset execution

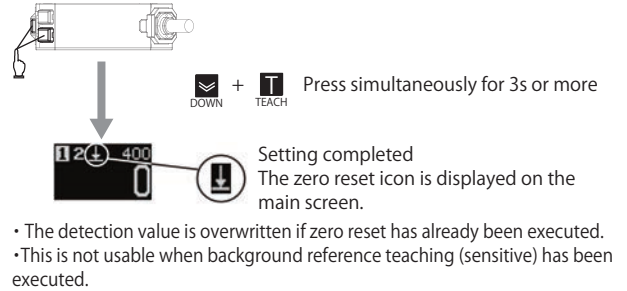

● Zero reset cancel

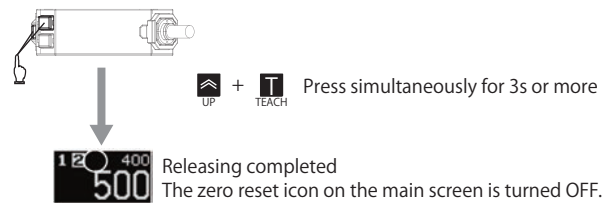

● Zero reset memory

The result of zero resetting can be saved even turning OFF the power after executing zero resetting by the external input or the communication commands of the IO-Link mode, only when the zero reset memory is set as [ON] described in "6 Detailed Settings" (page 9).

When the sensor is operated using the buttons, the result is saved regardless of the setting of zero reset memory.



This chart shows the transition of the menu setting screen.

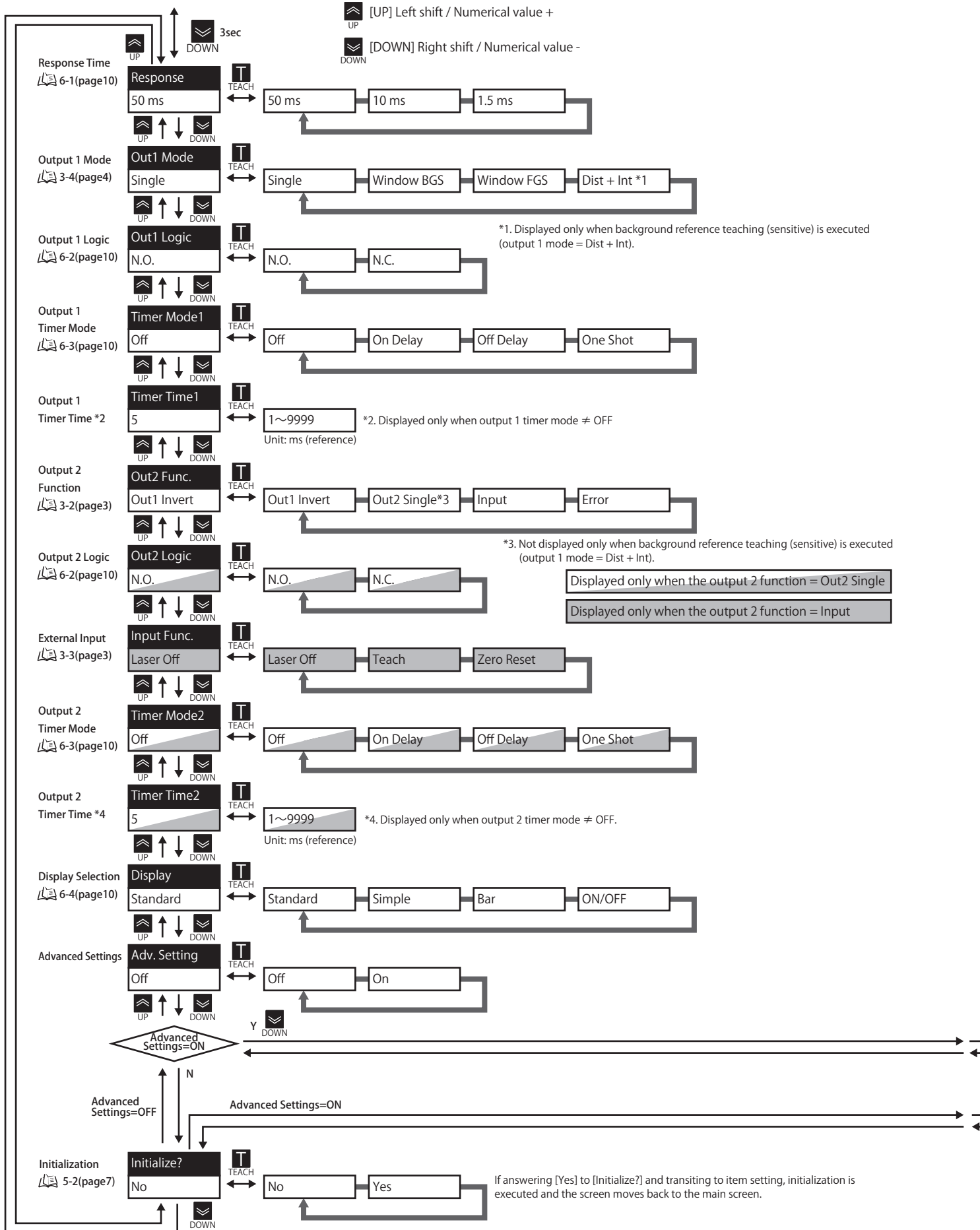

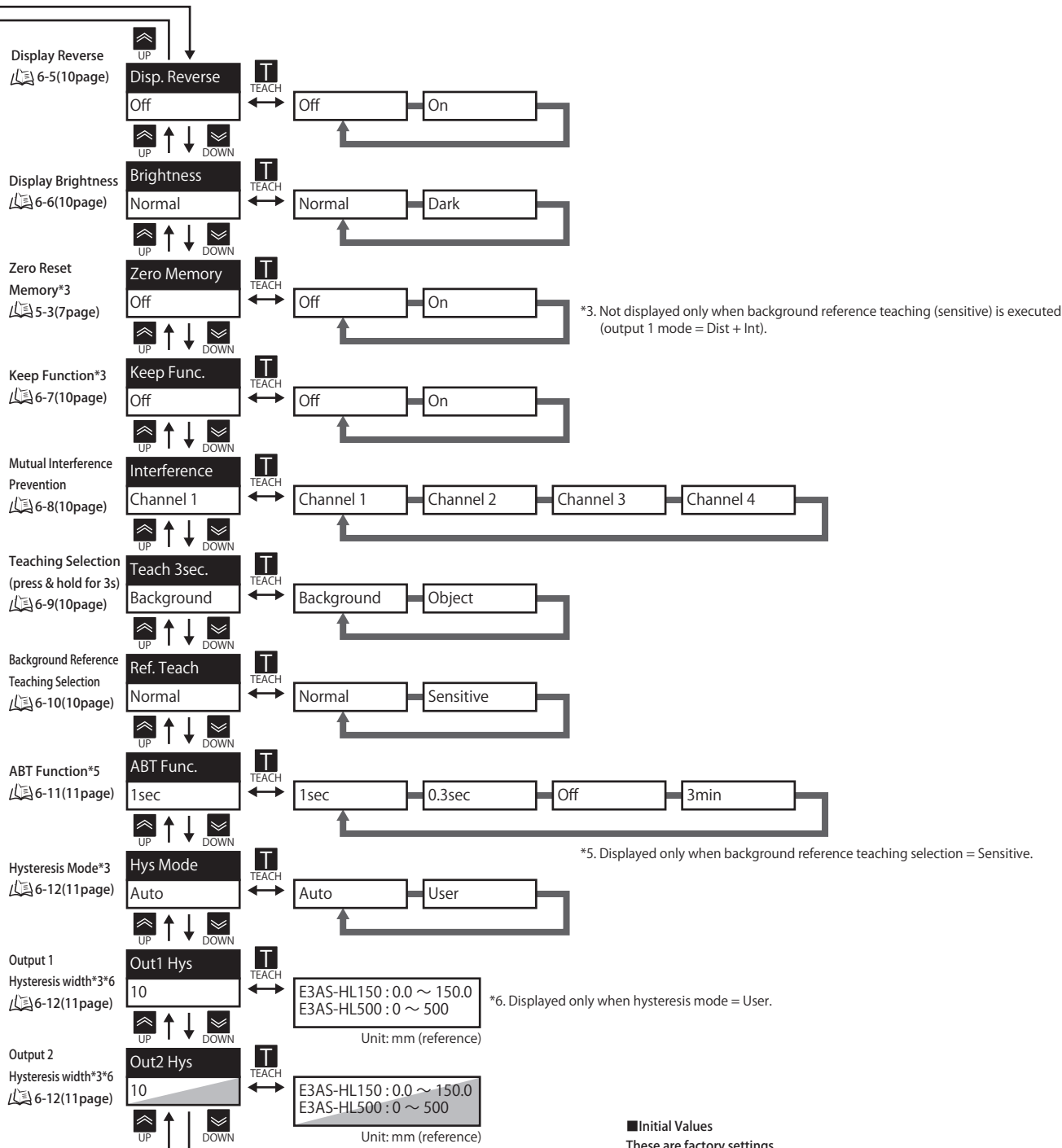

■ Initial Values

These are factory settings.

Item	Initial value	
	HL150□	HL500□
Response time	50ms	
Output 1 mode	Single	
Output 1 logic	N.O.	
Output 1 timer mode	Off	
Output 1 timer time	5	
Output 2 function	Out1 Invert	
Output 2 logic	N.O.	
External input	Laser Off	
Output 2 timer mode	Off	
Output 2 timer time	5	
Display selection	Standard	
Advanced settings	Off	
Display reverse	Off	
Display brightness	Normal	
Zero reset memory	Off	
Keep function	Off	
Mutual interference prevention	Channel 1	
Teaching selection (press & hold for 3s)	Background	
Background reference teaching selection	Normal	
ABT function	1sec	
Hysteresis mode	Auto	
Output 1 hysteresis width	1.0	10
Output 2 hysteresis width	1.0	10

For initial threshold values, refer to "4-4 Threshold Value Manual Operations" (page 7).

6-1 Response Time

Response time can be changed.
Detection becomes more stable as increasing response time.

6-2 Output 1 Mode

The output logic (N.O. or N.C.) of output 1 or output 2 can be switched.
The logic of output 2 can be changed only when the output 2 function is set to [Out2 Single].

6-3 Timer Mode

The timer operation of the output can be set.

Timer mode	Description on function
Off	The timer function is not used.
On Delay	Output ON is retarded after the object is detected.
Off delay	Output ON is held if the detection time is too short for PLC to detect the object.
One shot	Output is held for a certain period of time even if the object size varies.

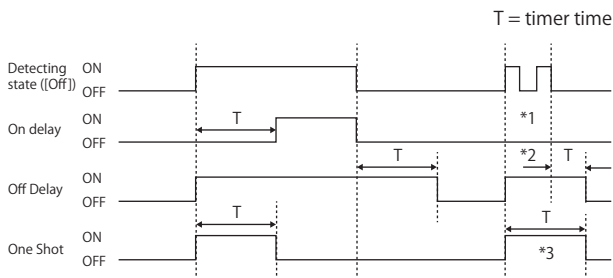

- *1. If the ON time < the timer time, output is not turned ON.
- *2. If the OFF time < the timer time, output is not turned OFF.
- *3. Even if the condition of switching OFF to ON is satisfied while output is effective, it is ignored.

6-4 Display Selection

The screen configuration of the main screen can be selected from 4 types.

Item	Display	Description
Standard		Displays the detected value, threshold value, I/O state, and setting state. This is the screen configuration of factory settings.
Simple		Displays the detected value only.
Bar		Displays the detected value as a bar and the output as an icon. The bar indicates conformity in a range of 0-100 when the output mode is "Distance + Intensity". In the other modes, it indicates the detecting distance between the upper and lower limits.
ON/OFF		Displays the I/O state only.

6-5 Display Reverse

By enabling display reverse, display is rotated by 180° and the [UP] button and [DOWN] button are switched.
However, the main screen and the menu setting screen are switched by the button beside the print, "MODE 3sec," regardless of valid or invalid of display reverse.

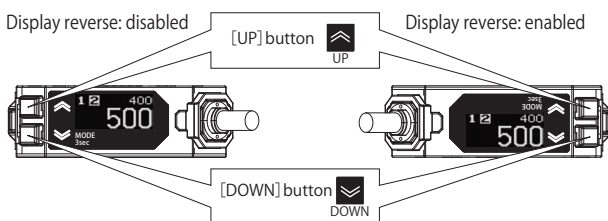

6-6 Display Brightness

Display brightness	Description
Normal	The brightness of the OLED display decreases after not operated for a certain time (60s).
Dark	The OLED display is turned OFF perfectly after not operated for a certain time (15s).

Note 1. Display's luminance decreases as the sensor is used for a long period.

6-7 Keep Function

The output when receiving light intensity is not sufficient or detection has not been determined yet can be set.

Keep Function	Output	
	N.O. setting	N.C. setting
Off	Output OFF	Output ON
On	The detected value directly before the sensor judges as impossible to detect is saved and output.	

- Note 1. If background reference teaching (normal) is executed (when output 1 mode = [Window FGS]), keeping is disabled on output 1 only.
- Note 2. If background reference teaching (sensitive) is executed (when output 1 mode = [Dist + Int]), keeping is disabled.

6-8 Mutual Interference Prevention Function

Influence of mutual interference between sensors can be reduced by changing the channel setting to change the interval of emitting pulse. If mounting more than one sensor close to each other, interference might occur between those sensors. So, set them to mutually different channels (up to 4 sensors).

Response time varies depending on the channel configured.

Channel	Response time		
	1.5ms	10ms	50ms *1
Channel 1 *1	1.5ms	10ms	50ms
Channel 2	2ms	13ms	65ms
Channel 3	1.7ms	11ms	55ms
Channel 4	1.8ms	12ms	60ms

*1. These are the factory settings.

If mutual interference between sensors is not improved even after changing the channel setting, consider installation of a light baffle or changing of sensor installation.

6-9 Teaching Selection

Teaching executed when pressing and holding the teaching button (longer than 1s and shorter than 5s) can be switched.
"4 Teaching" (page 5 to 6)

6-10 Background Reference Teaching Selection

Normal mode and Sensitive mode for background reference teaching can be switched."4 Teaching" (page 5 to 6)

6-11 ABT Function (Automatic-Background-Tracking)

The ABT function is enabled only when background reference teaching (sensitive) is executed. This function corrects variation of the detected value when background is detected (coincidence between distance and intensity) and keep the detected value at 100. The number of times of maintenance is reduced by automatically correcting the variation of the detected value due to stain on the sensor's receiving surface or the background object. The correction time can be selected from four options (OFF / 0.3sec / 1sec / 3min).

(Precautions)
If the object moves very slowly, correction keeps up with the movement of the object, so the object cannot be detected correctly. In this case, retard the correction time of the [ABT function] or set OFF the function

6-12 Hysteresis

Hysteresis Mode

Minute level difference can be judged by controlling the hysteresis width minutely according to the object.

Hysteresis mode	Description
Auto	The optimum hysteresis width is automatically set according to the threshold.
User	User can set any hysteresis width.

However, note that when the detected value is fluctuating due to the movement of the object or the small intensity of the reflected light, the output may become unstable.

Hysteresis Width

The point at which the output turns from OFF to ON is called the operating point and the point at which it turns from ON to OFF is called the return point. The distance between the operating and return points is called hysteresis width. For this sensor, threshold value is equal to operating point, so the The definition of hysteresis width for each output mode is shown on the figure below.

Single Point Mode[Single]

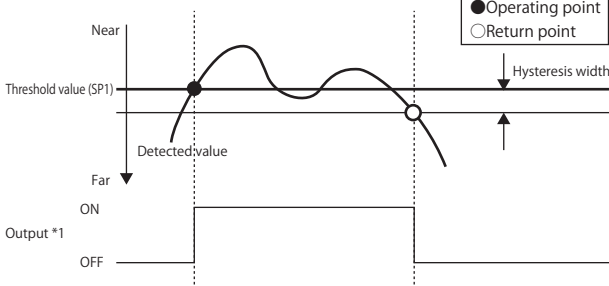

*1. This is a graph when the output logic is N.O. It is inverted in the case of N.C.

Window BGS mode[Window BGS]

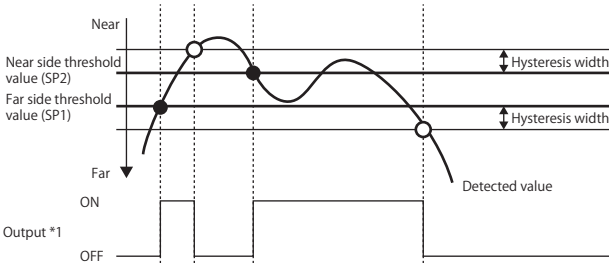

*1. This is a graph when the output logic is N.O. It is inverted in the case of N.C.

Window FGS mode[Window FGS]

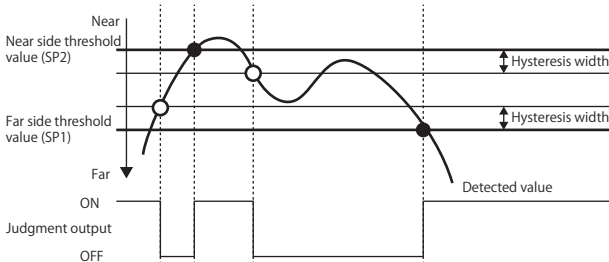

*1. This is a graph when the output logic is N.O. It is inverted in the case of N.C.

Distance + intensity mode [Dist + Int]

In the distance + intensity mode, user setup of hysteresis width is not allowed. A fixed value of 4 is always set.

7 Troubleshooting

Error Display

Error name / display	Indicator		Error details	Possible causes
	Orange	Green		
Laser failure error 			The laser diode might have been deteriorated.	Restart the sensor (turn the power off and on again). If the error remains, replace the sensor.
System error 	Orange and green indicators show quick flashing alternately (at 0.2s intervals)		An error occurred in the system.	Replace the sensor.
Data (EEPROM) error 	OFF		An error occurred on the memory inside the sensor.	Initialize the settings by pressing and holding the UP button for 3s. The sensor is out of order if the error is still not fixed. Replace the sensor.
Load short-circuit error 		OFF	The output line is short-circuited.	Check the wiring and connecting.

State Display

State name / display	Possible causes	Action and correction
Insufficient intensity 	The received light intensity from the object is not sufficient or the object is out of the detection distance range.	Retard the response time or adjust so that the distance between the sensor main unit and the object can be detected by the sensor.
Key lock 	The key lock function enabled.	If a button operation is required, release the key lock. "5-1 Key Lock" (page 7)
Laser emission OFF 	Pin2 terminal (white) might have been short-circuited	Check the wiring and external input setting.

8 Ratings and Specifications

Sensing method		Triangulation			
Model	NPN output	E3AS-HL500MN□ series	E3AS-HL500LMN□ series	E3AS-HL150MN□ series	E3AS-HL150LMN□ series
	PNP output/COM2	E3AS-HL500MD□ series	E3AS-HL500LMD□ series	E3AS-HL150MD□ series	E3AS-HL150LMD□ series
	PNP output/COM3	E3AS-HL500MT□ series	E3AS-HL500LMT□ series	E3AS-HL150MT□ series	E3AS-HL150LMT□ series
Sensing distance		35 to 500 mm		35 to 150 mm	
Standard detectable difference*1		35 to 180 mm: 9 mm 180 to 300 mm: 18 mm 300 to 400 mm: 30 mm 400 to 500 mm: 45 mm at 10 msec		35.0 to 50.0 mm: 1 mm 50.0 to 100.0 mm: 2 mm 100.0 to 150.0 mm: 4 mm at 10 msec	
Spot size (reference value)*2		2.5×1.5 mm at distance of 500 mm	18×1.5 mm at distance of 500 mm	2.5×1.3 mm at distance of 150 mm	8×1.3 mm at distance of 150 mm
Light source (wavelength)		Red laser (660 nm)			
Power supply voltage		10 to 30 VDC, (including ripple (p-p) 10%), Class2			
Consumption current		100 mA max.			
Control output		Load power supply voltage 30 VDC max.(Class2), the total load current of the two outputs is 100 mA max. Residual voltage(Load current 10 mA max.: 1 VDC max., Load current 10 to 100 mA: 2 VDC max.) Open collector output type (Depends on the NPN/PNP output type) N.O.(Normally Open) / N.C.(Normally Close) selectable			
External input		Laser OFF / Teaching / Zero reset selectable For the applied voltage, refer to "2-1 Input/Output Circuit Diagram"(2.1 page 2). For the input time, refer to "3-3 External Input"(3.3 page 3).			
Protection circuits		Reversed power polarity protection, Output short-circuit protection, and Output reverse polarity protection			
Indicator		OLED Display(White), Power/Communication indicator (Green), Operation indicator (Orange)			
Response time		1.5 ms / 10 ms / 50 ms selectable			
Mutual interference prevention		4 units max. (when using the mutual interference prevention function)			
Ambient illumination		Receiver surface illuminance: Incandescent lamp: 20,000 lx max., Sunlight: 25,000 lx max. at distance of 250 mm Incandescent lamp: 5,000 lx max., Sunlight: 10,000 lx max. at distance of 500 mm		Receiver surface illuminance: Incandescent lamp: 8,000 lx max., Sunlight: 16,000 lx max.	
Ambient temperature		Operating: -10 to +50°C (with no icing or condensation) Storage: -25 to +70°C (with no icing or condensation)			
Ambient humidity		Operating: 35 to 85%RH, Storage: 35~95%RH (with no condensation)			
Insulation resistance		20 MΩ min. at 500 VDC			
Dielectric strength		1,000 VAC at 50 / 60 Hz for 1 minute			
Vibration resistance		10 to 55 Hz, 1.5-mm double amplitude for 2 hours each in X, Y, and Z directions			
Shock resistance		500 m/s ² for 3 times each in X, Y, and Z directions			
Enclosure ratings		IP67 (IEC60529), IP69K (ISO20653), IP67G (JIS C 0920 Annex 1)			
Dimensions		Pre-wired type: 48.6×30.4×15.5 mm, Connector type: 47.1×28.9×15.5 mm			
Material	Case	SU5316L			
	Indicator	Polyamide 11 (PA11)			
	Lens cover and Display	Methacrylic resin (PMMA) (Lens cover: Antifouling coating)			
Communication specifications	IO-Link specification	Ver1.1			
	Baud rate	COM3: 230.4 kbps, COM2: 38.4 kbps			
	Data length	PD size: 4 byte, OD size: 1 byte (M-sequence type: TYPE_2_V)			
	Minimum cycle time	COM3: 1.2 ms, COM2: 3.5 ms			
Conformity standards		UL Certification, CE Marking, RCM, EAC, IEC 60825-1:2014 (Laser Class 1), FDA (Laser Class 1), Ecolab, RoHS2, WEEE2			

Note: 1. Altitude: Up to 2000m, Pollution degree: 3, Enclosure type: Type1.
 *1. Measured with OMRON's standard workpiece (White ceramic).
 *2. Defined by D4σ method at the maximum sensing distance. Detection may be influenced if there is light leakage outside the defined region and the surroundings of the target object have a high reflectance in comparison to the target object. Also, when detecting a workpiece that is smaller than the spot size, a correct value may not be obtained.

Model standard



Mark	Specification		
① HL	Sensing method	Triangulation	
② 500 150	Sensing distance	500 mm 150 mm	
	Emission spot shape	Spot Line	
③ Blank L	Light source	Red	
	Case material	Metal	
④ N ⑤ D ⑥ T	Output method	NPN open collector PNP open collector/COM2 PNP open collector/COM3	
	⑦ Blank - M1TJ - M3J M3	Connection method	Pre-wired Pre-wired M12 Smartclick Connector Pre-wired M8 Connector M8 Connector
		Optional suffix	Special specification
⑧ alphanumeric character ⑨ Blank 2M 5M 0.3M		Code length	M8 Connector 2 m+150/-0 mm(Pre-wired) 5 m+150/-0 mm(Pre-wired) 0.3 m+60/-0 mm(Pre-wired Connector)

Suitability for Use

OMRON Corporation shall not be responsible for conformity with any standards, codes or regulations which apply to the combination of the Product in the Buyer's application or use of the Product. At Buyer's request, Omron will provide applicable third party certification documents identifying ratings and limitations of use which apply to the Product. This information by itself is not sufficient for a complete determination of the suitability of the Product in combination with the end product, machine, system, or other application or use. Buyer shall be solely responsible for determining appropriateness of the particular Product with respect to Buyer's application, product or system. Buyer shall take application responsibility in all cases.

NEVER USE THE PRODUCT FOR AN APPLICATION INVOLVING SERIOUS RISK TO LIFE OR PROPERTY WITHOUT ENSURING THAT THE SYSTEM AS A WHOLE HAS BEEN DESIGNED TO ADDRESS THE RISKS, AND THAT THE OMRON PRODUCT(S) IS PROPERLY RATED AND INSTALLED FOR THE INTENDED USE WITHIN THE OVERALL EQUIPMENT OR SYSTEM.

OMRON Corporation Industrial Automation Company
 Kyoto, JAPAN Contact: www.ia.omron.com

Regional Headquarters

- OMRON EUROPE B.V.**
 Wegalaan 67-69, 2132 JD Hoofddorp
 The Netherlands
 Tel: (31)2356-81-300/Fax: (31)2356-81-388
- OMRON ELECTRONICS LLC**
 2895 Greenspoint Parkway, Suite 200
 Hoffman Estates, IL 60169 U.S.A.
 Tel: (1) 847-843-7900/Fax: (1) 847-843-7787
- OMRON ASIA PACIFIC PTE. LTD.**
 No. 438A Alexandra Road # 05-05/08 (Lobby 2),
 Alexandra Technopark,
 Singapore 119967
 Tel: (65) 6835-3011/Fax: (65) 6835-2711
- OMRON (CHINA) CO., LTD.**
 Room 2211, Bank of China Tower,
 200 Yin Cheng Zhong Road,
 PuDong New Area, Shanghai, 200120, China
 Tel: (86) 21-6023-0333/Fax: (86) 21-5037-2388

D ①