

OMRON

Model **E3AS-L80M** □ □ / **200M** □ □

Distance-settable photoelectric sensor

INSTRUCTION SHEET

Thank you for selecting OMRON product. This sheet primarily describes precautions required in installing and operating the product. Before operating the product, read the sheet thoroughly to acquire sufficient knowledge of the product. For your convenience, keep the sheet at your disposal.

TRACEABILITY INFORMATION:

Importer in EU: OMRON Europe B.V. Wegalaan 67-69 NL-2132 JD Hoofddorp, The Netherlands
 Manufacturer: OMRON Corporation, Shiokoji Horikawa, Shimogyo-ku, Kyoto 600-8530 JAPAN

The following notice applies only to products that carry the CE mark. Notice: This is a Class A product. In residential areas it may cause radio interface, in which case the user may be required to be take adequate measures to reduce interference.



© OMRON Corporation 2019 All Rights Reserved.

* 4 6 1 0 2 8 3 - 0 C *

PRECAUTIONS ON SAFETY

● Meaning of Signal Words

⚠ WARNING

Indicates a potentially hazardous situation which, if not avoided, will result in minor or moderate injury, or may result in serious injury or death. Additionally there may be significant property damage.

⚠ CAUTION

Indicates a potentially hazardous situation which, if not avoided, may result in minor or moderate injury or in property damage.

⚠ WARNING

This product is not designed or rated for ensuring safety of persons either directly or indirectly. Do not use it for such purpose.



Do not use the product with voltage in excess of the rated voltage. Excess voltage may result in malfunction or fire.



⚠ CAUTION

Its component may be damaged and/or degree of protection may be degraded. Please do not apply high pressure water intensively at one place during cleaning.



Precautions for Safe Use

- Please observe the following precautions for safe use of the products.
- Do not reverse connection of DC power supply polarity. Do not connect to AC power supply.
- Do not short-circuit the load.
- Never use this product with AC power supply. Otherwise it may explode.
- The maximum power supply voltage is 30 VDC. Before turning on the product's power, make sure that the supply voltage does not exceed the maximum power supply voltage.
- Do not use the product in environments where flammable or explosive gases are present.
- Please assess the safety beforehand when using the product in chemicals and/or oil environments.
- Do not remodel the product.

Precautions for Correct Use

- Do not hit the product using a hammer for installation.
- The product must be installed with the specified torque or less. For M8 connector and Pre-wired M8 connector the proper tightening torque is from 0.3 to 0.4 N×m. In case of M12 smartclick connector, manually tighten the connector.
- Do not use the product in ambient atmosphere or environment exceeding the rating.
- Output pulses may be generated when the power is turned off. It is recommended to turn off the power of the load or load line first.
- The extension of the cord under the standard I/O mode should be 100m or less. Under the IO-Link mode, the length should be 20m or less.
- Do not pull the cord too strongly.
- Please wait for at least 100 ms after turning on the product's power until it is available for use.
- The product is rated as IP67 but please avoid using the product underwater, under rain, and outdoors.
- If wiring product's cables and/or cords in the same piping or duct of high voltage cables or power lines may cause malfunction or breakdown due to induced noise. In principle the cables and cords of the product must be separately wired from the power lines, or otherwise shielded.
- Do not use the product in direct sunlight.
- Do not use the product where humidity is high and dew condensation may occur.
- Do not use the product where corrosive gases may exist.
- If high-pressure washing water and so on hits the teach button, it might lead to malfunctioning. So, consider use of the key lock function.
- Do not use the product at a location subject to shock or vibration.
- To use a commercially available switching regulator, FG (frame ground) must be grounded.
- This product cannot be used as a detection device for human body protection.
- Do not use organic solvents (e.g. paint thinner and alcohol) for cleaning. Otherwise optical properties and protective structure may deteriorate.
- Be sure to check the influence caused by surrounding environments such as background objects and/or LED lighting before using the product.
- Please discard the product as industrial waste at the time of disposal.
- Dispose in accordance with applicable regulations.

Package contents

Instruction sheet (this sheet), compliance sheet, index list (attached for IO-Link type only)

1 Installation

1-1 Installation of the sensor

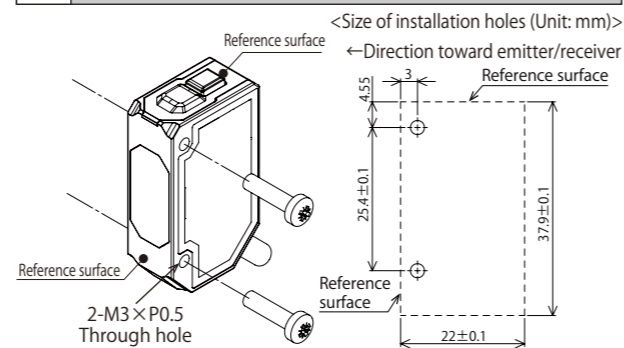

Mounting brackets are sold separately. Tightening torque for the mounting hole is 0.5 N×m or less (M3 screw).

- Do not touch the emitter and/or receiver block of the sensor. Fingerprint deposits may result in improper measurement. If accidentally touched, please wipe gently with a dry cloth. Do not use organic solvent (e.g. paint thinner and alcohol).
- If the object to be detected has a mirror surface, please install the product so that specular reflection light does not directly enter the light receiving block.

1-2 Constraints on sensor installation

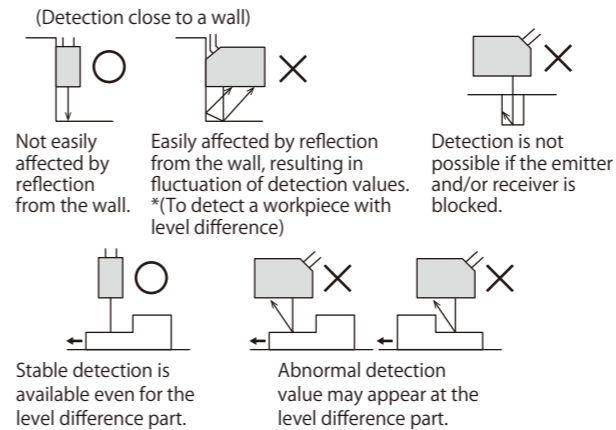

<Installation interval>

This product does not have any functions to prevent mutual interference. Keep a constant interval or longer between the emitting center of one sensor and the receiving center of the other sensor to prevent mutual interference.

- Interval between emitting and receiving centers (reference values)
 E3AS-L200□: Approx. 120 mm min.
 E3AS-L80□: Approx. 50 mm min.

For the detailed outline drawing, refer to the data sheet.

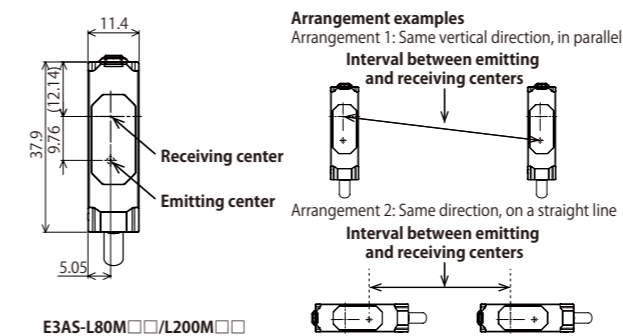

<For stable detection *L200□ only>



- Be sure to check the influence caused by surrounding environments such as background objects and/or LED lighting before using the product.

2 Connection

2-1 I/O stage circuit diagram

Model	Output	Output circuit
E3AS-□□N□	NPN	
E3AS-□□D□ or E3AS-□□T□	PNP/COM Standard I/O Mode	
	PNP/COM IO-Link Mode	

- Standard I/O mode is used as PNP ON/OFF output.
- IO-Link mode is used for communications with the IO-Link master.
- C/Q performs IO-Link communications. sensor output DO performs ON/OFF output.
- Detailed information of model and specification are described in 5. Model Standard and 6. Ratings and Specification

2-2 Connection method

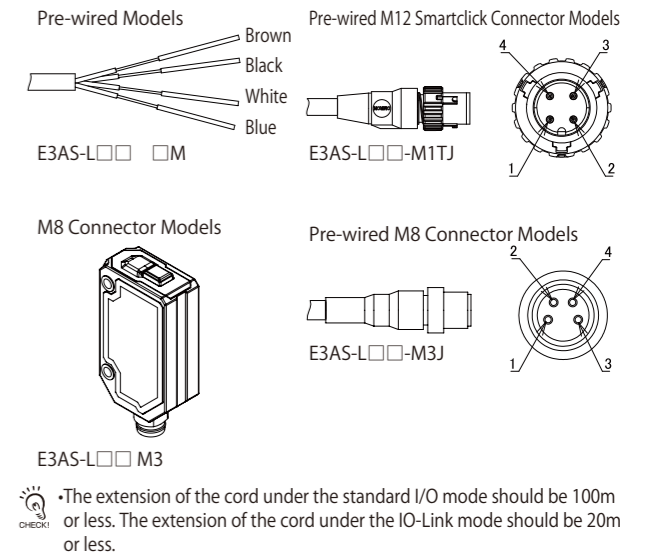

2-3 Sensor I/O connector cord

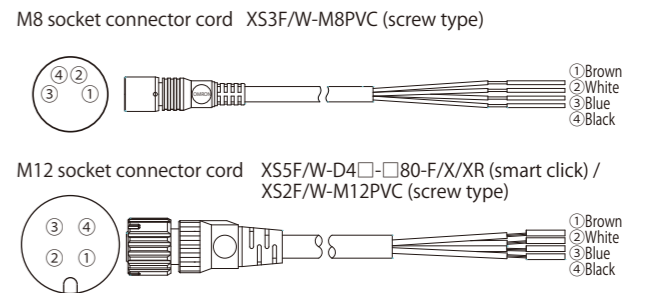

- The connector of each type is used in combination with the sensor I/O's connector cord.
- E3AS-L□□□-M1TJ (smart click) can be connected with connector cord XS2F series by screwing.
- The connector cords shown here are UL certified products. Connector cords that are not UL certified are also usable. But in this case, sensor/cord combination is not UL certified product.

2-4 About allowable bending radius of cord

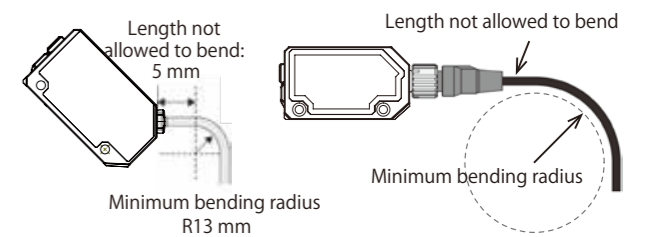

Bending for Pre-wired and Pre-wired Connector Models				
Material	External diameter	Minimum bending radius: mm	Length not allowed to bend: mm	
PVC	Φ4	13	5	
Bending of sensor I/O connector cord				
Model	Material	External diameter	Minimum bending radius: mm	Length not allowed to bend: mm
XS3F-M8PVC	PVC	Φ5	36	0
XS2F/W-D4-F	Incombustible robot	Φ6	40	0
XS5F/W-D4-F	Incombustible robot	Φ6	40	0
XS5F/W-D4-X	Highly oil-resistant PVC	Φ6	40	0
XS5F/W-D4-XR	Highly oil-resistant robot PVC	Φ6	40	0

3 Setting

3-1 Component Name & Function

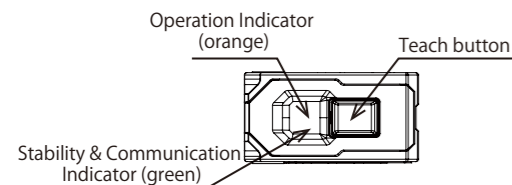

The indicators work differently depending on sensor status.

3-2 Key lock (Button lock)

It prevents accidental button operation.
 [To lock] Press and hold the Teach button for over 5 seconds but less than 10 seconds.
 [To unlock] Press and hold the Teach button for over 5 seconds but less than 10 seconds.
 *When the Teach button is pressed under the button lock status, the orange and green indicators continue to flash quickly (0.2 second cycle) and simultaneously for 3 seconds.

3-3 About teaching function (for output 1)

① To specify a threshold value for presence and non-presence of an object

● 2-point teaching

Press Teach button briefly (Less than 1 second) → Orange indicator flashes → Setup completed → Orange indicator stops flashing

* In case of default operation mode of NO.

*Specify a threshold as a distance in the middle between the presence and non-presence of an object.
 *The setting is available regardless of the order of presence and non-presence of an object.
 *Make sure to press the button for less than 1 second.

② To specify a threshold value for non-presence of an object

● Teaching without workpiece

press and hold the Teach button (Over 1 second and less than 5 seconds) → Setup completed → Orange indicator stops flashing

* In case of default operation mode of NO.

*Specify a threshold using the background as the base while there is no object to detect.
 *The range of margin is configured as an optimal value based on the background distance.

Initial value of set point 1: L80□/50, L200□/100

Indicators' behavior when the button is operated

	State	Orange indicator	Green indicator
NPN, PNP/COM Standard I/O Mode	Teaching in progress	Flashing (1 second cycle)	ON
	Teaching succeeded	Flashing (0.6 second cycle)*1	
	Teaching error	High-speed flashing (0.2 second cycle)*2	
PNP/COM IO-Link Mode	Teaching in progress	Output 1 state continues.	Flashing
	Teaching succeeded		
	Teaching error		

- * 1 1.2seconds two times flashing
- * 2 3seconds fifteen times flashing

④ When the button is operated, the output state continues.
 * If teaching is performed by the command, indicators do not change.
 * When performing teaching, threshold values are recording in EEPROM (non-volatile memory) in the sensor. The writing life of EEPROM is 100,000 times. Be careful of writing life when performing measurement-by-measurement teaching.

3-4 If a teaching error occurred

Confirm the following two items.
 1. Confirm that the object is within the measurement range.
 2. Widen the distance between the first and second points of two-point teaching.

3-5 Display specification (measurement status)

Standard I/O Mode	Indicator	State	Threshold	
			Stable NEAR	Stable FAR
Standard I/O Mode	Stability&Communication Indicator (green)*1	ON	ON	ON
	Operation Indicator (orange)	OFF	ON	ON
	Control Output 1	ON	ON	ON
IO-Link Mode	Stability&Communication Indicator (green)	Flashing (1second cycle)	ON	ON
	Operation Indicator (orange)	ON	ON	ON
	Communication Output	1	ON	ON
	Control Output 2 *2	OFF	ON	ON

Shown above are the factory settings. Refer to the index list for the default settings at time of shipment from factory.
 PNP/COM output logic can be reversed by IO-Link communication.
 The operation indicator (orange) lights up when control output 1 is ON or communication output is 1.
 * 1 Turns off when there is insufficient margin for incident light. In that case, place the workpiece closer to ensure sufficient receiving light intensity.
 * 2 The initial value of control output 2 is reverse of control output 1.

4 Errors and Actions

Indicator	Error details	Possible causes	Action and correction
Quick flashing	OFF	Load short-circuit error	The output line is short-circuited. Check the wiring.
OFF	Quick flashing	EEPROM error	Sensor's setting memory is abnormal. Initialize the setting values. Press and hold the Teach button for over 5 seconds.
Orange and green indicators alternately flash quickly	Breakdown error	The sensor itself may be out of order.	Restart the sensor (turn the power off and on again). If the error remains, replace the sensor.

Quick flashing cycle is 0.2 seconds.

5 Model standard

E3AS-L□□□M□□□□
 ①②③④⑤⑥⑦⑧⑨

① Sensing method	L: Triangulation
② Sensing distance	80: Sensing distance of 80 mm 200: Sensing distance of 200 mm
③ Emission spot shape	Blank: Spot
④ Light source	Blank: Red
⑤ Case material	M: Metal
⑥ Output method	N: NPN open collector D: PNP open collector/COM2 T: PNP open collector/COM3
⑦ Connection method	Blank: Pre-wired -M1T: Pre-wired M12 Smartclick Connector -M3J: Pre-wired M8 Connector M3: M8 Connector
⑧ Optional suffix	Special specification (alphanumerical character)
⑨ Code length	Blank: M8 Connector 2M, 5M, 0.3M (unit: m)

6 Ratings and Specifications

Sensing method		Triangulation	
Model	NPN output	E3AS-L200MN series	E3AS-L80MN series
	PNP output/COM2	E3AS-L200MD series	E3AS-L80MD series
	PNP output/COM3	E3AS-L200MT series	E3AS-L80MT series
Sensing distance	White or black paper (100 X 100mm): 10 to set distance	White or black paper (100 X 100mm): 10 to set distance	White or black paper (100 X 100mm): 20 to 80mm
Setting range	White or black paper (100 X 100mm): 40 to 200mm		White or black paper (100 X 100mm): 20 to 80mm
Differential travel	10% max. of set distance	White paper: 2% max. of set distance Black paper: 5% Max. of set distance	
B/W Error	10% max. of set distance	5% max. of set distance	
Spot size (reference value)	25 × 25mm at distance of 200mm	DIA 4mm max. at distance of 80mm	
Light source (Wavelength)	Red LED (624nm)	Red LED (650nm)	
Power supply voltage	10 to 30 VDC, (including ripple (p-p) 10%), Class2		
Current consumption	35mA max.		
Input/Output	Control output	Load power supply voltage: 30VDC max., Class2, Load current: 100mA max. Residual voltage: Load current less than 10mA: 1V max., Load current 10mA to 100mA: 2V max. Open collector output (NPN/PNP depending on model)	
		NPN	OUTPUT 1: NO, OUTPUT 2: NC
		PNP/COM2 PNP/COM3	OUTPUT 1: NO /COM□, OUTPUT 2: NC
Protection circuits	Reversed power supply polarity protection, Output short-circuit protection, and Reversed output polarity protection		
Response time	Operate or reset: 1ms max.		
Distance setting	Teaching method/IO-Link communication		
Ambient illumination	Illumination on received light surface: Incandescent lamp: 3000 lx max., Sunlight: 10000 lx max.		
Ambient temperature range	Operating: -25 to +55°C (with no icing or condensation) Storage: -40 to +70°C (with no icing or condensation)		
Ambient humidity range	Operating: 35 to 85%RH, Storage: 35~95%RH (with no condensation)		
Insulation resistance	20 MΩ min. at 500 VDC		
Dielectric strength	1,000 VAC at 50 / 60 Hz for 1 minute		
Vibration resistance	Destruction: 10 to 55 Hz, 1.5mm double amplitude for 2 hours each in X, Y, and Z directions		
Shock resistance	Destruction: 500 m/s ² for 3 times each in X, Y, and Z directions		
Enclosure ratings	IP67 (IEC60529), IP69K (ISO20653)		
Indicator	Stability/Communication indicator (Green*1), Operation indicator (Orange) *1: IO-Link mode: Blinking		
Size	H39.4mm × D22mm × W11.4mm Mounting hole pitch 25.4mm		
Material	Case	SUS316L	
	Indicator	Polyamide 11 (PA11)	
	Lens Cover	Methacrylic resin (PMMA)	
Communication specifications	IO-Link specification	Ver1.1	
	Baud rate	COM3:230.4kbps, COM2:38.4kbps	
	Data length	PD size: 1byte, OD size: 1byte (M-sequence type: TYPE_2_1)	
	Minimum cycle time	COM3:1.2ms, COM2:3.5ms	
Accessories	Instruction manual (this sheet), compliance sheet and index list (attached for IO-Link type only)		

*Altitude: Up to 2000m, Pollution degree: 3, Enclosure type: type1.

Suitability for Use

Omron Companies shall not be responsible for conformity with any standards, codes or regulations which apply to the combination of the Product in the Buyer's application or use of the Product. At Buyer's request, Omron will provide applicable third party certification documents identifying ratings and limitations of use which apply to the Product. This information by itself is not sufficient for a complete determination of the suitability of the Product in combination with the end product, machine, system, or other application or use. Buyer shall be solely responsible for determining appropriateness of the particular Product with respect to Buyer's application, product or system. Buyer shall take application responsibility in all cases.

NEVER USE THE PRODUCT FOR AN APPLICATION INVOLVING SERIOUS RISK TO LIFE OR PROPERTY WITHOUT ENSURING THAT THE SYSTEM AS A WHOLE HAS BEEN DESIGNED TO ADDRESS THE RISKS, AND THAT THE OMRON PRODUCT(S) IS PROPERLY RATED AND INSTALLED FOR THE INTENDED USE WITHIN THE OVERALL EQUIPMENT OR SYSTEM.

OMRON Corporation Industrial Automation Company
 Kyoto, JAPAN Contact: www.ia.omron.com

Regional Headquarters

- **OMRON EUROPE B.V.**
 Wegalaan 67-69, 2132 JD Hoofddorp
 The Netherlands
 Tel: (31)2356-81-300/Fax: (31)2356-81-388
- **OMRON ELECTRONICS LLC**
 2895 Greenspoint Parkway, Suite 200
 Hoffman Estates, IL 60169 U.S.A.
 Tel: (1) 847-843-7900/Fax: (1) 847-843-7787
- **OMRON ASIA PACIFIC PTE. LTD.**
 No. 438A Alexandra Road # 05-05/08 (Lobby 2),
 Alexandra Technopark,
 Singapore 119967
 Tel: (65) 6835-3011/Fax: (65) 6835-2711
- **OMRON (CHINA) CO., LTD.**
 Room 2211, Bank of China Tower,
 200 Yin Cheng Zhong Road,
 PuDong New Area, Shanghai, 200120, China
 Tel: (86) 21-5037-2222/Fax: (86) 21-5037-2200