

ROEQ TML US Pallet Lift solution for OMRON MD series



The ROEQ Pallet Lift US top module has been developed to transport US pallets, and other cargo, with payloads up to 500 kg on the OMRON MD-650, and up to 750 kg on the OMRON MD-900 AMR.

All ROEQ top modules come with the ROEQ Assist software tool which is fully compatible with the AMR software and ensures a consistent and faster set up.

The pallet lift has been developed to work with the ROEQ PR750 US Pallet Rack for reliable and robust performance.

All ROEQ solutions have been developed with safety standards in focus and they have undergone extensive quality testing.



Specifications

Robot compatibility: OMRON MD-650
OMRON MD-900

ROEQ product compatibility: PR750 US
Pallet Rack

Payload:
500 kg / 1100lbs on OMRON MD-650
750 kg / 1675lbs on OMRON MD-900

Top module weight:
140 kg / 308.6 lbs

Stroke:
70mm / 2.75"

Lifting time:
6 sec





Features

- Easy mounting of top module to the AMR
- ROEQ Assist software for quicker, easier and more consistent set-up
- Threaded mounting holes for adding customized equipment
- Can travel with forks up for reduced cycle time
- Add-on ROEQ Cargo Sensor Kit available, to prevent pick up of goods on occupied AMR and delivery of cargo to an occupied pallet rack
- Easy Access to robot I/O via top module, for adding blue light etc.
- ROEQ PR750 US Pallet Rack for complete solution
 - Space saving design with Multi Rack option
 - Designed to affix OMRON sensor to connect to Fleet Manager

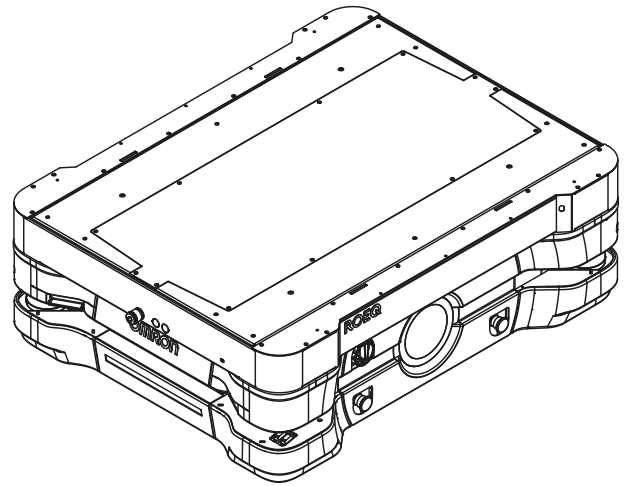
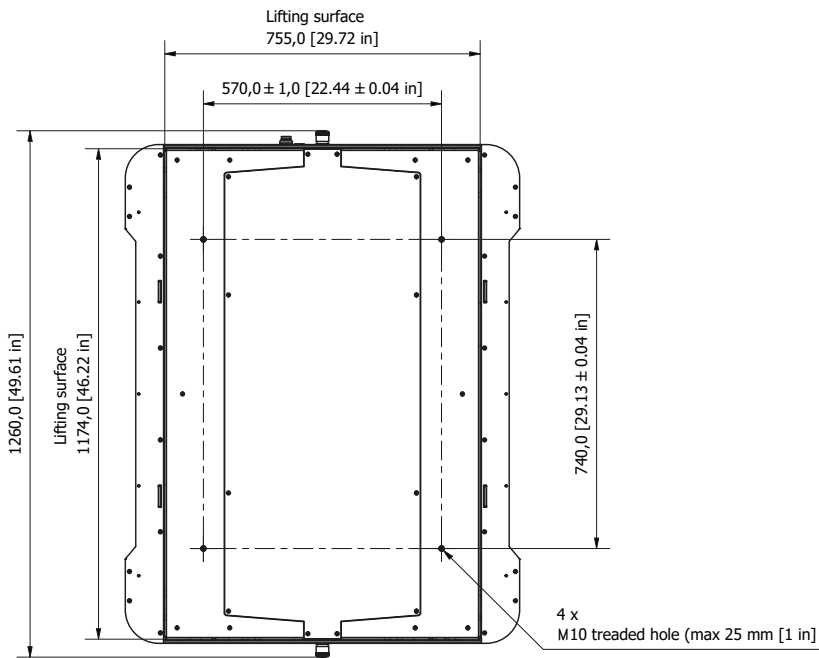
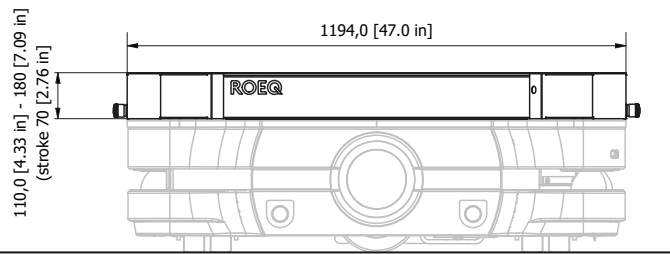
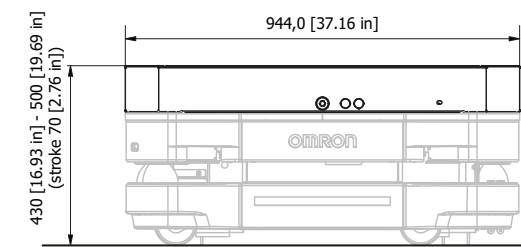

Compliant with safety standards:
ISO 3691-4:2020 Driverless Industrial trucks
EU Machinery Directive



Product name	Description	
TML500 US	Top Module for handling US pallets on the OMRON MD-650. Payload 500 kg	
TML750 US	Top Module for handling US pallets on the OMRON MD-900. Payload 750 kg	
PR750 US	Pallet Rack for pick up / drop off of US pallets. Payload 750 kg.	
Multi Rack US	Space saving add-on to the PR750 US for placing pallet racks in a row - saving approx. 250mm (10") per pallet	
ROEQ Cargo Sensor Kit	Two sensors which fit on the TML500 US top module to prevent pick up of goods on an occupied AMR and drop off to an occupied pallet rack	

Contact your local ROEQ Partner for more guidance