

# Photomicrosensor Selection Guide

Select the best suited sensor from our extensive line up



Find your desired sensor

# Omron's Photomicrosensor Line up

Compact, simple photoelectric sensors with built-in amplifier for Positioning and workpiece detection. Our broad product portfolio includes sensors for special applications as well as through-beam (slot-type) and reflective sensors.

We offer connector and pre-wired models, supporting manufacturing.

## Positioning Detection

### General-purpose Models

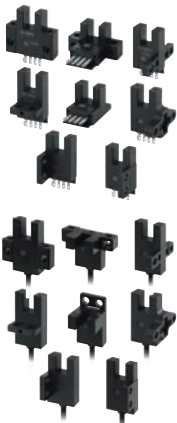

Connector and pre-wired models in eight different shapes.

Slot width  
**5 mm**

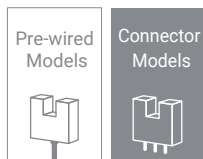

EE-SX47/67

P.04

### Compact Models



Saving space and wiring costs with the integrated connector and commercial connector.

Slot width  
**5 mm**



EE-SX97

P.08

### Ultra-compact Models



Ultra-compact, half the volume of general-purpose models. Mounting with M3 or M2 screws.

Slot width  
**5 mm**



EE-SX95

P.10

### Thin Models



4.6 mm-thick sensor for space saving mounting.

Slot width  
**5 mm**



EE-SX77/87

P.12

### Ambient Light-resistant Models



Light modulation to reduce ambient light interference. Connector and pre-wired models.

Slot width  
**5 mm**

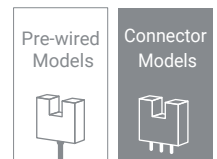

EE-SPX-W EE-SPX74/84

P.14 P.16



## Workpiece Detection

## Special Application

### Broad Slot-type Ambient Light-resistant Models



Light modulation to reduce ambient light interference. 13 mm slot width and high noise immunity.

Slot width  
**13 mm**



EE-SPX303N/EE-SPX403N

**P.18**

### Light Convergent Reflective Models



Less affected by background.

Sensing distance  
**2 to 5 mm**



EE-SPY31/41

**P.20**

### Diffuse-reflective Models



Light modulation to reduce ambient light interference.

Sensing distance  
**5 mm**



EE-SPY30/40

**P.22**

### Liquid Level Sensors



Pipe-mounting liquid level photomicrosensor.

Pipe diameter  
**6 dim. to 13 mm**



EE-SPX613

**P.24**

### Pushbutton-type Photomicrosensors



Accurately detecting without being affected by the material, color, or reflectance of the FOUF cassettes.

Pushbutton type



EE-SA701/801

**P.26**

# EE-SX47/67

## Global Standard Slot-type photomicrosensors with 50- to 100-mA direct switching capacity.



- Series includes models that enable switching between dark-ON and light-ON operation.
- Response frequency as high as 1 kHz.
- Easy operation monitoring with bright light indicator.
- Wide operating voltage range: 5 to 24 VDC
- Models in which the light indicator turns ON for dark-ON operation are also available.
- A wide range of variations in eight different shapes.
- Flexible robot cable is provided as a standard feature. \*2

\*1. Pre-wired Models are available only in the EE-SX67 Series.

\*2. Only for Pre-wired Models.



For the most recent information on models that have been certified for safety standards, refer to your OMRON website.

Be sure to read *Safety Precautions for All Photomicrosensors* on page 30.

## Ordering Information

### Connector

Infrared light

Appearance	Sensing method	Connect-ing method	Sensing distance	Output configuration	Indicator mode	Model	
						NPN output	PNP output
<p>Standard</p>	Through-beam (slot-type)	Connector (4 poles)	5 mm (slot width)	Dark-ON/Light-ON (selectable) *3 *4	Incident light	EE-SX670	EE-SX670P
				No incident light	EE-SX670A	EE-SX670R	
				Light-ON	Incident light	EE-SX470	—
<p>L-shaped</p>				Dark-ON/Light-ON (selectable) *3 *4	Incident light	EE-SX671	EE-SX671P
				No incident light	EE-SX671A	EE-SX671R	
				Light-ON	Incident light	EE-SX471	—
<p>T-shaped, slot center 7 mm</p>				Dark-ON/Light-ON (selectable) *3 *4	Incident light	EE-SX672	EE-SX672P
				No incident light	EE-SX672A	EE-SX672R	
				Light-ON	Incident light	EE-SX472	—
<p>Close-mounting</p>				Dark-ON/Light-ON (selectable) *3 *4	Incident light	EE-SX673	EE-SX673P
				No incident light	EE-SX673A	EE-SX673R	
				Light-ON	Incident light	EE-SX473	—
<p>Close-mounting</p>				Dark-ON/Light-ON (selectable) *3 *4	Incident light	EE-SX674	EE-SX674P
				No incident light	EE-SX674A	EE-SX674R	
				Light-ON	Incident light	EE-SX474	—
<p>T-shaped, slot center 10 mm</p>				Dark-ON/Light-ON (selectable) *3 *4	Incident light	EE-SX675	EE-SX675P
<p>F-shaped</p>	Dark-ON/Light-ON (selectable) *3 *4	Incident light	EE-SX676	EE-SX676P			
<p>R-shaped</p>	Dark-ON/Light-ON (selectable) *3 *4	Incident light	EE-SX677	EE-SX677P			

\*3. Dark-ON when the L terminal of the connector is opened, and light-ON when the L terminal and positive (+) terminal are connected. Do not connect the L terminal to 0 V when using dark-ON operation. When using light-ON, it is useful to select the connector EE-1001-1. The L terminal and positive (+) terminal of this connector are connected in advance.

\*4. If you do not use the L terminal wire ((2) pink) when you use a Connector with Cable for an EE-1006 or EE-1010-series Photomicrosensor, noise may affect the Photomicrosensor. To prevent the effects of noise, cut the unused L terminal wire at the base of the connector and wrap it with insulating tape to prevent it from coming in contact with other terminals.

Pre-wired Models

Infrared light

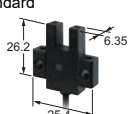
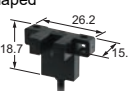
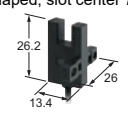
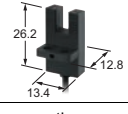
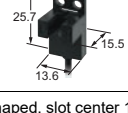
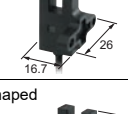
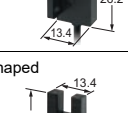
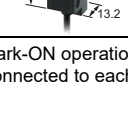
Appearance	Sensing method	Sensing distance		Output configuration	Indicator mode	Connecting method	Model	
							NPN output	PNP output
	Through-beam (slot-type)	5 mm (slot width)	Dark-ON/ Light-ON (selectable) *1	Incident light	Pre-wired Models (1m)	EE-SX670-WR 1M	EE-SX670P-WR 1M	
						EE-SX671-WR 1M	EE-SX671P-WR 1M	
						EE-SX672-WR 1M	EE-SX672P-WR 1M	
						EE-SX673-WR 1M	EE-SX673P-WR 1M	
						EE-SX674-WR 1M	EE-SX674P-WR 1M	
						EE-SX675-WR 1M	EE-SX675P-WR 1M	
						EE-SX676-WR 1M	EE-SX676P-WR 1M	
						EE-SX677-WR 1M	EE-SX677P-WR 1M	

\*1. Dark-ON operation can be used when the L terminal is left unconnected or Light-ON operation can be used when the L terminal and positive (+) terminal are connected to each other. Do not connect the L terminal to 0 V when using dark-ON operation.

Accessories (Order Separately) Connector Models

Type	Cable length	Model
Connector		EE-1001
		EE-1001-1
		EE-1009
Connector with Cable	1 m	EE-1006 1M
		EE-1010 1M
	2 m	EE-1006 2M
		EE-1010 2M
Connector with Robot Cable	1 m	EE-1010-R 1M
	2 m	EE-1010-R 2M
Connector Hold-down Clip		EE-1006A

Note: 1. If you do not use the L terminal wire ((2) pink) when you use a Connector with Cable for an EE-1006 or EE-1010-series Photomicrosensor, noise may affect the Photomicrosensor. To prevent the effects of noise, cut the unused L terminal wire at the base of the connector and wrap it with insulating tape to prevent it from coming in contact with other terminals.

2. For details, refer to the *Accessories (Order Separately)* on page 28.

# EE-SX47/67

## Ratings and Specifications

Item	Type		Standard	L-shaped	T-shaped, slot center 7 mm	Close-mounting		T-shaped, slot center 10 mm	F-shaped	R-shaped
	NPN models	Connector models	EE-SX670 EE-SX670A EE-SX470	EE-SX671 EE-SX671A EE-SX471	EE-SX672 EE-SX672A EE-SX472	EE-SX673 EE-SX673A EE-SX473	EE-SX674 EE-SX674A EE-SX474	EE-SX675	EE-SX676	EE-SX677
Item	PNP models	Connector models	EE-SX670P EE-SX670R	EE-SX671P EE-SX671R	EE-SX672P EE-SX672R	EE-SX673P EE-SX673R	EE-SX674P EE-SX674R	EE-SX675P	EE-SX676P	EE-SX677P
		Pre-wired models	EE-SX670P- WR	EE-SX671P- WR	EE-SX672P- WR	EE-SX673P- WR	EE-SX674P- WR	EE-SX675P- WR	EE-SX676P- WR	EE-SX677P- WR
<b>Sensing distance</b>			5 mm (slot width)							
<b>Sensing object</b>			Opaque: 2 × 0.8 mm min.							
<b>Differential distance</b>			0.025 mm							
<b>Light source</b>			Infrared LED with a peak wavelength of 940 nm							
<b>Indicator *1</b>			Light indicator (red) (turns ON when light is interrupted for models with A or R suffix)							
<b>Supply voltage</b>			5 to 24 VDC ±10%, ripple (p-p): 10% max.							
<b>Current consumption</b>			12 mA max.							
<b>Control output</b>			NPN open collector: 5 to 24 VDC, 100 mA max. 100 mA load current with a residual voltage of 0.8 V max. 40 mA load current with a residual voltage of 0.4 V max. OFF current (leakage current): 0.5 mA max. PNP open collector: 5 to 24 VDC, 50 mA max. 50 mA load current with a residual voltage of 1.3 V max. OFF current (leakage current): 0.5 mA max.							
<b>Protection circuits</b>			Load short circuit protection							
<b>Response frequency *2</b>			1 kHz min. (3 kHz average)							
<b>Ambient illumination</b>			1,000 lx max. with fluorescent light on the surface of the receiver.							
<b>Ambient temperature range</b>			Operating: -25 to +55°C, Storage: -30 to +80°C (with no icing or condensation)							
<b>Ambient humidity range</b>			Operating: 5% to 85%, Storage: 5% to 95% (with no icing or condensation)							
<b>Vibration resistance</b>			Destruction: 20 to 2,000 Hz (peak acceleration: 100 m/s <sup>2</sup> ) 1.5-mm double amplitude for 2 h (4-min periods) each in X, Y, and Z directions							
<b>Shock resistance</b>			Destruction: 500 m/s <sup>2</sup> for 3 times each in X, Y, and Z directions							
<b>Degree of protection</b>			IEC60529 IP50							
<b>Connecting method</b>			Connector Models (direct soldering possible), Pre-wired Models (Standard cable length: 1 m), Models with Connectors (Standard cable length: 0.1 m)							
<b>Wei- ght</b>	<b>Connector models</b>	Approx. 3.1 g	Approx. 3 g	Approx. 2.4 g	Approx. 2.3 g	Approx. 3 g	Approx. 2.7 g	Approx. 2.2 g	Approx. 2.2 g	
	<b>Pre-wired models</b>	Approx. 18.9 g	Approx. 17.3 g	Approx. 17.8 g	Approx. 16.8 g	Approx. 17.1 g	Approx. 18.3 g	Approx. 16.9 g	Approx. 16.9 g	
<b>Ma- teri- al</b>	<b>Case</b>	Polybutylene phthalate (PBT)								
	<b>Cover</b>	Polycarbonate								
	<b>Emitter/receiver</b>									

Note: For details, refer to *EE-SX47/SX67 Data sheet*.

\*1. The indicator is a GaP red LED (peak wavelength: 690 nm).

\*2. The response frequency was measured by detecting the rotating disk shown at the right.

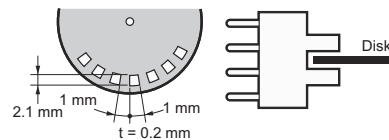



# EE-SX97

## Built-in connector enables downsizing and easier connection. Protective circuit for safe operation.



- A built-in connector minimizes the shape and dimensional requirements.
- Two outputs: light-ON and dark-ON.
- Complete lineup including seven different shapes.
- Safer operation with built-in power supply reverse polarity protection.
- Output overcurrent protection with a thermal shutdown circuit (patent pending). \*1
- The indicator can be seen from many directions to enable installation in more locations.
- Connector with lock that mates with commercially available connectors. \*2

\*1. Output overcurrent protection is provided only on output 2 (OUT2) on NPN models.

\*2. Recommended connector:

J.S.T. Mfg. Co., Ltd. Contacts: SPHD-001T-P0.5, Housing: PAP-04V-S

Ask the manufacturer of the connector for details.

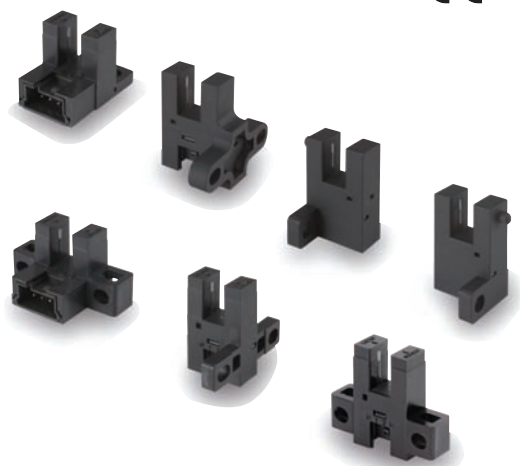



For the most recent information on models that have been certified for safety standards, refer to your OMRON website.

 Be sure to read *Safety Precautions for All Photomicrosensors* on page 30.

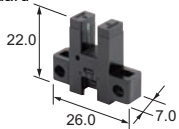

## Ordering Information

### Sensors

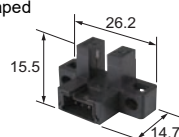
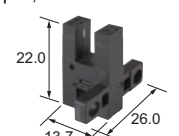
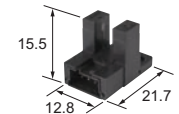
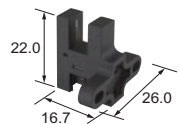
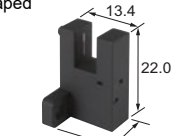
 Infrared light

Appearance	Sensing method	Connecting method	Sensing distance		Operating mode	Indicator mode	Model	
							NPN output	PNP output
Standard 	Through-beam (slot-type)	Connector model (4 poles)		5 mm (slot width)	Dark-ON/ Light-ON (2 outputs)	Incident light	EE-SX970-C1	EE-SX970P-C1
L-shaped 							EE-SX971-C1	EE-SX971P-C1
T-shaped, slot center 7 mm 							EE-SX972-C1	EE-SX972P-C1
Close-mounting 							EE-SX974-C1	EE-SX974P-C1
T-shaped, slot center 10 mm 							EE-SX975-C1	EE-SX975P-C1
F-shaped 							EE-SX976-C1	EE-SX976P-C1

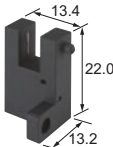

Appearance	Sensing method	Connecting method	Sensing distance		Operating mode	Indicator mode	Model	
							NPN output	PNP output
R-shaped 	Through-beam (slot-type)	Connector model (4 poles)		5 mm (slot width)	Dark-ON/ Light-ON (2 outputs)	Incident light	<b>EE-SX977-C1</b>	<b>EE-SX977P-C1</b>

## Accessories (Order Separately)

Type	Cable length	Model
Connector with Cable	1 m	<b>EE-1017 1M</b>
	3 m	<b>EE-1017 3M</b>
Connector with Robot Cable	1 m	<b>EE-1017-R 1M</b>
	3 m	<b>EE-1017-R 3M</b>

Note: For details, refer to the *Accessories (Order Separately)* on page 28.

## Ratings and Specifications

Item	Type	Standard	L-shaped	T-shaped, slot center 7 mm	Close-mounting	T-shaped, slot center 10 mm	F-shaped	R-shaped
		NPN	EE-SX970-C1	EE-SX971-C1	EE-SX972-C1	EE-SX974-C1	EE-SX975-C1	EE-SX976-C1
	PNP	EE-SX970P-C1	EE-SX971P-C1	EE-SX972P-C1	EE-SX974P-C1	EE-SX975P-C1	EE-SX976P-C1	EE-SX977P-C1
Sensing distance	5 mm (slot width)							
Sensing object	Opaque: 2 × 0.8 mm min.							
Differential distance	0.025 mm max. *1							
Light source (Peak wavelength)	Infrared LED with a peak wavelength of 940 nm							
Indicator	Light indicator (orange LED)							
Supply voltage	5 to 24 VDC ±10%, ripple (p-p): 10% max.							
Current consumption	21 mA max.							
Control output	Load power supply voltage: 5 to 24 VDC, Load current: 50 mA max., Off-state current : 0.5mA max, 50 mA load current with a residual voltage of 1.0 V max., 5 mA load current with a residual voltage of 0.4 V max.							
Protection circuit	Power supply reverse polarity protection; output reverse polarity protection; overcurrent protection (only OUT2 on models with NPN output)							
Response frequency	1 kHz min. (3 kHz average) *2							
Ambient illumination	1,000 lx max. with fluorescent light on the surface of the receiver							
Ambient temperature range	Operating: -25 to 55°C Storage: -30 to 80°C (with no icing or condensation)							
Ambient humidity range	Operating: 5% to 85% Storage: 5% to 95% (with no icing or condensation)							
Vibration resistance (Destruction)	10 to 2,000 Hz 0.75-mm single amplitude (15-min periods, 10 cycles) each in X, Y, and Z directions							
Shock resistance (Destruction)	Destruction: 500 m/s <sup>2</sup> for 3 times each in X, Y, and Z directions							
Degree of protection	IEC 60529 IP50							
Connecting method	Connector							
Weight (Packed state)	Approx. 3 g							
Material	Case/Cover	Polybutylene terephthalate (PBT)						
	Emitter/receiver	Polycarbonate (PC)						

Note: For details, refer to *EE-SX97 Data sheet*.

\*1. The differential distance is the value when a sensing object is moved in a lateral direction to the slot.

\*2. The response frequency was measured by detecting the following rotating disk.

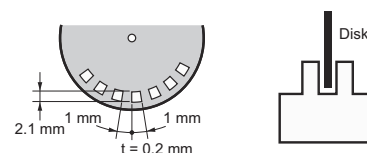

# EE-SX95

## Meeting Customer Needs with Ultra-compact Sensors that Mount with M3 Screws

- Mount using M3 or M2 screws.
- Reliable sensing slot depth of 6.5 mm.
- Indication of sensing window for easy confirmation of insertion depth.
- Bright indicator for confirmation from many directions.
- Both light-ON and dark-ON outputs provided.
- All models available with either standard cable or flexible robot cable.
- Load short-circuit protection circuit provided.



For the most recent information on models that have been certified for safety standards, refer to your OMRON website.

Be sure to read *Safety Precautions for All Photomicrosensors* on page page 30.

## Ordering Information

### Sensors

Infrared light

Appearance	Sensing method	Sensing distance	Output configuration	Connection method (Cable length)	Output type	Model
Standard 	Through-beam (slot-type)	5 mm (slot width)	Light-ON Dark-ON (2 outputs)	Pre-wired model with standard cable (1 m)	NPN	EE-SX950-W 1M *1
					PNP	EE-SX950P-W 1M *2
				Pre-wired model with robot cable (1 m)	NPN	EE-SX950-R 1M *1
Pre-wired connector model with robot cable (0.3 m)				NPN	EE-SX950-C1J-R 0.3M	
L-shaped 				Pre-wired model with standard cable (1 m)	NPN	EE-SX951-W 1M *1
					PNP	EE-SX951P-W 1M *2
				Pre-wired model with robot cable (1 m)	NPN	EE-SX951-R 1M *1
F-shaped 				Pre-wired model with standard cable (1 m)	NPN	EE-SX952-W 1M *1
				Pre-wired model with robot cable (1 m)	PNP	EE-SX952P-W 1M *2
					NPN	EE-SX952-R 1M *1
Pre-wired connector model with robot cable (0.3 m)				NPN	EE-SX952-C1J-R 0.3M	
R-shaped 				Pre-wired model with standard cable (1 m)	NPN	EE-SX953-W 1M *1
	PNP	EE-SX953P-W 1M *2				
	Pre-wired model with robot cable (1 m)	NPN	EE-SX953-R 1M *1			
Pre-wired connector model with robot cable (0.3 m)	NPN	EE-SX953-C1J-R 0.3M				
U-shaped 	Pre-wired model with standard cable (1 m)	NPN	EE-SX954-W 1M *1			
		PNP	EE-SX954P-W 1M *2			
	Pre-wired model with robot cable (1 m)	NPN	EE-SX954-R 1M *1			
Pre-wired connector model with robot cable (0.3 m)	NPN	EE-SX954-C1J-R 0.3M				

\*1. A model is available with a 3-m cable. The model number is EE-SX95□-□ 3M.(Example: EE-SX950-W 3M)

\*2. A pre-wired model with a PNP output and 1-m robot cable is available. The model number is EE-SX95□P-R 1M.(Example: EE-SX950P-R 1M)

## Accessories (Order Separately)

### Connector with Robot Cable

Type	Cable length	Model
Connector with Cable	2 m	EE-1016-R 2M

Note: For details, refer to the *Accessories (Order Separately)* on page page 28.

## Ratings and Specifications

Item	Type		Standard	L-shaped	F-shaped	R-shaped	U-shaped
	NPN output	Pre-wired models	EE-SX950-□	EE-SX951-□	EE-SX952-□	EE-SX953-□	EE-SX954-□
Item	PNP output	Pre-wired connector models	EE-SX950-C1J-R	EE-SX951-C1J-R	EE-SX952-C1J-R	EE-SX953-C1J-R	EE-SX954-C1J-R
		Pre-wired models	EE-SX950P-□	EE-SX951P-□	EE-SX952P-□	EE-SX953P-□	EE-SX954P-□
<b>Sensing distance</b>			5 mm (slot width)				
<b>Standard sensing object</b>			Opaque: 1.8 × 0.8 mm min.				
<b>Differential travel</b>			0.025 mm max. *1				
<b>Light source (wave length)</b>			Infrared LED (940 nm)				
<b>Indicator</b>			Light indicator (red LED)				
<b>Power supply voltage</b>			5 to 24 VDC ±10%, ripple (p-p): 10% max.				
<b>Current consumption</b>			15 mA max.				
<b>Control output</b>			Load power supply voltage: 5 to 24 VDC Load current: 50 mA max. OFF current: 0.5 mA max. 50 mA load current with a residual voltage of 0.7 V max. 5 mA load current with a residual voltage of 0.4 V max.				
<b>Protection circuit</b>			Load short-circuit protection				
<b>Response frequency</b>			1 kHz min. (3 kHz average) *2				
<b>Ambient illumination</b>			1,000 lx max. with fluorescent light on the surface of the receiver				
<b>Ambient temperature range</b>			Operating: -25 to 55°C Storage: -30 to 80°C (with no icing or condensation)				
<b>Ambient humidity range</b>			Operating: 5% to 85% Storage: 5% to 95% (with no icing or condensation)				
<b>Vibration resistance (destruction)</b>			10 to 2,000 Hz (peak acceleration: 150m/s <sup>2</sup> ) with a 0.75-mm single amplitude for 2.5 h (15-min periods, 10 cycles) each in X, Y, and Z directions				
<b>Shock resistance (destruction)</b>			500 m/s <sup>2</sup> for 3 times each in X, Y, and Z directions				
<b>Degree of protection</b>			IEC60529 IP50				
<b>Connection method</b>			Pre-wired models (standard length: 1 m), Pre-wired connector models (standard length: 0.3 m)				
<b>Weight (packed state)</b>	<b>Pre-wired models</b>		Approx. 15 g				
	<b>Pre-wired connector models</b>		Approx. 7 g				
<b>Materials</b>	<b>Case/cover</b>		Polybutylene terephthalate (PBT)				
	<b>Emitter/receiver</b>		Polycarbonate (PC)				

Note: For details, refer to *EE-SX95 Data sheet*.

\*1. The differential travel is the value when a sensing object is moved in a lateral direction to the slot.

\*2. The response frequency was measured by detecting the following rotating disk.

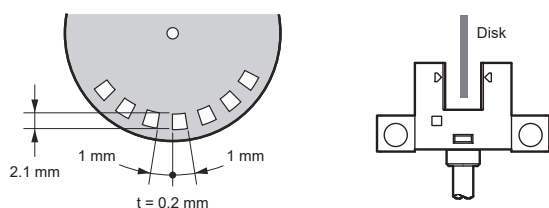

# EE-SX77/87

## Slim, Compact Photomicrosensor that is still easy to use.



- Compact, thin profile enables dense mounting.
- Indicator is visible from both sides.
- Wide operating voltage range: 5 to 24 VDC



For the most recent information on models that have been certified for safety standards, refer to your OMRON website.

Be sure to read *Safety Precautions for All Photomicrosensors* on page 30.

## Ordering Information

### Pre-wired Models

Infrared light

Appearance	Sensing method	Cable length	Sensing distance		Output configuration	Indicator mode	Model	
							NPN output	PNP output
<b>Standard</b> 	Through-beam (slot-type)	2 m		5 mm (slot width)	Dark-ON	Incident light	EE-SX770 2M	EE-SX770P 2M
						No incident light	EE-SX770A 2M	EE-SX770R 2M
Light-ON					Incident light	EE-SX870 2M	EE-SX870P 2M	
					No incident light	EE-SX870A 2M	EE-SX870R 2M	
<b>L-shaped</b> 					Dark-ON	Incident light	EE-SX771 2M	EE-SX771P 2M
						No incident light	EE-SX771A 2M	EE-SX771R 2M
Light-ON					Incident light	EE-SX871 2M	EE-SX871P 2M	
					No incident light	EE-SX871A 2M	EE-SX871R 2M	
<b>T-shaped</b> 					Dark-ON	Incident light	EE-SX772 2M	EE-SX772P 2M
						No incident light	EE-SX772A 2M	EE-SX772R 2M
Light-ON	Incident light	EE-SX872 2M	EE-SX872P 2M					
	No incident light	EE-SX872A 2M	EE-SX872R 2M					

## Ratings and Specifications

Item	Type	Standard	L-shaped	T-shaped
	NPN models	EE-SX770/EE-SX870 EE-SX770A/EE-SX870A	EE-SX771/EE-SX871 EE-SX771A/EE-SX871A	EE-SX772/EE-SX872 EE-SX772A/EE-SX872A
PNP models	EE-SX770P/EE-SX870P EE-SX770R/EE-SX870R	EE-SX771P/EE-SX871P EE-SX771R/EE-SX871R	EE-SX772P/EE-SX872P EE-SX772R/EE-SX872R	
Sensing distance	5 mm (slot width)			
Sensing object	Opaque: 2 × 0.8 mm min.			
Differential distance	0.025 mm			
Light source	GaAs infrared LED with a peak wavelength of 940 nm			
Indicator	Light indicator (red) (turns ON when light is interrupted for models with A or R suffix)			
Supply voltage	5 to 24 VDC ±10%, ripple (p-p): 10% max.			
Current consumption	12 mA max.			
Control output	NPN open collector: 5 to 24 VDC, 100 mA max. 100 mA load current with a residual voltage of 0.8 V max. 40 mA load current with a residual voltage of 0.4 V max. OFF current (leakage current): 0.5 mA max. PNP open collector: 5 to 24 VDC, 50 mA max. 50 mA load current with a residual voltage of 1.3 V max. OFF current (leakage current): 0.5 mA max.			
Protection circuits	Load short-circuit protection			
Response time	Light-ON: 20 μs max, Dark-ON: 100 μs max.			
Maximum response frequency *1	3 kHz max.			
Ambient illumination	1,000 lx max. with fluorescent light on the surface of the receiver			
Ambient temperature range	Operating: -25 to +55°C Storage: -30 to +80°C (with no icing)			
Ambient humidity range	Operating: 5% to 85% Storage: 5% to 95% (with no condensation)			
Vibration resistance	Destruction: 10 to 2,000 Hz (peak acceleration: 100 m/s <sup>2</sup> ) 1.5-mm double amplitude for 2 h (4-min periods) each in X, Y, and Z directions			
Shock resistance	Destruction: 500 m/s <sup>2</sup> for 3 times each in X, Y, and Z directions			
Degree of protection *2	IEC60529 IP64			
Connecting method	Pre-wired (standard cable length: 2 m)			
Weight (packaged)	Approx. 20 g			
Material	Case: Polybutylene phthalate (PBT)			
Conformity standards	UL Certification, CE Marking, ISO13849-1 (PLc, cat1) *2			

Note: For details, refer to *EE-SX77/SX87 Data sheet*.

\*1. The response frequency was measured by detecting the following rotating disk.

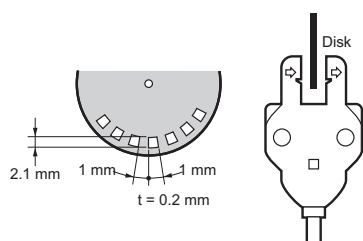

\*2. Degree of protection IP64 when conforming to ISO13849-1 (PLc, cat1). Conforms to September 2023.

Refer to the Instruction Sheet and Information for ISO13849-1 Compliance on our website ([www.fa.omron.co.jp/products/family/435/download/manual.html](http://www.fa.omron.co.jp/products/family/435/download/manual.html)) for conformance to ISO 13849-1.

# EE-SPX-W

**Photomicrosensor with built-in amplifier and attached cable reduces external light interference.**

- Light modulation effectively reduces external light interference.
- Wide operation voltage range: 5 to 24 VDC
- Easy operation monitoring with bright light indicator.

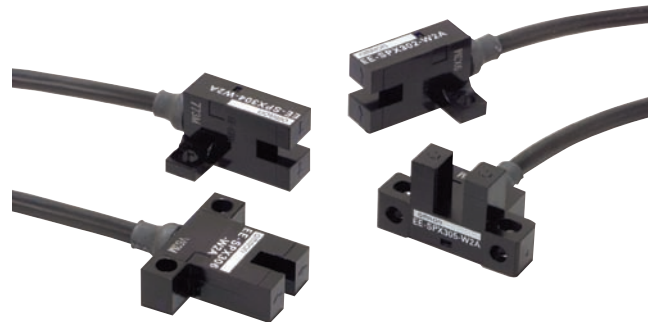

Be sure to read *Safety Precautions for All Photomicrosensors* on page 30.

For the most recent information on models that have been certified for safety standards, refer to your OMRON website.

## Ordering Information

Infrared light

Appearance	Sensing method	Sensing distance (slot width)		Output type	Output configuration	Cable length	Model
	Through-beam (slot-type)		3.6 mm	NPN output	Dark-ON	1 m	EE-SPX302-W2A 1M
					Light-ON		EE-SPX402-W2A 1M
			3.6 mm		Dark-ON		EE-SPX304-W2A 1M
					Light-ON		EE-SPX404-W2A 1M
			3.6 mm		Dark-ON		EE-SPX306-W2A 1M
					Light-ON		EE-SPX406-W2A 1M
			5 mm		Dark-ON		EE-SPX305-W2A 1M*
					Light-ON		EE-SPX405-W2A 1M*

\* These models (EE-SPX305/405-W2A only) are not conformed to CE standards.

## Ratings and Specifications

Item	Models	EE-SPX302-W2A, EE-SPX402-W2A EE-SPX304-W2A, EE-SPX404-W2A EE-SPX306-W2A, EE-SPX406-W2A	EE-SPX305-W2A EE-SPX405-W2A
Sensing distance		3.6 mm (slot width)	5 mm (slot width)
Sensing object		Opaque: 1 × 0.5 mm min.	Opaque: 2 × 0.8 mm min.
Differential distance		0.05 mm max.	
Light source		GaAs infrared LED (pulse lighting) with a peak wavelength of 940 nm	
Indicator *1		Light indicator (red)	
Supply voltage		5 to 24 VDC ±10%, ripple (p-p): 5% max.	
Current consumption		Average: 15 mA max.; Peak: 50 mA max.	
Control output		NPN voltage output: Load power supply voltage: 5 to 24 VDC Load current: 80 mA max. OFF current: 0.5 mA max. 80 mA load current with a residual voltage of 1.0 V max. 10 mA load current with a residual voltage of 0.4 V max.	
Response frequency *2		500 Hz min.	
Ambient illumination		3,000 lx max. with incandescent light or sunlight on the surface of the receiver	
Ambient temperature range		Operating: -10 to +55°C Storage: -25 to +65°C	
Ambient humidity range		Operating: 5% to 85% Storage: 5% to 95%	
Vibration resistance		Destruction: 10 to 55 Hz, 1.5-mm double amplitude for 2 h each in X, Y, and Z directions	
Shock resistance		Destruction: 500 m/s <sup>2</sup> for 3 times each in X, Y, and Z directions	
Degree of protection		IEC IP50	
Connecting method		Pre-wired (standard cable length: 1 m)	
Weight		18.5 g	
Material	Case	Polycarbonate	
	Holder		

Note: For details, refer to *EE-SPX-W Data sheet*.

- \*1. The indicator is a GaP red LED (peak wavelength: 700 nm).
- \*2. The response frequency was measured by detecting the following rotating disk.

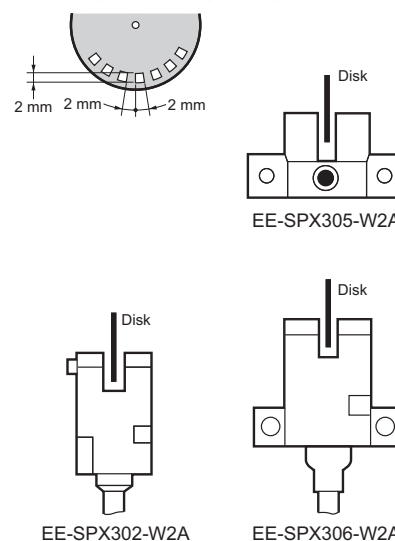

# EE-SPX74/84

**Photomicrosensor with light modulation for reduced external light interference and a connector for easy maintenance.**



- Built-in connectors
- Select from four easy-to-use shapes for efficient space utilization.
- Connectors with locks for safety against vibration.
- Convenient mounting method using M3 screws.
- Wide operating voltage range: 5 to 24 VDC

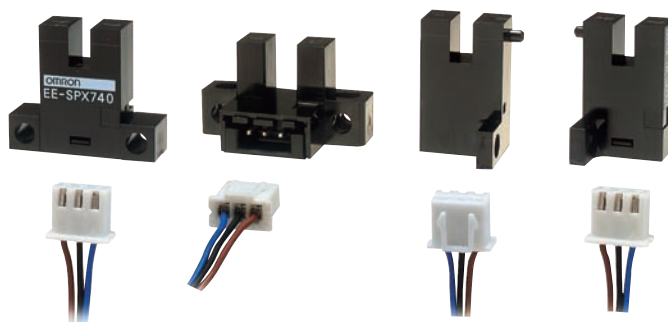

For the most recent information on models that have been certified for safety standards, refer to your OMRON website.

Be sure to read *Safety Precautions for All Photomicrosensors* on page 30.

## Ordering Information

### Sensors

Infrared light

Appearance	Sensing method	Sensing distance	Output type	Output configuration	Model
	Through-beam (slot-type)	3.6 mm (slot width)	NPN output	Dark-ON	<b>EE-SPX740</b>
				Light-ON	<b>EE-SPX840</b>
				Dark-ON	<b>EE-SPX742</b>
				Light-ON	<b>EE-SPX842</b>
				Dark-ON	<b>EE-SPX743</b>
				Light-ON	<b>EE-SPX843</b>
				Dark-ON	<b>EE-SPX741</b>
					5 mm (slot width)

### Accessories (Order Separately)

#### Connector with Cable

Type	Cable length	Model
Connector	1 m	<b>EE-1013 1M</b>

Note: For details, refer to the *Accessories (Order Separately)* on page 28.



Ratings and Specifications

Item	Models	EE-SPX740, EE-SPX840 EE-SPX742, EE-SPX842 EE-SPX743, EE-SPX843	EE-SPX741 EE-SPX841
Sensing distance		3.6 mm (slot width)	5 mm (slot width)
Sensing object		Opaque: 1 × 0.5mm min.	Opaque: 2 × 0.8 mm min.
Differential distance		0.05 mm max.	
Light source		GaAs infrared LED (pulse lighting) with a peak wavelength of 940 nm	
Indicator *1		Light indicator (red)	
Supply voltage		5 to 24 VDC ±10%, ripple (p-p): 5% max.	
Current consumption		Average: 15 mA max.; Peak: 50 mA max.	
Control output		NPN voltage output: Load power supply voltage: 5 to 24 VDC Load current: 50 mA max. OFF current: 0.5 mA max. 50 mA load current with a residual voltage of 1.0 V max. 10 mA load current with a residual voltage of 0.4 V max.	
Response frequency *2		500 Hz min.	
Ambient illumination		3,000 lx max. with incandescent light or sunlight on the surface of the receiver	
Ambient temperature range		Operating: -10 to +55°C Storage: -25 to +65°C	
Ambient humidity range		Operating: 5% to 85% Storage: 5% to 95%	
Vibration resistance		Destruction: 10 to 55 Hz, 1.5-mm double amplitude for 2 h each in X, Y, and Z directions	
Shock resistance		Destruction: 500 m/s <sup>2</sup> for 3 times each in X, Y, and Z directions	
Degree of protection		IEC IP50	
Connecting method		Special connector	
Weight		Approx. 2.4 g	
Material	Case	Polycarbonate	
	Holder		

\*1. The indicator is a GaAlAs red LED (peak wavelength: 660 nm).  
 \*2. The response frequency was measured by detecting the following rotating disk.

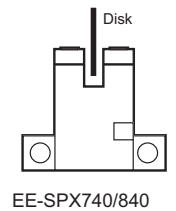
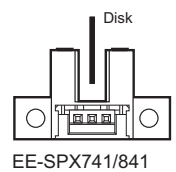
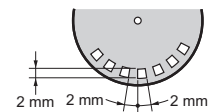

Note: For details, refer to *EE-SPX74/SPX84 Data sheet*.

# EE-SPX303N/403N

## A Wide Slot Width of 13 mm and Superior Resistance to Light Interference and Noise.



- Noise resistance equivalent to photomicrosensors with built-in amplifiers.
- Resistance to common noise at least 30 times that of previous models.
- Resistance to inverter noise at least 10 times that of previous models.
- Reverse polarity protection built in.



Be sure to read *Safety Precautions for All Photomicrosensors* on page 30.

For the most recent information on models that have been certified for safety standards, refer to your OMRON website.

## Ordering Information

### Sensors

Infrared light

Appearance	Sensing method	Sensing distance (slot width)		Output type	Output configuration	Model
	Through-beam (slot-type)			NPN output	Dark-ON	EE-SPX303N
		13 mm (slot width)			Light-ON	EE-SPX403N

### Accessories (Order Separately)

Type	Cable length	Model
Connector		EE-1001
		EE-1009
Connector with Cable	1 m	EE-1006 1M
		EE-1010 1M
	2 m	EE-1006 2M
		EE-1010 2M
Connector with Robot Cable	1 m	EE-1010-R 1M
	2 m	EE-1010-R 2M
NPN/PNP Conversion Connector	0.46 m (total length)	EE-2002

Note: For details, refer to the *Accessories (Order Separately)* on page 28.

## Ratings and Specifications

Item	Models	EE-SPX303N, EE-SPX403N
Sensing distance		13 mm (slot width)
Sensing object		Opaque: 2.2 × 0.5 mm min.
Differential distance		0.05 mm max.
Light source		Infrared LED (pulse lighting) with a peak wavelength of 940 nm
Indicator		Light indicator (red)
Supply voltage		12 to 24 VDC ±10%, ripple (p-p): 5% max.
Current consumption		15 mA max.
Control output		NPN voltage output: Load power supply voltage: 12 to 24 VDC Load current: 80 mA max. OFF current: 0.5 mA max. 80 mA load current with a residual voltage of 2.0 V max. 10 mA load current with a residual voltage of 1.0 V max.
Protection circuits		Power supply reverse polarity protection, Output reverse polarity protection
Response frequency *		100 Hz min.
Ambient illumination		3,000 lx max. with incandescent light or sunlight on the surface of the receiver.
Ambient temperature range		Operating: -10 to +55°C Storage: -25 to +65°C
Ambient humidity range		Operating: 5% to 85% Storage: 5% to 95%
Vibration resistance		Destruction: 10 to 55 Hz, 1.5-mm double amplitude for 2 h each in X, Y, and Z directions
Shock resistance		Destruction: 500 m/s <sup>2</sup> for 3 times each in X, Y, and Z directions
Degree of protection		IEC IP50
Connecting method		Special connector (soldering not possible)
Weight		Approx. 4 g
Material		Polycarbonate

Note: For details, refer to *EE-SPX303N/SPX403N Data sheet*.

\* The response frequency was measured by detecting the following rotating disk.

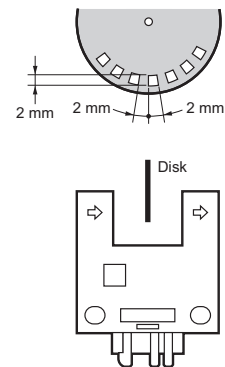

# EE-SPY31/41

## Accurately detects objects placed in front of shiny Background.



- A shiny background can be used as long as the distance between the sensor and the background is 20 mm or more.
- Detects minute objects such as a 0.05-mm-dia. pure copper wire.
- Small dispersion in sensing distance.
- Light modulation effectively reduces external light interference.
- Wide operating voltage range: 5 to 24 VDC



For the most recent information on models that have been certified for safety standards, refer to your OMRON website.

Be sure to read *Safety Precautions for All Photomicrosensors* on page 30.

## Ordering Information

### Sensors

Infrared light

Appearance	Sensing method	Sensing distance		Output type	Output configuration	Model
Horizontal type 	Convergent reflective type		2 to 5 mm	NPN output	Dark-ON	<b>EE-SPY311</b>
					Light-ON	<b>EE-SPY411</b>
Vertical type 		Dark-ON	<b>EE-SPY312</b>			
		Light-ON	<b>EE-SPY412</b>			

### Accessories (Order Separately)

Type	Cable length	Model	
Connector		<b>EE-1001</b>	
		<b>EE-1009</b>	
	Connector with Cable	1 m	<b>EE-1006 1M</b>
		2 m	<b>EE-1010 1M</b>
	Connector with Robot Cable	1 m	<b>EE-1006 2M</b>
		2 m	<b>EE-1010 2M</b>
	NPN/PNP Conversion Connector	0.46 m (total length)	<b>EE-1010-R 1M</b>
		<b>EE-1010-R 2M</b>	

Note: For details, refer to the *Accessories (Order Separately)* on page 28.

## Ratings and Specifications

Item	Models	EE-SPY311, EE-SPY411, EE-SPY312, EE-SPY412
Sensing distance		2 to 5 mm (Reflection factor: 90%; white paper 15 × 15 mm)
Minimum sensing object		Pure copper wire (0.05 mm dia.)
Distance to background *1		20 mm max. (glass with aluminum deposition)
Differential distance		0.2 mm (with a sensing distance of 3 mm, horizontally)
Light source		GaAs infrared LED with a peak wavelength of 940 nm
Indicator *2		Light indicator (red)
Supply voltage		5 to 24 VDC ±10%, ripple (p-p): 5% max.
Current consumption		Average: 15 mA max., Peak: 50 mA max.
Control output		NPN voltage output: Load power supply voltage: 5 to 24 VDC Load current: 80 mA max. OFF current: 0.5 mA max. 80 mA load current with a residual voltage of 1.0 V max. 10 mA load current with a residual voltage of 0.4 V max.
Response frequency *3		100 Hz min.
Ambient illumination		3,000 lx max. with incandescent light or sunlight on the surface of the receiver
Ambient temperature range		Operating: -10 to +55°C Storage: -25 to +65°C
Ambient humidity range		Operating: 5% to 85% Storage: 5% to 95%
Vibration resistance		Destruction: 10 to 50 Hz, 1.5-mm double amplitude for 2 h each in X, Y, and Z directions
Shock resistance		Destruction: 500m/s <sup>2</sup> for 3 times each in X, Y, and Z directions
Degree of protection		IEC IP50
Connecting method		Special connector (soldering not possible)
Weight		Approx. 2.6 g
Material	Case	Polycarbonate
	Holder	Polybutylene phthalate (PBT)

Note: For details, refer to *EE-SPY31/SPY41 Data sheet*.

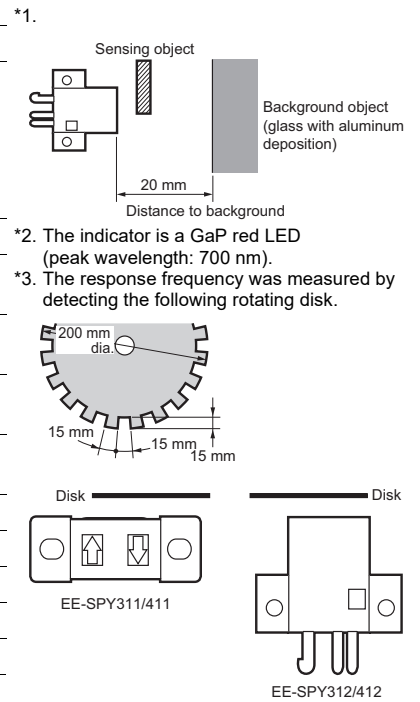

# EE-SPY30/40

**Photomicrosensor with light modulation is not influenced by external light.**



- Voltage-output models with wide operating voltage range (5 to 24 VDC).
- Fitted with an easy-to-adjust optical axis mark.
- Easy adjustment and optical axis monitoring with a light indicator.

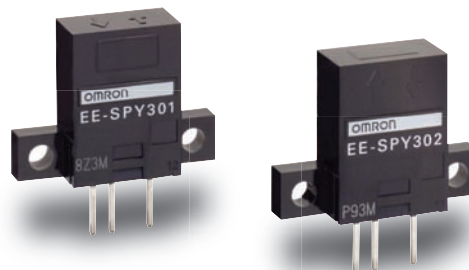

Be sure to read *Safety Precautions for All Photomicrosensors* on page 30.

For the most recent information on models that have been certified for safety standards, refer to your OMRON website.

## Ordering Information

### Sensors

Infrared light

Appearance	Sensing method	Sensing distance	Output type	Output configuration	Model
Horizontal type 	Reflective type	5 mm	NPN output	Dark-ON	<b>EE-SPY301</b>
				Light-ON	<b>EE-SPY401</b>
Vertical type 	Reflective type	5 mm		Dark-ON	<b>EE-SPY302</b>
				Light-ON	<b>EE-SPY402</b>

### Accessories (Order Separately)

Type	Cable length	Model
Connector		<b>EE-1002</b>
Connector with Cable	1 m	<b>EE-1003</b>
NPN/PNP Conversion Connector	0.46 m (total length)	<b>EE-2001</b>
Connector Hold-down Clip		<b>EE-1003A</b>

Note: For details, refer to the *Accessories (Order Separately)* on page 28.

## Ratings and Specifications

Sensing method		Reflective type
Item	Models	EE-SPY301, EE-SPY401 EE-SPY302, EE-SPY402
Sensing distance	5 mm (Reflection factor: 90%; white paper 15 × 15 mm) *1	
Sensing object	---	
Differential distance	0.2 mm max. (with a sensing distance of 3 mm, horizontally)	
Light source	GaAs infrared LED with a peak wavelength of 940 nm	
Indicator *2	Light indicator (red)	
Supply voltage	5 to 24 VDC ±10%, ripple (p-p): 5% max.	
Current consumption	Average: 15 mA max., Peak: 50 mA max.	
Control output	NPN voltage output: Load power supply voltage: 5 to 24 VDC Load current: 80 mA max. OFF current: 0.5 mA max. 80 mA load current with a residual voltage of 1.0 V max. 10 mA load current with a residual voltage of 0.4 V max.	
Response frequency *3	100 Hz min.	
Ambient illumination	3,000 lx max. with incandescent light or sunlight on the surface of the receiver	
Ambient temperature range	Operating: -10 to +55°C Storage: -25 to +65°C (with no icing)	
Ambient humidity range	Operating: 5% to 85% Storage: 5% to 95% (with no condensation)	
Vibration resistance	Destruction: 10 to 55 Hz, 1.5-mm double amplitude for 2 h each in X, Y, and Z directions	
Shock resistance	Destruction: 500 m/s <sup>2</sup> for 3 times each in X, Y, and Z directions	
Degree of protection	IEC IP50	
Connecting method	Special connector (soldering not possible)	
Weight	Approx. 2.6 g	
Material	Case	Polycarbonate

Note: For details, refer to *EE-SPX301/SPX401/SPY30/SPY40 Data sheet*.

\*1. Operation may not be possible near the Sensor.

\*2. The indicator is a GaP red LED (peak wavelength: 700 nm).

\*3. The response frequency was measured by detecting the following rotating disk.

EE-SPY30   
EE-SPY40

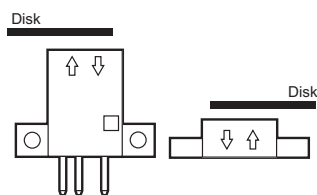
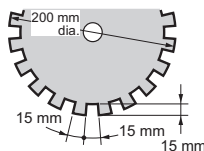

# EE-SPX613

## Liquid Level Photomicrosensor with operation mode and sensitivity selectors for easy application.



- Operation mode selector allows modes to be switched easily.
- Sensitivity selector is suitable for any 6- to 13-mm-diameter transparent or semi-transparent pipe with a wall thickness of 1 mm.
- Uses a clean (with no powder parting agent) cable.
- Operating voltage range: 12 to 24 VDC



For the most recent information on models that have been certified for safety standards, refer to your OMRON website.

 Be sure to read *Safety Precautions for All Photomicrosensors* on page 30.

## Ordering Information

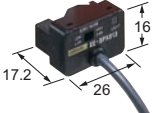
Appearance	Sensing method	Output type	Output configuration	Cable length	Model
	Through-beam type	NPN output	Dark-ON or Light-ON (selectable)	1 m	<b>EE-SPX613 1M</b>



## Ratings and Specifications

Item	Models	EE-SPX613
Applicable pipe		Any 6- to 13-mm-diameter pipe with a wall thickness of 1 mm that is made of FEP or any other material as transparent as FEP.
Sensing object		Liquids in pipes (High-viscosity liquids or liquids with floating materials may not be detected.)
Light source		GaAs infrared LED with a peak wavelength of 940 nm
Indicator		Light indicator GaP (Red LED: Peak wavelength of 700 nm)
Supply voltage		12 to 24 VDC $\pm$ 10%, ripple (p-p): 5% max.
Current consumption		Average: 30 mA max., Peak: 80 mA max.
Control output		NPN open collector: Load power supply voltage: 5 to 24 VDC Load current: 100 mA max. OFF current: 0.5 mA max. 100 mA load current with a residual voltage of 0.8 V max. 40 mA load current with a residual voltage of 0.4 V max.
Ambient illumination		3,000 lx max. with incandescent light or sunlight on the surface of the receiver
Ambient temperature range		Operating: $-10$ to $+55^{\circ}\text{C}$ Storage: $-25$ to $+65^{\circ}\text{C}$ (with no icing or condensation)
Ambient humidity range		Operating: 5% to 85% Storage: 5% to 95% (with no condensation)
Vibration resistance		Destruction: 10 to 500 Hz, 1.0-mm single amplitude or 150 m/s <sup>2</sup> in X, Y, and Z directions 3 times and for 11 min each
Shock resistance		Destruction: 500 m/s <sup>2</sup> for 3 times each in X, Y, and Z directions
Degree of protection		IEC 60529 IP50
Connecting method		Pre-wired (Standard length: 1 m)
Weight (packed state)		Approx. 55 g
Material	Case	Polycarbonate
	Cover	
Accessories		Support belt (2), slip protection tube (2), Instruction Manual

Note: For details, refer to *EE-SPX613 Data sheet*.

# EE-SA701/801

## Using a pushbutton enables accurately detecting difficult-to-detect objects.

- Conforms to standards for semiconductor FOUP cassettes to enable accurately detecting FOUP cassettes without being affected by the material, color, or reflectance of the bottoms of the cassettes.
- Thin design enables mounting in a wider range of applications, e.g., on transfer arms.
- Increased visibility with 4-direction indicator.
- Optical detection of actuator operation provides a long life (mechanical life: 5 million operations min.).
- Models available with PNP or NPN output.
- Models are available with very flexible robot cable.



 Be sure to read *Safety Precautions for All Photomicrosensors* on page 30.

For the most recent information on models that have been certified for safety standards, refer to your OMRON website.

## Ordering Information

### List of Models

Appearance	Sensing distance	Sensing method	Operation mode	Cable length	Model	
					NPN output	PNP output
	0 to 3.5 mm (pressed position) *1	Pushbutton	ON with no load	1 m	EE-SA801A 1M	EE-SA801R 1M
			OFF with no load	1 m (robot cable)	EE-SA801A-R 1M	EE-SA801R-R 1M
					EE-SA701-R 1M	EE-SA701P-R 1M

\*1. Distance from the top surface of the housing to the top of the actuator.

\*2. Output reverses between 3.5 and 4.5 mm.

## Ratings and Specifications

Item	Model	NPN output	EE-SA801A	EE-SA801A-R	EE-SA701-R
		PNP output	EE-SA801R	EE-SA801R-R	EE-SA701P-R
Indicator		Light red when actuator is pressed.			Lit red while there is no load on actuator
Operation Specifications *1	Free position (FP)		5.0±0.4 mm		
	Operating position (OP)		3.5 to 4.5 mm *2		
	Total travel position (TTP)		0 mm max.		
Operating load *3		3 N max. (typical: 0.5 N)			
Supply voltage		12 to 24 VDC±10%, ripple (p-p): 10% max.			
Current consumption		35 mA max.			
Control output		NPN Models: NPN open collector, 5 to 24 VDC, 50 mA max.; residual voltage of 0.4 V max. at 50-mA load current OFF current: 0.5 mA max. PNP Models: PNP open collector, 5 to 24 VDC, 50 mA max.; residual voltage of 0.4 V max. at 50-mA load current OFF current: 0.5 mA max.			
External diagnosis input	Input	NPN Models Emission OFF: Shorted to 0 V or 0.5 V max. (source current: 30 mA max.) Emission ON: Open (leakage current: 0.4 mA max.) PNP Models Emission OFF: Shorted to +DC or +DC-0.5 V max. (sink current: 30 mA max.) Emission ON: Open (leakage current: 0.4 mA max.)			
	Response time	1 ms max.			
Protection circuits		Reversed power supply polarity protection			
Ambient temperature range		Operating: -25 to +55°C Storage: -30 to +60°C (with no icing or condensation)			
Ambient humidity range		Operating: 5% to 85% Storage: 5% to 95% (with no condensation)			
Mechanical durability		5,000,000 operations min. (One operation is from the free position to operating position and back to the free position.)			
Vibration resistance		Destruction: 10 to 500 Hz, 1.0-mm single amplitude or 150 m/s <sup>2</sup> 3 times each in X, Y, and Z directions for 11 min. each			
Shock resistance		Destruction: 500 m/s <sup>2</sup> for 3 times each in X, Y, and Z directions			
Degree of protection		IEC IP40			
Connecting method		Pre-wired (standard cable length: 1 m)		Pre-wired (robot cable length: 1 m)	
Weight		Approx. 16.1 g			
Material	Case	Polycarbonate			
	Actuator	Polyacetal			
Accessories		Instruction Manual			

Note: For details, refer to *EE-SA701/SA801 Data sheet*.

- \*1. Free position (FP): The position of the top of the actuator when no force is being applied to the actuator.  
 Operating position (OP): The position of the top of the actuator when the actuator is pressed and the output transistor changes from OFF to ON for the EE-SA701-R/-SA701P-R and from ON to OFF for all other models.  
 Total travel position (TTP): The position of the top of the actuator when the actuator is pressed as far as it can be pressed.

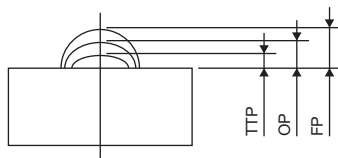

\*2. This does not indicate that the output will be ON from 3.5 to 4.5 mm, but rather that the output will change from ON to OFF at some point between 3.5 and 4.5 mm.

\*3. The force required to press the actuator from the FP to the OP.

Accessories (Order Separately)

Ordering Information

Connectors and Connector Hold-down Clips

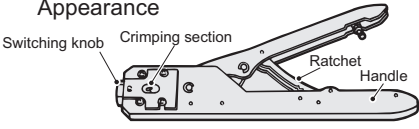
Applicable Sensor models EE-SX67□ (A, P, R), EE-SX47□, EE-SY67□, EE-SPY31□/41□, EE-SPX303N/403N, EE-SPW311/411			
Type	Cable length	Model	Remarks
Connector		EE-1001	
		EE-1001-1	L terminal and positive (+) terminal are already short-circuited.
		EE-1009 *1	
Connector with Cable	1 m	EE-1006 1M	
		EE-1010 1M *1	
	2 m	EE-1006 2M	4 conductors
		EE-1006D	3 conductors
		EE-1006L	2 conductors
		EE-1010 2M *1	
Connector with Robot Cable	1 m	EE-1010-R 1M *1	
	2 m	EE-1010-R 2M*1	
NPN/PNP Conversion Connector	0.46 m (total length)	EE-2002	
Connector Hold-down Clip		EE-1006A	For EE-1006, EE-SX670□, 470, EE-SY671, and 672 only.
Connector Parts *2	Case (housing)	EE-1006H	100 per carton
	Dispersion Pins	EE-1006C	500 per carton
	Special Crimping Tool	EE-1006T	Appearance 

\*1. EE-1009- or EE-1010-series Connectors have a built-in locking mechanism to prevent cable disconnection when only the cable is pulled. To remove the Connector from the Sensor, grip the top and bottom of the Connector firmly and push into the Sensor once before pulling out. The locking mechanism prevents the Connector from being removed by pulling on the cable only and enables removal only when the Connector (housing) is pulled.

\*2. The case (housing) and dispersion pins (for hand-crimping) for EE-1006 Connectors can be ordered separately. Use the EE-1006T Special Crimping Tool to prepare the Connector.

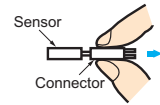

Applicable Sensor models EE-SX95□-C1J-R			
Item	Cable length	Model	Remarks
Connector with Robot Cable	2 m	EE-1016-R 2M	

Applicable Sensor models EE-SX97□-C1, EE-SX97□P-C1			
Item	Cable length	Model	Remarks
Connector with Cable	1 m	EE-1017 1M	
	3 m	EE-1017 3M	
Connector with Robot Cable	1 m	EE-1017-R 1M	
	3 m	EE-1017-R 3M	

Applicable Sensor models EE-SPX74□/84□			
Item	Cable length	Model	Remarks
Connector with Cable	1 m	EE-1013 1M	

Applicable Sensor models EE-SPY30□/40□, EE-SPZ301-A/401-A			
Item	Cable length	Model	Remarks
Connector		EE-1002	
Connector with Cable	1 m	EE-1003	
NPN/PNP Conversion Connector	0.46 m (total length)	EE-2001	
Connector Hold-down Clip		EE-1003A	For EE-1003 only.

Ratings and Specifications

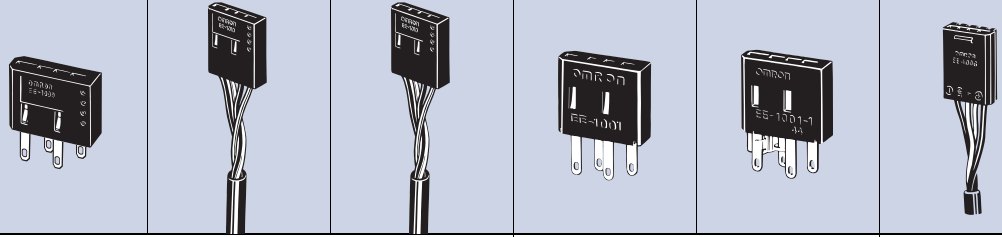
Product	Connector *1 *4	Connector with Cable *1	Connector with Robot Cable *1	Connector *4	Connector (short-circuited between positive (+) and L terminals) *2 *4	Connector with Cable
	EE-1009	EE-1010	EE-1010-R	EE-1001	EE-1001-1	EE-1006
Model						
Appearance						
Item						
Contact resistance	20 mΩ max. (at 20 mV max., 100 mA max.)			15 mΩ max. (at 100 VDC max.)		10 mΩ max. (100 VDC max.)
Insertion/removal durability *3	50 times min.			---		
Insertion strength	No. of poles × 6 N max.			68.6 N max.		50 N max.
Surplus strength (housing holding strength)	No. of poles × 0.4 N max.			---		20 N max.
Standard cable length	---	1 m, 2 m		---	1 m, 2 m	
Lock strength *3	No. of poles × 29 N min.			---		
Ambient humidity	-10 to +60°C			-10 to +75°C		-10 to 60°C
Material	Housing	Polybutylene phthalate (PBT)				
	Contact	Phosphor bronze				
Applicable Photomicrosensors	EE-SX67□ (A,P,R) (Connector Models only), EE-SX47□, EE-SY67□, EE-SPY31□/41□, EE-SPX303N/403N, EE-SPW311/411					

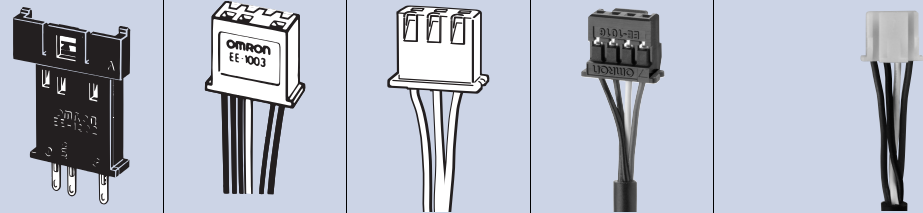
Product	Connector *4	Connector with Cable	Connector with Cable	Connector with Robot Cable	Connector with Cable	Connector with Robot Cable
	EE-1002	EE-1003	EE-1013	EE-1016-R	EE-1017	EE-1017-R
Model						
Appearance						
Item						
Contact resistance	10 mΩ max. (at 10 mADC and 1 ADC)	20 mΩ max. (at minute current of 1 kHz and 500 VDC)		25 mΩ max. (at 10 mA DC and 20 mV max.)		
Insertion strength	20 N max.	23.5 N max.	40 N max.	20 N max.		
Surplus strength (housing holding strength)	15 N min. (initial) 10 N min. (ten times)	3.5 N min.	10 N min.	15 N min.	1.5 N min.	
Cable length	---	1 m	---		2 m	1 m, 3 m
Ambient humidity	-10 to +75°C	-10 to +60°C	-10 to +55°C	-25 to +85°C	-10 to +60°C	
Material	Housing	Nylon				
	Contact	Phosphor bronze				
Applicable Photomicrosensors	EE-SPY30□/40□, EE-SPZ301-A/401-A		EE-SPX74□/84□	EE-SX95□-C1J-R	EE-SX97□C1, EE-SX97□P-C1	

\*1. The Connector has a built-in locking mechanism. To remove the Connector from the Sensor, grip the top and bottom of the Connector housing, as shown in the following diagram, and then pull out the Connector.

\*2. EE-SX67□ and EE-SY67□ are the best used in the light-ON state.

\*3. The insertion/removal durability and lock strength apply only to the lock mechanism.

They do not apply to the EE-1001, EE-1001-1, and EE-1006, which do not have lock mechanisms.

\*4. Do not store the type EE-1009, EE-1001, EE-1001-1 and EE-1002 under the following conditions since their terminals may discolor.

(1) In the place exposed to the direct sunlight, the high temperature or high humidity.

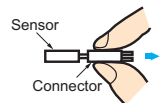

# Safety Precautions for All Photomicrosensors

Refer to **Safety Precautions** for individual models for specific precautions for each model.

## ⚠ WARNING

These products cannot be used in safety devices for presses or other safety devices used to protect human life.



This product is designed for use in applications for sensing workpieces and workers that will not affect levels of safety.

## Precautions for Safe Use

To ensure safety, observe the following precautions.

## Wiring

Item	Examples
<p><b>Power Supply</b> Do not apply any voltage exceeding the operating voltage range. Applying any excessive voltage or supplying AC power (100 VAC or higher) to a DC-type sensor may cause the Sensor to explode or burn.</p>	<p>· DC 3-Wire NPN Output Sensors</p>
<p><b>Load Short-circuit</b> Do not short-circuit the load. Doing so may cause the Sensor to explode or burn.</p>	<p>· DC 3-Wire NPN Output Sensors</p>
<p><b>Wiring</b> Be sure to wire the Sensor correctly and be careful not to connect the polarities incorrectly, otherwise the Sensor may explode or burn.</p>	<p>· DC 3-Wire NPN Output Sensors (Example) Wrong polarity</p> <p>· DC 3-Wire NPN Output Sensors (Example) Wrong polarity or wrong wiring</p>
<p><b>Connection with No Load</b> If connected to the power supply without any load, internal elements may explode or burn. Make sure that a proper load is connected to the Sensor.</p>	<p>· DC 3-Wire NPN Output Sensor</p>
<p><b>AND Connections</b> Do not use AND connections such as in the example shown in the diagram here. Voltage will be applied to the Vcc terminal without the GND terminal of Sensor 2 being securely grounded, and may cause the Sensor to fail. Depending on the model used, inrush current to Sensor 2 when Sensor 1 is turned ON may cause product failure.</p>	

## Precautions for Correct Use

### Installation

- The Photomicrosensors with Non-modulated Light (models that begin with EE-SX or EE-SY) are built into the device being used and are, therefore, not equipped to deal with interference from an external light source. When using a Photomicrosensor with Non-modulated Light in an area exposed to an incandescent light or other external light interference, install so as to minimize the effects of external light sources.
  - Mount the Photomicrosensors securely on a flat surface
  - Mount the Photomicrosensors with M3 screws, using a spring washer to ensure the screws will not become loose. Use a tightening force of 0.59 N·m max.
- Note:** Be sure to read the precautions for the model being used before tightening the screws.

- Install so that nothing can collide with the sensing section of the Photomicrosensor. Damage to the sensing surface will cause inferior performance.
- Before using the Photomicrosensor, check to be sure that it has not become loose due to vibration or shock.

### Wiring

#### Surge

- If there is surge in the power supply line, try connecting a capacitor (with a capacitance of 0.1 to 1 μF) or a Zener diode (Z<sub>D</sub> in the diagram below, with a rated voltage of 30 to 35 V). Use the Sensor only after confirming that the surge has been removed.

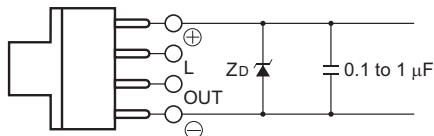

Z<sub>D</sub>: Zener diode

- When driving a small inductive load, such as a relay, wire as shown below. (Be sure to connect a diode to absorb the reverse voltage.)

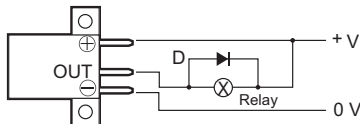

- Separate the wiring for the Photomicrosensor from high-voltage lines or power lines. If the wiring is routed in the same conduit or duct as such lines, the Photomicrosensor may malfunction or may be damaged by inductive interference.
- Make sure that the connectors (either dedicated or commercially available) are securely locked.

### Voltage Output

- A Sensor with an open-collector output can be connected to a counter with a voltage input by connecting a resistor between the power source and output. Select a resistor with reference to the following example. The resistance of the resistor is generally 4.7 kΩ and its wattage is 1/2 W for a supply voltage of 24 V and 1/4 W for 12 V.

#### Example

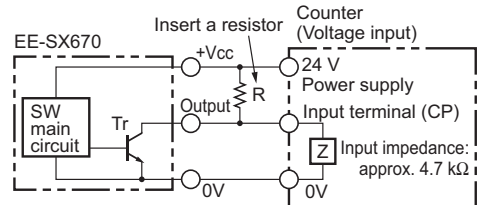

If resistance R = 4.7 kΩ for the EE-SX670, the input voltage at the high level is as follows:

$$\text{Input voltage } V_H = \frac{Z}{R+Z} V_{CC} = \frac{4.7k}{4.7k + 4.7k} \times 24V = 12V$$

And the input voltage and load current at the low level are as follows:

Input voltage  $V_L \leq 0.4 V$  (Residual voltage for 40-mA load current)

$$\text{Load current } I_C = \frac{V_{CC}}{R} = \frac{24V}{4.7k} = 5.1mA \leq 40mA$$

**Note:** Refer to the ratings of the Sensor for the residual voltage of the load current.

### Handling Methods when Wiring

- Do not apply stress (external force) to the terminals as shown in the figure below. Stress may damage the terminals.



# Safety Precautions for All Photomicrosensors

## Design

Design the application so that light will be completely interrupted. We recommend that you use a metal object as the sensing object. (The light beam from an Infrared Sensor may pass through plastic sensing objects, which may make detection unstable.)

Terminate the terminals that you do not use (e.g., the L terminal or output line) and do not connect them to anything.

### Precautions for Photomicrosensors with Modulated Light

When using Photomicrosensors with Modulated Light (models that begin with EE-SP), the design must take into account the effects of power source and cable length. Photomicrosensors with Modulated Light are more easily affected than Photomicrosensors with Non-modulated Light (models that begin with EE-SX or EE-SY).

#### • Photomicrosensors with Modulated Light that are easily affected:

EE-SPY30□/40□, E-SPZ301□/401□,  
EE-SPY31□/41□, EE-SPX303N/403N,  
EE-SPW311/411, EE-SPX74□/84□,  
EE-SPX□□□-W

#### • Photomicrosensors with Modulated Light that are not easily affected:

EE-SPX613, EE-SPY801/802

### Reasons for Interference from Power and Cable Length on Photomicrosensors with Modulated Light

As explained in the *Operating Principles* in the *Technical Explanation for Photomicrosensors*, an LED emitter is pulse-lighted to produce modulated light. A large current momentarily flows to the Photomicrosensor in sync with this pulse timing. This causes a pulsating consumption current.

A photoelectric sensor incorporates a capacitor with sufficient capacity, and is virtually unaffected by the pulse of the consumption current. With a small Photomicrosensor, however, it is difficult to have a capacitor with a sufficient capacity. Accordingly, when the cable length is long or depending on the type of power source, it may become impossible to keep up with the pulse of the consumption current and operation may become unstable.

## Countermeasures

### Adding a Capacitor

- Attach a capacitor of 10  $\mu\text{F}$  min. (e.g., a film capacitor) to the wires as close as possible to the Sensor. (Use a capacitor with a dielectric strength that is at least twice the Sensor's power supply voltage. Do not use tantalum capacitors. A short-circuit may cause the capacitor to ignite due to the large current flow.)

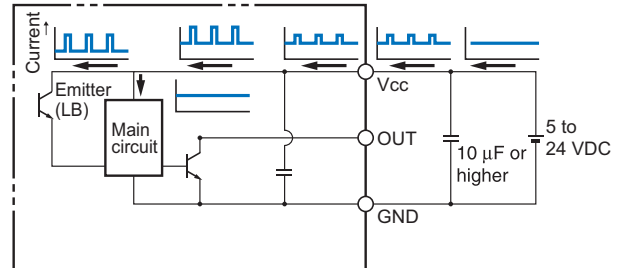

### Cable Length

- Design the configuration so that the maximum total cable length for the Photomicrosensor with Modulated Light is 2 m.
- When using a cable longer than 2 m, attach a capacitor (e.g., an aluminum electrolytic capacitor) with a capacity of approximately 10  $\mu\text{F}$  to the wires as shown below. The distance between the terminal and the capacitor must be within 2 m. Make sure that the total cable length is no longer than 5 m. To use a cable length longer than 5 m, use a PLC or other means to read the sensor output and then transmit the signals using a PLC's communications.
- Regardless of whether a Photomicrosensor with Modulated Light or a Photomicrosensor with Non-modulated Light is used, make sure that the total combined length of the Photomicrosensor cable and the connecting cable is less than 10 m.
- Although cables are capable of being extended longer than 5 m, performance is likely to be affected by noise interference from adjacent cables and other devices. Voltage drops due to the resistance of the cable material itself will also influence performance. Therefore, factors, such as the difference in voltage between the end of the cable and the sensor and noise levels, must be given full consideration.

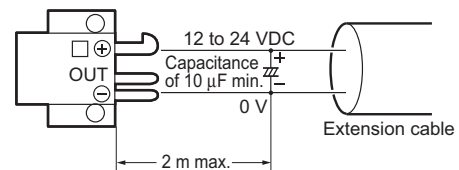



# Safety Precautions for All Photomicrosensors

## Countermeasures for Switching Power Supplies

- Take either of the following countermeasures as required if connecting a Photomicrosensor with Modulated Light to a switching power supply.
- Attach a capacitor of 10  $\mu\text{F}$  min. to the wires as close as possible to the Photomicrosensor. (Use a capacitor with a dielectric strength that is at least twice the Photomicrosensor's power supply voltage. Do not use tantalum capacitors. A short-circuit may cause the capacitor to ignite due to the large current flow.)

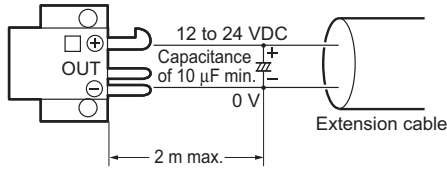

- Connect to the 0-V line of the power source or connect to the power source via a capacitor of approximately 0.47  $\mu\text{F}$  to reduce the impedance of the mounting base to prevent inductive noise from entering the mounting base.

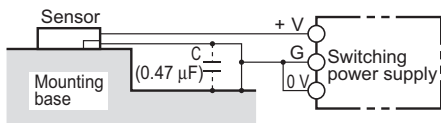

- Connect the noise filter terminal (neutral terminal to ACG) of the switching power supply to the case (FG) and 0-V terminal of the power supply.

The line connected as mentioned above should be grounded or connected to the mounting base to ensure stable operation. (Recommended by power supply manufacturers.)

## Countermeasures to Handle Inductive Noise

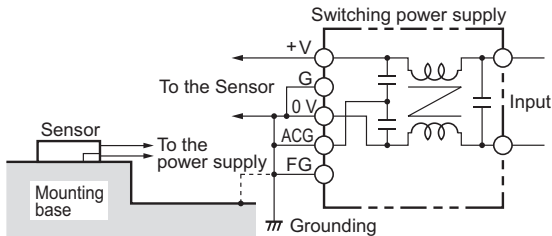

- Insert a plastic insulator of approximately 10 mm between the Sensor and the mounting base.

## Effects of Inductive Noise

- When there is inductive noise in the Sensor mounting frame (metal), the output of the Sensor may be affected. In this case, ensure that there is no electrical potential difference between the Sensor 0-V terminal and the Sensor mounting frame, or put a 0.47- $\mu\text{F}$  capacitor between the 0-V terminal and the frame.

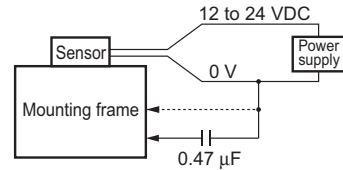

## Precautions for Reflective Photomicrosensors

### Sensing Distance

- The Reflective Photomicrosensor model is based on sensing a sheet of white paper with a reflection factor of 90%. The sensing distance varies with the other conditions of the objects being detected.

### Typical Example

#### EE-SPY30/40 Series

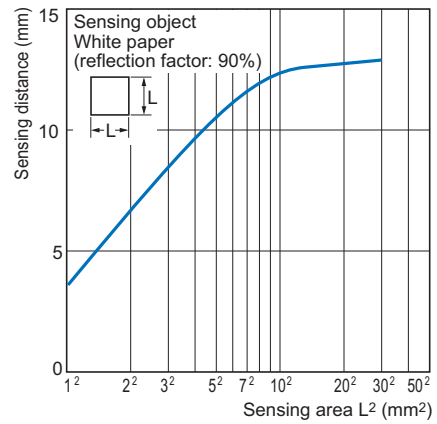

### Background Objects

- Use the Sensor only after carefully studying the possibility of light entering the Sensor due to light being reflected off background objects.

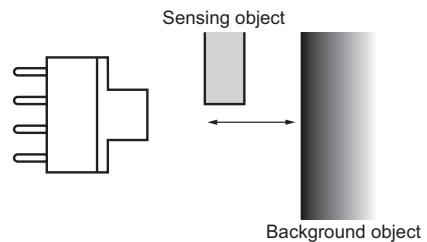

Decrease reflection from the background object, e.g., by providing a sufficient distance to the background or by using a black sponge as the background.

# Safety Precautions for All Photomicrosensors

## PLC Connections

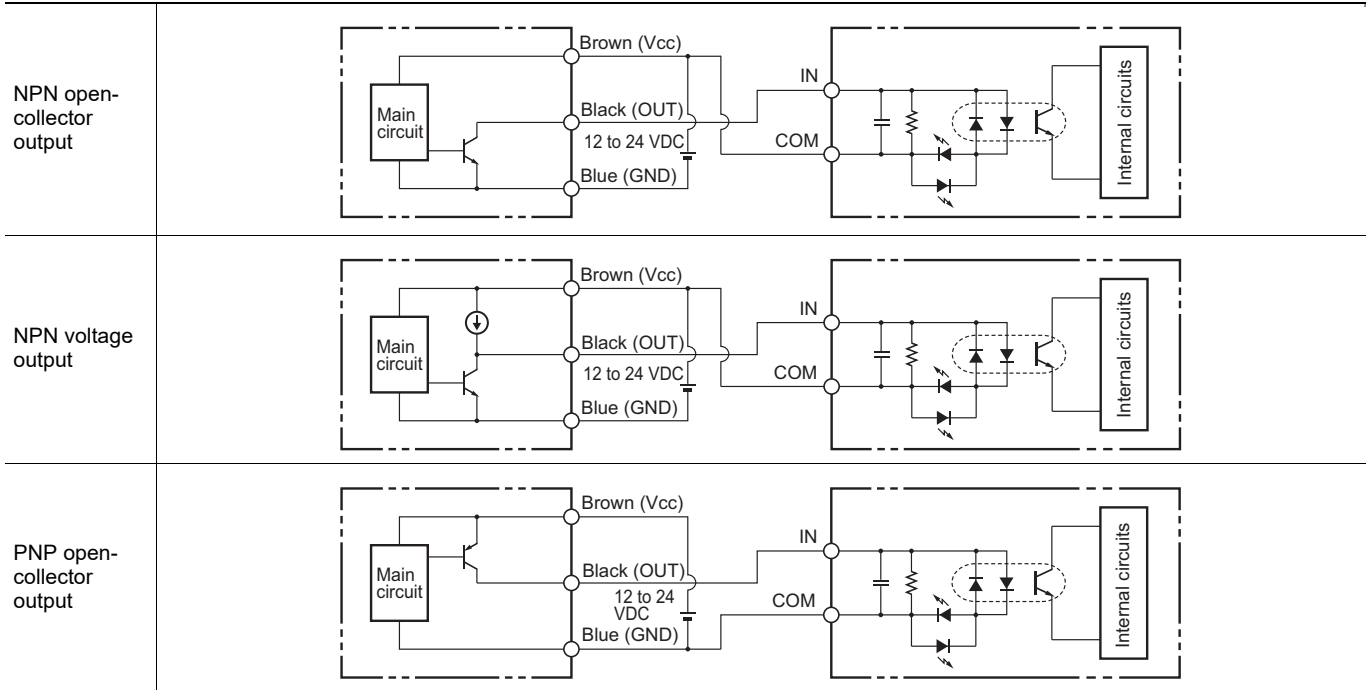

## Relay Connections

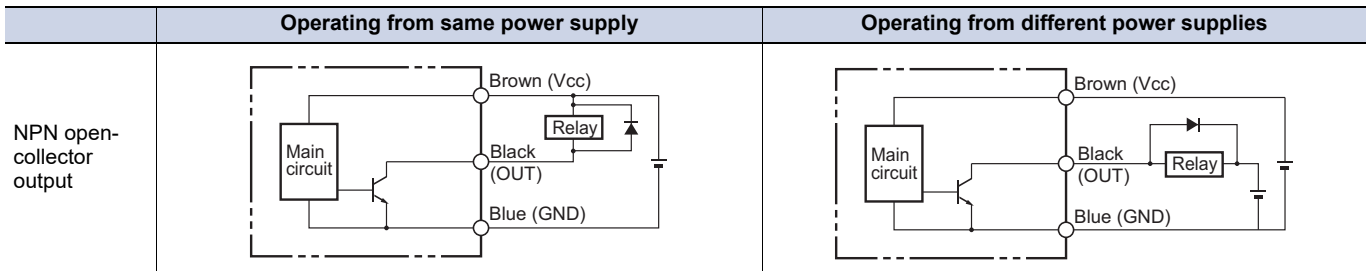

## Counter Connections

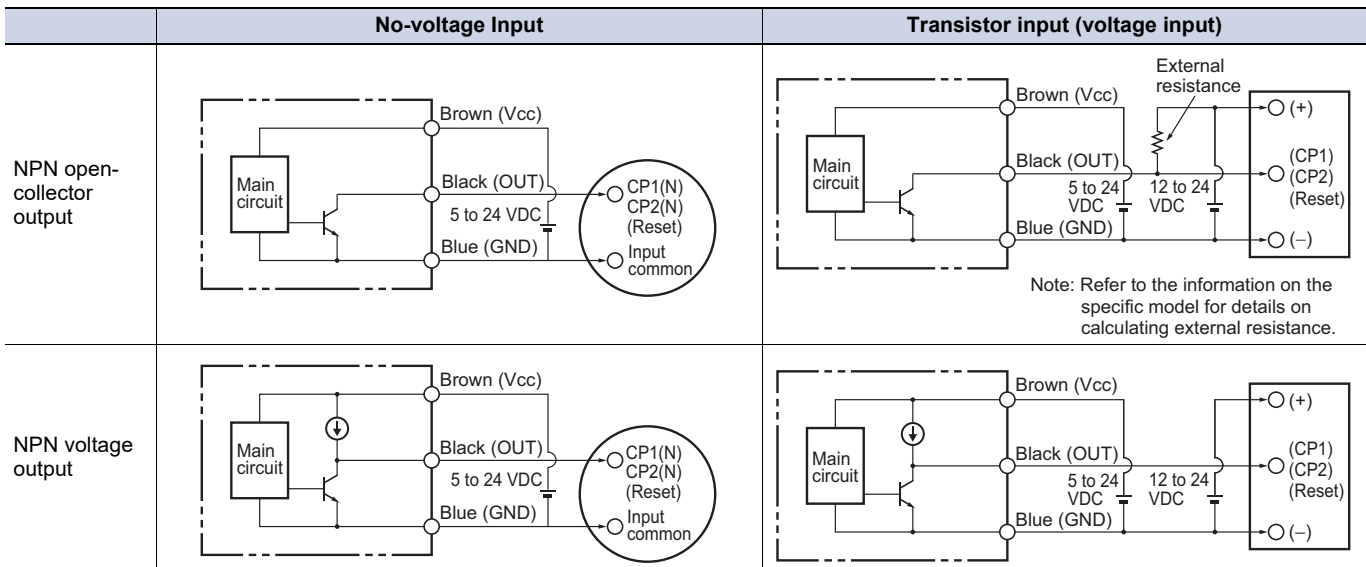

## Other Precautions

- Do not disconnect the Connector from the Sensor when power is supplied to the Sensor. Doing so may damage the Sensor.
- Avoid installing the Sensor in the following locations to prevent malfunction or product failure:
  - Location exposed to high concentrations of dust, oil mist, etc.
  - Locations exposed to corrosive gases
  - Locations exposed directly or indirectly to water, oil, or chemical spray
  - Outdoors or locations exposed to intensive light, such as direct sunlight
- Be sure to use the Sensor under the rated ambient temperature.
- The Sensor may be dissolved by exposure to organic solvents, acids, alkali, aromatic hydrocarbons or chloride resin hydrocarbons, causing deterioration in characteristics. Do not expose the Sensor to such chemicals.

# Terms and Conditions Agreement

## **Read and understand this catalog.**

Please read and understand this catalog before purchasing the products. Please consult your OMRON representative if you have any questions or comments.

## **Warranties.**

(a) Exclusive Warranty. Omron's exclusive warranty is that the Products will be free from defects in materials and workmanship for a period of twelve months from the date of sale by Omron (or such other period expressed in writing by Omron). Omron disclaims all other warranties, express or implied.

(b) Limitations. OMRON MAKES NO WARRANTY OR REPRESENTATION, EXPRESS OR IMPLIED, ABOUT NON-INFRINGEMENT, MERCHANTABILITY OR FITNESS FOR A PARTICULAR PURPOSE OF THE PRODUCTS. BUYER ACKNOWLEDGES THAT IT ALONE HAS DETERMINED THAT THE PRODUCTS WILL SUITABLY MEET THE REQUIREMENTS OF THEIR INTENDED USE.

Omron further disclaims all warranties and responsibility of any type for claims or expenses based on infringement by the Products or otherwise of any intellectual property right. (c) Buyer Remedy. Omron's sole obligation hereunder shall be, at Omron's election, to (i) replace (in the form originally shipped with Buyer responsible for labor charges for removal or replacement thereof) the non-complying Product, (ii) repair the non-complying Product, or (iii) repay or credit Buyer an amount equal to the purchase price of the non-complying Product; provided that in no event shall Omron be responsible for warranty, repair, indemnity or any other claims or expenses regarding the Products unless Omron's analysis confirms that the Products were properly handled, stored, installed and maintained and not subject to contamination, abuse, misuse or inappropriate modification. Return of any Products by Buyer must be approved in writing by Omron before shipment. Omron Companies shall not be liable for the suitability or unsuitability or the results from the use of Products in combination with any electrical or electronic components, circuits, system assemblies or any other materials or substances or environments. Any advice, recommendations or information given orally or in writing, are not to be construed as an amendment or addition to the above warranty.

See <http://www.omron.com/global/> or contact your Omron representative for published information.

## **Limitation on Liability; Etc.**

OMRON COMPANIES SHALL NOT BE LIABLE FOR SPECIAL, INDIRECT, INCIDENTAL, OR CONSEQUENTIAL DAMAGES, LOSS OF PROFITS OR PRODUCTION OR COMMERCIAL LOSS IN ANY WAY CONNECTED WITH THE PRODUCTS, WHETHER SUCH CLAIM IS BASED IN CONTRACT, WARRANTY, NEGLIGENCE OR STRICT LIABILITY.

Further, in no event shall liability of Omron Companies exceed the individual price of the Product on which liability is asserted.

## **Suitability of Use.**

Omron Companies shall not be responsible for conformity with any standards, codes or regulations which apply to the combination of the Product in the Buyer's application or use of the Product. At Buyer's request, Omron will provide applicable third party certification documents identifying ratings and limitations of use which apply to the Product. This information by itself is not sufficient for a complete determination of the suitability of the Product in combination with the end product, machine, system, or other application or use. Buyer shall be solely responsible for determining appropriateness of the particular Product with respect to Buyer's application, product or system. Buyer shall take application responsibility in all cases.

NEVER USE THE PRODUCT FOR AN APPLICATION INVOLVING SERIOUS RISK TO LIFE OR PROPERTY OR IN LARGE QUANTITIES WITHOUT ENSURING THAT THE SYSTEM AS A WHOLE HAS BEEN DESIGNED TO ADDRESS THE RISKS, AND THAT THE OMRON PRODUCT(S) IS PROPERLY RATED AND INSTALLED FOR THE INTENDED USE WITHIN THE OVERALL EQUIPMENT OR SYSTEM.

## **Programmable Products.**

Omron Companies shall not be responsible for the user's programming of a programmable Product, or any consequence thereof.

## **Performance Data.**

Data presented in Omron Company websites, catalogs and other materials is provided as a guide for the user in determining suitability and does not constitute a warranty. It may represent the result of Omron's test conditions, and the user must correlate it to actual application requirements. Actual performance is subject to the Omron's Warranty and Limitations of Liability.

## **Change in Specifications.**

Product specifications and accessories may be changed at any time based on improvements and other reasons. It is our practice to change part numbers when published ratings or features are changed, or when significant construction changes are made. However, some specifications of the Product may be changed without any notice. When in doubt, special part numbers may be assigned to fix or establish key specifications for your application. Please consult with your Omron's representative at any time to confirm actual specifications of purchased Product.

## **Errors and Omissions.**

Information presented by Omron Companies has been checked and is believed to be accurate; however, no responsibility is assumed for clerical, typographical or proofreading errors or omissions.

**Note: Do not use this document to operate the Unit.**

**OMRON Corporation Industrial Automation Company**

**Kyoto, JAPAN**

**Contact : [www.ia.omron.com](http://www.ia.omron.com)**

**Regional Headquarters**

**OMRON EUROPE B.V.**

Wegalaan 67-69, 2132 JD Hoofddorp  
The Netherlands

Tel: (31) 2356-81-300 Fax: (31) 2356-81-388

**OMRON ASIA PACIFIC PTE. LTD.**

438B Alexandra Road, #08-01/02 Alexandra  
Technopark, Singapore 119968

Tel: (65) 6835-3011 Fax: (65) 6835-3011

**OMRON ELECTRONICS LLC**

2895 Greenspoint Parkway, Suite 200  
Hoffman Estates, IL 60169 U.S.A.

Tel: (1) 847-843-7900 Fax: (1) 847-843-7787

**OMRON (CHINA) CO., LTD.**

Room 2211, Bank of China Tower,  
200 Yin Cheng Zhong Road,  
PuDong New Area, Shanghai, 200120, China

Tel: (86) 21-6023-0333 Fax: (86) 21-5037-2388

**Authorized Distributor:**

©OMRON Corporation 2023-2024 All Rights Reserved.  
In the interest of product improvement,  
specifications are subject to change without notice.

**CSM\_2\_2**

**Cat. No. E617-E1-04 0224 (0323)**