

Solid State Relays G3□-VD

G3H/G3HD

CSM_G3H_G3HD_DS_E_8_2

Solid State Relays Featuring the Same Profile as LY1 and LY2 Bi-power Relays



- Reduces wiring work by 60% when combined with the PTF-08-PU Push-In Plus Terminal blocks (according to actual OMRON measurements).
- Certified by UL, CSA, and VDE.
- Socket type, same size as LY Power Relays.
- Operation indicator provided to confirm input (models numbers with "N" before the suffix).



Note: The socket is optional.

For the most recent information on models that have been certified for safety standards, refer to your OMRON website.

 Refer to *Safety Precautions for All Solid State Relays*.

Model Number Structure

Model Number Legend

G3H-□□□□□□-□
1 2 3 4 5 6 7 8

1. Basic Model Name

G3H: Solid State Relay

2. Rated Load Power Supply Voltage

2: 200 VAC

3, 4. Rated Load Current

03: 3 A

5. Terminal Type

S: Plug-in terminals

6. Zero Cross Function

Blank: Equipped with zero cross function

L: Not equipped with zero cross function

7. Operation Indicator

Blank: Not equipped with operation indicator

N: Equipped with operation indicator

8. Certification

VD: Certified by UL, CSA, and VDE standards

G3HD-□□□□□-□
1 2 3 4 5 6 7

1. Basic Model Name

G3H: Solid State Relay

2. Load Power Supply Type

D: DC

3. Rated Load Power Supply Voltage

X: 50 VDC

4. Rated Load Current

03: 3 A

5. Terminal Type

S: Plug-in terminals

6. Operation Indicator

Blank: Not equipped with operation indicator

N: Equipped with operation indicator

7. Certification

VD: Certified by UL, CSA, VDE

Ordering Information

■ List of Models

Isolation	Zero cross function	Indicator	Rated output load	Rated input voltage	Model
Photocoupler	Yes	Yes	3 A at 100 to 240 VAC *1	5 to 24 VDC	G3H-203SN-VD DC5-24
Phototriac coupler	No			5 VDC	G3H-203SLN-VD DC5
				12 VDC	G3H-203SLN-VD DC12
				24 VDC	G3H-203SLN-VD DC24
Photocoupler	---		3 A at 4 to 48 VDC *2	5 to 24 VDC	G3HD-X03SN-VD DC5-24
Photocoupler	Yes	No	3 A at 100 to 240 VAC *1	4 to 24 VDC	G3H-203S-VD DC4-24
Phototriac coupler	No			5 VDC	G3H-203SL-VD DC5
				12 VDC	G3H-203SL-VD DC12
				24 VDC	G3H-203SL-VD DC24
Photocoupler	---		3 A at 4 to 48 VDC *2	4 to 24 VDC	G3HD-X03S-VD DC4-24
Photovoltaic coupler	---	Yes	2.5 A at 24 to 240 VDC *3 *4	12 to 24 VDC	G3HD-202SN-VD DC12-24V

*1 Product is labelled "240 VAC".



*2 Product is labelled "48 VDC".

*3 Product is labelled "240 VDC".

*4 Application is possible for a half-wave rectification load between 19.2 and 264 VAC.

■ Accessories (Order Separately)

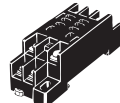
Connection Sockets

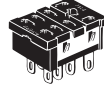
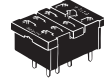
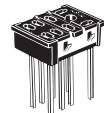

Classification	Terminal Type	Appearance	Model
Front-mounting	Push-In Plus Terminal blocks		PTF-08-PU
	Screw terminals		PTF08A
	Screw terminals (finger protection structure)		PTFZ-08-E
Back-mounting	Solder terminals		PT-08
	Relays with PCB Terminals		PT08-0
	Wrapping terminals		PT08QN

Hold-down Clip

Classification	Applicable Socket		Hold-down Clip Model
	Terminal Type	Model	
Front-mounting	Screw terminals (finger protection structure)	PTFZ-08-E	PYC-A1 *
	Screw terminals	PTF08A	
Back-mounting	Solder terminals	PT-08	PYC-P
			PYC-S
	Relays with PCB Terminals	PT08-0	PYC-P
	Wrapping terminals	PT08QN	PYC-P
			PYC-S

* One Set (2 Clips)

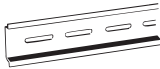
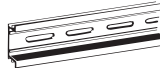
DIN Track Mounting Parts

Type		Appearance	Model
DIN Tracks	Shallow type, total length: 1 m		PFP-100N
	Shallow type, total length: 0.5 m		PFP-50N
	Deep type, total length: 1 m		PFP-100N2
End Plate			PFP-M
Spacer			PFP-S

Specifications

■ Ratings (at an Ambient Temperature of 25°C)

Input

Model	Rated voltage	Operating voltage	Impedance (See note 1.) Input current (See note 2.)	Voltage level	
				Must operate voltage	Must release voltage
G3H-203SN-VD	5 to 24 VDC	4 to 28 VDC	15 mA max. (See note 2.)	4 VDC max.	1 VDC min.
G3H-203SLN-VD	5 VDC	4 to 6 VDC	390 Ω±20%	4 VDC max.	1 VDC min.
	12 VDC	9.6 to 14.4 VDC	900 Ω±20%	9.6 VDC max.	
	24 VDC	19.2 to 28.8 VDC	2 kΩ±20%	19.2 VDC max.	
G3HD-X03SN-VD	5 to 24 VDC	4 to 28 VDC	1.5 kΩ ^{+20%} / _{-10%} (See note 1.)	4 VDC max.	1 VDC min.
G3H-203S-VD	4 to 24 VDC	3 to 28 VDC	15 mA max. (See note 2.)	3 VDC max.	1 VDC min.
G3H-203SL-VD	5 VDC	4 to 6 VDC	390 Ω±20%	4 VDC max.	1 VDC min.
	12 VDC	9.6 to 14.4 VDC	900 Ω±20%	9.6 VDC max.	
	24 VDC	19.2 to 28.8 VDC	2 kΩ±20%	19.2 VDC max.	
G3HD-X03S-VD	4 to 24 VDC	3 to 28 VDC	1.5 kΩ ^{+20%} / _{-10%} (See note 1.)	3 VDC max.	1 VDC min.
G3HD-202SN-VD	12 to 24 VDC	9.6 to 28.8 VDC	25 mA max. (at 24 VDC) (See note 2.)	9.6 VDC max.	1 VDC min.

Note: 1. The input impedance is given for the maximum operating voltage. (For example, with the model rated at 5 to 24 VDC, the input impedance is measured at 24 VDC.)

2. With constant current input system.

Output

Model	Applicable load			
	Rated load voltage	Load voltage range	Load current	Inrush current
G3H-203SN-VD G3H-203S-VD G3H-203SLN-VD G3H-203SL-VD	100 to 240 VAC	75 to 264 VAC	0.1 to 3 A at 40°C	45 A 60 Hz, 1 cycle
G3HD-X03SN-VD G3HD-X03S-VD	4 to 48 VDC	3 to 52.8 VDC	0.1 to 3 A at 40°C	18 A (10 ms)
G3HD-202SN-VD	24 to 240 VDC	19.2 to 264 VDC	0.001 to 2.5 A at 40°C	20 A (10 ms)

■ Characteristics

Model	G3H-203SN-VD/203S-VD	G3H-203SLN-VD/203SL-VD	G3HD-X03SN-VD/X03S-VD	G3HD-202SN-VD
Operate time	1/2 cycle of load power source + 1 ms max.	1 ms max.	0.5 ms max.	5 ms max.
Release time	1/2 cycle of load power source + 1 ms max.		2 ms max.	10 ms max.
Output ON voltage drop	1.6 V (RMS) max.			3 V max. (output ON-resistance: 1.25 Ω max.)
Leakage current	5 mA max. (at 100 VAC); 10 mA max. (at 200 VAC)	2.5 mA max. (at 100 VAC); 5 mA max. (at 200 VAC)	5 mA max. (at 50 VDC)	0.1 mA max. (at 200 VDC)
Insulation resistance	100 MΩ min. (at 500 VDC)			
Dielectric strength	2,000 VAC, 50/60 Hz for 1 min		1,500 VAC, 50/60 Hz for 1 min	
Vibration resistance	Destruction: 10 to 55 to 10 Hz, 0.75-mm single amplitude			
Shock resistance	Destruction: 1,000 m/s ²			
Ambient temperature	Operating: -30°C to 80°C (with no icing) Storage: -30°C to 100°C (with no icing)			
Ambient humidity	45% to 85%			
Certified standards	UL (File No.E64562), CSA (File No.LR35535) VDE (Certificate No.40000159, EN60947-4-3 (G3H-VD) No.40046471, EN62314 (G3HD-VD (except for G3HD-202SN-VD)) No.40012875, EN62314 (G3HD-202SN-VD))			
EMC	Emission: EN55011 Group 1 Class B Immunity: EN61000-6-2			
Weight	Approx. 50 g			
MTTFd (Reference value)	1,000 years min.			

Engineering Data

Load Current vs. Ambient Temperature Characteristics

G3H-203SN-VD/203S-VD/
203SLN-VD/203SL-VD
G3HD-X03SN-VD/X03S-VD
G3HD-202SN-VD

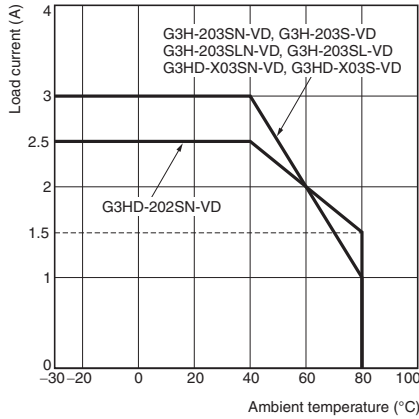

One Cycle Surge Current: Non-repetitive

Non-repetitive (Keep the inrush current to half the rated value if it occurs repetitively.)

G3H-203SN-VD/203S-VD/
203SLN-VD/G3H-203SL-VD

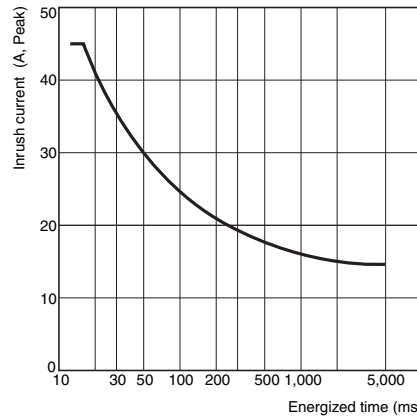

G3HD-X03SN-VD/X03S-VD
G3HD-202SN-VD

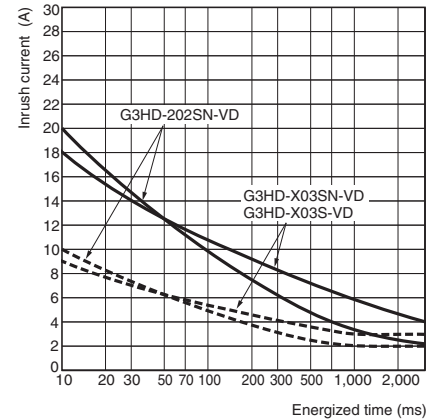

Dimensions

Note: All units are in millimeters unless otherwise indicated.

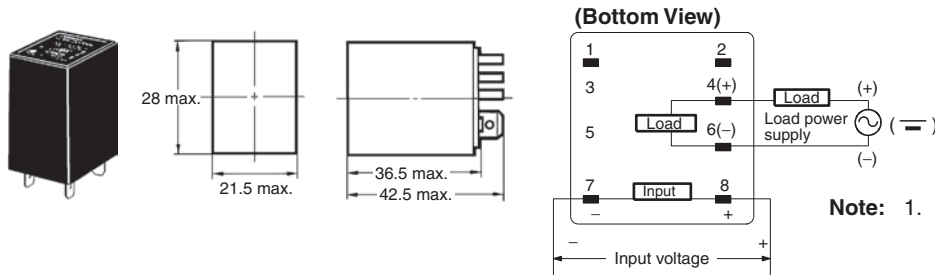

- Note:**
1. The plus and minus symbols shown in the parentheses are for DC loads.
 2. The coil has no polarity.
 3. The load is possible to connect either + side or - side.

Accessories (Order Separately)





Socket Characteristics

Model	Rated carry current	Dielectric strength	Insulation resistance *1	Remarks
PTF-08-PU	10 A	Between contact terminals of different polarity: 2,000 VAC, 1 min	1,000 MΩ min.	
		Between contact terminals of same polarity: 2,000 VAC, 1 min		
		Between coil and contact terminals: 2,000 VAC, 1 min		
PTFZ-08-E	12 A (@70°C) *2	Between contact terminals of different polarity: 2,500 VAC, 1 min	1,000 MΩ min.	
		Between contact terminals of same polarity: 2,500 VAC, 1 min		
		Between ground terminals: 2,500 VAC, 1 min		
PTF08A	10 A	Between terminals: 2,000 VAC for 1 min	100 MΩ min.	
PT-08	10 A	Between terminals: 2,000 VAC for 1 min	100 MΩ min.	
PT08-0	10 A	Between terminals: 2,000 VAC for 1 min	100 MΩ min.	
PT08QN	10 A	Between terminals: 2,000 VAC for 1 min	100 MΩ min.	

*1 The insulation resistance was measured with a 500-VDC insulation resistance meter at the same places as those used for measuring the dielectric strength.

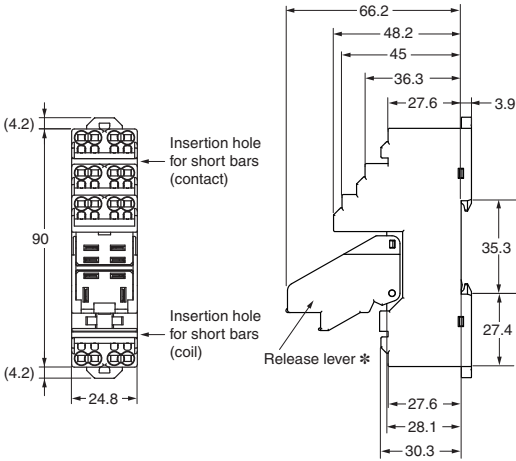
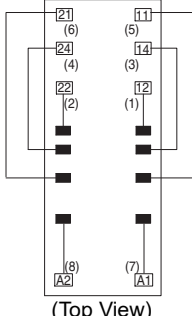
*2 However, do not exceed the continuous carry current of the socket to be mounted.

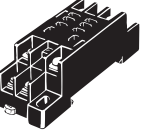
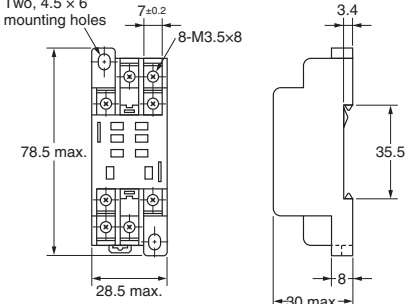
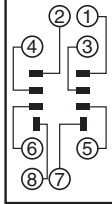
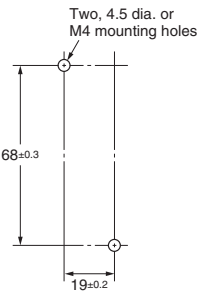
Connection Sockets

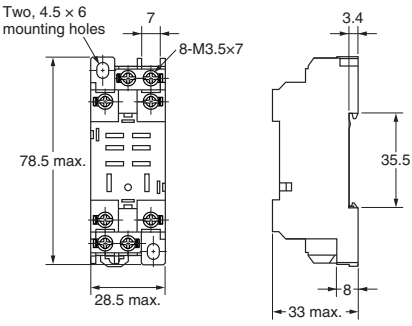
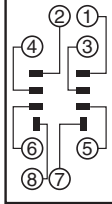
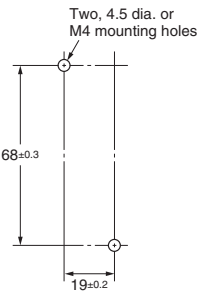
Dimensions	Terminal Arrangement/ Internal Connections	Mounting Hole Dimensions
<p>PTF-08-PU</p>  	 <p>(Top View)</p> <p>Note: The numbers in parentheses are traditionally used terminal numbers.</p>	 <p>(Top View)</p> <p>Note: Pull out the hooks to mount the Relay with screws.</p>
<p>PTF08A</p>  	 <p>(Top View)</p>	 <p>(Top View)</p>
<p>PTFZ-08-E (Finger Protection Structure)</p>  	 <p>(Top View)</p>	 <p>(Top View)</p> <p>Note: Track mounting is also possible.</p>

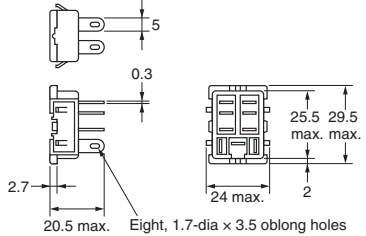
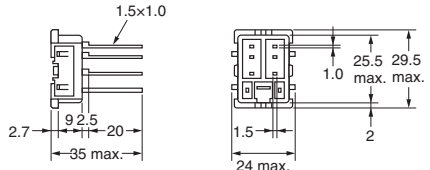
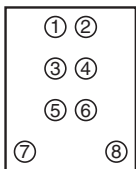
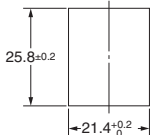
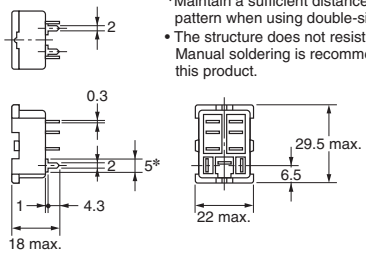
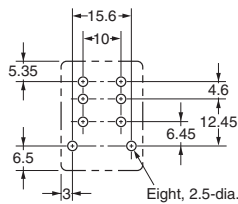
Dimensions	Terminal Arrangement/ Internal Connections	Mounting Hole Dimensions
<p>PT08</p>  <p>20.5 max. Eight, 1.7-dia x 3.5 oblong holes</p> <p>PT08QN</p> 	 <p>(Bottom View)</p>	
<p>PT08-0</p>  <p>*Maintain a sufficient distance from the pattern when using double-sided PCBs. • The structure does not resist flux. Manual soldering is recommended for this product.</p>		 <p>Eight, 2.5-dia. holes (±0.1 tolerance)</p>

Hold-down Clips

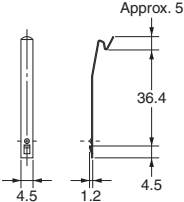
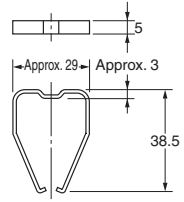
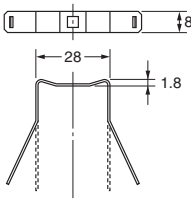
<p>PYC-A1 Approx. 0.54 g (per clip) One Set (2 Clips)</p> 	<p>PYC-P Approx. 1.4 g</p> 	<p>PYC-S Approx. 1.8 g</p> 
--	---	---

Mounting Height with Sockets

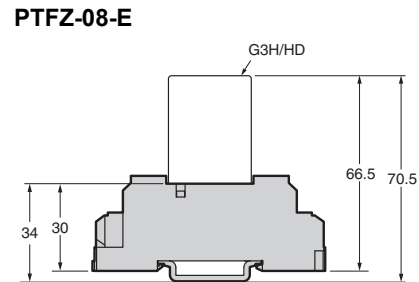

Safety Precautions

■ Precautions for Correct Use

Please observe the following precautions to prevent failure to operate, malfunction, or undesirable effect on product performance.

Connection

The SSR for DC switching use can connect to a load regardless of the polarity of the positive and negative output terminals.

Close Mounting of Multiple Relays

If multiple Relays are mounted side by side, be aware that the outer wall of each SSR works as a heat sink.

The SSR casing serves to dissipate heat. Install the Relays so that they are adequately ventilated. If poor ventilation is unavoidable, reduce the load current by half.

Protective Terminal

No overvoltage absorption element is built in. (The G3HD-202SN (-VD) has a built-in varistor.) Be sure to connect an overvoltage absorption element when using the G3H or G3HD with an inductive load.

EMC Directive Compliance

1. AC-switching models comply with EMC Directives under the following conditions.

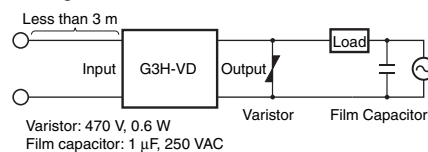

- Connect a varistor between the output terminals.
- Connect a film capacitor to the load power supply.
- The input cable must be less than 3 m.

2. DC-switching models comply with EMC Directives under the following conditions.

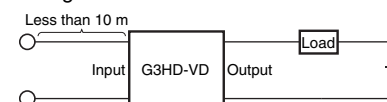

- The input cable must be less than 10 m.

ALL DIMENSIONS SHOWN ARE IN MILLIMETERS.

To convert millimeters into inches, multiply by 0.03937. To convert grams into ounces, multiply by 0.03527.

In the interest of product improvement, specifications are subject to change without notice.

Terms and Conditions Agreement

Read and understand this catalog.

Please read and understand this catalog before purchasing the products. Please consult your OMRON representative if you have any questions or comments.

Warranties.

(a) Exclusive Warranty. Omron's exclusive warranty is that the Products will be free from defects in materials and workmanship for a period of twelve months from the date of sale by Omron (or such other period expressed in writing by Omron). Omron disclaims all other warranties, express or implied.

(b) Limitations. OMRON MAKES NO WARRANTY OR REPRESENTATION, EXPRESS OR IMPLIED, ABOUT NON-INFRINGEMENT, MERCHANTABILITY OR FITNESS FOR A PARTICULAR PURPOSE OF THE PRODUCTS. BUYER ACKNOWLEDGES THAT IT ALONE HAS DETERMINED THAT THE PRODUCTS WILL SUITABLY MEET THE REQUIREMENTS OF THEIR INTENDED USE.

Omron further disclaims all warranties and responsibility of any type for claims or expenses based on infringement by the Products or otherwise of any intellectual property right. (c) Buyer Remedy. Omron's sole obligation hereunder shall be, at Omron's election, to (i) replace (in the form originally shipped with Buyer responsible for labor charges for removal or replacement thereof) the non-complying Product, (ii) repair the non-complying Product, or (iii) repay or credit Buyer an amount equal to the purchase price of the non-complying Product; provided that in no event shall Omron be responsible for warranty, repair, indemnity or any other claims or expenses regarding the Products unless Omron's analysis confirms that the Products were properly handled, stored, installed and maintained and not subject to contamination, abuse, misuse or inappropriate modification. Return of any Products by Buyer must be approved in writing by Omron before shipment. Omron Companies shall not be liable for the suitability or unsuitability or the results from the use of Products in combination with any electrical or electronic components, circuits, system assemblies or any other materials or substances or environments. Any advice, recommendations or information given orally or in writing, are not to be construed as an amendment or addition to the above warranty.

See <http://www.omron.com/global/> or contact your Omron representative for published information.

Limitation on Liability: Etc.

OMRON COMPANIES SHALL NOT BE LIABLE FOR SPECIAL, INDIRECT, INCIDENTAL, OR CONSEQUENTIAL DAMAGES, LOSS OF PROFITS OR PRODUCTION OR COMMERCIAL LOSS IN ANY WAY CONNECTED WITH THE PRODUCTS, WHETHER SUCH CLAIM IS BASED IN CONTRACT, WARRANTY, NEGLIGENCE OR STRICT LIABILITY.

Further, in no event shall liability of Omron Companies exceed the individual price of the Product on which liability is asserted.

Suitability of Use.

Omron Companies shall not be responsible for conformity with any standards, codes or regulations which apply to the combination of the Product in the Buyer's application or use of the Product. At Buyer's request, Omron will provide applicable third party certification documents identifying ratings and limitations of use which apply to the Product. This information by itself is not sufficient for a complete determination of the suitability of the Product in combination with the end product, machine, system, or other application or use. Buyer shall be solely responsible for determining appropriateness of the particular Product with respect to Buyer's application, product or system. Buyer shall take application responsibility in all cases.

NEVER USE THE PRODUCT FOR AN APPLICATION INVOLVING SERIOUS RISK TO LIFE OR PROPERTY OR IN LARGE QUANTITIES WITHOUT ENSURING THAT THE SYSTEM AS A WHOLE HAS BEEN DESIGNED TO ADDRESS THE RISKS, AND THAT THE OMRON PRODUCT(S) IS PROPERLY RATED AND INSTALLED FOR THE INTENDED USE WITHIN THE OVERALL EQUIPMENT OR SYSTEM.

Programmable Products.

Omron Companies shall not be responsible for the user's programming of a programmable Product, or any consequence thereof.

Performance Data.

Data presented in Omron Company websites, catalogs and other materials is provided as a guide for the user in determining suitability and does not constitute a warranty. It may represent the result of Omron's test conditions, and the user must correlate it to actual application requirements. Actual performance is subject to the Omron's Warranty and Limitations of Liability.

Change in Specifications.

Product specifications and accessories may be changed at any time based on improvements and other reasons. It is our practice to change part numbers when published ratings or features are changed, or when significant construction changes are made. However, some specifications of the Product may be changed without any notice. When in doubt, special part numbers may be assigned to fix or establish key specifications for your application. Please consult with your Omron's representative at any time to confirm actual specifications of purchased Product.

Errors and Omissions.

Information presented by Omron Companies has been checked and is believed to be accurate; however, no responsibility is assumed for clerical, typographical or proofreading errors or omissions.

2024.11

In the interest of product improvement, specifications are subject to change without notice.

OMRON Corporation
Industrial Automation Company

<http://www.ia.omron.com/>

(c)Copyright OMRON Corporation 2024 All Right Reserved.