

## Safety I/O Unit

# NX-SI/SO

### Build a simple and flexible safety system

- Free combination of four types of safety input and output units
- Flexible panel design with a width of 12 mm per unit
- Quick wiring with detachable screwless clamping terminal block
- Direct connection to dedicated safety input components



For the most recent information on models that have been certified for safety standards, refer to your OMRON website.

### Features



- Meets EN ISO 13849-1 (PLe/Category 4) and IEC 61508 (SIL3)
- Safety I/O can be freely placed and combined on the NX bus master and mixed with standard I/O
- Omron's safety input components that require dedicated controllers can be connected directly

• Sysmac is a trademark or registered trademark of OMRON Corporation in Japan and other countries for OMRON factory automation products.  
 • EtherCAT® is registered trademark and patented technology, licensed by Beckhoff Automation GmbH, Germany.  
 • Safety over EtherCAT® is registered trademark and patented technology, licensed by Beckhoff Automation GmbH, Germany.  
 • ODVA, CIP™, CompoNet™, DeviceNet™, EtherNet/IP™, and CIP Safety™ are trademarks of ODVA.  
 Other company names and product names in this document are the trademarks or registered trademarks of their respective companies.

## Ordering Information

### Safety I/O Unit

#### Safety Input Units

Unit type	Appearance	Specifications							Unit version	Model
		Number of safety input points	Number of test output points	Internal I/O common	Rated input voltage	OMRON special safety input devices *1	Number of safety slave connections	I/O refreshing method		
Safety Input Units		4 points	2 points	Sinking inputs (PNP)	24 VDC	Can be connected.	1	Free-Run refreshing	Ver. 1.1	<b>NX-SIH400</b>
		8 points	2 points	Sinking inputs (PNP)	24 VDC	Cannot be connected.	1	Free-Run refreshing	Ver. 1.0	<b>NX-SID800</b>



\*1 OMRON special safety input devices refer to devices listed below. These devices can be connected directly to the NX-SIH400 without any dedicated controller. Refer to the *NX-series Safety Control Unit User's Manual* (Cat. No. Z930) for details.

Type	Model and corresponding PL and safety category
OMRON Single-beam Safety Sensors	E3ZS
OMRON Non-contact Door Switches *2	D40A-2 D40A D40Z
OMRON Safety Mats	UM *3, UMA
OMRON Safety Edges	SGE (4-wire connection)

\*2 The D41D High-Coded Non-Contact Safety Door Switch, which requires no dedicated controller, can be connected directly to both the NX-SIH400 and NX-SID800.

\*3 UM series is no longer available for order after June 2019.

#### Safety Output Units

Unit type	Appearance	Specifications						Unit version	Model
		Number of safety output points	Internal I/O common	Maximum load current	Rated voltage	Number of safety slave connections	I/O refreshing method		
Safety Output Units		2 points	Sourcing outputs (PNP)	2.0 A/point, 4.0 A/Unit at 40°C, and 2.5 A/Unit at 55°C The maximum load current depends on the installation orientation and ambient temperature.	24 VDC	1	Free-Run refreshing	Ver. 1.0	<b>NX-SOH200</b>
		4 points	Sourcing outputs (PNP)	0.5 A/point and 2.0 A/Unit	24 VDC	1	Free-Run refreshing	Ver. 1.0	<b>NX-SOD400</b>

### Accessories

Not included.

### Option

#### Unit/Terminal Block Coding Pins

Product Name	Specification	Model
Unit/Terminal Block Coding Pins	For 10 Units (Terminal Block: 30 pins, Unit: 30 pins)	<b>NX-AUX02</b>

#### Terminal Block

Product name	Specification				Model
	No. of terminals	Terminal number indications	Ground terminal mark	Terminal current capacity	
Terminal Block	8	A/B	None	10A	<b>NX-TBA082</b>
	16	A/B	None	10A	<b>NX-TBA162</b>

## Regulations and Standards

### Safety I/O Units NX-SI/SO

Certification body	Standards
TÜV Rheinland *1	<ul style="list-style-type: none"> <li>• EN ISO 13849-1</li> <li>• EN ISO 13849-2</li> <li>• IEC 61508 parts 1-7</li> <li>• IEC/EN 61131-2</li> <li>• IEC 61326-3-1</li> </ul>
UL	<ul style="list-style-type: none"> <li>• NRAG (UL 508 and ANSI/ISA 12.12.01)</li> <li>• NRAG7 (CSA C22.2 No. 142 and CSA C22.2 No. 213)</li> </ul>
Shipbuilding Standards	NK, LK

\*1 Using the NX-series Safety I/O Units in conjunction with the NX-series Safety CPU Unit allows you to build a safety control system that meets the following standards:

- Requirements for SIL 3 in IEC 61508
- Requirements for PLe and Category 4 in EN ISO 13849-1

The NX-series Safety I/O Units are also registered for RCM, EAC, and KC compliance.

## General Specifications

Item	Specification	
Enclosure	Mounted in a panel (open)	
Grounding method	Ground to 100 Ω or less.	
Operating environment	Ambient operating temperature	0 to 55°C (The upper limit of the ambient operating temperature is restricted by the installation orientation.)
	Ambient operating humidity	10% to 95% (with no condensation or icing)
	Atmosphere	Must be free from corrosive gases.
	Ambient storage temperature	-25 to 70°C (with no condensation or icing)
	Altitude	2,000 m max.
	Pollution degree	2 or less.
	Noise immunity	Conforms to IEC 61131-2. 2 kV on power supply line (Conforms to IEC 61000-4-4.)
	Insulation class	Class III (SELV)
	Overvoltage category	II
	EMC immunity level	Zone B
	Vibration resistance	Conforms to IEC 60068-2-6. 5 to 8.4 Hz with 3.5-mm amplitude, 8.4 to 150 Hz, acceleration of 9.8 m/s <sup>2</sup> , 100 minutes each in X, Y, and Z directions (10 sweeps of 10 min each = 100 min total)
	Shock resistance	Conforms to IEC 60068-2-27. 147 m/s <sup>2</sup> , 3 times each in X, Y, and Z directions
Insulation resistance	20 MΩ between isolated circuits (at 100 VDC)	
Dielectric strength	510 VAC for 1 min between isolated circuits, leakage current: 5 mA max.	
Installation method	DIN Track (IEC 60715 TH35-7.5/TH35-15)	

# NX-SI/SO

## Unit Specifications

### Safety Input Units NX-SIH400/SID800

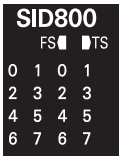
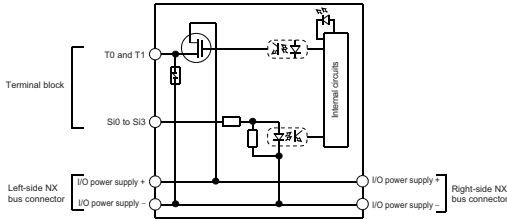
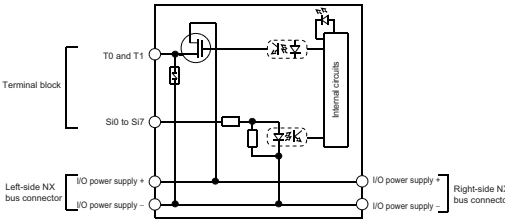
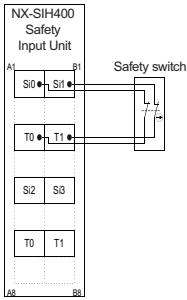
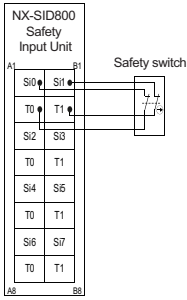

Unit name	Safety Input Unit	
Model	NX-SIH400	NX-SID800
Number of safety input points	4 points	8 points
Number of test output points	2 points	2 points
Internal I/O common	PNP (sinking inputs)	
Rated input voltage	24 VDC (20.4 to 28.8 VDC)	
OMRON special safety input devices	Can be connected.	Cannot be connected.
Number of safety slave connections	1	
I/O refreshing method	Free-Run refreshing	
External connection terminals	Screwless clamping terminal block (8 terminals)	Screwless clamping terminal block (16 terminals)
Indicators		
Safety input current	4.5 mA typical	3.0 mA typical
Safety input ON voltage	11 VDC min.	15 VDC min.
Safety input OFF voltage/OFF current	5 VDC max., 1 mA max.	
Test output type	Sourcing outputs (PNP)	
Test output load current	25 mA max.	50 mA max.
Test output residual voltage	1.2 V max. (Between IOV and all output terminals)	
Test output leakage current	0.1 mA max.	
Dimensions	12 × 100 × 71 mm (W × H × D)	
Isolation method	Photocoupler isolation	
Insulation resistance	20 MΩ min. between isolated circuits (at 100 VDC)	
Dielectric strength	510 VAC for 1 min between isolated circuits, leakage current: 5 mA max.	
I/O power supply method	Power supplied from the NX bus	
Current capacity of I/O power supply terminals	No applicable terminals.	
NX Unit power consumption	<ul style="list-style-type: none"> <li>Connected to a CPU Unit or a Communication Control Unit *1 1.10 W max.</li> <li>Connected to a Communications Coupler Unit *2 0.70 W max.</li> </ul>	<ul style="list-style-type: none"> <li>Connected to a CPU Unit or a Communication Control Unit *1 1.10 W max.</li> <li>Connected to a Communications Coupler Unit *2 0.75 W max.</li> </ul>
Current consumption from I/O power supply	20 mA max.	
Weight	70 g max.	
Circuit layout		
Terminal connection diagram	<p>Si0 to Si3: Safety input terminals T0 and T1: Test output terminals</p>  <p>Refer to User's manual (Cat.No.Z930) for details.</p>	<p>Si0 to Si7: Safety input terminals T0 and T1: Test output terminals</p>  <p>Refer to User's manual (Cat.No.Z930) for details.</p>

Unit name	Safety Input Unit
<b>Installation orientation and restrictions</b>	Installation orientation: <ul style="list-style-type: none"> <li>• Connected to a CPU Unit or a Communication Control Unit *1 Possible in the upright installation orientation.</li> <li>• Connected to a Communications Coupler Unit *2 6 possible orientations.</li> </ul> Restrictions: Maximum ambient temperature is 50°C for any orientation other than upright installation.
<b>Protective functions</b>	Overvoltage protection circuit and short detection (test outputs)

\*1 The NX102 CPU Unit, NX502 CPU Unit, and NX-CSG Communication Control Unit can be connected. It cannot be connected to the NX1P2 CPU unit.

\*2 The NX-ECC20 EtherCAT Coupler Unit and NX-EIC202 EtherNet/IP Coupler Unit can be connected.

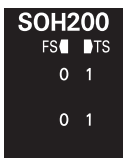
## Safety Output Units NX-SOH200/SOD400

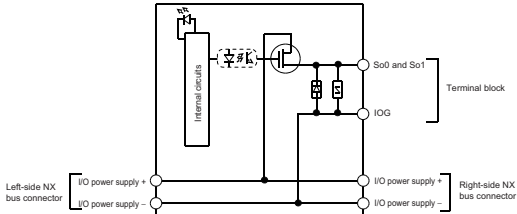
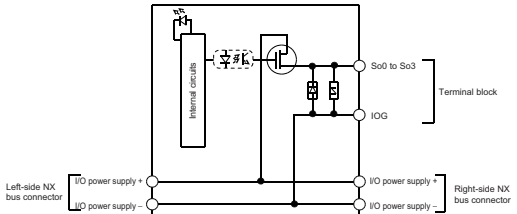
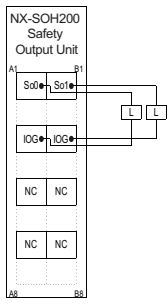
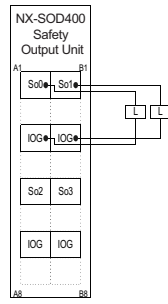
Unit name	Safety Output Unit	
Model	NX-SOH200	NX-SOD400
Number of safety output points	2 points	4 points
Internal I/O common	PNP (sourcing outputs)	
Maximum load current	2.0 A/point 4.0 A/Unit at 40°C 2.5 A/Unit at 55°C The maximum load current depends on the installation orientation and ambient temperature. See <i>Installation orientation and restrictions</i> .	0.5 A/point and 2.0 A/Unit
Rated voltage	24 VDC (20.4 to 28.8 VDC)	
Number of safety slave connections	1	
I/O refreshing method	Free-Run refreshing	
External connection terminals	Screwless clamping terminal block (8 terminals)	
Indicators		
Safety output ON residual voltage	1.2 V max. (Between IOV and all output terminals)	
Safety output OFF residual voltage	2 V max. (Between IOG and all output terminals)	
Safety output leakage current	0.1 mA max.	
Dimensions	12 × 100 × 71 mm (W × H × D)	
Isolation method	Photocoupler isolation	
Insulation resistance	20 MΩ min. between isolated circuits (at 100 VDC)	
Dielectric strength	510 VAC for 1 min between isolated circuits, leakage current: 5 mA max.	
I/O power supply method	Power supplied from the NX bus	
Current capacity of I/O power supply terminals	IOG: 2 A max./terminal	IOG (A3 and B3): 2 A max./terminal IOG (A7 and B7): 0.5 A max./terminal
NX Unit power consumption	<ul style="list-style-type: none"> <li>Connected to a CPU Unit or a Communication Control Unit *1 1.05 W max.</li> <li>Connected to a Communications Coupler Unit *2 0.70 W max.</li> </ul>	<ul style="list-style-type: none"> <li>Connected to a CPU Unit or a Communication Control Unit *1 1.10 W max.</li> <li>Connected to a Communications Coupler Unit *2 0.75 W max.</li> </ul>
Current consumption from I/O power supply	40 mA max.	60 mA max.
Weight	65 g max.	
Circuit layout		
Terminal connection diagram	<p>So0 and So1: Safety output terminals IOG: I/O power supply 0 V</p>  <p>Refer to User's manual (Cat.No.Z930) for details.</p>	<p>So0 to So3: Safety output terminals IOG: I/O power supply 0 V</p>  <p>Refer to User's manual (Cat.No.Z930) for details.</p>

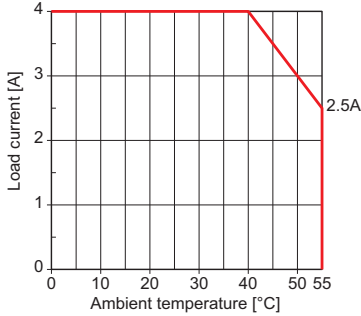
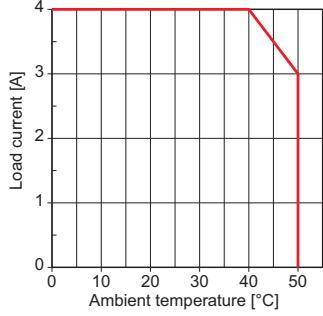
Unit name	Safety Output Unit	
Model	NX- SOH200	NX-SOD400
<p><b>Installation orientation and restrictions</b></p>	<p>Installation orientation:</p> <ul style="list-style-type: none"> <li>• Connected to a CPU Unit or a Communication Control Unit *1 Possible in the upright installation orientation.</li> <li>• Connected to a Communications Coupler Unit *2 6 possible orientations</li> </ul> <p>Restrictions: For upright installation, the ambient temperature is restricted as shown below depending on the total Unit load current.</p>  <p>For all installation orientations other than upright installation, the ambient temperature is restricted as shown below according to the total Unit load current.</p> 	<p>Installation orientation:</p> <ul style="list-style-type: none"> <li>• Connected to a CPU Unit or a Communication Control Unit *1 Possible in the upright installation orientation.</li> <li>• Connected to a Communications Coupler Unit *2 6 possible orientations</li> </ul> <p>Restrictions: None</p>
	<p><b>Protective functions</b>      Overvoltage protection circuit and short detection</p>	

\*1 The NX102 CPU Unit, NX502 CPU Unit, and NX-CSG Communication Control Unit can be connected. The NX1P2 CPU Unit cannot be connected.  
 \*2 The NX-ECC20 EtherCAT Coupler Unit and NX-EIC202 EtherNet/IP Coupler Unit can be connected.

# NX-SI/SO

## Version Information

The following table shows the possible combinations of versions of NX-series Safety I/O Units, CPU Units, Communications Coupler Units, Communication Control Unit, and Sysmac Studio. Available functions that are related to safety control vary depending on the versions of the units and Sysmac Studio. Refer to the *NX-series Safety Control Unit User's Manual* (Cat. No. Z930) for details.

Safety Control Unit model and version		NX bus master: NX102 CPU Unit		NX bus master: NX502 CPU Unit		NX bus master: EtherCAT Coupler Unit			NX bus master: EtherNet/IP Coupler Unit	
Model	Unit version	NX102-□□□□	Sysmac Studio	NX502-□□□□	Sysmac Studio	Communications Coupler Unit NX-ECC20□	NJ/NX1P/NX7 CPU Unit #1	Sysmac Studio	Communications Coupler Unit NX-EIC202	Sysmac Studio
NX-SIH400	Ver. 1.0	Ver. 1.30 or later	Ver. 1.22 or higher	Ver. 1.60 or later	Ver. 1.54 or higher	Ver. 1.2 or later	Ver. 1.06 or later	Ver. 1.07 or higher	---	---
	Ver. 1.1							Ver. 1.10 or higher		
NX-SID800	Ver. 1.0	Ver. 1.30 or later	Ver. 1.22 or higher	Ver. 1.60 or later	Ver. 1.54 or higher	Ver. 1.1 or later	Ver. 1.06 or later	Ver. 1.07 or higher	Ver. 1.0 or later	Ver. 1.10 or higher
NX-SOH200	Ver. 1.0	Ver. 1.30 or later	Ver. 1.22 or higher	Ver. 1.60 or later	Ver. 1.54 or higher	Ver. 1.1 or later	Ver. 1.06 or later	Ver. 1.07 or higher	Ver. 1.0 or later	Ver. 1.10 or higher
NX-SOD400	Ver. 1.0	Ver. 1.30 or later	Ver. 1.22 or higher	Ver. 1.60 or later	Ver. 1.54 or higher	Ver. 1.1 or later	Ver. 1.06 or later	Ver. 1.07 or higher	Ver. 1.0 or later	Ver. 1.10 or higher

\*1 This is version information when the NJ/NX1P/NX7 CPU Unit is used as the EtherCAT master in the system. The Safety Control Unit cannot be connected directly to these CPU Units.



## Part Names and Functions

Safety Input Unit NX-SIH400/SID800  
 Safety Output Unit NX-SOH200/SOD400

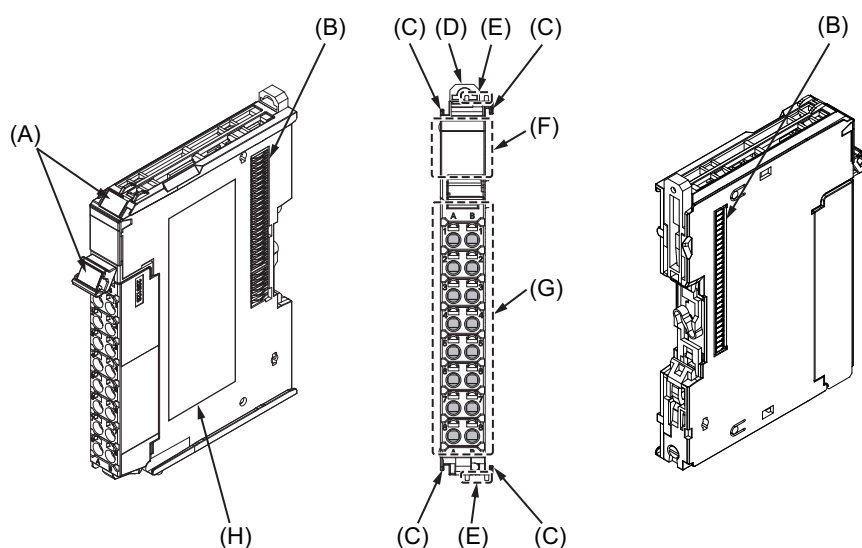

Letter	Item	Specification
(A)	Marker attachment locations	The locations where markers are attached. The markers made by OMRON are installed for the factory setting. Commercially available markers can also be installed.
(B)	NX bus connector	This is the NX-series bus connector. Connect this connector to another Unit, such as the NX-series Safety CPU Unit or a Safety I/O Unit.
(C)	Unit hookup guides	These guides are used to connect two Units.
(D)	DIN Track mounting hooks	These hooks are used to mount the NX Unit to a DIN Track.
(E)	Protrusions for removing the Unit	The protrusions to hold when removing the Unit.
(F)	Indicators	The indicators show the current operating status of the NX Unit or signal I/O status.
(G)	Terminal block	The terminal block is used to connect to external devices. It connects the safety outputs. The number of terminals depends on the NX Unit.
(H)	Unit specifications	The specifications of the NX Unit are given here.

## Indicators

The indicator pattern depends on the number of input points, as shown below.

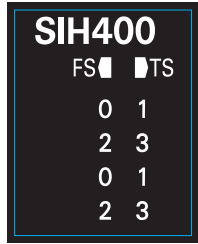

Unit with 4 I/O Points

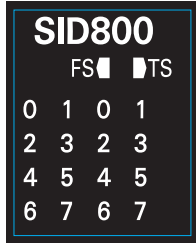

Unit with 8 I/O Points

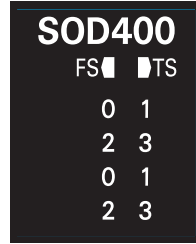

Unit with 4 I/O Points

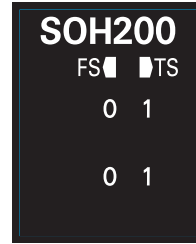

Unit with 2 I/O Points

Letter	Name	Function
(A)	Model number display	Displays part of the model number of the Safety I/O Units. The model number indication is red on all Safety Control Units.
(B)	Indicators	Show the current operating status and communications status of the Safety I/O Units.

## NX-SIH400/SID800

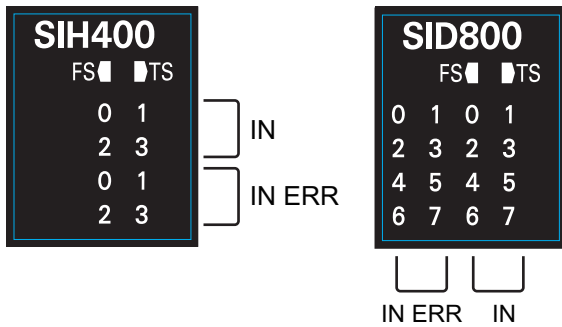

### Indicator specifications

[TS] LED	The TS indicator shows the current status of the Safety Input Unit and its communications status with the NX Bus Master.
[FS] LED	The FS indicator shows the FSoE communications status and safety function status of the Safety Input Unit.
[IN] LED	The IN indicator shows the signal input status of the safety input terminal.
[IN ERR] LED	The IN ERR indicator shows the error status of the safety input terminal.

## NX-SOD400/SOH200

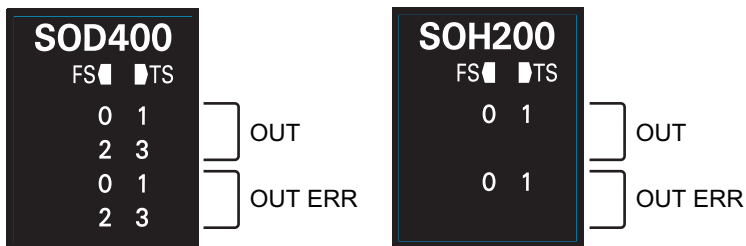

### Indicator specifications

[TS] LED	The TS indicator shows the current status of the Safety Output Unit and its communications status with the NX Bus Master.
[FS] LED	The FS indicator shows the FSoE communications status and safety function status of the Safety Output Unit.
[OUT] LED	The OUT indicator shows the signal input status of the safety output terminal.
[OUT ERR] LED	The OUT ERR indicator shows the error status of the safety output terminals.

## Terminal Blocks

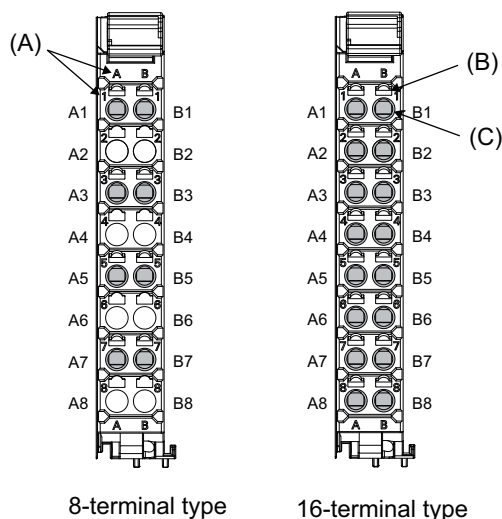

Letter	Item	Specification
(A)	Terminal number indications	The terminal numbers are given by column letters A and B, and row numbers 1 to 8. The combination of the column and row gives the terminal numbers from A1 to A8 and B1 to B8. The terminal number indicators are the same regardless of the number of terminals on the terminal block, as shown above.
(B)	Release holes	Insert a flat-blade screwdriver into these holes to connect and remove the wires.
(C)	Terminal holes	The wires are inserted into these holes.

## Applicable Terminal Blocks for Each Unit Model

Unit model number	Terminal Blocks				
	Model	No. of terminals	Terminal number indications	Ground terminal mark	Terminal current capacity
NX-SIH400	NX-TBA082	8	A/B	None	10A
NX-SID800	NX-TBA162	16	A/B	None	10A
NX-SOH200	NX-TBA082	8	A/B	None	10A
NX-SOD400	NX-TBA082	8	A/B	None	10A

## Applicable Wires

### Using Ferrules

If you use ferrules, attach the twisted wires to them.

Observe the application instructions for your ferrules for the wire stripping length when attaching ferrules.

Always use plated one-pin ferrules. Do not use unplated ferrules or two-pin ferrules.

The applicable ferrules, wires, and crimping tool are given in the following table.

Terminal types	Manufacturer	Ferrule model number	Applicable wire (mm <sup>2</sup> (AWG))	Crimping tool
Terminals other than ground terminals	Phoenix Contact	AI0,34-8	0.34 (#22)	Phoenix Contact (The figure in parentheses is the applicable wire size.) CRIMPFOX 6 (0.25 to 6 mm <sup>2</sup> , AWG24 to 10)
		AI0,5-8	0.5 (#20)	
		AI0,5-10	0.75 (#18)	
		AI0,75-8		
		AI0,75-10	1.0 (#18)	
		AI1,0-8		
		AI1,0-10	1.5 (#16)	
		AI1,5-8		
AI1,5-10	2.0 *			
Ground terminals		AI2,5-10		
Terminals other than ground terminals	Weidmuller	H0.14/12	0.14 (#26)	Weidmuller (The figure in parentheses is the applicable wire size.) PZ6 Roto (0.14 to 6 mm <sup>2</sup> , AWG 26 to 10)
		H0.25/12	0.25 (#24)	
		H0.34/12	0.34 (#22)	
		H0.5/14	0.5 (#20)	
		H0.5/16		
		H0.75/14	0.75 (#18)	
		H0.75/16		
		H1.0/14	1.0 (#18)	
		H1.0/16		
		H1.5/14	1.5 (#16)	
H1.5/16				

\* Some AWG 14 wires exceed 2.0 mm<sup>2</sup> and cannot be used in the screwless clamping terminal block.

When you use any ferrules other than those in the above table, crimp them to the twisted wires so that the following processed dimensions are achieved.

Finished Dimensions of Ferrules

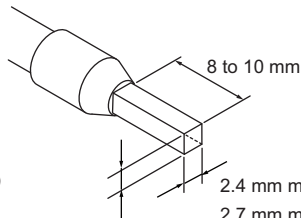

1.6 mm max. (except ground terminals)

2.0 mm max. (ground terminals)

2.4 mm max. (except ground terminals)

2.7 mm max. (ground terminals)

### Using Twisted Wires/Solid Wires

If you use the twisted wires or the solid wires, use the following table to determine the correct wire specifications.

Terminals		Wire type				Wire size	Conductor length (stripping length)
		Twisted wires		Solid wire			
Classification	Current capacity	Plated	Unplated	Plated	Unplated		
All terminals except ground terminals	2 A max.	Possible	Possible	Possible	Possible	0.08 to 1.5 mm <sup>2</sup> AWG28 to 16	8 to 10 mm
	Greater than 2 A and 4 A or less		Not Possible	Possible *1	Not Possible		
	Greater than 4 A		Possible *1	Not Possible	Not Possible		
Ground terminals	---	Possible	Possible	Possible *2	Possible *2	2.0 mm <sup>2</sup>	9 to 10 mm

\*1 Secure wires to the screwless clamping terminal block. Refer to the *Securing Wires* in the USER'S MANUAL for how to secure wires.

\*2 With the NX-TB□□□1 Terminal Block, use twisted wires to connect the ground terminal. Do not use a solid wire.

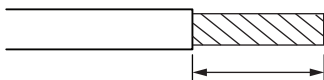

Conductor length (stripping length)

<Additional Information> If more than 2 A will flow on the wires, use plated wires or use ferrules.

# Dimensions

Safety Input Units NX-SIH400/SID800  
 Safety Output Units NX-SOH200/SOD400

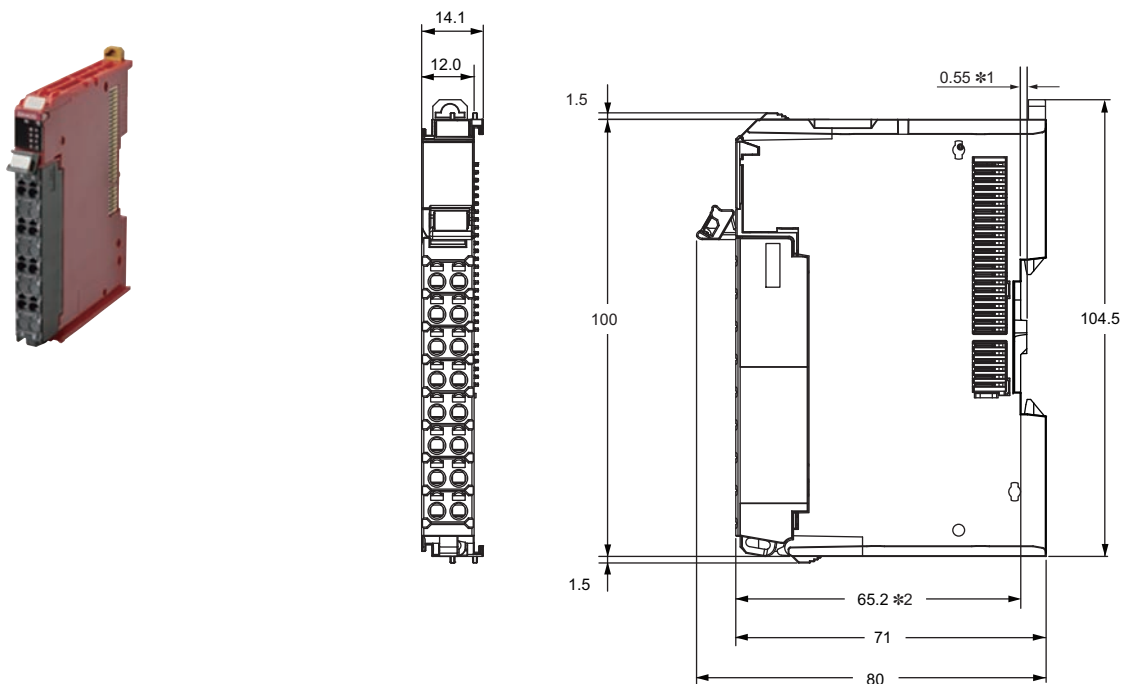

\*1 The dimension is 1.35 mm for Units with lot numbers through December 2014.

\*2 The dimension from the attachment surface of the DIN Track to the front surface of the Safety I/O Unit.

## NX-SI/SO

### Related Manuals

Manual name	Cat. No.	Model numbers	Application	Description
NX-series Safety Control Unit User's Manual	Z930	NX-SL□□□□ NX-SI□□□□ NX-SO□□□□	Learning how to use NX-series Safety Control Units.	Describes the hardware, setup methods, and functions of the NX-series Safety Control Units.
NX-series Safety Control Unit / Communication Control Unit User's Manual	Z395	NX-SL5□□□ NX-SI□□□□ NX-SO□□□□ NX-CSG□□□□	Learning how to use the NX-series Safety Control Units and Communication Control Units.	Describes the hardware, setup methods, and functions of the NX-series Safety Control Units and Communication Control Units.

### Safety Precautions

Be sure to read the Common Precautions for Safety Warning at the following URL: <http://www.ia.omron.com/>.  
Be sure to read the following user's manual for other details required for correct use of the Safety I/O Unit.

# Terms and Conditions Agreement

## **Read and understand this catalog.**

Please read and understand this catalog before purchasing the products. Please consult your OMRON representative if you have any questions or comments.

## **Warranties.**

(a) Exclusive Warranty. Omron's exclusive warranty is that the Products will be free from defects in materials and workmanship for a period of twelve months from the date of sale by Omron (or such other period expressed in writing by Omron). Omron disclaims all other warranties, express or implied.

(b) Limitations. OMRON MAKES NO WARRANTY OR REPRESENTATION, EXPRESS OR IMPLIED, ABOUT NON-INFRINGEMENT, MERCHANTABILITY OR FITNESS FOR A PARTICULAR PURPOSE OF THE PRODUCTS. BUYER ACKNOWLEDGES THAT IT ALONE HAS DETERMINED THAT THE PRODUCTS WILL SUITABLY MEET THE REQUIREMENTS OF THEIR INTENDED USE.

Omron further disclaims all warranties and responsibility of any type for claims or expenses based on infringement by the Products or otherwise of any intellectual property right. (c) Buyer Remedy. Omron's sole obligation hereunder shall be, at Omron's election, to (i) replace (in the form originally shipped with Buyer responsible for labor charges for removal or replacement thereof) the non-complying Product, (ii) repair the non-complying Product, or (iii) repay or credit Buyer an amount equal to the purchase price of the non-complying Product; provided that in no event shall Omron be responsible for warranty, repair, indemnity or any other claims or expenses regarding the Products unless Omron's analysis confirms that the Products were properly handled, stored, installed and maintained and not subject to contamination, abuse, misuse or inappropriate modification. Return of any Products by Buyer must be approved in writing by Omron before shipment. Omron Companies shall not be liable for the suitability or unsuitability or the results from the use of Products in combination with any electrical or electronic components, circuits, system assemblies or any other materials or substances or environments. Any advice, recommendations or information given orally or in writing, are not to be construed as an amendment or addition to the above warranty.

See <http://www.omron.com/global/> or contact your Omron representative for published information.

## **Limitation on Liability; Etc.**

OMRON COMPANIES SHALL NOT BE LIABLE FOR SPECIAL, INDIRECT, INCIDENTAL, OR CONSEQUENTIAL DAMAGES, LOSS OF PROFITS OR PRODUCTION OR COMMERCIAL LOSS IN ANY WAY CONNECTED WITH THE PRODUCTS, WHETHER SUCH CLAIM IS BASED IN CONTRACT, WARRANTY, NEGLIGENCE OR STRICT LIABILITY.

Further, in no event shall liability of Omron Companies exceed the individual price of the Product on which liability is asserted.

## **Suitability of Use.**

Omron Companies shall not be responsible for conformity with any standards, codes or regulations which apply to the combination of the Product in the Buyer's application or use of the Product. At Buyer's request, Omron will provide applicable third party certification documents identifying ratings and limitations of use which apply to the Product. This information by itself is not sufficient for a complete determination of the suitability of the Product in combination with the end product, machine, system, or other application or use. Buyer shall be solely responsible for determining appropriateness of the particular Product with respect to Buyer's application, product or system. Buyer shall take application responsibility in all cases.

NEVER USE THE PRODUCT FOR AN APPLICATION INVOLVING SERIOUS RISK TO LIFE OR PROPERTY OR IN LARGE QUANTITIES WITHOUT ENSURING THAT THE SYSTEM AS A WHOLE HAS BEEN DESIGNED TO ADDRESS THE RISKS, AND THAT THE OMRON PRODUCT(S) IS PROPERLY RATED AND INSTALLED FOR THE INTENDED USE WITHIN THE OVERALL EQUIPMENT OR SYSTEM.

## **Programmable Products.**

Omron Companies shall not be responsible for the user's programming of a programmable Product, or any consequence thereof.

## **Performance Data.**

Data presented in Omron Company websites, catalogs and other materials is provided as a guide for the user in determining suitability and does not constitute a warranty. It may represent the result of Omron's test conditions, and the user must correlate it to actual application requirements. Actual performance is subject to the Omron's Warranty and Limitations of Liability.

## **Change in Specifications.**

Product specifications and accessories may be changed at any time based on improvements and other reasons. It is our practice to change part numbers when published ratings or features are changed, or when significant construction changes are made. However, some specifications of the Product may be changed without any notice. When in doubt, special part numbers may be assigned to fix or establish key specifications for your application. Please consult with your Omron's representative at any time to confirm actual specifications of purchased Product.

## **Errors and Omissions.**

Information presented by Omron Companies has been checked and is believed to be accurate; however, no responsibility is assumed for clerical, typographical or proofreading errors or omissions.

# OMRON's Products Support IoT for Control Panels and Production Lines



NX -series Safety Controller stand-alone System Brochure

Cat. No. F100



NX -series Safety Controller EtherCAT System Brochure

Cat. No. F101



NX-series Safety Controller CIP Safety System Catalog

Cat. No. F104



Safety CPU Unit NX-SL3 Datasheet

Cat. No. F109



Safety CPU Unit NX-SL5 Datasheet

Cat. No. F124



Communication Control Unit NX-CSG Datasheet

Cat. No. F125

**Note: Do not use this document to operate the Unit.**

**OMRON Corporation Industrial Automation Company**

Kyoto, JAPAN

Contact : [www.ia.omron.com](http://www.ia.omron.com)

### Regional Headquarters

#### OMRON EUROPE B.V.

Wegalaan 67-69, 2132 JD Hoofddorp  
The Netherlands  
Tel: (31) 2356-81-300 Fax: (31) 2356-81-388

#### OMRON ELECTRONICS LLC

2895 Greenspoint Parkway, Suite 200  
Hoffman Estates, IL 60169 U.S.A.  
Tel: (1) 847-843-7900 Fax: (1) 847-843-7787

#### OMRON ASIA PACIFIC PTE. LTD.

438B Alexandra Road, #08-01/02 Alexandra  
Technopark, Singapore 119968  
Tel: (65) 6835-3011 Fax: (65) 6835-3011

#### OMRON (CHINA) CO., LTD.

Room 2211, Bank of China Tower,  
200 Yin Cheng Zhong Road,  
PuDong New Area, Shanghai, 200120, China  
Tel: (86) 21-6023-0333 Fax: (86) 21-5037-2388

Authorized Distributor:

©OMRON Corporation 2023-2024 All Rights Reserved.  
In the interest of product improvement,  
specifications are subject to change without notice.

**CSM\_4\_1**

Cat. No. F123-E1-05 0524 (0223)