

Smart Fiber Amplifier Units
E3X-ZV (1-channel model)
E3X-MZV (2-channel model)

OMRON

Solidly Stable Presence/Absence Detection at a Cost-effective Price

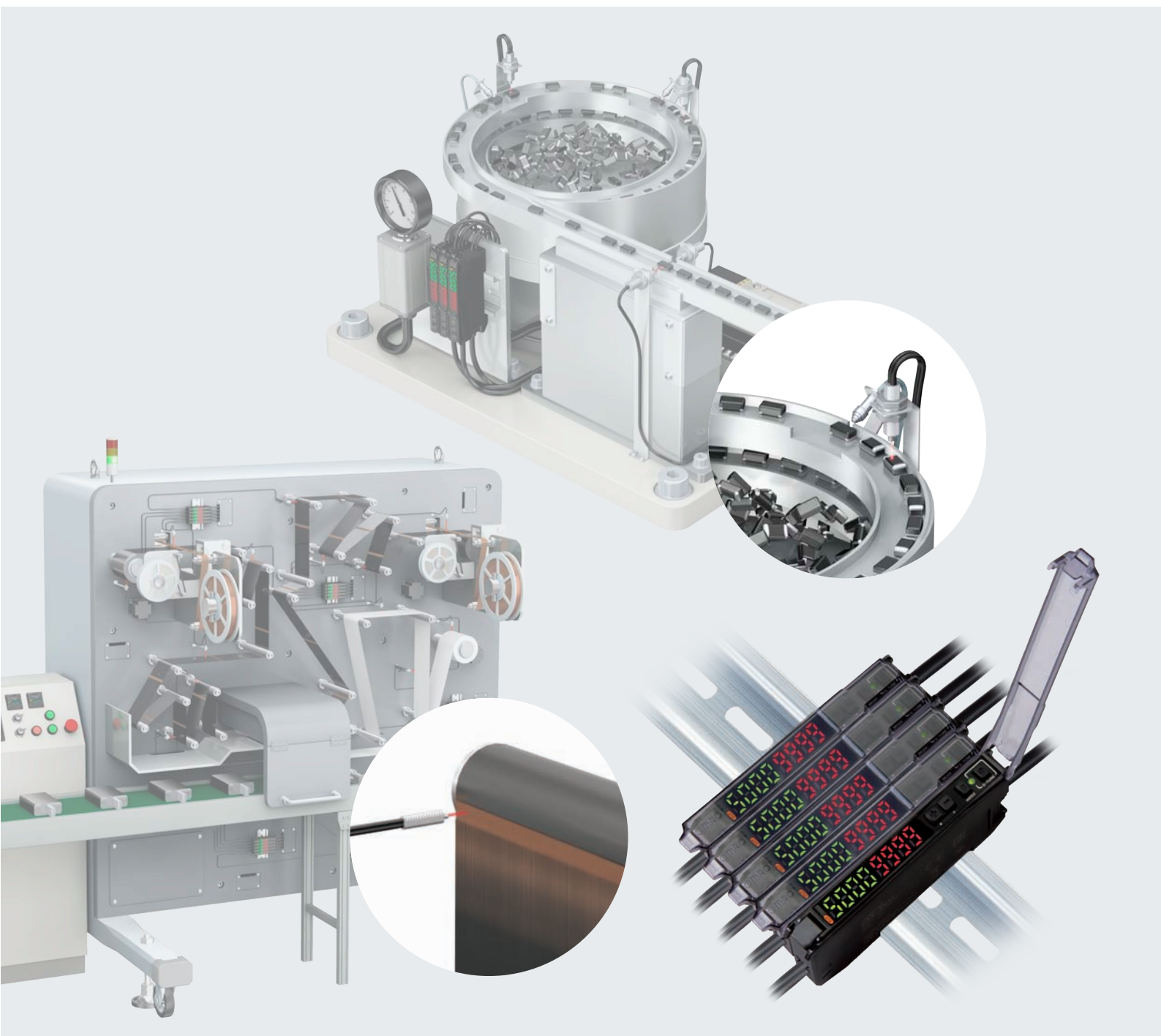

“Cost-effective Price”

×

“Stable Detection”

A new fiber amplifier unit able to detect the
“presence or absence” of workpieces
with “solid stability” at a “Cost-effective price” is now available.



Contributes to reducing your equipment cost

New technologies and efficient design allow cost reduction in manufacturing process.

Since fiber sensors are used in large quantities, E3X-ZV makes a huge contribution to reducing your equipment cost.

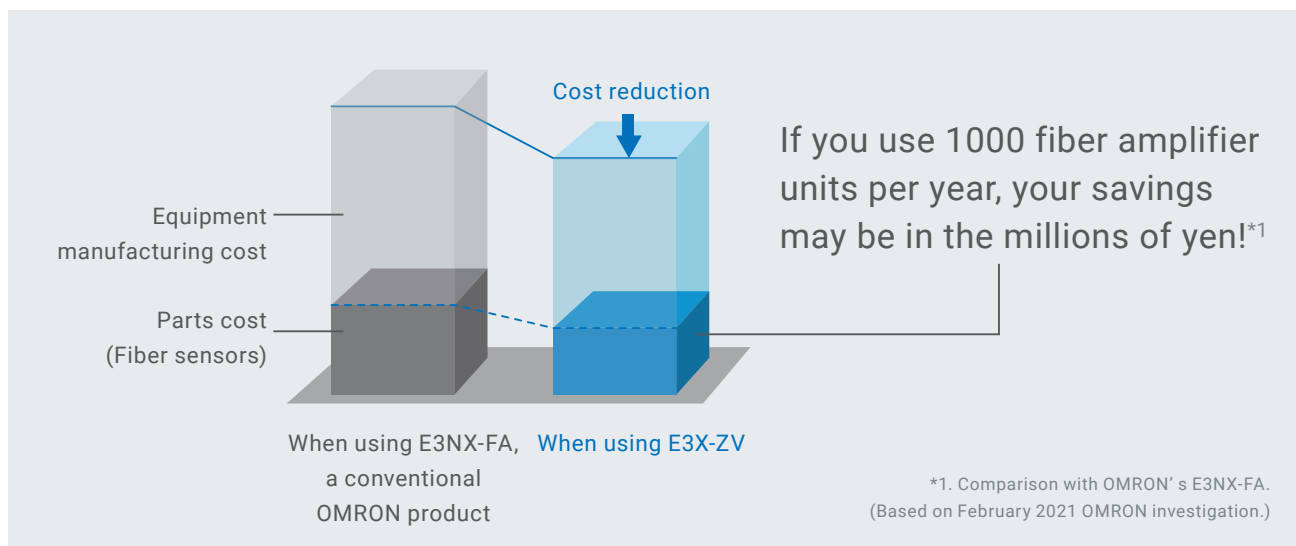

Reliable detection performance

Providing most relevant functions and keeping best performance to detect presence or absence, E3X-ZV can be used as-is in your equipment.

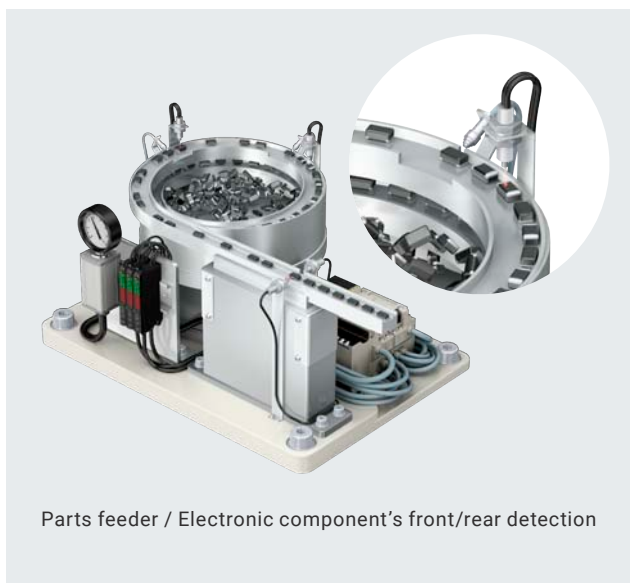

Minimum detectable object of 3 μm
timer function

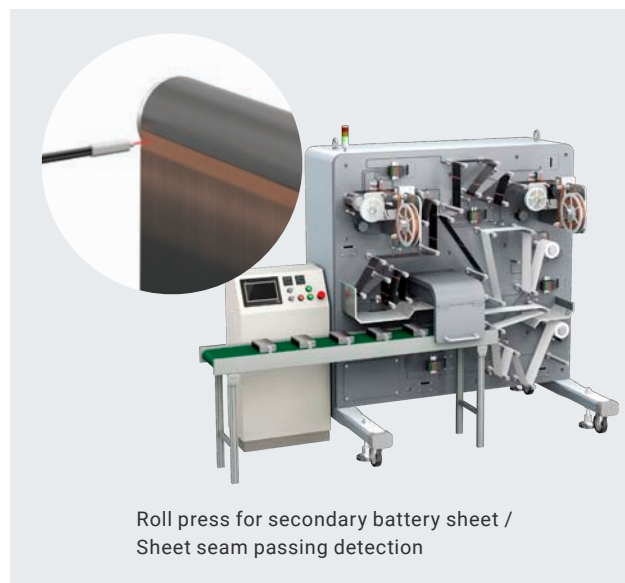

Response time of 50 μs *2
in super-high-speed mode
mutual interference prevention function

*2. For E3X-ZV

“Cost-effective price” achieved by carefully selecting the functions and performance required to detect presence or absence

Fiber sensors are used in large quantities in parts feeders, roll presses for secondary batteries, assembly machines for digital products, and so on to detect the presence or absence of workpieces. However, many customers are using fiber amplifier units with excessive functions and performance that may make them accordingly costly.

OMRON narrowed down functions and performance to those required to detect presence or absence, and optimized the materials used as well as the production process in addition to making full use of new technologies to achieve a cost-effective price. The more you use the more cost savings you gain, making E3X-ZV a fiber amplifier unit with the best cost performance.

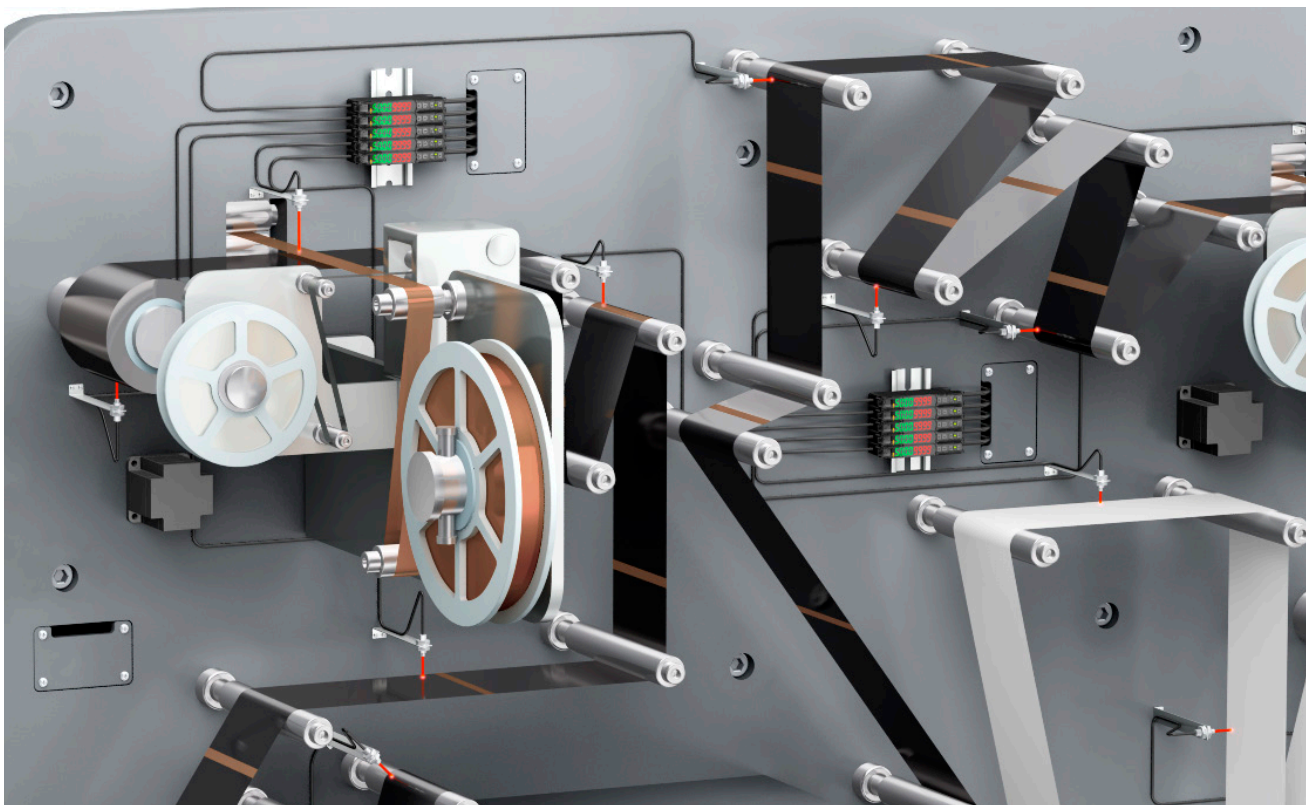

Three new technologies that enable “cost-effective price”

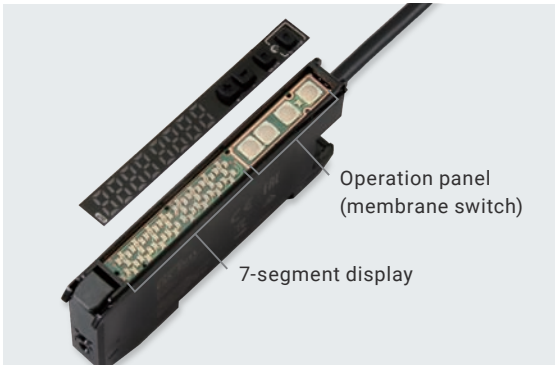

Integrated display and operation panel **Patent pending**^{*1}

Material cost is reduced by mounting the 7-segment display and operation panel on one substrate. Furthermore, “membrane switches” are used for operation buttons to achieve both cost reduction and improved click feeling.

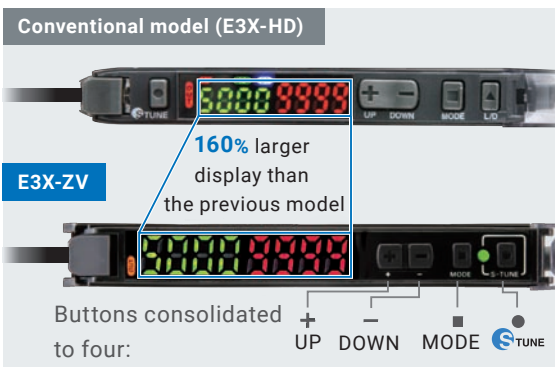

Revised user interface

The L/D (Light on / Dark on) button present on conventional models is eliminated, reflecting customer opinion that the button is rarely used and is a cause of malfunction by accidental pressing. This helped not only to reduce material cost, but also to enlarge the display and increase visibility.

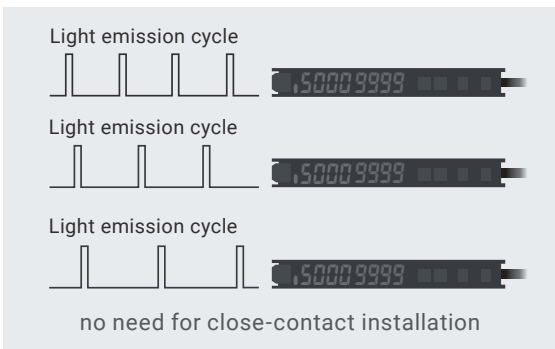

New mutual interference prevention function

Adopting the mutual interference prevention by light emission cycle change eliminated the optical communications function between amplifiers required in previous methods, and reduced the material cost.

Furthermore, this method allows the activation of the mutual interference prevention function without needing the fiber amplifier units to be installed in close contact with each other.

2-channel model option to attain the ultimate cost effectiveness

The 2-channel model equipped with amplifier functions for two fiber amplifier units enables substantial purchase cost reduction since the required number of units is halved. Furthermore, it greatly contributes to the downsizing of equipment and control panel in addition to allowing substantial reduction in wiring workload and power consumption.

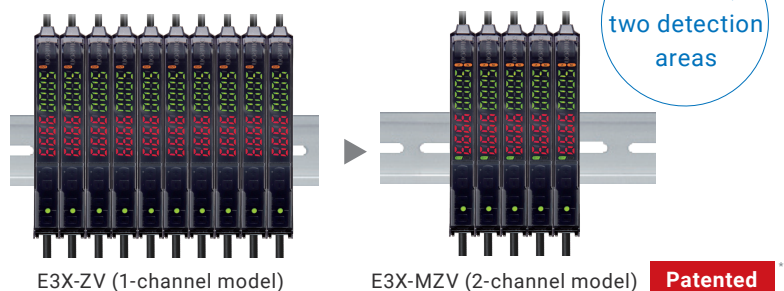

*1. “Patent pending or Patented” indication means patent is pending or is patented in Japan. (As of February 2021.)

Reliable detection performance

E3X-ZV is equipped with functions and performance for reliable use in a wide range of equipment.

Microscopic object's front/rear detection in parts feeders

3- μm minimum detectable object enables the stable detection of microscopic chips as well

With a detection performance equivalent to that of E3X-HD and a minimum detectable object of 3 μm , E3X-ZV has sufficient margin to detect small parts and the size of metallic parts of electronic components used to determine their front or rear.

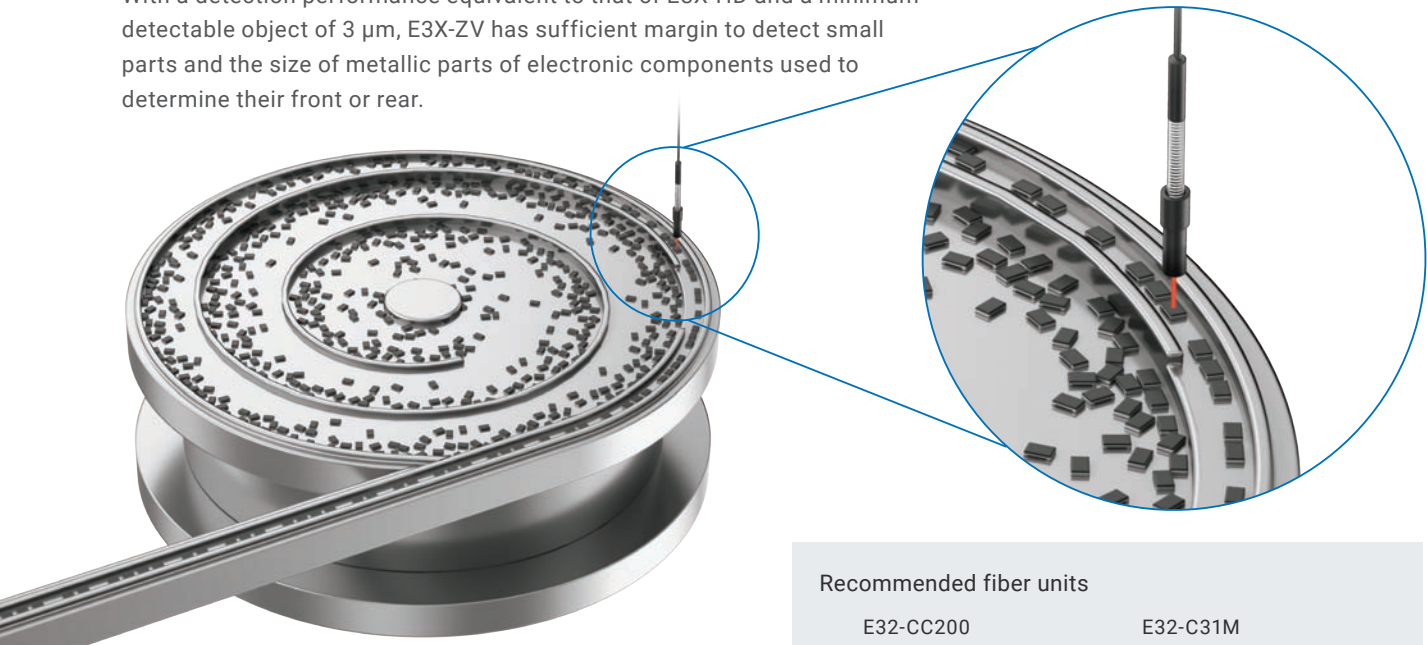

Recommended fiber units

E32-CC200

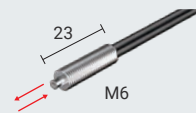

E32-C31M

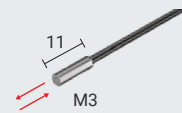

Resistant to differences in color and surface conditions

With high dynamic range (seven times that of E3X-HD), E3X-ZV stably detects from black to glossy objects. Light saturation is avoided, even when the background is a glossy surface, by sufficiently lowering the light intensity.

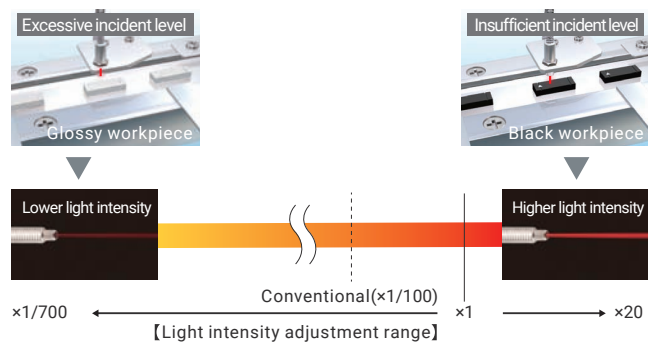

Stable output by timer function

E3X-ZV is equipped with ON/OFF-delay and one-shot timer to enable output control even in an environment without PLC.



Air blower output during chip's front/rear detection

Seam detection in roll presses for secondary battery sheets

50- μ s*¹ response time in high-speed mode enables the stable detection of workpieces moving at high speed

With a response time of 50 μ s, equivalent to that of E3X-HD, E3X-ZV captures seams on fast moving sheets without fail.

Given a 10-mm wide electrode, it can theoretically detect seams also on sheets moving at 200 m/s.

*1. For E3X-ZV

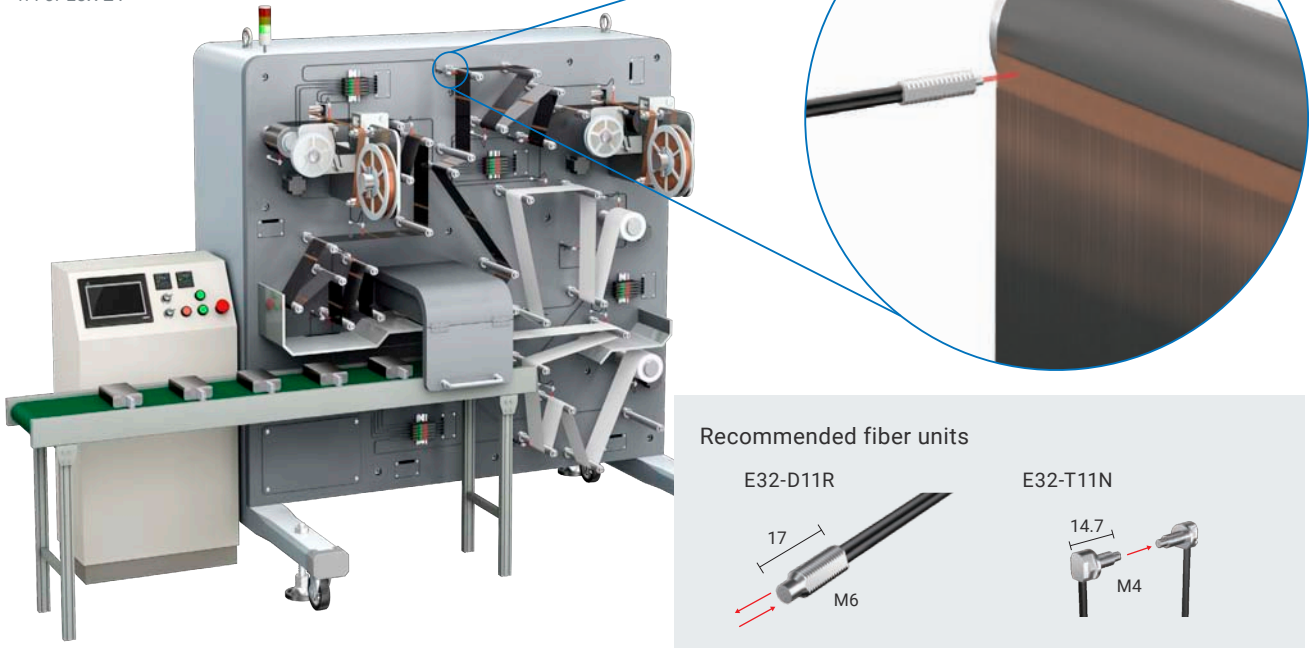

Mutual interference prevention function that does not need close-contact installation

The mutual interference prevention function based on different frequencies prevents mutual interference among up to four channels. Wiring the fiber units and cables is also easy since the fiber amplifier units need not be installed in close contact with each other.

Typical fiber amplifier unit (optical communications)

Cable routing takes time since there is no installation flexibility as they require close-contact installation.

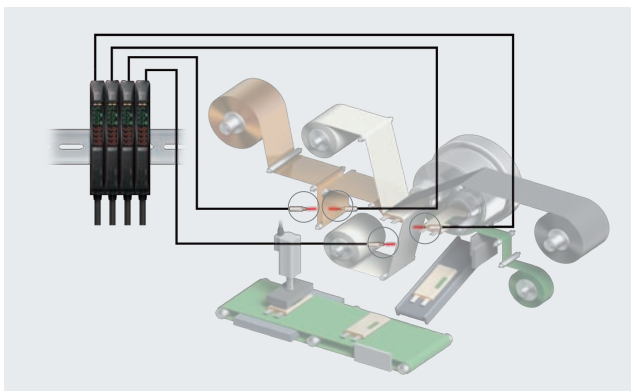

E3X-ZV/MZV (light emission cycle switching)

Complicated cable routing is unnecessary thanks to its installation flexibility as there is no need for close-contact installation.

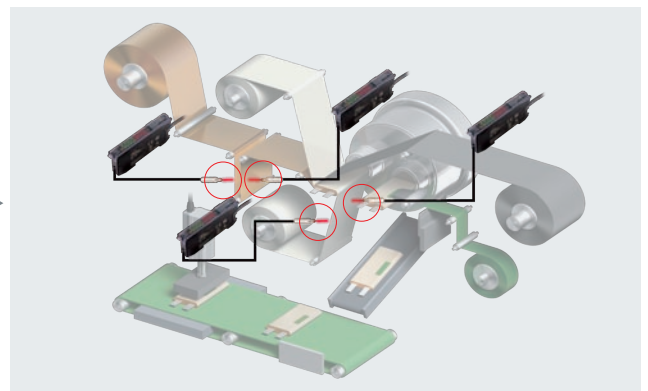

* Illustration is with E3X-ZV

Functions welcome when using in large quantities

Presence/absence detection in automatic assembly machines

Easy tuning to reduce tuning workload

Adjustment of light intensity and threshold level to their optimal value is possible by just pressing the button twice. The operation is common regardless of the workpiece or installation conditions, allowing for a unified setting method that eliminates variations owing to operators.

Simple, automatic tuning with smart tuning

Just press the **S-TUNE** button once each with and without a workpiece.

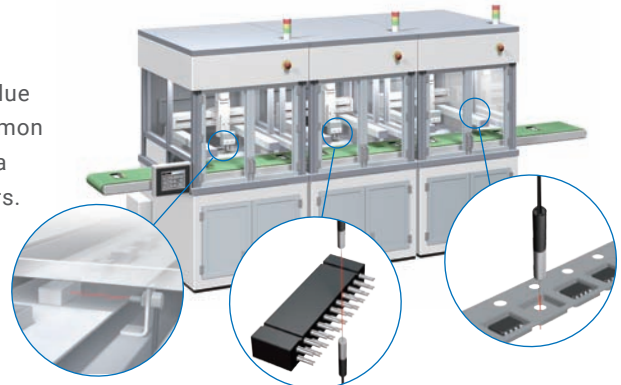

With workpiece

Without workpiece

Press twice to simultaneously adjust threshold level and light intensity

Threshold level
Set to intermediate value between incident levels with and without a workpiece

Incident level
Light intensity adjusted for optimal incident level

The green LED lights up when tuning is completed.

* Maximum incident level at tuning unified to "9999" (changeable to any value).

Fewer setting steps

| Typical fiber amplifier unit | E3X-ZV/MZV |
|--------------------------------------|---|
| 1 STEP Light intensity adjustment | <div style="border: 1px solid #0056b3; padding: 5px; display: inline-block;"> 1 STEP smart tuning Light intensity adjustment + Threshold level setting </div> |
| 2 STEP Threshold level setting | |
| Optimal settings | Optimal settings |

Optimal settings for saturated and low incident level

| Saturated incident level | | Low incident level | |
|--------------------------------|-----------------------|-----------------------|-----------------------|
| Example: Transparent sheet | | Example: Black rubber | |
| With workpiece | Without workpiece | With workpiece | Without workpiece |
| Smart tuning | | | |
| | | | |
| Optimal incident level setting | | | |

Wire-saving connector model to reduce wiring work NEW

Power supplied from the master connector simplifies wiring; just wire the output line when connecting the slave connector. Amplifier units can be replaced easily without the need for rewiring. The amplifier unit can be used as both master and slave, enabling standardization on a single model.

Only a disconnected connector needs to be replaced without replacement of the amplifier unit and reconfiguration after replacement. This reduces maintenance time and replacement costs.

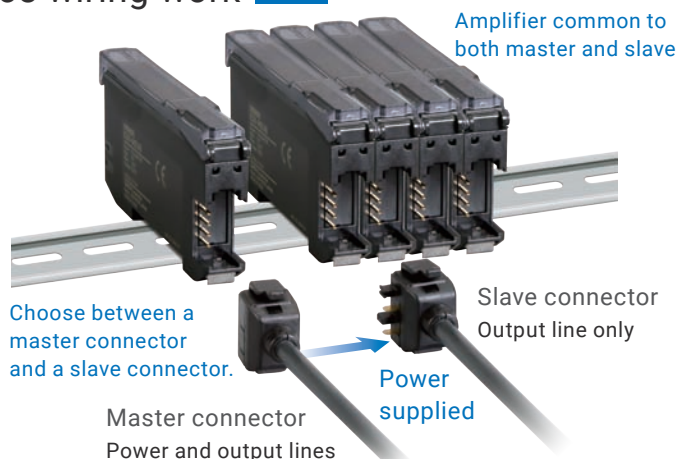

1/2 installation space with 2-channel model

The 2-channel model equipped with amplifier functions for two fiber amplifier units can halve the installation space. This helps miniaturize not only machines, but also power supplies because the power consumption will also be reduced by approximately half.

One unit, two detection areas

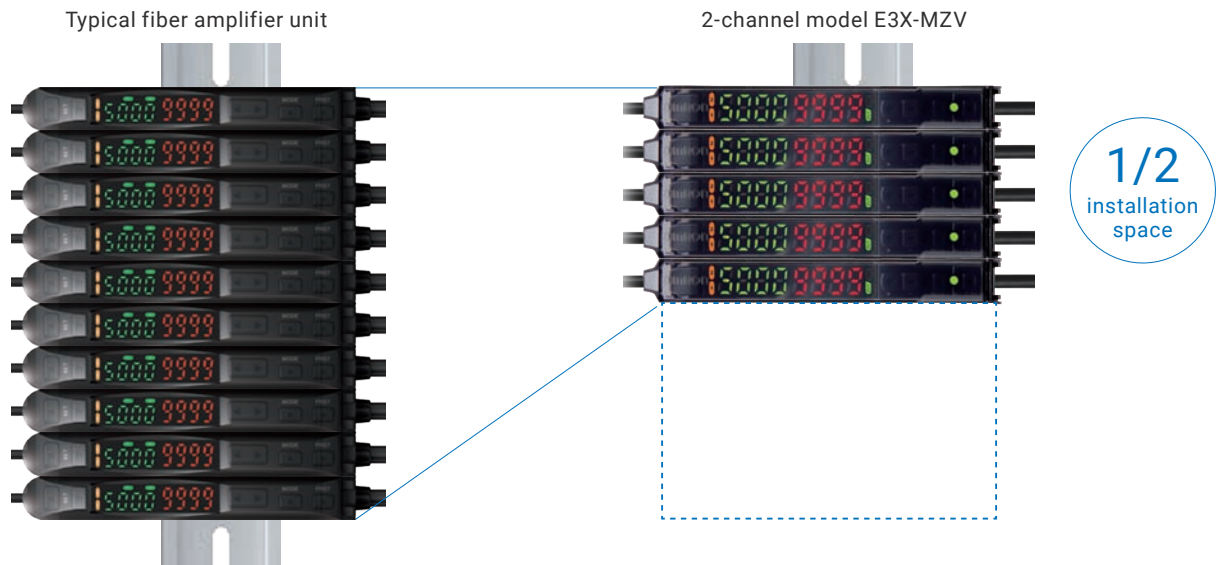

2-channel model for simplifying wiring

Wire-saving connector model for drastically reducing wiring

The use of the 2-channel model can reduce wiring by 33% *1.
The wire-saving connector model allows further reduction in wiring.

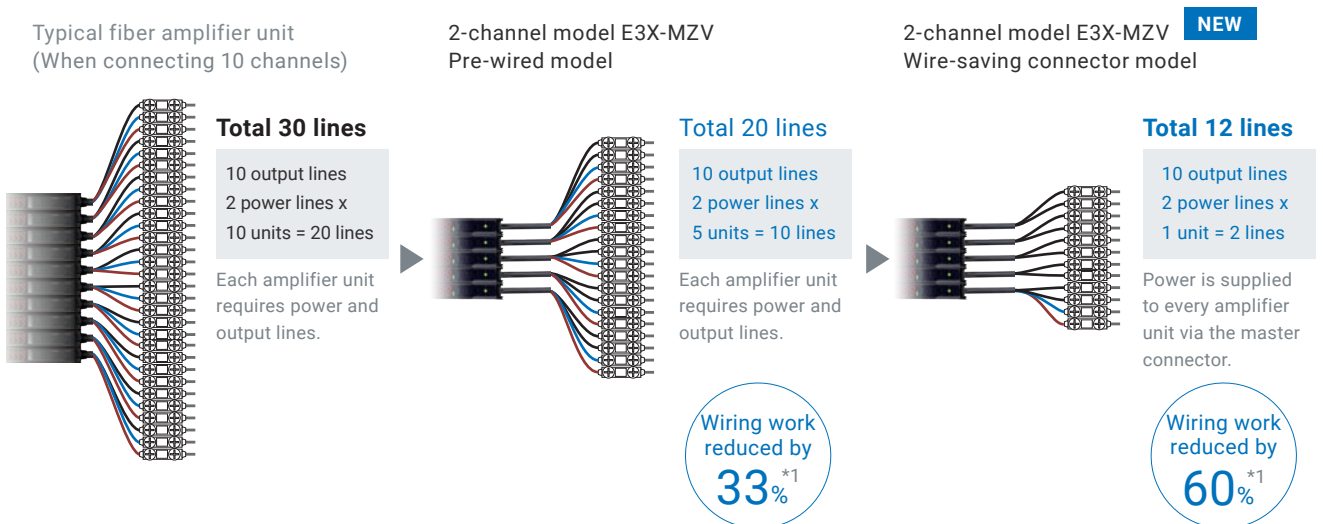

*1. Compared with a typical 1-channel fiber amplifier unit.

Three on-site work-saving functions that also contribute to labor saving

No need to re-tune even if the incident level decreases

DPC function (Dynamic Power Control)

Decrease in incident level due to LED deterioration or dirty fiber unit is detected to compensate and bring it to the level at the time of tuning to save you the trouble of re-tuning. It is particularly useful when working with through-beam or retro-reflective models.

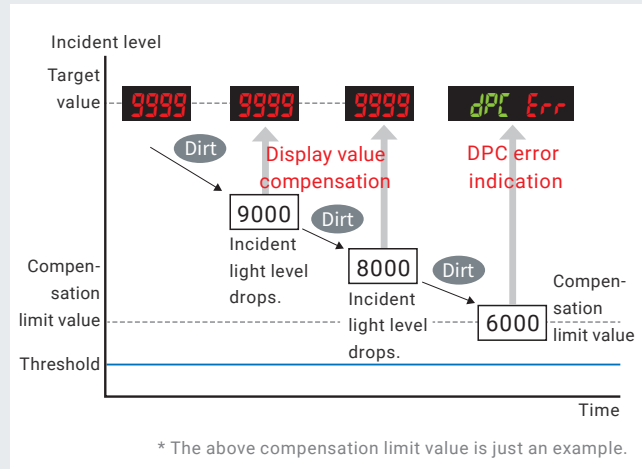

No need to make business trips to sites to explain operations

Operation buttons with symbols

Since buttons are indicated with +, -, □, and ○, operation can be easily transmitted over the phone, enabling remote support.



Hassle-free recovery also from erroneous operations

User save function

Saving the factory default settings or settings at the time of site start-up using the user save function saves all information including the tuning information. If during operation, a fiber amplifier unit needs to be restored to the saved settings as a result of an erroneous operation by a site operator, this can be done easily and on-site by instructing a user reset. Contents saved by the user save function are not cleared by the setting initialization.

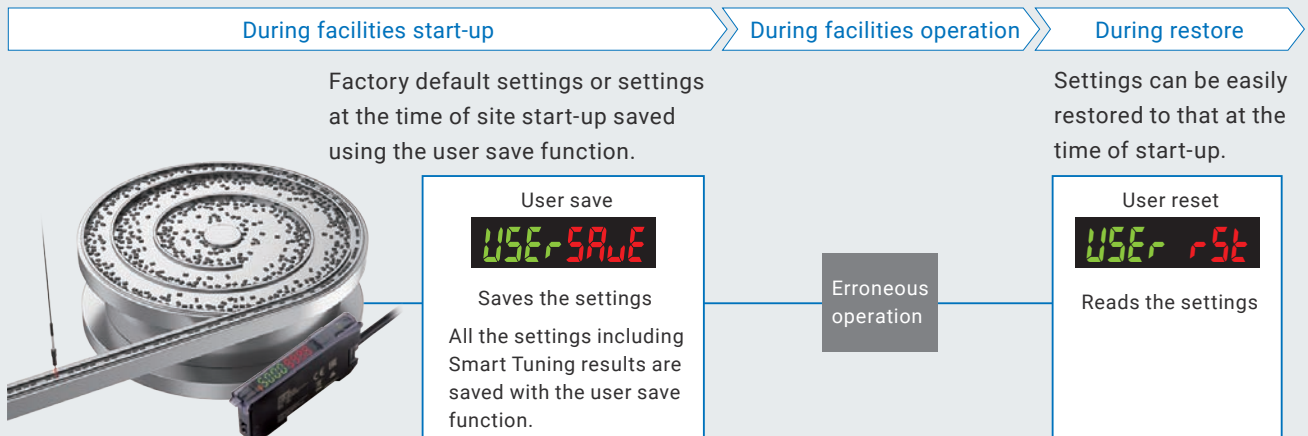

Smart Fiber Amplifier Units E3X-ZV / MZV

Solidly Stable Presence/Absence Detection at an Amazing Price



- Low price is achieved by carefully selected functions and performance to those required to detect presence or absence.
- Minimum detectable object 3 μm and Response time 50 μs in super-high-speed mode.
E3X-ZV is reliable detection performance can be used for such as parts feeders and roll press for secondary battery sheet.
- Equipped with Smart Tuning, which adjustment of light intensity and threshold level to their optimal value is possible by just pressing the button twice.
- Cost-saving, Space-saving, Wiring-saving 2-channel models also available.
- New external input models allowing remote tuning can be used for a wider range of applications including mounters that require frequent changeovers.
- External input models with standby mode contribute to reducing power consumption of equipment.



For the most recent information on models that have been certified for safety standards, refer to your OMRON website.

 Refer to *Safety Precautions* on page 21.

Ordering Information

Fiber Amplifier Units [Refer to Dimensions on pages 23 to 25]

1-channel model

| Type | Connecting method | Inputs/outputs | Model | |
|--------------------------------|-----------------------|--------------------|-------------|-------------|
| | | | NPN output | PNP output |
| Standard models | Pre-wired (2 m) | 1 output | E3X-ZV11 2M | E3X-ZV41 2M |
| | Wire-saving Connector | | E3X-ZV6 | E3X-ZV8 |
| External input models | Pre-wired (2 m) | 1 output + 1 input | E3X-ZV21 2M | E3X-ZV51 2M |
| | Wire-saving Connector | | E3X-ZV7 | E3X-ZV9 |
| Enhanced timer function models | Wire-saving Connector | 1 output | E3X-ZV6M | E3X-ZV8M |

2-channel model





| Type | Connecting method | Inputs/outputs | Model | |
|-----------------------|-----------------------|----------------------|--------------|--------------|
| | | | NPN output | PNP output |
| Standard models | Pre-wired (2 m) | 2 outputs | E3X-MZV11 2M | E3X-MZV41 2M |
| | Wire-saving Connector | | E3X-MZV6 | E3X-MZV8 |
| External input models | Pre-wired (2 m) | 2 outputs + 2 inputs | E3X-MZV21 2M | E3X-MZV51 2M |

Accessories (Sold Separately)

Wire-saving Connectors (Required for models for Wire-saving Connectors.) [Refer to *Dimensions* on page 26]

Connectors are not provided with the Fiber Amplifier Unit and must be ordered separately.

Note: Protective stickers are provided.

| Type | Appearance | Cable length | No. of conductors | Model | Applicable Fiber Amplifier Units |
|------------------|---|--------------|-------------------|----------|--|
| Master Connector |  | 2 m | 3 | E3X-CN11 | E3X-ZV6 E3X-ZV8 E3X-ZV6M E3X-ZV8M |
| Slave Connector |  | | 1 | E3X-CN12 | |
| Master Connector |  | | 4 | E3X-CN21 | E3X-ZV7 E3X-ZV9 E3X-MZV6 E3X-MZV8 |
| Slave Connector |  | | 2 | E3X-CN22 | |

DIN Track [Refer to *Dimensions* on page 26]

A DIN Track is not provided with the Fiber Amplifier Unit. It must be ordered separately as required.

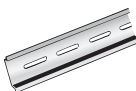
| Type | Appearance | Model | Quantity |
|-----------------------------------|---|----------|----------|
| Shallow type, total length: 1 m |  | PFP-100N | 1 |
| Shallow type, total length: 0.5 m | | PFP-50N | |

Note: For details, refer to DIN Track on PFP-□ which can be accessed from your OMRON website.

Mounting Bracket [Refer to *Dimensions* on page 26]

A Mounting Bracket is not provided with the Fiber Amplifier Unit. It must be ordered separately as required.

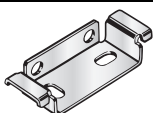
| Appearance | Model | Quantity |
|---|----------|----------|
|  | E39-L143 | 1 |

End Plate [Refer to *Dimensions* on page 26]

Two End Plates are provided with the Sensor Communications Unit. End Plates are not provided with the Fiber Amplifier Unit. They must be ordered separately as required.

| Appearance | Model | Quantity |
|---|-------|----------|
|  | PFP-M | 1 |

Note: 1. The minimum ordering quantity is 10.

2. For details, refer to End Plate on PFP-M which can be accessed from your OMRON website.

Ratings and Specifications

1-channel model

| Item | Type | Standard models/Enhanced timer function models | | External input models | |
|---|--|---|---------------------------|--|--------------------------|
| | NPN output | E3X-ZV11 | E3X-ZV6/ZV6M | E3X-ZV21 | E3X-ZV7 |
| | PNP output | E3X-ZV41 | E3X-ZV8/ZV8M | E3X-ZV51 | E3X-ZV9 |
| Connecting method | Pre-wired | Wire-saving Connector *1 | | Pre-wired | Wire-saving Connector *1 |
| Inputs/outputs | 1 output | | | 1 output + 1 input *2 | |
| Light source (wavelength) | Red, 4-element LED (625 nm) | | | | |
| Power supply voltage | 12 to 24 VDC \pm 10%, ripple (p-p) 10% max. | | | | |
| Power consumption | Normal mode: 720 mW max. (Power supply voltage 24 V: Current consumption 30 mA max. / Power supply voltage 12 V: Current consumption 60 mA max.) Eco function ON: 530 mW max. (Power supply voltage 24 V: Current consumption 22 mA max. / Power supply voltage 12 V: Current consumption 44 mA max.) Eco function Standby: 390 mW max. (Power supply voltage 24 V: Current consumption 16 mA max. / Power supply voltage 12 V: Current consumption 32 mA max.) | | | Normal mode: 720 mW max. (Power supply voltage 24 V: Current consumption 30 mA max. / Power supply voltage 12 V: Current consumption 60 mA max.) Eco function ON: 530 mW max. (Power supply voltage 24 V: Current consumption 22 mA max. / Power supply voltage 12 V: Current consumption 44 mA max.) Eco function Standby: 390 mW max. (Power supply voltage 24 V: Current consumption 16 mA max. / Power supply voltage 12 V: Current consumption 32 mA max.) | |
| Control output | Load power supply voltage: 26.4 VDC, open collector output type (NPN or PNP output differs depending on the type.) Load current: 100 mA max. (Residual voltage: Load current less than 10 mA: 1 V max., load current 10 to 100 mA: 2 V max.) OFF current: 0.1 mA max. | | | | |
| Indicators | 7-segment displays (Threshold Level display: green, Incident Light Level display: red) Display direction: Switchable between normal and reversed. Smart Tuning Indicator (green) OUT indicator (orange) | | | | |
| Protection circuits | Power supply reverse polarity protection, output short-circuit protection and output reverse polarity protection | | | | |
| Response time | Super-high-speed mode (SHS) | Operate or reset: 50 μ s | | | |
| | High-speed mode (HS) | Operate or reset: 250 μ s *3 | | | |
| | Standard mode (Std) | Operate or reset: 1 ms *4 | | | |
| | Giga-power mode (GIGA) | Operate or reset: 16 ms | | | |
| Sensitivity adjustment | Smart Tuning (2-point tuning, power tuning, percentage tuning (-99% to 99%), maximum sensitivity tuning, full auto tuning, position tuning) or manual adjustment | | | | |
| Mutual interference prevention function | Emission cycle setting switching type (up to 4 units) | | | | |
| Functions | DPC (Dynamic Power Control) | Yes | | | |
| | ATC (Active Threshold Control) | Yes | | | |
| | Timer | Select from timer disabled, OFF-delay, ON-delay, one-shot or On/Off-delay Timer *5 E3X-ZV11/41/6/8/21/7/9: 1 to 9,999 ms E3X-ZV6M/8M: 0.1 to 9,999 ms | | | |
| | Zero reset | Negative values can be displayed. (Threshold value is shifted.) | | | |
| | Resetting settings | Select from initial reset (factory defaults) or user reset (saved settings). | | | |
| | Eco mode | Select from OFF (digital display lit) and Eco ON (digital display not lit). | | Select from OFF (digital display lit), Eco ON (digital display not lit) and Standby (digital display not lit, emission stop). | |
| | Power tuning | Select from ON or OFF. | | | |
| Ambient illumination (Receiver side) | Incandescent lamp: 20,000 lx max., Sunlight: 30,000 lx max. | | | | |
| Ambient temperature range | Operating: -25°C to 55°C Storage: -30°C to 70°C (with no icing or condensation) | | | | |
| Ambient humidity range | Operating and storage: 35 to 85% (with no condensation) within the surrounding air temperature range shown above | | | | |
| Insulation resistance | 20 M Ω min. (at 500 VDC) | | | | |
| Dielectric strength | 1,000 VAC at 50/60 Hz for 1 min | | | | |
| Vibration resistance (destruction) | 10 to 55 Hz with a 1.5-mm double amplitude for 2 hours each in X, Y, and Z directions | | | | |
| Shock resistance (destruction) | 500 m/s ² for 3 times each in X, Y, and Z directions | | | | |
| Weight (packed state/Sensor only) | Approx. 95 g/approx. 65 g | Approx. 45 g/approx. 20 g | Approx. 95 g/approx. 65 g | Approx. 45 g/approx. 20 g | |
| Materials | Case | Polycarbonate (PC). | | | |
| | Cover | Polycarbonate (PC) | | | |
| | Cable | PVC | | | |
| Accessories | Instruction manual, Compliance sheet | | | | |

*1. One of the E3X-CN11 (bus-connector with 3 wires), E3X-CN12 (sub-connector with 1 wires)

*2. The following details apply to the input.

| | Contact input (relay or switch) | Non-contact input (transistor) | Input time |
|-----|---|--|-------------------------------------|
| NPN | ON: Shorted to 0 V (Sourcing current: 1 mA max.). OFF: Open or shorted to Vcc. | ON: 1.5 V max. (Sourcing current: 1 mA max.) OFF: Vcc - 1.5 V to Vcc (Leakage current: 0.1 mA max.) | ON: 100 ms min. OFF: 100 ms min. |
| PNP | ON: Shorted to Vcc (Sinking current: 3 mA max.). OFF: Open or shorted to 0 V. | ON: Vcc - 1.5 V to Vcc (Sinking current: 3 mA max.) OFF: 1.5 V max. (Leakage current: 0.1 mA max.) | |

*3. Mutual interference prevention function in the Response Time Priority Mode: 2 units: 350 μ s; 3 units: 400 μ s / In the Unit Number Priority Mode: 4 units: 700 μ s

*4. Mutual interference prevention function in the Unit Number Priority Mode: 4 units: 1.6 ms

*5. Only E3X-ZV6M/ZV8M can be selected.

2-channel model

| Item | Type | Standard models | | External input models |
|---|---|--|---|-----------------------|
| | NPN output | E3X-MZV11 | E3X-MZV6 | E3X-MZV21 |
| | PNP output | E3X-MZV41 | E3X-MZV8 | E3X-MZV51 |
| Connecting method | Pre-wired | Wire-saving Connector *1 | Pre-wired | |
| Inputs/outputs | 2 output | | 2 outputs + 2 inputs *2 | |
| Light source (wavelength) | Red, 4-element LED (625 nm) | | | |
| Power supply voltage | 12 to 24 VDC ±10%, ripple (p-p) 10% max. | | | |
| Power consumption | Normal mode: 820 mW max. (Power supply voltage 24 V: Current consumption 35 mA max. / Power supply voltage 12 V: Current consumption 69 mA max.) Eco function ON: 600 mW max. (Power supply voltage 24 V: Current consumption 25 mA max. / Power supply voltage 12 V: Current consumption 50 mA max.) Eco function Standby: 480 mW max. (Power supply voltage 24 V: Current consumption 20 mA max. / Power supply voltage 12 V: Current consumption 40 mA max.) | | Normal mode: 820 mW max. (Power supply voltage 24 V: Current consumption 35 mA max. / Power supply voltage 12 V: Current consumption 69 mA max.) Eco function ON: 600 mW max. (Power supply voltage 24 V: Current consumption 25 mA max. / Power supply voltage 12 V: Current consumption 50 mA max.) Eco function Standby: 480 mW max. (Power supply voltage 24 V: Current consumption 20 mA max. / Power supply voltage 12 V: Current consumption 40 mA max.) | |
| Control output | Load power supply voltage: 26.4 VDC, open collector output type (NPN or PNP output differs depending on the type.) Load current: 100 mA max. (Residual voltage: Load current less than 10 mA: 1 V max., load current 10 to 100 mA: 2 V max.) OFF current: 0.1 mA max. | | | |
| Indicators | 7-segment displays (Threshold Level display: green, Incident Light Level display: red) Display direction: Switchable between normal and reversed. Smart Tuning Indicator (green) OUT1/2 indicator (orange), CH Indicator (green) | | | |
| Protection circuits | Power supply reverse polarity protection, output short-circuit protection and output reverse polarity protection | | | |
| Response time | Super-highspeed mode (SHS) | Operate or reset: 100 μs | | |
| | High-speed mode (HS) | Operate or reset: 250 μs *3 | | |
| | Standard mode (Std) | Operate or reset: 1 ms *4 | | |
| | Giga-power mode (GIGA) | Operate or reset: 16 ms | | |
| Sensitivity adjustment | Smart Tuning (2-point tuning, power tuning, percentage tuning (-99% to 99%), maximum sensitivity tuning, full auto tuning, position tuning) or manual adjustment | | | |
| Mutual interference prevention function | Emission cycle setting switching type (up to 2 units) Or, up to 2 units for E3X-ZV (the Unit Number Priority Mode), and 1 unit for E3X-MZV. | | | |
| Functions | DPC (Dynamic Power Control) | Yes | | |
| | ATC (Active Threshold Control) | Yes | | |
| | Timer | Select from timer disabled, OFF-delay, ON-delay or one-shot timer: 1 to 9,999 ms | | |
| | Zero reset | Negative values can be displayed. (Threshold value is shifted.) | | |
| | Resetting settings | Select from initial reset (factory defaults) or user reset (saved settings). | | |
| | Eco mode | Select from OFF (digital display lit) and Eco ON (digital display not lit). | Select from OFF (digital display lit), Eco ON (digital display not lit) and Standby (digital display not lit, emission stop). | |
| | Power tuning | Select from ON or OFF. | | |
| Ambient illumination (Receiver side) | Incandescent lamp: 20,000 lx max., Sunlight: 30,000 lx max. | | | |
| Ambient temperature range | Operating: -25°C to 55°C Storage: -30°C to 70°C (with no icing or condensation) | | | |
| Ambient humidity range | Operating and storage: 35 to 85% (with no condensation) within the surrounding air temperature range shown above | | | |
| Insulation resistance | 20 MΩ min. (at 500 VDC) | | | |
| Dielectric strength | 1,000 VAC at 50/60 Hz for 1 min | | | |
| Vibration resistance (destruction) | 10 to 55 Hz with a 1.5-mm double amplitude for 2 hours each in X, Y, and Z directions | | | |
| Shock resistance (destruction) | 500 m/s ² for 3 times each in X, Y, and Z directions | | | |
| Weight (packed state/Sensor only) | Approx. 100 g/approx. 75 g | Approx. 45 g/approx. 20 g | Approx. 100 g/approx. 75 g | |
| Materials | Case | Polycarbonate (PC). | | |
| | Cover | Polycarbonate (PC) | | |
| | Cable | PVC | | |
| Accessories | Instruction manual, Compliance sheet | | | |

*1. One of the E3X-CN21 (bus-connector with 4 wires), E3X-CN22 (sub-connector with 2 wires)

*2. The following details apply to the input.

| | Contact input (relay or switch) | Non-contact input (transistor) | Input time |
|-----|---|--|-------------------------------------|
| NPN | ON: Shorted to 0 V (Sourcing current: 1 mA max.). OFF: Open or shorted to Vcc. | ON: 1.5 V max. (Sourcing current: 1 mA max.) OFF: Vcc - 1.5 V to Vcc (Leakage current: 0.1 mA max.) | ON: 100 ms min. OFF: 100 ms min. |
| PNP | ON: Shorted to Vcc (Sinking current: 3 mA max.). OFF: Open or shorted to 0 V. | ON: Vcc - 1.5 V to Vcc (Sinking current: 3 mA max.) OFF: 1.5 V max. (Leakage current: 0.1 mA max.) | |

*3. When using Mutual interference prevention function: 700 μs

*4. When using Mutual interference prevention function: 1.6 ms

Sensing Distances

Threaded Models

| Sensing method | Sensing direction | Size | Model | Sensing distance (mm) | | | |
|----------------|-------------------|-------------|--------------|-----------------------|---------------|-----------------|-----------------------|
| | | | | Giga mode | Standard mode | High-speed mode | Super-high-speed mode |
| Through-beam | Right-angle | M4 | E32-T11N 2M | 2,000 | 1,000 | 700 | 280 |
| | | | E32-LT11N 2M | 4,000 * | 3,500 | 2,300 | 920 |
| | Straight | | E32-T11R 2M | 2,000 | 1,000 | 700 | 280 |
| | | | E32-LT11 2M | 4,000 * | 4,000 * | 2,700 | 1,080 |
| | | | E32-LT11R 2M | 4,000 * | 3,500 | 2,300 | 920 |
| Reflective | Right-angle | M3 | E32-C31N 2M | 110 | 50 | 46 | 14 |
| | | | E32-C21N 2M | 290 | 130 | 90 | 39 |
| | | M4 | E32-D21N 2M | 840 | 350 | 240 | 100 |
| | | | E32-C11N 2M | 780 | 350 | 320 | 100 |
| | | M6 | E32-LD11N 2M | 840 | 350 | 240 | 100 |
| | | | E32-D21R 2M | 140 | 60 | 40 | 16 |
| | Straight | M3 | E32-C31 2M | 330 | 150 | 100 | 44 |
| | | | E32-C31M 1M | | | | |
| | | | M4 | E32-D211R 2M | 140 | 60 | 40 |
| | | E32-D11R 2M | | 840 | 350 | 240 | 100 |
| | | M6 | E32-CC200 2M | 1,400 | 600 | 400 | 180 |
| | | | E32-LD11 2M | 860 | 360 | 250 | 110 |
| | | | E32-LD11R 2M | 840 | 350 | 240 | 100 |

* The fiber length is 2 m on each side, so the sensing distance is given as 4,000 mm.

Cylindrical Models

| Sensing method | Size | Sensing direction | Model | Sensing distance (mm) | | | |
|----------------|---------------------|-------------------|--------------|-----------------------|---------------|-----------------|-----------------------|
| | | | | Giga mode | Standard mode | High-speed mode | Super-high-speed mode |
| Through-beam | 1 dia. | Top-view | E32-T223R 2M | 450 | 250 | 150 | 60 |
| | 1.5 dia. | | E32-T22B 2M | 680 | 400 | 220 | 90 |
| | 3 dia. | | E32-T12R 2M | 2,000 | 1,000 | 700 | 280 |
| Reflective | 1.5 dia. | Side-view | E32-T14LR 2M | 750 | 450 | 260 | 100 |
| | | | E32-D22B 2M | 140 | 60 | 40 | 16 |
| | 1.5 dia. + 0.5 dia. | Top-view | E32-D43M 1M | 28 | 12 | 8 | 4 |
| | | | E32-D22R 2M | 140 | 60 | 40 | 16 |
| | E32-D221B 2M | | 300 | 140 | 90 | 40 | |
| | 3 dia. | | E32-D32L 2M | 700 | 300 | 200 | 90 |
| | | | E32-D33 2M | 70 | 30 | 20 | 8 |
| | 3 dia. + 0.8 dia. | | | | | | |

Flat Models

| Sensing method | Sensing direction | Model | Sensing distance (mm) | | | |
|----------------|-------------------|--------------|-----------------------|---------------|-----------------|-----------------------|
| | | | Giga mode | Standard mode | High-speed mode | Super-high-speed mode |
| Through-beam | Top-view | E32-T15XR 2M | 2,000 | 1,000 | 700 | 280 |
| | Side-view | E32-T15YR 2M | 750 | 450 | 260 | 100 |
| | Flat-view | E32-T15ZR 2M | | | | |
| Reflective | Top-view | E32-D15XR 2M | 840 | 350 | 240 | 100 |
| | Side-view | E32-D15YR 2M | 200 | 100 | 52 | 24 |
| | Flat-view | E32-D15ZR 2M | | | | |

Sleeve Models

| Sensing method | Sensing direction | Model | Sensing distance (mm) | | | |
|----------------|-------------------|-----------------|-----------------------|---------------|-----------------|-----------------------|
| | | | Giga mode | Standard mode | High-speed mode | Super-high-speed mode |
| Through-beam | Side-view | E32-T24R 2M | 170 | 100 | 50 | 20 |
| | | E32-T24E 2M | 450 | 250 | 150 | 60 |
| | Top-view | E32-T33 1M | 150 | 90 | 50 | 20 |
| | | E32-T21-S1 2M | 510 | 300 | 170 | 68 |
| | | E32-TC200BR 2M | 2,000 | 1,000 | 700 | 280 |
| Reflective | Side-view | E32-D24R 2M | 70 | 30 | 20 | 8 |
| | | E32-D24-S2 2M | 120 | 53 | 45 | 14 |
| | Top-view | E32-D43M 1M | 28 | 12 | 8 | 4 |
| | | E32-D331 2M | 14 | 6 | 4 | 2 |
| | | E32-D33 2M | 70 | 30 | 20 | 8 |
| | | E32-D32-S1 0.5M | 63 | 27 | 18 | 7 |
| | | E32-D31-S1 0.5M | | | | |
| | | E32-DC200F4R 2M | 140 | 60 | 40 | 16 |
| | | E32-D22-S1 2M | 250 | 110 | 72 | 30 |
| | | E32-D21-S3 2M | | | | |
| | | E32-DC200BR 2M | 840 | 350 | 240 | 100 |
| | | E32-D25-S3 2M | 250 | 110 | 72 | 30 |

Small-spot, Reflective Models

| Type | Spot diameter | Center distance (mm) | Model | Sensing distance (mm) | | | |
|-----------------|---------------------|----------------------|---------------------------------|--|---------------|-----------------|-----------------------|
| | | | | Giga mode | Standard mode | High-speed mode | Super-high-speed mode |
| Variable spot | 0.1 to 0.6 dia. | 6 to 15 | E32-C42 1M+E39-F3A | Spot diameter of 0.1 to 0.6 mm at 6 to 15 mm. | | | |
| | 0.3 to 1.6 dia. | 10 to 30 | E32-C42 1M+E39-F17 | Spot diameter of 0.3 to 1.6 mm at 10 to 30 mm. | | | |
| Parallel light | 4 dia. | 0 to 20 | E32-C31 2M+E39-F3C | Spot diameter of 4 mm max. at 0 to 20 mm. | | | |
| | | | E32-C31N 2M+E39-F3C | | | | |
| Integrated lens | 0.1 dia. | 5 | E32-C42S 1M | Spot diameter of 0.1 mm at 5 mm. | | | |
| | 6 dia. | 50 | E32-L15 2M | Spot diameter of 6 mm at 50 mm. | | | |
| Small-spot | 0.1 dia. | 7 | E32-C41 1M+E39-F3A-5 | Spot diameter of 0.1 mm at 7 mm. | | | |
| | | | E32-C31 2M+E39-F3A-5 | Spot diameter of 0.5 mm at 7 mm. | | | |
| | 0.5 dia. | 17 | E32-C31N 2M+E39-F3A-5 | | | | |
| | 0.2 dia. | | E32-C41 1M+E39-F3B | Spot diameter of 0.2 mm at 17 mm. | | | |
| | | 0.5 dia. | E32-C31 2M+E39-F3B | Spot diameter of 0.5 mm at 17 mm. | | | |
| | E32-C31N 2M+E39-F3B | | | | | | |
| 3 dia. | 50 | E32-CC200 2M+E39-F18 | Spot diameter of 3 mm at 50 mm. | | | | |
| | | E32-C11N 2M+E39-F18 | | | | | |

High-power Beam Models

| Type | Sensing direction | Aperture angle | Model | Sensing distance (mm) | | | |
|--|-------------------|----------------------|----------------------|-----------------------|---------------|-----------------|-----------------------|
| | | | | Giga mode | Standard mode | High-speed mode | Super-high-speed mode |
| Through-beam models with integrated lens | Right-angle | 15° | E32-LT11N 2M | 4,000 *2 | 3,500 | 2,300 | 920 |
| | | 10° | E32-T17L 10M | 20,000 *1 | 20,000 *1 | 20,000 *1 | 8,000 |
| | Top-view | 15° | E32-LT11 2M | 4,000 *2 | 4,000 *2 | 2,700 | 1,080 |
| | | | E32-LT11R 2M | 4,000 *2 | 3,500 | 2,300 | 920 |
| Side-view | 30° | E32-T14 2M | 4,000 *2 | 4,000 *2 | 4,000 *2 | 1,800 | |
| Through-beam models with lenses | Right-angle | 12° | E32-T11N 2M+E39-F1 | 4,000 *2 | 4,000 *2 | 4,000 *2 | 2,000 |
| | | 6° | E32-T11N 2M+E39-F16 | 4,000 *2 | 4,000 *2 | 4,000 *2 | 3,600 |
| | Top-view | 12° | E32-T11R 2M+E39-F1 | 4,000 *2 | 4,000 *2 | 4,000 *2 | 2,000 |
| | | | 6° | E32-T11R 2M+E39-F16 | 4,000 *2 | 4,000 *2 | 4,000 *2 |
| | Side-view | 60° | E32-T11R 2M+E39-F2 | 1,450 | 800 | 500 | 200 |
| | Top-view | 12° | E32-T11 2M+E39-F1 | 4,000 *2 | 4,000 *2 | 4,000 *2 | 1,860 |
| | | | 6° | E32-T11 2M+E39-F16 | 4,000 *2 | 4,000 *2 | 4,000 *2 |
| | Side-view | 60° | E32-T11 2M+E39-F2 | 2,300 | 1,320 | 860 | 320 |
| | Top-view | 12° | E32-T51R 2M+E39-F1 | 4,000 *2 | 4,000 *2 | 3,900 | 1,500 |
| | | | 6° | E32-T51R 2M+E39-F16 | 4,000 *2 | 4,000 *2 | 4,000 *2 |
| | Side-view | 60° | E32-T51R 2M+E39-F2 | 1,400 | 720 | 500 | 200 |
| | Top-view | 12° | E32-T81R-S 2M+E39-F1 | 4,000 *2 | 4,000 *2 | 2,700 | 1,000 |
| | | | 6° | E32-T81R-S 2M+E39-F16 | 4,000 *2 | 4,000 *2 | 4,000 *2 |
| | Side-view | 60° | E32-T81R-S 2M+E39-F2 | 1,000 | 550 | 360 | 140 |
| | Top-view | 12° | E32-T61-S 2M+E39-F1 | 4,000 *2 | 4,000 *2 | 4,000 *2 | 1,800 |
| | | | 6° | E32-T61-S 2M+E39-F16 | 4,000 *2 | 4,000 *2 | 4,000 *2 |
| Side-view | 60° | E32-T61-S 2M+E39-F2 | 1,680 | 900 | 600 | 240 | |
| Top-view | 12° | E32-T51 2M+E39-F1-33 | 4,000 *2 | 4,000 *2 | 2,300 | 1,400 | |
| | | 6° | E32-T51 2M+E39-F16 | 4,000 *2 | 4,000 *2 | 4,000 *2 | 4,000 *2 |
| Reflective models with integrated lens | Top-view | 4° | E32-D16 2M | 40 to 2,800 | 40 to 1,400 | 40 to 900 | 40 to 480 |

*1. The fiber length is 10 m on each side, so the sensing distance is given as 20,000 mm.

*2. The fiber length is 2 m on each side, so the sensing distance is given as 4,000 mm.

Narrow View Models

| Sensing method | Sensing direction | Aperture angle | Model | Sensing distance (mm) | | | |
|----------------|-------------------|----------------|--------------|-----------------------|---------------|-----------------|-----------------------|
| | | | | Giga mode | Standard mode | High-speed mode | Super-high-speed mode |
| Through-beam | Side-view | 1.5° | E32-A03 2M | 3,220 | 1,780 | 1,200 | 500 |
| | | | E32-A03-1 2M | | | | |
| | | 3.4° | E32-A04 2M | 1,280 | 680 | 450 | 200 |
| | | 4° | E32-T24SR 2M | 4,000 * | 2,200 | 1,460 | 580 |
| | | | E32-T24S 2M | 4,000 * | 2,600 | 1,740 | 700 |
| | | | E32-T22S 2M | 4,000 * | 3,800 | 2,500 | 1,000 |

* The fiber length is 2 m on each side, so the sensing distance is given as 4,000 mm.

Models for Detection without Background Interference

| Sensing method | Sensing direction | Model | Sensing distance (mm) | | | |
|--------------------|-------------------|--------------|-----------------------|---------------|-----------------|-----------------------|
| | | | Giga mode | Standard mode | High-speed mode | Super-high-speed mode |
| Limited-reflective | Flat-view | E32-L16-N 2M | 0 to 15 | | | 0 to 12 |
| | | E32-L24S 2M | 0 to 4 | | | |
| | Side-view | E32-L25L 2M | 5.4 to 9 (center 7.2) | | | |

Transparent Object Detection (Retro-reflective Models)

| Sensing method | Feature | Size | Model | Sensing distance (mm) | | | |
|------------------|----------------|------|-------------------------------------|-----------------------|---------------|-----------------|-----------------------|
| | | | | Giga mode | Standard mode | High-speed mode | Super-high-speed mode |
| Retro-reflective | Film detection | M3 | E32-C31 2M +E39-F3R +E39-RP37 | 250 | | 200 | --- |
| | Square | --- | E32-R16 5M | 150 to 1,500 | | | |
| | Threaded | M6 | E32-R21 2M | 10 to 250 | | | |
| | Hex-shaped | | E32-LR11NP 2M +E39-RP1 | 1,350 | 1,200 | 1,000 | 550 |

Transparent Object Detection (Limited-reflective Models)

| Sensing method | Feature | Sensing direction | Model | Sensing distance (mm) | | | |
|--------------------|---------------------------------|-------------------|--------------|-----------------------|---------------|-----------------|-----------------------|
| | | | | Giga mode | Standard mode | High-speed mode | Super-high-speed mode |
| Limited-reflective | Small size | Flat-view | E32-L24S 2M | 0 to 4 | | | |
| | Standard | | E32-L16-N 2M | 0 to 15 | | | 0 to 12 |
| | Glass substrate alignment, 70°C | | E32-A08 2M | 10 to 20 | | | --- |
| | Standard/long-distance | | E32-A12 2M | 12 to 30 | | | --- |
| | Side-view form | Side-view | E32-L25L 2M | 5.4 to 9 (center 7.2) | | | |
| | Glass substrate mapping, 70°C | Top-view | E32-A09 2M | 15 to 38 | | | --- |

Chemical-resistant, Oil-resistant Models

| Sensing method | Type | Sensing direction | Model | Sensing distance (mm) | | | |
|----------------|---|-------------------|--------------|--|---------------|-----------------|-----------------------|
| | | | | Giga mode | Standard mode | High-speed mode | Super-high-speed mode |
| Through-beam | Oil-resistant | Right-angle | E32-T11NF 2M | 4,000 *1 | 4,000 *1 | 4,000 *1 | 2,200 |
| | Chemical/oil-resistant | Top-view | E32-T12F 2M | 4,000 *1 | 4,000 *1 | 4,000 *1 | 1,600 |
| | | Side-view | E32-T11F 2M | 4,000 *1 | 4,000 *1 | 2,600 | 1,000 |
| | | | E32-T14F 2M | 1,400 | 800 | 500 | 200 |
| | Chemical/oil-resistant at 150°C | Top-view | E32-T51F 2M | 4,000 *1 | 2,800 | 1,800 | 700 |
| Reflective | Semiconductors: Cleaning, developing, and etching; 60°C | Top-view | E32-L11FP 5M | 8 to 20 mm from tip of lens (Recommended sensing distance: 11 mm), 19 to 31 mm from center of mounting hole A (Recommended sensing distance: 22 mm) | | | |
| | Semiconductors: Resist stripping; 85°C | | E32-L11FS 5M | 8 to 20 mm from tip of lens (Recommended sensing distance: 11 mm), 32 to 44 mm from center of mounting hole A (Recommended sensing distance: 35 mm) | | | |
| | Chemical/oil-resistant | | E32-D12F 2M | --- | 190 | 130 | 60 |
| | Chemical-resistant cable | | E32-D11U 2M | 840 | 350 | 240 | 100 |

*1. The fiber length is 2 m on each side, so the sensing distance is given as 4,000 mm.

*2. Even if there is no sensing object, the Sensor will detect light that is reflected by the fluoro-resin.

Bending-resistant Models

| Sensing method | Size | Model | Sensing distance (mm) | | | |
|----------------|----------|--------------|-----------------------|---------------|-----------------|-----------------------|
| | | | Giga mode | Standard mode | High-speed mode | Super-high-speed mode |
| Through-beam | 1.5 dia. | E32-T22B 2M | 680 | 400 | 220 | 90 |
| | M3 | E32-T21 2M | | | | |
| | M4 | E32-T11 2M | 2,500 | 1,350 | 900 | 360 |
| | Square | E32-T25XB 2M | 500 | 300 | 170 | 70 |
| Reflective | 1.5 dia. | E32-D22B 2M | 140 | 60 | 40 | 16 |
| | M3 | E32-D21 2M | | | | |
| | 3 dia. | E32-D221B 2M | 300 | 140 | 90 | 40 |
| | M4 | E32-D21B 2M | | | | |
| | M6 | E32-D11 2M | 840 | 350 | 240 | 100 |
| | Square | E32-D25XB 2M | 240 | 100 | 60 | 30 |

Heat-resistant Models

| Sensing method | Size | Model | Sensing distance (mm) | | | | |
|----------------|-------|---------------|-----------------------|---------------|-----------------|-----------------------|-----|
| | | | Giga mode | Standard mode | High-speed mode | Super-high-speed mode | |
| Through-beam | 100°C | E32-T51R 2M | 1,600 | 800 | 560 | 225 | |
| | 150°C | E32-T51 2M | 2,800 | 1,500 | 1,000 | 400 | |
| | 200°C | E32-T81R-S 2M | 1,000 | 550 | 360 | 140 | |
| | 350°C | E32-T61-S 2M | 1,680 | 900 | 600 | 240 | |
| Reflective | 100°C | E32-D51R 2M | 670 | 280 | 190 | 80 | |
| | 150°C | E32-D51 2M | 1,120 | 450 | 320 | 144 | |
| | 200°C | E32-D81R-S 2M | 420 | 180 | 120 | 54 | |
| | 300°C | E32-A08H2 2M | 10 to 20 | | | | --- |
| | | E32-A09H2 2M | 20 to 30 (center 25) | | | | --- |
| | 350°C | E32-D611-S 2M | 420 | 180 | 120 | 54 | |
| | | E32-D61-S 2M | | | | | |
| | 400°C | E32-D73-S 2M | 280 | 120 | 80 | 36 | |

Area Detection Models

| Sensing method | Type | Sensing width | Model | Sensing distance (mm) | | | |
|----------------|-------|---------------|--------------|-----------------------|---------------|-----------------|-----------------------|
| | | | | Giga mode | Standard mode | High-speed mode | Super-high-speed mode |
| Through-beam | Area | 11 mm | E32-T16PR 2M | 3,100 | 1,700 | 1,120 | 440 |
| | | | E32-T16JR 2M | 2,750 | 1,500 | 960 | 380 |
| | | 30 mm | E32-T16WR 2M | 4,000 * | 2,600 | 1,700 | 680 |
| Reflective | Array | 11 mm | E32-D36P1 2M | 700 | 300 | 200 | 90 |

* The fiber length is 2 m on each side, so the sensing distance is given as 4,000 mm.

Liquid-level Detection Models

| Sensing method | Tube diameter | Feature | Model | Sensing distance (mm) | | | |
|---|-----------------------|------------------------------------|--------------|--|---------------|-----------------|-----------------------|
| | | | | Giga mode | Standard mode | High-speed mode | Super-high-speed mode |
| Tube-mounting | 3.2, 6.4, or 9.5 dia. | Stable residual quantity detection | E32-A01 5M | Applicable tube: Transparent tube with a diameter of 3.2, 6.4, or 9.5 mm, Recommended wall thickness: 1 mm | | | |
| | 8 to 10 dia. | Mounting at multiple levels | E32-L25T 2M | Applicable tube: Transparent tube with a diameter of 8 to 10 mm, Recommended wall thickness: 1 mm | | | |
| | No restrictions | Large tubes | E32-D36T 5M | Applicable tube: Transparent tube (no restrictions on diameter) | | | |
| Liquid contact (heat-resistant up to 200°C) | --- | --- | E32-D82F1 4M | Liquid-contact type | | | |

Vacuum-resistant Models

| Sensing method | Heat-resistant temperature | Model | Sensing distance (mm) | | | |
|----------------|----------------------------|---------------------|-----------------------|---------------|-----------------|-----------------------|
| | | | Giga mode | Standard mode | High-speed mode | Super-high-speed mode |
| Through-beam | 120°C | E32-T51V 1M | 720 | 400 | 260 | 100 |
| | | E32-T51V 1M+E39-F1V | 2,000 * | 2,000 * | 1,360 | 520 |
| | 200°C | E32-T84SV 1M | 1,760 | 950 | 640 | 260 |

* The fiber length is 1 m on each side, so the sensing distance is given as 2,000 mm.

Models for FPD, Semiconductors, and Solar Cells

| Sensing method | Application | Operating temperature | Model | Sensing distance (mm) | | | |
|--------------------|--|-----------------------|--------------|---|---------------|-----------------|-----------------------|
| | | | | Giga mode | Standard mode | High-speed mode | Super-high-speed mode |
| Limited-reflective | Glass presence detection | 70°C | E32-L16-N 2M | 0 to 15 | | | 0 to 12 |
| | | | E32-A08 2M | 10 to 20 | | | --- |
| | Glass substrate alignment | 300°C | E32-A08H2 3M | 12 to 30 | | | --- |
| | | | E32-A12 2M | 15 to 38 | | | --- |
| | Glass substrate mapping | 70°C | E32-A09 2M | 20 to 30 (center 25) | | | --- |
| | | 300°C | E32-A09H2 2M | 20 to 30 (center 25) | | | --- |
| Through-beam | Wet processes: Cleaning, Resist developing and etching | 60°C | E32-L11FP 5M | 8 to 20 mm from tip of lens (Recommended sensing distance: 11 mm), 19 to 31 mm from center of mounting hole A (Recommended sensing distance: 22 mm) | | | |
| | | | E32-L11FS 5M | 8 to 20 mm from tip of lens (Recommended sensing distance: 11 mm), 32 to 44 mm from center of mounting hole A (Recommended sensing distance: 35 mm) | | | |
| | Wafer mapping | 70°C | E32-A03 2M | 3,220 | 1,780 | 1,200 | 500 |
| | | | E32-A03-1 2M | | | | |
| | | | E32-A04 2M | 1,280 | 680 | 450 | 200 |
| E32-T24SR 2M | 4,000 * | 2,200 | 1,460 | 580 | | | |
| E32-T24S 2M | 4,000 * | 2,600 | 1,740 | 700 | | | |

* The fiber length is 2 m on each side, so the sensing distance is given as 4,000 mm.

I/O Circuit Diagrams

NPN Output

| Model | Operation mode | Timing chart | Output circuit |
|---------------------------------|----------------|--------------|----------------|
| E3X-ZV11 E3X-ZV6 E3X-ZV6M | Light-ON | | |
| | Dark-ON | | |
| E3X-ZV21 E3X-ZV7 | Light-ON | | |
| | Dark-ON | | |
| E3X-MZV11 E3X-MZV6 | Light-ON | | |
| | Dark-ON | | |
| E3X-MZV21 | Light-ON | | |
| | Dark-ON | | |

*1. For E3X-ZV7, this will be orange.

PNP Output

| Model | Operation mode | Timing chart | Output circuit |
|---------------------------------|----------------|--------------|----------------|
| E3X-ZV41 E3X-ZV8 E3X-ZV8M | Light-ON | | |
| | Dark-ON | | |
| E3X-ZV51 E3X-ZV9 | Light-ON | | |
| | Dark-ON | | |
| E3X-MZV41 E3X-MZV8 | Light-ON | | |
| | Dark-ON | | |
| E3X-MZV51 | Light-ON | | |
| | Dark-ON | | |

*1. For E3X-ZV9, this will be orange.

Nomenclature

E3X-ZV11
 E3X-ZV21
 E3X-ZV41
 E3X-ZV51
 E3X-ZV6
 E3X-ZV6M
 E3X-ZV7
 E3X-ZV8
 E3X-ZV8M
 E3X-ZV9

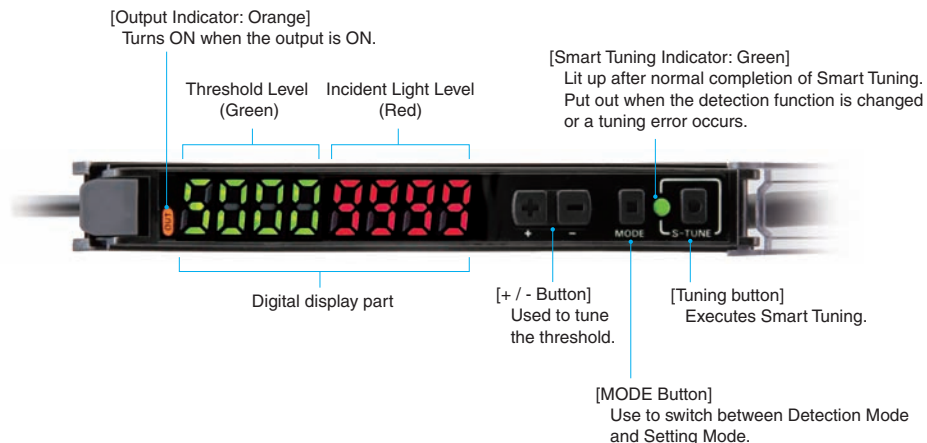

E3X-MZV11
 E3X-MZV21
 E3X-MZV41
 E3X-MZV51
 E3X-MZV6
 E3X-MZV8

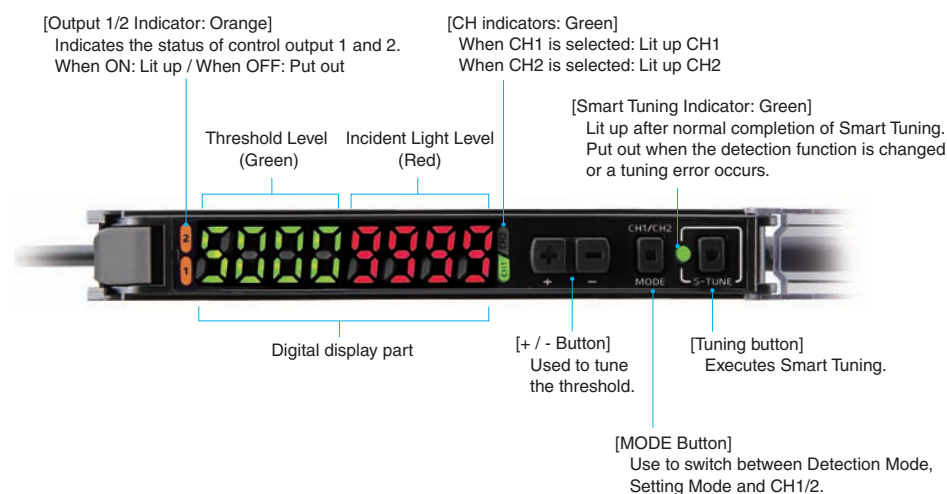

Safety Precautions

Be sure to read the precautions for all models in the website at: <http://www.ia.omron.com/>.

Warning Indications

| | |
|--|--|
|  WARNING | Warning level Indicates a potentially hazardous situation which, if not avoided, will result in minor or moderate injury, or may result in serious injury or death. Additionally there may be significant property damage. |
| Precautions for Safe Use | Supplementary comments on what to do or avoid doing, to use the product safely. |
| Precautions for Correct Use | Supplementary comments on what to do or avoid doing, to prevent failure to operate, malfunction or undesirable effect on product performance. |



⚠ WARNING

This product is not designed or rated for ensuring safety of persons either directly or indirectly. Do not use it for such purposes. 

Do not use it exceeding the rated voltage. There is a possibility of failure and fire. 

Never use the product with an AC power supply. Otherwise, explosion may result. 

Meaning of Product Safety Symbols

| | |
|---|---|
|  | General prohibition Instructions on unspecified prohibited action. |
|  | Caution, fire Indicates the possibility of fires under specific conditions. |
|  | Caution, explosion Indicates the possibility of explosion under specific conditions |

Precautions for Safe Use

The following precautions must be observed to ensure safe operation of the Amplifier Unit. Doing so may cause damage or fire.

1. Do not install the product in the following locations.
 - Locations subject to direct sunlight
 - Locations subject to condensation due to high humidity
 - Locations to corrosive, flammable or explosive gases
 - Locations subject to vibration or mechanical shocks exceeding the rated values
 - Locations subject to exposure to water, oil, chemicals
 - Locations subject to stream
 - Locations subjected to strong magnetic field or electric field
 - In water, rainfall or outdoors
 - Any atmosphere or environment that exceeds the ratings
2. To secure the safety of operation and maintenance, do not install the product close to high-voltage devices and power devices.
3. High-voltage lines and power lines must be wired separately from the product. Wiring them together or placing them in the same duct may cause induction, resulting in malfunction or damage.
4. Please apply the load under rating and connect the load correctly. Do not short the load.
5. Do not use the product if the case is damaged.
6. Burn injury may occur. The product surface temperature rises depending on application conditions, such as the ambient temperature and the power supply voltage. Attention must be paid during operation or cleaning.
7. When setting the sensor, be sure to check safety such as by stopping the equipment.
8. Be sure to turn off the power supply before connecting or disconnecting wires.
9. Do not attempt to disassemble, repair, or modify the product in any way.
10. When disposing of the product, treat it as industrial waste.
11. Do not remove the cover on the side of the case. Otherwise, electric shock or malfunction may result.
12. If you notice any abnormal condition, immediately stop using the product, turn off the power and consult your dealer without doing any operation such as initialization.
13. When using a connector type product, place a protective label (provided with the E3X-CN series) on the power supply connecting terminals that are not used, to prevent electric shock or short circuit.

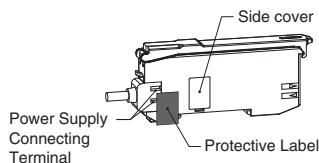

Precautions for Correct Use

1. Be sure to mount the unit to the DIN track and the connector until it clicks.
 2. The length for the cable extension must be 30 m or less. Be sure to use a cable of at least 0.3 mm² for extension.
 3. The power voltage must be 24 V when connecting amplifier units with extension cable and wire-saving connector.
 4. Do not apply the forces on the cord exceeding the limits. Do not use the cord while it is pinched or pressed.
Pull: 40 N; torque: 0.1 N·m; pressure: 20 N max; bending: 29.4 N
 5. Do not apply excessive force such as tension, compression or torsion to the amplifier unit with the fiber unit fixed to the amplifier unit.
 6. Please be aware of the polarity of the power supply to avoid miswiring. If there are input/output lines that are not used, insulate them.
 7. The product is ready to operate 250 ms after the power supply is turned ON.
 8. It may take time until the received light intensity become stable immediately after the power on.
 9. If the unit receives excessive light, the mutual interference prevention function may not work properly, resulting in malfunction of the unit. In such case, increase the threshold.
 10. Do not use the unit when EEPROM (non-volatile memory) exceeds its writing life (100,000 times). When you perform setting change, threshold change, tuning, zero reset and so on, the setting information is written.
 11. Use End Plates (PFP-M: separately sold) at the both ends of the grouped Amplifier Units to prevent them from separating due to vibration or other cause.
 12. Do not use alcohol, thinner, benzene, acetone, and lamp oil for cleaning.
 13. Please dispose the product  with on the case in accordance with relevant regulations (laws and regulations).
 14. The mutual interference prevention function does not work when in combination with series other than E3X-ZV/E3X-MZV series.
 15. The Communication Unit E3X-DRT21-S, E3X-CRT, E3X-ECT and E3NW cannot be connected.
 16. This product is not equipped with the Auto Power Control (APC) function.
 17. When being installed with amplifier tightly, connecting up to 16 wire-saving connector is allowed.
 18. The following notice applies only to products that carry the CE mark.
- Note:** In a residential environment, this product may cause radio interference, in which case the user may required to take adequate measures.

Dimensions

Fiber Amplifier Units

Pre-wired Amplifier Units

- E3X-ZV11
- E3X-ZV21
- E3X-ZV41
- E3X-ZV51



- *1. The Mounting Bracket can also be used on side B.
- *2. Cable Specifications

| Model | Outer diameter | No. of conductors | Others |
|----------------------|----------------|-------------------|---|
| E3X-ZV11 E3X-ZV41 | 4.0 dia. | 3 | Conductor cross-section: 0.12 mm ² |
| | | | Insulator dia.: 0.9 mm |
| | | | Standard cable length: 2 m |
| E3X-ZV21 E3X-ZV51 | 4.0 dia. | 4 | Conductor cross-section: 0.14 mm ² |
| | | | Insulator dia.: 0.85 mm |
| | | | Standard cable length: 2 m |
| | | | Minimum bending radius: 12 mm (Reference value) |
| | | | Minimum bending radius: 12 mm (Reference value) |

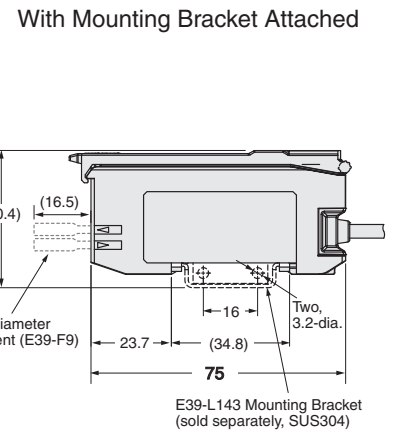
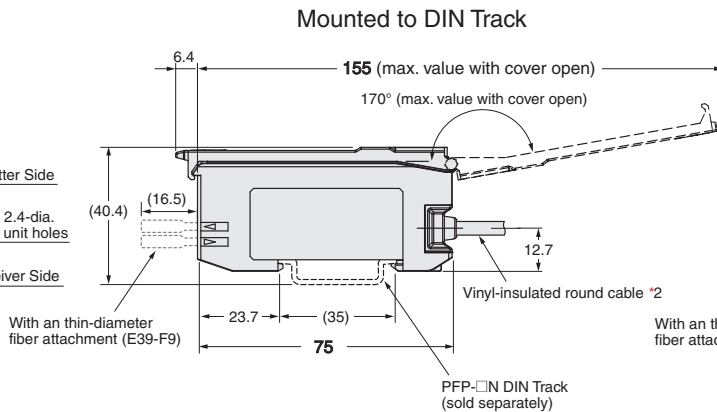
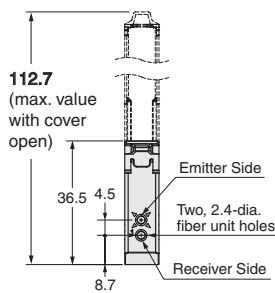
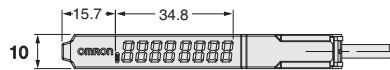

Mounting Holes

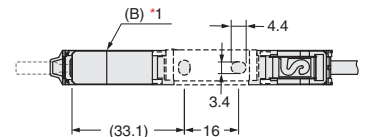
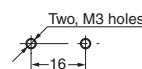

E3X-ZV / MZV

E3X-MZV11
E3X-MZV21
E3X-MZV41
E3X-MZV51



*1. The Mounting Bracket can also be used on side B.
*2. Cable Specifications

| Model | Outer diameter | No. of conductors | Others |
|------------------------|----------------|-------------------|---|
| E3X-MZV11 E3X-MZV41 | 4.0 dia. | 4 | Conductor cross-section: 0.22 mm ² |
| | | | Insulator dia.: 0.9 mm |
| E3X-MZV21 E3X-MZV51 | 4.0 dia. | 6 | Standard cable length: 2 m |
| | | | Minimum bending radius: 12 mm (Reference value) |
| | | | Conductor cross-section: 0.12 mm ² |
| | | | Insulator dia.: 0.9 mm |
| | | | Standard cable length: 2 m |
| | | | Minimum bending radius: 12 mm (Reference value) |

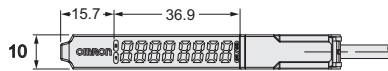

Mounted to DIN Track

With Mounting Bracket Attached

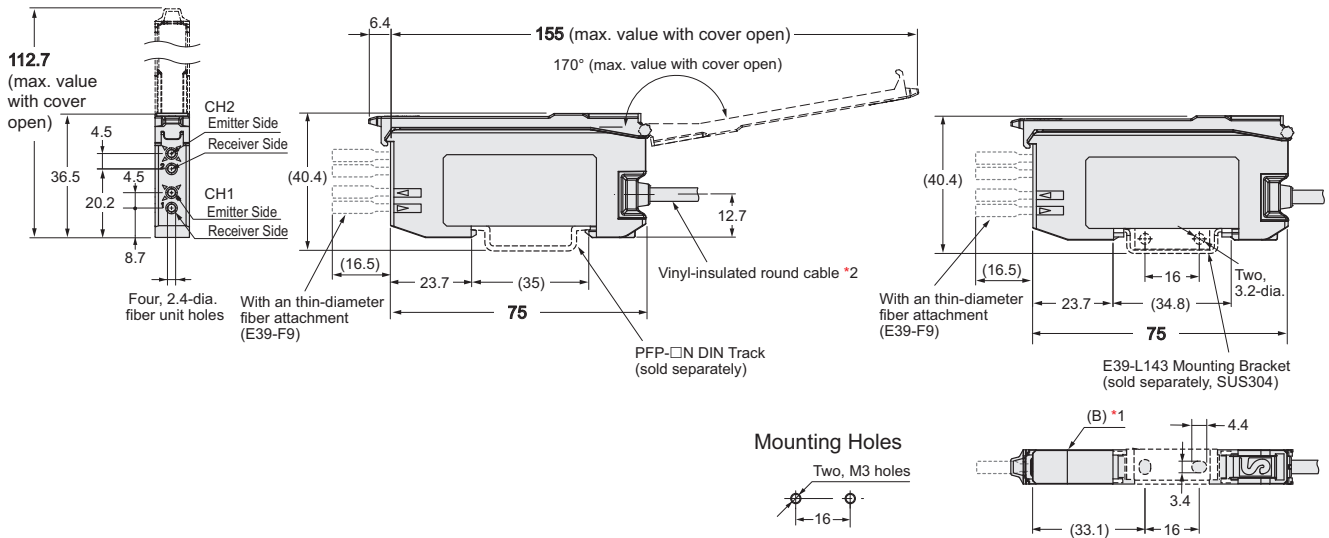

Wire-saving Connectors Units

- E3X-ZV6 E3X-ZV8
- E3X-ZV6M E3X-ZV8M
- E3X-ZV7 E3X-ZV9

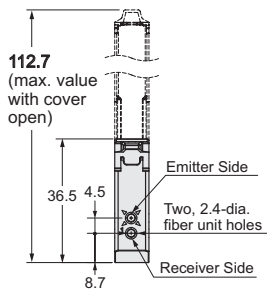
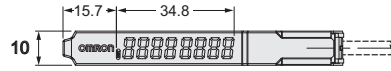

Mounted to DIN Track

With Mounting Bracket Attached

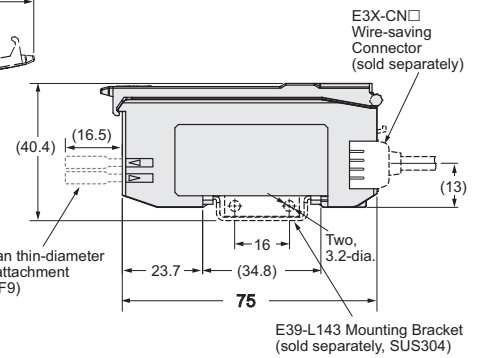
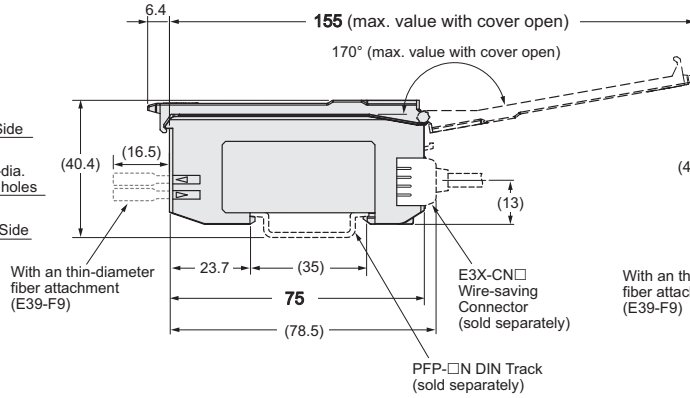

Mounting Holes

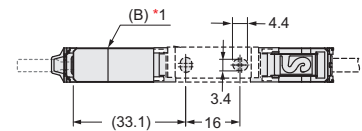
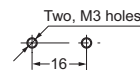

*1. The Mounting Bracket can also be used on side B.

E3X-MZV6
E3X-MZV8

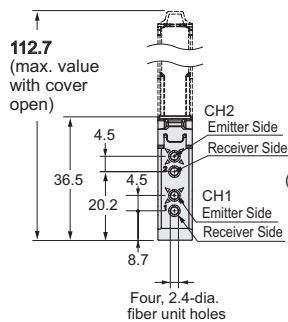
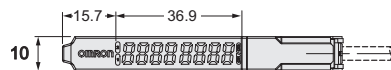

Mounted to DIN Track

With Mounting Bracket Attached

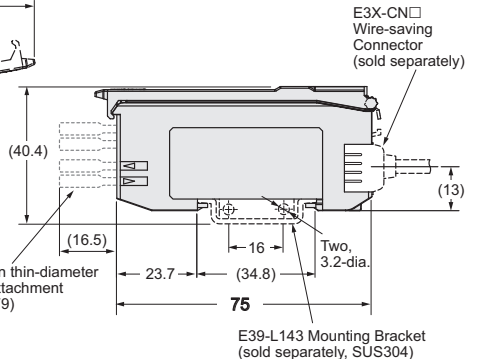
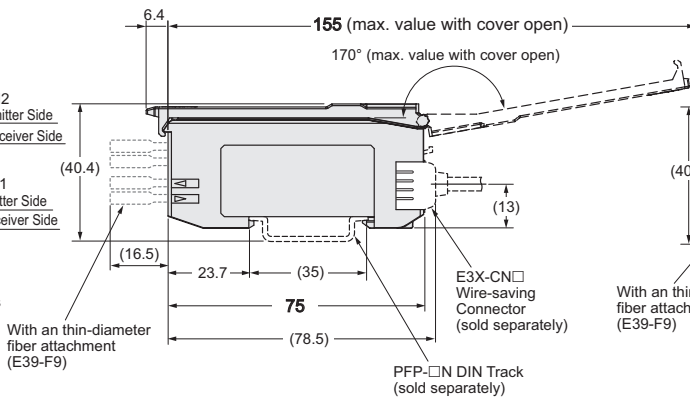

Mounting Holes

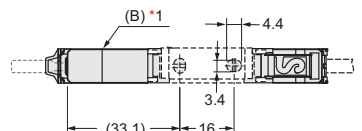
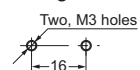

*1. The Mounting Bracket can also be used on side B.

Accessories (Sold Separately)

Wire-saving Connectors

Master Connector

E3X-CN11
E3X-CN21

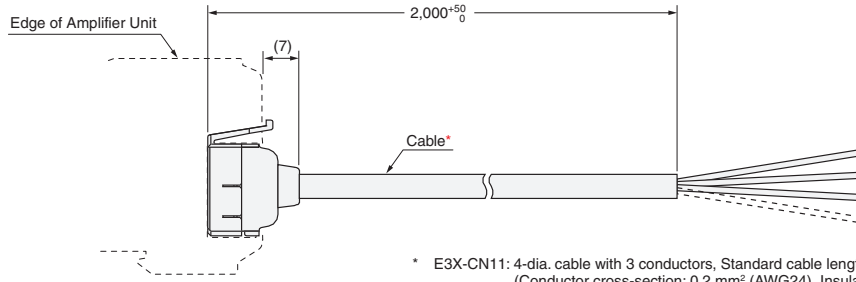

* E3X-CN11: 4-dia. cable with 3 conductors, Standard cable length: 2 m
(Conductor cross-section: 0.2 mm² (AWG24), Insulator diameter: 1.1 mm)
E3X-CN21: 4-dia. cable with 4 conductors, Standard cable length: 2 m
(Conductor cross-section: 0.2 mm² (AWG24), Insulator diameter: 1.1 mm)

Slave Connector

E3X-CN12
E3X-CN22

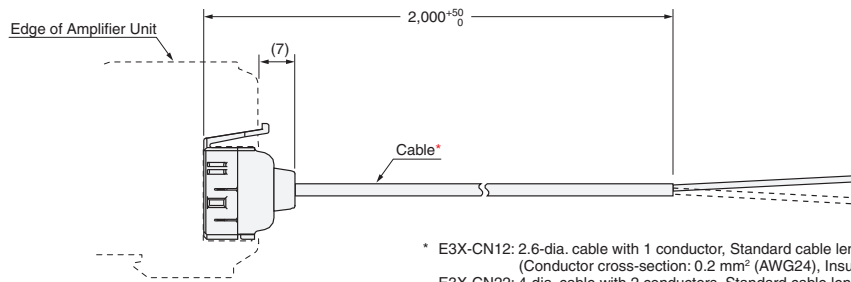

* E3X-CN12: 2.6-dia. cable with 1 conductor, Standard cable length: 2 m
(Conductor cross-section: 0.2 mm² (AWG24), Insulator diameter: 1.1 mm)
E3X-CN22: 4-dia. cable with 2 conductors, Standard cable length: 2 m
(Conductor cross-section: 0.2 mm² (AWG24), Insulator diameter: 1.1 mm)

DIN Track

PFP-100N
PFP-50N

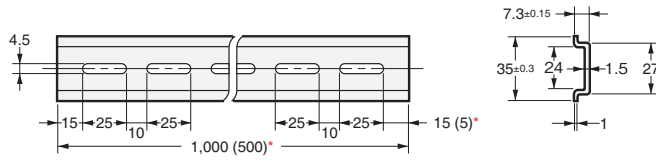

* Dimensions in parentheses are for the PFP-50N.

Material: Aluminum

Mounting Bracket

E39-L143

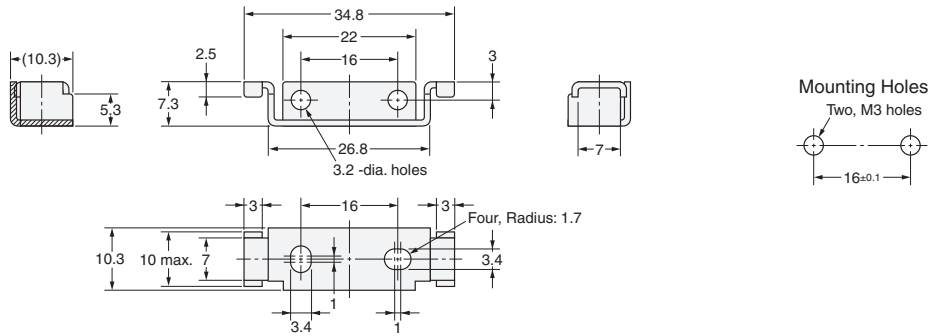
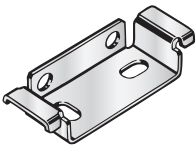

Material: Stainless steel (SUS304)

End Plate

PFP-M

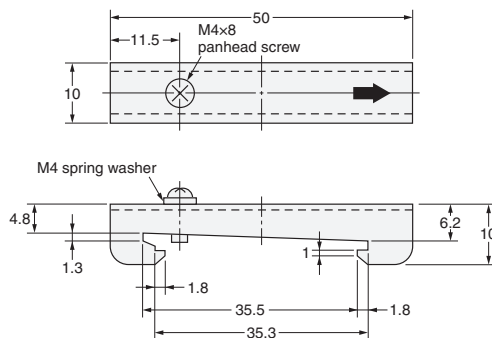
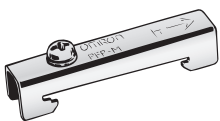

Materials: Iron, zinc plating

Terms and Conditions Agreement

Read and understand this catalog.

Please read and understand this catalog before purchasing the products. Please consult your OMRON representative if you have any questions or comments.

Warranties.

- (a) Exclusive Warranty. Omron's exclusive warranty is that the Products will be free from defects in materials and workmanship for a period of twelve months from the date of sale by Omron (or such other period expressed in writing by Omron). Omron disclaims all other warranties, express or implied.
- (b) Limitations. OMRON MAKES NO WARRANTY OR REPRESENTATION, EXPRESS OR IMPLIED, ABOUT NON-INFRINGEMENT, MERCHANTABILITY OR FITNESS FOR A PARTICULAR PURPOSE OF THE PRODUCTS. BUYER ACKNOWLEDGES THAT IT ALONE HAS DETERMINED THAT THE PRODUCTS WILL SUITABLY MEET THE REQUIREMENTS OF THEIR INTENDED USE.

Omron further disclaims all warranties and responsibility of any type for claims or expenses based on infringement by the Products or otherwise of any intellectual property right. (c) Buyer Remedy. Omron's sole obligation hereunder shall be, at Omron's election, to (i) replace (in the form originally shipped with Buyer responsible for labor charges for removal or replacement thereof) the non-complying Product, (ii) repair the non-complying Product, or (iii) repay or credit Buyer an amount equal to the purchase price of the non-complying Product; provided that in no event shall Omron be responsible for warranty, repair, indemnity or any other claims or expenses regarding the Products unless Omron's analysis confirms that the Products were properly handled, stored, installed and maintained and not subject to contamination, abuse, misuse or inappropriate modification. Return of any Products by Buyer must be approved in writing by Omron before shipment. Omron Companies shall not be liable for the suitability or unsuitability or the results from the use of Products in combination with any electrical or electronic components, circuits, system assemblies or any other materials or substances or environments. Any advice, recommendations or information given orally or in writing, are not to be construed as an amendment or addition to the above warranty.

See <http://www.omron.com/global/> or contact your Omron representative for published information.

Limitation on Liability; Etc.

OMRON COMPANIES SHALL NOT BE LIABLE FOR SPECIAL, INDIRECT, INCIDENTAL, OR CONSEQUENTIAL DAMAGES, LOSS OF PROFITS OR PRODUCTION OR COMMERCIAL LOSS IN ANY WAY CONNECTED WITH THE PRODUCTS, WHETHER SUCH CLAIM IS BASED IN CONTRACT, WARRANTY, NEGLIGENCE OR STRICT LIABILITY.

Further, in no event shall liability of Omron Companies exceed the individual price of the Product on which liability is asserted.

Suitability of Use.

Omron Companies shall not be responsible for conformity with any standards, codes or regulations which apply to the combination of the Product in the Buyer's application or use of the Product. At Buyer's request, Omron will provide applicable third party certification documents identifying ratings and limitations of use which apply to the Product. This information by itself is not sufficient for a complete determination of the suitability of the Product in combination with the end product, machine, system, or other application or use. Buyer shall be solely responsible for determining appropriateness of the particular Product with respect to Buyer's application, product or system. Buyer shall take application responsibility in all cases.

NEVER USE THE PRODUCT FOR AN APPLICATION INVOLVING SERIOUS RISK TO LIFE OR PROPERTY OR IN LARGE QUANTITIES WITHOUT ENSURING THAT THE SYSTEM AS A WHOLE HAS BEEN DESIGNED TO ADDRESS THE RISKS, AND THAT THE OMRON PRODUCT(S) IS PROPERLY RATED AND INSTALLED FOR THE INTENDED USE WITHIN THE OVERALL EQUIPMENT OR SYSTEM.

Programmable Products.

Omron Companies shall not be responsible for the user's programming of a programmable Product, or any consequence thereof.

Performance Data.

Data presented in Omron Company websites, catalogs and other materials is provided as a guide for the user in determining suitability and does not constitute a warranty. It may represent the result of Omron's test conditions, and the user must correlate it to actual application requirements. Actual performance is subject to the Omron's Warranty and Limitations of Liability.

Change in Specifications.

Product specifications and accessories may be changed at any time based on improvements and other reasons. It is our practice to change part numbers when published ratings or features are changed, or when significant construction changes are made. However, some specifications of the Product may be changed without any notice. When in doubt, special part numbers may be assigned to fix or establish key specifications for your application. Please consult with your Omron's representative at any time to confirm actual specifications of purchased Product.

Errors and Omissions.

Information presented by Omron Companies has been checked and is believed to be accurate; however, no responsibility is assumed for clerical, typographical or proofreading errors or omissions.

Fiber Sensor Best Selection Catalog

Refer to the Fiber Sensor Best Selection Catalog for information Fiber Units.

Cat.No.E418

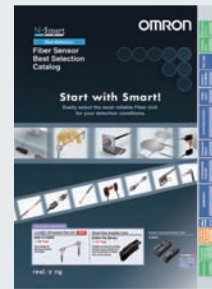

Note: Do not use this document to operate the Unit.

OMRON Corporation Industrial Automation Company

Kyoto, JAPAN

Contact : www.ia.omron.com

Regional Headquarters

OMRON EUROPE B.V.

Wegalaan 67-69, 2132 JD Hoofddorp
The Netherlands
Tel: (31) 2356-81-300 Fax: (31) 2356-81-388

OMRON ASIA PACIFIC PTE. LTD.

438B Alexandra Road, #08-01/02 Alexandra
Technopark, Singapore 119968
Tel: (65) 6835-3011 Fax: (65) 6835-3011

OMRON ELECTRONICS LLC

2895 Greenspoint Parkway, Suite 200
Hoffman Estates, IL 60169 U.S.A.
Tel: (1) 847-843-7900 Fax: (1) 847-843-7787

OMRON (CHINA) CO., LTD.

Room 2211, Bank of China Tower,
200 Yin Cheng Zhong Road,
PuDong New Area, Shanghai, 200120, China
Tel: (86) 21-6023-0333 Fax: (86) 21-5037-2388

Authorized Distributor:

©OMRON Corporation 2022-2024 All Rights Reserved.
In the interest of product improvement,
specifications are subject to change without notice.

CSM_1_3

Cat. No. E616-E1-03 1124 (1222)