

Smart Sensors (Inductive Displacement Type)

ZX-E Series

High-accuracy Detection of Metal Workpiece Displacement

- Sensor Heads support a wide variety of applications.
- Linearity can be adjusted for non-ferrous metals, such as SUS and aluminum, using the material selection function.
- Simple linearity compensation (teaching).
- Easily perform calculation for two Sensors by using a Calculating Unit.
- Prevent mutual interference for up to five Units by using a Calculating Unit



For the most recent information on models that have been certified for safety standards, refer to your OMRON website.

Ordering Information

■ Sensors

Sensor Heads (Refer to Dimensions on page 11.)

Shape	Dimensions	Sensing distance	Resolution *1	Model
Cylindrical	3 dia. x 18 mm	0.5 mm	1 μm	ZX-EDR5T
	5.4 dia. x 18 mm	1 mm		ZX-ED01T *2
	8 dia. x 22 mm	2 mm		ZX-ED02T *2
Screw-shaped	M10 x 22 mm			ZX-EM02T *2
	M18 x 46.3 mm	7 mm		ZX-EM07MT *2
Flat	30 x 14 x 4.8 mm	4 mm		ZX-EV04T *2 *3
Heat-resistant, cylindrical	M12 x 22 mm	2 mm	ZX-EM02HT *4	

*1: For an average count of 4,096.

*2: Models with Protective Spiral Tubes are also available. Add a suffix of "-S" to the above model numbers when ordering. (Example: ZX-ED01T-S)
As for ZX-EM07MT, please mention ZX-EM07M-S when ordering.
For detailed dimensions of the Protective Spiral Tube, refer to the information on the E39-F32A on the OMRON website.

*3: Be sure to use ZX-EDA Amplifier Unit version 1,200 or later with the ZX-EV04T.

*4: Be sure to use ZX-EDA Amplifier Unit version 1,300 or later with the ZX-EM02HT.

Amplifier Units (Refer to Dimensions on page 13.)

Appearance	Power supply	Output type	Model
	DC	NPN	ZX-EDA11 2M
		PNP	ZX-EDA41 2M

Note: Compatible connection with the Sensor Head.

Accessories (Order Separately)



Calculating Unit (Refer to Dimensions on page 14.)

Appearance	Model
	ZX-CAL2

Amplifier Mounting Brackets



A ZX-XBE1 is provided with the Sensor. Order an Amplifier Mounting Bracket separately if required.

(Refer to Dimensions on page 14.)

Appearance	Model	Remarks
	ZX-XBE1	Attached to each Sensor Head
	ZX-XBE2	For DIN track mounting

Logging Tool for Personal Computers

(Refer to Dimensions on page 15.)

Appearance	Name	Model
	Communications Interface Unit (RS-232C)	ZX-SF11
	Smart Monitor (Logging Software + Function Setting Software)	ZX-SW11EV3 (See note 1.)

Setup Tool for Personal Computer

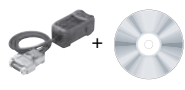
Appearance	Name	Model
	Communications Interface Unit (RS-232C) + Smart Monitor Basic*2 (Function Setting Software)	ZX-SFW11EV3 (See note 1.)

Note 1. The ZX-SFW11EV3 or ZX-SW11EV3 is required to use the Smart Monitor with the ZX-LDA11-N/41-N. Earlier versions cannot be used.

2. The Smart Monitor Basic does not have a logging function. Other than the logging function, the Smart Monitor Basic supports the same functions as the Smart Monitor.

Cables with Connectors on Both Ends (for Extension) (Refer to Dimensions on page 15.)*

Cable length	Model	Quantity
1 m	ZX-XC1A	1
4 m	ZX-XC4A	
8 m	ZX-XC8A	

* Robot cable models are also available. The model numbers are ZX-XC□R.

Bank Unit

Appearance	Model
	ZX-SB11

Specifications

■ Sensor Heads

Model		ZX-EDR5T	ZX-ED01T	ZX-ED02T/ EM02T	ZX-EM07MT	ZX-EV04T	ZX-EM02HT	
Measurement range		0 to 0.5 mm	0 to 1 mm	0 to 2 mm	0 to 7 mm	0 to 4 mm	0 to 2 mm	
Sensing object		Magnetic metals (Measurement ranges and linearities are different for non-magnetic metals. Refer to <i>Engineering Data</i> on page 4.)						
Standard reference object		18×18×3 mm	30×30×3 mm	60×60×3 mm	45×45×3 mm			
		Material: ferrous (S50C)						
Resolution *1		1 μm						
Linearity *2		±0.5% F.S.					±1.0% F.S. *5	
Linear output range		Same as measurement range.						
Temperature characteristic *3 (including Amplifier Unit)		0.15% F.S./°C		0.07% F.S./°C		0.1% F.S./°C		
Ambient temperature	Operating *4	0 to 50°C (with no icing or condensation)		-10 to 60°C (with no icing or condensation)		-10 to 200°C		
	Storage *4	-20 to 70°C (with no icing or condensation)				(with no icing or condensation)		
Ambient humidity		Operating and storage: 35% to 85% (with no condensation)						
Insulation resistance		50 MΩ min. (at 500 DC)						
Dielectric strength		1,000 VAC, 50/60 Hz for 1 min between charged parts and case						
Vibration resistance (destruction)		10 to 55 Hz with 1.5-mm double amplitude for 2 h each in X, Y, and Z directions						
Shock resistance (destruction)		500 m/s ² , 3 times each in X, Y, and Z directions						
Degree of protection (Sensor Head)		IEC60529, IP65		IEC60529, IP67		IEC60529, IP60 *6		
Connection method		Connector relay (standard cable length: 2 m)						
Weight (packed state)		Approx. 120 g	Approx. 140 g		Approx. 160 g	Approx. 130 g	Approx. 160 g	
Materials	Sensor Head	Case	Brass	Stainless steel	Brass	Zinc (nickel-plated)	Brass	
		Sensing surface	Heat-resistant ABS				PEEK	
		Tightening nut	---		Brass (nickel-plated) (except ZX-ED02T)		---	
		Toothed washer	---		Iron (zinc-plated) (except ZX-ED02T)		---	
Preamplifier		PES						
Accessories		Amplifier Mounting Brackets (ZX-XBE1), Instruction Manual						

- *1:Resolution: The resolution is the deviation ($\pm 3\sigma$) in the linear output when connected to the ZX-EDA Amplifier Unit. The above values indicate the deviations observed 30 minutes after the power is turned ON.
(The resolution is measured with OMRON's standard reference object at 1/2 of the measurement range with the ZX-EDA set for the maximum average count of 4,096 per period.)
The resolution is given at the repeat accuracy for a stationary workpiece, and is not an indication of the distance accuracy. The resolution may be adversely affected under strong electromagnetic fields.
- *2: Linearity: The linearity is given as the error in an ideal straight line displacement output when measuring the standard reference object. The linearity and measurement values vary with the object being measured.
- *3: Temperature characteristic: The temperature characteristic is measured with OMRON's standard reference object at 1/2 of the measurement range.
- *4: The ambient temperature given is only for the sensor head. It is -10 to 60°C for the preamp.
- *5: The value given is for an ambient temperature of 25°C.
- *6: Do not use in moist environments because the case is not waterproof.

■ Amplifier Units

Model	ZX-EDA11	ZX-EDA41
Measurement period *1	150 μ s	
Possible average count settings	1, 2, 4, 8, 16, 32, 64, 128, 256, 512, 1,024, 2,048, or 4,096	
Linear output *2	Current output: 4 to 20 mA/F.S., Max. load resistance: 300 Ω Voltage output: ± 4 V (± 5 V, 1 to 5 V *3), Output impedance: 100 Ω	
Judgement outputs (3 outputs: HIGH/PASS/LOW)	NPN open-collector outputs, 30 VDC, 50 mA max. Residual voltage: 1.2 V max.	PNP open-collector outputs, 30 VDC, 50 mA max. Residual voltage: 2 V max.
Zero reset input, timing input, reset input, judgement output hold input	ON: Short-circuited with 0-V terminal or 1.5 V or less OFF: Open (leakage current: 0.1 mA max.)	ON: Supply voltage short-circuited or supply voltage within 1.5 V OFF: Open (leakage current: 0.1 mA max.)
Function	<ul style="list-style-type: none"> <li style="width: 33%;">- Measurement value display <li style="width: 33%;">- Set value/output value/resolution display <li style="width: 33%;">- Linearity adjustment (materials selection) <li style="width: 33%;">- Scaling <li style="width: 33%;">- Display reverse <li style="width: 33%;">- Display OFF mode <li style="width: 33%;">- ECO mode <li style="width: 33%;">- Number of display digit changes <li style="width: 33%;">- Sample hold <li style="width: 33%;">- Peak hold <li style="width: 33%;">- Bottom hold, peak-to-peak hold <li style="width: 33%;">- Self-peak hold <li style="width: 33%;">- Self-bottom hold <li style="width: 33%;">- Average hold <li style="width: 33%;">- Delay hold <li style="width: 33%;">- Zero reset <li style="width: 33%;">- Initial reset <li style="width: 33%;">- Linearity initialization <li style="width: 33%;">- ON-delay timer <li style="width: 33%;">- OFF-delay timer <li style="width: 33%;">- One-shot timer <li style="width: 33%;">- Previous value comparison <li style="width: 33%;">- Non-measurement setting <li style="width: 33%;">- Direct threshold value setting <li style="width: 33%;">- Position teaching <li style="width: 33%;">- Automatic teaching <li style="width: 33%;">- Hysteresis width setting <li style="width: 33%;">- Timing inputs <li style="width: 33%;">- Reset input <li style="width: 33%;">- Judgement output hold input <li style="width: 33%;">- Monitor focus <li style="width: 33%;">- Linear output correction <li style="width: 33%;">- (A-B) calculations *4 <li style="width: 33%;">- (A+B) calculations *4 <li style="width: 33%;">- K-(A+B) calculation *4 <li style="width: 33%;">- Mutual interference prevention *4 <li style="width: 33%;">- Sensor disconnection detection <li style="width: 33%;">- Zero reset memory <li style="width: 33%;">- Zero reset indicator <li style="width: 33%;">- Key lock 	
Indications	Judgement indicators: High (orange), pass (green), low (yellow), 7-segment main digital display (red), 7-segment sub-digital display (yellow), power ON (green), zero reset (green), enable (green)	
Voltage influence (including Sensor)	0.5% F.S. of linear output value at $\pm 20\%$ of power supply voltage	
Power supply voltage	12 to 24 VDC $\pm 10\%$, Ripple (p-p): 10% max.	
Current consumption	140 mA max. with power supply voltage of 24 VDC (with Sensor connected)	
Ambient temperature	Operating and storage: 0 to 50°C (with no icing or condensation)	
Ambient humidity	Operating and storage: 35% to 85% (with no condensation)	
Insulation resistance	20 M Ω min. (at 500 DC)	
Dielectric strength	1,000 VAC, 50/60 Hz for 1 min	
Vibration resistance (destruction)	10 to 150 Hz with 0.7-mm double amplitude for 80 min each in X, Y, and Z directions	
Shock resistance (destruction)	300 m/s ² , 3 times each in 6 directions (up, down, left, right, forward, backward)	
Connection method	Prewired (standard cable length: 2 m)	
Weight (packed state)	Approx. 350 g	
Materials	Case: PBT (polybutylene terephthalate), Cover: Polycarbonate	
Accessories	Instruction Manual	

- *1:The response time for the first linear output or judgment output is calculated as follows (with fixed sensitivity): Measurement period \times (Average count setting + 1). The response time for the second and later outputs is the measurement period specified in the table.
- *2: The output can be switched between a current output and voltage output using a switch on the bottom of the Amplifier Unit.
- *3: Setting is possible via the monitor focus function.
- *4: A Calculating Unit (ZX-CAL2) is required.

Engineering Data (Reference Value)

Measurement Distance vs. Linearity (with Linearity Adjusted for Standard Sensing Object)

ZX-EDR5T



ZX-ED01T



ZX-ED02T/ZX-EM02T

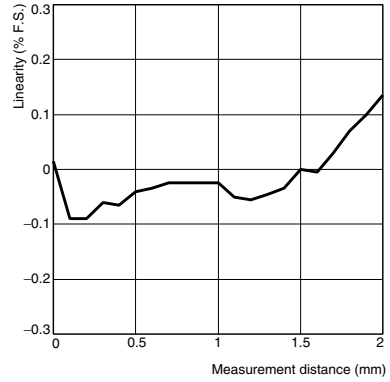

ZX-EM07MT



ZX-EV04T



ZX-EM02HT

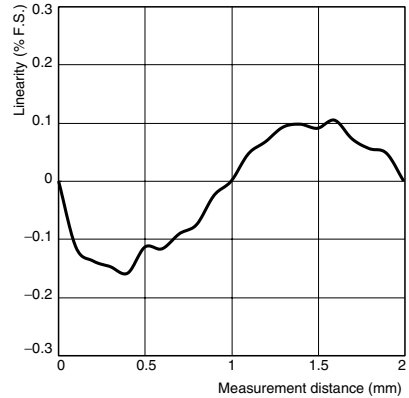

Size of Sensing Object vs. Linearity (with Linearity Adjusted for Each Sensing Object)

ZX-EDR5T



ZX-ED01T

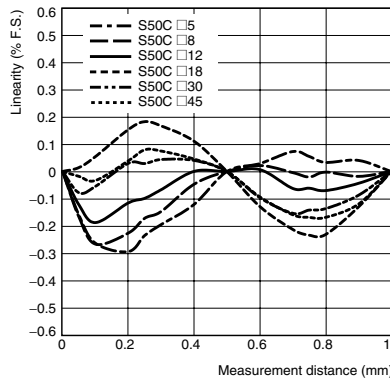

ZX-ED02T/ZX-EM02T

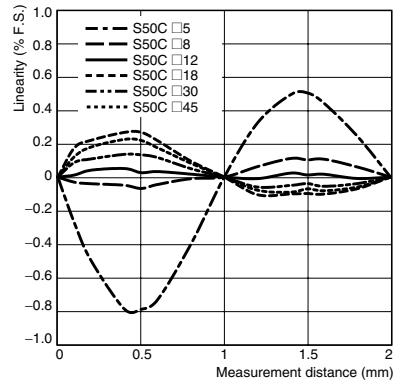

ZX-EM07MT

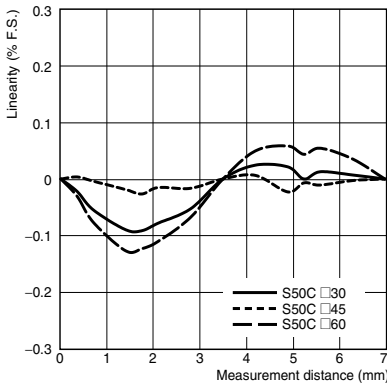

ZX-EV04T

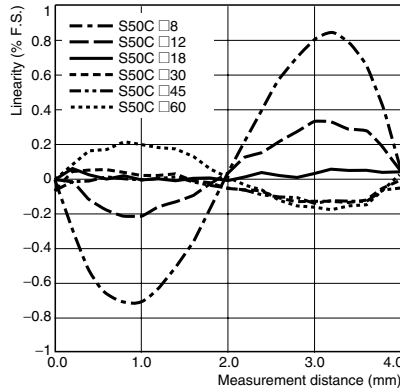

ZX-EM02HT

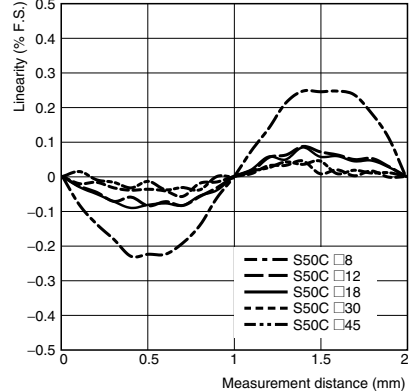

Size of Sensing Object vs. Linearity (with Linearity Adjusted for Standard Sensing Object)

ZX-EDR5T

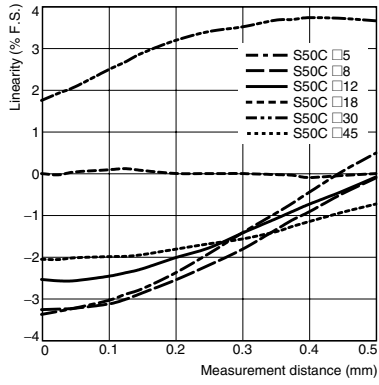

ZX-ED01T

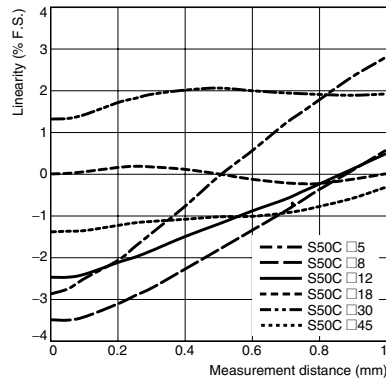

ZX-ED02T/ZX-EM02T

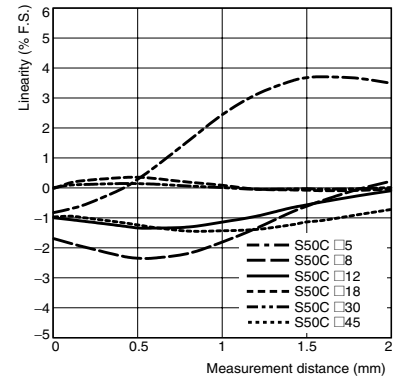

ZX-EM07MT



ZX-EV04T

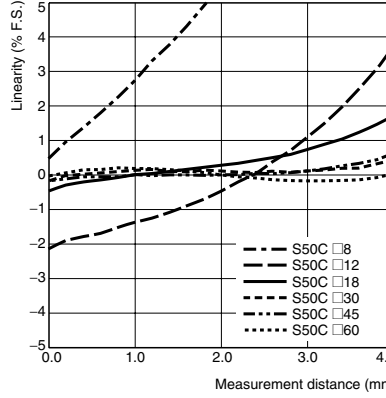

ZX-EM02HT



Material of Sensing Object vs. Linearity (with Linearity Adjusted for Each Sensing Object)

ZX-EDR5T



ZX-ED01T

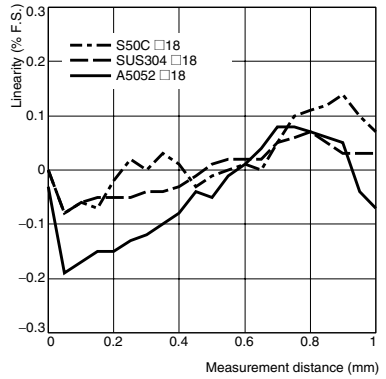

ZX-ED02T/ZX-EM02T

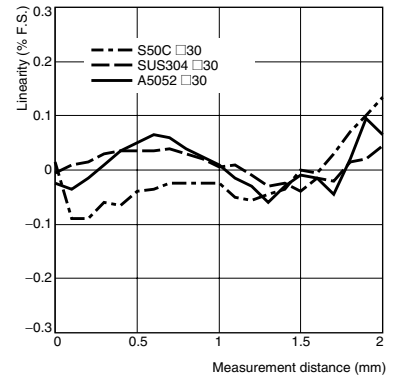

ZX-EM07MT

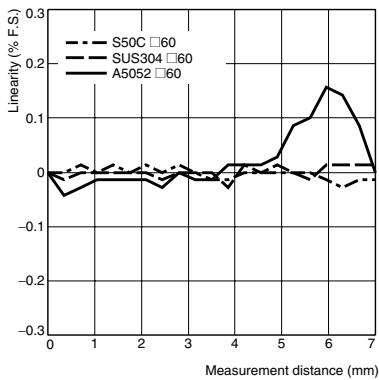

ZX-EV04T

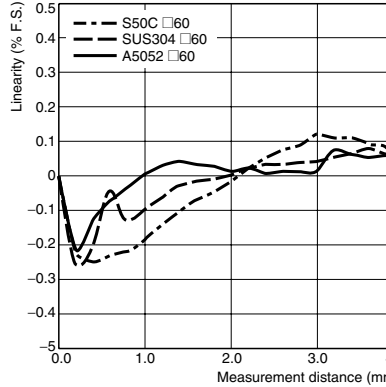

Material of Sensing Object vs. Linearity (with Linearity Adjusted for Standard Sensing Object and Iron)

ZX-EDR5T



ZX-ED01T



ZX-ED02T/ZX-EM02T



ZX-EM07MT



ZX-EV04T



Temperature Characteristics

ZX-EM02HT



I/O Circuit Diagrams

NPN Amplifier Unit: ZX-EDA11



PNP Amplifier Unit: ZX-EDA41



Connections: Amplifier Unit

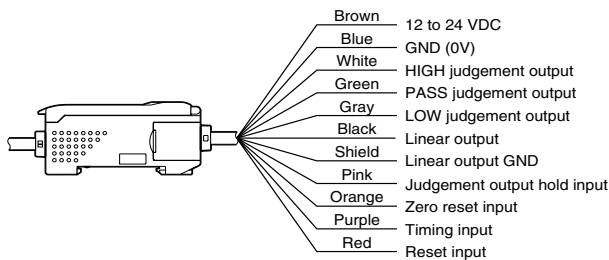

- Note 1.** Use a separate stabilized power supply for the Amplifier Unit, particularly when high resolution is required.
- 2.** Wire the Unit correctly. Incorrect wiring may result in damage to the Unit. (Do not allow wiring, particularly the linear output, to come into contact with other lines.)
- 3.** Use the blue (0-V) line for the power supply and use the shield wire (linear output ground) together with the black (linear output) line for linear output. Each of these grounds must be used for the designed purpose. When not using the linear output, connect the linear output ground to the 0-V ground.

Part Names

Sensors

- ZX-EDR5T
- ZX-ED01T
- ZX-ED02T
- ZX-EM02T
- ZX-EM07MT
- ZX-EM02HT



ZX-EV04T



Amplifier Units

- ZX-EDA11
- ZX-EDA41

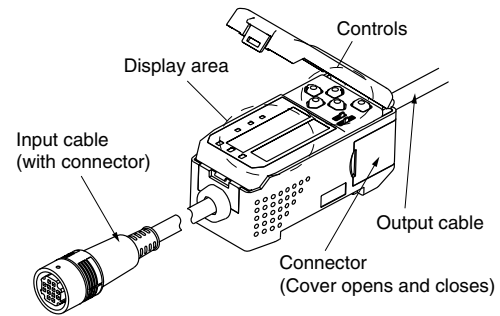

Calculating Unit

ZX-CAL2



Precautions

For details on information such as the usage precautions, → refer to the “ZX-E Series Smart Sensors Operation Manual” (Cat. No. Z166).

Design Precautions

Conform to the specified ratings and performance. Refer to *Specifications* on page 2 for details.

Objects of certain materials or shapes may not be detectable, or the detection accuracy may not be sufficiently high.

Environment

Do not operate the product in locations subject to flammable or explosive gases.

In order to ensure safe operation and maintenance, do not install the product in the vicinity of high-voltage devices or power equipment.

Wiring

Do not use the product at voltages exceeding the rated values. Doing so may result in damage.

Do not connect the product to an AC power supply or connect the power supply in reverse.

Do not short-circuit the load for open-collector output.

Do not lay the power cable for the product together with or in the same duct as high-voltage lines or power lines. Doing so may result in incorrect operation or damage due to induction.

Do not connect or disconnect connectors while the power is ON. Doing so may result in damage.

Adjustment

Setting

When setting threshold values, ensure that the Amplifier Unit's judgement output hold input line is ON so that there is no judgement output to external devices.

Other Precautions

Do not attempt to disassemble, repair, or modify the product.

Dispose of the product using standard procedures for industrial waste.

These Sensors are not compatible with the ZX-L□□ Smart Sensors (laser type). Do not connect combinations of ZX-E□□ Smart Sensors and ZX-T□□ Smart Sensors.

Correct Use

Design Precautions

Power Supplies

Allow a warm-up period of approximately 30 minutes after turning ON the power supply.

Mutual Interference

Up to 5 Sensor Heads can be used together by connecting the ZX-CAL2 Calculating Unit between Amplifier Units.

When installing Sensor Heads facing each other or in parallel, separate them by the minimum distances given in the table below.



Mutual Interference

Model	A	B
ZX-EDR5T	5 mm	20 (3.1) mm
ZX-ED01T	10 mm	50 (5.4) mm
ZX-ED02T	20 mm	50 (8) mm
ZX-EM02T	20 mm	50 (10) mm
ZX-EM07MT	100 mm	150 (30) mm
ZX-EV04T	80 mm	50 (14) mm
ZX-EM02HT	20 mm	50 (12) mm

Note: The figures in parentheses apply when the mutual interference prevention function is used.

Compatibility

Sensors and Amplifier Units are mutually compatible. Sensors can be added or replaced individually.

Influence of High-frequency Electromagnetic Fields

Using the product in the vicinity of devices that generate high-frequency electromagnetic fields, such as ultrasonic cleaning equipment, high-frequency generators, transceivers, mobile phones, and inverters, may result in malfunction.

Influence of Metallic Objects

When installing the product, separate it from metallic objects by the distances shown below.

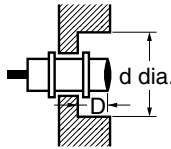

Influence of Metallic Objects

Model	d	D
ZX-EDR5T	8 mm	9 mm
ZX-ED01T	10 mm	
ZX-ED02T/EM02T	12 mm	
ZX-EM07MT	55 mm	20 mm
ZX-EV04T	16 × 32 mm	4.8 mm
ZX-EM02HT	18 mm	9 mm

Wiring

Wiring Check

After wiring is completed, before turning ON the power, confirm that the power supply is connected correctly, that there are no faulty connections, such as load short-circuits, and that the load current is correct. Incorrect wiring may result in failure.

Cable Extension

Do not extend the cable for the Sensor and the Amplifier Unit to a length exceeding 10 m. Use a ZX-XC□A Extension Cable (sold separately) to extend the Sensor's cable. Extend the Amplifier Unit's cable using a shielded cable of the same type.

Power Supply

When using a commercially available switching regulator, ground the FG (frame ground) terminal.

If the power supply line is subject to surges, connect a surge absorber that meets the conditions of the operating environment.

Calculating Unit

When using a Calculating Unit, connect the linear output ground of the corresponding Amplifier Unit.

Connectors

Do not connect or disconnect connectors while the power is ON.

Be sure hold to connectors by the cover when connecting or disconnecting.

Mounting

Handling

When mounting the Sensor Head, do not apply excessive shock by, for example, using a hammer. Doing so may result in damage or a reduction in the level of water-proofing. Also, there are screw-shaped models that require a toothed washer to allow for a tolerance in the tightening torque for the nut.

When using a heat-resistant model like the ZX-EM02HT, develop designs that account for thermal expansion due to rising sensing object temperature so the sensing object will never touch the sensing surface. Also note that any sudden rise in temperature will shorten the service life of the product.

Tightening Torque

Do not apply excessive torque when tightening the nut. Use a toothed washer if necessary.



Model	Tightening torque
ZX-EM02T	15 N·m
ZX-EM07MT	
ZX-EM02HT	59 N·m

Note: The above figure applies for use with a toothed washer.

Mounting Cylindrical Models:

Tighten set screws with a tightening torque of 0.2 N·m max.

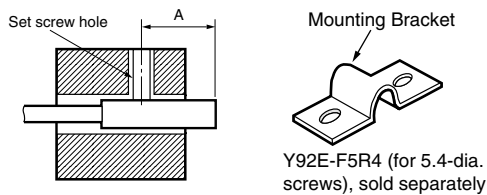

Model	A
ZX-EDR5T	9 to 18 mm
ZX-ED01T	
ZX-ED02T	11 to 22 mm

Installation Location

Do not install the product in the following locations.

- Locations subject to temperatures outside the specified range
- Locations subject to condensation due to sudden temperature changes
- Locations subject to humidity levels outside range 35% to 85%
- Locations subject to corrosive or flammable gases
- Locations subject to dust, salts, or metallic powder.
- Locations directly subject to vibrations and shocks
- Locations subject to direct sunlight
- Locations subject to splashes of water, oil, or chemicals
- Locations subject to strong electromagnetic or electrical fields

Maintenance and Inspection

- Be sure to turn OFF the power supply before adjusting or removing the Sensor Head.
- Cleaning:
Do not use thinners, benzine, acetone, or kerosene for cleaning.

Dimensions

Sensors

Sensor Heads

ZX-EDR5T



ZX-ED01T

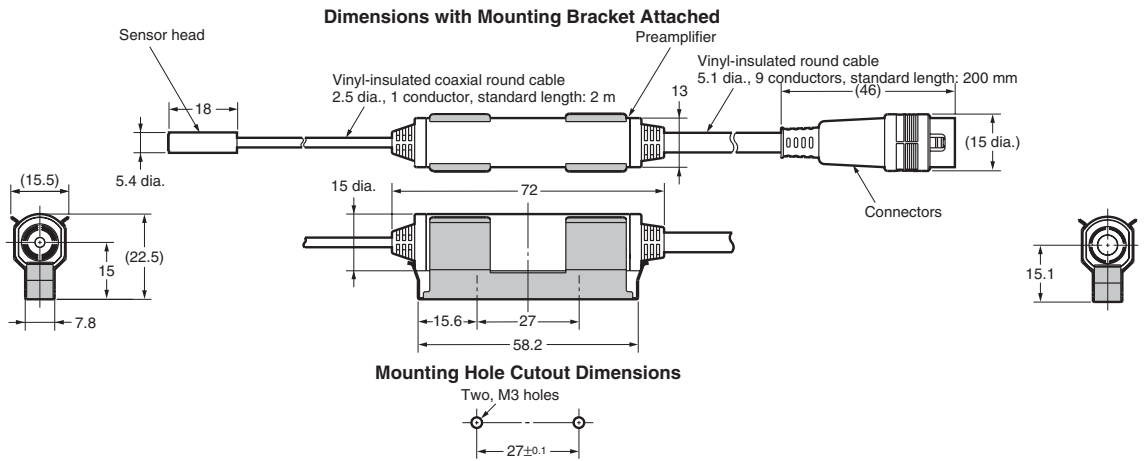

ZX-ED02T



ZX-EM02T

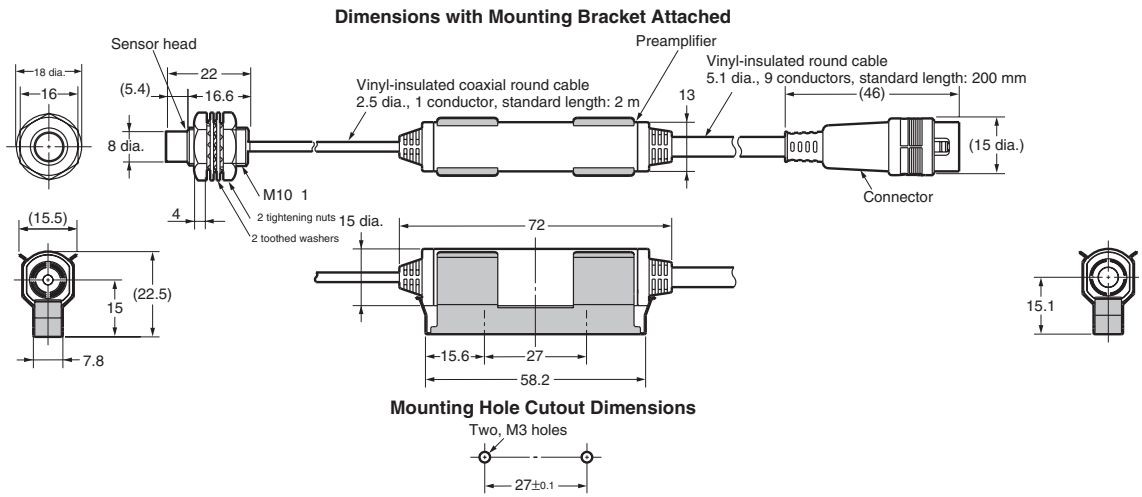

ZX-EM07MT

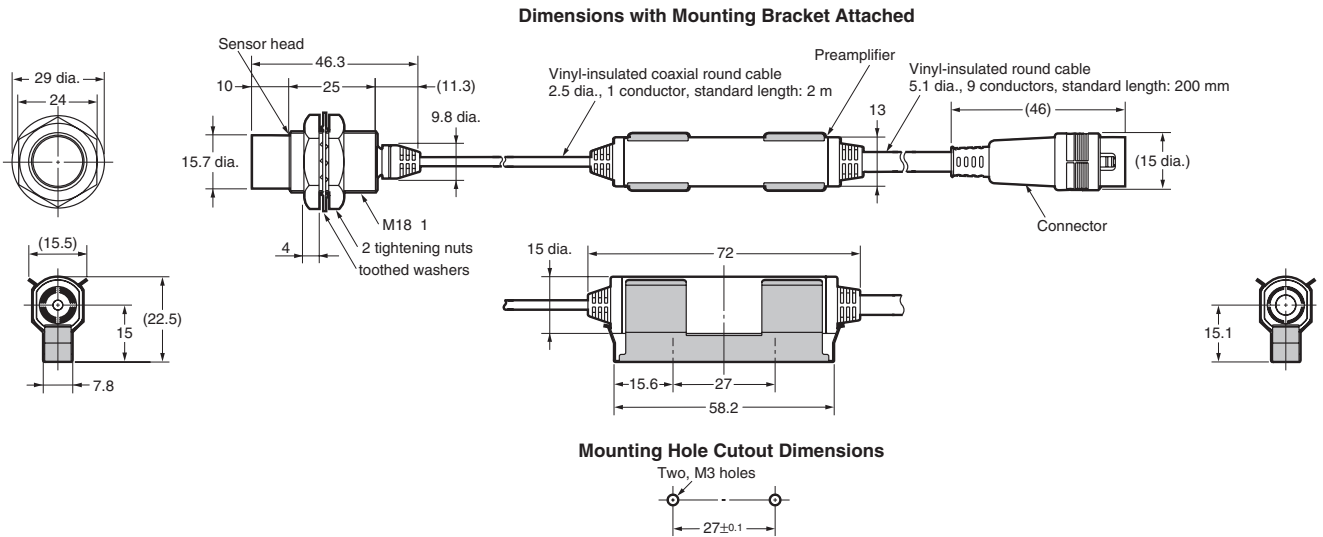

ZX-EV04T

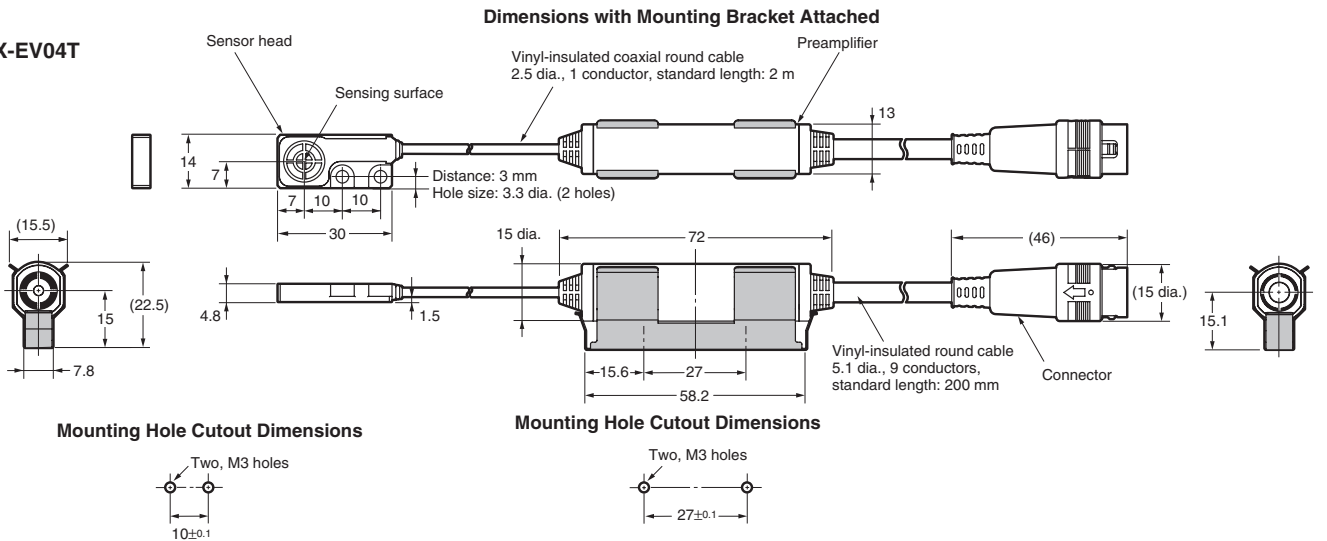

ZX-EM02HT



Mounting Hole Cutout Dimensions



Dimensions with Mounting Bracket Attached



Amplifier Units

- ZX-EDA11
- ZX-EDA41



ZX-series Communications Interface Unit

ZX-SF11



Cables with Connectors on Both Ends (for Extension)

- ZX-XC1A (1 m)
- ZX-XC4A (4 m)
- ZX-XC8A (8 m)



ALL DIMENSIONS SHOWN ARE IN MILLIMETERS.

To convert millimeters into inches, multiply by 0.03937. To convert grams into ounces, multiply by 0.03527.

This document provides information mainly for selecting suitable models. Please read the manual carefully for information that the user must understand and accept before purchase, including information on warranty, limitations of liability, and precautions.

CSM_8_2_1116
E331-E1

In the interest of product improvement, specifications are subject to change without notice.

OMRON Corporation

Industrial Automation Company

Sensing Devices Division H.Q.

Application Sensors Division

Shiokoji Horikawa, Shimogyo-ku,
Kyoto, 600-8530 Japan

Tel: (81)75-344-7068/Fax: (81)75-344-7107