

Machine Automation Controller NJ-series

# EtherCAT(R) Connection Guide

## OMRON Corporation

Displacement Sensor  
(ZW-7000 Series)

Network  
Connection  
Guide

### **About Intellectual Property Rights and Trademarks**

---

Microsoft product screen shots reprinted with permission from Microsoft Corporation.

Windows is a registered trademark of Microsoft Corporation in the USA and other countries.

EtherCAT(R) is registered trademark and patented technology, licensed by Beckhoff Automation GmbH, Germany.

Sysmac is a trademark or registered trademark of OMRON Corporation in Japan and other countries for OMRON factory automation products.

Company names and product names in this document are the trademarks or registered trademarks of their respective companies.

---

## Table of Contents

<b>1. Related Manuals .....</b>	<b>1</b>
<b>2. Terms and Definitions .....</b>	<b>2</b>
<b>3. Precautions.....</b>	<b>3</b>
<b>4. Overview .....</b>	<b>4</b>
<b>5. Applicable Devices and Device Configuration .....</b>	<b>5</b>
5.1. Applicable Devices .....	5
5.2. Device Configuration .....	6
<b>6. EtherCAT Settings .....</b>	<b>8</b>
6.1. Parameters .....	8
6.2. Device Variables .....	9
<b>7. EtherCAT Connection Procedure.....</b>	<b>12</b>
7.1. Work Flow.....	12
7.2. Sensor Controller Setup .....	13
7.3. Controller Setup.....	23
7.4. EtherCAT Communication Status Check .....	32
<b>8. Initialization method.....</b>	<b>36</b>
8.1. Initializing Controller .....	36
8.2. Initializing Sensor Controller .....	36
<b>9. Revision History .....</b>	<b>37</b>

## 1. Related Manuals

To ensure system safety, make sure to always read and follow the information provided in all Safety Precautions and Precautions for Safe Use in the manuals for each device which is used in the system.

Cat. No.	Model	Manual name
W500	NJ501-□□□□	NJ-series
	NJ301-□□□□	CPU Unit
	NJ101-□□□□	Hardware User's Manual
W501	NJ501-□□□□	NJ/NX-series
	NJ301-□□□□	CPU Unit
	NJ101-□□□□	Software User's Manual
W505	NJ501-□□□□	NJ/NX-series
	NJ301-□□□□	CPU Unit Built-in EtherCAT(R) Port
	NJ101-□□□□	User's Manual
W504	SYSMAC-SE2□□□□	Sysmac Studio Version 1 Operation Manual
0969584-7	W4S1-05□	Switching Hub
	W4S1-03B	W4S1-series Users Manual
Z362	ZW-7000□	Displacement Sensor ZW-7000 series Confocal Fiber Type Displacement Sensor User's Manual
Z363	ZW-7000□	Displacement Sensor ZW-7000 series Confocal Fiber Type Displacement Sensor User's Manual for Communications Settings

## 2. Terms and Definitions

Term	Explanation and Definition
PDO communications (Communications using Process Data Objects)	<p>This method is used for cyclic data exchange between a master unit and slave units.</p> <p>PDO data (i.e., I/O data that is mapped to PDOs) that is allocated in advance is refreshed periodically each EtherCAT process data communications cycle. (i.e., the period of primary periodic task)</p> <p>The NJ-series Machine Automation Controller uses the PDO communications for commands to refresh I/O data in a fixed control period, including I/O data for slave units, and the position control data for servomotors.</p> <p>It is accessed from NJ-series Machine Automation Controller in the following ways.</p> <ul style="list-style-type: none"> <li>· With device variables for EtherCAT slave I/O</li> <li>· With axis variables for a servo drive and an encoder input slave to which assigned as an axis</li> </ul>
SDO communications (Communications using Service Data Objects)	<p>This method is used to read and write the specified slave unit data from a master unit when required.</p> <p>The NJ-series Machine Automation Controller uses SDO communications for commands to read and write data, such as for parameter transfers, at specified times.</p> <p>The NJ-series Machine Automation Controller can read/write the specified slave data (parameters and error information, etc.) with the EC_CoESDORead (Read CoE SDO) instruction or the EC_CoESDOWrite (Write CoE SDO) instruction.</p>
Slave unit	<p>There are various types of slaves such as servo drives that handle position data and I/O terminals that handle the bit signals.</p> <p>The slave unit receives output data sent from the master, and sends input data to the master.</p>
Node address	<p>A node address is an address to identify a unit connected to EtherCAT.</p>

## 3. Precautions

- (1) Understand the specifications of devices which are used in the system. Allow some margin for ratings and performance. Provide safety measures, such as installing a safety circuit, in order to ensure safety and minimize the risk of abnormal occurrence.
- (2) To ensure system safety, make sure to always read and follow the information provided in all Safety Precautions and Precautions for Safe Use in the manuals for each device which is used in the system.
- (3) The user is encouraged to confirm the standards and regulations that the system must conform to.
- (4) It is prohibited to copy, to reproduce, and to distribute a part or the whole of this document without the permission of OMRON Corporation.
- (5) The information contained in this document is current as of May 2016. It is subject to change for improvement without notice.

The following notations are used in this document.



**WARNING**

Indicates a potentially hazardous situation which, if not avoided, may result in minor or moderate injury, or may result in serious injury or death. Additionally there may be significant property damage.



**Caution**

Indicates a potentially hazardous situation which, if not avoided, may result in minor or moderate injury or property damage.



### **Precautions for Correct Use**

Precautions on what to do and what not to do to ensure proper operation and performance.



### **Additional Information**

Additional information to read as required.

This information is provided to increase understanding or make operation easier.

### **Symbol**



The filled circle symbol indicates operations that you must do.  
The specific operation is shown in the circle and explained in the text.  
This example shows a general precaution for something that you must do.

## 4. Overview

This document describes the procedures for connecting Confocal Fiber Type Displacement Sensor (hereinafter referred to as Sensor Controller) to NJ-series Machine Automation Controller (hereinafter referred to as Controller) via EtherCAT, both produced by OMRON Corporation (hereinafter referred to as OMRON), and for checking their connections. Refer to *Section 6. EtherCAT Settings* and *Section 7. EtherCAT Connection Procedure* to understand setting methods and key points to perform PDO Communications via EtherCAT.

## 5. Applicable Devices and Device Configuration

### 5.1. Applicable Devices

The applicable devices are as follows:

Manufacturer	Name	Model
OMRON	NJ-series CPU Unit	NJ501-□□□□□ NJ301-□□□□□ NJ101-□□□□□
OMRON	Confocal Fiber Type Displacement Sensor Sensor Controller Sensor Head	ZW-7000□ ZW-S70□□



#### Precautions for Correct Use

In this document, the devices with models and versions listed in 5.2. *Device Configuration* are used as examples of applicable devices to describe the procedures for connecting the devices and checking their connections.

You cannot use devices with versions lower than the versions listed in 5.2.

To use the above devices with models not listed in 5.2. or versions higher than those listed in 5.2., check the differences in the specifications by referring to the manuals before operating the devices.



#### Additional Information

This document describes the procedures for establishing the network connections.

It does not provide information on operation, installation, wiring method, device functionality, or device operation, which is not related to the connection procedures.

Refer to the manuals or contact your OMRON representative.



**5.2. Device Configuration**

The hardware components to reproduce the connection procedures in this document are as follows:

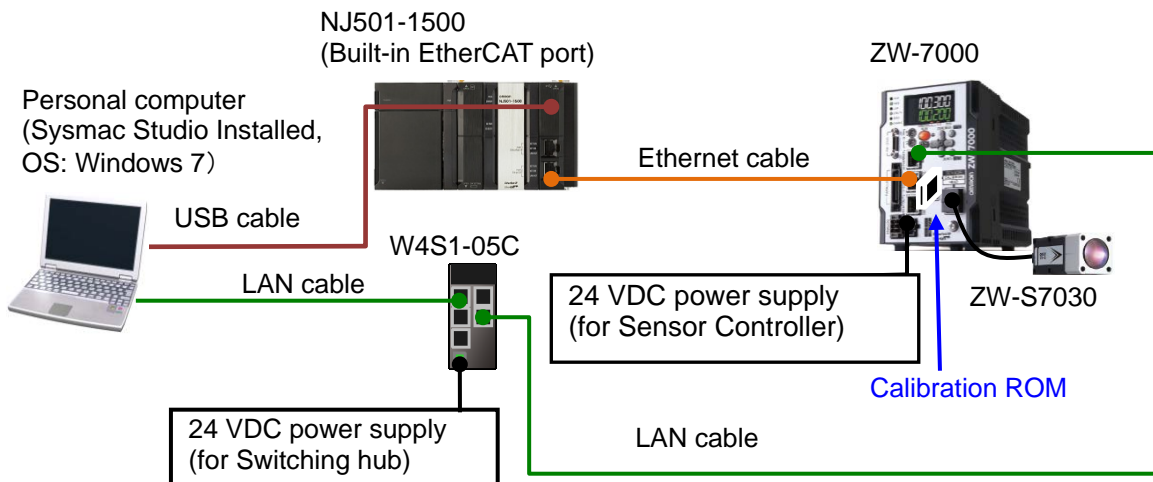

Manufacturer	Name	Model	Version
OMRON	CPU Unit (Built-in EtherCAT port)	NJ501-1500	Ver.1.10
OMRON	Power Supply Unit	NJ-PA3001	
OMRON	Sysmac Studio	SYSMAC-SE2[ ] [ ] [ ] [ ]	Ver.1.15
-	Personal computer (OS: Windows 7)	-	
-	USB cable (USB 2.0 type B connector)	-	
-	LAN cable (STP (shielded, twisted-pair) cable of Ethernet category 5 or higher)	-	
OMRON	Switching hub	W4S1-05C	Ver.1.00
-	24 VDC power supply (for switching hub)	-	
OMRON	Ethernet cable (with industrial Ethernet connector)	XS5W-T421-[ ]M[ ]-K	
OMRON	Sensor Controller	ZW-7000	Rev.1.0
OMRON	Sensor Head	ZW-S7030	
OMRON	Calibration ROM	(Supplied with Sensor Head)	
OMRON	24 VDC power supply (for Sensor Controller) (DC24V 2.5A 60W)	S8VS-06024	



**Precautions for Correct Use**

The connection line of EtherCAT communications cannot be shared with other Ethernet networks.

Do not use devices for Ethernet such as a switching hub.

Use the Ethernet cable (double shielding with aluminum tape and braiding) of Category 5 or higher, and use the shielded connector of Category 5 or higher.

Connect the cable shield to the connector hood at both ends of the cable.



### Precautions for Correct Use

---

Update Sysmac Studio to the version specified in this *Clause 5.2.* or to a higher version. If you use a version higher than the one specified, the procedures and related screenshots described in *Section 7.* and subsequent sections may not be applicable. In that case, use the equivalent procedures described in this document by referring to the *Sysmac Studio Version 1 Operation Manual* (Cat. No. W504).

---



### Additional Information

---

For specifications of Ethernet cables and network wiring, refer to *Section 4. EtherCAT Network Wiring* of the *NJ/NX-series CPU Unit Built-in EtherCAT(R) Port User's Manual* (Cat. No. W505).

---



### Additional Information

---

For specifications of 24 VDC power supply available for Sensor Controller, refer to the *Displacement Sensor ZW-7000 series Confocal Fiber Type Displacement Sensor User's Manual* (Cat. No. Z362).

---



### Additional Information

---

The system configuration in this document uses USB for the connection between Personal computer and Controller. For information on how to install the USB driver, refer to *A-1 Driver Installation for Direct USB Cable Connection* in *Appendices* of the *Sysmac Studio Version 1 Operation Manual* (Cat. No. W504).

---

## 6. EtherCAT Settings

This section describes the setting contents of parameters and device variables that are all defined in this document.

Hereinafter, Sensor Controller is referred to as "Slave Unit" in some descriptions.

### 6.1. Parameters

The parameters required for connecting Controller and Sensor Controller via EtherCAT are given below.

#### 6.1.1. Communication settings between Personal computer for setting and Sensor Controller

The parameters for Sensor Controller are set using the Ethernet communications with Personal Computer for settings.

The parameters required for connecting Personal computer for setting and Sensor Controller via Ethernet are shown below.

Item	Personal Computer for setting	Sensor Controller
IP address	192.168.250.100	192.168.250.50 (Default)
Subnet mask	255.255.255.0	255.255.255.0 (Default)

#### 6.1.2. Setting of EtherCAT

The table below shows the settings to use the EtherCAT communications.

Device	Item	Set value	Remarks
Sensor Controller	Node address	1	By the node address setting switches
	Fieldbus	EtherCAT (Default)	Using Sysmac Studio.
	GATE signal ON time	1ms (Default)	Using Sysmac Studio.

## 6.2. Device Variables

The PDO communications data with Sensor Controller are assigned to the Controller's device variables.

The device variables and the data types are shown below.

### ■ Output area (Controller to Sensor Controller)

Device variable name	Data type	Meaning
E001_Sensor_Head_Control_Signal1	DWORD	Sensor Head Control Signal 1
E001_EXE	BOOL	Control command execution
E001_SYNC	BOOL	Measurement synchronous start
E001_ERCLR	BOOL	Error clear
E001_Sensor_Head_Control_Signal2	DWORD	Sensor Head Control Signal 2
E001_TIMING	BOOL	Timing signal
E001_RESET	BOOL	Reset signal
E001_LIGHTOFF	BOOL	Light metering OFF
E001_ZERO_T1	BOOL	Zero reset execution signal of task 1
E001_ZERO_T2	BOOL	Zero reset execution signal of task 2
E001_ZERO_T3	BOOL	Zero reset execution signal of task 3
E001_ZERO_T4	BOOL	Zero reset execution signal of task 4
E001_ZEROCLR_T1	BOOL	Zero reset cancel signal of task 1
E001_ZEROCLR_T2	BOOL	Zero reset cancel signal of task 2
E001_ZEROCLR_T3	BOOL	Zero reset cancel signal of task 3
E001_ZEROCLR_T4	BOOL	Zero reset cancel signal of task 4
E001_Command	DWORD	Command code
E001_Command_Parameter1	UINT	Command parameter 1
E001_Command_Parameter2	UINT	Command parameter 2
E001_Command_Parameter3	DINT	Command parameter 3

## ■ Input area (Sensor Controller to Controller)

Device variable name	Data type	Meaning
E001_Sensor_Head_Status_Signal1	DWORD	Sensor Head Status Signal 1
E001_FLG	BOOL	Control command completion
E001_SYNCFLG	BOOL	Measurement synchronization completion
E001_READY	BOOL	Ready
E001_RUN	BOOL	RUN screen
E001_BANKOUT_A	BOOL	Current bank number bit0
E001_BANKOUT_B	BOOL	Current bank number bit1
E001_BANKOUT_C	BOOL	Current bank number bit2
E001_BANKOUT_D	BOOL	Current bank number bit3
E001_BANKOUT_E	BOOL	Current bank number bit4
E001_ERR	BOOL	Error signal
E001_Sensor_Head_Status_Signal2	DWORD	Sensor Head Status Signal 2
E001_HOLDSTAT	BOOL	Hold execution status
E001_RESETSTAT	BOOL	Reset execution status
E001_LIGHT	BOOL	Light status
E001_STABILITY	BOOL	Measurement position
E001_ENABLE	BOOL	Measurement state
E001_GATE	BOOL	Data output completed
E001_OR	BOOL	Overall judgement result
E001_TASKSTAT_T1	BOOL	TASK status of task 1
E001_TASKSTAT_T2	BOOL	TASK status of task 2
E001_TASKSTAT_T3	BOOL	TASK status of task 3
E001_TASKSTAT_T4	BOOL	TASK status of task 4
E001_ZEROSTAT_T1	BOOL	Zero reset status of task 1
E001_ZEROSTAT_T2	BOOL	Zero reset status of task 2
E001_ZEROSTAT_T3	BOOL	Zero reset status of task 3
E001_ZEROSTAT_T4	BOOL	Zero reset status of task 4
E001_HIGH_T1	BOOL	High output of task 1
E001_PASS_T1	BOOL	Pass output of task 1
E001_LOW_T1	BOOL	Low output of task 1
E001_HIGH_T2	BOOL	High output of task 2
E001_PASS_T2	BOOL	Pass output of task 2
E001_LOW_T2	BOOL	Low output of task 2
E001_HIGH_T3	BOOL	High output of task 3
E001_PASS_T3	BOOL	Pass output of task 3
E001_LOW_T3	BOOL	Low output of task 3
E001_HIGH_T4	BOOL	High output of task 4
E001_PASS_T4	BOOL	Pass output of task 4
E001_LOW_T4	BOOL	Low output of task 4
E001_Response	DWORD	Command code
E001_Response_Code	DWORD	Response code
E001_Response_Data1	DINT	Response data
E001_Output_Data_1	DINT	OUT1 measured value
E001_Output_Data_2	DINT	OUT2 measured value
E001_Output_Data_3	DINT	OUT3 measured value
E001_Output_Data_4	DINT	OUT4 measured value

■ Status area (Sensor Controller to Controller)

Device variable name	Data type	Meaning
E001_Sysmac_Error_Status	BYTE	Sysmac error status
E001_Observation	BOOL	Observation levels of information
E001_Minor_Fault	BOOL	Minor fault levels of information



#### Additional Information

---

Refer to 3-1 *EtherCAT Connection of the Displacement Sensor ZW-7000 series Confocal Fiber Type Displacement Sensor User's Manual for Communications Settings* (Cat. No. Z363) for details on assignments of input, output, and status areas.

---



#### Additional Information

---

The device variables are named automatically from a combination of the device names and the port names.

The default device names are "E" followed by a serial number that starts from 001.

---

## 7. EtherCAT Connection Procedure

This section describes the procedures for connecting Controller and Sensor Controller via EtherCAT. The explanations of procedures for setting up Controller and Sensor Controller given in this document are based on the factory default settings.

For the initialization, refer to *Section 8. Initialization Method*.

### 7.1. Work Flow

Take the following steps to perform the PDO communications by connecting Controller and Sensor Controller via EtherCAT.

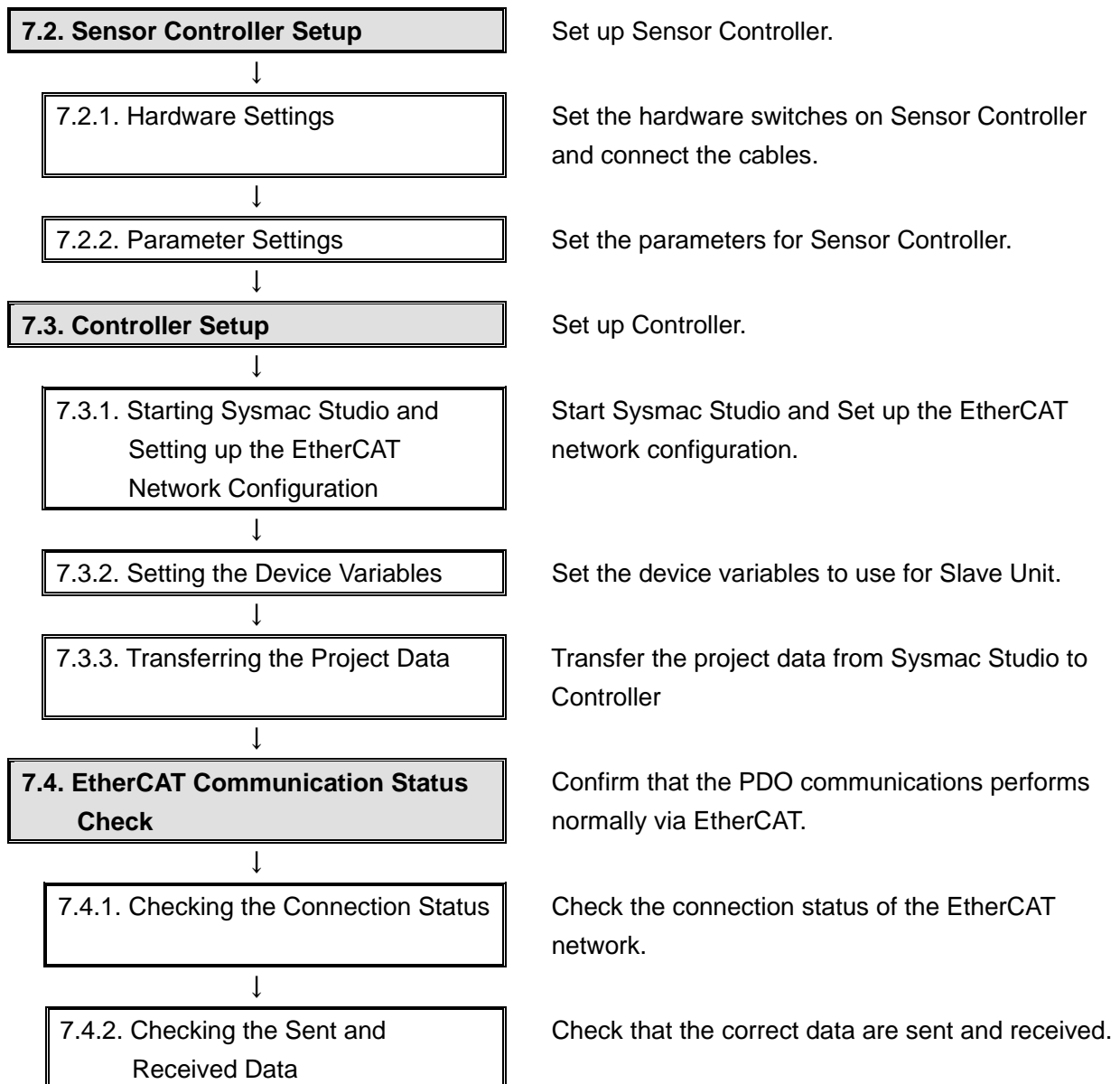

## 7.2. Sensor Controller Setup

Set up Sensor Controller.

### 7.2.1. Hardware Settings

Set the hardware switches on Sensor Controller and connect the cables.



#### Precautions for Correct Use

Make sure that the power supply is OFF when you set up.

- 1 Make sure that Sensor Controller is powered OFF.

\*If the power supply is turned ON, the settings described in the following steps and subsequent procedures may not be applicable.

- 2 Check the positions of the hardware switches and the connectors on Sensor Controller by referring to the figure on the right.

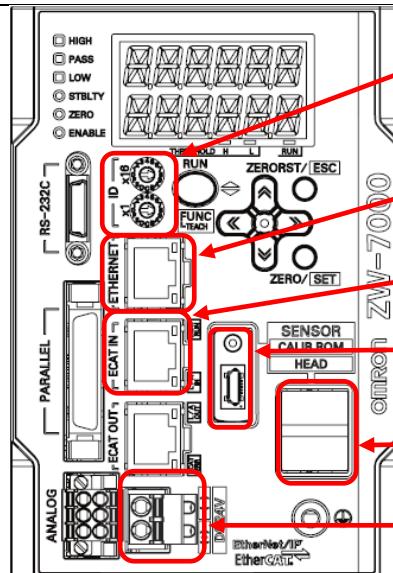

Node address setting switches (ID)

Ethernet connector

EtherCAT input connector

ROM connector

Fiber adapter

24 V input terminal block

- 3 Set Node address setting switches (ID) as shown below.

x16: 0

x1: 1

\*The node address is set to 1.

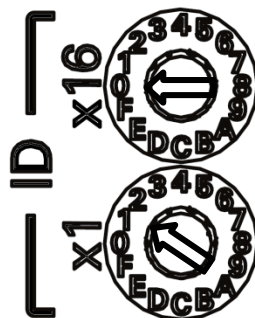

- 4 Connect Calibration ROM to ROM connector.

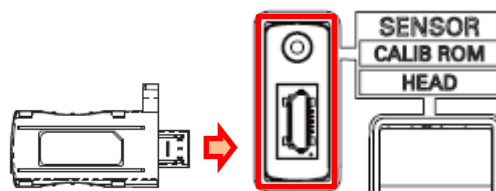

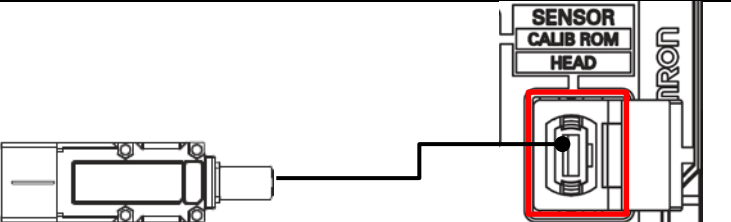
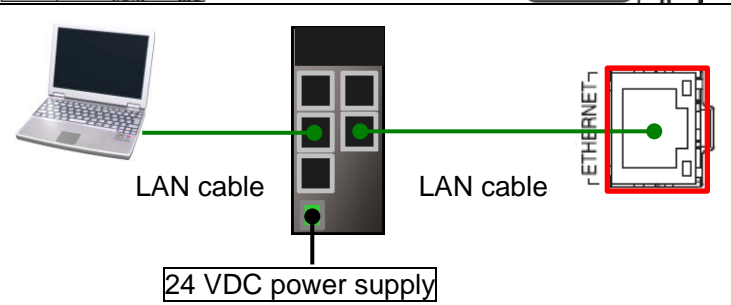
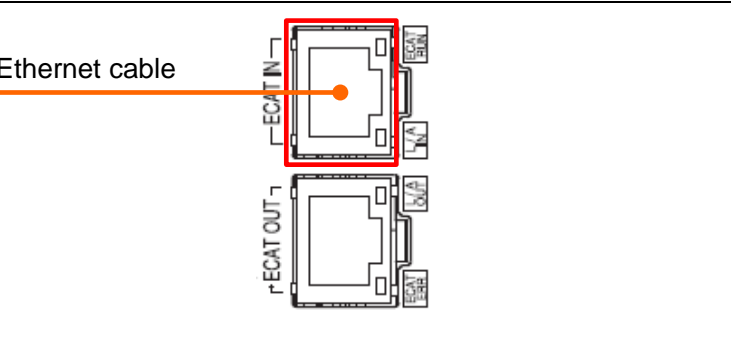
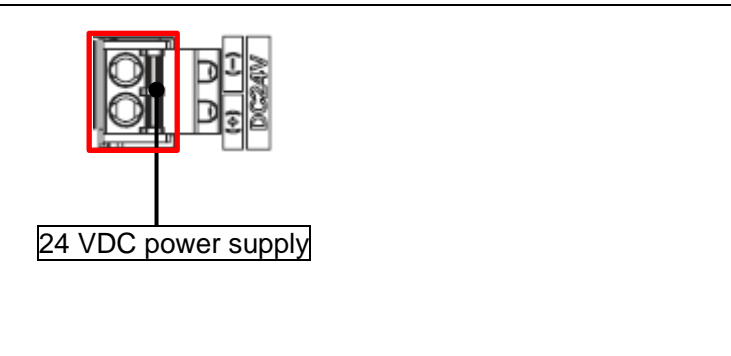

## 7. EtherCAT Connection Procedure

5	<p>Connect Fiber connector on Sensor Head to Fiber adapter.</p>	
6	<p>Connect Switching hub to Personal computer and to Ethernet connector on Sensor Controller with LAN cables. Connect 24 VDC power supply (for Switching hub) to Switching hub.</p>	
7	<p>Connect an Ethernet cable to EtherCAT input connector.</p>	
8	<p>Connect 24 VDC power supply to 24 V input terminal block.</p> <p>*For details on specifications of 24 VDC power supply available for Sensor Controller, refer to the <i>Displacement Sensor ZW-7000 series Confocal Fiber Type Displacement Sensor User's Manual</i> (Cat. No. Z362).</p>	

### 7.2.2. Parameter Settings

Set the parameters for Sensor Controller.

The Parameters are set using Sysmac Studio.

Install Sysmac Studio on Personal computer beforehand.

Since Personal computer and Sensor Controller are connected with LAN cables, set the IP address of Personal computer to *192.168.250.100*.



#### **Precautions for Correct Use**

---

The parameters for Sensor Controller are checked using the Ethernet communications with Personal computer.

Note that there may be some changes required for the Personal computer settings depending on the state of Personal computer.

---

- 
- 1 Turn ON Sensor Controller and Switching hub.
-

- 2 Set the IP address of Personal computer to *192.168.250.100*.

\*The IP address can be changed in the following way.

- (1) Start Personal computer and log in using an administrator account. From the Windows Start menu, select **Control Panel - Network and Internet - Network and Sharing Center**, and click **Change Adapter Settings**. Double-click **Local Area Connection**.

\*The procedure steps may be different depending on the environment settings of Personal computer.

- (2) The Local Area Connection Status Dialog Box is displayed. Click **Properties**.

- (3) The Local Area Connection Properties Dialog Box is displayed. Select **Internet Protocol Version 4 (TCP/IPv4)**, and click **Properties**.

\*The display differs depending on the configuration of Personal computer.

- (4) The Internet Protocol Version 4 (TCP/IPv4) Properties Dialog Box is displayed. Select **Use the following IP address**, and set the IP address to *192.168.250.100* and the subnet mask to *255.255.255.0*. Click **OK**.

- (5) Click **Close** or **OK** to close all the displayed dialog boxes.

Dialog box in (2)

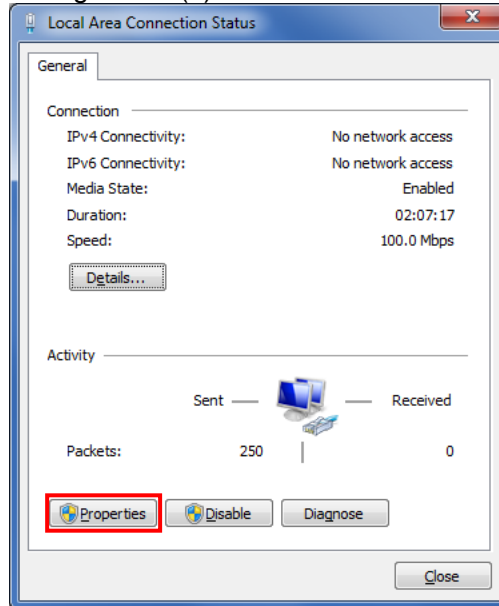

Dialog box in (3)

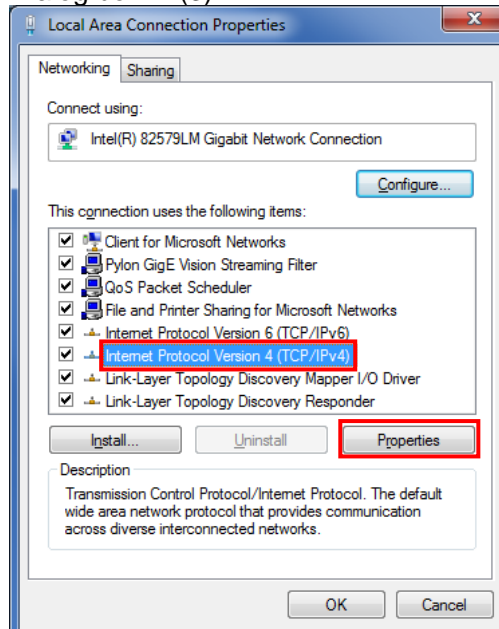

Dialog box in (4)

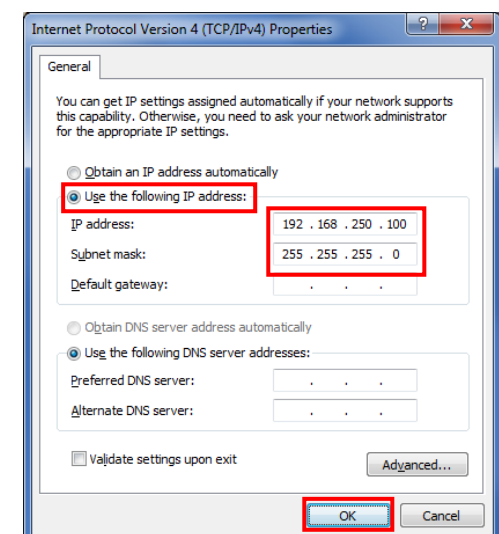

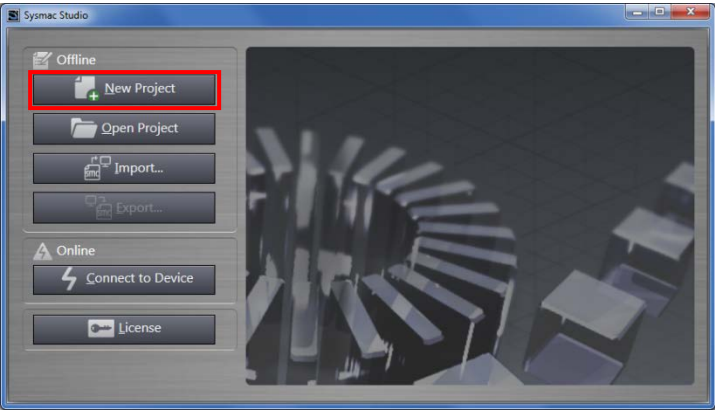
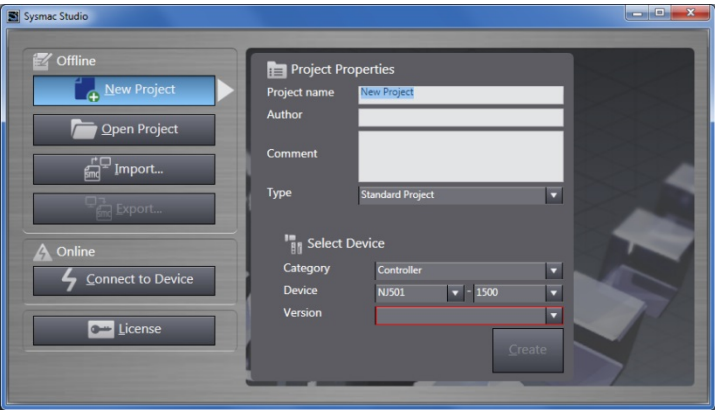
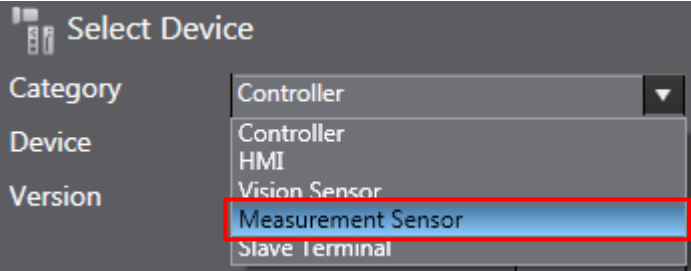
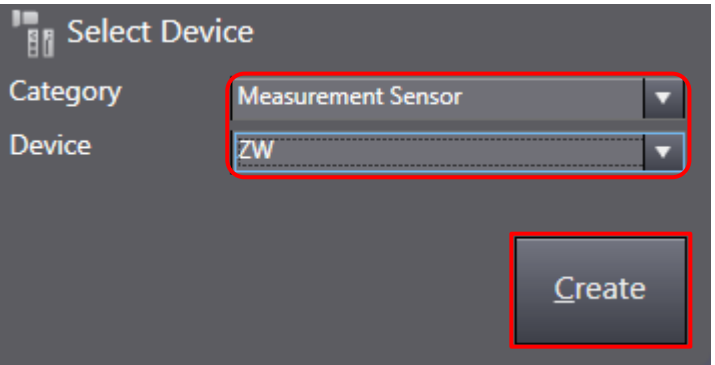
- |  |  |
|--|--|
| <p><b>3</b> Start Sysmac Studio.</p> <p>*If the User Account Control Dialog Box is displayed at start, make a selection to start Sysmac Studio.</p>  |     |
| <p><b>4</b> Sysmac Studio starts.<br/>Click <b>New Project</b>.</p>  |    |
| <p><b>5</b> The Project Properties Dialog Box is displayed.</p>  |   |
| <p><b>6</b> Select <b>Measurement Sensor</b> from the pull-down list of Category in the <i>Select Device</i> Field.</p>  |  |
| <p><b>7</b> Check that the category and the device in the <i>Select Device</i> Field are set as shown below.</p> <p style="margin-left: 20px;">Category: Measurement Sensor</p> <p style="margin-left: 20px;">Device: ZW</p> <p>Click <b>Create</b>.</p> |  |

8 The Select Sensor Dialog Box is displayed.

Select *Specify a sensor* and enter the IP address to

192.168.250.50.

Click **Confirm**.

Select Sensor

Specify a sensor

IP address 192.168.250.50

Confirm

Name	ZW
Sensor controller type	
Version	
Sensor head type	
Sensor serial No.	

Enter the type

Model ZW-CE10

Version 1.2\*\*

OK Cancel

9 The information of Sensor Controller and Sensor Head is displayed. Check that the information displayed there indicates the connected devices. Click **OK**.

\*If Sensor Controller is not specified, the IP address and other settings may not be in the factory default state. Refer to the *Displacement Sensor ZW-7000 series Confocal Fiber Type Displacement Sensor User's Manual* (Cat. No. Z362) to check the values of IP address and others.

Select Sensor

Specify a sensor

IP address 192.168.250.50

Confirm

Name	ZW-7
Sensor controller type	ZW-7000
Version	2.020
Sensor head type	ZW-S7030
Sensor serial No.	SAMH115

Enter the type

Model ZW-CE10

Version 1.2\*\*

OK Cancel

10 The Sensor Controller project is displayed online.  
When an online connection is established, the Edit Pane is surrounded with a yellow frame.

The following panes are displayed in this window.

Left: Multiview Explorer

Center: Edit Pane

The following tab pages are displayed in the Edit Pane.

Center: Sensing Monitor Pane

Right: Toolbox

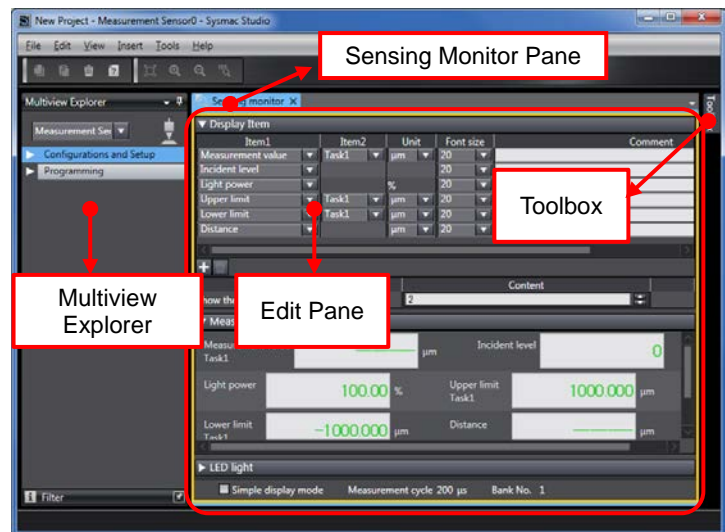

11 Double-click **1:ZW-7000(2.0):Online** under **Configurations and Setup - DeviceGroup** in the Multiview Explorer.

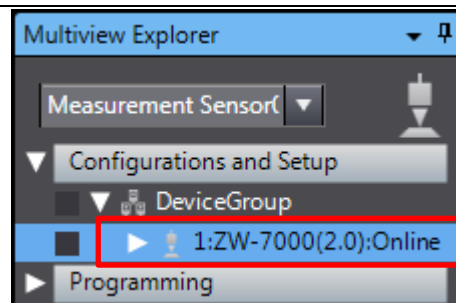

12 The 1:ZW-7000(2.0):Online Tab Page is displayed.  
Click the **Online** Icon.

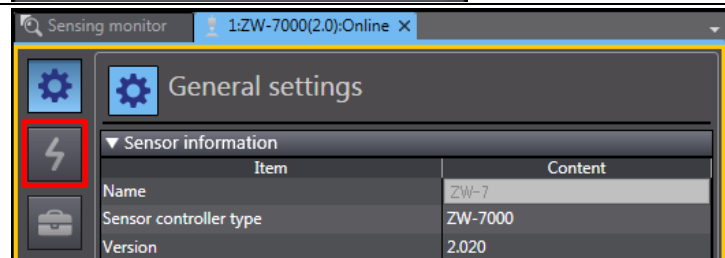

13 The Online view is displayed.  
Click **Setup** in the *Operation mode* Field.

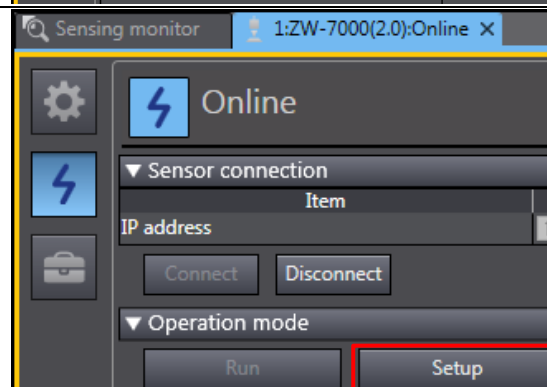

14 The Operation mode Dialog Box is displayed. Confirm that there is no problem and click **Yes**.

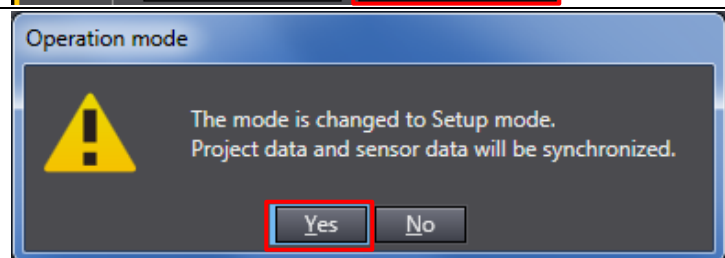

15 Double-click **System data** under **Configurations and Setup - DeviceGroup - 1:ZW-7000(2.0):Online - System** in the Multiview Explorer.

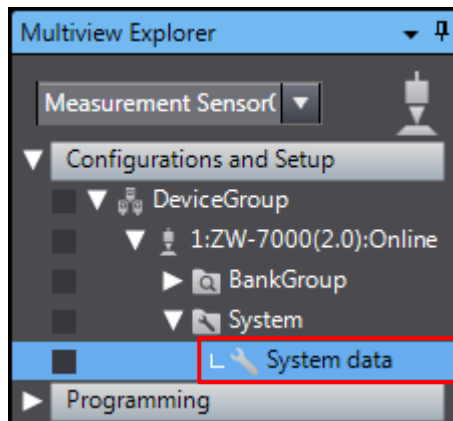

16 The System data Tab Page is displayed. Click the **Ethernet communication settings** icon.

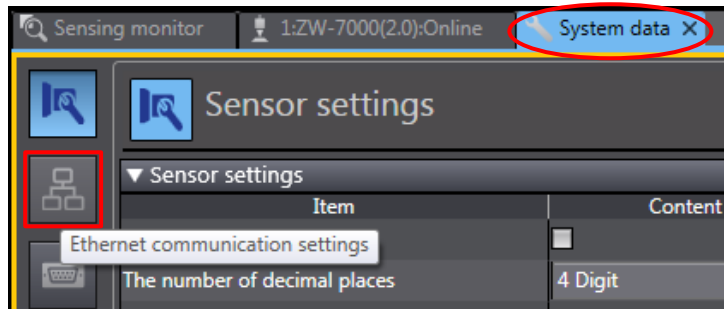

17 The Ethernet communication settings view is displayed. Check that the following fieldbus settings are made.  
 Fieldbus: EtherCAT(Default)  
 GATE signal ON time: 1 ms (Default)

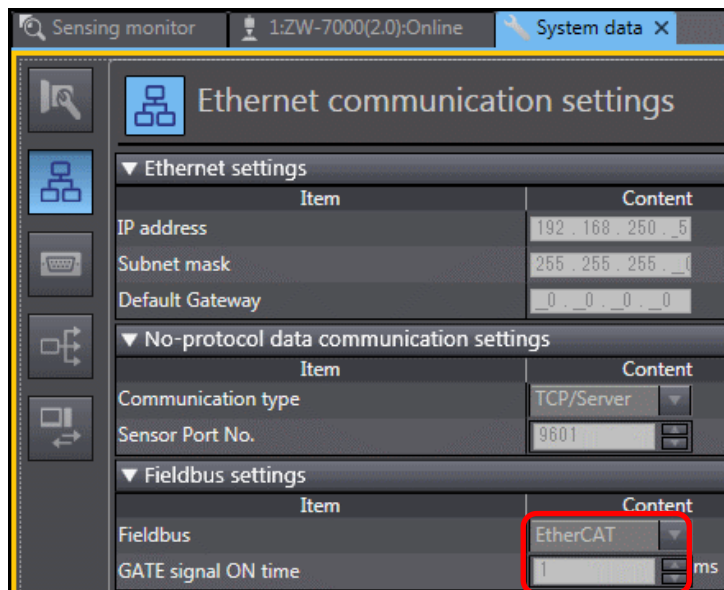

\*If the fieldbus is not set to EtherCAT, select **EtherCAT** from the pull-down list of Fieldbus.

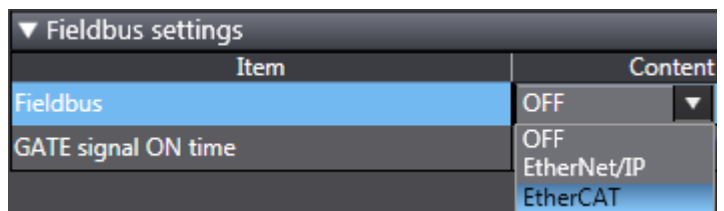

18 Double-click **1:ZW-7000(2.0):Online** under **Configurations and Setup - DeviceGroup** in the Multiview Explorer.

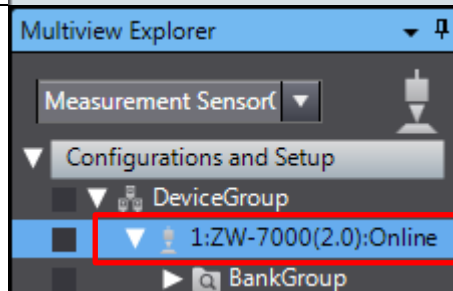

19 The Online view is displayed on the 1:ZW-7000(2.0):Online Tab Page.  
Click **Save settings (sensor internal memory)** in the *Save settings* Field.

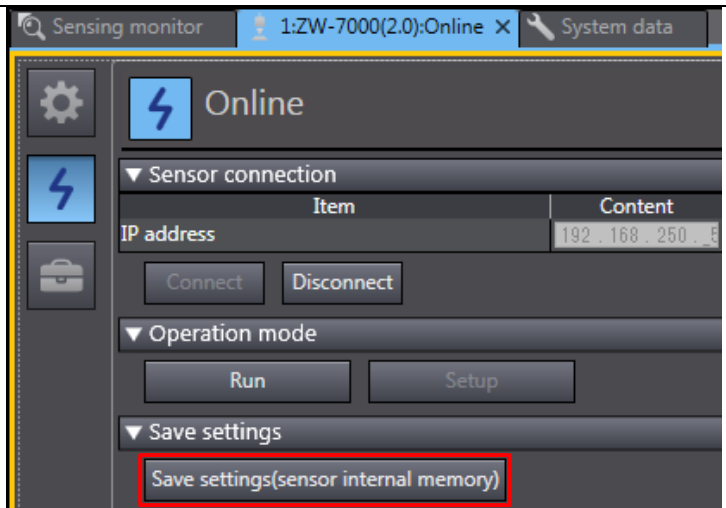

20 The Save settings Dialog Box is displayed. Check the contents and click **Yes**.

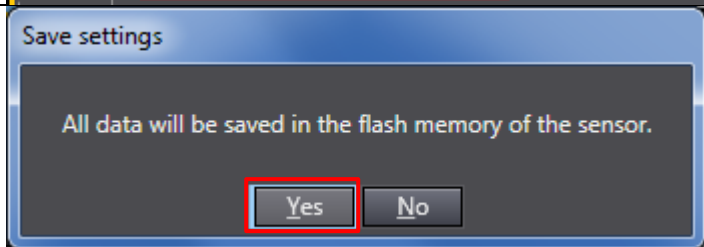

21 Click **Run** in the *Operation mode* Field.

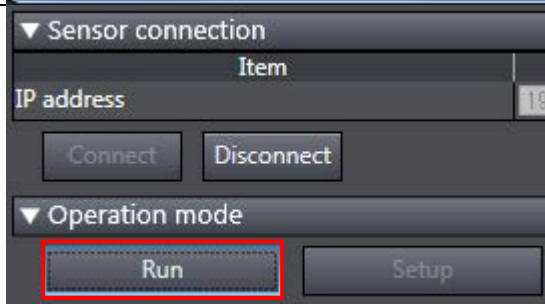

The Operation mode Dialog Box is displayed. Confirm that there is no problem and click **Yes**.

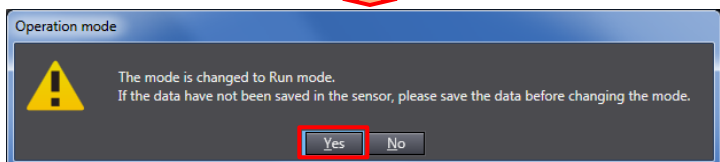

22 Check that the Run Button in the *Operation mode* Field becomes dim.  
Click **Disconnect** in the *Sensor connection* Field.

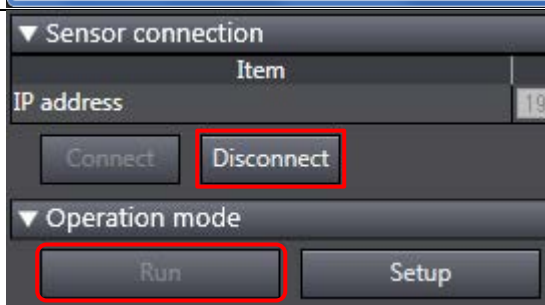

The Disconnect Dialog Box is displayed. Check the contents and click **Yes**.

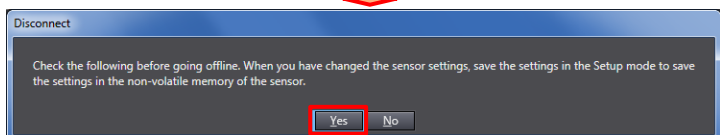



23 The online connection is established, and the yellow frame surrounding the Edit Pane disappears.

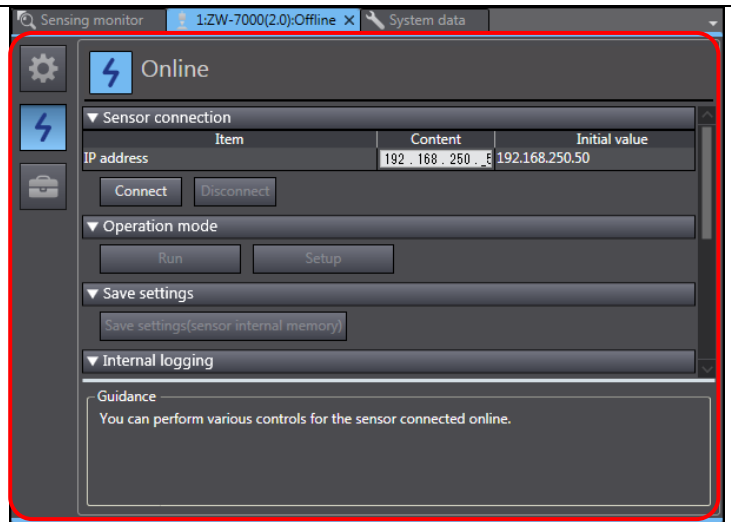

24 Select **Close** from the File Menu.  
  
The New Project Dialog Box is displayed.  
Click **No** if you do not need to save the project.

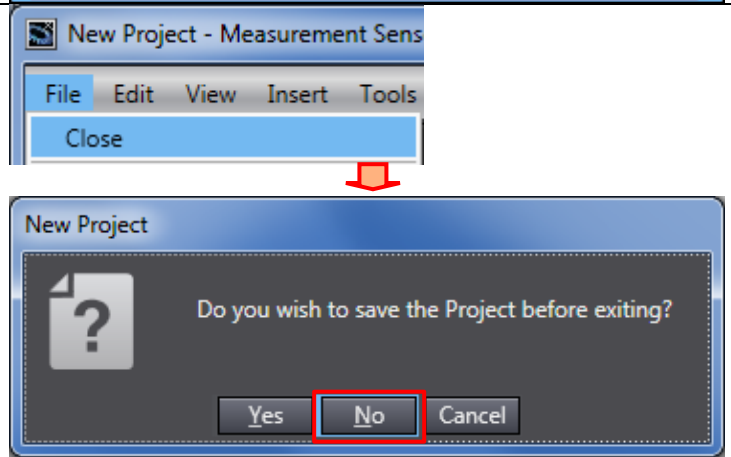

25 Turn OFF Sensor Controller and Switching hub.

26 Remove the LAN cable from Ethernet connector.

### 7.3. Controller Setup

Set up Controller.

#### 7.3.1. Starting Sysmac Studio and Setting up the EtherCAT Network Configuration

Start Sysmac Studio and Set up the EtherCAT network configuration.

- 1 Connect the Ethernet cable to the built-in EtherCAT port (PORT2) on Controller, and connect a USB cable to the peripheral (USB) port. As shown in 5.2. *Device Configuration*, connect Personal computer and Sensor Controller to Controller.

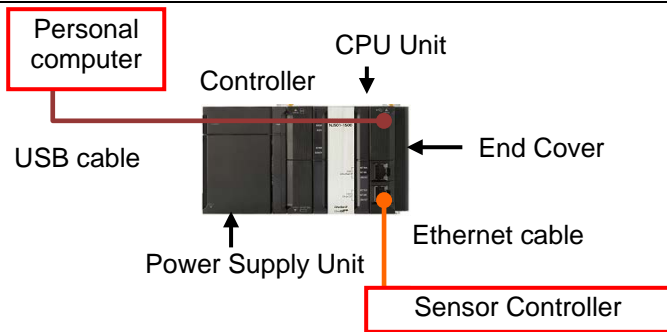

- 2 Turn ON Controller and Sensor Controller.

- 3 Click **Connect to Device** in the startup window of Sysmac Studio.

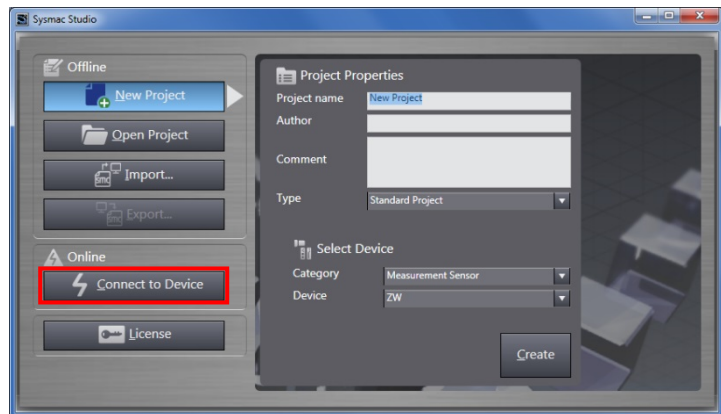

- 4 The Connect to Device Dialog Box is displayed. Select *Direct connection via USB* in the *Connection type* Field. Uncheck both *Upload the project* and *Display the Troubleshooting Dialog Box* in the *Operation after Connection* Field.

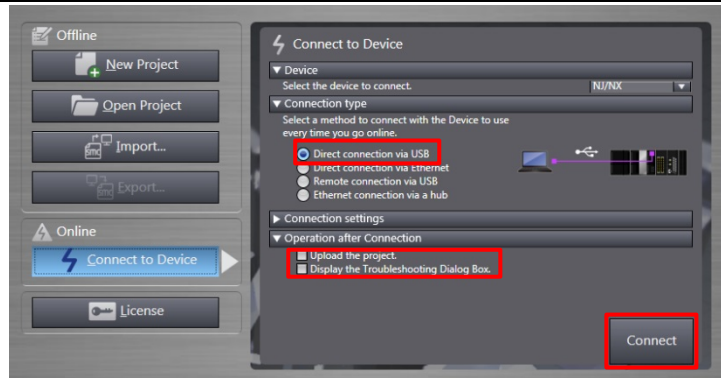

Click **Connect**.

- 5 A confirmation dialog box is displayed. Check the contents and click **OK**.
- \*The displayed dialog depends on the status of Controller. Check the contents and click on an appropriate button to proceed with the processing.
- 6 The dialog box on the right is displayed. Check the contents and click **OK**.
- 7 The Auto Connect Project Dialog Box is displayed online. When an online connection is established, a yellow bar is displayed under the toolbar.
- The following panes are displayed in this window.
- Left: Multiview Explorer
  - Top right: Toolbox
  - Bottom right: Controller Status Pane
  - Middle top: Edit Pane
- The following tabs are displayed in the bottom middle of this window.
- Output Tab Page
  - Build Tab Page

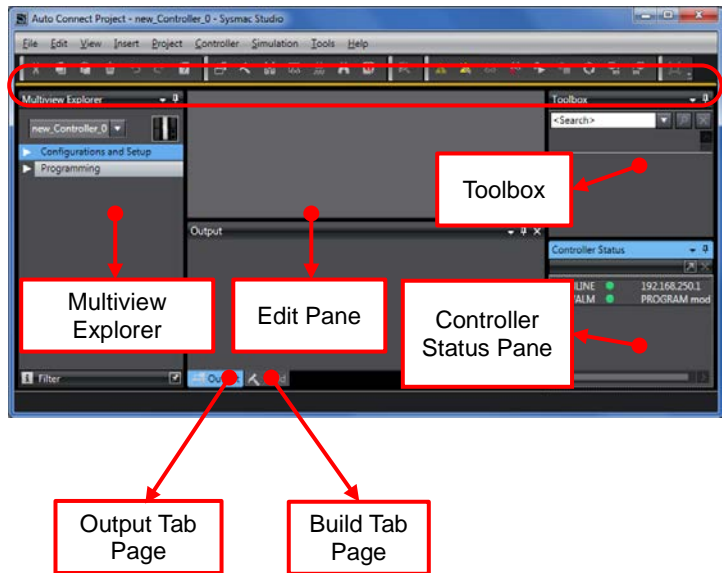
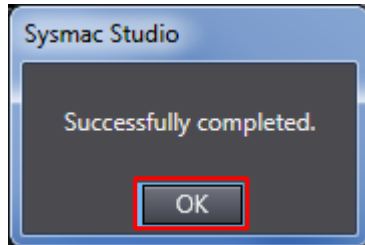
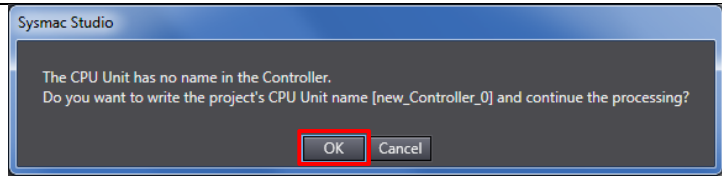

**Additional Information**

For details on online connections to Controller, refer to *Section 6. Online Connections to a Controller* of the *Sysmac Studio Version 1 Operation Manual* (Cat. No. W504).

- 8 Double-click **EtherCAT** under **Configurations and Setup** in the Multiview Explorer.

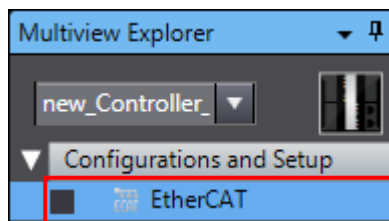

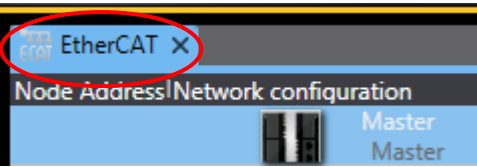
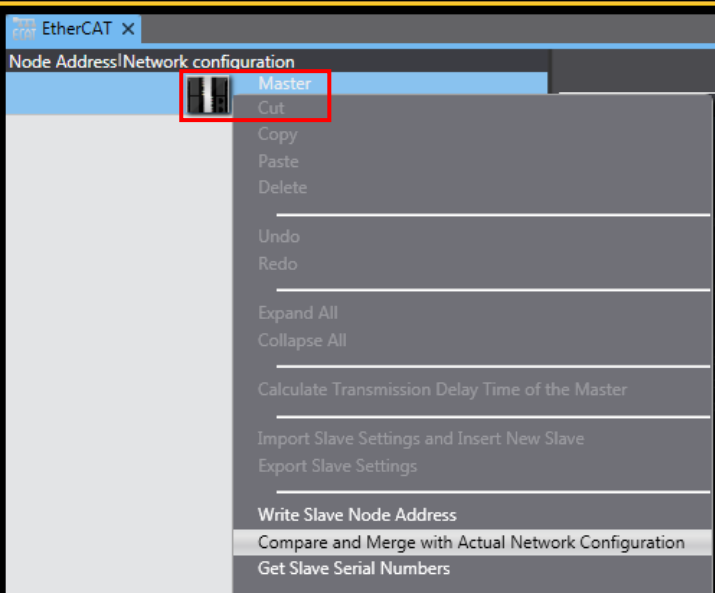
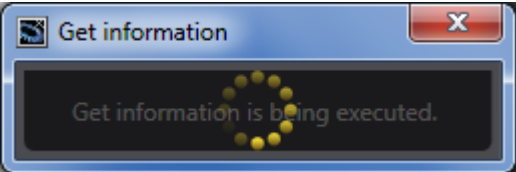
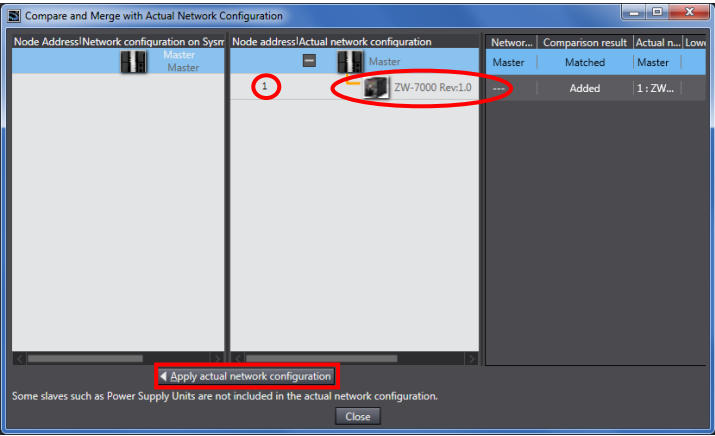
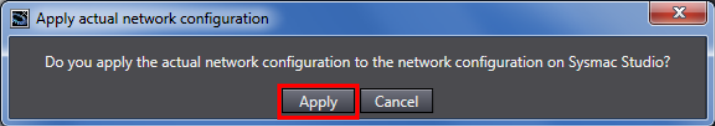
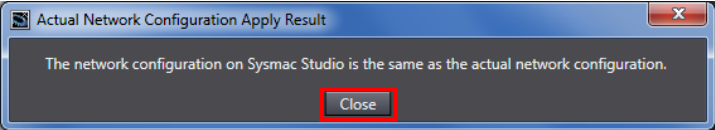
- 9 The EtherCAT Tab Page is displayed in the Edit Pane.
- 
- 10 Right-click **Master** on the EtherCAT Tab Page in the Edit Pane and select **Compare and Merge with Actual Network Configuration**.
- 
- A screen is displayed stating "Get information is being executed".
- 
- 11 The Compare and Merge with Actual Network Configuration Dialog Box is displayed. Node address 1 and ZW-7000 Rev:1.0 are added to the Actual network configuration after the comparison.
- 
- | Node Address/Network configuration on System | Node address/Actual network configuration | Network...      | Comparison result | Actual n... | Low |
|--|---|-----------------|-------------------|-------------|-----|
| Master                                       | Master                                    | Master          | Matched           | Master      |     |
|  | 1   | ZW-7000 Rev:1.0 | Added             | 1:ZW...     |     |
- Click **Apply actual network configuration**.
- 12 A confirmation dialog box is displayed. Check the contents and click **Apply**.
- 
- The confirmation dialog box on the right is displayed. Check the contents and click **Close**.
- 

13 As a node address 1 slave, E001 ZW-7000 Rev:1.0 is added to the Network configuration on Sysmac Studio.

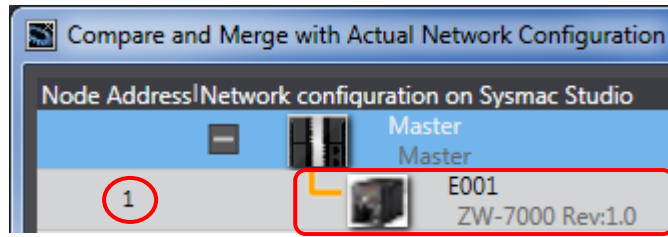

Check that the data above is added. Click **Close**.

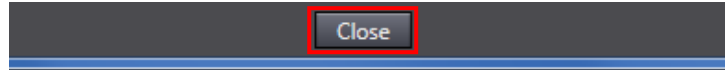

14 Node address 1 and E001 ZW-7000 Rev:1.0 are added to the EtherCAT Tab Page in the Edit Pane.

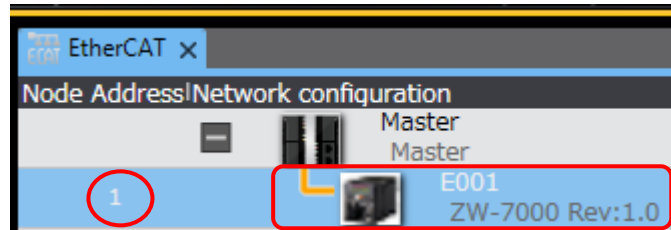

7.3.2. Setting the Device Variables

Set the device variables to use for Slave Unit.

- 1 Select **Offline** from the Controller Menu.

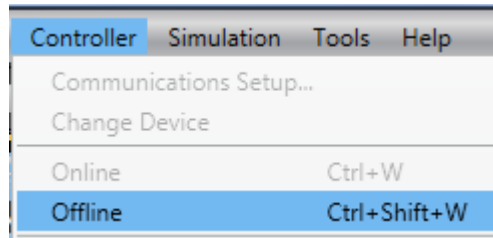

The yellow bar under the toolbar disappears.



- 2 Select the device with node address 1 added on the EtherCAT Tab Page in *Sub-Clause 7.3.1*. Check that the device name is E001.

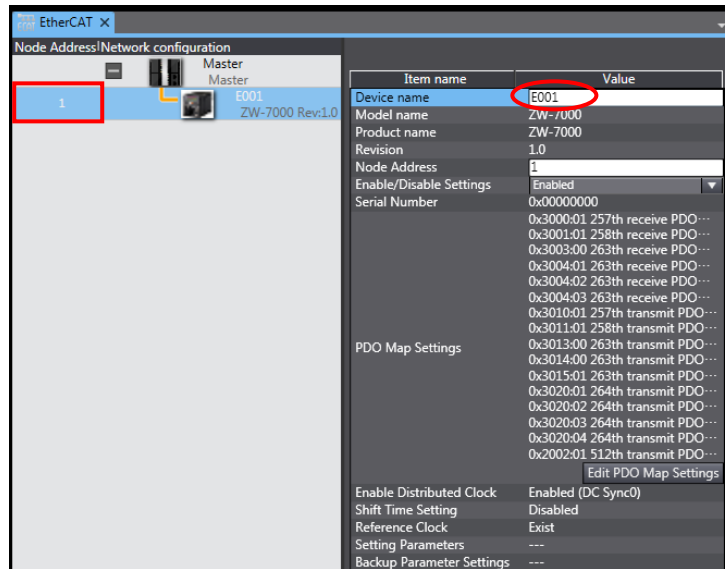

\*Device name can be changed as desired.

- 3 Double-click **I/O Map** under **Configurations and Setup** in the Multiview Explorer.

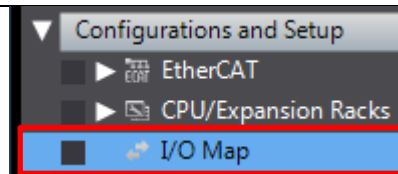

- 4 The I/O Map Tab Page is displayed in the Edit Pane. Check that Node1 is displayed in the *Position* Column and that the added Slave Unit is displayed in the *Port* Column.

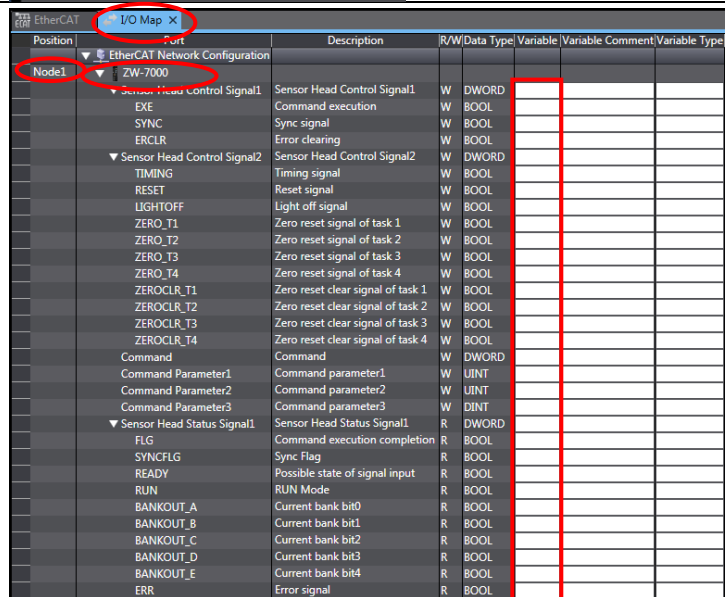

\*To manually set a variable name for a slave unit, click an entry cell in the *Variable* Column and enter a name.

5 Right-click **Node1** and select **Create Device Variable**.

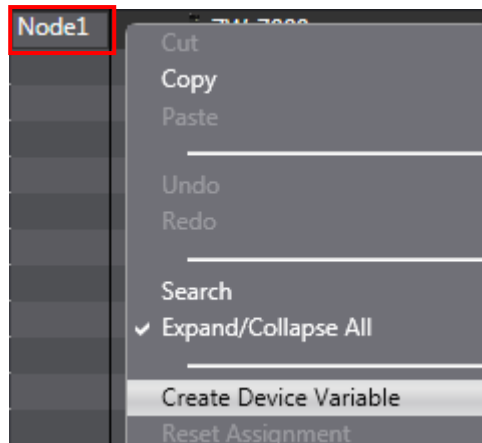

6 The variable names and types are set.

Position	Port	Description	R/W/Data Type	Variable	Variable Type
Node1	ZW7000				
	▼ Sensor Head Control Signal1	Sensor Head Control Signal1	W DWORD	ED01_Sensor_Head_Control_Signal1	Global Variables
	EKE	Command execution	W BOOL	ED01_EKE	Global Variables
	SYNC	Sync signal	W BOOL	ED01_SYNC	Global Variables
	ERCLR	Error clearing	W BOOL	ED01_ERCLR	Global Variables
	▼ Sensor Head Control Signal2	Sensor Head Control Signal2	W DWORD	ED01_Sensor_Head_Control_Signal2	Global Variables
	TIMING	Timing signal	W BOOL	ED01_TIMING	Global Variables
	RESET	Reset signal	W BOOL	ED01_RESET	Global Variables
	LIGHTOFF	Light off signal	W BOOL	ED01_LIGHTOFF	Global Variables
	ZERO_T1	Zero reset signal of task 1	W BOOL	ED01_ZERO_T1	Global Variables
	ZERO_T2	Zero reset signal of task 2	W BOOL	ED01_ZERO_T2	Global Variables
	ZERO_T3	Zero reset signal of task 3	W BOOL	ED01_ZERO_T3	Global Variables
	ZERO_T4	Zero reset signal of task 4	W BOOL	ED01_ZERO_T4	Global Variables
	ZEROCLEAR_T1	Zero reset clear signal of task 1	W BOOL	ED01_ZEROCLEAR_T1	Global Variables
	ZEROCLEAR_T2	Zero reset clear signal of task 2	W BOOL	ED01_ZEROCLEAR_T2	Global Variables
	ZEROCLEAR_T3	Zero reset clear signal of task 3	W BOOL	ED01_ZEROCLEAR_T3	Global Variables
	ZEROCLEAR_T4	Zero reset clear signal of task 4	W BOOL	ED01_ZEROCLEAR_T4	Global Variables
	Command	Command	W DWORD	ED01_Command	Global Variables
	Command Parameter1	Command parameter1	W LINT	ED01_Command_Parameter1	Global Variables
	Command Parameter2	Command parameter2	W LINT	ED01_Command_Parameter2	Global Variables
	Command Parameter3	Command parameter3	W DINT	ED01_Command_Parameter3	Global Variables
	▼ Sensor Head Status Signal1	Sensor Head Status Signal1	R DWORD	ED01_Sensor_Head_Status_Signal1	Global Variables
	FLG	Command execution completion	R BOOL	ED01_FLG	Global Variables
	SYNCFLG	Sync flag	R BOOL	ED01_SYNCFLG	Global Variables
	READY	Permissible state of signal input	R BOOL	ED01_READY	Global Variables
	RUN	RUN Mode	R BOOL	ED01_RUN	Global Variables
	BANKOUT_A	Current bank bit0	R BOOL	ED01_BANKOUT_A	Global Variables
	BANKOUT_B	Current bank bit1	R BOOL	ED01_BANKOUT_B	Global Variables
	BANKOUT_C	Current bank bit2	R BOOL	ED01_BANKOUT_C	Global Variables
	BANKOUT_D	Current bank bit3	R BOOL	ED01_BANKOUT_D	Global Variables
	BANKOUT_E	Current bank bit4	R BOOL	ED01_BANKOUT_E	Global Variables
	ERR	Error signal	R BOOL	ED01_ERR	Global Variables



**Additional Information**

The device variables are named automatically from a combination of the device names and the port names.

The default device names are "E" followed by a serial number that starts from 001.



**Additional Information**

In this document, device variables are automatically named for a unit (a slave).

Device variables can also be manually named for ports.

### 7.3.3. Transferring the Project Data

Transfer the project data from Sysmac Studio to Controller.

#### WARNING

When you transfer a user program, configuration data, setup data, device variables, or values in memory used for CJ-series Units from Sysmac Studio, the devices or machines may perform unexpected operation regardless of the operating mode of CPU Unit.

Always confirm safety at the destination node before you transfer the project data.



#### Caution

After you transfer the project data, CPU Unit restarts, and communications with slaves is cut off. During the period, the slave outputs behave according to the slave settings. The time that communications is cut off depends on the EtherCAT network configuration.

Before you transfer the project data, confirm that the slave settings will not adversely affect the device.



#### Caution

The Slave Unit will be reset after performing the synchronization in step 7 and subsequent steps, which may perform unexpected operation.

Always confirm safety before you perform the synchronization.

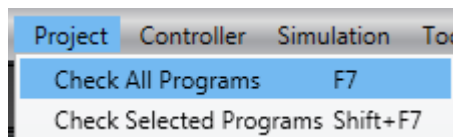
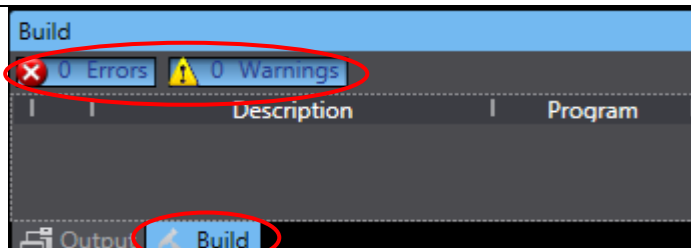
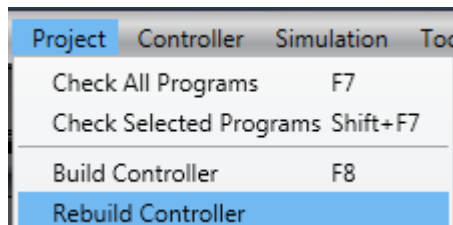

<p>1 Select <b>Check All Programs</b> from the Project Menu.</p>	
<p>2 The Build Tab Page is displayed. Check that "0 Errors" and "0 Warnings" are displayed.</p>	
<p>3 Select <b>Rebuild Controller</b> from the Project Menu.</p>	

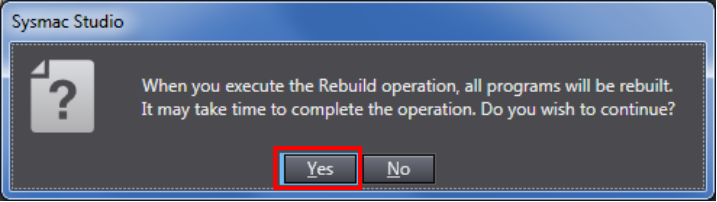
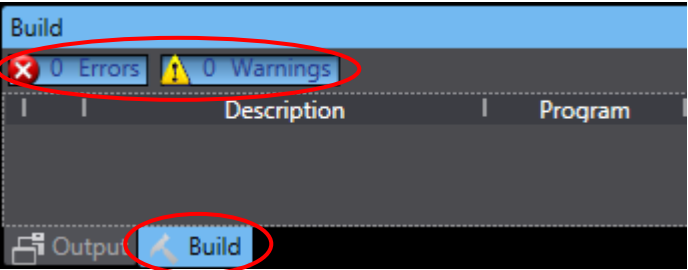
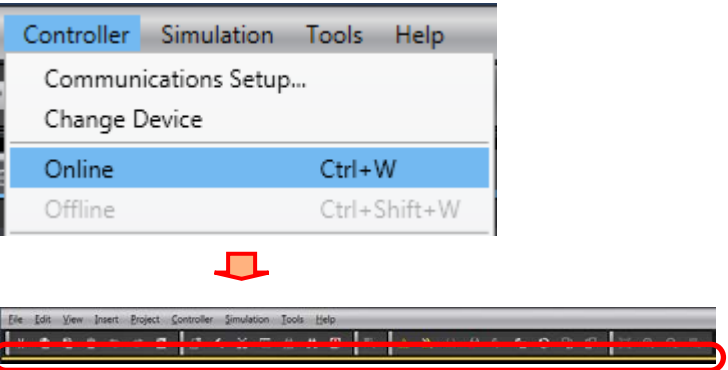
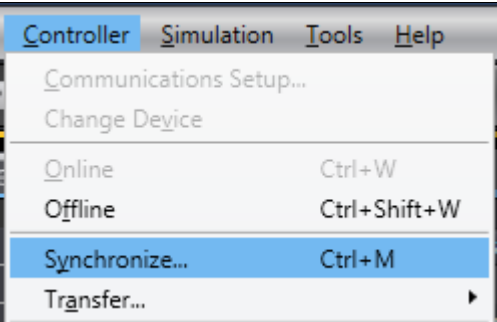
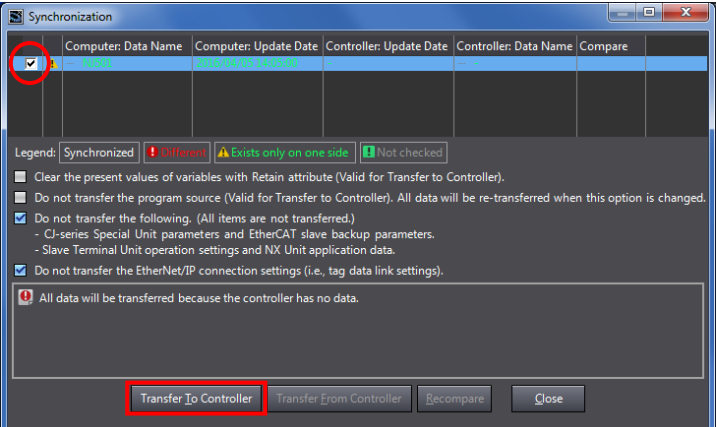

- |   |   |  |
|---|---|--|
| 4 | <p>A confirmation dialog box is displayed. Confirm that there is no problem and click <b>Yes</b>.</p>   |    |
| 5 | <p>Check that "0 Errors" and "0 Warnings" are displayed on the Build Tab Page.</p>  |    |
| 6 | <p>Select <b>Online</b> from the Controller Menu.</p> <p style="margin-top: 20px;">When an online connection is established, a yellow bar is displayed under the toolbar.</p>   |   |
| 7 | <p>Select <b>Synchronize</b> from the Controller Menu.</p>  |  |
| 8 | <p>The Synchronization Dialog Box is displayed.</p> <p>Check that the data to transfer (NJ501 in the right dialog box) is selected. Then, click <b>Transfer To Controller</b>.</p> <p style="margin-top: 20px;">*After executing Transfer To Controller, the Sysmac Studio data is transferred to Controller, and the data is compared.</p> |  |

9 A confirmation dialog box is displayed. Confirm that there is no problem and click **Yes**.

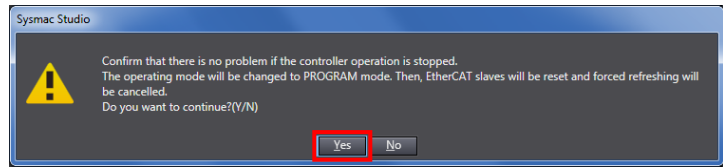

A screen stating "Synchronizing" is displayed.

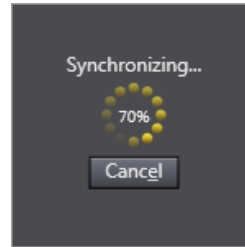

A confirmation dialog box is displayed. Confirm that there is no problem and click **No**.

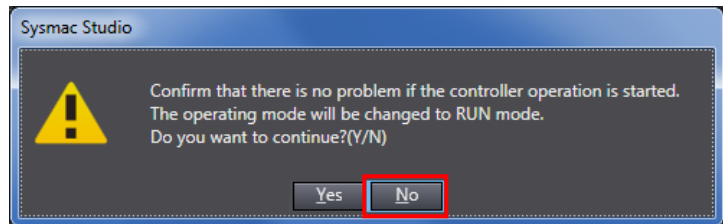

\*Do not return to RUN mode.

10 Check that the synchronized data is displayed with the color specified by "Synchronized" and that a message is displayed stating "The synchronization process successfully finished". If there is no problem, click **Close**.

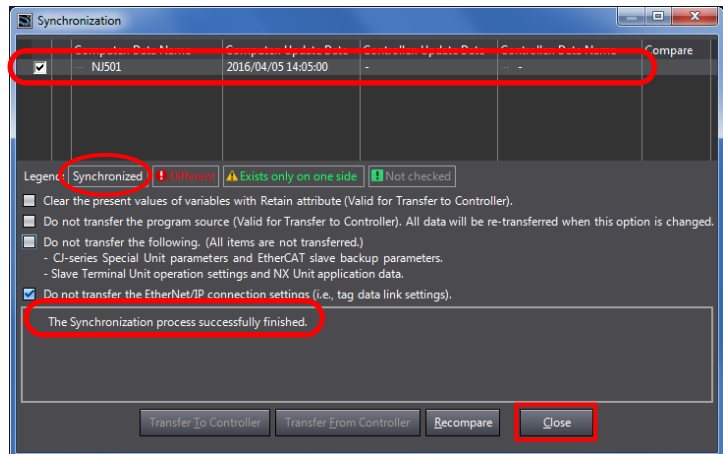

\*A message stating "The synchronization process successfully finished" is displayed if the Sysmac Studio project data coincides with the Controller data.

\*If the synchronization fails, check the wiring and repeat from step 1.

## 7.4. EtherCAT Communication Status Check

Confirm that the PDO communications performs normally via EtherCAT.

### 7.4.1. Checking the Connection Status

Check the connection status of the EtherCAT network.

- 1 Check with LED indicators on Controller that PDO communications via EtherCAT performs normally.

The LED indicators in normal status are as follows:

NET RUN: Green lit

NET ERR: Not lit

LINK/ACT: Yellow flashing

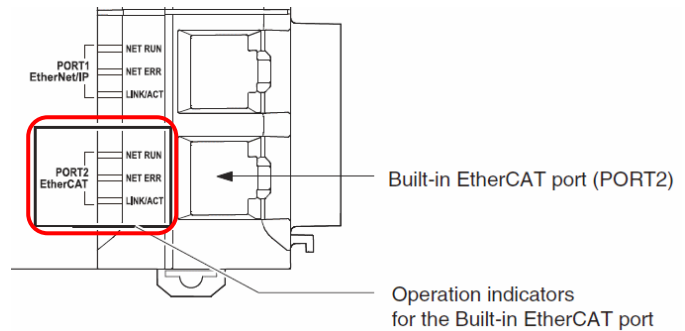

- 2 Check the LED indicators on Sensor Controller.

The LED indicators in normal status are as follows:

ECAT RUN: Green lit

L/A IN: Green flickering

ECAT ERROR: Not lit

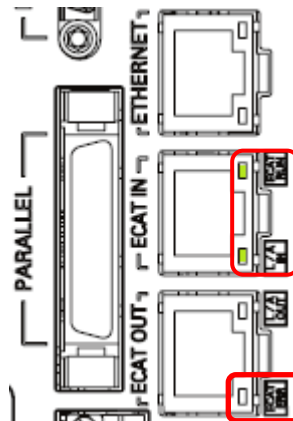

7.4.2. Checking the Sent and Received Data

Check that the correct data are sent and received.

In this document, the system data acquisition command and the number of digits displayed past decimal point for command parameters are set to device variables in the output area where Controller is output to Sensor Controller, and response data (the number of digits displayed past decimal point) from Sensor Controller are checked, which are stored in device variables in the input area.

**Caution**

If you change the variable values on a Watch Tab Page when Sysmac Studio is online with CPU Unit, the devices connected to the output unit may operate regardless of the operating mode of CPU Unit.

Adequately ensure safety before you change the variable values on a Watch Tab Page when Sysmac Studio is online with CPU Unit

- 1 Select **Watch Tab Page** from the View Menu.

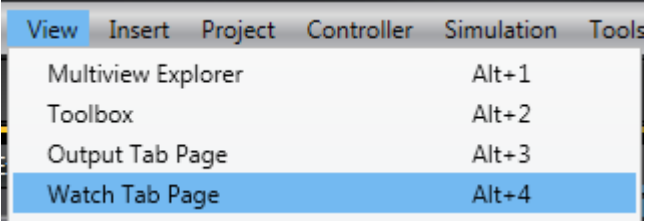

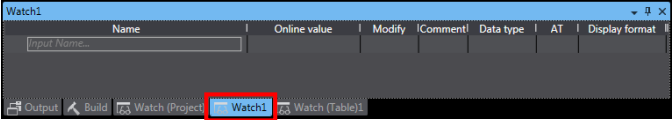
- 2 Select the **Watch1** Tab.

- 3 Click *Input Name* and enter the following variable names for monitoring.

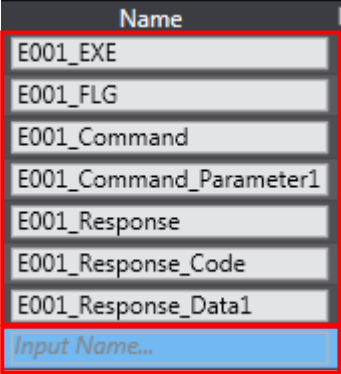
  - E001\_EXE*
  - E001\_FLG*
  - E001\_Command*
  - E001\_Command\_Parameter1*
  - E001\_Response*
  - E001\_Response\_Code*
  - E001\_Response\_Data1*

- 4 Check that the display formats of the variables you set in step 3 are as follows:

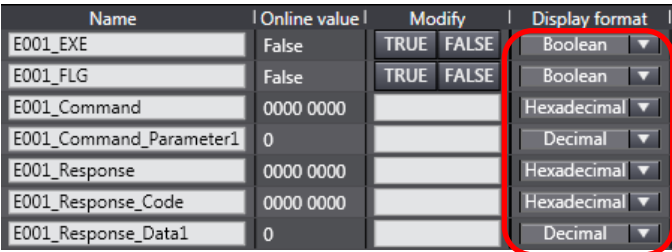
  - E001\_EXE:Boolean
  - E001\_FLG:Boolean
  - E001\_Command:Hexadecimal
  - E001\_Command\_Parameter1:  
Decimal
  - E001\_Response:Hexadecimal
  - E001\_Response\_Code:  
Hexadecimal
  - E001\_Response\_Data1:Decimal



<p>5 Enter 0040 4000 for <i>E001_Command</i> in the <i>Modify</i> Column.</p> <p>0040 4000 is displayed for <i>E001_Command</i> in the <i>Online value</i> Column.</p> <p>*The command code 0040 4000 (system data acquisition) is set.</p>	<table border="1"> <thead> <tr> <th>Name</th> <th>Online value</th> <th>Modify</th> </tr> </thead> <tbody> <tr> <td>E001_EXE</td> <td>False</td> <td>TRUE FALSE</td> </tr> <tr> <td>E001_FLG</td> <td>False</td> <td>TRUE FALSE</td> </tr> <tr> <td>E001_Command</td> <td>0000 0000</td> <td>0040 4000</td> </tr> <tr> <td>E001_Command_Parameter1</td> <td>0</td> <td></td> </tr> </tbody> </table> <p style="text-align: center;">↓</p> <table border="1"> <thead> <tr> <th>Name</th> <th>Online value</th> <th>Modify</th> </tr> </thead> <tbody> <tr> <td>E001_EXE</td> <td>False</td> <td>TRUE FALSE</td> </tr> <tr> <td>E001_FLG</td> <td>False</td> <td>TRUE FALSE</td> </tr> <tr> <td>E001_Command</td> <td>0040 4000</td> <td>0040 4000</td> </tr> <tr> <td>E001_Command_Parameter1</td> <td>0</td> <td></td> </tr> </tbody> </table>	Name	Online value	Modify	E001_EXE	False	TRUE FALSE	E001_FLG	False	TRUE FALSE	E001_Command	0000 0000	0040 4000	E001_Command_Parameter1	0		Name	Online value	Modify	E001_EXE	False	TRUE FALSE	E001_FLG	False	TRUE FALSE	E001_Command	0040 4000	0040 4000	E001_Command_Parameter1	0	
Name	Online value	Modify																													
E001_EXE	False	TRUE FALSE																													
E001_FLG	False	TRUE FALSE																													
E001_Command	0000 0000	0040 4000																													
E001_Command_Parameter1	0																														
Name	Online value	Modify																													
E001_EXE	False	TRUE FALSE																													
E001_FLG	False	TRUE FALSE																													
E001_Command	0040 4000	0040 4000																													
E001_Command_Parameter1	0																														
<p>6 In the same way as step 5, set 900 for <i>E001_Command_Parameter1</i> in the <i>Modify</i> Column.</p> <p>*The system data number 900 (Number of digits displayed past decimal point) is set.</p>	<table border="1"> <thead> <tr> <th>Name</th> <th>Online value</th> <th>Modify</th> </tr> </thead> <tbody> <tr> <td>E001_EXE</td> <td>False</td> <td>TRUE FALSE</td> </tr> <tr> <td>E001_FLG</td> <td>False</td> <td>TRUE FALSE</td> </tr> <tr> <td>E001_Command</td> <td>0040 4000</td> <td>0040 4000</td> </tr> <tr> <td>E001_Command_Parameter1</td> <td>900</td> <td>900</td> </tr> </tbody> </table>	Name	Online value	Modify	E001_EXE	False	TRUE FALSE	E001_FLG	False	TRUE FALSE	E001_Command	0040 4000	0040 4000	E001_Command_Parameter1	900	900															
Name	Online value	Modify																													
E001_EXE	False	TRUE FALSE																													
E001_FLG	False	TRUE FALSE																													
E001_Command	0040 4000	0040 4000																													
E001_Command_Parameter1	900	900																													
<p>7 Check that the online value of <i>E001_FLG</i> is False.</p> <p>Click <b>TRUE</b> for <i>E001_EXE</i> in the <i>Modify</i> Column.</p> <p>True is displayed for <i>E001_EXE</i> in the <i>Online value</i> Column.</p> <p>When the command execution is complete, True is displayed for <i>E001_FLG</i> in the <i>Online value</i> Column.</p>	<table border="1"> <thead> <tr> <th>Name</th> <th>Online value</th> <th>Modify</th> </tr> </thead> <tbody> <tr> <td>E001_EXE</td> <td>False</td> <td>TRUE FALSE</td> </tr> <tr> <td>E001_FLG</td> <td>False</td> <td>TRUE FALSE</td> </tr> <tr> <td>E001_Command</td> <td>0040 4000</td> <td>0040 4000</td> </tr> <tr> <td>E001_Command_Parameter1</td> <td>900</td> <td>900</td> </tr> </tbody> </table> <p style="text-align: center;">↓</p> <table border="1"> <thead> <tr> <th>Name</th> <th>Online value</th> <th>Modify</th> </tr> </thead> <tbody> <tr> <td>E001_EXE</td> <td>True</td> <td>TRUE FALSE</td> </tr> <tr> <td>E001_FLG</td> <td>True</td> <td>TRUE FALSE</td> </tr> <tr> <td>E001_Command</td> <td>0040 4000</td> <td>0040 4000</td> </tr> <tr> <td>E001_Command_Parameter1</td> <td>900</td> <td>900</td> </tr> </tbody> </table>	Name	Online value	Modify	E001_EXE	False	TRUE FALSE	E001_FLG	False	TRUE FALSE	E001_Command	0040 4000	0040 4000	E001_Command_Parameter1	900	900	Name	Online value	Modify	E001_EXE	True	TRUE FALSE	E001_FLG	True	TRUE FALSE	E001_Command	0040 4000	0040 4000	E001_Command_Parameter1	900	900
Name	Online value	Modify																													
E001_EXE	False	TRUE FALSE																													
E001_FLG	False	TRUE FALSE																													
E001_Command	0040 4000	0040 4000																													
E001_Command_Parameter1	900	900																													
Name	Online value	Modify																													
E001_EXE	True	TRUE FALSE																													
E001_FLG	True	TRUE FALSE																													
E001_Command	0040 4000	0040 4000																													
E001_Command_Parameter1	900	900																													
<p>8 When the process ends normally, the online values of the response variables are shown below.</p> <p><i>E001_Response</i>: 0040 4000 (Execution command code)</p> <p><i>E001_Response_Code</i>: 0000 0000 (Execution result (normal))</p> <p><i>E001_Response_Data1</i>: 1 (The number of digits displayed past decimal point is 1. (Default))</p>	<table border="1"> <thead> <tr> <th>Name</th> <th>Online value</th> <th>Modify</th> </tr> </thead> <tbody> <tr> <td>E001_EXE</td> <td>True</td> <td>TRUE FALSE</td> </tr> <tr> <td>E001_FLG</td> <td>True</td> <td>TRUE FALSE</td> </tr> <tr> <td>E001_Command</td> <td>0040 4000</td> <td>0040 4000</td> </tr> <tr> <td>E001_Command_Parameter1</td> <td>900</td> <td>900</td> </tr> <tr> <td>E001_Response</td> <td>0040 4000</td> <td></td> </tr> <tr> <td>E001_Response_Code</td> <td>0000 0000</td> <td></td> </tr> <tr> <td>E001_Response_Data1</td> <td>1</td> <td></td> </tr> </tbody> </table>	Name	Online value	Modify	E001_EXE	True	TRUE FALSE	E001_FLG	True	TRUE FALSE	E001_Command	0040 4000	0040 4000	E001_Command_Parameter1	900	900	E001_Response	0040 4000		E001_Response_Code	0000 0000		E001_Response_Data1	1							
Name	Online value	Modify																													
E001_EXE	True	TRUE FALSE																													
E001_FLG	True	TRUE FALSE																													
E001_Command	0040 4000	0040 4000																													
E001_Command_Parameter1	900	900																													
E001_Response	0040 4000																														
E001_Response_Code	0000 0000																														
E001_Response_Data1	1																														



**Additional Information**

For details on commands, refer to 3-1 EtherCAT Connection of the *Displacement Sensor ZW-7000 series Confocal Fiber Type Displacement Sensor User's Manual for Communications Settings* (Cat. No. Z363).



### **Additional Information**

---

For details on system data, refer to 8-2 *System data list* of the *Displacement Sensor ZW-7000 series Confocal Fiber Type Displacement Sensor User's Manual for Communications Settings* (Cat. No. Z363).

---

## 8. Initialization method

The setting procedures in this document are based on the factory default settings. Some settings may not be applicable unless you use the devices with the factory default settings.

### 8.1. Initializing Controller

To initialize the Controller settings, it is necessary to initialize CPU Unit. Change the operating mode of Controller to PROGRAM mode and select **Clear All Memory** from the Controller Menu in Sysmac Studio. The Clear All Memory Dialog Box is displayed. Check the contents and click **OK**.

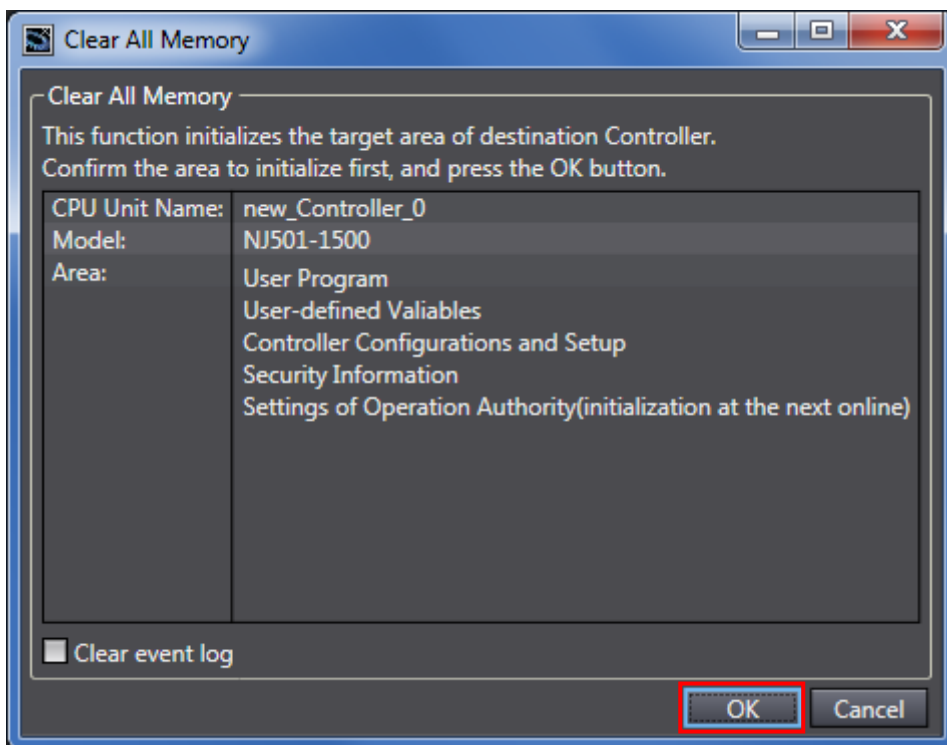

### 8.2. Initializing Sensor Controller

For information on how to initialize Sensor Controller, refer to *Initializing Settings* in 4-6 Setting Measurement Mode of the Sensor in *4.Settings for Function of the Displacement Sensor ZW-7000 series Confocal Fiber Type Displacement Sensor User's Manual* (Cat. No. Z362).

## 9. Revision History

Revision code	Date of revision	Description of revision
A	May 13, 2016	First edition





**OMRON Corporation Industrial Automation Company**

Tokyo, JAPAN

Contact: [www.ia.omron.com](http://www.ia.omron.com)

**Regional Headquarters**

**OMRON EUROPE B.V.**

Wegalaan 67-69, 2132 JD Hoofddorp  
The Netherlands  
Tel: (31)2356-81-300/Fax: (31)2356-81-388

**OMRON ELECTRONICS LLC**

2895 Greenspoint Parkway, Suite 200  
Hoffman Estates, IL 60169 U.S.A  
Tel: (1) 847-843-7900/Fax: (1) 847-843-7787

**OMRON ASIA PACIFIC PTE. LTD.**

No. 438A Alexandra Road # 05-05/08 (Lobby 2),  
Alexandra Technopark,  
Singapore 119967  
Tel: (65) 6835-3011/Fax: (65) 6835-2711

**OMRON (CHINA) CO., LTD.**

Room 2211, Bank of China Tower,  
200 Yin Cheng Zhong Road,  
PuDong New Area, Shanghai, 200120, China  
Tel: (86) 21-5037-2222/Fax: (86) 21-5037-2200

**Authorized Distributor:**

© OMRON Corporation 2016 All Rights Reserved.  
In the interest of product improvement,  
specifications are subject to change without notice.

**Cat. No. P651-E1-01**

01 16(-)