

# Özel ihtiyaçlarınız için en mükemmel çözüm

## Endüktif proximity sensörler



- 50 yılı aşkın deneyim
- Tüm çevresel koşullara uygun tasarım
- Küresel erişilebilirlik

## Yakınlık algılamada tarih yazılıyor

### "Rüya switch" in gelişimi

Otomasyon, Japonya çapında yayılmaya başladıkça 100 milyonu aşkın döngüyü kaldırabilecek yüksek performanslı hassas switch'lere olan pazar talebi de artmıştı. Bay Tateisi (Omron'un kurucusu), bunun yalnızca temassız (solid state) konfigürasyona sahip bir switch geliştirilerek elde edileceğine inanıyordu ve mühendislerine bu zorlu görevi verdi. Yedi genç araştırmacıdan oluşan ve meslektaşları tarafından "Yedi Samurai" olarak adlandırılan ekip, sonunda başarıya ulaştı.



1960'ta geliştirilip piyasaya sürülen proximity switch, Omron'un dünyada bir numaralı hacim üreticisi olmasını sağlayan geleneksel ana faaliyetinin bir parçasını oluşturuyor. YENİ proximity sensör teknolojisi geliştirmeye devam ediyoruz. Bu da, Omron'un proximity sensörü üzerine yaptığı çalışmaların, dünyadaki proximity sensör teknolojisini şekillendirdiği anlamına geliyor.

## Teknolojik yeniliklerle gelişim

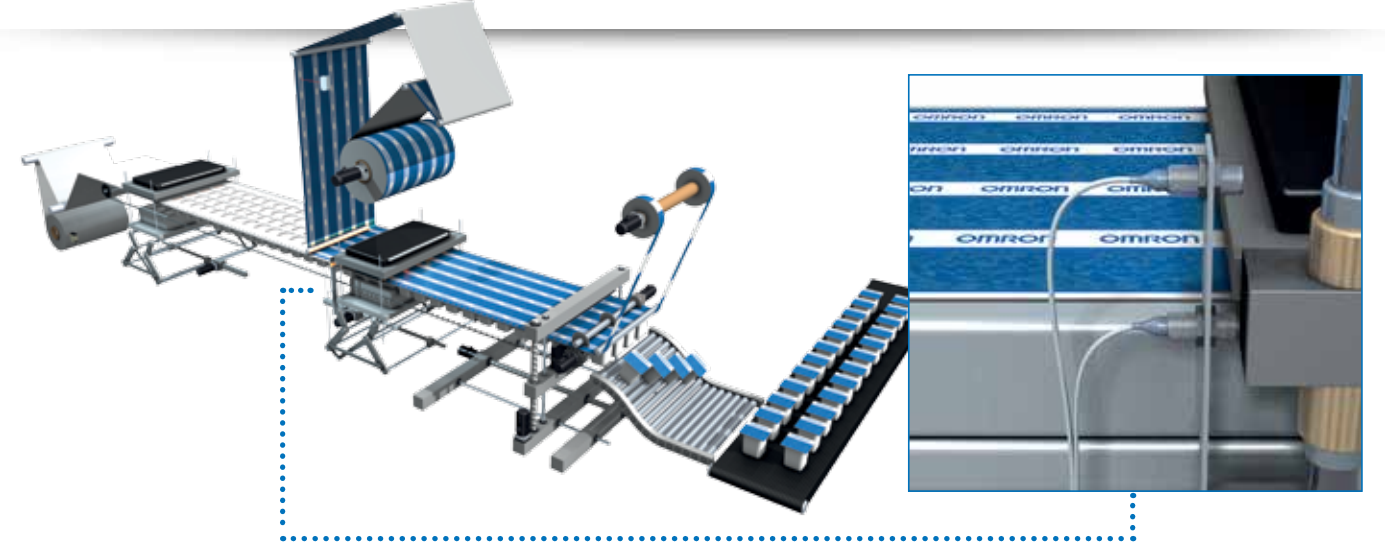

Endüktif sensörlerimiz, en zorlu ortamlarda bile uzun kullanım ömrü sunacak şekilde tasarlanmış ve test edilmiştir. Bu güvenilirlik, endüktif proximity sensörlerimizin dünyadaki en popüler seçim olmasını sağlıyor. Çalışma sırasında karşılaşılabilecek en çetin çevresel koşulların üstesinden gelen sensörler tasarlıyoruz. Proximity sensörler üzerindeki 50 yıllık mirasımızdan faydalanarak dünyanın dört bir yanındaki memnun müşterilere 200 milyonu aşkın proximity sensör teslimatı gerçekleştirdik.



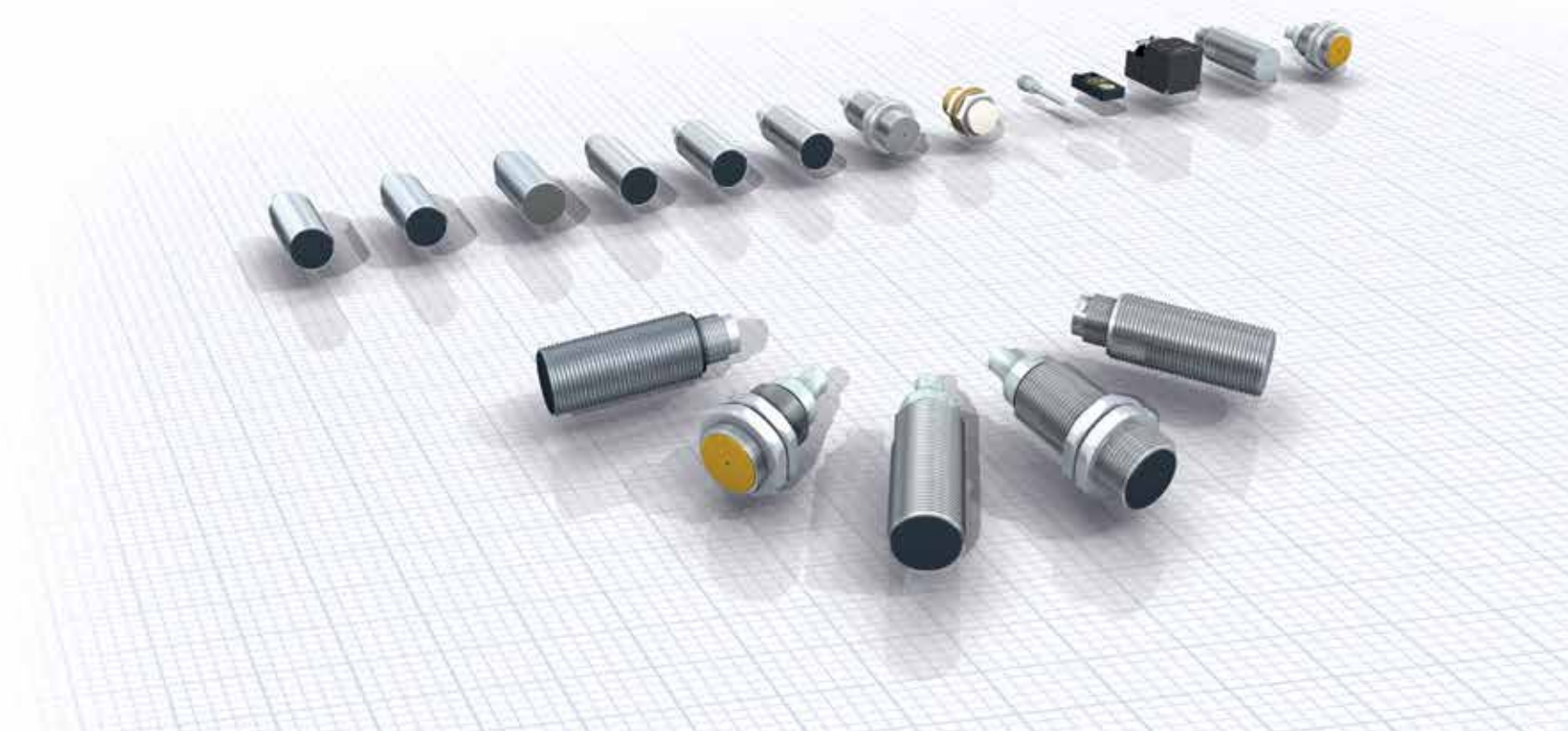
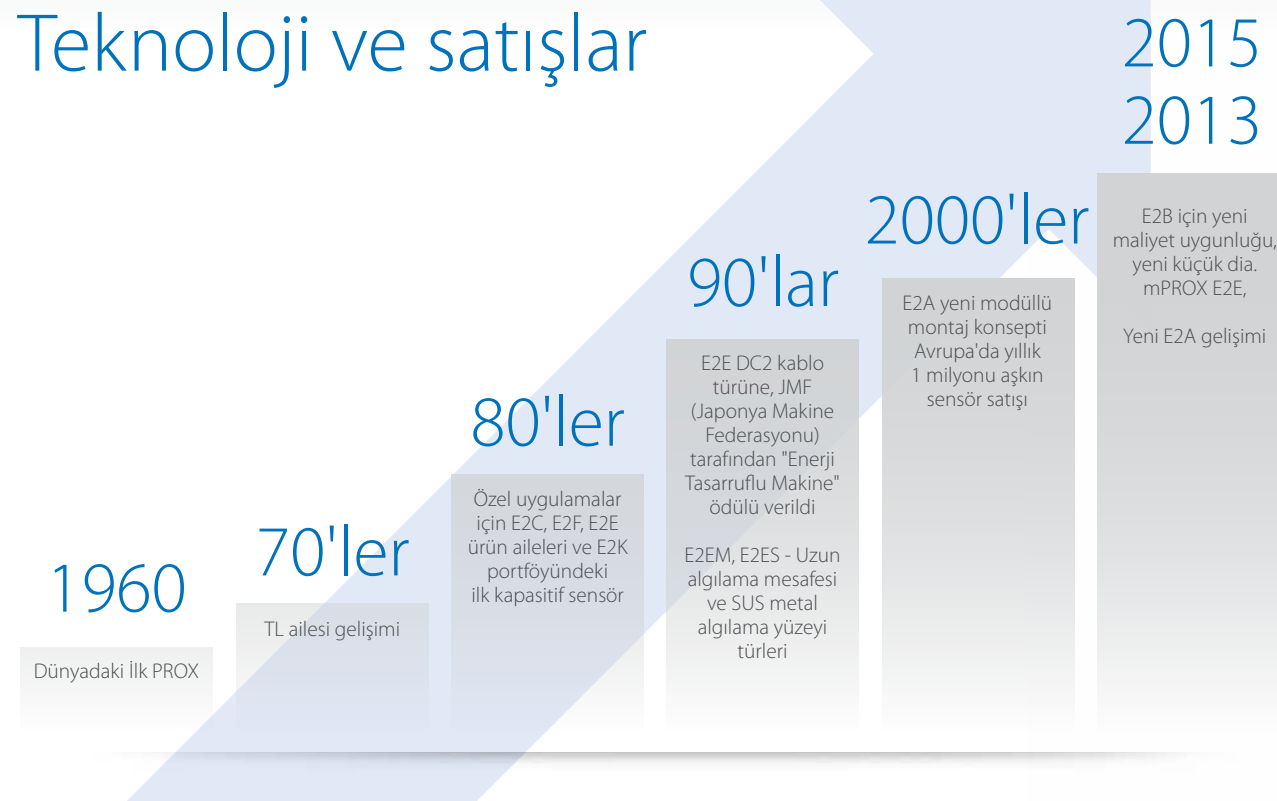

- Geniş portföy ve uygulama serisi
- Zorlu ortamlarda bile en üst düzey güvenilirlik
- En iyi fiyat-performans oranıyla esneklik sunmak üzere tasarlanmıştır



## Teknoloji ve satışlar





		Cylindrical				
						
Model		E2A	E2A DC 2-wire/4-wire	E2A3	E2A-S	E2B
Type		Compact	Compact	Long distance	Compact	Compact
Material		Brass, SUS	Brass, SUS	Brass	Stainless steel	Stainless steel
Max. sensing distance	dia 3	-	-	-	-	-
	dia 4	-	-	-	-	-
	M5	-	-	-	-	-
	dia 6.5	-	-	-	-	-
	M8	2/4 mm	2/4 mm	3mm / -	2/4 mm	2/4 mm
	M12	4/8 mm	4/8 mm	6mm / -	4/8 mm	4/8 mm
	M18	8/16 mm	8/16 mm	11mm / -	8/16 mm	8/16 mm
	M30	15/30 mm	15/30 mm	20mm / -	15/20 mm	15/30 mm
	19 × 6 × 6	-	-	-	-	-
	22 × 8 × 6	-	-	-	-	-
Mount.	31 × 18 × 10	-	-	-	-	-
	53 × 40 × 23	-	-	-	-	-
	67 × 40 × 40	-	-	-	-	-
	Shielded	■	■	■	■	■
	Non-shielded	■	■	-	■	■
Oper. mode	NO	■	■	■	■	■
	NC	■	■	■	■	■
	NO + NC	-	■	-	-	-
Wiring	DC 2-wire	-	■	-	-	-
	DC 3-wire	■	-	■	■	■
	DC 4-wire	-	■	-	-	-
	AC 2-wire	-	□	-	-	-
Voltage	10 to 30 VDC	■	■	■	■	■
	12 to 240 VAC	-	□	-	-	-
IP rating	IP67	■	■	■	■	■
	IP69K	■	■	■	■	-
Page		9	-	-	11	15

Special models

Type	Vehicle usage certified	Detergent and heat resistant	Chemical resistant	Small diameter	
					
Model	E2AU	E2EH	E2FQ	μPROX E2E	E2EC*
Key features	<ul style="list-style-type: none"> <li>e1 type approval (according to automotive directive 2005/83/EC)</li> <li>E1 (according to vehicle regulation)</li> </ul>	<ul style="list-style-type: none"> <li>stainless steel housing</li> <li>120°C heat resistance</li> </ul>	<ul style="list-style-type: none"> <li>PTFE housing</li> </ul>	<ul style="list-style-type: none"> <li>High frequency of 5 kHz: suitable for high-speed counting</li> <li>All sizes are also available as non-shielded types</li> </ul>	<ul style="list-style-type: none"> <li>Small diameter housing with short body length</li> </ul>
dia 3	-	-	-	0.8 to 2 mm	0.6 mm
dia 4	-	-	-	1.2 to 3 mm	-
dia 6.5	-	-	-	2 to 4 mm	-
M5	-	-	-	1.2 to 3 mm	-
M8	-	-	-	-	-
M12	■	■	■	-	2 mm
M18	■	■	■	-	7 mm
M30	■	■	■	-	-
Page	13	19	19	17	-

		Square		
				
Model		TL-W	E2S*	E2Q5
Type		Compact	Miniature	Long distance
Material		ABS	Polyarylate	PBT
Max. sensing distance	dia 3	-	-	-
	dia 4	-	-	-
	M5	-	-	-
	dia 5.4	-	-	-
	M8	-	-	-
	M12	-	-	-
	M18	-	-	-
	M30	-	-	-
	19 × 6 × 6	-	1.6 mm	-
	22 × 8 × 6	3 mm	2.5 mm	-
Mount.	31 × 18 × 10	5 mm	-	-
	53 × 40 × 23	20 mm	-	-
	67 × 40 × 40	-	-	40 mm
	Shielded	■	-	■
	Non-shielded	■	■	■
Oper. mode	NO	■	■	■
	NC	■	■	-
	NO + NC	-	-	■
Wiring	DC 2-wire	■	■	-
	DC 3-wire	■	■	■
	DC 4-wire	-	-	■
	AC 2-wire	-	-	-
Voltage	10 to 30 VDC	■	■	■
	12 to 240 VAC	-	-	-
IP rating	IP67	■	■	■
	IP69K	-	-	■
Page		24	-	21

Special models

Type	Full metal face	Oil resistant	High precision positioning
			
Model	E2FM	E2E	E2C-EDA*
Key features	<ul style="list-style-type: none"> <li>immune to aluminium and cast iron chips on sensing surface</li> <li>oil resistant</li> </ul>	<ul style="list-style-type: none"> <li>tested oil resistance on commonly used lubricants</li> </ul>	<ul style="list-style-type: none"> <li>distance teaching up to μm accuracy</li> </ul>
dia 3	-	-	■
dia 4	-	-	-
dia 6.5	-	-	-
M5	-	-	-
M8	■	■	-
M12	■	■	■
M18	■	■	■
M30	■	■	-
Page	23	22	-

\* The product is not represented in the brochure. For more information visit: [industrial.omron.eu/e2ec](http://industrial.omron.eu/e2ec)  
[industrial.omron.eu/e2s](http://industrial.omron.eu/e2s)  
[industrial.omron.eu/e2c](http://industrial.omron.eu/e2c)

■ Standard □ Available - No/not available



Food and Beverage Industry  
Processing control



Control positioning of valves in the processing systems of dairies or breweries.

Control position feedback in the splitter box of the beverage production process.



High water resistance    High mechanical resistance    High electro-magnetic noise immunity    High vibration resistance    High resistance against temperature change    Cable breakage protection

Extended sensing range inductive sensor  
in cylindrical brass housing



The high quality and the long-life design of the E2A extended sensing distance provide high operational reliability, accurate performance and long sensor lifetime for a wide range of applications.

- Extended (double) sensing distance
- IP67 and IP69k for highest water protection
- DC 3-wire (NO, NC)
- Wide temperature range –40 to 70°C
- 200 mA max load current
- Wide installation and connectivity range through modular concept

Ordering information

Pre-wired

Size	Connector type		Sensing distance	Thread length (overall length)	Output configuration	Order code (for pre-wired types with 2 m PVC cable)	
	NO	NC				Operation mode NO	Operation mode NC
M8	■	–	2.0 mm	27 (40) mm	PNP <sup>*1</sup>	E2A-S08KS02-WP-B1 2M <sup>*2</sup>	E2A-S08KS02-WP-B2 2M <sup>*2</sup>
	–	■	4.0 mm	21 (40) mm	PNP <sup>*1</sup>	E2A-S08KN04-WP-B1 2M <sup>*2</sup>	E2A-S08KN04-WP-B2 2M <sup>*2</sup>
M12	■	–	4.0 mm	34 (50) mm	PNP <sup>*1</sup>	E2A-M12KS04-WP-B1 2M	E2A-M12KS04-WP-B2 2M
	–	■	8.0 mm	27 (50) mm	PNP <sup>*1</sup>	E2A-M12KN08-WP-B1 2M	E2A-M12KN08-WP-B2 2M
M18	■	–	8.0 mm	39 (59) mm	PNP <sup>*1</sup>	E2A-M18KS08-WP-B1 2M	E2A-M18KS08-WP-B2 2M
	–	■	16.0 mm	29 (59) mm	PNP <sup>*1</sup>	E2A-M18KN16-WP-B1 2M	E2A-M18KN16-WP-B2 2M
M30	■	–	15.0 mm	44 (64) mm	PNP <sup>*1</sup>	E2A-M30KS15-WP-B1 2M	E2A-M30KS15-WP-B2 2M
	–	■	20.0 mm <sup>*3</sup>	29 (64) mm	PNP <sup>*1</sup>	E2A-M30KN20-WP-B1 2M	E2A-M30KN20-WP-B2 2M

Connector types (M12)

Size	Connector type		Sensing distance	Thread length (overall length)	Output configuration	Order code (for M12 connector types)	
	NO	NC				Operation mode NO	Operation mode NC
M8	■	–	2.0 mm	27 (43) mm	PNP <sup>*1</sup>	E2A-S08KS02-M1-B1 <sup>*2</sup>	E2A-S08KS02-M1-B2 <sup>*2</sup>
	–	■	4.0 mm	21 (43) mm	PNP <sup>*1</sup>	E2A-S08KN04-M1-B1 <sup>*2</sup>	E2A-S08KN04-M1-B2 <sup>*2</sup>
M12	■	–	4.0 mm	24 (48) mm	PNP <sup>*1</sup>	E2A-M12KS04-M1-B1	E2A-M12KS04-M1-B2
	–	■	8.0 mm	27 (48) mm	PNP <sup>*1</sup>	E2A-M12KN08-M1-B1	E2A-M12KN08-M1-B2
M18	■	–	8.0 mm	39 (53) mm	PNP <sup>*1</sup>	E2A-M18KS08-M1-B1	E2A-M18KS08-M1-B2
	–	■	16.0 mm	29 (53) mm	PNP <sup>*1</sup>	E2A-M18KN16-M1-B1	E2A-M18KN16-M1-B2
M30	■	–	15.0 mm	44 (58) mm	PNP <sup>*1</sup>	E2A-M30KS15-M1-B1	E2A-M30KS15-M1-B2
	–	■	20.0 mm <sup>*3</sup>	29 (58) mm	PNP <sup>*1</sup>	E2A-M30KN20-M1-B1	E2A-M30KN20-M1-B2

<sup>\*1</sup> NPN models are available. For ordering replace "-B1" or "-B2" by "-C1" or "-C2".

<sup>\*2</sup> M8 sized housings are only available in stainless steel (SUS 303).

<sup>\*3</sup> Models with longer sensing distances of 30 mm and 35 mm are available.

Specifications

(Exemplary for shielded versions.)

Item	M8	M12	M18	M30
	E2A-S08KS	E2A-M12KS	E2A-M18KS	E2A-M30KS
Sensing distance	2 mm±10%	4 mm±10%	8 mm±10%	15 mm±10%
Response frequency	1,500 Hz	1,000 Hz	500 Hz	250 Hz
Power supply voltage (operating voltage)	12 to 24 VDC. Ripple (p-p): 10% max. (10 to 32 VDC)			
Protective circuits	Power supply reverse polarity protection, surge suppressor, short-circuit protection		Output reverse polarity protection, power supply reverse polarity protection, surge suppressor, short-circuit protection	
Ambient temperature	Operating	–40 to 70°C		
	Storage	–40 to 85°C (with no icing or condensation)		
Degree of protection	IP67 after IEC 60529; IP69K after DIN 40050 part 9			
Material	Case	Stainless steel	Brass-nickel plated	
	Sensing surface	PBT		

Automotive industry  
Special application systems



Road Spreader. Proximity sensors control the rotor to ensure the correct speed for spreading of sand and reagents on the roads during wintertime. Extremely tough outdoor application conditions require the highest reliability of the sensors, housing and vibration-resistance of the sensor.



Car washing system. Proximity sensors control end positioning of the frame and also current position of wash brushes. The sensors should have a long life time to survive in high humidity and permanently changing external temperature.



High resistance against temperature change      High vibration resistance

Extended sensing range inductive sensor  
in cylindrical stainless steel housing

The performance and operational reliability of the E2A family is also available in stainless steel housing.

- stainless steel housing (SUS 303)



Ordering information

Pre-wired

Size	Connector type		Sensing distance	Thread length (overall length)	Output configuration	Order code (for pre-wired types with 2 m PVC cable)	
	PNP	NPN				Operation mode NO	Operation mode NC
M8	■	–	2.0 mm	27 (40) mm	PNP <sup>*1</sup>	E2A-S08KS02-WP-B1 2M	E2A-S08KS02-WP-B2 2M
	–	■	4.0 mm	21 (40) mm	PNP <sup>*1</sup>	E2A-S08KN04-WP-B1 2M	E2A-S08KN04-WP-B2 2M
M12	■	–	4.0 mm	34 (50) mm	PNP <sup>*1</sup>	E2A-S12KS04-WP-B1 2M	E2A-S12KS04-WP-B2 2M
	–	■	8.0 mm	27 (50) mm	PNP <sup>*1</sup>	E2A-S12KN08-WP-B1 2M	E2A-S12KN08-WP-B2 2M
M18	■	–	8.0 mm	39 (59) mm	PNP <sup>*1</sup>	E2A-S18KS08-WP-B1 2M	E2A-S18KS08-WP-B2 2M
	–	■	16.0 mm	29 (59) mm	PNP <sup>*1</sup>	E2A-S18KN16-WP-B1 2M	E2A-S18KN16-WP-B2 2M
M30	■	–	15.0 mm	44 (64) mm	PNP <sup>*1</sup>	E2A-S30KS15-WP-B1 2M	E2A-S30KS15-WP-B2 2M
	–	■	20.0 mm <sup>*2</sup>	29 (64) mm	PNP <sup>*1</sup>	E2A-S30KN20-WP-B1 2M	E2A-S30KN20-WP-B2 2M

Connector types (M12)

Size	Connector type		Sensing distance	Thread length (overall length)	Output configuration	Order code (for M12 connector types)	
	PNP	NPN				Operation mode NO	Operation mode NC
M8	■	–	2.0 mm	27 (43) mm	PNP <sup>*1</sup>	E2A-S08KS02-M1-B1	E2A-S08KS02-M1-B2
	–	■	4.0 mm	21 (43) mm	PNP <sup>*1</sup>	E2A-S08KN04-M1-B1	E2A-S08KN04-M1-B2
M12	■	–	4.0 mm	24 (48) mm	PNP <sup>*1</sup>	E2A-S12KS04-M1-B1	E2A-S12KS04-M1-B2
	–	■	8.0 mm	27 (48) mm	PNP <sup>*1</sup>	E2A-S12KN08-M1-B1	E2A-S12KN08-M1-B2
M18	■	–	8.0 mm	39 (53) mm	PNP <sup>*1</sup>	E2A-S18KS08-M1-B1	E2A-S18KS08-M1-B2
	–	■	16.0 mm	29 (53) mm	PNP <sup>*1</sup>	E2A-S18KN16-M1-B1	E2A-S18KN16-M1-B2
M30	■	–	15.0 mm	44 (58) mm	PNP <sup>*1</sup>	E2A-S30KS15-M1-B1	E2A-S30KS15-M1-B2
	–	■	20.0 mm <sup>*2</sup>	29 (58) mm	PNP <sup>*1</sup>	E2A-S30KN20-M1-B1	E2A-S30KN20-M1-B2

<sup>\*1</sup> NPN models are available. For ordering replace “-B1” or “-B2” by “-C1” or “-C2”.  
<sup>\*2</sup> Models with longer sensing distances of 30 mm and 35 mm are available.

Specifications

(Exemplary for shielded versions)

Item	M8		M12		M18		M30	
	E2A-S08KS		E2A-M12KS		E2A-M18KS		E2A-M30KS	
Sensing distance	2 mm±10%		4 mm±10%		8 mm±10%		15 mm±10%	
Response frequency	1,500 Hz		1,000 Hz		500 Hz		250 Hz	
Power supply voltage (operating voltage)	12 to 24 VDC. Ripple (p-p): 10% max. (10 to 32 VDC)							
Protective circuits	Power supply reverse polarity protection, surge suppressor, short-circuit protection				Output reverse polarity protection, power supply reverse polarity protection, surge suppressor, short-circuit protection			
Ambient temperature	Operating	–40 to 70°C						
	Storage	–40 to 85°C (with no icing or condensation)						
Degree of protection	IP67 after IEC 60529; IP69K after DIN 40050 part 9							
Material	Case	Stainless steel (SUS 303)						
	Sensing surface	PBT						



Utility vehicles



Garbage truck. Intended specifically for demanding applications in moving machinery such as refuse-disposal trucks, earth-moving equipment and construction and agricultural vehicles, E2AU sensors meet most severe regulatory standards for moving vehicles. These include e1 type approval (eMark) according to the European Automotive Directive 95/54/EC and electro-magnetic noise immunity up to 100 V/m according to ISO 11452-2.



High electro-magnetic noise immunity (fields and cable induced)

**e1**

e1 type approval after 2005/83/EC



E1 type approval after ECE-R10

Inductive sensor for mobile usage in cylindrical brass housing



Designed and tested to keep your mobile machines moving.

- IP69k tested and certified for highest water resistance
- e1 type approval (according to Automotive Directive 2005/83/EC)
- E1 type approval (according to vehicle regulation ECE-R10)
- Cable or connector breakage protection

Ordering information

Pre-wired

Size	[Symbol]	[Symbol]	Sensing distance	Thread length (overall length)	Output configuration	Order code (for pre-wired types with 2 m PVC cable)*1	
						Operation mode: NO	Operation mode: NC
M12	■	-	4.0 mm	34 mm (50 mm)	PNP	E2AU-M12KS04-WP-B1 2M	E2AU-M12KS04-WP-B2 2M
				56 mm (72 mm)	PNP	E2AU-M12LS04-WP-B1 2M	E2AU-M12LS04-WP-B2 2M
M18	■	-	8.0 mm	39 mm (59 mm)	PNP	E2AU-M18KS08-WP-B1 2M	E2AU-M18KS08-WP-B2 2M
				61 mm (81 mm)	PNP	E2AU-M18LS08-WP-B1 2M	E2AU-M18LS08-WP-B2 2M
M30	■	-	15.0 mm	44 mm (64 mm)	PNP	E2AU-M30KS15-WP-B1 2M	E2AU-M30KS15-WP-B2 2M
				66 mm (86 mm)	PNP	E2AU-M30LS15-WP-B1 2M	E2AU-M30LS15-WP-B2 2M

\*1 NPN types and pre-wired types with PUR cable are available. Contact your OMRON representative

Connector types (M12)

Size	[Symbol]	[Symbol]	Sensing distance	Thread length (overall length)	Output configuration	Order code (for M12 connector types)	
						Operation mode: NO	Operation mode: NC
M12	■	-	4.0 mm	34 mm (48 mm)	PNP	E2AU-M12KS04-M1-B1	E2AU-M12KS04-M1-B2
				56 mm (70 mm)	PNP	E2AU-M12LS04-M1-B1	E2AU-M12LS04-M1-B2
M18	■	-	8.0 mm	39 mm (53 mm)	PNP	E2AU-M18KS08-M1-B1	E2AU-M18KS08-M1-B2
				61 mm (75 mm)	PNP	E2AU-M18LS08-M1-B1	E2AU-M18LS08-M1-B2
M30	■	-	15.0 mm	44 mm (58 mm)	PNP	E2AU-M30KS15-M1-B1	E2AU-M30KS15-M1-B2
				66 mm (80 mm)	PNP	E2AU-M30LS15-M1-B1	E2AU-M30LS15-M1-B2

Specifications

Item	M12	M18	M30
	E2AU-M12_	E2AU-M18_	E2AU-M30_
Sensing distance	4 mm±10%	8 mm±10%	15 mm±10%
Response frequency	1,000 Hz	500 Hz	250 Hz
Power supply voltage (operating voltage)	12 to 24 VDC. Ripple (p-p): 10% max. (10 to 32 VDC)		
Protective circuits	Output reverse polarity protection, power supply reverse polarity protection, surge suppressor, short-circuit protection		
Ambient temperature	Operating	-40 to 70°C	
	Storage	-40 to 85°C (with no icing or condensation)	
Degree of protection	IP67 after IEC 60529, IP69K after DIN 40050 part 9		
Material	Case	Brass-nickel plated	
	Sensing surface	PBT	

Food and Beverage Industry  
Packaging

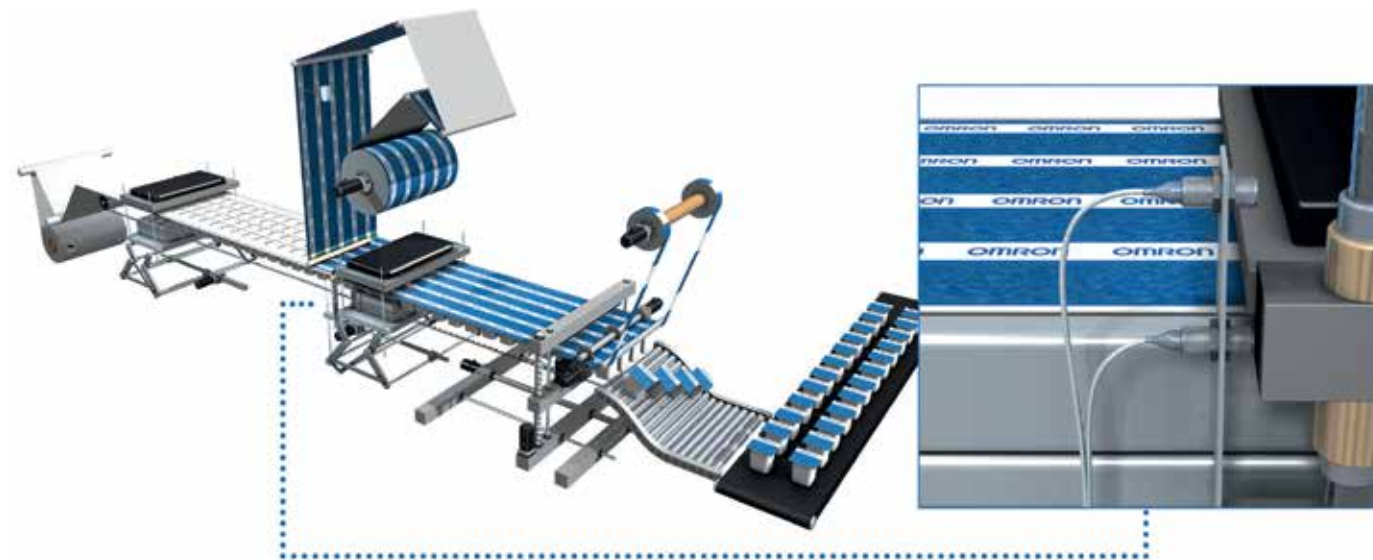

Control positioning of pressing elements in packaging machine for yogurts.

Machine tool

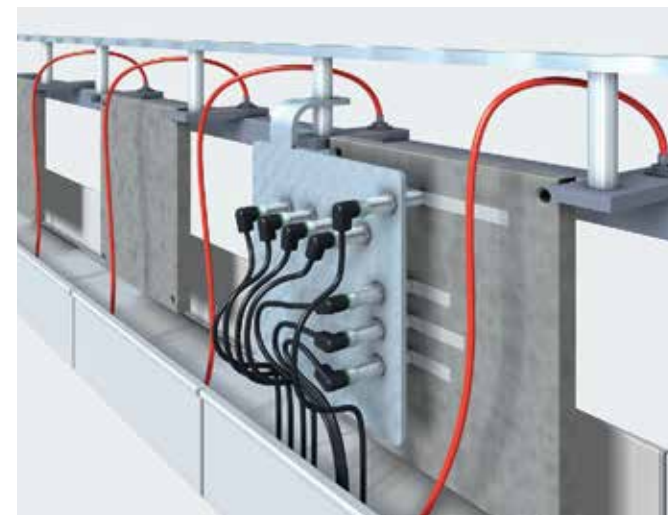

Liner encoder to control correct positioning in automatic bar feeders for single-spindle and multispindle lathes.

Access control

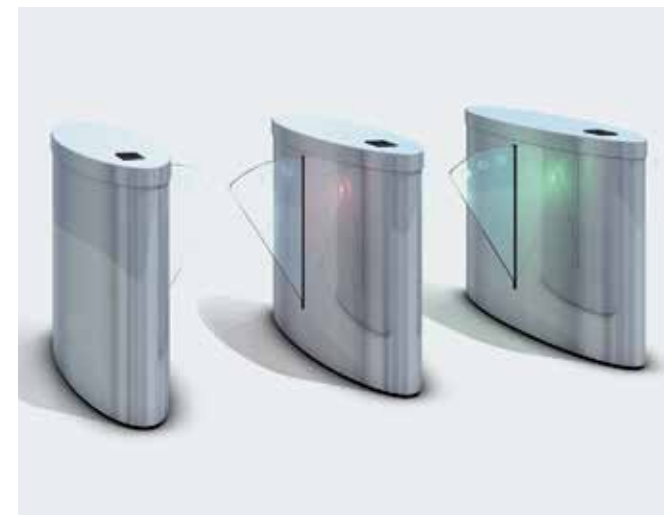

Control positioning of elements of turnstile for railway or underground stations.

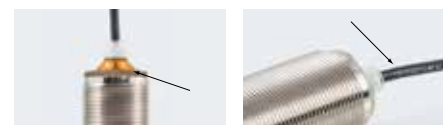

High-visibility ring LED indicator      Laser printing part number

The ideal solution for standard industrial conditions

Thanks to the simple construction and Omron's innovative "hot melt" production process, the E2B sensors embody two characteristics: value-for-money and high reliability.

- All-round-visible indicator
- The laser printed part number
- Vibration shock resistance: IEC 60947-5-2 (10 to 55 Hz)
- Operating temperature: -25 to 70°C
- Water resistance: IP67



Ordering information

Pre-wired

Size	Sensing distance		Output configuration	Order code (for pre-wired types with 2 m PVC cable)		
	PNP	NPN		Operation mode NO	Operation mode NC	
M8	■	–	2.0 mm	PNP <sup>*1</sup>	E2B-S08KS02-WP-B1 2M <sup>*2</sup>	E2B-S08KS02-WP-B2 2M <sup>*2</sup>
	–	■	4.0 mm	PNP <sup>*1</sup>	E2B-S08KN04-WP-B1 2M <sup>*2</sup>	E2B-S08KN04-WP-B2 2M <sup>*2</sup>
M12	■	–	4.0 mm	PNP <sup>*1</sup>	E2B-M12KS04-WP-B1 2M	E2B-M12KS04-WP-B2 2M
	–	■	8.0 mm	PNP <sup>*1</sup>	E2B-M12KN08-WP-B1 2M	E2B-M12KN08-WP-B2 2M
M18	■	–	8.0 mm	PNP <sup>*1</sup>	E2B-M18KS08-WP-B1 2M	E2B-M18KS08-WP-B2 2M
	–	■	16.0 mm	PNP <sup>*1</sup>	E2B-M18KN16-WP-B1 2M	E2B-M18KN16-WP-B2 2M
M30	■	–	15.0 mm	PNP <sup>*1</sup>	E2B-M30KS15-WP-B1 2M	E2B-M30KS15-WP-B2 2M
	–	■	30.0 mm	PNP <sup>*1</sup>	E2B-M30LN30-WP-B1 2M	E2B-M30LN30-WP-B2 2M

Connector types

Size	Sensing distance		Output configuration	Order code		
	PNP	NPN		Operation mode NO	Operation mode NC	
M8	■	–	2.0 mm	PNP <sup>*1</sup>	E2B-S08KS02-MC-B1 <sup>*2</sup>	E2B-S08KS02-MC-B2 <sup>*2</sup>
	–	■	4.0 mm	PNP <sup>*1</sup>	E2B-S08KN04-MC-B1 <sup>*2</sup>	E2B-S08KN04-MC-B2 <sup>*2</sup>
M12	■	–	4.0 mm	PNP <sup>*1</sup>	E2B-M12KS04-M1-B1	E2B-M12KS04-M1-B2
	–	■	8.0 mm	PNP <sup>*1</sup>	E2B-M12KN08-M1-B1	E2B-M12KN08-M1-B2
M18	■	–	8.0 mm	PNP <sup>*1</sup>	E2B-M18KS08-M1-B1	E2B-M18KS08-M1-B2
	–	■	16.0 mm	PNP <sup>*1</sup>	E2B-M18KN16-M1-B1	E2B-M18KN16-M1-B2
M30	■	–	15.0 mm	PNP <sup>*1</sup>	E2B-M30KS15-M1-B1	E2B-M30KS15-M1-B2
	–	■	30.0 mm	PNP <sup>*1</sup>	E2A-M30LN30-M1-B1	E2B-M30LN30-M1-B2

<sup>\*1</sup> NPN models are available. For ordering replace "-B1" or "-B2" by "-C1" or "-C2".

<sup>\*2</sup> M8 sized housings are only available in stainless steel (SUS 303).

Refer to complete datasheet or contact your OMRON representative for the below optional features

Specifications

(Exemplary for shielded versions.)

Item	M8	M12	M18	M30
	E2B-S08KS	E2B-M12KS	E2B-M18KS	E2B-M30KS
Sensing distance	2 mm±10%	4 mm±10%	8 mm±10%	15 mm±10%
Response frequency	1,500 Hz	1,000 Hz	500 Hz	250 Hz
Power supply voltage (operating voltage)	12 to 24 VDC. Ripple (p-p): 10% max. (10 to 32 VDC)			
Protective circuits	Output reverse polarity protection, Power source circuit reverse polarity protection			
Ambient temperature	Operating and storage: -25 to 70°C			
Degree of protection	IP67 after IEC 60529			
Material	Case		Brass-nickel plated	
	Sensing surface		PBT	



Machine tool



Control positioning of grabbing arms of robotic manipulators.

Packaging



Control positioning of welding elements in the compact packaging machines.



Lineup of global small-diameter types (3 dia., 4 dia., 6.5 dia., M4, M5)

Small diameter proximity sensors for high precision detection



Omron's latest inductive technology has now been applied to a new range of small diameter inductive sensors. The new μPROX E2E provides precision detection and allows installation in even the most confined spaces. The portfolio has been extended to include non-shielded types and versions with pig-tail connector leads.

- Miniature size: 3, 4, 6.5 mm and M4, M5 diameters
- High frequency of 5 kHz: suitable for high-speed counting
- All sizes are also available as non-shielded types
- IP67 water ingress protection
- Highly visible indicators for easy operation confirmation

Ordering information

Size	Sensing distance		Connection	Output configuration	Order code	
	Shielded	Non-shielded			Operation mode NO	Operation mode NC
dia 3 mm	■	0.8 mm	PW	PNP	E2E-C03SR8-WC-B1 2M OMS	E2E-C03SR8-WC-B2 2M OMS
		2 mm		NPN	E2E-C03SR8-WC-C1 2M OMS	E2E-C03SR8-WC-C2 2M OMS
	■	0.8 mm	PW	PNP	E2E-C03N02-WC-B1 2M OMS	E2E-C03N02-WC-B2 2M OMS
				NPN	E2E-C03N02-WC-C1 2M OMS	E2E-C03N02-WC-C2 2M OMS
M4	■	0.8 mm	PW	PNP	E2E-S04SR8-WC-B1 2M OMS	E2E-S04SR8-WC-B2 2M OMS
		2 mm		NPN	E2E-S04SR8-WC-C1 2M OMS	E2E-S04SR8-WC-C2 2M OMS
	■	1.2 mm	PW	PNP	E2E-S04N02-WC-B1 2M OMS	E2E-S04N02-WC-B2 2M OMS
				NPN	E2E-S04N02-WC-C1 2M OMS	E2E-S04N02-WC-C2 2M OMS
dia 4 mm	■	1.2 mm	PW	PNP	E2E-C04S12-WC-B1 2M OMS	E2E-C04S12-WC-B2 2M OMS
		3 mm		NPN	E2E-C04S12-WC-C1 2M OMS	E2E-C04S12-WC-C2 2M OMS
	■	1.2 mm	PW	PNP	E2E-C04N03-WC-B1 2M OMS	E2E-C04N03-WC-B2 2M OMS
				NPN	E2E-C04N03-WC-C1 2M OMS	E2E-C04N03-WC-C2 2M OMS
M5	■	1.2 mm	PW	PNP	E2E-S05S12-WC-B1 2M OMS	E2E-S05S12-WC-B2 2M OMS
		3 mm		NPN	E2E-S05S12-WC-C1 2M OMS	E2E-S05S12-WC-C2 2M OMS
	■	2 mm	PW	PNP	E2E-S05N03-WC-B1 2M OMS	E2E-S05N03-WC-B2 2M OMS
				NPN	E2E-S05N03-WC-C1 2M OMS	E2E-S05N03-WC-C2 2M OMS
dia 6.5 mm	■	2 mm	PW	PNP	E2E-C06S02-WC-B1 2M OMS	E2E-C06S02-WC-B2 2M OMS
				NPN	E2E-C06S02-WC-C1 2M OMS	E2E-C06S02-WC-C2 2M OMS
				PNP	E2E-C06S02-MC-B1 OMS	E2E-C06S02-MC-B2 OMS
				NPN	E2E-C06S02-MC-C1 OMS	E2E-C06S02-MC-C2 OMS
	■	4 mm	PW	PNP	E2E-C06N04-WC-B1 2M OMS	E2E-C06N04-WC-B2 2M OMS
				NPN	E2E-C06N04-WC-C1 2M OMS	E2E-C06N04-WC-C2 2M OMS
				PNP	E2E-C06N04-MC-B1 OMS	E2E-C06N04-MC-B2 OMS
				NPN	E2E-C06N04-MC-C1 OMS	E2E-C06N04-MC-C2 OMS

Specifications

Item	φ3/M4		Φ4/M5		Φ6.5	
	E2E-C03S/-S04S	E2E-C03N/-S04N	E2E-C04S/-S05S	E2E-C04N/-S05N	E2E-C06S	E2E-C06N
Sensing distance	0.8 mm±10%	2.0 mm±10%	1.2 mm±10%	3.0 mm±10%	2.0 mm±10%	4 mm±10%
Setting distance	0 to 0.56mm	0 to 1.4mm	0 to 0.84mm	0 to 2.1mm	0 to 1.4mm	0 to 2.8mm
Response frequency	5 kHz	3 kHz	4 kHz	2 kHz	3 kHz	4 kHz
Supply voltage	10 to 30 VDC					
Current consumption	≤10 mA					
Max. control output	≤50 mA		≤100 mA		≤200 mA	
Residual output voltage	≤2 V					
Ambient temperature range	-25 to 70°C					
Ambient temperature fluctuation	≤15%					
Degree of protection	IEC 60529 IP67					
Material	Case	Stainless steel (SUS303)				
	Sensing surface	Heat-resistant ABS				



Food and Beverage Industry  
Beverage processing



Control positioning of valves of the mixers or heating systems.



Control positioning of metal elements in the mixing systems at conditions of direct contact with beverage or active chemicals.

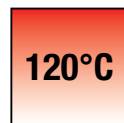

e1 type approval after 2005/83/EC

Enhanced detergent resistance



Heat and detergent resistant inductive sensor in cylindrical stainless steel housing

The heat and detergent resistant inductive sensors allow reliable metal object or machine part detection in demanding environments such as food processing.

- Temperature resistant up to 120°C
- SUS316L housing with heat resistant plastic sensing face
- IP69k for highest water resistance
- ECOLAB tested and certified detergent resistance

Specifications

Item	M12	M18	M30
	E2EH-X3_	E2EH-X7_	E2EH-X12_
Sensing distance	3 mm±10%	7 mm±10%	12 mm±10%
Response frequency (average)	500 Hz	300 Hz	100 Hz
Power supply voltage (operating voltage range)	12 to 24 VDC, ripple (p-p): 10% max. (10 to 32 VDC) (24 VDC max. at 100°C or higher)		
Protective circuits	Surge suppression, short circuit protection, power supply reverse polarity protection, output reverse polarity protection		
Ambient temperature*1	DC 3-wire models: 0 to 100°C (0 to 120°C for 1,000 hours), DC 2-wire models: 0 to 100°C (0 to 110°C for 1,000 hours)		
Degree of protection	IEC 60529 IP67, IP69k after DIN 40050-9		
Material	Case, clamping nuts	Stainless steel (SUS316L)	
	Sensing surface	PBT (polybutylene terephthalate)	
	Cable	Heat-resistant PVC	

\*1 Operation with power supplied for 1,000 h has been verified at 120°C for DC 3-wire models and at 110°C for DC 2-wire models. Do not bend the cable repeatedly at 100°C or higher.



Chemical resistant inductive sensor in cylindrical PTFE housing

The E2FQ features a full-body fluoro plastic housing for chemical resistance (e.g. against cleaning agents used in the semiconductor industry).

- Full body fluoro plastic housing for chemical resistance
- DC 2-wire and DC 3-wire models

Specifications

Item	M12	M18	M30
	E2FQ-X2_	E2FQ-X5_	E2FQ-X10_
Sensing distance	2 mm±10%	5 mm±10%	10 mm±10%
Response frequency	E1, F1 models: 1.5 kHz D1 models: 800 Hz	E1, F1 models: 600 Hz, D1 models: 500 Hz	E1, F1 models: 400 Hz, D1 models: 300 Hz
Power supply voltage (Operating voltage)	E1, F1 models: 12 to 24 VDC, ripple (p-p): 10% max., (10 to 30 VDC) D1 models: 12 to 24 VDC, ripple (p-p): 20% max., (10 to 36 VDC)		
Protective circuits	D1 models: surge suppressor E1, F1 models: power supply, reverse polarity protection, short circuit protection, surge suppressor		
Ambient temperature	Operating	-25 to 70°C (with no icing or condensation)	
	Storage		
Degree of protection	IEC60529 IP67		
Material	Case	PTFE	
	Sensing surface	PTFE	



### Inductive proximity sensor with gold-plated pins

Inductive proximity sensor E2A-4 was created and tested for applications in the harsh environment and at tough vibration conditions. Gold-plated contact pins provide increased protection against corrosion in high humidity and vibration.

- Gold-plated contact pins
- Connector type M8 and M12 models
- PNP/NPN NO

### Ordering information

Size	Sensing distance	Connection	Body material	Thread length (overall length)	Output configuration	Operation mode	Order code
M8	2 mm	Connector M8 3 pin: gold-plated	Stainless steel	27 (40) mm	NPN	NO	E2A-S08KS02-M5-C1-4
				49 (62) mm			E2A-S08LS02-M5-C1-4
M12	4 mm	Connector M12 4 pin: gold-plated	Brass-nickel plated	34 (48) mm	PNP		E2A-M12KS04-M1-B1-4
	8 mm						E2A-M12KN08-M1-B1-4

### Specifications

Size	M8		M12	
Model	E2A-S08KS02-M5-C1-4	E2A-S08LS02-M5-C1-4	E2A-M12KS04-M1-B1-4	E2A-M12KN08-M1-B1-4
Sensing distance (Standard target: mild steel ST37 8×8×1 mm)	2 mm±10%		4 mm±10%	8 mm±10%
Response frequency	1,500 Hz		1,000 Hz	800 Hz
Power supply voltage	10 to 32 VDC			
PIN	Bronze(C5441) / Gold-plated contacts			
Operating environment	Ambient air temperature	-40 to 70°C (with no icing or condensation)		
	Ambient air humidity	35% to 95% RH		
Degree of protection	IEC60529 IP67			
Materials Case	Stainless steel		Brass-nickel plated	
Sensing surface	PBT			

### Mobile machines



Gold plated pins of E2A-4 intend to prevent erosion of contacts with cable connectors in high humidity and permanent vibration of the wood harvesting machine.

### Windmill generators

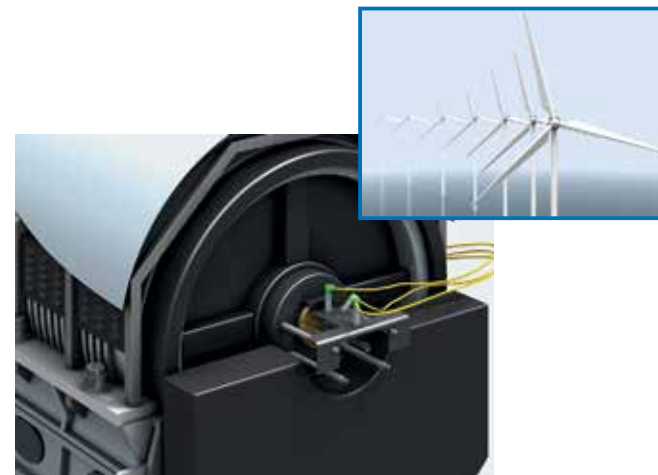

Inductive proximity sensors control the rotation axis of the windmill generator. Gold plated pins provide maximum reliability of contacts and prevent erosion in high humidity and vibration even in off-shore applications.



### Long distance inductive proximity sensor in plastic housing

The long sensing distance and simple installation on flat surfaces make the E2Q5 ideal for the detection of large metal objects for example in automotive assembly lines.

- M12 Plug-in connection
- Integrated short circuit and reverse polarity protection
- Sensing face positioning: Y-axis 15°, X-axis 90° increments

### Ordering information

#### Connector types (M12)

Size in mm (H × W × D)	Sensing distance		Sensing face	Output configuration	Order code (for M12 connector types)	
	20 mm	40 mm			Operation mode NO	Operation mode NO + NC
67 × 40 × 40	■	-	Changeable	NPN	E2Q5-N20E1-M1	E2Q5-N20E3-M1
				PNP	E2Q5-N20F1-M1	E2Q5-N20F3-M1
	-	■		NPN	E2Q5-N40ME1-M1	E2Q5-N40ME3-M1
				PNP	E2Q5-N40MF1-M1	E2Q5-N40MF3-M1

### Specifications

Item	E2Q5-N20__-M1	E2Q5-N40M_3-M1
Sensing distance	20 mm±10%	40 mm±10%
Response frequency	150 Hz	
Power supply voltage	10 to 30 VDC	
Protective circuits	Output reverse polarity protection, short-circuit protection	
Ambient temperature	Operating	-25 to 85°C
Degree of protection	IEC 60529 IP 67; IP69k after DIN 40050 part 9	
Material	Case	PBT
	Sensing face	PBT

### Agricultural industry



Control pallet positions of plants in green houses.





### Oil resistant inductive sensor in cylindrical brass housing

The E2E-\_-U offers tested oil resistance on commonly used oils in the automotive industry for reliable long-life operation in automotive assembly lines.

- Oil resistant PUR cable
- M8, M12, M18 and M30 standard sizes
- IP67g (water and oil resistance)

### Ordering information

#### DC 2-wire (pre-wired)

Size	Sensing distance		Order code (for pre-wired types with 2 m PUR cable)		
	Operation mode NO	Operation mode NC	Operation mode NO	Operation mode NC	
M8	■	—	2 mm	E2E-X2D1-U	E2E-X2D2-U
M12	■	—	3 mm	E2E-X3D1-U	E2E-X3D2-U
M18	■	—	7 mm	E2E-X7D1-U	E2E-X7D2-U
M30	■	—	10 mm	E2E-X10D1-U	E2E-X10D2-U

#### DC 2-wire (pre-wired with M12)

Size	Sensing distance		Order code (for pre-wired types with 30 cm PUR cable and M12 plug)		
	Operation mode NO	Operation mode NC	Operation mode NO	Operation mode NC	
M8	■	—	2 mm	E2E-X2D1-M1TGJ-U 0.3M	E2E-X2D2-M1TGJ-U 0.3M
M12	■	—	3 mm	E2E-X3D1-M1TGJ-U 0.3M	E2E-X3D2-M1TGJ-U 0.3M
M18	■	—	7 mm	E2E-X7D1-M1TGJ-U 0.3M	E2E-X7D2-M1TGJ-U 0.3M
M30	■	—	10 mm	E2E-X10D1-M1TGJ-U 0.3M	E2E-X10D2-M1TGJ-U 0.3M

### Specifications

Item	M8		M12	M18	M30
	E2E-X2D_	E2E-X3D_	E2E-X7D_	E2E-X10D_	
Sensing distance	2 mm±10%	3 mm±10%	7 mm±10%	10 mm±10%	
Response frequency	1.5 kHz	1.0 kHz	0.5 kHz	0.4 kHz	
Power supply voltage (operating voltage)	12 to 24 VDC (10 to 30 VDC), ripple (p-p): 10% max.				
Protective circuits	Surge suppressor, output short-circuit protection (for control and diagnostic output)				
Ambient temperature	Operating	-25 to 70°C			
	Storage	-40 to 85°C (with no icing or condensation)			
Degree of protection	IEC 60529 IP67 (JEM standard IP67g (waterproof and oil-proof))				
Material	Case	Stainless steel (SUS303)	Brass-nickel plated		
	Sensing surface	PBT (polybutylene terephthalate)			
	Cable	PUR for jacket, PE			

### Automotive and machine tool industry



Position monitoring systems of machine tool with direct oil contact.

[industrial.omron.eu/e2e](http://industrial.omron.eu/e2e)



### Inductive sensor in cylindrical full metal housing (case + sensing face)

The high durability stainless steel sensing face provides more than 20 times longer protection against mechanical damage than conventional sensors. The high mineral oil and coolant resistance and the immunity against small metal chips on the surface make this sensor ideal for metal cutting or drilling applications.

- Full body stainless steel housing for highest mechanical protection
- Low frequency modulation for metal chip immunity
- Flame retardant cable for high protection against welding spatter damage (pigtail models)

### Ordering information

#### DC 2-wire (with M12 pigtail connector)

Size	Sensing distance		Order code <sup>*1</sup>
	Operation mode NO	Operation mode NC	(for pre-wired types with 30 cm PVC cable and M12 plug)
M8	■	—	E2FM-X1R5D1-M1TGJ
M12	■	—	E2FM-X2D1-M1TGJ
M18	■	—	E2FM-X5D1-M1TGJ
M30	■	—	E2FM-X10D1-M1TGJ

#### DC 3-wire, M12 Connector types

Size	Sensing distance		Order code <sup>*1</sup> (for M12 connector types)	
	Operation mode NO	Operation mode NC	PNP	NPN
M8	■	—	E2FM-X1R5B1-M1	E2FM-X1R5C1-M1
M12	■	—	E2FM-X2B1-M1	E2FM-X2C1-M1
M18	■	—	E2FM-X5B1-M1	E2FM-X5C1-M1
M30	■	—	E2FM-X10B1-M1	E2FM-X10C1-M1

\*1 Output configuration normally open (NO)

### Specifications

Item	M8		M12	M18	M30
	E2FM-X1R5	E2FM-X2	E2FM-X5	E2FM-X10	
Sensing distance	1.5 mm±10%	2 mm±10%	5 mm±10%	10 mm±10%	
Response frequency	200 Hz	100 Hz	100 Hz	50 Hz	
Power supply voltage (operating voltage range)	12 to 24 VDC (10 to 30 VDC), ripple (p-p): 10% max.				
Protective circuits	E2FM-_D1: Surge suppressor, output short-circuit protection E2FM-_B1/C1: Output reverse polarity protection (not E2FM-X1R5B1-M1), power supply reverse polarity protection, surge suppressor, short-circuit protection				
Ambient temperature	Operating	-25 to 70°C (with no icing or condensation)			
	Storage				
Degree of protection	IEC60529 IP67, IP69k after DIN 40050 part 9				
Material	Case	Stainless steel (SUS303)			
	Sensing surface	Stainless steel (SUS303)			
	Cable	PVC (flame retardant)			



E2FM extra strong sensing face



Conventional metal face product



No interference by small metal chips on sensing surface



Cable resistant to welding spatter

[industrial.omron.eu/e2fm](http://industrial.omron.eu/e2fm)

Flat shape inductive sensor in compact plastic housing



The TL-W family offers a wide range of block style inductive sensors for simple mounting on flat surfaces. With sensing distances from 1.5 mm to 20 mm the TL-W is the ideal solution for all standard applications.

- IP67
- DC 2-wire and DC 3-wire models
- Sensing distances from 1.5 mm to 20 mm
- Side facing sensing face

Ordering information

DC 3-wire

Size in mm (H × W × D)	Sensing distance	Order code (for pre-wired types with 2 m PVC cable)			
		PNP-NO	PNP-NC	NPN-NO	NPN-NC
25 × 8 × 5	1.5 mm	TL-W1R5MB1	–	TL-W1R5MC1	–
22 × 8 × 6	3 mm	TL-W3MB1	TL-W3MB2	TL-W3MC1	TL-W3MC2
31 × 18 × 10	5 mm	TL-W5MB1	TL-W5MB2	TL-W5MC1	TL-W5MC2
53 × 40 × 23	20 mm	–	–	TL-W20ME1	TL-W20ME2
31 × 18 × 10	5 mm	TL-W5F1	TL-W5F2	TL-W5E1	TL-W5E2

Specifications

Item	TL-W5MD_	TL-W1R5M_1	TL-W3M_	TL-W5M_	TL-W5E_/F_	TL-W20ME_
Sensing distance	5 mm±10%	1.5 mm±10%	3 mm±10%	5 mm±10%		20 mm±10%
Response frequency	500 Hz	1 kHz min.	600 Hz min.	500 Hz min.	300 Hz min.	40 Hz min.
Power supply voltage (operating voltage)	12 to 24 VDC (10 to 30 VDC ripple (p-p): 10% max.)				10 to 30 VDC with a ripple (p-p) of 20% max.	12 to 24 VDC (10 to 30 VDC) ripple (p-p): 10% max.
Ambient temperature	Operating: –25 to 70°C (with no icing or condensation) Storage: –					
Degree of protection	IEC60529 IP67					
Material	Case	Heat-resistant ABS resin			Diecast aluminum	Heat-resistant ABS resin
	Sensing surface	Heat-resistant ABS resin				

Utility vehicles

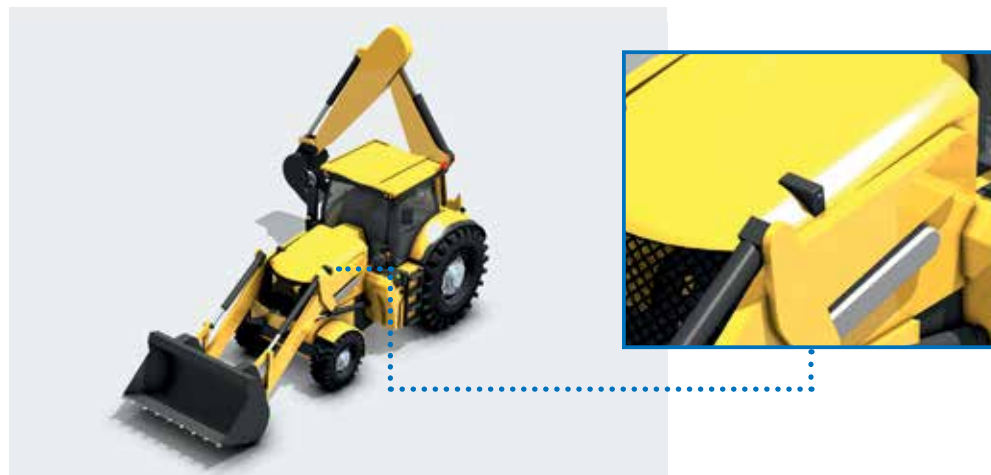

The inductive proximity sensors detects the bucket of the excavator in the tip position.

[industrial.omron.eu/tl-w](http://industrial.omron.eu/tl-w)

Size	Shape	Type	Features	Material		Order code			
				Nut	Cable				
M8		PRO	3 pin	Brass (CuZn)	PVC 2 m	XS3F-M8PVC3S2M-EU	XS3F-M8PVC3A2M-EU		
					PUR 2 m	XS3F-M8PUR3S2M-EU	XS3F-M8PUR3A2M-EU		
			4 pin		PVC 2 m	XS3F-M8PVC4S2M-EU	XS3F-M8PVC4A2M-EU		
					PUR 2 m	XS3F-M8PUR4S2M-EU	XS3F-M8PUR4A2M-EU		
		LITE	3 pin	Brass (CuZn)	PVC 2 m	XS3F-LM8PVC3S2M	XS3F-LM8PVC3A2M		
					4 pin	XS3F-LM8PVC4S2M	XS3F-LM8PVC4A2M		
M12		PRO	3 wire	Brass (CuZn)	PVC 2 m	XS2F-M12PVC3S2M-EU	XS2F-M12PVC3A2M-EU		
					PUR 2 m	XS2F-M12PUR3S2M-EU	XS2F-M12PUR3A2M-EU		
			4 wire		PVC 2 m	XS2F-M12PVC4S2M-EU	XS2F-M12PVC4A2M-EU		
					PUR 2 m	XS2F-M12PUR4S2M-EU	XS2F-M12PUR4A2M-EU		
			5 wire		PVC 2 m	XS2F-M12PVC5S2M-EU	XS2F-M12PVC5A2M-EU		
					PUR 2 m	XS2F-M12PUR5S2M-EU	XS2F-M12PUR5A2M-EU		
		LITE	3 wire	Brass (CuZn)	PVC 2 m	XS2F-LM12PVC3S2M	XS2F-LM12PVC3A2M		
					4 wire	XS2F-LM12PVC4S2M	XS2F-LM12PVC4A2M		
		PRO <sup>plus</sup> LED (power and output LED, PNP)	3 wire	Nickel plated brass	PVC 2 m	–	XS2F-M12PVC3A2MPLLED		
						4 wire	–	XS2F-M12PVC4A2MPLLED	
						3 wire	PUR 2 m	–	XS2F-M12PUR3A2MPLLED
							4 wire	–	XS2F-M12PUR4A2MPLLED
	PRO <sup>plus</sup> Detergent resistant	4 wire	Stainless steel (SUS316L)	PVC 2 m	Y92E-S12PVC4S2M-L	Y92E-S12PVC4A2M-L			
						Brass	n.a.	XS5G-D418	–
								4 pins Socket	XS5C-D418

S8VK-G

Single-phase

The standard book type power supply



The standard S8VK-G Pro line is our “install and forget” option, offering longer lifetime, higher protection and more features. The S8VK-G offers a wide product range (from 15 up to 480 W), in a very compact package. There are models available for 5, 12, 24 and 48 VDC output voltage. DC input (90 to 350 VDC) is also available through the whole range.

- Wide operating temperature range (–40 to 70°C) that guarantees stable operation
- Double set of DC output terminals (three for the negative) provide easy wiring
- High efficiency 90% to reduce the energy consumption
- Power boost functionality (120%) for the right start of the application
- Improved DIN-rail mounting clip provides a better resistance to vibrations and allows easy installation (using one hand to mount in a flash)

Ordering information

Type	Power ratings	Input voltage	Output voltage	Output current	Size (W × H × D) [mm]	Order code
Power supply Single-phase	15 W	100 to 240 VAC	24 VDC	0.65 A	22.5 × 90 × 90	S8VK-G01524
	30 W			1.3 A	32 × 90 × 90	S8VK-G03024
	60 W			2.5 A	32 × 90 × 110	S8VK-G06024
	120 W			5 A	40 × 125 × 113	S8VK-G12024
	240 W			10 A	60 × 125 × 140	S8VK-G24024
	480 W			20 A	95 × 125 × 140	S8VK-G48024



Daha fazlasını öğrenmek ister misiniz?

OMRON TÜRKİYE

+90 (216) 556 51 30

industrial.omron.tr

## Satış & Destek Ofisleri

### Almanya

Tel: +49 (0) 2173 680 00  
industrial.omron.de

### Avusturya

Tel: +43 (0) 2236 377 800  
industrial.omron.at

### Belçika

Tel: +32 (0) 2 466 24 80  
industrial.omron.be

### Çek Cumhuriyeti

Tel: +420 234 602 602  
industrial.omron.cz

### Danimarka

Tel: +45 43 44 00 11  
industrial.omron.dk

### Finlandiya

Tel: +358 (0) 207 464 200  
industrial.omron.fi

### Fransa

Tel: +33 (0) 1 56 63 70 00  
industrial.omron.fr

### Güney Afrika

Tel: +27 (0)11 579 2600  
industrial.omron.co.za

### Hollanda

Tel: +31 (0) 23 568 11 00  
industrial.omron.nl

### İngiltere

Tel: +44 (0) 1908 258 258  
industrial.omron.co.uk

### İspanya

Tel: +34 902 100 221  
industrial.omron.es

### İsveç

Tel: +46 (0) 8 632 35 00  
industrial.omron.se

### İsviçre

Tel: +41 (0) 41 748 13 13  
industrial.omron.ch

### İtalya

Tel: +39 02 326 81  
industrial.omron.it

### Macaristan

Tel: +36 1 399 30 50  
industrial.omron.hu

### Norveç

Tel: +47 22 65 75 00  
industrial.omron.no

### Polonya

Tel: +48 22 458 66 66  
industrial.omron.pl

### Portekiz

Tel: +351 21 942 94 00  
industrial.omron.pt

### Rusya

Tel: +7 495 648 94 50  
industrial.omron.ru

### Diğer Omron Temsilcileri

industrial.omron.eu