

Compact design only requires 50 mm installation space

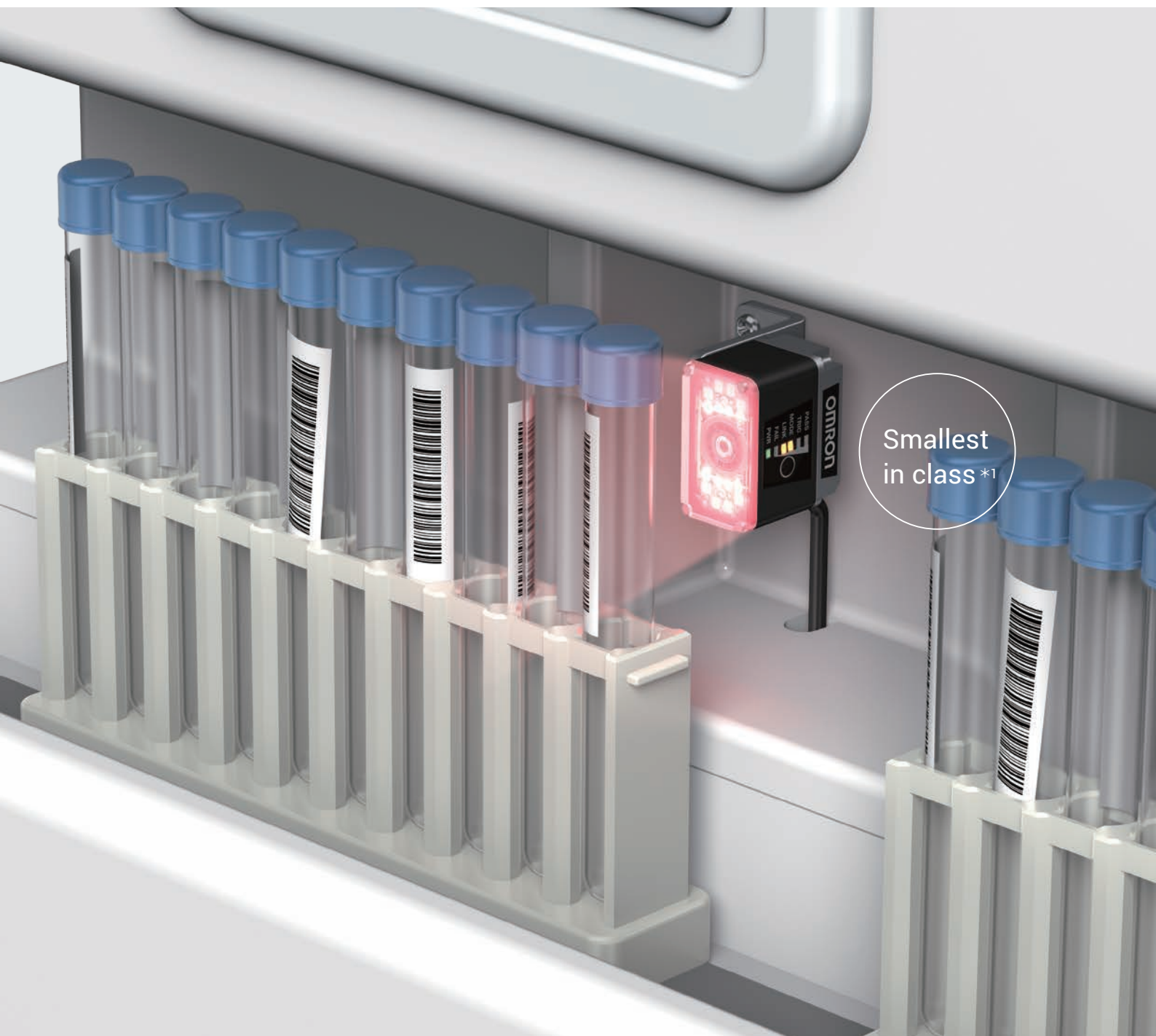

The most compact design in its class for space-saving installation^{*1}

Fits in 50 mm space



Code readers built into machines need to be space-saving designs and offer flexibility in design change according to end users' requirements. To meet these needs, we have developed the V430-F/V420-F Series that is an easy-to-integrate, ultra-compact code reader with optical options that allow standardization of designs. In addition, stable reading and quick troubleshooting can reduce unscheduled downtime, making traceability easier and more reliable.

Examples of installation in machines

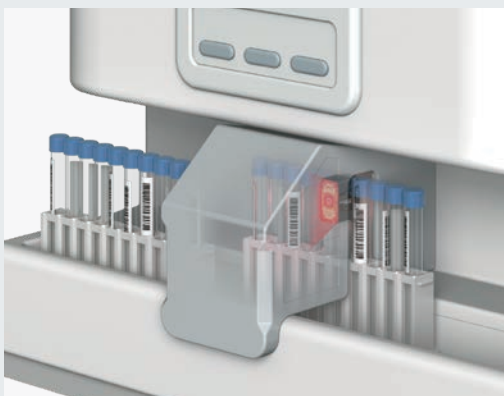

Vitro diagnostic analyzer



Electronic component manufacturing equipment

*1. Fixed mount industrial imager-based 2D code readers with 3 Mpix or more. (Based on Omron investigation in September 2022)

Delivers three essential features for code readers

Designing

Easy integration and customization P4



Reading

Reliable reading of misaligned or poorly printed codes P6

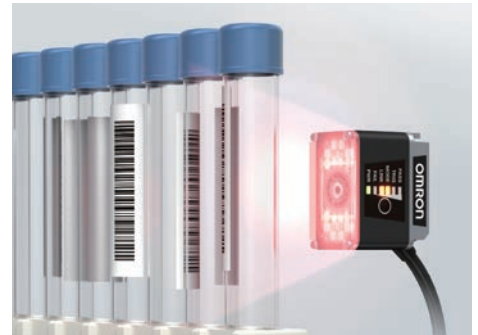

Operation

Easy status monitoring and quick troubleshooting P8



Easy integration and customization

Options for confined spaces

Right angle connector



When wiring space is limited

Right angle mirror

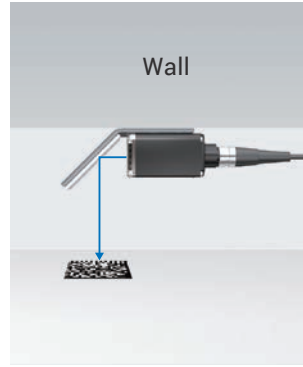

When there is not enough space over a code

Wide view with short reading distance

The product line up includes models with up to 5 Mpix that provide a wide-angle of view and a short reading distance. The code readers that have the same size and reading distance are available with different field of view, allowing you to easily meet machine end users' requirements without redesign.

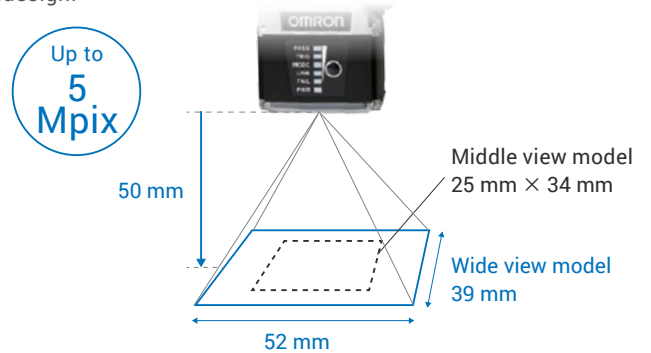

Easy fine-tuning of reading angle

L bracket



The reading angle of the code reader that is loosely screwed to the L bracket can be adjusted using the position adjustment holes.

Aiming light



Aiming light assists you in positioning and locating codes in the center of the code reader's field of view.

No need to change reading distance or code reader itself

The autofocus lens eliminates the need to change hardware design when target objects are changed. The V430-F/V420-F Series provides unlimited autofocus and long life.

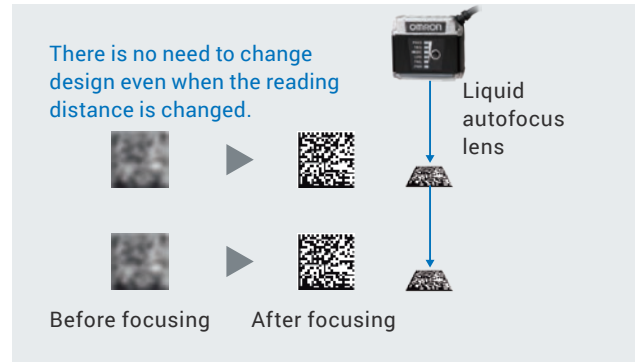

Various interfaces to communicate with PC or PLC

The V430-F/V420-F Series includes models with a major interface to connect to the host PC or PLC.



MicroHAWK V430-F Series
Ethernet TCP/IP
EtherNet/IP™
PROFINET



MicroHAWK V420-F Series
RS-232C
USB
Ethernet over USB

A variety of optical accessories to standardize designs

The V430-F/V420-F Series has optical accessories to easily meet varying requirements from machine end users. All you need is replace the accessory without changing the code reader, helping you standardize designs.



Outer LEDs

A blue LED provides more contrast than a red LED for some color combinations of the bar code or 2D code and background. This increases reading reliability without relying on decoding ability.

Even if the color combination varies depending on items, reliable code reading is possible by using preferable outer LEDs without changing the code reader.

Examples of color combinations of code and background



	Green	Orange	Red	Blue
Red LEDs	[Image]	[Image]	[Image]	[Image]
Blue LEDs	[Image]	[Image]	[Image]	[Image]

Note: Images are illustration purposes only. Actual presentation will vary depending on the marking method and material.

Polarizer and diffuser

Attaching a polarizer or diffuser reduces halation and reflection without the need to install the code reader at an angle.

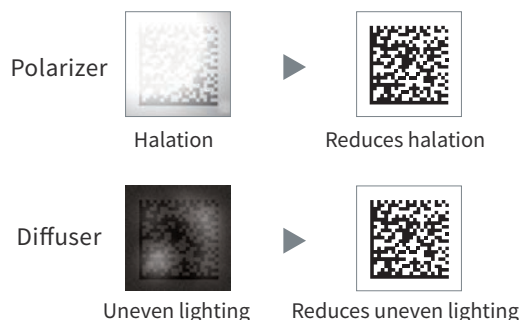

ESD safe window

The ESD safe window is used to prevent line or object problems caused by electrostatic discharge (ESD) from the code reader.

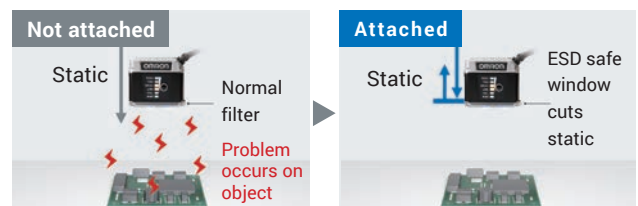

YAG filter

When the code reader is installed near YAG laser equipment (e.g., laser marker, laser engraver, and laser cutter), the YAG filter is used to protect image elements against laser light.

Ring light model

This model can provide reliable inspection even under uneven lighting conditions, which is difficult with a standard light. (The ring light model is available with V430-F 1.2 Mpix models.)



Reliable reading of misaligned or poorly printed codes

Reliable reading regardless of code position variations

This imager-based code reader provides a wide reading area and reliably reads codes even if there are variations in code positions on objects.

1D scanner

The scan type cannot read misaligned labels due to its linear reading area.

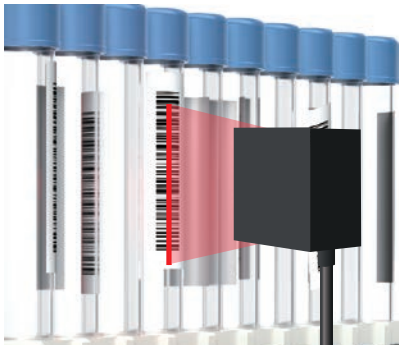

Fail to read

V430-F/V420-F

The imager type can read misaligned labels thanks to its wide reading area.



Able to read

Increase speed

Using the WOI function*1 that narrows the scan area, the code reader can read codes as fast as the scan type.

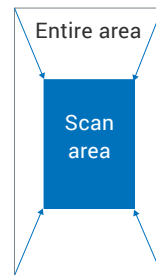

* 1. The Window of Interest (WOI) function scans codes within a window of interest.

Reliable reading despite inconsistent print quality

The V430-F/V420-F Series includes our unique and robust X-Mode decoding algorithms. Expanded X-Mode algorithms can reliably read distorted and damaged codes by correcting variations in print quality.

Damaged Mode

Corrects damaged 2D codes.

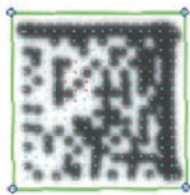

Morphology

Enhances the contrast of cells.

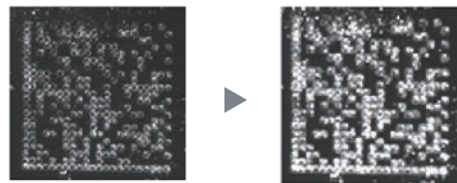

Scale Up

Scales up the captured image to the ideal size.

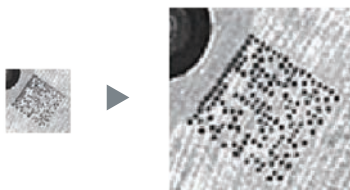

Scale Down

Scales down the captured image to the ideal size.

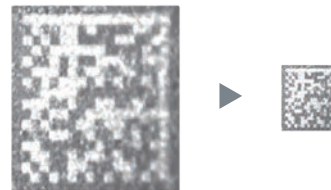

Automatic setting of reading conditions

Parameter settings are optimized automatically. Specific skills are no longer required.

Step1 Optimize focus distance. *2

Select the Autofocus icon to automatically adjust the focus distance of the code reader.

Autofocus icon

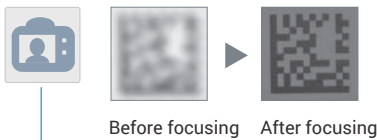

Step2 Optimize reading conditions. *3

Select the Train icon and then click a code on the screen to optimize shutter speed, preprocessing, and other parameters.

Train icon

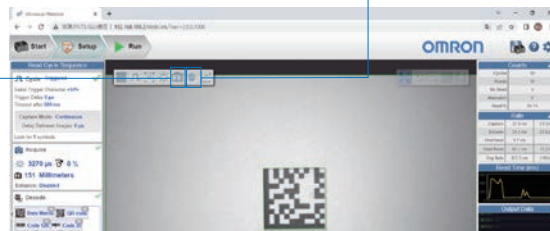
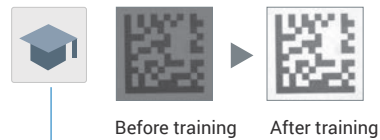

Flexible output of reading results

You can compare character strings using wildcards and partially output strings.

ISO grading of code print quality

The Print Quality Grading function enables an in-line check of the relative quality change and the parameter where the change occurred, avoiding problems.

Applicable standards

ISO/IEC 15415
 ISO/IEC 15416
 ISO/IEC TR29158
 (AIM DPM-1-2006)*4
 ISO/IEC 16022*5

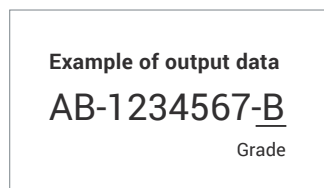

Batch output of results from up to 8 code readers

A Daisy Chain is a grouping of 2 to 8 code readers that function as one. The host PLC needs to control only the master code reader, reducing programming effort.

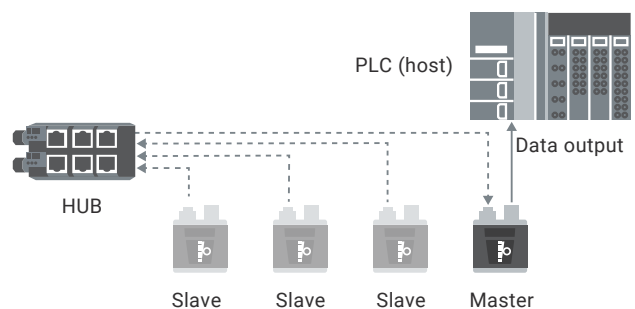

Easy communication with Omron PLC

We provide EtherNet/IP™ and serial communications connection guides and sample project files so that virtually anyone who is unfamiliar with building a system using Omron products can easily set up and check communications. Ask your Omron representative for more information.

* 2. Available with the autofocus model.

* 3. The following parameters are adjusted during training: gain, exposure, window of interest (WOI), pre-processing, pre-processing size, and pixel binning.

* 4. Data Matrix only. * 5. The grading criteria in ISO/IEC 16022 have been integrated with ISO/IEC 15415.

Easy status monitoring and quick troubleshooting

Easy access to code readers on browser-based software WebLink

The V430-F/V420-F Series has pre-installed software for setup. There is no need to install software on your PC or to seek the same software version on your PC. You can easily troubleshoot using a PC or tablet with the browser-based interface. When you are connected to the intranet, you can flexibly deal with problems from the factory, office or anywhere else.



Reading error occurs.

Operator goes to factory with PC.

Operator checks and tunes code reader on web browser.

Configuration example using a wireless terminal

Remote access is possible if devices are on the same network.

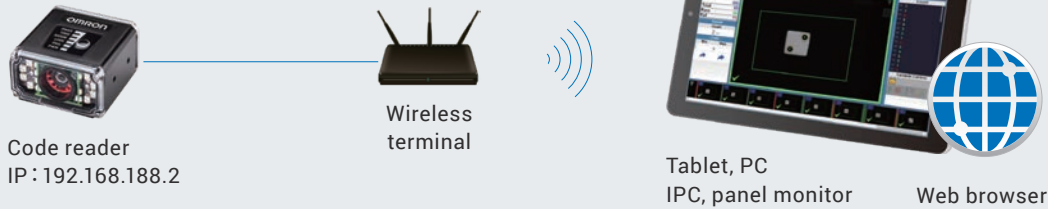

Note: When wireless connection is not available, the code reader needs to be connected to the device with a web browser using a cable.

Enter the IP address of the code reader to display into the web browser.
<http://192.168.188.2>

Access control to prevent unintended setting change

Privilege levels and passwords can be set to open any session of WebLink. This prevents settings from being changed by incorrect operation.

Administrator: Full Access as well as the ability to manage user accounts and enable or disable Account Management

Controller: Full Access

Monitor: View-Only Access

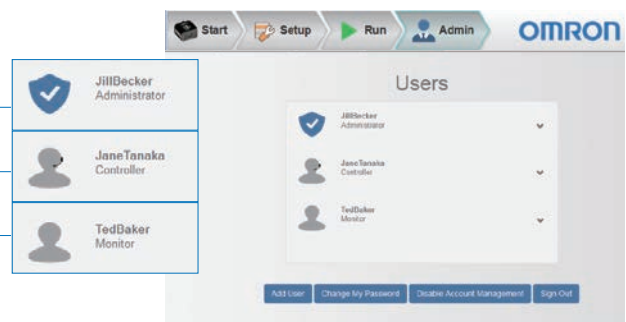

Intuitive usability requiring no specialized experience or skills

Easy-to-use UI design, and easy-to-understand tutorial and help functions guide inexperienced operators through the process of setup and adjustment.

Easy-to-understand intuitive design

3-step navigation bar

Easy-to-see reading results

Statistical results

Counts	
Cycles	2
Reads	2
No Read	0
Mismatch	0
Read %	100.00

Rate		
Capture	32.0 ms	31.3%
Decode	22.3 ms	44.0%
Overhead	0.0 ms	
Total Read	54.0 ms	18.5%
Trig Rate	120458.0 ms	0.01%

Filmstrip

Reading results together with the images are constantly updated, allowing you to check errors in real time.

Functions to assist inexperienced users in setup and tuning

Guided Tour

Guided Tour guides users through operating procedures by showing explanation of icons.

Control Toolbar

- Start the reader.
- Position a Window of Interest.
- Train the decoder.
- Optimize the decoder.

Help

You can quickly learn how to operate WebLink without referring to manuals.

WebLink Help

- Autocalibration
- Cycle
- Acquire
- Decode
- Match String
- Format Output
- Outputs
- Configuration Database
- Favorites
- Run
- Application Settings
- Terminal
- Advanced Settings

Autocalibration

This section describes how to perform Autocalibration. Autocalibration automatically determines and sets the optimum settings necessary for decoding. This feature calculates the optimum settings necessary for decoding. Decode speed is also optimized, but is secondary to accuracy. To begin, navigate to WebLink's Setup view. If you do not have a barcode, you can use the Autocalibration feature to generate a barcode.

Code readers

Auto Focus Multi Code Reader
MicroHAWK V430-F/V420-F Series

5 Mpix

Wide view

(Unit: mm)

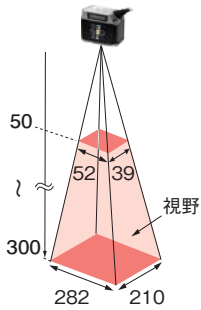

Reading distance	Field of view		Minimum cell size	
	H	V	Bar code	2D code
50	52	39	0.0269	0.0470
100	98	73	0.0503	0.0881
150	144	107	0.0738	0.1291
200	190	142	0.0979	0.1713
250	236	176	0.1213	0.2123
300	282	210	0.1448	0.2533

Middle view

(Unit: mm)

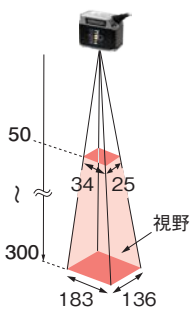

Reading distance	Field of view		Minimum cell size	
	H	V	Bar code	2D code
50	34	25	0.0172	0.0302
100	64	48	0.0331	0.0579
150	94	70	0.0483	0.0844
200	123	92	0.0634	0.1110
250	153	114	0.0786	0.1375
300	183	136	0.0937	0.1641

1.2 Mpix

Wide view

(Unit: mm)

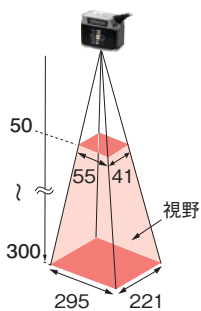

Reading distance	Field of view		Minimum cell size	
	H	V	Bar code	2D code
50	55	41	0.0422	0.0738
100	103	77	0.0792	0.1386
150	151	113	0.1163	0.2034
200	199	149	0.1533	0.2683
250	247	185	0.1903	0.3331
300	295	221	0.2274	0.3979

Middle view

(Unit: mm)

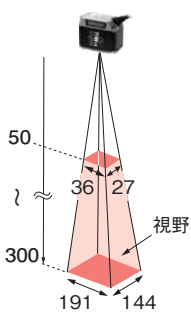

Reading distance	Field of view		Minimum cell size	
	H	V	Bar code	2D code
50	36	27	0.0278	0.0486
100	67	50	0.0514	0.0900
150	98	73	0.0751	0.1314
200	129	97	0.0998	0.1746
250	160	120	0.1235	0.2160
300	191	144	0.1481	0.2593

Note: Refer to the datasheets (Cat. No. Q274, Q275) for details of models and specifications.

1.2 Mpix

Narrow view

(Unit: mm)

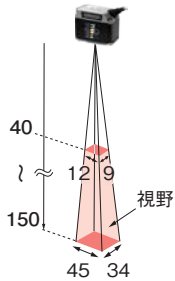

Reading distance	Field of view		Minimum cell size	
	H	V	Bar code	2D code
40	12	9	0.0093	0.0162
100	31	23	0.0237	0.0414
150	45	34	0.0350	0.0612

Long range

(Unit: mm)

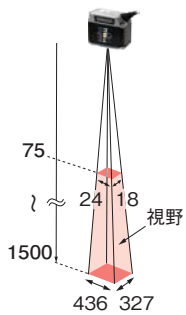

Reading distance	Field of view		Minimum cell size	
	H	V	Bar code	2D code
75	24	18	0.0185	0.0324
100	31	23	0.0237	0.0414
300	89	67	0.0689	0.1206
500	147	110	0.1132	0.1980
700	204	153	0.1574	0.2755
900	262	197	0.2027	0.3547
1100	320	240	0.2469	0.4321
1300	378	283	0.2912	0.5095
1500	436	327	0.3364	0.5887

0.3 Mpix

Wide view

(Unit: mm)

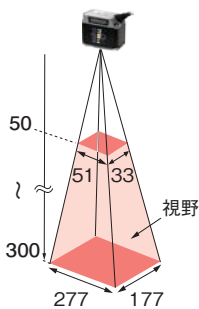

Reading distance	Field of view		Minimum cell size	
	H	V	Bar code	2D code
50	51	33	0.1375	0.2406
100	97	62	0.2583	0.4521
150	142	90	0.3750	0.6563
200	187	119	0.4958	0.8677
250	232	148	0.6167	1.0792
300	277	177	0.7375	1.2906

Middle view

(Unit: mm)

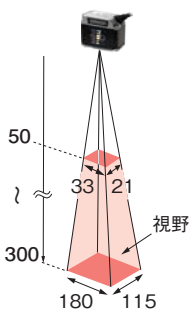

Reading distance	Field of view		Minimum cell size	
	H	V	Bar code	2D code
50	33	21	0.0875	0.1531
100	63	40	0.1667	0.2917
150	92	59	0.2458	0.4302
200	121	77	0.3208	0.5615
250	151	96	0.4000	0.7000
300	180	115	0.4792	0.8385

Related products

Additional propositions to improve machine performance

We support you in solving issues of code reading, which the V430-F/V420-F Series cannot solely solve, by offering other products.

Proposition 1

Code verification system to international standards avoids unreadability

Code verification systems generate print quality reports according to ISO Standards. This is helpful to define intercompany criteria for ensuring print quality and to provide evidence.



LVS-958 □ /LVS-9510-series
Code Verification System

Grading results

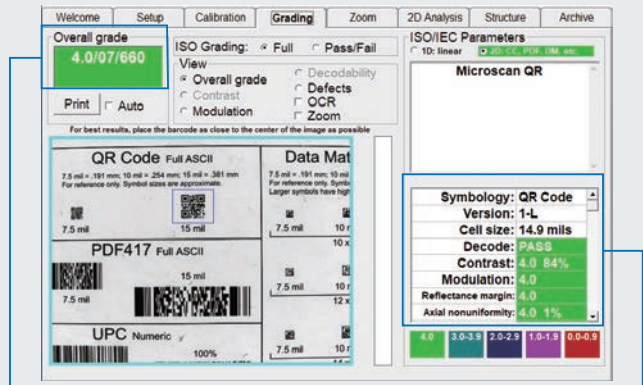

An overall grade is determined from the results of individual verification items.

Quality is graded through verification items specified in international standards.

Proposition 2

Handheld code reader checks IDs outside machine

Models with X-Mode algorithms to reliably read DPM are available. The alcohol-disinfectable body makes the code readers safe for use in production sites where infection measures are required * 1.



For healthcare use

For paper and labels

For DPM

V410-H Handheld Code Reader

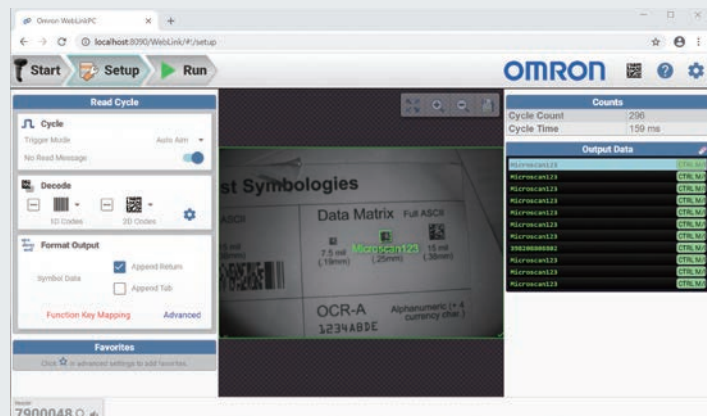

Simple setting: WebLink PC

* 1. Use isopropyl alcohol 70%.

Proposition 3

C-mount code reader enables more flexible customization of reading range and distance

Various combinations of the V440-F C-Mount Code Reader and lens offer flexibility to customize the field of view and installation distance.



V440-F C-Mount Code Reader

Application example When adding management with 2D codes
 Condition 1: Code reader does not interfere with equipment.
 Condition 2: The same equipment can read codes located at different positions.

The V440-F Series can read codes in a large field of view from a long distances at high resolution (5 Mpix).

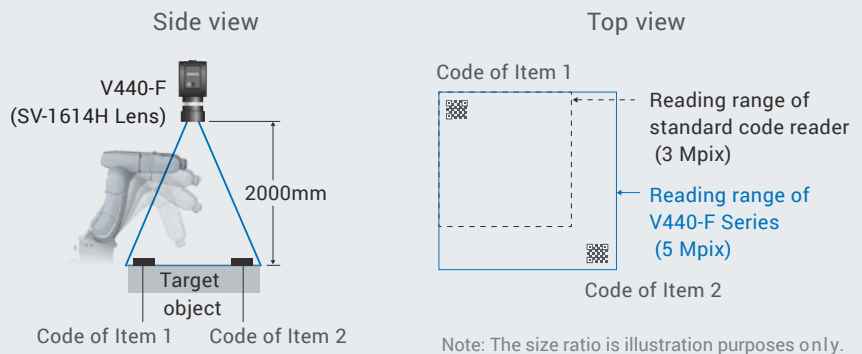

Proposition 4

RFID is ideal for processes where code quality would be worse

Since codes are attached to surfaces, they can sometimes easily be blemished or deteriorate, resulting in reading failure. Data management using RFID is suitable for such environments because data can be read without being affected by blemishes.

Example in digital industry (assembly process)

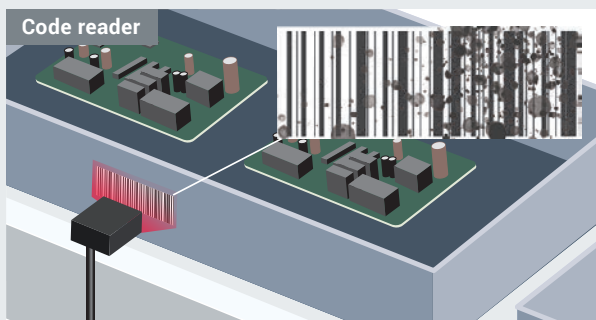

The reading rate gradually decreases due to aged deterioration and blemishes.

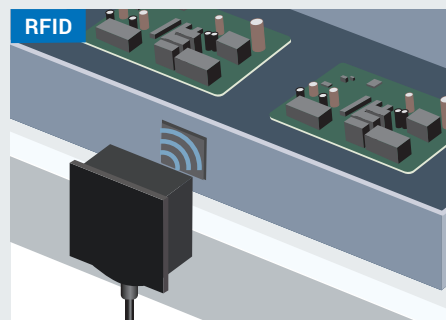

V680S RFID System



RFID is robust and reliable enough to use for a long time.

Applications

Digital industry

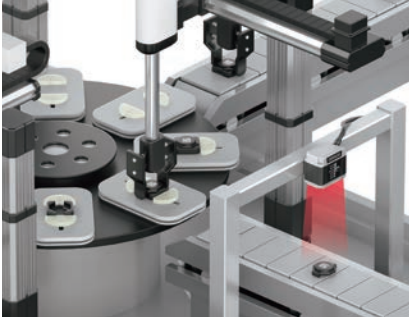

Installation in complicated space

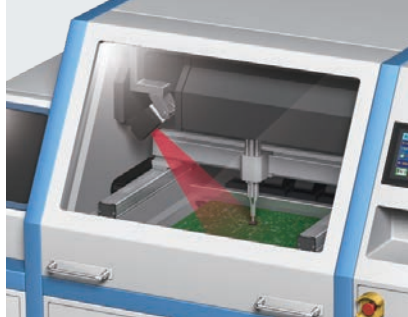

Retrofit into small machine

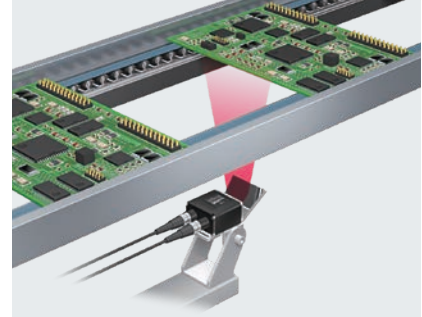

Installation in space with limited depth

Biochemical analyzer and medical device industry

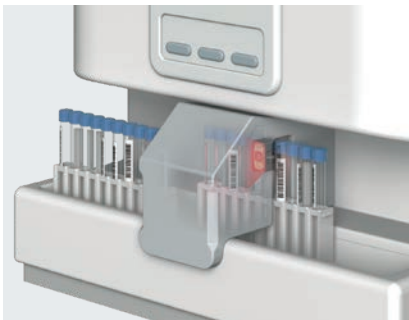

Integration into in vitro diagnostic analyzer

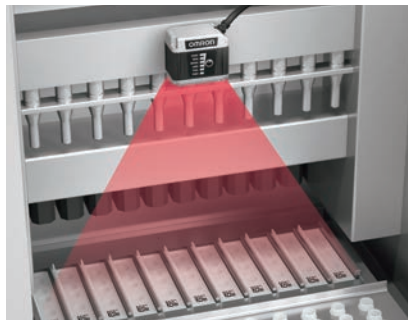

Integration into nucleic acid extractor



Integration into laboratory analyzer

Food industry



Reading on high-speed production line

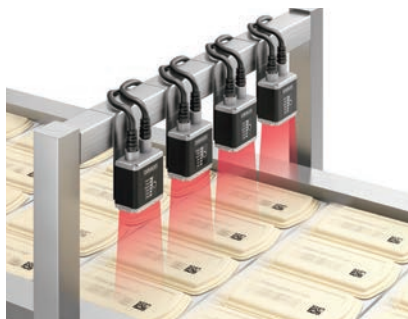

4-line parallel reading in confined space



Reading from beneath conveyor

EtherNet/IP™ is a trademark of ODVA.

QR code is the registered trademark of DENSO WAVE.

Windows is registered trademarks or trademarks of Microsoft Corporation in the United States and/or other countries.

Other company names and product names in this document are the trademarks or registered trademarks of their respective companies.

The product photographs and figures that are used in this catalog may vary somewhat from the actual products.

Terms and Conditions Agreement

Read and understand this catalog.

Please read and understand this catalog before purchasing the products. Please consult your OMRON representative if you have any questions or comments.

Warranties.

- (a) Exclusive Warranty. Omron's exclusive warranty is that the Products will be free from defects in materials and workmanship for a period of twelve months from the date of sale by Omron (or such other period expressed in writing by Omron). Omron disclaims all other warranties, express or implied.
- (b) Limitations. OMRON MAKES NO WARRANTY OR REPRESENTATION, EXPRESS OR IMPLIED, ABOUT NON-INFRINGEMENT, MERCHANTABILITY OR FITNESS FOR A PARTICULAR PURPOSE OF THE PRODUCTS. BUYER ACKNOWLEDGES THAT IT ALONE HAS DETERMINED THAT THE PRODUCTS WILL SUITABLY MEET THE REQUIREMENTS OF THEIR INTENDED USE.

Omron further disclaims all warranties and responsibility of any type for claims or expenses based on infringement by the Products or otherwise of any intellectual property right. (c) Buyer Remedy. Omron's sole obligation hereunder shall be, at Omron's election, to (i) replace (in the form originally shipped with Buyer responsible for labor charges for removal or replacement thereof) the non-complying Product, (ii) repair the non-complying Product, or (iii) repay or credit Buyer an amount equal to the purchase price of the non-complying Product; provided that in no event shall Omron be responsible for warranty, repair, indemnity or any other claims or expenses regarding the Products unless Omron's analysis confirms that the Products were properly handled, stored, installed and maintained and not subject to contamination, abuse, misuse or inappropriate modification. Return of any Products by Buyer must be approved in writing by Omron before shipment. Omron Companies shall not be liable for the suitability or unsuitability or the results from the use of Products in combination with any electrical or electronic components, circuits, system assemblies or any other materials or substances or environments. Any advice, recommendations or information given orally or in writing, are not to be construed as an amendment or addition to the above warranty.

See <http://www.omron.com/global/> or contact your Omron representative for published information.

Limitation on Liability: Etc.

OMRON COMPANIES SHALL NOT BE LIABLE FOR SPECIAL, INDIRECT, INCIDENTAL, OR CONSEQUENTIAL DAMAGES, LOSS OF PROFITS OR PRODUCTION OR COMMERCIAL LOSS IN ANY WAY CONNECTED WITH THE PRODUCTS, WHETHER SUCH CLAIM IS BASED IN CONTRACT, WARRANTY, NEGLIGENCE OR STRICT LIABILITY.

Further, in no event shall liability of Omron Companies exceed the individual price of the Product on which liability is asserted.

Suitability of Use.

Omron Companies shall not be responsible for conformity with any standards, codes or regulations which apply to the combination of the Product in the Buyer's application or use of the Product. At Buyer's request, Omron will provide applicable third party certification documents identifying ratings and limitations of use which apply to the Product. This information by itself is not sufficient for a complete determination of the suitability of the Product in combination with the end product, machine, system, or other application or use. Buyer shall be solely responsible for determining appropriateness of the particular Product with respect to Buyer's application, product or system. Buyer shall take application responsibility in all cases.

NEVER USE THE PRODUCT FOR AN APPLICATION INVOLVING SERIOUS RISK TO LIFE OR PROPERTY OR IN LARGE QUANTITIES WITHOUT ENSURING THAT THE SYSTEM AS A WHOLE HAS BEEN DESIGNED TO ADDRESS THE RISKS, AND THAT THE OMRON PRODUCT(S) IS PROPERLY RATED AND INSTALLED FOR THE INTENDED USE WITHIN THE OVERALL EQUIPMENT OR SYSTEM.

Programmable Products.

Omron Companies shall not be responsible for the user's programming of a programmable Product, or any consequence thereof.

Performance Data.

Data presented in Omron Company websites, catalogs and other materials is provided as a guide for the user in determining suitability and does not constitute a warranty. It may represent the result of Omron's test conditions, and the user must correlate it to actual application requirements. Actual performance is subject to the Omron's Warranty and Limitations of Liability.

Change in Specifications.

Product specifications and accessories may be changed at any time based on improvements and other reasons. It is our practice to change part numbers when published ratings or features are changed, or when significant construction changes are made. However, some specifications of the Product may be changed without any notice. When in doubt, special part numbers may be assigned to fix or establish key specifications for your application. Please consult with your Omron's representative at any time to confirm actual specifications of purchased Product.

Errors and Omissions.

Information presented by Omron Companies has been checked and is believed to be accurate; however, no responsibility is assumed for clerical, typographical or proofreading errors or omissions.

Note: Do not use this document to operate the Unit.

OMRON Corporation Industrial Automation Company

Kyoto, JAPAN

Contact : www.ia.omron.com

Regional Headquarters

OMRON EUROPE B.V.

Wegalaan 67-69, 2132 JD Hoofddorp
The Netherlands
Tel: (31) 2356-81-300 Fax: (31) 2356-81-388

OMRON ASIA PACIFIC PTE. LTD.

438B Alexandra Road, #08-01/02 Alexandra
Technopark, Singapore 119968
Tel: (65) 6835-3011 Fax: (65) 6835-2711

OMRON ELECTRONICS LLC

2895 Greenspoint Parkway, Suite 200
Hoffman Estates, IL 60169 U.S.A.
Tel: (1) 847-843-7900 Fax: (1) 847-843-7787

OMRON (CHINA) CO., LTD.

Room 2211, Bank of China Tower,
200 Yin Cheng Zhong Road,
PuDong New Area, Shanghai, 200120, China
Tel: (86) 21-5037-2222 Fax: (86) 21-5037-2200

Authorized Distributor:

©OMRON Corporation 2022 All Rights Reserved.
In the interest of product improvement,
specifications are subject to change without notice.

Printed in Japan
Cat. No. Q346-E1-01 0922 (0922)