

Relay Sockets with Push-In Plus technology

PYF-PU (Sockets for MY Relays)

G6D-F4PU/G3DZ-F4PU (Terminal Relays)

PTF-PU (Sockets for LY Relays)

G70V (I/O Relay Terminals)

P2RF-PU (Sockets for G2R-S Relays)

P7SA-PU (Sockets for G7SA Relays with Forcibly Guided Contacts)

G2RV-ST/G3RV-ST (Slim I/O Relays)

**A New Standard for Reducing Work in
Control Panel**

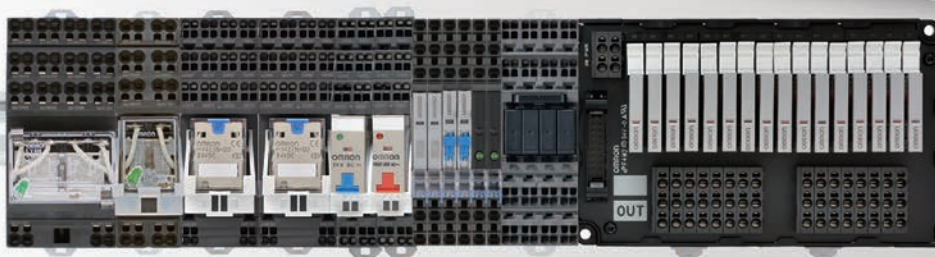

- Sockets with Push-In Plus technology for easy wiring
- A compact design and unique structure help reduce work from designing to maintenance

For building green control panels

Natural disasters caused by global warming and climate change are becoming a global social issue, that drives over 150 countries and regions worldwide to take action toward decarbonization. Our goal is to reduce greenhouse gas (GHG) emissions toward half by through new ways of building control panels, that key figure of the manufacturing site.



Process

Realize greatly
reduces design/
manufacturing work

Innovation for
design, building
Process

Further Evolution
for
Panels

Panel

Realize compact &
highly reliable control
panels

Building sustainable
control panels

Creating green
control panels

Simple & Easy
People

Green

Reducing GHG
emission of control
panels to achieve
carbon neutrality

People

Provide reliable and comfortable
manufacturing for all people who
deal with control panels

Integrating green perspectives into Value Design

Value Design for Panel (Value Design) is the common concept shared across OMRON's in-panel product specifications to deliver new value to your control panels. This Value Design also integrate environment consideration concept that enable earth and user-friendly control panel building.



- 1 Unified height & slim size*1
- 2 Side-by-side mounting at (55°C) ambient temperature*2
- 3 Unique Push-In Plus technology*1
- 4 Front-in and front-release wiring
- 5 eCAD library
- 6 Certification for CE, UL, and CSA
- 7 Green features that save energy and resources*3

CFP of control panel (total GHG emissions)*4

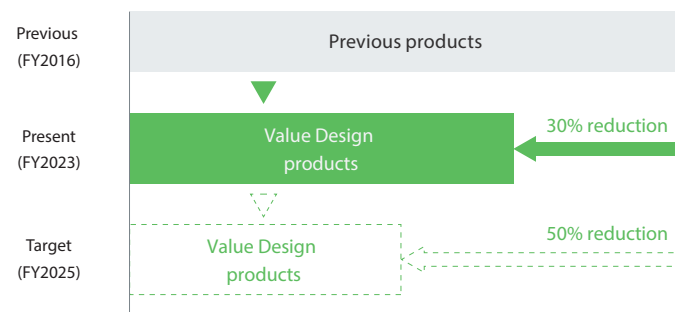

*1. Expect for some products

*2. Side-by-side mounting is possible in the same series

*3. Greener design compared to previous (2016) products

*4. CFP (carbon footprint) of control panel is a calculation result of referring the life cycle assessment method that based on international standards ISO14067 which define CO2 quantitative conversion of the environmental burden at every stage, from manufacturing, transportation, use, and disposal of the control panel (product). According to OMRON investigation in May 2023.

Push-In Plus technology Reduces Wiring and Workload

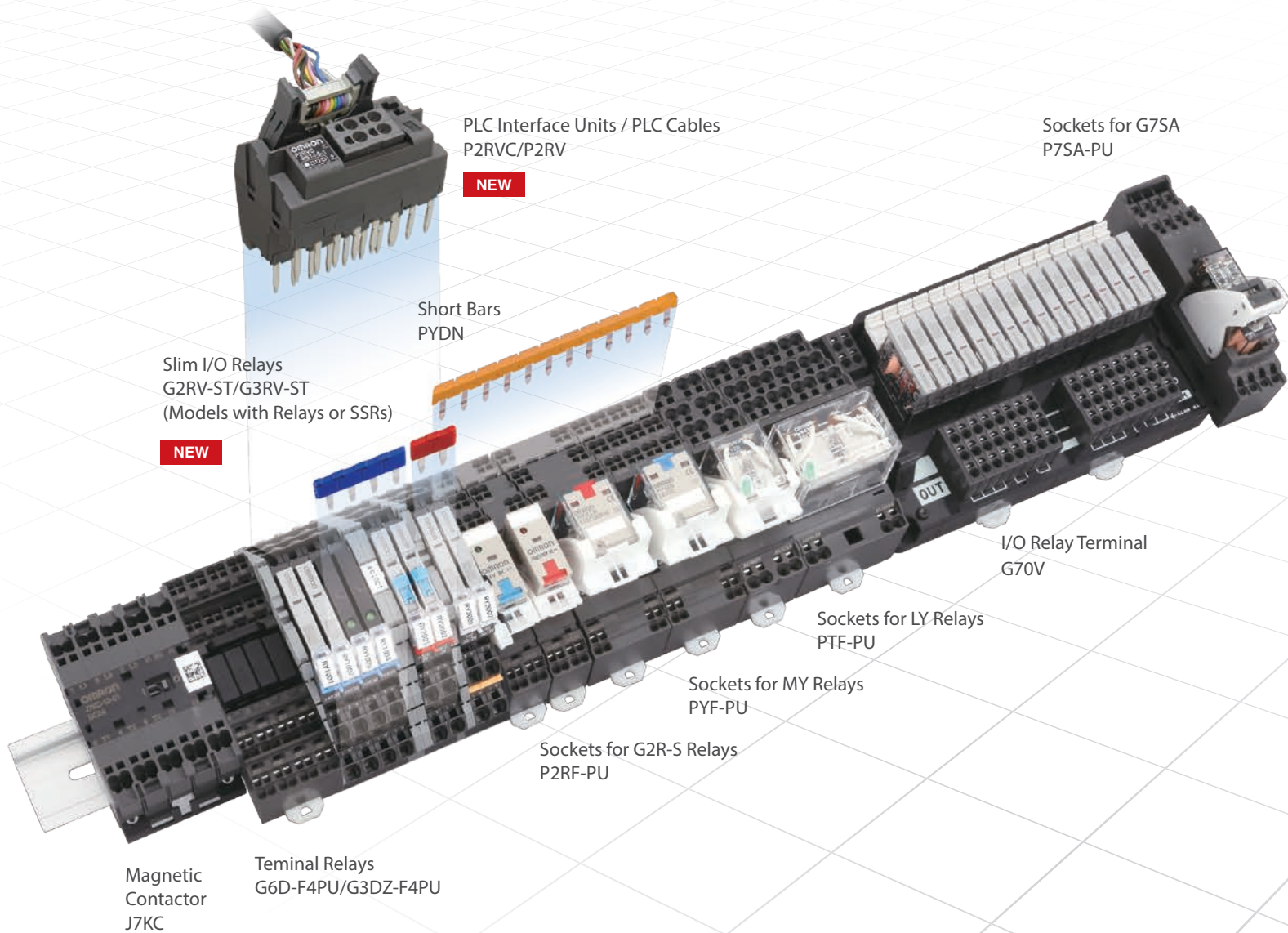

OMRON provides many accessories that make I/O products more convenient.

Push-In Plus technology for Easy Wiring

Just Insert Wires: No Tools Required

Now you can use Push-In Plus technology to reduce the time and work involved in wiring.

Greatly Reduce Wiring Work with Push-In Plus technology



Conventional screw terminal blocks OMRON Push-In Plus terminal block

*Information for Push-In Plus and screw terminal blocks is based on OMRON's actual measurement value data.

Screwdriver Held in Place to Free Both Your Hands

Optimized shape to hold the screwdriver was created by the resin parts and the spring. Work goes smoothly when connecting stranded wires directly to the terminal because it's easier to aim at the desired terminal.

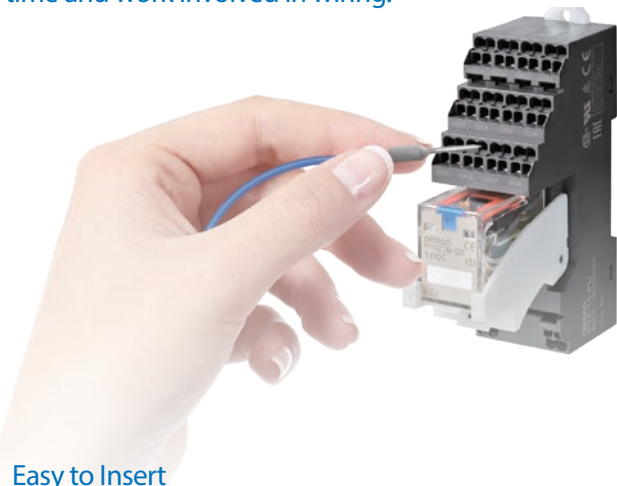

Easy to Insert

OMRON's Push-In Plus technology are as easy as inserting to an earphone jack. They help reduce the work load and improve wiring quality.

Wiring

Just Insert Wires: No Tools Required. Now you can use Push-In Plus terminal blocks. (solid wires, or ferrules)

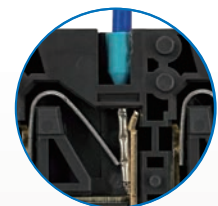

Held Firmly in Place

Even though less insertion force is required, the wires are held firmly in place. The advanced mechanism design technology and manufacturing technology produced a spring that ensures better workability and reliability. The same strength as screw terminal blocks is provided.

No Retightening Required

Tightening screws is necessary for screw terminal blocks, but with Push-In Plus technology, there is no need for retightening. This reduces works for wirings, inspections, delivery (shipping), or maintenance.

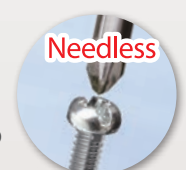

Slim I/O Relays G2RV-ST/G3RV-ST

Compatible Space Saving and Usability with Slim Structure

G2RV-ST NEW

G2RV Relays, which were optimally designed for in-panel applications, width 6.2mm for miniaturization. Improved usability including Wiring, visibility and handling.

Smallest in industry^{*1}

Large-diameter wiring holes
2.5 mm² ferrule available
Diagonal structure makes Wiring easier

Color coded stoppers
Detachment prevention of relays/coil voltage line identification

Release lever
Relay easily fixed/removed

Test switch
Easy circuit check

6.2 mm

90 mm

LED
Visibility is enhanced

Transparent case
Relay contact Easy confirmation of the situation

Plug-in terminal
Easy relay replacement by hard to bend terminal structure

Insulation plate
Electrification of the short bar fracture plane is prevented

*1. According to OMRON investigation in August 2023

G3RV-ST NEW

SSR(Solid state Relay) type with the same slim shape and size as G2RV-ST. In addition to the lineup of high-speed type (-H), this product is also capable of high-speed opening and closing.

Smallest in industry^{*1}

80 mm

90 mm

6.2 mm

High speed type (-H)
Supports high-speed opening and closing in DC24V

Model	Operate time	Release time
G3RV-ST500-D-H DC24	0.2 ms max.	0.4 ms max.
G3RV-ST500-D DC24	6 ms max.	21 ms max.

*1. According to OMRON investigation in August 2023

Slim I/O Relays, I/O Relay Terminals
G2RV-ST/G3RV-ST, G70V

Compatible with PLC Cabling for Further Wiring Savings

Using a PLC Interface Unit with G2RV-ST/G3RV-ST Slim I/O Relays

You can connect 8 I/O points directly with just one PLC cable to effectively reduce wiring work.

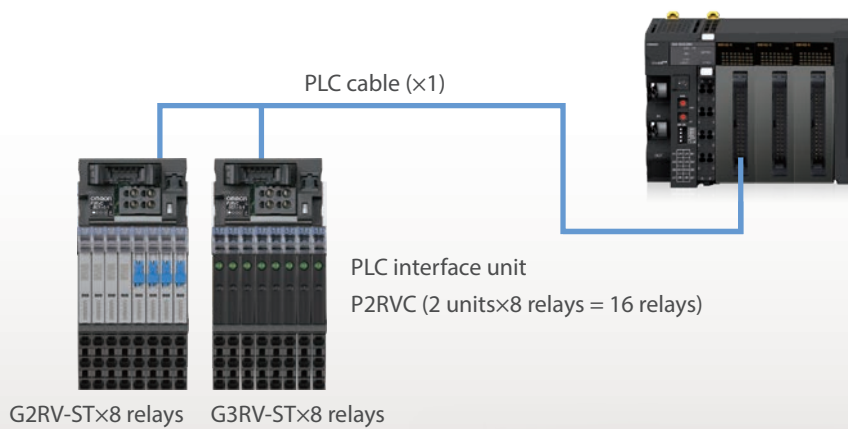

Using a G70V I/O Relay Terminal

You can connect 16 I/O points with just one cable with connectors to reduce wiring work.

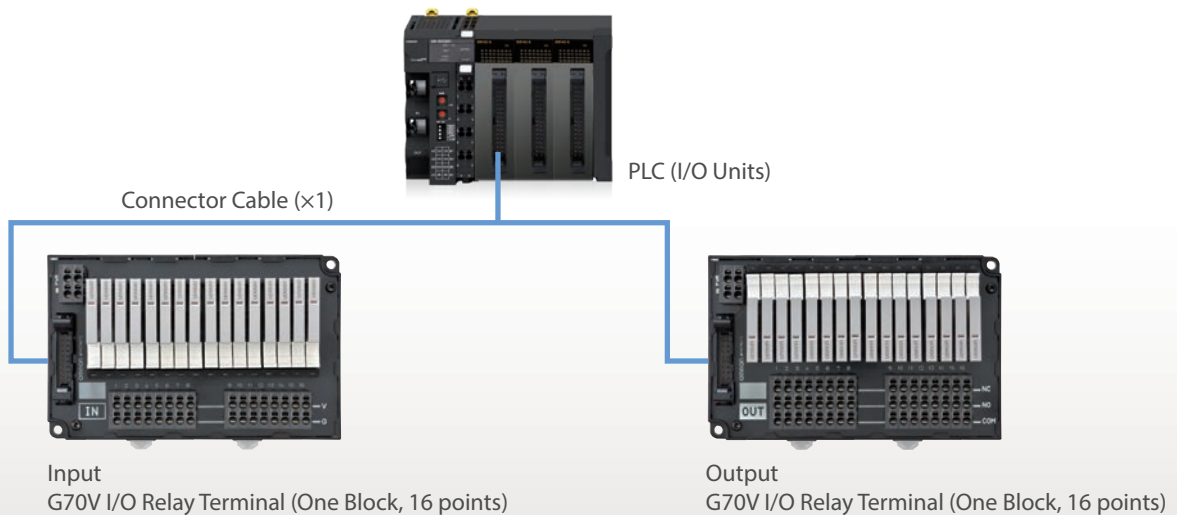

Relay sockets, Sockets for Relays with Forcibly Guided Contacts PYF-PU/PTF-PU/P2RF-PU, P7SA-PU Contributed to reduction of wiring man-hours and maintenance man-hours on the control panel

PYF-PU/PTF-PU/P2RF-PU

Complete lineup of Push-In Plus relay sockets

MY
Series



LY
Series



G2R-S
Series



PYF-PU



PTF-PU



P2RF-PU

By unifying into Push-In Plus, unification of tools and workability, improvement of maintainability

Before Mixture of Screw and Push-In



After Unifying into Push-In Plus



P7SA-PU

Featuring Sockets with Push-In Plus technology on Sockets for G7SA Relays with Forcibly Guided Contacts

Double-wire Terminals on the Coil Side and Short Bars on the Contact Side Reduce Crossover Wiring Time

Industry's **slimmest** design*
[P7SA-PU (6-pole)]

Industry's slimmest design

Control panel sizes can be kept to a minimum.

Built-in LED operation indicator and diode

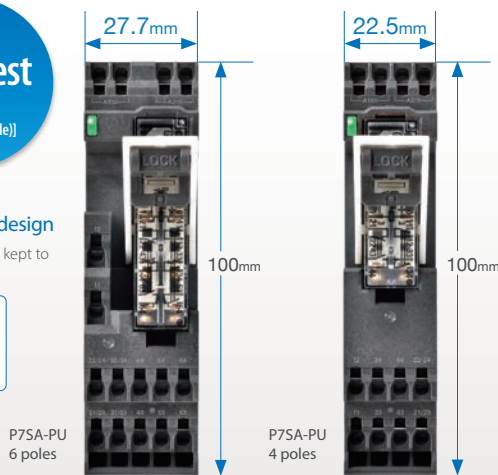

P7SA-PU 6 poles

P7SA-PU 4 poles

Coil side

The wiring can be crossed-over if crossover wiring of the coil terminals is necessary.

Contact side

The short bars can be crossed-over on the contact side if necessary.

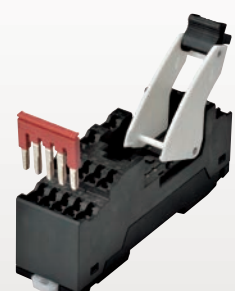

*Six-pole Sockets for Relays with Forcibly Guided Contacts. According to OMRON investigation in July 2016.

Terminal Relays
G6D-F4PU/G3DZ-F4PU

Save Space with a Compact Body

High-capacity Load and Slim Body

Model	Rated load	Width	Terminal Type
G6D-F4B	3 A	31 mm	Screw terminal model
G6D-F4PU	5 A	31 mm	Push-In Plus terminal model
G6B-4BND	5 A	43 mm	Screw terminal model

Load current
 Approx. **67% Higher**

Width
 Approx. **30% Reduced**

A Wide Range of Applications

Save Space with a Low-profile Body

Junction Box etc.





Small control panels for various equipment

Control box etc.

Dimensions: 90 mm (height), 31 mm (width), 35 mm (depth)







Product Lineup

PYF-PU-Applicable Models

Applicable models	General-purpose Relays		SSRs	Timers	
	MY2	MY4	G3F / G3FD	H3Y(N)-2-B	H3Y(N)-4-B
No. of poles	2	4	1	2	4
Socket model	PYF-08-PU	PYF-14-PU	PYF-08-PU	PYF-08-PU-L*	PYF-14-PU-L*
Appearance					







*A release lever is not included.

PTF-PU-Applicable Models



Applicable models	General-purpose Relays			SSRs	Temperature Controllers	
	LY2□	LY2□-CR	LY4□	G3H/G3HD /G9H	E5L-A □	E5L-C □
No. of poles	2	2	4	1	-	-
Socket model	PTF-08-PU	PTF-08-PU-L*	PTF-14-PU-L*	PTF-08-PU	PTF-14-PU-L*	PTF-14-PU-L*
Appearance						

*A release lever is not included.



P2RF-PU-Applicable Models

Applicable models	General-purpose Relays		SSRs	Timers		Liquid Leakage Sensor Amplifiers
	G2R-1-S	G2R-2-S	G3R-I/O / G3RZ	H3RN-1-B	H3RN-2-B	K7L-□-B
No. of poles	1	2	1	1	2	-
Socket model	P2RF-05-PU	P2RF-08-PU	P2RF-05-PU	P2RF-05-PU	P2RF-08-PU	P2RF-08-PU
Appearance						

P7SA-PU-Applicable Models

Applicable models	Relays with Forcibly Guided Contacts G7SA	
	4	6
No. of poles	4	6
Socket model	P7SA-10F-ND-PU DC24	P7SA-14F-ND-PU DC24
Appearance		

Terminal Relays

	Relay output	Power MOS FET Relay output
Model	G6D-F4PU*	G3DZ-F4PU*
AC load	5 A at 250 VAC	0.3 A at 3 to 264 VAC
DC load	5 A at 30 VDC	0.3 A at 3 to 125 VDC
Appearance		





*Relays are also available with screw terminals.

Slim I/O Relays

	Basic model	With latching lever	For microloads (gold-plated contacts)	Solid State Relays (SSRs)
Model	G2RV-ST500*	G2RV-ST501*	G2RV-ST500-AP*	G3RV-ST500*
AC load	6 A at 250 VAC	6 A at 250 VAC	50 mA at 30 VAC	2 A at 100 to 250 VAC
DC load	6 A at 30 VDC	6 A at 30 VDC	50 mA at 36 VDC	3 A at 5 to 24 VDC
Appearance				

*Relays are also available with screw terminals.





I/O Relay Terminals

		For inputs		For outputs	
Model	No internal connections	G70V-SID16P-1*	G70V-SID16P*	G70V-SOC16P-1*	G70V-SOC16P*
	Internal connections	G70V-SID16P-1-C16*	G70V-SID16P-C16*	G70V-SOC16P-1-C4*	G70V-SOC16P-C4*
Transistor output		PNP	NPN	PNP	NPN
Appearance					

*Models with Sockets (nine models total) are also available.

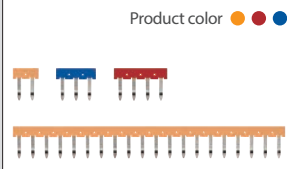
Replacement Parts and Accessories Available for Different Applications

Accessories Accessories that make I/O products more convenient

	Short Bars		Separator Plate	Isolation plate	PLC Interface Units / PLC Cables	Connector Cables for I/O Relay Terminal
Model	PYDN	XW5S-P2.5	XW5Z-EP12	P2RV-P3.1ST	P2RVC / P2RV	XW2Z-R
Application	Reducing wiring and device connections		Insulation	Insulation / Partition	Reducing wiring	Reducing wiring
Applicable models	PYF-PU P2RF-PU G2RV-ST G3RV-ST G6D-F4PU G3DZ-F4PU	P75A-PU	G2RV-ST G3RV-ST	G2RV-ST G3RV-ST	G2RV-ST G3RV-ST	G70V
Appearance	<p>Product color ● ● ●</p>  <p>The photo shows the PYDN-7.75 model.</p>					

Before you place an order, please read and understand "Agreement for Using the Product" available on Omron's latest "Best control devices Omron", "General Brochure" or Omron's website.

Refer to the PYF-□□-PU/PTF-□□-PU/P2RF-□□-PU Sockets with Push-In Plus technology Datasheet (Cat. No. J212), the G2RV-ST/G3RV-ST Slim I/O Relays Datasheet (Cat. No. J265), the G70V I/O Relay Terminal Datasheet (Cat. No. J215), the G6D-F4PU/G3DZ4-F4PU, G6D-F4B/G3DZ-F4B Terminal Relays Datasheet (Cat. No. J228), and the G7SA Relays with Forcibly Guided Contacts Datasheet (Cat. No. J120) for details.

Note: Do not use this document to operate the Unit.

OMRON Corporation Industrial Automation Company

Kyoto, JAPAN

Contact : www.ia.omron.com

Regional Headquarters

OMRON EUROPE B.V.

Wegalaan 67-69, 2132 JD Hoofddorp
The Netherlands
Tel: (31) 2356-81-300 Fax: (31) 2356-81-388

OMRON ELECTRONICS LLC

2895 Greenspoint Parkway, Suite 200
Hoffman Estates, IL 60169 U.S.A.
Tel: (1) 847-843-7900 Fax: (1) 847-843-7787

OMRON ASIA PACIFIC PTE. LTD.

438B Alexandra Road, #08-01/02 Alexandra
Technopark, Singapore 119968
Tel: (65) 6835-3011 Fax: (65) 6835-3011

OMRON (CHINA) CO., LTD.

Room 2211, Bank of China Tower,
200 Yin Cheng Zhong Road,
PuDong New Area, Shanghai, 200120, China
Tel: (86) 21-6023-0333 Fax: (86) 21-5037-2388

Authorized Distributor:

©OMRON Corporation 2016-2023 All Rights Reserved.
In the interest of product improvement,
specifications are subject to change without notice.

CSM_2_1

Cat. No. J213-E1-08 0823 (0316)