

NEW

# OMRON

## N-Smart

Presence / Detection / Measurement

Smart Fiber Amplifier Units  
E3NX-FA

# Industry-leading Levels\* of Performance Highly Stable Detection

Easy Setup for Any Workpiece by Any Operator



realizing

EtherCAT®  
CompoNet™  
CC-Link V2

\* For performance (sensing distance and minimum sensing object) based on November 2013 OMRON investigation.

# The No. 1 Performance Worldwide<sup>\*1</sup> for Even More Applications

## Best Performance in the World<sup>\*1</sup>

1.5 Times the Sensing Distance<sup>\*2</sup>

**6 m**

For E32-LT11 Fiber Unit with a fiber length of 3.5 m

1/10th the Minimum Sensing Object<sup>\*2</sup>

**0.3 μm dia.**

Typical example of actual measurements  
with E32-D11R Fiber Unit

### Three Technologies That Support High Performance

#### Optical Coupling Efficiency of 40%

The lens and reflector eliminate lost light to emit powerful, uniform emission.

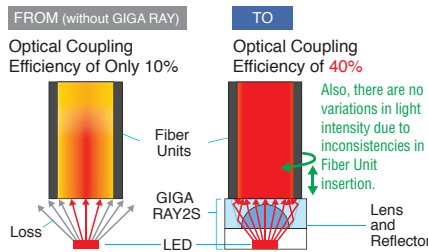

#### High Power to Achieve Stable Detection

HIGH-EFFICIENCY  
COUPLING ELEMENT<sup>\*3</sup>  
**GIGA RAY2S**

**PAT**



#### Low Noise to Accurately Capture Signals

LIGHT RECEPTION  
ALGORITHM  
**Smart Noise  
Reduction**

#### Signal-to-Noise Ratio Improved 2.5 Times

The influences of noise are reduced to achieve stable incident light levels by increasing the number of samples taken. This increases the margin for threshold values to achieve stable detection.

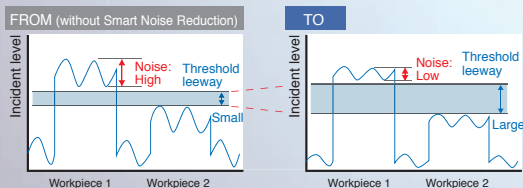

#### High-speed, High-precision Signal Processing

HIGH-SPEED,  
HIGH-PRECISION IC  
**N-Core**

**Twice** the Processing Speed<sup>\*4</sup>

#### Point



**Response Time of 30 μs in High-speed Mode<sup>\*5</sup>**

You can adjust the light intensity to detect fast-moving workpieces more accurately.<sup>\*2</sup>

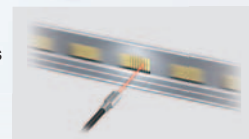

\*1. For performance (sensing distance and minimum sensing object) based on November 2013 OMRON investigation. \*2. Compared with E3X-HD.

\*3. Infrared models (E3NX-FAH) are not equipped with GIGA RAY2S. \*4. Compared with E3X-HD for normal operation processing. \*5. Model with 1 output: 30 μs, model with 2 outputs: 32 μs.

Ultra-easy

# Easily Handle a Wide Range of Applications with the Press of a Single Button

Consistent Settings for All Users **Smart Tuning Settings** PAT

Conventional Models\*<sup>1</sup>

1<sup>st</sup> Step

Adjust light intensity.

2<sup>nd</sup> Step

Set threshold.

\*1. Fiber Amplifier Unit without Smart Tuning.

E3NX-FA

Press the **S<sub>TUNE</sub>** button **once** with a workpiece and **once** without a workpiece

Automatically set the light intensity and threshold to optimum values in **1 Step**.

Threshold	Incident Level
5000	9999

Set to the intermediate value between the incident levels with and without a workpiece. Incident level adjustment with and without a workpiece.

Automatic Adjustment to Optimum Incident Level

Wide Light Intensity Adjustment Range from Transparent Objects to Black Workpieces

Excessive Incident Level

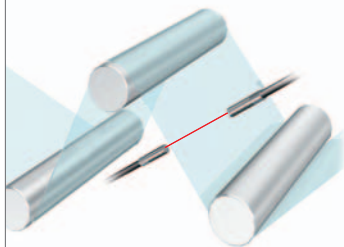

Transparent object

Insufficient Incident Level



Black workpiece

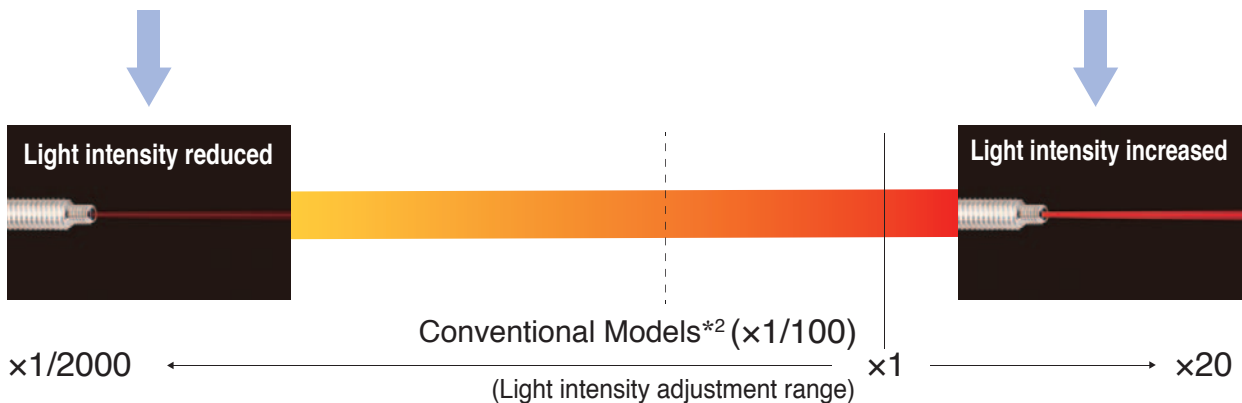

Wider light intensity adjustment range of 40,000 times (Conventional models\*<sup>2</sup>: 2,000 times)  
You can automatically adjust the light intensity to an optimum value for stable detection even with saturated or insufficient incident light.

\*2. E3X-HD

Ultra-reliable

# Two Decision Support Functions to Help You

Visual Displays of the Passing Time and Difference in Incident Levels.

## Solution Viewer **PAT**



### Selecting Fiber Units

Just about anyone can make a quantitative decision without special skills.

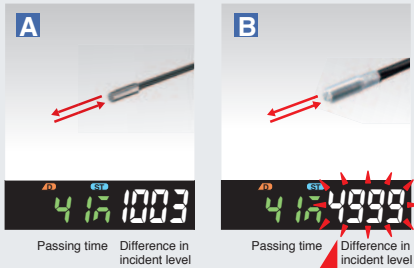

The difference in incident level is large, so use B.

### Setting Optimum Thresholds and Modes

You can see the passing time and difference in incident levels to facilitate manual setup.



The passing time is "13 ms", so it is OK with Standard Mode.

The incident light level difference is 4,000 when the level is 5,000 with a workpiece, so a threshold of 3,000 is OK.

Visual Information for Fast Workpieces

## Change Finder **PAT**

You can confirm changes in displayed values for fast workpieces to accurately set the threshold.

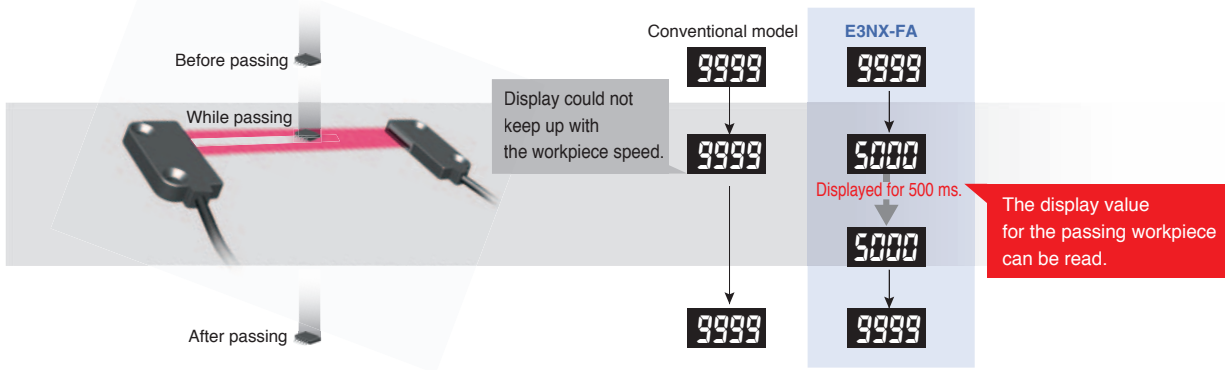

Point



## Advanced DPC (Dynamic Power Control) **PAT**

# Predictive Maintenance to Reduce Downtime

An alarm output\* has been added to the DPC that automatically compensates differences in the incident level. A maintenance signal is output when the incident level drops due to dirt or vibration for use in predictive maintenance. (We recommend DPC for through-beam or retro-reflective models.)

\*An alarm output is supported only on models with two outputs.

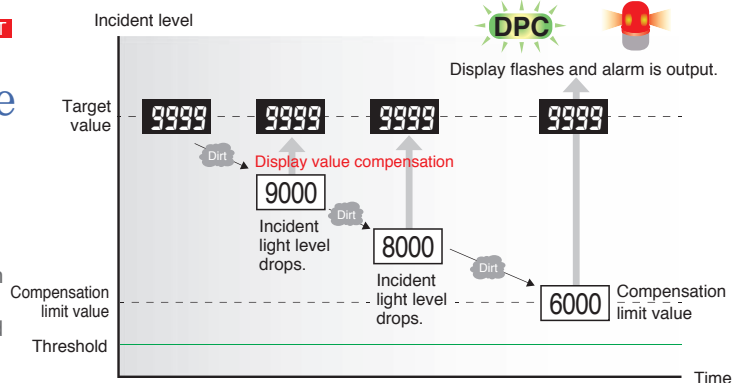

The IoT platform that enables you to see, complete a lineup, and deliver

Winner of the Good Design Award

**N-Smart**  
Presence / Detection / Measurement

**N-Smart Amplifier Units**  
Easy application with consistent operating procedures.

**E3NX-FA** Fiber Amplifier Units  
Cat. No. E426  
Stable Detection with the No. 1 Performance\*

**E3NX-CA** Color Fiber Amplifier Units  
Cat. No. Y216  
High Color Discrimination Capability

**E3NC** Smart Laser Sensors  
Cat. No. E427  
From Minute Workpieces to Long-distance Detection

**E3NC-T** Contact-Type Smart Sensors  
Cat. No. E433  
Handles Advanced Measurement Applications

**E2NC** Smart Proximity Sensors  
Cat. No. E473  
High-precision sensitivity setting is easy.

**E9NC-AA/VA** IoT Status Monitoring Amplifiers  
Cat. No. E474  
Various condition-monitoring sensors are connected.

**E3NX-MA** Smart Fiber Amplifier Units (2-channel models)  
Cat. No. E468  
Space-saving and high performance

**E3NW** Sensor Communications Units  
Cat. No. E428  
EtherCAT, CC-Link V2

**Applications with Many Sensors:**  
More convenience and even lower costs with a network.

## Common Features and Models in the N-Smart Series

Common Buttons

Intuitive Operation and Easy Setup.

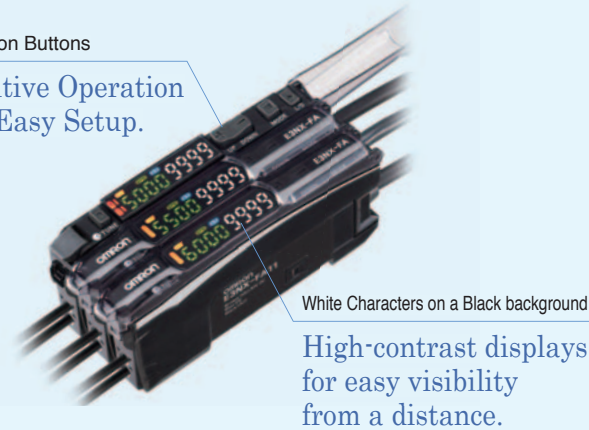

Models with Wire-saving Connectors **Popular**

## No Master/Slave Distinctions in Amplifier Units

- Reduce model numbers in stock**  
You do not need to stock both master and slave amplifier units.
  - Greatly reduced wiring work**  
Power is supplied from the Master Connector. Slave Connectors have only output lines.
  - Expansion is easy and reliable**  
Mutual interference prevention works even if you use a Master Connector instead of a Slave Connector or combine them with pre-wired models.
- Optical communications (mutual interference prevention)
- Slave Connector Output line only.
- Power supplied.
- Master Connector Power line + Output line

## Model for Sensor Communications Unit

### Data Management and Time Reduction with Network Communications

- Three communications methods are supported
- Use Distributed Sensor Units to reduce equipment production costs and commissioning time

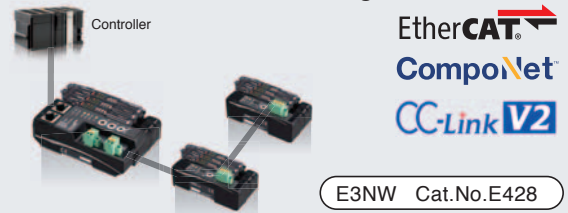

## Model for Sensor Communications Unit (With wired output) **NEW**

### Offers Both Network Communications and High-speed Response

- **Communications model with a wired output**  
Network communications can be used for an application that requires a high-speed response.
- **Greatly reduced wiring work**  
Power is supplied from the E3NW Sensor Communications Units.

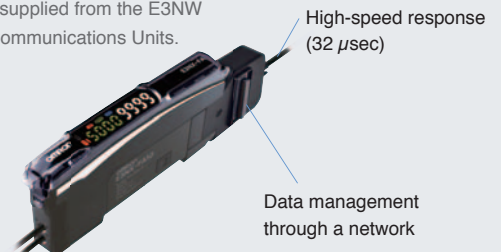

# Ordering Information

## Fiber Amplifier Units (Dimensions → pages 10 and 11)

Type	Connecting method	Appearance	Inputs/outputs	Model	
				NPN output	PNP output
Standard models	Pre-wired (2 m)		1 output	E3NX-FA11 2M	E3NX-FA41 2M
				E3NX-FA11-5 2M *1	---
	Wire-saving Connector		1 output	E3NX-FA6	E3NX-FA8
Advanced models	Pre-wired (2 m)		2 outputs + 1 input	E3NX-FA21 2M	E3NX-FA51 2M
			1 output + 1 input	E3NX-FA7	E3NX-FA9
	Wire-saving Connector		2 outputs	E3NX-FA7TW	E3NX-FA9TW
			1 output + 1 input	E3NX-FA24	E3NX-FA54
M8 Connector		2 outputs	---	E3NX-FA54TW	
Infrared models	Pre-wired (2 m)		1 output	E3NX-FAH11 2M	E3NX-FAH41 2M
			1 output	E3NX-FAH6	E3NX-FAH8
	Wire-saving Connector		1 output	E3NX-FAH6	E3NX-FAH8
Analog output models	Pre-wired (2 m)		2 outputs	E3NX-FA11AN 2M	E3NX-FA41AN 2M
Model for Sensor Communications Unit *2	Connector for Sensor Communications Unit		---	E3NX-FA0	
				E3NX-FAH0	
	Connector for Sensor Communications Unit Pre-wired (2 m)		1 output	E3NX-FA10 2M	E3NX-FA40 2M





\*1. This type can prevent mutual interference for two units in the SHS2 mode.

\*2. A Sensor Communications Unit is required if you want to use the Fiber Amplifier Unit on a network.

## Accessories (Sold Separately)



### Wire-saving Connectors (Required for models for Wire-saving Connectors.)

Connectors are not provided with the Fiber Amplifier Unit and must be ordered separately. Note: Protective stickers are provided.

Type	Appearance	Cable length	No. of conductors	Model	Applicable Fiber Amplifier Units
Master Connector		2 m	4	E3X-CN21	E3NX-FA7 E3NX-FA7TW E3NX-FA9 E3NX-FA9TW
Slave Connector			2	E3X-CN22	
Master Connector			3	E3X-CN11	E3NX-FA6 E3NX-FA8 E3NX-FAH6 E3NX-FAH8
Slave Connector			1	E3X-CN12	

### Sensor I/O Connectors (Required for models for M8 Connectors.)

Connectors are not provided with the Fiber Amplifier Unit and must be ordered separately.

Size	Cable	Appearance	Cable type	Model	
M8	Standard cable	Straight 	2m	4-wire	XS3F-M421-402-A
			5m		XS3F-M421-405-A
		L-shaped 	2m		XS3F-M422-402-A
			5m		XS3F-M422-405-A

### Mounting Bracket

A Mounting Bracket is not provided with the Fiber Amplifier Unit. It must be ordered separately as required.

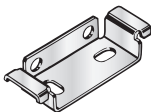
Appearance	Model	Quantity
	E39-L143	1

### DIN Track

A DIN Track is not provided with the Fiber Amplifier Unit. It must be ordered separately as required.

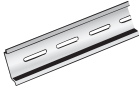
Appearance	Type	Model	Quantity
	Shallow type, total length: 1 m	PFP-100N	1
	Shallow type, total length: 0.5 m	PFP-50N	
	Deep type, total length: 1 m	PFP-100N2	

### End Plate

Two End Plates are provided with the Sensor Communications Unit. End Plates are not provided with the Fiber Amplifier Unit. They must be ordered separately as required.

Appearance	Model	Quantity
	PFP-M	1



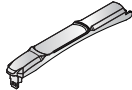

### Cover

Attach these Covers to Amplifier Units. Order a Cover when required, e.g., if you lose the covers.

Appearance	Model	Quantity
	E39-G25 FOR E3NX-FA	1

## Related Products

### Sensor Communications Units

Type	Appearance	Model
Sensor Communications Unit for EtherCAT		E3NW-ECT
Sensor Communications Unit for CompoNet		E3NW-CRT *1
Sensor Communications Unit for CC-Link		E3NW-CCL
Distributed Sensor Unit *2		E3NW-DS

Refer to your OMRON website for details.

\*1. E3NX-FAH0 can not be connected.

\*2. The Distributed Sensor Unit can be connected to any of the Sensor Communications Units.

EtherCAT® is a registered trademark and patented technology, licensed by Beckhoff Automation GmbH, Germany.

CompoNet is a registered trademark of the ODVA. CC-Link is a registered trademark of Mitsubishi Electric Corporation. The trademark is managed by the CC-Link Partner Association.

# Ratings and Specifications

## Standard models/ Advanced models/ Infrared models

Item	Type	Standard models			Advanced models					Infrared models	
	NPN output	E3NX-FA11	E3NX-FA6	E3NX-FA11-5*1	E3NX-FA21	E3NX-FA7	E3NX-FA7TW	E3NX-FA24	---	E3NX-FAH11	E3NX-FAH6
	PNP output	E3NX-FA41	E3NX-FA8	---	E3NX-FA51	E3NX-FA9	E3NX-FA9TW	E3NX-FA54	E3NX-FA54TW	E3NX-FAH41	E3NX-FAH8
	Connecting method	Pre-wired	Wire-saving Connector	Pre-wired	Pre-wired	Wire-saving Connector	M8 Connector		Pre-wired	Wire-saving Connector	
Inputs/ outputs	Outputs	1 output			2 outputs	1 output	2 outputs	1 output	2 outputs	1 outputs	
	External inputs	---			1 input	1 input	---	1 input	---	---	
Light source (wavelength)		Red, 4-element LED (625 nm)							Infrared LED (870nm)		
Power supply voltage		10 to 30 VDC, including 10% ripple (p-p)									
Power consumption *2		At Power supply voltage of 24 VDC Standard Models: Normal mode : 840 mW max. (Current consumption at 35 mA max.) Eco function ON : 650 mW max. (Current consumption at 27 mA max.) Eco function LO : 750 mW max. (Current consumption at 31 mA max.) Advanced Models or Model for Sensor Communications Unit: Normal mode : 920 mW max. (Current consumption at 38 mA max.) Eco function ON : 680 mW max. (Current consumption at 28 mA max.) Eco function LO : 800 mW max. (Current consumption at 33 mA max.) Infrared models: Normal mode : 1080 mW max. (Current consumption at 45 mA max.) Eco function ON : 920 mW max. (Current consumption at 38 mA max.) Eco function LO : 1020 mW max. (Current consumption at 42 mA max.)									
Control output		Load power supply voltage: 30 VDC max., open-collector output (depends on the NPN/PNP output format) Load current: Groups of 1 to 3 Amplifier Units: 100 mA max., Groups of 4 to 30 Amplifier Units: 20 mA max. (Residual voltage: At load current of less than 10 mA: 1 V max. At load current of 10 to 100 mA: 2 V max.) OFF current: 0.1 mA max.									
Response time	Super-high-speed mode (SHS)	Operate or reset for model with 1 output: 30 μs (Super High Speed mode (SHS2) of E3NX-FA11-5 is 60 μs each), with 2 outputs: 32 μs									
	High-speed mode (HS)	Operate or reset: 250 μs									
	Standard mode (Stnd)	Operate or reset: 1 ms									
	Giga-power mode (GI GA)	Operate or reset: 16 ms									
Maximum connectable Units		30									
No. of Units for mutual interference prevention *3	Super-high-speed mode (SHS)	0 Note: 2 units when the detection mode is set to Super High Speed mode (SHS2), and for other models, the mutual interference prevention function is disabled.									
	High-speed mode (HS)	10									
	Standard mode (Stnd)	10									
	Giga-power mode (GI GA)	10									
Functions		Auto power control (APC), dynamic power control (DPC), timer, zero reset, resetting settings, eco mode, bank switching, power tuning, and hysteresis width									

\* Refer to E3NX-FA/ Fiber Amplifier on your OMRON website for details.

\*1. This type can prevent mutual interference for two units in the SHS2 mode.

\*2. At Power supply voltage of 10 to 30 VDC

Standard Models:

Normal mode : 990 mW max. (Current consumption: 33 mA max. at 30 VDC, 65 mA max. at 10 VDC)

Eco function ON : 780 mW max. (Current consumption: 26 mA max. at 30 VDC, 42 mA max. at 10 VDC)

Eco function LO : 840 mW max. (Current consumption: 28 mA max. at 30 VDC, 45 mA max. at 10 VDC)

Advanced Models:

Normal mode : 1,020 mW max. (Current consumption: 34 mA max. at 30 VDC, 67 mA max. at 10 VDC)

Eco function ON : 810 mW max. (Current consumption: 27 mA max. at 30 VDC, 44 mA max. at 10 VDC)

Eco function LO : 870 mW max. (Current consumption: 29 mA max. at 30 VDC, 48 mA max. at 10 VDC)

Infrared models:

Normal mode : 1,260 mW max. (Current consumption: 42 mA max. at 30 VDC, 80 mA max. at 10 VDC)

Eco function ON : 1,050 mW max. (Current consumption: 35 mA max. at 30 VDC, 60 mA max. at 10 VDC)

Eco function LO : 1,140 mW max. (Current consumption: 38 mA max. at 30 VDC, 70 mA max. at 10 VDC)

\*3. The tuning will not change the number of units. The least unit count among the mutual interference prevention units of E3NX and E3NC.

Check the mutual interference prevention unit count and response speed of each model.



## Analog output models/ Model for Sensor Communications Unit

Item	Type	Analog output models	Model for Sensor Communications Unit		
	NPN output	E3NX-FA11AN	E3NX-FA10	E3NX-FA0	E3NX-FAH0
	PNP output	E3NX-FA41AN	E3NX-FA40		
Connecting method	Pre-wired	Connector for Sensor Communications Unit Pre-wired	Connector for Sensor Communications Unit		
Inputs/ outputs	Outputs	2 outputs	1 outputs	--- *1	
	External inputs	---	---		
Light source (wavelength)		Red, 4-element LED (625 nm)			Infrared LED (870nm)
Power supply voltage		10 to 30 VDC, including 10% ripple (p-p)			
Power consumption *2		At Power supply voltage of 24 VDC Normal mode : 960 mW max. (Current consumption at 40 mA max.) Eco function ON: 770 mW max. (Current consumption at 32 mA max.) Eco function LO : 870 mW max. (Current consumption at 36 mA max.)	At Power supply voltage of 24 VDC Normal mode : 920 mW max. (Current consumption at 38 mA max.) Eco function ON: 680 mW max. (Current consumption at 26 mA max.) Eco function LO : 800 mW max. (Current consumption at 33 mA max.)	At Power supply voltage of 24 VDC Normal mode : 1,080 mW max. (Current consumption at 45 mA max.) Eco function ON: 920 mW max. (Current consumption at 38 mA max.) Eco function LO : 1,020 mW max. (Current consumption at 42 mA max.)	
Control output		Load power supply voltage: 30 VDC max., open-collector output (depends on the NPN/PNP output format) Load current: Groups of 1 to 3 Amplifier Units: 100 mA max., Groups of 4 to 30 Amplifier Units: 20 mA max. ( Residual voltage: At load current of less than 10 mA: 1 V max. ) At load current of 10 to 100 mA: 2 V max. ) OFF current: 0.1 mA max.			---
Analog output (reference value)		Voltage output: 1-5 VDC (10 kΩ or more connected load), temperature characteristics: 0.3% F.S. / °C			
Control output Response time	Super-high-speed mode (SHS)	Operate or reset: 80 μs	Operate or reset: 32 μs		
	High-speed mode (HS)	Operate or reset: 250μs	Operate or reset: 250 μs		
	Standard mode (Stnd)	Operate or reset: 1 ms	Operate or reset: 1 ms		
	Giga-power mode (GIGA)	Operate or reset: 16 ms	Operate or reset: 16 ms		
Maximum connectable Units		30	16	With E3NW-ECT: 30 units (When connected to an OMRON NJ-series Controller.) With E3NW-CRT: 16 units (Note: E3NX-FAH0 can not be connected.) With E3NW-CCL: 16 units	
No. of Units for mutual interference prevention *3	Super-high-speed mode (SHS)	0 (The mutual interference prevention function is disabled if the detection mode is set to super-high-speed mode.)			
	High-speed mode (HS)	10			
	Standard mode (Stnd)	10			
	Giga-power mode (GIGA)	10			
Functions		Auto power control (APC), dynamic power control (DPC), timer, zero reset, resetting settings, eco mode, bank switching, power tuning, and hysteresis width			

\* Refer to E3NX-FA/ Fiber Amplifier on your OMRON website for details.

\*1. Two sensor outputs are allocated in the programmable logic controller PLC I/O table.  
PLC operation via Communications Unit enables reading detected values and changing settings.

\*2. At Power supply voltage of 10 to 30 VDC  
Analog output models:  
Normal mode : 1,080 mW max. (Current consumption: 36 mA max. at 30 VDC, 75 mA max. at 10 VDC)  
Eco function ON : 840 mW max. (Current consumption: 28 mA max. at 30 VDC, 55 mA max. at 10 VDC)  
Eco function LO : 960 mW max. (Current consumption: 32 mA max. at 30 VDC, 65 mA max. at 10 VDC)

\*3. The tuning will not change the number of units.  
The least unit count among the mutual interference prevention units of E3NX and E3NC.  
Check the mutual interference prevention unit count and response speed of each model.

# Dimensions

(Unit: mm)

Tolerance class IT16 applies to dimensions in this data sheet unless otherwise specified.

## Fiber Amplifier Units

### Pre-wired Amplifier Units

E3NX-FA□1(-5)  
E3NX-FAH□1  
E3NX-FA□AN



E3NX-FA11(-5)/FA41/  
FAH□1/FA□AN

E3NX-FA21/FA51

\*Cable Specifications

Model	Outer diameter	No. of conductors	Others
E3NX-FA11(-5)	4.0 dia.	3	Conductor cross-section: 0.2 mm <sup>2</sup> Insulator dia.: 0.9 mm Standard cable length: 2 m Minimum bending radius: 12 mm
E3NX-FA41			
E3NX-FAH□1			
E3NX-FA□AN	4.0 dia.	4	Standard cable length: 2 m Minimum bending radius: 12 mm
E3NX-FA21			
E3NX-FA51	4.0 dia.	5	

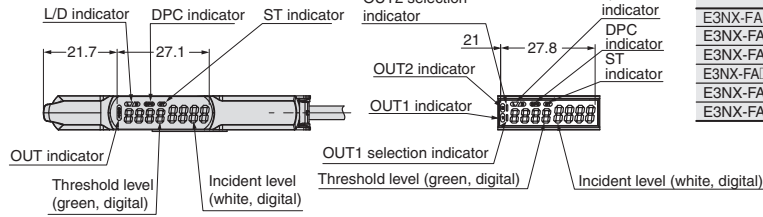

Mounted to DIN Track

With Mounting Bracket Attached

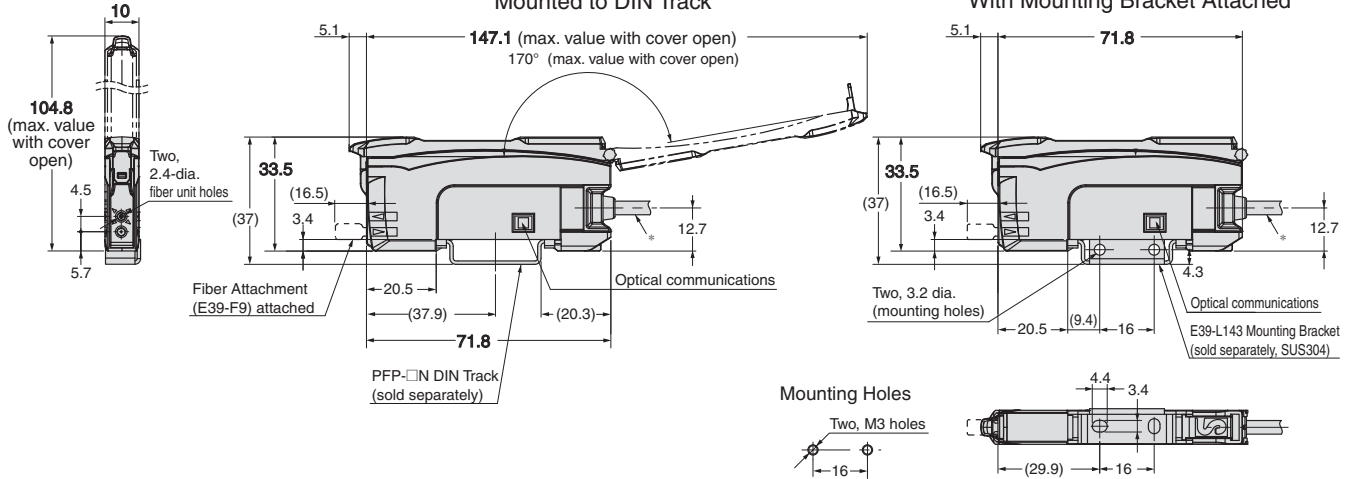

### Amplifier Units with Wire-saving Connectors

E3NX-FA6  
E3NX-FA7(TW)  
E3NX-FA8  
E3NX-FA9(TW)  
E3NX-FAH6  
E3NX-FAH8



E3NX-FA6/FA7(TW)/FA8  
/FA9(TW)/FAH6/FAH8

E3NX-FA7TW/FA9TW

\*Cable Specifications

Model	Outer diameter	No. of conductors
E3X-CN12	2.6 dia.	1
E3X-CN22	4.0 dia.	2
E3X-CN11		3
E3X-CN21		4

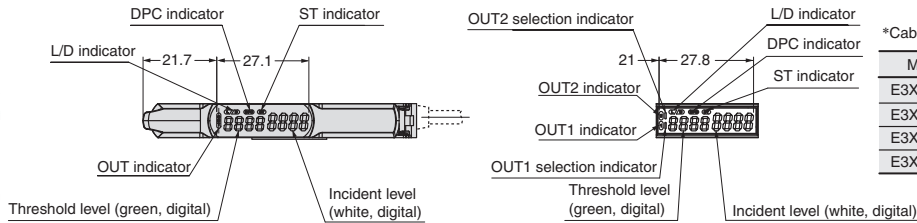

Mounted to DIN Track

With Mounting Bracket Attached

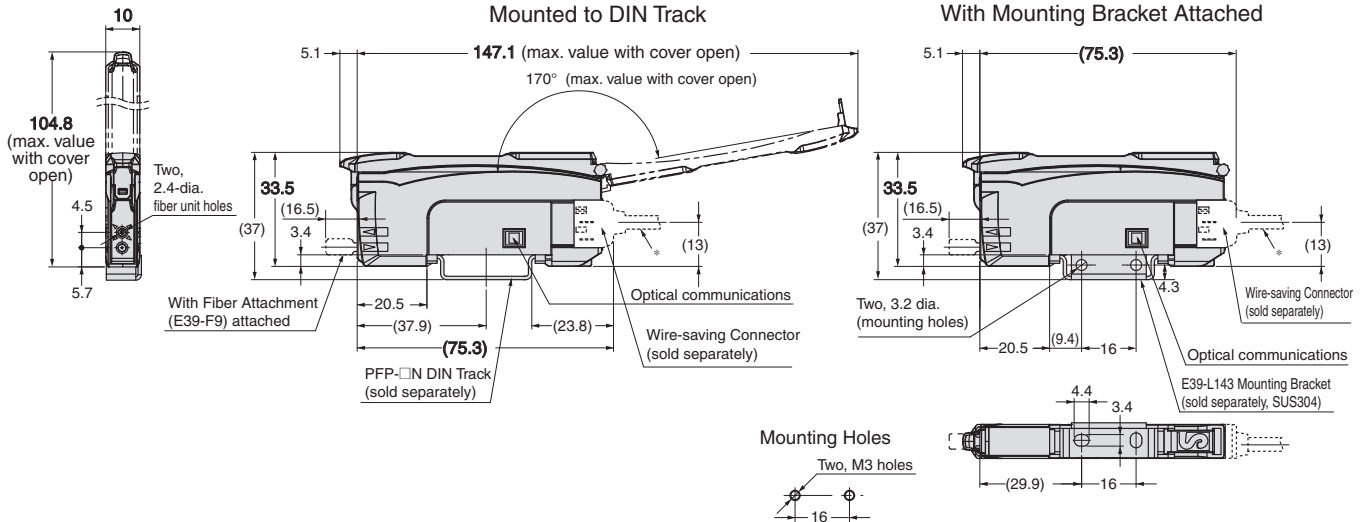

### Amplifier Units with M8 Connectors

E3NX-FA24  
E3NX-FA54  
E3NX-FA54TW

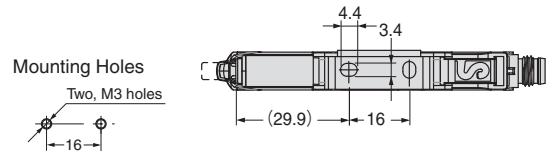
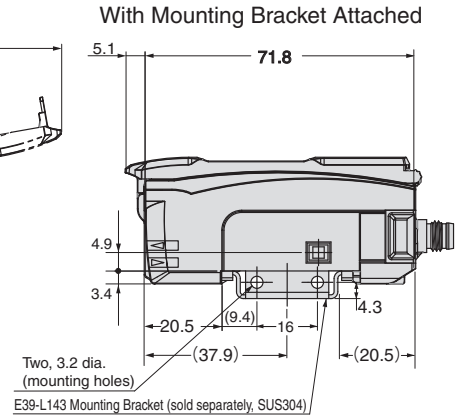
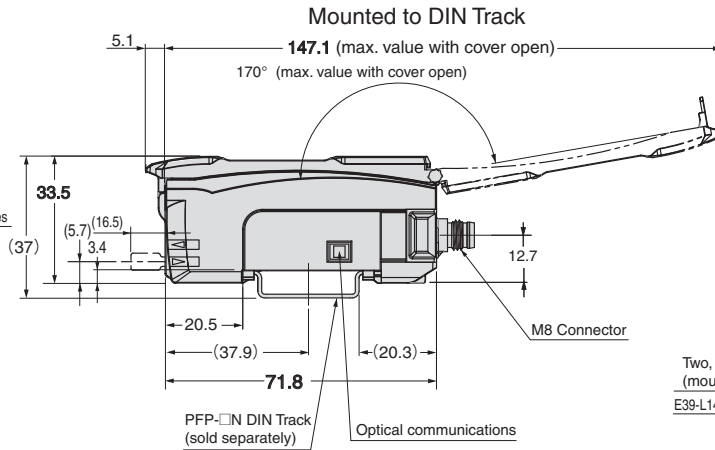
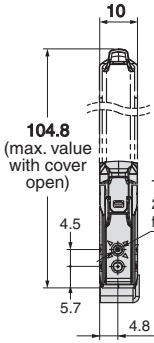
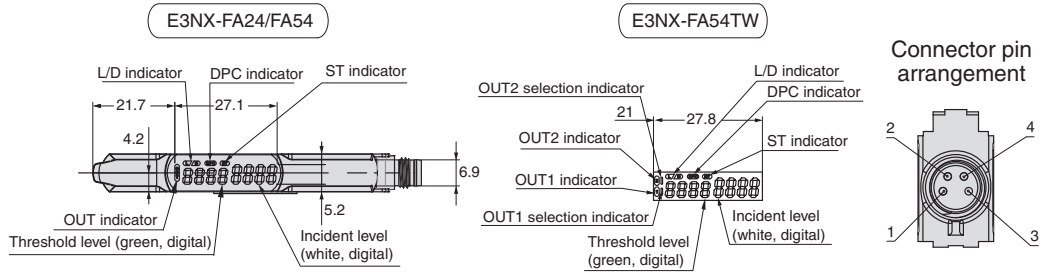

### Amplifier Unit with Connector for Sensor Communications Unit

E3NX-FA0/FAH0/FA10/FA40

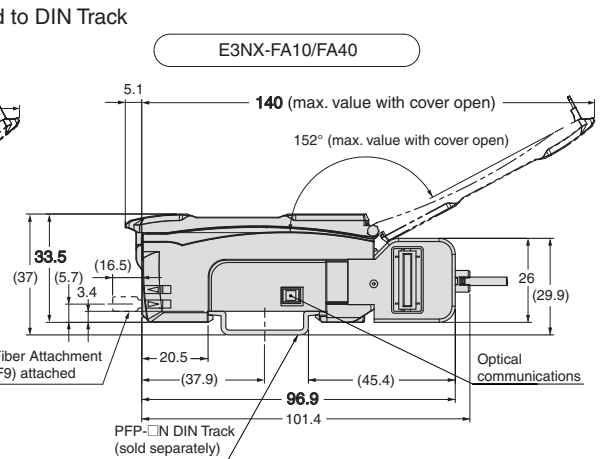
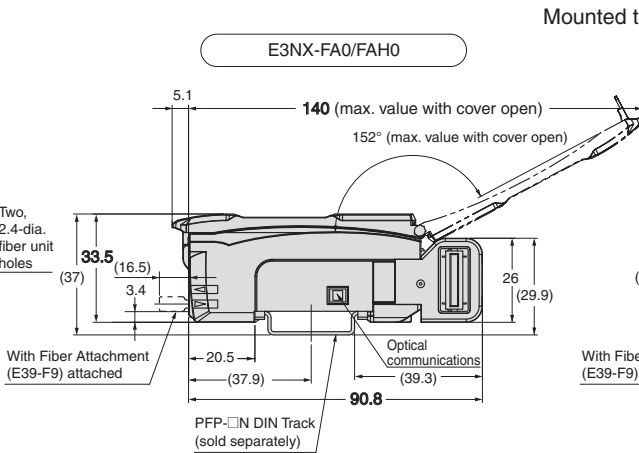
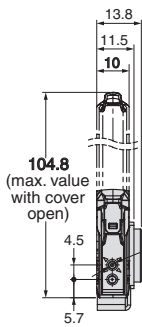
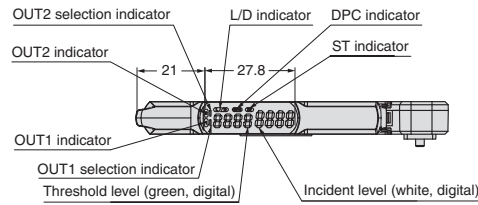

# Introduction to New Fiber Units

A New Standard: **Build-in Lens** Series

## Hex Shape

**E32-LT11N**  
**E32-LD11N**

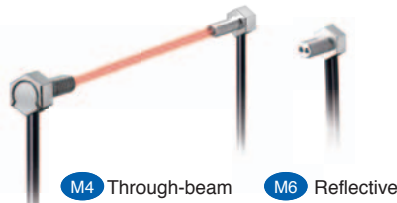

## Straight Type

**E32-LT11 (R)**  
**E32-LD11 (R)**

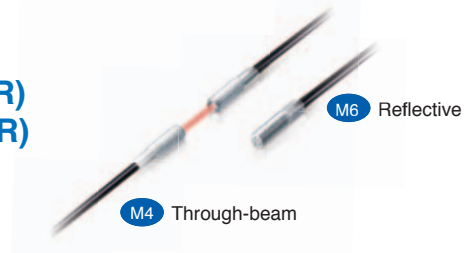

## Flat Models

**E32-LT35Z**

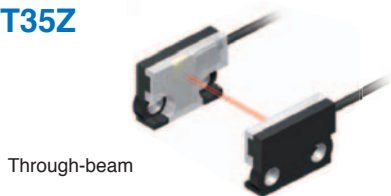

## Oil-resistant

**E32-T11NFS** **NEW**  
**E32-T11NF**

New release of the long-awaited M4 model



## Fiber Sensor Best Selection Catalog

Refer to the Fiber Sensor Best Selection Catalog for information on the above Fiber Units and detailed information on the E3NX-FA.

Cat. No. E418



### Compliance with International Standards



\* Only the E3NX-FA11, E3NX-FA21, E3NX-FA41 and E3NX-FA51 are certified for UL standards.

EtherCAT® is a registered trademark and patented technology, licensed by Beckhoff Automation GmbH, Germany.

CompoNet is a registered trademark of the ODVA.

CC-Link is a registered trademark of Mitsubishi Electric Corporation. The trademark is managed by the CC-Link Partner Association.

**OMRON Corporation** Industrial Automation Company  
Kyoto, JAPAN

Contact: [www.ia.omron.com](http://www.ia.omron.com)

#### Regional Headquarters

**OMRON EUROPE B.V.**  
**Sensor Business Unit**  
Carl-Benz-Str. 4, D-71154 Nufringen, Germany  
Tel: (49) 7032-811-0/Fax: (49) 7032-811-199

**OMRON ELECTRONICS LLC**  
2895 Greenspoint Parkway, Suite 200  
Hoffman Estates, IL 60169 U.S.A.  
Tel: (1) 847-843-7900/Fax: (1) 847-843-7787

**OMRON ASIA PACIFIC PTE. LTD.**  
No. 438A Alexandra Road # 05-05/08 (Lobby 2),  
Alexandra Technopark,  
Singapore 119967  
Tel: (65) 6835-3011/Fax: (65) 6835-2711

**OMRON (CHINA) CO., LTD.**  
Room 2211, Bank of China Tower,  
200 Yin Cheng Zhong Road,  
PuDong New Area, Shanghai, 200120, China  
Tel: (86) 21-5037-2222/Fax: (86) 21-5037-2200

Authorized Distributor:

© OMRON Corporation 2012-2018 All Rights Reserved.  
In the interest of product improvement,  
specifications are subject to change without notice.

CSM\_10\_4\_0420

Cat. No. E426-E1-06

0718(1212)