

OMRON

Smart Sensors ZS Series

2D CMOS Laser Type

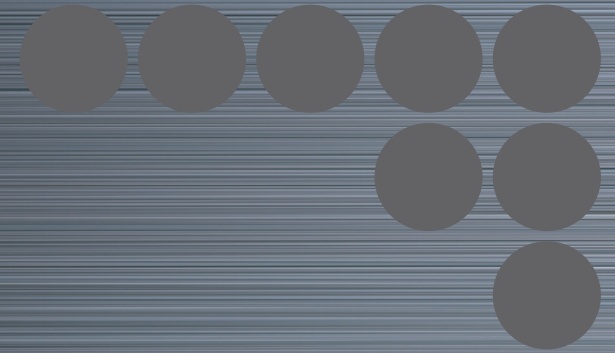

High-precision Displacement Measurement Sensors Bringing Smart Sensors into New Fields.



realizing

ZS-HL Series

More P.6

Very High-performance Sensors that Support Core Quality from Very Long-range to Extremely Precise Measurements

- Range of models with measuring center distance of 20 to 1,500 mm.
- Achieves maximum resolution of 0.25 μm .
- Maximum response speed of 110 μs .
- Parallel output supported.

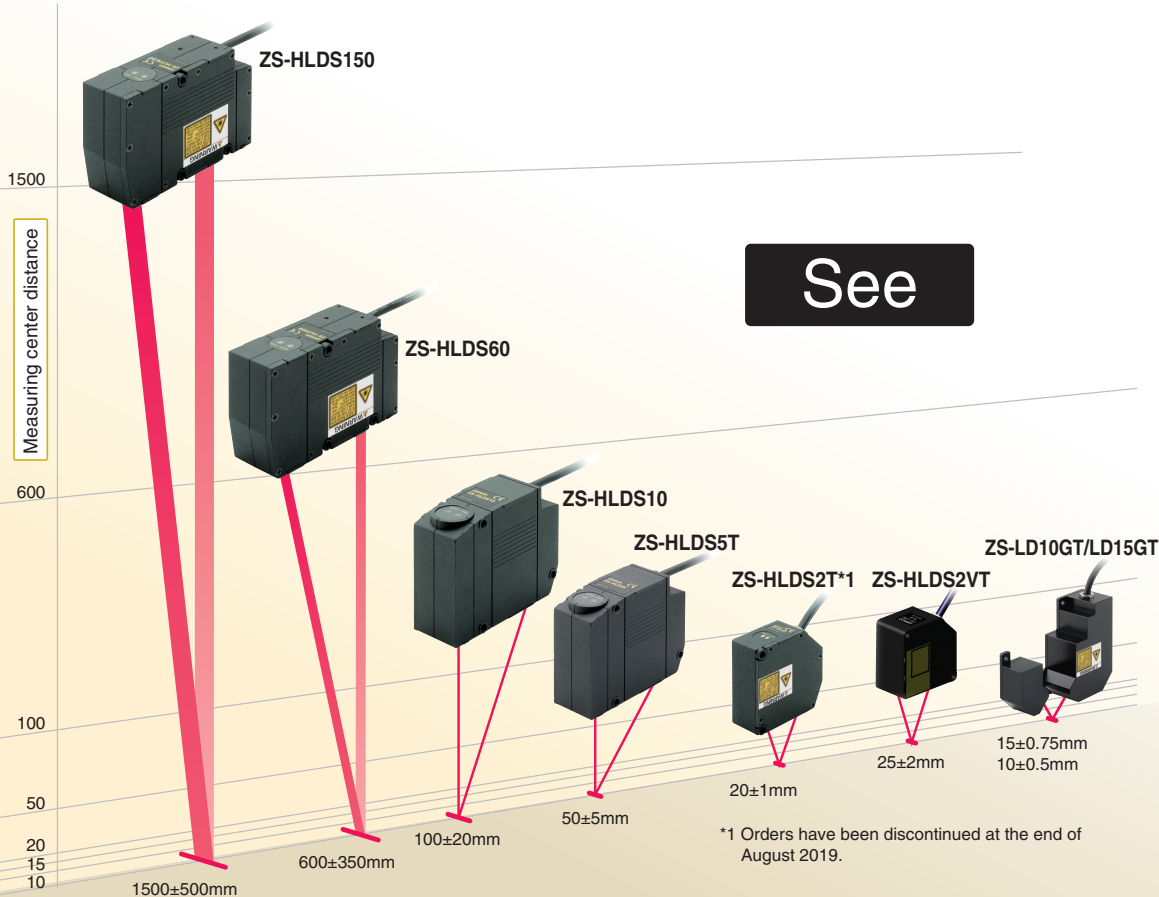

Highly Advanced Sensing Fu



Record

Data Storage Unit ZS-DSU ZS-DSU *2

Ideal for ZS Series Data Logging

Enables onsite high-speed logging of data in external memory (compact flash card) for the Sensor Controller or Multi-Controller.

Effective for building traceability systems, statistical process control (SPC), and much more.

High-speed sampling rate: 150 μs
Powerful support for logging data using various trigger functions.

More P.18

Control

Multi-Controller ZS-MDC *2

Enables full application of Sensor Controller information.

Transfers data between multi-connected Sensor Controllers and performs high-speed multiprocessing.

Connects to up to nine Sensor Controllers.

More P.17

*2 Orders will be accepted until the end of April 2023.

Smart Sensor

Advanced technology is carried

Functions in a Compact Package



Manipulate

Sensor Controllers ZS-HLDC/LDC *3
 Enable maximum sensing performance with fully digital processing.

Culmination of OMRON's lead-edge digital technology. Enables easy utilization of the ultimate in measurement performance.

- Business card size
- USB provided as a standard feature.

More P.12

*3 Orders will be accepted until the end of April 2023.

Monitor

SmartMonitor Professional ZS-SW11E V3
 Setting Software for the ZS Series

Meets a wide range of logging needs.
 Supports high-speed simultaneous multichannel waveform graphs.
 Excel macros provided for simple analysis.

More P.19

ZS-L Series

More P.14

Standard Sensors Most Suitable for a Variety of High-precision Displacement Measurements, Including Spot Detection, Wide-range Detection, and Long-distance Detection.

- Beam Shapes
 Spot and line beam selection.
- Wide Range of Products
 Long-range, middle-range, and short-range models.

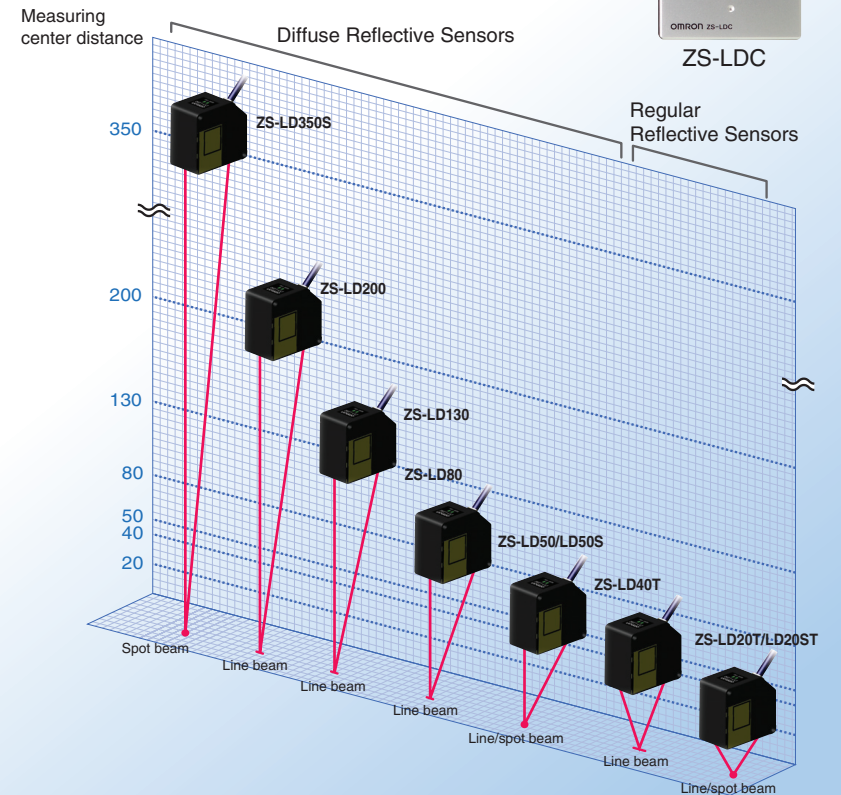

High-performance Sensors

Standard Sensors

Expansion Units

Ratings and Specifications

Main Applications

High Performance Very High-performance Sensors that Support Core Quality from Very Long-range to Extremely Precise Measurements

ZS-HL Series



ZS-LD10GT/LD15GT

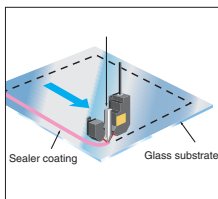

Ideal for measuring and controlling dispenser nozzle gaps when applying sealer.

ZS-HLDS2T*



Ideal for measuring the thickness of silicone or compound semiconductor wafers in polishing and testing processes.

* Orders have been discontinued at the end of August 2019.

ZS-HLDS2VT

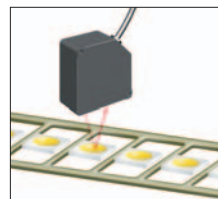

Ideal for measuring the potting resin height for electronic components.

ZS-HLDS5T



Ideal for measuring liquid gasket (FPIG) application amounts. Prevents defects such as insufficient seal.

ZS-HLDS10

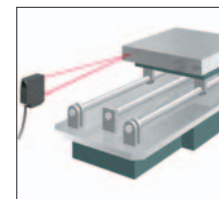

Ideal for confirming positioning and repeatability accuracy of XY stages.

ZS-HLDS60

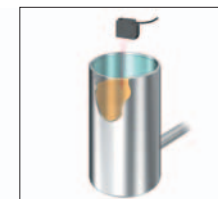

Ideal for level detection for liquid crystal coaters and PDP fluorescent substances.

ZS-HLDS150



Protruding objects and steps can be measured from a distance for measurement objects that cannot be accessed easily.

Standard

ZS-L Series



ZS-LD20ST

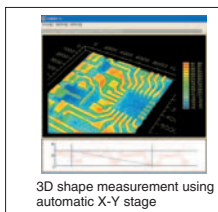

Ideal for measurements requiring discrimination between minute parts or fine shape repeatability.

ZS-LD40T

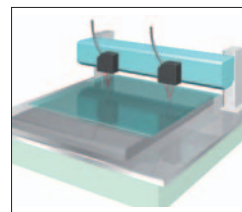

Ideal for measuring glass thickness and nozzle gaps when coating glass with resist or sealer.

ZS-LD50/LD80

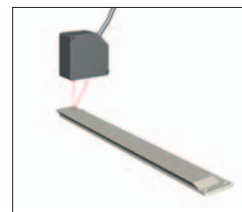

Ideal for measuring the warp of resin blades in copy machine toners.

ZS-LD200



Ideal for checking the precision of door installations.

ZS-LD350S

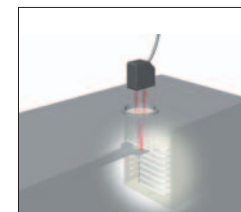

Ideal for checking the flatness of robot arms that transport wafers in load ports.

Applications by Industry

Automobile and Automotive Parts

Measuring Car Bodies



Measuring Door Attachment Offsets

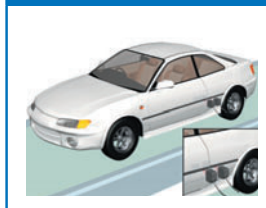

Measuring Tire Exteriors



Semiconductors

Measuring Electrode Thickness on Compound Semiconductors



Measuring Wafer Warping and Thickness

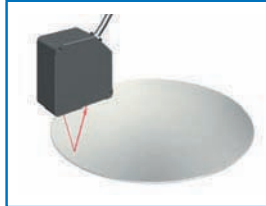

Measuring Arm Inclination

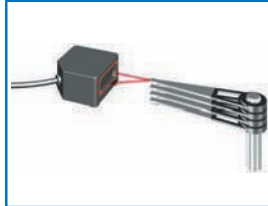

LCDs and PDPs

Measuring Glass Undulation

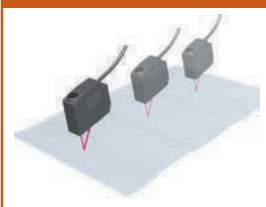

Measuring Glass Surfaces

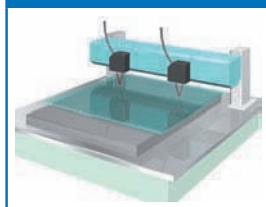

Inspecting Glass Heights (Autofocus)



Electronic Components

Inspecting Board Heights



Inspecting for Board Coplanarity



Measuring Shape for Positioning Laminated Ceramics

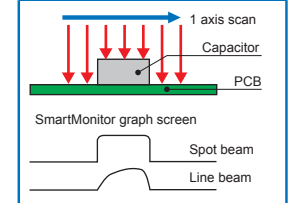

Household Appliances and Audio-visual

Simultaneous Measuring of Touch Panel Film Thickness and Gap

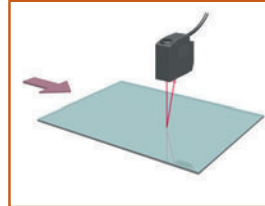

DVD Chassis Flatness Inspections

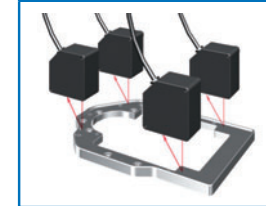

Digital Camera Tube Lens Inspection



Rubber, Resin, and Film

Measuring Electrode Thickness on Dielectrics

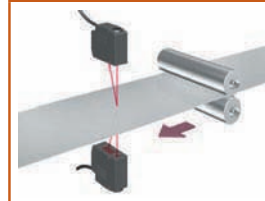

Moving Workpieces (Black Rubber)

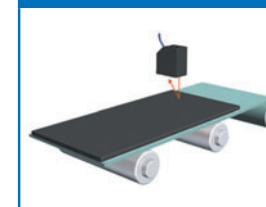

Measuring Depth of O-Ring Insertion



High-performance Sensors

High grade

ZS-HL Series Product Lineup 2D CMOS High-end Displacement Sensors

Advanced sensing technology packed into the best Sensor Head for the highest sensing precision

Wide lineup of products from 0.25 μm high-resolution models to 1,500 mm long-range models.



Model	ZS-HLDS150	ZS-HLDS60	ZS-HLDS10	ZS-HLDS5T	ZS-HLDS2T*	ZS-HLDS2VT	ZS-LD10GT/LD15GT
Measuring center distance	1500 \pm 500 mm	600 \pm 350 mm	100 \pm 20 mm	50 \pm 5 mm	20 \pm 1 mm	25 \pm 2 mm	10 \pm 0.5 mm /15 \pm 0.75 mm
Resolution	500 μm	8 μm	1 μm	0.25 μm	0.25 μm	0.6 μm	0.25 μm
Linearity	\pm 0.2%F.S.	\pm 0.07%F.S.	\pm 0.1%F.S.	\pm 0.1%F.S.	\pm 0.05%F.S.	\pm 0.2%F.S.	\pm 0.1%F.S.
Beam shape	1.5 mm \times 40 mm	0.3 mm \times 16 mm	60 μm \times 3.5 mm	30 μm \times 1 mm	20 μm \times 1 mm	45 μm \times 2.2 mm	25 μm \times 900 μm

* Orders have been discontinued at the end of August 2019.

All Models Are Class 2 Lasers.

Digital Sensing

Totally reliable measurements with completely digital sensing.

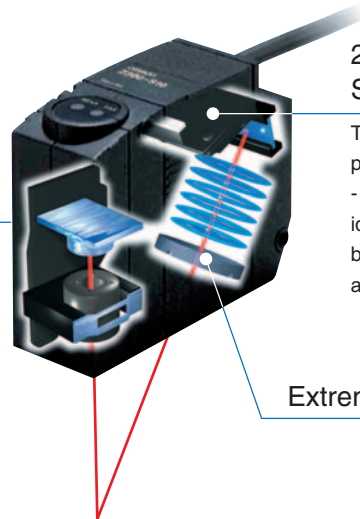

2D CMOS Laser Image Sensing Element

The three basics of sensing - precision, speed, and sensitivity - can be balanced because ideal measurement settings can be made for light reception area.

Extremely Sensitive Lenses

$\pm 0.05\%$ FS Linearity (ZS-HLDS2T)*

Unique OMRON algorithms reduce detection error to improve workpiece measurement accuracy.

* Orders have been discontinued at the end of August 2019.

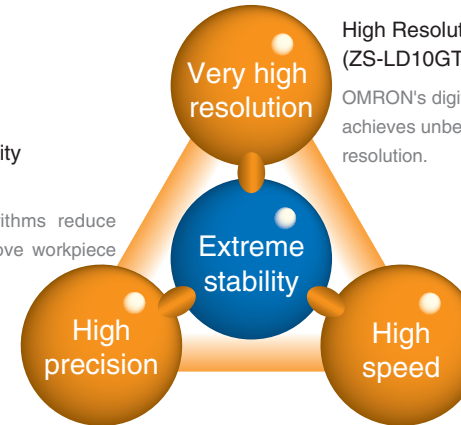

High Resolution at $0.001 \mu\text{m}$ (ZS-LD10GT)

OMRON's digital sensing technology achieves unbelievably high resolution.

Super-high-speed Sampling at $110 \mu\text{s}$ (ZS-HLDS□□/LD□□)

You get exact sensing with superior workpiece following performance. CMOS high-speed data reading accurately catches moving workpieces inline.

Extreme Stability

Ideal Size and Stability

Head Size

Complete sensing stability with optimum Sensor Head size for best performance and holding mechanism secured at 3 points. (See note.)



◀ ZS-HLDS60/HLDS150

▲ ZS-HLDS2T* ▲ ZS-HLDS5T/HLDS10

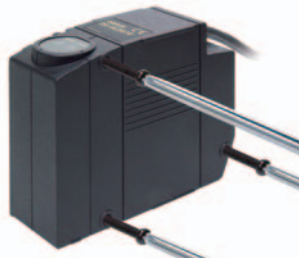

Note: ZS-HLDS2T not applicable.
* Orders have been discontinued at the end of August 2019.

Superior Moving Resolution

Increased Lens Resolution

Moving resolution (error based on workpiece surface position) has been reduced dramatically by optimizing the optical system with increased sensitivity and resolution of the light receiving lenses.

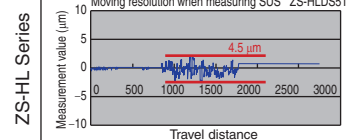
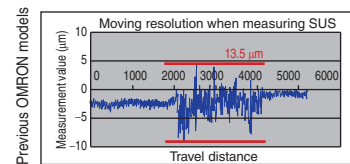

Sampling: 4 ms

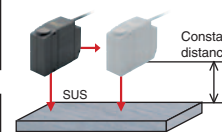

Reduced Error for Different Materials

2D CMOS

With a CCD, the charge overflows to the next pixel when excessive light is received. This phenomenon does not occur with CMOS, so there are no effects from light fluctuations from different materials or excessive light reception.

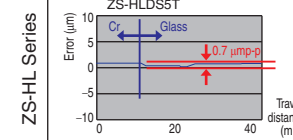
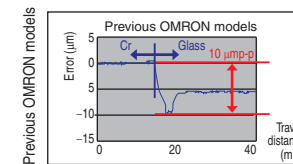

Sampling: 4 ms

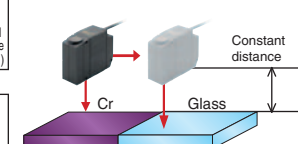

High-performance Sensors

High grade

ZS-HLDS5T/HLDS10 Detect Essentially Any Object

Reduced Variation in Linearity between Different Objects, and Linearity Determines Measurement Accuracy.
Makes it easier to introduce a variety of detection objects.

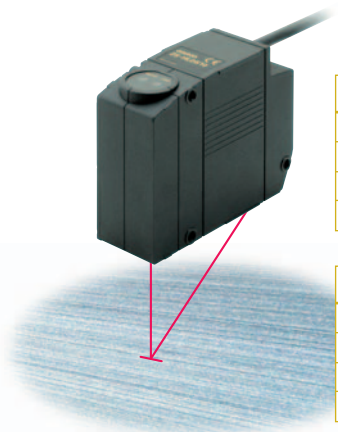

Model	ZS-HLDS5T
Measuring center distance	50±5 mm
Resolution	0.25 μm
Linearity	±0.1%F.S.
Beam shape	30 μm × 1 mm

Model	ZS-HLDS10
Measuring center distance	100±20 mm
Resolution	1 μm
Linearity	±0.1%F.S.
Beam shape	60 μm × 3.5 mm

Linearity Characteristic

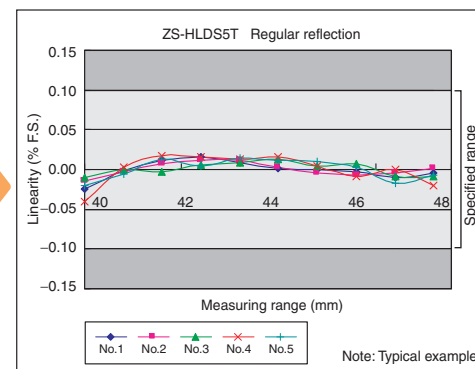
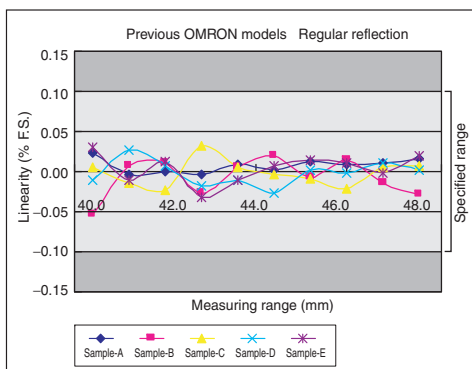

Measuring Car Body Widths (ZS-HLDS10)



Manage trends by measuring widths of each car model.

ZS-HLDS60/HLDS150 A Long Range That Handles Essentially Any Installation Site

First 1,500 mm long range sensing in the industry enables measurement of previously impossible points.

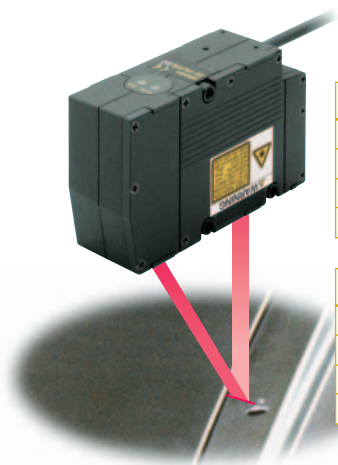

Model	ZS-HLDS60
Measuring center distance	600±350 mm
Resolution	8 μm
Linearity	±0.07%F.S.
Beam shape	0.3 mm × 16 mm

Model	ZS-HLDS150
Measuring center distance	1500±500 mm
Resolution	500 μm
Linearity	±0.2%F.S.
Beam shape	1.5 mm × 40 mm

Simple Long-distance Step Measurement

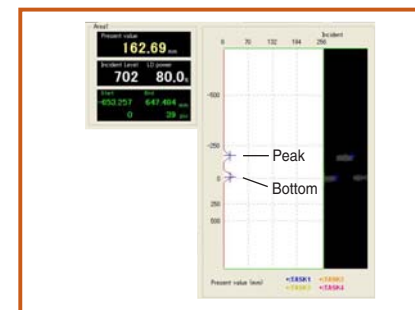
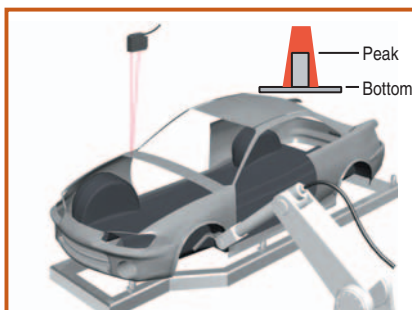

Peak/bottom measurement

Note: This function may not be applicable in bright surrounds.

ZS-HLDS2VT

Ideal for Measuring the Height and Thickness of Transparent Objects

Tilted and moving workpieces can also be stably measured.



Model	ZS-HLDS2VT
Measuring center distance	25±2 mm
Resolution	0.6 μm
Linearity	±0.2%F.S.
Beam shape	45 μm × 2.2 mm

A special aspherical lens was developed for the ZS-HLDS2VT, and the design of the optical structure was optimized for regular-reflective workpieces. This has greatly increased the allowable degree of tilt and improved stability for measuring transparent and regular-reflective workpieces.

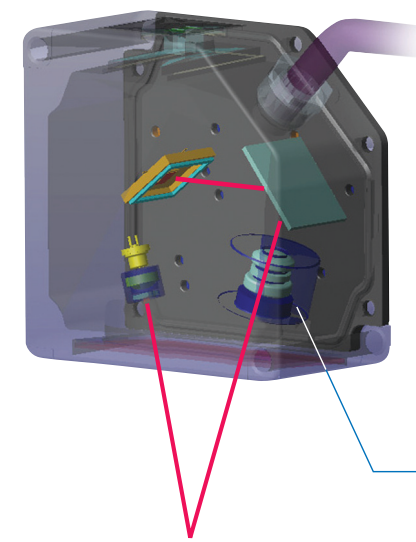

Aspherical lens (newly developed)

Angle Characteristics

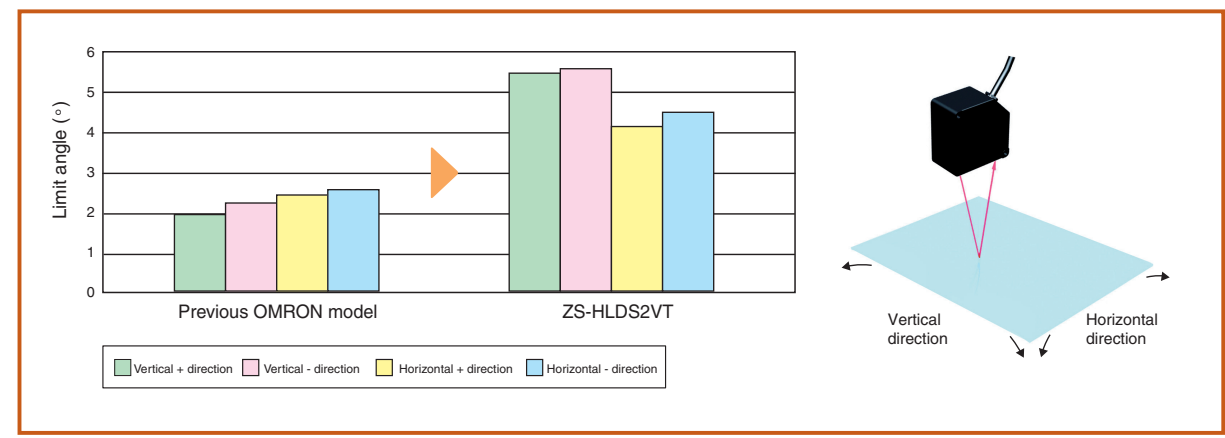

High-performance Sensors

High grade

ZS-HLDS2T*/ZS-LD10GT/LD15GT

The Only Way to Very High-precision Measurements

Superior Features for Semiconductor Wafer, Glass, and Other Measurements Requiring Precision

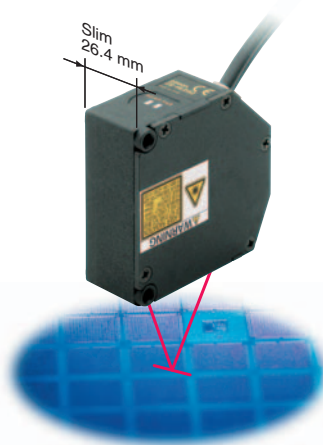

Model	ZS-HLDS2T*
Measuring center distance	20±1 mm
Resolution	0.25 μm
Linearity	±0.05%F.S.
Beam shape	20 μm × 1 mm

* Orders have been discontinued at the end of August 2019.

Simultaneous Measuring of Touch Panel Film Thickness and Gap

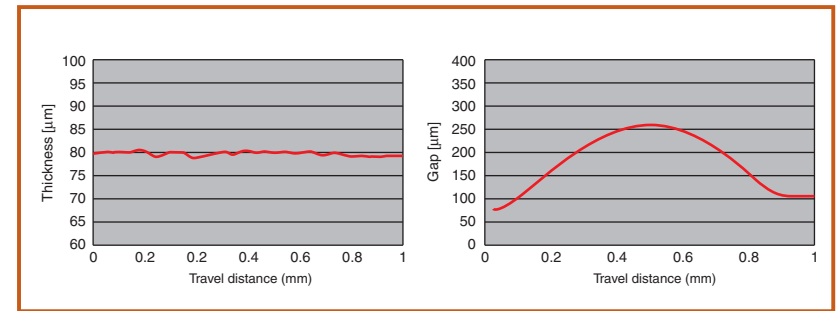
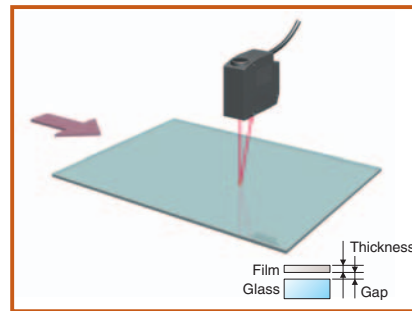

Simultaneous measurement of transparent object thickness and gap

An unbelievable stationary measurement precision of 0.25 μm, the highest in this product class.



Ideal for Measuring Nozzle Gaps!

- Reduced pattern influence for moving measurement, the best in the moving resolution industry.
- Possible to match nozzle drip point and measurement point then measure.
- Sensor Head with separate light emission and reception in one unit to create nozzle space.

Model	ZS-LD10GT/LD15GT
Measuring center distance	10±0.5 mm/15±0.75 mm
Resolution	0.25 μm
Linearity	±0.1%F.S.
Beam shape	25 × 900 μm

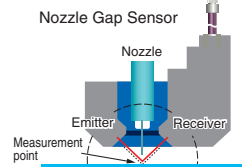

Height Control of Sealant Dispensers

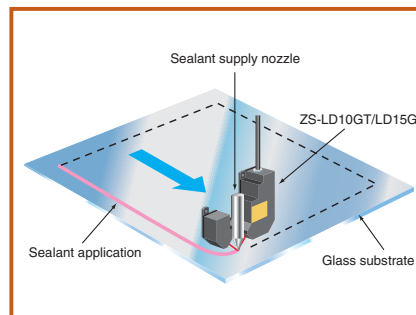

Inspection of Disk Play on HDD Motor Rotating Plate

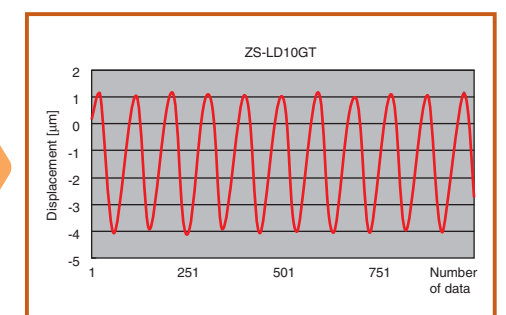
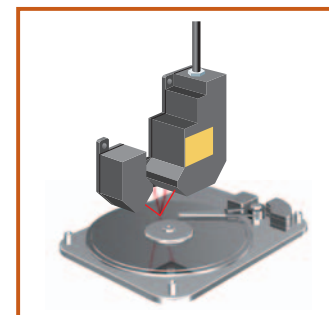

Measures amplitude undulations of 5 μm.

Technology

With OMRON's sensing technology and newly developed algorithms, stable, high-precision measurement is possible of workpieces that were difficult to measure using laser displacement meters due to laser light penetration, transmission, excessive reflection, or insufficient light.

Mechanisms for Stable Measurement Patent Pending

No more errors due to reflection coefficients between glass gaps

Stable measurement by adding received light waveform in 2D image and digital zoom processing.

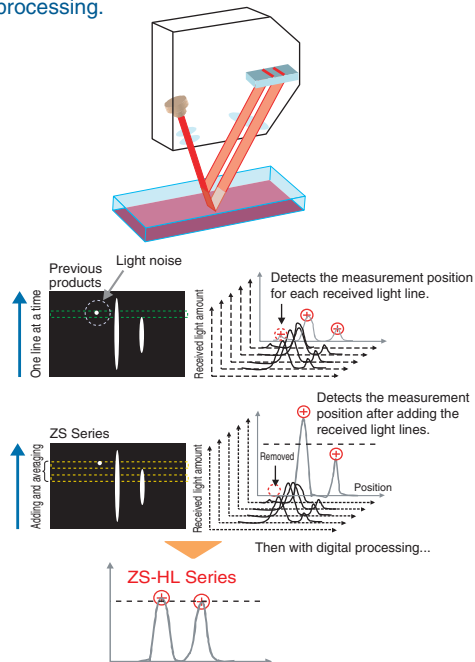

Measurement cycle time 1/8 better than previous models with addition of received light waveform captured by 2D CMOS and simultaneous measurement of front and back glass surfaces with separate sensitivities.

Mechanisms for Stable Measurement Patent Pending

No more errors due to workpiece reflection coefficients.

Stable measurement using laser power algorithms that can be adjusted to any value.

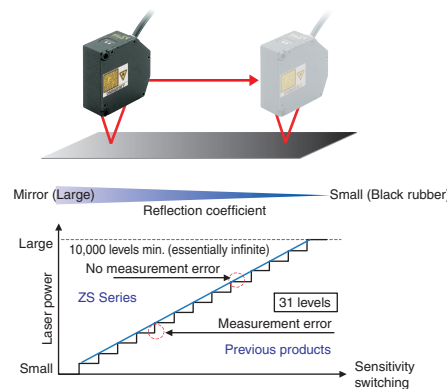

Light quantity adjustment algorithms have evolved for stable measurement of a variety of measurement objects. Even if the workpiece status changes suddenly, the sensitivity can compensate at any level so there is no measurement error from sensitivity switching.

Mechanisms for High Resolution Patent Pending

No more resolution errors.

Digital processing technology between the Sensor and Controller provides high resolution.

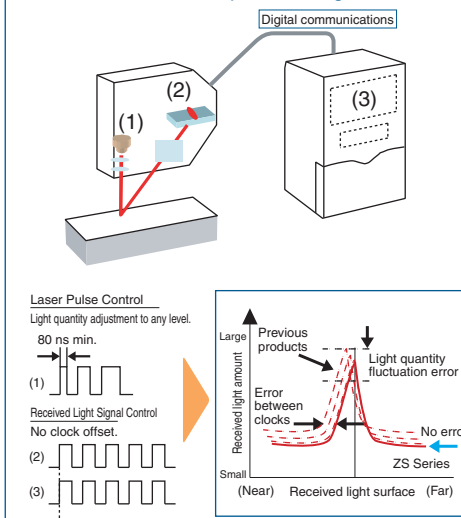

High-speed digital communications (LVDS) used between Sensor and Controller. Image signal stabilizes because the clock error between the control signal from the Controller and the light reception device disappears. Optimum light quantity adjustment is possible with laser power algorithms that can be adjusted to any level, which facilitates super high resolution.

Mechanisms for Stable Measurement

No more error due to penetration.

Stable measurements are achieved by correctly recognizing the light reception distribution on the 2D CMOS.

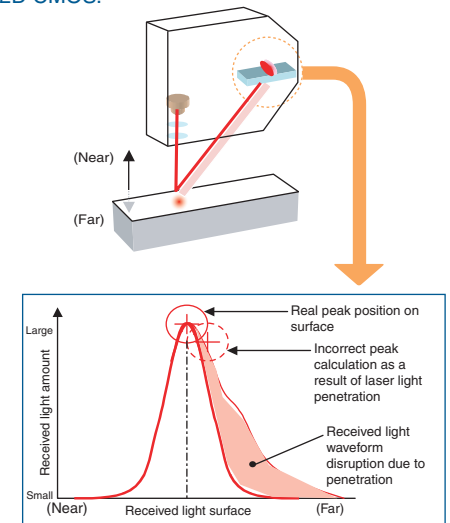

Real surface displacement detected by eliminating penetration effects for PCBs, plastic, and other workpieces penetrated by laser light.

High-performance Sensors

High grade

Sensor Controllers ZS-HLDC (Multitasking)

Enables maximum sensing performance with fully digital processing and multitasking functions.

A controller the size of a business card filled with OMRON's leading-edge digital technology.

Enables easy utilization of the ultimate in measurement performance.



Outline of Functions

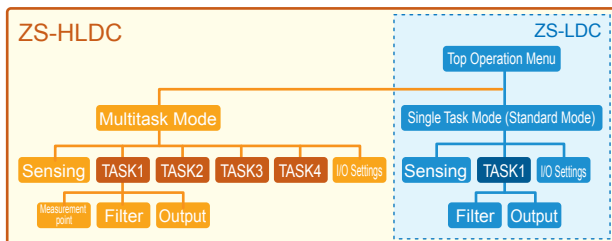

High-performance Sensing (Multitasking)

Simultaneous Measurement and Output of Up to 4 Features

- When simultaneous measurement of distance to glass, glass thickness, gap, etc., required in glass measurement applications

Setting example
 ■Task 1: Average
 ■Task 2: Thickness

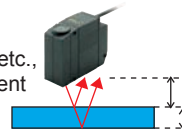

- For simultaneous measurement of HDD surface deflection and distance to HDD surface

Setting example
 ■Task 1: Average, Average hold
 ■Task 2: Average, Point-to-point hold

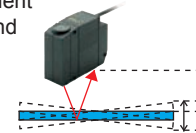

- For detection of small recesses and protrusions in measurement location

Setting example
 ■Task 1: Step

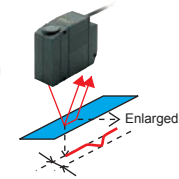

- For measurement of steps in different locations with moving Sensor or workpiece

Setting example
 ■Task 1: Average
 Self-down trigger
 Average hold
 With delay
 ■Task 2: Average
 Average hold
 With delay
 ■Task 3: Calculation (Task 2 - Task 1)

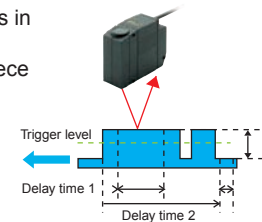

Simultaneous Control in 2 Systems of Data Confirmation and Analysis and Data Collection, Control, and Changeovers

Control Using CompoWay/F*

Data Confirmation and Analysis

- Checks sensing screen.
- Checks measurement values.
- Logs measurement values.



* OMRON's unique communications protocol.

Control Using No-protocol Communications

Data collection, control, and changeovers

- Gets measurement results.
- Resets to zero.
- Switches banks.

Improved Total Cycle Time with 1-second High-speed Bank Switching

Smart Sensor

Advanced technology is carried

High-performance Sensors

Easy Sensing with an HMI That Couldn't Be Easier to Use (Common Functions)

Information at the Touch of a Button

In RUN (measurement) Mode, measured values and information are displayed using 2 rows of 8-segment LEDs. The large LED display improves visibility. Measurement information includes the threshold, current, resolution, and received light amount and is available with simple key operations. LCD screens can be customized to change the display of desired information to easier-to-understand terminology.

RUN
(measurement mode)

Example of
Display Customization

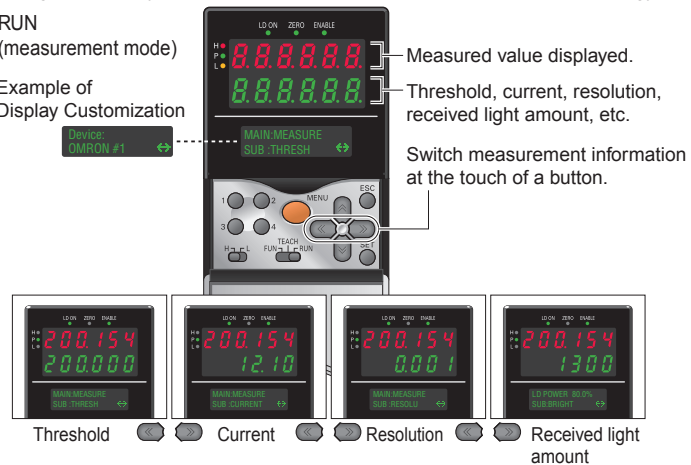

Mount to DIN Track or
directly to control
panels.

Patent Pending



Panel Mounting Adapter (Option, Sold Separately)

Set Sensing Directly Patent Pending

In FUN (setting) Mode, setting menus are displayed on the 2 rows of the LCD. Easy-to-understand guidance simplifies setting the many display capabilities of the LCD. Function keys correspond to displayed menu items for intuitive setting of measurement conditions and other parameters. You can also easily switch between Japanese and English displays. Communication with the operator is better than ever before.

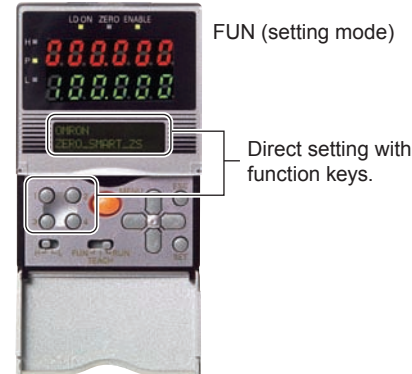

Connect directly to a PC using USB.

USB 2.0 and RS-232C provided as standard features. LVDS, a new-generation digital high-speed communications interface, is used between the Sensor Head and Controller, an industry first. If USB is used to connect to the computer, high-speed all digital measurement data transfer is possible. Firmware can be updated easily using the SmartMonitor WarpEngine.

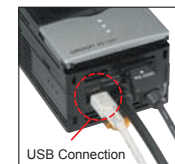

ZS-LDC Single Task Controller

Simple Operation
Reasonable Price

ZS-L Series Product Lineup 2D CMOS Low-end Displacement Sensors

Advanced sensing technology packed into the smallest Sensor Heads in this class.

- Smallest size in this class (65 × 65 mm)
- Uniform Sensor Head size
- Line/spot beam type
- Detects black rubber, mirror, and transparent workpieces

ZS-LD50/LD80/LD130/LD200/LD350S

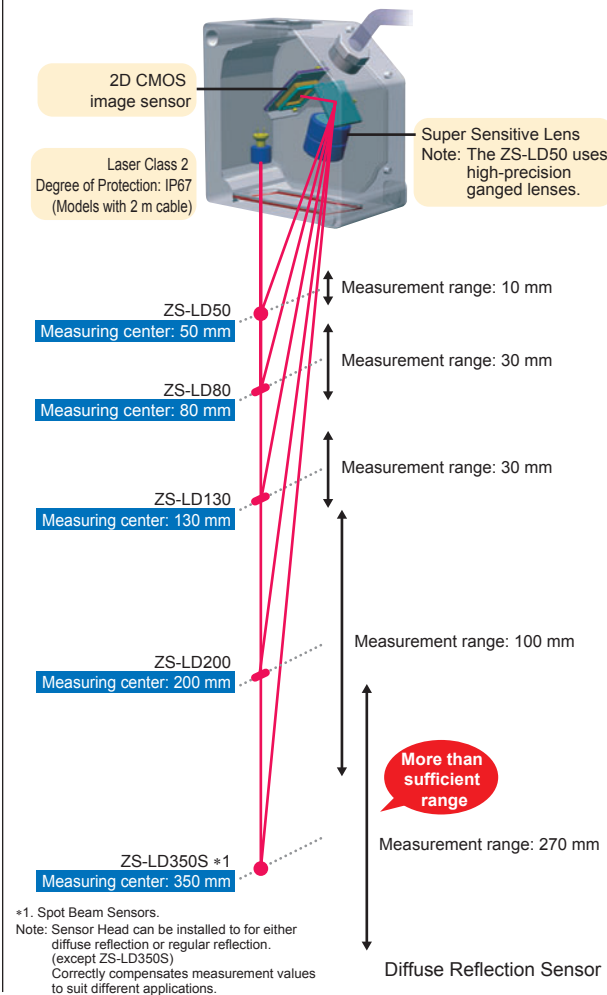

ZS-LD20T/LD40T

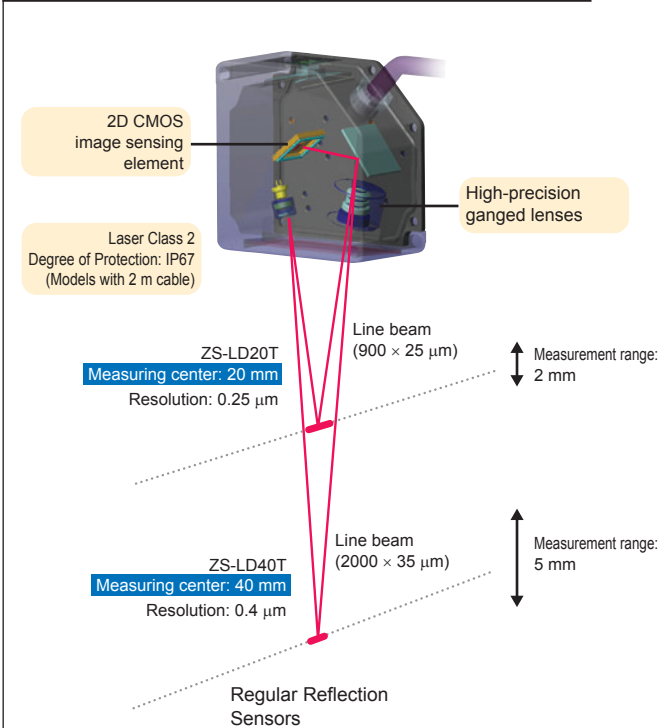

ZS-LD20ST/LD50S

Spot Beam Sensors

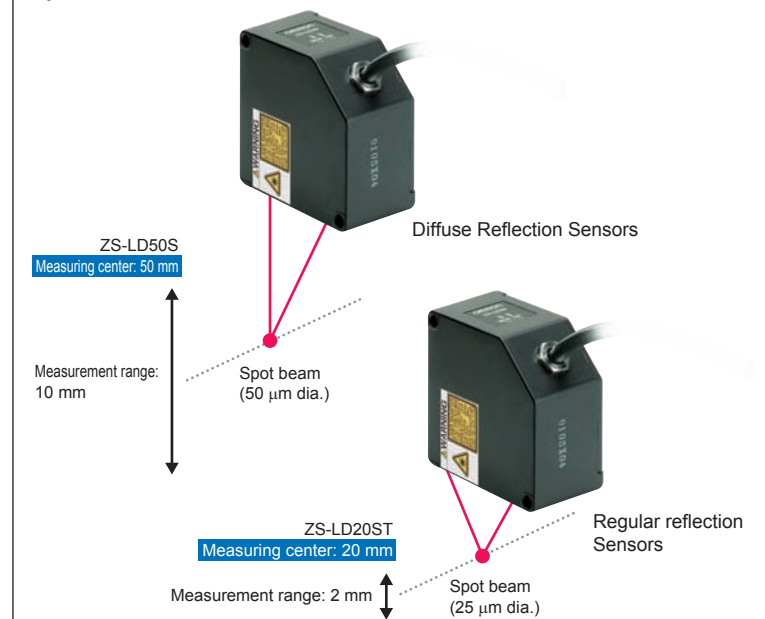

Stable Measurements for PCBs, Black Resin, and Metal

■ All you need to do is select the proper mode to achieve stable sensing of PCBs, resins, black rubber, and other light-penetrating workpieces (these could not be easily handled with previous reflective laser displacement meters.)

ZS-LD80

Measuring the Shape of Black Resin Workpieces

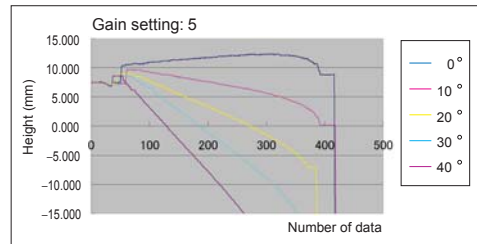

Complete measurement data will be obtained at angles of up to 40°.

ZS-LD50

Measuring the Shape PCB Surfaces

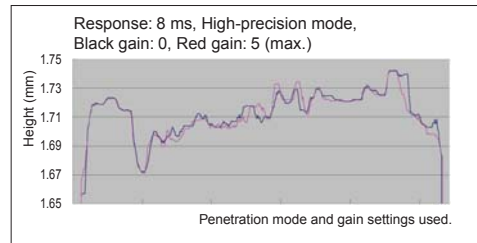
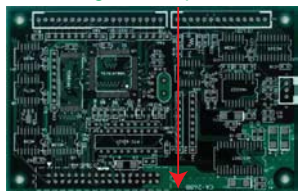

PCB shapes can be measured without burs or waveform disruptions.

Stable Measurements for Glass

■ Stably measure height and undulations in transparent, coated, or colored glass on work tables. Stable detection at 40 mm with a line beam of 2 mm.

A 2-mm line beam reduces the influence of black and white patterns on granite work tables to achieve stable measurements.

ZS-LD40T

Measuring Glass Surfaces

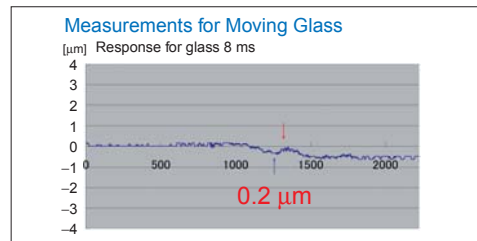
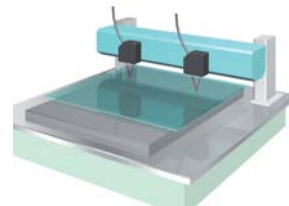

Ideal for measuring glass thickness and slit nozzle gaps when coating glass with resist or sealer.

Line Beam Sensors for Emphasis on Stable Measurement

Line beams produce an averaging affect that is less likely to be affected by surface irregularities, creating stable measurements. Ideal for stable measurements that do not rely on the surface of the target workpiece.

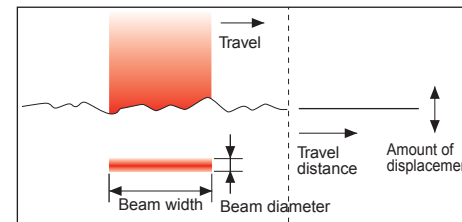

Line Beam sensors	ZS-LD20T	ZS-LD40T	ZS-LD50	ZS-LD80	ZS-LD130	ZS-LD200
Beam diameter	25 µm	35 µm	60 µm	60 µm	70 µm	100 µm
Beam width	0.9 mm	2 mm	0.9 mm	0.9 mm	0.6 mm	0.9 mm

Spot Beam Sensors Ideal for Minute Workpieces and Shape Measurement

Ideal for measurements requiring minute shape repeatability while matching laser beam position with a minute target measurement area.

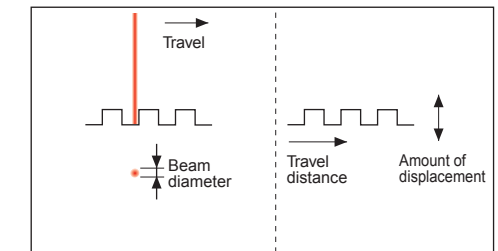

Spot Beam sensors	ZS-LD20ST	ZS-LD50S	ZS-LD350S
Beam width	25 µm dia.	50 µm dia.	240 µm dia.

Easy Sensing with an HMI That Couldn't Be Easier to Use

- Just select High-precision Mode to stably measure black rubber.
- Just select Penetration Mode to stably measure PCBs or black resin.

Set Sensing Directly

FUN (setting mode)



Direct setting with function keys.

Expansion Units

Enhancing unit

System Configuration

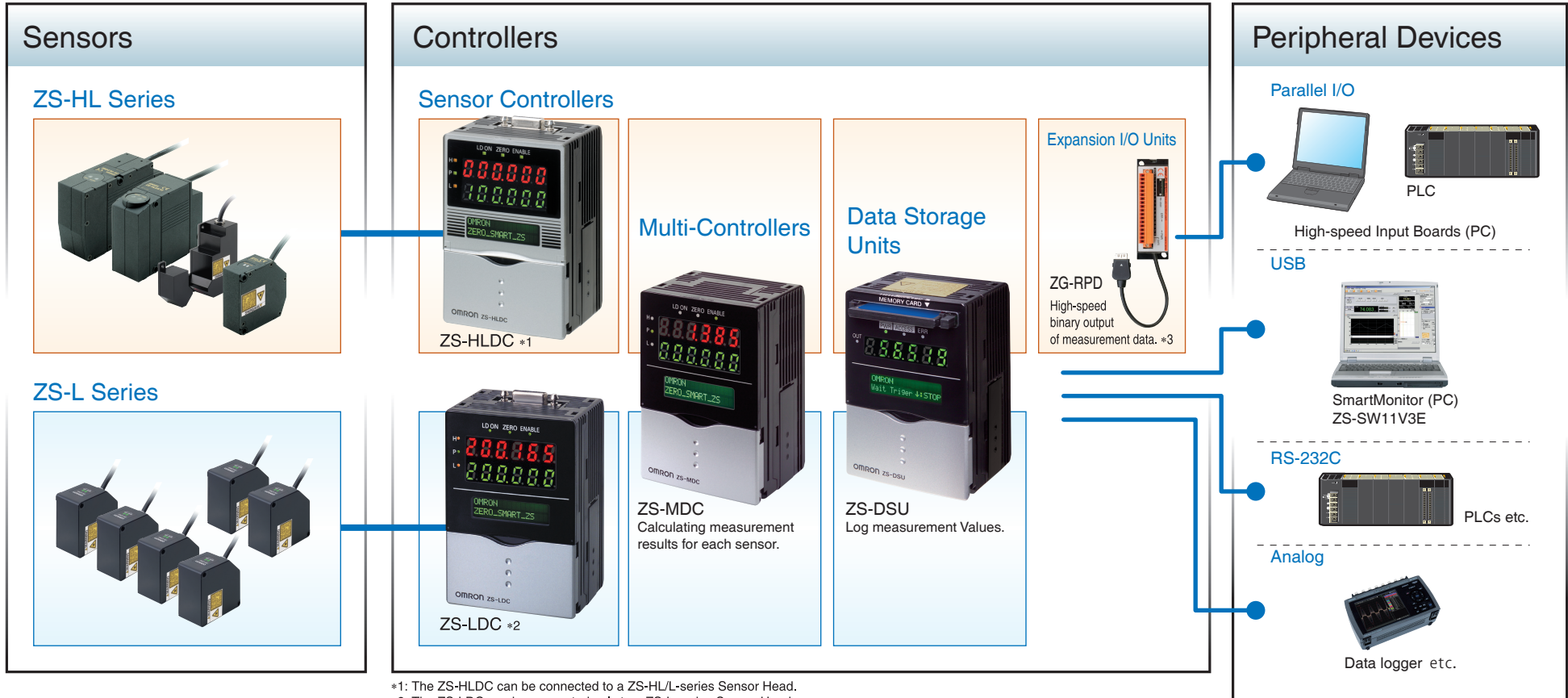

*1: The ZS-HLDC can be connected to a ZS-HL/L-series Sensor Head.

*2: The ZS-LDC can be connected only to a ZS-L-series Sensor Head.

*3: The ZG-RPD Expansion I/O Unit can be connected only to a ZS-HL-series Sensor Controller.

ZS-HL-series Long-distance Extension Cable

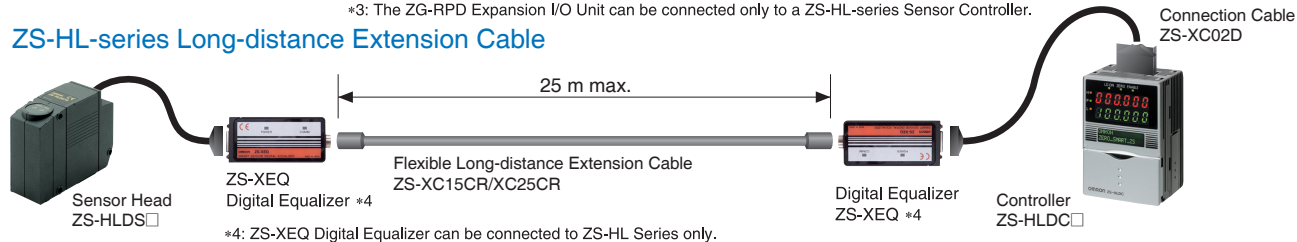

Multi-Controller ZS-MDC

Centralized Controller Information Calculations

Transfers data between multi-connected Controllers and performs high-speed multiprocessing.

High-speed Connections for Up To 9 Controllers

See the difference in applications requiring multipoint measurement, such as thickness, steps, and flatness measurements. Connect up to 9 Controllers with the fastest high-speed bus in the industry. Digital processing prevents data dropouts to provide the capability to measure exactly what is seen.

Sampling speed with 3 Controllers connected: 110 μ s, Sampling speed with 9 Controllers connected: 380 μ s

Note: When using communications commands.

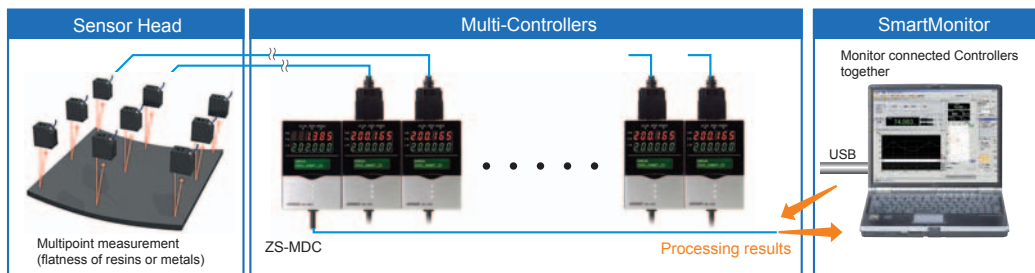

Expansion Units

Processing Enabled by the Multi-Controller

Flatness Calculations

Calculating the difference between the maximum and minimum values.

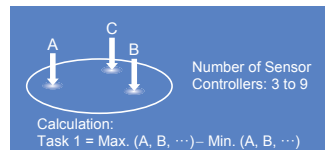

Reference Step Calculations

Calculating the difference between a reference point (A) and other points.

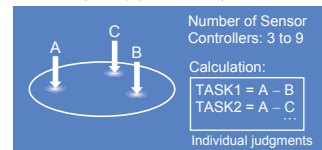

Relative Step Calculations

Calculating the difference between all points.

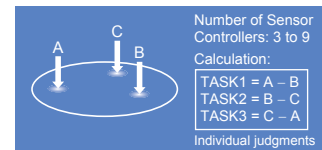

Twisting Calculations

Calculating twisting between opposing sides.

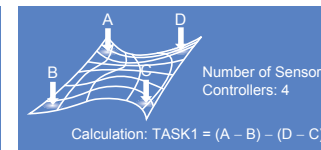

Multipoint Thickness Calculations

Calculating the difference between pairs of points.

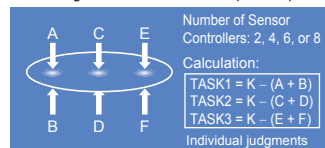

Average Height Calculations

Calculating the average surface height.

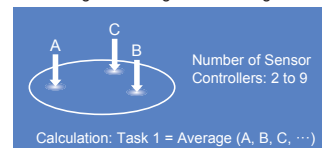

Warp Calculations

Calculating warping of selected sides

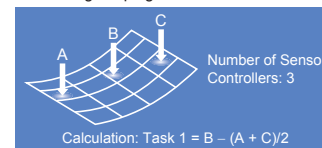

User-set Calculations

Formulas can be flexibly set.

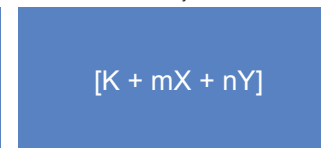

Multi-calculations of Data

Multipoint measurement

High-speed data transfer

Data Storage Unit ZS-DSU

Logging Software for Onsite Installed



Efficiently stores sensing data using a variety of logging functions.
 High-speed, long term logging settings can be used to precisely process the required sensing data, which can be reliably and completely collected using USB and an all-digital bus.
 Sensor setting data can also be stored.
 Data for up to 128 banks can be stored and transferred to the Master Unit for changeovers.

- High-speed sampling rate: 150 μ s max.
- Powerful support for logging data using various trigger functions.

Config-uration	Number of connectable Controllers	10 max. (ZS-MDC: 1, ZS-HLDC/LDC: 9 max.)
	Connectable Controllers	ZS-HLDC□, ZS-LDC□, ZS-MDC□
Perform-ance	Data resolution	32 bits
	Sampling rate	<ul style="list-style-type: none"> • Shortest high-speed logging mode (One-shot Mode) *1 • Long-term logging mode (Repeat Mode) *2 • Sampling period: 10 ms to 1 h (at 1-ms intervals)
Func-tions	Trigger functions	Start and end triggers can be set separately. External trigger/data trigger (self-trigger) Time triggers
	Other functions	<ul style="list-style-type: none"> • External bank function • Alarm output function • Saved data format customization function • Time function (timestamps)
Software (included)		<ul style="list-style-type: none"> • CSV file generation Software • Excel macros for simple analysis (Equivalent to software provided with SmartMonitor Professional.)

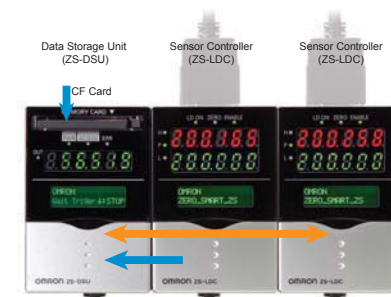

Data Storage Unit ZS-DSU

Multipoint data collection

Traceability

Changeover Unit

*1) For One-shot Mode

• Connected to ZS-LDC

Number of channels	Min. sampling interval	Longest logging time
1	150 μ s	10 min
2	200 μ s	6.5 min
4	350 μ s	5.5 min
9	650 μ s	4.5 min

Typical examples

*2) For Repeat Mode (Logging time depends on capacity of Memory Card.)

• Example for 64-MB Memory Card

Number of channels	Min. sampling interval	Longest logging time
1	10 ms	20 h
2	10 ms	10 h
4	10 ms	5 h
9	10 ms	2 h

Typical examples

• Connected to ZS-MDC

Number of channels	Min. sampling interval	Longest logging time
1	350 μ s	20 min
2	400 μ s	12 min
4	500 μ s	8 min
9	700 μ s	5 min

Typical examples

Setting Software for ZS Series SmartMonitor V3 Professional ZS-SW11V3E

Use a Computer for Everything from Ideal ZS Settings to Powerful Support of Data Collection and Analysis.
Easy Settings Using USB.

More Powerful Setting Support

The CMOS light reception image and the received light waveform can be displayed. The real power of the SmartMonitor is seen when measuring transparent objects and other workpieces that create multiple received light waveforms.

●Received Light Monitor

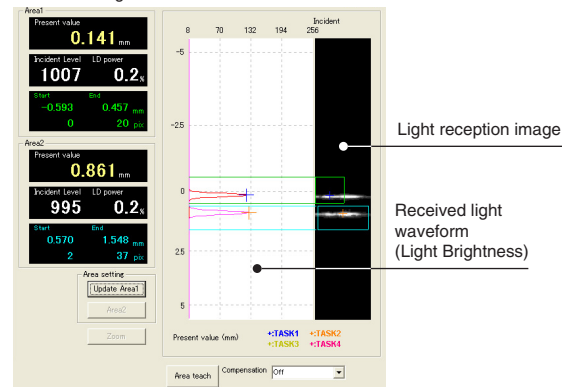

Meets a wide range of logging needs.

Log measurement results at various times to leave judgment and inspection results.

The fastest sampling interval is 500 μ s (see note).

Note: Data may be skipped, depending on the computer system.

Use a computer that meets the recommended system requirements.

●Logging

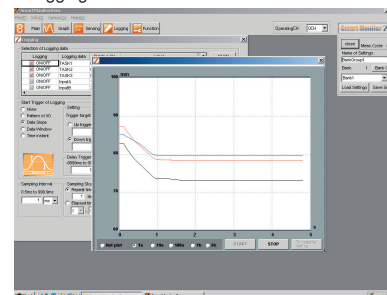

High-speed simultaneous multichannel waveform graphs.

High-speed display: 2-ms interval at max. speed (see note);
Simultaneous multichannel waveform display: Up to 9 waveforms can be displayed.

Note: Data may be skipped, depending on the computer system. Use a computer that meets the recommended system requirements.

●Multi-channel Waveform Display

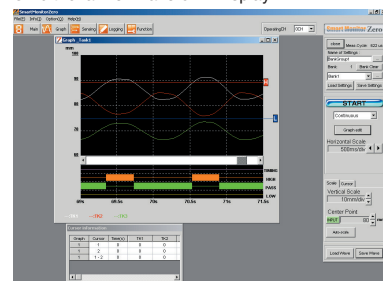

Excel macro provided for simple analysis.

Data collected by logging can be processed with an Excel macro using filters, slope compensation, filter median transitions, differentiation, integration, and arithmetic functions and then used for nominal judgments and other determinations.

●Analysis

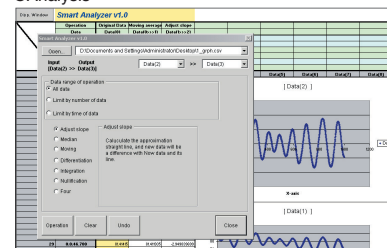

Recommended System Requirements
SmartMonitor Professional
OS: Windows 10 (32-bit/64-bit version)
Windows 7 (32-bit/64-bit version)
Windows XP (Service Pack3 or higher, 32-bit version)
CPU: Intel Pentium III 1 GHz or faster (2 GHz min. recommended.)
Memory: 1 GB min.

Available hard disk space: 50 MB min.

Display screen: 1,024 x 768 dots min., 16 million colors min.

Note: If the recommended system requirements are not met, data may be interrupted and waveforms not displayed correctly when using the logging, high-speed graph drawing, and multi-channel waveform drawing functions.

SmartAnalyzer Macro Edition

For Microsoft Excel Macro Programming

Microsoft Excel 2000 or later required.

- Window is registered trademarks of Microsoft Corporation in the USA and other countries.
- Other company names and product names in this document are the trademarks or registered trademarks of their respective companies.

Ratings and Specifications

Specification

Ordering Information Smart Sensor

ZS-HL-series Sensor Heads

Optical system	Sensing distance	Beam shape	Beam diameter	Resolution (see note)	Cable length	Model
Regular Reflective Models	20±1 mm	Line beam	1.0 mm × 20 μm	0.25 μm	2 m	ZS-HLDS2T 2M*
					0.5 m	ZS-HLDS2T 0.5M*
	25±2 mm	Line beam	2.2 mm × 45 μm	0.6 μm	2 m	ZS-HLDS2VT 2M
Diffuse Reflective Models	50±5 mm	Line beam	1.0 mm × 30 μm	0.25 μm	0.5 m	ZS-HLDS2VT 0.5M
					2 m	ZS-HLDS5T 2M
	100±20 mm	Line beam	3.5 mm × 60 μm	1 μm	0.5 m	ZS-HLDS5T 0.5M
					2 m	ZS-HLDS10 2M
	600±350 mm	Line beam	16 mm × 0.3 mm	8 μm	0.5 m	ZS-HLDS10 0.5M
					2 m	ZS-HLDS60 2M
	1500±500 mm	Line beam	40 mm × 1.5 mm	500 μm	0.5 m	ZS-HLDS60 0.5M
					2 m	ZS-HLDS150 2M
				0.5 m	ZS-HLDS150 0.5M	

Note : Refer to the table of ratings and specifications for details.
* Orders have been discontinued at the end of August 2019.

ZS-HL-series Sensor Heads (For Nozzle Gaps)

Optical system	Sensing distance	Beam shape	Beam diameter	Resolution (see note)	Cable length	Model
Regular Reflective Models	10±0.5 mm	Line beam	900 × 25 μm	0.25 μm	2 m	ZS-LD10GT 2M
					0.5 m	ZS-LD10GT 0.5M
	15±0.75 mm	Line beam	900 × 25 μm	0.25 μm	2 m	ZS-LD15GT 2M
					0.5 m	ZS-LD15GT 0.5M

Note : Refer to the table of ratings and specifications for details.

ZS-L-series Sensor Heads

Optical system	Sensing distance	Beam shape	Beam diameter	Resolution (see note)	Cable length	Model
Regular Reflective Models	20±1 mm	Line beam	900 × 25 μm	0.25 μm	2 m	ZS-LD20T 2M
					0.5 m	ZS-LD20T 0.5M
	40±2.5 mm	Spot beam	25 μm dia.	0.25 μm	2 m	ZS-LD20ST 2M
					0.5 m	ZS-LD20ST 0.5M
					4 m	ZS-LD40T 4M*1
Diffuse Reflective Models	50±5 mm	Line beam	900 × 60 μm	0.8 μm	2 m	ZS-LD40T 2M
					0.5 m	ZS-LD40T 0.5M
	50±5 mm	Spot beam	50 μm dia.	0.8 μm	2 m	ZS-LD50 2M
					0.5 m	ZS-LD50S 2M
	80±15 mm	Line beam	900 × 60 μm	2 μm	0.5 m	ZS-LD50S 0.5M
					2 m	ZS-LD80 2M
					1 m	ZS-LD80 1M*2
	130±15 mm	Line beam	600 × 70 μm	3 μm	0.5 m	ZS-LD80 0.5M
2 m					ZS-LD130 2M	
200±50 mm	Line beam	900 × 100 μm	5 μm	0.5 m	ZS-LD130 0.5M	
				2 m	ZS-LD200 2M	
350±135 mm	Spot beam	240 μm dia.	20 μm	0.5 m	ZS-LD200 0.5M	
				2 m	ZS-LD350S 2M	
				0.5 m	ZS-LD350S 0.5M	

Note : No. of samples to average: 128 when set to High-precision Mode.

*1. Orders have been discontinued at the end of August 2019.

*2. Orders have been discontinued at the end of January 2021.

ZS-HL-series Sensor Controllers

Shape	Supply voltage	Control outputs	Model
	24 VDC	NPN outputs	ZS-HLDC11*3
		PNP outputs	ZS-HLDC41*3

ZS-L-series Sensor Controllers

Shape	Supply voltage	Control outputs	Model
	24 VDC	NPN outputs	ZS-LDC11*3
		PNP outputs	ZS-LDC41*3

Multi-Controllers

Shape	Supply voltage	Control outputs	Model
	24 VDC	NPN outputs	ZS-MDC11*3
		PNP outputs	ZS-MDC41*3

Data Storage Units

Shape	Supply voltage	Control outputs	Model
	24 VDC	NPN outputs	ZS-DSU11*3
		PNP outputs	ZS-DSU41*3



*3. Orders will be accepted until the end of April 2023.

Accessories (Sold Separately)

Controller Link Unit

Shape	Model
	ZS-XCN

Panel Mount Adapter

Shape	Model	
	ZS-XPM1	For 1st Controller
	ZS-XPM2	For expansion (from 2nd Controller on)

RS-232C Cables

Connected to	Model	Qty
Personal computer (2 m)	ZS-XRS3	1
PLC/PT (2 m)	ZS-XPT3	1

Extension Cables for Sensor Heads

Cable length	Model	Qty
1 m	ZS-XC1A	1
4 m	ZS-XC4A	1
5 m	ZS-XC5B (*1, *2)	1
8 m	ZS-XC8A	1
10 m	ZS-XC10B (*1)	1

- *1. Up to two ZS-XC□B Cables can be connected. (22 m max.)
- *2. A Robot Cable (ZS-XC5BR) is also available.

Long Extension Cables for Sensor Heads (Used with a Digital Equalizer for ZS-HL Series)

Name	Model	Qty
Digital Equalizer (Relay)	ZS-XEQ	1
Extension Cable (long distance, flexible 15 m cable)	ZS-XC15CR	1
Extension Cable (long distance, flexible 25 m cable)	ZS-XC25CR	1
Digital Equalizer Connection Cable (0.2 m)	ZS-XC02D	1

Logging Software

Name	Model
SmartMonitor Professional	ZS-SW11V3E

Realtime Parallel Output Unit (for ZS-HL Series)

Shape	Control outputs	Model
	NPN outputs	ZG-RPD11-N
	PNP outputs	ZG-RPD41-N

Memory Cards

Model	Capacity
HMC-EF283	256 MB
HMC-EF583	512 MB

Quick Reference for Extension Cable Connections

Extension Cable			Sensor Head		Controller		Remarks
Model	Length	Bend resistant	ZS-LD□ ZS-HLDS2V	ZS-HLDS2/ -HLDS5/-HLDS10/ -HLDS60/-HLDS150	ZS-LDC□	ZS-HLDC□	
ZS-XC1A	1m		○	○	○	○	Only one Extension Cable can be used.
ZS-XC4A	4m		○	○	○	○	
ZS-XC8A	8m		○	○	○	○	
ZS-XC5B	5m		○	○	○	○	Up to two Extension Cables can be used. (The maximum length is 22 m.)
ZS-XC10B	10m		○	○	○	○	
ZS-XC5BR	5m	○	○	○	○	○	A ZS-XEQ Digital Equalizer and ZS-XC02D Digital Equalizer Connecting Cable are required.
ZS-XC15CR	15m	○		○		○	
ZS-XC25CR	25m	○		○		○	

Ratings and Specifications

ZS-HL/L-series Sensor Controllers

Item	Model	ZS-HLDC11/LDC11	ZS-HLDC41/LDC41	
No. of samples to average		1, 2, 4, 8, 16, 32, 64, 128, 256, 512, 1,024, 2,048, or 4,096		
Number of mounted Sensors		1 per Sensor Controller		
External interface	Connection method	Serial I/O: connector, Other: pre-wired (Standard cable length: 2 m)		
	Serial I/O	USB 2.0	1 port, Full Speed (12 Mbps max.), MINI-B	
		RS-232C	1 port, 115,200 bps max.	
	Output	Judgment output	HIGH/PASS/LOW 3 outputs NPN open collector, 30 VDC, 50 mA max., residual voltage 1.2 V max.	HIGH/PASS/LOW: 3 outputs PNP open collector, 50 mA max., residual voltage 1.2 V max.
		Linear output	Selectable from 2 types of output, voltage or current (selected by slide switch on bottom). • Voltage output: -10 to 10 V, output impedance: 40 Ω • Current output: 4 to 20 mA, maximum load resistance: 300 Ω	
Inputs	Laser OFF, ZERO reset timing, RESET	ON: Short-circuited with 0 V terminal or 1.5 V or less OFF: Open (leakage current: 0.1 mA max.)	ON: Short-circuited to supply voltage or within 1.5 V of supply voltage. OFF: Open (leakage current: 0.1 mA max.)	
Functions		Display: Measured value, threshold value, voltage/current, received light amount, and resolution/terminal block output *2 Sensing: Mode, gain, measurement object, head installation Measurement point *1: Average, peak, bottom, thickness, step, and calculations Filter: Smooth, average, and differentiation Outputs: Scaling, various hold values, and zero reset I/O settings: Linear (focus/correction), judgments (hysteresis and timer), non-measurement, and bank (switching and clear) *2 System: Save, initialization, measurement information display, communications settings, key lock, language, and data load Task: ZS-HLDC□1: Single task or multitask (up to 4) ZS-LDC□1: Single task		
Status indicators		HIGH (orange), PASS (green), LOW (orange), LDON (green), ZERO (orange), and ENABLE (green)		
Segment display	Main digital	8-segment red LED, 6 digits		
	Sub-digital	8-segment green LEDs, 6 digits		
LCD		16 digits x 2 rows, Color of characters: green, Resolution per character: 5 x 8 pixel matrix		
Setting inputs	Setting keys	Direction keys (UP, DOWN, LEFT, and RIGHT), SET key, ESC key, MENU key, and function keys (1 to 4)		
	Slide switch	Threshold switch (2 states: High/Low), mode switch (3 states: FUN, TEACH, and RUN)		
Power supply voltage		21.6 V to 26.4 VDC (including ripple)		
Current consumption		0.5 A max. (when Sensor Head is connected)		
Ambient temperature		Operating: 0 to 50°C, Storage: -15 to +60°C (with no icing or condensation)		
Ambient humidity		Operating and storage: 35% to 85% (with no condensation)		
Degree of protection		IP20 (IEC60529)		
Materials		Case: Polycarbonate (PC)		
Cable length		2 m		
Weight		Approx. 280 g (excluding packing materials and accessories)		
Accessories		Ferrite core (1), instruction sheet		

*1. Can be used with ZS-HLDC□1 when Multitask Mode selected.

*2. Terminal block output is a function of the ZS-HLDC□1.

Ratings and Specifications

ZS-HL-series Sensor Heads

Item	Model	ZS-HLDS2T	ZS-HLDS2VT	ZS-HLDS5T	ZS-HLDS10	ZS-HLDS60	ZS-HLDS150		
Applicable Controllers	ZS-HLDC series								
Optical system	Regular reflection	Diffuse reflection	Regular reflection	Diffuse reflection	Regular reflection	Diffuse reflection	Diffuse reflection		
Measuring center distance	20 mm	5.2 mm	25 mm	50 mm	44 mm	100 mm	94 mm		
Measuring range	±1 mm	±1 mm	±2 mm	±5 mm	±4 mm	±20 mm	±16 mm		
Light source	Visible semiconductor laser (wavelength: 650 nm, 1 mW max., JIS Class 2)								
Beam shape	Line beam								
Beam diameter *1	1.0 mm × 20 μm		2.2 mm × 45 μm		1.0 mm × 30 μm		3.5 mm × 60 μm		
Linearity *2	±0.05%F.S.		±0.2%F.S.		±0.1%F.S.		±0.07%F.S. (250 to 750 mm), ±0.1%F.S. (750 to 950 mm)		
Resolution *3	0.25 μm (No. of samples to average: 256)		0.6 μm (No. of samples to average: 128)		0.25 μm (No. of samples to average: 512)		1 μm (No. of samples to average: 64)		
Temperature characteristic *4	0.01%F.S./°C		0.1%F.S./°C		0.01%F.S./°C				
Sampling cycle	110 μs (High-speed Mode), 500 μs (Standard Mode), 2.2 ms (High-precision Mode), 4.4 ms (High-sensitivity Mode)								
LED Indicators	NEAR indicator	Lights near the measuring center distance, and closer than the measuring center distance inside the measuring range. Flashes when the measurement target is outside of the measuring range or when the received light amount is insufficient.							
	FAR indicator	Lights near the measuring center distance, and farther than the measuring center distance inside the measuring range. Flashes when the measurement target is outside of the measuring range or when the received light amount is insufficient.							
Operating ambient illumination	Illumination on received light surface: 3000 lx or less (incandescent light)					Illumination on received light surface: 1000 lx or less (incandescent light)		Illumination on received light surface: 500 lx or less (incandescent light)	
Ambient temperature	Operating: 0 to 50°C, Storage: -15 to 60°C (with no icing or condensation)								
Ambient humidity	Operating and storage: 35% to 85% (with no condensation)								
Degree of protection *5	IP64		IP67		Cable length 0.5 m: IP66, cable length 2 m: IP67		IP66 *6		
Materials	Case: Aluminum die-cast, Front cover: Glass								
Cable length	0.5 m, 2 m		2 m		0.5 m, 2 m				
Weight	Approx. 350 g			Approx. 600 g			Approx. 800 g		
Accessories	Laser labels (1 each for JIS/EN, 3 for FDA), ferrite cores (4), insure locks (2), instruction sheet		Laser labels (1 each for JIS/EN), ferrite cores (2), insure locks (2), instruction sheet		Laser labels (1 each for JIS/EN, 3 for FDA), ferrite cores (4), insure locks (2), instruction sheet				

*1. Defined as 1/e² (13.5%) of the center optical intensity at the actual measuring center distance (effective value). The beam diameter is sometimes influenced by the ambient conditions of the workpiece, such as leaked light from the main beam.

*2. This is the error in the measured value with respect to an ideal straight line.

Linearity may change according to the workpiece.

The following options are available.

Model	Diffuse reflection	Mirror reflection
ZS-HLDS2T	SUS block	Glass
ZS-HLDS2VT	---	Glass
ZS-HLDS5T	White alumina ceramic	Glass
ZS-HLDS10	White alumina ceramic	
ZS-HLDS60/HLDS150	White alumina ceramic	---

*3. This is the peak-to-peak displacement conversion value in the displacement output at the measuring center distance in high-precision mode when the number of samples to average is set to within the graph.

The maximum resolution at 250 mm is also shown for the ZS-HLDS60. The following options are available.

Model	Diffuse reflection	Mirror reflection
ZS-HLDS2T	SUS block	Glass
ZS-HLDS2VT	---	Glass
ZS-HLDS5T	White alumina ceramic	Glass
ZS-HLDS10	White alumina ceramic	
ZS-HLDS60/HLDS150	White alumina ceramic	---

*4. This is the value obtained at the measuring center distance when the Sensor and workpiece are fixed by an aluminum jig. (typical example)

*5. Protection structure of connector area is IP40.

*6. Ask your OMRON representative about Sensor Heads with IP67 protection.

Ratings and Specifications

ZS-L-series Sensor Heads

Item	Model	ZS-LD20T	ZS-LD20ST	ZS-LD40T	ZS-LD10GT	ZS-LD15GT			
Applicable Controllers		ZS-HLDC/LDC Series							
Optical system		Regular reflection	Diffuse reflection	Regular reflection	Diffuse reflection	Regular reflection			
Measuring center distance		20 mm	6.3 mm	20 mm	6.3 mm	40 mm	30 mm	10 mm	15 mm
Measuring range		±1 mm	±1 mm	±1 mm	±1 mm	±2.5 mm	±2 mm	±0.5 mm	±0.75 mm
Light source		Visible semiconductor laser (wavelength: 650 nm, 1 mW max., JIS Class 2)							
Beam shape		Line beam		Spot beam		Line beam			
Beam diameter *1		900 × 25 μm		25 μm dia.		2000 × 35 μm		Approx. 25 × 900 μm	
Linearity *2		±0.1% FS							
Resolution *3		0.25 μm		0.25 μm		0.4 μm		0.25 μm	
Temperature characteristic *4		0.04% FS/°C		0.04% FS/°C		0.02% FS/°C		0.04% FS/°C	
Sampling cycle		110 μs (High-speed Mode), 500 μs (Standard Mode), 2.2 ms (High-precision Mode), 4.4 ms (High-sensitivity Mode)							
LED Indicators	NEAR indicator	Lights near the measuring center distance, and closer than the measuring center distance inside the measuring range. Flashes when the measurement target is outside of the measuring range or when the received light amount is insufficient.							
	FAR indicator	Lights near the measuring center distance, and farther than the measuring center distance inside the measuring range. Flashes when the measurement target is outside of the measuring range or when the received light amount is insufficient.							
Operating ambient illumination		Illumination on received light surface: 3000 lx or less (incandescent light)							
Ambient temperature		Operating: 0 to 50°C, Storage: -15 to 60°C (with no icing or condensation)							
Ambient humidity		Operating and storage: 35% to 85% (with no condensation)							
Degree of protection *5		Cable length 0.5 m: IP66, cable length 2 m: IP67						IP40	
Materials		Case: Aluminum die-cast, Front cover: Glass							
Cable length		0.5 m, 2 m							
Weight		Approx. 350 g						Approx. 400 g	
Accessories		Laser labels (1 each for JIS/EN, 3 for FDA), ferrite cores (2), insure locks (2), instruction sheet						Laser safety labels (1 each for JIS/EN), ferrite cores (2), insure locks (2)	

*1. Defined as $1/e^2$ (13.5%) of the center optical intensity at the actual measuring center distance (effective value). The beam diameter is sometimes influenced by the ambient conditions of the workpiece, such as leaked light from the main beam.

*2. This is the error in the measured value with respect to an ideal straight line. The standard workpiece is white aluminum ceramics and glass in the regular reflection mode. Linearity may change according to the workpiece.

*3. This is the peak-to-peak displacement conversion value in the displacement output at the measuring center distance in high-precision mode when the number of samples to average is set to 128 and the measuring mode is set to the high-resolution mode.
The standard workpiece is white aluminum ceramics and glass in the regular reflection mode.

*4. This is the value obtained at the measuring center distance when the Sensor and workpiece are fixed by an aluminum jig. (typical example)

*5. Protection structure of connector area is IP40.

Ratings and Specifications

ZS-L-series Sensor Heads

Item	Model	ZS-LD50	ZS-LD50S	ZS-LD80	ZS-LD130	ZS-LD200	ZS-LD350S						
Applicable Controllers		ZS-HLDC/LDC Series											
Optical system		Diffuse reflection	Regular reflection	Diffuse reflection	Regular reflection	Diffuse reflection	Regular reflection	Diffuse reflection	Regular reflection	Diffuse reflection	Regular reflection	Diffuse reflection	
Measuring center distance		50 mm	47 mm	50 mm	47 mm	80 mm	78 mm	130 mm	130 mm	200 mm	200 mm	350 mm	
Measuring range		±5 mm	±4 mm	±5 mm	±4 mm	±15 mm	±14 mm	±15 mm	±12 mm	±50 mm	±48 mm	±135 mm	
Light source		Visible semiconductor laser (wavelength: 650 nm, 1 mW max., JIS Class 2)											
Beam shape		Line beam		Spot beam		Line beam		Line beam		Line beam		Spot beam	
Beam diameter *1		900 × 60 μm		50 μm dia.		900 × 60 μm		600 × 70 μm		900 × 100 μm		240 μm dia.	
Linearity *2 ±0.1% FS		±0.1% FS											
Resolution *3		0.8 μm		0.8 μm		2 μm		3 μm		5 μm		20 μm	
Temperature characteristic *4		0.02% FS/°C		0.02% FS/°C		0.01% FS/°C		0.02% FS/°C		0.02% FS/°C		0.04% FS/°C	
Sampling cycle		110 μs (High-speed Mode), 500 μs (Standard Mode), 2.2 ms (High-precision Mode), 4.4 ms (High-sensitivity Mode)											
LED Indicators	NEAR indicator	Lights near the measuring center distance, and closer than the measuring center distance inside the measuring range. Flashes when the measurement target is outside of the measuring range or when the received light amount is insufficient.											
	FAR indicator	Lights near the measuring center distance, and farther than the measuring center distance inside the measuring range. Flashes when the measurement target is outside of the measuring range or when the received light amount is insufficient.											
Operating ambient illumination		Illumination on received light surface: 3000 lx or less (incandescent light)						Illumination on received light surface: 2000 lx or less (incandescent light)		Illumination on received light surface: 3000 lx or less (incandescent light)			
Ambient temperature		Operating: 0 to 50°C, Storage: -15 to 60°C (with no icing or condensation)											
Ambient humidity		Operating and storage: 35% to 85% (with no condensation)											
Degree of protection *5		Cable length 0.5 m: IP66, cable length 2 m: IP67											
Materials		Case: Aluminum die-cast, Front cover: Glass											
Cable length		0.5 m, 2 m											
Weight		Approx. 350g											
Accessories		Laser labels (1 each for JIS/EN, 3 for FDA), ferrite cores (2), insure locks (2), instruction sheet											

*1. Defined as $1/e^2$ (13.5%) of the center optical intensity at the actual measuring center distance (effective value). The beam diameter is sometimes influenced by the ambient conditions of the workpiece, such as leaked light from the main beam.

*2. This is the error in the measured value with respect to an ideal straight line. The standard workpiece is white aluminum ceramics and glass in the ZS-LD50/LD50S regular reflection mode. Linearity may change according to the workpiece.

*3. This is the peak-to-peak displacement conversion value in the displacement output at the measuring center distance in high-precision mode when the number of samples to average is set to 128 and the measuring mode is set to the high-resolution mode.
The standard workpiece is white aluminum ceramics and glass in the ZS-LD50/LD50S regular reflection mode.

*4. This is the value obtained at the measuring center distance when the Sensor and workpiece are fixed by an aluminum jig.

*5. Protection structure of connector area is IP40.

Ratings and Specifications

ZS-MDC□1 Multi-Controllers

Basic specifications are the same as those for the ZS-LDC□1 Sensor Controllers. The following points, however, are different.

1. Sensor Heads cannot be connected.
2. Control Link Units are required to connect up to 9 Controllers.
Control Link Units are required to connect Controllers.
3. Processing functions between Controllers: Arithmetic functions

Controller Link Units

Connection Using the ZS-XCN

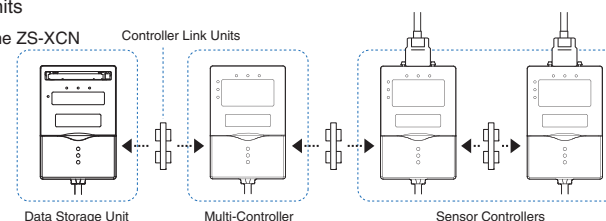

ZS-DSU□1 Data Storage Unit

Item	Model	ZS-DSU11	ZS-DSU41
Number of mounted Sensor Heads		Cannot be connected	
Number of connectable Controllers		10 max. (ZS-MDC: 1, ZS-HLDC/LDC: 9 max.) *1	
Connectable Controllers		ZS-HLDC□□, ZS-LDC□□, ZS-MDC□□	
External interface	Connection method	Serial I/O: connector, Other: pre-wired (standard cable length: 2 m)	
	Serial I/O	USB 2.0	1 port, Full Speed (12 Mbps max.), MINI-B
		RS-232C	1 port, 115,200 bps max.
	Output	3 outputs: HIGH, PASS, and LOW; NPN open-collector, 30 VDC, 50 mA max., residual voltage: 1.2 V max.	3 outputs: HIGH, PASS, and LOW; PNP open-collector, 50 mA max., residual voltage: 1.2 V max.
Inputs	ON: Short-circuited with 0 V terminal or 1.5 V or less; OFF: Open (leakage current: 0.1 mA max.)	ON: Short-circuited to supply voltage or within 1.5 V of supply voltage; OFF: Open (leakage current: 0.1 mA max.)	
Data resolution		32 bits	
Functions	Logging trigger functions	Start and stop triggers can be set separately; external triggers, data triggers (self-triggers), and time triggers	
	Other functions	External banks, alarm outputs, saved data format customization, and clock	
Status indicators		OUT (orange), PWR (green), ACCESS (orange), and ERR (red)	
Segment display		8-segment green LEDs, 6 digits	
LCD		16 digits x 2 rows, Color of characters: green, Resolution per character: 5 x 8 pixel matrix	
Setting inputs	Setting keys	Direction keys (UP, DOWN, LEFT, and RIGHT), SET key, ESC key, MENU key, and function keys (1 to 4)	
	Slide switch	Threshold switch (2 states: High/Low), mode switch (3 states: FUN, TEACH, and RUN)	
Power supply voltage		21.6 V to 26.4 VDC (including ripple)	
Current consumption		0.5 A max.	
Ambient temperature		Operating: 0 to 50°C, Storage: 0 to 60°C (with no icing or condensation)	
Ambient humidity		Operating and storage: 35% to 85% (with no condensation)	
Degree of protection		IP20 (IEC60529)	
Materials		Case: Polycarbonate (PC)	
Weight		Approx. 280 g (excluding packing materials and accessories)	
Accessories		Ferrite core (1), instruction sheet for Data Storage Unit: CSV File Converter for Data Storage Unit/Smart Analyzer Macro Edition	

*1. Control Link Units are required to connect Controllers.

Dimensions

Sensor Controllers

ZS-HLDC□1/LDC□1

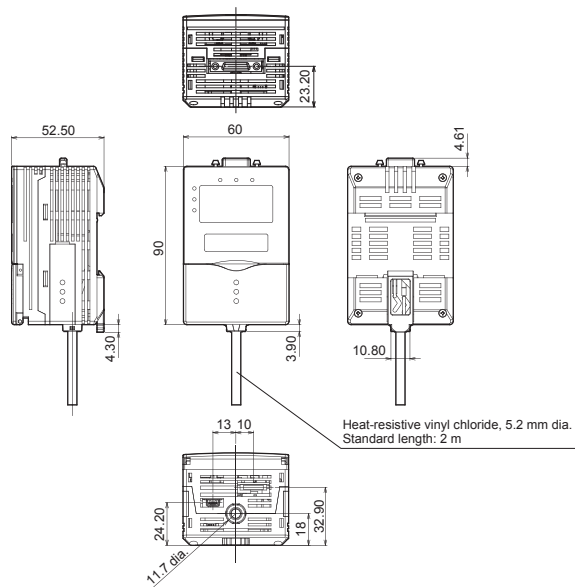

Multi-Controllers

ZS-MDC□1

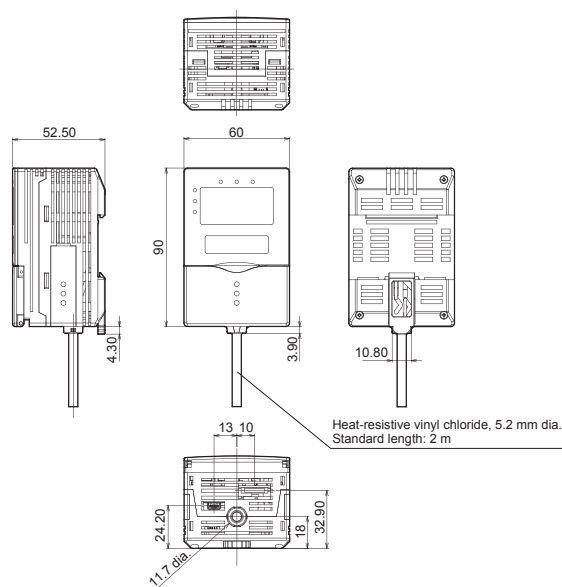

Data Storage Units

ZS-DSU□1

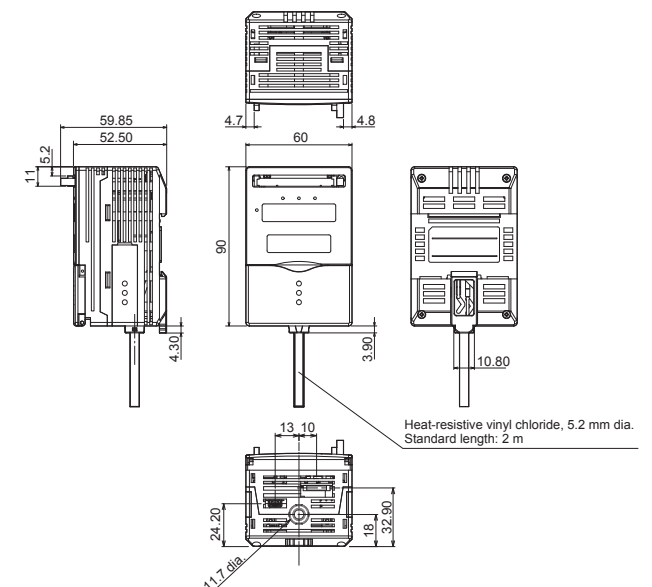

Dimensions

Sensor Heads

ZS-HLDS2T

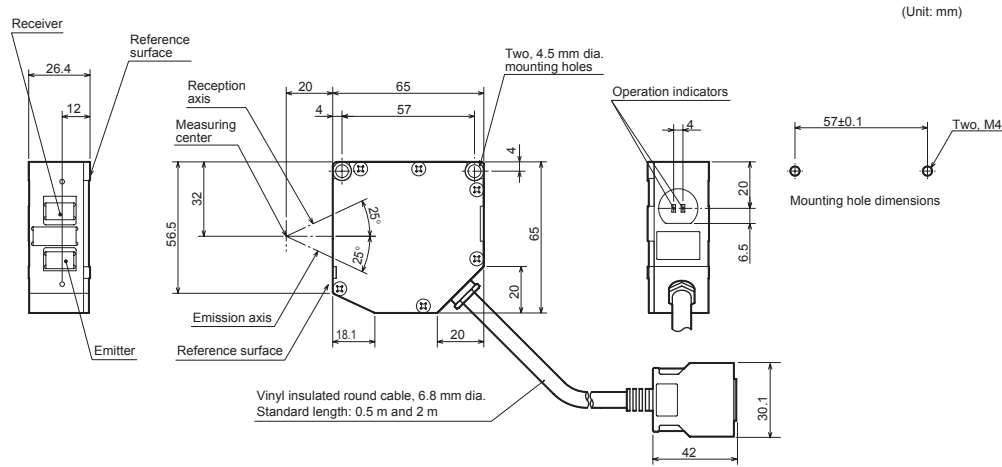

Sensor Heads

ZS-HLDS5T/HLDS10

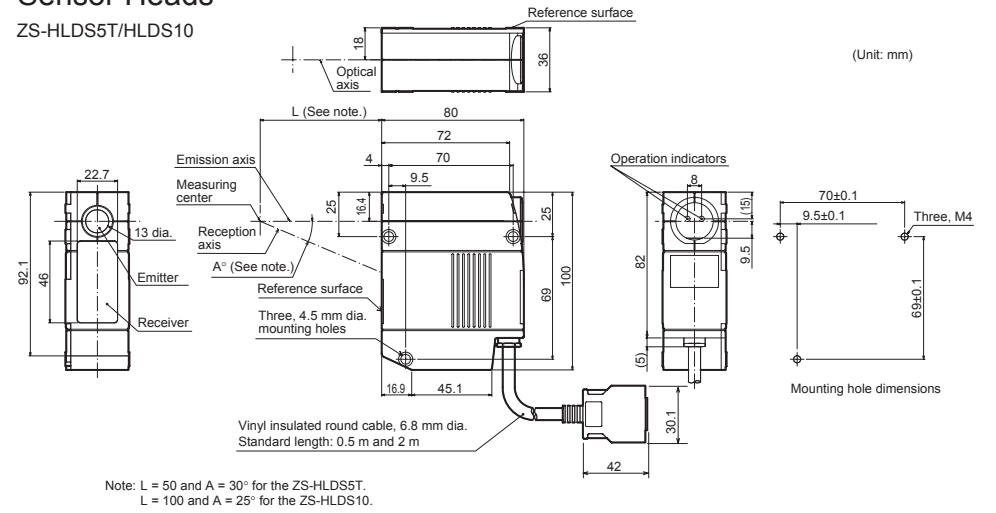

Sensor Heads

ZS-HLDS60/HLDS150

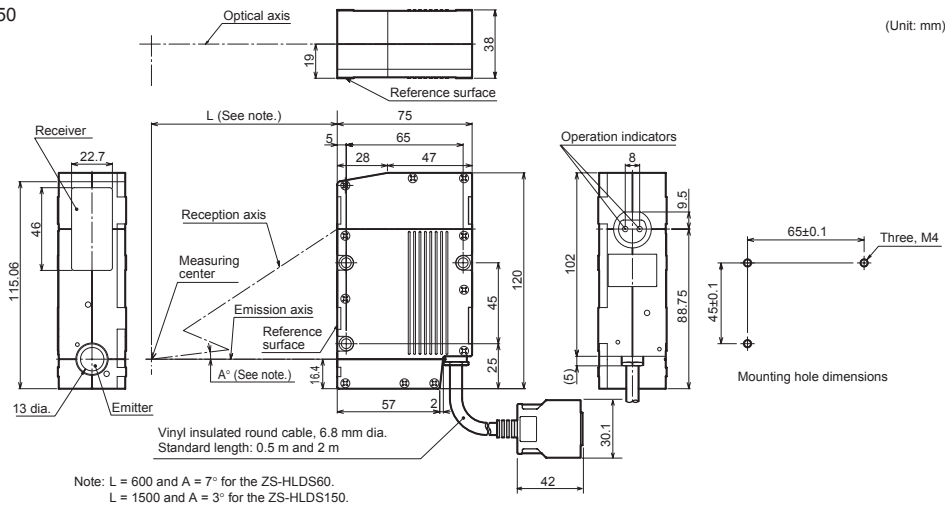

Dimensions

Sensor Heads

ZS-LD10GT

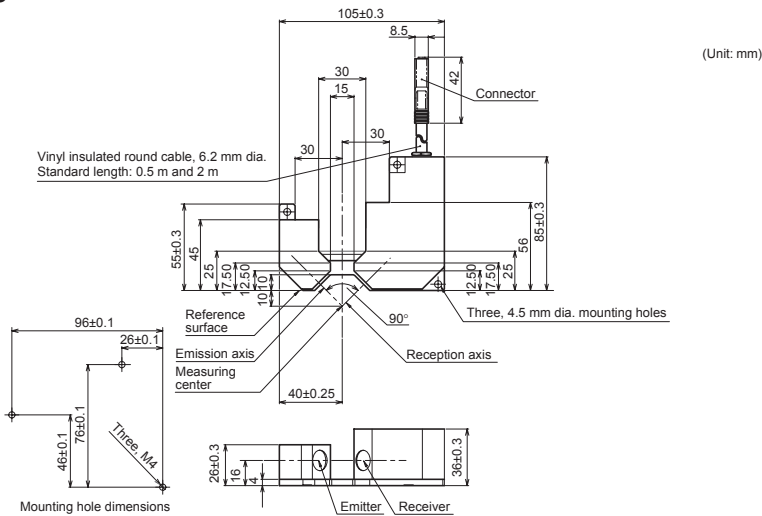

ZS-LD15GT

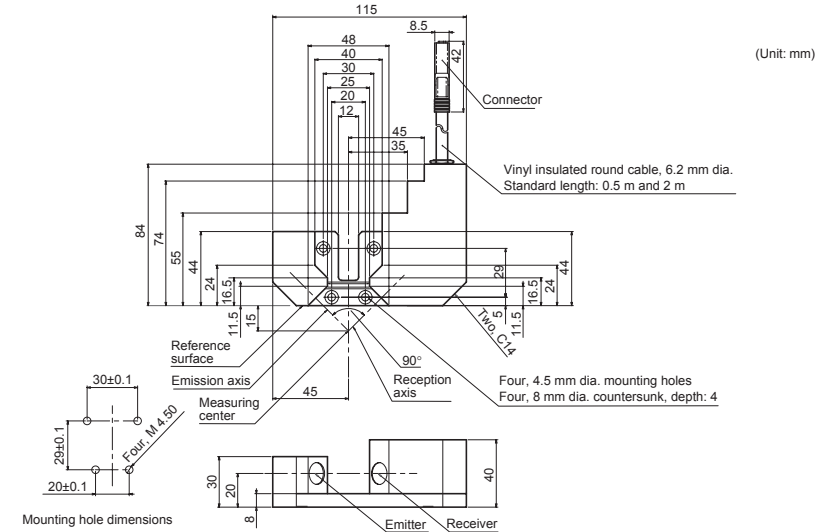

Sensor Heads

ZS-LD50/LD50S/LD80/LD130/LD200/LD350S

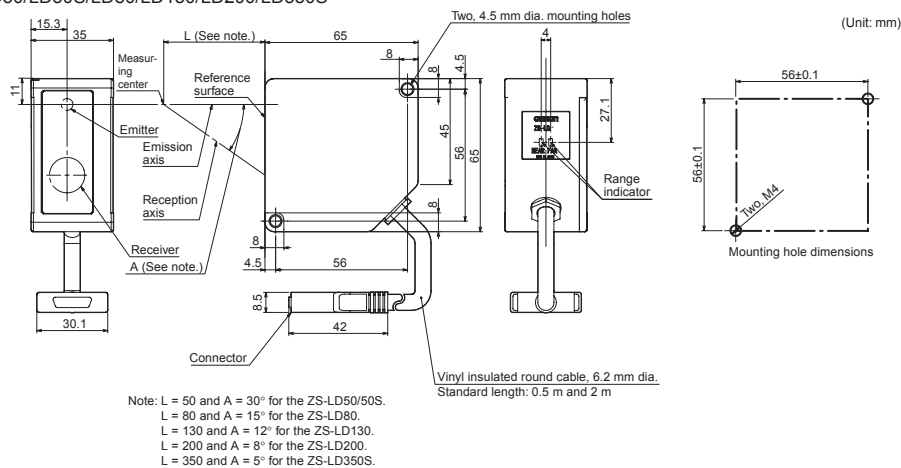

ZS-HLDS2VT/LD20T/LD20ST/LD40T

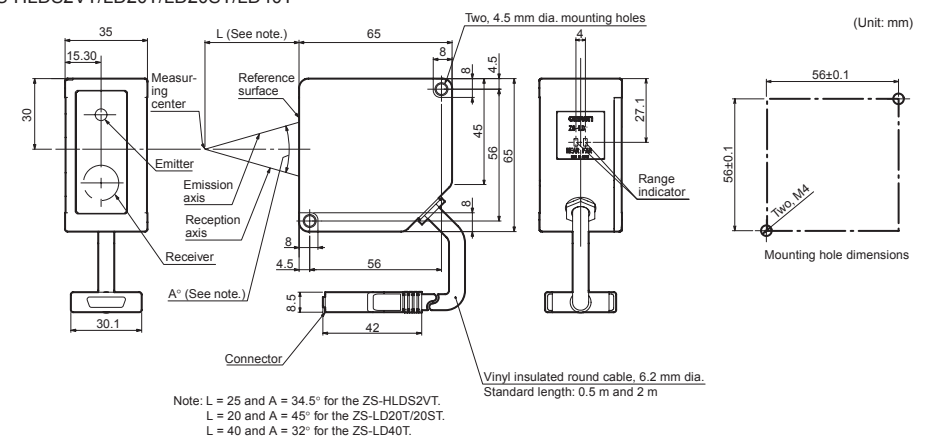

Safety Precautions for Using Laser Equipment

WARNING

Do not expose your eyes to the laser radiation either directly or indirectly (i.e., after reflection from a mirror or shiny surface). The laser radiation has a high power density and exposure may result in loss of sight.

Laser Label Indications

Attach the following warning label to the side of the ZS series Sensor Head.



READ AND UNDERSTAND THIS DOCUMENT

Please read and understand this document before using the products. Please consult your OMRON representative if you have any questions or comments.

WARRANTY

OMRON's exclusive warranty is that the products are free from defects in materials and workmanship for a period of one year (or other period if specified) from date of sale by OMRON.

OMRON MAKES NO WARRANTY OR REPRESENTATION, EXPRESS OR IMPLIED, REGARDING NON-INFRINGEMENT, MERCHANTABILITY, OR FITNESS FOR PARTICULAR PURPOSE OF THE PRODUCTS. ANY BUYER OR USER ACKNOWLEDGES THAT THE BUYER OR USER ALONE HAS DETERMINED THAT THE PRODUCTS WILL SUITABLY MEET THE REQUIREMENTS OF THEIR INTENDED USE. OMRON DISCLAIMS ALL OTHER WARRANTIES, EXPRESS OR IMPLIED.

LIMITATIONS OF LIABILITY

OMRON SHALL NOT BE RESPONSIBLE FOR SPECIAL, INDIRECT, OR CONSEQUENTIAL DAMAGES, LOSS OF PROFITS OR COMMERCIAL LOSS IN ANY WAY CONNECTED WITH THE PRODUCTS, WHETHER SUCH CLAIM IS BASED ON CONTRACT, WARRANTY, NEGLIGENCE, OR STRICT LIABILITY.

In no event shall responsibility of OMRON for any act exceed the individual price of the product on which liability is asserted.

IN NO EVENT SHALL OMRON BE RESPONSIBLE FOR WARRANTY, REPAIR, OR OTHER CLAIMS REGARDING THE PRODUCTS UNLESS OMRON'S ANALYSIS CONFIRMS THAT THE PRODUCTS WERE PROPERLY HANDLED, STORED, INSTALLED, AND MAINTAINED AND NOT SUBJECT TO CONTAMINATION, ABUSE, MISUSE, OR INAPPROPRIATE MODIFICATION OR REPAIR.

SUITABILITY FOR USE

THE PRODUCTS CONTAINED IN THIS DOCUMENT ARE NOT SAFETY RATED. THEY ARE NOT DESIGNED OR RATED FOR ENSURING SAFETY OF PERSONS, AND SHOULD NOT BE RELIED UPON AS A SAFETY COMPONENT OR PROTECTIVE DEVICE FOR SUCH PURPOSES. Please refer to separate catalogs for OMRON's safety rated products.

OMRON shall not be responsible for conformity with any standards, codes, or regulations that apply to the combination of products in the customer's application or use of the product.

At the customer's request, OMRON will provide applicable third party certification documents identifying ratings and limitations of use that apply to the products. This information by itself is not sufficient for a complete determination of the suitability of the products in combination with the end product, machine, system, or other application or use.

The following are some examples of applications for which particular attention must be given. This is not intended to be an exhaustive list of all possible uses of the products, nor is it intended to imply that the uses listed may be suitable for the products:

- Outdoor use, uses involving potential chemical contamination or electrical interference, or conditions or uses not described in this document.
- Nuclear energy control systems, combustion systems, railroad systems, aviation systems, medical equipment, amusement machines, vehicles, safety equipment, and installations subject to separate industry or government regulations.
- Systems, machines, and equipment that could present a risk to life or property.

Please know and observe all prohibitions of use applicable to the products.

NEVER USE THE PRODUCTS FOR AN APPLICATION INVOLVING SERIOUS RISK TO LIFE OR PROPERTY WITHOUT ENSURING THAT THE SYSTEM AS A WHOLE HAS BEEN DESIGNED TO ADDRESS THE RISKS, AND THAT THE OMRON PRODUCT IS PROPERLY RATED AND INSTALLED FOR THE INTENDED USE WITHIN THE OVERALL EQUIPMENT OR SYSTEM.

PERFORMANCE DATA

Performance data given in this document is provided as a guide for the user in determining suitability and does not constitute a warranty. It may represent the result of OMRON's test conditions, and the users must correlate it to actual application requirements. Actual performance is subject to the OMRON Warranty and Limitations of Liability.

CHANGE IN SPECIFICATIONS

Product specifications and accessories may be changed at any time based on improvements and other reasons.

It is our practice to change model numbers when published ratings or features are changed, or when significant construction changes are made. However, some specifications of the product may be changed without any notice. When in doubt, special model numbers may be assigned to fix or establish key specifications for your application on your request. Please consult with your OMRON representative at any time to confirm actual specifications of purchased products.

DIMENSIONS AND WEIGHTS

Dimensions and weights are nominal and are not to be used for manufacturing purposes, even when tolerances are shown.

ERRORS AND OMISSIONS

The information in this document has been carefully checked and is believed to be accurate; however, no responsibility is assumed for clerical, typographical, or proofreading errors, or omissions.

PROGRAMMABLE PRODUCTS

OMRON shall not be responsible for the user's programming of a programmable product, or any consequence thereof.

COPYRIGHT AND COPY PERMISSION

This document shall not be copied for sales or promotions without permission.

This document is protected by copyright and is intended solely for use in conjunction with the product. Please notify us before copying or reproducing this document in any manner, for any other purpose. If copying or transmitting this document to another, please copy or transmit it in its entirety.



This document provides information mainly for selecting suitable models. Please read the manual carefully for information that the user must understand and accept before purchase, including information on warranty, limitations of liability, and precautions.

Note: Do not use this document to operate the Unit.

OMRON Corporation Industrial Automation Company

Kyoto, JAPAN

Contact : www.ia.omron.com

Regional Headquarters

OMRON EUROPE B.V.

Wegalaan 67-69, 2132 JD Hoofddorp
The Netherlands

Tel: (31) 2356-81-300 Fax: (31) 2356-81-388

OMRON ASIA PACIFIC PTE. LTD.

438B Alexandra Road, #08-01/02 Alexandra
Technopark, Singapore 119968

Tel: (65) 6835-3011 Fax: (65) 6835-2711

OMRON ELECTRONICS LLC

2895 Greenspoint Parkway, Suite 200
Hoffman Estates, IL 60169 U.S.A.

Tel: (1) 847-843-7900 Fax: (1) 847-843-7787

OMRON (CHINA) CO., LTD.

Room 2211, Bank of China Tower,
200 Yin Cheng Zhong Road,
PuDong New Area, Shanghai, 200120, China

Tel: (86) 21-5037-2222 Fax: (86) 21-5037-2200

Authorized Distributor:

©OMRON Corporation 2008-2023 All Rights Reserved.

In the interest of product improvement,
specifications are subject to change without notice.

CSM_5_12

Printed in Japan

Cat. No. E375-E1-07

0123 (0308)